

DESCRIPTION

Analog Devices Power Supplies are designed to provide OEMs and circuit designers with a broad line of high reliability, regulated and short circuit protected power supplies at low overall cost. These modules are available with 5 volt to 24 volt output (single and dual), and current ratings from 25mA to 1 amp. Most Analog Devices Power Supplies are available from stock in both large and small quantities. Substantial discounts apply on quantity orders.

ADVANTAGES

Packaged circuit modules have found wide acceptance. Engineers have discovered the convenience and economy of plug-in building blocks ... op amps, logic cards, miniature A/D and D/A converters are now available in wide varieties. Now a complete line of modular power supplies is available from Analog Devices. Most of these units are packaged in the popular encapsulated case. They are shipped ready to use, at prices below the internal manufacturing cost of most OEM users. Further savings and reduced lead time are achieved by eliminating engineering start-up, documentation costs, and manufacturing delays. Designed by experts in op amp and digital logic technology, these units offer features that you would expect to find only in considerably more expensive supplies.

ENCAPSULATED MODULES (900 SERIES)

This line of modular power supplies covers most popular applications except for high current loads. These supplies all feature line and load regulation and are short circuit protected. Mating sockets are available, or the unit may be mounted on and soldered directly to a printed circuit card. Voltage ranges include 5VDC to ± 24 VDC. Current ranges extend from 25mA up to 1 amp.

METAL CASED MODULES (900 SERIES)

The ± 15 VDC, 300mA, 500mA and 1 amp cased power supplies are designed with the system designer's needs in mind. These units provide the power needed to run large Modularized, Transistorized and Integrated Circuit systems. The 300 and 500mA supplies come in 3.5 inch cube cases with an 11 pin connector (supplied). The ± 15 volt, 1 amp unit is mounted in a finned case and has barrier terminal strip connectors. All of these units provide for remote sensing.

EXTRA-HIGH ACCURACY SUPPLIES (MPD SERIES)

Analog Devices "MPD" line of Power Supplies are intended for applications where the ultimate in performance is required. They feature excellent regulation and low temperature coefficients. Typical applications include providing stable references for computing, instrument, and data reduction circuitry. All MPD supplies are sealed in anodized aluminum enclosures for maximum ruggedness and minimum RFI. Being essentially DC to DC converters, these units feature low "see through" capacitance (typically 20pF) and are desirable for powering floated circuits and use in systems having considerable ground noise.

OPTIONS

Most supplies are available with 205-240VAC, 50-400Hz input at no additional charge. Specify option "E" when ordering. Models 904 and 909 are available with a transformer shield which reduces input to output see-through capacity to 10pF max. Specify option "I" when ordering and add \$8 each to unit prices. Model 906 (5VDC/250mA) available with 6.0VDC overvoltage protection at \$8 each additional. All other 5VDC logic supplies (Models 903 and 905) include overvoltage protection at no additional charge.

900 SERIES, MPD SERIES MODULAR POWER SUPPLIES FOR OP AMPS & LOGIC CIRCUITRY

FEATURES

Short Circuit Protected
Line & Load Regulated
Small Size
5VDC to ± 24 VDC
25mA to 1000mA
Temperature Compensated
Low Cost, from \$23 (1-9)

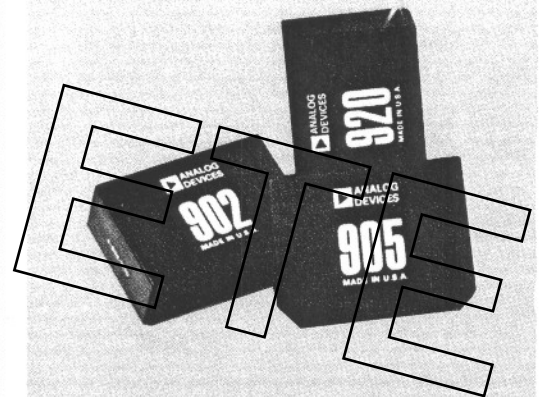

Encapsulated "P" Case

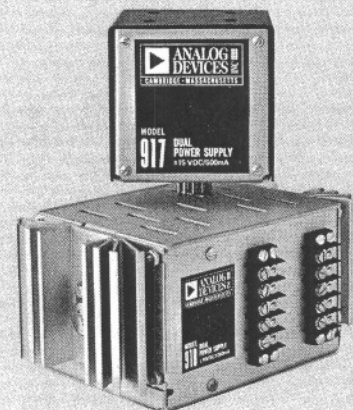

Cube "C" and Finned Case



ROUTE ONE INDUSTRIAL PARK
P. O. BOX 280 NORWOOD, MASS. 02062
TEL: 617/329-4700 TWX: 710/394-6577

Model 950 Power Supply Manifold

REFERENCE GUIDE

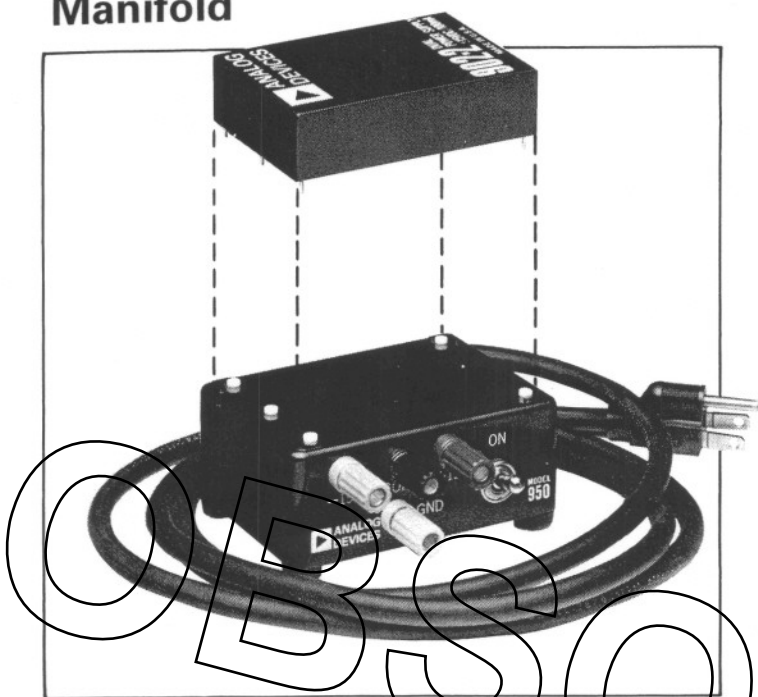

This 950 power supply manifold provides a fast, convenient, and inexpensive bench supply for breadboarding, testing, or general laboratory use. Five ports are supplied which enable the 900 series P-1 cased modules to be directly plugged-in to this manifold. Three output terminals provide easy user access to selected dual DC output or single DC output voltage source. Cost is just \$82.00.

902	± 15V @ 100mA	915	± 15V @ 25mA
902-2	± 15V @ 100mA	920	± 15V @ 200mA
903	± 5V @ 500mA	921	± 12V @ 240mA
904	± 15V @ 50mA	922	+ 5V @ 2000mA
905	+ 5V @ 1000mA	925	± 15V @ 350mA
906	+ 5V @ 250mA	928	+ 5V @ 3000mA

Model	Input	Output V/mA	Height (Inches)	Case	Weight (Grams)	Socket No.
902	AC	± 15/100	1.25	P-1	530	AC1013
902-2	AC	± 15/100	0.875	P-1	330	AC1013
903	AC	5/500	1.25	P-1	530	AC1013
904	AC	± 15/50	0.875	P-1	330	AC1013
905	AC	5/1000	1.25	P-1	530	AC1013
906	AC	5/250	0.875	P-1	330	AC1013
915	AC	± 15/25	0.875	P-1	330	AC1013
920	AC	± 15/200	1.25	P-1	530	AC1013
921	AC	± 12/240	1.25	P-1	530	AC1013
922	AC	5/2000	1.62	P-1	750	AC1013
923	AC	± 15/100; + 5/500	1.25	P-2	560	AC1581
925	AC	± 15/350	1.62	P-1	750	AC1013
926	AC	± 15/150; + 5/300	1.25	P-2	475	AC1581
927	AC	± 15/150; + 5/1000	1.62	P-2	645	AC1581
928	AC	+ 5/3000	1.25	P-1	325	AC1013
940	5V	± 15/150	0.38	A-1	85	AC1051
941	5V	± 12/150	0.38	A-1	85	AC1051
943	5V	± 5/1000	0.38	A-1	85	AC1051
945	28V	± 15/150	0.38	A-1	85	AC1051
949	5V	± 15/60	0.375	A-2	45	AC1051
951	5V	± 15/410	0.88	P-3	220	AC1013
952	AC	± 15/100	1.44	CM-2AA	590	N/A
953	12V	± 15/150	0.38	A-1	85	AC1051
955	AC	+ 5/1000	1.44	CM-2AA	590	N/A
957	5V	+ 5/100	0.40	A-3	12	HSA-1
958	5V	+ 5/100	0.40	A-3	12	HSA-1
959	5V	± 12/40	0.40	A-3	12	HSA-1
960	5V	± 12/40	0.40	A-3	12	HSA-1
961	5V	± 15/33	0.40	A-3	12	HSA-1
962	5V	+ 15/33	0.40	A-3	12	HSA-1
963	12V	± 15/33	0.40	A-3	12	HSA-1
964	12V	± 15/33	0.40	A-3	12	HSA-1
965	5V	± 15/190	0.40	A-1	54	AC1051
966	12V	± 15/190	0.40	A-1	54	AC1051
967	24V	± 15/190	0.40	A-1	54	AC1051
968	28V	± 15/190	0.40	A-1	54	AC1051
970	AC	± 15/200	1.44	CM-2AA	590	N/A
972	AC	± 15/150; + 5/300	1.45	CM-2B	598	N/A
973	AC	± 15/350	2.00	CM-2AA	880	N/A
974	AC	± 15/150; + 5/1000	2.00	CM-2B	840	N/A
975	AC	± 15/500	2.00	CM-2AA	880	N/A
976	AC	+ 5/3000	1.45	CM-2A	465	N/A
2B35	AC	± 15/65; + 1 to + 15/125	1.25	P-4	550	AC1212

Socket Pricing	1-4
AC 1013	\$15.00
AC 1051	\$15.00
AC 1212	\$11.00
AC 1581	\$14.00
HSA-1	\$ 2.50

MECHANICAL OUTLINES

CHASSIS MOUNTED MODELS

CM-2

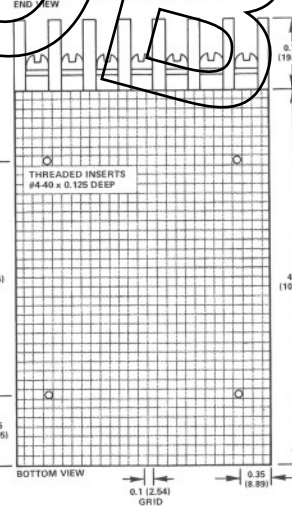
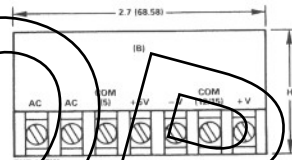
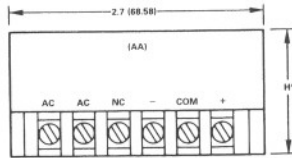
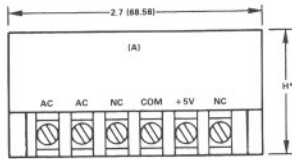

OUTLINE DIMENSIONS

Dimensions shown in inches and (mm).

PC MOUNTED MODELS

"P" CASE

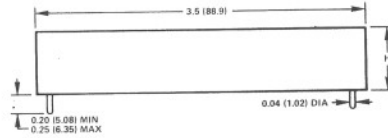

P-1 CASE

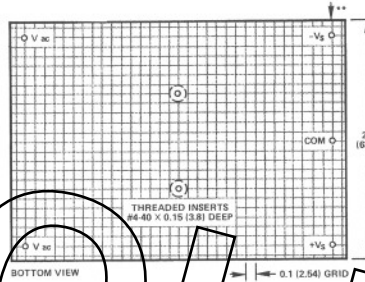

P-2 CASE

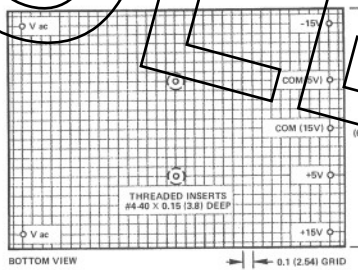

P-3 CASE

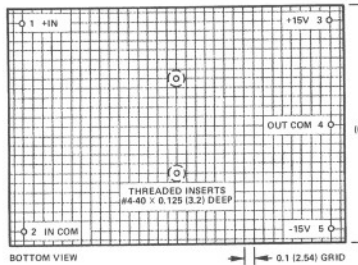

P-4 CASE

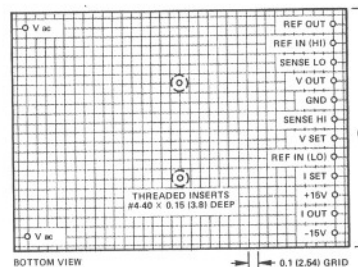

"A" CASE

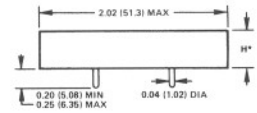

A-1 CASE

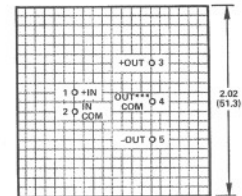

***PIN 4 NOT USED ON MODEL 943

A-2 CASE

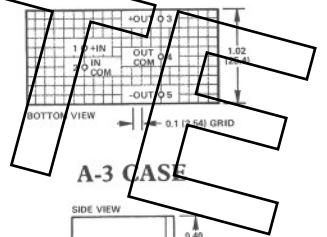

A-3 CASE

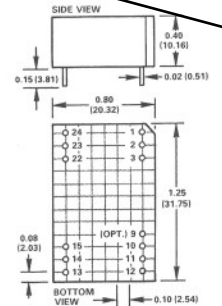

A-3 Case

Pin Connections

Single Output Models

- + V Input 1,2,4
- V Input 12,13
- + V Output 11,14
- V Output 10,15

Dual Output Models

- + V Input 1,2,4
- V Input 12,13
- + V Output 11,14
- V Output 2,23
- Common 3,10,22,15
- Balance (Optional) 9

Alternate Pin Configuration (Models 959R through 964R)

- + V Input 1,2,3
- V Input 22,23,24
- + V Output 15
- V Output 13
- Common 10,11
- Balance 14
- No Connection 12

Options (A-3 Case Dual Output Models Only):

External Balance Pin for output voltage adjustment or equalization (Models 959P through 964P). Alternate Pin Configuration including external balance pin (Models 959R through 964R). **Note:** Multiple pins listed for the same function are internally connected together. Balance Adjustment Connections for A-3 Case (for models with "P" or "R" suffix only):



*SEE REFERENCE GUIDE FOR HEIGHT DIMENSIONS.
**INDICATES NO CONNECTION FOR SINGLE OUTPUT SUPPLIES.



900 SERIES MODULAR POWER SUPPLIES 5V to

SPECIFICATIONS (Typical @ +25°C and 115VAC unless otherwise noted)

	±12 VOLTS			±15 VOLTS							
MODEL	907	909	908	915	904	902	916	917	918	920	931
E out (V)	±12	±12	±12	±15	±15	±15	±15	±15	±15	±15	±18
I out (mA) (min full load)	±25	±50	±100	±25	±50	±100	±300	±500	±1000	±200	±25
PRICE (1-9)	\$23.	\$49.	\$59.	\$23.	\$39.	\$49.	\$98.	\$114.	\$148.	\$69.	\$23.
PRICE (10-24)	\$22.	\$47.	\$56.	\$22.	\$38.	\$47.	\$93.	\$108.	\$141.	\$62.	\$22.
CASE	P	P	P	P	P	P	C	C	Fin	P ⁵	P
LINE REG. (MAX) (105-125 VAC)	0.2%	0.01%	0.01%	0.2%	0.1%	0.05%	0.05%	0.05%	0.05%	0.05%	0.2%
LOAD REG. (MAX) (0-100%)	0.2%	0.05%	0.05%	0.2%	0.1%	0.1%	0.1%	0.1%	0.1%	0.1%	0.2%
TEMP COEF. (°C)	0.02%	0.015%	0.015%	0.02%	0.015%	0.015%	0.02%	0.02%	0.02%	0.015%	0.02%
WARM UP DRIFT	30mV	15mV	15mV	30mV	37mV*	45mV*	25mV*	25mV*	25mV*	45mV*	30mV
OPERATING TEMP RANGE (°C)	-25 to +71	-25 to +71	-25 to +71	-25 to +71	0 to +71 ¹	0 to +71	-25 to +71	-25 to +71	-25 to +71	0 to +71 ²	-25 to +71
STORAGE TEMP RANGE (°C)	-25 to +85	-25 to +85	-25 to +85	-25 to +85	-25 to +85	-25 to +85	-25 to +85	-25 to +85	-25 to +85	-25 to +85	-25 to +85
OPTIONS	—	—	—	E, I, H	E, I, H	E, I, H	I, D	I, D	I, D	E, H	—
RIPPLE & NOISE rms (MAX)	1mV	1mV	1mV	1mV	0.5mV	0.5mV	1mV	1mV	1mV	0.5mV	1mV
INPUT ISOLATION	50MΩ	50MΩ	50MΩ	50MΩ	500MΩ	50MΩ	50MΩ	50MΩ	50MΩ	50MΩ	50MΩ
OUTPUT IMPEDANCE (@ 90% I _L ±10% I _L)	0.2Ω @ 10kHz	0.2Ω @ 10kHz	0.2Ω @ 10kHz	0.2Ω @ 10kHz	0.2Ω @ 10kHz	0.2Ω @ 10kHz	0.2Ω @ 10kHz	0.2Ω @ 10kHz	0.2Ω @ 10kHz	0.2Ω @ 10kHz	0.2Ω @ 10kHz
OUTPUT VOLTAGE ERROR (MAX)	±1%	±1%	±1%	±1%	+200mV ⁶ -0mV	+300mV ⁶ -0mV	±1%	±1%	±1%	+300mV ⁶ -0mV	±1%
WEIGHT	12 oz.	12 oz.	12 oz.	12 oz.	12 oz.	1 lb.	1 lb.	2 lbs.	5 lbs.	18 oz.	12 oz.
MATING SOCKET	AC1013	AC1013	AC1013	see dwg.	see dwg.	see dwg.	see dwg.	see dwg.	see dwg.	AC1013	AC1013

Specifications subject to change without notice

OPTIONS AVAILABLE

- "E" Option— 205-240VAC, 50-400Hz input. No additional charge.
- "I" Option— Units have transformer interwinding shield with separate ground lead. Maximum input to output see-through capacitance with this option is 10pF. \$8 additional per unit.
- "D" Option— Overvoltage protection available at \$8/unit additional charge. Nominally at 1 volt above rated output.
- "H" Option— 220-260VAC, 50-400Hz input. No additional charge.

GENERAL INFORMATION

1. All supplies have 105-125VAC, 50-400Hz input unless Option "E" is ordered.
2. All Cube "C" case modules shipped with mating 11 pin Amphenol connector at no additional charge.

3. MPD series supplies housed in Aluminum cases for maximum RFI suppression.
4. All supplies are short circuit protected except MPD series supplies are not short protected between different outputs. MPD5-150A short protected only on 5VDC output.

FOOTNOTES

- *Indicates "maximum" specification.
- ¹ Derate 5mA/°C above +55°C.
- ² Derate 12mA/°C above +50°C.
- ³ Derate 7mA/°C above +55°C.
- ⁴ Overvoltage protection at 6.5VDC included.
- ⁵ Aluminum "P" case. Tolerance is increased to 0.05" on the 2.50" and 3.50" dimension.
- ⁶ Outputs track within 1% (¾% for Model 904).

24V FOR ALL OP AMP AND LOGIC REQUIREMENTS

3 VOLTS		±24 VOLTS		5 VOLTS			MPD SERIES POWER SUPPLIES (High Stability)			
935	932	933	934	906	903	905	MPD 15/100A	MPD 15/300A	MPD 5-150A	MPD 5/750A
±18	±18	±24	±24	5	5	5	±15	±15	5VDC 150VDC	5
±50	±100	±50	±100	250	500	1000	±100	±300	600mA(5V) 5mA(150V)	750
\$55	\$65	\$55	\$65	\$39	\$49	\$69	\$149	\$275	\$149	\$149
\$52	\$62	\$52	\$62	\$38	\$47	\$66	\$141	\$260	\$141	\$141
P	P	P	P	P	P	P ⁵	see dwg.	see dwg.	see dwg.	see dwg.
0.01%	0.01%	0.01%	0.01%	0.05%	0.15%	0.05%	0.005%	0.005%	0.005%	0.005%
0.05%	0.05%	0.05%	0.05%	0.1%	0.3%	0.1%	0.02%	0.02%	12.5mV	12.5mV
0.015%	0.015%	0.015%	0.015%	0.02%	0.02%	0.02%	0.015%*	0.015%*	0.05%*	0.05%*
15mV	15mV	15mV	24mV	25mV	15mV	40mV	—	—	—	—
-25 to +71	-25 to +71	-25 to +71	-25 to +71	-25 to +71	0 to +71 ²	-25 to +71	-55 to +71	-55 to +71 ³	-55 to +71	-55 to +71
-25 to +85	-25 to +85	-25 to +85	-25 to +85	-25 to +85	-25 to +85	-25 to +85	-55 to +125	-55 to +125	-55 to +125	-55 to +125
—	—	—	—	—	E ⁴	E ⁵	—	—	—	—
1mV	1mV	1mV	1mV	1mV	1mV	1mV	0.5mVp-p	0.5mVp-p	6mVp-p	6mVp-p
50MΩ	50MΩ	50MΩ	50MΩ	50MΩ	500MΩ	25MΩ	10MΩ	10MΩ	10MΩ	10MΩ
0.2Ω @ 10kHz	0.2Ω @ 10kHz	0.2Ω @ 10kHz	0.2Ω @ 10kHz	0.05Ω @ 10kHz	0.05Ω @ 10kHz	0.05Ω @ 10kHz	—	—	—	—
±1%	±1%	±1%	±1%	±1%	±1%	±1%	Adj.	Adj.	Adj.	Adj.
12 oz.	18 oz.	12 oz.	18 oz.	12 oz.	17 oz.	18 oz.	7 oz.	22 oz.	7 oz.	7 oz.
AC1013	AC1013	AC1013	AC1013	AC1013	AC1013	AC1013	see dwg.	see dwg.	see dwg.	see dwg.

MODEL 950 POWER SUPPLY MANIFOLD

This manifold permits use of the 900 series "P" cased modules on the design bench. In combination with these supplies the 950 provides a safe, convenient, and inexpensive bench supply for breadboarding, testing, or general laboratory use. Cost is just \$16 (1-9), and \$15 (10-24).

MODEL 194 AMPLIFIER MANIFOLD

The Model 194 manifold is ideal for experimenting, breadboarding, and/or teaching with op amps. Completely self-contained, it includes a ±15VDC 100mA power supply, and accepts up to 5 amplifiers in the popular 7 pin "Q" case configuration. Adapters are available for other configurations and provisions are made for a balance potentiometer for each amplifier. The unit is designed for maximum flexibility, with all connection points 3/4 in. apart. Price is \$250 each (1-9), substantially less in higher quantities.

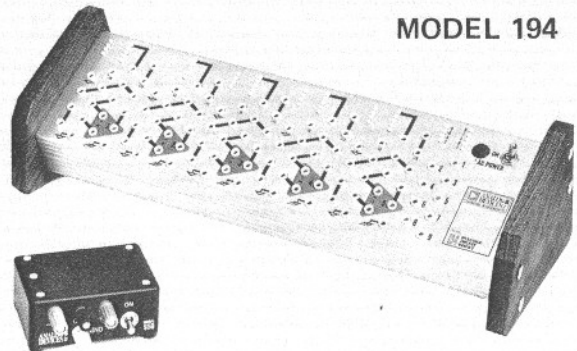

MODEL 194



MODEL 950

300 SERIES POWER SUPPLIES DIMENSIONS & CONNECTIONS (In Inches)

"P" CASE (Encapsulated)

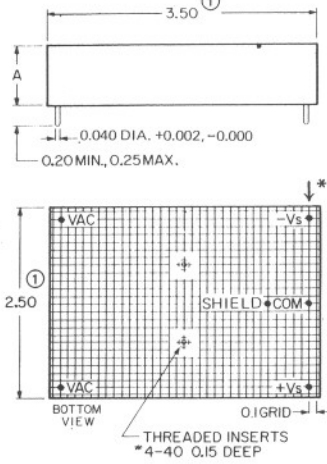

MATING SOCKET AC1013

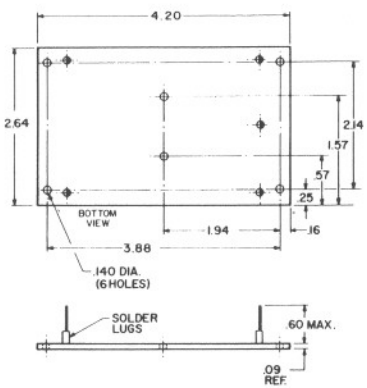

**\$3.50 each (1-9)
\$3.15 each (10-24)**

For units with Interwinding Shield, order Socket number AC1028, same price as AC1013

Tolerances: 2 decimal ± 0.015
3 decimal ± 0.010

NOTE 1 Tolerance = 0.05" for Models 905 and 920

"C" CASE (Cube)

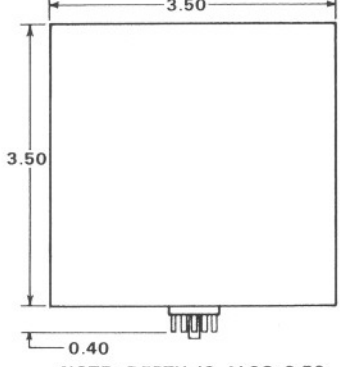

NOTE: DEPTH IS ALSO 3.50
Tolerances ± 0.030 "

"C" CASE CONNECTIONS

- Pins 1 and 11 AC line
- Pin 2 positive output
- Pin 3 positive sense, to Pin 2 at load
- Pin 4 positive supply sense common, to Pin 5 at load
- Pin 5 common for both positive and negative outputs
- Pin 6 case ground
- Pin 7 negative supply sense common, to Pin 5 at load
- Pin 8 negative supply sense, to Pin 9 at load
- Pin 9 negative output, supply
- Pin 10 no connection, or I option shield
- Connector: Amphenol 77MIP11 (supplied)

*Indicates no connection on 5VDC logic supplies
"A" dimension 0.88" except 1.25" on Models 902, 903, 905, 932, 934
Shield pin 0.500" from common

FINNED CASE

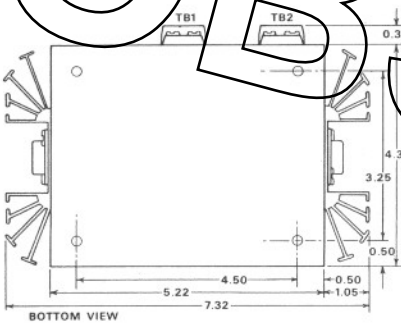

Tolerances ± 0.030 " except mounting holes ± 0.01 "

HEIGHT: 3.54
MOUNTING HOLES, TAPPED FOR 6-32 SCREW
6-32 MOUNTING HOLES ALSO ON REAR SURFACE, LOCATED ON 4.50x2.43 PATTERN

FINNED CASE CONNECTIONS

- TB1, pins 1 & 2: AC line
- TB1, pins 3, 4: +15VDC, +15V sense
- TB1, pin 5: case ground
- TB2, pin 1: +15V ground sense
- TB2, pin 2: -15V common (both outputs)
- TB2, pin 3: -15V ground sense
- TB2, pins 4,5: -15V sense, -15V output

MPD SERIES POWER SUPPLIES

DIMENSIONS & CONNECTIONS (In Inches)

MODEL MPD 15/100 USE MOUNTING CARD 2417A

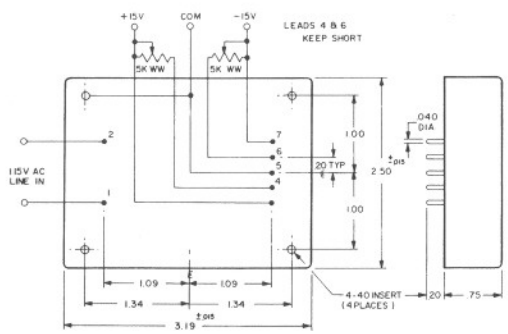

MOUNTING CARD 2417A

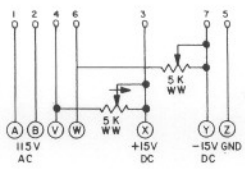
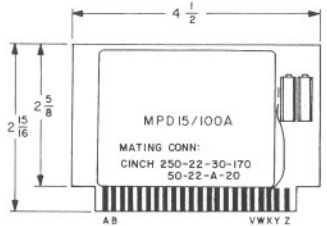

Price \$20. ea. (1-9)

MODELS MPD 5-150 and MPD 5/750 USE MOUNTING CARD 2417B

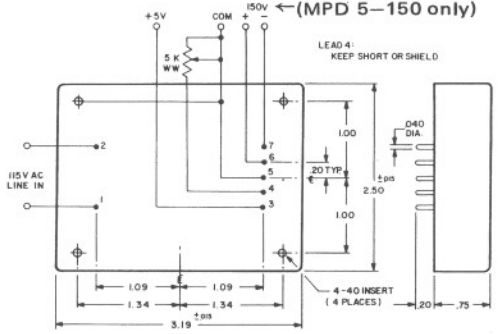

MOUNTING CARD 2417B

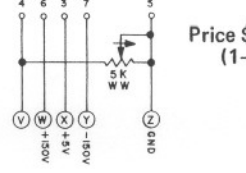
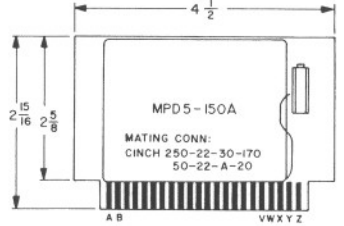

Price \$20. ea. (1-9)

MODEL MPD 15/300 USE MOUNTING CARD 4482

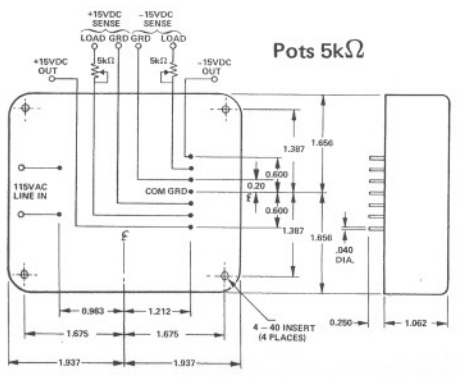

Mounting Card 4482, \$25. ea. (1-9)

