

AD1878/AD1879*

FEATURES

Fully Differential Dual Channel Analog Inputs
103 dB Signal-to-Noise (AD1879 typ)
-98 dB THD+N (AD1879 typ)
0.001 dB Passband Ripple and 115 dB Stopband Attenuation
Fifth-Order, 64 Times Oversampling $\Sigma\Delta$ Modulator
Single Stage, Linear Phase Decimator
 $256 \times F_S$ Input Clock

APPLICATIONS

Digital Tape Recorders
Professional, DCC, and DAT
A/V Digital Amplifiers
CD-R
Sound Reinforcement

PRODUCT OVERVIEW

The AD1879 is a two-channel, 18-bit oversampling ADC based on $\Sigma\Delta$ technology and intended primarily for digital audio applications. The AD1878 is identical to the 18-bit AD1879 except that it outputs 16-bit data words. Statements in this data sheet should be read as applying to both parts unless otherwise noted.

Each input channel of these ADCs is fully differential. Each data conversion channel consists of a fifth order one-bit noise shaping modulator and a digital decimation filter. An on-chip voltage reference provides a voltage source to both channels stable over temperature and time. Digital output data from both channels is time-multiplexed to a single, flexible serial interface. The AD1878/AD1879 accepts a $256 \times F_S$ input master clock.

Input signals are sampled at $64 \times F_S$ on switched-capacitors, eliminating external sample-and-hold amplifiers and minimizing the requirements for antialias filtering at the input. With simplified antialiasing, linear phase can be preserved across the passband. The AD1878/AD1879's proprietary fifth-order differential switched-capacitor modulator architecture shapes the one-bit comparator's quantization noise out of the audio passband. The high order of the modulator randomizes the modulator output, reducing idle tones in the AD1878/AD1879 to very low levels. The AD1878/AD1879's differential architecture provides increased dynamic range and excellent common-mode rejection characteristics. Because its modulator is single-bit, AD1878/AD1879 is inherently monotonic and has no mechanism for producing differential linearity errors.

The digital decimation filters are single-stage, 4095-tap finite impulse response filters for filtering the modulator's high frequency quantization noise and reducing the $64 \times F_S$ single-bit output data rate to a F_S word rate. They provide linear

*Protected by U.S. Patent Numbers 5055843, 5126653, and others pending.

REV. 0

Information furnished by Analog Devices is believed to be accurate and reliable. However, no responsibility is assumed by Analog Devices for its use, nor for any infringements of patents or other rights of third parties which may result from its use. No license is granted by implication or otherwise under any patent or patent rights of Analog Devices.

FUNCTIONAL BLOCK DIAGRAM

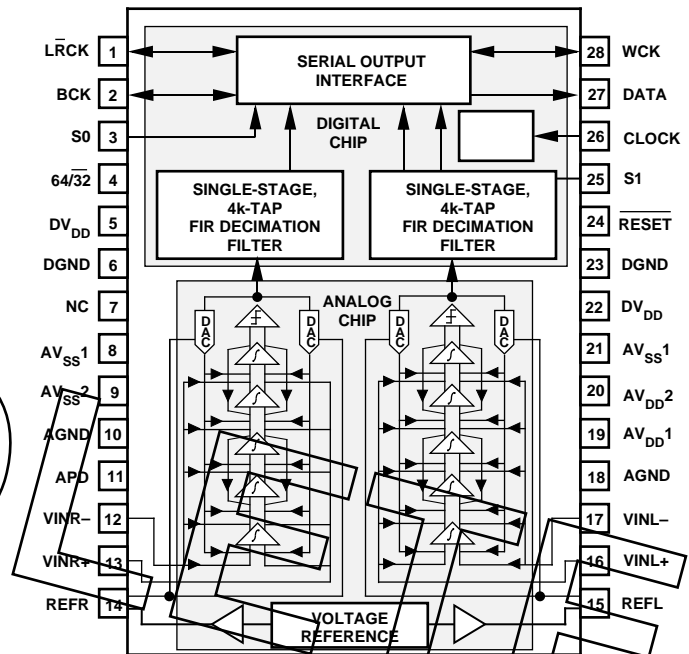

phase and a narrow transition band that permits the digitization of 20 kHz signals while preventing aliasing into the passband even when using a 44.1 kHz sampling frequency. Passband ripple is less than 0.001 dB, and stopband attenuation exceeds 115 dB.

The flexible serial output port produces data in two's-complement, MSB-first format. Input and output signals are to TTL and CMOS-compatible logic levels. The port is configured by pin selections. The AD1878/AD1879 can operate in either master or slave mode. Each 16-/18-bit output word of a stereo pair can be formatted within a 32-bit field as either right-justified, I²S-compatible, or at user-selected positions. The output can also be truncated to 16-bits by formatting into a 16-bit field.

The AD1878/AD1879 consists of two integrated circuits in a single ceramic 28-pin DIP package. The modulators and reference are fabricated in a BiCMOS process; the decimator and output port, in a 1.0 μm CMOS process. Separating these functions reduces digital crosstalk to the analog circuitry. Analog and digital supply connections are separated to further isolate the analog circuitry from the digital supplies.

The AD1878/AD1879 operates from ± 5 V power supplies over the temperature range of -25°C to $+70^\circ\text{C}$.

AD1878/AD1879—SPECIFICATIONS

TEST CONDITIONS UNLESS OTHERWISE NOTED

Supply Voltages	±5	V
Ambient Temperature	25	°C
Input Clock (F_{CLOCK})	12.288	MHz
Input Signal	974	Hz
	-0.5	dB Full Scale

All minimums and maximums tested except as noted.

ANALOG PERFORMANCE

	Min	Typ	Max	Units
AD1879 Resolution		18		Bits
AD1878 Resolution		16		Bits
Clock Input Frequency Range				
CLOCK Input (F_{CLOCK})	0.01	12.288	14.286	MHz
Modulator Sample Rate ($F_{\text{CLOCK}}/4$)	0.0025	3.072	3.5715	MHz
Output Word Rate ($F_s = F_{\text{CLOCK}}/256$)	0.039	48	55.8	kHz
AD1879 Dynamic Range (0 kHz to 20 kHz, -60 dB input)				
Stereo Mode (No A-Weight Filter)	100	103		dB
Mono Mode ¹ (No A-Weight Filter)		106		dB
Stereo Mode (with A-Weight Filter)		105		dB
AD1879 Trimmed ² Signal to (Noise + Distortion)				
Full Scale	93	98		dB
-20 dB		83		dB
AD1879 Untrimmed ³ Signal to (Noise + Distortion)				
Full Scale	91	96		dB
-20 dB		83		dB
AD1879 Trimmed ² Signal to Total Harmonic Distortion				
Full Scale		98		dB
-20 dB		100		dB
AD1878 Dynamic Range (0 kHz to 20 kHz, -60 dB 1.0936 kHz Input Dithered with a -10 dB 21.873 kHz Sine Wave)				
Stereo Mode (No A-Weight Filter)	95	97		dB
AD1878 Trimmed ² Signal to (Noise + Distortion)				
Full Scale	93	95		dB
-20 dB		77		dB
AD1878 Untrimmed ³ Signal to (Noise + Distortion)				
Full Scale	91	94		dB
-20 dB		77		dB
AD1878 Trimmed ² Signal to Total Harmonic Distortion				
Full Scale		98		dB
-20 dB		100		dB
Analog Inputs				
Differential Input Range ⁴	±5.985	±6.3	±6.615	V
Input Impedance at Each Input Pin		7.0		kΩ
DC Accuracy				
Gain Error		±1	±5	%
Interchannel Gain Mismatch		0.05	0.15	dB
Gain Drift		150		ppm/°C
AD1879 Midscale Offset Error		±200	±750	18-Bit LSBs
AD1878 Midscale Offset Error		±50	±200	16-Bit LSBs
Midscale Drift		13		ppm/°C
Voltage Reference	2.4	2.86	3.2	V
Crosstalk (EIAJ Method)	100	105		dB
Interchannel Phase Deviation		±0.001		Degrees

NOTES

¹Both channels connected together for mono operations as described below in "How to Extend SNR."

²Differential gain imbalance manually trimmed to eliminate second harmonic. See "Applications Issues" below.

³Test performed without part-to-part trimming.

⁴The differential input range is twice the range seen at each input pin. The input range corresponds to the full-scale digital output range.

Specifications subject to change without notice.

DIGITAL INPUTS

	Min	Max	Units
V _{IH}			V
V _{IL}		0.8	V
I _{IH} @ V _{IH} = 5 V		10	μA
I _{IL} @ V _{IL} = 0 V		10	μA
V _{OH} @ I _{OH} = 360 μA	4.0		V
V _{OL} @ I _{OL} = 1.6 mA		0.5	V

DIGITAL TIMING

	Min	Typ	Max	Units
CLOCK				
Period (T _{CLOCK} = 1/F _{CLOCK})	0.07		100	μs
LO Pulse Width	35			ns
HI Pulse Width	35			ns
BCK Pulse Width		2		CLOCK Periods
64-Bit Frame LRCK Pulse Width		32		BCK Periods
32-Bit Frame LRCK Pulse Width		16		BCK Periods
WCK Pulse Width	1			BCK Periods
t _{RSET}	5			ns
t _{RHLD}	20			ns
t _{RSL}	4		10 μs	CLOCK Periods
t _{WSET}	5			ns
t _{WHLD}	20			ns
t _{DLYCK}			65	ns
t _{SET}	5			ns
t _{HLD}	20			ns
t _{DLYD, MSB}			65	ns
t _{DLYD}			70	ns

POWER

	Min	Typ	Max	Units
Supplies				
Voltage, DV _{DD} /AV _{DD} 1/AV _{DD} 2	4.75	5	5.25	V
Voltage, AV _{SS} 1/AV _{SS} 2	-5.25	-5	-4.75	V
Current, AV _{DD} 1/AV _{SS} 1		73	92	mA
Current, AV _{DD} 1/AV _{SS} 1—Power Down		13	23	mA
Current, AV _{DD} 2/AV _{SS} 2		8	10	mA
Current, DV _{DD}		64	70	mA
Dissipation				
Operation		1,130	1,370	mW
Operation—Analog Supplies		810	1,020	mW
Operation—Digital Supplies		320	350	mW
Power Down (All Supplies)		530	680	mW
Power Supply Rejection				
1 kHz 300 mV p-p Signal at Analog Supply Pins		102		dBFS
Passband—Any 300 mV p-p Signal		92		dBFS
Stopband—Any 300 mV p-p Signal		105		dBFS

TEMPERATURE RANGE

	Min	Typ	Max	Units
Specifications Guaranteed		+25		°C
Functionality Guaranteed	-25		+70	°C
Storage	-60		+100	°C

AD1878/AD1879

ABSOLUTE MAXIMUM RATINGS

	Min	Typ	Max	Units
DV _{DD} to DGND and AV _{DD1} /AV _{DD2} to AGND	0		6	V
AV _{SS1} /AV _{SS2} to AGND	-6		0	V
AV _{SS2} to AV _{SS1}	-0.3			V
Digital Inputs to DGND	-0.3		DV _{DD} + 0.3	V
Analog Inputs	AV _{SS1} - 0.3		AV _{DD1} + 0.3	V
AGND to DGND	-0.3		0.3	V
Reference Voltage		Indefinite Short Circuit to Ground		°C
Soldering			+300	sec
			10	

DIGITAL FILTER CHARACTERISTICS

	Min	Typ	Max	Units
Decimation Factor		64		
Passband Ripple			0.001	dB
Stopband ¹ Attenuation	115			dB
48 kHz F _S (12.288 MHz CLOCK)				
Passband	0		21.7	kHz
Stopband	26.2		3,045	kHz
44.1 kHz F _S (11.2896 MHz CLOCK)				
Passband	0		20.9	kHz
Stopband	24.1		2,708	kHz
32 kHz F _S (8.192 MHz CLOCK)				
Passband	0		14.5	kHz
Stopband	17.5		2,030	kHz
Other F _S				
Passband	0		0.4535	F _S
Stopband	0.5458		63.4542	F _S
Group Delay ([4096/2]/[64 × F _S])		32/F _S		μs
Group Delay Variation			0	

NOTE

¹Stopband repeats itself at multiples of 64 × F_S, where F_S is the output word rate. Thus the digital filter will attenuate to 115 dB across the frequency spectrum except for a range ±0.5458 × F_S wide at multiples of 64 × F_S.

Specifications subject to change without notice.

ORDERING GUIDE

Model	Temperature	Package Description	Package Option
AD1878JD	-25°C to +70°C	Ceramic DIP	D-28
AD1879JD	-25°C to +70°C	Ceramic DIP	D-28

CAUTION

ESD (electrostatic discharge) sensitive device. Electrostatic charges as high as 4000 V readily accumulate on the human body and test equipment and can discharge without detection. Although the AD1878/AD1879 features proprietary ESD protection circuitry, permanent damage may occur on devices subjected to high energy electrostatic discharges. Therefore, proper ESD precautions are recommended to avoid performance degradation or loss of functionality.



DEFINITIONS

Dynamic Range

The ratio of a full-scale output signal to the integrated output noise in the passband (0 kHz to 20 kHz), expressed in decibels (dB). Dynamic range is measured with a -60 dB input signal and is equal to $(S/[THD+N]) + 60$ dB.

Signal to (Noise + Distortion)

The ratio of the root-mean-square (rms) value of the fundamental input signal to the rms sum of all spectral components in the passband, expressed in decibels (dB).

Signal to Total Harmonic Distortion (THD)

The ratio of the rms sum of all harmonically related spectral components in the passband to the fundamental input signal, expressed either as a percentage (%) or in decibels (dB).

Passband

The region of the frequency spectrum unaffected by the attenuation of the digital decimator's filter.

Passband Ripple

The peak-to-peak variation in amplitude response from equal amplitude input signal frequencies within the passband, expressed in decibels.

Stopband

The region of the frequency spectrum attenuated by the digital decimator's filter to the degree specified by "stopband attenuation."

Gain Error

With a near full-scale input, the ratio of actual output to expected output, expressed as a percentage.

Interchannel Gain Mismatch

With near full-scale inputs, the ratio of outputs of the two stereo channels, expressed in decibels.

Gain Drift

Change in response to a near full-scale input with a change in temperature, expressed as parts-per-million (ppm) per °C.

Midscale Offset Error

Output response to a midscale input (i.e., zero volts dc), expressed in least-significant bits (LSBs).

Midscale Drift

Change in midscale offset error with a change in temperature, expressed as parts-per-million (ppm) of full scale per °C.

Crosstalk

Ratio of response on one channel with a grounded input to a full-scale 1 kHz sine-wave input on the other channel, expressed in decibels.

Interchannel Phase Deviation

Difference in input sampling times between stereo channels, expressed as a phase difference in degrees between 1 kHz inputs.

Power Supply Rejection

With analog inputs grounded, energy at the output when a 300 mV p-p signal is applied to power supply pins, expressed in decibels of full scale.

Group Delay

Intuitively, the time interval required for an input pulse to appear at the converter's output, expressed in milliseconds (ms). More precisely, the derivative of radian phase with respect to radian frequency at a given frequency.

Group Delay Variation

The difference in group delays at different input frequencies. Specified as the difference between largest and the smallest group delays in the passband, expressed in microseconds (μs).

AD1878/AD1879 PIN LIST

Pin	Input/Output	Pin Name	Description
1	I/O	LRCK	Left/Right Clock
2	I/O	BCK	Bit Clock
3	I	S0	Mode Select 0
4	I	64/32	Bit Rate Select
5	I	DV _{DD}	+5 V Digital Supply
6	I	DGND	Digital Ground
7		N/C	No Connection; Do Not Connect
8	I	AV _{SS1}	-5 V Analog Supply
9	I	AV _{SS2}	-5 V Analog Logic Supply
10	I	AGND	Analog Ground
11	I	APD	Analog Power Down
12	I	VINR-	Right Inverting Input
13	I	VINR+	Right Noninverting Input
14	I/O	REFR	Right Reference Capacitor
15	I/O	REFL	Left Reference Capacitor
16	I	VINL+	Left Noninverting Input
17	I	VINL-	Left Inverting Input
18	I	AGND	Analog Ground
19	I	AV _{DD1}	+5 V Analog Supply
20	I	AV _{DD2}	+5 V Analog Logic Supply
21	I	AV _{SS1}	-5 V Analog Supply
22	I	DV _{DD}	+5 V Digital Supply
23	I	DGND	Digital Ground
24	I	RESET	Reset
25	I	S1	Mode Select 1
26	I	CLOCK	Master Clock Input
27	O	DATA	Serial Data Output
28	I/O	WCK	Word Clock

THEORY OF OPERATION

ΣΔ Modulator Noise-Shaping

The stereo, differential analog modulators of the AD1878/AD1879 employ a proprietary feedforward and feedback architecture that passes input signals in the audio band with a unity transfer function yet simultaneously shape the quantization noise generated by the one-bit comparator out of the audio band. See Figure 1. Without the ΣΔ architecture, this quantization noise would be spread uniformly from dc to one-half the oversampling frequency, $64 \times F_S$. (Regardless of architecture, 64 times oversampling by itself significantly reduces the quantization noise in the audio band if the input is properly dithered. However, the noise reduction is only $[\log_2 64] \times 3$ dB = 18 dB.)

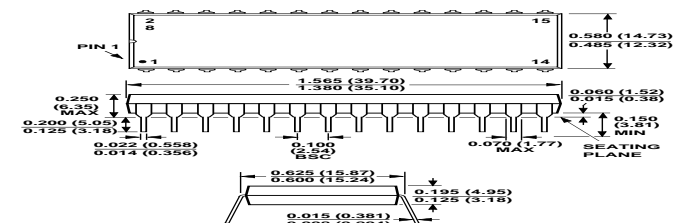

Figure 1. AD1878/AD1879 Modulator Noise-Shaper (One Channel)

AD1878/AD1879

The AD1878/AD1879's patented $\Sigma\Delta$ architectures "shape" the quantization noise-transfer function in a nonuniform manner. Through careful design, this transfer function can be specified to high-pass filter the quantization noise out of the audio band into higher frequency regions. See Figure 27. The Analog Devices' AD1878/AD1879 also incorporates feedback resonators from the third integrator's output to the second integrator's input and from the fifth integrator's output to the fourth integrators' input. These resonators do not affect the signal transfer function but allow flexible placement of zeros in the noise transfer function. For the AD1878/AD1879, these zeros were placed near the high frequency end of the audio passband, reducing the quantization noise in a region where it otherwise would have been increasing.

Oversampling by 64 simplifies the implementation of a high performance audio analog-to-digital conversion system. Antialias requirements are minimal; a single pole of filtering will usually suffice to eliminate inputs near F_S and its higher multiples.

A fifth-order architecture was chosen both to strongly shape the noise out of the audio band and to help break up the idle tones produced in all $\Sigma\Delta$ architectures. These architectures have a tendency to generate periodic patterns with a constant dc input, a response that looks like a tone in the frequency domain. These idle tones have a direct frequency dependence on the input dc offset and indirect dependence on temperature and time as it affects dc offset. The human ear operates effectively like a spectrum analyzer and can be sensitive to tones below the integrated noise floor, depending on frequency and level. The AD1878/AD1879 suppresses idle tones typically 110 dB or better below full-scale input levels.

Previously it was thought that higher-order modulators could not be designed to be globally stable. However, the AD1878/AD1879's modulator was designed, simulated, and exhaustively tested to remain stable for any input within a wide tolerance of its rated input range. The AD1878/AD1879 was designed to reset itself should it ever be overdriven and go unstable. It will reset itself within 5 μ s at a 48 kHz sampling frequency. Any such reset events will be invisible to the user since overdriving the inputs will produce a "clipped" waveform at the output.

The AD1878/AD1879 modulator architecture has been implemented using switched-capacitors. A systems benefit is that external sample-and-hold amplifiers are unnecessary since the capacitors perform the sample-and-hold function. Coefficient weights are created out of varying capacitor sizes. The dominant noise source in this design is kT/C noise, and the input capacitors are accordingly very large to achieve the AD1878/AD1879's performance levels. (Each 6 dB improvement in dynamic range requires a quadrupling of input capacitor size, as well as an increase in size of the op amps to drive them.) This AD1878/AD1879 thermal noise has been controlled to properly dither the input to an 18-bit level. (Note that 16-bit results from either the AD1878 or AD1879 will be underdithered.)

With capacitors of adequate size and op amps of adequate drive, a well-designed switched-capacitor modulator will be relatively insensitive to jitter on the sampling clock. The key issue is whether the capacitors have had sufficient time to charge or discharge during the clock period. A properly designed switched capacitor modulator should be no more sensitive to clock jitter than are traditional nonoversampled ADCs. This contrasts with

continuous-time modulators, which are very sensitive to the exact location of sampling clock edges.

See Figures 20–23 for illustrations of the AD1878/AD1879's typical analog performance resulting from this design. Signal-to-noise+distortion is shown under a range of conditions. Note the very good linearity performance of the AD1878/AD1879 as a consequence of its single-bit $\Sigma\Delta$ architecture in Figure 24. The common-mode rejection (Figure 25) graph illustrates the benefits of the AD1878/AD1879's differential architecture. The excellent channel separation shown in Figure 26 is the result of careful chip design and layout. The relatively small change in gain over temperature (Figure 31) results from a robust reference design.

The output of the AD1878/AD1879 modulators is a stereo bitstream at $64 \times F_S$ (3.072 MHz for $F_S = 48$ kHz). Spectral analysis of these bits would show that they contain a high quality replica of the input in the audio band and an enormous amount of quantization noise at higher frequencies. The input signal can be recreated directly if these bits are fed into a properly designed analog low-pass filter.

Digital Filter Characteristics

The digital decimator accepts the modulators' stereo bitstream and simultaneously performs two operations on it. First, the decimator low-pass filters the quantization noise that the modulator shaped to high frequencies and filters any other out-of-audio-band input signals. Second, it reduces the data rate to an output word rate equal to F_S . The high frequency bitstream is reduced to stereo 16-/18-bit words at 48 kHz (or other desired F_S). The one-bit quantization noise, other high-frequency components of the bitstream, and analog signals in the stopband are attenuated by at least 115 dB.

The AD1878/AD1879 decimator implements a symmetric Finite Impulse Response (FIR) filter, resulting in its linear phase response. This filter achieves a narrow transition band ($0.0923 \times F_S$), high stopband attenuation (> 115 dB), and low passband ripple (< 0.001 dB). The narrow transition band allows the unattenuated digitization of 20 kHz input signals with F_S as low as 44.1 kHz. The stopband attenuation is sufficient to eliminate modulator quantization noise from affecting the output. Low passband ripple prevents the digital filter from coloring the audio signal. For this level of performance, 4095 22-bit coefficients (taps) were required in each channel of this filter. The AD1878/AD1879's decimator employs a proprietary single-stage, multiplier-free structure developed in conjunction with Ensoniq Corporation. See Figures 28 and 29 for the digital filter's characteristics.

The output from the decimator is available as a single serial output, multiplexed between left and right channels.

Note that the digital filter itself is operating at $64 \times F_S$. As a consequence, Nyquist images of the passband, transition band, and stopband will be repeated in the frequency spectrum at multiples of $64 \times F_S$. Thus the digital filter will attenuate to 115 dB across the frequency spectrum except for a window $\pm 0.5458 \times F_S$ wide centered at multiples of $64 \times F_S$. Any input signals, clock noise, or digital noise in these frequency windows will not be attenuated to the full 115 dB. If the high frequency signals or noise appear within the passband images within these windows, they will not be digitally attenuated at all.

Sample Delay

The sample delay or “group delay” of the AD1878/AD1879 is dominated by the processing time of the digital decimation filter. FIR filters convolve a vector representing time samples of the input with an equal-sized vector of coefficients. After each convolution, the input vector is updated by adding a new sample at one end of the “pipeline” and eliminating the oldest input sample at the other. For an FIR filter, the time at which a step input appears at the output will be approximately when that step input is halfway through the input sample vector pipeline. The input sample vector is updated every $64 \times F_S$. Thus, the sample delay will be given by the equation,

$$\text{Group Delay} = (4096 \div 2) / (64 \times F_S) = 32 / F_S$$

For the most common sample rates this can be summarized as:

F_S	Group Delay
48 kHz	667 μs
44.1 kHz	725 μs
32 kHz	1000 μs

Due to the linear phase properties of FIR filters, the group delay variation, or differences in group delay at different frequencies is zero.

OPERATING FEATURES

Voltage Reference

The AD1878/AD1879 includes a +3 V on-board reference which determines the AD1878/AD1879’s input range. This reference is buffered to both channels of the AD1878/AD1879’s modulator, providing a well-matched reference to minimize interchannel gain mismatch. The reference should be bypassed with 10 μF tantalum capacitors as shown in Figure 2. The internal reference can be overpowered by applying an external reference at the REFR (Pin 14) and REFL (Pin 15) pins, allowing multiple AD1878/AD1879s to be calibrated to the same gain. Note that the reference pins still must be bypassed as shown.

Sample Clock

An external master clock supplied to CLOCK (Pin 26) drives the AD1878/AD1879 modulator, decimator, and digital interface. As with any analog-to-digital conversion system, the sampling clock must be low jitter to prevent conversion errors.

The input clock operates at $256 \times F_S$. The clock is divided down to obtain the $64 \times F_S$ clock required for the modulator. The output word rate will be at F_S itself. This relationship is illustrated for popular sample rates below:

AD1879 CLOCK Input	Modulator Sample Rate	Output Word Rate
12.288 MHz	3.072 MHz	48 kHz
11.2896 MHz	2.822 MHz	44.1 kHz
8.192 MHz	2.048 MHz	32 kHz

The AD1878/AD1879 serial interface supports both “master” and “slave” modes. Note that even in slave mode it is presumed that the serial interface clocks are derived from the master clock input, CLOCK. Slave mode does *not* support asynchronous data transfers, since asynchronous data transfers would compromise the performance of any high performance converter.

The AD1878/AD1879 decimator makes use of dynamic logic to minimize die area. There is, therefore, a minimum clock frequency that the AD1878/AD1879 will support specified in “Specifications” above. Operation of the AD1878/AD1879 at lower frequencies will cause the device to consume excessive power and may damage the converter.

Reset

The active LO $\overline{\text{RESET}}$ pin (Pin 24) allows initializing the AD1879. This is of value only for synchronizing multiple AD1878/AD1879s in Master Mode—WCK Output. Unless you are interested in synchronizing multiple AD1878/AD1879s, we recommend tying $\overline{\text{RESET}}$ HI. The reset function is useful for nothing else. In fact, there is a maximum specification on $\overline{\text{RESET}}$ LO; excessive power consumption may occur with loss of reliability if left LO too long due to the dynamic logic on the chip.

Figure 14 illustrates the timing parameters for $\overline{\text{RESET}}$ to accomplish synchronization of multiple Master Mode—Word Clock Output ADCs. (This sequence is not necessary for synchronizing multiple AD1878/AD1879s in other modes. See “Synchronizing Multiple AD1878/AD1879s” below.) Note that $\overline{\text{RESET}}$ first has to be LO for at least four CLOCK periods (three CLOCKS plus t_{RESET} plus t_{THLD} , to be more precise). Then $\overline{\text{RESET}}$ must be HI for a minimum of one CLOCK and a maximum of two CLOCKS. Then $\overline{\text{RESET}}$ must be LO for at least another four CLOCKS. From the time when $\overline{\text{RESET}}$ goes HI again, exactly 127 CLOCKS will occur before $\overline{\text{LRCK}}$ goes LO.

Analog Power Down

The AD1878/AD1879 features a power-down mode that reduces current to the analog modulator. It is controlled by the active HI APD (Pin 11). The power savings are specified in “Specifications.” The converter is still “alive” in the power-down state but will not produce valid results for all audio-band inputs.

Power consumption can be further reduced by slowing down the master clock input to the minimum clock frequency, F_{CLOCK} , specified for the AD1878/AD1879.

APPLICATIONS ISSUES

Recommended Input Structure

The AD1878/AD1879 input structure is fully differential for improved common-mode rejection properties and increased dynamic range. Since each input pin sees ± 3 V swings, each channel’s input signal effectively swings ± 6 V, i.e., across a 12 V range.

In most cases, a single-ended-to-differential input circuit is required. Shown in Figure 2 is our recommended circuit, based on extensive experimentation. Note that to maximize signal swing, the op amps in this circuit are powered by ± 12 V or greater supplies. The AD1878/AD1879 itself requires ± 5 V supplies. If ± 5 V supplies are not already available in your system, Figure 3 illustrates our recommended circuit for generating these supplies.

AD1878/AD1879

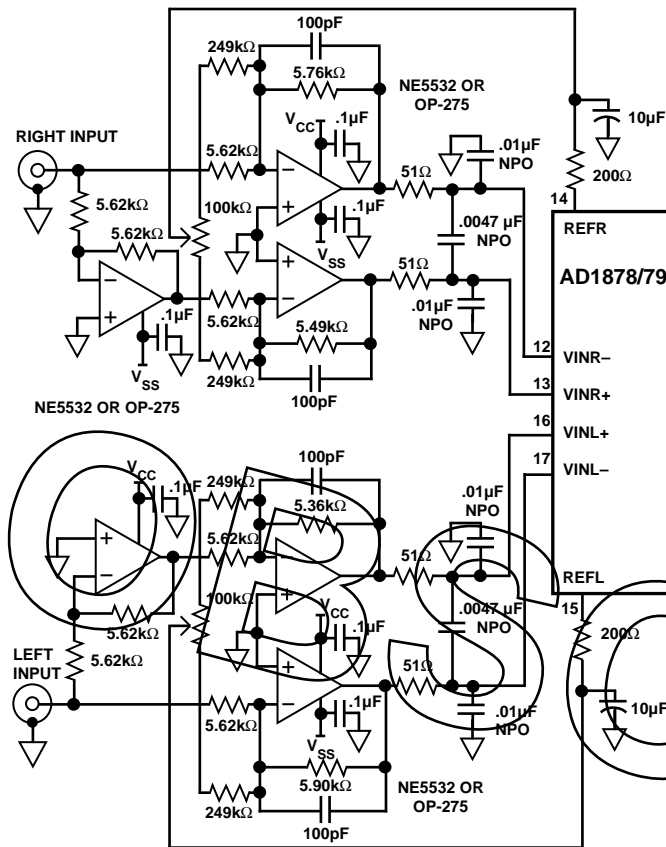

Figure 2. AD1878/AD1879 Recommended Input Structure

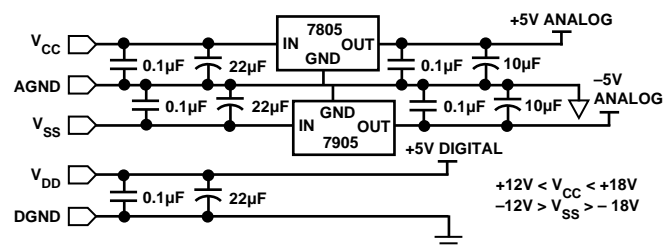

Figure 3. AD1878/AD1879 Recommended Power Conditioning Circuit (If ± 5 V Supplies Are Not Already Available)

The trim potentiometers shown in Figure 2 connecting the minus (-) inputs of the driving op amps permit trimming out dc offset, if desired.

Note that the driving op amp feedback resistors are all slightly different values. These values produce a slight differential gain imbalance and were derived empirically to minimize second harmonic distortion on average and produce the best overall THD without part-by-part trimming. Replacing one of these feedback resistors in each channel with a trim potentiometer allows trimming the differential gain imbalance for part-by-part optimal performance. We have done this in the lab by paralleling 100 kΩ trim potentiometers around the 5.49 kΩ and 5.36 kΩ input feedback resistors for the V_{IN} plus (+) signals that can be found in Figure 2. By trimming gain imbalance, second harmonic distortion can always be eliminated. In “Specifications,” a distinction is drawn between trimmed and untrimmed signal-to (noise + distortion) and trimmed and untrimmed total harmonic distortion. The untrimmed specifications are tested to

the input structure shown in Figure 2. The trimmed specifications are based on a part-by-part trim of this differential gain to eliminate the second harmonic.

The input circuit of Figure 2 could be implemented with a single pair of operational amplifiers per channel, one inverting and one noninverting. The recommended architecture shown in Figure 2 using three inverting op amps per channel provides isolation of the op amp inputs from charge dumped back from the AD1878/AD1879’s input capacitors when these large capacitors switch. The performance from a two op amp per channel input structure is not quite as good as the structure recommended, but it is close and may be adequate in many applications.

Layout and Decoupling Considerations

Obtaining the best possible performance from a state-of-the-art data converter like the AD1878/AD1879 requires close attention to board layout. From extensive experimentation, we have discovered principles that produce typical values of 103 dB dynamic range and 98 dB S/(THD+N) in your system. Schematics of our AD1878/AD1879 Evaluation Board, which implements these recommendations, are available from Analog Devices.

The principles and their rationales are listed below in descending order of importance. The first two pertain to bypassing and are illustrated in Figure 4.

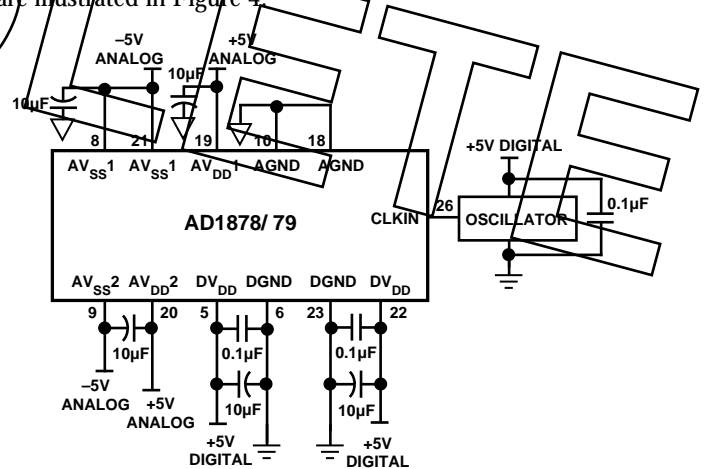

Figure 4. AD1878/AD1879 Recommended Bypassing and Oscillator Circuits

- The digital bypassing of the AD1878/AD1879 is the most critical item on the board layout. There are two pairs of digital supply pins of the part, each pair on opposite sides (Pins 5 and 6 and Pins 22 and 23). The user should tie a bypass capacitor set (0.1 μF ceramic and 10 μF tantalum) on EACH pair of supply pins as close to the pins as possible. The traces between these package pins and the capacitors should be as short and as wide as possible. This will prevent digital supply current transients from being inductively transmitted to the inputs of the part.
- The analog input bypassing is the second most critical item. Use 0.01 μF NPO ceramic capacitors from each input pin to the analog ground plane, with a clear ground path from the bypass capacitor to the AGND pin on the same side of the package (Pins 10 and 18). The trace between this package pin and the capacitor should be as short and as wide as possible. A 0.0047 μF NPO ceramic capacitor should be placed

between each set of input pins (12 to 13, and 17 to 16) to complete the input bypassing. This input bypassing minimizes the RF transmission and reception capability of the AD1878/AD1879 inputs.

- For best performance, do not use a socket with the AD1878/AD1879. If you must socket the part, use pin clips to keep the part flush with the board, thus keeping bypassing as close to the chip as possible.
- The AD1878/AD1879 should be placed on a split ground plane as illustrated in Figure 5. The digital ground plane should be placed under the top end of the package and the analog ground plane should be placed under the bottom end of the package as shown in Figure 5. The split should be between Pins 7 and 8 and between Pins 21 and 22. The ground planes should be tied together at one spot underneath the center of the package. This ground plane technique also minimizes RF transmission and reception.

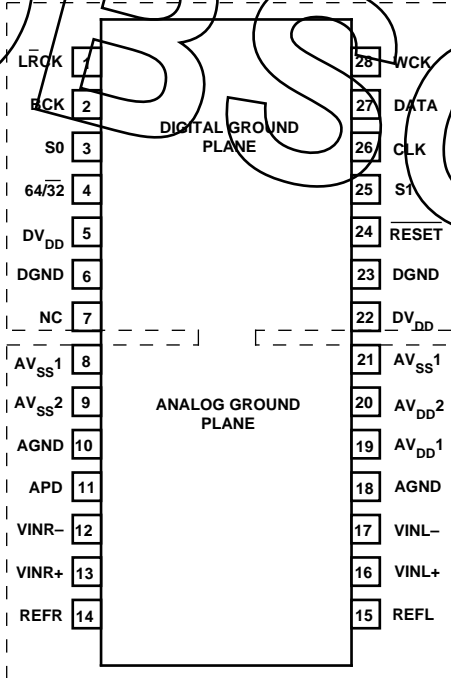

Figure 5. AD1878/AD1879 Recommended Ground Plane

- Each reference pin (14 and 15) should be bypassed with a resistor and a capacitor. One end of the resistor should be placed as close to the package pin as possible, and the trace to it from the reference pin should be as short and as wide as possible. Keep this trace away from input pin traces! Coupling between input and reference traces will cause second harmonic distortion. The resistor is used to reduce the high frequency coupling into the references from the board.
- Wherever possible, minimize the capacitive load on digital outputs of the part. This will reduce the digital spike currents drawn from the digital supply pins.

How to Extend SNR

A cost-effective method of improving the dynamic range and SNR of an analog-to-digital conversion system is to use multiple AD1879 channels in parallel with a common analog input. (The same technique would work with the AD1878. However, this would be of little value since using a single AD1879 would

be more effective.) This technique makes use of the fact that the noise in independent modulator channels is uncorrelated. Thus every doubling of the number of AD1879 channels used will improve system dynamic range by 3 dB. The digital outputs from the corresponding decimator channels have to be arithmetically averaged to obtain the improved results in the correct data format. A digital processor, either general-purpose or DSP, can easily perform the averaging operation.

Shown below in Figure 6 is a circuit for obtaining a 3 dB improvement in dynamic range by using both channels of a single AD1879 with a mono input. The minus (-) output from the input buffer is sent to both right and left minus AD1879 inputs; the plus (+) output from the input buffer is sent to both right and left plus AD1879 inputs. A stereo implementation would require using two AD1879s and using the full recommended input structure shown above in Figure 2. Note that a single digital processor would likely be able to handle the averaging requirements for both left and right channels.

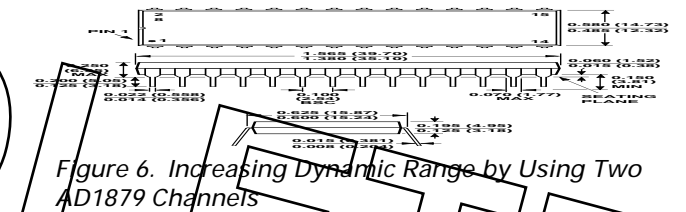

Figure 6. Increasing Dynamic Range by Using Two AD1879 Channels

DIGITAL INTERFACE Modes of Operation

The AD1878/AD1879's flexible serial output port produces data in two's-complement, MSB-first format. Output signals are to TTL/CMOS logic levels. The port is configured by pin selections. The AD1879 can operate in either master or slave modes. Each 16-/18-bit output word of a stereo pair can be formatted within a 32-bit field as right-justified, as I²S-compatible, or at user-selected positions. The two 32-bit fields constitute a 64-bit frame (64-bit mode). The output can also be truncated to 16 bits and formatted in a 16-bit field with two 16-bit fields in a 32-bit frame (32-bit mode).

The various mode options are pin-programmed with the S0 Mode Select Pin (3), the S1 Mode Select Pin (25), and the 64/32 Bit Rate Select Pin (4). The function of these pins is summarized:

Serial Port Operation Mode	64/32	S0	S1
64-Bit Master Mode—Word Clock Output	1	0	0
64-Bit Master Mode—Word Clock Input	1	1	0
64-Bit Slave Mode	1	1	1
Reserved	1	0	1
32-Bit Master Mode—Word Clock Out HI	0	0	0
32-Bit Master Mode—Word Clock Ignored	0	1	0
32-Bit Slave Mode	0	1	1
Reserved	0	0	1

Serial Port Data Timing Sequences

In the "master modes," the bit clock (BCK) and left/right clock (LRCK) are always outputs, generated internally in the AD1878/AD1879 from the master clock (CLOCK) input. The word clock (WCK) may either be an internally generated output or a user-supplied input, depending on the pin-programmed mode

AD1878/AD1879

In the “slave modes,” the bit clock (BCK), the word clock (WCK), and the left/right clock (LRCK) are user-supplied inputs. Note that, for performance reasons, the AD1878/AD1879 does not support asynchronous operation; these clocks must be externally derived from the master clock (CLOCK). The functional sequence of the signals in the slave modes is identical to the master modes with word clock input, and they share the same sequence timing diagrams.

In 64-Bit Master Mode with Word Clock Output, the 16-/18-bit words are right-justified in 32-bit fields as shown in Figures 7 and 8. The WCK output goes HI approximately with the falling edge of the BCK output, indicating that the MSB on DATA will be externally valid at the next BCK rising edge. The LRCK output discriminates the left from the right output fields.

In 64-bit frame modes with word clock (WCK) is an input, the 16-/18-bit words can be placed in user-defined locations within 32-bit fields. This is true in both master and slave modes. The

options are illustrated in Figures 9, 10, 11, and 12. For all options, the first occurrence in a 32-bit field when the word clock (WCK) is HI on a bit clock (BCK) falling edge will cause the beginning of data transmission. The MSB on DATA will be valid at the next BCK rising edge. Again, the LRCK output discriminates the left from the right output fields.

Figure 9 illustrates the general case for 64-bit frame modes with word clock input where the MSB is valid on the rising edge of the Nth bit clock (BCK). Figures 10 and 11 illustrate the limits. If WCK is still LO at the falling edge of the 14th bit clock (BCK) for the AD1879 or 16th bit clock (BCK) for the AD1878, then the MSB of the current word will be output anyway, valid at the rising edge of the 15th bit clock (BCK) in the field for the AD1879, 17th for the AD1878. This limit insures that all 16/18 bits will be output within the current field. The effect is to right-justify the data.

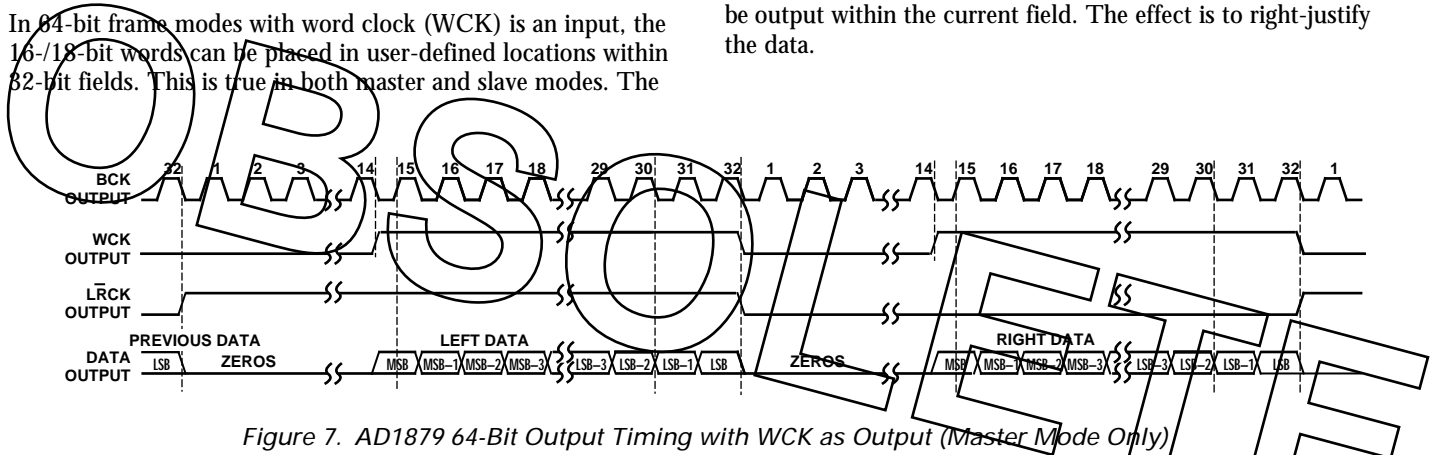

Figure 7. AD1879 64-Bit Output Timing with WCK as Output (Master Mode Only)

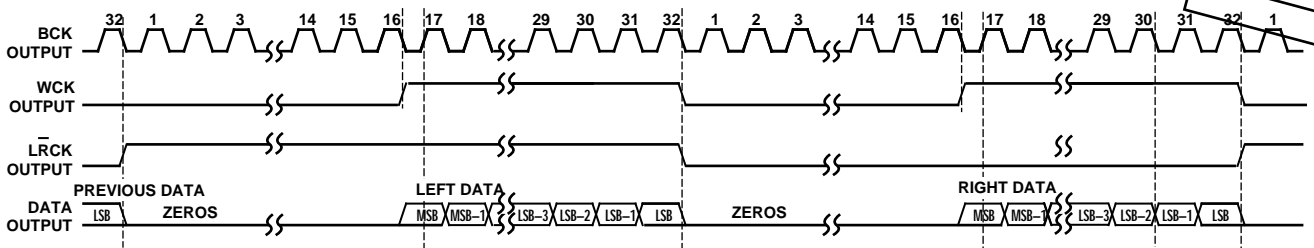

Figure 8. AD1878 64-Bit Frame Output Timing with WCK as Output (Master Mode Only)

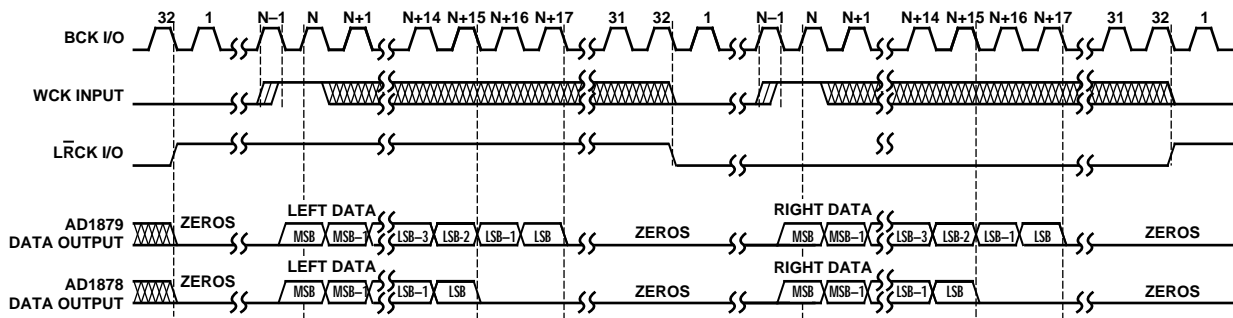

Figure 9. AD1878/AD1879 64-Bit Frame Output Timing with WCK as Input: WCK Transitions HI Before 16th BCK (AD1878)/14th BCK (AD1879) (Master Mode or Slave Mode)

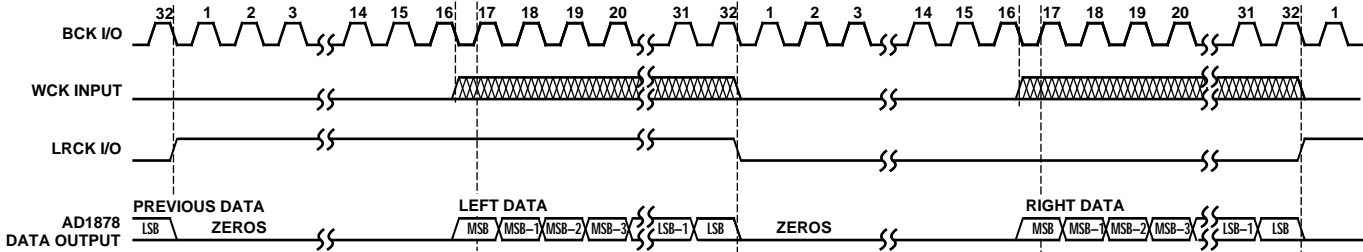

Figure 10. AD1878 64-Bit Frame Output Timing with WCK as Input: WCK Held LO Until 16th BCK (Master Mode or Slave Mode)

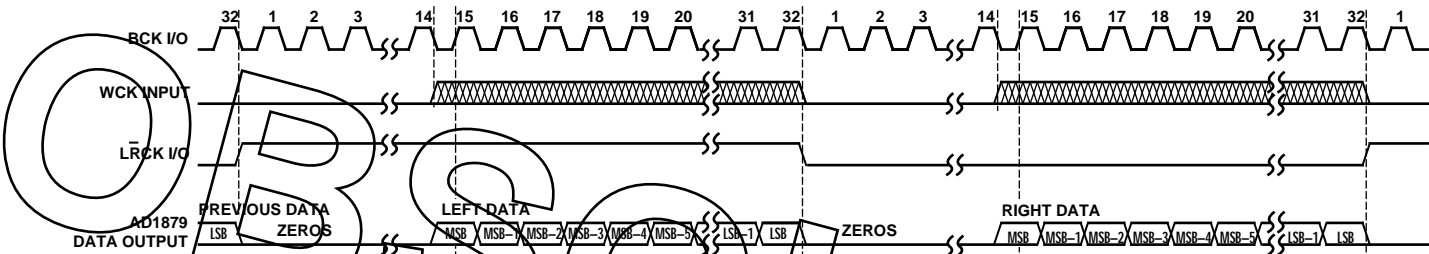

Figure 11. AD1879 64-Bit Frame Output Timing with WCK as Input: WCK Held LO Until 14th BCK (Master Mode or Slave Mode)

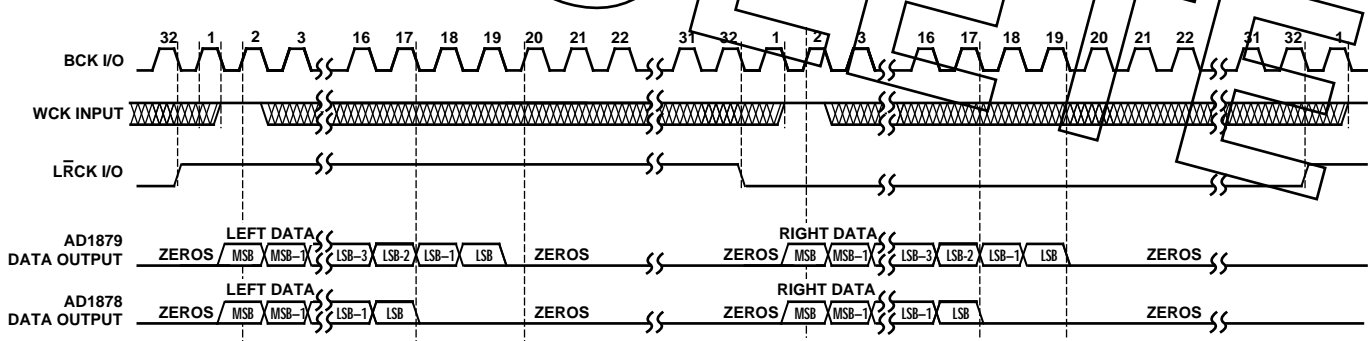

Figure 12. AD1878/AD1879 64-Bit Output Frame Timing with WCK as Input: WCK HI During 1st BCK (Master Mode or Slave Mode)

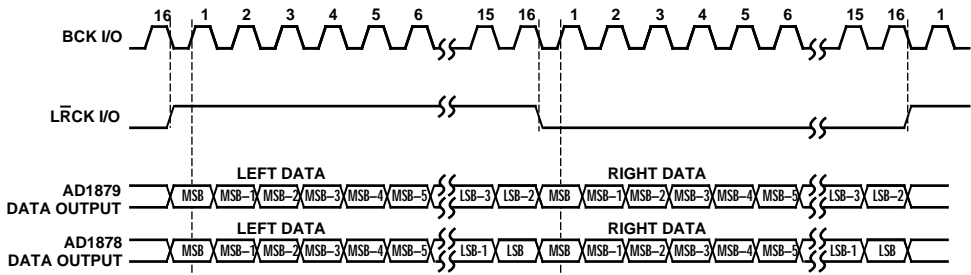

Figure 13. AD1878/AD1879 32-Bit Output Frame Timing (Master Mode or Slave Mode)

At the other limit, if the word clock (WCK) is HI during the first bit clock (BCK) of the field, then the MSB of the output word will be valid on the rising edge of the 2nd bit clock (BCK) as shown in Figure 12. The effect is to delay the MSB for one bit clock cycle into the field, making the output data compatible at the data format level with the I²S data format.

In 64-bit frame modes with word clock (WCK) as an input, the relative placement of the word clock (WCK) input can vary from 32-bit field to 32-bit field, even within the same 64-bit frame. For example, within a single 64-bit frame the left word could be right-justified (by keeping WCK LO) and the right word could be in an I²S-compatible data format (by having WCK HI at the beginning of the second field).

AD1878/AD1879

Also available with the AD1878/AD1879 is a 32-bit frame mode where the 1879's 18-bit output is truncated to 16-bit words and for both parts the output packed "tightly" into two 16-bit fields in the 32-bit frame as shown in Figure 13. Note that the bit clock (BCK) and data transmission (DATA) are operating at one-half the rate as they would in the 64-bit frame modes. The distinction between master and slave modes still holds in the 32-bit frame modes, though the word clock (WCK) becomes irrelevant. If "32-Bit Master Mode With Word Clock Out HI" is selected, the word clock (WCK) will stay in a constant HI state. If "32-Bit Master Mode With Word Clock Ignored" is selected, the word clock pin (WCK) will be three-stated and any input to it is ignored as meaningless. (However, such an input should be tied off to HI or LO and not left to float.)

In both 32-bit master modes, the left/right clock ($\overline{\text{LRCK}}$) will be an output, indicating the difference between the left word/field and right word/field. In 32-Bit Slave Mode, the left/right clock ($\overline{\text{LRCK}}$) is an input.

Timing Parameters

The AD1878/AD1879 uses its master clock, CLOCK to resynchronize all inputs and outputs. The discussion above presumed that most timing parameters are relative to the bit clock, BCK. This is approximately true and provides an accurate model of the sequence of timing events. However, to be more precise, we have to specify all setup and hold times relative to CLOCK . These are illustrated in Figures 15, 16, and 17.

For master modes with word clock (WCK) output, bit clock (BCK), left/right clock ($\overline{\text{LRCK}}$), and word clock (WCK) will be

delayed from a master clock input (CLOCK) rising edge by t_{DLYCK} as shown in Figure 15. The MSB of the DATA output will be delayed from a falling edge of master clock (CLOCK) by $t_{\text{DLYD,MSB}}$. Subsequent bits of the DATA output in contrast will be delayed from a rising edge of master clock (CLOCK) by t_{DLYD} . (The MSB is valid one-half CLOCK period less than the subsequent bits.)

For master modes with word clock (WCK) inputs, bit clock (BCK) and left/ right clock ($\overline{\text{LRCK}}$) will be delayed from a master clock input (CLOCK) rising edge by t_{DLYCK} as shown in Figure 16, the same delay as with word clock output modes. The word clock (WCK) input, however, now has a setup time requirement, t_{WSET} , to the rising edge of master clock (CLOCK at "W") and a corresponding hold time, t_{WHLD} , from the rising of the third rising edge of CLOCK (W+3) after the setup edge. See Figure 16. As in the Master Mode—Word Clock Output case, the MSB of the DATA output will be delayed from a falling edge of master clock (CLOCK) by $t_{\text{DLYD,MSB}}$. Subsequent bits of the DATA output in contrast will be delayed from a rising edge of master clock (CLOCK) by t_{DLYD} .

For slave modes, bit clock (BCK) and left/right clock ($\overline{\text{LRCK}}$) will be inputs with setup time, t_{SET} , and hold time t_{HLD} , requirements to the falling edges of CLOCK as shown in Figure 17. Note that both edges of BCK and of $\overline{\text{LRCK}}$ have setup and hold time requirements. Note also that $\overline{\text{LRCK}}$ is setup to the falling edge of the "L" CLOCK , coincident with the CLOCK edge to which a falling edge of BCK is setup (B+3). $\overline{\text{LRCK}}$'s hold time requirements are relative to the falling edge of the "L + 31" CLOCK edge.

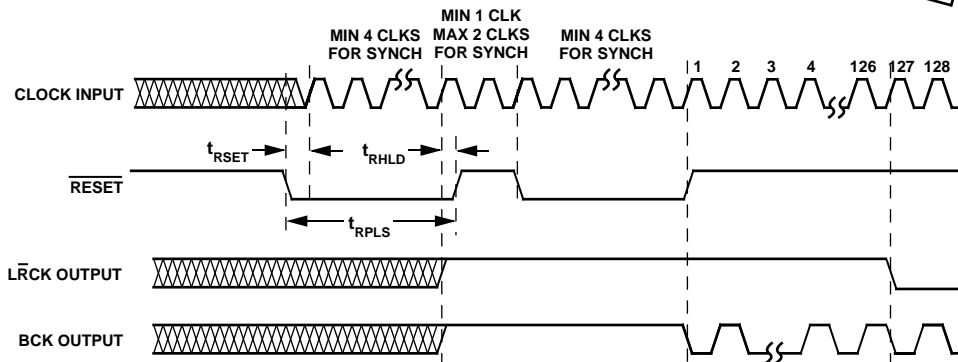

Figure 14. AD1878/AD1879 $\overline{\text{RESET}}$ Clock Timing for Synchronizing Master Mode WCK Output

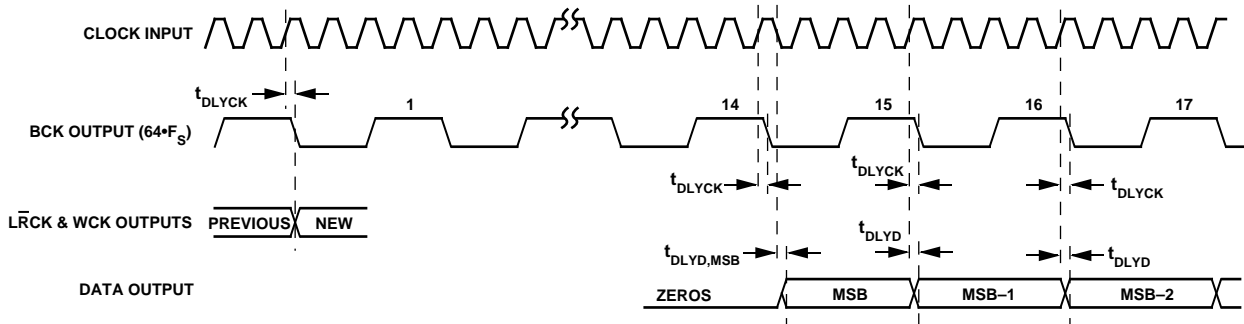

Figure 15. AD1878/AD1879 Master Mode Clock Timing: WCK Output

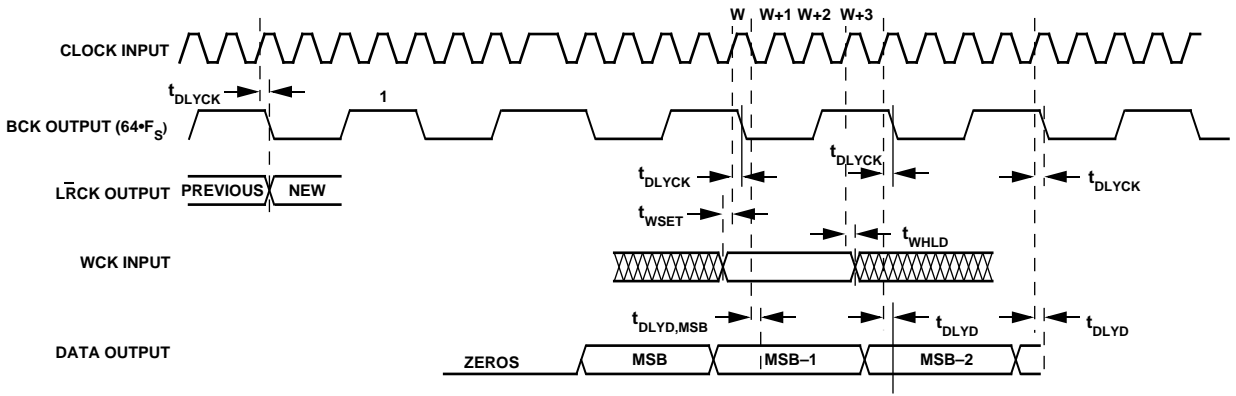

Figure 16. AD1878/AD1879 Master Mode Clock Timing: WCK Input

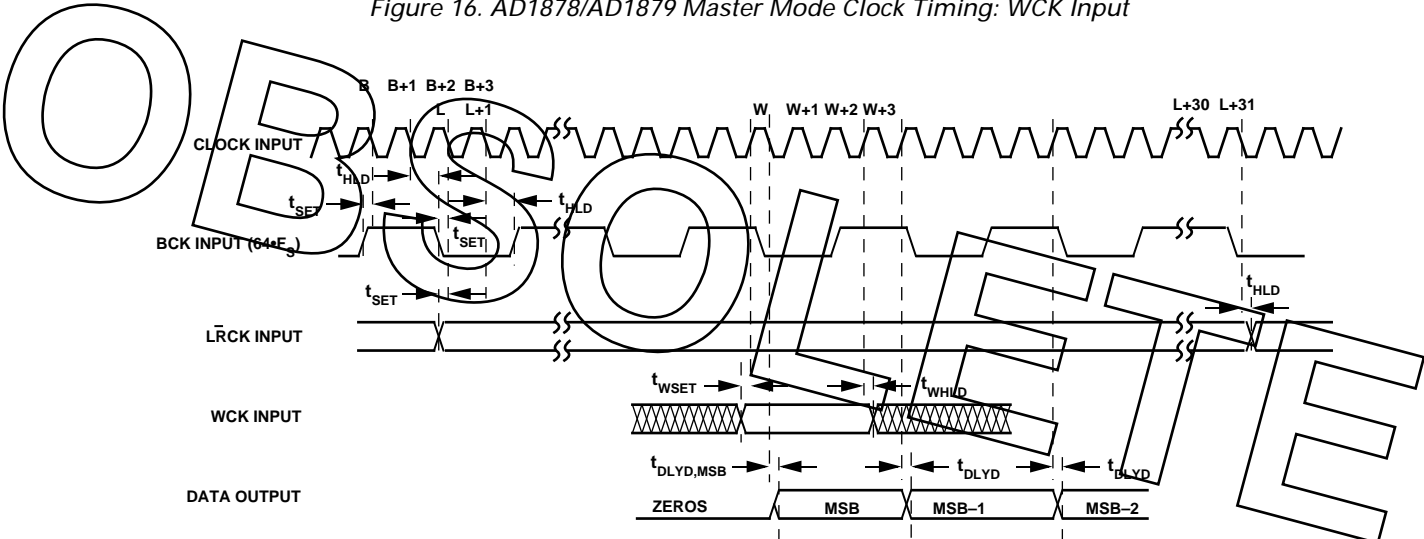

Figure 17. AD1878/AD1879 Slave Mode Timing

For slave modes, the word clock (WCK) input has the same setup time requirement, t_{WSET} , to the rising edge of master clock (CLOCK at "W") as in Figure 16 and a corresponding hold time, t_{WHLD} , from the rising edge of CLOCK (W+3) after the setup edge. The MSB of the DATA output will be delayed from a falling edge of master clock (CLOCK) by $t_{DLYD,MSB}$. Subsequent bits of the DATA output in contrast will be delayed from a rising edge of master clock (CLOCK) by t_{DLYD} .

Synchronizing Multiple AD1878/AD1879s

Multiple AD1878/AD1879s can be synchronized either by making all AD1878/AD1879s serial port slaves or by making one AD1879 the serial port master and all other AD1879s slaves. These two options are illustrated in Figure 18.

As a third alternative, it is possible to synchronize multiple masters all in Master Mode—Word Clock Output mode. See the "Reset" discussion above in the "Operating Features" section for timing considerations.

AD1878/AD1879 to DSP56001 Interface

The 18-bit AD1878/AD1879 can be interfaced quite simply to the DSP56001 Digital Signal Processor. Figure 19 illustrates one method of connection. In this implementation, the AD1878/AD1879 is configured to operate in 64-Bit Master Mode With

Word Clock Output. Thus, the AD1878/AD1879 is the master of the serial interface. The AD1878/AD1879 operates independently from the DSP's clock. The DSP56001 serial port is configured to operate in synchronous mode with the AD1878/AD1879 connected to its synchronous serial interface (SSI) port.

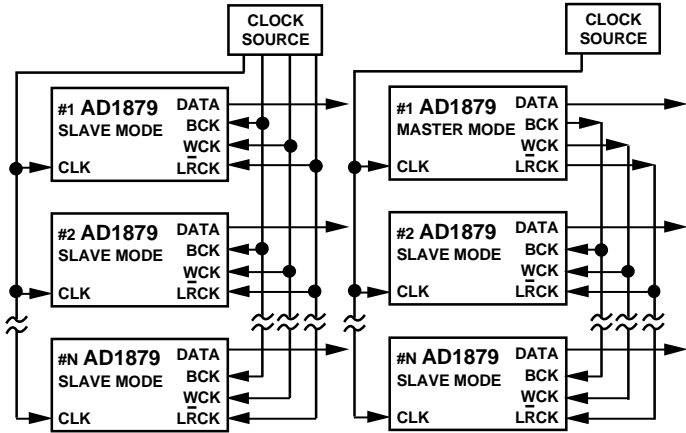

Figure 18. Synchronizing Multiple AD1878/AD1879s

AD1878/AD1879

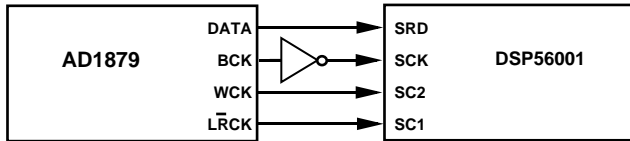

Figure 19. AD1879 to DSP56001 Interface

To configure the DSP56001 for proper operation, the CRA register must be programmed for a 24-bit receive data register (RX). The CRB register must be programmed with the following conditions: receiver enabled, normal mode, continuous clock, word length frame synch, MSB first, SCK an input, SC1 an input and SC2 an input. The PCC register must be programmed to set the SCK, SC1, SC2, and SRD pins of Port C to operate as a serial interface rather than in general-purpose parallel I/O mode.

When SSI detects the rising edge of the AD1878/AD1879's word clock (WCK), the next 24-bits on the AD1878/AD1879's DATA pin will be clocked into the DSP56001's SSI receive shift register on the falling edges of the inverted bit-clock (BCK) signal. This data is then transferred to the RX register. The 16-/18-bit word from the AD1879 will be located in Bits 8 through 23/21 of the RX register. Bits 0 through 7 will be zero-filled. The user may poll Bit 7 (RDF) of the SSI status register (SSISR) to detect when the data has been transferred to RX. Alternatively, the RIE bit can be set, allowing an interrupt to occur when the data has been transferred.

To differentiate left and right data, the SC1 pin of the SSI is an input and is connected to the LRCK of the AD1878/AD1879. After a data word is transferred to the RX register, the software reads the IF1 bit in the SSISR, which contains the left/right information. In order to use the SC1 pin as indicated, the SSI must operate in synchronous mode. An DSP56001 assembly code fragment for this approach (with polling) is shown in Table I.

Table I. DSP56001 Assembly Code for AD1878/AD1879 Data Transfer

poll	jclr	#7,X:\$FFEE,poll	:loop until RX reg. has data
	movep	X:\$FFEF,a1	:transfer ADC to a1 register
	jset	#I:X:\$FFEE,left	:if LRCK=1, save left else
	move	a1,X:\$C000	:store right channel
	jmp	poll	:wait for next input
left	move	a1,Y:\$C000	:store left channel
	jump poll		

If the SSI is set up for asynchronous operation, the SC0 and SC1 pins are unavailable for left/right detection. If asynchronous operation is essential, left/right information can be obtained by synchronizing the AD1878/AD1879 with a software reset. Coming out of reset, the AD1878/AD1879 will transmit left channel data first. A flag maintained in software can maintain the synchronization.

AD1878/AD1879 PERFORMANCE GRAPHS

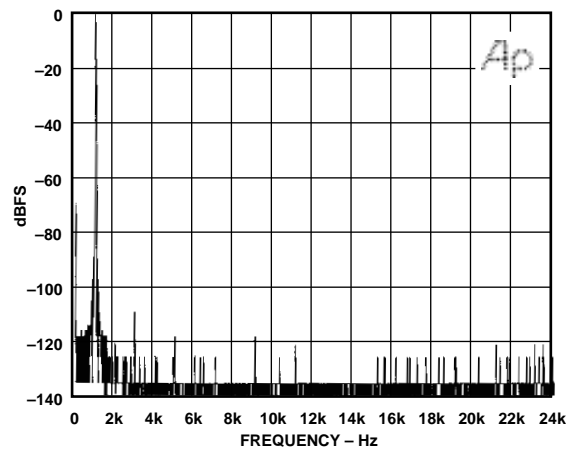

Figure 20. AD1879 S/(THD+N)—1 kHz Tone at -0.5 dBFS (4k-Point FFT)

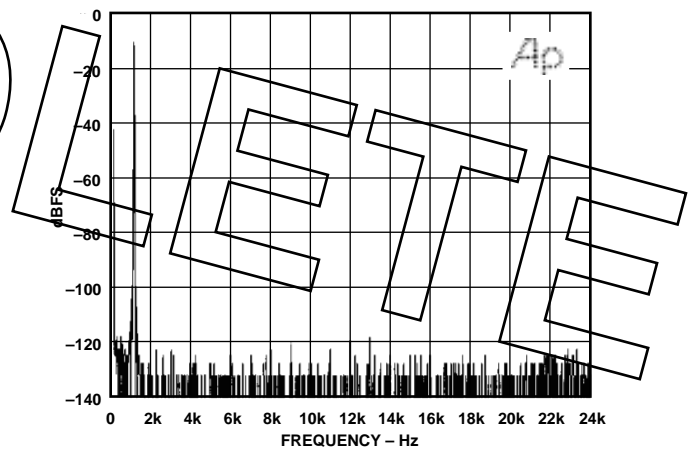

Figure 21. AD1879 S/(THD+N)—1 kHz Tone at -10 dBFS (4k-Point FFT)

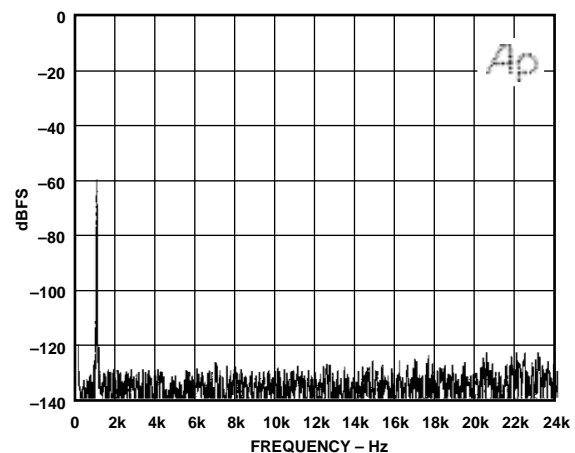

Figure 22. AD1879 S/(THD+N)—1 kHz Tone at -60 dBFS (4k-Point FFT)

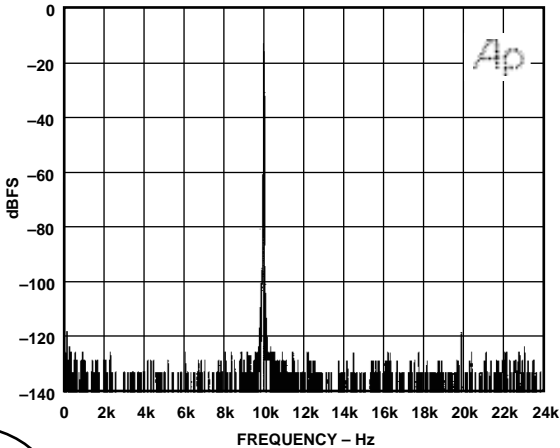

Figure 23. AD1879 S/(THD+N)—10 kHz Tone at -10 dBFS (4k-Point FFT)

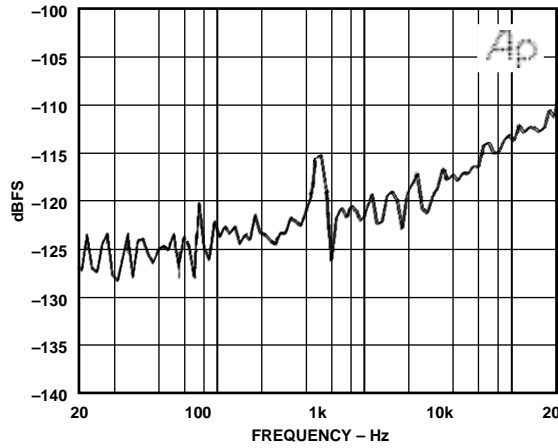

Figure 26. AD1878/AD1879 Channel Separation—0 kHz to 20 kHz

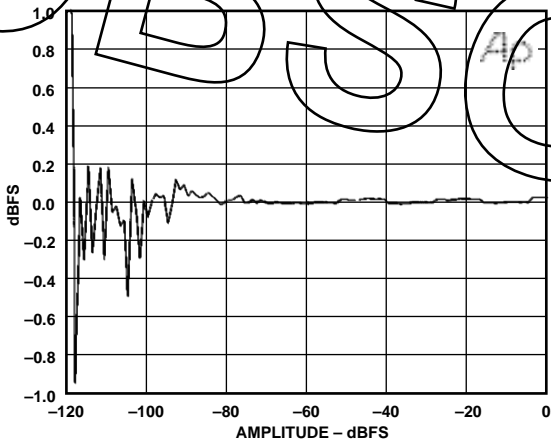

Figure 24. AD1879 Linearity Test—10 kHz Tone Fade to Noise

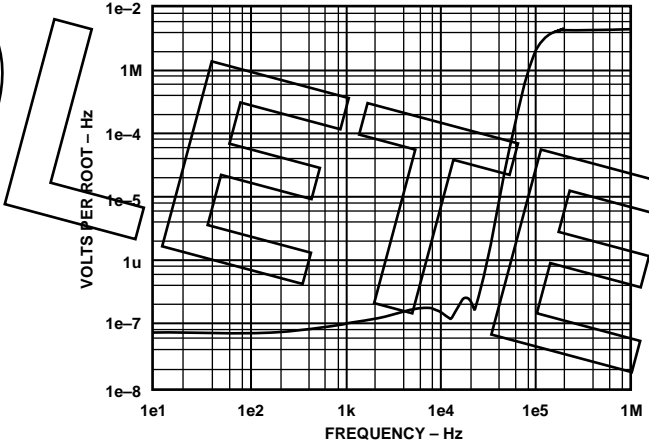

Figure 27. AD1878/AD1879 Modulator Noise Transfer Function—0 MHz to 1 MHz

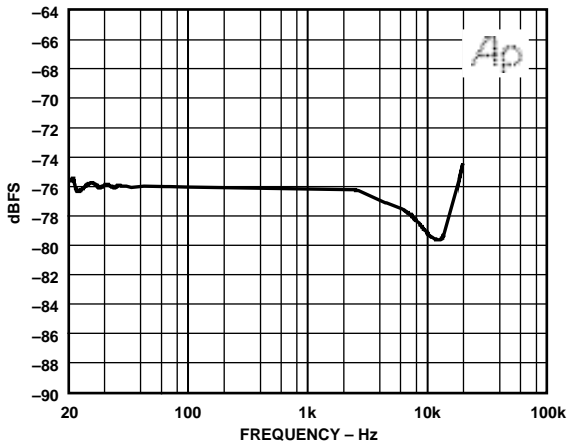

Figure 25. AD1878/AD1879 Common-Mode Rejection Ratio—0 kHz to 20 kHz

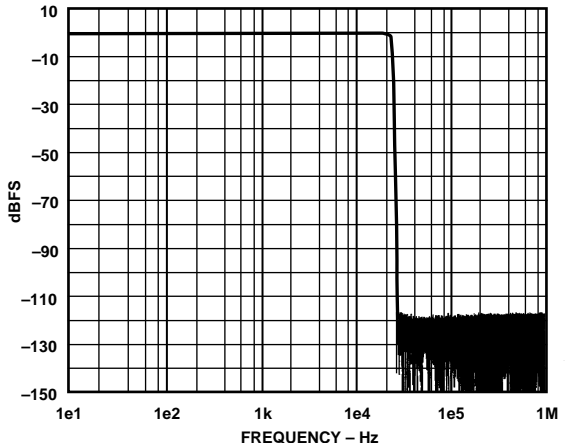

Figure 28. AD1878/AD1879 Digital Filter Signal Transfer Function—0 MHz to 1 MHz

AD1878/AD1879

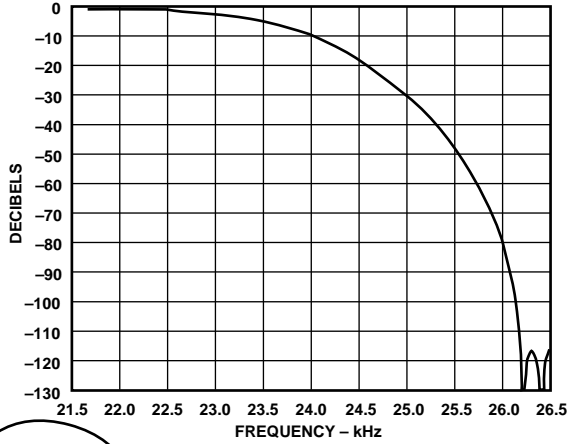

Figure 29. AD1878/AD1879 Digital Filter Signal Transfer Function— Transition Band: 21.5 kHz to 26.5 kHz

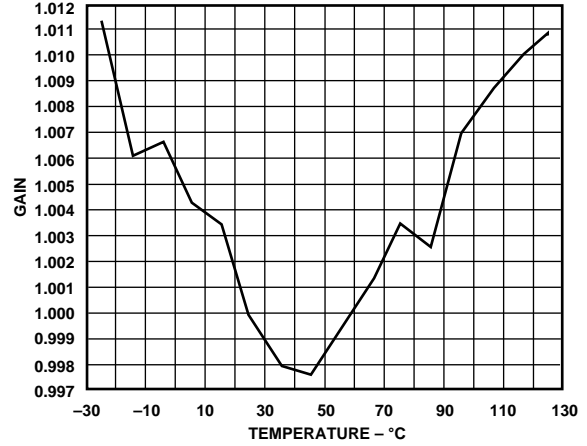

Figure 30. AD1878/AD1879 Typical Gain Over Temperature— -30°C to $+130^{\circ}\text{C}$

OBSOLETE

OUTLINE DIMENSIONS

Dimensions shown in inches and (mm).

D-28

28-Lead Side Brazed Ceramic DIP

