



Self-Contained High Performance Wide Band Instrumentation Amplifier

AD612/AD614

FEATURES

- Internal Gain Setting Resistors
- Wide Gain Range: 1 to 1024 in Binary Steps
- Settling Time: 30 μ s max to 0.01%, G = 128 (AD614A, B)
- Low Gain Error: $\pm 0.02\%$ max (AD612C)
- Low Gain Drift: ± 10 ppm max
- Low Offset Drift: $\pm 1\mu$ V/ $^{\circ}$ C max, RTI, G = 1024V/V (AD612C)
- High CMR: 94dB min, G = 1024V/V

APPLICATIONS

- Low Level High Speed Data Acquisition Systems
- Bridge Amplifiers for Resistance Transducers
- Precision Current Amplifiers
- Preamplifier for Recorder Instrumentation

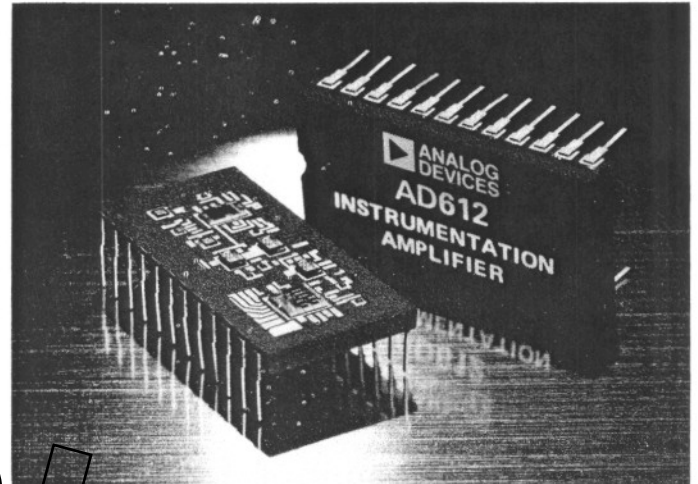

INTERCONNECTION DIAGRAM AND SHIELDING TECHNIQUES

Figure 2 shows the interconnection diagram for the AD612/AD614 along with the recommended shielding and grounding techniques. Because the AD612/AD614 are direct coupled, a ground return path for amplifier bias currents must be provided either by direct connection (as shown) or by an implicit ground path having up to 1M Ω resistance between signal ground and amplifier common. For best performance, sensitive input and gain setting terminals should be shielded from noise sources especially at high gains. The AD612/AD614 provide a guard terminal to drive the input cable shield at the

(continued on page 3)

PRODUCT DESCRIPTION

The AD612/AD614 are self-contained, high accuracy, high speed hybrid instrumentation amplifiers designed for data acquisition applications requiring speed and accuracy under worst-case operating conditions. Three versions (A, B, C) of the AD612 are available which provide superior dc characteristics with good dynamic performance, while the AD614 (A & B) versions provide superior dynamic performance with good dc characteristics.

The AD612/AD614 contain precision thin-film resistor networks that allows the user to set the gain in binary steps from 1 to 1024V/V by strapping the appropriate gain pins. In addition the excellent tracking characteristics of the active laser-trimmed thin-film resistors provide maximum gain drift of ± 10 ppm/ $^{\circ}$ C max.

The AD612/AD614 are designed to provide high speed and high accuracy signal conditioning. It provides input offset drift of 1μ V/ $^{\circ}$ C max, output offset drift of $\pm 75\mu$ V/ $^{\circ}$ C max, CMR of 74dB min at unity gain (94dB min at G = 1024) in the highest accuracy version (AD612C) or 160kHz small signal bandwidth and settling time to 0.01% of 30 μ s max in the high speed version (AD614A or B).

APPLICATIONS

The AD612/AD614 offer exceptional quality and value to the data acquisition designer, either as a signal conditioner per channel or as a high speed instrumentation amplifier in multi-channel data acquisition systems, analytical instruments and transducer interfacing.

High CMR, input protection, low noise and excellent temperature stability make the AD612/AD614 an excellent choice for precise measurement and control in harsh industrial environments. The high speed of the AD612/AD614 provide higher throughput rates in multichannel data acquisition systems.

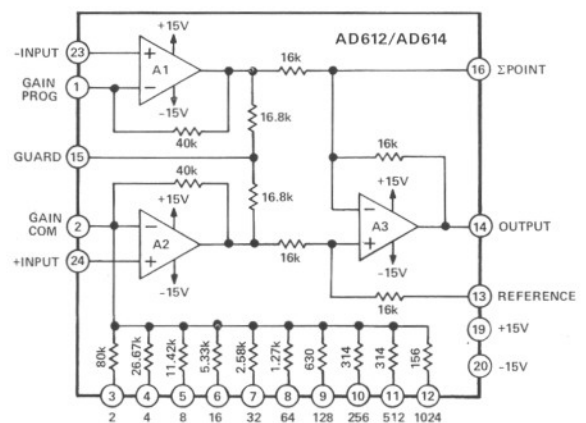

Figure 1. Simplified Schematic

Information furnished by Analog Devices is believed to be accurate and reliable. However, no responsibility is assumed by Analog Devices for its use; nor for any infringements of patents or other rights of third parties which may result from its use. No license is granted by implication or otherwise under any patent or patent rights of Analog Devices.

Route 1 Industrial Park; P.O. Box 280; Norwood, Mass. 02062
 Tel: 617/329-4700 TWX: 710/394-6577
 West Coast Mid-West Texas
 714/842-1717 312/894-3300 214/231-5094

SPECIFICATIONS (typical @ +25°C and $V_S = \pm 15V$, unless otherwise noted)

MODEL	HIGH ACCURACY			HIGH SPEED	
	AD612A	AD612B	AD612C	AD614A	AD614B
GAIN					
Gain Range, in Binary Steps	1 to 1024V/V	*	*	1 to 1024V/V	**
Gain Temperature Coefficient	$\pm 10\text{ppm}/^\circ\text{C}$ max	*	*	$\pm 10\text{ppm}/^\circ\text{C}$ max	**
Gain Accuracy, $R_L = 10\text{k}\Omega$	$\pm 0.1\%$ max	$\pm 0.04\%$ max	$\pm 0.02\%$ max	$\pm 0.1\%$ max	$\pm 0.04\%$ max
Gain Nonlinearity	$\pm 0.001\%$	*	*	$\pm 0.001\%$	**
RATED OUTPUT					
Voltage	$\pm 10V$ min	*	*	$\pm 10V$ min	**
Current	$\pm 5\text{mA}$ min	*	*	$\pm 5\text{mA}$ min	**
Impedance	0.15Ω	*	*	0.15Ω	**
INPUT CHARACTERISTICS					
Absolute Max Voltage	$\pm V_S$	*	*	$\pm V_S$	**
Common Mode Voltage	$\pm 10V$ min	*	*	$\pm 10V$ min	**
Differential and Common Mode Impedance	$10^9\Omega \parallel 3\text{pF}$	*	*	$10^9\Omega \parallel 3\text{pF}$	**
OFFSET VOLTAGES					
Input Offset Voltage					
Initial @ +25°C (Adjustable to Zero)	$\pm 200\mu\text{V}$	*	*	$\pm 200\mu\text{V}$	**
vs. Temperature ($G = 1024$)(-25°C to +85°C)	$\pm 5\mu\text{V}/^\circ\text{C}$ max	$\pm 2\mu\text{V}/^\circ\text{C}$ max	$\pm 1\mu\text{V}/^\circ\text{C}$ max	$\pm 5\mu\text{V}/^\circ\text{C}$ max	$\pm 2\mu\text{V}/^\circ\text{C}$ max
vs. Supply ($G = 1024$)	$\pm 25\text{mV}/\text{V}$	*	*	$\pm 25\text{mV}/\text{V}$	**
Output Offset Voltage $G = 1$					
Initial @ +25°C (Adjustable to Zero)	$\pm 2\text{mV}$	*	*	$\pm 2\text{mV}$	**
vs. Temperature (-25°C to +85°C)	$\pm 200\mu\text{V}/^\circ\text{C}$ max	$\pm 150\mu\text{V}/^\circ\text{C}$ max	$\pm 75\mu\text{V}/^\circ\text{C}$ max	$\pm 200\mu\text{V}/^\circ\text{C}$ max	$\pm 150\mu\text{V}/^\circ\text{C}$ max
INPUT BIAS CURRENT					
Initial @ +25°C	+100nA max	*	*	+100nA max	**
vs. Temperature (-25°C to +85°C)	$\pm 0.5\text{nA}/^\circ\text{C}$	*	*	$\pm 0.5\text{nA}/^\circ\text{C}$	**
INPUT DIFFERENCE CURRENT					
Initial @ +25°C	$\pm 2\text{nA}$	*	*	$\pm 2\text{nA}$	**
vs. Temperature (-25°C to +85°C)	$\pm 10\text{pA}/^\circ\text{C}$	*	*	$\pm 10\text{pA}/^\circ\text{C}$	**
INPUT VOLTAGE NOISE, $G = 1024$					
0.01Hz to 10Hz	$1\mu\text{V}$ p-p	*	*	$1\mu\text{V}$ p-p	**
10Hz to 10kHz	$2\mu\text{V}$ rms	*	*	$2\mu\text{V}$ rms	**
OUTPUT VOLTAGE NOISE, ($G = 1$)					
0.01Hz to 10Hz	$20\mu\text{V}$ p-p	*	*	$20\mu\text{V}$ p-p	**
10Hz to 10kHz	$50\mu\text{V}$ rms	*	*	$50\mu\text{V}$ rms	**
COMMON MODE REJECTION RATIO					
1k Ω Source Imbalance, dc to 60Hz					
$G = 1$	74dB min	*	*	74dB min	**
$G = 1024$	94dB min	*	*	94dB min	**
DYNAMIC RESPONSE					
Slew Rate					
	$1\text{V}/\mu\text{s}$	*	*	$1\text{V}/\mu\text{s}$	**
Small Signal Bandwidth (-3dB)					
$G = 1$	100kHz	*	*	100kHz	**
$G = 128$	60kHz	*	*	160kHz	**
$G = 1024$	10kHz	*	*	20kHz	**
Settling Time to 0.01% 20V p-p Output Step					
$G = 1$	200 μs max	*	*	40 μs max	**
$G = 128$	100 μs max	*	*	30 μs max	**
Settling Time to 0.05% 20V p-p Output Step					
$G = 1$ to 128	60 μs max	*	*	20 μs max	**
$G = 1024$	150 μs max	*	*	70 μs max	**
POWER SUPPLY¹					
Voltage, Rated Performance					
	$\pm 15V$	*	*	$\pm 15V$	**
Voltage, Operating					
	$\pm 8V$ to $\pm 18V$	*	*	$\pm 8V$ to $\pm 18V$	**
Current, Quiescent					
	$\pm 8\text{mA}$	*	*	$\pm 8\text{mA}$	**
TEMPERATURE RANGE					
Rated Performance					
	-25°C to +85°C	*	*	-25°C to +85°C	**
Storage					
	-55°C to +125°C	*	*	-55°C to +125°C	**
PRICE					
(1-24)	\$62.00	\$68.00	\$79.00	\$75.50	\$93.00
(25-99)	\$48.50	\$53.00	\$63.00	\$60.00	\$74.00
(100's)	\$40.00	\$45.00	\$52.00	\$49.50	\$61.00

*Specifications same as AD612A.

**Specifications same as AD614A.

¹ Recommend model 904, $\pm 15V$ @ $\pm 50\text{mA}$.

Specifications subject to change without notice.

OUTLINE DIMENSIONS

Dimensions shown in inches and (mm).

24-PIN DUAL-IN-LINE

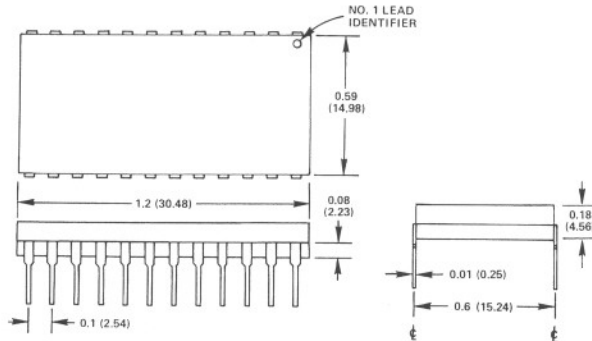

PIN CONFIGURATION

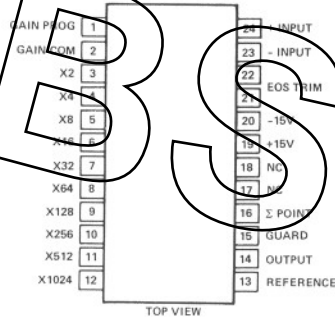

(continued from page 1)

input common mode voltage. This feature greatly reduces noise pickup and improves CMRR by maintaining the shield at the common mode voltage.

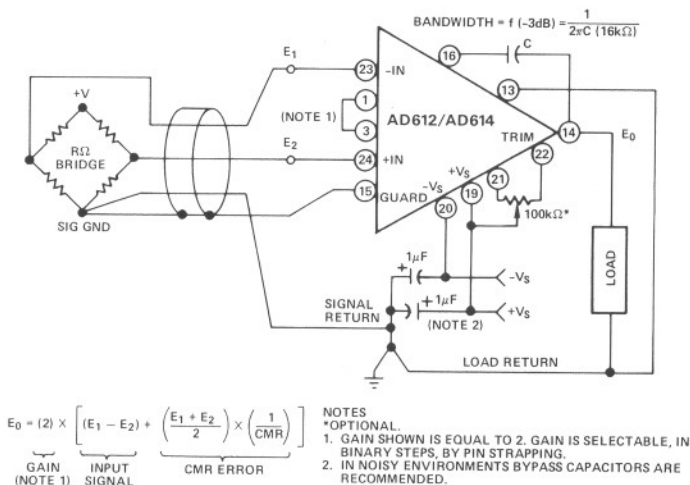

Figure 2. Typical Bridge Application

TYPICAL ERROR BUDGET ANALYSIS

The error calculations for a typical transducer application shown in Figure 2 (350Ω bridge, 1mV/V F.S., 10V excitation) are listed in Table 1.

Assumptions: AD612C is used, G = 1024V/V, temperature range is +25°C ±10°C, source imbalance is 100Ω, common mode noise is 0.05V rms (60Hz) on the ground return.

Error	% of FS (10V)	Calculations
Gain Nonlinearity	±0.001%	
Gain Accuracy	±0.02%	
Gain Drift	±0.01%	
Voltage Offset Drift	±0.11%	±11mV/°C (RTO) x ΔT x 1/10V
Offset Current Drift	±0.0004%	±10pA/°C x G x ΔT x 350Ω x 1/10V
Noise	±0.01%	
Total Output Error	±0.15% Worst Case	

Table 1. Error Budget Analysis

OPERATING INSTRUCTIONS

Install AD612/AD614 as shown in the diagram of Figure 2. Gain setting, offset trim and use of reference and guard terminals are described below.

Gain Setting: The AD612/AD614 operates at G = 1 without pin strapping. For binary gains 2 thru 256, strap appropriate gain pin (3 thru 10) to the gain programming pin (1). For gain 512, strap both pins 10 and 11 to pin 1; for gain 1024, strap pins 10, 11 and 12 to pin 1. The exceptional gain accuracy and gain drift of the AD612/AD614 are provided by the internal laser trimmed thin-film resistor network.

If a nonbinary gain is required, an external resistor (R_G) can be connected between pins 1 and 2 to set the gain according to the formula $G = 1 + (80k/R_G)$. For R_G a precision resistor with a 10ppm/°C temperature coefficient is recommended. An external R_G affects both the gain accuracy and drift due to the inherent mismatch between it and the internal thin-film resistor network. Gain accuracy is determined by the tolerance of the external R_G and the absolute accuracy of the internal thin-film resistor network (±1% typ). Gain drift is determined by the tolerance of R_G plus the absolute drift of the internal thin-film resistor network (±50ppm/°C max).

Figure 3 shows a way to reduce the effects of R_G on gain accuracy and drift by using part of the internal resistor network in parallel with an external resistor to set the gain. Since the current flowing through the external resistor in Figure 3 is a small part of the total current, the effect of the external resistor is reduced by the ratio.

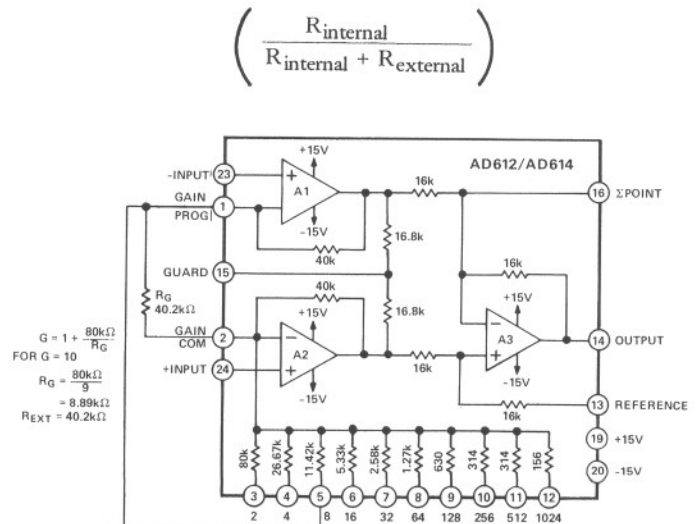

Figure 3. Nonbinary Gain Setting

initial offset error can be trimmed to zero potentiometer shown in Figure 2. Note that 5ppm) potentiometer is necessary to maintain specification.

REF: Normally tied to load low, the reference (REF) may be connected to a stable reference to permit adjustment of the output level independent of initial offset adjustments. The choice of E_{REF} will be critical to CMR rating since the gain at pin 13 is $16k\Omega$ and forms a balanced bridge with the output amplifier stage. (For example, a $16k\Omega/60\Omega = 49dB$) results in a CMR of 49dB; $16k\Omega/60\Omega = 49dB$). The output buffer amplifier, as shown below, will eliminate the offset errors. Reference source stability becomes critical at low gains since any shifts may be referred as RTI offset errors; i.e., $\Delta E_{REF}/G = \text{Offset Error}$

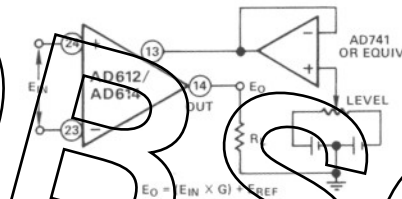

Figure 4. Output Level Control

Low Pass Filter Bandwidth: Active low pass filtering can be accomplished by adding an external capacitor between pins 14 and 15 as shown in Figure 2. The breakpoint of this filter can be adjusted to all bandwidth to below 1Hz and is defined by

$$f(\text{Hz}) = \frac{1}{2\pi C (16k\Omega)}$$

AC Drive: A passive data guard (as shown in Figure 2) is recommended to improve ac common mode rejection by compensating for unbalanced capacitance due to long input leads. Use the data guard is recommended where input leads are longer than a few inches. In cases where the input leads are quite long or where system bandwidth is very high, the addition of a buffer amplifier as shown in Figure 5 is recommended.

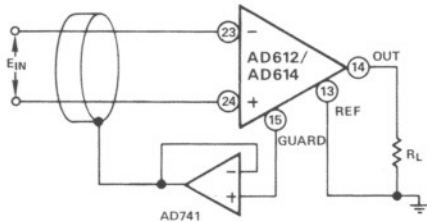

Figure 5. Guard Drive Connections

Total Offset Voltage and Offset Voltage Drift: Total Offset Voltage is composed of two sources (input stage and output stage) and is gain dependent. Figure 6 shows the typical RTO offset voltage vs. gain, both initial and after user trimming @ $G = 1024$. Warm-up response (see Figure 7 below) is quite fast as is expected from a high performance instrumentation amplifier. The AD612/AD614 are available in three offset voltage drift selections. Figure 8 is a graph of the typical RTO offset voltage drift vs. gain for all versions.

Common Mode Rejection: CMR is dependent on source impedance imbalance, signal frequency and amplifier gain. CMR is specified at gains 1 and 1024 with $\pm 10V$ CMV and $1k\Omega$ source impedance over the frequency range of dc to 60Hz. Figure 9 shows the typical CMR performance vs. gain and frequency. For the AD612/AD614, CMR is typically 26dB above

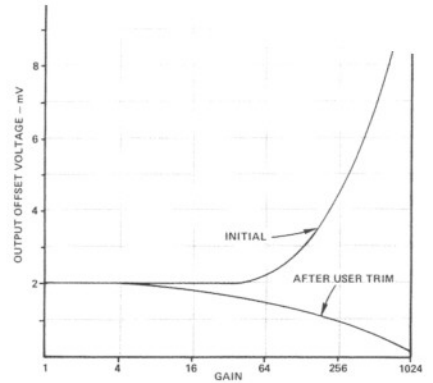

Figure 6. Total Offset Voltage (Typical) vs. Gain (RTI)

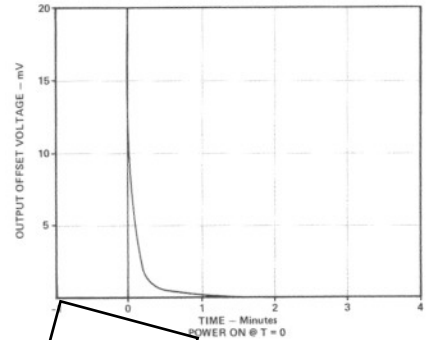

Figure 7. Warm-Up Response

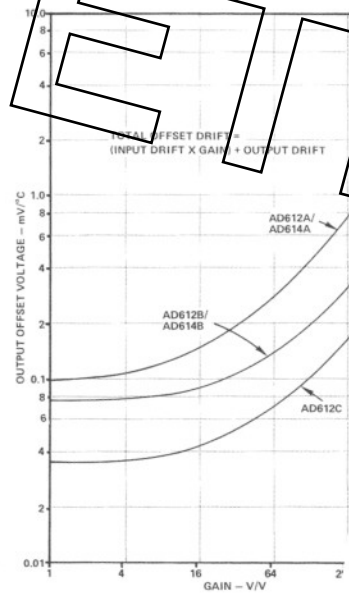

Figure 8. Total Offset Voltage Drift (Typical)

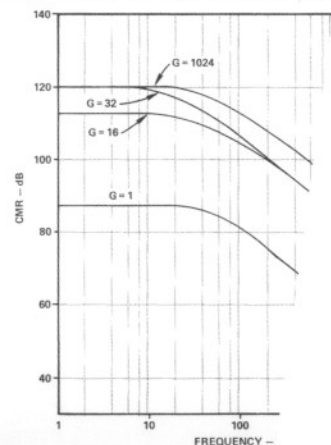

Figure 9. Common-Mode Rejection

Figures 10 and 11 illustrate the effect of source imbalance on CMR performance at dc (Figure 10) and at 60Hz (Figure 11) for several gains. CMR is typically 120dB at 60Hz and a 1k Ω source imbalance. At Gain = 1, CMR is maintained greater than 80dB for source imbalances up to 100k Ω .

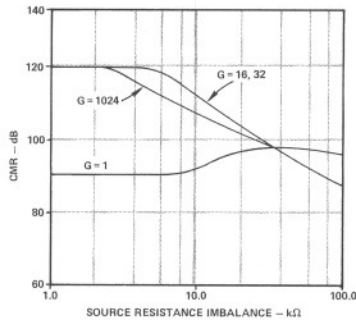

Figure 10. DC Common-Mode Rejection vs. Source Resistance Imbalance

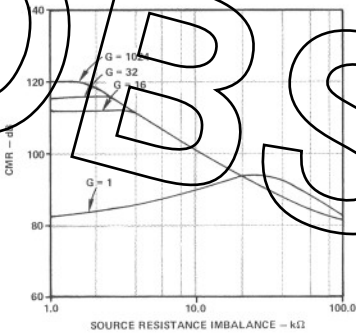

Figure 11. 60Hz Common-Mode Rejection vs. Source Resistance Imbalance

Gain Nonlinearity: Nonlinearity is specified as a % of 10V full scale; e.g., 0.2mV RTO for 0.002%. Figure 12 shows the typical nonlinearity vs. gain.

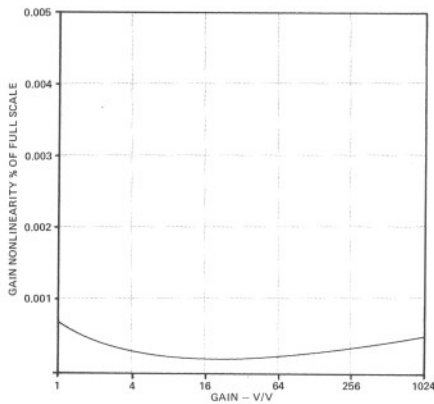

Figure 12. Gain Nonlinearity vs. Gain

Output Noise: As one would expect, total output voltage noise increases with gain and frequency. Figure 13 shows the typical wideband (10Hz to 10kHz) output noise performance vs. gain for 0 Ω and 100k Ω source resistances.

Figure 14 shows output noise for several source resistances.

Bandwidth and Settling Time: Bandwidth (-3dB) is relatively constant with gain (see Figure 15 below) and is typically 100kHz at gain 1. At 4V/V and below, gain starts peaking at about 20kHz. Full power response and slew rate are 16kHz and 1V/ μ s (typ) respectively, independent of gain.

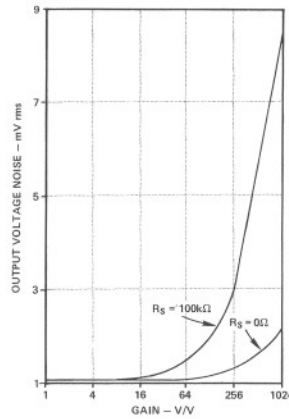

Figure 13. Wideband Output Voltage Noise vs. Gain

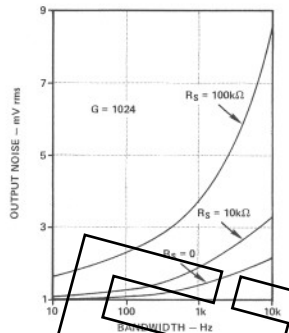

Figure 14. Output Voltage Noise vs. Bandwidth

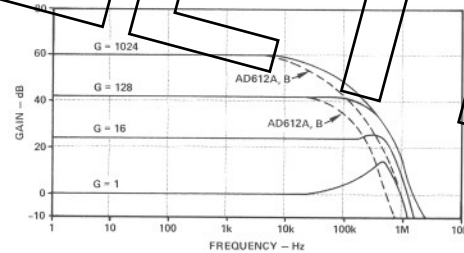

Figure 15. Small Signal Frequency Response

Settling time response to ± 10 V step output is relatively constant and gain insensitive, except for gains below 4V/V.

AD612/AD614 have two speed selections with the AD612A, B, C being the slower versions and the AD614A, B the faster versions. Settling times are specified to 0.01% for gains 1 and 128, and to 0.05% for gains 1, 128 and 1024. Figure 16 shows typical settling times vs. gain for both versions to 0.01% and 0.05% accuracies. Settling time to 0.01% for gains greater than 128 are not shown because of the effects of voltage noise at the higher gains.

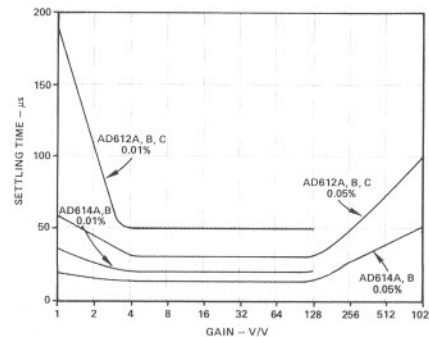

Figure 16. Settling Time vs. Gain

DATA ACQUISITION SYSTEM

Figure 17 shows the AD612/AD614 used with the AD583 sample-and-hold amplifier and the AD574 12-bit ADC in a multi-channel data acquisition system.* The throughput rate of this system can vary with the application and depends upon the relationship between IA settling time and the sum of SHA acquisition time plus ADC conversion time. If the settling time of the AD612/AD614 exceed the SHA acquisition time plus ADC conversion time, system throughput rate is the inverse of AD612/AD614 settling time. If SHA acquisition time plus ADC conversion time exceeds the AD612/AD614 settling time, system throughput rate is the inverse of the sum of SHA acquisition time and ADC conversion time. In systems where fast throughput rates are not required, the SHA may be eliminated.

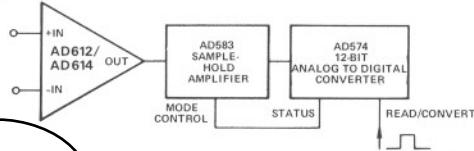

Figure 17. High Speed Data Acquisition System

Figure 18 shows AD612/AD614 being used as preamplifiers in a multichannel programmable gain data acquisition system. Amplifying low level signals with an amplifier per channel offers the advantages of high speed channel sampling, high accuracy, signal isolation, low crosstalk and low noise.

The input to each AD612/AD614 is amplified and converted from a differential input to a ground referenced voltage. An optional capacitor added to each AD612/AD614 form a low pass filter. The addition of a low pass active filter following each AD612/AD614 would further attenuate high frequency noise thereby reducing aliasing effects.

The DAS1151 is a data acquisition module consisting of a 1-2-4-8 software gain programmable amplifier, sample-and-hold amplifier and 12-bit successive approximation A/D converter. The DAS1151 optimizes the input signal by digitally programming the gain in steps of 1-2-4-8, effectively extending the dynamic range capability of the DAS from 12 bits to 15 bits by subranging.

The DAS1151 offers true 12-bit performance at a 35kHz throughput rate. The high throughput rate is accomplished by using the Overlap Mode, i.e., the input to the DAS1151 is updating during the analog to digital conversion.

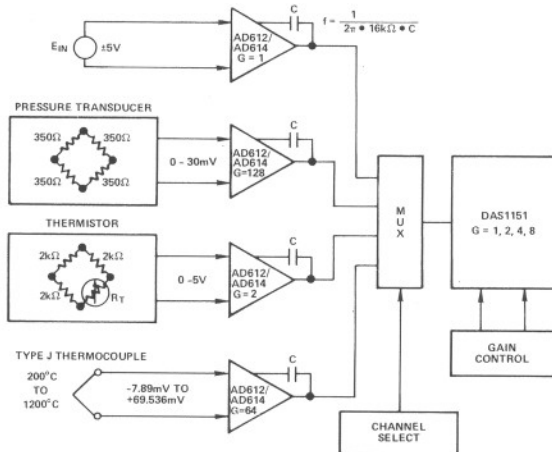

Figure 18. Multichannel Programmable Gain Data Acquisition System

*Similar systems can be configured using other Analog Devices data acquisition components, such as the AD582 sample-and-hold amplifier, AD572 or AD ADC80 12-bit ADCs, AD571 10-bit ADC.

PROGRAMMABLE GAIN

Figure 19 shows AD612/AD614 being used as a programmable gain amplifier. Gain switching can be accomplished with mechanical switches such as pushbutton switches or reed relays, or with electrical switches such as CMOS multiplexers or n-channel J-FETs. It should be noted that the "on" impedance of the switch in series with the internal gain resistor becomes part of the gain equation and will, therefore, have an effect on gain accuracies. At high gains where gain accuracy is important, mechanical switches or low on-resistance n-channel J-FETs such as Siliconix E105 are recommended.

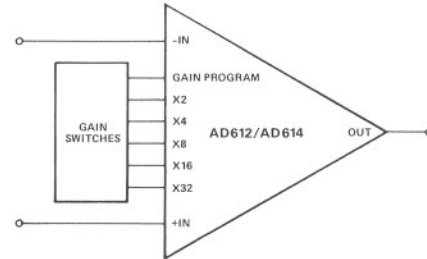

Figure 19. Programmable Gain Instrumentation Amplifier

BIPOTENTIAL AMPLIFIER

Figure 20 shows the AD612/AD614 being used to amplify a weak electrical signal of biologic origin. The input impedance ($10^9 \Omega || 3 \text{ pF}$) minimizes loading of the signal being measured. The guard terminal drives the input cable shield thereby minimizing common-mode errors due to cable to shield capacitance interacting with the unbalanced electrode impedance.

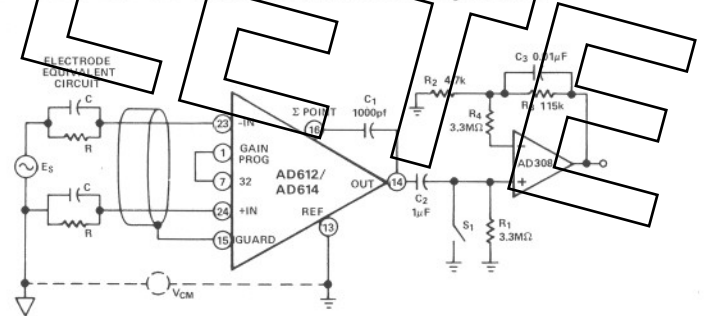

Figure 20. Biopotential Amplifier

Biopotential signals can have bandwidths from dc to 10kHz and amplitudes of a few mV or less. These low level signals often require amplification of 1000V/V or more. However, the electrodes used to produce the signal can also produce a large dc offset potential ($\approx 200\text{mV}$). To eliminate saturating effects of offset potential, the preamplifier gain is kept low ($G = 32$) and its output is capacitively coupled.

The $1\mu\text{F}$ coupling capacitor plus the $3.3\text{M}\Omega$ resistor form a high pass filter for frequencies above 0.05Hz . The output stage is a follower with a gain of 25. The R_3 and C_3 form a low pass filter attenuating frequencies above 140Hz . C_1 limits the AD612/AD614 bandwidth thereby improving the signal to noise ratio.

In applications where protection from macroshock or microshock is required, such as ECG monitoring, an isolation amplifier should be chosen. Analog Devices offers several models designed to provide complete galvanic isolation between input signals and the recording instrumentation. Leakage currents (input/output) are typically $2\mu\text{A rms @ 60\text{Hz}}$. Input defibrillator protection to 8.5kV is also provided. Consider models 284J and model 286J for biomedical applications.