

## FEATURES

- Large, triple 16 × 9 high speed, nonblocking switch array
  - Pin compatible with **AD8175** (16 × 9 switch array) and **AD8177, AD8178** (16 × 5 switch arrays)
  - Differential or single-ended operation
  - Supports sync-on common-mode and sync-on color operating modes
  - RGB and HV outputs available for driving monitor directly
  - G = +4 operation (differential input to differential output)
  - Flexible power supplies: +5 V or ±2.5 V
  - Logic ground for convenient control interface
  - Serial or parallel programming of switch array
  - High impedance output disable allows connection of multiple devices with minimal loading on output bus
  - Adjustable output CM and black level through external pins
  - Excellent ac performance
    - Bandwidth: 450 MHz
    - Slew rate: 1650 V/μs
    - Settling time: 4 ns to 1% to support 1600 × 1200 at 85 Hz
  - Low power of 3.5 W
  - Low all hostile crosstalk
    - −82 dB at 5 MHz
    - −47 dB at 500 MHz
  - Wide input common-mode range of 4 V
  - Reset pin allows disabling of all outputs
  - Fully populated 26 × 26 ball PBGA package (27 mm × 27 mm, 1 mm ball pitch)
  - Convenient grouping of RGB signals for easy routing
- ## APPLICATIONS
- RGB video switching
  - KVM
  - Professional video

## GENERAL DESCRIPTION

The **AD8176** is a high speed, triple 16 × 9 video crosspoint switch matrix. It supports 1600 × 1200 RGB displays at 85 Hz refresh rate, by offering a 450 MHz bandwidth and a slew rate of 1650 V/μs. With −82 dB of crosstalk and −83 dB isolation (at 5 MHz), the **AD8176** is useful in many high speed video applications.

The **AD8176** supports two modes of operation: differential-in to differential-out mode with sync-on CM signaling passed through the switch and differential-in to differential-out mode with CM signaling removed through the switch. The output

## FUNCTIONAL BLOCK DIAGRAM

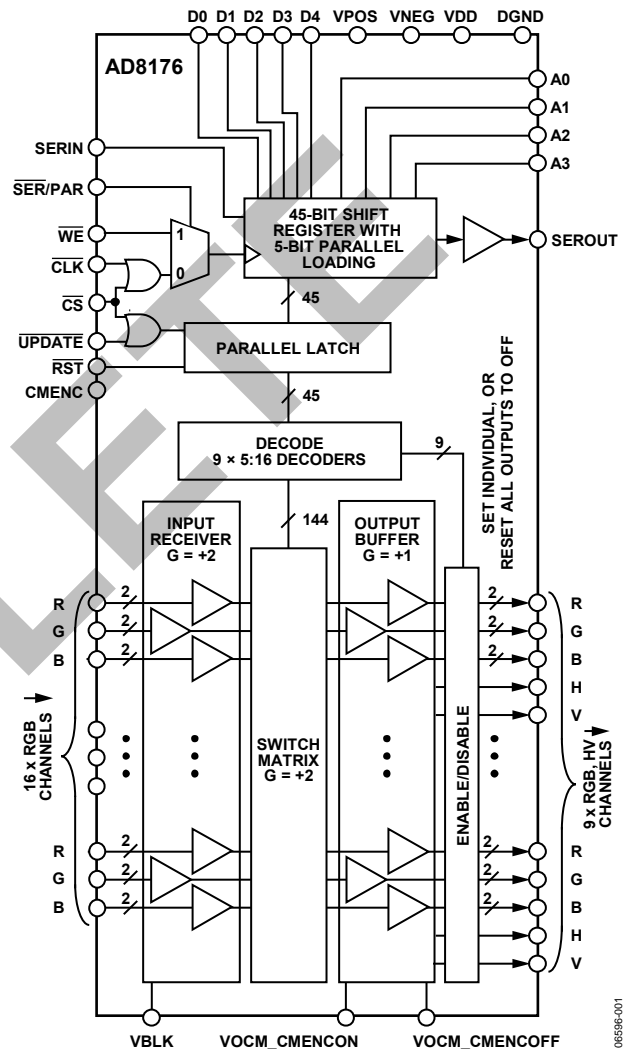

Figure 1.

CM and black level can be conveniently set via external pins. The outputs can be used single-ended in conjunction with decoded H and V outputs to drive a monitor directly.

The independent output buffers of the **AD8176** can be placed into a high impedance state to create larger arrays by paralleling crosspoint outputs. Inputs can be paralleled as well. The **AD8176** offers both serial and a parallel programming modes.

The **AD8176** is packaged in a fully populated 26 × 26 ball PBGA package and is available over the extended industrial temperature range of −40°C to +85°C.

Rev. A

[Document Feedback](#)

Information furnished by Analog Devices is believed to be accurate and reliable. However, no responsibility is assumed by Analog Devices for its use, nor for any infringements of patents or other rights of third parties that may result from its use. Specifications subject to change without notice. No license is granted by implication or otherwise under any patent or patent rights of Analog Devices. Trademarks and registered trademarks are the property of their respective owners.

## TABLE OF CONTENTS

Features .....	1	Pin Configuration and Function Descriptions.....	8
Applications.....	1	Truth Table and Logic Diagram .....	17
Functional Block Diagram .....	1	Equivalent Circuits.....	19
General Description .....	1	Typical Performance Characteristics .....	21
Revision History .....	2	Theory of Operation .....	26
Specifications.....	3	Applications Information .....	27
Timing Characteristics (Serial Mode) .....	5	Operating Modes.....	27
Timing Characteristics (Parallel Mode) .....	6	Programming.....	28
Absolute Maximum Ratings.....	7	Differential and Single-Ended Operation.....	29
Thermal Resistance .....	7	Outline Dimensions.....	37
Power Dissipation.....	7	Ordering Guide .....	37
ESD Caution.....	7		

## REVISION HISTORY

### 5/16—Rev. 0 to Rev. A

Changes to General Description Section .....	1
Changes to Off Isolation, Input-Output Parameter, Table 1.....	3
Changes to Areas of Crosstalk Section .....	34
Deleted Figure 53; Renumbered Sequentially.....	37
Changes to Ordering Guide .....	37

### 7/07—Revision 0: Initial Version

## SPECIFICATIONS

$V_S = \pm 2.5$  V at  $T_A = 25^\circ\text{C}$ ,  $G = +4$ ,  $R_L = 100\ \Omega$  (each output),  $V_{BLK} = 0$  V, output CM voltage = 0 V, differential input/output mode, unless otherwise noted.

Table 1.

Parameter	Test Conditions/Comments	Min	Typ	Max	Unit
<b>DYNAMIC PERFORMANCE</b>					
-3 dB Bandwidth	200 mV p-p		450		MHz
	2 V p-p		420		MHz
Gain Flatness	0.1 dB, 200 mV p-p		17		MHz
Propagation Delay	2 V p-p		1.3		ns
Settling Time	1%, 2 V step		4		ns
Slew Rate, Differential Output	2 V step		1650		V/ $\mu$ s
	2 V step, 10% to 90%		1450		V/ $\mu$ s
Slew Rate, RGB Common Mode	1 V step, 10% to 90%		300		V/ $\mu$ s
Slew Rate, HV Outputs	Rail-to-rail, TTL load		400		V/ $\mu$ s
<b>NOISE/DISTORTION PERFORMANCE</b>					
Crosstalk, All Hostile	f = 5 MHz		-82		dB
	f = 10 MHz		-74		dB
	f = 100 MHz		-56		dB
	f = 500 MHz		-47		dB
Off Isolation, Input-Output	f = 5 MHz, $R_L = 100\ \Omega$ , one channel		-83		dB
Input Voltage Noise	0.01 MHz to 50 MHz		50		nV/ $\sqrt{\text{Hz}}$
<b>DC PERFORMANCE</b>					
Gain Error			1		%
Gain Matching	R, G, B same channel		0.5		%
Gain Temperature Coefficient			32		ppm/ $^\circ\text{C}$
<b>OUTPUT CHARACTERISTICS</b>					
Output Offset Voltage	CMENC on or off		20		mV
	Temperature coefficient		58		$\mu\text{V}/^\circ\text{C}$
Output Offset Voltage, RGB Common Mode	CMENC on or off		10		mV
	Temperature coefficient		-16		$\mu\text{V}/^\circ\text{C}$
Output Impedance	Enabled, differential		1.5		$\Omega$
	Disabled, differential		2.7		k $\Omega$
Output Disable Capacitance	Disabled		2		pF
Output Leakage Current	Disabled		1		$\mu\text{A}$
Output Voltage Range	No load, differential	4			V p-p
Output Current	Short circuit		45		mA
<b>INPUT CHARACTERISTICS</b>					
Input Voltage Range, Differential Mode		1			V p-p
Input Voltage Range, Common Mode	$V_{IN} = 1$ V p-p		$\pm 2.25$		V p-p
CMR, RGB Input	$\Delta V_{OUT,DM}/\Delta V_{IN,CM}$ , $\Delta V_{IN,CM} = \pm 0.5$ V, CMENC off		-62		dB
	$\Delta V_{OUT,DM}/\Delta V_{IN,CM}$ , $\Delta V_{IN,CM} = \pm 0.5$ V, CMENC on		-45		dB
CM Gain, RGB Input	$\Delta V_{OUT,CM}/\Delta V_{IN,CM}$ , $\Delta V_{IN,CM} = \pm 0.5$ V, CMENC off		-70		dB
	$\Delta V_{OUT,CM}/\Delta V_{IN,CM}$ , $\Delta V_{IN,CM} = \pm 0.5$ V, CMENC on		0		dB
Input Capacitance	Any switch configuration		2		pF
Input Resistance	Differential		3.33		k $\Omega$
Input Offset Current			1		$\mu\text{A}$

Parameter	Test Conditions/Comments	Min	Typ	Max	Unit
SWITCHING CHARACTERISTICS					
Enable On Time	50% $\overline{\text{UPDATE}}$ to 50% output		80		ns
Switching Time, 2 V Step	50% $\overline{\text{UPDATE}}$ to 50% output		70		ns
POWER SUPPLIES					
Supply Current	$V_{\text{POS}}$ , outputs enabled, no load		600		mA
	Outputs disabled		290		mA
	$V_{\text{NEG}}$ , outputs enabled, no load		600		mA
	Outputs disabled		290		mA
	$D_{\text{VDD}}$ , outputs enabled, no load		4		mA
Supply Voltage Range			4.5 to 5.5		V
PSR	$\Delta V_{\text{OUT, DM}}/\Delta V_{\text{POS}}$ , $\Delta V_{\text{POS}} = \pm 0.5 \text{ V}$		-55		dB
	$\Delta V_{\text{OUT, DM}}/\Delta V_{\text{NEG}}$ , $\Delta V_{\text{NEG}} = \pm 0.5 \text{ V}$		-55		dB
OPERATING TEMPERATURE RANGE					
Temperature Range	Operating (still air)		-40 to +85		°C
$\theta_{\text{JA}}$	Operating (still air)		15		°C/W

**TIMING CHARACTERISTICS (SERIAL MODE)**

Table 2.

Parameter	Symbol	Min	Limit		Unit
			Typ	Max	
Serial Data Setup Time	$t_1$	40			ns
CLK Pulse Width	$t_2$	60			ns
Serial Data Hold Time	$t_3$	50			ns
CLK Pulse Separation	$t_4$	140			ns
CLK to UPDATE Delay	$t_5$	10			ns
UPDATE Pulse Width	$t_6$	90			ns
CLK to SEROUT Valid	$t_7$	120			ns
Propagation Delay, UPDATE to Switch On Data Load Time, CLK = 5 MHz, Serial Mode		9	80		ns
RST Time			140	200	ns

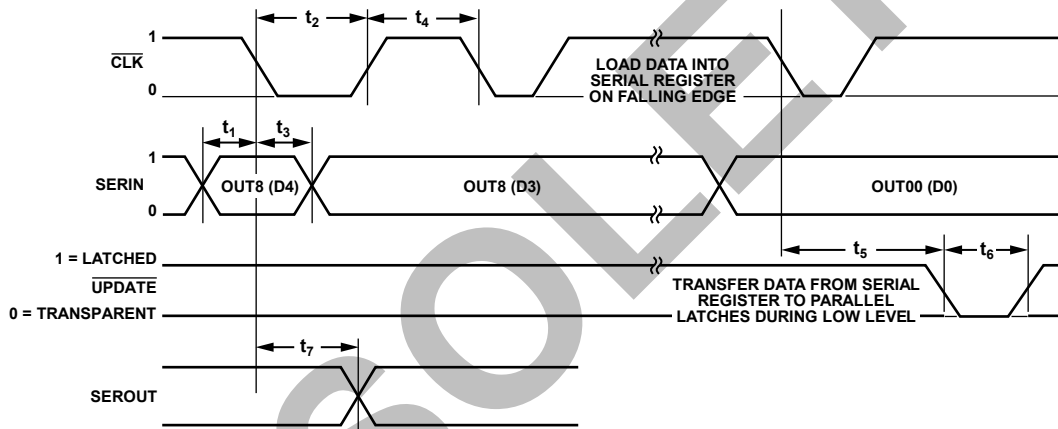

Figure 2. Timing Diagram, Serial Mode

06596-002

Table 3. Logic Levels,  $V_{DD} = 3.3\text{ V}$

$V_{IH}$	$V_{IL}$	$V_{OH}$	$V_{OL}$	$I_{IH}$	$I_{IL}$	$I_{OH}$	$I_{OL}$
SER/PAR, CLK, SERIN, UPDATE	SER/PAR, CLK, SERIN, UPDATE	SEROUT	SEROUT	SER/PAR, CLK, SERIN, UPDATE	SER/PAR, CLK, SERIN, UPDATE	SEROUT	SEROUT
2.0 V min	0.6 V max	2.8 V min	0.4 V max	20 $\mu\text{A}$ max	-20 $\mu\text{A}$ max	-1 mA min	1 mA min

Table 4. H and V Logic Levels,  $V_{DD} = 3.3\text{ V}$

$V_{OH}$	$V_{OL}$	$I_{OH}$	$I_{OL}$
2.7 V min	0.5 V max	-3 mA max	3 mA max

Table 5. RST Logic Levels,  $V_{DD} = 3.3\text{ V}$

$V_{IH}$	$V_{IL}$	$I_{IH}$	$I_{IL}$
2.0 V min	0.6 V max	-60 $\mu\text{A}$ max	-120 $\mu\text{A}$ max

Table 6. CS Logic Levels,  $V_{DD} = 3.3\text{ V}$

$V_{OH}$	$V_{OL}$	$I_{IH}$	$I_{OL}$
2.0 V min	0.6 V max	100 $\mu\text{A}$ max	40 $\mu\text{A}$ max

**TIMING CHARACTERISTICS (PARALLEL MODE)**

Table 7.

Parameter	Symbol	Limit			Unit
		Min	Typ	Max	
Parallel Data Setup Time	$t_1$	80			ns
$\overline{\text{WE}}$ Pulse Width	$t_2$	110			ns
Parallel Hold Time	$t_3$	150			ns
$\overline{\text{WE}}$ Pulse Separation	$t_4$	90			ns
$\overline{\text{WE}}$ to $\overline{\text{UPDATE}}$ Delay	$t_5$	10			ns
$\overline{\text{UPDATE}}$ Pulse Width	$t_6$	90			ns
Propagation Delay, $\overline{\text{UPDATE}}$ to Switch On			80		ns
$\overline{\text{RST}}$ Time			140	200	ns

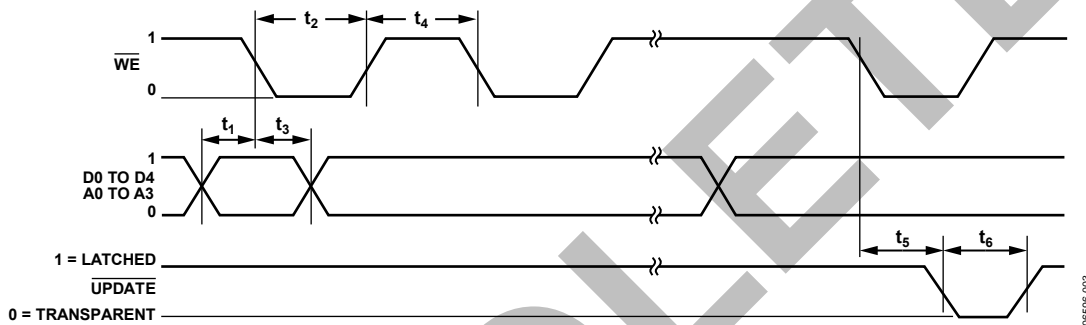

Figure 3. Timing Diagram, Parallel Mode

Table 8. Logic Levels,  $V_{DD} = 3.3\text{ V}$

$V_{IH}$	$V_{IL}$	$V_{OH}$	$V_{OL}$	$I_{IH}$	$I_{IL}$	$I_{OH}$	$I_{OL}$
SER/PAR, $\overline{\text{WE}}$ , D0, D1, D2, D3, D4, A0, A1, A2, A3, $\overline{\text{UPDATE}}$	SER/PAR, $\overline{\text{WE}}$ , D0, D1, D2, D3, D4, A0, A1, A2, A3, $\overline{\text{UPDATE}}$	SEROUT	SEROUT	SER/PAR, $\overline{\text{WE}}$ , D0, D1, D2, D3, D4, A0, A1, A2, A3, $\overline{\text{UPDATE}}$	SER/PAR, $\overline{\text{WE}}$ , D0, D1, D2, D3, D4, A0, A1, A2, A3, $\overline{\text{UPDATE}}$	SEROUT	SEROUT
2.0 V min	0.6 V max	Disabled	Disabled	20 $\mu\text{A}$ max	-20 $\mu\text{A}$ max	Disabled	Disabled

Table 9. H and V Logic Levels,  $V_{DD} = 3.3\text{ V}$

$V_{OH}$	$V_{OL}$	$I_{OH}$	$I_{OL}$
2.7 V min	0.5 V max	-3 mA max	3 mA max

Table 10.  $\overline{\text{RST}}$  Logic Levels,  $V_{DD} = 3.3\text{ V}$

$V_{IH}$	$V_{IL}$	$I_{IH}$	$I_{IL}$
2.0 V min	0.6 V max	-60 $\mu\text{A}$ max	-120 $\mu\text{A}$ max

Table 11.  $\overline{\text{CS}}$  Logic Levels,  $V_{DD} = 3.3\text{ V}$

$V_{OH}$	$V_{OL}$	$I_{IH}$	$I_{OL}$
2.0 V min	0.6 V max	100 $\mu\text{A}$ max	40 $\mu\text{A}$ max

## ABSOLUTE MAXIMUM RATINGS

Table 12.

Parameter	Rating
Analog Supply Voltage ( $V_{POS} - V_{NEG}$ )	6 V
Digital Supply Voltage ( $V_{DD} - D_{GND}$ )	6 V
Ground Potential Difference ( $V_{NEG} - D_{GND}$ )	+0.5 V to -2.5 V
Maximum Potential Difference ( $V_{DD} - V_{NEG}$ )	8 V
Common-Mode Analog Input Voltage Range	( $V_{NEG} - 0.5$ V) to ( $V_{POS} + 0.5$ V)
Differential Analog Input Voltage	$\pm 2$ V
Digital Input Voltage	$V_{DD}$
Output Voltage Range (Disabled Analog Output)	( $V_{POS} - 1$ V) to ( $V_{NEG} + 1$ V)
Output Short-Circuit Duration	Momentary
Storage Temperature Range	-65°C to +125°C
Operating Temperature Range	-40°C to +85°C
Lead Temperature (Soldering 10 sec)	300°C
Junction Temperature	150°C

Stresses at or above those listed under Absolute Maximum Ratings may cause permanent damage to the product. This is a stress rating only; functional operation of the product at these or any other conditions above those indicated in the operational section of this specification is not implied. Operation beyond the maximum operating conditions for extended periods may affect product reliability.

## THERMAL RESISTANCE

$\theta_{JA}$  is specified for the worst-case conditions, that is, a device soldered in a circuit board for surface-mount packages.

Table 13. Thermal Resistance

Package Type	$\theta_{JA}$	Unit
PBGA	15	°C/W

## POWER DISSIPATION

The AD8176 is operated with  $\pm 2.5$  V or +5 V supplies and can drive loads down to 100  $\Omega$ , resulting in a large range of possible power dissipations. For this reason, extra care must be taken derating the operating conditions based on ambient temperature.

Packaged in a 676-lead PBGA, the AD8176 junction-to-ambient thermal impedance ( $\theta_{JA}$ ) is 15°C/W. For long-term reliability, the maximum allowed junction temperature of the die must not exceed 150°C. Temporarily exceeding this limit may cause a shift in parametric performance due to a change in stresses exerted on the die by the package. Exceeding a junction temperature of 175°C for an extended period can result in device failure. Figure 4 shows the range of allowed internal die power dissipations that meet these conditions over the -40°C to +85°C ambient temperature range. When using Table 13, do not include external load power in the maximum power calculation, but do include load current dropped on the die output transistors.

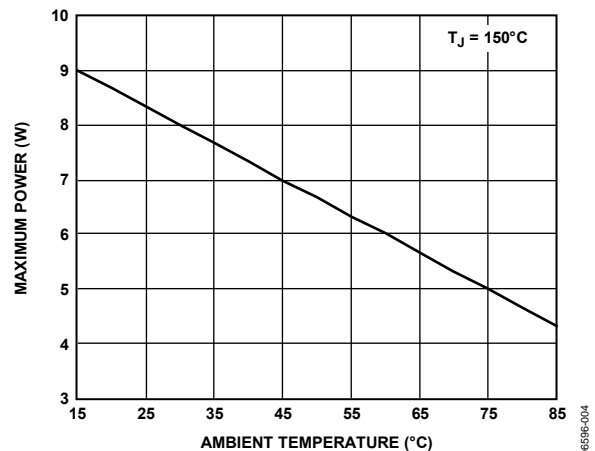

Figure 4. Maximum Die Power Dissipation vs. Ambient Temperature

## ESD CAUTION



**ESD (electrostatic discharge) sensitive device.** Charged devices and circuit boards can discharge without detection. Although this product features patented or proprietary protection circuitry, damage may occur on devices subjected to high energy ESD. Therefore, proper ESD precautions should be taken to avoid performance degradation or loss of functionality.

# PIN CONFIGURATION AND FUNCTION DESCRIPTIONS

	26	25	24	23	22	21	20	19	18	17	16	15	14	13	12	11	10	9	8	7	6	5	4	3	2	1		
A	VNEG	VNEG	VNEG	OPR7	ONB7	VNEG	OPR8	ONB8	VPOS	IPR8	INB8	VNEG	IPR9	INB9	VPOS	IPR10	INB10	VNEG	IPR11	INB11	VPOS	IPR12	INB12	VNEG	VNEG	VNEG	A	
B	VNEG	VNEG	VNEG	ONR7	OPB7	VNEG	ONR8	OPB8	VPOS	INR8	IPB8	VNEG	INR9	IPB9	VPOS	INR10	IPB10	VNEG	INR11	IPB11	VPOS	INR12	IPB12	VNEG	VNEG	VNEG	B	
C	VNEG	VNEG	VNEG	OPG7	ONG7	VNEG	OPG8	ONG8	VPOS	IPG8	ING8	VNEG	IPG9	ING9	VPOS	IPG10	ING10	VNEG	IPG11	ING11	VPOS	IPG12	ING12	VNEG	VNEG	VNEG	C	
D	VNEG	VNEG	VNEG	H7	V7	VPOS	H8	V8	VPOS	VPOS	VPOS	VPOS	VPOS	VPOS	VPOS	VPOS	VPOS	VPOS	VPOS	VPOS	VPOS	VPOS	VPOS	IPG13	INR13	IPR13	D	
E	VNEG	VNEG	VNEG	VPOS	VPOS	VPOS	VPOS	VPOS	DGND	VDD	SEROUT	CS	CLK	SERIN	SERPAR	A3	A2	A1	A0	VDD	DGND	VPOS	VPOS	ING13	IPB13	INB13	E	
F	VPOS	VPOS	VPOS	VPOS	VPOS	VPOS	VPOS	VPOS	VPOS	VPOS	VPOS	VPOS	VPOS	VPOS	VPOS	VPOS	VPOS	VPOS	VPOS	VPOS	VPOS	VPOS	VPOS	VPOS	VPOS	VPOS	VPOS	F
G	ONB6	OPB6	ONG6	V6	VPOS	VPOS	VPOS	VPOS	VPOS	VPOS	VPOS	VPOS	VPOS	VPOS	VPOS	VPOS	VPOS	VPOS	VPOS	VPOS	VPOS	VPOS	VPOS	VPOS	VPOS	VPOS	G	
H	OPR6	ONR6	OPG6	H6	VPOS	VPOS	VNEG	VNEG	VNEG	VNEG	VNEG	VNEG	VNEG	VNEG	VNEG	VNEG	VNEG	VNEG	VNEG	VPOS	VPOS	VPOS	VPOS	IPG14	INR14	IPR14	H	
J	VNEG	VNEG	VNEG	VPOS	VPOS	VPOS	VNEG	VNEG	VNEG	VNEG	VNEG	VNEG	VNEG	VNEG	VNEG	VNEG	VNEG	VNEG	VNEG	VNEG	VPOS	VPOS	VPOS	VPOS	ING14	IPB14	INB14	J
K	ONB5	OPB5	ONG5	V5	VPOS	VPOS	VNEG	VNEG	VNEG	VNEG	VNEG	VNEG	VNEG	VNEG	VNEG	VNEG	VNEG	VNEG	VNEG	VPOS	VPOS	VPOS	VPOS	VNEG	VNEG	VNEG	K	
L	OPR5	ONR5	OPG5	H5	VPOS	VPOS	VNEG	VNEG	VNEG	VNEG	VNEG	VNEG	VNEG	VNEG	VNEG	VNEG	VNEG	VNEG	VNEG	VPOS	VPOS	VPOS	VPOS	IPG15	INR15	IPR15	L	
M	VPOS	VPOS	VPOS	VPOS	VPOS	VPOS	VNEG	VNEG	VNEG	VNEG	VNEG	VNEG	VNEG	VNEG	VNEG	VNEG	VNEG	VNEG	VNEG	VPOS	VPOS	VPOS	VPOS	ING15	IPB15	INB15	M	
N	ONB4	OPB4	ONG4	V4	VPOS	VPOS	VNEG	VNEG	VNEG	VNEG	VNEG	VNEG	VNEG	VNEG	VNEG	VNEG	VNEG	VNEG	VNEG	VPOS	VPOS	VPOS	VPOS	VPOS	VPOS	VPOS	N	
P	OPR4	ONR4	OPG4	H4	VPOS	VPOS	VNEG	VNEG	VNEG	VNEG	VNEG	VNEG	VNEG	VNEG	VNEG	VNEG	VNEG	VNEG	VNEG	VPOS	VPOS	VBLK	VPOS	VPOS	VPOS	VPOS	P	
R	VNEG	VNEG	VNEG	VPOS	VPOS	VPOS	VNEG	VNEG	VNEG	VNEG	VNEG	VNEG	VNEG	VNEG	VNEG	VNEG	VNEG	VNEG	VNEG	VPOS	VPOS	VPOS	VPOS	VPOS	IPG7	INR7	IPR7	R
T	ONB3	OPB3	ONG3	V3	VPOS	VPOS	VNEG	VNEG	VNEG	VNEG	VNEG	VNEG	VNEG	VNEG	VNEG	VNEG	VNEG	VNEG	VNEG	VPOS	VPOS	VPOS	VPOS	ING7	IPB7	INB7	T	
U	OPR3	ONR3	OPG3	H3	VPOS	VPOS	VNEG	VNEG	VNEG	VNEG	VNEG	VNEG	VNEG	VNEG	VNEG	VNEG	VNEG	VNEG	VNEG	VPOS	VPOS	VPOS	VPOS	VNEG	VNEG	VNEG	U	
V	VPOS	VPOS	VPOS	VPOS	VPOS	VPOS	VNEG	VNEG	VNEG	VNEG	VNEG	VNEG	VNEG	VNEG	VNEG	VNEG	VNEG	VNEG	VNEG	VPOS	VPOS	VPOS	VPOS	IPG6	INR6	IPR6	V	
W	ONB2	OPB2	ONG2	V2	VPOS	VPOS	VNEG	VNEG	VNEG	VNEG	VNEG	VNEG	VNEG	VNEG	VNEG	VNEG	VNEG	VNEG	VNEG	VPOS	VPOS	VPOS	VPOS	ING6	IPB6	INB6	W	
Y	OPR2	ONR2	OPG2	H2	VPOS	VPOS	VPOS	VPOS	VPOS	VPOS	VPOS	VPOS	VPOS	VPOS	VPOS	VPOS	VPOS	VPOS	VPOS	VPOS	VPOS	VPOS	VPOS	VPOS	VPOS	VPOS	Y	
AA	VNEG	VNEG	VNEG	VPOS	VPOS	VPOS	VPOS	VPOS	VPOS	VPOS	VPOS	VPOS	VPOS	VPOS	VPOS	VPOS	VPOS	VPOS	VPOS	VPOS	VPOS	VPOS	VPOS	VPOS	VPOS	VPOS	AA	
AB	VNEG	VNEG	VNEG	VPOS	VPOS	VPOS	VPOS	VPOS	DGND	VDD	RST	UPDATE	WE	CMENC	D4	D3	D2	D1	D0	VDD	DGND	VPOS	VPOS	IPG5	INR5	IPR5	AB	
AC	VNEG	VNEG	VNEG	V1	H1	VPOS	V0	H0	VPOS	VPOS	VPOS	VPOS	VPOS	VPOS	VPOS	VPOS	VPOS	VPOS	VPOS	VPOS	VPOS	VPOS	VPOS	ING5	IPB5	INB5	AC	
AD	VNEG	VNEG	VNEG	ONG1	OPG1	VPOS	ONG0	OPG0	VNEG	ING0	IPG0	VPOS	ING1	IPG1	VNEG	ING2	IPG2	VPOS	ING3	IPG3	VNEG	ING4	IPG4	VNEG	VNEG	VNEG	AD	
AE	VNEG	VNEG	VNEG	OPB1	ONR1	VPOS	OPB0	ONR0	VNEG	IPB0	INR0	VPOS	IPB1	INR1	VNEG	IPB2	INR2	VPOS	IPB3	INR3	VNEG	IPB4	INR4	VNEG	VNEG	VNEG	AE	
AF	VNEG	VNEG	VNEG	ONB1	OPR1	VPOS	ONB0	OPR0	VNEG	INB0	IPR0	VPOS	INB1	IPR1	VNEG	INB2	IPR2	VPOS	INB3	IPR3	VNEG	INB4	IPR4	VNEG	VNEG	VNEG	AF	

Figure 5. 676-Ball PBGA Pin Configuration, Bottom View



	1	2	3	4	5	6	7	8	9	10	11	12	13	14	15	16	17	18	19	20	21	22	23	24	25	26		
A	VNEG	VNEG	VNEG	INB12	IPR12	VPOS	INB11	IPR11	VNEG	INB10	IPR10	VPOS	INB9	IPR9	VNEG	INB8	IPR8	VPOS	ONB8	OPR8	VNEG	ONB7	OPR7	VNEG	VNEG	VNEG	A	
B	VNEG	VNEG	VNEG	IPB12	INR12	VPOS	IPB11	INR11	VNEG	IPB10	INR10	VPOS	IPB9	INR9	VNEG	IPB8	INR8	VPOS	OPB8	ONR8	VNEG	OPB7	ONR7	VNEG	VNEG	VNEG	B	
C	VNEG	VNEG	VNEG	ING12	IPG12	VPOS	ING11	IPG11	VNEG	ING10	IPG10	VPOS	ING9	IPG9	VNEG	ING8	IPG8	VPOS	ONG8	OPG8	VNEG	ONG7	OPG7	VNEG	VNEG	VNEG	C	
D	IPR13	INR13	IPG13	VPOS	VPOS	VPOS	VPOS	VPOS	VPOS	VPOS	VPOS	VPOS	VPOS	VPOS	VPOS	VPOS	VPOS	VPOS	V8	H8	VPOS	V7	H7	VNEG	VNEG	VNEG	D	
E	INB13	IPB13	ING13	VPOS	VPOS	DGND	VDD	A0	A1	A2	A3	SER-PAR	SER-IN	CLK	C3	SER-OUT	VDD	DGND	VPOS	VPOS	VPOS	VPOS	VPOS	VNEG	VNEG	VNEG	E	
F	VPOS	VPOS	VPOS	VPOS	VPOS	VPOS	VPOS	VPOS	VPOS	VPOS	VPOS	VPOS	VPOS	VPOS	VPOS	VPOS	VPOS	VPOS	VPOS	VPOS	VPOS	VPOS	VPOS	VPOS	VPOS	VPOS	F	
G	VPOS	VPOS	VPOS	VPOS	VPOS	VPOS	VPOS	VPOS	VPOS	VPOS	VPOS	VPOS	VPOS	VPOS	VPOS	VPOS	VPOS	VPOS	VPOS	VPOS	VPOS	VPOS	V6	ONG6	OPB6	ONB6	G	
H	IPR14	INR14	IPG14	VPOS	VPOS	VPOS	VPOS	VNEG	VNEG	VNEG	VNEG	VNEG	VNEG	VNEG	VNEG	VNEG	VNEG	VNEG	VNEG	VNEG	VNEG	VPOS	VPOS	H6	OPG6	ONR6	OPR6	H
J	INB14	IPB14	ING14	VPOS	VPOS	VPOS	VPOS	VNEG	VNEG	VNEG	VNEG	VNEG	VNEG	VNEG	VNEG	VNEG	VNEG	VNEG	VNEG	VNEG	VNEG	VPOS	VPOS	VPOS	VNEG	VNEG	VNEG	J
K	VNEG	VNEG	VNEG	VPOS	VPOS	VPOS	VPOS	VNEG	VNEG	VNEG	VNEG	VNEG	VNEG	VNEG	VNEG	VNEG	VNEG	VNEG	VNEG	VNEG	VNEG	VPOS	VPOS	V5	ONG5	OPB5	ONB5	K
L	IPR15	INR15	IPG15	VPOS	VPOS	VPOS	VPOS	VNEG	VNEG	VNEG	VNEG	VNEG	VNEG	VNEG	VNEG	VNEG	VNEG	VNEG	VNEG	VNEG	VNEG	VPOS	VPOS	H5	OPG5	ONR5	OPR5	L
M	INB15	IPB15	ING15	VPOS	VPOS	VPOS	VPOS	VNEG	VNEG	VNEG	VNEG	VNEG	VNEG	VNEG	VNEG	VNEG	VNEG	VNEG	VNEG	VNEG	VNEG	VPOS	VPOS	VPOS	VPOS	VPOS	VPOS	M
N	VPOS	VPOS	VPOS	VPOS	VOCM_CMENCON	VPOS	VPOS	VNEG	VNEG	VNEG	VNEG	VNEG	VNEG	VNEG	VNEG	VNEG	VNEG	VNEG	VNEG	VNEG	VNEG	VPOS	VPOS	V4	ONG4	OPB4	ONB4	N
P	VPOS	VPOS	VPOS	VPOS	VBLK	VPOS	VPOS	VNEG	VNEG	VNEG	VNEG	VNEG	VNEG	VNEG	VNEG	VNEG	VNEG	VNEG	VNEG	VNEG	VNEG	VPOS	VPOS	H4	OPG4	ONR4	OPR4	P
R	IPR7	INR7	IPG7	VPOS	VOCM_CMENCOFF	VPOS	VPOS	VNEG	VNEG	VNEG	VNEG	VNEG	VNEG	VNEG	VNEG	VNEG	VNEG	VNEG	VNEG	VNEG	VNEG	VPOS	VPOS	VPOS	VNEG	VNEG	VNEG	R
T	INB7	IPB7	ING7	VPOS	VPOS	VPOS	VPOS	VNEG	VNEG	VNEG	VNEG	VNEG	VNEG	VNEG	VNEG	VNEG	VNEG	VNEG	VNEG	VNEG	VNEG	VPOS	VPOS	V3	ONG3	OPB3	ONB3	T
U	VNEG	VNEG	VNEG	VPOS	VPOS	VPOS	VPOS	VNEG	VNEG	VNEG	VNEG	VNEG	VNEG	VNEG	VNEG	VNEG	VNEG	VNEG	VNEG	VNEG	VNEG	VPOS	VPOS	H3	OPG3	ONR3	OPR3	U
V	IPR6	INR6	IPG6	VPOS	VPOS	VPOS	VPOS	VNEG	VNEG	VNEG	VNEG	VNEG	VNEG	VNEG	VNEG	VNEG	VNEG	VNEG	VNEG	VNEG	VNEG	VPOS	VPOS	VPOS	VPOS	VPOS	VPOS	V
W	INB6	IPB6	ING6	VPOS	VPOS	VPOS	VPOS	VNEG	VNEG	VNEG	VNEG	VNEG	VNEG	VNEG	VNEG	VNEG	VNEG	VNEG	VNEG	VNEG	VNEG	VPOS	VPOS	V2	ONG2	OPB2	ONB2	W
Y	VPOS	VPOS	VPOS	VPOS	VPOS	VPOS	VPOS	VPOS	VPOS	VPOS	VPOS	VPOS	VPOS	VPOS	VPOS	VPOS	VPOS	VPOS	VPOS	VPOS	VPOS	VPOS	VPOS	H2	OPG2	ONR2	OPR2	Y
AA	VPOS	VPOS	VPOS	VPOS	VPOS	VPOS	VPOS	VPOS	VPOS	VPOS	VPOS	VPOS	VPOS	VPOS	VPOS	VPOS	VPOS	VPOS	VPOS	VPOS	VPOS	VPOS	VPOS	VPOS	VNEG	VNEG	VNEG	AA
AB	IPR5	INR5	IPG5	VPOS	VPOS	DGND	VDD	D0	D1	D2	D3	D4	CMENC	WE	UPDATE	RST	VDD	DGND	VPOS	VPOS	VPOS	VPOS	VPOS	VPOS	VNEG	VNEG	VNEG	AB
AC	INB5	IPB5	ING5	VPOS	VPOS	VPOS	VPOS	VPOS	VPOS	VPOS	VPOS	VPOS	VPOS	VPOS	VPOS	VPOS	VPOS	VPOS	H0	V0	VPOS	H1	V1	VNEG	VNEG	VNEG	AC	
AD	VNEG	VNEG	VNEG	IPG4	ING4	VNEG	IPG3	ING3	VPOS	IPG2	ING2	VNEG	IPG1	ING1	VPOS	IPG0	ING0	VNEG	OPG0	ONG0	VPOS	OPG1	ONG1	VNEG	VNEG	VNEG	AD	
AE	VNEG	VNEG	VNEG	INR4	IPB4	VNEG	INR3	IPB3	VPOS	INR2	IPB2	VNEG	INR1	IPB1	VPOS	INR0	IPB0	VNEG	ONR0	OPB0	VPOS	ONR1	OPB1	VNEG	VNEG	VNEG	AE	
AF	VNEG	VNEG	VNEG	IPR4	INB4	VNEG	IPR3	INB3	VPOS	IPR2	INB2	VNEG	IPR1	INB1	VPOS	IPR0	INB0	VNEG	OPR0	ONB0	VPOS	OPR1	ONB1	VNEG	VNEG	VNEG	AF	
	1	2	3	4	5	6	7	8	9	10	11	12	13	14	15	16	17	18	19	20	21	22	23	24	25	26		

Figure 6. 676-Ball PBGA Pin Configuration, Top View

06559E-006

Table 14. Pin Function Description

Pin No.	Mnemonic	Description	Pin No.	Mnemonic	Description
A1	VNEG	Negative Analog Power Supply.	C1	VNEG	Negative Analog Power Supply.
A2	VNEG	Negative Analog Power Supply.	C2	VNEG	Negative Analog Power Supply.
A3	VNEG	Negative Analog Power Supply.	C3	VNEG	Negative Analog Power Supply.
A4	INB12	Input Number 12, Negative Phase.	C4	ING12	Input Number 12, Negative Phase.
A5	IPR12	Input Number 12, Positive Phase.	C5	IPG12	Input Number 12, Positive Phase.
A6	VPOS	Positive Analog Power Supply.	C6	VPOS	Positive Analog Power Supply.
A7	INB11	Input Number 11, Negative Phase.	C7	ING11	Input Number 11, Negative Phase.
A8	IPR11	Input Number 11, Positive Phase.	C8	IPG11	Input Number 11, Positive Phase.
A9	VNEG	Negative Analog Power Supply.	C9	VNEG	Negative Analog Power Supply.
A10	INB10	Input Number 10, Negative Phase.	C10	ING10	Input Number 10, Negative Phase.
A11	IPR10	Input Number 10, Positive Phase.	C11	IPG10	Input Number 10, Positive Phase.
A12	VPOS	Positive Analog Power Supply.	C12	VPOS	Positive Analog Power Supply.
A13	INB9	Input Number 9, Negative Phase.	C13	ING9	Input Number 9, Negative Phase.
A14	IPR9	Input Number 9, Positive Phase.	C14	IPG9	Input Number 9, Positive Phase.
A15	VNEG	Negative Analog Power Supply.	C15	VNEG	Negative Analog Power Supply.
A16	INB8	Input Number 8, Negative Phase.	C16	ING8	Input Number 8, Negative Phase.
A17	IPR8	Input Number 8, Positive Phase.	C17	IPG8	Input Number 8, Positive Phase.
A18	VPOS	Positive Analog Power Supply.	C18	VPOS	Positive Analog Power Supply.
A19	ONB8	Output Number 8, Negative Phase.	C19	ONG8	Output Number 8, Negative Phase.
A20	OPR8	Output Number 8, Positive Phase.	C20	OPG8	Output Number 8, Positive Phase.
A21	VNEG	Negative Analog Power Supply.	C21	VNEG	Negative Analog Power Supply.
A22	ONB7	Output Number 7, Negative Phase.	C22	ONG7	Output Number 7, Negative Phase.
A23	OPR7	Output Number 7, Positive Phase.	C23	OPG7	Output Number 7, Positive Phase.
A24	VNEG	Negative Analog Power Supply.	C24	VNEG	Negative Analog Power Supply.
A25	VNEG	Negative Analog Power Supply.	C25	VNEG	Negative Analog Power Supply.
A26	VNEG	Negative Analog Power Supply.	C26	VNEG	Negative Analog Power Supply.
B1	VNEG	Negative Analog Power Supply.	D1	IPR13	Input Number 13, Positive Phase.
B2	VNEG	Negative Analog Power Supply.	D2	INR13	Input Number 13, Negative Phase.
B3	VNEG	Negative Analog Power Supply.	D3	IPG13	Input Number 13, Positive Phase.
B4	IPB12	Input Number 12, Positive Phase.	D4	VPOS	Positive Analog Power Supply.
B5	INR12	Input Number 12, Negative Phase.	D5	VPOS	Positive Analog Power Supply.
B6	VPOS	Positive Analog Power Supply.	D6	VPOS	Positive Analog Power Supply.
B7	IPB11	Input Number 11, Positive Phase.	D7	VPOS	Positive Analog Power Supply.
B8	INR11	Input Number 11, Negative Phase.	D8	VPOS	Positive Analog Power Supply.
B9	VNEG	Negative Analog Power Supply.	D9	VPOS	Positive Analog Power Supply.
B10	IPB10	Input Number 10, Positive Phase.	D10	VPOS	Positive Analog Power Supply.
B11	INR10	Input Number 10, Negative Phase.	D11	VPOS	Positive Analog Power Supply.
B12	VPOS	Positive Analog Power Supply.	D12	VPOS	Positive Analog Power Supply.
B13	IPB9	Input Number 9, Positive Phase.	D13	VPOS	Positive Analog Power Supply.
B14	INR9	Input Number 9, Negative Phase.	D14	VPOS	Positive Analog Power Supply.
B15	VNEG	Negative Analog Power Supply.	D15	VPOS	Positive Analog Power Supply.
B16	IPB8	Input Number 8, Positive Phase.	D16	VPOS	Positive Analog Power Supply.
B17	INR8	Input Number 8, Negative Phase.	D17	VPOS	Positive Analog Power Supply.
B18	VPOS	Positive Analog Power Supply.	D18	VPOS	Positive Analog Power Supply.
B19	OPB8	Output Number 8, Positive Phase.	D19	V8	Output Number 8, V Sync.
B20	ONR8	Output Number 8, Negative Phase.	D20	H8	Output Number 8, H Sync.
B21	VNEG	Negative Analog Power Supply.	D21	VPOS	Positive Analog Power Supply.
B22	OPB7	Output Number 7, Positive Phase.	D22	V7	Output Number 7, V Sync.
B23	ONR7	Output Number 7, Negative Phase.	D23	H7	Output Number 7, H Sync.
B24	VNEG	Negative Analog Power Supply.	D24	VNEG	Negative Analog Power Supply.
B25	VNEG	Negative Analog Power Supply.	D25	VNEG	Negative Analog Power Supply.
B26	VNEG	Negative Analog Power Supply.	D26	VNEG	Negative Analog Power Supply.

Pin No.	Mnemonic	Description	Pin No.	Mnemonic	Description
E1	INB13	Input Number 13, Negative Phase.	G2	VPOS	Positive Analog Power Supply.
E2	IPB13	Input Number 13, Positive Phase.	G3	VPOS	Positive Analog Power Supply.
E3	ING13	Input Number 13, Negative Phase.	G4	VPOS	Positive Analog Power Supply.
E4	VPOS	Positive Analog Power Supply.	G5	VPOS	Positive Analog Power Supply.
E5	VPOS	Positive Analog Power Supply.	G6	VPOS	Positive Analog Power Supply.
E6	DGND	Digital Power Supply.	G7	VPOS	Positive Analog Power Supply.
E7	VDD	Digital Power Supply.	G8	VPOS	Positive Analog Power Supply.
E8	A0	Control Pin 0, Output Address Bit 0.	G9	VPOS	Positive Analog Power Supply.
E9	A1	Control Pin 1, Output Address Bit 1.	G10	VPOS	Positive Analog Power Supply.
E10	A2	Control Pin 2, Output Address Bit 2.	G11	VPOS	Positive Analog Power Supply.
E11	A3	Control Pin 3, Output Address Bit 3.	G12	VPOS	Positive Analog Power Supply.
E12	$\overline{\text{SER/PAR}}$	Control Pin: Serial Parallel Select Mode.	G13	VPOS	Positive Analog Power Supply.
E13	SERIN	Control Pin: Serial Data In.	G14	VPOS	Positive Analog Power Supply.
E14	$\overline{\text{CLK}}$	Control Pin: Serial Data Clock.	G15	VPOS	Positive Analog Power Supply.
E15	$\overline{\text{CS}}$	Control Pin: Chip Select.	G16	VPOS	Positive Analog Power Supply.
E16	SEROUT	Control Pin: Serial Data Out.	G17	VPOS	Positive Analog Power Supply.
E17	VDD	Digital Power Supply.	G18	VPOS	Positive Analog Power Supply.
E18	DGND	Digital Power Supply.	G19	VPOS	Positive Analog Power Supply.
E19	VPOS	Positive Analog Power Supply.	G20	VPOS	Positive Analog Power Supply.
E20	VPOS	Positive Analog Power Supply.	G21	VPOS	Positive Analog Power Supply.
E21	VPOS	Positive Analog Power Supply.	G22	VPOS	Positive Analog Power Supply.
E22	VPOS	Positive Analog Power Supply.	G23	V6	Output Number 6, V Sync.
E23	VPOS	Positive Analog Power Supply.	G24	ONG6	Output Number 6, Negative Phase.
E24	VNEG	Negative Analog Power Supply.	G25	OPB6	Output Number 6, Positive Phase.
E25	VNEG	Negative Analog Power Supply.	G26	ONB6	Output Number 6, Negative Phase.
E26	VNEG	Negative Analog Power Supply.	H1	IPR14	Input Number 14, Positive Phase.
F1	VPOS	Positive Analog Power Supply.	H2	INR14	Input Number 14, Negative Phase.
F2	VPOS	Positive Analog Power Supply.	H3	IPG14	Input Number 14, Positive Phase.
F3	VPOS	Positive Analog Power Supply.	H4	VPOS	Positive Analog Power Supply.
F4	VPOS	Positive Analog Power Supply.	H5	VPOS	Positive Analog Power Supply.
F5	VPOS	Positive Analog Power Supply.	H6	VPOS	Positive Analog Power Supply.
F6	VPOS	Positive Analog Power Supply.	H7	VPOS	Positive Analog Power Supply.
F7	VPOS	Positive Analog Power Supply.	H8	VNEG	Negative Analog Power Supply.
F8	VPOS	Positive Analog Power Supply.	H9	VNEG	Negative Analog Power Supply.
F9	VPOS	Positive Analog Power Supply.	H10	VNEG	Negative Analog Power Supply.
F10	VPOS	Positive Analog Power Supply.	H11	VNEG	Negative Analog Power Supply.
F11	VPOS	Positive Analog Power Supply.	H12	VNEG	Negative Analog Power Supply.
F12	VPOS	Positive Analog Power Supply.	H13	VNEG	Negative Analog Power Supply.
F13	VPOS	Positive Analog Power Supply.	H14	VNEG	Negative Analog Power Supply.
F14	VPOS	Positive Analog Power Supply.	H15	VNEG	Negative Analog Power Supply.
F15	VPOS	Positive Analog Power Supply.	H16	VNEG	Negative Analog Power Supply.
F16	VPOS	Positive Analog Power Supply.	H17	VNEG	Negative Analog Power Supply.
F17	VPOS	Positive Analog Power Supply.	H18	VNEG	Negative Analog Power Supply.
F18	VPOS	Positive Analog Power Supply.	H19	VNEG	Negative Analog Power Supply.
F19	VPOS	Positive Analog Power Supply.	H20	VNEG	Negative Analog Power Supply.
F20	VPOS	Positive Analog Power Supply.	H21	VPOS	Positive Analog Power Supply.
F21	VPOS	Positive Analog Power Supply.	H22	VPOS	Positive Analog Power Supply.
F22	VPOS	Positive Analog Power Supply.	H23	H6	Output Number 6, H Sync.
F23	VPOS	Positive Analog Power Supply.	H24	OPG6	Output Number 6, Positive Phase.
F24	VPOS	Positive Analog Power Supply.	H25	ONR6	Output Number 6, Negative Phase.
F25	VPOS	Positive Analog Power Supply.	H26	OPR6	Output Number 6, Positive Phase.
F26	VPOS	Positive Analog Power Supply.	J1	INB14	Input Number 14, Negative Phase.
G1	VPOS	Positive Analog Power Supply.	J2	IPB14	Input Number 14, Positive Phase.

Pin No.	Mnemonic	Description	Pin No.	Mnemonic	Description
J3	ING14	Input Number 14, Negative Phase.	L4	VPOS	Positive Analog Power Supply.
J4	VPOS	Positive Analog Power Supply.	L5	VPOS	Positive Analog Power Supply.
J5	VPOS	Positive Analog Power Supply.	L6	VPOS	Positive Analog Power Supply.
J6	VPOS	Positive Analog Power Supply.	L7	VPOS	Positive Analog Power Supply.
J7	VPOS	Positive Analog Power Supply.	L8	VNEG	Negative Analog Power Supply.
J8	VNEG	Negative Analog Power Supply.	L9	VNEG	Negative Analog Power Supply.
J9	VNEG	Negative Analog Power Supply.	L10	VNEG	Negative Analog Power Supply.
J10	VNEG	Negative Analog Power Supply.	L11	VNEG	Negative Analog Power Supply.
J11	VNEG	Negative Analog Power Supply.	L12	VNEG	Negative Analog Power Supply.
J12	VNEG	Negative Analog Power Supply.	L13	VNEG	Negative Analog Power Supply.
J13	VNEG	Negative Analog Power Supply.	L14	VNEG	Negative Analog Power Supply.
J14	VNEG	Negative Analog Power Supply.	L15	VNEG	Negative Analog Power Supply.
J15	VNEG	Negative Analog Power Supply.	L16	VNEG	Negative Analog Power Supply.
J16	VNEG	Negative Analog Power Supply.	L17	VNEG	Negative Analog Power Supply.
J17	VNEG	Negative Analog Power Supply.	L18	VNEG	Negative Analog Power Supply.
J18	VNEG	Negative Analog Power Supply.	L19	VNEG	Negative Analog Power Supply.
J19	VNEG	Negative Analog Power Supply.	L20	VNEG	Negative Analog Power Supply.
J20	VNEG	Negative Analog Power Supply.	L21	VPOS	Positive Analog Power Supply.
J21	VPOS	Positive Analog Power Supply.	L22	VPOS	Positive Analog Power Supply.
J22	VPOS	Positive Analog Power Supply.	L23	H5	Output Number 5, H Sync.
J23	VPOS	Positive Analog Power Supply.	L24	OPG5	Output Number 5, Positive Phase.
J24	VNEG	Negative Analog Power Supply.	L25	ONR5	Output Number 5, Negative Phase.
J25	VNEG	Negative Analog Power Supply.	L26	OPR5	Output Number 5, Positive Phase.
J26	VNEG	Negative Analog Power Supply.	M1	INB15	Input Number 15, Negative Phase.
K1	VNEG	Negative Analog Power Supply.	M2	IPB15	Input Number 15, Positive Phase.
K2	VNEG	Negative Analog Power Supply.	M3	ING15	Input Number 15, Negative Phase.
K3	VNEG	Negative Analog Power Supply.	M4	VPOS	Positive Analog Power Supply.
K4	VPOS	Positive Analog Power Supply.	M5	VPOS	Positive Analog Power Supply.
K5	VPOS	Positive Analog Power Supply.	M6	VPOS	Positive Analog Power Supply.
K6	VPOS	Positive Analog Power Supply.	M7	VPOS	Positive Analog Power Supply.
K7	VPOS	Positive Analog Power Supply.	M8	VNEG	Negative Analog Power Supply.
K8	VNEG	Negative Analog Power Supply.	M9	VNEG	Negative Analog Power Supply.
K9	VNEG	Negative Analog Power Supply.	M10	VNEG	Negative Analog Power Supply.
K10	VNEG	Negative Analog Power Supply.	M11	VNEG	Negative Analog Power Supply.
K11	VNEG	Negative Analog Power Supply.	M12	VNEG	Negative Analog Power Supply.
K12	VNEG	Negative Analog Power Supply.	M13	VNEG	Negative Analog Power Supply.
K13	VNEG	Negative Analog Power Supply.	M14	VNEG	Negative Analog Power Supply.
K14	VNEG	Negative Analog Power Supply.	M15	VNEG	Negative Analog Power Supply.
K15	VNEG	Negative Analog Power Supply.	M16	VNEG	Negative Analog Power Supply.
K16	VNEG	Negative Analog Power Supply.	M17	VNEG	Negative Analog Power Supply.
K17	VNEG	Negative Analog Power Supply.	M18	VNEG	Negative Analog Power Supply.
K18	VNEG	Negative Analog Power Supply.	M19	VNEG	Negative Analog Power Supply.
K19	VNEG	Negative Analog Power Supply.	M20	VNEG	Negative Analog Power Supply.
K20	VNEG	Negative Analog Power Supply.	M21	VPOS	Positive Analog Power Supply.
K21	VPOS	Positive Analog Power Supply.	M22	VPOS	Positive Analog Power Supply.
K22	VPOS	Positive Analog Power Supply.	M23	VPOS	Positive Analog Power Supply.
K23	V5	Output Number 5, V Sync.	M24	VPOS	Positive Analog Power Supply.
K24	ONG5	Output Number 5, Negative Phase.	M25	VPOS	Positive Analog Power Supply.
K25	OPB5	Output Number 5, Positive Phase.	M26	VPOS	Positive Analog Power Supply.
K26	ONB5	Output Number 5, Negative Phase.	N1	VPOS	Positive Analog Power Supply.
L1	IPR15	Input Number 15, Positive Phase.	N2	VPOS	Positive Analog Power Supply.
L2	INR15	Input Number 15, Negative Phase.	N3	VPOS	Positive Analog Power Supply.
L3	IPG15	Input Number 15, Positive Phase.	N4	VPOS	Positive Analog Power Supply.

Pin No.	Mnemonic	Description	Pin No.	Mnemonic	Description
N5	VOCM_ CMENCON	Output CM Reference with CM Encoding On.	R5	VOCM_ CMENCOFF	Output Reference with CM Encoding Off.
N6	VPOS	Positive Analog Power Supply.	R6	VPOS	Positive Analog Power Supply.
N7	VPOS	Positive Analog Power Supply.	R7	VPOS	Positive Analog Power Supply.
N8	VNEG	Negative Analog Power Supply.	R8	VNEG	Negative Analog Power Supply.
N9	VNEG	Negative Analog Power Supply.	R9	VNEG	Negative Analog Power Supply.
N10	VNEG	Negative Analog Power Supply.	R10	VNEG	Negative Analog Power Supply.
N11	VNEG	Negative Analog Power Supply.	R11	VNEG	Negative Analog Power Supply.
N12	VNEG	Negative Analog Power Supply.	R12	VNEG	Negative Analog Power Supply.
N13	VNEG	Negative Analog Power Supply.	R13	VNEG	Negative Analog Power Supply.
N14	VNEG	Negative Analog Power Supply.	R14	VNEG	Negative Analog Power Supply.
N15	VNEG	Negative Analog Power Supply.	R15	VNEG	Negative Analog Power Supply.
N16	VNEG	Negative Analog Power Supply.	R16	VNEG	Negative Analog Power Supply.
N17	VNEG	Negative Analog Power Supply.	R17	VNEG	Negative Analog Power Supply.
N18	VNEG	Negative Analog Power Supply.	R18	VNEG	Negative Analog Power Supply.
N19	VNEG	Negative Analog Power Supply.	R19	VNEG	Negative Analog Power Supply.
N20	VNEG	Negative Analog Power Supply.	R20	VNEG	Negative Analog Power Supply.
N21	VPOS	Positive Analog Power Supply.	R21	VPOS	Positive Analog Power Supply.
N22	VPOS	Positive Analog Power Supply.	R22	VPOS	Positive Analog Power Supply.
N23	V4	Output Number 4, V Sync.	R23	VPOS	Positive Analog Power Supply.
N24	ONG4	Output Number 4, Negative Phase.	R24	VNEG	Negative Analog Power Supply.
N25	OPB4	Output Number 4, Positive Phase.	R25	VNEG	Negative Analog Power Supply.
N26	ONB4	Output Number 4, Negative Phase.	R26	VNEG	Negative Analog Power Supply.
P1	VPOS	Positive Analog Power Supply.	T1	INB7	Input Number 7, Negative Phase.
P2	VPOS	Positive Analog Power Supply.	T2	IPB7	Input Number 7, Positive Phase.
P3	VPOS	Positive Analog Power Supply.	T3	ING7	Input Number 7, Negative Phase.
P4	VPOS	Positive Analog Power Supply.	T4	VPOS	Positive Analog Power Supply.
P5	VBLK	Output Blank Level.	T5	VPOS	Positive Analog Power Supply.
P6	VPOS	Positive Analog Power Supply.	T6	VPOS	Positive Analog Power Supply.
P7	VPOS	Positive Analog Power Supply.	T7	VPOS	Positive Analog Power Supply.
P8	VNEG	Negative Analog Power Supply.	T8	VNEG	Negative Analog Power Supply.
P9	VNEG	Negative Analog Power Supply.	T9	VNEG	Negative Analog Power Supply.
P10	VNEG	Negative Analog Power Supply.	T10	VNEG	Negative Analog Power Supply.
P11	VNEG	Negative Analog Power Supply.	T11	VNEG	Negative Analog Power Supply.
P12	VNEG	Negative Analog Power Supply.	T12	VNEG	Negative Analog Power Supply.
P13	VNEG	Negative Analog Power Supply.	T13	VNEG	Negative Analog Power Supply.
P14	VNEG	Negative Analog Power Supply.	T14	VNEG	Negative Analog Power Supply.
P15	VNEG	Negative Analog Power Supply.	T15	VNEG	Negative Analog Power Supply.
P16	VNEG	Negative Analog Power Supply.	T16	VNEG	Negative Analog Power Supply.
P17	VNEG	Negative Analog Power Supply.	T17	VNEG	Negative Analog Power Supply.
P18	VNEG	Negative Analog Power Supply.	T18	VNEG	Negative Analog Power Supply.
P19	VNEG	Negative Analog Power Supply.	T19	VNEG	Negative Analog Power Supply.
P20	VNEG	Negative Analog Power Supply.	T20	VNEG	Negative Analog Power Supply.
P21	VPOS	Positive Analog Power Supply.	T21	VPOS	Positive Analog Power Supply.
P22	VPOS	Positive Analog Power Supply.	T22	VPOS	Positive Analog Power Supply.
P23	H4	Output Number 4, H Sync.	T23	V3	Output Number 3, V Sync.
P24	OPG4	Output Number 4, Positive Phase.	T24	ONG3	Output Number 3, Negative Phase.
P25	ONR4	Output Number 4, Negative Phase.	T25	OPB3	Output Number 3, Positive Phase.
P26	OPR4	Output Number 4, Positive Phase.	T26	ONB3	Output Number 3, Negative Phase.
R1	IPR7	Input Number 7, Positive Phase.	U1	VNEG	Negative Analog Power Supply.
R2	INR7	Input Number 7, Negative Phase.	U2	VNEG	Negative Analog Power Supply.
R3	IPG7	Input Number 7, Positive Phase.	U3	VNEG	Negative Analog Power Supply.
R4	VPOS	Positive Analog Power Supply.	U4	VPOS	Positive Analog Power Supply.

Pin No.	Mnemonic	Description	Pin No.	Mnemonic	Description
U5	VPOS	Positive Analog Power Supply.	W6	VPOS	Positive Analog Power Supply.
U6	VPOS	Positive Analog Power Supply.	W7	VPOS	Positive Analog Power Supply.
U7	VPOS	Positive Analog Power Supply.	W8	VNEG	Negative Analog Power Supply.
U8	VNEG	Negative Analog Power Supply.	W9	VNEG	Negative Analog Power Supply.
U9	VNEG	Negative Analog Power Supply.	W10	VNEG	Negative Analog Power Supply.
U10	VNEG	Negative Analog Power Supply.	W11	VNEG	Negative Analog Power Supply.
U11	VNEG	Negative Analog Power Supply.	W12	VNEG	Negative Analog Power Supply.
U12	VNEG	Negative Analog Power Supply.	W13	VNEG	Negative Analog Power Supply.
U13	VNEG	Negative Analog Power Supply.	W14	VNEG	Negative Analog Power Supply.
U14	VNEG	Negative Analog Power Supply.	W15	VNEG	Negative Analog Power Supply.
U15	VNEG	Negative Analog Power Supply.	W16	VNEG	Negative Analog Power Supply.
U16	VNEG	Negative Analog Power Supply.	W17	VNEG	Negative Analog Power Supply.
U17	VNEG	Negative Analog Power Supply.	W18	VNEG	Negative Analog Power Supply.
U18	VNEG	Negative Analog Power Supply.	W19	VNEG	Negative Analog Power Supply.
U19	VNEG	Negative Analog Power Supply.	W20	VNEG	Negative Analog Power Supply.
U20	VNEG	Negative Analog Power Supply.	W21	VPOS	Positive Analog Power Supply.
U21	VPOS	Positive Analog Power Supply.	W22	VPOS	Positive Analog Power Supply.
U22	VPOS	Positive Analog Power Supply.	W23	V2	Output Number 2, V Sync.
U23	H3	Output Number 3, H Sync.	W24	ONG2	Output Number 2, Negative Phase.
U24	OPG3	Output Number 3, Positive Phase.	W25	OPB2	Output Number 2, Positive Phase.
U25	ONR3	Output Number 3, Negative Phase.	W26	ONB2	Output Number 2, Negative Phase.
U26	OPR3	Output Number 3, Positive Phase.	Y1	VPOS	Positive Analog Power Supply.
V1	IPR6	Input Number 6, Positive Phase.	Y2	VPOS	Positive Analog Power Supply.
V2	INR6	Input Number 6, Negative Phase.	Y3	VPOS	Positive Analog Power Supply.
V3	IPG6	Input Number 6, Positive Phase.	Y4	VPOS	Positive Analog Power Supply.
V4	VPOS	Positive Analog Power Supply.	Y5	VPOS	Positive Analog Power Supply.
V5	VPOS	Positive Analog Power Supply.	Y6	VPOS	Positive Analog Power Supply.
V6	VPOS	Positive Analog Power Supply.	Y7	VPOS	Positive Analog Power Supply.
V7	VPOS	Positive Analog Power Supply.	Y8	VPOS	Positive Analog Power Supply.
V8	VNEG	Negative Analog Power Supply.	Y9	VPOS	Positive Analog Power Supply.
V9	VNEG	Negative Analog Power Supply.	Y10	VPOS	Positive Analog Power Supply.
V10	VNEG	Negative Analog Power Supply.	Y11	VPOS	Positive Analog Power Supply.
V11	VNEG	Negative Analog Power Supply.	Y12	VPOS	Positive Analog Power Supply.
V12	VNEG	Negative Analog Power Supply.	Y13	VPOS	Positive Analog Power Supply.
V13	VNEG	Negative Analog Power Supply.	Y14	VPOS	Positive Analog Power Supply.
V14	VNEG	Negative Analog Power Supply.	Y15	VPOS	Positive Analog Power Supply.
V15	VNEG	Negative Analog Power Supply.	Y16	VPOS	Positive Analog Power Supply.
V16	VNEG	Negative Analog Power Supply.	Y17	VPOS	Positive Analog Power Supply.
V17	VNEG	Negative Analog Power Supply.	Y18	VPOS	Positive Analog Power Supply.
V18	VNEG	Negative Analog Power Supply.	Y19	VPOS	Positive Analog Power Supply.
V19	VNEG	Negative Analog Power Supply.	Y20	VPOS	Positive Analog Power Supply.
V20	VNEG	Negative Analog Power Supply.	Y21	VPOS	Positive Analog Power Supply.
V21	VPOS	Positive Analog Power Supply.	Y22	VPOS	Positive Analog Power Supply.
V22	VPOS	Positive Analog Power Supply.	Y23	H2	Output Number 2, H Sync.
V23	VPOS	Positive Analog Power Supply.	Y24	OPG2	Output Number 2, Positive Phase.
V24	VPOS	Positive Analog Power Supply.	Y25	ONR2	Output Number 2, Negative Phase.
V25	VPOS	Positive Analog Power Supply.	Y26	OPR2	Output Number 2, Positive Phase.
V26	VPOS	Positive Analog Power Supply.	AA1	VPOS	Positive Analog Power Supply.
W1	INB6	Input Number 6, Negative Phase.	AA2	VPOS	Positive Analog Power Supply.
W2	IPB6	Input Number 6, Positive Phase.	AA3	VPOS	Positive Analog Power Supply.
W3	ING6	Input Number 6, Negative Phase.	AA4	VPOS	Positive Analog Power Supply.
W4	VPOS	Positive Analog Power Supply.	AA5	VPOS	Positive Analog Power Supply.
W5	VPOS	Positive Analog Power Supply.	AA6	VPOS	Positive Analog Power Supply.

Pin No.	Mnemonic	Description	Pin No.	Mnemonic	Description
AA7	VPOS	Positive Analog Power Supply.	AC8	VPOS	Positive Analog Power Supply.
AA8	VPOS	Positive Analog Power Supply.	AC9	VPOS	Positive Analog Power Supply.
AA9	VPOS	Positive Analog Power Supply.	AC10	VPOS	Positive Analog Power Supply.
AA10	VPOS	Positive Analog Power Supply.	AC11	VPOS	Positive Analog Power Supply.
AA11	VPOS	Positive Analog Power Supply.	AC12	VPOS	Positive Analog Power Supply.
AA12	VPOS	Positive Analog Power Supply.	AC13	VPOS	Positive Analog Power Supply.
AA13	VPOS	Positive Analog Power Supply.	AC14	VPOS	Positive Analog Power Supply.
AA14	VPOS	Positive Analog Power Supply.	AC15	VPOS	Positive Analog Power Supply.
AA15	VPOS	Positive Analog Power Supply.	AC16	VPOS	Positive Analog Power Supply.
AA16	VPOS	Positive Analog Power Supply.	AC17	VPOS	Positive Analog Power Supply.
AA17	VPOS	Positive Analog Power Supply.	AC18	VPOS	Positive Analog Power Supply.
AA18	VPOS	Positive Analog Power Supply.	AC19	H0	Output Number 0, H Sync.
AA19	VPOS	Positive Analog Power Supply.	AC20	V0	Output Number 0, V Sync.
AA20	VPOS	Positive Analog Power Supply.	AC21	VPOS	Positive Analog Power Supply.
AA21	VPOS	Positive Analog Power Supply.	AC22	H1	Output Number 1, H Sync.
AA22	VPOS	Positive Analog Power Supply.	AC23	V1	Output Number 1, V Sync.
AA23	VPOS	Positive Analog Power Supply.	AC24	VNEG	Negative Analog Power Supply.
AA24	VNEG	Negative Analog Power Supply.	AC25	VNEG	Negative Analog Power Supply.
AA25	VNEG	Negative Analog Power Supply.	AC26	VNEG	Negative Analog Power Supply.
AA26	VNEG	Negative Analog Power Supply.	AD1	VNEG	Negative Analog Power Supply.
AB1	IPR5	Input Number 5, Positive Phase.	AD2	VNEG	Negative Analog Power Supply.
AB2	INR5	Input Number 5, Negative Phase.	AD3	VNEG	Negative Analog Power Supply.
AB3	IPG5	Input Number 5, Positive Phase.	AD4	IPG4	Input Number 4, Positive Phase.
AB4	VPOS	Positive Analog Power Supply.	AD5	ING4	Input Number 4, Negative Phase.
AB5	VPOS	Positive Analog Power Supply.	AD6	VNEG	Negative Analog Power Supply.
AB6	DGND	Digital Power Supply.	AD7	IPG3	Input Number 3, Positive Phase.
AB7	VDD	Digital Power Supply.	AD8	ING3	Input Number 3, Negative Phase.
AB8	D0	Control Pin, Input Address Bit 0.	AD9	VPOS	Positive Analog Power Supply.
AB9	D1	Control Pin, Input Address Bit 1.	AD10	IPG2	Input Number 2, Positive Phase.
AB10	D2	Control Pin, Input Address Bit 2.	AD11	ING2	Input Number 2, Negative Phase.
AB11	D3	Control Pin, Input Address Bit 3.	AD12	VNEG	Negative Analog Power Supply.
AB12	D4	Control Pin, Input Address Bit 4.	AD13	IPG1	Input Number 1, Positive Phase.
AB13	CMENC	Control Pin, Pass/Stop CM Encoding.	AD14	ING1	Input Number 1, Negative Phase.
AB14	$\overline{WE}$	Control Pin, 1st Rank Write Strobe.	AD15	VPOS	Positive Analog Power Supply.
AB15	$\overline{UPDATE}$	Control Pin, 2nd Rank Write Strobe.	AD16	IPG0	Input Number 0, Positive Phase.
AB16	$\overline{RST}$	Control Pin, 2nd Rank Data Reset.	AD17	ING0	Input Number 0, Negative Phase.
AB17	VDD	Digital Power Supply.	AD18	VNEG	Negative Analog Power Supply.
AB18	DGND	Digital Power Supply.	AD19	OPG0	Output Number 0, Positive Phase.
AB19	VPOS	Positive Analog Power Supply.	AD20	ONG0	Output Number 0, Negative Phase.
AB20	VPOS	Positive Analog Power Supply.	AD21	VPOS	Positive Analog Power Supply.
AB21	VPOS	Positive Analog Power Supply.	AD22	OPG1	Output Number 1, Positive Phase.
AB22	VPOS	Positive Analog Power Supply.	AD23	ONG1	Output Number 1, Negative Phase.
AB23	VPOS	Positive Analog Power Supply.	AD24	VNEG	Negative Analog Power Supply.
AB24	VNEG	Negative Analog Power Supply.	AD25	VNEG	Negative Analog Power Supply.
AB25	VNEG	Negative Analog Power Supply.	AD26	VNEG	Negative Analog Power Supply.
AB26	VNEG	Negative Analog Power Supply.	AE1	VNEG	Negative Analog Power Supply.
AC1	INB5	Input Number 5, Negative Phase.	AE2	VNEG	Negative Analog Power Supply.
AC2	IPB5	Input Number 5, Positive Phase.	AE3	VNEG	Negative Analog Power Supply.
AC3	ING5	Input Number 5, Negative Phase.	AE4	INR4	Input Number 4, Negative Phase.
AC4	VPOS	Positive Analog Power Supply.	AE5	IPB4	Input Number 4, Positive Phase.
AC5	VPOS	Positive Analog Power Supply.	AE6	VNEG	Negative Analog Power Supply.
AC6	VPOS	Positive Analog Power Supply.	AE7	INR3	Input Number 3, Negative Phase.
AC7	VPOS	Positive Analog Power Supply.	AE8	IPB3	Input Number 3, Positive Phase.

Pin No.	Mnemonic	Description
AE9	VPOS	Positive Analog Power Supply.
AE10	INR2	Input Number 2, Negative Phase.
AE11	IPB2	Input Number 2, Positive Phase.
AE12	VNEG	Negative Analog Power Supply.
AE13	INR1	Input Number 1, Negative Phase.
AE14	IPB1	Input Number 1, Positive Phase.
AE15	VPOS	Positive Analog Power Supply.
AE16	INR0	Input Number 0, Negative Phase.
AE17	IPB0	Input Number 0, Positive Phase.
AE18	VNEG	Negative Analog Power Supply.
AE19	ONR0	Output Number 0, Negative Phase.
AE20	OPB0	Output Number 0, Positive Phase.
AE21	VPOS	Positive Analog Power Supply.
AE22	ONR1	Output Number 1, Negative Phase.
AE23	OPB1	Output Number 1, Positive Phase.
AE24	VNEG	Negative Analog Power Supply.
AE25	VNEG	Negative Analog Power Supply.
AE26	VNEG	Negative Analog Power Supply.
AF1	VNEG	Negative Analog Power Supply.
AF2	VNEG	Negative Analog Power Supply.
AF3	VNEG	Negative Analog Power Supply.
AF4	IPR4	Input Number 4, Positive Phase.

Pin No.	Mnemonic	Description
AF5	INB4	Input Number 4, Negative Phase.
AF6	VNEG	Negative Analog Power Supply.
AF7	IPR3	Input Number 3, Positive Phase.
AF8	INB3	Input Number 3, Negative Phase.
AF9	VPOS	Positive Analog Power Supply.
AF10	IPR2	Input Number 2, Positive Phase.
AF11	INB2	Input Number 2, Negative Phase.
AF12	VNEG	Negative Analog Power Supply.
AF13	IPR1	Input Number 1, Positive Phase.
AF14	INB1	Input Number 1, Negative Phase.
AF15	VPOS	Positive Analog Power Supply.
AF16	IPR0	Input Number 0, Positive Phase.
AF17	INB0	Input Number 0, Negative Phase.
AF18	VNEG	Negative Analog Power Supply.
AF19	OPR0	Output Number 0, Positive Phase.
AF20	ONB0	Output Number 0, Negative Phase.
AF21	VPOS	Positive Analog Power Supply.
AF22	OPR1	Output Number 1, Positive Phase.
AF23	ONB1	Output Number 1, Negative Phase.
AF24	VNEG	Negative Analog Power Supply.
AF25	VNEG	Negative Analog Power Supply.
AF26	VNEG	Negative Analog Power Supply.



## TRUTH TABLE AND LOGIC DIAGRAM

Table 15. Operation Truth Table<sup>1</sup>

WE	UPDATE	CLK	SERIN	SEROUT	RST	SER/PAR	CS	CMENC	Operation/Comment
X	X	X	X	X	0	X	X	X	Asynchronous reset. All outputs are disabled. Contents of 45-bit shift register are unchanged.
0	1	1	X	X	1	0	0	X	Broadcast. The data on D0 through D4 is loaded into all locations of the 45-bit shift register. Data is not applied to switch array.
1	1	1	SERIN <sub>i</sub>	SERIN <sub>i-45</sub>	1	0	0	X	Serial mode. The data on the SERIN line is loaded into the 45-bit shift register. The first bit clocked into the shift register appears at SEROUT 45 clock cycles later. Data is not applied to switch array.
0	1	1	X	X	1	1	0	X	Parallel mode. The data on parallel lines D0 through D4 is loaded into the shift register location addressed by A0 through A3. Data is not applied to switch array.
1	0	1	X	X	1	X	0	X	Switch array update. Data in the 45-bit shift register is transferred to the parallel latches and applied to the switch array.
1	X	X	X	X	1	1	0	X	No change in logic.

<sup>1</sup>X = don't care.

620-6690

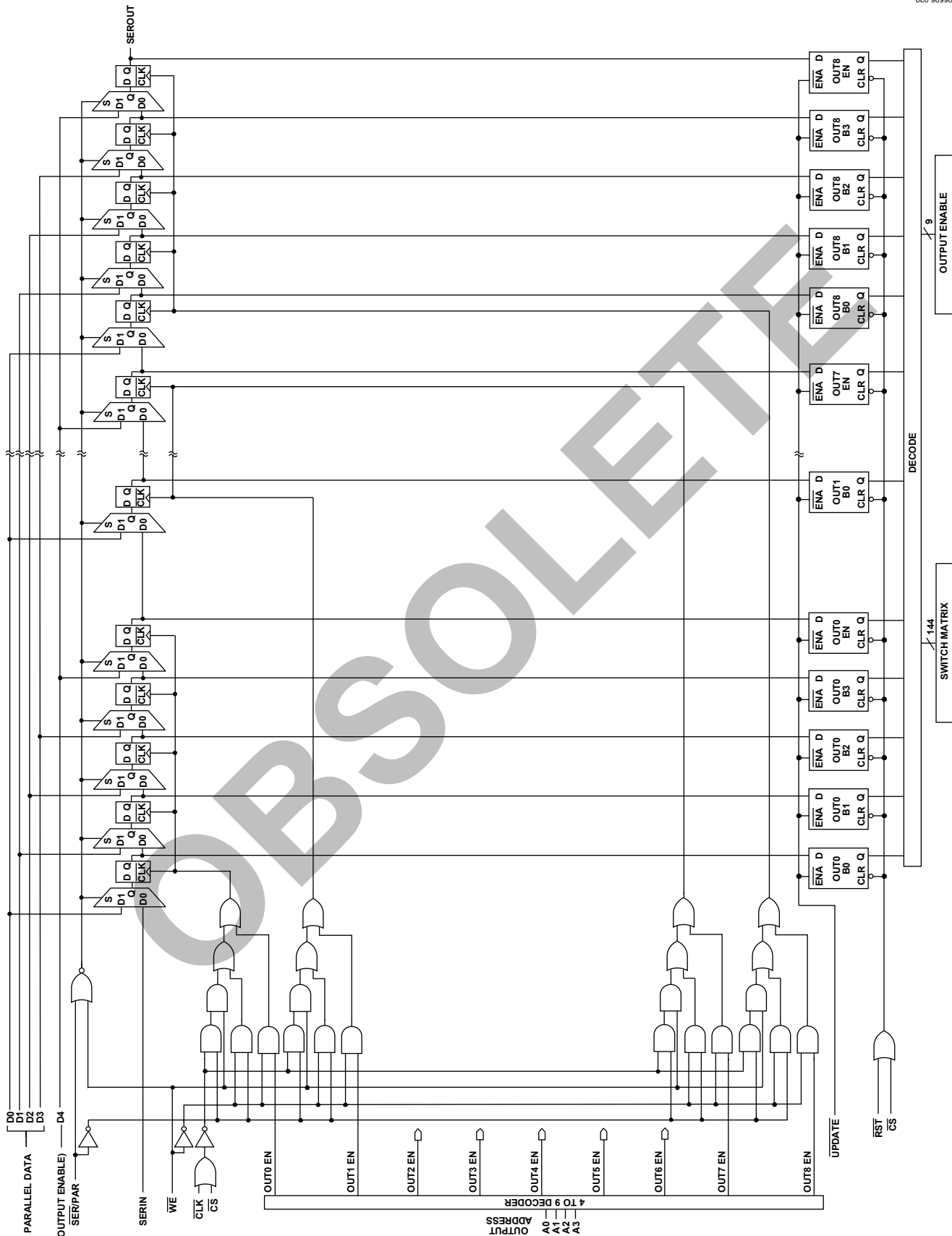

Figure 7. Logic Diagram

# EQUIVALENT CIRCUITS

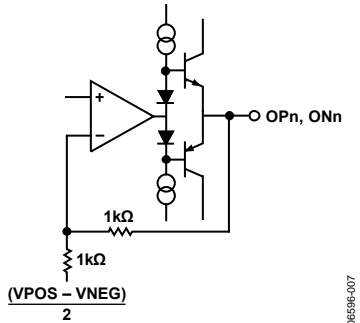

Figure 8. Enabled Output (See Also ESD Protection Map, Figure 19)

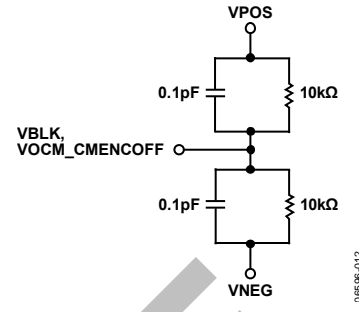

Figure 13. VBLK and VOVM\_CMENCOFF Inputs (See Also ESD Protection Map, Figure 19)

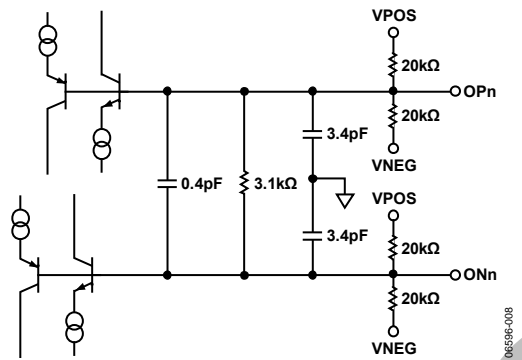

Figure 9. Disabled Output (See Also ESD Protection Map, Figure 19)

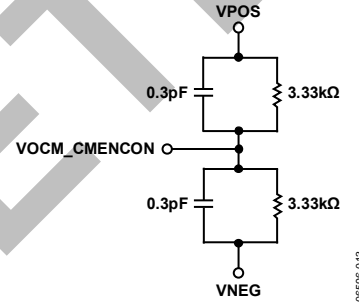

Figure 14. VOVM\_CMENCON Input (See Also ESD Protection Map, Figure 19)

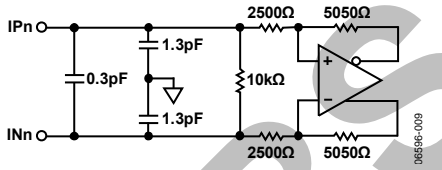

Figure 10. Receiver Differential (See Also ESD Protection Map, Figure 19)

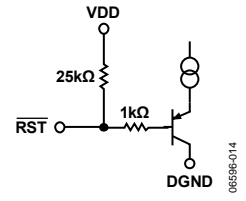

Figure 15.  $\overline{RST}$  Input (See Also ESD Protection Map, Figure 19)

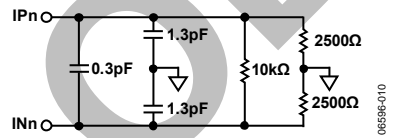

Figure 11. Receiver Simplified Equivalent Circuit When Driving Differentially

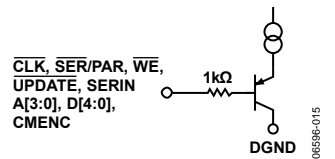

Figure 16. Logic Input (See Also ESD Protection Map, Figure 19)

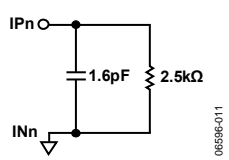

Figure 12. Receiver Simplified Equivalent Circuit When Driving Single-Ended

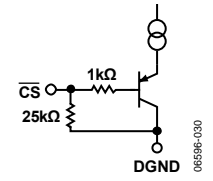

Figure 17.  $\overline{CS}$  Input (See Also ESD Protection Map, Figure 19)

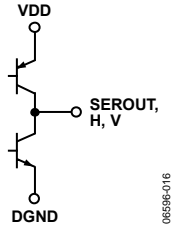

Figure 18. SEROUT, H, V Logic Outputs  
(See Also ESD Protection Map, Figure 19)

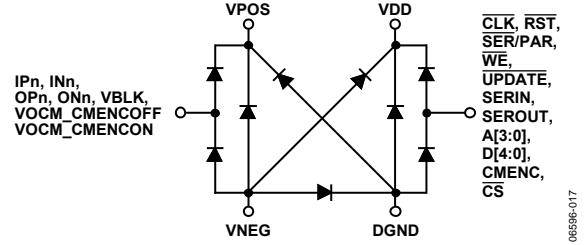

Figure 19. ESD Protection Map

OBSOLETE

# TYPICAL PERFORMANCE CHARACTERISTICS

$V_S = \pm 2.5$  V at  $T_A = 25^\circ\text{C}$ ,  $G = +2$ ,  $R_L = 100 \Omega$  (each output),  $V_{BLK} = 0$  V, output CM voltage = 0 V, differential input/output mode, unless otherwise noted.

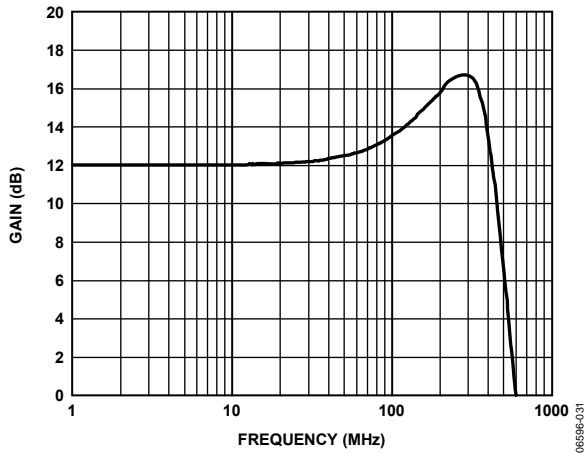

Figure 20. Small Signal Frequency Response, 200 mV p-p

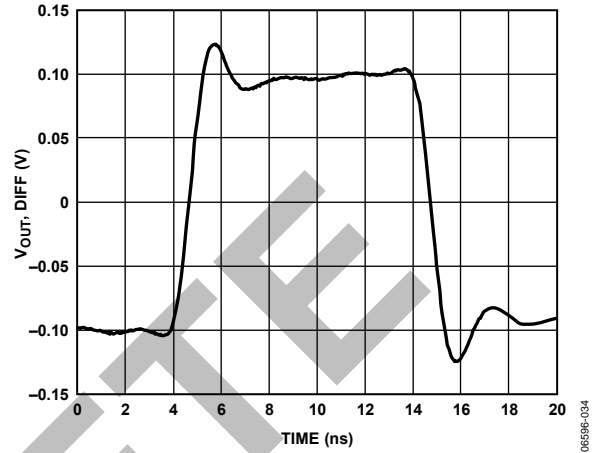

Figure 23. Small Signal Pulse Response, 200 mV p-p

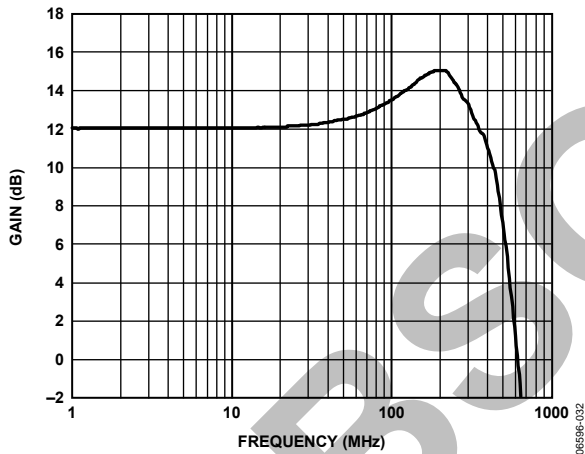

Figure 21. Large Signal Frequency Response, 2 V p-p

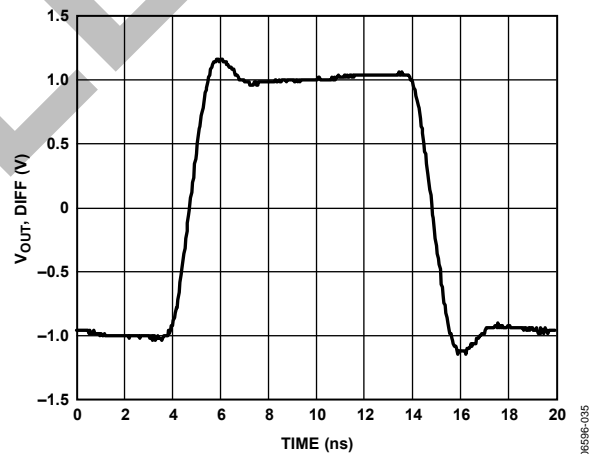

Figure 24. Large Signal Pulse Response, 2 V p-p

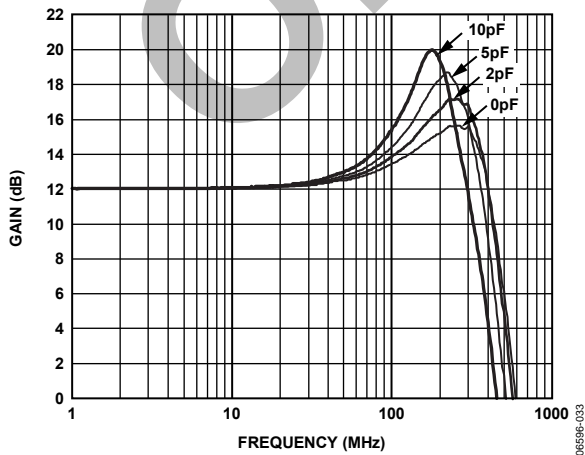

Figure 22. Small Signal Frequency Response with Capacitive Loads

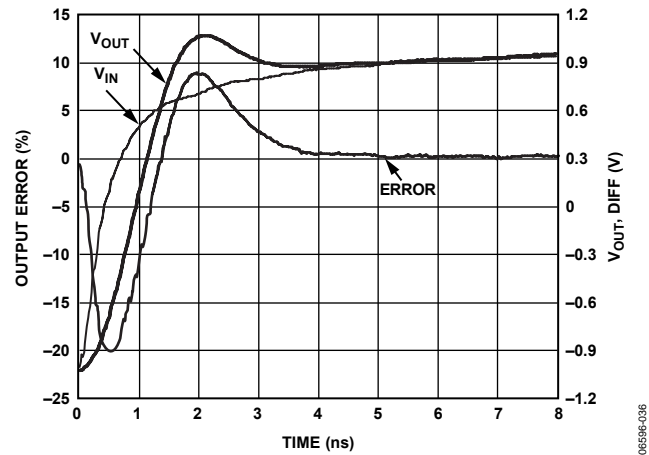

Figure 25. Settling Time

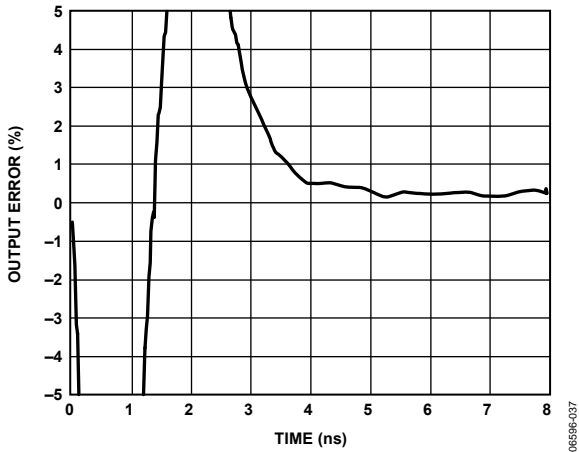

Figure 26. Settling Time, 1% Zoom

06596-037

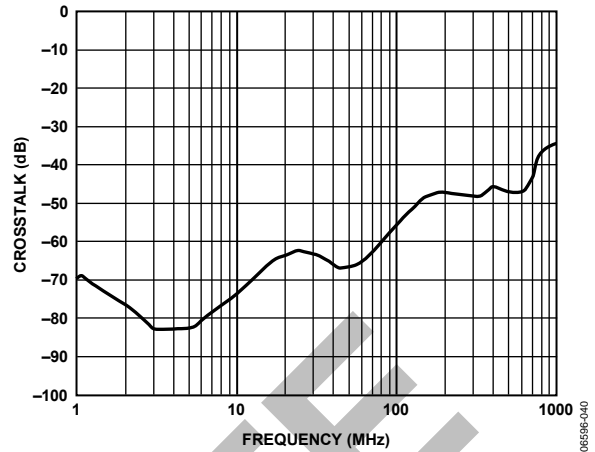

Figure 29. Crosstalk, All Hostile

06596-040

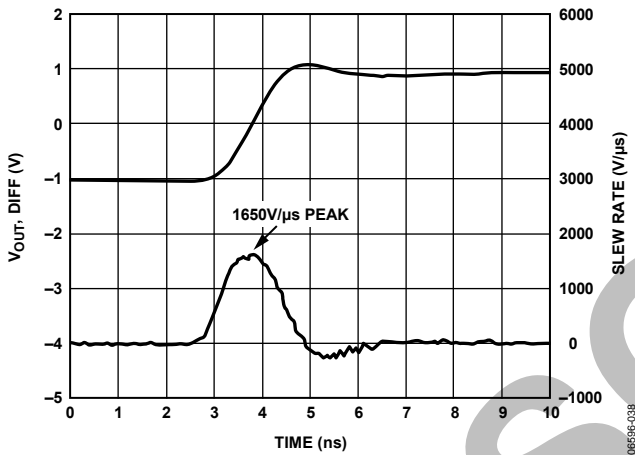

Figure 27. Large Signal Rising Edge Slew Rate

06596-038

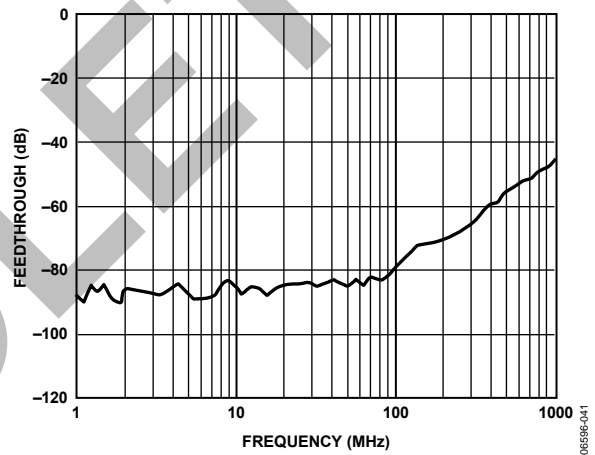

Figure 30. Crosstalk, Off Isolation

06596-041

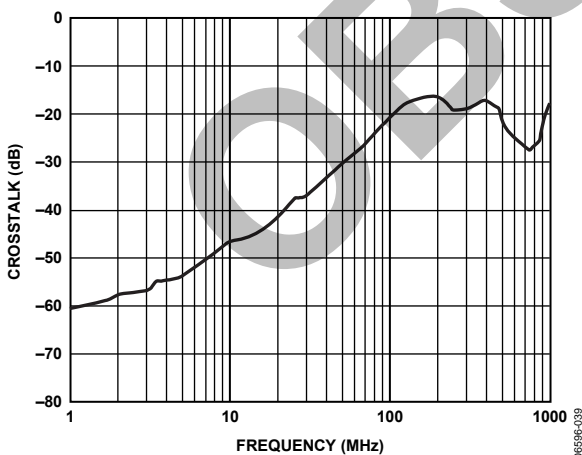

Figure 28. Crosstalk, All Hostile, Single-Ended

06596-039

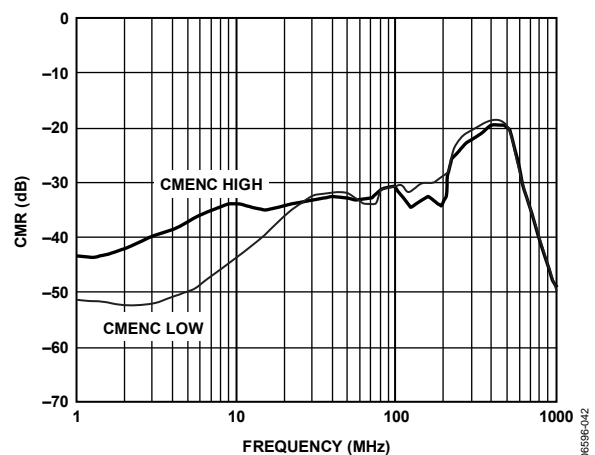

Figure 31. Common-Mode Rejection

06596-042

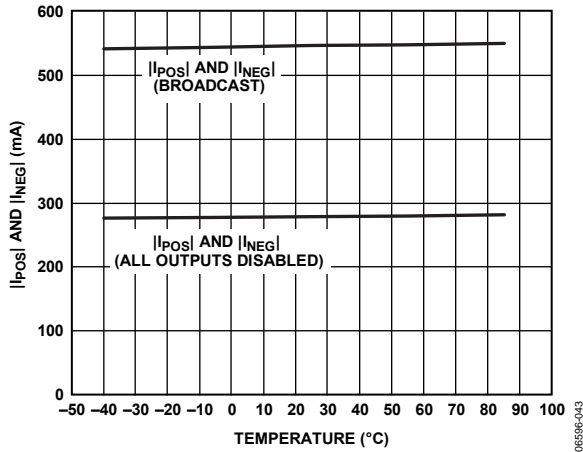

Figure 32. Quiescent Supply Currents vs. Temperature

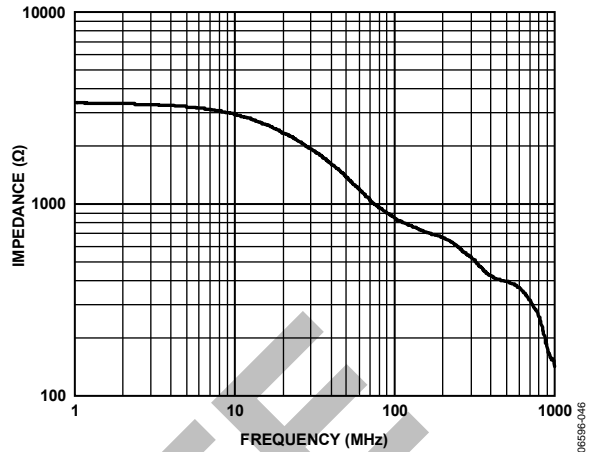

Figure 35. Input Impedance

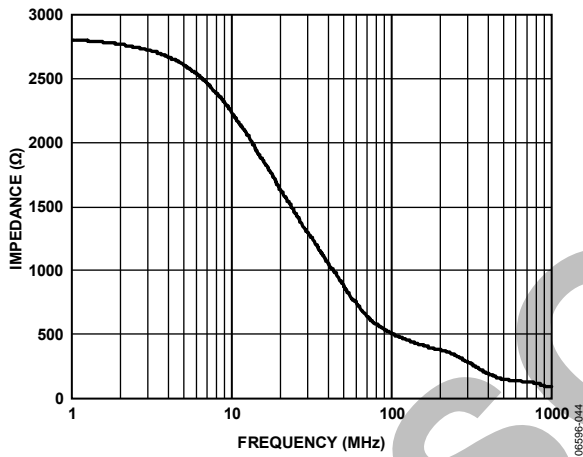

Figure 33. Output Impedance, Disabled

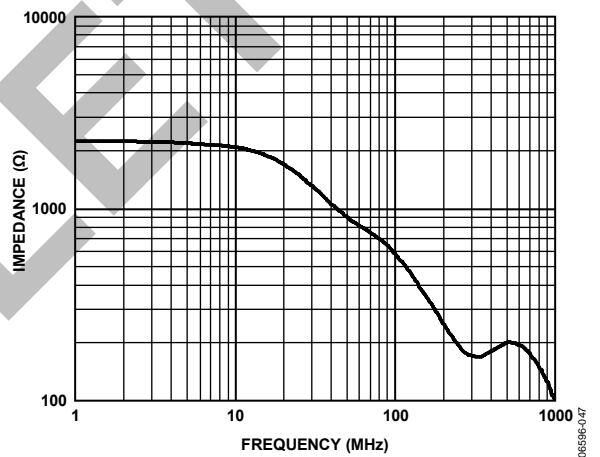

Figure 36. Input Impedance, Single-Ended

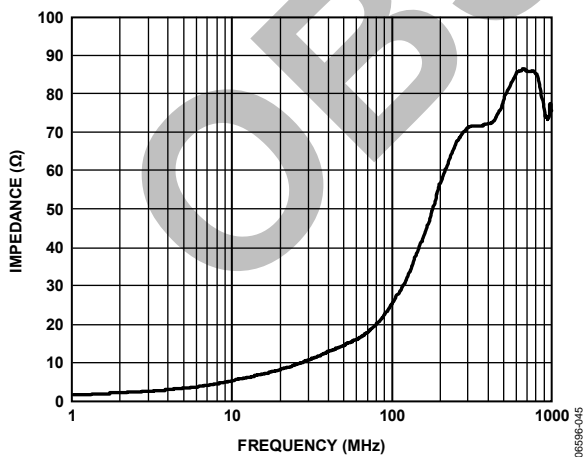

Figure 34. Output Impedance, Enabled

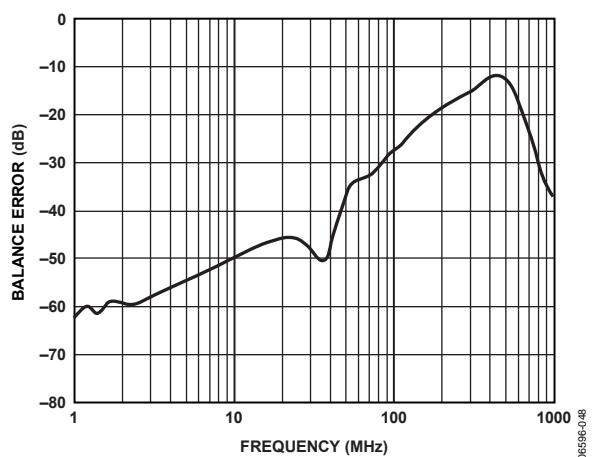

Figure 37. Output Balance Error

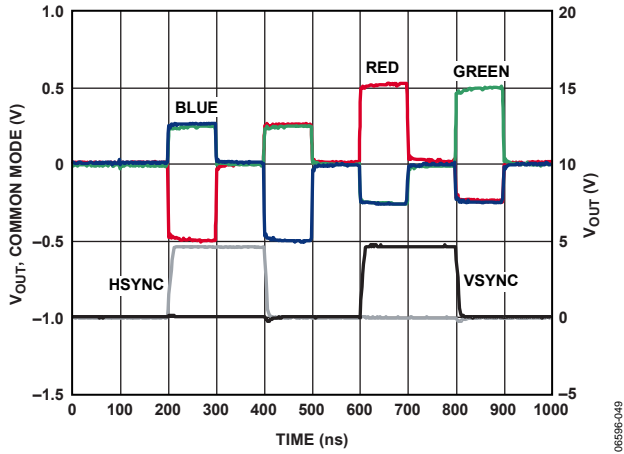

Figure 38. Common-Mode Pulse Response

06596-049

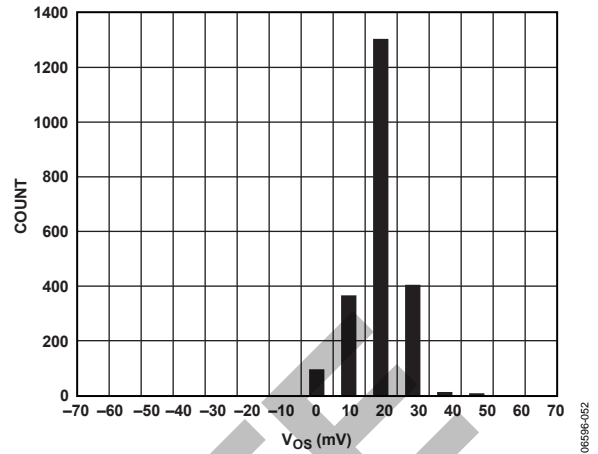

Figure 41. Vos Distribution

06596-052

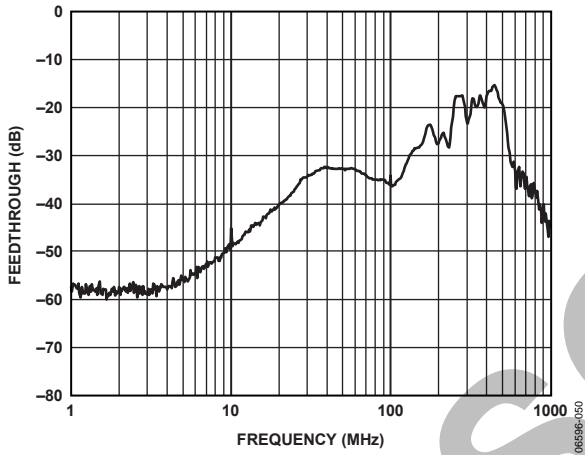

Figure 39. Common-Mode Isolation, CMENC Low

06596-050

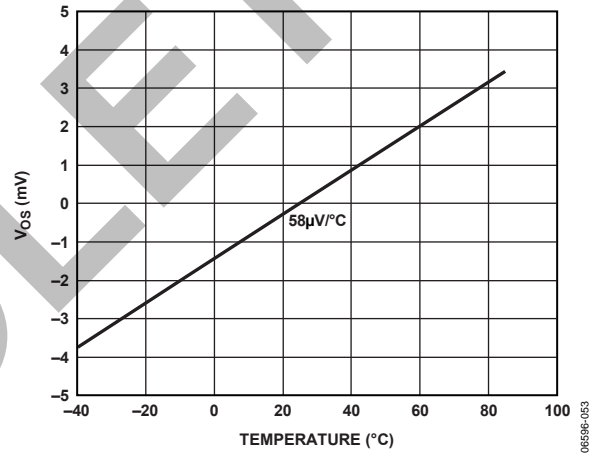

Figure 42. Vos Drift, RTO

06596-053

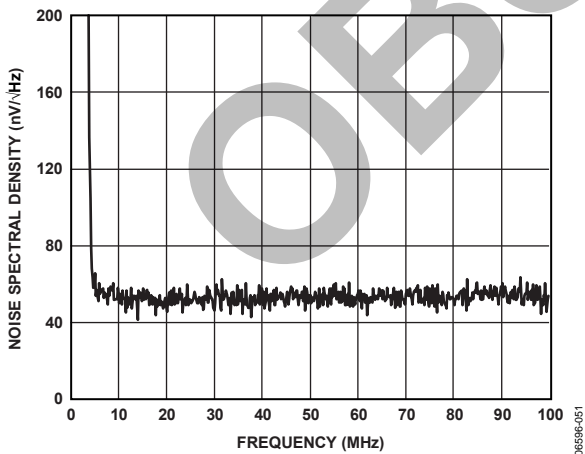

Figure 40. Noise Spectral Density

06596-051

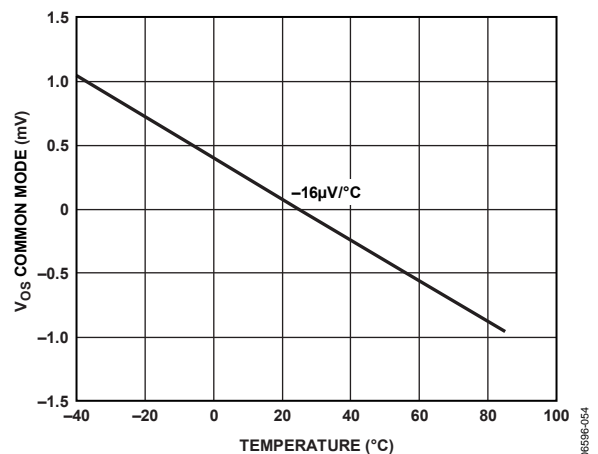

Figure 43. Vos Drift, Common Mode, RTO

06596-054



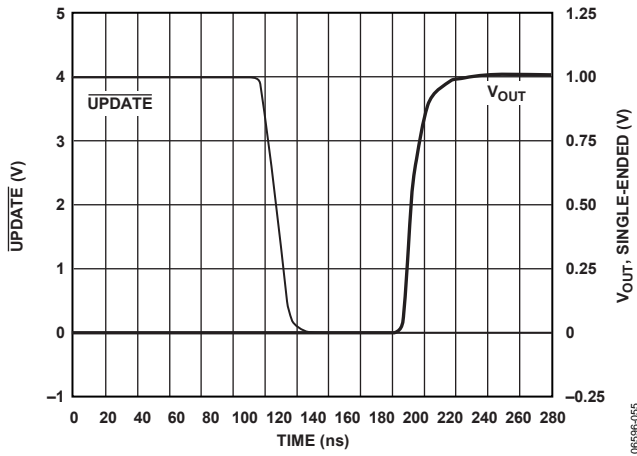

Figure 44. Enable Time

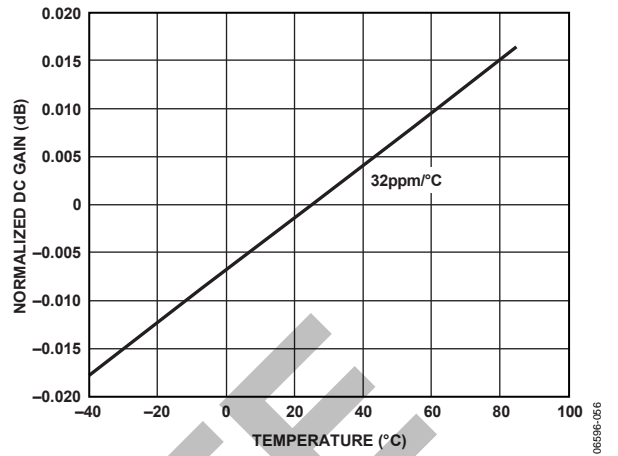

Figure 45. Normalized DC Gain vs. Temperature

OBSOLETE

## THEORY OF OPERATION

The AD8176 is a non-blocking crosspoint with 16 RGB input channels and 9 RGB output channels. Architecturally, the AD8176 is a differential-in, differential-out crosspoint suited for middle of Cat-5 run applications. Furthermore, its differential-in, differential-out gain of +4 and its decoded H and V sync outputs make it the ideal solution for driving a monitor directly. The ability to set the output common mode (CM) and black level through external pins offers additional flexibility.

Processing of CM voltage levels is achieved by placing the AD8176 in either of its two operation modes. In the first operation mode (CMENC low), the input CM of each RGB differential pair (possibly present either in the form of sync-on CM signaling or noise) is removed through the switch, and the output CM is set to a global reference voltage via the VOVM\_CMENCOFF analog input. In this mode, the AD8176 behaves as a traditional differential-in, differential-out switch. If sync-on CM signaling is present at the differential RGB inputs, then the H and V outputs represent decoded syncs. In the second operation mode (CMENC high), input sync-on CM signaling is propagated through the switch with unity gain. In this mode, the overall output CM is set to a global reference voltage via the VOVM\_CMENCON analog input. Note that in both operation modes, the overall input CM is blocked through the switch.

Input pin VBLK defines the black level of the positive output phase. The combination of VBLK and VOVM\_CMENCOFF allows the user to position the positive and negative output phases anywhere in the allowable output voltage range, thus maximizing output headroom usage.

The switch is organized into nine 16:1 RGB multiplexers, with each being responsible for connecting an RGB input channel to its respective RGB output channel. Decoding logic selects a single input (or none) in each multiplexer and connects it to its respective output. Feedback around each multiplexer realizes a closed-loop differential-in, differential-out gain of +2 in the core.

Each differential RGB input channel is buffered by a differential receiver, which is capable of accepting input CM voltages extending all the way to either supply rail. Excess closed-loop receiver bandwidth reduces the effect of the receiver on the overall device bandwidth. Feedback around each differential receiver realizes a gain of +2 yielding an overall differential-in, differential-out crosspoint gain of +4. A separate loop realizes a closed-loop common-mode gain of +1.

The output stage is designed for fast slew rate and settling time while driving a series-terminated Cat-5 cable. Unlike competing multiplexer designs, the small signal bandwidth closely approaches the large signal bandwidth.

The outputs of the AD8176 can be disabled to minimize on-chip power dissipation. When disabled, there is only a common-mode feedback network of 2.7 k $\Omega$  between the differential outputs. This high impedance allows multiple ICs to be bussed together without additional buffering. Care must be taken to reduce output capacitance, which can result in overshoot and frequency domain peaking. A series of internal amplifiers drive internal nodes such that wideband high impedance is presented at the disabled output, even while the output bus experiences fast signal swings. When the outputs are disabled and driven externally, the voltage applied to them must not exceed the valid output swing range for the AD8176 to keep these internal amplifiers in their linear range of operation. Applying excessive differential voltages to the disabled outputs can cause damage to the AD8176 and must be avoided (see the Absolute Maximum Ratings section for guidelines).

The connectivity of the AD8176 is controlled by a flexible TTL-compatible logic interface. Either parallel or serial loading into a first rank of latches preprograms each output. A global update signal moves the programming data into the second rank of latches, simultaneously updating all outputs. In serial mode, a serial-out pin allows devices to be daisy-chained together for a single-pin programming of multiple ICs. A power-on reset pin is available to avoid bus conflicts by disabling all outputs. This power-on reset clears the second rank of latches, but does not clear the first rank of latches. A broadcast parallel programming feature is available in parallel mode to quickly clear the first rank. In serial mode, preprogramming individual inputs is not possible and the entire shift register needs to be flushed. A global chip-select pin gates the input clock and the global update signal to the second rank of buffers.

The AD8176 can operate on a single +5 V supply, powering both the signal path (with the VPOS/VNEG supply pins) and the control logic interface (with the VDD/DGND supply pins). Split supply operation is possible with  $\pm 2.5$  V supplies to easily interface to ground-referenced video signals. In this case, a flexible logic interface allows the control logic supplies (VDD/DGND) to be run off +5 V/0 V to +3.3 V/0 V while the analog core remains on split supplies. Additional flexibility in the analog output common-mode level (VOVM\_CMENCOFF) and output black level (VBLK) facilitates operation with unequally split supplies. If +3 V/-2 V supplies to +2 V/-3 V supplies are desired, the output CM can still be set to 0 V for ground-referenced video signals.

# APPLICATIONS INFORMATION

## OPERATING MODES

Depending on the state of the CMENC logic input, the AD8176 can be set in either of two differential-in, differential-out operating modes. In addition, monitors can be driven directly by tapping the outputs single-ended and making use of the decoded H and V sync outputs.

### Middle of Cat-5 Run Application, CM Encoding Turned Off

In this application, the AD8176 is placed somewhere in the middle of a Cat-5 run. By tying CMENC low, the CM of each RGB differential pair is removed through the device (or turned off), while the overall CM at the output is defined by the reference value VOCM\_CMENCOFF. In this mode of operation, CM noise is removed, while the intended differential RGB signals are buffered and passed to the outputs. The AD8176 is placed in this operation mode when used in a sync-on color scheme. Figure 46 shows the voltage levels and CM handling for a single input channel connected to a single output channel in a middle of Cat-5 run application with CM encoding turned off.

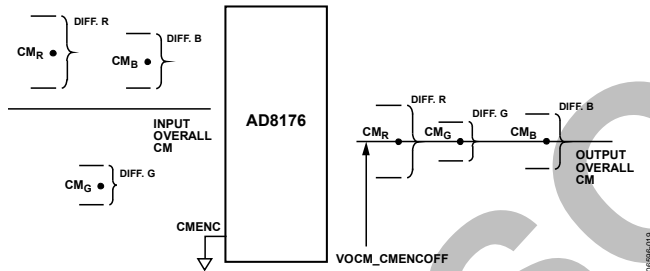

Figure 46. AD8176 in a Middle of Cat-5 Run Application, CM Encoding Off (Note that in this application, the H and V outputs, though asserted, are not used.)

Inputs VBLK and VOCM\_CMENCOFF allow the user complete flexibility in defining the output CM level and the amount of overlap between the positive and negative phases, thus maximizing output headroom usage. Whenever VBLK differs from VOCM\_CMENCOFF by more than  $\pm 100$  mV, a differential voltage  $\Delta_{diff}$  is added at the outputs according to the expression  $\Delta_{diff} = 2 \times (VBLK - VOCM\_CMENCOFF)$ . Conversely, whenever the difference between VBLK and VOCM\_CMENCOFF is less than  $\pm 100$  mV, no differential voltage is added at the outputs.

### Middle of Cat-5 Run Application, CM Encoding Turned On

In this application, the AD8176 is also placed somewhere in the middle of a Cat-5 run, although the common-mode handling is different. By tying CMENC high, the CM of each RGB input is passed through the device with a gain of +1, while at the same time, the overall output CM is stripped and set equal to the voltage applied at the VOCM\_CMENCON pin. The AD8176 is placed in this operation mode when used with a sync-on CM scheme. Although asserted, the H and V outputs are not used in this application. Figure 47 shows the voltage levels and CM handling

for a single input channel connected to a single output channel in a middle of Cat-5 run application with CM encoding turned on.

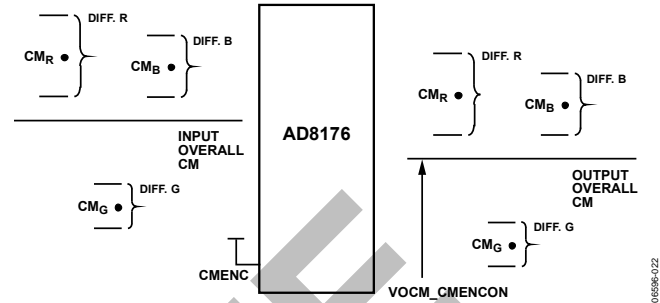

Figure 47. AD8176 in Middle of Cat-5 Run Application, CM Encoding On (Note that in this application, the H and V outputs, though asserted, are not used)

In this operation mode, the difference  $\Delta_{diff} = 2 \times (VBLK - VOCM\_CMENCOFF)$  still adds an output differential voltage, as described in the previous section.

### End of Cat-5 Run Application, CM Encoding Turned Off—Driving a Monitor Directly

In this application, the AD8176 is placed at the end of a Cat-5 run to drive a monitor directly—the differential outputs are tapped single-ended to drive the inputs of the monitor, CMENC is tied to logic low to remove the sync-on CM information at the output of the device, and the decoded H and V sync outputs are tied to the sync inputs of the monitor.

The differential-in, differential-out gain of +4 provides a differential-in, single-ended out gain of +2 at the output pins of the AD8176. This yields the correct differential-in, single-ended out gain of +1 at the input of the monitor.

The relationship between the incoming sync-on CM signaling and the H and V syncs is defined according to Table 16.

Table 16. H and V Sync Truth Table ( $V_{POS}/V_{NEG} = \pm 2.5$  V)

CM <sub>R</sub>	CM <sub>G</sub>	CM <sub>B</sub>	H	V
0.5	0	0	Low	High
0	0.5	-0.5	Low	Low
-0.5	0.5	0	High	Low
0	-0.5	0.5	High	High

The following two statements are equivalent to the truth table (see Table 16) in producing H and V for all allowable CM inputs:

- H sync is high when the CM of blue is larger than the CM of red
- V sync is high when the combined CM of red and blue is larger than the CM of green.

For a practical example, refer to Figure 48. (Note that the output pulses have been shifted slightly with respect to each other for clarity.)

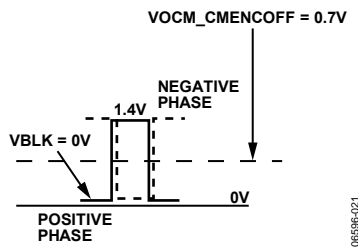

Figure 48. Output at the AD8176 pins for 0 V to 0.7 V Input Differential Pulse,  $VBLK = 0\text{ V}$ ,  $VOVM\_CMENCOFF = 0.7\text{ V}$

The input to the AD8176 is a differential pulse with a low level of 0 V and a high level of 0.7 V. VBLK is set to 0 V, while VOVM\_CMENCOFF is set to 0.7 V. With this choice of values, the positive and negative output phases are overlapped, (with the positive phase ranging from 0 V to 1.4 V, and the negative phase ranging from 1.4 V to 0 V, respectively). The supplies are set to +3 V/−2 V to be in compliance with output headroom requirements.

The voltage on the positive output phase for a 0 V differential input is equal to the voltage on VBLK, for all cases when VBLK and VOVM\_CMENCOFF differ by more than  $\pm 100\text{ mV}$ .

## PROGRAMMING

The AD8176 has two options for changing the programming of the crosspoint matrix. In the first option, a serial word of 45 bits can be provided that updates the entire matrix each time. The second option allows for changing programming of a single output via a parallel interface. The serial option requires fewer signals, but more time (clock cycles) for changing the programming; the parallel programming technique requires more signals, but allows for changing a single output at a time, therefore requiring fewer clock cycles.

### Serial Programming Description

The serial programming mode uses the  $\overline{CS}$ , CLK, SERIN,  $\overline{UPDATE}$ , and SER/PAR device pins. The first step is to enable the CLK on by pulling  $\overline{CS}$  low. Next, SER/PAR is pulled low to enable the serial programming mode. Hold the parallel clock  $\overline{WE}$  high during the entire serial programming operation.

Ensure that the  $\overline{UPDATE}$  signal is high during the time that the data is shifted into the serial port of the device. Although the data still shifts in when  $\overline{UPDATE}$  is low, the transparent, asynchronous latches allow the shifting data to reach the matrix. This causes the matrix to try to update to every intermediate state as defined by the shifting data.

The data at SERIN is clocked in at every falling edge of CLK. A total of 45 bits must be shifted in to complete the programming. A total of five bits must be supplied for each of the nine RGB output channels, an output enable bit (D4) and four bits (D3 to D0) that determine the input channel. If D4 is low (output

disabled), the four associated bits (D3 to D0) do not matter, because no input is switched to that output.

The most-significant-output-address data is shifted in first, with the enable bit (D4) shifted in first, followed by the input address (D3 to D0) entered sequentially with D3 first and D0 last. Each remaining output is programmed sequentially, until the least-significant-output-address data is shifted in. At this point,  $\overline{UPDATE}$  can be taken low, which causes the programming of the device according to the data that was just shifted in. The  $\overline{UPDATE}$  latches are asynchronous and when  $\overline{UPDATE}$  is low, they are transparent.

If more than one AD8176 device is to be serially programmed in a system, the SEROUT signal from one device can be connected to the SERIN of the next device to form a serial chain. Connect all of the  $\overline{CLK}$ ,  $\overline{UPDATE}$ , and SER/PAR pins in parallel and operate as described previously. The serial data is input to the SERIN pin of the first device of the chain, and it ripples through to the last. Therefore, the data for the last device in the chain must come at the beginning of the programming sequence. The length of the programming sequence is 45 bits times the number of devices in the chain.  $\overline{CS}$  gates the CLK and  $\overline{UPDATE}$  signals; when  $\overline{CS}$  is held high, both  $\overline{CLK}$  and  $\overline{UPDATE}$  are held in their inactive high state, and when  $\overline{CS}$  is held low, both CLK and  $\overline{UPDATE}$  function normally.

### Parallel Programming Description

When using the parallel programming mode, it is not necessary to reprogram the entire device when making changes to the matrix. In fact, parallel programming allows the modification of a single output or more at a time. Since this takes only one  $\overline{WE}/\overline{UPDATE}$  cycle, significant time savings can be realized by using parallel programming.

One important consideration in using parallel programming is that the RST signal does not reset all registers in the AD8176. When taken low, the RST signal only sets each output to the disabled state. This is helpful during power-up to ensure that two parallel outputs are not active at the same time.

After initial power-up, the internal registers in the device generally have random data, even though the RST signal has been asserted. If parallel programming is used to program one output, that output is properly programmed, but the rest of the device will have a random program state depending on the internal register content at power-up. Therefore, when using parallel programming, it is essential that all outputs be programmed to a desired state after power-up. This ensures that the programming matrix is always in a known state. From then on, parallel programming can be used to modify a single output or more at a time.

In similar fashion, if  $\overline{\text{UPDATE}}$  is taken low after initial power-up, the random power-up data in the shift register is programmed into the matrix. Therefore, to prevent the crosspoint from being programmed into an unknown state, do not apply a logic level to  $\overline{\text{UPDATE}}$  after power is initially applied. Programming the full shift register once to a desired state, by either serial or parallel programming after initial power-up, eliminates the possibility of programming the matrix to an unknown state.

To change the programming output via parallel programming, take  $\overline{\text{CS}}$  low, while  $\overline{\text{SER/PAR}}$  and  $\overline{\text{UPDATE}}$  are taken high. Leave the serial programming clock,  $\overline{\text{CLK}}$ , high during parallel programming. Start the parallel clock,  $\overline{\text{WE}}$ , in a high state. Put the 4-bit address of the output to be programmed on A3 to A0. Data Bit D3 to Data Bit D0 must contain the information that identifies the input that is programmed to the output that is addressed. Data Bit D4 determines the enabled state of the output. If D4 is low (output disabled), the data on D3 to D0 does not matter.

After the desired address and data signals have been established, they can be latched into the shift register by a high to low transition of the  $\overline{\text{WE}}$  signal. The matrix is not programmed, however, until the  $\overline{\text{UPDATE}}$  signal is taken low. It is thus possible to latch in new data for several or all of the outputs first via successive negative transitions of  $\overline{\text{WE}}$  while  $\overline{\text{UPDATE}}$  is held high, and then have all the new data take effect when  $\overline{\text{UPDATE}}$  goes low. Use this technique when programming the device for the first time after power-up when using parallel programming.

### Reset

When powering up the AD8176, it is usually desirable to have the outputs come up in the disabled state. The  $\overline{\text{RST}}$  pin, when taken low, causes all outputs to be in the disabled state. However, the  $\overline{\text{RST}}$  signal does not reset all registers in the AD8176. This is important when operating in the parallel programming mode. Please refer to that section for information about programming internal registers after power-up. Serial programming programs the entire matrix each time, so no special considerations apply.

Because the data in the shift register is random after power-up, do not use it to program the matrix, or the matrix can enter unknown states. To prevent this, do not apply a logic low signal to  $\overline{\text{UPDATE}}$  initially after power-up. Load the shift register first with the desired data, and only then can  $\overline{\text{UPDATE}}$  go low to program the device.

The  $\overline{\text{RST}}$  pin has a 20 k $\Omega$  pull-up resistor to VDD that can be used to create a simple power-up reset circuit. A capacitor from  $\overline{\text{RST}}$  to ground holds  $\overline{\text{RST}}$  low for some time while the rest of the device stabilizes. The low condition causes all the outputs to be disabled. The capacitor then charges through the pull-up resistor to the high state, thus allowing full programming capability of the device.

### Broadcast

The AD8176 logic interface has a broadcast mode, in which all first rank latches can be simultaneously parallel-programmed to the same data in one write-cycle. This is especially useful in clearing random first rank data after power-up. To access the broadcast mode, the device is parallel programmed using the  $\overline{\text{WE}}$ , A0 to A3, D0 to D4, and  $\overline{\text{UPDATE}}$  device pins. The only difference is that the  $\overline{\text{SER/PAR}}$  pin is held low, as if serial programming were taking place. By holding  $\overline{\text{CLK}}$  high, no serial clocking occurs, and instead, the  $\overline{\text{WE}}$  can be used to clock all first rank latches in the chip at once.

### DIFFERENTIAL AND SINGLE-ENDED OPERATION

Although the AD8176 has fully differential inputs and outputs, it can also be operated in a single-ended fashion. Single-ended and differential configurations are discussed in the following sections, along with implications on gain, impedances, and terminations.

#### Differential Input

Each differential input to the AD8176 is applied to a differential receiver. These receivers allow the user to drive the inputs with an uncertain common-mode voltage, such as from a remote source over twisted pair. The receivers respond only to the differences in input voltages and restore an internal common mode suitable for the internal signal path. Noise or crosstalk, which affect the inputs of each receiver equally, are rejected by the input stage, as specified by its common-mode rejection ratio (CMRR).

Furthermore, the overall common-mode voltage of all three differential pairs comprising an RGB channel is processed and rejected by a separate circuit block. For example, a static discharge or a resistive voltage drop in a middle of Cat-5 run application with sync-on CM signaling coupling into all three pairs in an RGB channel are rejected at the output of the AD8176, while the sync-on CM signals are allowed through the switch.

The circuit configuration used by the differential input receivers is similar to that of several Analog Devices, Inc. general-purpose differential amplifiers, such as the AD8131. The topology is that of a voltage-feedback amplifier with internal gain resistors. The input differential impedance for each receiver is 5 k $\Omega$  in parallel with 10 k $\Omega$  or 3.33 k $\Omega$ , as shown in Figure 49.

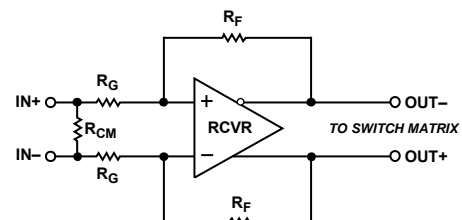

Figure 49. Input Receiver Equivalent Circuit

065596-023

This impedance creates a small differential termination error if the user does not account for the 3.33 k $\Omega$  parallel element. However, this error is less than 1% in most cases. Additionally, the source impedance driving the AD8176 appears in parallel with the internal gain-setting resistors, such that there may be a gain error for some values of source resistance. The AD8176 is adjusted such that its gain is correct when driven by a back terminated Cat-5 cable (25  $\Omega$  effective impedance to ground at each input pin, or 100  $\Omega$  differential source impedance across pairs of input pins). If a different source impedance is presented, calculate the differential gain of the AD8176 input receiver by

$$G_{DM} = \frac{5.05 \text{ k}\Omega}{2.5 \text{ k}\Omega + R_S}$$

where  $R_S$  is the effective impedance to ground at each input pin.

When operating with a differential input, care must be taken to keep the common-mode, or average, of the input voltages within the linear operating range of the AD8176 receiver. For the AD8176 receiver, this common-mode range can extend rail-to-rail, provided the differential signal swing is small enough to avoid forward biasing the ESD diodes (it is safest to keep the common-mode plus differential signal excursions within the supply voltages of the device).

The input voltage of the AD8176 is linear for  $\pm 0.5$  V of differential input voltage difference (this limitation is primarily due to the ability of the output to swing close to the rails, because the differential gain through the device is +4). Beyond this level, the signal path saturates and limits the signal swing. This is not a desired operation, as the supply current increases and the signal path slows to recover from clipping. The absolute maximum allowed differential input signal is limited by long-term reliability of the input stage. Observed the limits in the Absolute Maximum Ratings section to avoid degrading device performance permanently.

### AC Coupling of Inputs

It is possible to ac-couple the inputs of the AD8176 receiver, so that bias current does not need to be supplied externally. A capacitor in series with the inputs to the AD8176 creates a high-pass filter with the input impedance of the device. This capacitor needs to be sized large enough so that the corner frequency includes all frequencies of interest.

### Single-Ended Input

The AD8176 input receiver can be driven single-ended (unbalanced). Single-ended inputs apply a component of common-mode signal to the receiver inputs, which is then rejected by the receiver (see the Specifications section for common-mode-to-differential-mode ratio of the device).

The single-ended input resistance,  $R_{IN}$ , differs from the differential input impedance, and is equal to

$$R_{IN} = \frac{R_G}{1 - \frac{R_F}{2 \times (R_G + R_F)}} \quad (1)$$

with  $R_G$  and  $R_F$ , as shown in Figure 49.

Note that this value is smaller than the differential input resistance, but it is larger than  $R_G$ . The difference is due to the component of common-mode level applied to the receiver by single-ended inputs. A second, smaller component of input resistance ( $R_{CM}$ , also shown in Figure 49) is present across the inputs in both single-ended and differential operation.

In single-ended operation, an input is driven, and the undriven input is often tied to midsupply or ground. Because signal frequency current flows at the undriven input, treat such an input as a signal line in the board design.

For example, to achieve best dynamic performance, terminate the undriven input with impedance matching that is seen by the device at the driven input.

## Differential Output

### Benefits of Differential Operation

The AD8176 has a fully differential switch core with differential outputs. The two output voltages move in opposite directions, with a differential feedback loop maintaining a fixed output stage differential gain of +2 through the core. This differential output stage provides improved crosstalk cancellation due to parasitic coupling from one output to another being equal and out of phase. Additionally, if the output of the device is utilized in a differential design, then noise, crosstalk, and offset voltages generated on-chip that are coupled equally into both outputs are cancelled by the common-mode rejection ratio of the next device in the signal chain. By utilizing the AD8176 outputs in a differential application, the best possible noise and offset specifications can be realized.

### Differential Gain

The specified signal path gain of the AD8176 refers to its differential gain. For the AD8176, the gain of +4 means that the difference in voltage between the two output terminals is equal to four times the difference between the two input terminals.

### Common-Mode Gain

The common mode, or average voltage pairs of output signals is set by the voltage on the VOVM\_CMENCOFF pin when common-mode encoding is off (CMENC is a logic low), or by the voltage on the VOVM\_CMENCON pin when common-mode encoding is on (CMENC is a logic high). Note that in the latter case, VCOM\_CMENCON sets the overall common-mode of RGB triplets of differential outputs, while the individual common-mode of each RGB output is free to change. VCOM\_CMENCON and VCOM\_CMENCOFF are typically set to midsupply (often ground), but can be moved approximately  $\pm 0.5$  V to accommodate cases where the desired output common-mode voltage may not be midsupply (as in the case of unequal split supplies). Adjusting the output common-mode voltage beyond  $\pm 0.5$  V can limit differential swing internally below the specifications on the data sheet. The overall common-mode of the output voltages follow the voltage applied to VOVM\_

CMENCON or VCOM\_CMENCOFF, implying a gain of +1. Likewise, sync-on common-mode signaling is carried through the AD8176 (CMENC must be in its high state), implying a gain of +1 for this path as well.

The common-mode reference pins are analog signal inputs, common to all output stages on the device. They require only small amounts of bias current, but noise appearing on these pins is buffered to all the output stages. As such, connect them to low noise, low impedance voltage references to avoid being sources of noise, offset, and crosstalk in the signal path.

### Termination

The AD8176 is designed to drive 100  $\Omega$  terminated to ground on each output (or an effective 200  $\Omega$  differential) while meeting data sheet specifications over the specified operating temperature range, if care is taken to observe the maximum power derating curves.

Termination at the load end is recommended to shorten settling time and for best signal integrity. In differential signal paths, it is often desirable to series-terminate the outputs, with a resistor in series with each output. A side effect of termination is an attenuation of the output signal by a factor of two. In this case, gain is usually necessary somewhere else in the signal path to restore the signal level.

Whenever a differential output is used single-ended, it is desirable to terminate the used single-ended output with a series resistor, as well as to place a resistor on the unused output to match the load seen by the used output.

When disabled, the outputs float to midsupply. A small current is required to drive the outputs away from their midsupply state. This current is easily provided by an AD8176 output (in its enabled state) bussed together with the disabled output. Exceeding the allowed output voltage range may saturate internal nodes in the disabled output, and consequently an increase in disabled output current may be observed.

### Single-Ended Output

#### Usage

The AD8176 output pairs can be used single-ended, taking only one output and not using the second. This is often desired to reduce the routing complexity in the design, or because a single-ended load is being driven directly. This mode of operation produces good results, but has some shortcomings when compared to taking the output differentially. When observing the single-ended output, noise that is common to both outputs appears in the output signal.

When observing the output single-ended, the distribution of offset voltages appear greater. In the differential case, the difference between the outputs when the difference between the inputs is zero is a small differential offset. This offset is created from mismatches in devices in the signal path. In the single-ended case, this differential offset is still observed, but an additional offset component is also relevant. This additional component is

the common-mode offset, which is the difference between the average of the outputs and the output common-mode reference. This offset is created by mismatches that affect the signal path in a common-mode manner. A differential receiver rejects this common-mode offset voltage, but in the single-ended case, this offset is observed with respect to the signal ground. The single-ended output sums half the differential offset voltage and all of the common-mode offset voltage for a net increase in observed offset.

### Single-Ended Gain

The AD8176 operates as a closed-loop differential amplifier. The primary control loop forces the difference between the output terminals to be a ratio of the difference between the input terminals. One output increases in voltage, while the other decreases an equal amount to make the total output voltage difference correct. The average of these output voltages is forced to the voltage on the common-mode reference terminal (VOCM\_CMENCOFF or VOCM\_CMENCON) by a second control loop. If only one output terminal is observed with respect to the common-mode reference terminal, only half of the difference voltage is observed. This implies that when using only one output of the device, half of the differential gain is observed. An AD8176 taken with single-ended output appears to have a gain of +2.

It is important to note that all considerations applying to the used output phase regarding output voltage headroom, apply unchanged to the complement output phase even if this is not actually used.

### Termination

When operating the AD8176 with a single-ended output, the preferred output termination scheme is to refer the load to the output common-mode. A series-termination can be used, at an additional cost of one half the signal gain.

In single-ended output operation, the complementary phase of the output is not used, and may or may not be terminated locally. Although the unused output can be floated to reduce power dissipation, there are several reasons for terminating the unused output with a load resistance matched to the load on the signal output.

One component of crosstalk is magnetic coupling by mutual inductance between output package traces and bond wires that carry load current. In a differential design, there is coupling from one pair of outputs to other adjacent pairs of outputs. The differential nature of the output signal simultaneously drives the coupling field in one direction for one phase of the output, and in an opposite direction for the other phase of the output. These magnetic fields do not couple equally into adjacent output pairs due to different proximities, but they do destructively cancel the crosstalk to some extent. If the load current in each output is equal, this cancellation is greater and less adjacent crosstalk is observed (regardless of whether the second output is actually being used).

A second benefit of balancing the output loads in a differential pair is to reduce fluctuations in current requirements from the power supply. In single-ended loads, the load currents alternate from the positive supply to the negative supply. This creates a parasitic signal voltage in the supply pins due to the finite resistance and inductance of the supplies. This supply fluctuation appears as crosstalk in all outputs, attenuated by the power supply rejection ratio (PSRR) of the device. At low frequencies, this is a negligible component of crosstalk, but PSRR falls off as frequency increases. With differential, balanced loads, as one output draws current from the positive supply, the other output draws current from the negative supply. When the phase alternates, the first output draws current from the negative supply and the second from the positive supply. The effect is that a more constant current is drawn from each supply, such that the crosstalk-inducing supply fluctuation is minimized.

A third benefit of driving balanced loads can be seen if one considers that the output pulse response changes as load changes. The differential signal control loop in the AD8176 forces the difference of the outputs to be a fixed ratio to the difference of the inputs. If the two output responses are different due to loading, this creates a difference that the control loop sees as signal response error, and it attempts to correct this error. This distorts the output signal from the ideal response compared to the case when the two outputs are balanced.

### Decoupling

The signal path of the AD8176 is based on high open-loop gain amplifiers with negative feedback. Dominant-pole compensation is used on-chip to stabilize these amplifiers over the range of expected applied swing and load conditions. To guarantee this designed stability, proper supply decoupling is necessary with respect to both the differential control loops and the common-mode control loops of the signal path. Signal-generated currents must return to their sources through low impedance paths at all frequencies in which there is still loop gain (up to 700 MHz at a minimum).

The signal path compensation capacitors in the AD8176 are connected to the VNEG supply. At high frequencies, this limits the power supply rejection ratio (PSRR) from the VNEG supply to a lower value than that from the VPOS supply. If given a choice, design an application board such that the VNEG power is supplied from a low inductance plane, subject to a least amount of noise.

VOCM\_CMENCON and VOCM\_CMENCOFF are high speed common-mode control loops of all output drivers. In the single-ended output sense, there is no rejection from noise on these inputs to the outputs. For this reason, care must be taken to produce low noise sources over the entire range of frequencies of interest. This is not only important to single-ended operation, but to differential operation, as there is a common-mode-to-differential gain conversion that becomes greater at higher frequencies.

VOCM\_CMENCON and VOCM\_CMENCOFF are internally buffered to prevent transients flowing into or out of these inputs from acting on the source impedance and becoming sources of crosstalk.

### Power Dissipation

#### Calculation of Power Dissipation

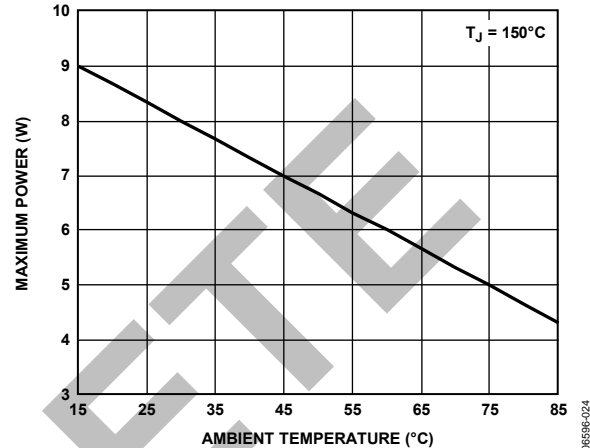

Figure 50. Maximum Die Power Dissipation vs. Ambient Temperature

The curve in Figure 50 was calculated from

$$P_{D,MAX} = \frac{T_{JUNCTION,MAX} - T_{AMBIENT}}{\theta_{JA}} \quad (2)$$

As an example, if the AD8176 is enclosed in an environment at 45°C ( $T_A$ ), the total on-chip dissipation under all load and supply conditions must not be allowed to exceed 7.0 W.

When calculating on-chip power dissipation, it is necessary to include the power dissipated in the output devices due to current flowing in the loads. For a sinusoidal output about ground and symmetrical split supplies, the on-chip power dissipation due the load can be approximated by

$$P_{D,OUTPUT} = (V_{POS} - V_{OUTPUT,RMS}) \times I_{OUTPUT,RMS} \quad (3)$$

For nonsinusoidal output, calculate the power dissipation by integrating the on-chip voltage drop across the output devices multiplied by the load current over one period.

The user can subtract the quiescent current for the Class AB output stage when calculating the loaded power dissipation. For each output stage driving a load, subtract a quiescent power, according to

$$P_{DQ,OUTPUT} = (V_{POS} - V_{NEG}) \times I_{OUTPUT,QUIESCENT} \quad (4)$$

where  $I_{OUTPUT,QUIESCENT} = 1.65$  mA for each single-ended output pin for the AD8176.

For each disabled RGB output channel, the quiescent power supply current in VPOS and VNEG drops by approximately 34 mA.



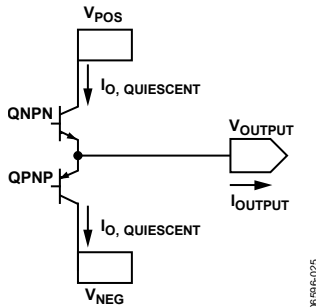

Figure 51. Simplified Output Stage

### Example

For the AD8176, with an ambient temperature of 85°C, all nine RGB output channels driving 1 V rms into 100 Ω loads, and power supplies at ±2.5 V, follow these steps:

1. Calculate power dissipation of AD8176 using data sheet quiescent currents. Neglecting  $V_{DD}$  current, as it is insignificant.

$$P_{D, QUIESCENT} = (V_{POS} \times I_{VPOS}) + (V_{NEG} \times I_{VNEG}) \quad (5)$$

$$P_{D, QUIESCENT} = (2.5 \text{ V} \times 600 \text{ mA}) + (2.5 \text{ V} \times 600 \text{ mA}) = 3 \text{ W}$$

2. Calculate power dissipation from loads. For a differential output and ground-referenced load, the output power is symmetrical in each output phase.

$$P_{D, OUTPUT} = (V_{POS} - V_{OUTPUT, RMS}) \times I_{OUTPUT, RMS} \quad (6)$$

$$P_{D, OUTPUT} = (2.5 \text{ V} - 1 \text{ V}) \times (1 \text{ V} / 100 \Omega) = 15 \text{ mW}$$

There are 27 output pairs, or 54 output currents.

$$nP_{D, OUTPUT} = 54 \times 15 \text{ mW} = 0.81 \text{ W}$$

3. Subtract quiescent output stage current for number of loads (54 in this example). The output stage is either standing or driving a load, but the current only needs to be counted once (valid for output voltages > 0.5 V).

$$P_{DQ, OUTPUT} = (V_{POS} - V_{NEG}) \times I_{OUTPUT, QUIESCENT} \quad (7)$$

$$P_{DQ, OUTPUT} = (2.5 \text{ V} - (-2.5 \text{ V})) \times 1.65 \text{ mA} = 8.25 \text{ mW}$$

There are 27 output pairs, or 54 output currents.

$$nP_{D, OUTPUT} = 54 \times 8.25 \text{ mW} = 0.45 \text{ W}$$

4. Verify that the power dissipation does not exceed the maximum allowed value.

$$P_{D, ON-CHIP} = P_{D, QUIESCENT} + nP_{D, OUTPUT} - nP_{DQ, OUTPUT} \quad (8)$$

$$P_{D, ON-CHIP} = 3 \text{ W} + 0.81 \text{ W} - 0.45 \text{ W} = 3.36 \text{ W}$$

From Figure 50 or Equation 2, this power dissipation is below the maximum allowed dissipation for all ambient temperatures up to and including 85°C.

In a general case, the power delivered by the digital supply and dissipated into the digital output devices has to be taken into account following a similar derivation. However, because the loads driven by the H and V outputs are high and the voltage at

these outputs typically sits close either rail, the correction to the on-chip power estimate is small. Furthermore, the H and V outputs are active only briefly during sync generation and returned to digital ground thereafter.

### Short-Circuit Output Conditions

Although there is short-circuit current protection on the AD8176 outputs, the output current can reach values of 80 mA into a grounded output. Any sustained operation with too many shorted outputs can exceed the maximum die temperature and can result in device failure (see the Absolute Maximum Ratings section).

### Crosstalk

Many systems (such KVM switches) that handle numerous analog signal channels have strict requirements for keeping the various signals from influencing any of the other signals in the system. Crosstalk is the term used to describe the coupling of the signals of other nearby channels to a given channel.

When there are many signals in close proximity in a system, as is undoubtedly the case in a system that uses the AD8176, the crosstalk issues can be quite complex. A good understanding of the nature of crosstalk and some definition of terms is required to specify a system that uses one or more crosspoint devices.

### Types of Crosstalk

Crosstalk can be propagated by means of any of three methods. These fall into the categories of electric field, magnetic field, and the sharing of common impedances. This section explains these effects.

Every conductor can be both a radiator of electric fields and a receiver of electric fields. The electric field crosstalk mechanism occurs when the electric field created by the transmitter propagates across a stray capacitance (for example, free space) and couples with the receiver and induces a voltage. This voltage is an unwanted crosstalk signal in any channel that receives it.

Currents flowing in conductors create magnetic fields that circulate around the currents. These magnetic fields then generate voltages in any other conductors whose paths they link. The undesired induced voltages in these other channels are crosstalk signals. The channels that crosstalk can be said to have a mutual inductance that couples signals from one channel to another.

Various channels generally share the power supplies, grounds, and other signal return paths of a multichannel system. When a current from one channel flows in one of these paths, a voltage that is developed across the impedance becomes an input crosstalk signal for other channels that share the common impedance.

All these sources of crosstalk are vector quantities, so the magnitudes cannot simply be added together to obtain the total crosstalk. In fact, there are conditions where driving additional circuits in parallel in a given configuration can actually reduce

the crosstalk. The fact that the AD8176 is a fully differential design means that many sources of crosstalk either destructively cancel, or are common-mode to the signal and can be rejected by a differential receiver.

### Areas of Crosstalk

A practical AD8176 circuit must be mounted to an actual circuit board to connect it to power supplies and measurement equipment. This, however, raises the issue that the crosstalk of a system is a combination of the intrinsic crosstalk of the devices in addition to the circuit board to which they are mounted. It is important to try to separate these two areas when attempting to minimize the effect of crosstalk.

In addition, crosstalk can occur among the inputs to a crosspoint and among the outputs. It can also occur from input to output. In the following sections, techniques are discussed for diagnosing which part of a system is contributing to crosstalk.

### Measuring Crosstalk

Crosstalk is measured by applying a signal to one or more channels and measuring the relative strength of that signal on a desired selected channel. The measurement is usually expressed as decibels down from the magnitude of the test signal. The crosstalk is expressed by

$$|XT| = 20 \log_{10} \left( \frac{A_{SEL}(s)}{A_{TEST}(s)} \right) \quad (9)$$

where:

$s$  is the Laplace transform variable ( $s = j\omega$ ).

$A_{SEL}(s)$  is the amplitude of the crosstalk induced signal in the selected channel.

$A_{TEST}(s)$  is the amplitude of the test signal.

It can be seen that crosstalk is a function of frequency, but not a function of the magnitude of the test signal (to first order). In addition, the crosstalk signal has a phase relative to the test signal associated with it.

A network analyzer is most commonly used to measure crosstalk over a frequency range of interest. It can provide both magnitude and phase information about the crosstalk signal.

As a crosspoint system or device grows larger, the number of theoretical crosstalk combinations and permutations can become extremely large. For example, in the case of the triple  $16 \times 9$  matrix of the AD8176, look at the number of crosstalk terms that can be considered for a single channel, say input channel INPUT0. INPUT0 is programmed to connect to one of the AD8176 outputs where the measurement can be made.

First, the crosstalk terms associated with driving a test signal into each of the other 15 input channels can be measured one at a time, while applying no signal to INPUT0. Then, the crosstalk terms associated with driving a parallel test signal into all 15 other inputs can be measured two at a time in all possible combinations, then three at a time, and so on, until, finally,

there is only one way to drive a test signal into all 15 other input channels in parallel.

Each of these cases is legitimately different from the others and can yield a unique value, depending on the resolution of the measurement system, but it is hardly practical to measure all these terms and then specify them. In addition, this describes the crosstalk matrix for just one input channel. A similar crosstalk matrix can be proposed for every other input. In addition, if the possible combinations and permutations for connecting inputs to the other outputs (not used for measurement) are taken into consideration, the numbers rather quickly grow to astronomical proportions. If a larger crosspoint array of multiple AD8176s is constructed, the numbers grow larger still.

Obviously, some subset of all these cases must be selected to be used as a guide for a practical measure of crosstalk. One common method is to measure all hostile crosstalk; this means that the crosstalk to the selected channel is measured while all other system channels are driven in parallel. In general, this yields the worst crosstalk number, but this is not always the case, due to the vector nature of the crosstalk signal.

Other useful crosstalk measurements are those created by one nearest neighbor or by the two nearest neighbors on either side. These crosstalk measurements are generally higher than those of more distant channels, so they can serve as a worst-case measure for any other one-channel or two-channel crosstalk measurements.

### Input and Output Crosstalk

Capacitive coupling is voltage-driven ( $dV/dt$ ), but is generally a constant ratio. Capacitive crosstalk is proportional to input or output voltage, but this ratio is not reduced by simply reducing signal swings. Attenuation factors must be changed by changing impedances (lowering mutual capacitance), or destructive canceling must be utilized by summing equal and out of phase components. For high input impedance devices such as the AD8176, capacitances generally dominate input-generated crosstalk.

Inductive coupling is proportional to current ( $dI/dt$ ), and often scales as a constant ratio with signal voltage, but also shows a dependence on impedances (load current). Inductive coupling can also be reduced by constructive canceling of equal and out of phase fields. In the case of driving low impedance video loads, output inductances contribute highly to output crosstalk.

The flexible programming capability of the AD8176 can be used to diagnose whether crosstalk is occurring more on the input side or the output side. Some examples are illustrative. A given input channel (INPUT7 roughly in the middle for this example) can be programmed to drive OUTPUT4 (exactly in the middle). The inputs to INPUT7 are terminated to ground (via  $50 \Omega$  or  $75 \Omega$ ) and no signal is applied.

All the other inputs are driven in parallel with the same test signal (practically provided by a distribution amplifier), with all other outputs except OUTPUT4 disabled. Because grounded INPUT7 is programmed to drive OUTPUT4, no signal should be present. Any signal that is present can be attributed to the other 15 hostile input signals, because no other outputs are driven (they are all disabled). Thus, this method measures the all hostile input contribution to crosstalk into INPUT7. Of course, the method can be used for other input channels and combinations of hostile inputs.

For output crosstalk measurement, a single input channel is driven (INPUT0, for example) and all outputs other than a given output (OUTPUT4 in the middle) are programmed to connect to INPUT0. OUTPUT4 is programmed to connect to INPUT15 (far away from INPUT0), which is terminated to ground. Thus, OUTPUT4 should not have a signal present because it is listening to a quiet input. Any signal measured at the OUTPUT4 can be attributed to the output crosstalk of the other eight hostile outputs. Again, this method can be modified to measure other channels and other crosspoint matrix combinations.

### Effect of Impedances on Crosstalk

The input side crosstalk can be influenced by the output impedance of the sources that drive the inputs. The lower the impedance of the drive source, the lower the magnitude of the crosstalk. The dominant crosstalk mechanism on the input side is capacitive coupling. The high impedance inputs do not have significant current flow to create magnetically induced crosstalk. However, significant current can flow through the input termination resistors and the loops that drive them. Thus, the PC board on the input side can contribute to magnetically coupled crosstalk.

From a circuit standpoint, the input crosstalk mechanism looks like a capacitor coupling to a resistive load. For low frequencies, the magnitude of the crosstalk is given by

$$|XT| = 20 \log_{10} [(R_S C_M) \times s] \quad (10)$$

where:

$R_S$  is the source resistance.

$C_M$  is the mutual capacitance between the test signal circuit and the selected circuit.

$s$  is the Laplace transform variable.

From Equation 10, it can be observed that this crosstalk mechanism has a high-pass nature; it can also be minimized by reducing the coupling capacitance of the input circuits and lowering the output impedance of the drivers. If the input is driven from a 75  $\Omega$  terminated cable, the input crosstalk can be reduced by buffering this signal with a low output impedance buffer.

On the output side, the crosstalk can be reduced by driving a lighter load. Although the AD8176 is specified with excellent settling time when driving a properly terminated Cat-5, the crosstalk is higher than the minimum obtainable due to the high output currents. These currents induce crosstalk via the mutual inductance of the output pins and bond wires of the AD8176.

From a circuit standpoint, this output crosstalk mechanism looks like a transformer with a mutual inductance between the windings that drives a load resistor. For low frequencies, the magnitude of the crosstalk is given by

$$|XT| = 20 \log_{10} \left( M_{XY} \times \frac{s}{R_L} \right) \quad (11)$$

where:

$M_{XY}$  is the mutual inductance of output X to output Y.

$R_L$  is the load resistance on the measured output.

This crosstalk mechanism can be minimized by keeping the mutual inductance low and increasing  $R_L$ . The mutual inductance can be kept low by increasing the spacing of the conductors and minimizing their parallel length.

### PCB Layout

Extreme care must be exercised to minimize additional crosstalk generated by the system circuit board(s). The areas that must be carefully detailed are grounding, shielding, signal routing, and supply bypassing.

The packaging of the AD8176 is designed to help keep the crosstalk to a minimum. On the PBGA substrate, each pair is carefully routed to predominately couple to each other, with shielding traces separating adjacent signal pairs. The ball grid array is arranged such that similar board routing can be achieved. Input and output differential pairs are grouped by channel rather than by color to allow for easy, convenient board routing.

The input and output signals have minimum crosstalk if they are located between ground planes on layers above and below, and separated by ground in between. Locate vias as close to the IC as possible to carry the inputs and outputs to the inner layer. The input and output signals surface at the input termination resistors and the output series back termination resistors. To the extent possible, also separate these signals as soon as they emerge from the IC package.

### PCB Termination Layout

As frequencies of operation increase, the importance of proper transmission line signal routing becomes more important. The bandwidth of the AD8176 is large enough that using high impedance routing does not provide a flat in-band frequency response for practical signal trace lengths. It is necessary for the user to choose a characteristic impedance suitable for the application and properly terminate the input and output signals of the AD8176. Traditionally, video applications have used 75  $\Omega$  single-ended environments. RF applications are generally 50  $\Omega$  single-ended (and board manufacturers have the most experience with this application). CAT- cabling is usually driven as differential pairs of 100  $\Omega$  differential impedance.

For flexibility, the AD8176 does not contain on-chip termination resistors. This flexibility in application comes with some board layout challenges. The distance between the termination of the input transmission line and the AD8176 die is a high impedance stub, and causes reflections of the input signal. With some simplification, it can be shown that these reflections cause peaking of the input at regular intervals in frequency, dependent on the propagation speed ( $V_p$ ) of the signal in the chosen board material and the distance ( $d$ ) between the termination resistor and the AD8176. If the distance is great enough, these peaks can occur in-band. In fact, practical experience shows that these peaks are not high-Q, and must be pushed out to three or four times the desired bandwidth to not have an effect on the signal. For a board designer using FR4 ( $V_p = 144 \times 10^6$  m/s), this means the AD8176 must be no more than 1.5 cm after the termination resistors, and preferably placed even closer. The PBGA substrate routing inside the AD8176 is approximately 1 cm in length and adds to the stub length, so 1.5 cm PCB routing equates to  $d = 2.5 \times 10^{-2}$  m in the calculations.

$$f_{PEAK} = \frac{(2n + 1)V_p}{4d} \quad (12)$$

where  $n = \{0, 1, 2, 3, \dots\}$ .

In some cases, it is difficult to place the termination close to the AD8176 due to space constraints, differential routing, and large resistor footprints. A preferable solution in this case is to maintain a controlled transmission line past the AD8176 inputs and terminate the end of the line. This is known as fly-by termination. The input impedance of the AD8176 is large enough and stub length inside the package is small enough that this works well in practice. Implementation of fly-by input termination often includes bringing the signal in on one routing layer, then passing through a filled-via under the AD8176 input ball, then back out to termination on another signal layer. In this case, care must be taken to tie the reference ground planes together near the signal via if the signal layers are referenced to different ground planes.

If multiple AD8176s are driven in parallel, a fly-by input termination scheme is very useful, but the distance from each AD8176 input to the driven input transmission line is a stub that must be minimized in length and parasitics using the discussed guidelines.

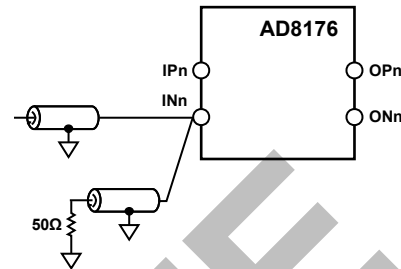

Figure 52. Fly-By Input Termination (Grounds for the two transmission lines shown must be tied together close to the INn pin.)

When driving the AD8176 single-ended, the undriven input is often terminated with a resistance to balance the input stage. It is seen that by terminating the undriven input with a resistor of one-half the characteristic impedance, the input stage is perfectly balanced (25  $\Omega$ , for example, to balance the two parallel 50  $\Omega$  terminations on the driven input). However, due to the feedback in the input receiver, there is high speed signal current leaving the undriven input. To terminate this high speed signal, use proper transmission line techniques. One solution is to adjust the trace width to create a transmission line of half the characteristic impedance and terminate the far end with this resistance (25  $\Omega$  in a 50  $\Omega$  system). This is not often practical as trace widths become large. In most cases, the best practical solution is to place the half-characteristic impedance resistor as close as possible (preferably less than 1.5 cm away) and to reduce the parasitics of the stub (by removing the ground plane under the stub, for example). In either case, the designer must decide if the layout complexity created by a balanced, terminated solution is preferable to simply grounding the undriven input at the ball with no trace.

While the examples discussed so far are for input termination, the theory is similar for output back termination. Taking the AD8176 as an ideal voltage source, any distance of routing between the AD8176 and a back termination resistor is an impedance mismatch that potentially creates reflections. For this reason, also place back termination resistors close to the AD8176. In practice, because back termination resistors are series elements, they can be placed close to the AD8176 outputs.

Finally, the AD8176 pinout allows the user to bring the outputs out as surface traces to the back termination resistors. The designer can avoid creating stubs and reflections by keeping the AD8176 output signal path on the surface of the board. A stub is created when a top-to-bottom via connection is made on the output signal path that is perpendicular to the signal flow.

OUTLINE DIMENSIONS

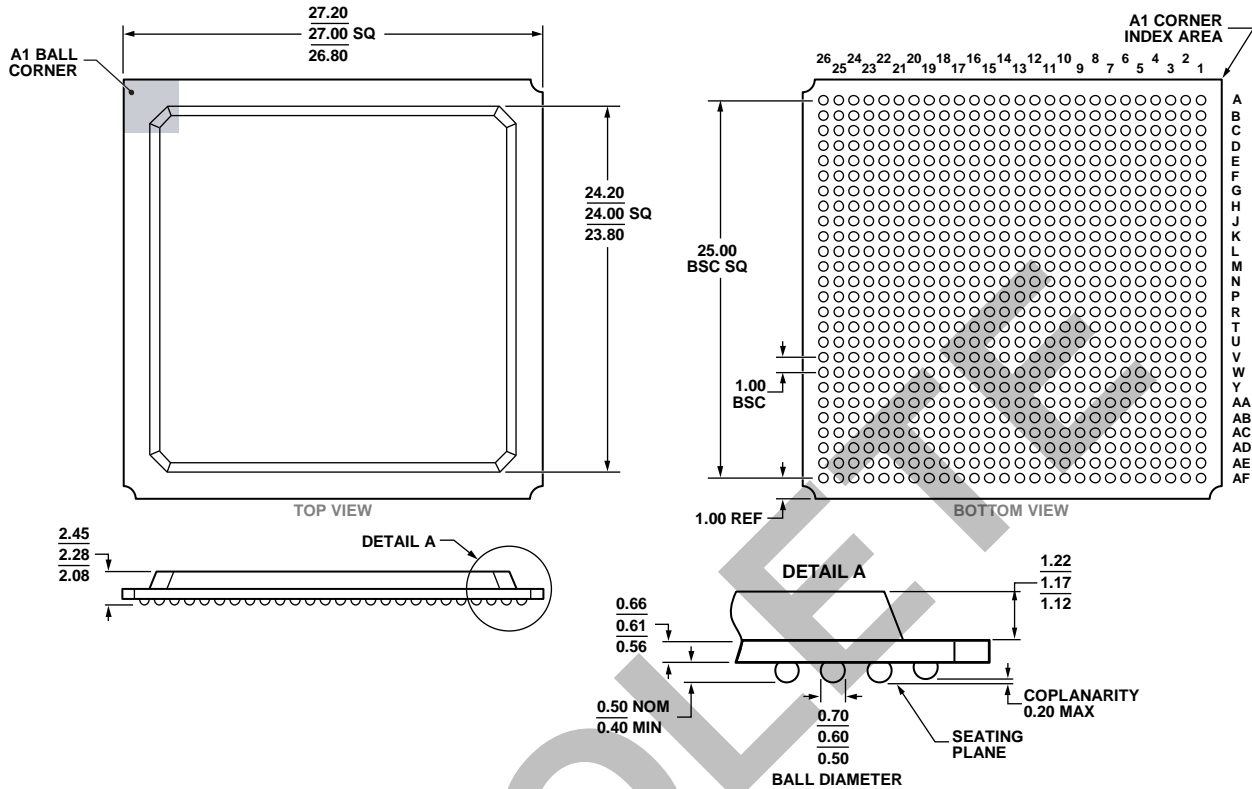

COMPLIANT TO JEDEC STANDARDS MS-034-AAL-1

Figure 53. 676-Ball Plastic Ball Grid Array [PBGA] (B-676)

Dimensions shown in millimeters

05-12-2008-C

ORDERING GUIDE

Model <sup>1</sup>	Temperature Range	Package Description	Package Option
AD8176ABPZ	-40°C to +85°C	676-Ball Plastic Ball Grid Array [PBGA]	B-676

<sup>1</sup> Z = RoHS Compliant Part.