

**FEATURES**

**12-bit resolution, 200 MSPS input data rate**  
**Selectable 2x/4x/8x interpolation filters**  
**Selectable  $f_{DAC}/2$ ,  $f_{DAC}/4$ ,  $f_{DAC}/8$  modulation modes**  
**Single or dual-channel signal processing**  
**Selectable image rejection Hilbert transform**  
**Flexible calibration engine**  
**Direct IF transmission features**  
**Serial control interface**  
**Versatile clock and data interface**  
**SFDR 90 dBc @ 10 MHz**  
**WCDMA ACLR = 80 dBc @ 40 MHz IF**  
**DNL =  $\pm 0.75$  LSB**  
**INL =  $\pm 1.5$  LSB**  
**3.3 V compatible digital Interface**  
**On-chip 1.2 V reference**  
**80-lead thermally enhanced TQFP package**

**APPLICATIONS**

**Digital quadrature modulation architectures**  
**Multicarrier WCDMA, GSM, TDMA, DCS,**  
**PCS, CDMA Systems**

**PRODUCT DESCRIPTION**

The AD9782 is a 12-bit, high speed, CMOS DAC with 2x/4x/8x interpolation and signal processing features tuned for communications applications. It offers state of the art distortion and noise performance. The AD9782 was developed to meet the demanding performance requirements of multicarrier and third generation base stations. The selectable interpolation filters simplify interfacing to a variety of input data rates while also taking advantage of oversampling performance gains. The modulation modes allow convenient bandwidth placement and selectable sideband suppression.

The flexible clock interface accepts a variety of input types such as 1 V p-p sine wave, CMOS, and LVPECL in single ended or differential mode. Internal dividers generate the required data rate interface clocks.

The AD9782 provides a differential current output, supporting single-ended or differential applications; it provides a nominal full-scale current from 10 mA to 20 mA. The AD9782 is manufactured on an advanced low cost 0.25  $\mu\text{m}$  CMOS process.

**FUNCTIONAL BLOCK DIAGRAM**

Figure 1.

**Rev. PrC**

Information furnished by Analog Devices is believed to be accurate and reliable. However, no responsibility is assumed by Analog Devices for its use, nor for any infringements of patents or other rights of third parties that may result from its use. Specifications subject to change without notice. No license is granted by implication or otherwise under any patent or patent rights of Analog Devices. Trademarks and registered trademarks are the property of their respective owners.

## TABLE OF CONTENTS

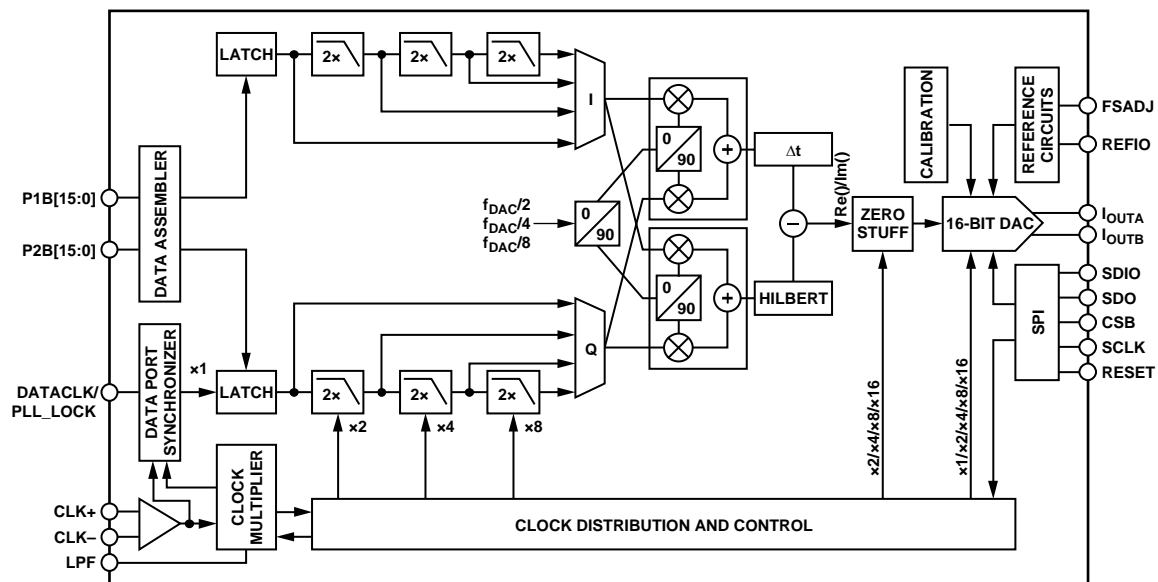
Product Highlights .....	3	Digital Filter Specifications .....	23
AD9782–Specifications.....	4	Digital Interpolation Filter Coefficients.....	23
DC Specifications .....	4	AD9782 Clock/Data Timing.....	24
Dynamic Specifications .....	5	Interpolation Modes .....	27
Digital Specifications .....	6	Real and Complex Signals.....	28
Pin Configuration and Function Descriptions.....	7	Modulation Modes.....	29
Clock .....	7	Power Dissipation .....	34
Analog.....	8	Dual Channel Complex Modulation with Hilbert .....	35
Data .....	8	Hilbert Transform Implementation .....	36
Serial Interface .....	9	Operating the AD9782 Rev E Evaluation Board.....	40
Definitions of Specifications .....	10	Power Supplies.....	40
Typical Performance Characteristics .....	12	PECL Clock Driver .....	40
Serial Control Interface.....	17	Data Inputs.....	41
General Operation of the Serial Interface.....	17	SPI Port .....	41
Instruction Byte .....	17	Operating with PLL Disabled .....	41
Serial Interface Port Pin Descriptions .....	17	Operating with PLL Enabled .....	42
MSB/LSB Transfers.....	18	Analog Output .....	42
Notes on Serial Port Operation .....	18	Outline Dimensions .....	52
Mode Control (via SPI Port) .....	19	ESD Caution.....	52

## REVISION HISTORY

Revision PrC: Preliminary Version

## PRODUCT HIGHLIGHTS

1. The AD9782 is a member of a high speed interpolating TxDAC+ family with 16-/14-/12-bit resolutions.
2. 2×/4×/8× user selectable interpolating filter eases data rate and output signal reconstruction filter requirements.
3. 200 MSPS input data rate.
4. Ultrahigh speed 500 MSPS DAC conversion rate.
5. Internal PLL/clock divider provides data rate clock for easy interfacing.
6. Flexible clock with single-ended or differential input: CMOS, 1 V p-p sine wave and LVPECL capability.
7. Complete CMOS DAC function operates from a 2.7 V to 3.6 V single analog (AVDD) supply and a 2.5 V (DVDD) digital supply. The DAC full-scale current can be reduced for lower power operation, and a sleep mode is provided for low-power idle periods.
8. On-chip voltage reference: The AD9782 includes a 1.20 V temperature-compensated band gap voltage reference.

## AD9782—SPECIFICATIONS

## DC SPECIFICATIONS

Table 1.  $T_{MIN}$  to  $T_{MAX}$ , AVDD1, AVDD2 = 3.3 V, ACVDD, ADVDD, CLKVDD, DVDD, DRVDD = 2.5 V,  $I_{OUTFS}$  = 20 mA, unless otherwise noted

Parameter	Min	Typ	Max	Unit
RESOLUTION		12		Bits
DC Accuracy <sup>1</sup>				
Integral Nonlinearity		1.5		LSB
Differential Nonlinearity		0.75		LSB
ANALOG OUTPUT				
Offset Error				% of FSR
Gain Error (Without Internal Reference)				% of FSR
Gain Error (With Internal Reference)				% of FSR
Full-Scale Output Current <sup>2</sup>	10		20	mA
Output Compliance Range	-1.0		+1.0	V
Output Resistance		TBD		k $\Omega$
Output Capacitance		3		pF
REFERENCE OUTPUT				
Reference Voltage	1.14	1.20	1.26	V
Reference Output Current <sup>3</sup>		1		$\mu$ A
REFERENCE INPUT				
Input Compliance Range	0.1		1.25	V
Reference Input Resistance (Ext Reference Mode)		10		M $\Omega$
Small Signal Bandwidth		0.5		MHz
TEMPERATURE COEFFICIENTS				
Unipolar Offset Drift				ppm of FSR/ $^{\circ}$ C
Gain Drift (Without Internal Reference)				ppm of FSR/ $^{\circ}$ C
Gain Drift (With Internal Reference)				ppm of FSR/ $^{\circ}$ C
Reference Voltage Drift				ppm / $^{\circ}$ C
POWER SUPPLY				
AVDD1, AVDD2				
Voltage Range	3.1	3.3	3.5	V
Analog Supply Current ( $I_{AVDD1}$ )				mA
Analog Supply Current ( $I_{AVDD2}$ )				mA
$I_{AVDD1}$ in SLEEP Mode				mA
ACVDD, ADVDD				
Voltage Range	2.35	2.5	2.65	V
Analog Supply Current ( $I_{ACVDD}$ )				mA
Analog Supply Current ( $I_{ADVDD}$ )				mA
CLKVDD				
Voltage Range	2.35	2.5	2.65	V
Clock Supply Current ( $I_{CLKVDD}$ )				mA
DVDD				
Voltage Range	2.35	2.5	2.65	V
Digital Supply Current ( $I_{DVDD}$ )				mA
DRVDD				
Voltage Range	2.35	2.5/3.3	3.5	V
Digital Supply Current ( $I_{DRVDD}$ )				mA
Nominal Power Dissipation <sup>4</sup>		1.25		W
OPERATING RANGE	-40		+85	$^{\circ}$ C

<sup>1</sup> Measured at IOUTA driving a virtual ground.<sup>2</sup> Nominal full-scale current,  $I_{OUTFS}$ , is 32 $\times$  the  $I_{REF}$  current.<sup>3</sup> Use an external amplifier to drive any external load.<sup>4</sup> Measured under the following conditions:  $f_{DATA}$  = 125 MSPS,  $f_{DAC}$  = 500 MSPS, 4 $\times$  Interpolation,  $f_{DAC}/4$  Modulation, Hilbert Off.

**DYNAMIC SPECIFICATIONS**

**Table 2.** T<sub>MIN</sub> to T<sub>MAX</sub>, AVDD1, AVDD2 = 3.3 V, ACVDD, ADVDD, CLKVDD, DVDD, DRVDD = 2.5 V, I<sub>OUTFS</sub> = 20 mA, Differential Transformer Coupled Output, 50 Ω Doubly Terminated, unless otherwise noted

Parameter	Min	Typ	Max	Unit
<b>DYNAMIC PERFORMANCE</b>				
Maximum DAC Output Update Rate (f <sub>DAC</sub> )	500			MSPS
Output Settling Time (t <sub>ST</sub> ) (to 0.025%)				ns
Output Propagation Delay <sup>5</sup> (t <sub>PD</sub> )				ns
Output Rise Time (10%–90%) <sup>6</sup>				ns
Output Fall Time (90%–10%) <sup>6</sup>				ns
Output Noise (I <sub>OUTFS</sub> = 20 mA)				µA/√Hz
<b>AC LINEARITY—BASEBAND MODE</b>				
Spurious-Free Dynamic Range (SFDR) to Nyquist (f <sub>OUT</sub> = 0 dBFS)		95		dBc
f <sub>DATA</sub> = 160 MSPS; f <sub>OUT</sub> = 1 MHz				dBc
f <sub>DATA</sub> = MSPS; f <sub>OUT</sub> = MHz				dBc
f <sub>DATA</sub> = MSPS; f <sub>OUT</sub> = MHz				dBc
f <sub>DATA</sub> = MSPS; f <sub>OUT</sub> = MHz				dBc
f <sub>DATA</sub> = MSPS; f <sub>OUT</sub> = MHz				dBc
f <sub>DATA</sub> = MSPS; f <sub>OUT</sub> = MHz				dBc
Two-Tone Intermodulation (IMD) to Nyquist (f <sub>OUT1</sub> = f <sub>OUT2</sub> = –6 dBFS)		80		dBc
f <sub>DATA</sub> = 160 MSPS; f <sub>OUT1</sub> = 25 MHz; f <sub>OUT2</sub> = 31 MHz				dBc
f <sub>DATA</sub> = MSPS; f <sub>OUT1</sub> = MHz; f <sub>OUT2</sub> = MHz				dBc
f <sub>DATA</sub> = MSPS; f <sub>OUT1</sub> = MHz; f <sub>OUT2</sub> = MHz				dBc
f <sub>DATA</sub> = MSPS; f <sub>OUT1</sub> = MHz; f <sub>OUT2</sub> = MHz				dBc
f <sub>DATA</sub> = MSPS; f <sub>OUT1</sub> = MHz; f <sub>OUT2</sub> = MHz				dBc
f <sub>DATA</sub> = MSPS; f <sub>OUT1</sub> = MHz; f <sub>OUT2</sub> = MHz				dBc
Total Harmonic Distortion (THD)				dB
f <sub>DATA</sub> = MSPS; f <sub>OUT</sub> = MHz; 0 dBFS				dB
f <sub>DATA</sub> = MSPS; f <sub>OUT</sub> = MHz; 0 dBFS				dB
Signal-to-Noise Ratio (SNR)				dBFS
f <sub>DATA</sub> = MSPS; f <sub>OUT</sub> = MHz; 0 dBFS				dBFS
f <sub>DATA</sub> = MSPS; f <sub>OUT</sub> = MHz; 0 dBFS				dBFS
Adjacent Channel Power Ratio (ACPR)				dBc
WCDMA with MHz BW, MHz Channel Spacing				dBc
IF = 16 MHz, f <sub>DATA</sub> = 65.536 MSPS				dBc
IF = 32 MHz, f <sub>DATA</sub> = 131.072 MSPS				dBc
Four-Tone Intermodulation				dBFS
MHz, MHz, MHz and MHz at –12 dBFS (f <sub>DATA</sub> = MSPS, Missing Center)				dBFS
<b>AC LINEARITY—IF MODE</b>				
Four-Tone Intermodulation at IF = MHz				dBFS
MHz, MHz, MHz and MHz at dBFS				dBFS
f <sub>DATA</sub> = MSPS, f <sub>DAC</sub> = MHz				dBFS

<sup>5</sup> Propagation delay is delay from CLK input to DAC update.

<sup>6</sup> Measured single-ended into 50 Ω load.

**DIGITAL SPECIFICATIONS**

Table 3.  $T_{MIN}$  to  $T_{MAX}$ , AVDD1, AVDD2 = 3.3 V, ACVDD, ADVDD, CLKVDD, DVDD = 2.5 V,  $I_{OUTFS}$  = 20 mA, unless otherwise noted

Parameter	Min	Typ	Max	Unit
<b>DIGITAL INPUTS</b>				
Logic 1 Voltage	DRVDD – 0.9	DRVDD		V
Logic 0 Voltage		0	0.9	V
Logic 1 Current	–10		+10	$\mu$ A
Logic 0 Current	–10		+10	$\mu$ A
Input Capacitance		5		pF
<b>LOCK INPUTS</b>				
Input Voltage Range	0		2.65	V
Common-Mode Voltage	0.75	1.5	2.25	V
Differential Voltage	0.5	1.5		V
<b>PLL CLOCK ENABLED</b>				
Input Setup Time ( $t_s$ )				ns
Input Hold Time ( $t_H$ )				ns
Latch Pulse Width ( $t_{LPW}$ )				ns
<b>PLL CLOCK DISABLED</b>				
Input Setup Time ( $t_s$ )				ns
Input Hold Time ( $t_H$ )				ns
Latch Pulse Width ( $t_{LPW}$ )				ns
CLK to PLLLOCK Delay ( $t_{OD}$ )				ns

# PIN CONFIGURATION AND FUNCTION DESCRIPTIONS

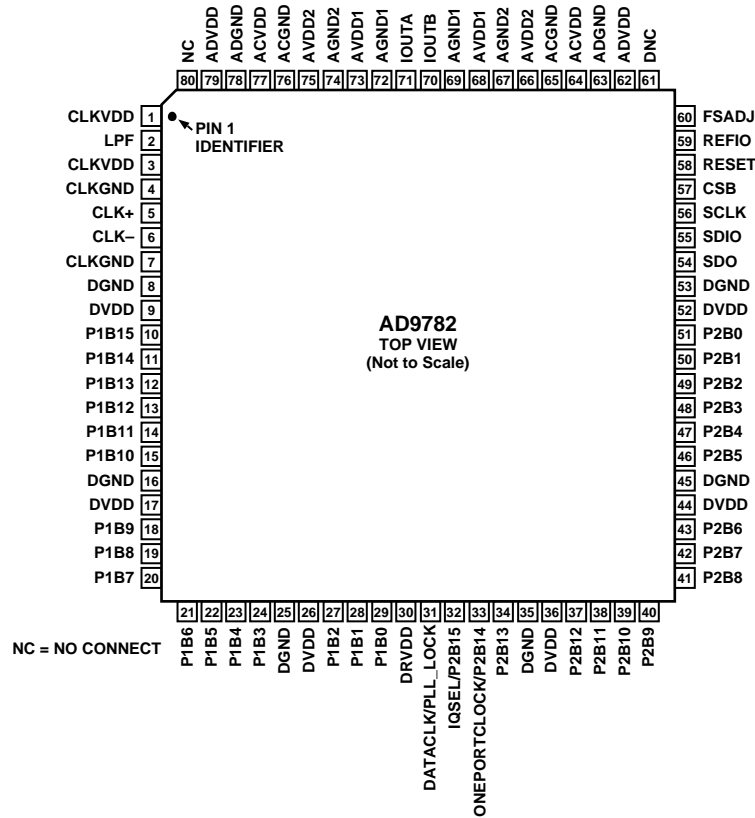

Figure 2. Pin Configuration

## CLOCK

Table 4. Clock Pin Function Descriptions

Pin No.	Mnemonic	Direction	Description		
5, 6	CLK+, CLK-	I	Differential Clock Input.		
2	LPF	I/O	PLL Loop Filter.		
31	DATACLK/PLL_LOCK	I/O	<b>PLOCKEXT</b> 04h[0]	<b>DCLKEXT</b> 02h[3]	<b>Mode</b>
			0	0	Pin configured for input of channel data rate or synchronizer clock. Internal clock synchronizer may be turned on or off with DCLKCRC (02h[2]).
			0	1	Pin configured for output of channel data rate or synchronizer clock
			1	X	Internal Clock PLL Status Output: 0: Internal clock PLL is not locked. 1: Internal clock PLL is locked.
1, 3	CLKVDD		Clock Domain 2.5 V.		
4, 7	CLKGND		Clock Domain 0 V.		

**ANALOG**

Table 5. Analog Pin Function Descriptions

Pin No.	Mnemonic	Direction	Description
59	REFIO	A	Reference.
60	FSADJ	A	Full-Scale Adjust.
70, 71	IOUTB, IOUTA	A	Differential DAC Output Currents.
61	DNC		Do not connect.
62, 79	ADVDD		Analog Domain Digital Content 2.5 V.
63, 78	ADGND		Analog Domain Digital Content 0 V.
64, 77	ACVDD		Analog Domain Clock Content 2.5 V.
65, 76	ACGND		Analog Domain Clock Content 0 V.
66, 75	AVDD2		Analog Domain Clock Switching 3.3 V.
67, 74	AGND2		Analog Domain Switching 0 V.
68, 73	AVDD1		Analog Domain Quiet 3.3 V.
69, 72	AGND1		Analog Domain Quiet 0 V.

**DATA**

Table 6. Data Pin Function Descriptions

Pin No.	Mnemonic	Direction	Description			
10–15, 18–24, 27–29	P1B15–P1B0	I	Input Data Port One.			
			<b>ONEPORT 02h[6]</b>	<b>Mode</b>		
			0 1	Latched Data Routed for 1 Channel Processing. Latched Data Demultiplexed by IQSEL and Routed for Interleaved I/Q Processing.		
32	IQSEL/P2B15	I	<b>ONEPORT 02h[6]</b>	<b>IQPOL 02h[1]</b>	<b>IQSEL/ P2B15</b>	<b>Mode (IQPOL == 0)</b>
			0	X	X	Latched data routed to Q channel bit 15(MSB) processing.
			1	0	0	Latched data on data port one routed to Q channel processing.
			1	0	1	Latched data on data port one routed to I channel processing.
			1	1	0	Latched data on data port one routed to I channel processing.
			1	1	1	Latched data on data port one routed to Q channel processing.
33	ONEPORTCLK/P2B14	I/O	<b>ONEPORT 02h[6]</b>			
			0 1	Latched data routed for Q channel Bit 14 processing. Pin configured for output of clock at twice the channel data rate.		
			Input Data Port Two Bits 13–0.			
34, 37–43, 46–51	P2B13–P2B0	I	Input Data Port Two Bits 13–0.			
			Digital Output Pin Supply, 2.5 V or 3.3 V.			
			Digital Domain 2.5 V.			
			Digital Domain 0 V.			
30	DRVDD		Digital Output Pin Supply, 2.5 V or 3.3 V.			
9, 17, 26, 36, 44, 52	DVDD		Digital Domain 2.5 V.			
8, 16, 25, 35, 45, 53	DGND		Digital Domain 0 V.			



**SERIAL INTERFACE**

Table 7. Serial Interface Pin Function Descriptions

Pin No.	Mnemonic	Direction	Description		
54	SDO	O		<b>SDIODIR</b>	
			<b>CSB</b>	<b>00h[7]</b>	<b>Mode</b>
			1	X	High Impedance.
			0	0	Serial Data Output.
55	SDIO	I/O	0	1	High Impedance.
				<b>SDIODIR</b>	
			<b>CSB</b>	<b>00h[7]</b>	<b>Mode</b>
			1	X	High Impedance.
56	SCLK	I	0	0	Serial Data Output.
			0	1	Serial Data Input/Output Depending on Bit 7 of the Serial Instruction Byte.
			0	1	Serial Data Input/Output Depending on Bit 7 of the Serial Instruction Byte.
57	CSB	I	Serial interface chip select.		
58	RESET	I	Resets entire chip to default state.		

## DEFINITIONS OF SPECIFICATIONS

### Linearity Error (Integral Nonlinearity or INL)

Linearity error is defined as the maximum deviation of the actual analog output from the ideal output, determined by a straight line drawn from zero to full scale.

### Differential Nonlinearity (or DNL)

DNL is the measure of the variation in analog value, normalized to full scale, associated with a 1 LSB change in digital input code.

### Monotonicity

A D/A converter is monotonic if the output either increases or remains constant as the digital input increases.

### Offset Error

The deviation of the output current from the ideal of zero is called offset error. For  $I_{OUTA}$ , 0 mA output is expected when the inputs are all 0s. For  $I_{OUTB}$ , 0 mA output is expected when all inputs are set to 1s.

### Gain Error

The difference between the actual and ideal output span. The actual span is determined by the output when all inputs are set to 1s, minus the output when all inputs are set to 0s.

### Output Compliance Range

The range of allowable voltage at the output of a current-output DAC. Operation beyond the maximum compliance limits may cause either output stage saturation or breakdown, resulting in nonlinear performance.

### Temperature Drift

Temperature drift is specified as the maximum change from the ambient (+25°C) value to the value at either  $T_{MIN}$  or  $T_{MAX}$ . For offset and gain drift, the drift is reported in ppm of full-scale range (FSR) per degree C. For reference drift, the drift is reported in ppm per degree C.

### Power Supply Rejection

The maximum change in the full-scale output as the supplies are varied from minimum to maximum specified voltages.

### Settling Time

The time required for the output to reach and remain within a specified error band about its final value, measured from the start of the output transition.

### Glitch Impulse

Asymmetrical switching times in a DAC give rise to undesired output transients that are quantified by a glitch impulse. It is specified as the net area of the glitch in pV-s.

### Spurious-Free Dynamic Range

The difference, in dB, between the rms amplitude of the output signal and the peak spurious signal over the specified bandwidth.

### Total Harmonic Distortion

THD is the ratio of the rms sum of the first six harmonic components to the rms value of the measured fundamental. It is expressed as a percentage or in decibels (dB).

### Signal-to-Noise Ratio (SNR)

S/N is the ratio of the rms value of the measured output signal to the rms sum of all other spectral components below the Nyquist frequency, excluding the first six harmonics and dc. The value for SNR is expressed in decibels.

### Interpolation Filter

If the digital inputs to the DAC are sampled at a multiple rate of  $f_{DATA}$  (interpolation rate), a digital filter can be constructed which has a sharp transition band near  $f_{DATA}/2$ . Images which would typically appear around  $f_{DAC}$  (output data rate) can be greatly suppressed.

### Pass-Band

Frequency band in which any input applied therein passes unattenuated to the DAC output.

### Stop-Band Rejection

The amount of attenuation of a frequency outside the pass-band applied to the DAC, relative to a full-scale signal applied at the DAC input within the pass-band.

### Group Delay

Number of input clocks between an impulse applied at the device input and peak DAC output current. A half-band FIR filter has constant group delay over its entire frequency range.

### Impulse Response

Response of the device to an impulse applied to the input.

**Adjacent Channel Power Ratio (or ACPR)**

A ratio in dBc between the measured power within a channel relative to its adjacent channel.

**Complex Modulation**

The process of passing the real and imaginary components of a signal through a complex modulator (transfer function =  $e^{j\omega t} = \cos\omega t + j\sin\omega t$ ) and realizing real and imaginary components on the modulator output.

**Complex Image Rejection**

In a traditional two part upconversion, two images are created around the second IF frequency. These images are redundant and have the effect of wasting transmitter power and system bandwidth. By placing the real part of a second complex modulator in series with the first complex modulator, either the upper or lower frequency image near the second IF can be rejected.

## TYPICAL PERFORMANCE CHARACTERISTICS

( $T_{MIN}$  to  $T_{MAX}$ , AVDD1, AVDD2 = 3.3 V, ACVDD, ADVDD, CLKVDD, DVDD, DRVDD = 2.5 V,  $I_{OUTFS}$  = 20 mA, Differential Transformer Coupled Output, 50  $\Omega$  Doubly Terminated, unless otherwise noted)

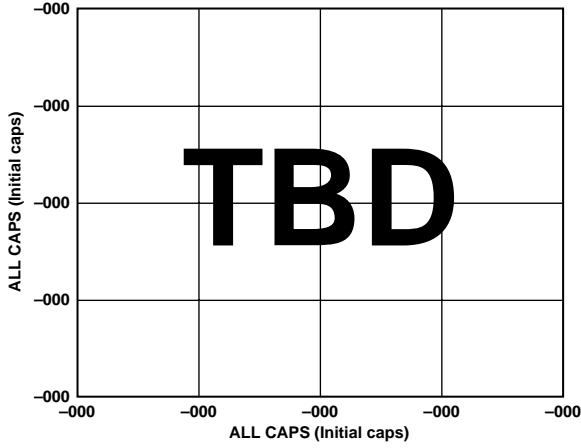

Figure 3 Single-Tone Spectrum @  $F_{DATA} = 65$  MSPS With  $F_{OUT} = F_{DATA}/3$

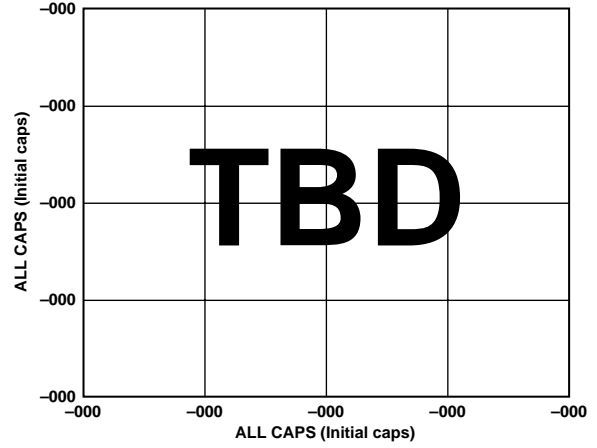

Figure 6. Single-Tone Spectrum @  $F_{DATA} = 78$  MSPS with  $F_{OUT} = F_{DATA}/3$

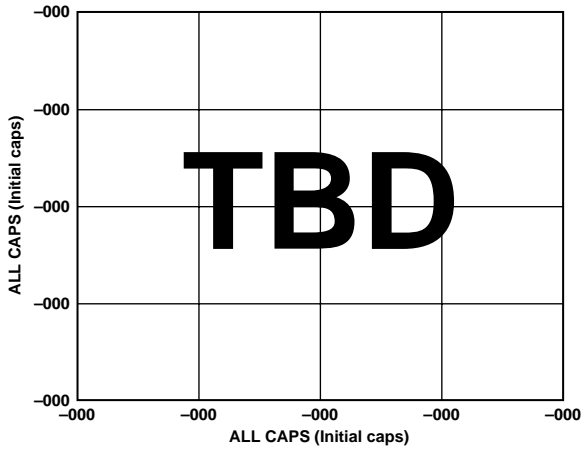

Figure 4. In-Band SFDR vs.  $F_{OUT}$  @  $F_{DATA} = 65$  MSPS

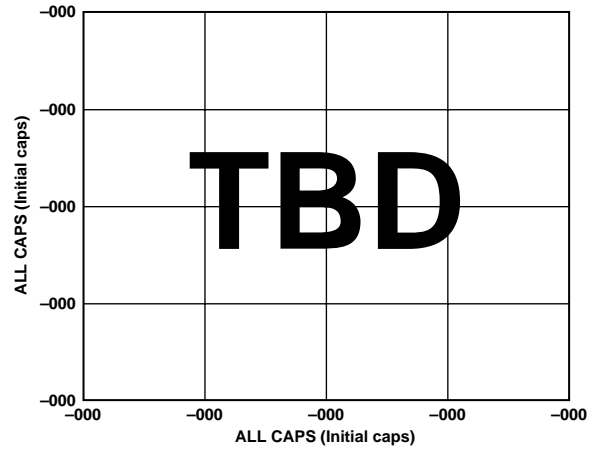

Figure 7. In-Band SFDR vs.  $F_{OUT}$  @  $F_{DATA} = 78$  MSPS

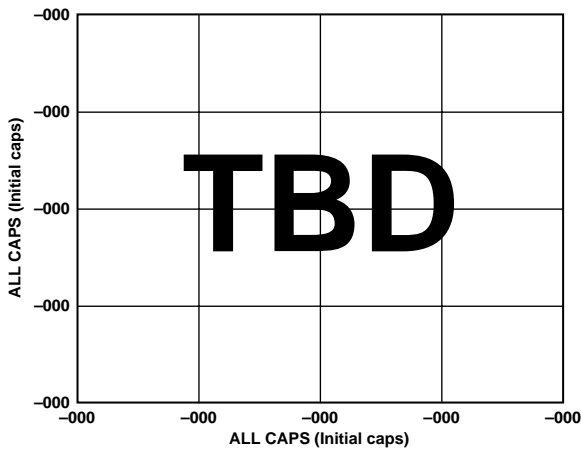

Figure 5. Out-of-Band SFDR vs.  $F_{OUT}$  @  $F_{DATA} = 65$  MSPS

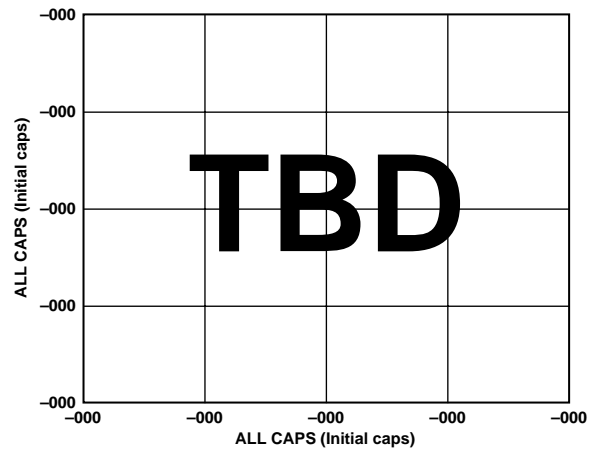

Figure 8. Out-of-Band SFDR vs.  $F_{OUT}$  @  $F_{DATA} = 78$  MSPS

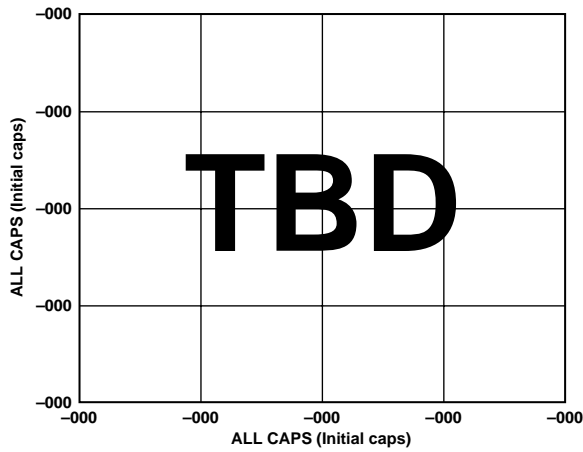

Figure 9. Single-Tone Spectrum @  $F_{DATA} = 160$  MSPS with  $F_{OUT} = F_{DATA}/3$

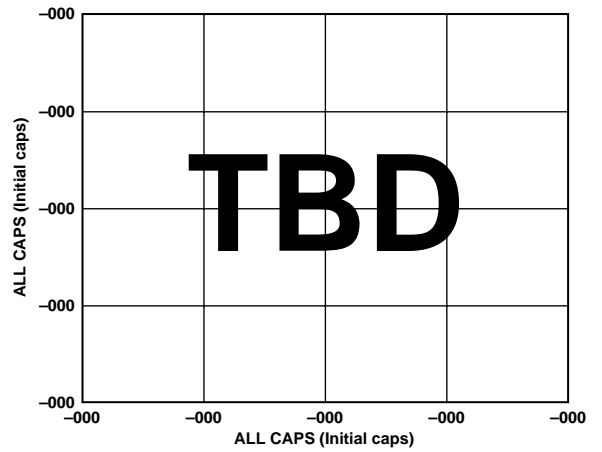

Figure 12. Third Order IMD Products vs.  $F_{OUT}$  @  $F_{DATA} = 65$  MSPS

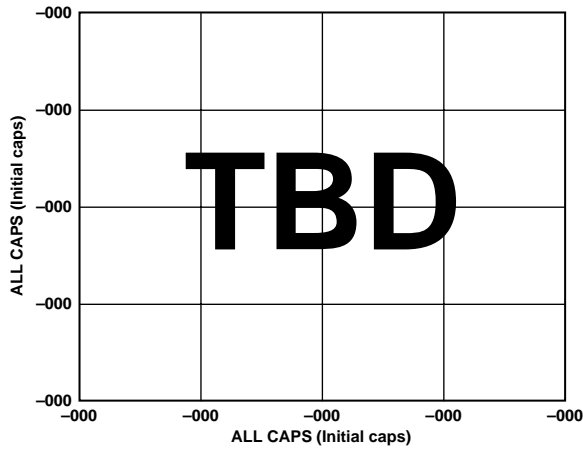

Figure 10. In-Band SFDR vs.  $F_{OUT}$  @  $F_{DATA} = 160$  MSPS

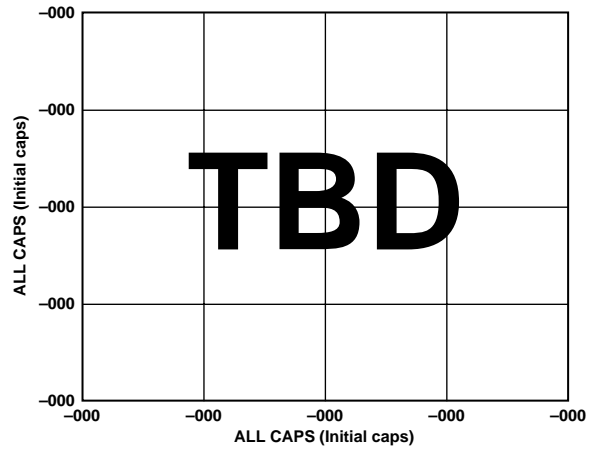

Figure 13. Third Order IMD Products vs.  $F_{OUT}$  @  $F_{DATA} = 78$  MSPS

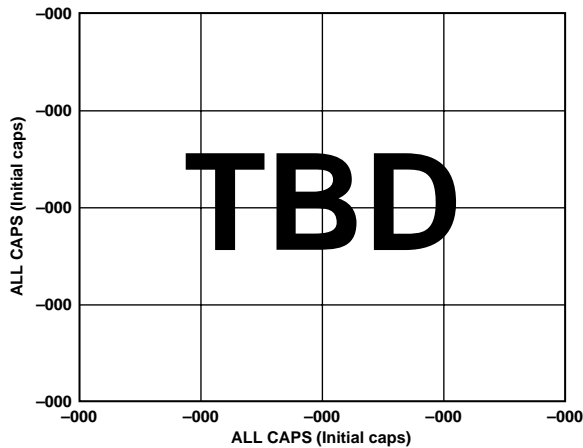

Figure 11. Out-of-Band SFDR vs.  $F_{OUT}$  @  $F_{DATA} = 160$  MSPS

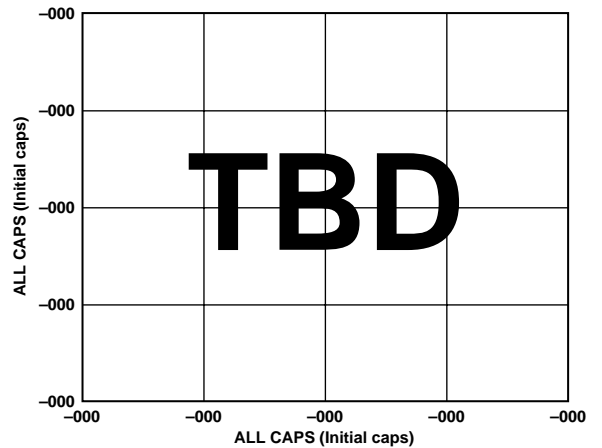

Figure 14. Third Order IMD Products vs.  $F_{OUT}$  @  $F_{DATA} = 160$  MSPS

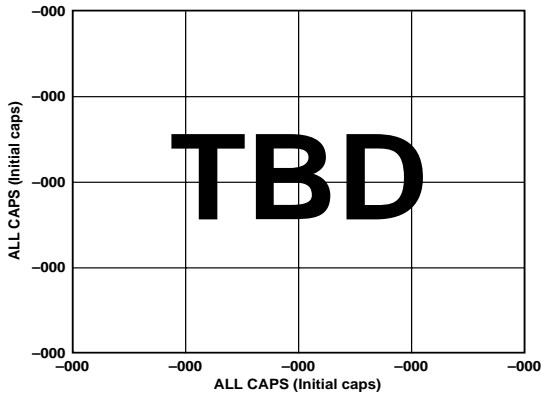

Figure 15. TPC 13. Third Order IMD Products vs.  $F_{OUT}$  and Interpolation Rate

$1\times - F_{DATA} = 160 \text{ MSPS}$

$2\times - F_{DATA} = 160 \text{ MSPS}$

$4\times - F_{DATA} = 80 \text{ MSPS}$

$8\times - F_{DATA} = 50 \text{ MSPS}$

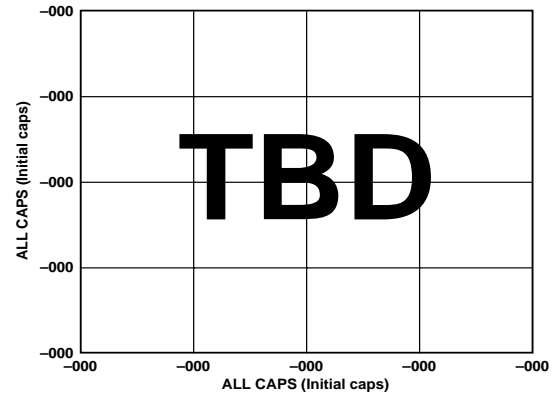

Figure 18. 3<sup>rd</sup> Order IMD Products vs. AVDD @  $F_{OUT} = 10 \text{ MHz}$ ,  $F_{DAC} = 320 \text{ MSPS}$ ,  $F_{DATA} = 160 \text{ MSPS}$

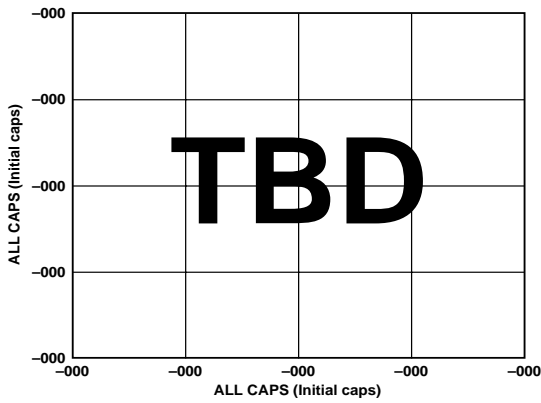

Figure 16. Third Order IMD Products vs. AOUT and Interpolation Rate  $F_{DATA} = 50 \text{ MSPS}$  for All Cases

$1\times - F_{DAC} = 50 \text{ MSPS}$

$2\times - F_{DAC} = 100 \text{ MSPS}$

$4\times - F_{DAC} = 200 \text{ MSPS}$

$8\times - F_{DAC} = 400 \text{ MSPS}$

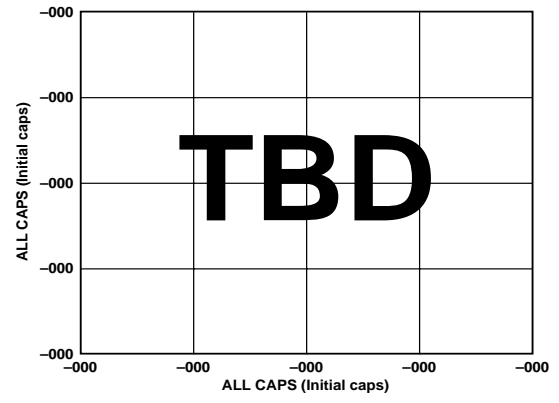

Figure 19. SNR vs. Data Rate for  $f_{OUT} = 5 \text{ MHz}$

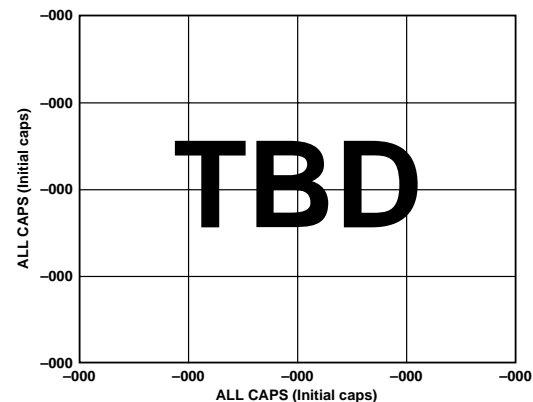

Figure 17. SFDR vs. AVDD @  $F_{OUT} = 10 \text{ MHz}$ ;  $F_{DAC} = 320 \text{ MSPS}$   $F_{DATA} = 160 \text{ MSPS}$

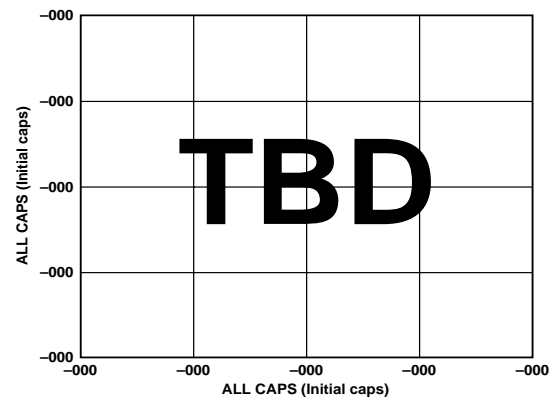

Figure 20. SFDR vs. Temperature @  $f_{OUT} = f_{DATA}/11$

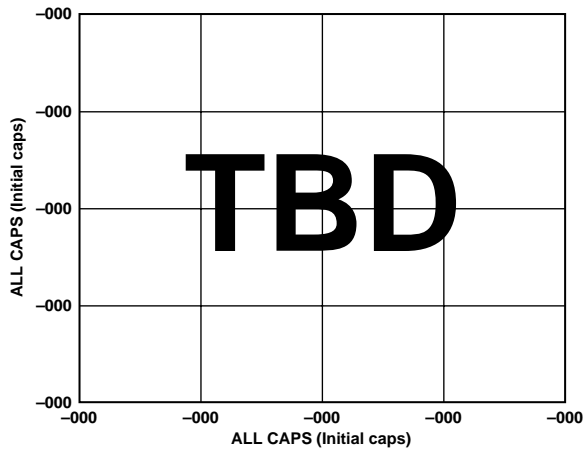

Figure 21. Single Tone Spurious Performance,  $f_{OUT} = 10\text{ MHz}$ ,  $F_{DATA} = 150\text{ MSPS}$ , No Interpolation

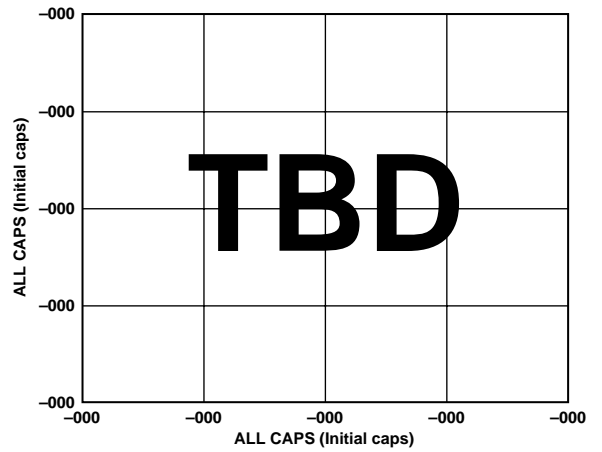

Figure 24. Two Tone IMD Performance,  $F_{DATA} = 90\text{ MSPS}$ , Interpolation = 4x

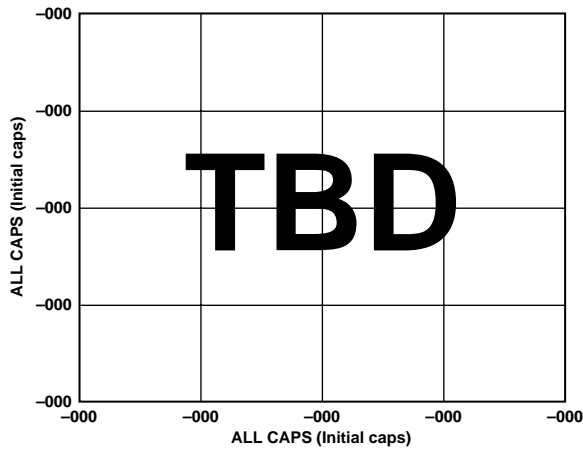

Figure 22. Two Tone IMD Performance,  $F_{DATA} = 150\text{ MSPS}$ , No Interpolation

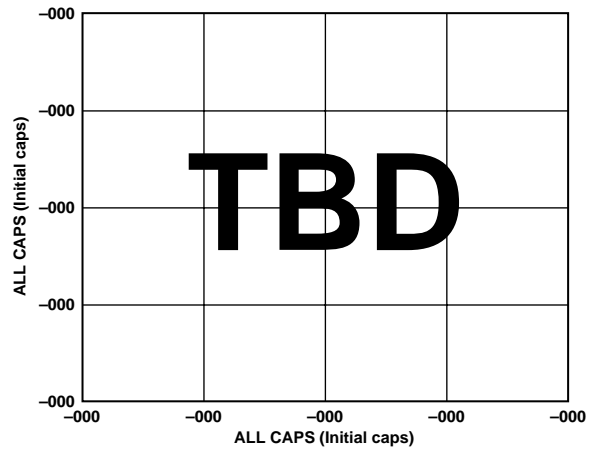

Figure 25. Single Tone Spurious Performance,  $F_{OUT} = 10\text{ MHz}$ ,  $F_{DATA} = 80\text{ MSPS}$ , Interpolation = 4x

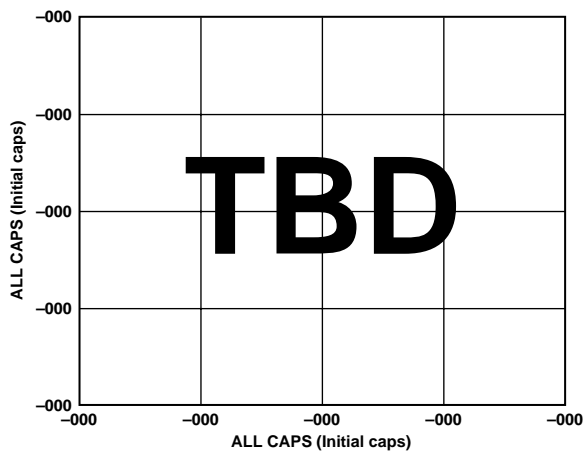

Figure 23. Single Tone Spurious Performance,  $F_{OUT} = 10\text{ MHz}$ ,  $F_{DATA} = 150\text{ MSPS}$ , Interpolation = 2x

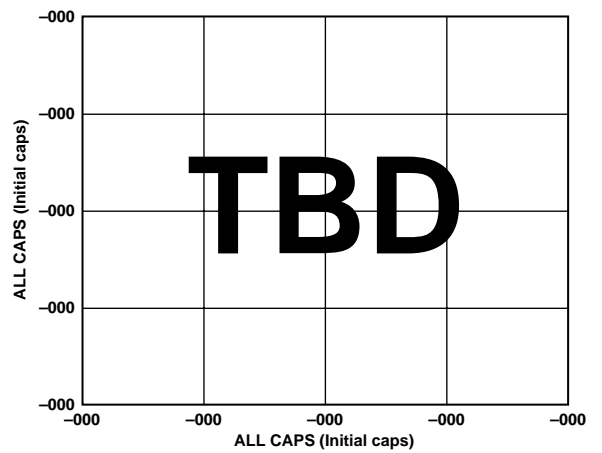

Figure 26. Two Tone IMD Performance,  $F_{OUT} = 10\text{ MHz}$ ,  $F_{DATA} = 50\text{ MSPS}$ , Interpolation = 8x

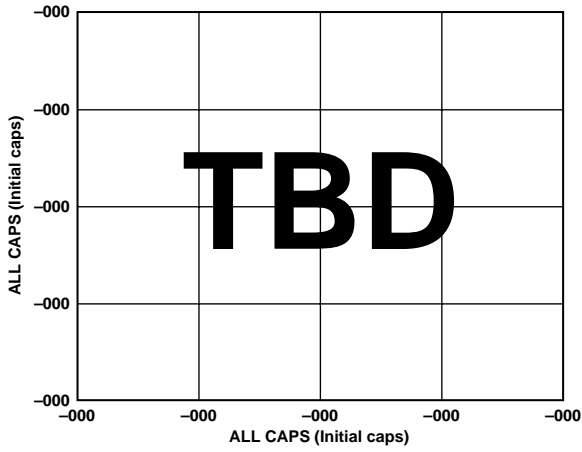

Figure 27. Single Tone Spurious Performance,  $F_{OUT} = 10\text{ MHz}$ ,  $F_{DATA} = 50\text{ MSPS}$ , Interpolation = 8x

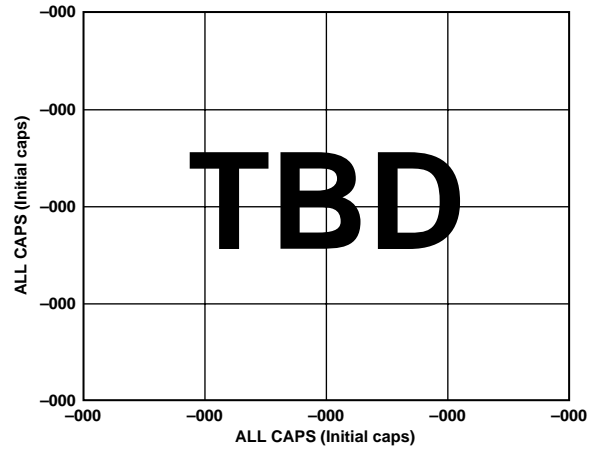

Figure 28. Eight Tone IMD Performance,  $F_{DATA} = 160\text{ MSPS}$ , Interpolation = 8x



## SERIAL CONTROL INTERFACE

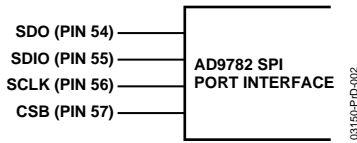

Figure 29. AD9782 SPI Port Interface

The AD9782 serial port is a flexible, synchronous serial communications port allowing easy interface to many industry-standard microcontrollers and microprocessors. The serial I/O is compatible with most synchronous transfer formats, including both the Motorola SPI® and Intel® SSR protocols. The interface allows read/write access to all registers that configure the AD9782. Single or multiple byte transfers are supported as well as MSB first or LSB first transfer formats. The AD9782's serial interface port can be configured as a single pin I/O (SDIO) or two unidirectional pins for in/out (SDIO/SDO).

### GENERAL OPERATION OF THE SERIAL INTERFACE

There are two phases to a communication cycle with the AD9782. Phase 1 is the instruction cycle, which is the writing of an instruction byte into the AD9782, coincident with the first eight SCLK rising edges. The instruction byte provides the AD9782 serial port controller with information regarding the data transfer cycle, which is Phase 2 of the communication cycle. The Phase 1 instruction byte defines whether the upcoming data transfer is read or write, the number of bytes in the data transfer, and the starting register address for the first byte of the data transfer. The first eight SCLK rising edges of each communication cycle are used to write the instruction byte into the AD9782.

A logic high on the CS pin, followed by a logic low, will reset the SPI port timing to the initial state of the instruction cycle. This is true regardless of the present state of the internal registers or the other signal levels present at the inputs to the SPI port. If the SPI port is in the midst of an instruction cycle or a data transfer cycle, none of the present data will be written.

The remaining SCLK edges are for Phase 2 of the communication cycle. Phase 2 is the actual data transfer between the AD9782 and the system controller. Phase 2 of the communication cycle is a transfer of 1, 2, 3, or 4 data bytes as determined by the instruction byte. Normally, using one multibyte transfer is the preferred method. However, single byte data transfers are useful to reduce CPU overhead when register access requires one byte only. Registers change immediately upon writing to the last bit of each transfer byte.

### INSTRUCTION BYTE

The instruction byte contains the following information:

Table 8.

N1	N2	Description
0	0	Transfer 1 Byte
0	1	Transfer 2 Bytes
1	0	Transfer 3 Bytes
1	1	Transfer 4 Bytes

R/W, Bit 7 of the instruction byte, determines whether a read or a write data transfer will occur after the instruction byte write. Logic high indicates read operation. Logic 0 indicates a write operation. N1, N0, Bits 6 and 5 of the instruction byte, determine the number of bytes to be transferred during the data transfer cycle. The bit decodes are shown in the following table:

Table 9.

MSB				LSB			
17	16	15	14	13	12	11	10
R/W	N1	N0	A4	A3	A2	A1	A0

A4, A3, A2, A1, A0, Bits 4, 3, 2, 1, 0 of the instruction byte, determine which register is accessed during the data transfer portion of the communications cycle. For multibyte transfers, this address is the starting byte address. The remaining register addresses are generated by the AD9782.

### SERIAL INTERFACE PORT PIN DESCRIPTIONS

**SCLK—Serial Clock.** The serial clock pin is used to synchronize data to and from the AD9782 and to run the internal state machines. SCLK's maximum frequency is 15 MHz. All data input to the AD9782 is registered on the rising edge of SCLK. All data is driven out of the AD9782 on the falling edge of SCLK.

**CSB—Chip Select.** Active low input starts and gates a communication cycle. It allows more than one device to be used on the same serial communications lines. The SDO and SDIO pins will go to a high impedance state when this input is high. Chip select should stay low during the entire communication cycle.

**SDIO—Serial Data I/O.** Data is always written into the AD9782 on this pin. However, this pin can be used as a bidirectional data line. The configuration of this pin is controlled by Bit 7 of register address 00h. The default is Logic 0, which configures the SDIO pin as unidirectional.

**SDO—Serial Data Out.** Data is read from this pin for protocols that use separate lines for transmitting and receiving data. In the case where the AD9782 operates in a single bidirectional I/O mode, this pin does not output data and is set to a high impedance state.

**MSB/LSB TRANSFERS**

The AD9782 serial port can support both most significant bit (MSB) first or least significant bit (LSB) first data formats. This functionality is controlled by register address DATADIR (00h[6]). The default is MSB first. When this bit is set active high, the AD9782 serial port is in LSB first format. That is, if the AD9782 is in LSB first mode, the instruction byte must be written from least significant bit to most significant bit. Multibyte data transfers in MSB format can be completed by writing an instruction byte that includes the register address of the most significant byte. In MSB first mode, the serial port internal byte address generator decrements for each byte required of the multibyte communication cycle. Multibyte data transfers in LSB first format can be completed by writing an instruction byte that includes the register address of the least significant byte. In LSB first mode, the serial port internal byte address generator increments for each byte required of the multibyte communication cycle.

The AD9782 serial port controller address will increment from 1Fh to 00h for multibyte I/O operations if the MSB first mode is active. The serial port controller address will decrement from 00h to 1Fh for multibyte I/O operations if the LSB first mode is active.

**NOTES ON SERIAL PORT OPERATION**

The AD9782 serial port configuration bits reside in Bits 6 and 7 of register address 00h. It is important to note that the configuration changes immediately upon writing to the last bit of the register. For multibyte transfers, writing to this register may occur during the middle of communication cycle. Care must be taken to compensate for this new configuration for the remaining bytes of the current communication cycle.

The same considerations apply to setting the software reset, SWRST (00h[5]) bit. All other registers are set to their default values but the software reset doesn't affect the bits in register address 00h and 04h.

It is recommended to use only single byte transfers when changing serial port configurations or initiating a software reset.

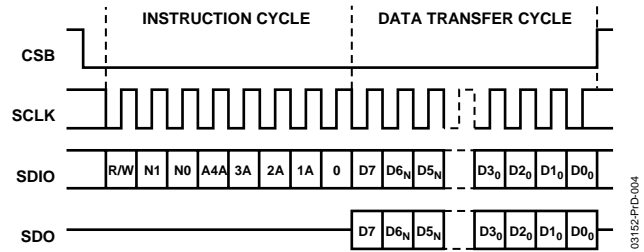

Figure 30. Serial Register Interface Timing MSB First

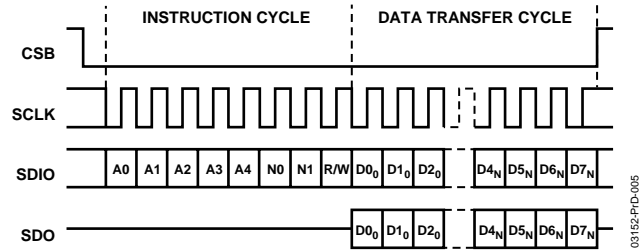

Figure 31. Serial Register Interface Timing LSB First

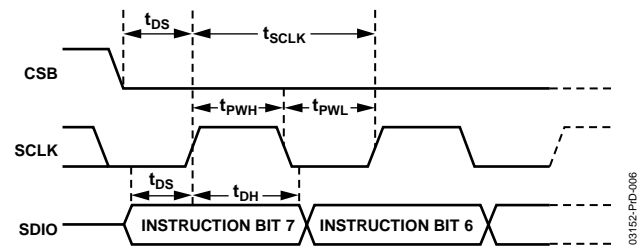

Figure 32. Timing Diagram for Register Write

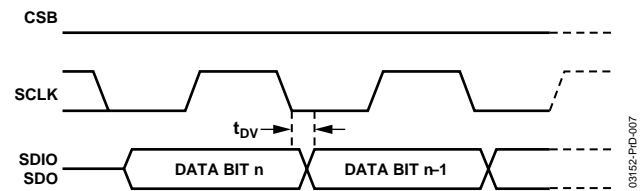

Figure 33. Timing Diagram for Register Read

## MODE CONTROL (VIA SPI PORT)

Table 10.

Address		Bit 7	Bit 6	Bit 5	Bit 4	Bit 3	Bit 2	Bit 1	Bit 0
COMMS	00	SDIODIR	DATADIR	SWRST	SLEEP	PDN		PLLLOCK	EXREF
FILTER	01	INTERP[1]	INTERP[0]			ZSTUFF	HPFX8	HPFX4	HPFX2
DATA	02	DATAFMT	ONEPORT	DCLKSTR	DCLKPOL	DCLKEXT	DCLKCRC	IQPOL	CRAYDIN
MODULATE	03	CHANNEL	HILBERT	MODDUAL	SIDEBAND	MOD[1]	MOD[0]		
PLL	04	PLLON	PLLMULT[1]	PLLMULT[0]	PLLDIV[1]	PLLDIV[0]	PLLAZ[1]	PLLAZ[0]	PLOCKEXT
DCLKCRC	05	DATADJ[3]	DATADJ[2]	DATADJ[1]	DATADJ[0]	MODSYNC	MODADJ[2]	MODADJ[1]	MODADJ[0]
	06	Reserved							
	07	Reserved							
	08	Reserved							
	09	Reserved							
	0A	Reserved							
	0B	Reserved							
	0C	Reserved							
VERSION	0D					VERSION[3]	VERSION[3]	VERSION[3]	VERSION[3]
CALMEMCK	0E	RESERVED	RESERVED	CALMEM[1]	CALMEN[0]		CALCKDIV[2]	CALCKDIV[2]	CALCKDIV[2]
MEMRDWR	0F	CALSTAT	CALEN	XFERSTAT	XFEREN	SMEMWR	SMEMRD	FMEMRD	UNCAL
MEMADDR	10	MEMADDR[7]	MEMADDR[6]	MEMADDR[5]	MEMADDR[4]	MEMADDR[3]	MEMADDR[2]	MEMADDR[1]	MEMADDR[0]
MEMDATA	11			MEMDATA[5]	MEMDATA[4]	MEMDATA[3]	MEMDATA[2]	MEMDATA[1]	MEMDATA[0]
DCRSTAT	12						DCRSTAT[2]	DCRSTAT[1]	DCRSTAT[0]

Table 11.

COMMS(00)	Bit	Direction	Default	Description
SDIODIR	7	I	0	0: SDIO pin configured for input only during data transfer 1: SDIO configured for input or output during data transfer
DATADIR	6	I	0	0: Serial data uses MSB first format 1: Serial data uses LSB first format
SWRST	5	I	0	1: Default all serial register bits, except addresses 00h and 04h
SLEEP	4	I	0	1: DAC output current off
PDN	3	I	0	1: All analog and digital circuitry, except serial interface, off
PLLLOCK	1	O	0	0: With PLL on, indicates that PLL is not locked 1: With PLL on, indicates that PLL is locked
EXREF	0	I	0	0: Internal band gap reference 1: External reference

Table 12.

FILTER(01)	Bit	Direction	Default	Description
INTERP[1:0]	[7:6]	I	00	00: No interpolation 01: Interpolation 2x 10: Interpolation 4x 11: Interpolation 8x
ZSTUFF	3	I	0	1: Zero Stuffing on
HPFX8	2	I	0	0: x8 interpolation filter configured for low pass 1: x8 interpolation filter configured for high pass
HPFX4	1	I	0	0: x4 interpolation filter configured for low pass 1: x4 interpolation filter configured for high pass
HPFX2	0	I	0	0: x2 interpolation filter configured for low pass 1: x2 interpolation filter configured for high pass

Table 13.

DATA(02)	Bit	Direction	Default	Description
DATAFMT	7	I	0	0: Twos complement data format 1: Unsigned binary input data format
ONEPORT	6	I	0	0: I and Q input data onto ports one and two respectively 1: I and Q input data interleaved onto port one
DCLKSTR	5	I	0	0: DATACLK pin 12 mA drive strength 1: DATACLK pin 24 mA drive strength
DCLKPOL	4	I	0	0: Input data latched on DATACLK rising edge 1: Input data latched on DATACLK falling edge
DCLKEXT	3	I	0	0: With PLOCKEXT off, DATACLK pin inputs channel data rate or modulator synchronizer clock 1: With PLOCKEXT off, DATACLK pin outputs channel data rate or modulator synchronizer clock
DCLKCRC	2	I	0	0: With PLOCKEXT off, and DATACLK pin as input, DATACLK clock recovery off 1: With PLOCKEXT off, and DATACLK pin as input, DATACLK clock recovery on
IQPOL	1	I	0	0: In one port mode, IQSEL = 1 latches data into I channel, IQSEL = 0 latches data into Q channel 1: In one port mode, IQSEL = 0 latches data into I channel, IQSEL = 1 latches data into Q channel
GRAYDIN	0	I	0	0: Gray decoder off 1: Gray decoder on

Table 14.

MODULATE(03)	Bit	Direction	Default	Description		
CHANNEL	7	I	0	<b>MODDUAL</b>	<b>CHANNEL</b>	
				<b>03h [5]</b>	<b>03h[7]</b>	
				0	0	I channel processing routed to DAC
				0	1	Q channel processing routed to DAC
				1	0	Modulator real output routed to DAC
				1	1	Modulator imaginary output routed to DAC
HILBERT	6	I	0	1: With MODDUAL on, Hilbert transform on		
MODDUAL	5	I	0	0: Modulator uses a single channel 1: Modulator uses both I and Q channels		
SIDEBAND	4	I	0	0: With MODDUAL on, lower sideband rejected 1: With MODDUAL on, upper sideband rejected		
MOD[1:0]	[3:2]	I	00	00: No modulation 01: $f_s/2$ modulation 10: $f_s/4$ modulation 11: $f_s/8$ modulation		

Table 15.

PLL(04)	Bit	Direction	Default	Description
PLLON	7	I	0	0: PLL off 1: PLL on
PLLMULTI[1:0]	[6:5]	I	00	PLL MULTIPLY FACTOR 00: ×2 00: ×4 00: ×8 00: ×16
PLLDIV[1:0]	[4:3]	I	00	PLLMULT rate divide factor 00:/1 00:/2 00:/4 00:/8
PLLAZBW[1:0]	[2:1]	I	00	PLL Autozero settling bandwidth as fraction of CLK ±rate 00: /8 (lowest) 01: /4 10: /2 (highest)
PLOCKEXT	0	I	0	0: With PLL on, DATACLK/PLL_LOCK pin configured for DATACLK input/output 1: With PLL on, DATACLK/PLL_LOCK pin configured for output of PLLLOCK

Table 16.

DCLKCRC(05)	Bit	Direction	Default	Description																																					
DATADJ[3:0]	[7:4]	I	0000	DATACLK offset. Twos complement representation 0111: +7 : 0000: 0 : 1000: -8																																					
MODSYNC	3	I	00	0: With PLOCKEXT off, channel data rate clock synchronizer mode 1: With PLOCKEXT off, state machine clock synchronizer mode																																					
MODADJ[2:0]	[2:0]	I	000	<table border="1"> <thead> <tr> <th></th> <th><math>f_s/8</math></th> <th><math>f_s/4</math></th> <th><math>f_s/2</math></th> <th rowspan="9">Modulator coefficient offset</th> </tr> </thead> <tbody> <tr> <td>000</td> <td>1</td> <td>1</td> <td>1</td> </tr> <tr> <td>001</td> <td><math>1/\sqrt{2}</math></td> <td>0</td> <td>-1</td> </tr> <tr> <td>010</td> <td>0</td> <td>-1</td> <td>1</td> </tr> <tr> <td>011</td> <td><math>-1/\sqrt{2}</math></td> <td>0</td> <td>-1</td> </tr> <tr> <td>100</td> <td>-1</td> <td>1</td> <td>1</td> </tr> <tr> <td>101</td> <td><math>-1/\sqrt{2}</math></td> <td>0</td> <td>-1</td> </tr> <tr> <td>110</td> <td>0</td> <td>-1</td> <td>1</td> </tr> <tr> <td>111</td> <td><math>1/\sqrt{2}</math></td> <td>0</td> <td>-1</td> </tr> </tbody> </table>		$f_s/8$	$f_s/4$	$f_s/2$	Modulator coefficient offset	000	1	1	1	001	$1/\sqrt{2}$	0	-1	010	0	-1	1	011	$-1/\sqrt{2}$	0	-1	100	-1	1	1	101	$-1/\sqrt{2}$	0	-1	110	0	-1	1	111	$1/\sqrt{2}$	0	-1
	$f_s/8$	$f_s/4$	$f_s/2$	Modulator coefficient offset																																					
000	1	1	1																																						
001	$1/\sqrt{2}$	0	-1																																						
010	0	-1	1																																						
011	$-1/\sqrt{2}$	0	-1																																						
100	-1	1	1																																						
101	$-1/\sqrt{2}$	0	-1																																						
110	0	-1	1																																						
111	$1/\sqrt{2}$	0	-1																																						

Table 17.

VERSION(0D)	Bit	Direction	Default	Description
VERSION[3:0]	[3:0]	O	–	Hardware version identifier

Table 18.

CALMEMCK(OE)	Bit	Direction	Default	Description
CALMEM	[5:4]	O	00	Calibration memory 00: Uncalibrated 01: Self Calibration 10: Factory calibration 11: User input
CALCKDIV[2:0]	[2:0]	I	00	Calibration clock divide ratio from channel data rate 000: /32 001: /64 : 110: /2048 111: /4096

Table 19.

MEMRDWR(OE)	Bit	Direction	Default	Description
CALSTAT	7	O	0	0: Self Calibration cycle not complete 1: Self Calibration cycle complete
CALEN	6	I	0	1: Self Calibration in progress
XFERSTAT	5	O	0	0: Factory memory transfer not complete 1: Factory memory transfer complete
XFEREN	4	I	0	1: Factory memory transfer in progress
SMEMWR	3	I	0	1: Write static memory data from external port
SMEMRD	2	I	0	1: Read static memory to external port
FMEMRD	1	I	0	1: Read factory memory data to external port
UNCAL	0	I	0	1: Use uncalibrated

Table 20.

MEMADDR(10)	Bit	Direction	Default	Description
MEMADDR [7:0]	[7:0]	I/O	00000000	Address of factory or static memory to be accessed

Table 21.

MEMDATA(11)	Bit	Direction	Default	Description
MEMDATA [5:0]	[5:0]	I/O	000000	Data or factory or static memory access

Table 22.

DCRCSTAT(12)	Bit	Direction	Default	Description
DCRCSTAT (2)	2	O	0	0: With DATACLK CRC on, lock has never been achieved 1: With DATACLK CRC on, lock has been achieved at least once
DCRCSTAT(1)	1	O	0	0: With DATACLK CRC on, system is currently not locked 1: With DATACLK CRC on, system is currently locked
DCRCSTAT(0)	0	O	0	0: With DATACLK CRC on, system is currently locked 1: With DATACLK CRC on, system lost lock due to jitter

# DIGITAL FILTER SPECIFICATIONS

## DIGITAL INTERPOLATION FILTER COEFFICIENTS

Table 23. Stage 1 Interpolation Filter Coefficients

Lower Coefficient	Upper Coefficient	Integer Value
H(1)	H(43)	9
H(2)	H(42)	0
H(3)	H(41)	-27
H(4)	H(40)	0
H(5)	H(39)	65
H(6)	H(38)	0
H(7)	H(37)	-131
H(8)	H(36)	0
H(9)	H(35)	239
H(10)	H(34)	0
H(11)	H(33)	-407
H(12)	H(32)	0
H(13)	H(31)	665
H(14)	H(30)	0
H(15)	H(29)	-1070
H(16)	H(28)	0
H(17)	H(27)	1764
H(18)	H(26)	0
H(19)	H(25)	-3273
H(20)	H(24)	0
H(21)	H(23)	10358
H(22)		16384

Table 24. Stage 2 Interpolation Filter Coefficients

Lower Coefficient	Upper Coefficient	Integer Value
H(1)	H(19)	19
H(2)	H(18)	0
H(3)	H(17)	-120
H(4)	H(16)	0
H(5)	H(15)	436
H(6)	H(14)	0
H(7)	H(13)	-1284
H(8)	H(12)	0
H(9)	H(11)	5045
H(10)		8192

Table 25. Stage 3 Interpolation Filter Coefficients

Lower Coefficient	Upper Coefficient	Integer Value
H(1)	H(11)	7
H(2)	H(10)	0
H(3)	H(9)	-53
H(4)	H(8)	0
H(5)	H(7)	302
H(6)		512

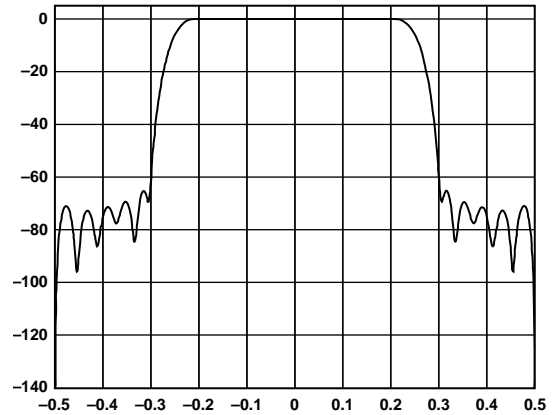

Figure 34.  $\times 2$  Interpolation Filter Response

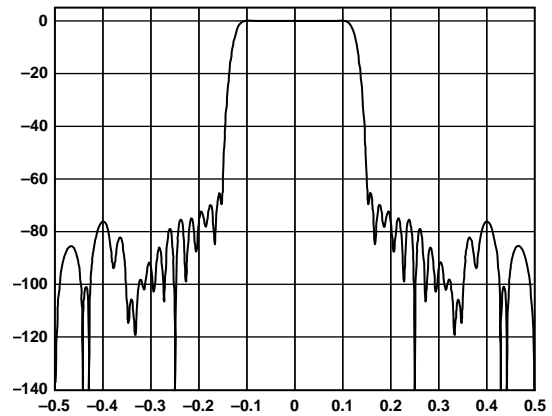

Figure 35.  $\times 4$  Interpolation Filter Response

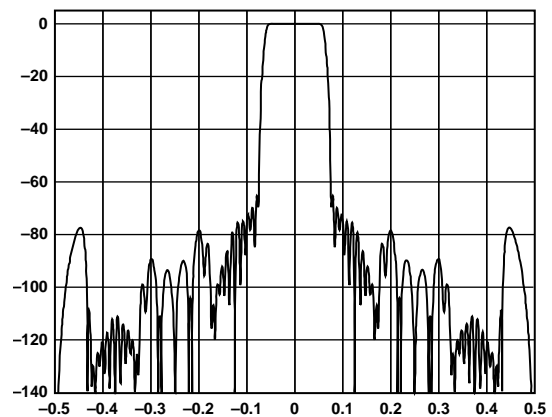

Figure 36.  $\times 8$  Interpolation Filter Response

**AD9782 CLOCK/DATA TIMING**

**DLL Disabled, Two-Port Data Mode, DATACLK as Output**

With the interpolation set to 1x, the DATACLK output is a delayed and inverted version of DACCLK at the same frequency. Note that DACCLK refers to the differential clock inputs applied at Pins 5 and 6. As Figure 37 shows, there is a constant delay between the rising edge of DACCLK and the falling edge of DATACLK.

The DCLKPOL bit (Reg 02 Bit 4) allows the data to be latched into the AD9782 on either the rising or falling edge of DACCLK. With DCLKPOL = 1, the data is latched in on the rising edge of Diff Clk, as shown in Figure 37. With DCLKPOL = 0, as shown in Figure 38, data is latched in on the falling edge of DACCLK. The setup and hold times are always with respect to the latched edge of DACCLK.

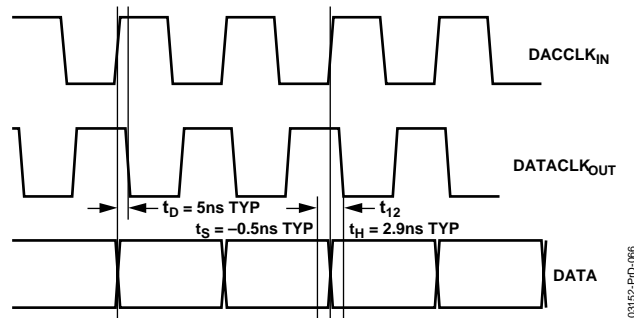

Figure 37. Data Timing, DLL Off, 1x Interpolation, DCLKPOL = 1

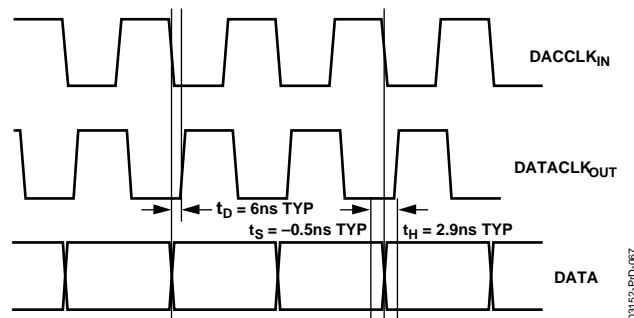

Figure 38. Data Timing, DLL Off, 1x Interpolation, DCLKPOL = 0



With the interpolation set to 2x, the DACCLK input runs at twice the speed of the DATACLK. Data is latched into the AD9782's inputs on every other rising edge of DACCLK, as shown in Figure 40 and Figure 41. With DCLKPOL = 1, as shown in Figure 40, the latching edge of DACCLK is the rising edge that occurs just before the falling edge of DATACLK. With DCLKPOL = 0, as in Figure 41, the latching edge of DACCLK is the rising edge of DACCLK that occurs just before the rising edge of DATACLK. The setup and hold time values are identical to those in Figure 37 and Figure 38.

Note that there is a slight difference in the delay from the rising edge of DACCLK to the falling edge of DATACLK, and the delay from the rising edge of DACCLK to the rising edge of DATACLK. As Figure 39 shows, the DATACLK duty cycle is slightly less than 50%. This is true in all modes.

With the interpolation set to 4x or 8x, the DACCLK input runs at 4x or 8x the speed of the DATACLK output. The data is latched in on a rising edge of DACCLK, similar to the 2x interpolation mode. However, the latching edge is every fourth edge in 4x interpolation mode and every eighth edge in the 8x

interpolation mode. Again, similar to operation in the 2x interpolation mode, with DCLKPOL = 1, the latching edge of DACCLK is the rising edge that occurs just before the falling edge of DATACLK. With DCLKPOL = 0, the latching edge of DACCLK is the rising edge that occurs just before the rising edge of DATACLK. The setup and hold time values are identical to those in 1x and 2x interpolation

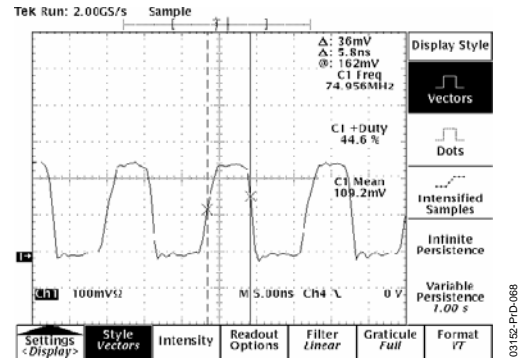

Figure 39.

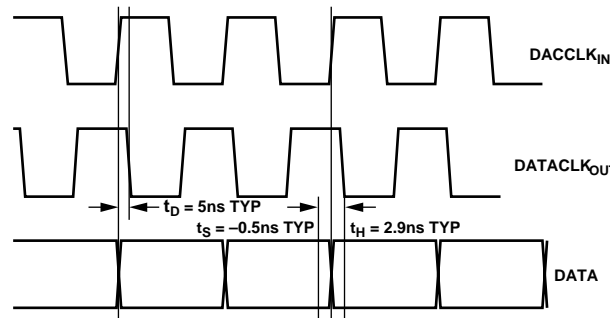

Figure 40. Data Timing, DLL Off, 2x Interpolation, DCLKPOL = 1

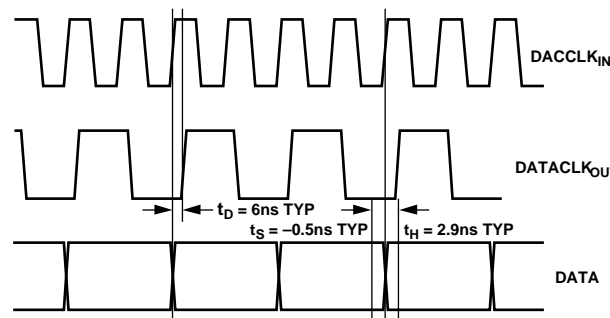

Figure 41. Data Timing, DLL Off, 2x Interpolation, DCLKPOL = 0

**DATAADJUST Synchronization**

When designing the digital interface for high speed DACs, care must be taken to ensure that the DAC input data meets setup-and-hold requirements. Often, compensation must be used in the clock delay path to the digital engine driving the DAC. The AD9782 has the on chip capability to vary the DACCLK's latching edge. With the interpolation function enabled, this allows the user the choice of multiple edges upon which to latch the data. For instance, if the AD9782 is using 8x interpolation, the user may latch from one of eight edges before the rising edge of DATACLK, or seven edges after this rising edge. The specific edge upon which data is latched is controlled by SPI Register 05h, Bits 7:4. Table 26 shows the relationship of the latching edge of DACCLK and DATACLK with the various settings of the DATAADJ bits.

Table 26.

SPI Reg 05h				Latching Edge wrt DATACLK
Bit 7	Bit 6	Bit 5	Bit 4	
0	0	0	0	0
0	0	0	1	+1
0	0	1	0	+2
0	0	1	1	+3
0	1	0	0	+4
0	1	0	1	+5
0	1	1	0	+6
0	1	1	1	+7
1	0	0	0	-8
1	0	0	1	-7
1	0	1	0	-6
1	0	1	1	-5
1	1	0	0	-4
1	1	0	1	-3
1	1	1	0	-2
1	1	1	1	-1

Note that the data in Figure 40 and Figure 41 was taken with the DATAADJ default of 0000. With DCLKPOL = 0, the latching edge of DACCLK is just previous to the rising edge of DATACLK; with DCLKPOL = 1, the latching edge of DACCLK is just previous to the falling edge of DATACLK.

With 8x interpolation, the user has the capability of using one of 16 edges to latch the data. This is due to the fact that there are eight DAC clock edges before and after the DATACLK until the next DATACLK latching edge. With 4x interpolation, there are only four latching edges of DACCLK available before and after each DATACLK edge. Therefore, in 4x interpolation, only the even numbered values for DATAADJ are available, and the options are changed from +3 cycles to -4 cycles. With 2x interpolation, there are only two edges available before and after DATACLK, so the choices for DATAADJ are diminished to +1 cycle to -2 cycles.

Figure 42, Figure 43, and Figure 44 show the alignment for the latching edge of DACCLK with 4x interpolation and different settings for DATAADJ. In Figure 42, DATAADJ is set to 0000, with DCLKPOL set to 0 so that the latching edge of DACCLK is immediately before the rising edge of DATACLK. The data transitions shown in Figure 42 are synchronous with the DACCLK, so that DACCLK and data are constant with respect to each other. The only visible change when DATAADJ is altered is that DATACLK moves, indicating the latching edge has moved as well. Note that when DATAADJ is altered, the latching edge with respect to DATACLK remains the same, but the latching edge of DACCLK follows the edge of DATACLK.

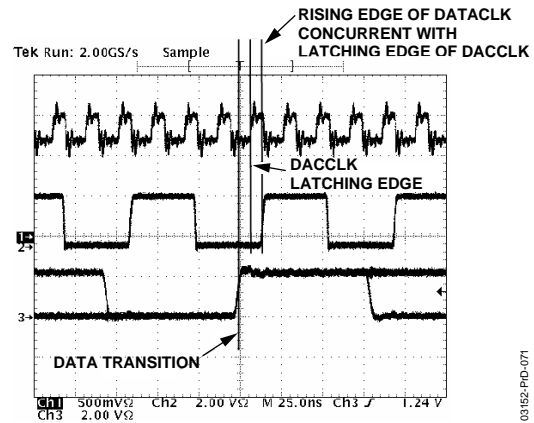

Figure 42. DATAADJ = 0000

Figure 43 shows the same conditions, but now DATAADJ is set to 1111. This moves DATACLK to the left in the plot, indicating that it occurs one DACCLK cycle before it did in Figure 42. As explained previously, the latching edge of DACCLK also moves one cycle back in time.

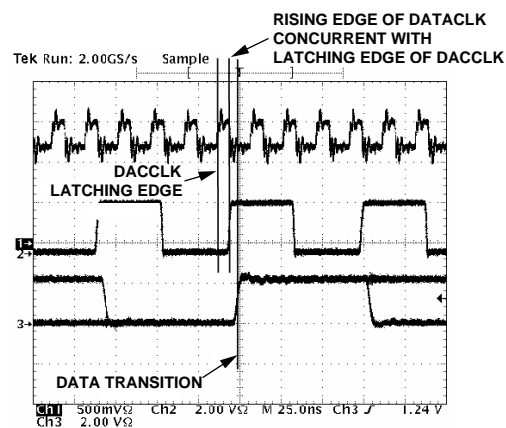

Figure 43. DATAADJ = 1111

Figure 44 shows the same conditions, with DATAADJ now set to 0001, thus moving DATACLK to the right in the plot. This indicates that it occurs one DACCLK cycle after it did in Figure 42. Now the latching edge of DACCLK moves forward in time one cycle.

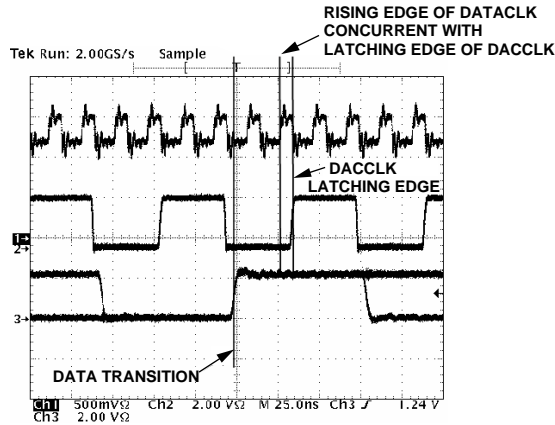

Figure 44. DATAADJ = 0001

**INTERPOLATION MODES**

Table 27.

INTERP[1]	INTERP[0]	Mode
0	0	No Interpolation
0	1	×2 Interpolation
1	0	×4 Interpolation
1	1	×8 Interpolation

Interpolation is the process of increasing the number of points in a time domain waveform by approximating points between the input data points; on a uniform time grid, this produces a higher output data rate. Applied to an interpolation DAC, a digital interpolation filter is used to approximate the interpolated points, having an output data rate increased by the interpolation factor. Interpolation filter responses are achieved by cascading individual digital filter banks, whose filter coefficients are given in Table 1; filter responses are shown in Figure 34.

The digital filter’s frequency domain response exhibits symmetry about half the output data rate and dc. It will cause images of the input data to be shaped by the interpolation filter’s frequency response. This has the advantage of causing input data images, which fall in the stop band of the digital filter to be rejected by the stop-band attenuation of the interpolation filter; input data images falling in the interpolation filter’s pass-band will be passed. In band-limited applications, the images at the output of the DAC must be limited by an analog reconstruction filter. The complexity of the analog reconstruction filter is determined by the proximity of the closest image to the required signal band. Higher interpolation rates yield larger stop-band regions, suppressing more input images and resulting in a much relaxed analog reconstruction filter.

A DAC shapes its output with a sinc function, having a null at the sampling frequency of the DAC. The higher the DAC sampling rate compared to the input signal bandwidth, the less the DAC sinc function will shape the output. Figure 45 shows the interpolation filters of the AD9782 under different interpolation rates, normalized to the input data rate,  $f_{SIN}$ . The higher the interpolation rate the more input data images fall in the interpolation filter stop band and are rejected; the band-width between passed images is larger with higher interpolation factors. The sinc function shaping is also reduced with a higher interpolation factor.

Table 28.

Mode	Sinc Shaping at $0.43f_{SIN}$ (dB)	Bandwidth to First Image
No Interpolation	-2.8241	$f_{SIN}$
×2 Interpolation	-0.6708	$2f_{SIN}$
×4 Interpolation	-0.1657	$4f_{SIN}$
×8 Interpolation	-0.0413	$8f_{SIN}$

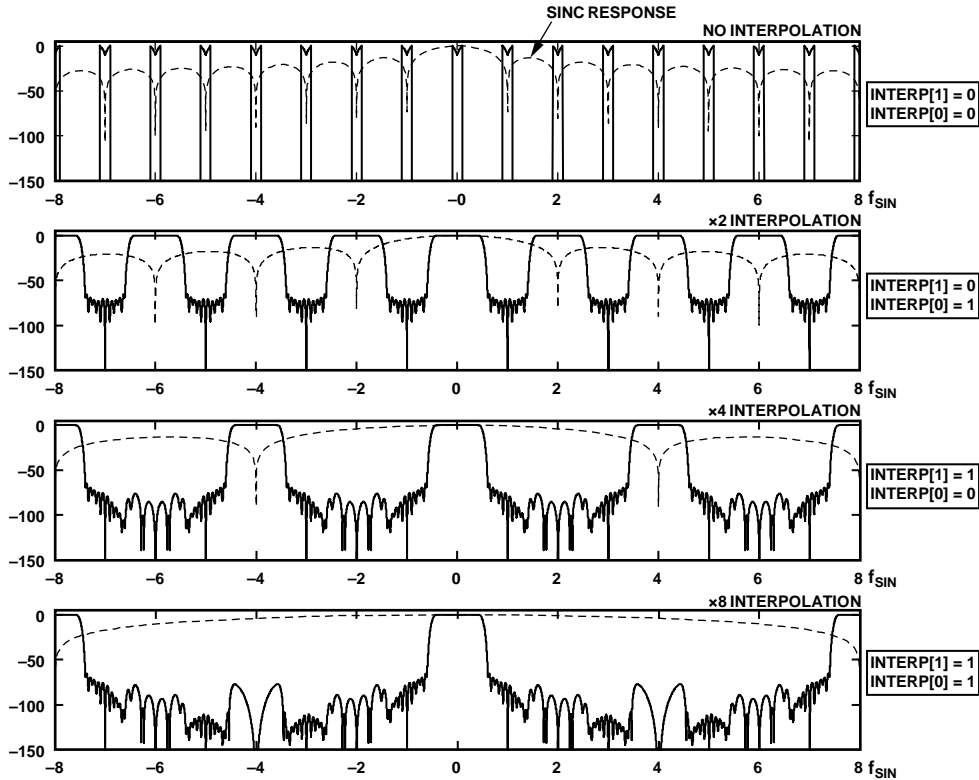

Figure 45. Interpolation Modes

**REAL AND COMPLEX SIGNALS**

A complex signal contains both magnitude and phase information. Given two signals at the same frequency, if a point in time can be taken such that the signal leading in phase is cosinusoidal and the lagging signal is sinusoidal, then information pertaining to the magnitude and phase of a combination of the two signals can be derived; the combination of the two signals can be considered a complex signal. The cosine and sine can be represented as a series of exponentials; recalling that a multiplication by *j* is a counter clockwise rotation about the Re/Im plane, the phasor representation of a complex signal, with frequency *f*, can be shown Figure 46.

The cosine term represents a signal on the real plane with mirror symmetry about dc; this is referred to as the real, in-phase or I component of a complex signal. The sine term represents a signal on the imaginary plane with mirror asymmetry about dc; this term is referred to as the imaginary, quadrature or Q complex signal component.

The AD9782 has two channels of interpolation filters, allowing both I and Q components to be shaped by the same filter transfer function. The interpolation filters' frequency response is a real transfer function. Two DACs are required to represent a complex signal. A single DAC can only synthesize a real signal. When a DAC synthesizes a real signal, negative frequency components fold onto the positive frequency axis. If the input to the DAC is mirror symmetrical about dc, the folded negative frequency components fold directly onto the positive frequency components in phase producing constructive signal summation. If the input to the DAC is not mirror symmetric about dc, negative frequency components may not be in phase with positive frequency components and will cause destructive signal summation. Different applications may or may not benefit from either type of signal summation.

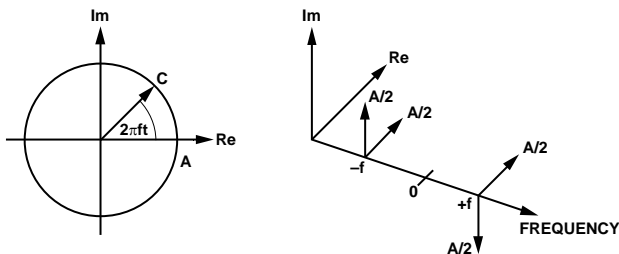

$$C = Ae^{j2\pi ft} = A\cos(2\pi ft) + jA\sin(2\pi ft)$$

$$A\cos(2\pi ft) = A \left[ \frac{e^{+j2\pi ft} + e^{-j2\pi ft}}{2} \right] = \frac{A}{2} [e^{+j2\pi ft} + e^{-j2\pi ft}]$$

$$A\sin(2\pi ft) = A \left[ \frac{e^{+j2\pi ft} - e^{-j2\pi ft}}{2j} \right] = \frac{A}{2} [je^{+j2\pi ft} - e^{-j2\pi ft}]$$

Figure 46. Complex Phasor Representation

03152-PD-012

**MODULATION MODES**

**Table 29. Single Channel Modulation**

MODDUAL	CHANNEL	MOD[1]	MOD[0]	Mode
0	0	0	0	I Channel, no modulation
0	0	0	1	I Channel, modulation by $f_{DAC}/2$
0	0	1	0	I Channel, modulation by $f_{DAC}/4$
0	0	1	1	I Channel, modulation by $f_{DAC}/8$
0	1	0	0	Q Channel, no modulation
0	1	0	1	Q Channel, modulation by $f_{DAC}/2$
0	1	1	0	Q Channel, modulation by $f_{DAC}/4$
0	1	1	1	Q Channel, modulation by $f_{DAC}/8$

Either channel of the AD9782’s interpolation filter channels can be routed to the DAC and modulated. In single channel operation the input data may be modulated by a real sinusoid; the input data and the modulating sinusoid will contain both positive and negative frequency components. A double sideband output results when modulating two real signals. At the DAC output the positive and negative frequency components will add in phase resulting in constructive signal summation.

As the modulating sinusoidal frequency becomes a larger fraction of the DAC update rate,  $f_{DAC}$ , the more the sinc function of the DAC shapes the modulated signal bandwidth, and the closer the first image moves. As the AD9782 interpolation filter’s pass band represents a large portion of the input data’s Nyquist band, under certain modulation and interpolation modes it is possible for modulated signal bands to touch or overlap images if sufficient interpolation is not used.

Figure 48 shows the effect of real modulation under all interpolation modes. The sinc shaping at the corners of the modulated signal band and the bandwidth to the first image for those cases whose pass bands do not touch or overlap are tabulated.

**Table 30.**

Modulation	Interpolation			
	None	×2	×4	×8
none	$f_{SIN}$	$2 f_{SIN}$	$4 f_{SIN}$	$8 f_{SIN}$
$f_{DAC}/2$	$f_{SIN}$	$2 f_{SIN}$	$4 f_{SIN}$	$8 f_{SIN}$
$f_{DAC}/4$	Overlap	Touching	$2 f_{SIN}$	$4 f_{SIN}$
$f_{DAC}/8$	Overlap	Overlap	Touching	$6 f_{SIN}$

**Table 31.**

Modulation	Interpolation			
	None	×2	×4	×8
None	0 -2.8241	0 -0.6708	0 -0.1657	0 -0.0413
$f_{DAC}/2$	-0.0701 -22.5378	-1.1932 -9.1824	-2.3248 -6.1190	-3.0590 -4.9337
$f_{DAC}/4$	Overlap	Touching	-0.2921 -1.9096	-0.5974 -1.3607
$f_{DAC}/8$	Overlap	Overlap	Touching	-0.0727 -0.4614

Modulated pass band edges sinc shaping(lower/upper).

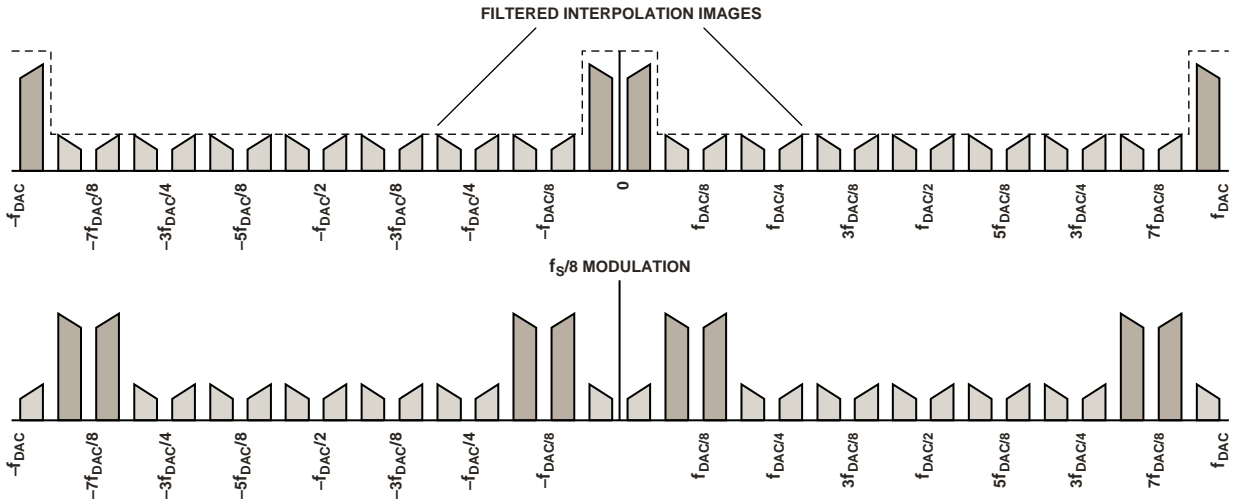

Figure 47. Double Sideband Modulation

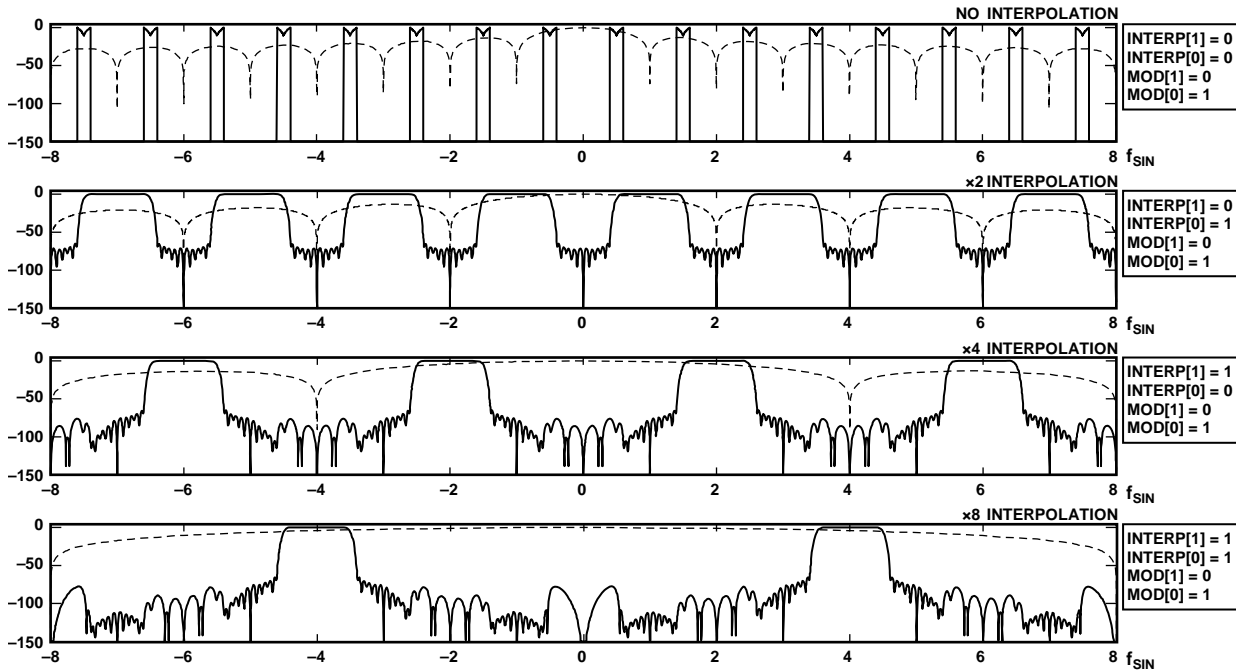

Figure 48. Real Modulation by  $f_{DAC}/2$  under all Interpolation Modes

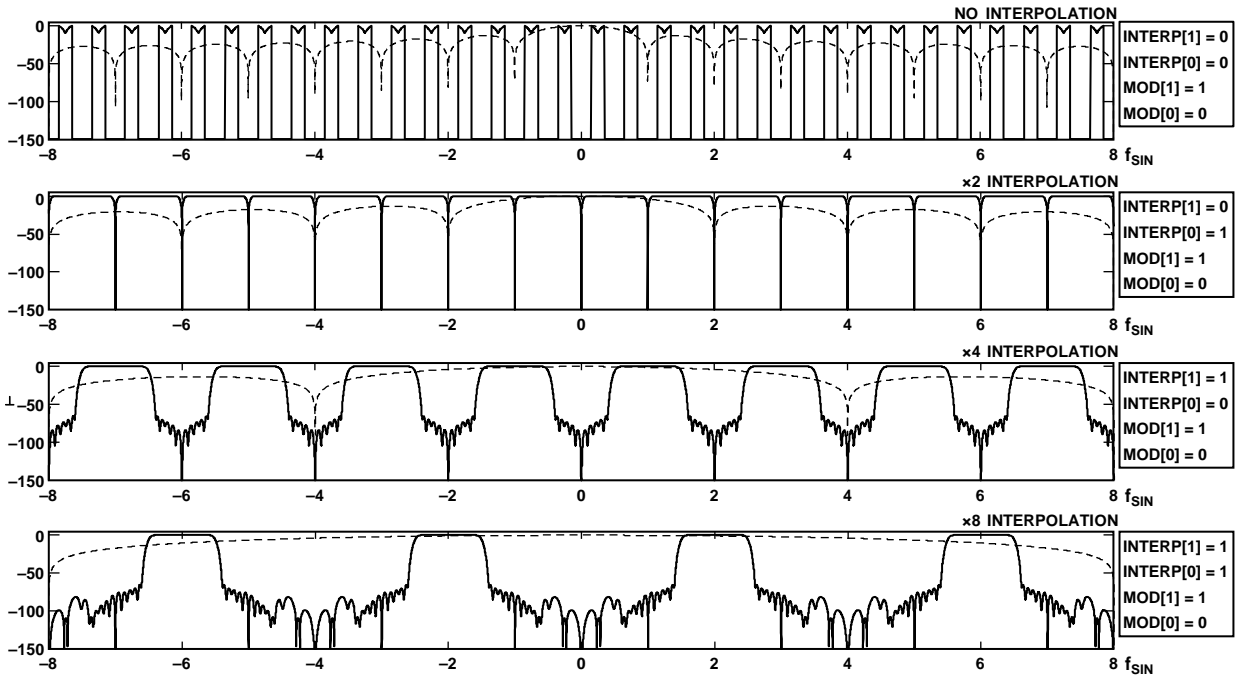

Figure 49. Real Modulation by  $f_{DAC}/4$  under all Interpolation Modes

03215-PD-015

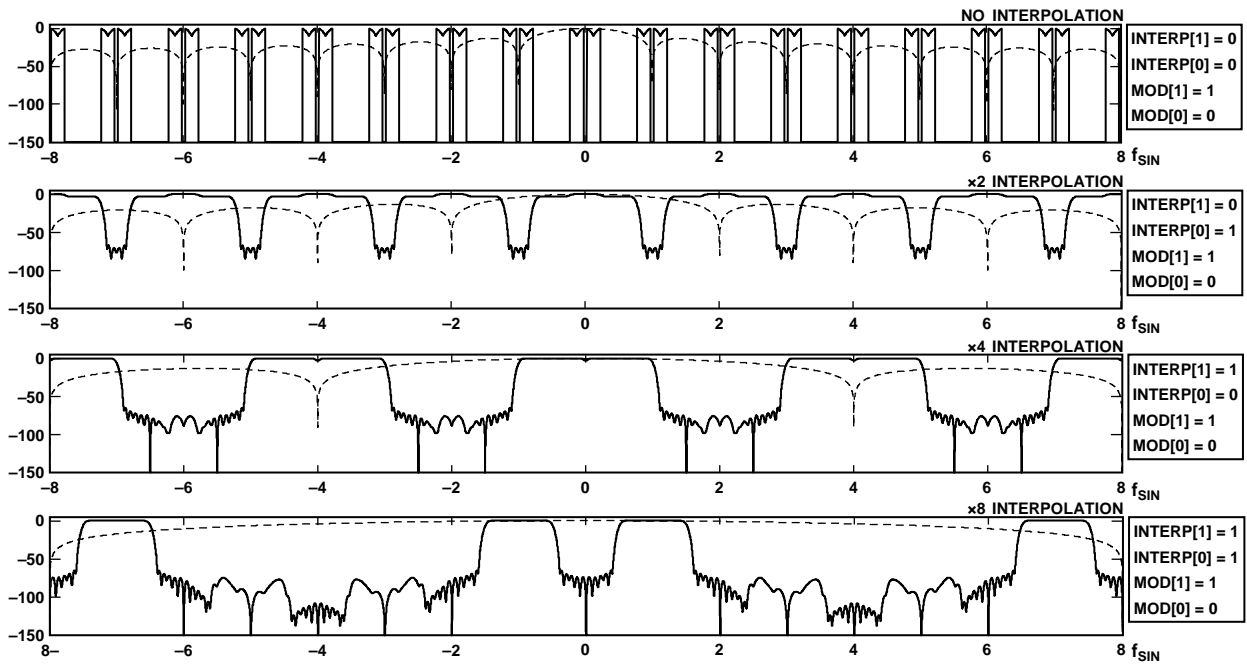

Figure 50. Real Modulation by  $f_{DAC}/8$  under all Interpolation Modes

03152-PD-017

Table 32. Dual Channel Complex Modulation

MODSING	REALIMAG	MOD[1]	MOD[0]	Mode
0	0	0	0	Real output, no modulation
0	0	0	1	Real output, modulation by $f_{DAC}/2$
0	0	1	0	Real output, modulation $f_{DAC}/4$
0	0	1	1	Real output, modulation $f_{DAC}/8$
0	1	0	0	Image output, no modulation
0	1	0	1	Imag output, modulation by $f_{DAC}/2$
0	1	1	0	Imag output, modulation by $f_{DAC}/4$
0	1	1	1	Imag output, modulation by $f_{DAC}/8$

In dual channel mode, the two channels may be modulated by a complex signal, with either the real or imaginary modulation result directed to the DAC. Assume initially that the complex modulating signal is defined for a positive frequency only; this causes the output spectrum to be translated in frequency by the modulation factor only. No additional sidebands are created as a result of the modulation process, and therefore the bandwidth to the first image from the baseband bandwidth is the same as the output of the interpolation filters. Furthermore, pass bands will not overlap or touch. The sinc shaping at the corners of the modulated signal band are tabulated. Figure 52 shows the complex modulations.

Table 33.

Modulation	Interpolation			
	None	x2	x4	x8
None	0	0	0	0
$f_{DAC}/2$	-2.8241	-0.6708	-0.1657	-0.0413
$f_{DAC}/4$	-0.0701	-1.1932	-2.3248	-3.0590
$f_{DAC}/8$	-0.4680	-0.0175	-0.2921	-0.5974
	-6.0630	-3.3447	-1.9096	-1.3607
	-1.3723	-0.1160	-0.0044	-0.0727
	-4.9592	-1.7195	-0.7866	-0.4614

Modulated passband edges sinc shaping(lower/upper).

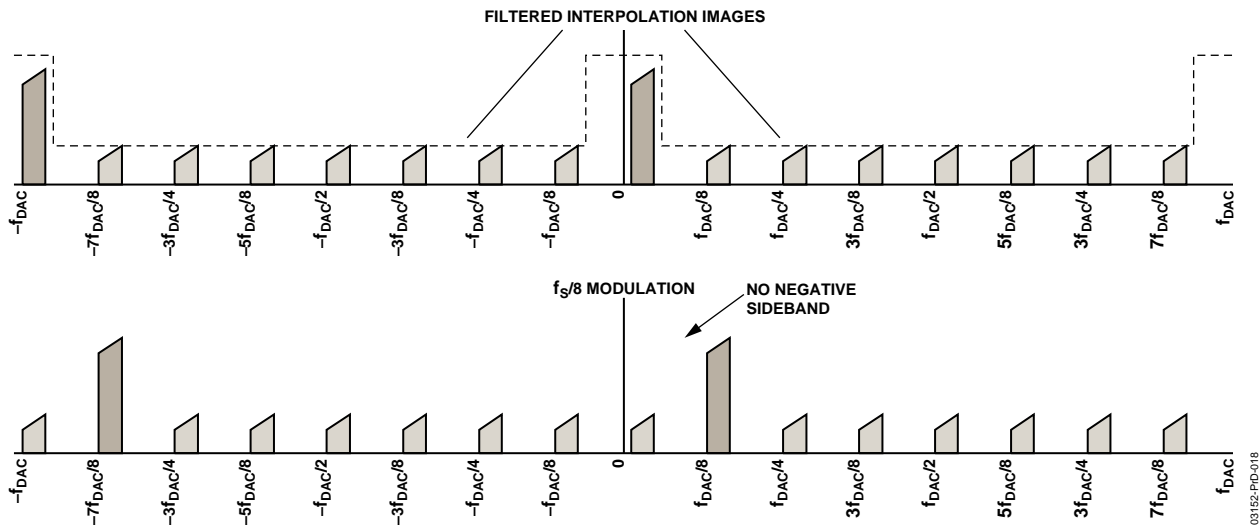

Figure 51. Complex Modulation



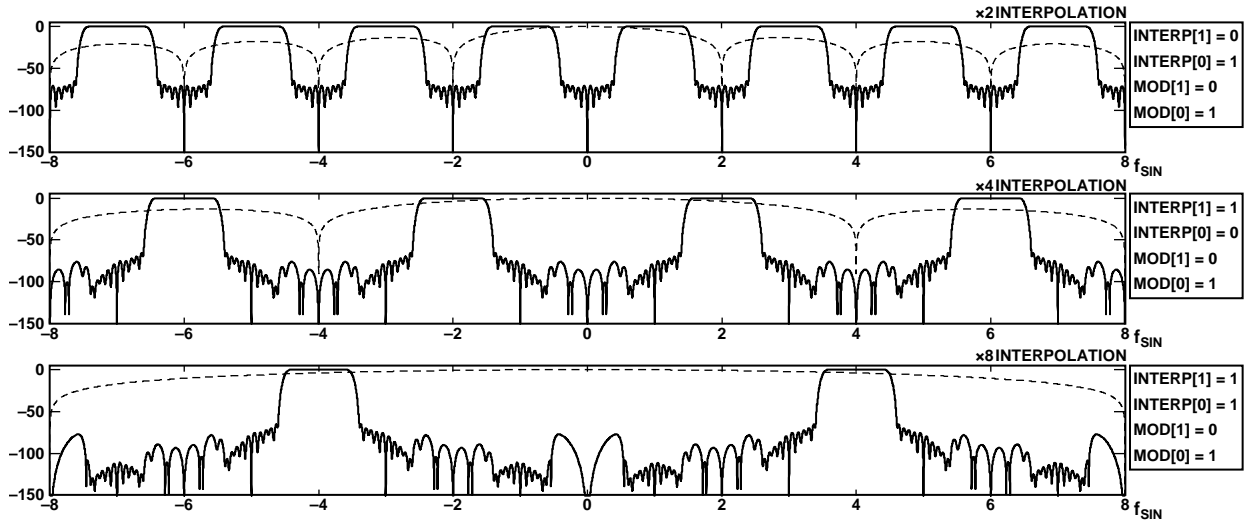

Figure 52. Complex Modulation by  $f_{DAC}/2$  under all Interpolation Modes

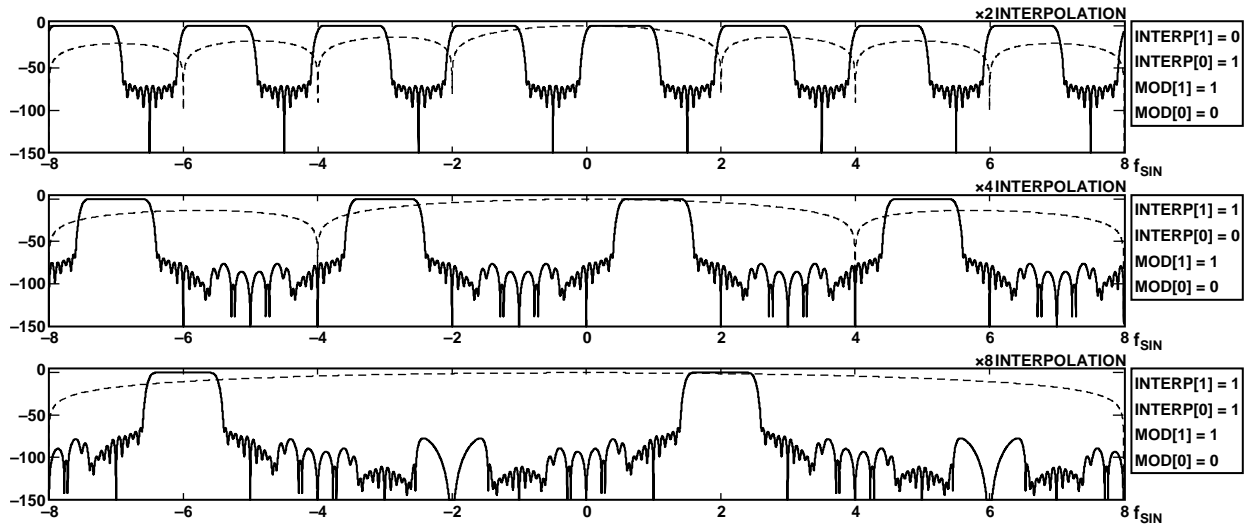

Figure 53. Complex Modulation by  $f_{DAC}/4$  under all Interpolation Modes

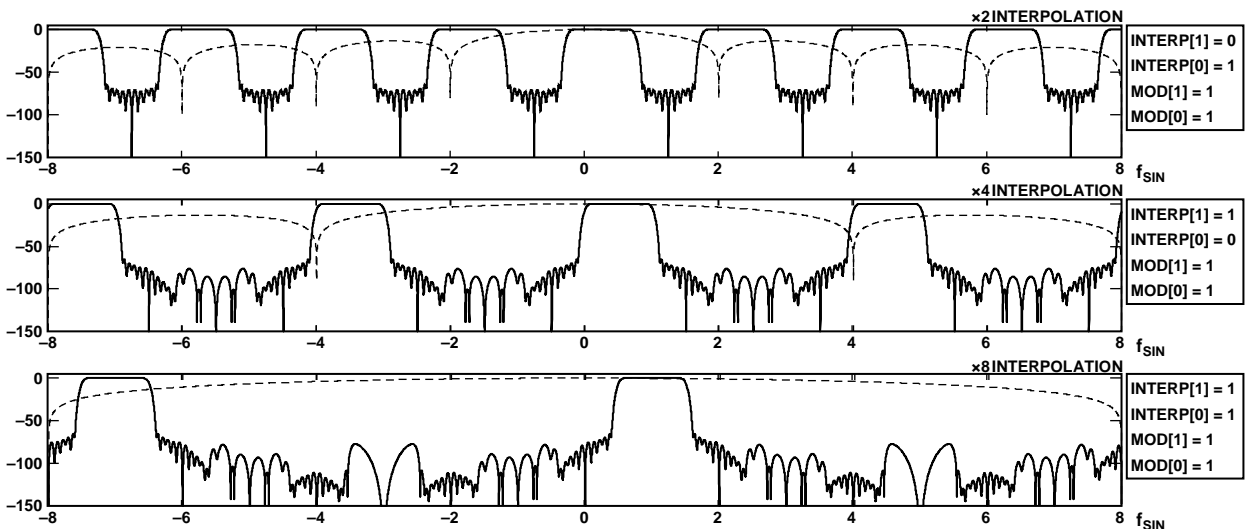

Figure 54. Complex Modulation by  $f_{DAC}/8$  under all Interpolation Modes

**POWER DISSIPATION**

The AD9782 has seven power supply domains: two 3.3 V analog domains (AVDD1 and AVDD2), two 2.5 V analog domains (ADVDD and ACVDD), one 2.5 V clock domain (CLKVDD), and two digital domains (DVDD, which runs from 2.5 V, and DRVDD, which can run from 2.5 V or 3.3 V).

The current needed for the 3.3 V analog supplies, AVDD1 and AVDD2, is consistent across speed and varying modes of the AD9782. Nominally, the current for AVDD1 is 29 mA across all speeds and modes, while the current for AVDD2 is 20 mA.

The current for the 2.5 V analog supplies and the digital supplies varies depending on speed and mode of operation. Figure 55, Figure 56, and Figure 57 show this variation. Note that CLKVDD, ADVDD, and ACVDD vary with clock speed and interpolation rate, but not with modulation rate.

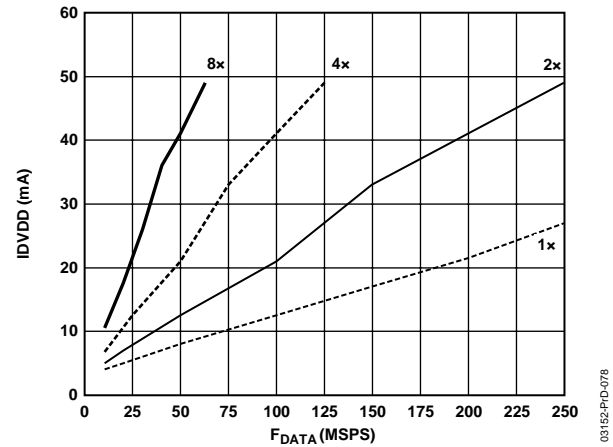

Figure 56. CLKVDD Supply Current vs. Clock Speed and Interpolation Rates

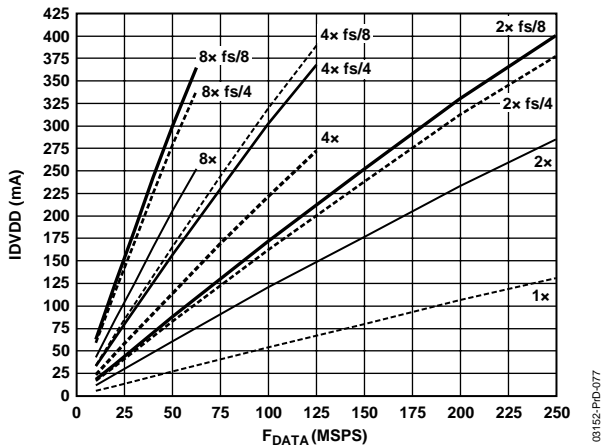

Figure 55. DVDD Supply Current vs. Clock Speed, Interpolation, and Modulation Rates

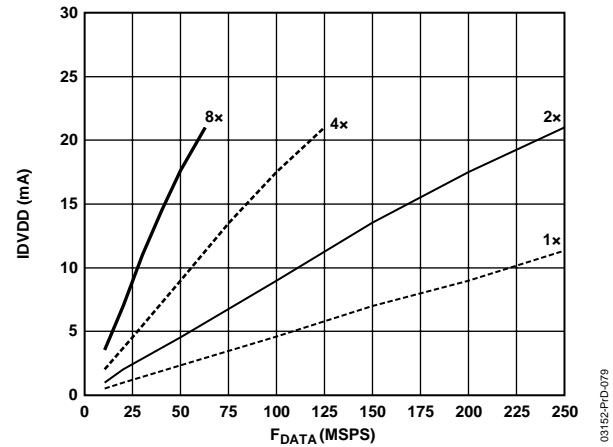

Figure 57. ADVDD and ACVDD Supply Current vs. Clock Speed and Interpolation Rates

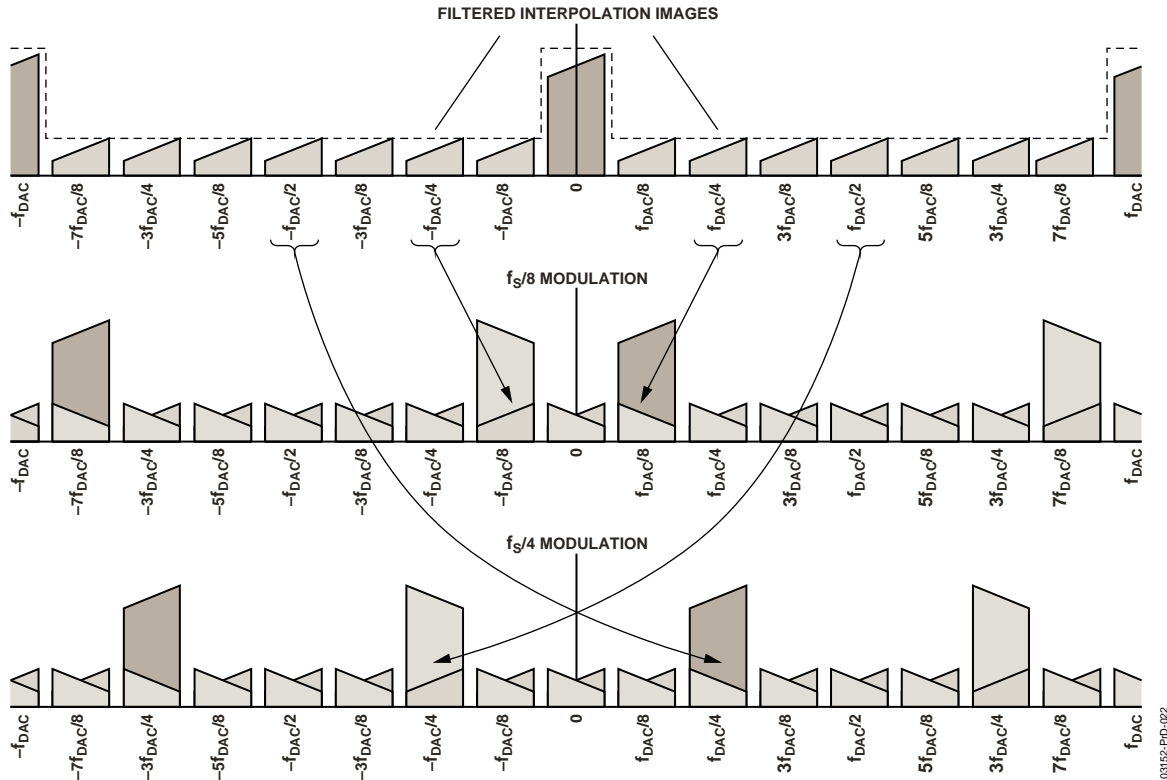

Figure 58. Complex Modulation with Negative Frequency Aliasing

**DUAL CHANNEL COMPLEX MODULATION WITH HILBERT**

Table 34.

HILBERT	Mode
0	Hilbert transform off
1	Hilbert transform on

When complex modulation is performed, the entire spectrum is translated by the modulation factor. If the resulting modulated spectrum is not mirror symmetric about dc, when the DAC synthesizes the modulated signal, negative frequency components will fall on the positive frequency axis and can cause destructive summation of the signals. For some applications, this can be seen as distorting the modulated output signal.

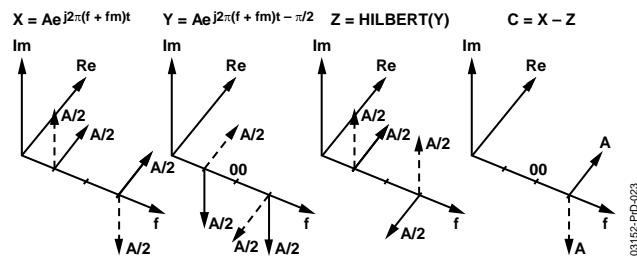

Figure 59. Negative Frequency Image Rejection

By performing a second complex modulation with a modulating signal having a fixed  $\pi/2$  phase difference, Figure 59 (Y), relative to the original complex modulation signal, Figure 59 (X), taking the Hilbert transform of the new resulting complex modulation, and subtracting it from the original complex modulation output all negative frequency components can be folded in phase to the positive frequency axis before being synthesized by the DAC. When the DAC synthesizes the modulated output there are no negative frequency components to fold onto the positive frequency axis out of phase; consequently no distortion is produced as a result of the modulation process.

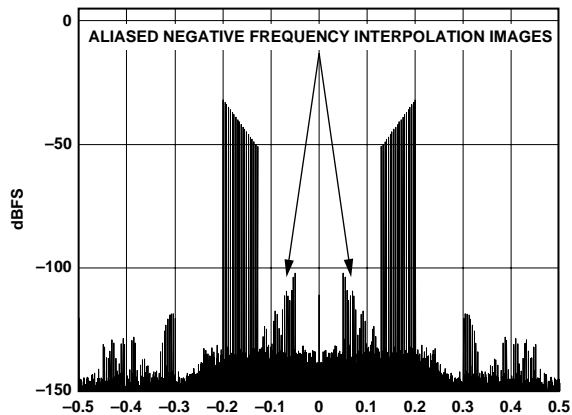

Figure 60. Negative Frequency Aliasing Distortion

Figure 60 shows this effect at the DAC output for a mirror asymmetric signal about dc produced by complex modulation without a Hilbert transform. The signal bandwidth was narrowed to show the aliased negative frequency interpolation images.

In contrast, Figure 61 shows the same waveform with the Hilbert transform applied. Clearly, the aliased interpolation images are not present.

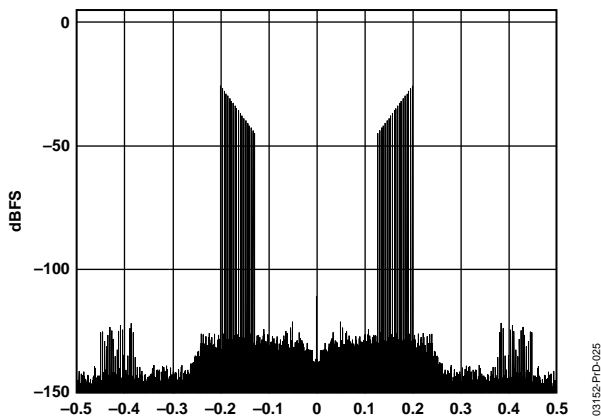

Figure 61. Effects of Hilbert Transform

If the output of the AD9782 is to be used with a quadrature modulator, negative frequency images are cancelled without the need of a Hilbert transform.

**HILBERT TRANSFORM IMPLEMENTATION**

The Hilbert transform on the AD9782 is implemented as a 19-coefficient FIR. The coefficients are given in Table 35

Table 35.

Coefficient	Integer Value
H(1)	-6
H(2)	0
H(3)	-17
H(4)	0
H(5)	-40
H(6)	0
H(7)	-91
H(8)	0
H(9)	-318
H(10)	0
H(11)	318
H(12)	0
H(13)	91
H(14)	0
H(15)	40
H(16)	0
H(17)	17
H(18)	0
H(19)	6

The transfer function of an ideal Hilbert transform has a +90° phase shift for negative frequencies, and a -90° phase shift for positive frequencies. Because of the discontinuities that occur at 0 Hz and at 0.5 × Sample Rate, any real implementation of the Hilbert Transform trades off bandwidth versus ripple.

Figure 62 and Figure 63 show the gain of the Hilbert transform versus frequency. Gain is essentially flat, with a pass-band ripple of 0.1dB over the frequency range 0.1 × Sample Rate to 0.43 × Sample Rate.

Figure 64 shows the phase response of the Hilbert transform implemented in the AD9782. The phase response for positive frequencies begins at -90° at 0 Hz, followed by a linear phase response (pure time delay) equal to nine filter taps (nine clock cycles). For negative frequencies, the phase response at 0 Hz is +90°, again followed by a linear phase delay of nine filter taps. To compensate for the unwanted 9-cycle delay, an equal delay of nine taps is used in the AD9782 digital signal path opposite to the Hilbert transform. This delay block is noted as t on the data sheet.

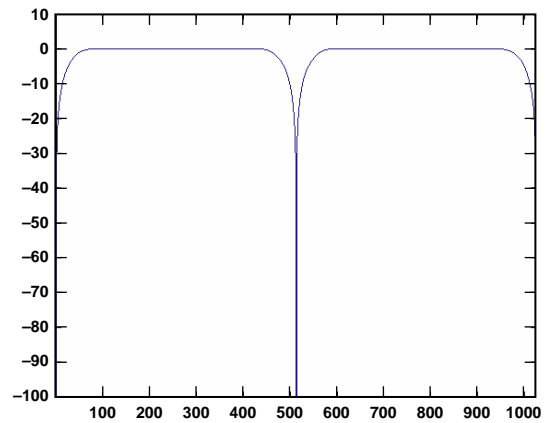

Figure 62. Hilbert Transform Gain

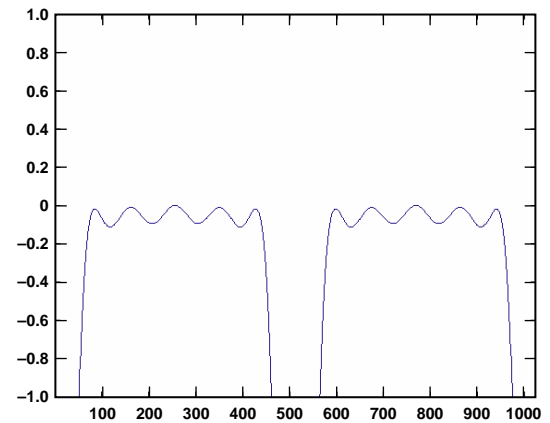

Figure 63. Hilbert Transform Ripple

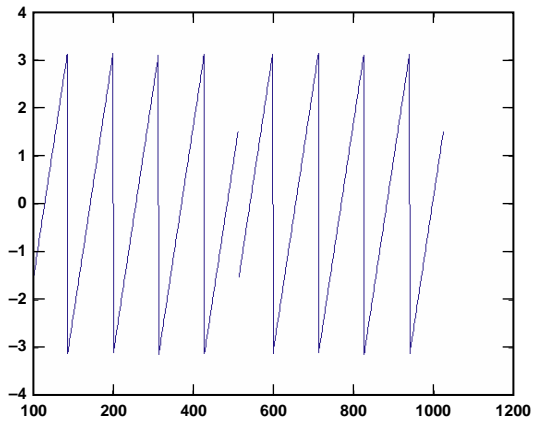

Figure 64. Phase Response of Hilbert Transform

Table 36. Dual Channel Complex Modulation Sideband Selection

Sideband	Mode
0	Lower IF sideband rejected
1	Upper IF sideband rejected

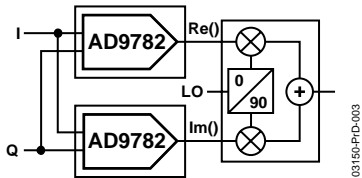

Figure 65. AD9782 Driving Quadrature Modulator

The AD9782 can be configured to drive a quadrature modulator, representatively as in Figure 65. Where two AD9782s are used with one AD9782 producing the real output, the second AD9782 produces the imaginary output. By configuring the AD9782 as a complex modulator coupled to a quadrature modulator, IF image rejection is possible. The quadrature modulator acts as the real part of a complex modulation producing a double sideband spectrum at the local oscillator (LO) frequency, with mirror symmetry about dc.

A baseband double sideband signal modulated to IF increases IF filter complexity and reduces power efficiency. If the baseband signal is complex, a single sideband IF modulation can be used, relaxing IF filter complexity and increasing power efficiency.

The AD9782 has the ability to place the baseband single sideband complex signal either above the IF frequency or below it. Figure 66 illustrates the baseband selection.

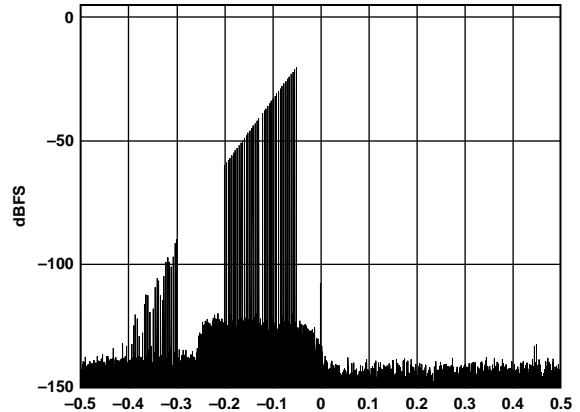

Figure 66. Upper IF Sideband Rejected

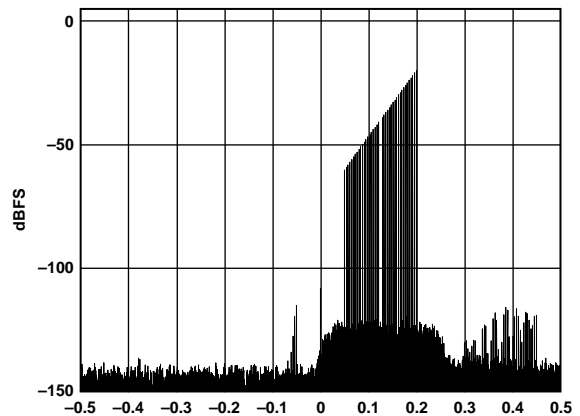

Figure 67. Lower IF Sideband Rejected

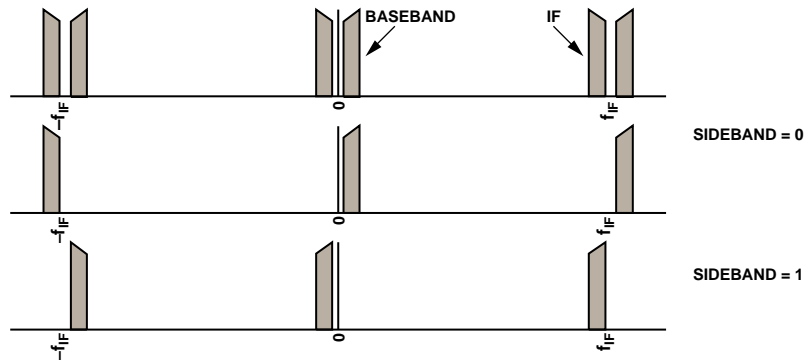

Figure 68. IF Quadrature Modulation of Real and Complex Baseband Signals

Table 37. Data Port Synchronization

PLOCKEXT	DCLKEXT	MODSYNC	DCLKCRC	Mode	Function
1	X	X	X	PLL output	PLL locked flag output, synchronizer disabled
0	0	0	X	Dataclk Master	Channel data rate clock output
0	0	1	X	Modulator Master	Modulator synchronization clock output
0	1	0	0	Dataclk Slave	Input channel data rate clock, DLL off
0	1	0	1	Dataclk Slave	Input channel data rate clock, DLL on
0	1	1	0	Modulator Slave	Input modulator synchronizer clock, DLL off
0	1	1	1	Modulator Slave	Input modulator synchronizer clock, DLL on

In applications where two or more AD9782s are used to synthesize several digital data paths, it may be necessary to ensure that the digital inputs to each device are latched synchronously. In complex data processing applications, digital modulator phase alignment may be required between two AD9782s. In order to allow data synchronization and phase alignment, only one AD9782 should be configured as a master device, providing a reference clock for another slave-configured AD9782.

With synchronization enabled, a reference clock signal is generated on the DATACLK/PLL\_LOCK pin of the master. The DATACLK/PLL\_LOCK pins on the slave devices act as inputs for the reference clock generated by the master. The DATACLK/PLL\_LOCK pin on the master and all slaves must be directly connected. All master and slave devices must have the same clock source connected to their respective CLK+/CLK- pins.

When configured as a master, the reference clock generated may take one of two forms. In modulator master mode, the reference clock will be a square wave with a period equal to 16 cycles of the DAC update clock. Internal to the AD9782 is a 16-state finite state machine, running at the DAC update rate. This state machine generates all internal and external synchronization clocks and modulator phasings. The rising edge of the master reference clock is time aligned to the internal state machine's state zero. Slave devices use the master's reference clock to synchronize their data latching and align their modulator's phase by aligning their local state machine state zero to the master.

The second master mode, DATACLK master mode, generates a reference clock that is at the channel data rate. In this mode, the slave devices align their internal channel data rate clock to the master. If modulator phase alignment is needed, a concurrent serial write to all slave devices is necessary. To achieve this, the CSB pin on all slaves must be connected together and a group serial write to the MODADJ register bits must be performed; the modulator coefficient alignment is updated on the next rising edge of the internal state machine following a successful serial write, Figure 69. Modulator master mode does not need a concurrent serial write as slaves lock to the master phase automatically.

In a slave device, the local channel data rate clock and the digital modulator clock are created from the internal state machine. The local channel data rate clock is used by the slave to latch digital input data. At high data rates, the delay inherent in the signal path from master to slave may cause the slave to lag the master when acquiring synchronization. To account for this, an integer number of the DAC update clock cycles may be programmed into the slave device as an offset. The value in DATADJ allows the local channel data rate clock in the slave device to advance by up to eight cycles of the DAC clock or delayed by up to seven cycles, Figure 70.

The digital modulator coefficients are updated at the DAC clock rate and decoded in sequential order from the state machine according to Figure 71. The MODADJ bits can be used to align a different coefficient to the finite state machine's zero state as shown in Figure 72.

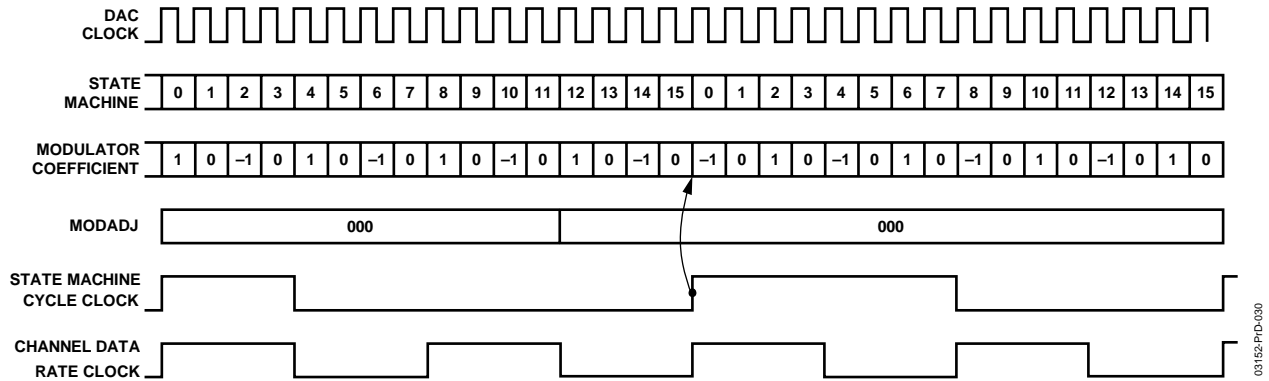

Figure 69. Synchronous Serial Modulator Phase Alignment

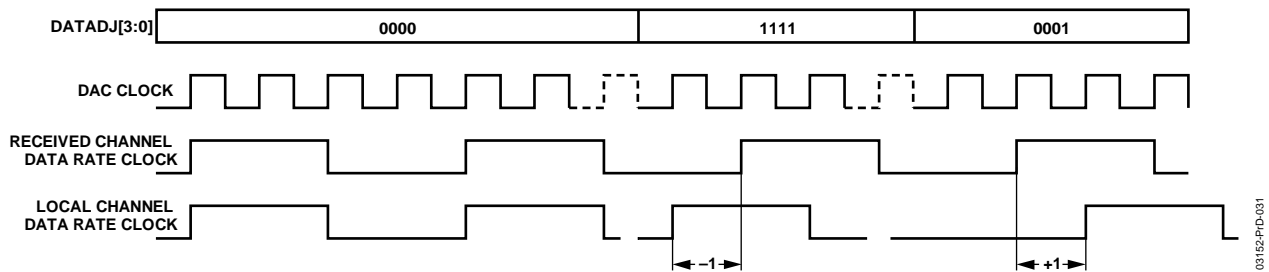

Figure 70. Local Channel Data Rate Clock Synchronized with Offset

STATE	0	1	2	3	4	5	6	7	8	9	10	11	12	13	14	15	
DECODE	1	0	$1/\sqrt{2}$	0	0	0	$-1/\sqrt{2}$	0	-1	0	$-1/\sqrt{2}$	0	0	0	$-1/\sqrt{2}$	0	
fs/8	0	→	1	→	2	→	3	→	4	→	5	→	6	→	7	→	
fs/4	0	→		1	→		2		→		3		→				
fs/2	0	→				1				→							

Figure 71. Digital Modulator State Machine Decode

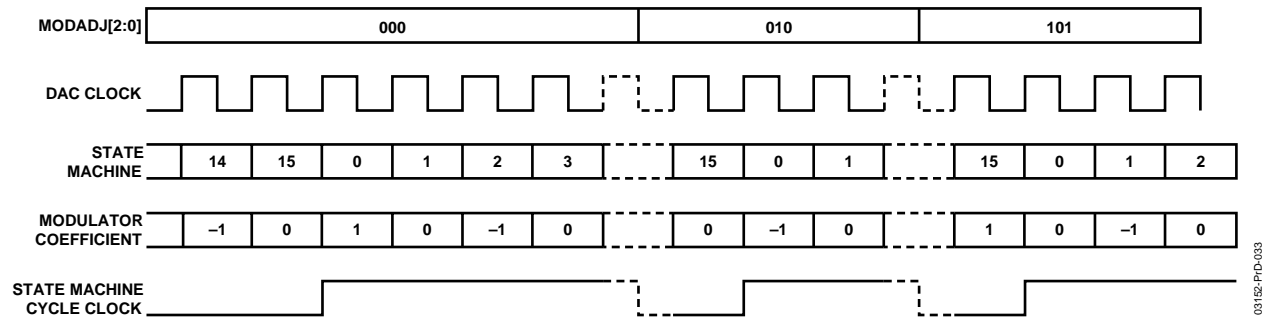

Figure 72. Local Modulator Coefficient Synchronized with Offset

## OPERATING THE AD9782 REV E EVALUATION BOARD

This section helps the user get started with the AD9782 evaluation board. Because it is intended to provide starter information to power up the board and verify correct operation, a description of some of the more advanced modes of operation has been omitted. For a description of the various SPI registers and the effect they have on the operating modes of the AD9782, see the Mode Control (via SPI Port) section.

### POWER SUPPLIES

The AD9782 Rev E Evaluation Board has five power supply connectors, labeled VDDIN, CVDIN, VDD2IN, VDD3IN, and AVDIN. The AD9782 itself actually has seven power supply domains. To reconcile the power supply domains on the chip with the power supply connectors on the evaluation board, use Table 38.

Additionally, the DRVDD power supply on the AD9782 is used to supply power for the digital input bus. DRVDD can be run from 2.5 V or 3.3 V. On the evaluation board, DRVDD is jumper selectable by JP1, just to the left of the chip on the evaluation board. With the jumper set to the 3.3 V position, DRVDD chip receives its power from VDD3IN. With the jumper set to the 2.5 V position, DRVDD receives its power from AVDIN.

### PECL CLOCK DRIVER

The AD9782 system clock is driven from an external source via connector S1. The AD9782 Evaluation Board includes an OnSemiconductor MC100EPT22 PECL clock driver. In the factory, the evaluation board is set to use this PECL driver as a single-ended-to-differential clock receiver. The PECL driver can be set to run from 2.5 V from the CVDIN power connector, or 3.3 V from the VDD3IN power connector. This setting is done via jumper, JP2, situated next to the CVDIN power connector, and by setting input bias resistors R23 and R4 on the evaluation board. The factory default is for the PECL driver to be powered from CVDIN at 2.5 V ( $R23 = 90.9 \Omega$ ,  $R4 = 115 \Omega$ ). To operate the PECL driver with a 3.3 V supply, R23 must be replaced with a  $115 \Omega$  resistor and R4 must be replaced with a  $90.9 \Omega$  resistor, as well as changing the position of JP2. The schematic of the PECL driver section of the evaluation board is shown below in Figure 73. A low jitter sine wave can be used as the clock source. Care must be taken to make sure the clock amplitude does not exceed the power supply rails for the PECL driver.

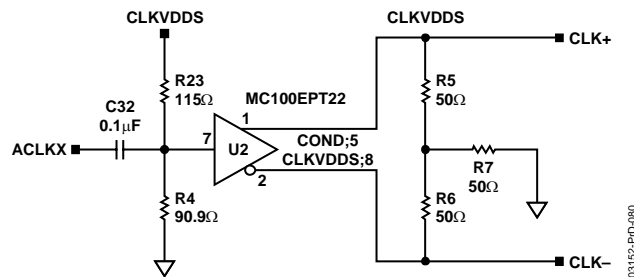

Figure 73. PECL Driver on AD9782 Rev E Evaluation Board

Table 38.

Evaluation Board Label	PS Domain on Chip	Nominal Power Supply Voltage (V)	Description
VDDIN	DVDD	2.5	SPI port
CVDIN	CLKVDD	2.5	Clock circuitry
VDD2IN	ACVDD and ADVDD	2.5	Analog circuitry containing clock and digital interface circuitry
VDD3IN	AVDD2	3.3	Switching analog circuitry
AVDIN	AVDD1	3.3	Analog output circuitry



### DATA INPUTS

Digital data inputs to the AD9782 are accessed on the evaluation board through connectors J1 and J2. These are 40 pin right angle connectors that are intended to be used with standard ribbon cable connectors. The input levels should be either 3.3 V or 2.5 V CMOS, depending on the setting of the DRVDD jumper JP1. The data format is selectable through Register 02h, Bit 7 (DATAFMT). With this bit set to a default 0, the AD9782 assumes that the input data is in twos complement format. With this bit set to 1, data should be input in offset binary format.

When the evaluation board is first powered up and the clock and data are running, it is recommended that the proper operating current is verified. Depress reset switch SW1 to ensure that the AD9782 is in the default mode. The default mode for the AD9782 is for the internal PLL to be disabled, and the interpolation set to 1x. The modulator is turned off in the default mode. The nominal operating currents for the evaluation board in the power-up default mode are shown in Table 39.

Additionally, the DRVDD power supply on the AD9782 is used to supply power for the digital input bus. DRVDD can be run from 2.5 V or 3.3 V. On the evaluation board, DRVDD is jumper selectable by JP1, just to the left of the chip on the evaluation board. With the jumper set to the 3.3 V position, DRVDD chip receives its power from VDD3IN. With the jumper set to the 2.5 V position, DRVDD receives its power from AVDIN.

**Table 39. Nominal Operating Currents in Power-Up Default Mode**

Evaluation Board Power Supply	Nominal Current @ Speed (mA)			
	50 MSPS	100 MSPS	150 MSPS	200 MSPS
VDDIN	24	49	74	99
CVDIN	79	83	87	92
VDD2IN	1	4	6	8
VDD3IN	30	30	30	30
AVDIN	27	27	27	27

**Table 40. SPI Registers**

Register	Bit 7	Bit 6	Bit 5	Bit 4	Bit 3	Bit 0
01h	INTERP[1]	INTERP[0]				
04h	PLLON	PLLMULT[1]	PLLMULT[0]	PLLDIV[1]	PLLDIV[0]	PLOCKEXT

Interpolation Rate			PLL Multiplier			PLL Divider		
Bit 7	Bit 6	Rate	Bit 6	Bit 5	Mult	Bit 4	Bit 3	Div
0	0	1x	0	0	2x	0	0	÷1
0	1	2x	0	1	4x	0	1	÷2
1	0	4x	1	0	8x	1	0	÷4
1	1	8x	1	1	16x	1	1	÷8

### SPI PORT

SW1 is a hard reset switch that sets the AD9782 to its default state. It should be used every time the AD9782 power supply is cycled or the clock is interrupted, or if new data is to be written via the SPI port. For a description of the various SPI registers and the effect they have on the operating modes of the AD9782, see the Mode Control (via SPI Port) section. Set the SPI software to read back data from the AD9782 and verify that when the software is run, the expected values are read back.

### OPERATING WITH PLL DISABLED

The SPI registers referenced in this section are shown in Table 40.

With the PLL disabled, the evaluation board clock input must be run at the intended DAC sample rate, up to the specified limit of 500 MSPS. At the same time, the interpolation rate should be set so the input data rate does not exceed the 200 MSPS limit. In the default mode with the PLL disabled, the DATACLK signal from the AD9782 is available at connector S2. The rate of this clock is the system clock applied at S1, divided by the interpolation rate. DATACLK can be used to synchronize the external data into the AD9782.

## OPERATING WITH PLL ENABLED

Note that a specific revision of the AD9782 on the Rev E Evaluation Board has a nonfunctioning PLL. This revision can be identified by the xxx.

With the AD9782 PLL enabled, the evaluation board clock input must be run at the data input rate, up to the specified 200 MSPS limit. The PLL controls the internal clock multiplication and drives the interpolation filters and digital modulator. The internal PLL has a VCO in the control loop that is designed to operate optimally over the 200 MHz to 500 MHz range. The VCO speed can be calculated as follows:

$$VCO\ Speed = Input\ Data\ Rate \times PLLMULT[1,0]$$

The interpolation rate is set by Bits 6 and 7. With the PLL enabled, the settings for the interpolation rate, the PLL multiplier, and the PLL divide are interrelated. The interpolation rate must meet the following criteria:

$$Interpolation\ Rate = [Settings\ of\ Bits\ 6,\ 7] = [PLLMULT \div PLLDIVIDER]$$

Therefore, assuming the input data rate is constant and the VCO is at optimal speed, if the interpolation rate is increased by a factor of M, the PLLMULT setting must be decreased by the same factor M.

With the PLL enabled, DATACLK connector S2 indicates the lock state of the PLL. A Logic 1 from S2 indicates lock; a Logic 0 indicates the PLL is not currently locked.

## ANALOG OUTPUT

The analog output of the AD9782 is accessed via connector S3. Once all settings are selected and current levels, PLL lock state, and SPI port functionality are verified, the analog signal at S3 can be viewed. For most of the AD9782's applications, a spectrum analyzer is the instrument of choice to verify proper performance. A typical spectral plot is shown in Figure 74, with the AD9782 synthesizing a two-tone signal in the default mode with a 200 MSPS sample rate. A single tone CW signal should provide output power of approximately +0.5 dBm to the spectrum analyzer.

If the spectrum does not look correct at this point, the data input may be violating setup and hold times with respect to the input clock. To correct this, the user should vary the input data timing. If this is not possible, SPI Register 02h, Bit 4 can be inverted. This bit controls the clock edge upon which the data is latched. If these methods do not correct the spectrum, it is unlikely that the issue is timing related. This note should then be reread to verify that all instructions have been followed.

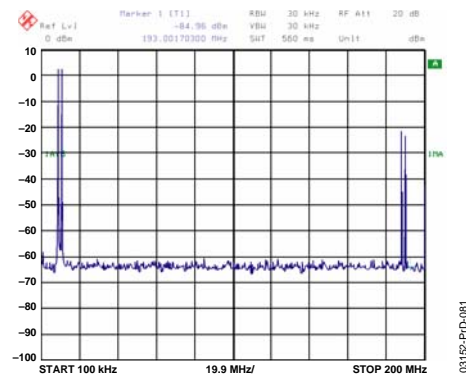
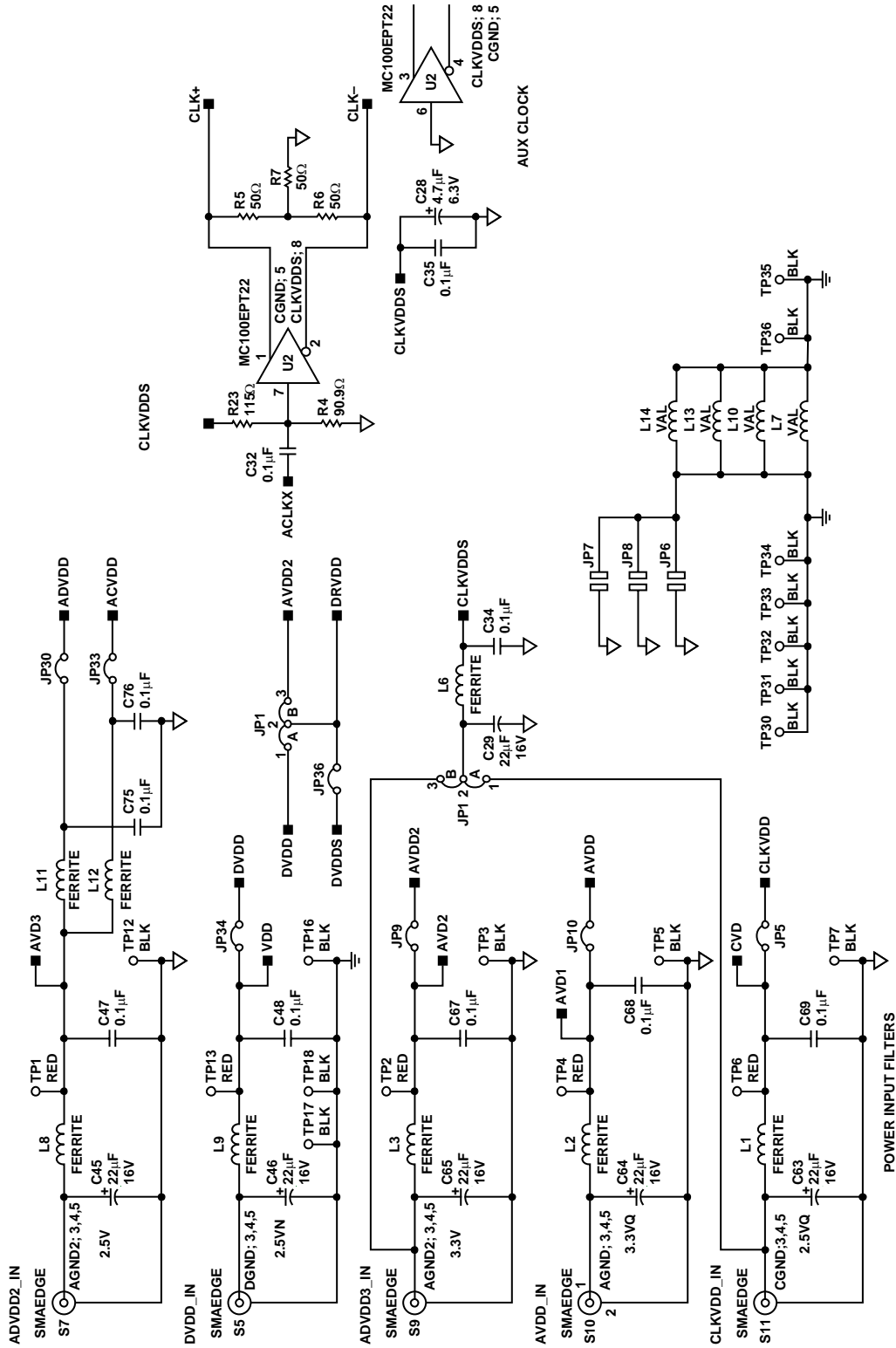

Figure 74. Typical Spectral Plot



08152-PD-082

Figure 75. Power Supply Distribution

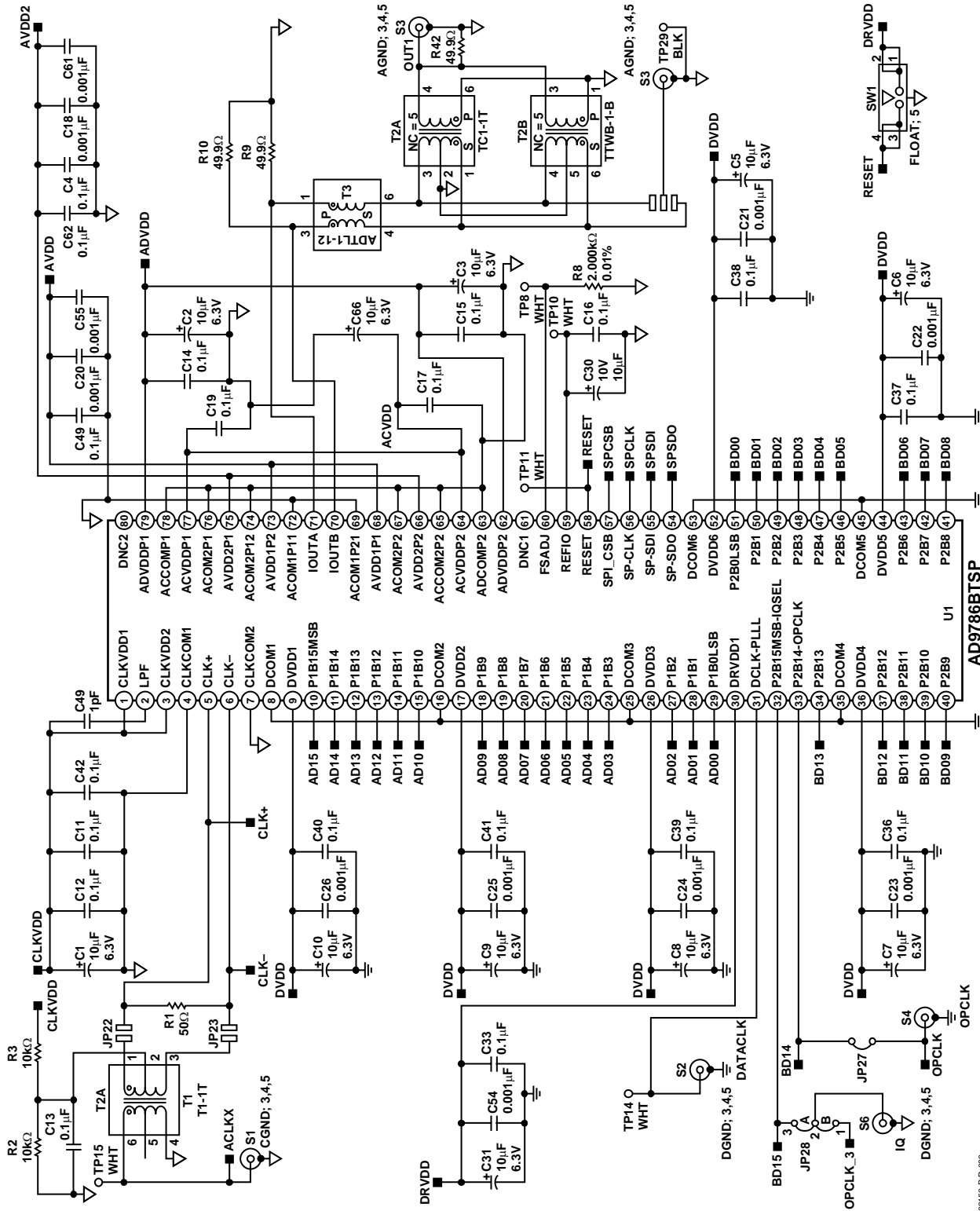
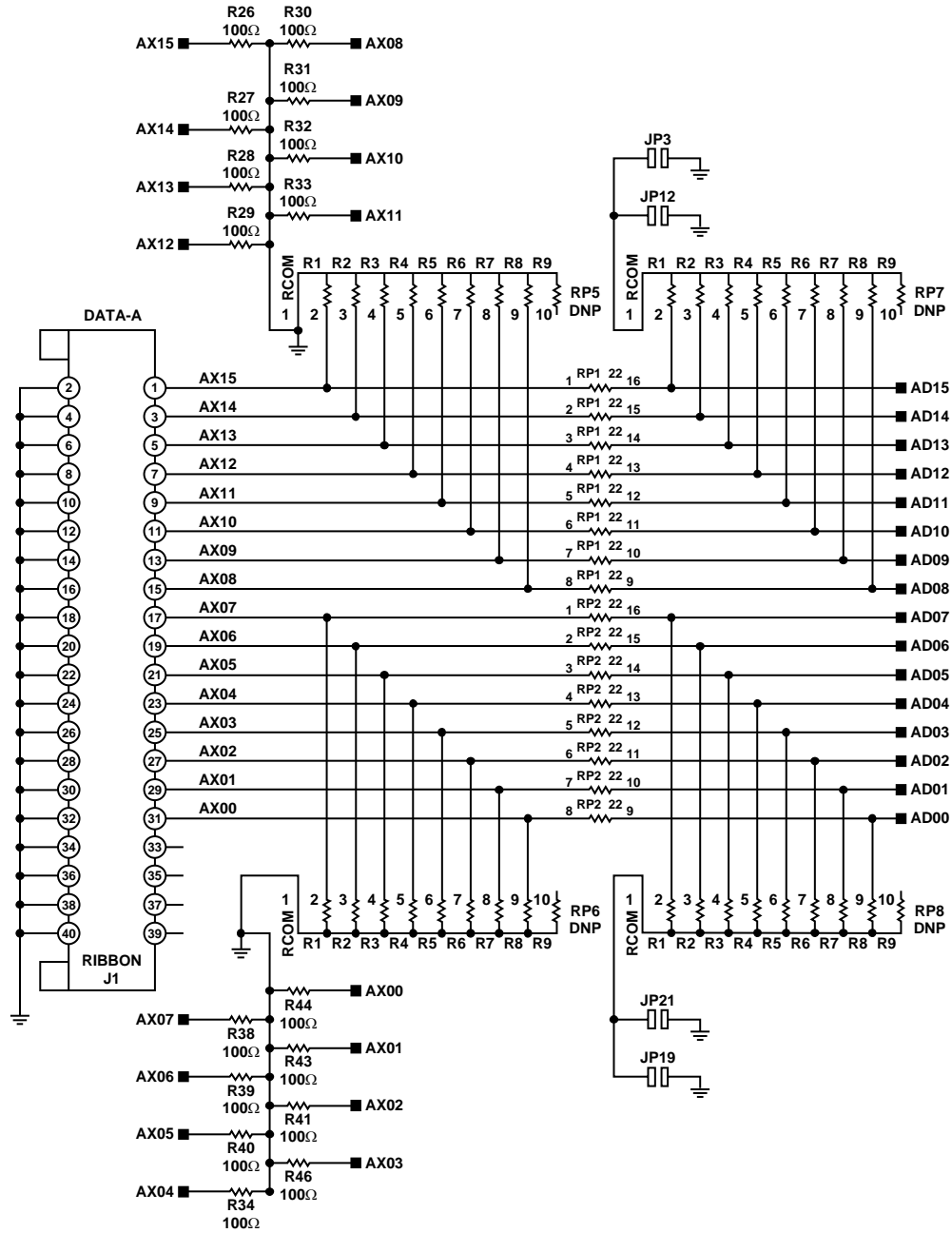

Figure 76. Local Circuitry

03152-PD-083



03152-PrD-084

Figure 77. Digital Data Port A Input Terminations

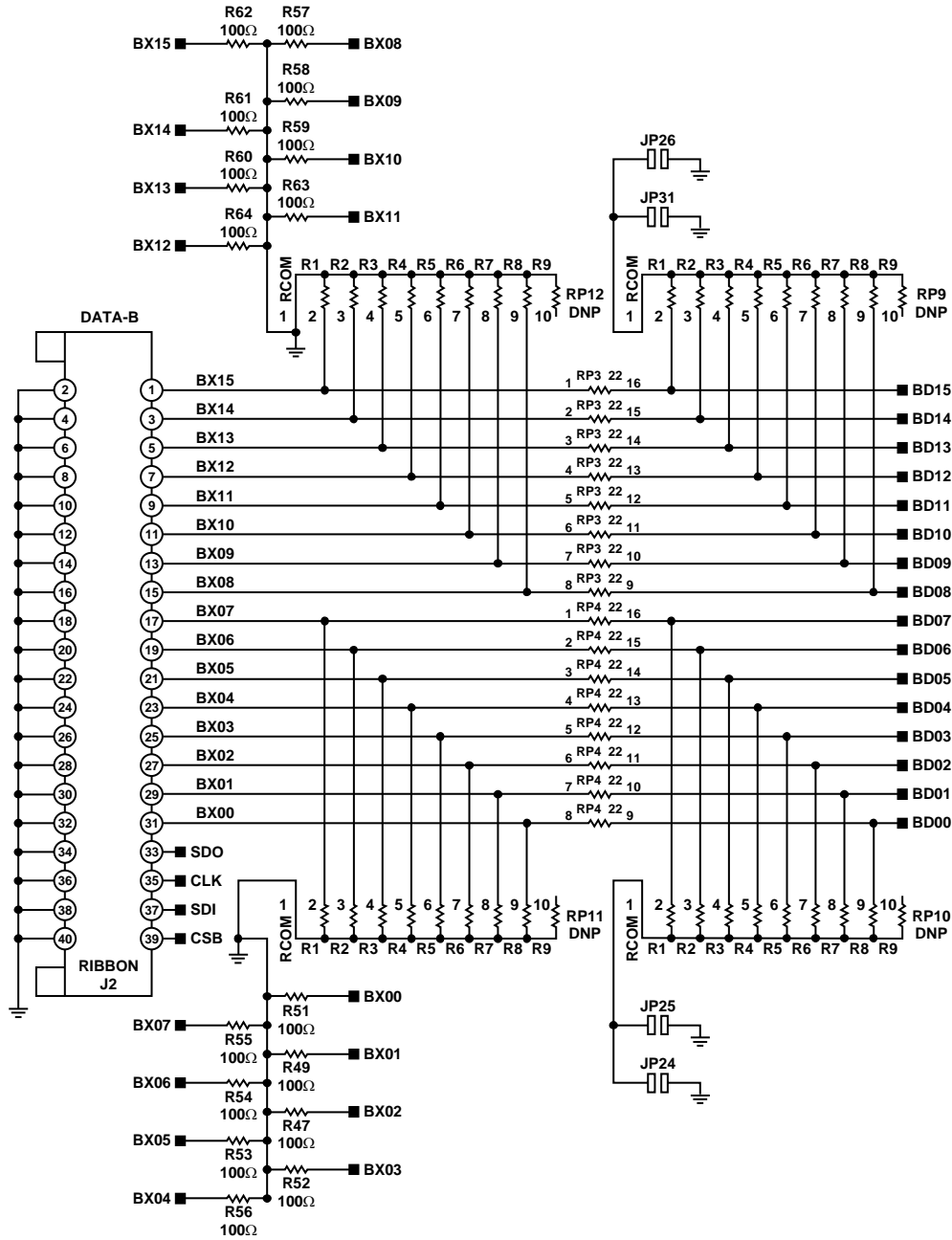

03152-PD-085

Figure 78. Digital Data Port B Input Terminations

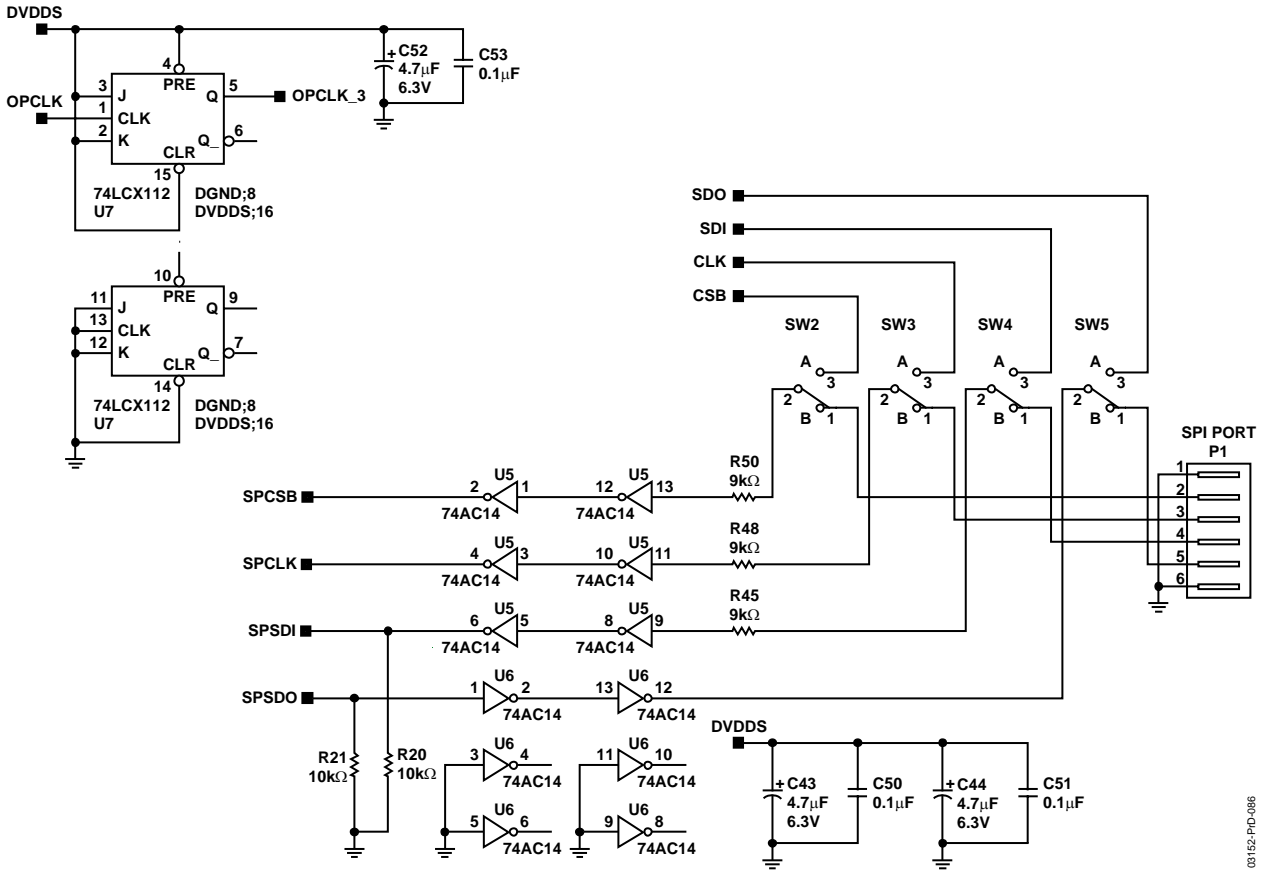

Figure 79. SPI and One-Port Clock Circuitry

03152-PD-086

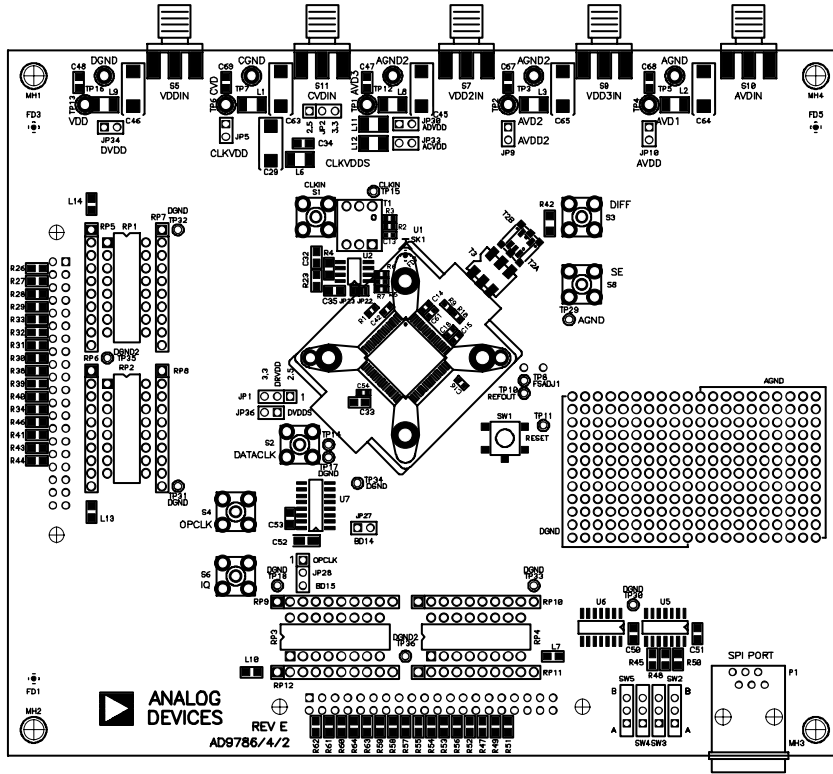

Figure 80. PCB Assembly, Primary Side

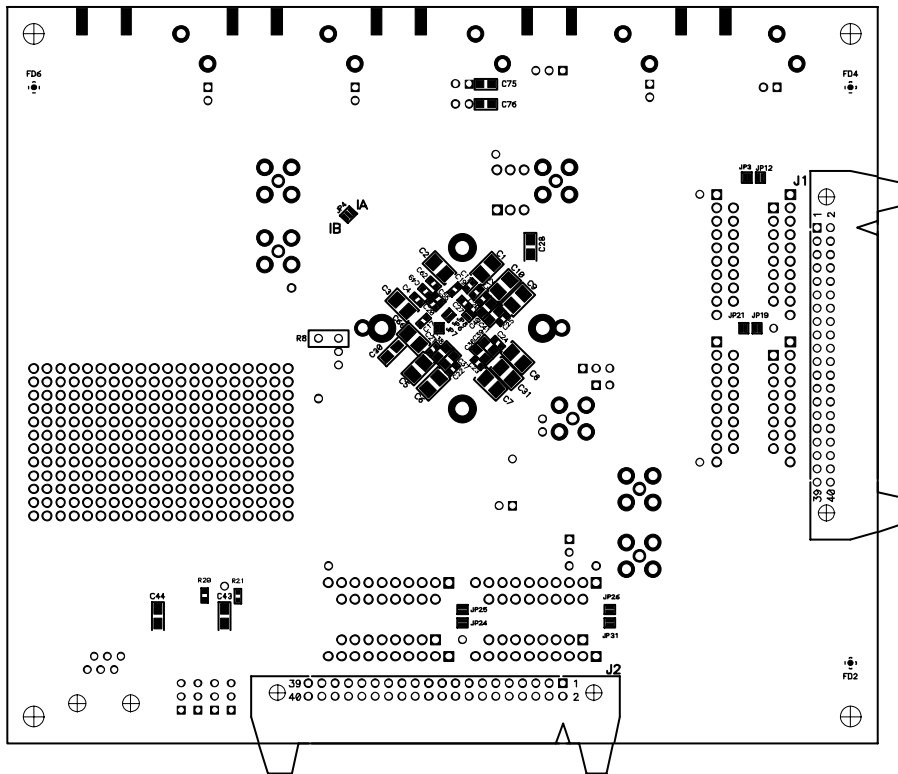

Figure 81. PCB Assembly, Secondary Side



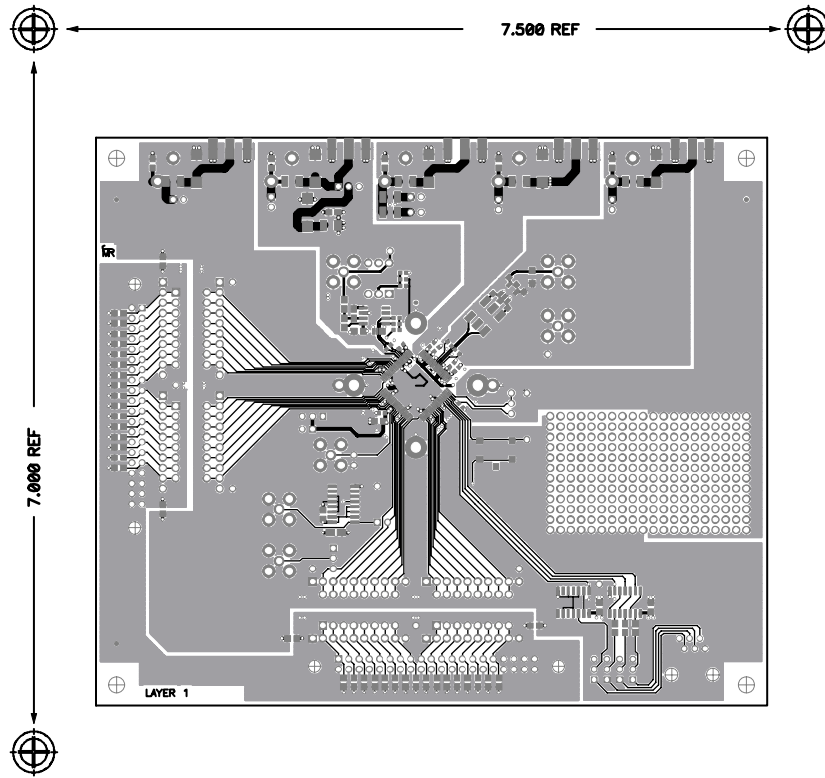

Figure 82. PCB Assembly, Layer 1 Metal

03152-PID-089

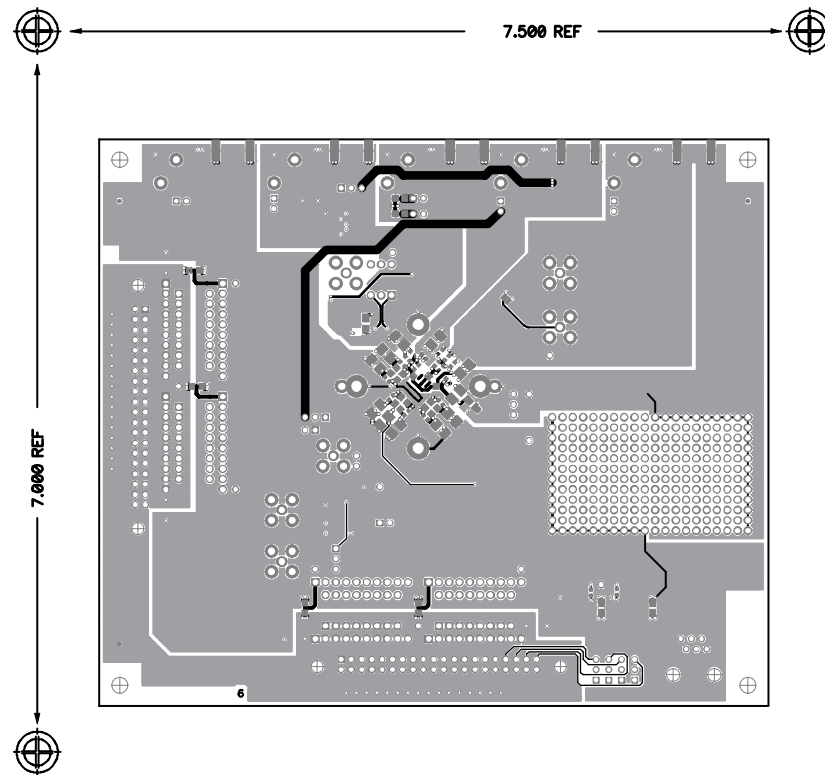

Figure 83. PCB Assembly, Layer 6 Metal

03152-PID-090

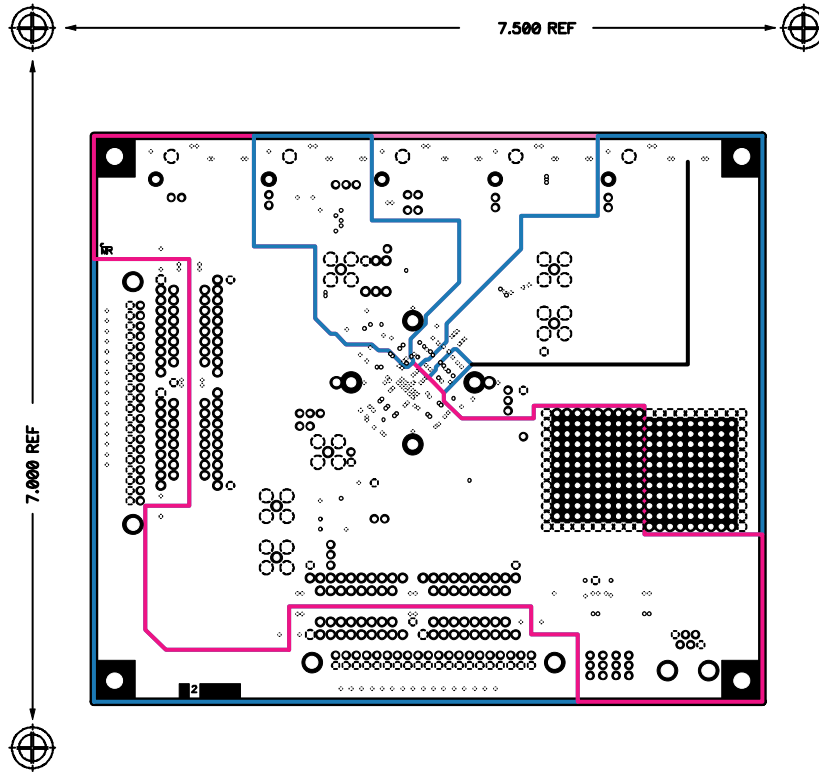

Figure 84. PCB Assembly, Layer 2 Metal (Ground Plane)

03152-PID-091

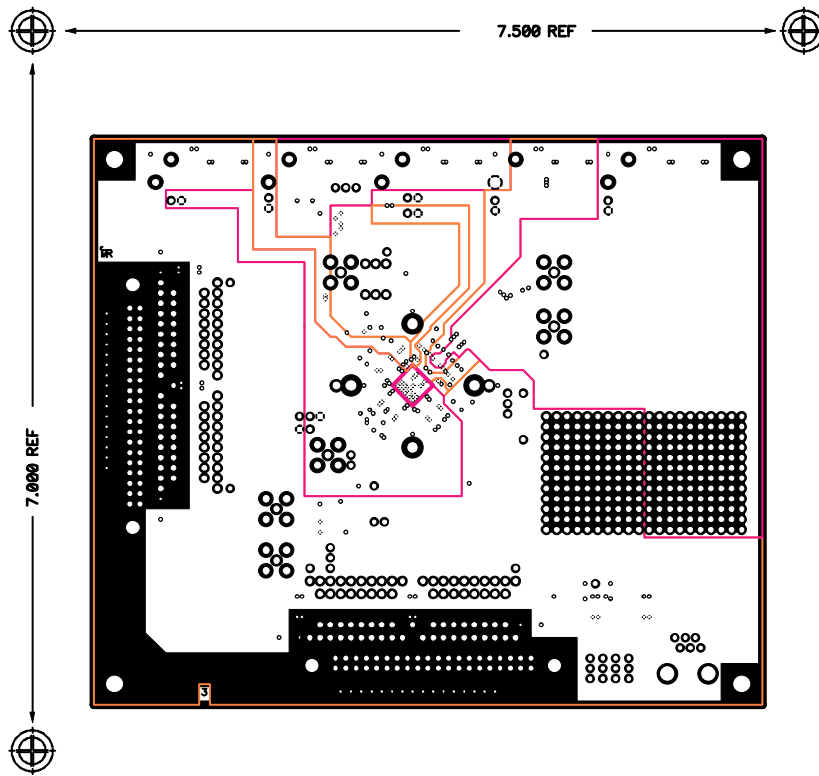

Figure 85. PCB Assembly, Layer 3 Metal (Power Plane)

03152-PID-092

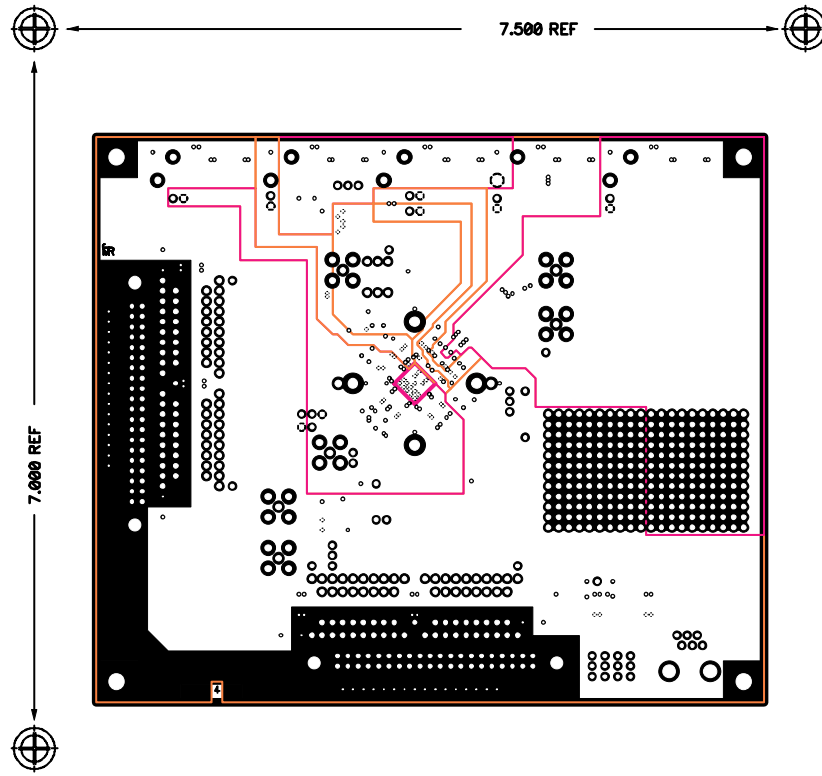

Figure 86. PCB Assembly, Layer 4 Metal (Power Plane)

03152-PD-093

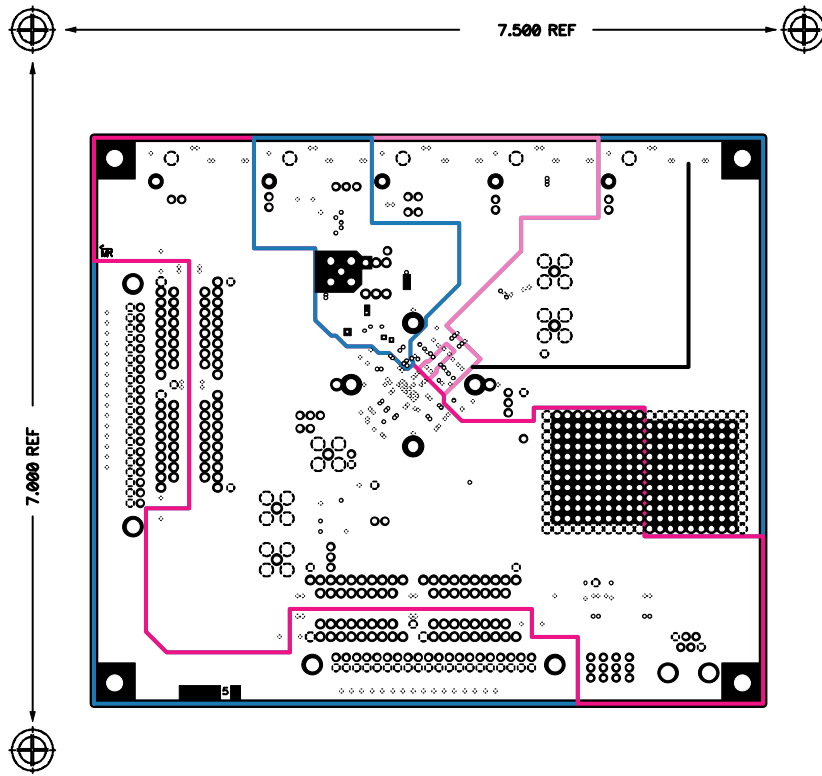
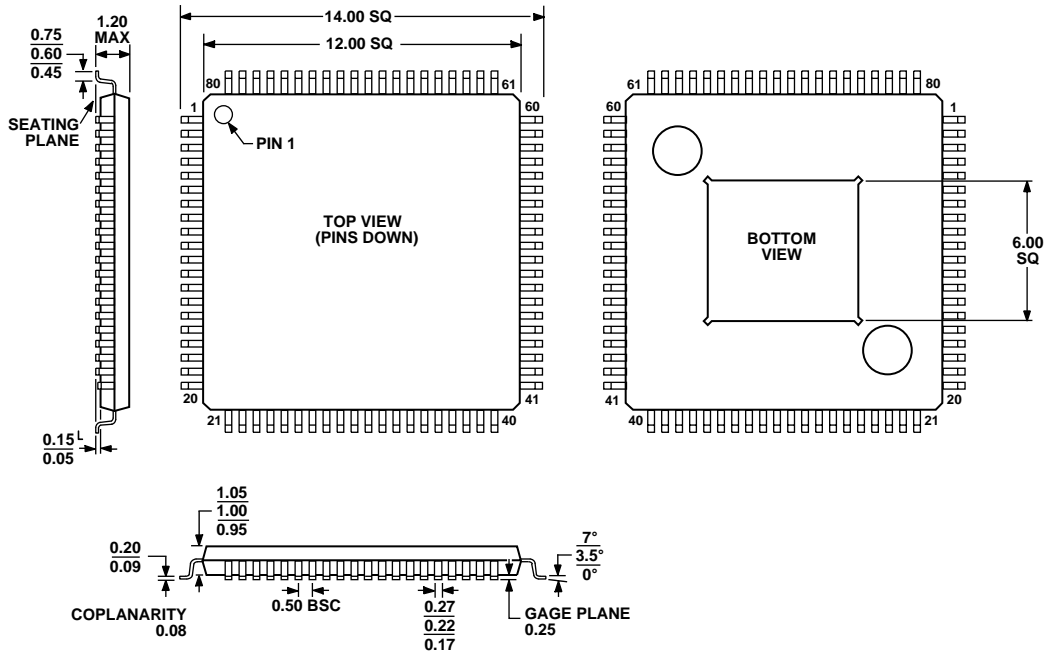

Figure 87. PCB Assembly, Layer 5 Metal (Ground Plane)

03152-PD-094

OUTLINE DIMENSIONS



COMPLIANT TO JEDEC STANDARDS MS-026-ADD-HD

Figure 88. 80-Lead Thermally Enhanced TQFP (SV-80)  
Dimensions shown in millimeters

ESD CAUTION

ESD (electrostatic discharge) sensitive device. Electrostatic charges as high as 4000 V readily accumulate on the human body and test equipment and can discharge without detection. Although this product features proprietary ESD protection circuitry, permanent damage may occur on devices subjected to high energy electrostatic discharges. Therefore, proper ESD precautions are recommended to avoid performance degradation or loss of functionality.

