

## Voltage Feedback Op Amp Gain and Bandwidth

### INTRODUCTION

This tutorial examines the common ways to specify op amp gain and bandwidth. It should be noted that this discussion applies to voltage feedback (VFB) op amps—current feedback (CFB) op amps are discussed in a later tutorial ([MT-034](#)).

### OPEN-LOOP GAIN

Unlike the ideal op amp, a practical op amp has a finite gain. The open-loop dc gain (usually referred to as  $A_{VOL}$ ) is the gain of the amplifier without the feedback loop being closed, hence the name “open-loop.” For a precision op amp this gain can be vary high, on the order of 160 dB (100 million) or more. This gain is flat from dc to what is referred to as the *dominant pole corner frequency*. From there the gain falls off at 6 dB/octave (20 dB/decade). An octave is a doubling in frequency and a decade is  $\times 10$  in frequency). If the op amp has a single pole, the open-loop gain will continue to fall at this rate as shown in Figure 1A. A practical op amp will have more than one pole as shown in Figure 1B. The second pole will double the rate at which the open-loop gain falls to 12 dB/octave (40 dB/decade). If the open-loop gain has dropped below 0 dB (unity gain) before it reaches the frequency of the second pole, the op amp will be unconditionally stable at any gain. This will be typically referred to as *unity gain stable* on the data sheet. If the second pole is reached while the closed-loop gain is greater than 1 (0 db), then the amplifier may not be stable. Some op amps are designed to be stable only at higher closed-loop gains, and these are referred to as *decompensated* op amps.

An op amp may have more additional parasitic poles at higher frequencies, however, the first two poles are generally the most important.

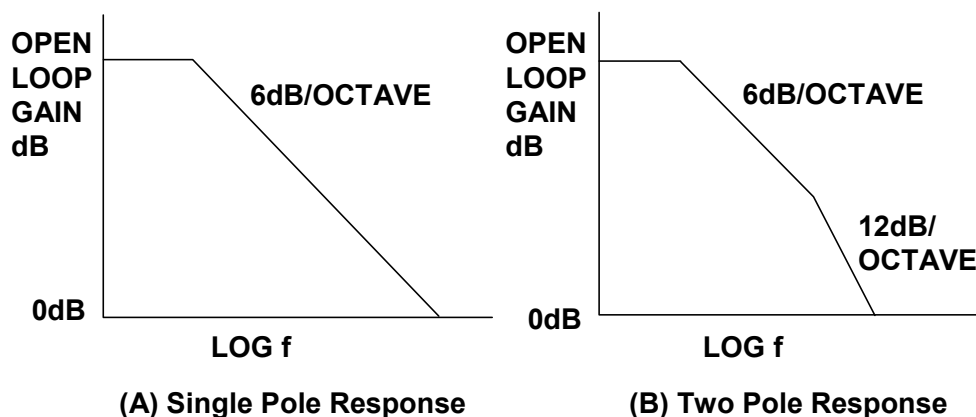

**Figure 1: Open-Loop Gain (Bode Plot)**  
**(A) Single-Pole Response, (B) Two-Pole Response**

It is important to understand the differences between *open-loop gain*, *closed-loop gain*, *loop gain*, *signal gain* and *noise gain*. They are similar in nature, interrelated, but different. We will discuss them all in detail.

The open-loop gain is not a precisely controlled spec. It has a relatively large range and will be given in the specifications as a typical number rather than a min/max number, in most cases. In some cases, typically high precision op amps, the spec will be given a minimum value.

In addition, the open-loop gain can change due to output voltage levels and loading. This is referred to as *open-loop gain non-linearity*. There is also some dependency on temperature. In general, these effects are of a very minor degree and can, in most cases, be ignored. In fact open-loop gain non-linearity is not always included in the data sheet for some op amps.

## CLOSED-LOOP GAIN

Closed-loop gain is the gain of the amplifier with the feedback loop closed, as opposed the open-loop gain, which is the gain with the feedback loop opened. Closed-loop gain has two forms: *signal gain* and *noise gain*. These are described and differentiated below.

The classic expression for the gain of a closed-loop amplifier involves the open-loop gain. If  $G$  is the actual closed-loop gain,  $N_G$  is the noise gain (see below), and  $A_{VOL}$  is the open-loop gain of the amplifier, it can be shown that:

$$G = \frac{N_G}{1 + \frac{N_G}{A_{VOL}}}. \quad \text{Eq. 1}$$

From this you can see that if the open-loop gain is very high, which it typically is, the closed-loop gain of the circuit is simply the noise gain.

## SIGNAL GAIN AND NOISE GAIN

*Signal gain* is the gain applied to the input signal with the feedback loop connected. In [Tutorial MT-032](#), when we talked about the gain of the inverting and non-inverting circuits, we were actually more correctly talking about the closed-loop signal gain. Signal gain can be positive (non-inverting mode) or negative (inverting mode), and can be less than unity for the inverting case. Signal gain is the gain of most interest when we are designing the elements in the signal path. Figure 2 illustrates the various gains in detail.

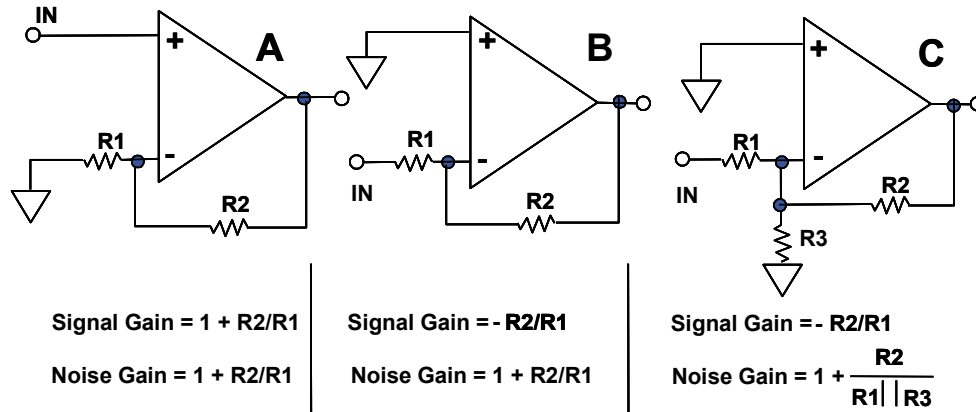

- Voltage Noise and Offset Voltage of the op amp are reflected to the output by the Noise Gain.
- Noise Gain, not Signal Gain, is relevant in assessing stability.
- Circuit C has unchanged Signal Gain, but higher Noise Gain, thus better stability, worse noise, and higher output offset voltage.

**Figure 2: Signal Gain and Noise Gain**

The signal gain for an inverting amplifier stage is:

$$\text{Signal Gain} = -\frac{R2}{R1}, \tag{Eq. 2}$$

and for a non-inverting amplifier it is:

$$\text{Signal Gain} = 1 + \frac{R2}{R1}. \tag{Eq. 3}$$

*Noise gain* is the gain seen by a noise source (input voltage noise) or voltage source (input offset voltage) connected in series with an op amp input. The noise gain is equal to

$$\text{Noise Gain} = 1 + \frac{R2}{R1}. \tag{Eq. 4}$$

Noise gain is equal to the signal gain of a non-inverting amp. Noise gain is also the same for either an inverting or non-inverting stage.

It is the noise gain that is used to determine op amp stability. Noise gain is equal to the closed-loop gain that is used in Bode plots. Resistances were used in the above expressions for noise gain, however, in practical applications they are actually impedances with real and imaginary components.

## LOOP GAIN

The difference between the open-loop gain and the closed-loop gain is known as the loop gain as shown in Figure 3. Loop gain shows you the amount of negative feedback that can be applied to the amplifier at a given frequency.

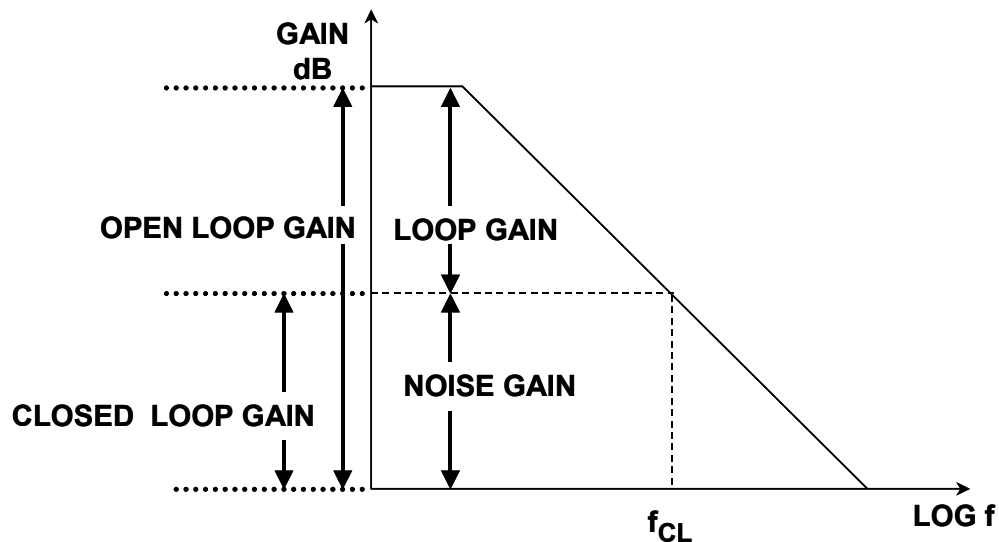

**Figure 3: Gain Definitions**

## BODE PLOT: ASYMPTOTIC AND ACTUAL RESPONSES

The plot of open-loop gain vs. frequency on a log-log scale gives is what is known as a Bode (pronounced *boh dee*) plot. It is one of the primary tools in evaluating whether an op amp is suitable for a particular application.

If you plot the open-loop gain and then the noise gain on a Bode plot as shown in Figure 4, the point where they intersect will determine the maximum closed-loop bandwidth of the amplifier system. This is commonly referred to as the closed-loop frequency ( $F_{CL}$ ). Remember that the actual response at the intersection is actually 3 dB down from this value. At frequencies beyond one octave above and one octave below  $F_{CL}$ , the difference between the asymptotic response and the real response will be less than 1 dB.

The Bode plot is also useful in determining stability. As stated above, if the closed-loop gain (noise gain) intersects the open-loop gain at a slope of greater than 6 dB/octave (20 dB/decade) the amplifier may be unstable (depending on the phase margin).

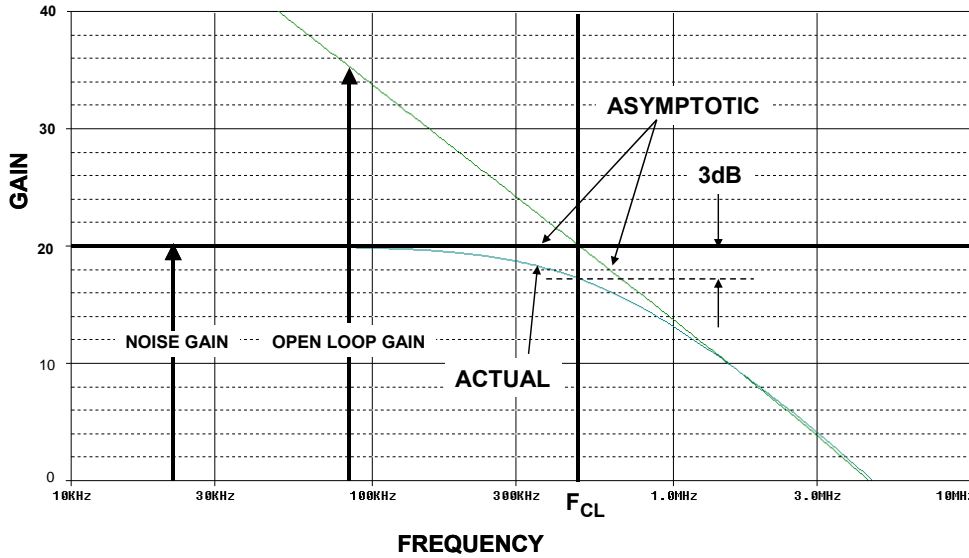

Figure 4: Bode Plot Showing Asymptotic and Actual Response

**GAIN-BANDWIDTH PRODUCT**

The open-loop gain falls at 6 dB/ octave for a single-pole response. This means that if we double the frequency, the gain drops by a factor of two. Conversely, if the frequency is halved, the open-loop gain will double, as shown in Figure 5. This gives rise to what is known as the *Gain-Bandwidth Product*. If we multiply the open-loop gain by the frequency, the product is always a constant. The caveat for this is that we have to be in the part of the curve that is falling at 6 dB/octave. This gives us a convenient figure of merit with which to determine if a particular op amp is useable in a particular application. Note that the gain-bandwidth product is meaningful only for voltage feedback (VFB) op amps. The discussion of current feedback (CFB) op amp bandwidth can be found in [Tutorial MT-034](#).

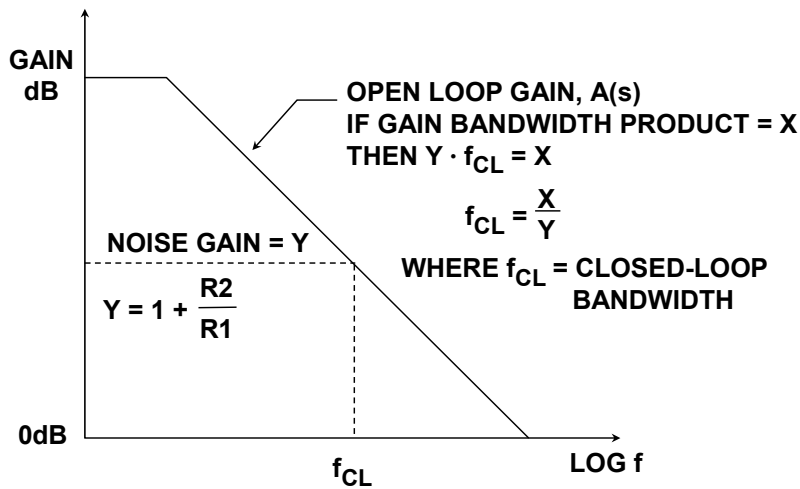

Figure 5: Gain-Bandwidth Product

For example, if we have an application which requires a closed-loop gain of 10 and a bandwidth of 100 kHz, we need an op amp with a minimum gain-bandwidth product of 1 MHz. This is a slight oversimplification, however, because of the variability of the gain-bandwidth product and the fact that at the location where the closed-loop gain intersects the open-loop gain, the response is actually down 3 dB. In addition, some extra margin should be allowed.

In the application described above, an op amp with a gain-bandwidth product of 1 MHz would be marginal. A safety factor of at least 5 would be better insurance that the expected performance is achieved, and an op amp with a gain-bandwidth product of 5 MHz would therefore be chosen.

## STABILITY CRITERIA

Feedback stability theory states that the closed-loop gain must intersect the open-loop gain at a slope no greater than 6 dB/octave (single pole response) for the system to be unconditionally stable. If the response is 12 dB/octave (two pole response), the op amp will oscillate. The easiest way to think of this is that each pole adds 90° of phase shift. Two poles yields 180° phase shift, and 180° of phase shift turns negative feedback into positive feedback which means oscillations.

The question could be asked—why would you want an amplifier that is not unity gain stable? The answer is that for a given amplifier, the bandwidth can be increased at higher gains if the amplifier is not designed to be unity gain stable. This type of op amp is sometimes referred to as a *decompensated* op amp. However, the stability criteria still must be met. This criteria is that the closed-loop gain must intercept the open-loop gain at a slope of 6 dB/octave (single pole response). If not, the amplifier will oscillate. Decompensated op amps will therefore only be stable at higher gains which are specified on the data sheet.

As an example, compare the open-loop gain graphs in Figure 6. The three parts shown, the [AD847](#), [AD848](#) and [AD849](#), are basically the same design with different internal compensation. The AD847 is unity gain stable and has a specified gain-bandwidth of 50 MHz. The AD848 is stable for gains of 5 or more and has a gain-bandwidth of 175 MHz. The AD849 is stable for a gain of 25 or more and has a gain-bandwidth of 725 MHz. This illustrates how op amp internal compensation can be modified to yield various gain-bandwidth products as a function of minimum stable gain for the same basic design.

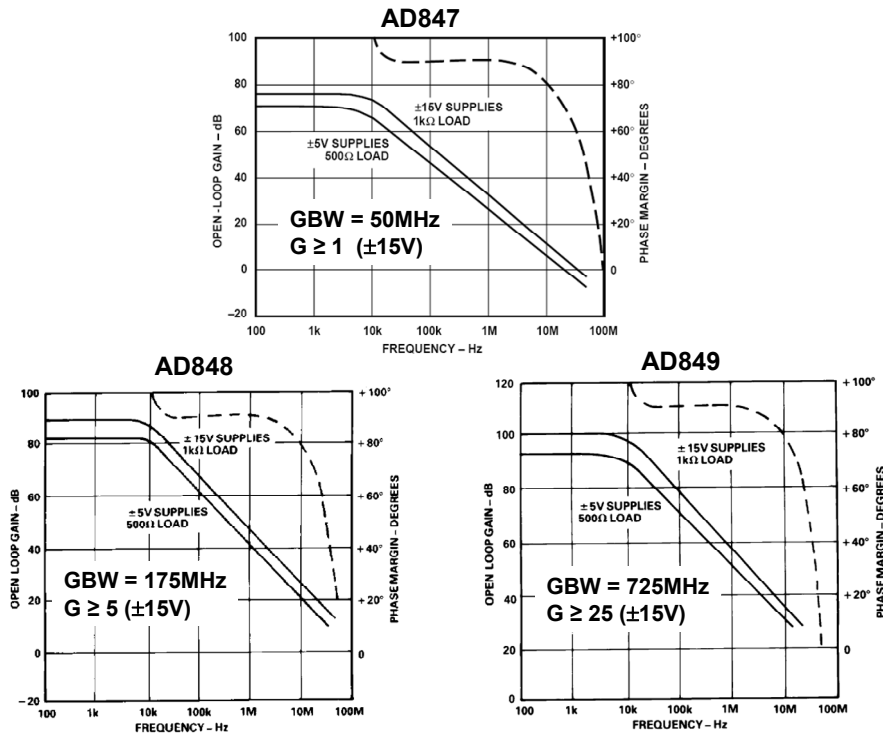
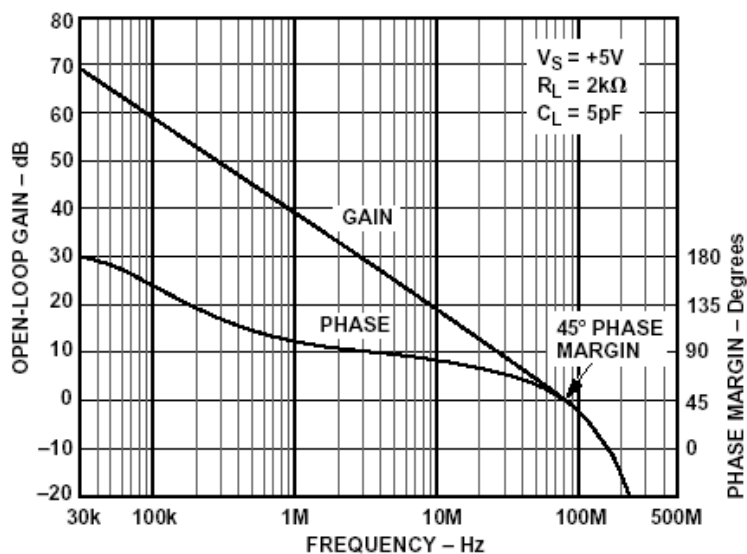

**Figure 6: AD847, AD848, AD849 Open-Loop Gain Characteristics, Gain-Bandwidth Products, and Minimum Stable Closed-Loop Gains**

### PHASE MARGIN

One measure of stability is *phase margin*. Just as the amplitude response doesn't stay flat and then change instantaneously, the phase response will also change gradually, starting approximately a decade before the corner frequency. Phase margin is the amount of phase shift that is left until you reach  $180^\circ$ , measured at the frequency at which the closed-loop gain intersects the open-loop gain.

The result of low phase margin is an increase in gain peaking just before the frequency at which the closed-loop gain intersects the open-loop gain. Figure 7 shows the gain and phase response for the [AD8051](#) op amp. In this case the phase margin is  $45^\circ$  at the frequency of unity gain.



**Figure 7: AD8051 Phase Margin**

#### REFERENCES:

1. Hank Zumbahlen, *Basic Linear Design*, Analog Devices, 2006, ISBN: 0-915550-28-1. Also available as [Linear Circuit Design Handbook](#), Elsevier-Newnes, 2008, ISBN-10: 0750687037, ISBN-13: 978-0750687034. Chapter 1
2. Walter G. Jung, *Op Amp Applications*, Analog Devices, 2002, ISBN 0-916550-26-5, Also available as [Op Amp Applications Handbook](#), Elsevier/Newnes, 2005, ISBN 0-7506-7844-5. Chapter 1.

Copyright 2009, Analog Devices, Inc. All rights reserved. Analog Devices assumes no responsibility for customer product design or the use or application of customers' products or for any infringements of patents or rights of others which may result from Analog Devices assistance. All trademarks and logos are property of their respective holders. Information furnished by Analog Devices applications and development tools engineers is believed to be accurate and reliable, however no responsibility is assumed by Analog Devices regarding technical accuracy and topicality of the content provided in Analog Devices Tutorials.