

FEATURES

High performance, dual-axis accelerometer on a single IC chip
Specified at $V_s = 3.3\text{ V}$
5 mm \times 5 mm \times 2 mm LCC package
Better than 2 mg resolution at 60 Hz
Low power: 500 μA at $V_s = 3.3\text{ V}$ (typical)
High zero g bias stability
High sensitivity accuracy
 -40°C to $+125^\circ\text{C}$ temperature range
X-axis and Y-axis aligned to within 0.1° (typical)
BW adjustment with a single capacitor
Single-supply operation
3500 g shock survival
RoHS compliant
Compatible with Sn/Pb- and Pb-free solder processes

APPLICATIONS

Vehicle dynamic control (VDC)/electronic stability program (ESP) systems
Electronic chassis controls
Electronic braking
Platform stabilization/leveling
Navigation
Alarms and motion detectors
High accuracy, 2-axis tilt sensing

GENERAL DESCRIPTION

The ADXL204 is a high precision, low power, complete dual-axis accelerometer with signal-conditioned voltage outputs, all on a single monolithic IC. Like the ADXL203, it measures acceleration with a full-scale range of $\pm 1.7\text{ g}$; however, the ADXL204 is tested and specified for 3.3 V supply voltage, whereas the ADXL203 is tested and specified at 5 V. Both parts function well over a wide 3 V to 6 V operating voltage range. The ADXL204 can measure both dynamic acceleration (for example, vibration) and static acceleration (for example, gravity).

The typical noise floor is $170\text{ }\mu\text{g}/\sqrt{\text{Hz}}$, allowing signals below 2 mg (0.1° of inclination) to be resolved in tilt sensing applications using narrow bandwidths ($<60\text{ Hz}$).

The user selects the bandwidth of the accelerometer using Capacitor C_x and Capacitor C_y at the X_{OUT} and Y_{OUT} pins. Bandwidths of 0.5 Hz to 2.5 kHz can be selected to suit the application.

The ADXL204 is available in a 5 mm \times 5 mm \times 2 mm, 8-terminal hermetic LCC package.

FUNCTIONAL BLOCK DIAGRAM

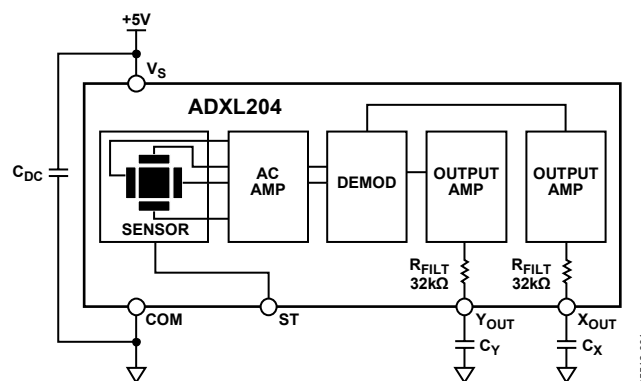

Figure 1.

Rev. A

Information furnished by Analog Devices is believed to be accurate and reliable. However, no responsibility is assumed by Analog Devices for its use, nor for any infringements of patents or other rights of third parties that may result from its use. Specifications subject to change without notice. No license is granted by implication or otherwise under any patent or patent rights of Analog Devices. Trademarks and registered trademarks are the property of their respective owners.

TABLE OF CONTENTS

Features	1	Applications.....	10
Applications.....	1	Power Supply Decoupling	10
General Description	1	Setting the Bandwidth Using C_X and C_Y	10
Functional Block Diagram	1	Self Test	10
Revision History	2	Design Trade-Offs for Selecting Filter Characteristics: The Noise/BW Trade-Off.....	10
Specifications.....	3	Using the ADXL204 with Operating Voltages Other than 3.3 V	11
Absolute Maximum Ratings.....	4	Using the ADXL204 as a Dual-Axis Tilt Sensor	11
ESD Caution.....	4	Outline Dimensions	12
Pin Configuration and Function Descriptions.....	5	Ordering Guide	12
Typical Performance Characteristics	6		
Theory of Operation	9		
Performance	9		

REVISION HISTORY

3/06—Rev. 0 to Rev. A

Changes to Format	Universal
Changes to Product Title, Features, and General Description ...	1
Changes to Table 1	3
Changes to Table 2.....	4
Added Figure 2 and Table 4.....	4
Changes to Figure 3.....	5
Changes to Figure 11 and Figure 14.....	7
Changes to Table 7.....	10

4/05—Revision 0: Initial Version

SPECIFICATIONS

All minimum and maximum specifications are guaranteed. Typical specifications are not guaranteed.

$T_A = -40^{\circ}\text{C}$ to $+125^{\circ}\text{C}$; $V_S = 3.3\text{ V}$; $C_X = C_Y = 0.1\ \mu\text{F}$; acceleration = 0 g, unless otherwise noted.

Table 1.

Parameter	Conditions	Min	Typ	Max	Unit
SENSOR INPUT	Each axis				
Measurement Range ¹		± 1.7			g
Nonlinearity	% of full scale		± 0.2	± 1.25	%
Package Alignment Error			± 1		Degrees
Alignment Error	X sensor to Y sensor		± 0.1		Degrees
Cross Axis Sensitivity			± 1.5	± 3	%
SENSITIVITY (RATIOMETRIC) ²	Each axis				
Sensitivity at X_{OUT}, Y_{OUT}	$V_S = 3.3\text{ V}$	595	620	645	mV/g
Sensitivity Change due to Temperature ³	$V_S = 3.3\text{ V}$		± 0.3		%
ZERO g BIAS LEVEL (RATIOMETRIC)	Each axis				
0 g Voltage at X_{OUT}, Y_{OUT}	$V_S = 3.3\text{ V}$	1.55	1.65	1.75	V
Initial 0 g Output Deviation from Ideal	$V_S = 3.3\text{ V}, 25^{\circ}\text{C}$		± 50		mg
0 g Offset vs. Temperature			± 0.15	± 0.8	mg/ $^{\circ}\text{C}$
NOISE PERFORMANCE					
Output Noise	<4 kHz, $V_S = 3.3\text{ V}$		1	3	mV rms
Noise Density			170		$\mu\text{g}/\sqrt{\text{Hz}}$ rms
FREQUENCY RESPONSE ⁴					
C_X, C_Y Range ⁵		0.002		10	μF
R_{FILT} Tolerance		24	32	40	k Ω
Sensor Resonant Frequency			5.5		kHz
SELF TEST ⁶					
Logic Input Low				0.66	V
Logic Input High		2.64			V
ST Input Resistance to Ground		30	50		k Ω
Output Change at X_{OUT}, Y_{OUT}	Self test 0 to 1	100	200	300	mV
OUTPUT AMPLIFIER					
Output Swing Low	No load	0.05	0.2		V
Output Swing High	No load		2.9	3.1	V
POWER SUPPLY					
Operating Voltage Range		3		6	V
Quiescent Supply Current			0.5	0.9	mA
Turn-On Time ⁷			20		ms

¹ Guaranteed by measurement of initial offset and sensitivity.

² Sensitivity is essentially ratiometric to V_S . For $V_S = 3.0\text{ V}$ to 3.6 V , sensitivity is typically 185 mV/V/g to 190 mV/V/g.

³ Defined as the change from ambient-to-maximum temperature or ambient-to-minimum temperature.

⁴ Actual frequency response controlled by user-supplied external capacitor (C_X, C_Y).

⁵ Bandwidth = $1/(2 \times \pi \times 32\text{ k}\Omega \times C)$. For $C_X, C_Y = 0.002\ \mu\text{F}$, bandwidth = 2500 Hz. For $C_X, C_Y = 10\ \mu\text{F}$, bandwidth = 0.5 Hz. Minimum/maximum values are not tested.

⁶ Self-test response changes cubically with V_S .

⁷ Larger values of C_X, C_Y increase turn-on time. Turn-on time is approximately $160 \times C_X$ or $C_Y + 4\text{ ms}$, where C_X, C_Y are in μF .

ABSOLUTE MAXIMUM RATINGS

Table 2.

Parameter	Rating
Acceleration (Any Axis, Unpowered)	3500 g
Acceleration (Any Axis, Powered)	3500 g
Drop Test (Concrete Surface)	1.2 m
V _s	-0.3 V to +7.0 V
All Other Pins	(COM - 0.3 V) to (V _s + 0.3 V)
Output Short-Circuit Duration (Any Pin to Common)	Indefinite
Temperature Range (Powered)	-55°C to +125°C
Temperature Range (Storage)	-65°C to +150°C

Stresses above those listed under Absolute Maximum Ratings may cause permanent damage to the device. This is a stress rating only; functional operation of the device at these or any other conditions above those indicated in the operational section of this specification is not implied. Exposure to absolute maximum rating conditions for extended periods may affect device reliability.

Table 3. Package Characteristics

Package Type	θ_{JA}	θ_{JC}	Device Weight
8-Terminal LCC	120°C/W	20°C/W	<1.0 gram

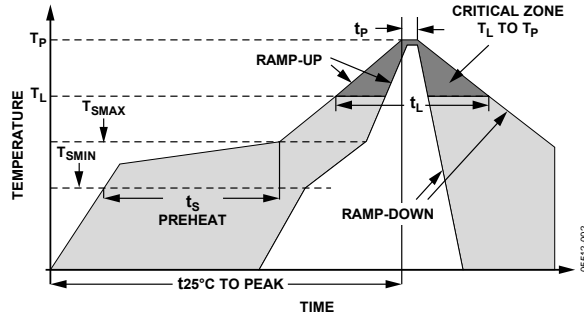

Figure 2. Recommended Soldering Profile

Table 4.

Profile Feature	Condition	
	Sn63/Pb37	Pb-Free
AVERAGE RAMP RATE (T _L TO T _P)	3°C/sec maximum	3°C/sec maximum
PREHEAT		
Minimum Temperature (T _{SMIN})	100°C	150°C
Minimum Temperature (T _{SMAX})	150°C	200°C
Time (T _{SMIN} to T _{SMAX}) (t _s)	60 sec to 120 sec	60 sec to 150 sec
T _{SMAX} TO T _L		
Ramp-Up Rate	3°C/sec	3°C/sec
TIME MAINTAINED ABOVE LIQUIDOUS (T _L)		
Liquidous Temperature (T _L)	183°C	217°C
Time (t _L)	60 sec to 150 sec	60 sec to 150 sec
PEAK TEMPERATURE (T _P)	240°C +0°C/-5°C	260°C +0°C/-5°C
TIME WITHIN 5°C OF ACTUAL PEAK TEMPERATURE (t _p)	10 sec to 30 sec	20 sec to 40 sec
RAMP-DOWN RATE	6°C/sec maximum	6°C/sec maximum
TIME 25°C TO PEAK TEMPERATURE	6 minutes maximum	8 minutes maximum

ESD CAUTION

ESD (electrostatic discharge) sensitive device. Electrostatic charges as high as 4000 V readily accumulate on the human body and test equipment and can discharge without detection. Although this product features proprietary ESD protection circuitry, permanent damage may occur on devices subjected to high energy electrostatic discharges. Therefore, proper ESD precautions are recommended to avoid performance degradation or loss of functionality.



PIN CONFIGURATION AND FUNCTION DESCRIPTIONS

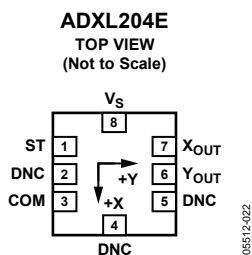

Figure 3. Pin Configuration

Table 5. Pin Function Descriptions

Pin No.	Mnemonic	Description
1	ST	Self Test
2	DNC	Do Not Connect
3	COM	Common
4	DNC	Do Not Connect
5	DNC	Do Not Connect
6	Y _{OUT}	Y Channel Output
7	X _{OUT}	X Channel Output
8	V _S	3 V to 6 V

TYPICAL PERFORMANCE CHARACTERISTICS

$V_s = 3.3\text{ V}$ for all graphs, unless otherwise noted.

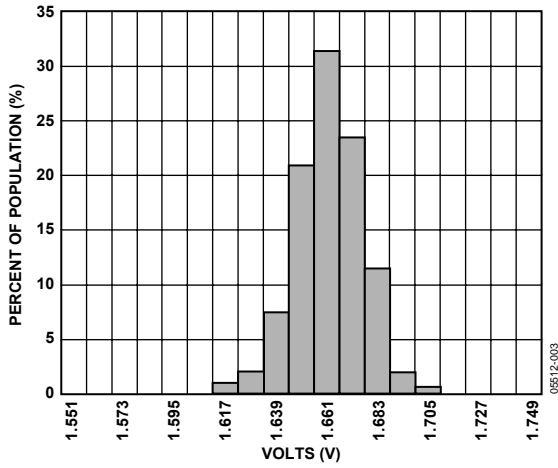

Figure 4. X-Axis Zero g Bias Output at 25°C

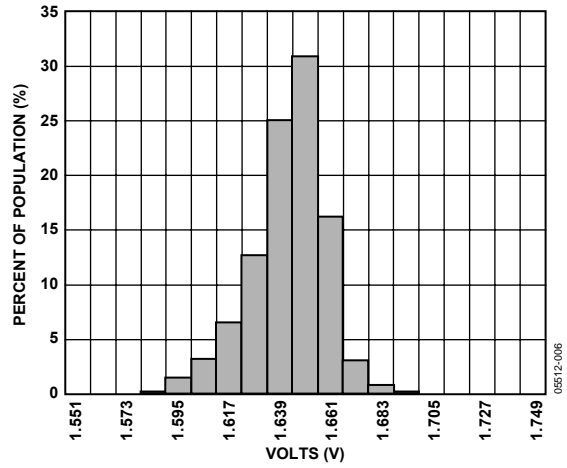

Figure 7. Y-Axis Zero g Bias Output at 25°C

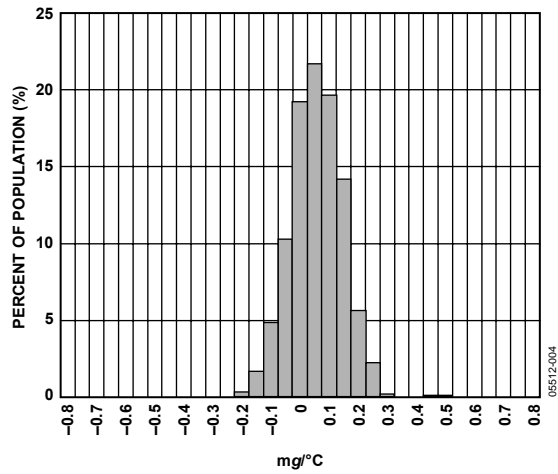

Figure 5. X-Axis Zero g Bias Temperature Coefficient

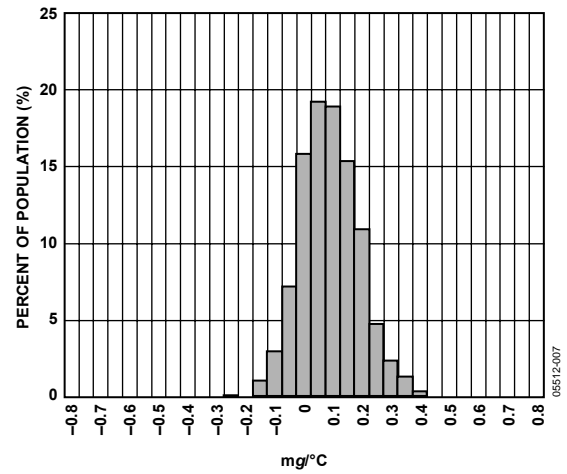

Figure 8. Y-Axis Zero g Bias Temperature Coefficient

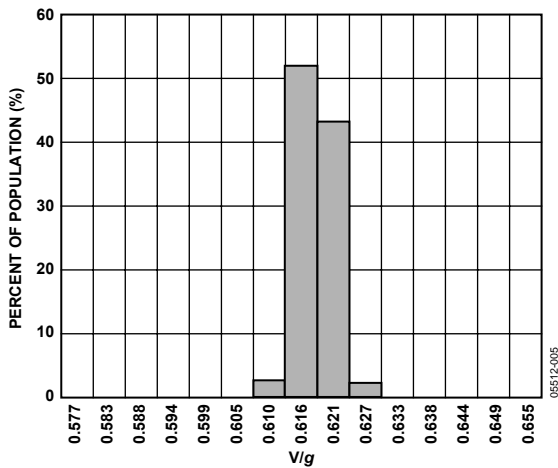

Figure 6. X-Axis Sensitivity at 25°C

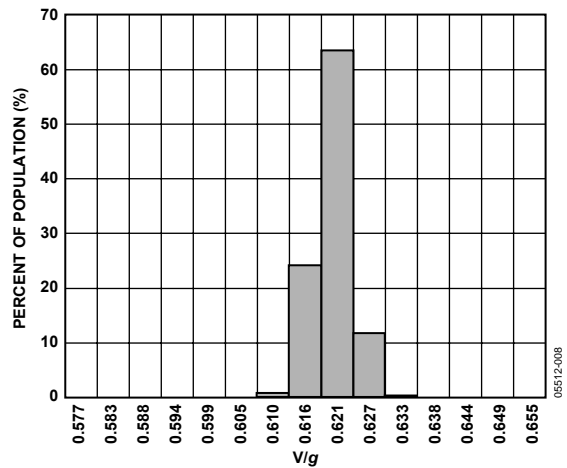

Figure 9. Y-Axis Sensitivity at 25°C

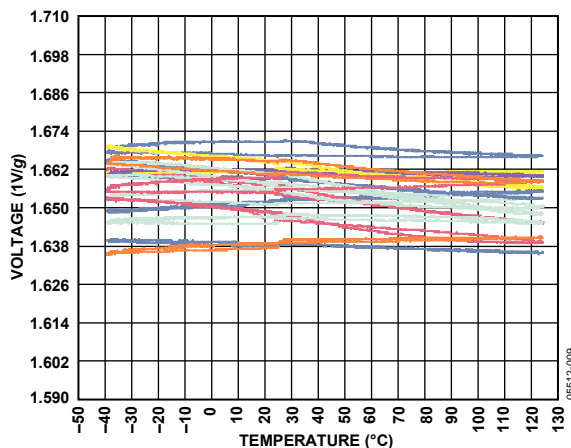

Figure 10. Zero g Bias vs. Temperature—Parts Soldered to PCB

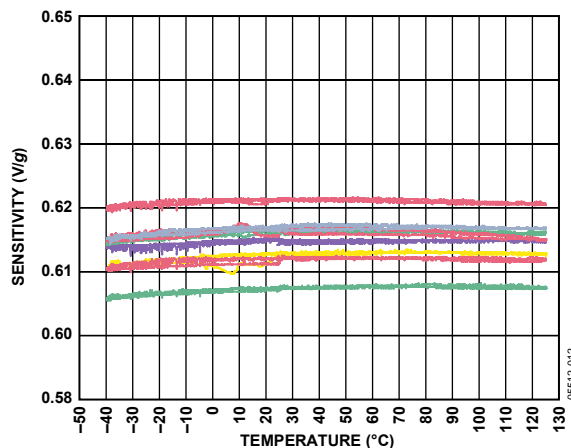

Figure 13. Sensitivity vs. Temperature—Parts Soldered to PCB

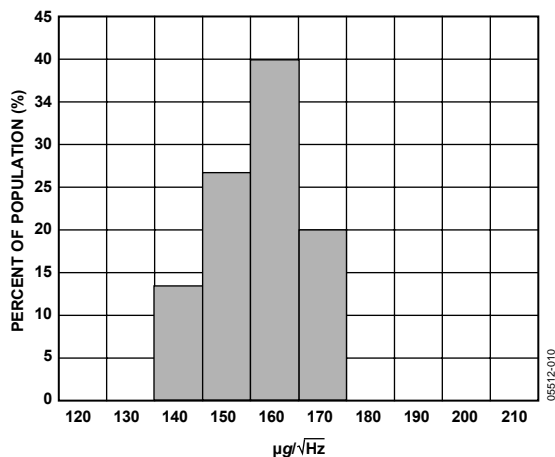

Figure 11. X-Axis Noise Density at 25°C

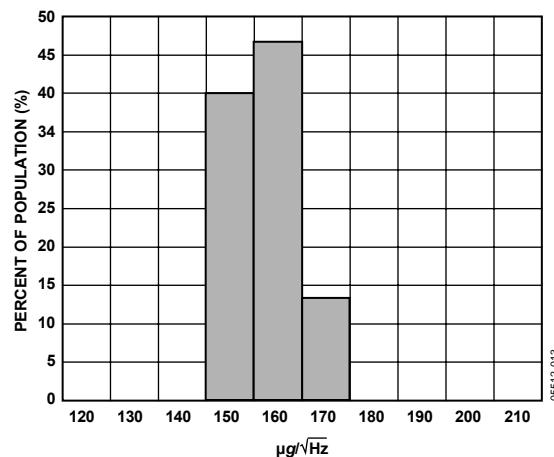

Figure 14. Y-Axis Noise Density at 25°C

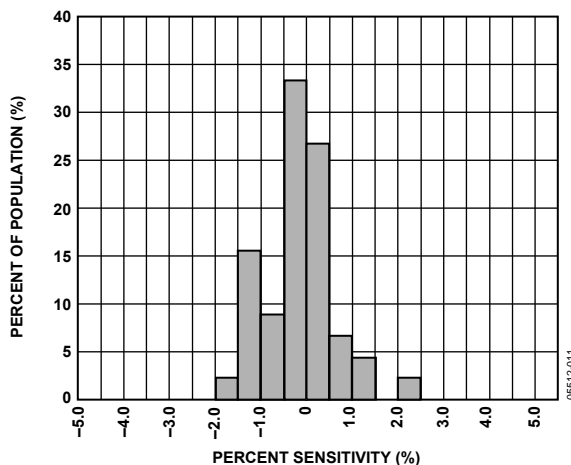

Figure 12. Z vs. X Cross-Axis Sensitivity

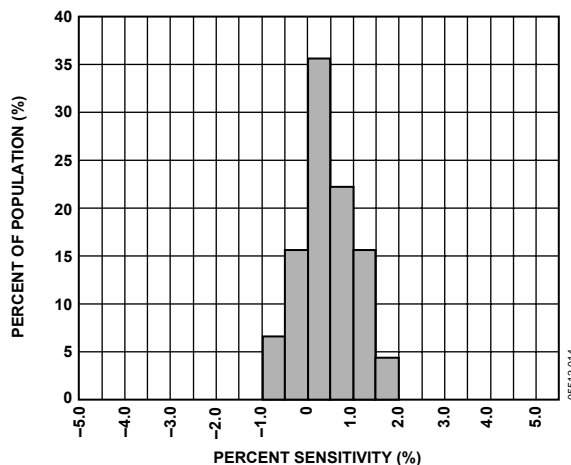

Figure 15. Z vs. Y Cross-Axis Sensitivity

ADXL204

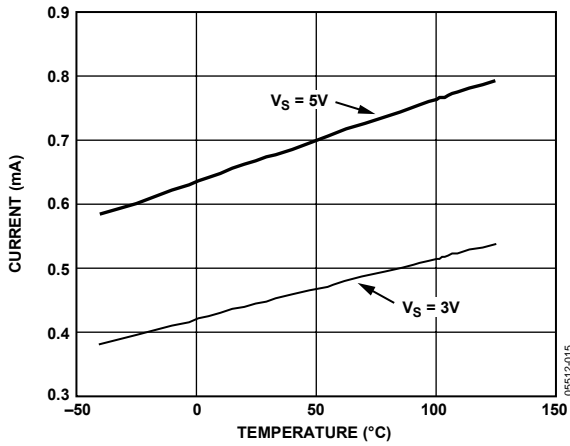

Figure 16. Supply Current vs. Temperature

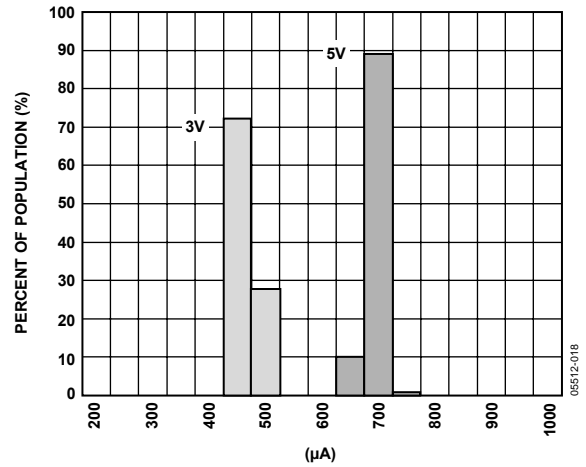

Figure 19. Supply Current at 25°C

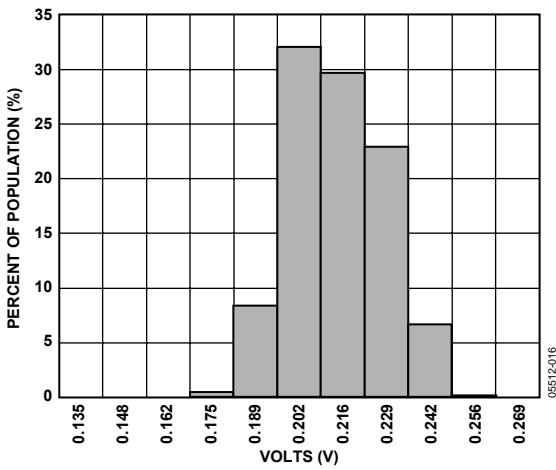

Figure 17. X-Axis Self-Test Response at 25°C

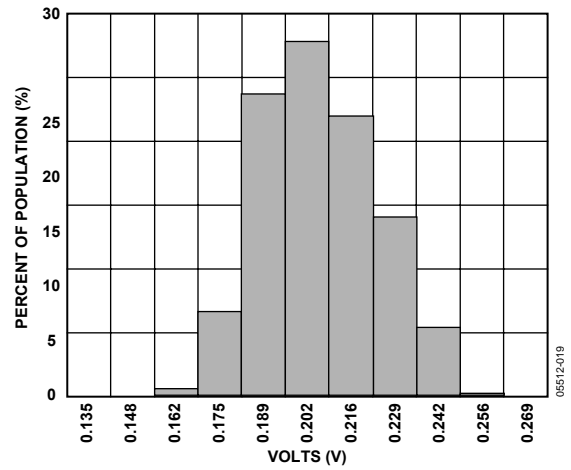

Figure 20. Y-Axis Self-Test Response at 25°C

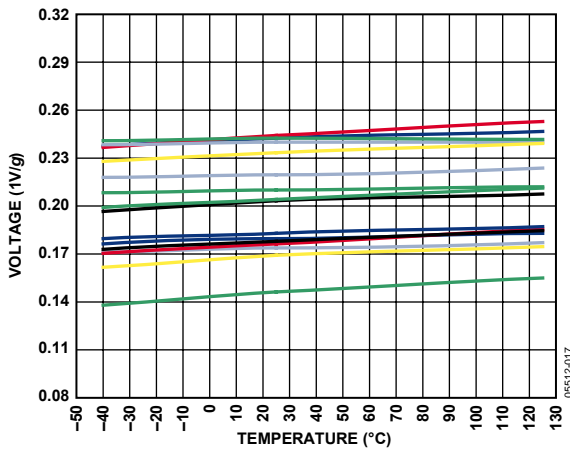

Figure 18. Self-Test Response vs. Temperature

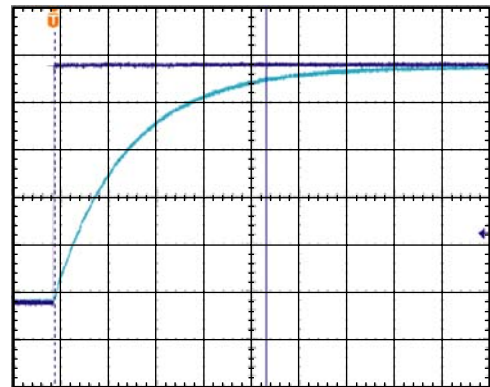

Figure 21. Turn-On Time— $C_x, C_y = 0.1 \mu F$, Time Scale = 2 ms/DIV

THEORY OF OPERATION

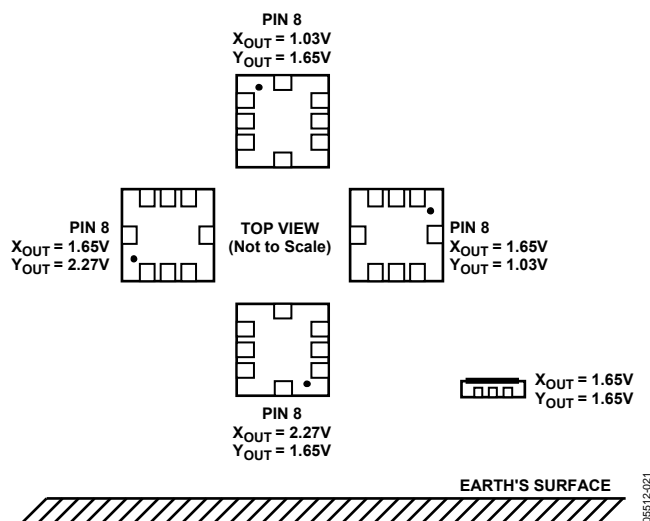

Figure 22. Output Response vs. Orientation

The ADXL204 is a complete acceleration measurement system on a single monolithic IC. The ADXL204 is a dual-axis accelerometer. It contains a polysilicon surface-micromachined sensor and signal conditioning circuitry to implement an open-loop acceleration measurement architecture. The output signals are analog voltages proportional to acceleration. The ADXL204 is capable of measuring both positive and negative accelerations to at least $\pm 1.7 g$. The accelerometer can measure static acceleration forces, such as gravity, allowing it to be used as a tilt sensor.

The sensor is a surface-micromachined polysilicon structure built on top of the silicon wafer. Polysilicon springs suspend the structure over the surface of the wafer and provide a resistance against acceleration forces. Deflection of the structure is measured using a differential capacitor that consists of independent fixed plates and plates attached to the moving mass. The fixed plates are driven by 180° out-of-phase square waves. Acceleration deflects the beam and unbalances the differential capacitor, resulting in an output square wave whose amplitude is proportional to acceleration. Phase-sensitive demodulation techniques are then used to rectify the signal and determine the direction of the acceleration.

The output of the demodulator is amplified and brought off-chip through a $32 k\Omega$ resistor. At this point, the user can set the signal bandwidth of the device by adding a capacitor. This filtering improves measurement resolution and helps prevent aliasing.

PERFORMANCE

Rather than using additional temperature compensation circuitry, innovative design techniques have been used to ensure high performance is built in. As a result, there is essentially no quantization error or nonmonotonic behavior, and temperature hysteresis is very low, typically less than $10 mg$ over the $-40^\circ C$ to $+125^\circ C$ temperature range.

Figure 10 shows the zero g output performance of eight parts (X-axis and Y-axis) over a $-40^\circ C$ to $+125^\circ C$ temperature range.

Figure 13 demonstrates the typical sensitivity shift over temperature for $V_s = 3.3 V$. Sensitivity stability is typically better than $\pm 1\%$ over temperature.

APPLICATIONS

POWER SUPPLY DECOUPLING

For most applications, a single 0.1 μF capacitor, C_{DC} , adequately decouples the accelerometer from noise on the power supply. However in some cases, particularly where noise is present at the 140 kHz internal clock frequency (or any harmonic thereof), noise on the supply can cause interference on the ADXL204 output. If additional decoupling is needed, a 100 Ω , or smaller, resistor or ferrite bead can be inserted in the supply line of the ADXL204. Additionally, a larger bulk bypass capacitor, in the 1 μF to 22 μF range, can be added in parallel to C_{DC} .

SETTING THE BANDWIDTH USING C_X AND C_Y

The ADXL204 has provisions for bandlimiting the X_{OUT} and Y_{OUT} pins. Capacitors must be added at these pins to implement low-pass filtering for antialiasing and noise reduction. The equation for the 3 dB bandwidth is

$$F_{-3 \text{ dB}} = 1/(2\pi(32 \text{ k}\Omega) \times C_{(X, Y)})$$

or more simply,

$$F_{-3 \text{ dB}} = 5 \mu\text{F}/C_{(X, Y)}$$

The tolerance of the internal resistor (R_{FILT}) can vary typically as much as $\pm 25\%$ of its nominal value (32 k Ω); thus, the bandwidth varies accordingly. A minimum capacitance of 2000 pF for C_X and C_Y is required in all cases.

Table 6. Filter Capacitor Selection, C_X and C_Y

Bandwidth (Hz)	Capacitor (μF)
1	4.7
10	0.47
50	0.10
100	0.05
200	0.027
500	0.01

SELF TEST

The ST pin controls the self-test feature. When this pin is set to V_s , an electrostatic force is exerted on the beam of the accelerometer. The resulting movement of the beam allows the user to test if the accelerometer is functional. The typical change in output is 325 mg (corresponding to 200 mV). This pin can be left open-circuit or connected to common in normal use.

The ST pin should never be exposed to voltage greater than $V_s + 0.3 \text{ V}$. If the system design is such that this condition cannot be guaranteed (that is, multiple supply voltages present), a low V_F clamping diode between ST and V_s is recommended.

DESIGN TRADE-OFFS FOR SELECTING FILTER CHARACTERISTICS: THE NOISE/BW TRADE-OFF

The accelerometer bandwidth selected ultimately determines the measurement resolution (smallest detectable acceleration). Filtering can be used to lower the noise floor, which improves the resolution of the accelerometer. Resolution is dependent on the analog filter bandwidth at X_{OUT} and Y_{OUT} .

The output of the ADXL204 has a typical bandwidth of 2.5 kHz. The user must filter the signal at this point to limit aliasing errors. The analog bandwidth must be no more than half the A/D sampling frequency to minimize aliasing. The analog bandwidth can be further decreased to reduce noise and improve resolution.

The ADXL204 noise has the characteristics of white Gaussian noise, which contributes equally at all frequencies and is described in terms of $\mu\text{g}/\sqrt{\text{Hz}}$ (that is, the noise is proportional to the square root of the accelerometer's bandwidth). The user should limit bandwidth to the lowest frequency needed by the application to maximize the resolution and dynamic range of the accelerometer.

With the single-pole, roll-off characteristic, the typical noise of the ADXL204 is determined by

$$rmsNoise = (170 \mu\text{g}/\sqrt{\text{Hz}}) \times (\sqrt{\text{BW}} \times 1.6)$$

At 100 Hz the noise is

$$rmsNoise = (170 \mu\text{g}/\sqrt{\text{Hz}}) \times (\sqrt{\text{BW}} \times 1.6) = 2.15 \text{ mg}$$

Often, the peak value of the noise is desired. Peak-to-peak noise can only be estimated by statistical methods. Table 7 is useful for estimating the probabilities of exceeding various peak values, given the rms value.

Table 7. Estimation of Peak-to-Peak Noise

Peak-to-Peak Value	% of Time Noise Exceeds Nominal Peak-to-Peak Value
2 \times rms	32
4 \times rms	4.6
6 \times rms	0.27
8 \times rms	0.006

Peak-to-peak noise values give the best estimate of the uncertainty in a single measurement and is estimated by $6 \times \text{rms}$. Table 8 gives the typical noise output of the ADXL204 for various C_X and C_Y values.

Table 8. Filter Capacitor Selection (C_X , C_Y)

Bandwidth(Hz)	C_X , C_Y (μF)	RMS Noise (mg)	Peak-to-Peak Noise Estimate (mg)
10	0.47	0.7	4.1
50	0.1	1.5	9.1
100	0.047	2.2	12.9
500	0.01	4.8	28.8

USING THE ADXL204 WITH OPERATING VOLTAGES OTHER THAN 3.3 V

The ADXL204 is tested and specified at $V_S = 3.3 \text{ V}$; however, it can be powered with V_S as low as 3 V or as high as 6 V. Some performance parameters change as the supply voltage is varied.

The ADXL204 output is ratiometric, so the output sensitivity, or scale factor, varies proportionally to supply voltage. At $V_S = 3 \text{ V}$, the output sensitivity is typically 560 mV/g. At $V_S = 5 \text{ V}$, the output sensitivity is typically 1000 mV/g.

The zero g bias output is also ratiometric, so the zero g output is nominally equal to $V_S/2$ at all supply voltages.

The output noise is not ratiometric but is absolute in volts; therefore, the noise density decreases as the supply voltage increases. This is because the scale factor (mV/g) increases while the noise voltage remains constant. At $V_S = 3 \text{ V}$, the noise density is typically $190 \mu\text{g}/\sqrt{\text{Hz}}$. At $V_S = 5 \text{ V}$, the noise density is typically $110 \mu\text{g}/\sqrt{\text{Hz}}$.

Self-test response in g is roughly proportional to the square of the supply voltage. However, when ratiometricity of sensitivity is factored in with supply voltage, self-test response in volts is roughly proportional to the cube of the supply voltage. This means at $V_S = 3 \text{ V}$, the self-test response is approximately equivalent to 150 mV, or equivalent to 270 mg (typical). At $V_S = 5 \text{ V}$, the self-test response is approximately equivalent to 750 mV, or equivalent to 750 mg (typical).

The supply current decreases as the supply voltage decreases. Typical current consumption at $V_{DD} = 5 \text{ V}$ is 750 μA .

USING THE ADXL204 AS A DUAL-AXIS TILT SENSOR

One of the most popular applications of the ADXL204 is tilt measurement. An accelerometer uses the force of gravity as an input vector to determine the orientation of an object in space.

An accelerometer is most sensitive to tilt when its sensitive axis is perpendicular to the force of gravity, that is, parallel to the earth's surface. At this orientation, its sensitivity to changes in tilt is highest. When the accelerometer is oriented on axis to gravity, that is, near its +1 g or -1 g reading, the change in output acceleration per degree of tilt is negligible. When the accelerometer is perpendicular to gravity, its output changes nearly 17.5 mg per degree of tilt. At 45°, its output changes at only 12.2 mg per degree and resolution declines.

Dual-Axis Tilt Sensor: Converting Acceleration to Tilt

When the accelerometer is oriented, so both its x-axis and y-axis are parallel to the earth's surface, it can be used as a 2-axis tilt sensor with a roll axis and a pitch axis. Once the output signal from the accelerometer is converted to an acceleration that varies between -1 g and +1 g, the output tilt in degrees is calculated as:

$$PITCH = \text{ASIN}(A_x/1 \text{ g})$$

$$ROLL = \text{ASIN}(A_y/1 \text{ g})$$

Be sure to account for overranges. It is possible for the accelerometers to output a signal greater than $\pm 1 \text{ g}$ due to vibration, shock, or other accelerations.

ADXL204

OUTLINE DIMENSIONS

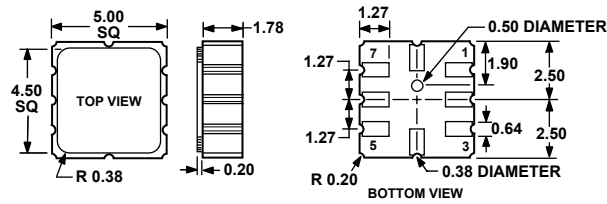

Figure 23. 8-Terminal Ceramic Leadless Chip Carrier [LCC]
(E-8)
Dimensions shown in millimeters

ORDERING GUIDE

Model	Number of Axes	Specified Voltage (V)	Temperature Range	Package Description	Package Option
ADXL204CE	2	3.3	-40°C to +125°C	8-Terminal Ceramic Leadless Chip Carrier (LCC)	E-8
ADXL204CE-REEL	2	3.3	-40°C to +125°C	8-Terminal Ceramic Leadless Chip Carrier (LCC)	E-8
ADXL204EB				Evaluation Board	