

Analog Devices Welcomes Hittite Microwave Corporation

NO CONTENT ON THE ATTACHED DOCUMENT HAS CHANGED



THIS PAGE INTENTIONALLY LEFT BLANK

NEW SiGe BiCMOS PLL

New Article Feature by Hittite Microwave Corporation

High Performance SiGe PLLs Pair with Low Phase Noise GaAs VCOs for Microwave Radio

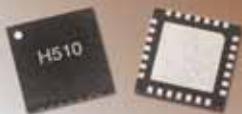

INTEGRATION, PERFORMANCE & FUNCTIONALITY

Integration, performance and functionality, are three of the most common

requests made by RF & Microwave designers striving for leading edge systems with components that can help them deliver that often elusive market edge. In the world of signal generation, Hittite Microwave Corporation is meeting these challenges with the introduction of broadband Frequency Synthesizers and Phase Locked Loop (PLL) integrated circuits which are designed to deliver superior performance and innovative features, all within a miniature surface mount package.

The introduction of new digital modulation schemes coupled with consumer demand for increased bandwidth and data capacity, have accelerated the need for microwave radio backhaul systems. These radios require integrated synthesizers that deliver high accuracy and can support signals with exceptional signal-to-noise-ratio (SNR). The phase noise and distortion of the synthesizer can limit the maximum achievable SNR of a modulated signal, while increases in the data throughput of the radio place an even greater demand on the synthesizer phase noise. In addition, synthesizer spurious products and far out noise, must be kept to a minimum so as not to impair transceivers operating in adjacent bands.

Hittite Microwave Corporation has developed a core expertise in frequency generation products including: low noise MMIC VCOs, frequency dividers, frequency multipliers, phase frequency detectors (PFDs), and now a new line of dual-mode integrated synthesizer solutions. The HMC700LP4E is a SiGe BiCMOS frequency synthesizer that can be operated in fractional or integer mode over a frequency range of 0.1 to

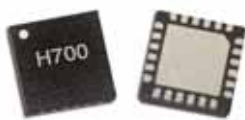

HMC700LP4E
Fractional-N Synthesizer PLL

9 GHz (8 GHz fractional). Primarily designed for ultra low phase noise applications, its internal architecture includes a very low noise phase

frequency detector and a precision controlled charge pump. **Figure 1** shows how the HMC700LP4E is best employed with Hittite GaAs HBT VCOs for microwave radio frequency synthesis. The fractional-N synthesizer features a delta-sigma modulator design that allows both ultra fine step sizes and low noise high reference frequency. The HMC700LP4E phase-frequency detector also features cycle slip prevention for faster frequency hopping.

The Bit Error Rate (BER) is a critical measure of the radio performance and is directly related to the achievable Signal-to- Noise ratio (SNR) within the system. Critical components in the radio such as the power amplifier and synthesizer can limit the maximum SNR achievable due to distortion or unwanted phase noise. Some systems refer to this type of distortion as the Error Vector Magnitude (EVM), which is a measure of the signal distortion and noise when the signal is strong. A degraded EVM can limit the achievable data throughput of the radio link. The problem becomes more severe as the modulation scheme, data rate and frequency increase. Typically the power amplifier distortion is the dominant component limiting the attainable EVM. Despite this fact, it can be a challenge for a high frequency synthesizer to generate a clean carrier that doesn't contribute to EVM. It is difficult to discuss high performance frequency synthesis without mentioning the contributions of the phase locked loop (PLL). In order to achieve excellent phase noise, wide tuning range and frequency accuracy, designers almost exclusively deploy phase locked loop architectures within wireless communications systems. While PLL architectures are widely understood, achieving peak performance for a particular application is often challenging for even the most seasoned engineer.

Many factors influence noise and spurious outputs of a PLL, which is why a thorough understanding of the key building blocks and how they interact is critical. Hittite Microwave Corporation has a long history of expertise in the development of phase locked loop (PLL) architectures. Our products and experience span the spectrum from discrete component design and integrated RFICs to complex signal generator systems. The design of a PLL depends heavily on the choice of components within the loop and how they

Figure of Merit = Measured Phase Noise (PN) at the VCO, input referred to the input of the phase detector (PFD) at the PFD operating frequency (20logN), then normalized to 1 Hz based upon the fact that the duty cycle of the PFD decreases linearly with operating frequency.

Restated:

FOM = PN at the VCO - 20logN - 10log(fpfd) {where f0 = 5 GHz, fpfd = 50 MHz, N=100}

FOM = -104 - 40 - 77

FOM = -221 dBc/Hz

LOW PHASE NOISE, HIGH FUNDAMENTAL FREQUENCY

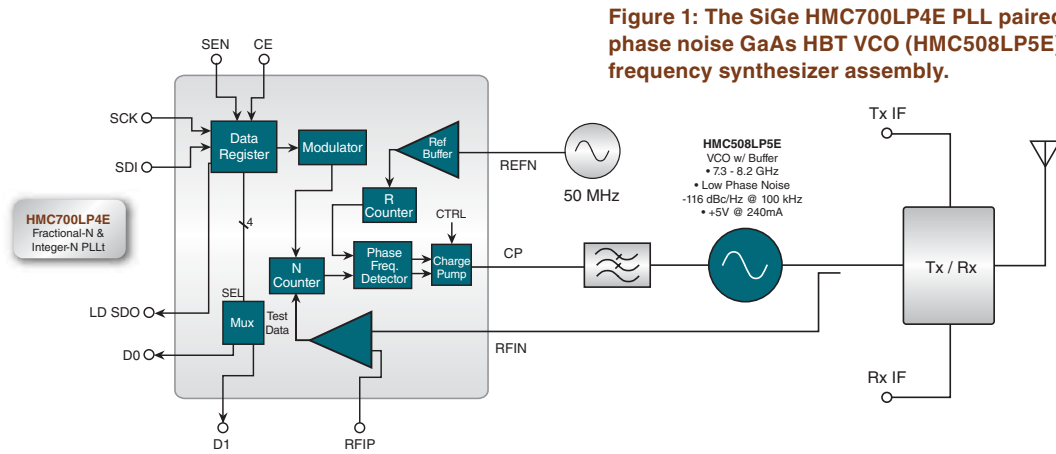

Figure 1: The SiGe HMC700LP4E PLL paired with a low phase noise GaAs HBT VCO (HMC508LP5E) to form a high frequency synthesizer assembly.

interact with each other. Hittite's industry leading MMIC VCOs, broadband dividers and wideband fractional synthesizers, provide a wealth of complete high performance integrated solutions. Our goal is to provide the best possible solution using our SiGe BiCMOS PLL IC technology, and our low phase noise GaAs HBT VCO technology.

The HMC700LP4E is the first wideband integrated frequency synthesizer of its kind, enabling the development of high performance phase locked loops for cellular base stations and point-to-point radio links, using the same PLL device. Furthermore, the HMC700LP4E provides the system designer with a distinct performance advantage by delivering 10 dBc/Hz better performance than the closest alternative.

Figure 2 shows the phase noise performance for the HMC700LP4E, configured with Hittite's wideband VCOs, over various center frequencies. Lower frequencies in this plot were obtained with Hittite's low noise dividers. The HMC700LP4E achieves a figure of merit (FOM) of -226 dBc/Hz for integer mode and -221 dBc/Hz for fractional mode. It is important to note that all Hittite synthesizers are designed to work with Hittite's wide selection of high performance VCOs and low noise dividers. This gives Hittite a unique capability to guarantee performance of the PLL and the VCO components together, while offering the flexibility of standalone VCOs.

Hittite synthesizers feature very high reference frequency operation and low noise delta sigma modulator design, two critical factors in achieving ultra-low phase noise. Any signal that a synthesizer generates, other than the desired central tone, may be considered a spurious product. The spurious performance is a critical factor in the design of a synthesizer and fractional synthesizers are especially notorious for spurious

products. A discussion of spurious products is a complex subject because it depends on many factors both internal to the RFIC and external to the RFIC in the surrounding board and components. Yet it is a critical performance attribute, therefore many synthesizer manufacturers

Figure 2: Typical Phase Noise performance of the HMC700LP4E paired with Hittite Microwave VCOs

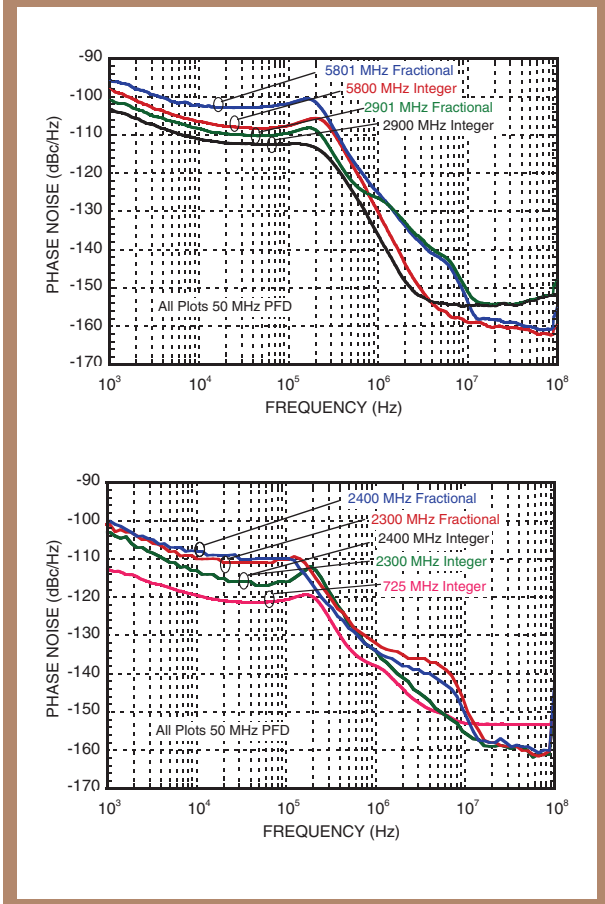

ULTRA FLEXIBLE PLL DESIGN SOFTWARE

typically display performance for conditions that are favorable to their part, and hence demonstrate only peak capability. The reality is most often situation specific.

The HMC700LP4E, in fractional mode, typically achieves -90 dBc spurious products when operated at 10x loop bandwidth from an integer boundary. Operation at closer offsets will see the fractional spurious rise at the rate of the reference transfer function. Operation on an integer boundary will suppress all spurs except the reference sideband. Some of the variables that affect spurious product generation include: mode of operation, reference frequency, channel step size, board layout, frequency

of operation, component isolation, loop bandwidth and VCO characteristics. It is with this core understanding and MMIC & Subsystem experience that Hittite provides dedicated product support to solve specific challenges and maximize the performance of the components selected. Reference spurious levels are typically below -100dBc, and in-band fractional boundary spurious are typically below the integrated phase noise.

Other features of the HMC700LP4E include a lock detect and cycle slip prevention. The lock detect circuit alerts the user when the reference crystal frequency and the divided VCO signal are in phase. An effective lock detect function accurately distinguishes between normal phase jitter when in lock and phase jitter when not in lock. The PLL must not interpret fractional modulation as being out of lock while at the same time recognizing loss of lock when it truly exists. The HMC700LP4E features digital control of lock detect characteristics such as window, duration, trigger etc. The high performance lock detect circuit can detect even a single cycle phase hit. The circuit can also be configured to hold the outoflock detect signal for longer periods to make short phase hits detectable to slower external monitoring circuitry.

The HMC700LP4E phase frequency detector features an ability to virtually eliminate cycle slipping during acquisition. When enabled, the Cycle Slip Prevention (CSP) feature essentially holds the PFD gain at maximum until the frequency difference is near zero. This feature allows faster lock times when frequency hopping. Hittite offers a simple solution to suit designer's PLL needs. The HMC700LP4E is housed in a 4x4mm 24 lead QFN package and can be ordered as part of an evaluation kit. The HMC700LP4E evaluation kit includes an evaluation board (Figure 3) with a passive loop filter, crystal reference oscillator, voltage regulators and a digital interface for a USB controller.

The kit includes a USB controller board and an installation CD containing schematic documentation, measured performance data, register files and USB drivers. The CD also contains Hittite's PLL Design Software Package, a screen capture of which is shown in Figure 4. This easy to use tool simplifies the process of loop filter design. The PLL Design Software includes full models for all of the PLL components and allows easy insertion of new models for customer supplied components such as reference crystal, op-amp or VCO. The PLL Design Software includes numerous loop filter models which allow the designer to optimize the loop filter for each application, with excellent accuracy. As shown in Figure 5,

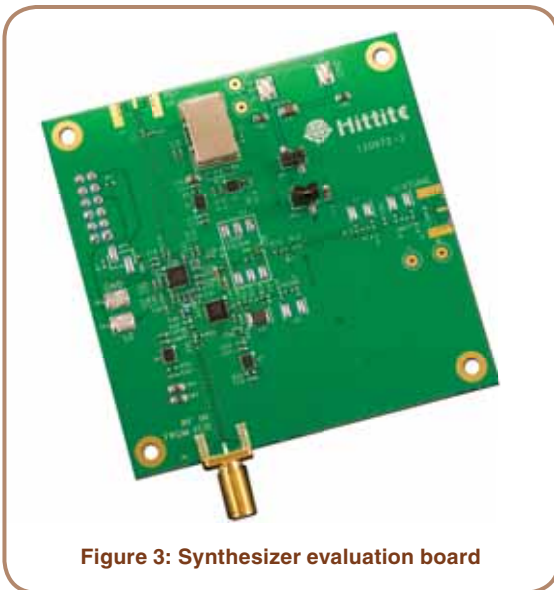

Figure 3: Synthesizer evaluation board

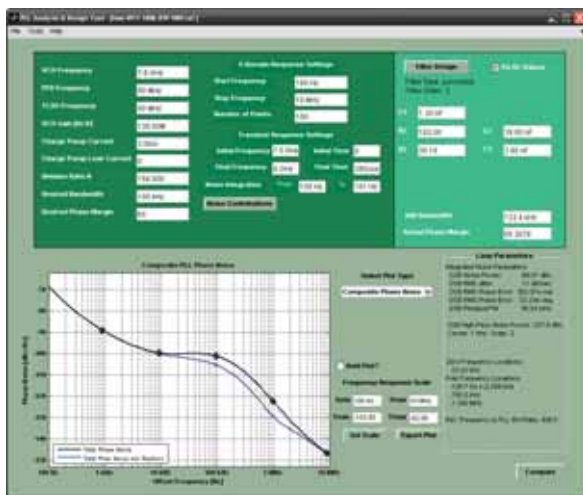

Figure 4: PLL Design Software for loop filter design interface

CONTACT US FOR YOUR CUSTOM PLL REQUIREMENTS

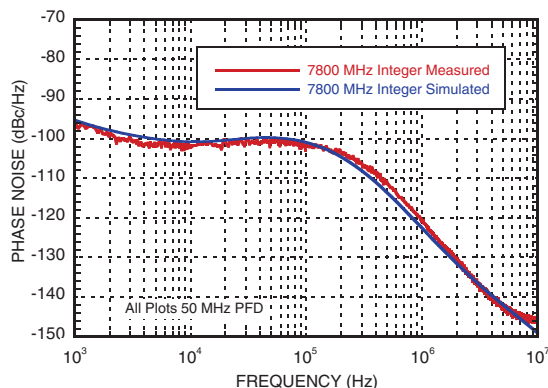

Figure 5: Simulated versus measured data for the HMC700LP4E, paired with the HMC508LP5E GaAs HBT VCO in a PLL application

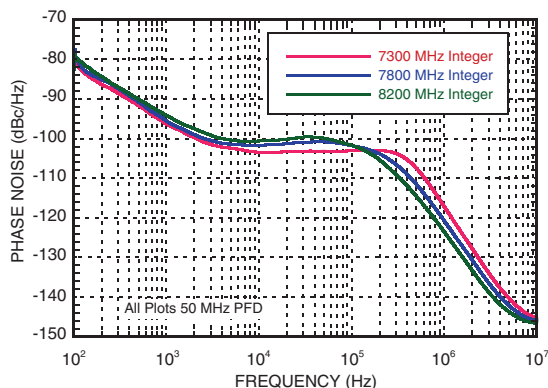

Figure 6: Phase noise performance of a PLL with the HMC700LP4E & Hittite VCO

the simulated phase noise results given by the PLL Design Software is in close agreement with the measured phase noise performance of the HMC700LP4E paired with the HMC508LP5E high frequency GaAs HBT VCO.

The design software includes the capability of using active or passive loop filters as well as the ability to adjust performance characteristics when using other popular Hittite wideband VCOs. It is the intention of this software to dramatically reduce the design time while enabling first pass success. The performance benefit of this new wideband fractional-N synthesizer can be fully realized using Hittite's wide range of integrated IC surface mount VCO products.

Table 1 displays the performance of the HMC700LP4E when used in a PLL with other high performance Hittite VCOs. These products have simplified the implementation and the intricacies of designing high frequency PLLs with excellent unit to unit match and an evaluation kit flexibility that accommodates various product choices and loop filter design options. These market leading product families were designed to provide optimized solutions

for commercial point-to-point, private and military radio markets that exist in the 7 to 15 GHz frequency band. High frequency kits are available including PLL examples that maximize performance in this frequency band.

Performance of the HMC700LP4E & HMC508LP5E can be seen in **Figure 6** and demonstrates a phase noise performance that is 13 to 15dB better than alternative hybrid 'can' solutions. The ultimate challenge of all PLL designers is to achieve the maximum performance while limiting the tradeoffs that exist in the application.

Hittite Microwave Corporation is committed to providing superior component solutions and product support that enables our customers to be the best in the RF & Microwave industry. Our product strategy is to continue to provide levels of integration that deliver incremental performance and value while maintaining the features that permit user flexibility. For product information on the HMC700LP4E, or other integrated synthesizers, dividers and wideband VCOs, please visit www.hittite.com. For help in designing your next microwave frequency synthesizer, please contact apps@hittite.com.

Table 1: Hittite VCOs paired with the HMC700LP4E PLL IC for Microwave Radio applications

Hittite VCO + HMC700LP4E PLL Phase Noise (Fref=50MHz, BW=100kHz, T= 25°C)

VCO Part Number	Frequency Band (GHz)	Phase Noise (dBc/Hz)
HMC508LP5E	7.3 - 8.2	-102
HMC509LP5E	7.8 - 8.5	-102
HMC510LP5E	8.45 - 9.55	-101
HMC512LP5E	9.6 - 10.8	-100
HMC515LP5E	11.5 - 12.5	-100
HMC529LP5E	12.4 - 13.4	-98

Order On-Line at: www.hittite.com

Connecting Our World Through Integrated Solutions

Hittite Microwave Worldwide Sales Offices

**Hittite Microwave Corporation
USA Corporate Headquarters**
Phone: 978-250-3343
Fax: 978-250-3373
sales@hittite.com

Central North America
Phone: 817-727-7146
usa-central@hittite.com

Eastern North America
Phone: 978-337-1226
usa-east@hittite.com

Western North America
Phone: 978-808-0652
usa-west@hittite.com

**Western & Southern Europe
Hittite Microwave Europe Limited**
Phone: +44-870-7664355
Fax: 978-250-3373
europe@hittite.com

**Northern Europe
Hittite Microwave Europe Limited**
Phone: +44-870-7664355
Fax: +978-250-3373
nordic@hittite.com

**Central & Eastern Europe
Hittite Microwave Deutschland GmbH**
Phone: +49 8031-97654
Fax: +49 8031-98883
germany@hittite.com

**Republic of Korea
Hittite Microwave Asia Co., Limited**
Phone: +82 2559-0638
Fax: +82 2559-0639
korea@hittite.com

**Peoples Republic of China
Hittite Microwave Co., Limited
Shanghai Office**
Phone: +86 21 6209-8809
Fax: +86 21 6209-6730
china@hittite.com

Shenzhen Office
Phone: +86 755 3322-2116
Fax: +86 755 3322-2117
shenzhen@hittite.com

Japan Hittite KK
Phone: +81-3-6853-6654
Fax: +81-3-6853-6674
japan@hittite.com

Sales Representatives

AMERICAS

Brazil:
Vermont Rep. Com. Ltda
+55 11 3726-6655

Canada:
Repwave
Calgary, Ottawa & Montreal:
+613-270-9811
Toronto:
+647-883-7360
Vancouver:
+604-929-8541

USA North East & Mid-Atlantic;

CT, MA, ME, E. PA, NH,
So. NJ, RI & VT:
Microwave Marketing Specialist
978-392-0110

Western NY:
Zimmerman Sales
585-385-2103

So. CT, Metro LI & No. NJ:
Comp Tech
201-288-7400

Western PA
Schillinger Associates, Inc.
765-457-7241

DC, DE, MD, VA & WV:
Vincent Pirro Electronics
410-489-9554

USA Mid-West;

IA
Essig & Associates
319-363-8703

KS & W. MO
Quad State Sales & Marketing
978-499-1711

IL & WI:
TEQ Sales
847-742-3767

IN, KY, MI & OH:
Schillinger Associates, Inc.
765-457-7241

MN, ND, SD & NE:
HMC Central
817-727-7146

USA South East;

FL:
Spartech South
321-727-8045

GA, NC, SC, TN, AL & MS:
RFM Marketing Inc.
770-267-1295

USA South West;

TX, OK, LA & AR:
NW Sales, LP.
817-483-5676

AZ & NM:
Saguaro Technical Sales, Inc.
480-947-3724

USA West;

No. CA & NV:
Custom & Wireless Sales
408-371-0222

So. CA:
Acetec
858-784-0900

OR & WA:
Sea-Port Technical Sales
425-702-8300

CO, ID, UT, MT & WY:
Hittite Central North America
817-727-7146

EUROPE, MID-EAST & AFRICA

Austria, Belgium, Czech Republic, Estonia,
France, Germany, Hungary, Italy, Latvia,
Lithuania, Luxemburg, Netherlands,
Poland, Slovakia, & Switzerland:
Hittite Microwave Deutschland GmbH
+49 8031-97654

Bosnia Herzegovina, Bulgaria,
Croatia, Macedonia, Romania,
Serbia Montenegro & Slovenia
IC Electronika
+386(0) 1 568-01-20
Denmark, Finland, Norway & Sweden:
Hittite Microwave Europe Limited
+44-870-7664355

Finland:
LKC OY
+358-400-460-646

France:
Salies SA
+33-1-69-02-2560

Greece:
Hittite Microwave Europe Limited
+44-870-7664355

Israel:
Starlight Technologies, Inc.
+972-3-9410555

Italy:
Special-Ind SPA
+39-02-6074741

Norway:
Bredengen AS
+47-2100-9100

Russia
Radiant-Elcom Ltd.
+7(495) 725-0404

Spain & Portugal:
Altaix Electronica S.A.L
+34-91-636-39-39

South Africa:
RF Design Laboratory CC
+27-21-555-8400

Turkey:
EMPA Electronics
+90 (212) 465-71-99

United Kingdom & Ireland:
Link Microtek Ltd
+44-1256-355-771

ASIA & SOUTH PACIFIC

Australia & New Zealand:
Braemac
+61-8-8301-8450

China & Hong Kong:
Secom Telecom Co., Ltd.
+86-755-25155888

Wai Tat Electronics Ltd.
+852-2799-7393

India:
Syratron
+91-802-5591107/5591031

Indonesia, Malaysia,
Philippines & Singapore
MEDs Technologies, Pte., Ltd.
+65-6453-8313

Japan:
Saint Technology
+81-3-5330-6411
AMT Incorporated
+81-742-30-0070

Korea:
JS Comtech
+82-2-574-6100
EZ Hightech
+82-031-382-6500

Taiwan R.O.C.:
Bandtek International Co., Ltd.
+886-2-2657-2615

Instrumentation Sales Representatives

NORTH AMERICA

CT, MA, ME, E. PA, NH,
So. NJ, RI & VT:
GTEK, LLC
(Instrumentation Only)
978-692-4954

N. & E. IA, N. IL, IN, W. KY,
MN, ND, SD & WI:
Dytec / Midwest Inc.
847-255-3200

TX:
Testech
972-644-5010

EUROPE, MID-EAST & AFRICA

France:
MB Electronique
+33-1-39-67-67-67

Greece:
Vector Technologies LTD
+30-210-68-58-008

Finland & Sweden:
RF Partner AB
+46-31-475100

ASIA & SOUTH PACIFIC

Japan:
Farad
+82-3-5261-3091

© 2009, Hittite Microwave Corporation, All Rights Reserved.

20 Alpha Road, Chelmsford, MA 01824 Phone: 978-250-3343 Fax: 978-250-3373

Boston • Colorado Springs • Istanbul • Tokyo • London • Munich • Ottawa • Seoul • Shanghai