

LTC4125 and LT3652HV 650mA Wireless Battery Charger Demonstration Kit

DESCRIPTION

DC2554A-KIT is a kit of the DC2556A transmitter, featuring [LTC®4125](#), the DC2555A-A/DC2555A-B receiver, featuring LT3652HV. The DC2555A-A/DC2555A-B receiver can charge a single Li-Ion battery at up to 650mA with an air gap of 3.0mm to 12.0mm between the transmit

and receive coils. The DC2556A transmitter supports Optimum Power Search and Foreign Object Detection features via LTC4125.

[Design files for this circuit board are available.](#)

All registered trademarks and trademarks are the property of their respective owners.

CONTENTS

- 1 × DC2556A (LTC4125) Transmitter Demo Board
- 1 × DC2555A-A/DC2555A-B (LT3652HV) Receiver Demo Board (with 9.5mm (0.375”) Nylon Standoffs, 5.25mm Gap)
- 4 × 12.5mm (0.375”) Nylon Standoffs (8.25mm Gap)
- 4 × 15.9 mm (0.625”) Nylon Standoffs (11.65mm Gap)

KIT NUMBER	TX BOARD	TX PART NUMBER	RX BOARD	RX PART NUMBER	RX OPTION
DC2554A-A-KIT	DC2556A	LTC4125	DC2555A-A	LT3652HV	Fixed 4.2V Float Voltage
DC2554A-B-KIT	DC2556A	LTC4125	DC2555A-B	LT3652HV	Fixed 3.6V Float Voltage

PERFORMANCE SUMMARY

SYMBOL	PARAMETER	CONDITIONS	MIN	TYP	MAX	UNITS
V _{IN}	DC2556A Voltage Input	I _{VIN} ≤ 2.5A	4.5		5.5	V
I _{IN}	DC2556A V _{IN} Current	V _{IN} = 5V			2.5	A
V _{BAT}	DC2555A-A Battery Charge Voltage		4.12	4.2	4.28	V
V _{BAT}	DC2555A-B Battery Charge Voltage		3.53	3.6	3.67	V
I _{BAT}	DC2555A-A/ DC2555A-B Charge Current	V _{FB} = 3V		650		mA
AIR-GAP	Separation Between L _{TX} and L _{RX}		3.0	5.25	12	mm

BOARD PHOTO



Figure 1. DC2556A Picture

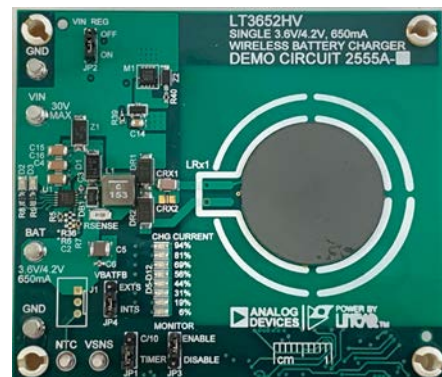

Figure 2. DC2555A-A/DC2555A-B Picture

DEMO MANUAL

DC2554A-A-KIT/DC2554A-B-KIT

QUICK START PROCEDURE

Refer to Figure 3 to 5 for the proper measurement equipment setup, DC2555A (for both -A and -B) mounting on DC2556A, and follow the procedure below:

1. Place the DC2555A board atop the DC2556A board by aligning the mounting standoffs (Figure 3). This should result in the transmit coil being directly above the receive coil, with the centers aligned. The DC2554A-A-KIT/DC2554A-B-KIT ships with two additional standoff sizes. This allows the air gap to be varied from 5.25mm to 11.65mm.
2. Connect a voltage source PS1 and a 3Ω resistor RBAT1 in parallel between the BAT and GND turrets of DC2555A (Figure 4). PS1 and RBAT1 make up the battery emulator. Typical power supplies cannot sink current. By adding a resistor across the power supply inputs that draws more current than the maximum battery charging current, the power supply only sources current even when the battery charge current is at its maximum value.
3. If an ammeter is used to measure the charge current, please be sure to use the external sensing by selecting EXTS jumper and connecting a pair of cable from VSNS and GND turrets to PS1 as Kelvin sensing connection. If an ammeter is not needed, INTS can be selected and Kelvin sensing connection is not needed.
4. Connect a power supply (PS2) between DC2556A VIN GND turrets. DC2556A can also be powered through Micro-USB cable to a 2.5A, 5V power source.

5. Set PS1 = 3.7V for DC2555A-A (set PS1= 3.2V for DC2555A-B), PS2 = 5V and enable both power supplies simultaneously. The DC2556A should start sweeping the LTx current, looking for a receiver. When a valid receiver is found, the LED sweeping will freeze until the next search period. This is also indicated by the DC2556A green status LED being turned on. The input current monitor LED string will show the input current percentage with respect to 2.5A current limit.
 6. The DC2555A green LED string should be turned on, indicating power is delivered to the load. If all the green LEDs are lit, the LT3652HV on the DC2555A is delivering full programmed battery charge current, which is 650mA in this demo.
 7. The LTC4125 on the DC2556A keeps the transmit power required by the receiver for about 5 seconds. Then, the LTC4125 enters another search cycle to check the receiver side power demand.
 8. When the system is operating correctly, slide a piece of blank PCB*, or coin between the transmit and receive coil. The transmit current should immediately drop to 0A.
 9. When test is done, turn off PS1 and PS2 simultaneously.
- *Testing with a blank PCB of at least 10 cm² (1.5 IN²) of copper.



Figure 3. DC2555A-A-KIT in Operation

TEST SETUP

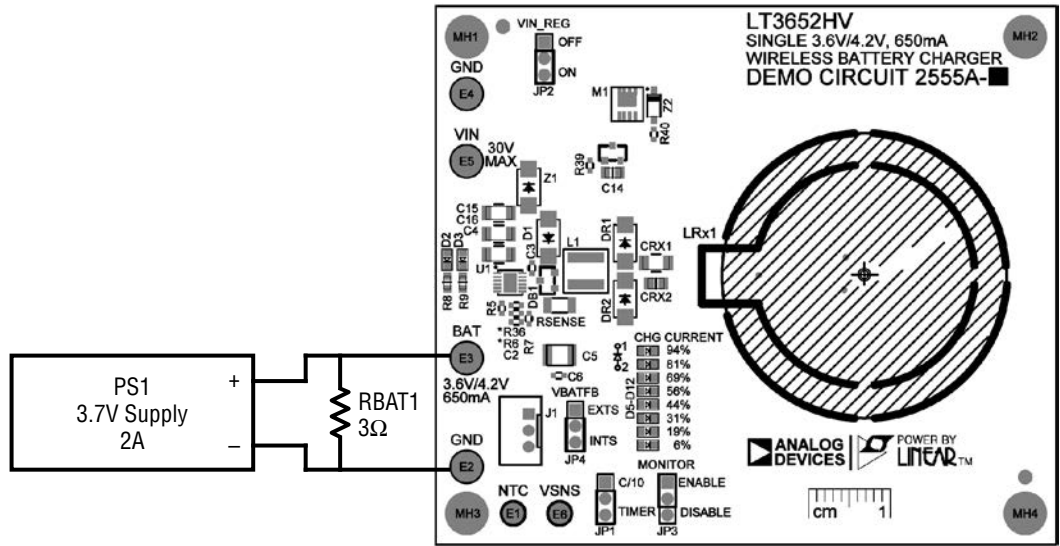

Figure 4. DC2555A-A/ DC2555A-B Connection

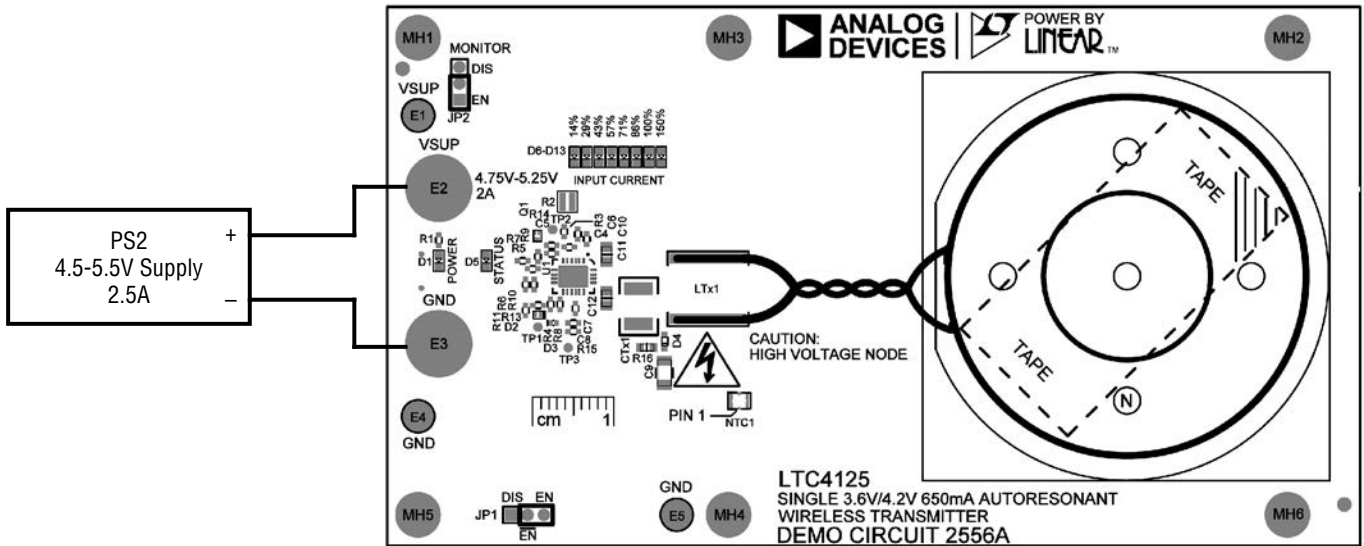

Figure 5. DC2556A Connection

THEORY OF OPERATION

The DC2554A-A-KIT/DC2554A-B-KIT demonstrates the operation of a magnetically coupled resonant Wireless Power Transfer (WPT) system. The LTC4125 detects the power demand from the LT3652HV receiver and provides efficient wireless power for the receiver to charge the Li-Ion or LiFePO₄ battery.

DC2556A – Wireless Power Transmitter Board featuring the LTC4125

The LTC4125 implements an AutoResonant drive of the series resonant transmit tank composed of the transmit coil LT_x , and the transmit capacitor CT_x . The AutoResonant driver uses a zero-crossing detector to determine the resonant frequency of the tank. All subsequent duty cycles discussed here use the resonant period determined by the AutoResonant circuitry.

The SW1 and SW2 pins each have a half bridge driver. At zero current crossing, whichever SW_x pin has positive going current, is set to V_{IN} for a duty cycle determined by the corresponding PTH_x pin. When the SW_x pin is set to V_{IN} , it increases the current flowing in the transmitter resonant tank. Figure 6 shows tank current and voltage waveforms when duty cycle is less than 50%. The absolute value of the tank current is determined by the resonant tank components and also by the reflected load impedance.

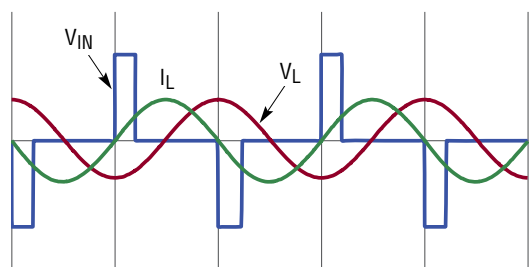

Figure 6. Measuring Input or Output Ripple

The LTC4125 sweeps the duty cycle by way of a 5-bit DAC that sets the PTH_x voltage, and hence the duty cycle. The duration of each step of this DAC is programmable via CTS pin, which is set at 18ms in this demo.

The FB pin is driven by the node forming the junction of the transmit coil LT_x , and the transmit capacitor CT_x . The voltage at this node is proportional to the circulating current in the transmitter resonant tank.

The LTC4125 monitors the FB pin, and when a valid exit condition is found, it stops incrementing the PTH_x voltage. The PTH_x voltage is held at the detection level for the rest of the sweep cycle. This sweep cycle timer is programmable by CTD pin, which is approximately 5 seconds in this demo.

If the receiver is removed from the transmitter, resonant tank current will rise significantly. The FB pin captures the rise of resonant current and terminates both half bridge drivers. As a result, the transmit power is reduced to standby mode.

If metal foreign objects are inserted between the transmit coil and the receive coil, the resonant frequency will increase significantly. The LTC4125 captures the rise of resonant frequency and reduces the transmit power to standby mode.

In standby mode, the LTC4125 will look for a valid receiver every 5s. If a valid receiver is found, the power transfer is resumed.

The LTC4125 uses an NTC resistor to monitor the temperature of the LT_x and shut off the transmit power if the NTC reports a temperature higher than approximately 42°C. Please see the applications section of the data sheet for more detailed information.

DC2555A-A/DC2555A-B – Wireless Power Receiver Board featuring the LT3652HV

The DC2555A-A/DC2555A-B demo board implements a series resonant LC circuit. The AC waveform on the resonant circuit is rectified and applied to the V_{IN} pin of the LT3652HV battery charger. The input regulation voltage of the LT3652HV is set at $\approx 16.5V$. When V_{IN} exceeds the input regulation voltage, the LT3652HV tries to charge a battery on its BAT pin.

THEORY OF OPERATION

When the DC2556A transmitter provides enough power for the LT3652HV to reach target charge current, the DC2555A temporarily allows the V_{IN} voltage to reach 33V. This will trigger the exit condition of the LTC4125 search algorithm, indicating a valid load is found.

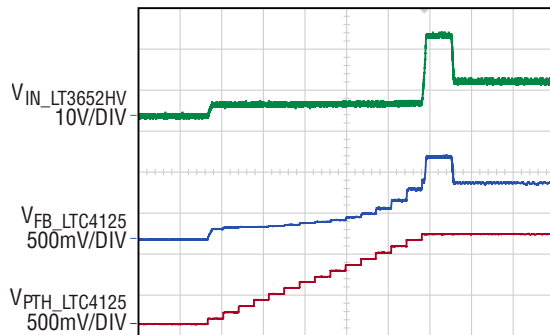

Figure 7. Measuring Input or Output Ripple

When the LT3652HV demands less current at the end of the charging cycle, the exit condition of the LTC4125 is triggered earlier than full load condition, and the power delivered from the DC2556A transmitter is reduced. This search algorithm helps to improve overall efficiency of the wireless charger solution at various load and coupling condition.

The LT3652HV is a full featured CC/CV (Constant Current/Constant Voltage) step-down(buck) battery charger, with low battery trickle charge. An external sense resistor between SENSE and BAT pins is used as the current feedback input to regulate the output current in CC mode. The charge current is programmed by this sense resistor. The BAT pin voltage is monitored through a voltage divider connected with V_{FB} pin, which serve as the voltage feedback input to regulate the output voltage in CV mode. The charge voltage is programmed by this voltage divider from BAT pin to V_{FB} pin.

The LT3652HV provides C/10 charge termination or safety timer termination scheme, which can be selected by the jumper on DC2555A board. External Kelvin sensing is jumper selectable when battery is connected with high resistance cable to the charger (when battery has to be placed far away from the charger).

Summary

The DC2554A-A-KIT/DC2554A-B-KIT allows full exploration of the LTC4125 wireless power transmitter and LT3652HV battery charger.

The DC2554A-A-KIT/DC2554A-B-KIT makes it possible to determine how the LTC4125 identifies a valid load or foreign object.

DEMO MANUAL

DC2554A-A-KIT/DC2554A-B-KIT

PARTS LIST

ITEM	QTY	REFERENCE	PART DESCRIPTION	MANUFACTURER/PART NUMBER
DC2556A-A Required Circuit Components				
1	3	C1-C3	CAP, 100uF, X5R, 6.3V, 10%, 1206	GRM31CR60J107KE39L
2	1	C4	CAP, 0.01uF, X7R, 50V, 10%, 0402	KEMET, C0402C103K5RAC7867
3	1	C5	CAP, 0.68uF, X5R, 10V, 10%, 0402	GRM155R61A684KE15D
4	1	C6	CAP, 4700pF, X7R, 50V, 10%, 0402	GRM155R71H472KA01D
5	1	C7	CAP, 680pF, C0G, 25V, 5%, 0402	GRM1555C1E681JA01D
6	2	C8, C10	CAP, 1uF, X5R, 16V, 10%, 0402	EMK105BJ105KV-F
7	1	C9	CAP CER 0.1UF 250V X7R 1206	GRM31CR72E104KW03L
8	2	C11, C12	CAP, 47uF, X5R, 6.3V, 20%, 0805	JMK212BBJ476MG-T
9	1	CTx1	CAP CER 0.1UF 250V C0G 1812	C4532C0G2E104J320KN
10	1	D3	DIODE, SCHOTTKY, 70V, 70mA, 0402/SOD-923F	CDBQR70
11	1	D4	DIODE, SWITCHING, 300V, 250mA, SOD523-2	BAS521-7
12	1	D3	DIODE, SCHOTTKY, 70V, 70mA, 0402/SOD-923F	COMCHIP, CDBQR70
13	1	D4	DIODE, SWITCHING, 300V, 250mA, SOD-523	DIODES INC., BAS521-7
14	1	LTx1	IND., 24uH, WIRELESS PWR CHRГ TX COIL, 10%, 6A, 0.1 OHM, ROUND 50mm DIA.	760308100110
15	1	NTC1	CONN., JSC COAXIAL SOCKET, RCPT., FEMALE, SMD, 1PORT, I/O TERM.	MM5831-2700R
16	1	NTC_ASSEMBLY_1	NTC resistor assembly, 10k@25°C, ±1%	FTN55XH103FD4B
17	1	Q1	XSTR., NPN, 40V, 0.2A, SOT883, AEC-Q101	PMBT3904M, 315
18	4	R1, R3, R17, R41	RES., 2.2k OHMS, 5%, 1/16W, 0402	CRCW04022K20JNED
19	1	R2	RES SMD 22 MOHM 1W 0805	KRL2012E-M-R022-F-T5
20	3	R4-R6	RES., 100k OHMS, 1%, 1/16W, 0402	CRCW0402100KFKED
21	1	R8	RES., AEC-Q200, 8.06k OHMS, 1%, 1/16W, 0402	CRCW04028K06FKED
22	1	R9	RES., AEC-Q200, 3.48k OHMS, 1%, 1/16W, 0402	CRCW04023K48FKED
23	1	R10	RES., AEC-Q200, 59k OHMS, 1%, 1/16W, 0402	CRCW040259K0FKED
24	8	R12, R24-R30	RES., AEC-Q200, 102k OHMS, 1%, 1/16W, 0402	CRCW0402102KFKED
25	1	R13	RES., 0 OHM, 1/16W, 0402	CRCW04020000Z0ED
26	1	R14	RES., 30.1k OHMS, 1%, 1/16W, 0402	CRCW040230K1FKED
27	1	R15	RES., AEC-Q200, 3.92k OHMS, 1%, 1/10W, 0402	ERJ2RKF3921X
28	1	R16	RES., 350V, AEC-Q200, 100k OHMS, 1%, 1/10W, 0603	KTR03EZPF1003
29	1	R18	RES., 10k OHMS, 5%, 1/16W, 0402	RC0402JR-0710KL
30	1	U1	IC, 5W Wireless Power Transmitter, QFN-20 (4x5), AutoResonant	LTC4125EUFDP#PBF

DEMO MANUAL

DC2554A-A-KIT/DC2554A-B-KIT

PARTS LIST

ITEM	QTY	REFERENCE	PART DESCRIPTION	MANUFACTURER/PART NUMBER
Additional Demo Board Circuit Components				
1	3	C13, C15, C16	CAP., 0.01uF, X7R, 50V, 10%, 0402	C0402C103K5RAC7867
2	2	C14, C17	CAP., 1uF, X5R, 16V, 10%, 0402	EMK105BJ105KV-F
3	1	D1	LED, RED, WATER-CLEAR, 0603	LITE-ON, LTST-C193KRKT-5A
4	1	D5	LED, GREEN, WATER CLEAR, 0603	LITE-ON, LTST-C190KGKT
5	7	D6-D12	LED, BLUE, WATER CLEAR, 0603	SML-LXFP0603USBCTR
6	1	R19	RES., 10k OHMS, 5%, 1/16W, 0402	RC0402JR-0710KL
7	2	R20, R33	RES., 430 OHMS, 5%, 1/16W, 0402	RC0402JR-07430RL
8	1	R21	RES., AEC-Q200, 15.4k OHMS, 1%, 1/16W, 0402	CRCW040215K4FKED
9	1	R22	RES., AEC-Q200, 27.4k OHMS, 1%, 1/16W, 0402	CRCW040227K4FKED
10	1	R23	RES., 340k OHMS, 1%, 1/16W, 0402	RC0402FR-07340KL
11	1	R31	RES., AEC-Q200, 11.3k OHMS, 1%, 1/16W, 0402	CRCW040211K3FKED
12	1	R32	RES., 787k OHMS, 1%, 1/16W, 0402	NRC04F7873TRF
13	7	R34-R40	RES., 6.2k OHMS, 1%, 1/16W, 0402	RC0402FR-076K2L
14	1	R43	RES., AEC-Q200, 1 OHM, 5%, 1/10W, 0603	ERJ3GEYJ1R0V
15	2	R20, R33	RES., 430 OHMS, 5%, 1/16W, 0402	RC0402JR-07430RL
16	1	R21	RES., AEC-Q200, 15.4k OHMS, 1%, 1/16W, 0402	CRCW040215K4FKED
Hardware: For Demo Board Only				
1	3	E1, E4, E5	TEST POINT, TURRET, 0.094" MTG. HOLE, PCB 0.062" THICK	MILL-MAX, 2501-2-00-80-00-00-07-0
2	2	E2, E3	CONN., BANANA JACK, FEMALE, THT, NON-INSULATED, SWAGE, 0.218"	KEYSTONE, 575-4
3	1	J1	CONN., MICRO USB-B, RCPT., FEMALE, 5-PIN, HORZ. R/A SMT	WURTH ELEKTRONIK, 629105136821
4	2	JP1, JP2	CONN., HDR., MALE, 1x3, 2mm, THT, STR, NO SUBS. ALLOWED	SAMTEC, TMM-103-02-L-S
5	4	MP1-MP4	STANDOFF, NYLON, SNAP-ON, 0.250"	8831
6	1	NTC ASSEMBLY_1	CONN., JSC COAXIAL SOCKET, RCPT., FEMALE, SMD, 1PORT, I/O TERM.	MURATA, MM5831-2700RB
7	2	XJP1, XJP3	CONN., SHUNT, FEMALE, 2 POS, 2mm	WURTH ELEKTRONIK, 60800213421

DEMO MANUAL

DC2554A-A-KIT/DC2554A-B-KIT

PARTS LIST

ITEM	QTY	REFERENCE	PART DESCRIPTION	MANUFACTURER/PART NUMBER
DC2555A-A/DC2555A-B: Required Circuit Components				
1	1	C1	CAP, 0.68uF, X5R, 10V, 10%, 0402	GRM155R61A684KE15D
2	3	C3, C10, C13	CAP, 1uF, X5R, 16V, 10%, 0402	EMK105BJ105KV-F
4	3	C4, C15, C16	CAP, 10uF, X7R, 50V, 20%, 1206	C3216X5R1H106K160AB
5	1	C5	CAP, 47uF, X5R, 16V, 20%, 1210	1210YD476MAT2A
6	1	C6	CAP, 0.1uF, X5R, 50V, 10%, 0402	GRM155R61H104KE14D
7	4	C8, C9, C11, C12	CAP, 0.01uF, X7R, 50V, 10%, 0402	C0402C103K5RAC7867
8	1	C14	CAP, 47uF, X5R, 6.3V, 20%, 0805	GRM21BR60J476ME15L
9	1	CRX1	CAP, 0.033uF, NPO, 100V, 5%, 1206	C3216NP02A333J160AA
10	1	D1	DIODE, SCHOTTKY RECT., 40V, 3A, SMA	CMSH3-40MA TR13 LEAD FREE
11	2	DR1, DR2	DIODE, SCHOTTKY, 100V, 3A, SMA	CMSH3-100MA TR13
12	1	DB1	DIODE, SCHOTTKY RECT., 40V, 1.75A, SOT-23F	CMPSH1-4 TR LEAD FREE
13	1	FD1	FERRITE, DISC, 26mm DIA X 0.6mm THICK	B67410A0223X195
14	1	L1	IND., 15uH, FIXED, 20%, 3.9A	XAL5050-153MEC
15	1	M1	XSTR., MOSFET, N-CH, 60V, 6A, PowerPAK 1212-8	Si7308DN-T1-GE3
16	1	Q1	XSTR., NPN, 40V, 200mA, SOT23-3	MMBT3904
17	1	R3	RES., 511k OHMS, 1%, 1/16W, 0402, AEC-Q200	CRCW0402511KFKED
18	1	R4	RES., 100k OHMS, 1%, 1/10W, 0402	ERJ2RKF1003X
19	1	R5	RES., 332k OHMS, 1%, 1/16W, 0402	NRC04F3323TRF
20	1	R37	RES., 20k OHMS, 1%, 1/16W, 0402, AEC-Q200	CRCW040220K0FKED
21	1	R38	RES., 1M OHMS, 1%, 1/16W, 0402, AEC-Q200	CRCW04021M00FKED
22	1	R39	RES., 49.9k OHMS, 1%, 1/16W, 0402	NRC04F4992TRF
23	1	R40	RES., 1k OHMS, 5%, 1/16W, 0402	MCR01MZPF1001
24	1	RSENSE1	RES., 0.15 OHM, 1%, 3/4W, 1206, SHORT-SIDE TERM., AEC-Q200, METAL, SENSE	KRL1632E-M-R150-F-T5
25	1	U1	IC, PWR Tracking 2A Batt.Charger, 3x3 DFN-12	LT3652HVEDD#PBF
26	1	Z1	DIODE, ZENER, 33V, 1W, SMA	SMAZ33-13-F
27	1	Z2	DIODE, ZENER, 20V, 500mW, SOD-123	MMSZ5250B-7-F

DEMO MANUAL

DC2554A-A-KIT/DC2554A-B-KIT

PARTS LIST

ITEM	QTY	REFERENCE	PART DESCRIPTION	MANUFACTURER/PART NUMBER
Additional Circuit Components				
1	1	D2	LED, SUPER RED, MILKY WHITE DIFF, 0603 SMD, 660nm	SML-LX0603SRW-TR
2	9	D3, D5-D12	LED, GREEN, MILKY WHITE DIFFUSED, 0603	SML-LX0603SUGW-TR
3	1	R1	RES., 0 OHM, 1/16W, 0402	CRCW04020000Z0ED
4	1	R7	RES., 20 OHMS, 5%, 1/16W, 0402	RK73B1ETTP200J
5	2	R8, R9	RES., 5.1k OHMS, 5%, 1/10W, 0603	CRCW06035K10JNEA
6	2	R10, R11	RES., 100 OHMS, 1%, 1/16W, 0402, AEC-Q200	CRCW0402100RFKED
7	4	R27-R34	RES., 1k OHMS, 5%, 1/16W, 0402	NRC04J102TRF
8	1	R12	RES., 1.21k OHMS, 1%, 1/16W, 0402, AEC-Q200	CRCW04021K21FKED
9	2	R13, R24	RES., AEC-Q200, 22.6k OHMS, 1%, 1/16W, 0402	CRCW040222K6FKED
10	2	R14, R26	RES., 430 OHMS, 5%, 1/16W, 0402	RC0402JR-07430RL
11	1	R15	RES., AEC-Q200, 34.8k OHMS, 1%, 1/10W, 0402	ERJ2RKF3482X
12	7	R16-R22	RES., 100k OHMS, 5%, 1/16W, 0402	NRC04J104TRF
13	1	R23	RES., 49.9k OHMS, 1%, 1/16W, 0402	NRC04F4992TRF
14	1	R25	RES., 787k OHMS, 1%, 1/16W, 0402	NRC04F7873TRF
15	1	U2	IC, CURRENT SENSE AMP, MSOP-8	LT6105CMS8#PBF
16	2	U3, U4	IC, QUAD COMPARATOR LP 1.221VREF, DFN-16 (5x4)	LTC1445CDHD#PBF
Hardware: For Demo Board Only				
1	4	BP1-BP4	BUMPER, CLEAR, SELF-ADHESIVE, 0.085" H, 0.335" DIA.	784-C
2	2	E1, E6	TEST POINT, TURRET, 0.064" MTG. HOLE, PCB 0.062" THICK	2308-2-00-80-00-00-07-0
3	4	E2, E3, E4, E5	TEST POINT, TURRET, 0.094" MTG. HOLE, PCB 0.062" THICK	2501-2-00-80-00-00-07-0
	4	JP1, JP2, JP3, JP4	CONN., HDR., MALE, 1X3, 2MM, THT, STR	TMM-103-02-L-S
	4	MP1-MP4	STANDOFF NYLON, SNAP-ON, 0.375"	8832
	4	XJP3, XJP4, XJP5, XJP6	CONN., SHUNT, FEMALE, 2 POS, 2mm	4
DC2555A-A: Required Circuit Components				
	1	R6	RES., 90.9k OHMS, 1%, 1/16W, 0402, AEC-Q200	CRCW040290K9FKED
	1	R36	RES., 178K OHMS, 1%, 1/16W, 0402, AEC-Q200	CRCW0402178KFKED
DC2555A-B: Required Circuit Components				
	1	R6	RES., 30.1k OHMS, 1%, 1/16W, 0402	CRCW040230K1FKED
	1	R36	RES., AEC-Q200, 221k OHMS, 1%, 1/16W, 0402	CRCW0402221KFKED

DEMO MANUAL

DC2554A-A-KIT/DC2554A-B-KIT

SCHEMATIC DIAGRAM

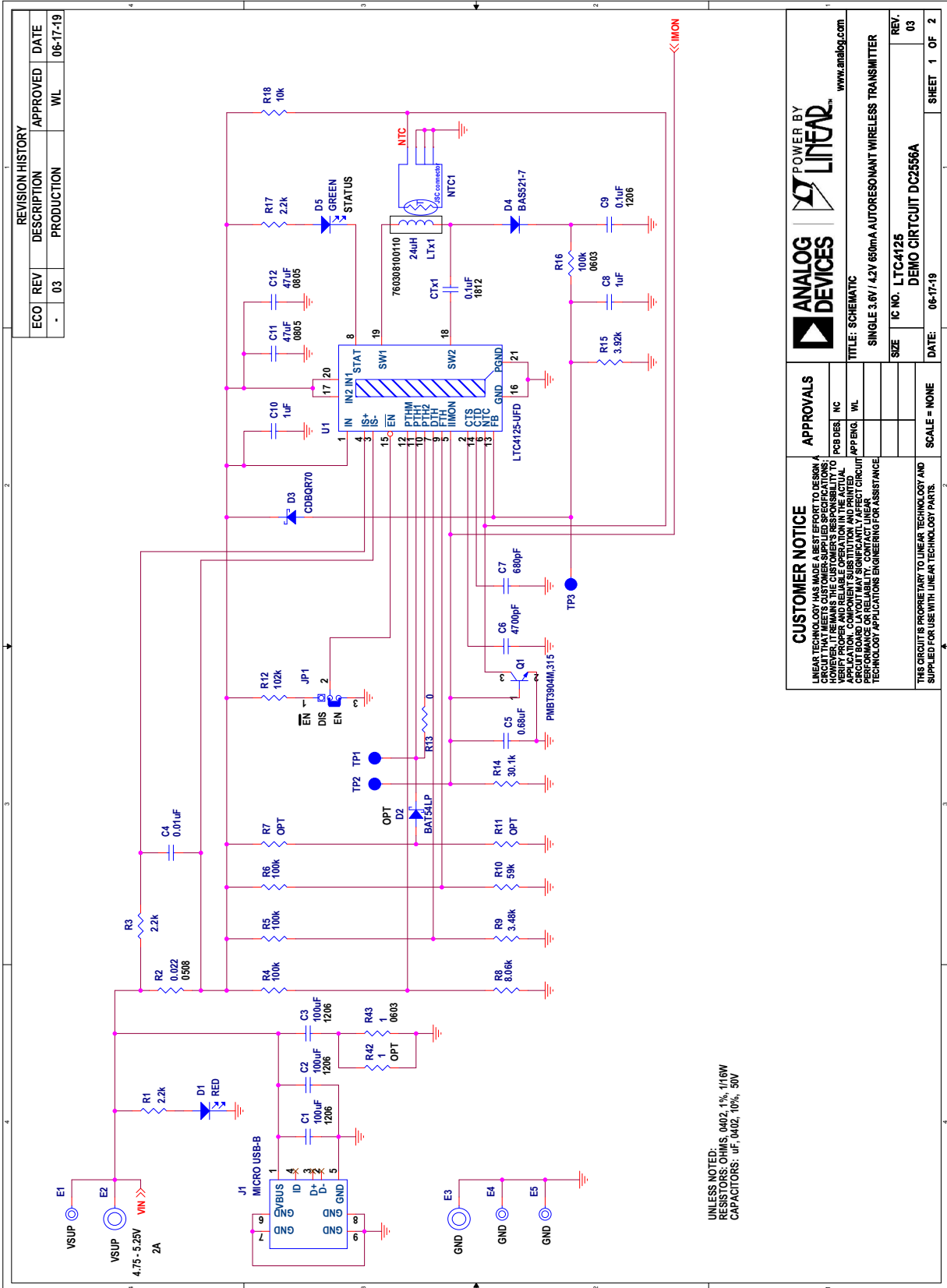

Figure 8. DC2556A Circuit Schematic Page 1 of 2

SCHEMATIC DIAGRAM

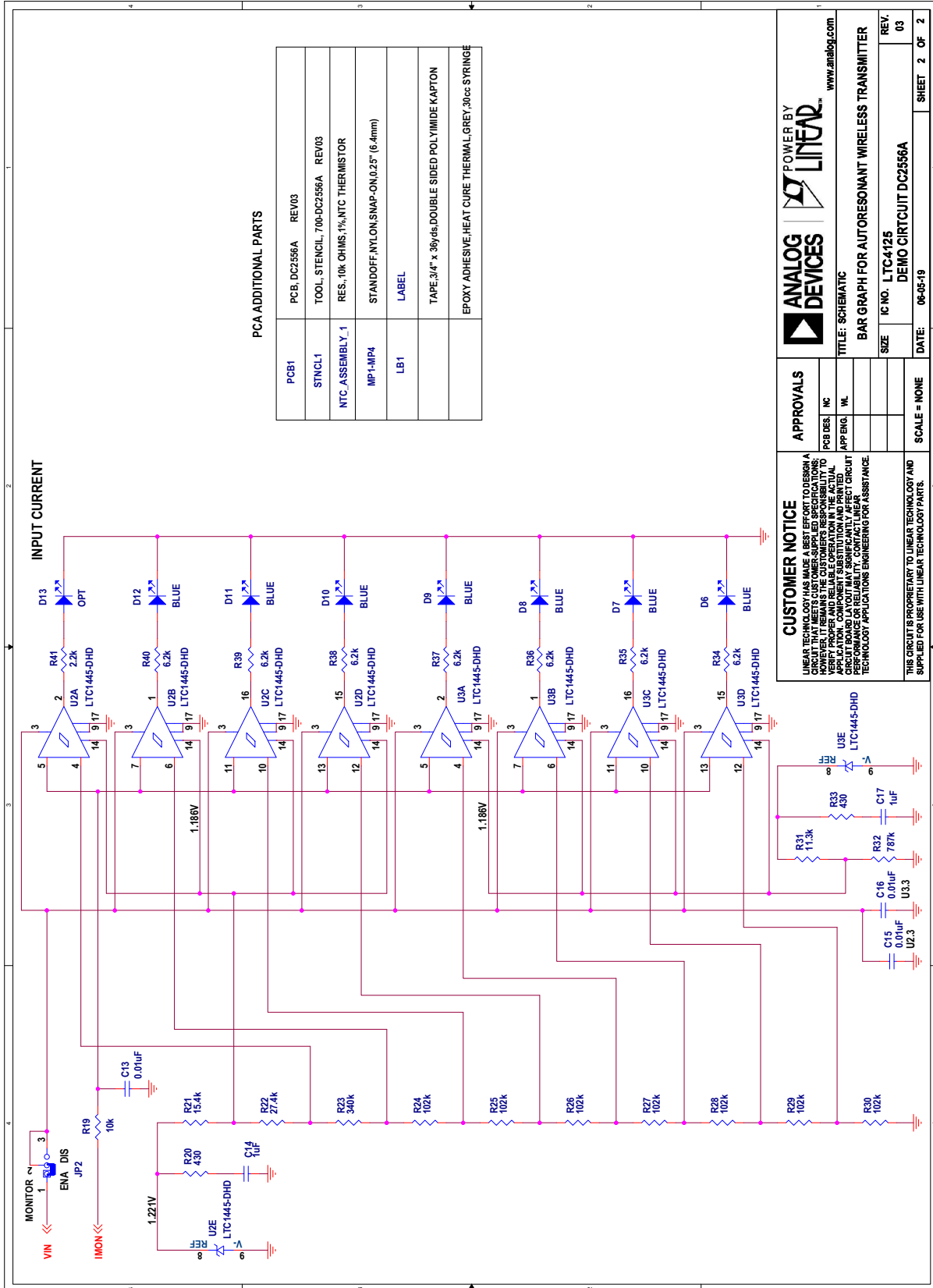

Figure 9. DC2556A Circuit Schematic Page 2 of 2

DEMO MANUAL

DC2554A-A-KIT/DC2554A-B-KIT

SCHEMATIC DIAGRAM

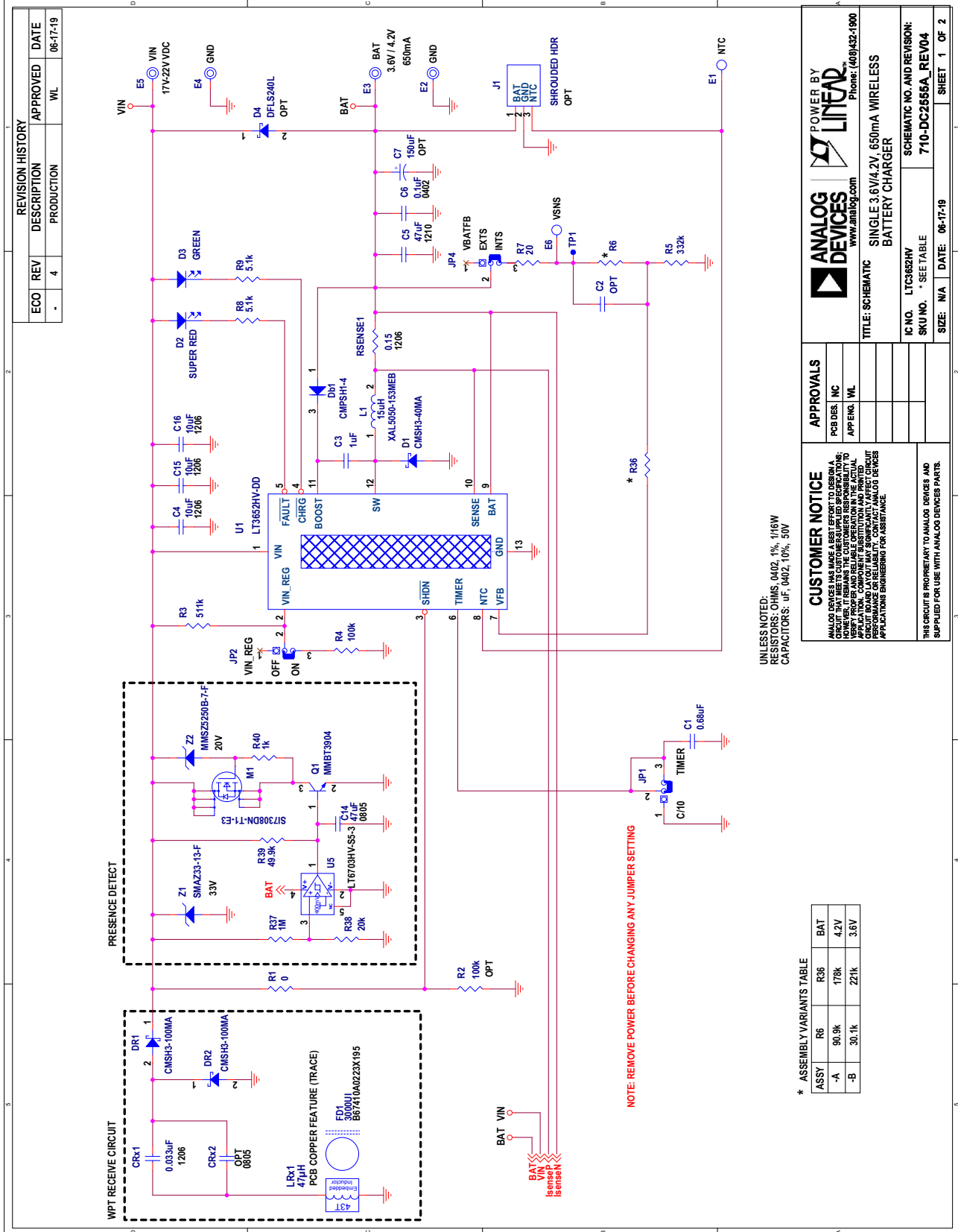
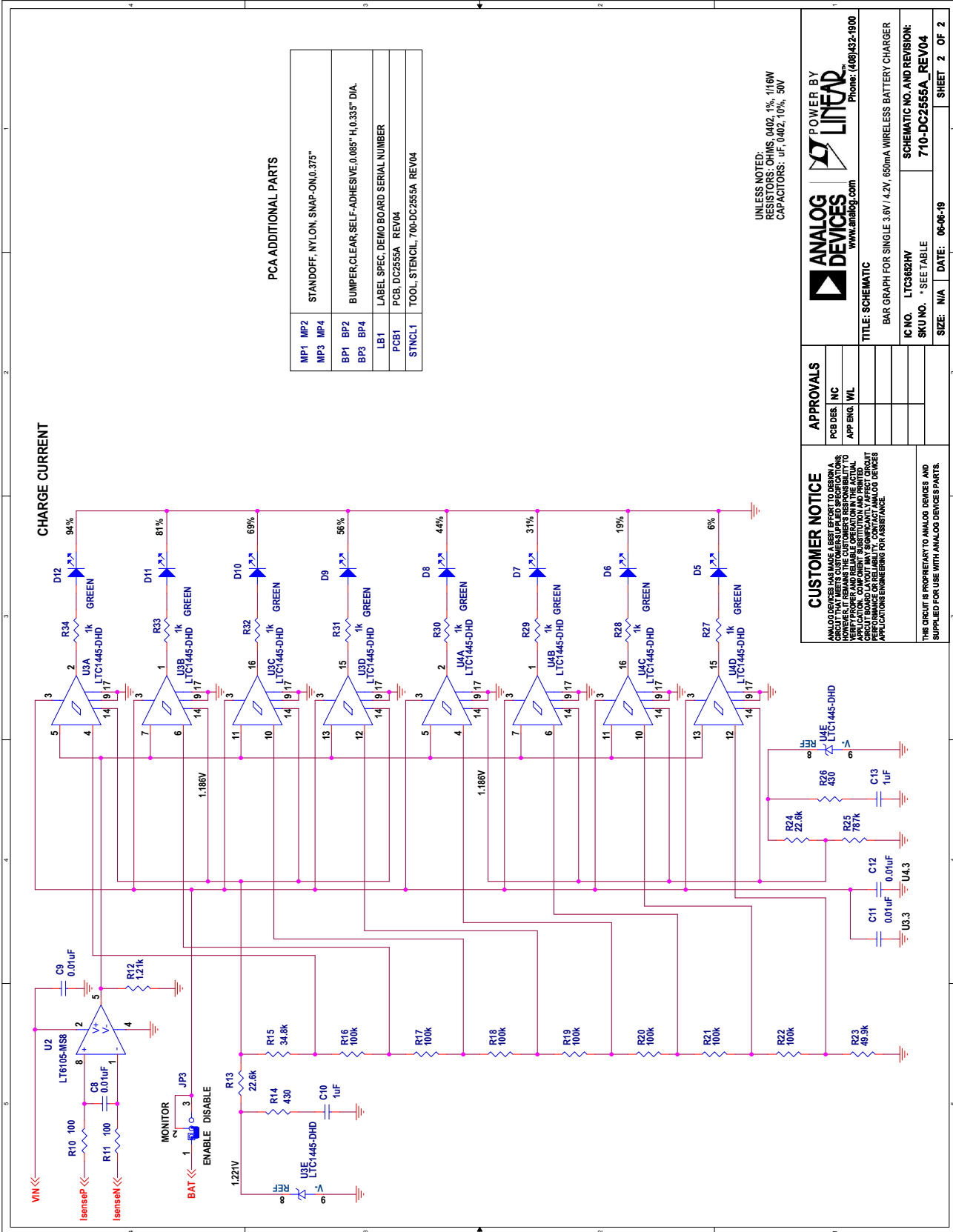

Figure 10. DC2555A-A/ DC2555A-B Circuit Schematic Page 1 of 2

SCHEMATIC DIAGRAM



ANALOG DEVICES www.analog.com	POWER BY LINEAR Phone: (609)432-1900
TITLE: SCHEMATIC	
BAR GRAPH FOR SINGLE 3.6V / 4.2V, 600mA WIRELESS BATTERY CHARGER	
IC NO. LTC3682HV	SCHEMATIC NO. AND REVISION: 710-DC2555A_REV04
SIZE: N/A	DATE: 06-06-19
SHEET 2	OF 2

Figure 11. DC2555A-A/ DC2555A-B Circuit Schematic Page 2 of 2

DEMO MANUAL

DC2554A-A-KIT/DC2554A-B-KIT



ESD Caution

ESD (electrostatic discharge) sensitive device. Charged devices and circuit boards can discharge without detection. Although this product features patented or proprietary protection circuitry, damage may occur on devices subjected to high energy ESD. Therefore, proper ESD precautions should be taken to avoid performance degradation or loss of functionality.

Legal Terms and Conditions

By using the evaluation board discussed herein (together with any tools, components documentation or support materials, the "Evaluation Board"), you are agreeing to be bound by the terms and conditions set forth below ("Agreement") unless you have purchased the Evaluation Board, in which case the Analog Devices Standard Terms and Conditions of Sale shall govern. Do not use the Evaluation Board until you have read and agreed to the Agreement. Your use of the Evaluation Board shall signify your acceptance of the Agreement. This Agreement is made by and between you ("Customer") and Analog Devices, Inc. ("ADI"), with its principal place of business at One Technology Way, Norwood, MA 02062, USA. Subject to the terms and conditions of the Agreement, ADI hereby grants to Customer a free, limited, personal, temporary, non-exclusive, non-sublicensable, non-transferable license to use the Evaluation Board FOR EVALUATION PURPOSES ONLY. Customer understands and agrees that the Evaluation Board is provided for the sole and exclusive purpose referenced above, and agrees not to use the Evaluation Board for any other purpose. Furthermore, the license granted is expressly made subject to the following additional limitations: Customer shall not (i) rent, lease, display, sell, transfer, assign, sublicense, or distribute the Evaluation Board; and (ii) permit any Third Party to access the Evaluation Board. As used herein, the term "Third Party" includes any entity other than ADI, Customer, their employees, affiliates and in-house consultants. The Evaluation Board is NOT sold to Customer; all rights not expressly granted herein, including ownership of the Evaluation Board, are reserved by ADI. CONFIDENTIALITY. This Agreement and the Evaluation Board shall all be considered the confidential and proprietary information of ADI. Customer may not disclose or transfer any portion of the Evaluation Board to any other party for any reason. Upon discontinuation of use of the Evaluation Board or termination of this Agreement, Customer agrees to promptly return the Evaluation Board to ADI. ADDITIONAL RESTRICTIONS. Customer may not disassemble, decompile or reverse engineer chips on the Evaluation Board. Customer shall inform ADI of any occurred damages or any modifications or alterations it makes to the Evaluation Board, including but not limited to soldering or any other activity that affects the material content of the Evaluation Board. Modifications to the Evaluation Board must comply with applicable law, including but not limited to the RoHS Directive. TERMINATION. ADI may terminate this Agreement at any time upon giving written notice to Customer. Customer agrees to return to ADI the Evaluation Board at that time. LIMITATION OF LIABILITY. THE EVALUATION BOARD PROVIDED HEREUNDER IS PROVIDED "AS IS" AND ADI MAKES NO WARRANTIES OR REPRESENTATIONS OF ANY KIND WITH RESPECT TO IT. ADI SPECIFICALLY DISCLAIMS ANY REPRESENTATIONS, ENDORSEMENTS, GUARANTEES, OR WARRANTIES, EXPRESS OR IMPLIED, RELATED TO THE EVALUATION BOARD INCLUDING, BUT NOT LIMITED TO, THE IMPLIED WARRANTY OF MERCHANTABILITY, TITLE, FITNESS FOR A PARTICULAR PURPOSE OR NON-INFRINGEMENT OF INTELLECTUAL PROPERTY RIGHTS. IN NO EVENT WILL ADI AND ITS LICENSORS BE LIABLE FOR ANY INCIDENTAL, SPECIAL, INDIRECT, OR CONSEQUENTIAL DAMAGES RESULTING FROM CUSTOMER'S POSSESSION OR USE OF THE EVALUATION BOARD, INCLUDING BUT NOT LIMITED TO LOST PROFITS, DELAY COSTS, LABOR COSTS OR LOSS OF GOODWILL. ADI'S TOTAL LIABILITY FROM ANY AND ALL CAUSES SHALL BE LIMITED TO THE AMOUNT OF ONE HUNDRED US DOLLARS (\$100.00). EXPORT. Customer agrees that it will not directly or indirectly export the Evaluation Board to another country, and that it will comply with all applicable United States federal laws and regulations relating to exports. GOVERNING LAW. This Agreement shall be governed by and construed in accordance with the substantive laws of the Commonwealth of Massachusetts (excluding conflict of law rules). Any legal action regarding this Agreement will be heard in the state or federal courts having jurisdiction in Suffolk County, Massachusetts, and Customer hereby submits to the personal jurisdiction and venue of such courts. The United Nations Convention on Contracts for the International Sale of Goods shall not apply to this Agreement and is expressly disclaimed.