

LTM4662
Dual 15A or Single 30A
µModule Regulator

DESCRIPTION

Demonstration circuit DC2527A-A features the LTM®4662EY, a dual 15A or single 30A high efficiency, switch mode step-down power µModule regulator. The input voltage range is from 4.5V to 20V. With CPWR bias, input voltage can be as low as 2.375V. The output voltage range is 0.6V to 5.5V. Derating is necessary for certain V_{IN} , V_{OUT} , frequency and thermal conditions. The DC2527A-A offers the TRACK/SS pin allowing the user to program output tracking or soft-start period. The board operates in continuous conduction mode in heavy load conditions. For high efficiency at low load currents, the MODE_PLLIN jumper can select discontinuous conduction mode. The

MODE_PLLIN pin also allows the LTM4662 to synchronize to an external clock signal (between 250kHz and 1MHz). DC2527A-A has the option of choosing both internal and external compensation circuit for LTM4662. Tying the PHASMD pin to different pins generates certain phases of CLKOUT and Channel 2. The LTM4662 data sheet must be read in conjunction with this demo manual prior to working on or modifying demo circuit DC2527A-A.

Design files for this circuit board are available at <http://www.analog.com/DC2527A-A>

All registered trademarks and trademarks are the property of their respective owners.

BOARD PHOTO

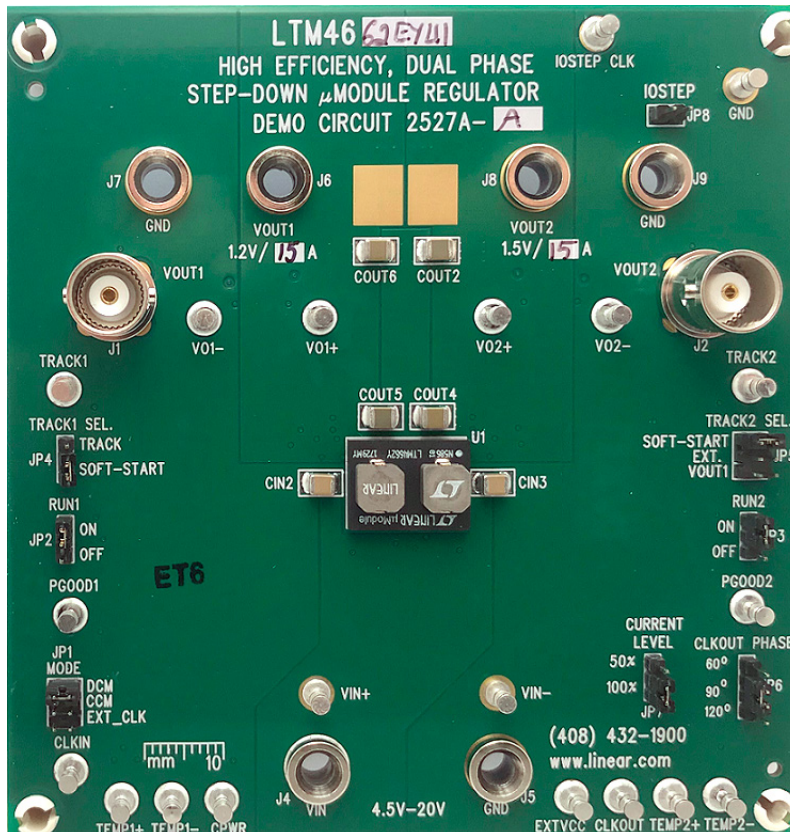

PERFORMANCE SUMMARY Specifications are at $T_A = 25^\circ\text{C}$

PARAMETER	CONDITIONS/NOTES	VALUE
Input Voltage Range		4.5V to 20V
Output Voltages		1.2V, 1.5V \pm 1.5%
Maximum Continuous Output Current	Derating is necessary for certain operating conditions. See data sheet for details.	15ADC for Each Channel
Operating Frequency		350kHz
Efficiency of Channel 1	$V_{IN} = 12\text{V}$, $V_{OUT1} = 1.2\text{V}$, $I_{OUT1} = 15\text{A}$	86.91% See Figure 2
Efficiency of Channel 2	$V_{IN} = 12\text{V}$, $V_{OUT2} = 1.5\text{V}$, $I_{OUT2} = 15\text{A}$	88.47% See Figure 3
Load Transient of Channel 1	$V_{IN} = 12\text{V}$, $V_{OUT1} = 1.2\text{V}$, $I_{STEP} = 0\text{A TO } 7.5\text{A}$	97mV See Figure 4
Load Transient of Channel 2	$V_{IN} = 12\text{V}$, $V_{OUT2} = 1.5\text{V}$, $I_{STEP} = 0\text{A TO } 7.5\text{A}$	117mV See Figure 5

QUICK START PROCEDURE

Demonstration circuit DC2527A-A is an easy way to evaluate the performance of the LTM4662EY. Please refer to Figure 1 for proper measurement equipment setup and follow the procedure below:

- Place jumpers in the following positions for a typical application:

MODE	RUN1	RUN2
CCM	ON	ON

TRACK1	TRACK2	CLKOUT PHASE	CURRENT LEVEL
Soft-Start	Soft-Start	90°	100%

- With power off, connect the input power supply, load and meters as shown in Figure 1. Preset the load to 0A and V_{IN} supply to 12V.
- Turn on the power supply at the input. The output voltage of Channel 1 should be 1.2V \pm 1.5% (1.182V to 1.218V). The output voltage of Channel 2 should be 1.5V \pm 1.5% (1.478V to 1.522V).
- Vary the input voltage from 4.5V to 20V and adjust the load current of each channel from 0A to 15A. Observe the output voltage regulation, ripple voltage, efficiency and other parameters.

- (Optional) For optional load transient test, apply an adjustable pulse signal between I_{STEP_CLK} and GND test points. The pulse amplitude sets the load step current amplitude. Keep the pulse width short (<1ms) and pulse duty cycle low (<5%) to limit the thermal stress on the load transient circuit. Switch the jumper resistors R34, R35 (on the backside of boards) to apply load transient on Channel 1, Channel 2 correspondingly.
- (Optional) LTM4662 can be synchronized to an external clock signal. Place the JP1 jumper on EXT_CLK and apply a clock signal (0V to 5V, square wave) on the CLKIN test point.
- (Optional) The outputs of LTM4662 can track another supply. If tracking external voltage is selected, the corresponding test points, TRACK1, TRACK2, need to be connected to a valid voltage signal.
- (Optional) Channel 1 and 2 can be connected in parallel for a 30A polyphase operation on DC2527A-A. Install 0 Ω resistors on R39 and R17.

QUICK START PROCEDURE

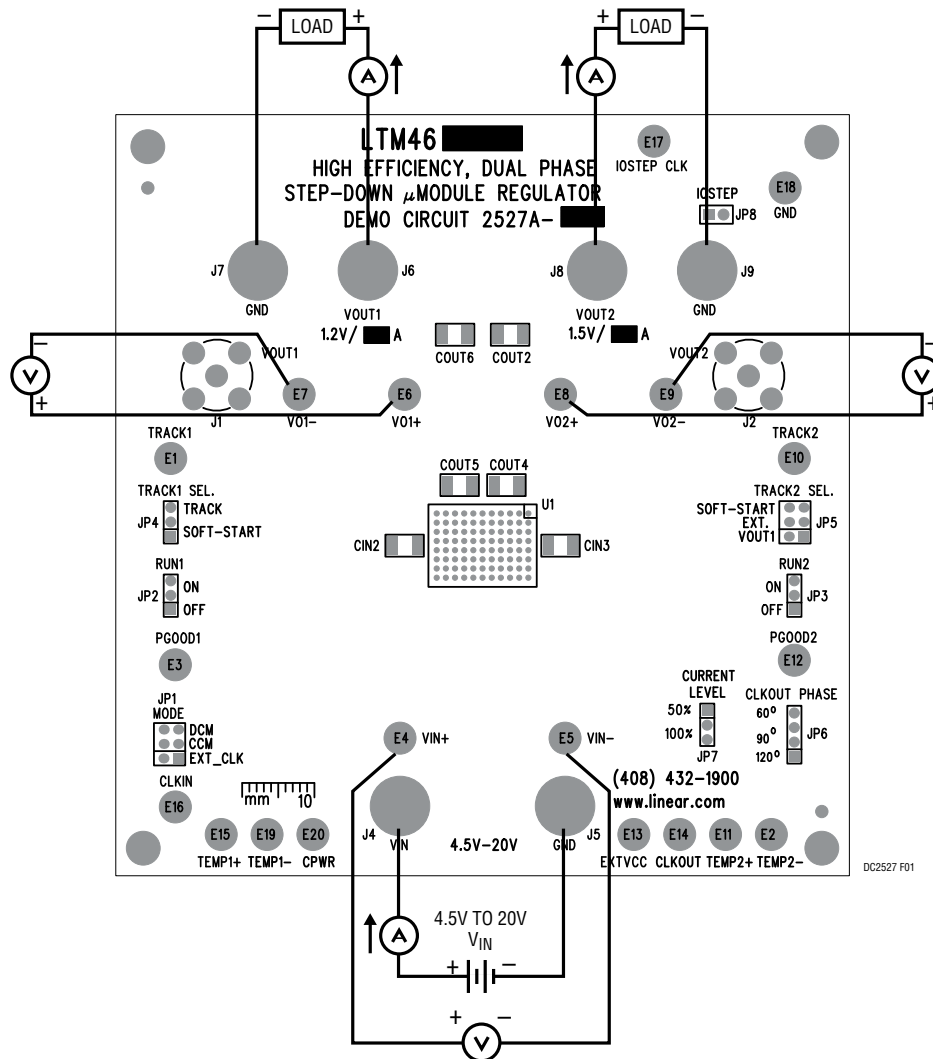

Figure 1. Measurement Setup of DC2527A

QUICK START PROCEDURE

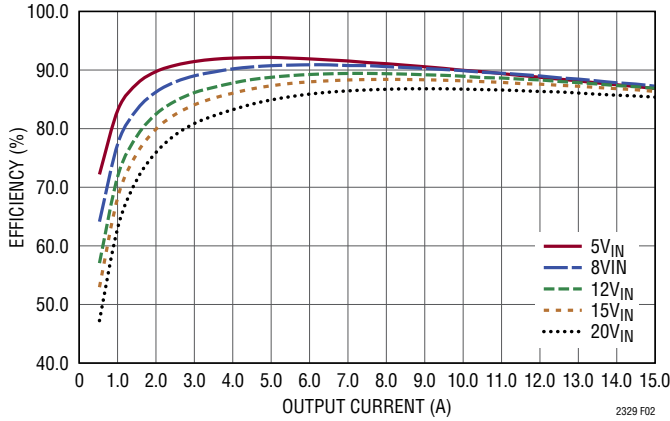

Figure 2. Measured Efficiency of Channel 1 at $V_{OUT1} = 1.2V$, $f_{SW} = 350kHz$, CCM

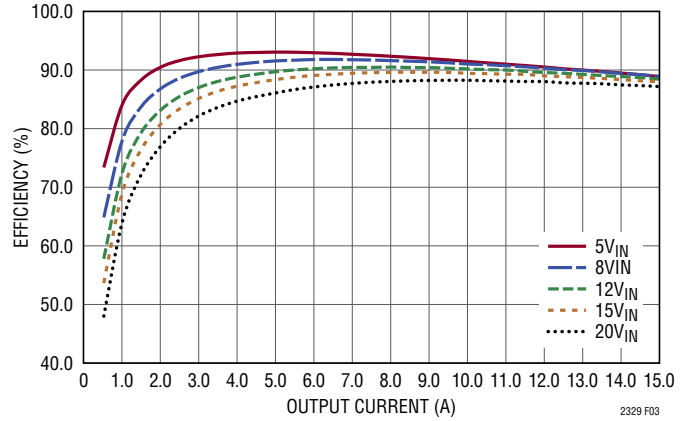

Figure 3. Measured Efficiency of Channel 2 at $V_{OUT1} = 1.5V$, $f_{SW} = 350kHz$, CCM

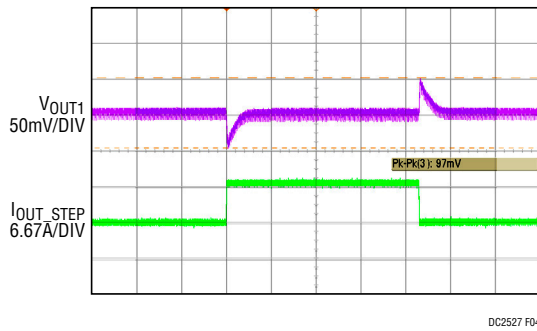

Figure 4. Measured Load Transient $V_{IN} = 12V$, $V_{OUT1} = 1.2V$, $I_{STEP} = 0A$ to $7.5A$

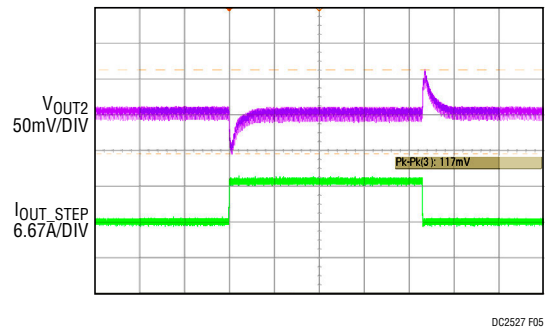
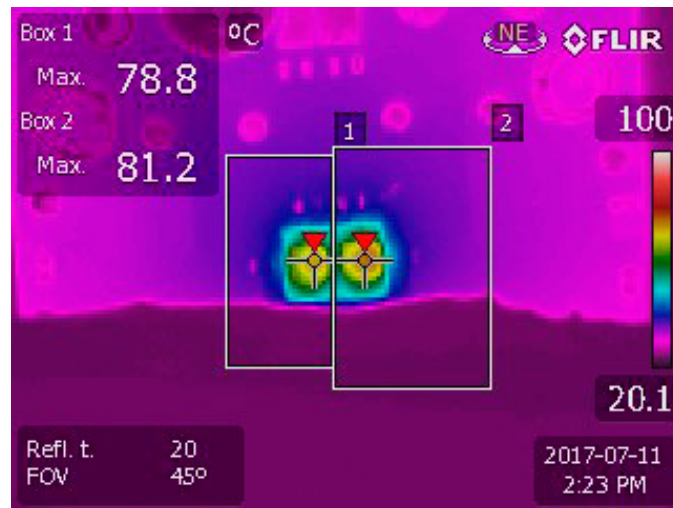

Figure 5. Measured Load Transient $V_{IN} = 12V$, $V_{OUT2} = 1.5V$, $I_{STEP} = 0A$ to $7.5A$



**Figure 6. Thermal Image of LTM4662 $V_{IN} = 12V$, $V_{OUT1} = 1.2V$, $I_{LOAD1} = 15A$, $V_{OUT2} = 1.5V$, $I_{LOAD2} = 15A$
Ambient Temperature = $25.0^{\circ}C$, 200LFM Air Flow**

PARTS LIST

ITEM	QTY	REFERENCE	PART DESCRIPTION	MANUFACTURER/PART NUMBER
Required Circuit Components				
1	1	CIN1	CAP., 180µF, 25V, OS-CON 8X11.9	PANASONIC, 25SVPF180M
2	4	CIN2, CIN3, CIN4, CIN5	CAP., X5R, 22µF, 25V, 10%, 1210	MURATA, GRM32ER61E226KE15L
3	2	COU1, COU7	CAP., 470µF, 2.5V, POSCAP, D3L	PANASONIC, ETPF470M5H
4	6	COU2, COU3, COU4, COU5, COU6, COU8	CAP., X5R, 100µF, 6.3V, 20%, 1210	AVX, 12106D107MAT2A
5	2	C5, C7	CAP., X5R, 0.1µF, 25V, 10%, 0603	AVX, 06033D104KAT2A
6	2	C10, C12	CAP., C0G, 100pF, 50V, 1%, 0603	AVX, 06035A101FAT2A
7	1	C20	CAP., X5R, 4.7µF, 10V, 10%, 0603	TDK, CGB3B1X5R1A475K055AC
8	4	R1, R3, R22, R26	RES., 10Ω, 1%, 0603	NIC, NRC06F10R0TRF
9	2	R2, R4	RES., 249k, 1%, 0603	VISHAY, CRCW0603249KFKEA
10	5	R9, R12, R15, R18, R25	RES., 60.4k, 1%, 0603	VISHAY, CRCW060360K4FKEA
11	2	R10, R13	RES., 6.04k, 1%, 0603	VISHAY, CRCW06036K04FKEA
12	1	R19	RES., 40.2k, 1%, 0603	VISHAY, CRCW060340K2FKEA
13	3	R24, R27, R36	RES., 10k, 1%, 0603	VISHAY, CRCW060310K0FKEA
14	1	R30	RES., 115k, 1%, 0603	VISHAY, CRCW0603115KFKEA
15	2	R40, R52	RES., 49.9k, 1/10W, 1%, 0603	VISHAY, CRCW060349K9FKEA
16	1	R51	RES., 24.3k, 1%, 0603	VISHAY, CRCW060324K3FKEA
17	1	U1	IC, LTM4662EY, BGA88-15X11.25-6.01	ANALOG DEVICES, LTM4662EY#PBF
Additional Demo Board Circuit Components				
1	0	C1, C2	CAP., OPT, 0805	OPT
2	0	C6, C8, C11, C17, C18, C19, C21, C22	CAP., OPT, 0603	OPT
3	1	Q1	XSTR, N-CH 40V 14A TO-252	VISHAY SUD50N04-8M8P-4GE3
4	0	R5, R17, R39, R46, R47, R50, R55, R56	RES., OPT, 0603	OPT
5	7	R7, R21, R42, R45, R49, R53, R54	RES., 0Ω, 1%, 0603	VISHAY, CRCW06030000Z0EA
6	1	R34	RES., 0Ω, 1/2W, 2010	VISHAY, CRCW20100000Z0EF
7	0	R35	RES., OPT, 2010	OPT
8	1	R37	RES., 0.015Ω, 2W, 2512	VISHAY, WSL2512R0150FEA
9	0	R38	RES., OPT, 2512	OPT
10	2	C13, C14	CAP., X5R, 0.01µF, 50V, 10%, 0603	AVX, 06035C103KAT2A
11	2	C15, C16	CAP., X7R, 1µF, 10V, 10%, 0603	AVX, 0603ZC105KAT2A
Hardware: For Demo Board Only				
1	20	E1-E20	TESTPOINT, TURRET, .094" pbf	MILL-MAX, 2501-2-00-80-00-00-07-0
2	2	JP1, JP5	CONN., HEADER, 2X3, 2mm	WURTH ELEKTRONIK, 62000621121
3	4	JP2, JP3, JP4, JP7	CONN., HEADER, 1X3, 2mm	WURTH ELEKTRONIK, 62000821121
4	1	JP6	CONN., HEADER, 1X4, 2mm	WURTH ELEKTRONIK, 62000411121
5	1	JP8	CONN., HEADER, 1X2, 2mm	WURTH ELEKTRONIK, 62000211121
6	7	XJP1-XJP7	SHUNT, 2mm	WURTH ELEKTRONIK, 60800213421
7	2	J1, J2	CONN, BNC, 5 PINS	CONNEX, 112404
8	6	J4-J9	JACK BANANA	KEYSTONE, 575-4
9	4	(STAND-OFF)	STAND-OFF, SNAP ON NYLON 0.50" tall	KEYSTONE, 8833(SNAP ON)



ESD Caution

ESD (electrostatic discharge) sensitive device. Charged devices and circuit boards can discharge without detection. Although this product features patented or proprietary protection circuitry, damage may occur on devices subjected to high energy ESD. Therefore, proper ESD precautions should be taken to avoid performance degradation or loss of functionality.

Legal Terms and Conditions

By using the evaluation board discussed herein (together with any tools, components documentation or support materials, the "Evaluation Board"), you are agreeing to be bound by the terms and conditions set forth below ("Agreement") unless you have purchased the Evaluation Board, in which case the Analog Devices Standard Terms and Conditions of Sale shall govern. Do not use the Evaluation Board until you have read and agreed to the Agreement. Your use of the Evaluation Board shall signify your acceptance of the Agreement. This Agreement is made by and between you ("Customer") and Analog Devices, Inc. ("ADI"), with its principal place of business at One Technology Way, Norwood, MA 02062, USA. Subject to the terms and conditions of the Agreement, ADI hereby grants to Customer a free, limited, personal, temporary, non-exclusive, non-sublicensable, non-transferable license to use the Evaluation Board FOR EVALUATION PURPOSES ONLY. Customer understands and agrees that the Evaluation Board is provided for the sole and exclusive purpose referenced above, and agrees not to use the Evaluation Board for any other purpose. Furthermore, the license granted is expressly made subject to the following additional limitations: Customer shall not (i) rent, lease, display, sell, transfer, assign, sublicense, or distribute the Evaluation Board; and (ii) permit any Third Party to access the Evaluation Board. As used herein, the term "Third Party" includes any entity other than ADI, Customer, their employees, affiliates and in-house consultants. The Evaluation Board is NOT sold to Customer; all rights not expressly granted herein, including ownership of the Evaluation Board, are reserved by ADI. CONFIDENTIALITY. This Agreement and the Evaluation Board shall all be considered the confidential and proprietary information of ADI. Customer may not disclose or transfer any portion of the Evaluation Board to any other party for any reason. Upon discontinuation of use of the Evaluation Board or termination of this Agreement, Customer agrees to promptly return the Evaluation Board to ADI. ADDITIONAL RESTRICTIONS. Customer may not disassemble, decompile or reverse engineer chips on the Evaluation Board. Customer shall inform ADI of any occurred damages or any modifications or alterations it makes to the Evaluation Board, including but not limited to soldering or any other activity that affects the material content of the Evaluation Board. Modifications to the Evaluation Board must comply with applicable law, including but not limited to the RoHS Directive. TERMINATION. ADI may terminate this Agreement at any time upon giving written notice to Customer. Customer agrees to return to ADI the Evaluation Board at that time. LIMITATION OF LIABILITY. THE EVALUATION BOARD PROVIDED HEREUNDER IS PROVIDED "AS IS" AND ADI MAKES NO WARRANTIES OR REPRESENTATIONS OF ANY KIND WITH RESPECT TO IT. ADI SPECIFICALLY DISCLAIMS ANY REPRESENTATIONS, ENDORSEMENTS, GUARANTEES, OR WARRANTIES, EXPRESS OR IMPLIED, RELATED TO THE EVALUATION BOARD INCLUDING, BUT NOT LIMITED TO, THE IMPLIED WARRANTY OF MERCHANTABILITY, TITLE, FITNESS FOR A PARTICULAR PURPOSE OR NON-INFRINGEMENT OF INTELLECTUAL PROPERTY RIGHTS. IN NO EVENT WILL ADI AND ITS LICENSORS BE LIABLE FOR ANY INCIDENTAL, SPECIAL, INDIRECT, OR CONSEQUENTIAL DAMAGES RESULTING FROM CUSTOMER'S POSSESSION OR USE OF THE EVALUATION BOARD, INCLUDING BUT NOT LIMITED TO LOST PROFITS, DELAY COSTS, LABOR COSTS OR LOSS OF GOODWILL. ADI'S TOTAL LIABILITY FROM ANY AND ALL CAUSES SHALL BE LIMITED TO THE AMOUNT OF ONE HUNDRED US DOLLARS (\$100.00). EXPORT. Customer agrees that it will not directly or indirectly export the Evaluation Board to another country, and that it will comply with all applicable United States federal laws and regulations relating to exports. GOVERNING LAW. This Agreement shall be governed by and construed in accordance with the substantive laws of the Commonwealth of Massachusetts (excluding conflict of law rules). Any legal action regarding this Agreement will be heard in the state or federal courts having jurisdiction in Suffolk County, Massachusetts, and Customer hereby submits to the personal jurisdiction and venue of such courts. The United Nations Convention on Contracts for the International Sale of Goods shall not apply to this Agreement and is expressly disclaimed.