



# High-Output-Current Operational Amplifier ( $A_{VCL} \geq 5$ )

## OP-50

### FEATURES

- Open-Loop Gain ..... 10,000,000V/V Min
- Low Input Offset Voltage ..... 25 $\mu$ V Max
- Low Input Bias Current ..... 5nA Max
- Excellent  $TC_{V_{OS}}$  ..... 0.3 $\mu$ V/ $^{\circ}$ C Max
- High CMRR ..... 126dB Min
- High PSRR ..... 126dB Min
- Low Noise ..... 5.5nV/ $\sqrt{\text{Hz}}$  @ f = 10Hz  
4.5nV/ $\sqrt{\text{Hz}}$  @ f = 1kHz
- High Output Current .....  $\pm 50$ mA
- Drives Capacitive Loads up to 10nF
- On-Board Thermal Shutdown Circuit
- Available in Die Form

### ORDERING INFORMATION†

$T_A = 25^{\circ}\text{C}$ $V_{OS}$ MAX ( $\mu\text{V}$ )	PACKAGE	OPERATING TEMPERATURE RANGE
	CERDIP 14-PIN	
25	OP-50AY*	MIL
100	OP-50BY*	MIL
25	OP-50EY	IND
100	OP-50FY	IND

\* For devices processed in total compliance to MIL-STD-883, add/883 after part number. Consult factory for 883 data sheet.

† Burn-in is available on commercial and industrial temperature range parts in CerDIP, plastic DIP, and TO-can packages.

### GENERAL DESCRIPTION

The OP-50 eliminates the need for an output buffer in applications which require high load-driving capability coupled with premium amplifier performance. The output stage can drive  $\pm 50$ mA into 50 $\Omega$  loads. In addition, the output is stable with capacitive loads of up to 10nF. This load driving ability makes the OP-50 ideal for amplifying small signals for transmission through long cables. The amplifier features open-loop voltage gain of over 10 million with common-mode rejection and power supply rejection of greater than 126dB (A/E grades).

### PIN CONNECTIONS

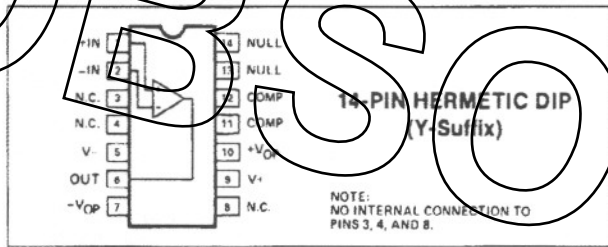

### SIMPLIFIED SCHEMATIC

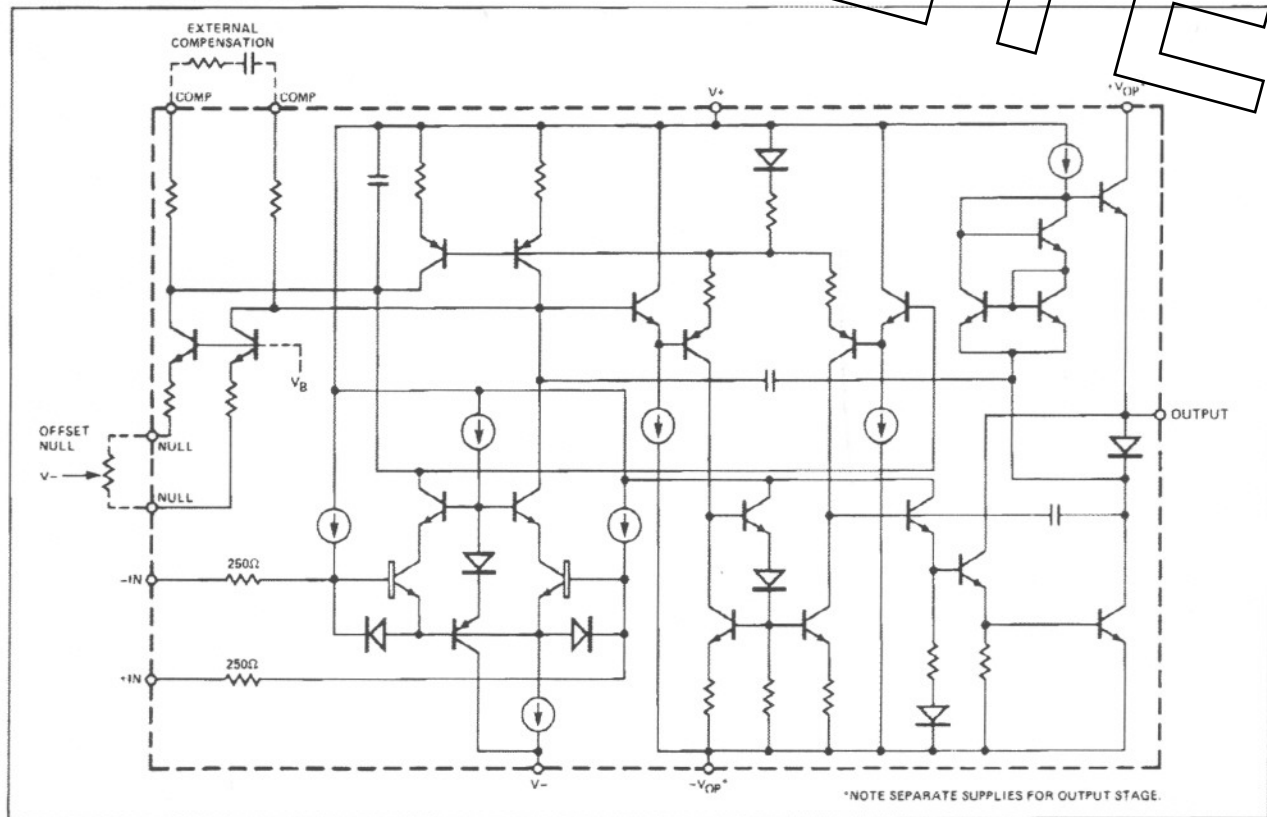

Manufactured under the following patents: 4,471,321 and 4,503,381.

# OP-50

The OP-50 is stable for closed-loop gains above 50, and can be externally compensated for closed-loop gains in the range of 5 to 50. The amplifier is designed for use in high-gain and/or high-output-current applications. For example, an OP-07 coupled with an output buffer can be replaced by a single OP-50 amplifier.

Ion-implanted superbeta transistors, combined with a patented input bias current cancellation circuit, provide an input bias current of only 5nA and input offset current of 1nA. Over the full military temperature range, input bias current and input offset current for an A-grade device does not exceed 8nA and 3nA, respectively. Input offset voltages are trimmed to a maximum of 25µV (A/E grades) and 100µV (B/F grades) using PMI's zener-zapping technique. This low offset eliminates the need for an offset trimpot in most applications.

Low voltage-noise, typically 4.5nV/√Hz at 1kHz, is achieved in the OP-50 with minimum sacrifice of input protection. Overload protection is provided by input resistors of 250Ω and emitter-base diodes. The input resistors provide current limit protection against differential inputs of up to ±10V; and the diodes prevent avalanche breakdown which could degrade the I<sub>b</sub>, I<sub>os</sub>, and matching of the input stage transistors. External resistors can be added to the input to guard against higher input voltages; however, the added resistors will degrade noise voltage performance. When minimum noise voltage is required, source resistance should be kept below a few hundred ohms.

Separate output-stage power supply pins are provided on the OP-50 to allow control of device power dissipation and output voltage swing. The maximum voltage which may be applied across the power supply pins is ±18V. The guaranteed specifications are based on operating both stages at ±15V; however, there is minimal effect on DC performance when the main amplifier is operated at ±15V and the output stage is operated at a reduced voltage. When operating both the main amplifier and the output stage at the same voltages, the corresponding power supply pins may be tied together. Decoupling capacitors are recommended between the power supply pins and analog ground. It is necessary to use decoupling capacitors on each power supply pin when operating the output stage at supply voltages less than the amplifier supply voltage. Do not operate the output-stage negative power supply pin at a more negative voltage than the negative supply pin (V-).

A thermally-symmetric die layout, which differs from other op amp designs by the positioning of more devices along the center line, provides the OP-50 with a thermal drift of less than 0.3µV/°C. This layout feature is critical to the maintenance of high open-loop gain when driving large-current loads and dissipating hundreds of milliwatts in the device. The use of a heatsink is recommended to reduce internal temperature rise when operating at high output power levels. The use of standard dual-in-line package heatsinks will help to dissipate heat to the environment. Other techniques, such as the use of external voltage-dropping resistors, allow heat to be dissipated **outside** of the package. See Figure 5, "Driving 50Ω Loads", in the applications section.

A thermal-shutdown circuit protects the OP-50 from overdisipation. When the die temperature reaches approximately 165°C, the output stage automatically shuts down. The amplifier input stage remains fully operational, thereby protecting the signal source from any loading changes caused by a complete shutdown.

## COMPENSATION FOR GAINS BETWEEN 5 AND 50

The OP-50 can be compensated for inverting gains between 5 and 50 using a series resistor and capacitor. These values can be adjusted to minimize overshoot for a given application. The recommended compensation is:

GAIN RANGE	R <sub>c</sub>	C <sub>c</sub>
5 ≤ A <sub>VCL</sub> ≤ 20	560Ω	4.7nF
20 ≤ A <sub>VCL</sub> ≤ 50	3.3kΩ	1nF
A <sub>VCL</sub> ≥ 50	No compensation required	

## COMPENSATION

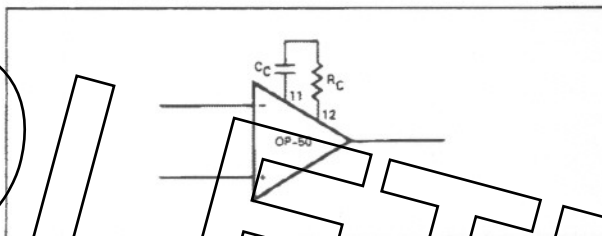

## ABSOLUTE MAXIMUM RATINGS (Note 1)

Supply Voltage (Note 2)	±18V
Input Voltage	Supply Voltage
Differential Input Voltage (Note 3)	+10V
Differential Input Current (Note 3)	±20mA
Output Short-Circuit Duration	Indefinite
Storage Temperature Range	-65°C to +150°C
Operating Temperature Range	
OP-50A, B	-55°C to +125°C
OP-50E, F	-25°C to +85°C
Lead Temperature (Soldering, 60 sec)	300°C
Junction Temperature (T <sub>j</sub> )	-65°C to +150°C

PACKAGE TYPE	θ <sub>JA</sub> (NOTE 4)	θ <sub>JC</sub>	UNITS
14-Pin Hermetic DIP (Y)	99	12	°C/W

### NOTES:

- Absolute ratings apply to both DICE and packaged parts, unless otherwise noted.
- Supply voltage rating applies to all power supply pins. No device pins should be connected to a voltage more negative than the supply to V-, pin 5.
- The OP-50's inputs are protected by 250Ω series resistors and protection diodes. If the differential input voltage exceeds ±10V, the input current must be limited to ±20mA.
- θ<sub>JA</sub> is specified for worst case mounting conditions, i.e., θ<sub>JA</sub> is specified for device in socket for CerDIP package.

**OP-50**

**ELECTRICAL CHARACTERISTICS** at  $V_+ = +V_{OP} = +15V$ ,  $V_- = -V_{OP} = -15V$ ,  $T_A = 25^\circ C$ , no compensation, unless otherwise noted.

PARAMETER	SYMBOL	CONDITIONS	OP-50A/E			OP-50B/F			UNITS
			MIN	TYP	MAX	MIN	TYP	MAX	
Input Offset Voltage	$V_{OS}$		—	10	25	—	50	100	$\mu V$
Input Bias Current	$I_B$		—	$\pm 1$	$\pm 5$	—	$\pm 1$	$\pm 10$	nA
Input Offset Current	$I_{OS}$		—	0.1	1	—	0.1	3	nA
Input Voltage Range	IVR	CMRR $\geq 100dB$	$\pm 12$	—	—	$\pm 12$	—	—	V
Output Voltage Swing	$V_O$	$R_L \geq 500\Omega$	$\pm 13$	$\pm 13.4$	—	$\pm 13$	$\pm 13.4$	—	V
		$R_L \geq 50\Omega$ (Note 1)	$\pm 2.5$	$\pm 4.0$	—	$\pm 2.5$	$\pm 4.0$	—	
Output Voltage Swing	$V_O$	$V_+ = +V_{OP} = +5V$ , $V_- = -V_{OP} = -5V$ $R_L = 500\Omega$ $R_L = 50\Omega$	$\pm 3.5$	$\pm 3.8$	—	$\pm 3.5$	$\pm 3.8$	—	V
Slew Rate	SR	$R_L \geq 2k\Omega$	2.5	3.0	—	2.5	3.0	—	V/ $\mu s$
		$R_L = 560\Omega$ $C_C = 4.7nF$	—	—	—	—	—	—	—
Common-Mode Rejection Ratio	CMRR	$V_{CM} = \pm 10V$	126	140	—	110	120	—	dB
Power Supply Rejection Ratio	PSRR	$V_S = \pm 5V$ to $\pm 15V$	—	0.1	0.5	—	0.5	1	$\mu V/V$
Large-Signal Voltage Gain	$A_{VO}$	$V_O = \pm 10V$ , $R_L = 1k\Omega$	10	20	—	7.5	15	—	V/V
Gain-Bandwidth Product	GBW	$A_{VCL} = 50$ (Note 2)	15	25	—	15	25	—	MHz
Offset Voltage Range Adjust		$R_P = 100k\Omega$	$\pm 1.0$	$\pm 2.5$	—	$\pm 1.0$	$\pm 2.5$	—	mV
Input Noise Voltage	$e_{np-p}$	$f = 0.1Hz$ to $10Hz$	—	0.12	—	—	0.12	—	$\mu V_{p-p}$
Noise Voltage Density	$e_n$	$f = 10Hz$	—	5.5	8.5	—	5.5	8.5	nV/ $\sqrt{Hz}$
		$f = 1kHz$ (Note 3)	—	4.5	6.0	—	4.5	6.0	
Noise Current	$i_{np-p}$	$f = 0.1Hz$ to $10Hz$	—	2	—	—	2	—	$pA_{p-p}$
Noise Current Density	$i_n$	$f = 100Hz$	—	0.3	—	—	0.3	—	$pA/\sqrt{Hz}$
		$f = 1kHz$	—	0.23	—	—	0.23	—	
Quiescent Supply Current	$I_{SY}$	No Load	—	2.6	3.3	—	2.6	3.3	mA
Positive Current Limit	$+I_{SC}$	Output shorted to Ground	60	95	120	60	95	120	mA
Negative Current Limit	$-I_{SC}$	Output shorted to Ground	60	85	120	60	85	120	mA
Differential-Mode Input Resistance	$R_{IND}$		—	2	—	—	2	—	M $\Omega$
Common-Mode Input Resistance	$R_{INCM}$		—	20	—	—	20	—	G $\Omega$
Capacitive Load Capability	$C_L$	$A_{VCL} \geq 5$ $R_C = 560\Omega$ (Note 2) $C_C = 4.7nF$	10	—	—	10	—	—	nF
Settling-Time	$t_s$	Settling to 0.01%, $V_O = 20V_{p-p}$	—	30	—	—	30	—	$\mu s$
		$A_{VCL} = 500$	—	60	—	—	60	—	
		$A_{VCL} = 1000$	—	—	—	—	—	—	

**NOTES:**

1. Guaranteed by current limit tests.
2. Guaranteed by design.
3. Sample tested.

# OP-50

**ELECTRICAL CHARACTERISTICS** at  $V_+ = +V_{OP} = +15V$ ,  $V_- = -V_{OP} = -15V$ ,  $-25^\circ C \leq T_A \leq +85^\circ C$ , no compensation, unless otherwise noted.

PARAMETER	SYMBOL	CONDITIONS	OP-50E			OP-50F			UNITS
			MIN	TYP	MAX	MIN	TYP	MAX	
Input Offset Voltage	$V_{OS}$		—	20	45	—	50	150	$\mu V$
Input Offset Voltage Drift	$TCV_{OS}$	(Note 1)	—	0.15	0.3	—	0.3	1	$\mu V/^\circ C$
Input Bias Current	$I_B$		—	$\pm 2$	$\pm 7$	—	$\pm 2$	$\pm 25$	nA
Input Offset Current	$I_{OS}$		—	0.2	2.5	—	0.2	20	nA
Input Offset Current Drift	$TCI_{OS}$		—	3	—	—	5	—	$\mu A/^\circ C$
Input Bias Current Drift	$TCI_B$		—	20	—	—	50	—	$\mu A/^\circ C$
Input Voltage Range	IVR	CMRR $\geq 100dB$	$\pm 11.5$	—	—	$\pm 11.5$	—	—	V
Output Voltage Swing	$V_O$	$R_L \geq 500\Omega$	$\pm 12$	$\pm 13.4$	—	$\pm 12$	$\pm 13.4$	—	V
Common-Mode Rejection Ratio	CMRR	$V_{CM} = \pm 10V$	120	130	—	105	120	—	dB
Power Supply Rejection Ratio	PSRR	$V_S = \pm 5V$ to $\pm 15V$	—	0.5	1.25	—	0.5	1.25	$\mu V/V$
Quiescent Supply Current	$I_{SY}$	No Load	—	2.8	4	—	2.8	4	mA
Open-Loop Gain	$A_{VO}$	$V_{OUT} = \pm 10V$ , $R_L = 1k\Omega$ (Note 2)	4	15	—	4	15	—	V/ $\mu V$

**NOTES:**

1.  $TCV_{OS}$  tested on E grade, guaranteed by design on F grade specification.
2. Guaranteed by design.

**ELECTRICAL CHARACTERISTICS** at  $V_+ = +V_{OP} = +15V$ ,  $V_- = -V_{OP} = -15V$ ,  $-55^\circ C \leq T_A \leq +125^\circ C$ , no compensation, unless otherwise noted.

PARAMETER	SYMBOL	CONDITIONS	OP-50A			OP-50B			UNITS
			MIN	TYP	MAX	MIN	TYP	MAX	
Input Offset Voltage	$V_{OS}$		—	20	55	—	50	200	$\mu V$
Input Offset Voltage Drift	$TCV_{OS}$		—	0.15	0.3	—	0.3	1	$\mu V/^\circ C$
Input Bias Current	$I_B$		—	$\pm 2$	$\pm 8$	—	$\pm 2$	$\pm 20$	nA
Input Offset Current	$I_{OS}$		—	0.5	3	—	0.5	12	nA
Input Offset Current Drift	$TCI_{OS}$		—	3	—	—	5	—	$\mu A/^\circ C$
Input Bias Current Drift	$TCI_B$		—	20	—	—	50	—	$\mu A/^\circ C$
Input Voltage Range	IVR	CMRR $\geq 100dB$	$\pm 11.5$	—	—	$\pm 11.5$	—	—	V
Output Voltage Swing	$V_O$	$R_L > 500\Omega$	$\pm 12$	$\pm 13.2$	—	$\pm 12$	$\pm 13.2$	—	V
Common-Mode Rejection Ratio	CMRR	$V_{CM} = \pm 10V$	120	130	—	105	120	—	dB
Power Supply Rejection Ratio	PSRR	$V_S = \pm 5V$ to $\pm 15V$	—	0.5	1.25	—	0.5	1.25	$\mu V/V$
Quiescent Supply Current	$I_{SY}$	No Load	—	2.8	4	—	2.8	4	mA
Open-Loop Gain	$A_{VO}$	$V_O = \pm 10V$ , $R_L = 1k\Omega$ (Note 1)	4	10	—	4	10	—	V/ $\mu V$

**NOTE:**

1. Tested at  $+125^\circ C$ , guaranteed by design at  $-55^\circ C$ .

OP-50

DICE CHARACTERISTICS

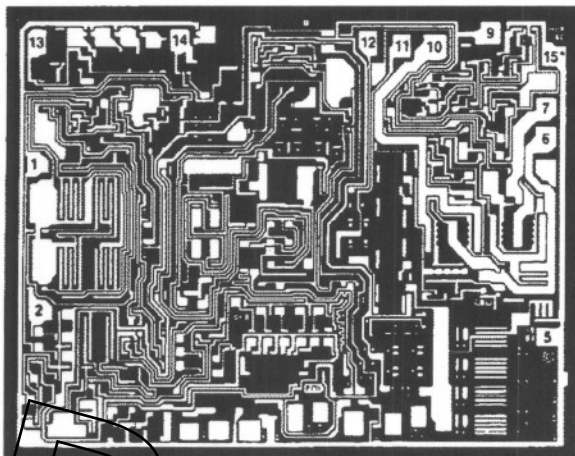

- 1. NONINVERTING INPUT
- 2. INVERTING INPUT
- 5. V-
- 6. OUTPUT
- 7. -V<sub>OP</sub>
- 9. V+
- 10. +V<sub>OP</sub>
- 11. COMPENSATION
- 12. COMPENSATION
- 13. NULL
- 14. NULL
- 15. V- (OPTIONAL BONDING PAD)\*

DIE SIZE 0.149 × 0.111 inch, 16,539 sq. mils  
(3.78 × 2.82 mm, 10.46 sq. mm)

WAFER TEST LIMITS at V+ = +V<sub>OP</sub> = +15V, V- = -V<sub>OP</sub> = -15V, T<sub>A</sub> = 25°C, no compensation, unless otherwise noted.

PARAMETER	SYMBOL	CONDITIONS	OP-50G LIMIT	UNITS
Input Offset Voltage	V <sub>OS</sub>		100	μV MAX
Input Bias Current	I <sub>B</sub>		±10	nA MAX
Input Offset Current	I <sub>OS</sub>		3	nA MAX
Output Voltage Swing	V <sub>O</sub>	R <sub>L</sub> ≥ 500Ω	±13	V MIN
Output Voltage Swing	V <sub>O</sub>	V+ = +V <sub>OP</sub> = +5V, V- = -V <sub>OP</sub> = -5V R <sub>L</sub> = 500Ω	±3.5	V MIN
Output Voltage Swing	V <sub>O</sub>	R <sub>L</sub> = 50Ω	±2.5	V MIN
Common-Mode Rejection Ratio	CMRR	V <sub>CM</sub> = ±10V	110	dB MIN
Power Supply Rejection Ratio	PSRR	V <sub>S</sub> = ±5V to ±15V	1	μV/V MAX
Large-Signal Voltage Gain	A <sub>VO</sub>	V <sub>O</sub> = ±10V, R <sub>L</sub> = 1kΩ	7.5	V/μV MIN
Positive Current Limit	+I <sub>SC</sub>	Output shorted to Ground	60	mA MIN
Negative Current Limit	-I <sub>SC</sub>	Output shorted to Ground	60	mA MIN
Quiescent Supply Current	I <sub>SV</sub>	No Load	3.3	mA MAX

NOTE:

Electrical tests are performed at wafer probe to the limits shown. Due to variations in assembly methods and normal yield loss, yield after packaging is not guaranteed for standard product dice. Consult factory to negotiate specifications based on dice lot qualification through sample lot assembly and testing.



# OP-50

**TYPICAL ELECTRICAL CHARACTERISTICS** at  $V_+ = +V_{OP} = +15V$ ,  $V_- = -V_{OP} = -15V$ ,  $T_A = 25^\circ C$ , no compensation, unless otherwise noted.

PARAMETER	SYMBOL	CONDITIONS	OP-50G TYPICAL	UNITS
Slew Rate	SR	$R_L \geq 2k\Omega$ $R_C = 560\Omega$ $C_C = 4.7nF$	3	V/ $\mu s$
Noise Voltage Density	$e_n$	$f = 10Hz$ $f = 1kHz$	5.5 4.5	nV/ $\sqrt{Hz}$
Input Noise Voltage	$e_{np-p}$	$f = 0.1Hz$ to 10Hz	0.12	$\mu V_{p-p}$
Noise Current Density	$i_n$	$f = 10Hz$ $f = 1kHz$	0.2 0.15	pA/ $\sqrt{Hz}$
Capacitive Load Capability	$C_L$	$A_{VCL} \geq 5$ $R_C = 560\Omega$ $C_C = 4.7nF$	10	nF

**NOISE TEST CIRCUIT (0.1 TO 10Hz)**

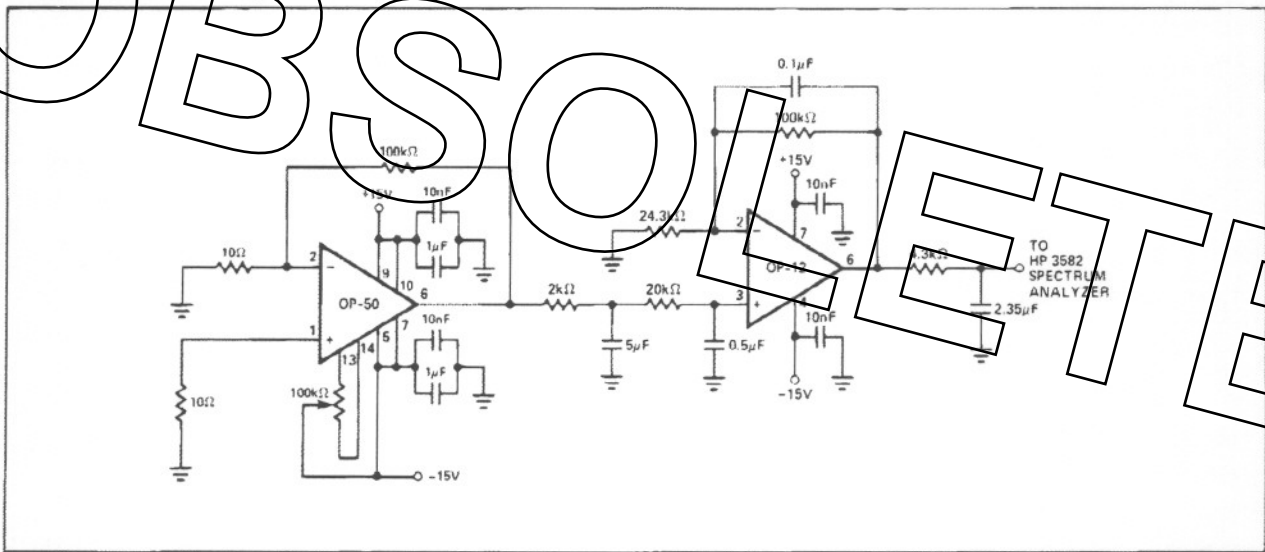

**BURN-IN CIRCUIT**

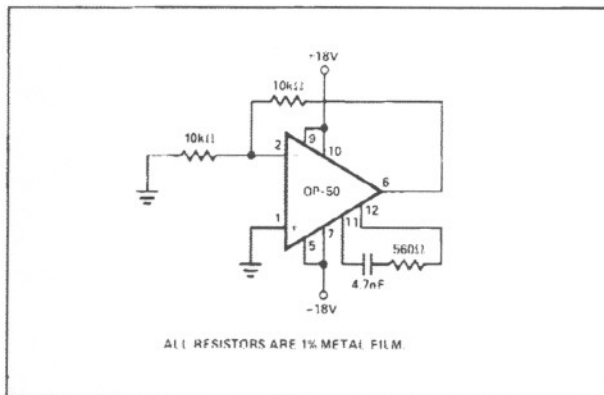

**OFFSET NULLING CIRCUIT**

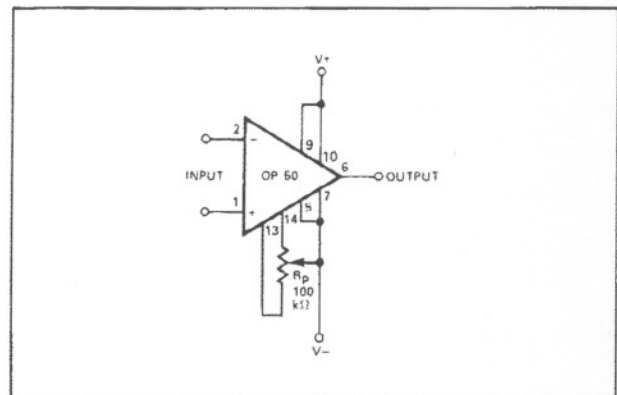

OP-50-7

OP-50

**TYPICAL PERFORMANCE CHARACTERISTICS**

**INPUT OFFSET VOLTAGE vs TEMPERATURE**

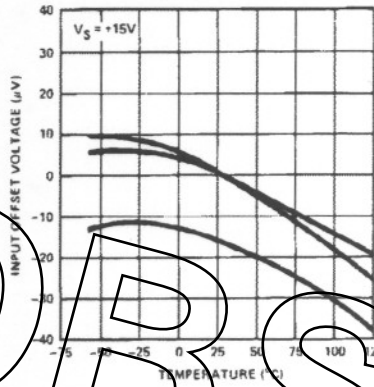

**INPUT BIAS CURRENT vs SUPPLY VOLTAGE**

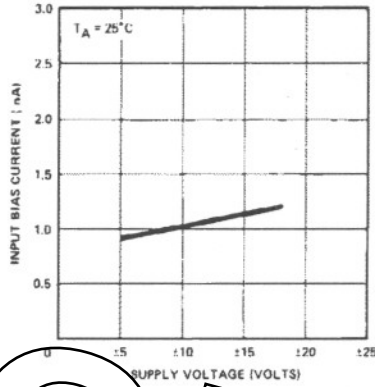

**INPUT BIAS CURRENT vs COMMON-MODE VOLTAGE**

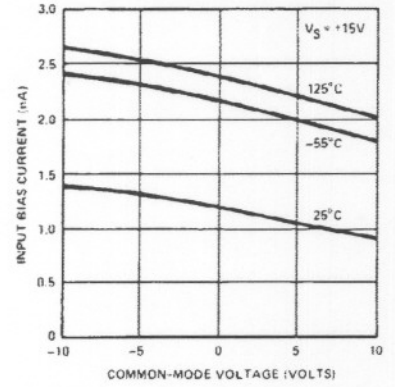

**INPUT OFFSET CURRENT vs TEMPERATURE**

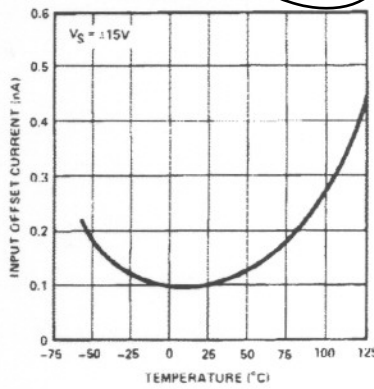

**SLEW RATE vs TEMPERATURE**

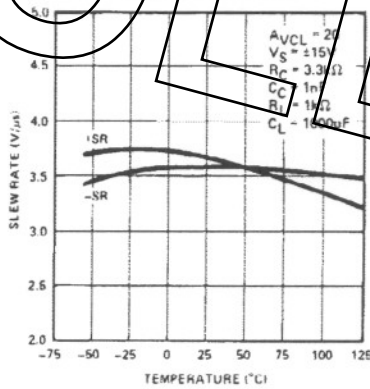

**SLEW RATE vs TEMPERATURE**

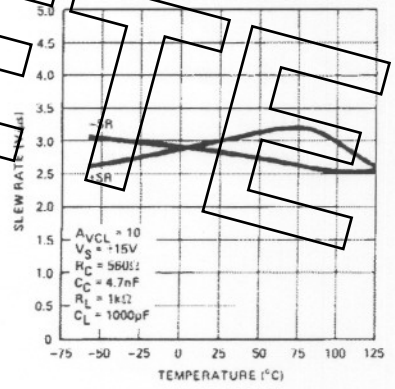

**SLEW RATE vs CAPACITIVE LOAD**

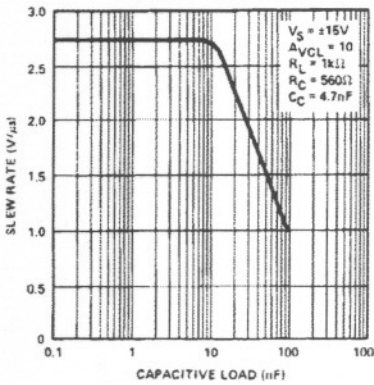

**CMRR vs FREQUENCY**

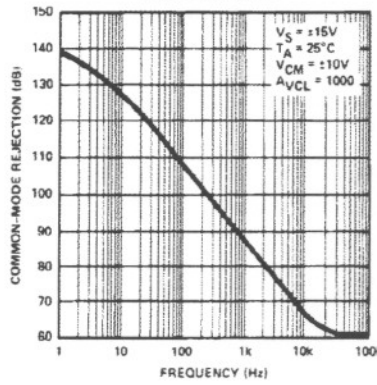

**PSRR vs FREQUENCY**

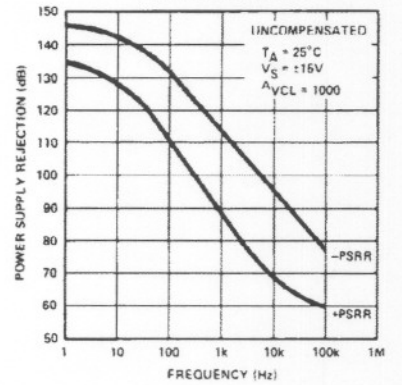

**NOTE:**  
The symbol  $\pm V_S$  is used to indicate the supply voltages when the main amplifier and the output stage are being operated at the same voltages.

# OP-50

## TYPICAL PERFORMANCE CHARACTERISTICS

**PSRR vs FREQUENCY**

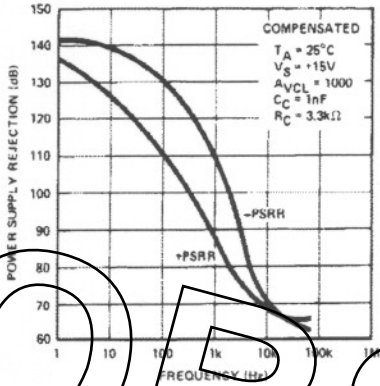

**SUPPLY CURRENT vs TEMPERATURE**

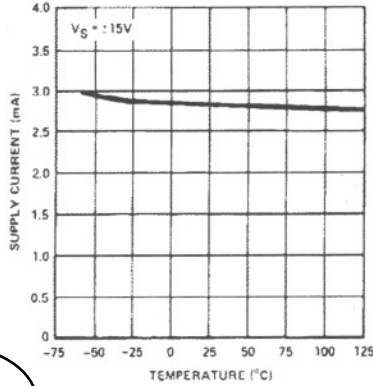

**SUPPLY CURRENT vs SUPPLY VOLTAGE**

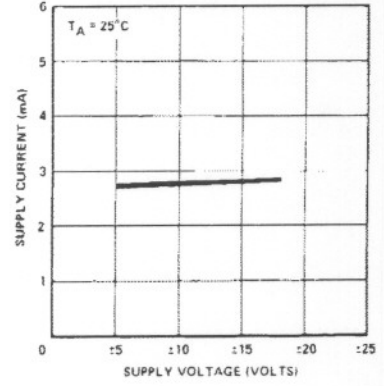

**SHORT-CIRCUIT CURRENT vs TEMPERATURE**

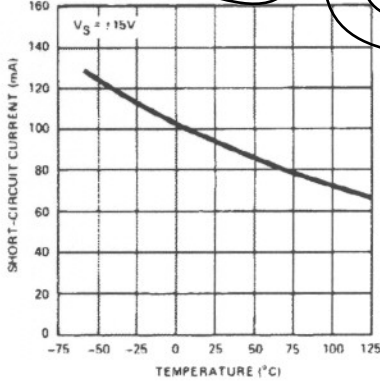

**CURRENT NOISE DENSITY vs FREQUENCY**

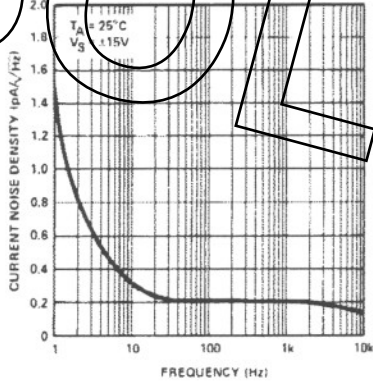

**VOLTAGE NOISE DENSITY vs FREQUENCY**

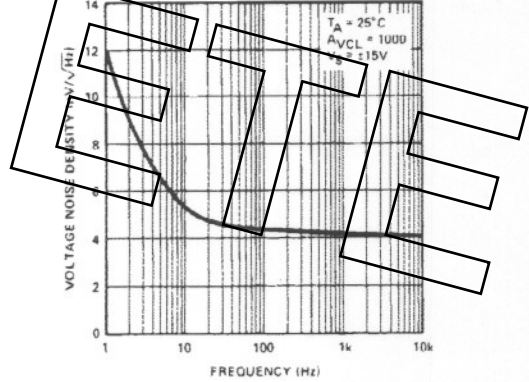

**TOTAL HARMONIC DISTORTION vs FREQUENCY**

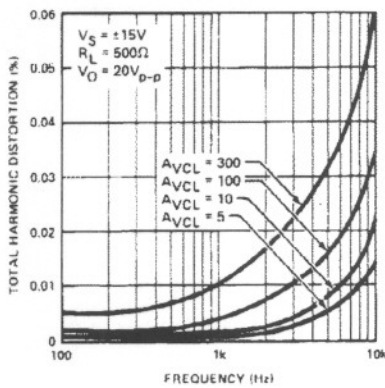

**TOTAL HARMONIC DISTORTION vs LOAD RESISTANCE**

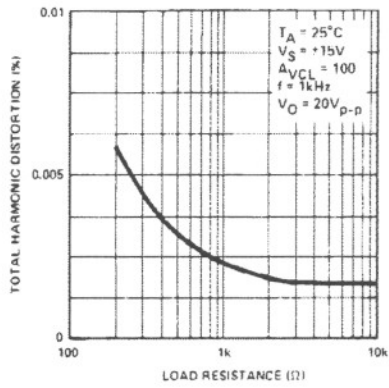

**0 TO 1Hz NOISE VOLTAGE DENSITY**

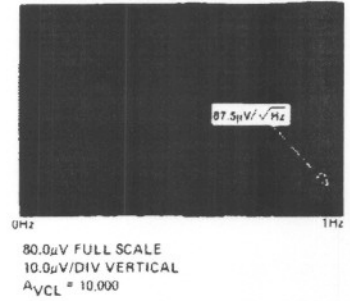



TYPICAL PERFORMANCE CHARACTERISTICS

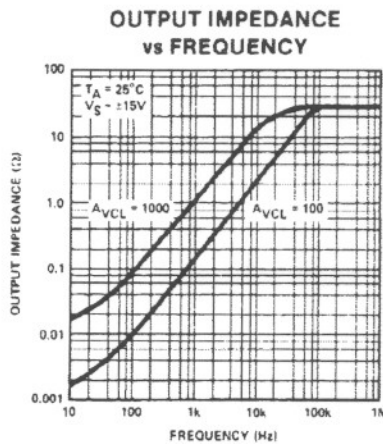
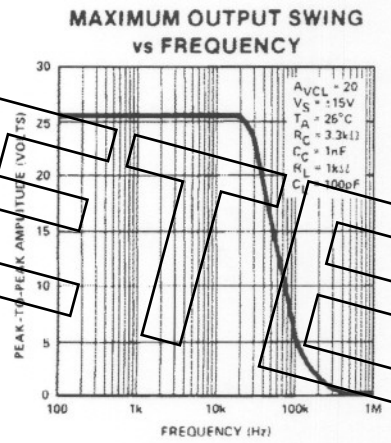
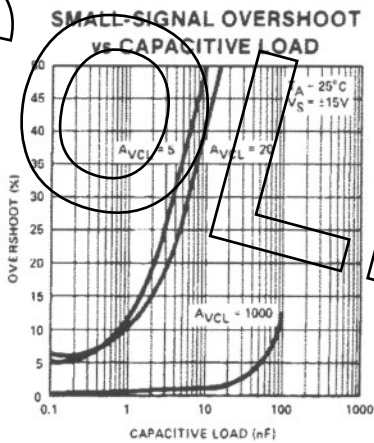
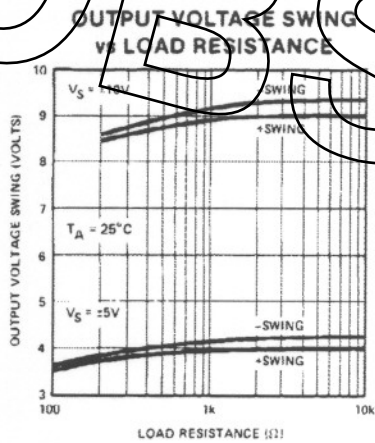
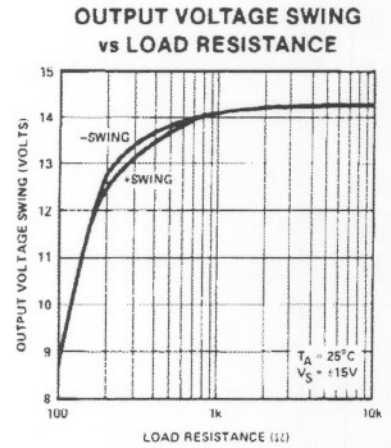
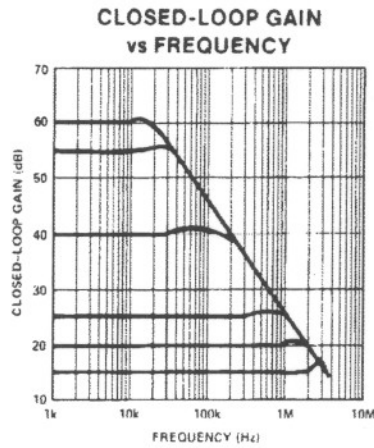
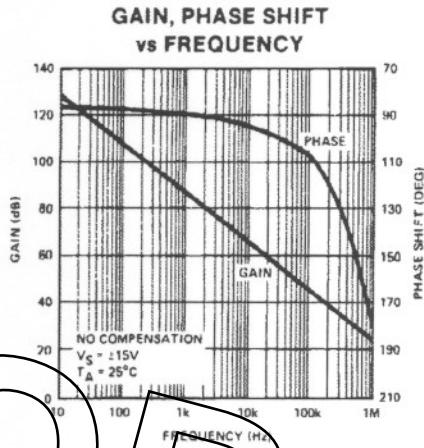

# OP-50

## TCV<sub>OS</sub> TEST CIRCUIT

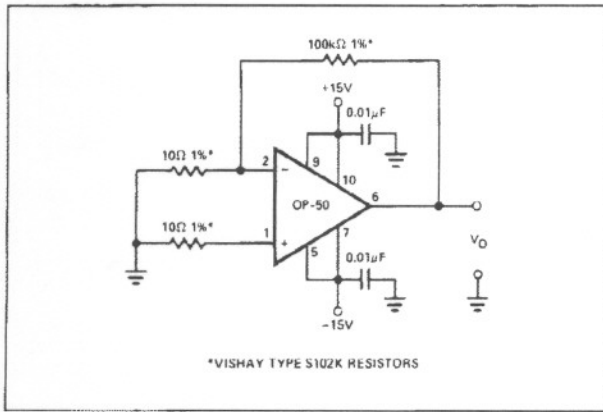

overdriving of the long-tailed transistor pair and stop saturation of the output transistor. Power supply voltage is set to  $\pm 5V$  to lower the quiescent power dissipation and minimize thermal feedback due to output stage dissipation. Operating from  $\pm 5V$  supplies also reduces the OP-50 rise and fall times as the output slews over a reduced voltage range. This, in turn, reduces the output response time.

It is common practice with voltage comparators to ground one input terminal and to use a single-ended input. The historic reason is poor common-mode rejection on the input stage. In contrast, the OP-50 has very high common-mode rejection and is capable of detecting microvolt level differences in the presence of large common-mode signals.

The comparator is not fast, but it is very sensitive and can detect signal differences as low as  $0.3\mu V$ . With large input overdrives, the circuit responds in approximately  $3\mu s$ . If sharp transitions are needed, the use of a TTL Schmitt-trigger input is recommended. A table of Response Time vs. Input Overdrive is shown below.

INPUT OVERDRIVE	100mV	10mV	1mV	100μV	10μV
Positive Output Delay	3.2μs	5μs	40μs	340μs	2.4ms
Negative Output Delay	1.8μs	5μs	50μs	380μs	4.5ms

## APPLICATIONS INFORMATION

### HIGH-SENSITIVITY VOLTAGE COMPARATOR

A comparator capable of resolving a submicrovolt difference signal is shown in Figure 1. The OP-50, operating without feedback, drives a second gain stage which generates a TTL-compatible output signal. Schottky-clamp diodes prevent

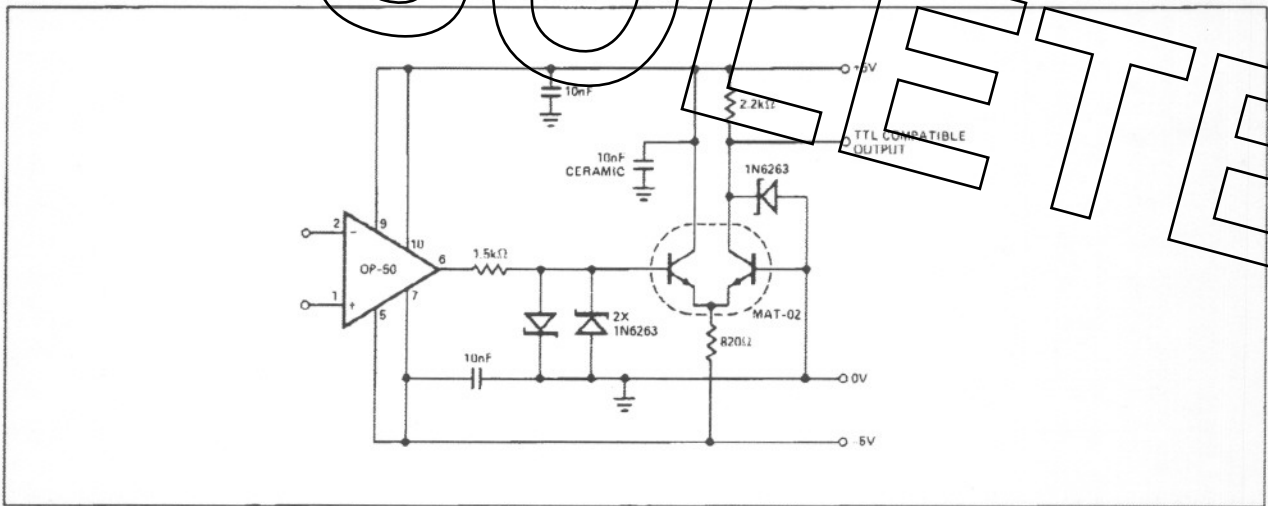

FIGURE 1: HIGH-SENSITIVITY VOLTAGE COMPARATOR

OP-50

**INTEGRATOR AND UNITY-GAIN BUFFER**

Figure 2 shows a method of obtaining unity-gain in a buffer configuration. The R1 and C1 network provides input compensation to circumvent the minimum gain requirement. Figure 3 shows the same technique applied in the inverting mode to form a high precision integrator.

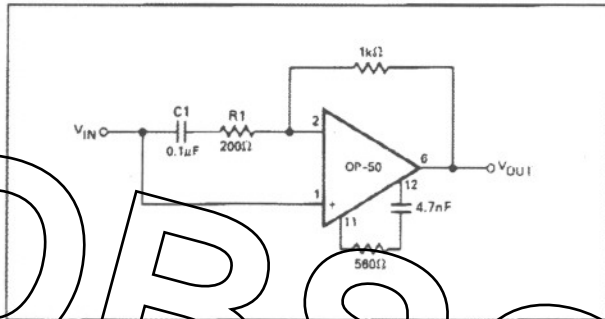

FIGURE 2: UNITY GAIN BUFFER

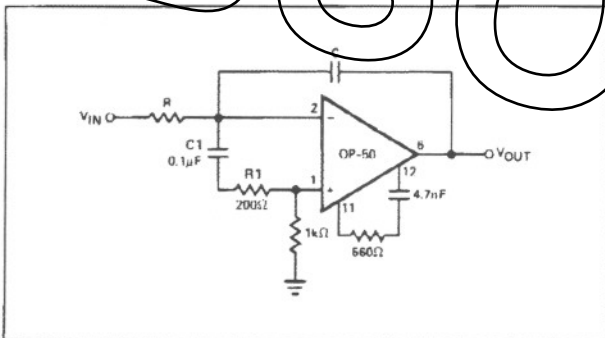

FIGURE 3: INTEGRATOR

**20mA CURRENT SOURCE**

The 20mA current source exploits the high output current and high linearity capabilities of the OP-50. Five precision resistors and a trim potentiometer are required in this circuit configuration, known as the Howland Current Pump. The trim potentiometer is used to balance the resistive feedback dividers. This maximizes the current-source output impedance. Compensation is selected for a voltage gain of 10.

Compliance is better than ±11V at an output current of 20mA and the trimmed output resistance is typically 2MΩ with  $R_L \leq 500\Omega$ . The transfer function is given by:

$$I_{OUT} = \frac{V_{IN(DIFF)} \times 10.1}{101} \text{ Amps}$$

$V_{IN(DIFF)}$  is the differential input voltage. For the resistor values shown in Figure 4, the maximum  $V_{IN(DIFF)}$  is 200mV.

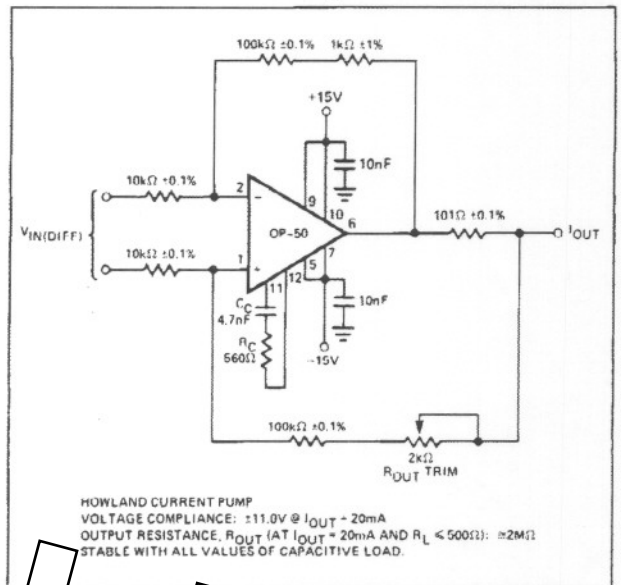

HOWLAND CURRENT PUMP  
 VOLTAGE COMPLIANCE: ±11.0V @  $I_{OUT} = 20\text{mA}$   
 OUTPUT RESISTANCE,  $R_{OUT}$  (AT  $I_{OUT} = 20\text{mA}$  AND  $R_L \leq 500\Omega$ ): ≈2MΩ  
 STABLE WITH ALL VALUES OF CAPACITIVE LOAD.

FIGURE 4: 20mA CURRENT SOURCE

**DRIVING 50Ω LOADS**

The OP-50 can provide up to 60mA into a 50Ω load and up to 26mA into a 500Ω load. The output is stable driving capacitive loads of up to 10nF.

Applications that make use of the high output current capability of the OP-50 will cause increased power dissipation in the amplifier. To reduce internal dissipation in these applications, external voltage dropping resistors can be connected in series with the output-stage power supply pins. As shown in Figure 5, 130Ω resistors can be attached to pin 7 (-V<sub>OP</sub>) and to pin 10 (+V<sub>OP</sub>). To maintain stability and specified performance levels, 0.047µF decoupling capacitors should be used as indicated from pin 7 and pin 10 to ground.

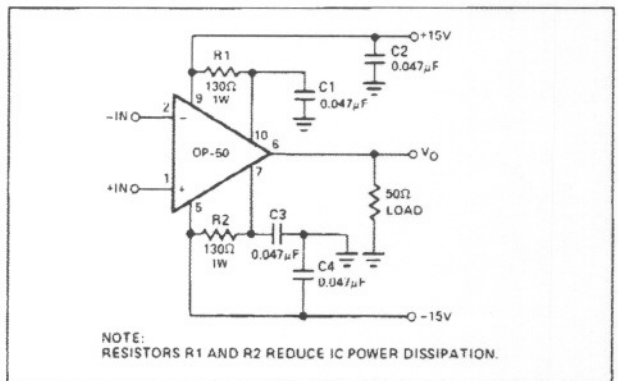

NOTE:  
 RESISTORS R1 AND R2 REDUCE IC POWER DISSIPATION.

FIGURE 5: DRIVING 50Ω LOADS