



Total Ionizing Dose (TID) Radiation Testing of the RH1014MW Quad Precision Operational Amplifier for Linear Technology

Customer: Linear Technology, PO# 60735L

RAD Job Number: 11-572

Part Type Tested: RH1014MW Quad Precision Operational Amplifier, RH1014M datasheet

Traceability Information: Lot Number: 628465.1, Fab Lot Number: W10905043, Wafer Number: 07, Date Code 1122A. See photograph of unit under test in Appendix A.

Quantity of Units: 12 units received, 5 units for biased irradiation, 5 units for unbiased irradiation and 2 units for control. Serial numbers 1831-1835 were biased during irradiation, serial numbers 1836-1840 were unbiased during irradiation and serial numbers 1851 and 1852 were used as control. Control units will be shared with RAD Job 11-573. See Appendix B for the radiation bias connection table.

Radiation and Electrical Test Increments: 50 to 300rad(Si)/s ionizing radiation with electrical test increments: pre-irradiation, 10krad(Si), 20krad(Si), 30krad(Si) and 50krad(Si).

Pre-Irradiation Burn-In: Burn-In performed by Linear Technology prior to receipt by RAD.

Overtest and Post-Irradiation Anneal: No overtest. 24-hour room temperature anneal followed by a 168-hour 100°C anneal. Both anneals shall be performed in the same electrical bias condition as the irradiations. Electrical measurements shall be made following each anneal increment.

Radiation Test Standard: MIL-STD-750E TM1019 and/or MIL-STD-883H TM1019 Condition A.

Test Hardware and Software: LTS2020 Automated Tester, Entity ID TS04, Calibration Date: 4/28/2011, Calibration Due: 4/28/2012. LTS2101 Family Board, Entity ID FB10. LTS0600 Test Fixture, Entity ID TF01. BGSS-970312 RH1014 DUT Board. Test Program: RH1014LT.SRC

Facility and Radiation Source: Aeroflex RAD's Longmire Laboratories, Colorado Springs, CO. Gamma rays provided by JLSA 81-24 Co60 source. Dosimetry performed by Air Ionization Chamber (AIC) traceable to NIST. Aeroflex RAD's dosimetry has been audited by DSCC and Aeroflex RAD has been awarded Laboratory Suitability for MIL-STD-750 and MIL-STD-883 TM 1019.

Irradiation and Test Temperature: Room temperature controlled to 24°C±6°C per MIL-STD-883 and MIL-STD-750.

Total Ionizing Dose Test Result: PASSED the total ionizing dose test to the maximum tested dose level of 50krad(Si) with all parameters remaining within their datasheet specifications.

An ISO 9001:2008 and DSCC Certified Company



1.0. Overview and Background

It is well known that total dose ionizing radiation can cause parametric degradation and ultimately functional failure in electronic devices. The damage occurs via electron-hole pair production, transport and trapping in the dielectric and interface regions. In discrete devices the bulk of the damage is frequently manifested as a reduction in the gain and/or breakdown voltage of the device. The damage will usually anneal with time following the end of the radiation exposure. Due to this annealing, and to ensure a worst-case test condition MIL-STD-883 TM1019.8 calls out a dose rate of 50 to 300rad(Si)/s as Condition A and further specifies that the time from the end of an incremental radiation exposure and electrical testing shall be 1-hour or less and the total time from the end of one incremental irradiation to the beginning of the next incremental radiation step should be 2-hours or less. The work described in this report was performed to meet MIL-STD-883 TM1019.8 Condition A.

2.0. Radiation Test Apparatus

The total ionizing dose testing described in this final report was performed using the facilities at Aeroflex RAD's Longmire Laboratories in Colorado Springs, CO. The high dose rate total ionizing dose (TID) source is a JLSA 81-24 irradiator modified to provide a panoramic exposure. The Co-60 rods are held in the base of the irradiator heavily shielded by lead. During the radiation exposures the rod is raised by an electronic timer/controller and the exposure is performed in air. The dose rate for this irradiator in this configuration ranges from <1rad(Si)/s to a maximum of approximately 120rad(Si)/s, determined by the distance from the source. For high-dose rate experiments the bias boards are placed in a radial fashion equidistant from the raised Co-60 rods with the distance adjusted to provide the required dose rate. The irradiator calibration is maintained by Aeroflex RAD Longmire Laboratories using air ionization chamber (AIC) equipment calibrated with traceability to the National Institute of Standards and Technology (NIST). Figure 2.1 shows a photograph of the JLSA 81-24 Co-60 irradiator at Aeroflex RAD's Longmire Laboratory facility.

Aeroflex RAD is currently certified by the Defense Supply Center Columbus (DSCC) for Laboratory Suitability under MIL STD 750 and MIL-STD-883. Additional details regarding Aeroflex RAD dosimetry for TM1019 Condition A testing are available in Aeroflex RAD's report to DSCC entitled: "Dose Rate Mapping of the J.L. Shepherd and Associates Model 81 Irradiator Installed by Radiation Assured Devices".



Figure 2.1. Aeroflex RAD's high dose rate Co-60 irradiator. The dose rate is obtained by positioning the device-under-test at a fixed distance from the gamma cell. The dose rate for this irradiator varies from approximately 120rad(Si)/s close to the rods down to 1rad(Si)/s at a distance of approximately 2-feet.



3.0. Radiation Test Conditions

The RH1014MW Quad Precision Operational Amplifier described in this final report were irradiated using a split 15 supply and with all pins tied to ground, that is biased and unbiased. See the TID Bias Table in Appendix B for the full bias circuits. In our opinion, this bias circuit satisfies the requirements of MIL-STD-883H TM1019.8 Section 3.9.3 Bias and Loading Conditions which states "The bias applied to the test devices shall be selected to produce the greatest radiation induced damage or the worst-case damage for the intended application, if known. While maximum voltage is often worst case some bipolar linear device parameters (e.g. input bias current or maximum output load current) exhibit more degradation with 0 V bias."

The devices were irradiated to a maximum total ionizing dose level of 50krad(Si) with incremental readings at 10krad(Si), 20krad(Si) and 30krad(Si). Electrical testing occurred within one hour following the end of each irradiation segment. For intermediate irradiations, the parts were tested and returned to total dose exposure within two hours from the end of the previous radiation increment.

The TID bias board was positioned in the Co-60 cell to provide the required minimum of 50rad(Si)/s and was located inside a lead-aluminum enclosure. The lead-aluminum enclosure is required under MIL-STD-883H TM1019.8 Section 3.4 that reads as follows: "Lead/Aluminum (Pb/Al) container. Test specimens shall be enclosed in a Pb/Al container to minimize dose enhancement effects caused by low-energy, scattered radiation. A minimum of 1.5 mm Pb, surrounding an inner shield of at least 0.7 mm Al, is required. This Pb/Al container produces an approximate charged particle equilibrium for Si and for TLDs such as CaF₂. The radiation field intensity shall be measured inside the Pb/Al container (1) initially, (2) when the source is changed, or (3) when the orientation or configuration of the source, container, or test-fixture is changed. This measurement shall be performed by placing a dosimeter (e.g., a TLD) in the device-irradiation container at the approximate test-device position. If it can be demonstrated that low energy scattered radiation is small enough that it will not cause dosimetry errors due to dose enhancement, the Pb/Al container may be omitted."

The final dose rate within the high dose rate lead-aluminum enclosure was determined using calibration calculations based on air ionization chamber (AIC) dosimetry performed just prior to beginning the total dose irradiations. The final dose rate for this work was 50.01 with a precision of $\pm 5\%$.



4.0. Tested Parameters

During the total ionizing dose characterization testing the following electrical parameters were measured pre- and post-irradiation:

1. Positive Supply Current @ +/-15V (A)
2. Negative Supply Current @ +/-15V (A)
3. Offset Voltage 1 @ +/-15V (V)
4. Offset Voltage 2 @ +/-15V (V)
5. Offset Voltage 3 @ +/-15V (V)
6. Offset Voltage 4 @ +/-15V (V)
7. Offset Current 1 @ +/-15V (A)
8. Offset Current 2 @ +/-15V (A)
9. Offset Current 3 @ +/-15V (A)
10. Offset Current 4 @ +/-15V (A)
11. Positive Bias Current 1 @ +/-15V (A)
12. Positive Bias Current 2 @ +/-15V (A)
13. Positive Bias Current 3 @ +/-15V (A)
14. Positive Bias Current 4 @ +/-15V (A)
15. Negative Bias Current 1 @ +/-15V (A)
16. Negative Bias Current 2 @ +/-15V (A)
17. Negative Bias Current 3 @ +/-15V (A)
18. Negative Bias Current 4 @ +/-15V (A)
19. Common Mode Rejection Ratio 1 (dB)
20. Common Mode Rejection Ratio 2 (dB)
21. Common Mode Rejection Ratio 3 (dB)
22. Common Mode Rejection Ratio 4 (dB)
23. Power Supply Rejection Ratio 1 (dB)
24. Power Supply Rejection Ratio 2 (dB)
25. Power Supply Rejection Ratio 3 (dB)
26. Power Supply Rejection Ratio 4 (dB)
27. Open Loop Gain 1 RL=10k VO=+/-10V (V/mV)
28. Open Loop Gain 2 RL=10k VO=+/-10V (V/mV)
29. Open Loop Gain 3 RL=10k VO=+/-10V (V/mV)
30. Open Loop Gain 4 RL=10k VO=+/-10V (V/mV)
31. Positive Output Voltage 1 @ +/-15V (V)
32. Positive Output Voltage 2 @ +/-15V (V)
33. Positive Output Voltage 3 @ +/-15V (V)
34. Positive Output Voltage 4 @ +/-15V (V)
35. Negative Output Voltage 1 @ +/-15V (V)
36. Negative Output Voltage 2 @ +/-15V (V)
37. Negative Output Voltage 3 @ +/-15V (V)



38. Negative Output Voltage 4 @ +/-15V (V)
39. Positive Slew Rate 1 @ +/-15V (V/us)
40. Positive Slew Rate 2 @ +/-15V (V/us)
41. Positive Slew Rate 3 @ +/-15V (V/us)
42. Positive Slew Rate 4 @ +/-15V (V/us)
43. Negative Slew Rate 1 @ +/-15V (V/us)
44. Negative Slew Rate 2 @ +/-15V (V/us)
45. Negative Slew Rate 3 @ +/-15V (V/us)
46. Negative Slew Rate 4 @ +/-15V (V/us)
47. Positive Supply Current @ +5V (A)
48. Negative Supply Current @ +5V (A)
49. Offset Voltage 1 @ +5V (V)
50. Offset Voltage 2 @ +5V (V)
51. Offset Voltage 3 @ +5V (V)
52. Offset Voltage 4 @ +5V (V)
53. Offset Current 1 @ +5V (A)
54. Offset Current 2 @ +5V (A)
55. Offset Current 3 @ +5V (A)
56. Offset Current 4 @ +5V (A)
57. Positive Bias Current 1 @ +5V (A)
58. Positive Bias Current 2 @ +5V (A)
59. Positive Bias Current 3 @ +5V (A)
60. Positive Bias Current 4 @ +5V (A)
61. Negative Bias Current 1 @ +5V (A)
62. Negative Bias Current 2 @ +5V (A)
63. Negative Bias Current 3 @ +5V (A)
64. Negative Bias Current 4 @ +5V (A)
65. Positive Output Voltage 1 RL=open @ +5V (V)
66. Positive Output Voltage 2 RL=open @ +5V (V)
67. Positive Output Voltage 3 RL=open @ +5V (V)
68. Positive Output Voltage 4 RL=open @ +5V (V)
69. Positive Output Voltage 1 RL=600 @ +5V (V)
70. Positive Output Voltage 2 RL=600 @ +5V (V)
71. Positive Output Voltage 3 RL=600 @ +5V (V)
72. Positive Output Voltage 4 RL=600 @ +5V (V)
73. Output Voltage Low 1 RL=open @ +5V (V)
74. Output Voltage Low 2 RL=open @ +5V (V)
75. Output Voltage Low 3 RL=open @ +5V (V)
76. Output Voltage Low 4 RL=open @ +5V (V)
77. Output Voltage Low 1 RL=600 @ +5V (V)
78. Output Voltage Low 2 RL=600 @ +5V (V)
79. Output Voltage Low 3 RL=600 @ +5V (V)



- 80. Output Voltage Low 4 RL=600 @ +5V (V)
- 81. Output Voltage Low 1 IL=1mA @ +5V (V)
- 82. Output Voltage Low 2 IL=1mA @ +5V (V)
- 83. Output Voltage Low 3 IL=1mA @ +5V (V)
- 84. Output Voltage Low 4 IL=1mA @ +5V (V)

Appendix C details the measured parameters, test conditions, pre-irradiation specification and measurement resolution for each of the measurements.

The parametric data was obtained as "read and record" and all the raw data plus an attributes summary are contained in this report as well as in a separate Excel file. The attributes data contains the average, standard deviation and the average with the KTL values applied. The KTL value used in this work is 2.742 per MIL-HDBK-814 using one sided tolerance limits of 90/90 and a 5-piece sample size. The 90/90 KTL values were selected to match the statistical levels specified in the MIL-PRF-38535 sampling plan for the qualification of a radiation hardness assured (RHA) component. Note that the following criteria must be met for a device to pass the total ionizing dose test: following the radiation exposure each of the 5 pieces irradiated under electrical bias shall pass the specification value. The units irradiated without electrical bias and the KTL statistics are included in this report for reference only. If any of the 5 pieces irradiated under electrical bias exceed the device post radiation data sheet specification limits, then the lot could be logged as a failure.

Further, MIL-STD-883H, TM 1019.8 Section 3.13.1.1 Characterization test to determine if a part exhibits ELDRS' states the following: Select a minimum random sample of 21 devices from a population representative of recent production runs. Smaller sample sizes may be used if agreed upon between the parties to the test. All of the selected devices shall have undergone appropriate elevated temperature reliability screens, e.g. burn-in and high temperature storage life. Divide the samples into four groups of 5 each and use the remaining part for a control. Perform pre-irradiation electrical characterization on all parts assuring that they meet the Group A electrical tests. Irradiate 5 samples under a 0 volt bias and another 5 under the irradiation bias given in the acquisition specification at 50-300 rad(Si)/s and room temperature. Irradiate 5 samples under a 0 volt bias and another 5 under irradiation bias given in the acquisition specification at < 10mrads(Si)/s and room temperature. Irradiate all samples to the same dose levels, including 0.5 and 1.0 times the anticipated specification dose, and repeat the electrical characterization on each part at each dose level. Post irradiation electrical measurements shall be performed per paragraph 3.10 where the low dose rate test is considered Condition D. Calculate the radiation induced change in each electrical parameter (Δ_{para}) for each sample at each radiation level. Calculate the ratio of the median Δ_{para} at low dose rate to the median Δ_{para} at high dose rate for each irradiation bias group at each total dose level. If this ratio exceeds 1.5 for any of the most sensitive parameters then the part is considered to be ELDRS susceptible. This test does not apply to parameters which exhibit changes that are within experimental error or whose values are below the pre-irradiation electrical specification limits at low dose rate at the specification dose.

Therefore, the data in this report can be analyzed along with the low dose rate report titled "Enhanced



Low Dose Rate Sensitivity (ELDRS) Radiation Testing of the RH1014MW Quad Precision Operational Amplifier for Linear Technology" to demonstrate that these parts do not exhibit ELDRS as defined in the current test method.

5.0. Total Ionizing Dose Test Results

Based on this criterion the RH1014MW Quad Precision Operational Amplifier (from the lot traceability information provided on the first page of this test report) PASSED the total ionizing dose test to the maximum tested dose level of 50krad(Si) with all parameters remaining within their datasheet specifications.

Figures 5.1 through 5.84 show plots of all the measured parameters versus total ionizing dose while Tables 5.1 - 5.84 show the corresponding raw data for each of these parameters. In the data plots the solid diamonds are the average of the measured data points for the sample irradiated under electrical bias while the shaded diamonds are the average of the measured data points for the units irradiated with all pins tied to ground. The black lines (solid or dashed) are the average of the data points after application of the KTL statistics on the sample irradiated in the biased condition while the shaded lines (solid or dashed) are the average of the data points after application of the KTL statistics on the sample irradiated in the unbiased condition. The red dotted line(s) are the pre- and/or post-irradiation minimum and/or maximum specification value as defined in the datasheet and/or test plan.

In addition to the radiation test results, the data plots and tables described above contain anneal data. The anneals are performed to better understand the underlying physical mechanisms responsible for radiation-induced parametric shifts and are not part of the criteria used to establish whether or not the lot passes or fails the low dose rate test. In all cases the parts either improved or exhibited no change during the anneal.

The control units, as expected, show no significant changes to any of the parameters. Therefore we can conclude that the electrical testing remained in control throughout the duration of the tests and the observed degradation was due to the radiation exposure. Appendix D lists the figures used in this section to facilitate the location of a particular parameter.

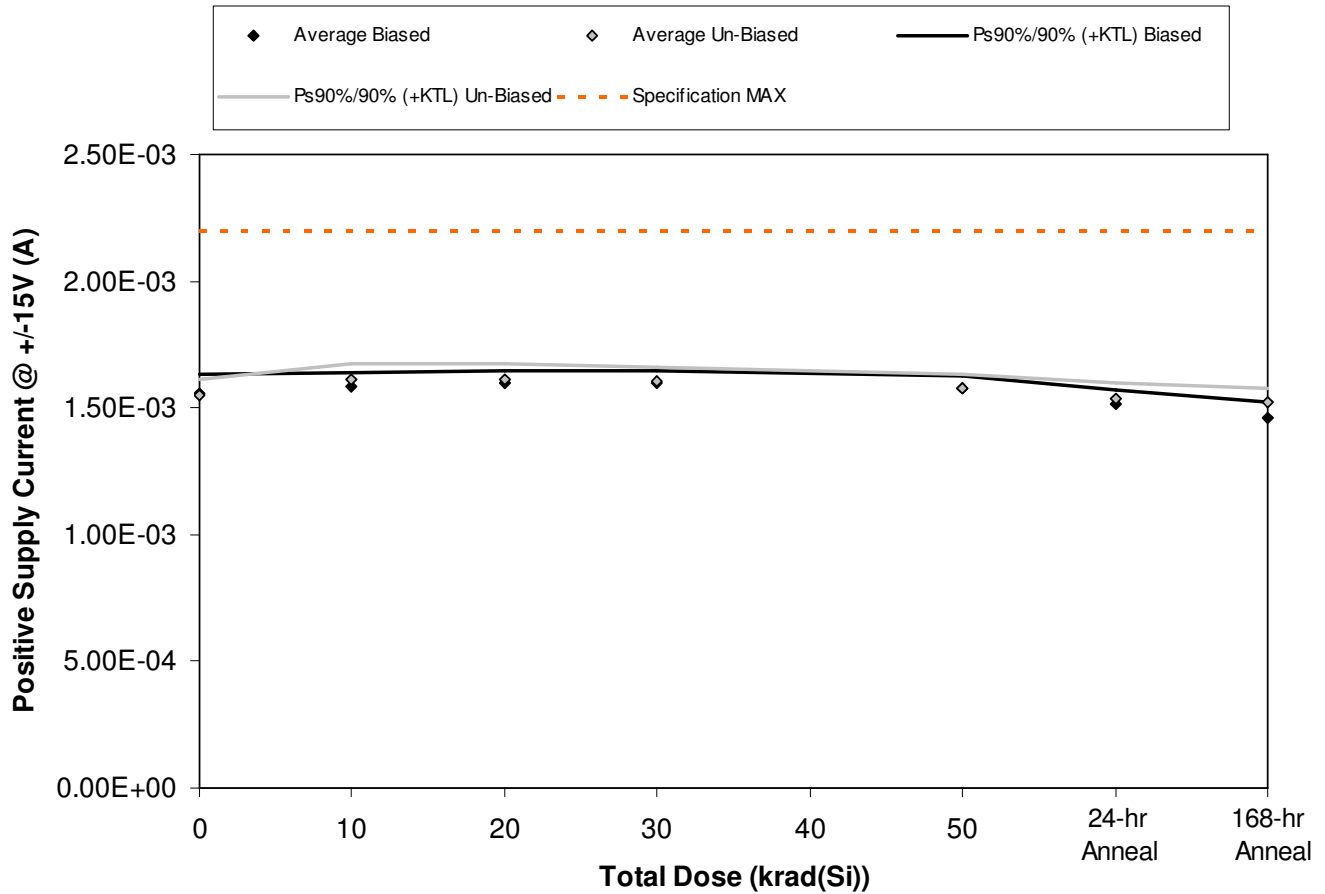

Figure 5.1. Plot of Positive Supply Current @ +/-15V (A) versus total dose. The solid diamonds are the average of the measured data points for the samples irradiated under electrical bias while the shaded diamonds are the average of the measured data points for the samples irradiated with all pins tied to ground. The black lines (solid and/or dashed) are the average of the data points after application of the KTL statistics on the samples irradiated under electrical bias while the gray lines (solid and/or dashed) are the average of the data points after application of the KTL statistics on the samples irradiated in the unbiased condition. The red dotted line(s) are the pre- and/or post-irradiation minimum and/or maximum specification value as defined in the datasheet and/or test plan.



**TID Report
11-572 R1.0**

**Aeroflex RAD
5017 N. 30th Street
Colorado Springs, CO 80919
(719) 531-0800**

Table 5.1. Raw data for Positive Supply Current @ +/-15V (A) versus total dose, including the statistical analysis, specification and the status of the testing (pass/fail).

Positive Supply Current @ +/-15V (A)	Total Dose (krad(Si))					24 hr	168 hr
	0	10	20	30	50	Anneal	Anneal
Device	10/20/2011	11/3/2011	11/3/2011	11/3/2011	11/3/2011	11/4/2011	11/11/2011
1831	1.54E-03	1.58E-03	1.60E-03	1.59E-03	1.58E-03	1.51E-03	1.45E-03
1832	1.58E-03	1.58E-03	1.61E-03	1.61E-03	1.59E-03	1.53E-03	1.48E-03
1833	1.52E-03	1.56E-03	1.58E-03	1.57E-03	1.55E-03	1.49E-03	1.43E-03
1834	1.59E-03	1.61E-03	1.62E-03	1.62E-03	1.59E-03	1.54E-03	1.49E-03
1835	1.56E-03	1.60E-03	1.60E-03	1.60E-03	1.57E-03	1.52E-03	1.46E-03
1836	1.53E-03	1.59E-03	1.59E-03	1.58E-03	1.56E-03	1.52E-03	1.50E-03
1837	1.53E-03	1.60E-03	1.60E-03	1.59E-03	1.57E-03	1.52E-03	1.51E-03
1838	1.58E-03	1.64E-03	1.64E-03	1.63E-03	1.60E-03	1.57E-03	1.55E-03
1839	1.55E-03	1.61E-03	1.61E-03	1.60E-03	1.57E-03	1.53E-03	1.51E-03
1840	1.57E-03	1.63E-03	1.63E-03	1.62E-03	1.59E-03	1.55E-03	1.53E-03
1851	1.53E-03	1.54E-03	1.54E-03	1.54E-03	1.54E-03	1.53E-03	1.53E-03
1852	1.58E-03	1.58E-03	1.58E-03	1.59E-03	1.59E-03	1.58E-03	1.58E-03
Biased Statistics							
Average Biased	1.56E-03	1.58E-03	1.60E-03	1.60E-03	1.57E-03	1.52E-03	1.46E-03
Std Dev Biased	2.73E-05	1.98E-05	1.67E-05	1.81E-05	1.77E-05	1.90E-05	2.16E-05
Ps90%/90% (+KTL) Biased	1.63E-03	1.64E-03	1.65E-03	1.65E-03	1.62E-03	1.57E-03	1.52E-03
Ps90%/90% (-KTL) Biased	1.48E-03	1.53E-03	1.55E-03	1.55E-03	1.53E-03	1.46E-03	1.40E-03
Un-Biased Statistics							
Average Un-Biased	1.55E-03	1.61E-03	1.61E-03	1.61E-03	1.58E-03	1.54E-03	1.52E-03
Std Dev Un-Biased	2.23E-05	2.25E-05	2.10E-05	1.99E-05	1.94E-05	2.17E-05	2.04E-05
Ps90%/90% (+KTL) Un-Biased	1.61E-03	1.67E-03	1.67E-03	1.66E-03	1.63E-03	1.60E-03	1.58E-03
Ps90%/90% (-KTL) Un-Biased	1.49E-03	1.55E-03	1.56E-03	1.55E-03	1.53E-03	1.48E-03	1.46E-03
Specification MAX	2.20E-03	2.20E-03	2.20E-03	2.20E-03	2.20E-03	2.20E-03	2.20E-03
Status	PASS	PASS	PASS	PASS	PASS	PASS	PASS

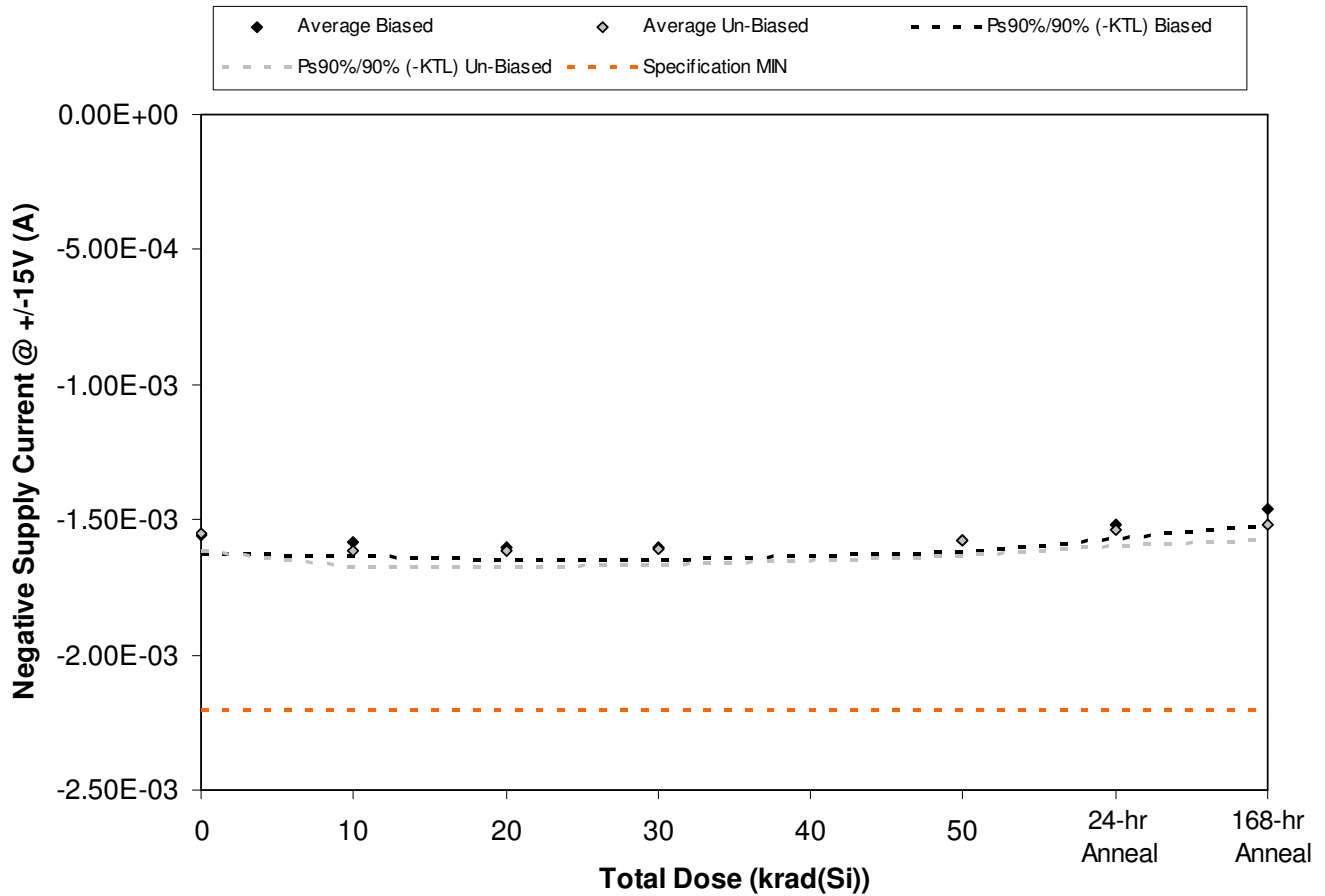

Figure 5.2. Plot of Negative Supply Current @ +/-15V (A) versus total dose. The solid diamonds are the average of the measured data points for the samples irradiated under electrical bias while the shaded diamonds are the average of the measured data points for the samples irradiated with all pins tied to ground. The black lines (solid and/or dashed) are the average of the data points after application of the KTL statistics on the samples irradiated under electrical bias while the gray lines (solid and/or dashed) are the average of the data points after application of the KTL statistics on the samples irradiated in the unbiased condition. The red dotted line(s) are the pre- and/or post-irradiation minimum and/or maximum specification value as defined in the datasheet and/or test plan.



Table 5.2. Raw data for Negative Supply Current @ +/-15V (A) versus total dose, including the statistical analysis, specification and the status of the testing (pass/fail).

Negative Supply Current @ +/-15V (A)	Total Dose (krad(Si))					24 hr	168 hr
	0	10	20	30	50	Anneal	Anneal
Device							
	10/20/2011	11/3/2011	11/3/2011	11/3/2011	11/3/2011	11/4/2011	11/11/2011
1831	-1.54E-03	-1.58E-03	-1.60E-03	-1.59E-03	-1.58E-03	-1.51E-03	-1.45E-03
1832	-1.58E-03	-1.58E-03	-1.61E-03	-1.61E-03	-1.59E-03	-1.53E-03	-1.48E-03
1833	-1.53E-03	-1.56E-03	-1.58E-03	-1.58E-03	-1.55E-03	-1.49E-03	-1.44E-03
1834	-1.59E-03	-1.61E-03	-1.62E-03	-1.62E-03	-1.59E-03	-1.54E-03	-1.49E-03
1835	-1.56E-03	-1.60E-03	-1.60E-03	-1.60E-03	-1.57E-03	-1.52E-03	-1.46E-03
1836	-1.53E-03	-1.59E-03	-1.59E-03	-1.58E-03	-1.56E-03	-1.52E-03	-1.50E-03
1837	-1.53E-03	-1.60E-03	-1.60E-03	-1.59E-03	-1.57E-03	-1.53E-03	-1.51E-03
1838	-1.58E-03	-1.64E-03	-1.64E-03	-1.63E-03	-1.61E-03	-1.57E-03	-1.55E-03
1839	-1.55E-03	-1.61E-03	-1.61E-03	-1.60E-03	-1.57E-03	-1.53E-03	-1.52E-03
1840	-1.57E-03	-1.63E-03	-1.63E-03	-1.62E-03	-1.59E-03	-1.55E-03	-1.53E-03
1851	-1.54E-03	-1.54E-03	-1.54E-03	-1.54E-03	-1.54E-03	-1.53E-03	-1.53E-03
1852	-1.58E-03	-1.58E-03	-1.59E-03	-1.59E-03	-1.59E-03	-1.58E-03	-1.58E-03
Biased Statistics							
Average Biased	-1.56E-03	-1.58E-03	-1.60E-03	-1.60E-03	-1.58E-03	-1.52E-03	-1.46E-03
Std Dev Biased	2.60E-05	1.93E-05	1.67E-05	1.68E-05	1.73E-05	1.87E-05	2.06E-05
Ps90%/90% (+KTL) Biased	-1.49E-03	-1.53E-03	-1.55E-03	-1.55E-03	-1.53E-03	-1.46E-03	-1.40E-03
Ps90%/90% (-KTL) Biased	-1.63E-03	-1.64E-03	-1.65E-03	-1.65E-03	-1.62E-03	-1.57E-03	-1.52E-03
Un-Biased Statistics							
Average Un-Biased	-1.55E-03	-1.61E-03	-1.62E-03	-1.61E-03	-1.58E-03	-1.54E-03	-1.52E-03
Std Dev Un-Biased	2.32E-05	2.28E-05	2.04E-05	2.09E-05	2.01E-05	2.15E-05	2.13E-05
Ps90%/90% (+KTL) Un-Biased	-1.49E-03	-1.55E-03	-1.56E-03	-1.55E-03	-1.52E-03	-1.48E-03	-1.46E-03
Ps90%/90% (-KTL) Un-Biased	-1.61E-03	-1.67E-03	-1.67E-03	-1.66E-03	-1.63E-03	-1.60E-03	-1.58E-03
Specification MIN	-2.20E-03	-2.20E-03	-2.20E-03	-2.20E-03	-2.20E-03	-2.20E-03	-2.20E-03
Status	PASS	PASS	PASS	PASS	PASS	PASS	PASS

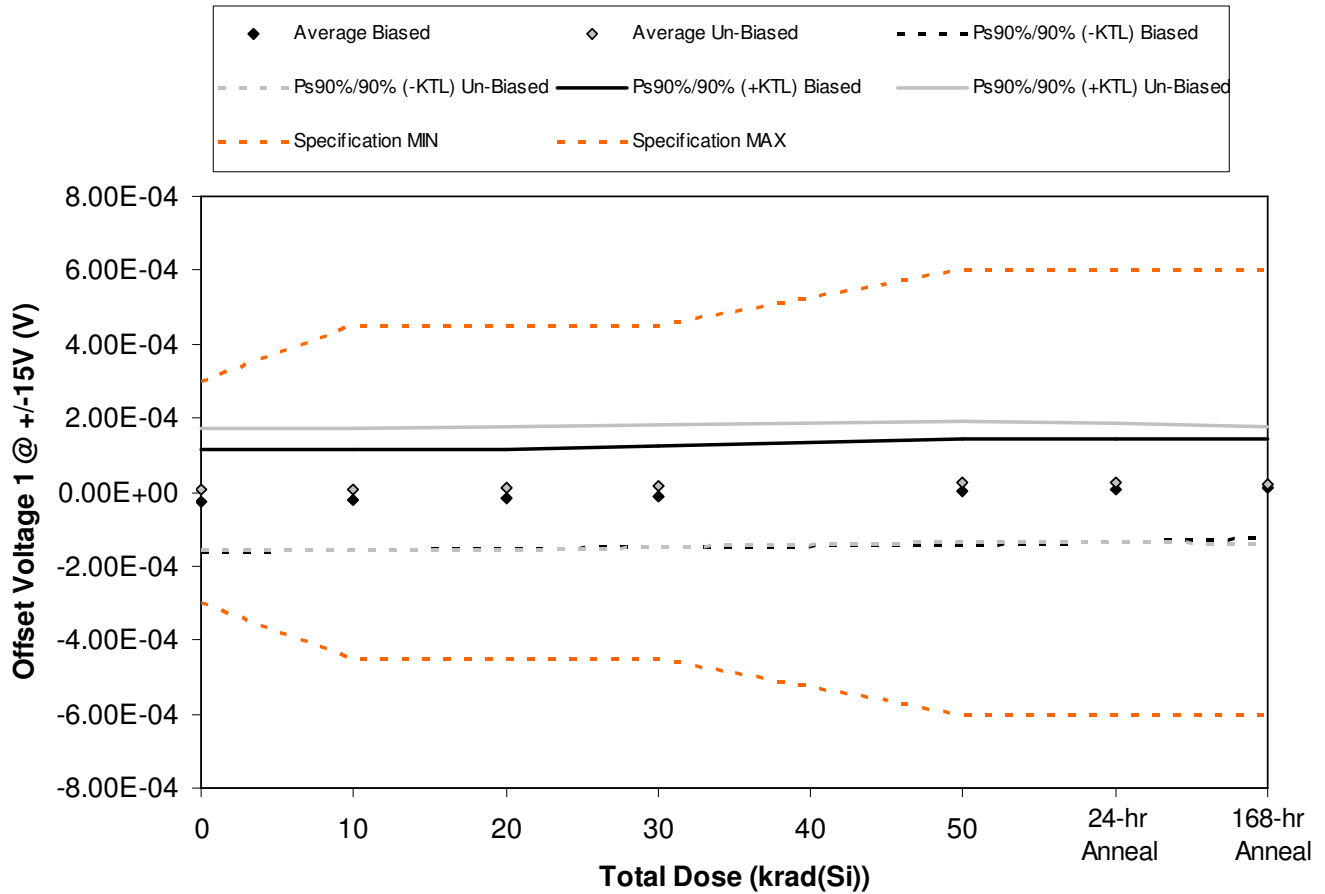

Figure 5.3. Plot of Offset Voltage 1 @ +/-15V (V) versus total dose. The solid diamonds are the average of the measured data points for the samples irradiated under electrical bias while the shaded diamonds are the average of the measured data points for the samples irradiated with all pins tied to ground. The black lines (solid and/or dashed) are the average of the data points after application of the KTL statistics on the samples irradiated under electrical bias while the gray lines (solid and/or dashed) are the average of the data points after application of the KTL statistics on the samples irradiated in the unbiased condition. The red dotted line(s) are the pre- and/or post-irradiation minimum and/or maximum specification value as defined in the datasheet and/or test plan.



**TID Report
11-572 R1.0**

**Aeroflex RAD
5017 N. 30th Street
Colorado Springs, CO 80919
(719) 531-0800**

Table 5.3. Raw data for Offset Voltage 1 @ +/-15V (V) versus total dose, including the statistical analysis, specification and the status of the testing (pass/fail).

Offset Voltage 1 @ +/-15V (V)	Total Dose (krad(Si))					24 hr	168 hr
	0	10	20	30	50	Anneal	Anneal
Device							
	10/20/2011	11/3/2011	11/3/2011	11/3/2011	11/3/2011	11/4/2011	11/11/2011
1831	-5.28E-05	-3.05E-05	-2.65E-05	-2.24E-05	-9.72E-06	-1.88E-06	-1.42E-05
1832	-3.45E-05	-3.28E-05	-3.11E-05	-2.66E-05	-1.48E-05	-8.04E-06	-7.67E-06
1833	5.37E-05	5.32E-05	5.76E-05	6.32E-05	8.02E-05	8.20E-05	8.58E-05
1834	-9.48E-06	-1.34E-05	-1.17E-05	-4.41E-06	8.38E-06	1.91E-05	2.67E-05
1835	-7.78E-05	-8.36E-05	-7.96E-05	-7.31E-05	-6.39E-05	-5.84E-05	-4.18E-05
1836	7.46E-05	7.36E-05	8.01E-05	8.84E-05	1.00E-04	9.74E-05	7.68E-05
1837	-3.34E-05	-3.36E-05	-3.00E-05	-2.34E-05	-1.17E-05	-1.19E-05	1.02E-06
1838	-6.13E-05	-6.18E-05	-5.89E-05	-4.92E-05	-3.83E-05	-3.73E-05	-4.76E-05
1839	6.77E-05	6.55E-05	6.65E-05	7.14E-05	7.79E-05	7.61E-05	8.32E-05
1840	-1.02E-05	-1.02E-05	-6.95E-06	-1.64E-06	6.82E-06	4.88E-06	-1.27E-05
1851	2.72E-05	2.75E-05	2.79E-05	2.79E-05	2.79E-05	2.26E-05	2.75E-05
1852	5.37E-05	5.52E-05	5.55E-05	5.51E-05	5.57E-05	5.34E-05	5.43E-05
Biased Statistics							
Average Biased	-2.42E-05	-2.14E-05	-1.82E-05	-1.27E-05	3.20E-08	6.57E-06	9.76E-06
Std Dev Biased	5.02E-05	4.93E-05	4.95E-05	4.94E-05	5.22E-05	5.09E-05	4.90E-05
Ps90%/90% (+KTL) Biased	1.13E-04	1.14E-04	1.17E-04	1.23E-04	1.43E-04	1.46E-04	1.44E-04
Ps90%/90% (-KTL) Biased	-1.62E-04	-1.57E-04	-1.54E-04	-1.48E-04	-1.43E-04	-1.33E-04	-1.25E-04
Un-Biased Statistics							
Average Un-Biased	7.47E-06	6.69E-06	1.01E-05	1.71E-05	2.70E-05	2.58E-05	2.01E-05
Std Dev Un-Biased	6.09E-05	6.03E-05	6.07E-05	6.00E-05	5.94E-05	5.81E-05	5.75E-05
Ps90%/90% (+KTL) Un-Biased	1.74E-04	1.72E-04	1.77E-04	1.82E-04	1.90E-04	1.85E-04	1.78E-04
Ps90%/90% (-KTL) Un-Biased	-1.59E-04	-1.59E-04	-1.56E-04	-1.48E-04	-1.36E-04	-1.33E-04	-1.38E-04
Specification MIN	-3.00E-04	-4.50E-04	-4.50E-04	-4.50E-04	-6.00E-04	-6.00E-04	-6.00E-04
Status	PASS	PASS	PASS	PASS	PASS	PASS	PASS
Specification MAX	3.00E-04	4.50E-04	4.50E-04	4.50E-04	6.00E-04	6.00E-04	6.00E-04
Status	PASS	PASS	PASS	PASS	PASS	PASS	PASS

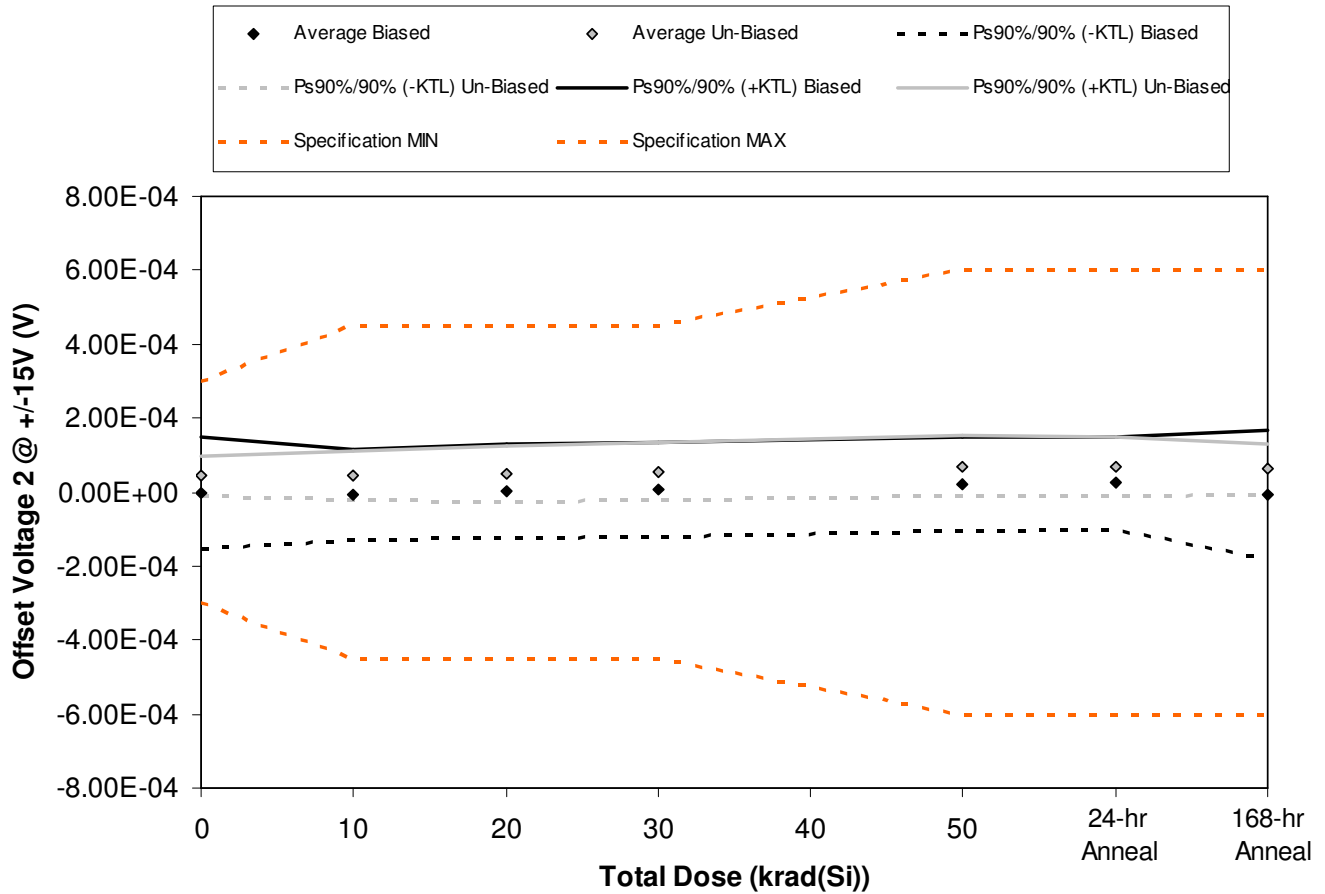

Figure 5.4. Plot of Offset Voltage 2 @ +/-15V (V) versus total dose. The solid diamonds are the average of the measured data points for the samples irradiated under electrical bias while the shaded diamonds are the average of the measured data points for the samples irradiated with all pins tied to ground. The black lines (solid and/or dashed) are the average of the data points after application of the KTL statistics on the samples irradiated under electrical bias while the gray lines (solid and/or dashed) are the average of the data points after application of the KTL statistics on the samples irradiated in the unbiased condition. The red dotted line(s) are the pre- and/or post-irradiation minimum and/or maximum specification value as defined in the datasheet and/or test plan.



**TID Report
11-572 R1.0**

**Aeroflex RAD
5017 N. 30th Street
Colorado Springs, CO 80919
(719) 531-0800**

Table 5.4. Raw data for Offset Voltage 2 @ +/-15V (V) versus total dose, including the statistical analysis, specification and the status of the testing (pass/fail).

Offset Voltage 2 @ +/-15V (V)	Total Dose (krad(Si))					24 hr	168 hr
	0	10	20	30	50	Anneal	Anneal
Device							
	10/20/2011	11/3/2011	11/3/2011	11/3/2011	11/3/2011	11/4/2011	11/11/2011
1831	-8.40E-05	-5.78E-05	-5.16E-05	-4.59E-05	-3.51E-05	-3.39E-05	-4.58E-05
1832	-4.29E-06	-2.80E-05	-1.73E-05	-1.27E-05	-2.00E-06	6.20E-06	-8.98E-05
1833	-2.11E-05	-2.37E-05	-2.04E-05	-1.32E-05	1.50E-06	3.79E-06	-1.88E-06
1834	4.57E-05	3.82E-05	4.94E-05	5.69E-05	6.79E-05	7.01E-05	5.46E-05
1835	4.85E-05	4.46E-05	5.17E-05	5.76E-05	7.04E-05	7.30E-05	5.57E-05
1836	1.49E-05	1.32E-05	1.38E-05	1.91E-05	3.14E-05	3.25E-05	3.13E-05
1837	5.87E-05	5.91E-05	6.20E-05	6.96E-05	8.84E-05	8.63E-05	9.12E-05
1838	4.85E-05	4.71E-05	5.08E-05	5.69E-05	7.01E-05	7.06E-05	6.10E-05
1839	5.91E-05	7.56E-05	8.63E-05	9.36E-05	1.09E-04	1.03E-04	8.11E-05
1840	3.19E-05	3.21E-05	3.58E-05	4.23E-05	5.10E-05	4.57E-05	4.55E-05
1851	4.93E-05	5.04E-05	5.06E-05	5.02E-05	4.98E-05	4.87E-05	4.98E-05
1852	-2.94E-05	-2.90E-05	-2.96E-05	-2.93E-05	-2.93E-05	-2.97E-05	-2.90E-05
Biased Statistics							
Average Biased	-3.03E-06	-5.33E-06	2.37E-06	8.53E-06	2.06E-05	2.38E-05	-5.43E-06
Std Dev Biased	5.46E-05	4.47E-05	4.60E-05	4.65E-05	4.66E-05	4.64E-05	6.34E-05
Ps90%/90% (+KTL) Biased	1.47E-04	1.17E-04	1.29E-04	1.36E-04	1.48E-04	1.51E-04	1.69E-04
Ps90%/90% (-KTL) Biased	-1.53E-04	-1.28E-04	-1.24E-04	-1.19E-04	-1.07E-04	-1.03E-04	-1.79E-04
Un-Biased Statistics							
Average Un-Biased	4.26E-05	4.54E-05	4.97E-05	5.63E-05	7.00E-05	6.76E-05	6.20E-05
Std Dev Un-Biased	1.90E-05	2.41E-05	2.72E-05	2.80E-05	3.05E-05	2.88E-05	2.47E-05
Ps90%/90% (+KTL) Un-Biased	9.48E-05	1.11E-04	1.24E-04	1.33E-04	1.54E-04	1.47E-04	1.30E-04
Ps90%/90% (-KTL) Un-Biased	-9.53E-06	-2.06E-05	-2.50E-05	-2.06E-05	-1.35E-05	-1.13E-05	-5.61E-06
Specification MIN	-3.00E-04	-4.50E-04	-4.50E-04	-4.50E-04	-6.00E-04	-6.00E-04	-6.00E-04
Status	PASS	PASS	PASS	PASS	PASS	PASS	PASS
Specification MAX	3.00E-04	4.50E-04	4.50E-04	4.50E-04	6.00E-04	6.00E-04	6.00E-04
Status	PASS	PASS	PASS	PASS	PASS	PASS	PASS

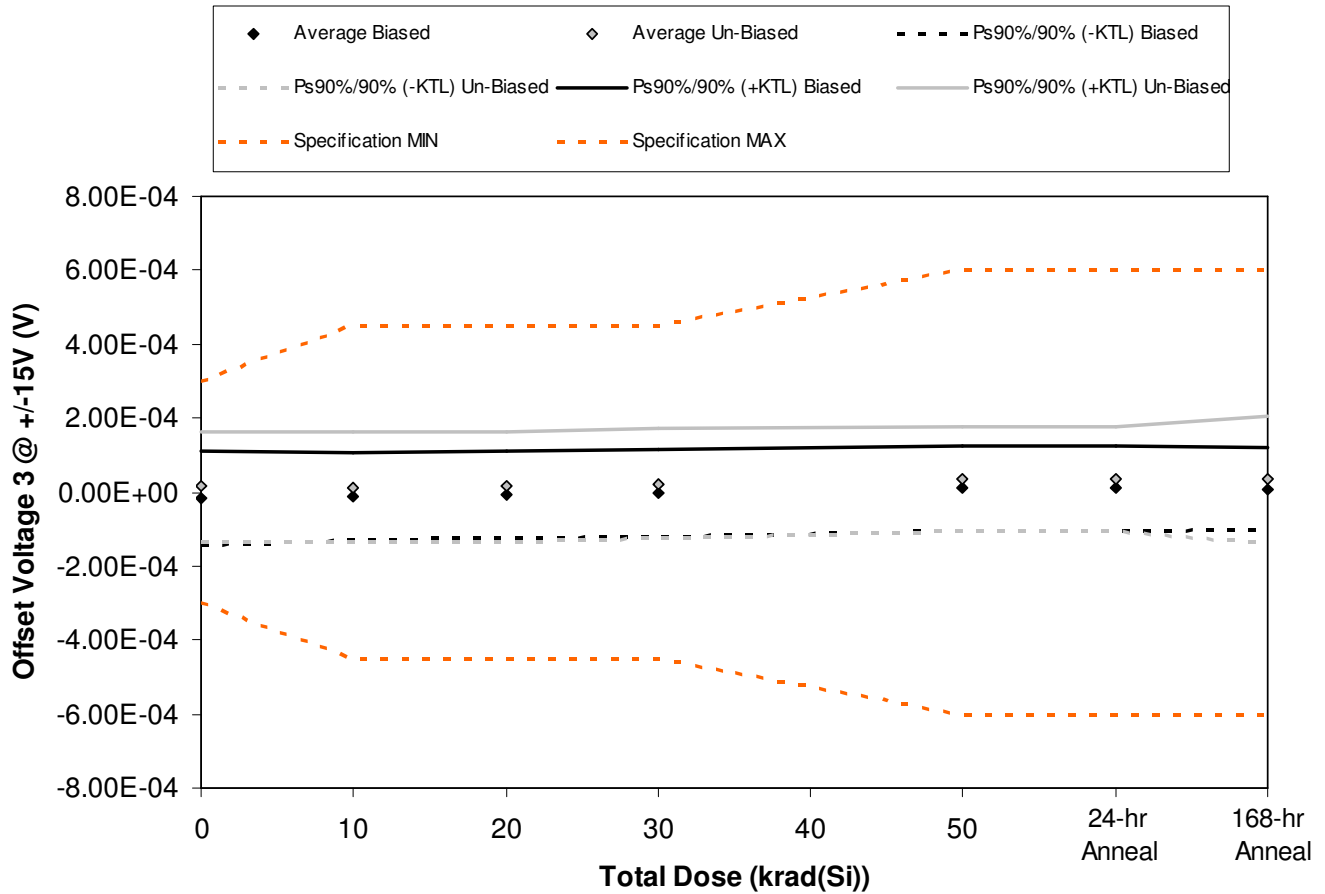

Figure 5.5. Plot of Offset Voltage 3 @ +/-15V (V) versus total dose. The solid diamonds are the average of the measured data points for the samples irradiated under electrical bias while the shaded diamonds are the average of the measured data points for the samples irradiated with all pins tied to ground. The black lines (solid and/or dashed) are the average of the data points after application of the KTL statistics on the samples irradiated under electrical bias while the gray lines (solid and/or dashed) are the average of the data points after application of the KTL statistics on the samples irradiated in the unbiased condition. The red dotted line(s) are the pre- and/or post-irradiation minimum and/or maximum specification value as defined in the datasheet and/or test plan.



**TID Report
11-572 R1.0**

**Aeroflex RAD
5017 N. 30th Street
Colorado Springs, CO 80919
(719) 531-0800**

Table 5.5. Raw data for Offset Voltage 3 @ +/-15V (V) versus total dose, including the statistical analysis, specification and the status of the testing (pass/fail).

Offset Voltage 3 @ +/-15V (V)	Total Dose (krad(Si))					24 hr	168 hr
	0	10	20	30	50	Anneal	Anneal
Device	10/20/2011	11/3/2011	11/3/2011	11/3/2011	11/3/2011	11/4/2011	11/11/2011
1831	-5.46E-05	-2.20E-05	-1.60E-05	-1.27E-05	-2.48E-06	-2.25E-06	-9.72E-06
1832	-4.17E-05	-4.29E-05	-3.92E-05	-3.64E-05	-2.47E-05	-2.56E-05	-1.71E-05
1833	-5.79E-05	-6.15E-05	-5.46E-05	-4.66E-05	-3.33E-05	-3.05E-05	-3.45E-05
1834	3.01E-05	2.87E-05	3.53E-05	4.17E-05	5.27E-05	5.29E-05	4.16E-05
1835	3.65E-05	3.70E-05	3.91E-05	4.68E-05	5.56E-05	5.67E-05	5.98E-05
1836	3.16E-05	3.24E-05	3.31E-05	3.94E-05	4.75E-05	4.85E-05	5.34E-05
1837	-6.47E-05	-6.68E-05	-6.41E-05	-5.89E-05	-4.59E-05	-4.45E-05	-6.12E-05
1838	2.69E-05	2.55E-05	2.84E-05	3.95E-05	5.32E-05	5.40E-05	6.42E-05
1839	-2.84E-06	-3.93E-06	-1.88E-06	6.57E-06	2.13E-05	1.97E-05	9.59E-06
1840	8.22E-05	8.08E-05	8.29E-05	8.75E-05	9.41E-05	9.37E-05	1.05E-04
1851	-1.46E-05	-1.34E-05	-1.31E-05	-1.30E-05	-1.41E-05	-1.43E-05	-1.47E-05
1852	1.64E-05	1.48E-05	1.53E-05	1.56E-05	1.61E-05	1.44E-05	1.50E-05
Biased Statistics							
Average Biased	-1.75E-05	-1.22E-05	-7.09E-06	-1.44E-06	9.57E-06	1.03E-05	8.03E-06
Std Dev Biased	4.69E-05	4.35E-05	4.27E-05	4.35E-05	4.22E-05	4.21E-05	4.05E-05
Ps90%/90% (+KTL) Biased	1.11E-04	1.07E-04	1.10E-04	1.18E-04	1.25E-04	1.26E-04	1.19E-04
Ps90%/90% (-KTL) Biased	-1.46E-04	-1.31E-04	-1.24E-04	-1.21E-04	-1.06E-04	-1.05E-04	-1.03E-04
Un-Biased Statistics							
Average Un-Biased	1.46E-05	1.36E-05	1.57E-05	2.28E-05	3.40E-05	3.43E-05	3.42E-05
Std Dev Un-Biased	5.38E-05	5.43E-05	5.40E-05	5.40E-05	5.18E-05	5.13E-05	6.32E-05
Ps90%/90% (+KTL) Un-Biased	1.62E-04	1.62E-04	1.64E-04	1.71E-04	1.76E-04	1.75E-04	2.07E-04
Ps90%/90% (-KTL) Un-Biased	-1.33E-04	-1.35E-04	-1.32E-04	-1.25E-04	-1.08E-04	-1.06E-04	-1.39E-04
Specification MIN	-3.00E-04	-4.50E-04	-4.50E-04	-4.50E-04	-6.00E-04	-6.00E-04	-6.00E-04
Status	PASS	PASS	PASS	PASS	PASS	PASS	PASS
Specification MAX	3.00E-04	4.50E-04	4.50E-04	4.50E-04	6.00E-04	6.00E-04	6.00E-04
Status	PASS	PASS	PASS	PASS	PASS	PASS	PASS

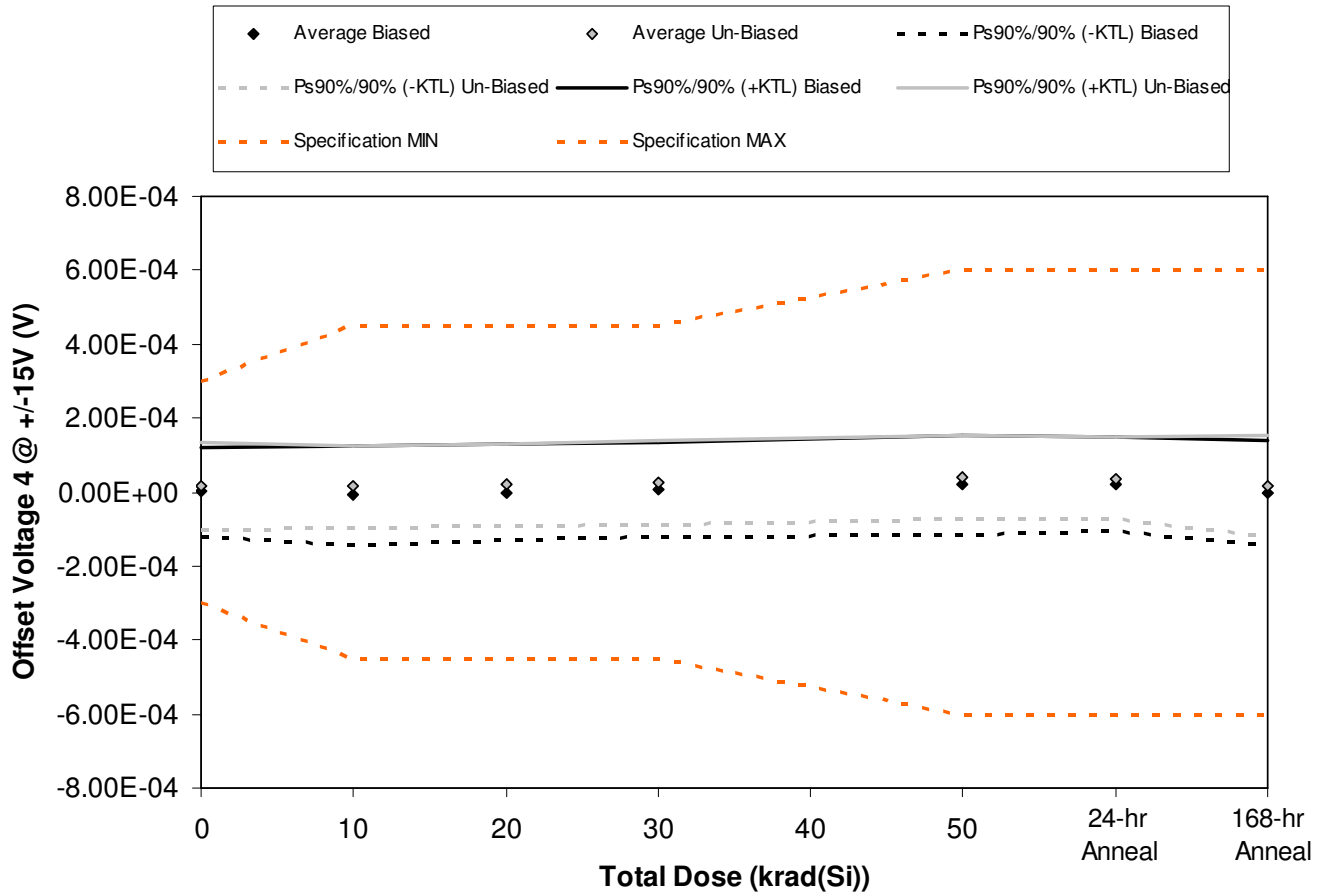

Figure 5.6. Plot of Offset Voltage 4 @ +/-15V (V) versus total dose. The solid diamonds are the average of the measured data points for the samples irradiated under electrical bias while the shaded diamonds are the average of the measured data points for the samples irradiated with all pins tied to ground. The black lines (solid and/or dashed) are the average of the data points after application of the KTL statistics on the samples irradiated under electrical bias while the gray lines (solid and/or dashed) are the average of the data points after application of the KTL statistics on the samples irradiated in the unbiased condition. The red dotted line(s) are the pre- and/or post-irradiation minimum and/or maximum specification value as defined in the datasheet and/or test plan.



**TID Report
11-572 R1.0**

**Aeroflex RAD
5017 N. 30th Street
Colorado Springs, CO 80919
(719) 531-0800**

Table 5.6. Raw data for Offset Voltage 4 @ +/-15V (V) versus total dose, including the statistical analysis, specification and the status of the testing (pass/fail).

Offset Voltage 4 @ +/-15V (V)	Total Dose (krad(Si))					24 hr	168 hr
	0	10	20	30	50	Anneal	Anneal
Device							
	10/20/2011	11/3/2011	11/3/2011	11/3/2011	11/3/2011	11/4/2011	11/11/2011
1831	-3.70E-05	-2.78E-05	-1.76E-05	-1.06E-05	4.28E-06	7.65E-06	-8.15E-06
1832	6.38E-05	6.45E-05	6.86E-05	7.50E-05	9.16E-05	8.88E-05	8.03E-05
1833	3.05E-05	1.62E-05	2.41E-05	3.23E-05	4.56E-05	4.54E-05	-1.85E-05
1834	-2.55E-05	-3.25E-05	-2.66E-05	-1.95E-05	-1.17E-05	-6.59E-06	-3.10E-07
1835	-3.04E-05	-6.10E-05	-5.25E-05	-4.39E-05	-3.03E-05	-2.80E-05	-6.18E-05
1836	-2.98E-05	-3.13E-05	-2.74E-05	-1.90E-05	-3.93E-06	-4.54E-06	-2.29E-05
1837	5.66E-05	5.58E-05	5.96E-05	6.75E-05	8.28E-05	7.86E-05	4.85E-05
1838	-1.03E-06	7.80E-07	7.78E-06	1.52E-05	2.89E-05	2.34E-05	-1.06E-05
1839	6.61E-05	5.90E-05	6.48E-05	7.04E-05	8.18E-05	8.18E-05	8.69E-05
1840	-1.13E-05	-1.09E-05	-8.27E-06	-3.69E-06	7.06E-06	5.12E-06	-2.39E-05
1851	9.23E-05	9.28E-05	9.27E-05	9.30E-05	9.34E-05	9.07E-05	9.33E-05
1852	1.23E-04	1.23E-04	1.22E-04	1.23E-04	1.23E-04	1.22E-04	1.23E-04
Biased Statistics							
Average Biased	2.72E-07	-8.13E-06	-7.90E-07	6.67E-06	1.99E-05	2.15E-05	-1.68E-06
Std Dev Biased	4.46E-05	4.91E-05	4.76E-05	4.71E-05	4.89E-05	4.62E-05	5.16E-05
Ps90%/90% (+KTL) Biased	1.22E-04	1.27E-04	1.30E-04	1.36E-04	1.54E-04	1.48E-04	1.40E-04
Ps90%/90% (-KTL) Biased	-1.22E-04	-1.43E-04	-1.31E-04	-1.22E-04	-1.14E-04	-1.05E-04	-1.43E-04
Un-Biased Statistics							
Average Un-Biased	1.61E-05	1.47E-05	1.93E-05	2.61E-05	3.93E-05	3.69E-05	1.56E-05
Std Dev Un-Biased	4.27E-05	4.07E-05	4.11E-05	4.10E-05	4.10E-05	4.08E-05	4.97E-05
Ps90%/90% (+KTL) Un-Biased	1.33E-04	1.26E-04	1.32E-04	1.39E-04	1.52E-04	1.49E-04	1.52E-04
Ps90%/90% (-KTL) Un-Biased	-1.01E-04	-9.69E-05	-9.34E-05	-8.64E-05	-7.30E-05	-7.51E-05	-1.21E-04
Specification MIN	-3.00E-04	-4.50E-04	-4.50E-04	-4.50E-04	-6.00E-04	-6.00E-04	-6.00E-04
Status	PASS	PASS	PASS	PASS	PASS	PASS	PASS
Specification MAX	3.00E-04	4.50E-04	4.50E-04	4.50E-04	6.00E-04	6.00E-04	6.00E-04
Status	PASS	PASS	PASS	PASS	PASS	PASS	PASS

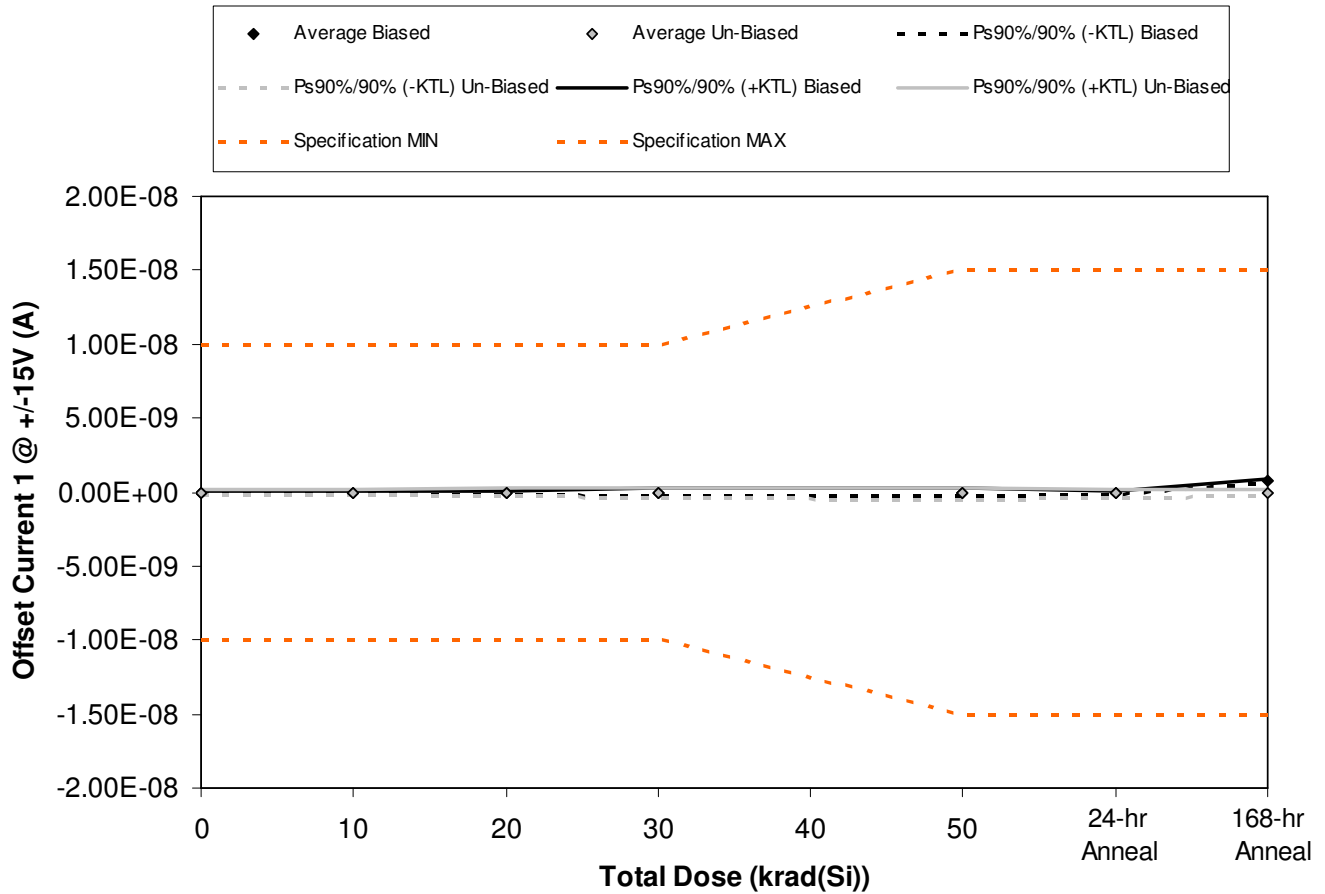

Figure 5.7. Plot of Offset Current 1 @ +/-15V (A) versus total dose. The solid diamonds are the average of the measured data points for the samples irradiated under electrical bias while the shaded diamonds are the average of the measured data points for the samples irradiated with all pins tied to ground. The black lines (solid and/or dashed) are the average of the data points after application of the KTL statistics on the samples irradiated under electrical bias while the gray lines (solid and/or dashed) are the average of the data points after application of the KTL statistics on the samples irradiated in the unbiased condition. The red dotted line(s) are the pre- and/or post-irradiation minimum and/or maximum specification value as defined in the datasheet and/or test plan.



**TID Report
11-572 R1.0**

**Aeroflex RAD
5017 N. 30th Street
Colorado Springs, CO 80919
(719) 531-0800**

Table 5.7. Raw data for Offset Current 1 @ +/-15V (A) versus total dose, including the statistical analysis, specification and the status of the testing (pass/fail).

Offset Current 1 @ +/-15V (A)	Total Dose (krad(Si))					24 hr	168 hr
	0	10	20	30	50	Anneal	Anneal
Device	0	10	20	30	50		
	10/20/2011	11/3/2011	11/3/2011	11/3/2011	11/3/2011	11/4/2011	11/11/2011
1831	3.50E-11	-4.40E-11	3.00E-11	2.30E-11	5.40E-11	-3.30E-11	7.28E-10
1832	-5.10E-11	-7.90E-11	-1.11E-10	-2.23E-10	-1.94E-10	-6.00E-11	8.54E-10
1833	-6.00E-12	-4.20E-11	-7.70E-11	-4.60E-11	-7.60E-11	-2.20E-11	7.71E-10
1834	7.00E-12	-5.50E-11	-6.30E-11	2.90E-11	9.10E-11	-7.00E-12	7.72E-10
1835	1.00E-11	-2.80E-11	-5.30E-11	-1.10E-11	1.40E-11	4.20E-11	7.92E-10
1836	-9.70E-11	-1.00E-10	-1.48E-10	-2.28E-10	-1.75E-10	-6.20E-11	-9.20E-11
1837	-3.00E-12	-2.90E-11	-2.30E-11	-1.00E-12	-1.94E-10	-8.90E-11	-1.05E-10
1838	-4.70E-11	2.10E-11	2.20E-11	-5.20E-11	-2.01E-10	-2.20E-10	-7.50E-11
1839	2.00E-12	2.00E-12	-8.00E-12	-1.05E-10	-1.05E-10	-1.45E-10	-1.58E-10
1840	4.50E-11	8.60E-11	1.04E-10	1.54E-10	1.85E-10	6.70E-11	4.80E-11
1851	2.90E-11	6.00E-12	4.10E-11	0.00E+00	3.50E-11	6.10E-11	1.30E-11
1852	-1.50E-11	-9.00E-12	8.00E-12	9.00E-12	-3.00E-12	-1.10E-11	4.00E-12
Biased Statistics							
Average Biased	-1.00E-12	-4.96E-11	-5.48E-11	-4.56E-11	-2.22E-11	-1.60E-11	7.83E-10
Std Dev Biased	3.16E-11	1.90E-11	5.22E-11	1.04E-10	1.14E-10	3.78E-11	4.59E-11
Ps90%/90% (+KTL) Biased	8.58E-11	2.59E-12	8.84E-11	2.38E-10	2.91E-10	8.76E-11	9.09E-10
Ps90%/90% (-KTL) Biased	-8.78E-11	-1.02E-10	-1.98E-10	-3.30E-10	-3.36E-10	-1.20E-10	6.58E-10
Un-Biased Statistics							
Average Un-Biased	-2.00E-11	-4.00E-12	-1.06E-11	-4.64E-11	-9.80E-11	-8.98E-11	-7.64E-11
Std Dev Un-Biased	5.40E-11	6.82E-11	9.12E-11	1.40E-10	1.63E-10	1.06E-10	7.62E-11
Ps90%/90% (+KTL) Un-Biased	1.28E-10	1.83E-10	2.39E-10	3.38E-10	3.48E-10	2.02E-10	1.32E-10
Ps90%/90% (-KTL) Un-Biased	-1.68E-10	-1.91E-10	-2.61E-10	-4.31E-10	-5.44E-10	-3.82E-10	-2.85E-10
Specification MIN	-1.00E-08	-1.00E-08	-1.00E-08	-1.00E-08	-1.50E-08	-1.50E-08	-1.50E-08
Status	PASS	PASS	PASS	PASS	PASS	PASS	PASS
Specification MAX	1.00E-08	1.00E-08	1.00E-08	1.00E-08	1.50E-08	1.50E-08	1.50E-08
Status	PASS	PASS	PASS	PASS	PASS	PASS	PASS

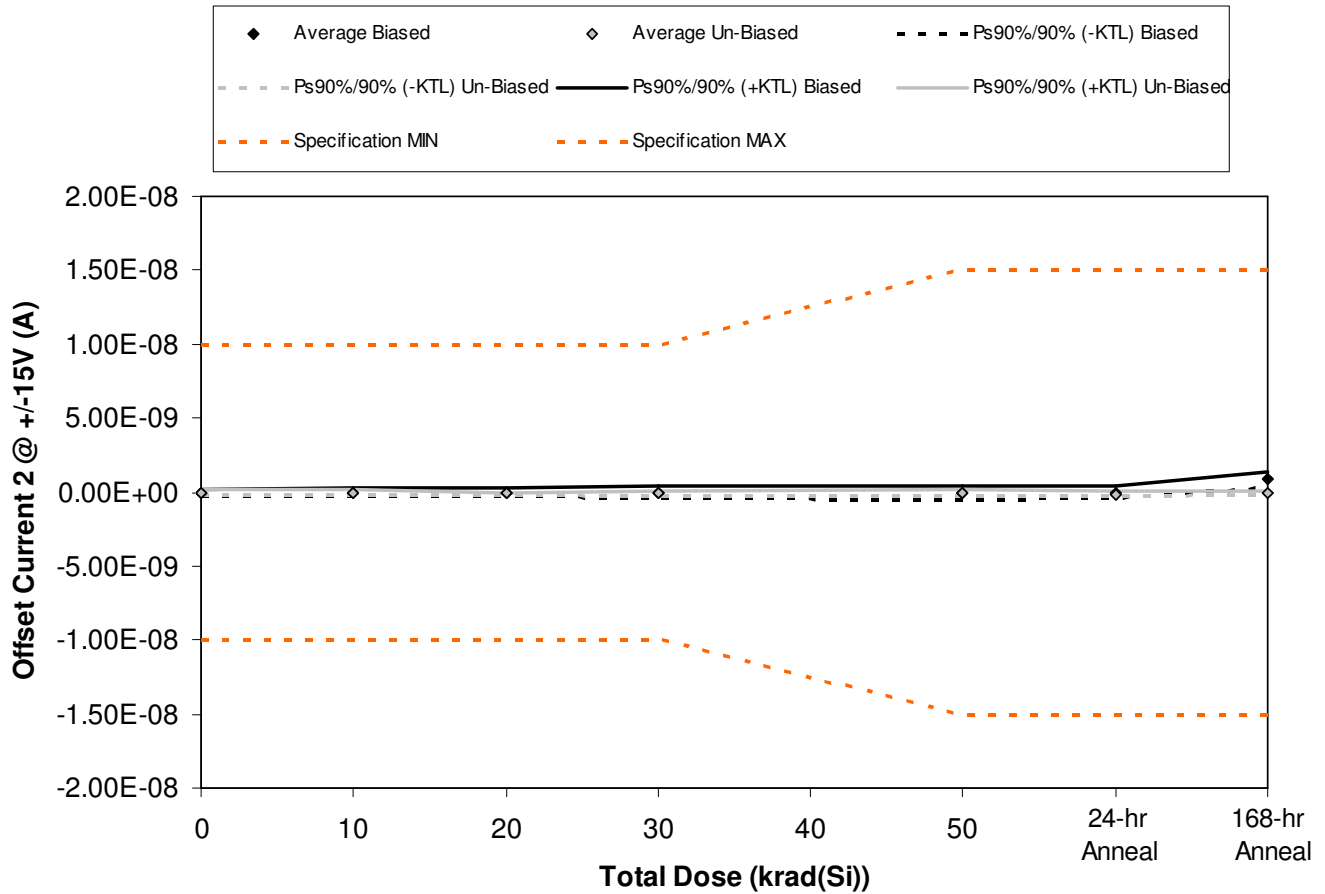

Figure 5.8. Plot of Offset Current 2 @ +/-15V (A) versus total dose. The solid diamonds are the average of the measured data points for the samples irradiated under electrical bias while the shaded diamonds are the average of the measured data points for the samples irradiated with all pins tied to ground. The black lines (solid and/or dashed) are the average of the data points after application of the KTL statistics on the samples irradiated under electrical bias while the gray lines (solid and/or dashed) are the average of the data points after application of the KTL statistics on the samples irradiated in the unbiased condition. The red dotted line(s) are the pre- and/or post-irradiation minimum and/or maximum specification value as defined in the datasheet and/or test plan.



**TID Report
11-572 R1.0**

**Aeroflex RAD
5017 N. 30th Street
Colorado Springs, CO 80919
(719) 531-0800**

Table 5.8. Raw data for Offset Current 2 @ +/-15V (A) versus total dose, including the statistical analysis, specification and the status of the testing (pass/fail).

Offset Current 2 @ +/-15V (A)	Total Dose (krad(Si))					24 hr	168 hr
	0	10	20	30	50	Anneal	Anneal
Device	0	10	20	30	50		
	10/20/2011	11/3/2011	11/3/2011	11/3/2011	11/3/2011	11/4/2011	11/11/2011
1831	5.30E-11	3.70E-11	7.80E-11	1.20E-10	8.60E-11	1.27E-10	9.95E-10
1832	-1.53E-10	-2.25E-10	-1.93E-10	-2.60E-10	-2.71E-10	-1.94E-10	7.25E-10
1833	-7.30E-11	-7.10E-11	-5.90E-11	-1.22E-10	-1.94E-10	-1.72E-10	8.22E-10
1834	-3.00E-12	2.80E-11	2.60E-11	1.20E-11	1.35E-10	1.53E-10	1.13E-09
1835	-3.80E-11	-1.40E-11	1.70E-11	4.10E-11	-4.90E-11	-3.60E-11	6.63E-10
1836	-9.00E-12	-1.50E-11	-4.40E-11	-3.30E-11	-6.30E-11	-5.10E-11	-4.70E-11
1837	2.70E-11	-4.60E-11	-6.70E-11	-3.80E-11	-6.50E-11	-1.30E-10	-4.50E-11
1838	-6.20E-11	-3.00E-11	-8.80E-11	-1.36E-10	-2.50E-10	-1.98E-10	-1.70E-11
1839	-1.04E-10	-1.43E-10	-8.90E-11	-1.67E-10	-1.31E-10	-2.18E-10	5.60E-11
1840	8.00E-12	1.50E-11	-4.90E-11	-9.50E-11	-4.00E-11	-5.40E-11	1.60E-11
1851	-1.43E-10	-1.40E-10	-1.32E-10	-1.56E-10	-1.33E-10	-1.35E-10	-1.54E-10
1852	-1.77E-10	-1.77E-10	-1.53E-10	-1.62E-10	-1.65E-10	-1.89E-10	-1.44E-10
Biased Statistics							
Average Biased	-4.28E-11	-4.90E-11	-2.62E-11	-4.18E-11	-5.86E-11	-2.44E-11	8.68E-10
Std Dev Biased	7.72E-11	1.07E-10	1.05E-10	1.50E-10	1.75E-10	1.62E-10	1.94E-10
Ps90%/90% (+KTL) Biased	1.69E-10	2.45E-10	2.63E-10	3.69E-10	4.20E-10	4.20E-10	1.40E-09
Ps90%/90% (-KTL) Biased	-2.54E-10	-3.43E-10	-3.15E-10	-4.53E-10	-5.37E-10	-4.69E-10	3.35E-10
Un-Biased Statistics							
Average Un-Biased	-2.80E-11	-4.38E-11	-6.74E-11	-9.38E-11	-1.10E-10	-1.30E-10	-7.40E-12
Std Dev Un-Biased	5.39E-11	5.98E-11	2.11E-11	5.91E-11	8.54E-11	7.81E-11	4.37E-11
Ps90%/90% (+KTL) Un-Biased	1.20E-10	1.20E-10	-9.60E-12	6.81E-11	1.24E-10	8.39E-11	1.12E-10
Ps90%/90% (-KTL) Un-Biased	-1.76E-10	-2.08E-10	-1.25E-10	-2.56E-10	-3.44E-10	-3.44E-10	-1.27E-10
Specification MIN	-1.00E-08	-1.00E-08	-1.00E-08	-1.00E-08	-1.50E-08	-1.50E-08	-1.50E-08
Status	PASS	PASS	PASS	PASS	PASS	PASS	PASS
Specification MAX	1.00E-08	1.00E-08	1.00E-08	1.00E-08	1.50E-08	1.50E-08	1.50E-08
Status	PASS	PASS	PASS	PASS	PASS	PASS	PASS

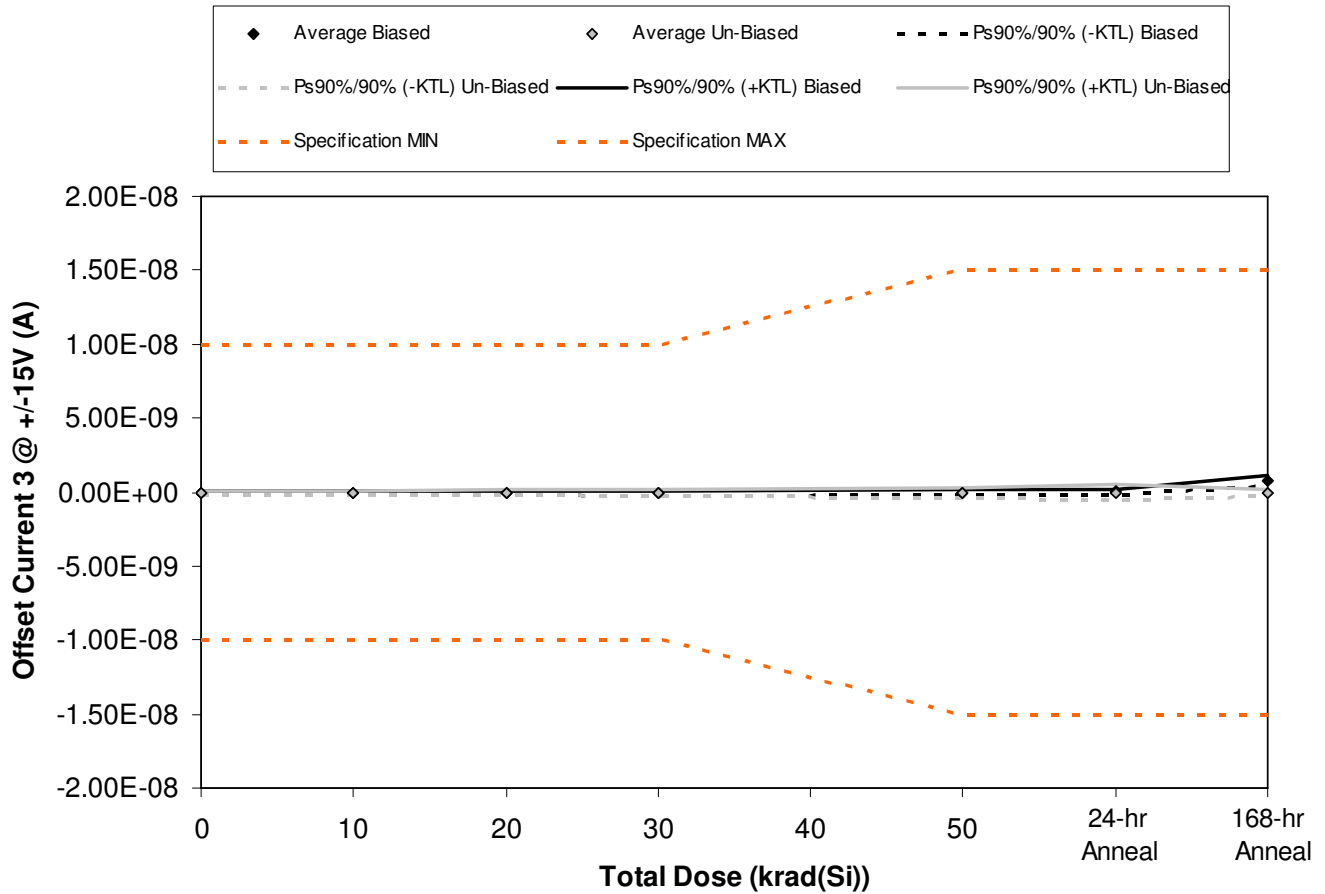

Figure 5.9. Plot of Offset Current 3 @ +/-15V (A) versus total dose. The solid diamonds are the average of the measured data points for the samples irradiated under electrical bias while the shaded diamonds are the average of the measured data points for the samples irradiated with all pins tied to ground. The black lines (solid and/or dashed) are the average of the data points after application of the KTL statistics on the samples irradiated under electrical bias while the gray lines (solid and/or dashed) are the average of the data points after application of the KTL statistics on the samples irradiated in the unbiased condition. The red dotted line(s) are the pre- and/or post-irradiation minimum and/or maximum specification value as defined in the datasheet and/or test plan.



**TID Report
11-572 R1.0**

**Aeroflex RAD
5017 N. 30th Street
Colorado Springs, CO 80919
(719) 531-0800**

Table 5.9. Raw data for Offset Current 3 @ +/-15V (A) versus total dose, including the statistical analysis, specification and the status of the testing (pass/fail).

Offset Current 3 @ +/-15V (A)	Total Dose (krad(Si))					24 hr	168 hr
	0	10	20	30	50	Anneal	Anneal
Device	10/20/2011	11/3/2011	11/3/2011	11/3/2011	11/3/2011	11/4/2011	11/11/2011
1831	1.40E-11	-3.50E-11	-1.10E-11	-1.30E-11	7.00E-12	2.60E-11	8.61E-10
1832	-1.60E-11	-3.30E-11	-4.90E-11	-2.50E-11	-8.90E-11	-4.70E-11	7.44E-10
1833	-3.10E-11	-3.90E-11	-1.02E-10	-1.36E-10	-1.25E-10	-7.10E-11	5.93E-10
1834	-4.60E-11	-3.90E-11	-2.00E-11	-1.10E-11	5.10E-11	9.70E-11	8.72E-10
1835	-4.70E-11	-8.30E-11	-7.40E-11	-1.30E-10	-3.00E-12	2.00E-11	8.31E-10
1836	6.00E-12	-2.70E-11	-5.70E-11	-4.00E-12	1.00E-11	1.88E-10	2.80E-11
1837	-9.80E-11	-1.01E-10	-1.34E-10	-7.70E-11	-2.70E-11	-9.00E-11	4.20E-11
1838	-6.40E-11	-4.20E-11	-3.70E-11	-1.67E-10	-2.08E-10	-2.49E-10	-1.77E-10
1839	-6.00E-11	-5.30E-11	6.30E-11	2.00E-11	-1.31E-10	-3.00E-11	-9.00E-12
1840	-8.80E-11	-3.80E-11	-1.40E-11	7.00E-12	1.22E-10	1.36E-10	1.40E-11
1851	-1.24E-10	-1.74E-10	-1.55E-10	-1.48E-10	-1.29E-10	-1.67E-10	-1.48E-10
1852	1.25E-10	1.19E-10	7.90E-11	1.00E-10	1.10E-10	1.07E-10	1.00E-10
Biased Statistics							
Average Biased	-2.52E-11	-4.58E-11	-5.12E-11	-6.30E-11	-3.18E-11	5.00E-12	7.80E-10
Std Dev Biased	2.53E-11	2.10E-11	3.77E-11	6.42E-11	7.27E-11	6.64E-11	1.16E-10
Ps90%/90% (+KTL) Biased	4.42E-11	1.17E-11	5.23E-11	1.13E-10	1.68E-10	1.87E-10	1.10E-09
Ps90%/90% (-KTL) Biased	-9.46E-11	-1.03E-10	-1.55E-10	-2.39E-10	-2.31E-10	-1.77E-10	4.62E-10
Un-Biased Statistics							
Average Un-Biased	-6.08E-11	-5.22E-11	-3.58E-11	-4.42E-11	-4.68E-11	-9.00E-12	-2.04E-11
Std Dev Un-Biased	4.06E-11	2.88E-11	7.13E-11	7.83E-11	1.28E-10	1.76E-10	8.95E-11
Ps90%/90% (+KTL) Un-Biased	5.06E-11	2.68E-11	1.60E-10	1.70E-10	3.03E-10	4.75E-10	2.25E-10
Ps90%/90% (-KTL) Un-Biased	-1.72E-10	-1.31E-10	-2.31E-10	-2.59E-10	-3.97E-10	-4.93E-10	-2.66E-10
Specification MIN	-1.00E-08	-1.00E-08	-1.00E-08	-1.00E-08	-1.50E-08	-1.50E-08	-1.50E-08
Status	PASS	PASS	PASS	PASS	PASS	PASS	PASS
Specification MAX	1.00E-08	1.00E-08	1.00E-08	1.00E-08	1.50E-08	1.50E-08	1.50E-08
Status	PASS	PASS	PASS	PASS	PASS	PASS	PASS

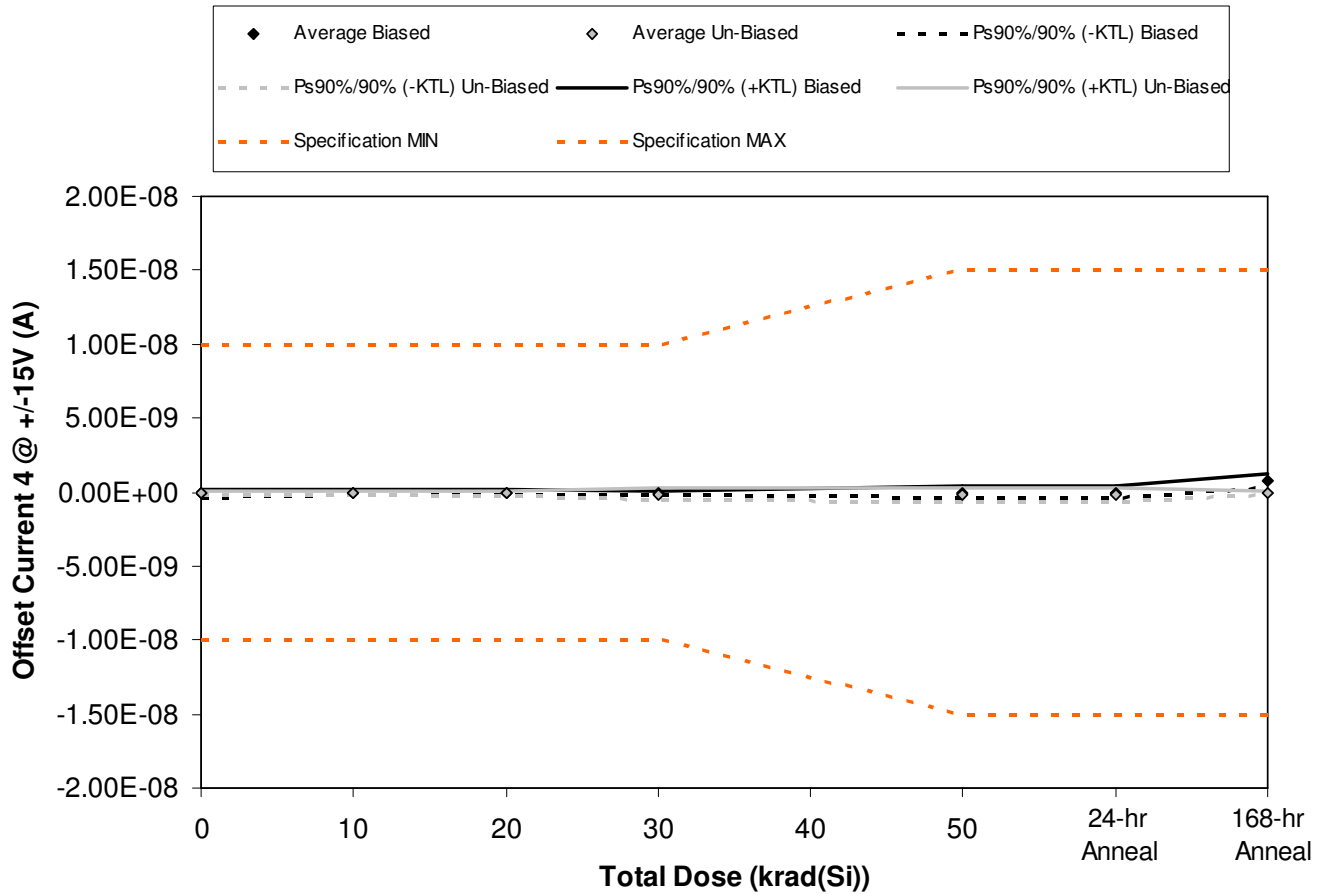

Figure 5.10. Plot of Offset Current 4 @ +/-15V (A) versus total dose. The solid diamonds are the average of the measured data points for the samples irradiated under electrical bias while the shaded diamonds are the average of the measured data points for the samples irradiated with all pins tied to ground. The black lines (solid and/or dashed) are the average of the data points after application of the KTL statistics on the samples irradiated under electrical bias while the gray lines (solid and/or dashed) are the average of the data points after application of the KTL statistics on the samples irradiated in the unbiased condition. The red dotted line(s) are the pre- and/or post-irradiation minimum and/or maximum specification value as defined in the datasheet and/or test plan.



**TID Report
11-572 R1.0**

**Aeroflex RAD
5017 N. 30th Street
Colorado Springs, CO 80919
(719) 531-0800**

Table 5.10. Raw data for Offset Current 4 @ +/-15V (A) versus total dose, including the statistical analysis, specification and the status of the testing (pass/fail).

Offset Current 4 @ +/-15V (A)	Total Dose (krad(Si))					24 hr	168 hr
	0	10	20	30	50	Anneal	Anneal
Device	10/20/2011	11/3/2011	11/3/2011	11/3/2011	11/3/2011	11/4/2011	11/11/2011
1831	-9.50E-11	-4.50E-11	-1.20E-10	-1.28E-10	-1.14E-10	-2.04E-10	7.22E-10
1832	-4.00E-12	-3.00E-12	-2.70E-11	-3.00E-12	9.10E-11	1.20E-10	9.11E-10
1833	-1.37E-10	-1.50E-11	3.00E-12	-9.60E-11	1.17E-10	4.90E-11	7.22E-10
1834	3.40E-11	2.60E-11	1.80E-11	-2.70E-11	7.60E-11	4.30E-11	9.93E-10
1835	-2.17E-10	-1.27E-10	-8.70E-11	-4.60E-11	-2.48E-10	-2.03E-10	5.55E-10
1836	-9.40E-11	-9.30E-11	-1.27E-10	-2.32E-10	-1.78E-10	-3.32E-10	-4.70E-11
1837	-2.60E-11	1.50E-11	-3.40E-11	8.30E-11	5.10E-11	8.00E-12	4.10E-11
1838	-2.10E-11	-4.60E-11	-1.34E-10	-2.11E-10	-3.32E-10	-1.97E-10	1.10E-11
1839	-7.20E-11	-6.50E-11	-1.53E-10	-2.74E-10	-3.64E-10	-3.63E-10	-1.60E-11
1840	2.00E-12	-1.90E-11	-4.90E-11	-9.00E-11	-6.00E-12	-2.80E-11	-5.80E-11
1851	1.20E-11	6.00E-12	-2.00E-11	3.40E-11	-3.00E-12	6.00E-12	-7.00E-12
1852	-5.00E-12	-2.00E-12	-2.50E-11	-8.00E-12	0.00E+00	-2.90E-11	-1.10E-11
Biased Statistics							
Average Biased	-8.38E-11	-3.28E-11	-4.26E-11	-6.00E-11	-1.56E-11	-3.90E-11	7.81E-10
Std Dev Biased	1.01E-10	5.85E-11	5.91E-11	5.11E-11	1.59E-10	1.53E-10	1.73E-10
Ps90%/90% (+KTL) Biased	1.94E-10	1.28E-10	1.19E-10	8.02E-11	4.20E-10	3.81E-10	1.26E-09
Ps90%/90% (-KTL) Biased	-3.61E-10	-1.93E-10	-2.05E-10	-2.00E-10	-4.51E-10	-4.59E-10	3.06E-10
Un-Biased Statistics							
Average Un-Biased	-4.22E-11	-4.16E-11	-9.94E-11	-1.45E-10	-1.66E-10	-1.82E-10	-1.38E-11
Std Dev Un-Biased	3.95E-11	4.16E-11	5.40E-11	1.45E-10	1.87E-10	1.70E-10	4.09E-11
Ps90%/90% (+KTL) Un-Biased	6.61E-11	7.25E-11	4.86E-11	2.52E-10	3.46E-10	2.83E-10	9.82E-11
Ps90%/90% (-KTL) Un-Biased	-1.50E-10	-1.56E-10	-2.47E-10	-5.41E-10	-6.78E-10	-6.48E-10	-1.26E-10
Specification MIN	-1.00E-08	-1.00E-08	-1.00E-08	-1.00E-08	-1.50E-08	-1.50E-08	-1.50E-08
Status	PASS	PASS	PASS	PASS	PASS	PASS	PASS
Specification MAX	1.00E-08	1.00E-08	1.00E-08	1.00E-08	1.50E-08	1.50E-08	1.50E-08
Status	PASS	PASS	PASS	PASS	PASS	PASS	PASS

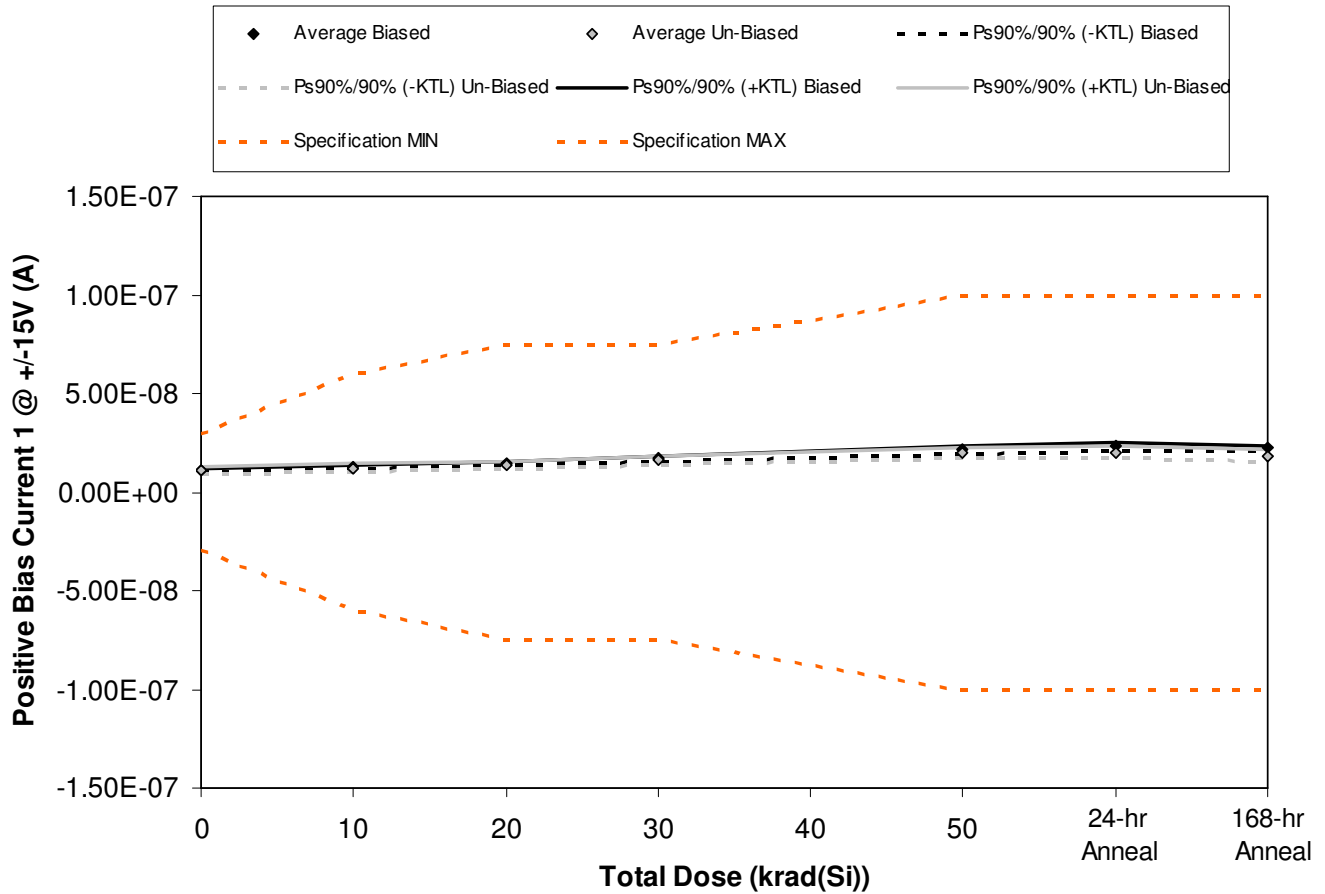

Figure 5.11. Plot of Positive Bias Current 1 @ +/-15V (A) versus total dose. The solid diamonds are the average of the measured data points for the samples irradiated under electrical bias while the shaded diamonds are the average of the measured data points for the samples irradiated with all pins tied to ground. The black lines (solid and/or dashed) are the average of the data points after application of the KTL statistics on the samples irradiated under electrical bias while the gray lines (solid and/or dashed) are the average of the data points after application of the KTL statistics on the samples irradiated in the unbiased condition. The red dotted line(s) are the pre- and/or post-irradiation minimum and/or maximum specification value as defined in the datasheet and/or test plan.



Table 5.11. Raw data for Positive Bias Current 1 @ +/-15V (A) versus total dose, including the statistical analysis, specification and the status of the testing (pass/fail).

Positive Bias Current 1 @ +/-15V (A)	Total Dose (krad(Si))					24 hr	168 hr
	0	10	20	30	50	Anneal	Anneal
Device	10/20/2011	11/3/2011	11/3/2011	11/3/2011	11/3/2011	11/4/2011	11/11/2011
1831	1.14E-08	1.28E-08	1.46E-08	1.66E-08	2.07E-08	2.25E-08	2.17E-08
1832	1.15E-08	1.29E-08	1.48E-08	1.71E-08	2.13E-08	2.32E-08	2.24E-08
1833	1.09E-08	1.23E-08	1.41E-08	1.63E-08	2.08E-08	2.25E-08	2.16E-08
1834	1.16E-08	1.31E-08	1.52E-08	1.77E-08	2.25E-08	2.43E-08	2.30E-08
1835	1.12E-08	1.26E-08	1.46E-08	1.68E-08	2.12E-08	2.28E-08	2.18E-08
1836	1.16E-08	1.30E-08	1.46E-08	1.68E-08	2.09E-08	2.11E-08	1.97E-08
1837	1.06E-08	1.19E-08	1.37E-08	1.55E-08	1.98E-08	1.98E-08	1.84E-08
1838	1.16E-08	1.30E-08	1.48E-08	1.70E-08	2.10E-08	2.11E-08	1.95E-08
1839	1.01E-08	1.16E-08	1.35E-08	1.58E-08	2.00E-08	1.97E-08	1.80E-08
1840	1.03E-08	1.16E-08	1.31E-08	1.50E-08	1.85E-08	1.84E-08	1.71E-08
1851	1.04E-08	1.04E-08	1.04E-08	1.04E-08	1.05E-08	1.03E-08	1.04E-08
1852	1.06E-08	1.07E-08	1.07E-08	1.07E-08	1.06E-08	1.06E-08	1.06E-08
Biased Statistics							
Average Biased	1.13E-08	1.27E-08	1.47E-08	1.69E-08	2.13E-08	2.31E-08	2.21E-08
Std Dev Biased	2.82E-10	3.17E-10	4.03E-10	5.32E-10	7.21E-10	7.28E-10	5.83E-10
Ps90%/90% (+KTL) Biased	1.21E-08	1.36E-08	1.58E-08	1.84E-08	2.33E-08	2.51E-08	2.37E-08
Ps90%/90% (-KTL) Biased	1.05E-08	1.19E-08	1.36E-08	1.54E-08	1.93E-08	2.11E-08	2.05E-08
Un-Biased Statistics							
Average Un-Biased	1.08E-08	1.22E-08	1.39E-08	1.60E-08	2.00E-08	2.00E-08	1.85E-08
Std Dev Un-Biased	6.98E-10	7.36E-10	7.23E-10	8.74E-10	1.03E-09	1.13E-09	1.06E-09
Ps90%/90% (+KTL) Un-Biased	1.28E-08	1.42E-08	1.59E-08	1.84E-08	2.29E-08	2.31E-08	2.14E-08
Ps90%/90% (-KTL) Un-Biased	8.93E-09	1.02E-08	1.19E-08	1.36E-08	1.72E-08	1.69E-08	1.56E-08
Specification MIN	-3.00E-08	-6.00E-08	-7.50E-08	-7.50E-08	-1.00E-07	-1.00E-07	-1.00E-07
Status	PASS	PASS	PASS	PASS	PASS	PASS	PASS
Specification MAX	3.00E-08	6.00E-08	7.50E-08	7.50E-08	1.00E-07	1.00E-07	1.00E-07
Status	PASS	PASS	PASS	PASS	PASS	PASS	PASS

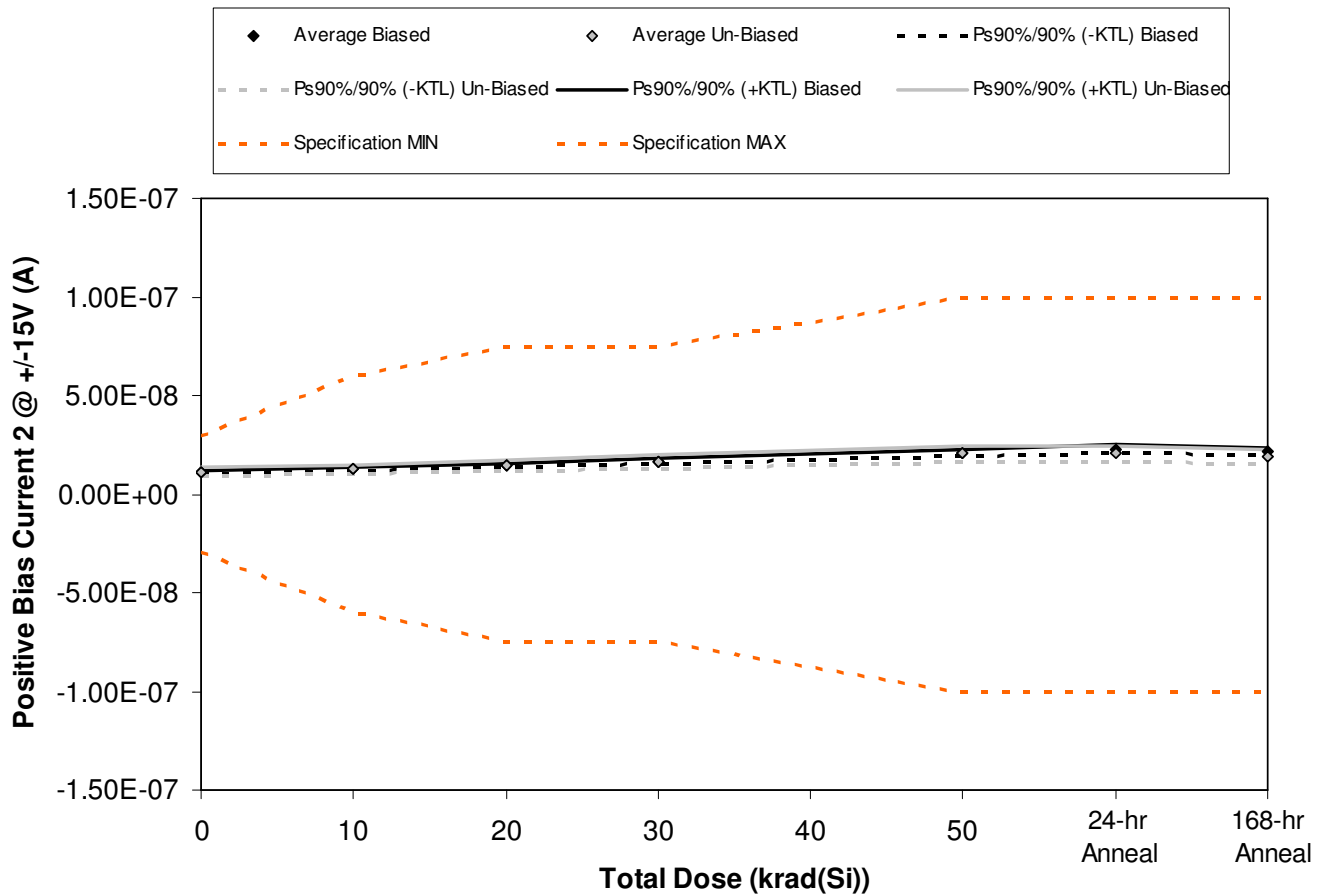

Figure 5.12. Plot of Positive Bias Current 2 @ +/-15V (A) versus total dose. The solid diamonds are the average of the measured data points for the samples irradiated under electrical bias while the shaded diamonds are the average of the measured data points for the samples irradiated with all pins tied to ground. The black lines (solid and/or dashed) are the average of the data points after application of the KTL statistics on the samples irradiated under electrical bias while the gray lines (solid and/or dashed) are the average of the data points after application of the KTL statistics on the samples irradiated in the unbiased condition. The red dotted line(s) are the pre- and/or post-irradiation minimum and/or maximum specification value as defined in the datasheet and/or test plan.



Table 5.12. Raw data for Positive Bias Current 2 @ +/-15V (A) versus total dose, including the statistical analysis, specification and the status of the testing (pass/fail).

Positive Bias Current 2 @ +/-15V (A)	Total Dose (krad(Si))					24 hr	168 hr
	0	10	20	30	50	Anneal	Anneal
Device	10/20/2011	11/3/2011	11/3/2011	11/3/2011	11/3/2011	11/4/2011	11/11/2011
1831	1.12E-08	1.26E-08	1.43E-08	1.64E-08	2.04E-08	2.21E-08	2.13E-08
1832	1.13E-08	1.26E-08	1.45E-08	1.66E-08	2.09E-08	2.26E-08	2.16E-08
1833	1.18E-08	1.32E-08	1.52E-08	1.74E-08	2.21E-08	2.40E-08	2.29E-08
1834	1.09E-08	1.23E-08	1.40E-08	1.62E-08	2.04E-08	2.20E-08	2.11E-08
1835	1.12E-08	1.26E-08	1.45E-08	1.67E-08	2.10E-08	2.27E-08	2.18E-08
1836	1.06E-08	1.19E-08	1.35E-08	1.55E-08	1.95E-08	1.95E-08	1.80E-08
1837	1.16E-08	1.30E-08	1.48E-08	1.69E-08	2.13E-08	2.14E-08	1.98E-08
1838	1.20E-08	1.35E-08	1.53E-08	1.76E-08	2.16E-08	2.16E-08	2.01E-08
1839	1.17E-08	1.27E-08	1.47E-08	1.70E-08	2.13E-08	2.11E-08	1.93E-08
1840	1.01E-08	1.14E-08	1.29E-08	1.48E-08	1.82E-08	1.81E-08	1.69E-08
1851	1.14E-08	1.14E-08	1.14E-08	1.14E-08	1.14E-08	1.13E-08	1.14E-08
1852	1.20E-08	1.19E-08	1.20E-08	1.20E-08	1.20E-08	1.19E-08	1.20E-08
Biased Statistics							
Average Biased	1.13E-08	1.27E-08	1.45E-08	1.67E-08	2.10E-08	2.27E-08	2.18E-08
Std Dev Biased	3.06E-10	3.50E-10	4.26E-10	4.64E-10	7.07E-10	7.81E-10	7.09E-10
Ps90%/90% (+KTL) Biased	1.21E-08	1.36E-08	1.57E-08	1.79E-08	2.29E-08	2.48E-08	2.37E-08
Ps90%/90% (-KTL) Biased	1.04E-08	1.17E-08	1.33E-08	1.54E-08	1.90E-08	2.06E-08	1.98E-08
Un-Biased Statistics							
Average Un-Biased	1.12E-08	1.25E-08	1.42E-08	1.64E-08	2.04E-08	2.04E-08	1.88E-08
Std Dev Un-Biased	8.04E-10	8.49E-10	9.96E-10	1.14E-09	1.47E-09	1.51E-09	1.34E-09
Ps90%/90% (+KTL) Un-Biased	1.34E-08	1.48E-08	1.70E-08	1.95E-08	2.44E-08	2.45E-08	2.25E-08
Ps90%/90% (-KTL) Un-Biased	8.99E-09	1.02E-08	1.15E-08	1.32E-08	1.64E-08	1.62E-08	1.51E-08
Specification MIN	-3.00E-08	-6.00E-08	-7.50E-08	-7.50E-08	-1.00E-07	-1.00E-07	-1.00E-07
Status	PASS	PASS	PASS	PASS	PASS	PASS	PASS
Specification MAX	3.00E-08	6.00E-08	7.50E-08	7.50E-08	1.00E-07	1.00E-07	1.00E-07
Status	PASS	PASS	PASS	PASS	PASS	PASS	PASS

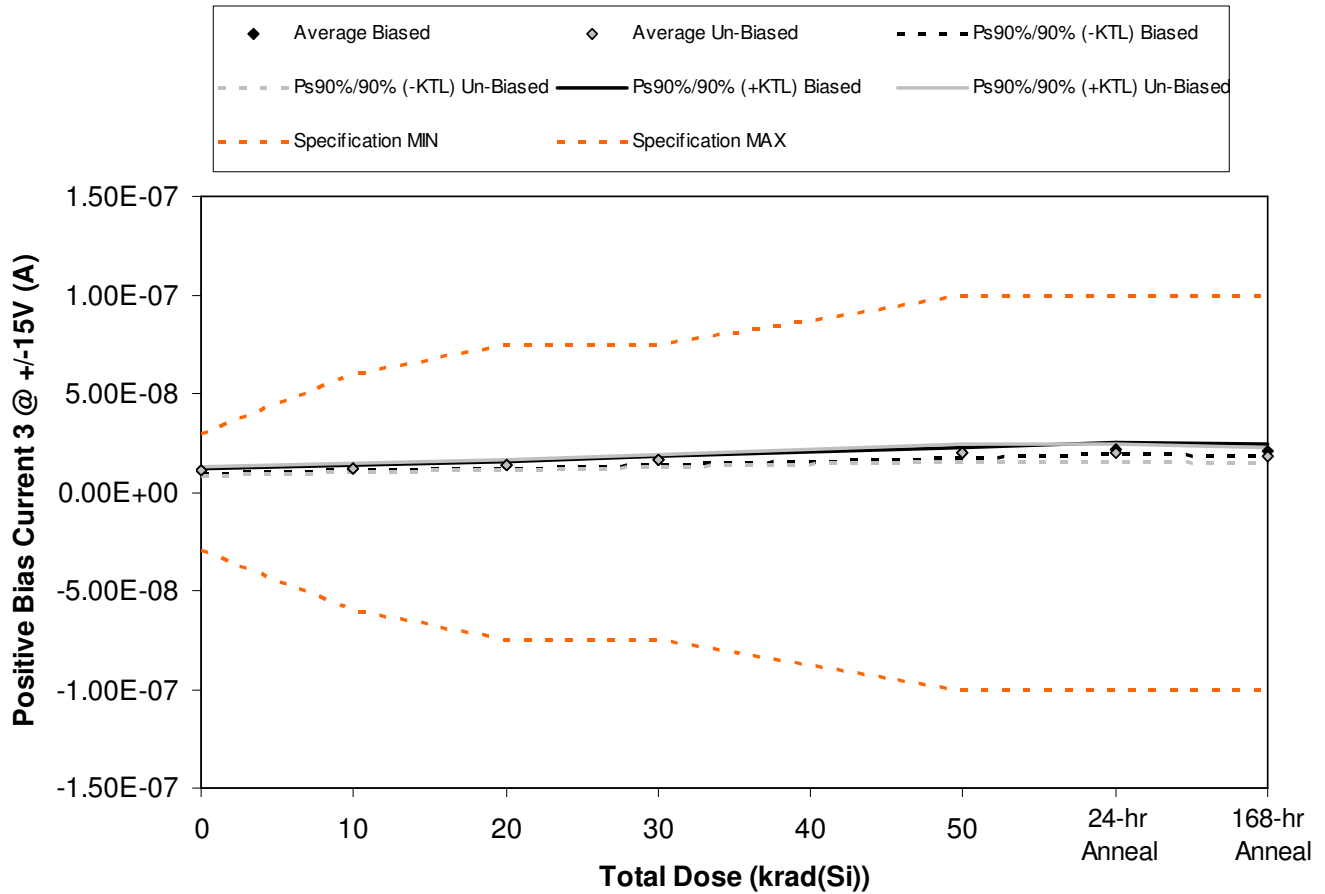

Figure 5.13. Plot of Positive Bias Current 3 @ +/-15V (A) versus total dose. The solid diamonds are the average of the measured data points for the samples irradiated under electrical bias while the shaded diamonds are the average of the measured data points for the samples irradiated with all pins tied to ground. The black lines (solid and/or dashed) are the average of the data points after application of the KTL statistics on the samples irradiated under electrical bias while the gray lines (solid and/or dashed) are the average of the data points after application of the KTL statistics on the samples irradiated in the unbiased condition. The red dotted line(s) are the pre- and/or post-irradiation minimum and/or maximum specification value as defined in the datasheet and/or test plan.



Table 5.13. Raw data for Positive Bias Current 3 @ +/-15V (A) versus total dose, including the statistical analysis, specification and the status of the testing (pass/fail).

Positive Bias Current 3 @ +/-15V (A)	Total Dose (krad(Si))					24 hr	168 hr
	0	10	20	30	50	Anneal	Anneal
Device	10/20/2011	11/3/2011	11/3/2011	11/3/2011	11/3/2011	11/4/2011	11/11/2011
1831	1.09E-08	1.23E-08	1.40E-08	1.61E-08	2.01E-08	2.17E-08	2.08E-08
1832	1.09E-08	1.21E-08	1.38E-08	1.60E-08	2.02E-08	2.18E-08	2.10E-08
1833	1.14E-08	1.28E-08	1.48E-08	1.70E-08	2.15E-08	2.33E-08	2.24E-08
1834	1.00E-08	1.13E-08	1.29E-08	1.49E-08	1.89E-08	2.04E-08	1.94E-08
1835	1.09E-08	1.23E-08	1.42E-08	1.64E-08	2.06E-08	2.23E-08	2.14E-08
1836	1.02E-08	1.14E-08	1.30E-08	1.49E-08	1.86E-08	1.86E-08	1.72E-08
1837	1.14E-08	1.27E-08	1.45E-08	1.65E-08	2.07E-08	2.08E-08	1.92E-08
1838	1.15E-08	1.30E-08	1.47E-08	1.69E-08	2.10E-08	2.10E-08	1.95E-08
1839	1.15E-08	1.29E-08	1.49E-08	1.72E-08	2.15E-08	2.14E-08	1.96E-08
1840	9.95E-09	1.11E-08	1.26E-08	1.44E-08	1.78E-08	1.77E-08	1.65E-08
1851	1.11E-08	1.12E-08	1.12E-08	1.12E-08	1.12E-08	1.11E-08	1.11E-08
1852	1.05E-08	1.05E-08	1.05E-08	1.05E-08	1.05E-08	1.05E-08	1.05E-08
Biased Statistics							
Average Biased	1.08E-08	1.22E-08	1.40E-08	1.61E-08	2.03E-08	2.19E-08	2.10E-08
Std Dev Biased	4.89E-10	5.51E-10	6.99E-10	7.63E-10	9.68E-10	1.07E-09	1.06E-09
Ps90%/90% (+KTL) Biased	1.21E-08	1.37E-08	1.59E-08	1.82E-08	2.29E-08	2.48E-08	2.39E-08
Ps90%/90% (-KTL) Biased	9.46E-09	1.07E-08	1.20E-08	1.40E-08	1.76E-08	1.90E-08	1.81E-08
Un-Biased Statistics							
Average Un-Biased	1.09E-08	1.22E-08	1.39E-08	1.60E-08	1.99E-08	1.99E-08	1.84E-08
Std Dev Un-Biased	7.55E-10	8.79E-10	1.05E-09	1.25E-09	1.61E-09	1.65E-09	1.46E-09
Ps90%/90% (+KTL) Un-Biased	1.30E-08	1.46E-08	1.68E-08	1.94E-08	2.44E-08	2.44E-08	2.24E-08
Ps90%/90% (-KTL) Un-Biased	8.82E-09	9.81E-09	1.11E-08	1.25E-08	1.55E-08	1.54E-08	1.44E-08
Specification MIN	-3.00E-08	-6.00E-08	-7.50E-08	-7.50E-08	-1.00E-07	-1.00E-07	-1.00E-07
Status	PASS	PASS	PASS	PASS	PASS	PASS	PASS
Specification MAX	3.00E-08	6.00E-08	7.50E-08	7.50E-08	1.00E-07	1.00E-07	1.00E-07
Status	PASS	PASS	PASS	PASS	PASS	PASS	PASS

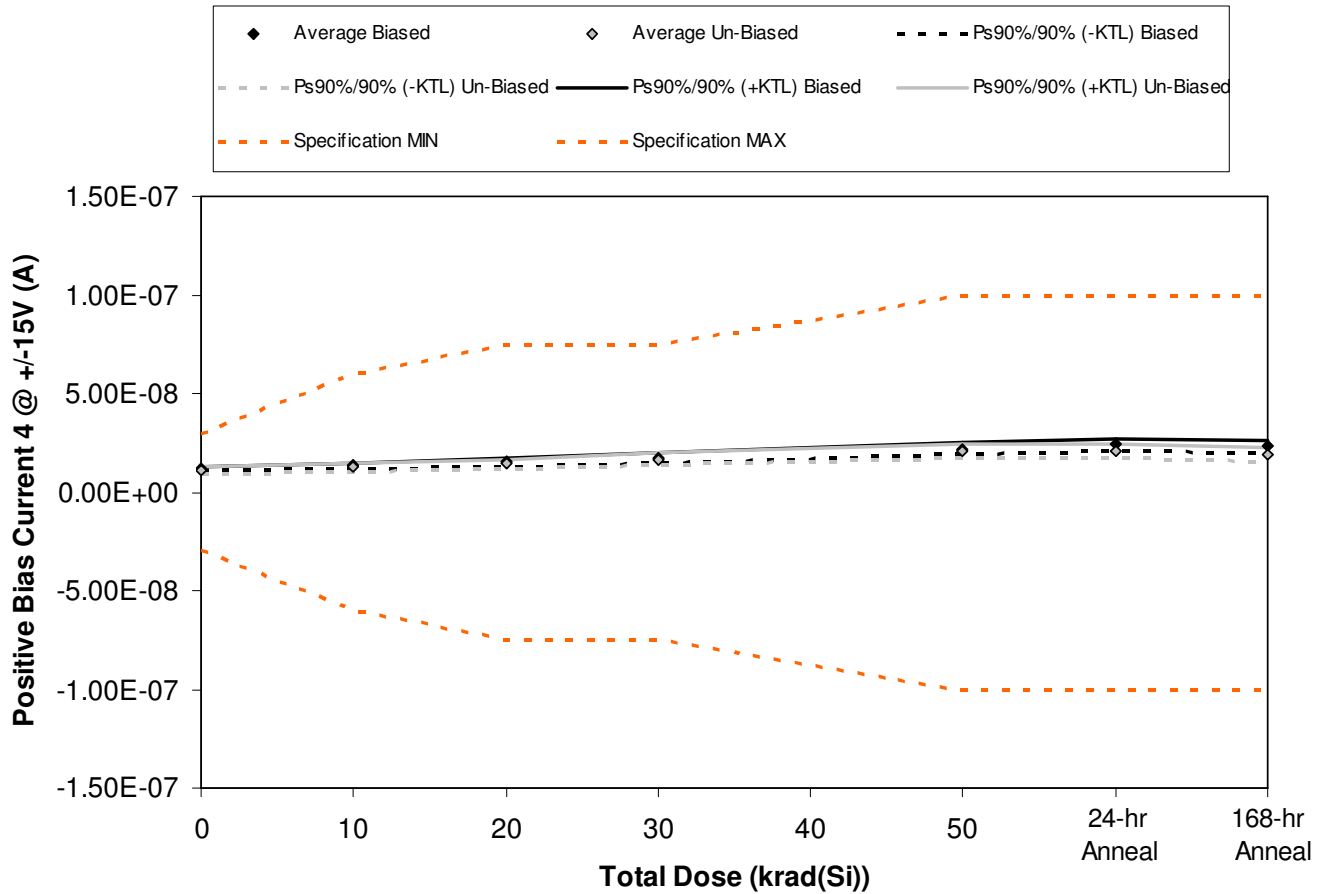

Figure 5.14. Plot of Positive Bias Current 4 @ +/-15V (A) versus total dose. The solid diamonds are the average of the measured data points for the samples irradiated under electrical bias while the shaded diamonds are the average of the measured data points for the samples irradiated with all pins tied to ground. The black lines (solid and/or dashed) are the average of the data points after application of the KTL statistics on the samples irradiated under electrical bias while the gray lines (solid and/or dashed) are the average of the data points after application of the KTL statistics on the samples irradiated in the unbiased condition. The red dotted line(s) are the pre- and/or post-irradiation minimum and/or maximum specification value as defined in the datasheet and/or test plan.



Table 5.14. Raw data for Positive Bias Current 4 @ +/-15V (A) versus total dose, including the statistical analysis, specification and the status of the testing (pass/fail).

Positive Bias Current 4 @ +/-15V (A)	Total Dose (krad(Si))					24 hr	168 hr
	0	10	20	30	50	Anneal	Anneal
Device							
	10/20/2011	11/3/2011	11/3/2011	11/3/2011	11/3/2011	11/4/2011	11/11/2011
1831	1.18E-08	1.33E-08	1.52E-08	1.74E-08	2.15E-08	2.33E-08	2.26E-08
1832	1.18E-08	1.33E-08	1.52E-08	1.75E-08	2.19E-08	2.38E-08	2.31E-08
1833	1.13E-08	1.23E-08	1.41E-08	1.62E-08	2.05E-08	2.24E-08	2.15E-08
1834	1.21E-08	1.37E-08	1.59E-08	1.85E-08	2.35E-08	2.53E-08	2.41E-08
1835	1.25E-08	1.39E-08	1.60E-08	1.85E-08	2.32E-08	2.51E-08	2.41E-08
1836	1.19E-08	1.32E-08	1.50E-08	1.72E-08	2.15E-08	2.18E-08	2.02E-08
1837	1.05E-08	1.18E-08	1.34E-08	1.53E-08	1.94E-08	1.95E-08	1.81E-08
1838	1.19E-08	1.34E-08	1.53E-08	1.76E-08	2.17E-08	2.18E-08	2.00E-08
1839	1.11E-08	1.26E-08	1.47E-08	1.72E-08	2.18E-08	2.15E-08	1.94E-08
1840	1.06E-08	1.19E-08	1.35E-08	1.53E-08	1.90E-08	1.89E-08	1.75E-08
1851	1.07E-08	1.07E-08	1.07E-08	1.07E-08	1.07E-08	1.06E-08	1.07E-08
1852	1.15E-08	1.15E-08	1.15E-08	1.16E-08	1.16E-08	1.15E-08	1.15E-08
Biased Statistics							
Average Biased	1.19E-08	1.33E-08	1.53E-08	1.76E-08	2.21E-08	2.40E-08	2.31E-08
Std Dev Biased	4.40E-10	6.10E-10	7.75E-10	9.59E-10	1.23E-09	1.22E-09	1.08E-09
Ps90%/90% (+KTL) Biased	1.31E-08	1.49E-08	1.74E-08	2.02E-08	2.55E-08	2.73E-08	2.60E-08
Ps90%/90% (-KTL) Biased	1.07E-08	1.16E-08	1.32E-08	1.50E-08	1.88E-08	2.06E-08	2.01E-08
Un-Biased Statistics							
Average Un-Biased	1.12E-08	1.26E-08	1.44E-08	1.65E-08	2.07E-08	2.07E-08	1.90E-08
Std Dev Un-Biased	7.00E-10	7.38E-10	8.72E-10	1.13E-09	1.38E-09	1.39E-09	1.17E-09
Ps90%/90% (+KTL) Un-Biased	1.31E-08	1.46E-08	1.68E-08	1.96E-08	2.45E-08	2.45E-08	2.22E-08
Ps90%/90% (-KTL) Un-Biased	9.27E-09	1.05E-08	1.20E-08	1.34E-08	1.69E-08	1.69E-08	1.58E-08
Specification MIN	-3.00E-08	-6.00E-08	-7.50E-08	-7.50E-08	-1.00E-07	-1.00E-07	-1.00E-07
Status	PASS	PASS	PASS	PASS	PASS	PASS	PASS
Specification MAX	3.00E-08	6.00E-08	7.50E-08	7.50E-08	1.00E-07	1.00E-07	1.00E-07
Status	PASS	PASS	PASS	PASS	PASS	PASS	PASS

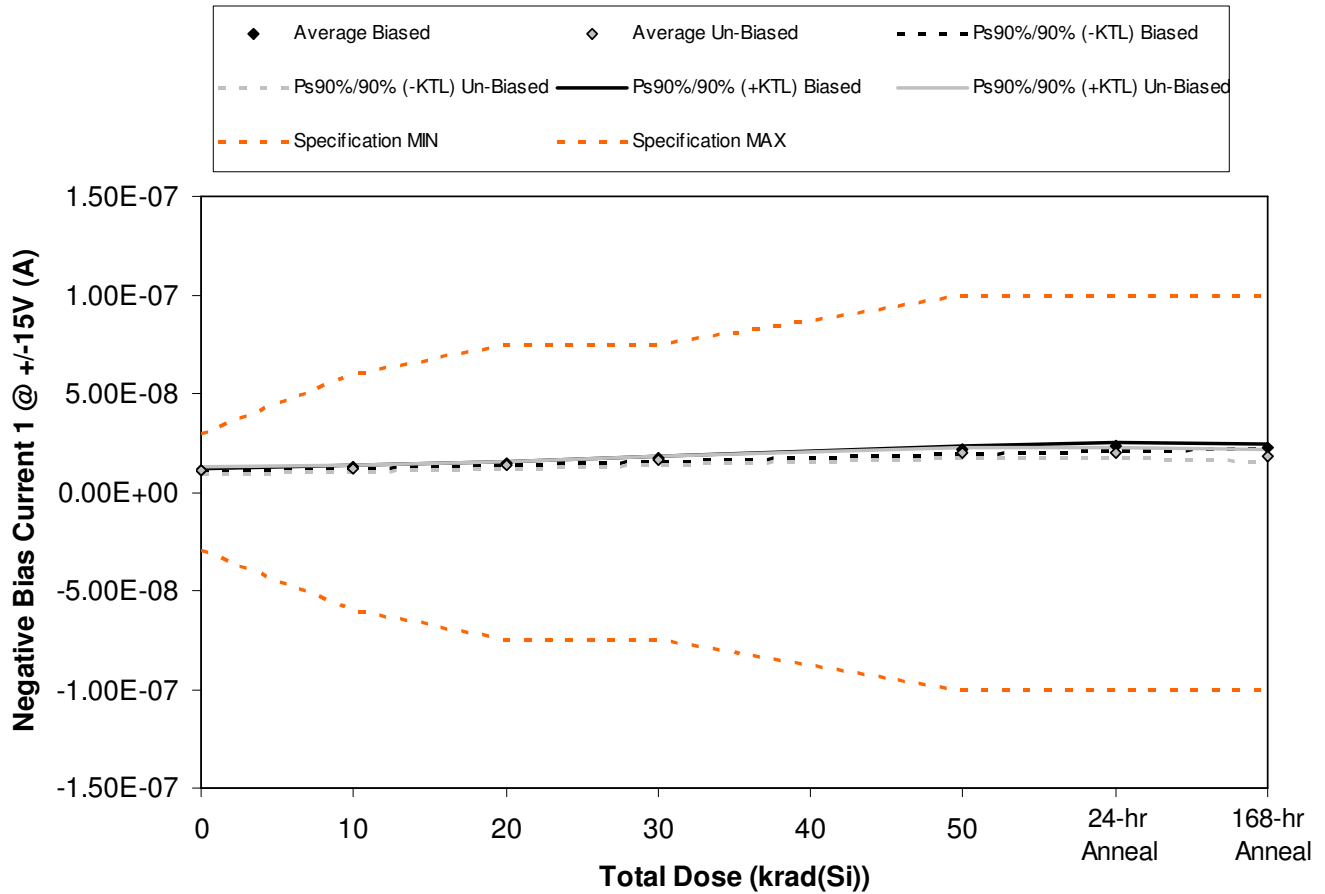

Figure 5.15. Plot of Negative Bias Current 1 @ +/-15V (A) versus total dose. The solid diamonds are the average of the measured data points for the samples irradiated under electrical bias while the shaded diamonds are the average of the measured data points for the samples irradiated with all pins tied to ground. The black lines (solid and/or dashed) are the average of the data points after application of the KTL statistics on the samples irradiated under electrical bias while the gray lines (solid and/or dashed) are the average of the data points after application of the KTL statistics on the samples irradiated in the unbiased condition. The red dotted line(s) are the pre- and/or post-irradiation minimum and/or maximum specification value as defined in the datasheet and/or test plan.



Table 5.15. Raw data for Negative Bias Current 1 @ +/-15V (A) versus total dose, including the statistical analysis, specification and the status of the testing (pass/fail).

Negative Bias Current 1 @ +/-15V (A)	Total Dose (krad(Si))					24 hr	168 hr
	0	10	20	30	50	Anneal	Anneal
Device	10/20/2011	11/3/2011	11/3/2011	11/3/2011	11/3/2011	11/4/2011	11/11/2011
1831	1.14E-08	1.27E-08	1.46E-08	1.67E-08	2.07E-08	2.25E-08	2.25E-08
1832	1.14E-08	1.28E-08	1.47E-08	1.69E-08	2.12E-08	2.31E-08	2.33E-08
1833	1.09E-08	1.22E-08	1.41E-08	1.63E-08	2.06E-08	2.26E-08	2.24E-08
1834	1.17E-08	1.31E-08	1.52E-08	1.77E-08	2.25E-08	2.43E-08	2.38E-08
1835	1.11E-08	1.26E-08	1.45E-08	1.69E-08	2.12E-08	2.29E-08	2.26E-08
1836	1.15E-08	1.28E-08	1.44E-08	1.66E-08	2.07E-08	2.11E-08	1.97E-08
1837	1.06E-08	1.19E-08	1.36E-08	1.55E-08	1.96E-08	1.97E-08	1.83E-08
1838	1.16E-08	1.30E-08	1.48E-08	1.69E-08	2.09E-08	2.09E-08	1.94E-08
1839	1.01E-08	1.15E-08	1.35E-08	1.58E-08	1.99E-08	1.96E-08	1.78E-08
1840	1.04E-08	1.16E-08	1.32E-08	1.51E-08	1.87E-08	1.85E-08	1.72E-08
1851	1.04E-08	1.05E-08	1.05E-08	1.04E-08	1.05E-08	1.04E-08	1.04E-08
1852	1.06E-08	1.06E-08	1.06E-08	1.06E-08	1.06E-08	1.06E-08	1.06E-08
Biased Statistics							
Average Biased	1.13E-08	1.27E-08	1.46E-08	1.69E-08	2.13E-08	2.31E-08	2.29E-08
Std Dev Biased	2.97E-10	3.28E-10	3.97E-10	5.29E-10	7.57E-10	7.09E-10	5.96E-10
Ps90%/90% (+KTL) Biased	1.21E-08	1.36E-08	1.57E-08	1.83E-08	2.33E-08	2.50E-08	2.46E-08
Ps90%/90% (-KTL) Biased	1.05E-08	1.18E-08	1.35E-08	1.54E-08	1.92E-08	2.11E-08	2.13E-08
Un-Biased Statistics							
Average Un-Biased	1.08E-08	1.22E-08	1.39E-08	1.60E-08	2.00E-08	2.00E-08	1.85E-08
Std Dev Un-Biased	6.51E-10	6.90E-10	6.67E-10	7.70E-10	8.80E-10	1.04E-09	1.05E-09
Ps90%/90% (+KTL) Un-Biased	1.26E-08	1.41E-08	1.57E-08	1.81E-08	2.24E-08	2.28E-08	2.13E-08
Ps90%/90% (-KTL) Un-Biased	9.05E-09	1.03E-08	1.21E-08	1.39E-08	1.76E-08	1.71E-08	1.56E-08
Specification MIN	-3.00E-08	-6.00E-08	-7.50E-08	-7.50E-08	-1.00E-07	-1.00E-07	-1.00E-07
Status	PASS	PASS	PASS	PASS	PASS	PASS	PASS
Specification MAX	3.00E-08	6.00E-08	7.50E-08	7.50E-08	1.00E-07	1.00E-07	1.00E-07
Status	PASS	PASS	PASS	PASS	PASS	PASS	PASS

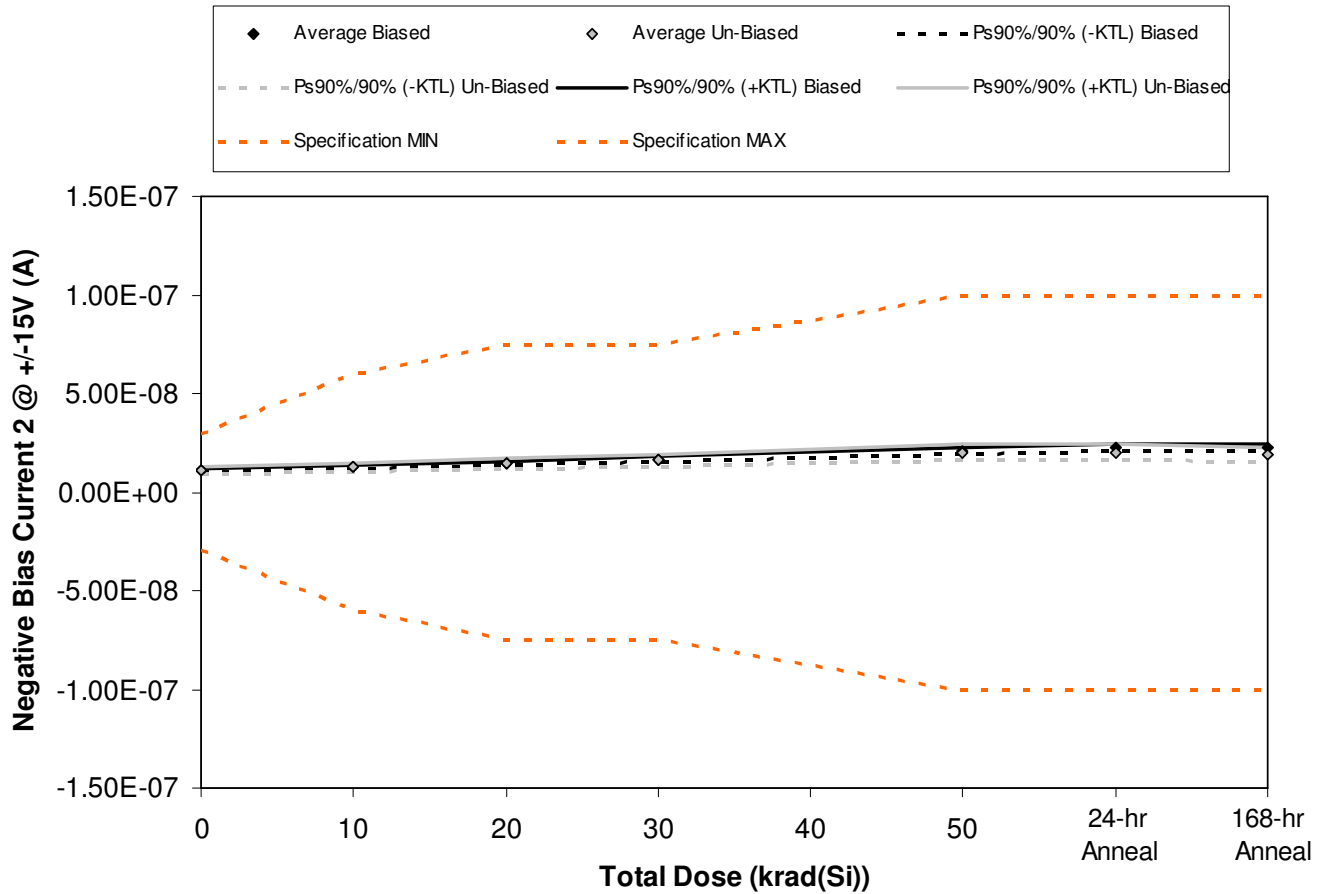

Figure 5.16. Plot of Negative Bias Current 2 @ +/-15V (A) versus total dose. The solid diamonds are the average of the measured data points for the samples irradiated under electrical bias while the shaded diamonds are the average of the measured data points for the samples irradiated with all pins tied to ground. The black lines (solid and/or dashed) are the average of the data points after application of the KTL statistics on the samples irradiated under electrical bias while the gray lines (solid and/or dashed) are the average of the data points after application of the KTL statistics on the samples irradiated in the unbiased condition. The red dotted line(s) are the pre- and/or post-irradiation minimum and/or maximum specification value as defined in the datasheet and/or test plan.



Table 5.16. Raw data for Negative Bias Current 2 @ +/-15V (A) versus total dose, including the statistical analysis, specification and the status of the testing (pass/fail).

Negative Bias Current 2 @ +/-15V (A)	Total Dose (krad(Si))					24 hr	168 hr
	0	10	20	30	50	Anneal	Anneal
Device	10/20/2011	11/3/2011	11/3/2011	11/3/2011	11/3/2011	11/4/2011	11/11/2011
1831	1.13E-08	1.26E-08	1.44E-08	1.65E-08	2.05E-08	2.22E-08	2.23E-08
1832	1.11E-08	1.24E-08	1.42E-08	1.64E-08	2.06E-08	2.25E-08	2.24E-08
1833	1.17E-08	1.31E-08	1.51E-08	1.73E-08	2.20E-08	2.38E-08	2.37E-08
1834	1.09E-08	1.23E-08	1.41E-08	1.61E-08	2.05E-08	2.22E-08	2.23E-08
1835	1.11E-08	1.26E-08	1.45E-08	1.68E-08	2.10E-08	2.27E-08	2.25E-08
1836	1.05E-08	1.19E-08	1.35E-08	1.55E-08	1.94E-08	1.95E-08	1.79E-08
1837	1.16E-08	1.30E-08	1.48E-08	1.68E-08	2.13E-08	2.14E-08	1.98E-08
1838	1.19E-08	1.35E-08	1.52E-08	1.74E-08	2.14E-08	2.15E-08	2.00E-08
1839	1.16E-08	1.26E-08	1.46E-08	1.69E-08	2.11E-08	2.09E-08	1.93E-08
1840	1.01E-08	1.13E-08	1.29E-08	1.47E-08	1.82E-08	1.82E-08	1.69E-08
1851	1.13E-08	1.13E-08	1.13E-08	1.13E-08	1.13E-08	1.12E-08	1.13E-08
1852	1.18E-08	1.18E-08	1.18E-08	1.18E-08	1.18E-08	1.18E-08	1.18E-08
Biased Statistics							
Average Biased	1.12E-08	1.26E-08	1.45E-08	1.66E-08	2.09E-08	2.27E-08	2.26E-08
Std Dev Biased	2.76E-10	3.23E-10	3.85E-10	4.38E-10	6.31E-10	6.85E-10	6.26E-10
Ps90%/90% (+KTL) Biased	1.20E-08	1.35E-08	1.55E-08	1.78E-08	2.26E-08	2.46E-08	2.43E-08
Ps90%/90% (-KTL) Biased	1.05E-08	1.17E-08	1.34E-08	1.54E-08	1.92E-08	2.08E-08	2.09E-08
Un-Biased Statistics							
Average Un-Biased	1.11E-08	1.24E-08	1.42E-08	1.63E-08	2.03E-08	2.03E-08	1.88E-08
Std Dev Un-Biased	7.60E-10	8.56E-10	9.69E-10	1.13E-09	1.42E-09	1.44E-09	1.34E-09
Ps90%/90% (+KTL) Un-Biased	1.32E-08	1.48E-08	1.68E-08	1.94E-08	2.42E-08	2.42E-08	2.25E-08
Ps90%/90% (-KTL) Un-Biased	9.06E-09	1.01E-08	1.15E-08	1.32E-08	1.64E-08	1.63E-08	1.51E-08
Specification MIN	-3.00E-08	-6.00E-08	-7.50E-08	-7.50E-08	-1.00E-07	-1.00E-07	-1.00E-07
Status	PASS	PASS	PASS	PASS	PASS	PASS	PASS
Specification MAX	3.00E-08	6.00E-08	7.50E-08	7.50E-08	1.00E-07	1.00E-07	1.00E-07
Status	PASS	PASS	PASS	PASS	PASS	PASS	PASS

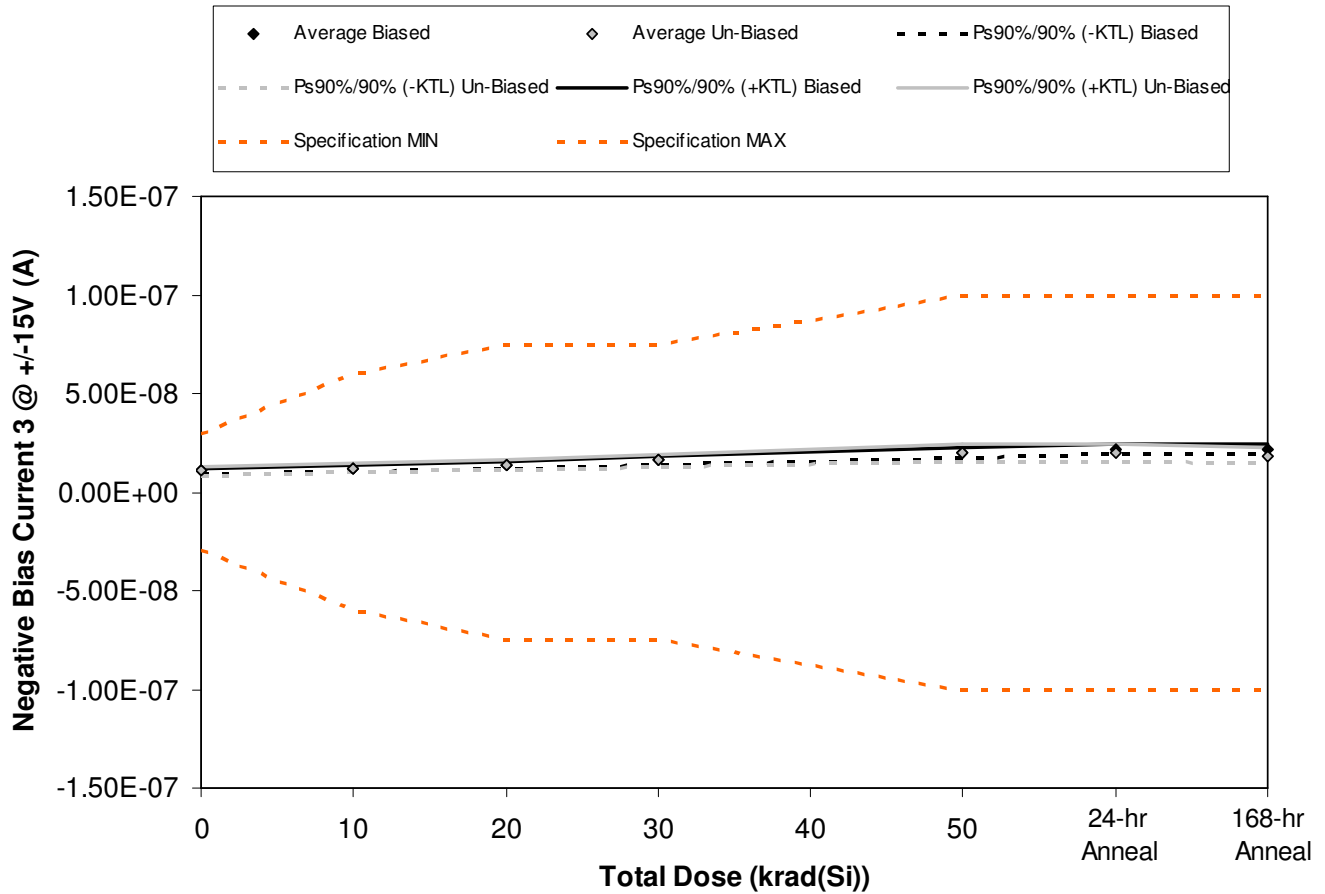

Figure 5.17. Plot of Negative Bias Current 3 @ +/-15V (A) versus total dose. The solid diamonds are the average of the measured data points for the samples irradiated under electrical bias while the shaded diamonds are the average of the measured data points for the samples irradiated with all pins tied to ground. The black lines (solid and/or dashed) are the average of the data points after application of the KTL statistics on the samples irradiated under electrical bias while the gray lines (solid and/or dashed) are the average of the data points after application of the KTL statistics on the samples irradiated in the unbiased condition. The red dotted line(s) are the pre- and/or post-irradiation minimum and/or maximum specification value as defined in the datasheet and/or test plan.



Table 5.17. Raw data for Negative Bias Current 3 @ +/-15V (A) versus total dose, including the statistical analysis, specification and the status of the testing (pass/fail).

Negative Bias Current 3 @ +/-15V (A)	Total Dose (krad(Si))					24 hr	168 hr
	0	10	20	30	50	Anneal	Anneal
Device	10/20/2011	11/3/2011	11/3/2011	11/3/2011	11/3/2011	11/4/2011	11/11/2011
1831	1.09E-08	1.23E-08	1.41E-08	1.60E-08	2.00E-08	2.17E-08	2.17E-08
1832	1.08E-08	1.20E-08	1.38E-08	1.59E-08	2.00E-08	2.18E-08	2.17E-08
1833	1.13E-08	1.28E-08	1.47E-08	1.69E-08	2.15E-08	2.33E-08	2.30E-08
1834	9.98E-09	1.12E-08	1.29E-08	1.49E-08	1.89E-08	2.05E-08	2.04E-08
1835	1.07E-08	1.22E-08	1.41E-08	1.64E-08	2.06E-08	2.23E-08	2.22E-08
1836	1.02E-08	1.14E-08	1.29E-08	1.49E-08	1.87E-08	1.88E-08	1.72E-08
1837	1.12E-08	1.26E-08	1.44E-08	1.64E-08	2.08E-08	2.08E-08	1.92E-08
1838	1.14E-08	1.29E-08	1.47E-08	1.68E-08	2.08E-08	2.08E-08	1.93E-08
1839	1.14E-08	1.29E-08	1.49E-08	1.72E-08	2.15E-08	2.14E-08	1.96E-08
1840	9.81E-09	1.10E-08	1.26E-08	1.44E-08	1.79E-08	1.79E-08	1.65E-08
1851	1.10E-08	1.10E-08	1.10E-08	1.10E-08	1.10E-08	1.09E-08	1.10E-08
1852	1.06E-08	1.06E-08	1.06E-08	1.06E-08	1.06E-08	1.05E-08	1.06E-08
Biased Statistics							
Average Biased	1.07E-08	1.21E-08	1.39E-08	1.60E-08	2.02E-08	2.19E-08	2.18E-08
Std Dev Biased	4.82E-10	5.79E-10	6.66E-10	7.18E-10	9.28E-10	1.03E-09	9.49E-10
Ps90%/90% (+KTL) Biased	1.21E-08	1.37E-08	1.57E-08	1.80E-08	2.28E-08	2.48E-08	2.44E-08
Ps90%/90% (-KTL) Biased	9.42E-09	1.05E-08	1.21E-08	1.41E-08	1.77E-08	1.91E-08	1.92E-08
Un-Biased Statistics							
Average Un-Biased	1.08E-08	1.22E-08	1.39E-08	1.60E-08	1.99E-08	1.99E-08	1.84E-08
Std Dev Un-Biased	7.48E-10	8.62E-10	1.06E-09	1.22E-09	1.54E-09	1.53E-09	1.40E-09
Ps90%/90% (+KTL) Un-Biased	1.29E-08	1.45E-08	1.68E-08	1.93E-08	2.41E-08	2.41E-08	2.22E-08
Ps90%/90% (-KTL) Un-Biased	8.76E-09	9.79E-09	1.10E-08	1.26E-08	1.57E-08	1.57E-08	1.45E-08
Specification MIN	-3.00E-08	-6.00E-08	-7.50E-08	-7.50E-08	-1.00E-07	-1.00E-07	-1.00E-07
Status	PASS	PASS	PASS	PASS	PASS	PASS	PASS
Specification MAX	3.00E-08	6.00E-08	7.50E-08	7.50E-08	1.00E-07	1.00E-07	1.00E-07
Status	PASS	PASS	PASS	PASS	PASS	PASS	PASS

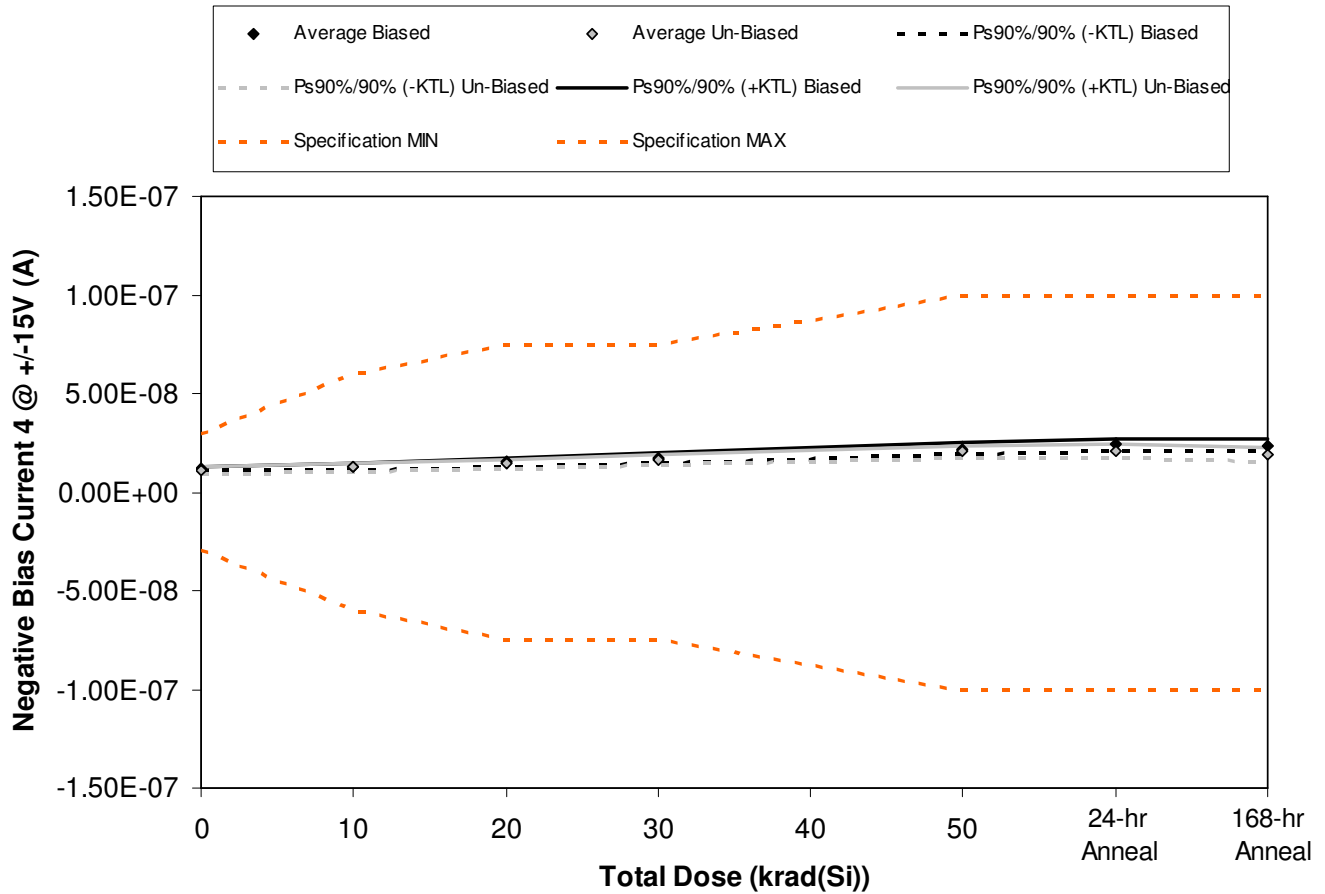

Figure 5.18. Plot of Negative Bias Current 4 @ +/-15V (A) versus total dose. The solid diamonds are the average of the measured data points for the samples irradiated under electrical bias while the shaded diamonds are the average of the measured data points for the samples irradiated with all pins tied to ground. The black lines (solid and/or dashed) are the average of the data points after application of the KTL statistics on the samples irradiated under electrical bias while the gray lines (solid and/or dashed) are the average of the data points after application of the KTL statistics on the samples irradiated in the unbiased condition. The red dotted line(s) are the pre- and/or post-irradiation minimum and/or maximum specification value as defined in the datasheet and/or test plan.



Table 5.18. Raw data for Negative Bias Current 4 @ +/-15V (A) versus total dose, including the statistical analysis, specification and the status of the testing (pass/fail).

Negative Bias Current 4 @ +/-15V (A)	Total Dose (krad(Si))					24 hr	168 hr
	0	10	20	30	50	Anneal	Anneal
Device	10/20/2011	11/3/2011	11/3/2011	11/3/2011	11/3/2011	11/4/2011	11/11/2011
1831	1.17E-08	1.32E-08	1.51E-08	1.72E-08	2.14E-08	2.32E-08	2.33E-08
1832	1.18E-08	1.32E-08	1.52E-08	1.75E-08	2.19E-08	2.39E-08	2.40E-08
1833	1.12E-08	1.22E-08	1.41E-08	1.61E-08	2.07E-08	2.25E-08	2.23E-08
1834	1.21E-08	1.37E-08	1.59E-08	1.85E-08	2.36E-08	2.54E-08	2.51E-08
1835	1.23E-08	1.37E-08	1.59E-08	1.84E-08	2.30E-08	2.49E-08	2.47E-08
1836	1.18E-08	1.31E-08	1.48E-08	1.70E-08	2.13E-08	2.16E-08	2.01E-08
1837	1.05E-08	1.18E-08	1.34E-08	1.54E-08	1.95E-08	1.96E-08	1.81E-08
1838	1.19E-08	1.33E-08	1.52E-08	1.73E-08	2.14E-08	2.16E-08	2.00E-08
1839	1.10E-08	1.25E-08	1.46E-08	1.69E-08	2.15E-08	2.12E-08	1.93E-08
1840	1.06E-08	1.18E-08	1.34E-08	1.52E-08	1.90E-08	1.89E-08	1.76E-08
1851	1.06E-08	1.07E-08	1.07E-08	1.07E-08	1.07E-08	1.06E-08	1.07E-08
1852	1.15E-08	1.15E-08	1.15E-08	1.15E-08	1.15E-08	1.15E-08	1.15E-08
Biased Statistics							
Average Biased	1.18E-08	1.32E-08	1.52E-08	1.75E-08	2.21E-08	2.40E-08	2.39E-08
Std Dev Biased	4.25E-10	6.24E-10	7.58E-10	9.92E-10	1.20E-09	1.20E-09	1.12E-09
Ps90%/90% (+KTL) Biased	1.30E-08	1.49E-08	1.73E-08	2.03E-08	2.54E-08	2.72E-08	2.69E-08
Ps90%/90% (-KTL) Biased	1.07E-08	1.15E-08	1.31E-08	1.48E-08	1.88E-08	2.07E-08	2.08E-08
Un-Biased Statistics							
Average Un-Biased	1.11E-08	1.25E-08	1.43E-08	1.64E-08	2.05E-08	2.06E-08	1.90E-08
Std Dev Un-Biased	6.57E-10	7.08E-10	8.22E-10	9.90E-10	1.19E-09	1.25E-09	1.14E-09
Ps90%/90% (+KTL) Un-Biased	1.29E-08	1.45E-08	1.65E-08	1.91E-08	2.38E-08	2.40E-08	2.22E-08
Ps90%/90% (-KTL) Un-Biased	9.35E-09	1.06E-08	1.20E-08	1.37E-08	1.73E-08	1.71E-08	1.59E-08
Specification MIN	-3.00E-08	-6.00E-08	-7.50E-08	-7.50E-08	-1.00E-07	-1.00E-07	-1.00E-07
Status	PASS	PASS	PASS	PASS	PASS	PASS	PASS
Specification MAX	3.00E-08	6.00E-08	7.50E-08	7.50E-08	1.00E-07	1.00E-07	1.00E-07
Status	PASS	PASS	PASS	PASS	PASS	PASS	PASS

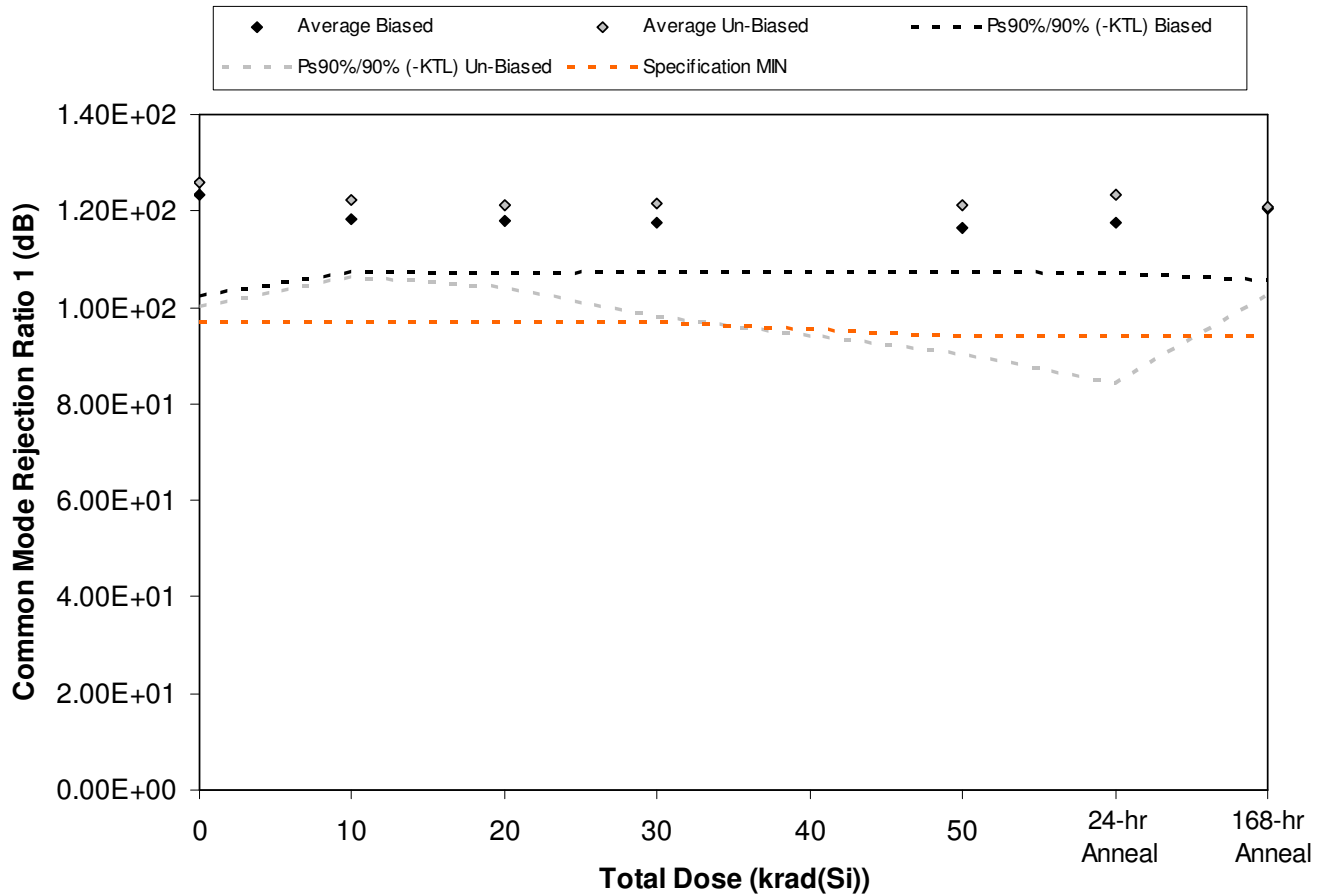

Figure 5.19. Plot of Common Mode Rejection Ratio 1 (dB) versus total dose. The solid diamonds are the average of the measured data points for the samples irradiated under electrical bias while the shaded diamonds are the average of the measured data points for the samples irradiated with all pins tied to ground. The black lines (solid and/or dashed) are the average of the data points after application of the KTL statistics on the samples irradiated under electrical bias while the gray lines (solid and/or dashed) are the average of the data points after application of the KTL statistics on the samples irradiated in the unbiased condition. The red dotted line(s) are the pre- and/or post-irradiation minimum and/or maximum specification value as defined in the datasheet and/or test plan.



Table 5.19. Raw data for Common Mode Rejection Ratio 1 (dB) versus total dose, including the statistical analysis, specification and the status of the testing (pass/fail).

Common Mode Rejection Ratio 1 (dB)	Total Dose (krad(Si))					24 hr Anneal	168 hr Anneal
	0	10	20	30	50		
Device	10/20/2011	11/3/2011	11/3/2011	11/3/2011	11/3/2011	11/4/2011	11/11/2011
1831	1.20E+02	1.16E+02	1.16E+02	1.15E+02	1.15E+02	1.15E+02	1.16E+02
1832	1.19E+02	1.19E+02	1.18E+02	1.18E+02	1.17E+02	1.18E+02	1.20E+02
1833	1.28E+02	1.21E+02	1.21E+02	1.20E+02	1.19E+02	1.21E+02	1.25E+02
1834	1.34E+02	1.23E+02	1.23E+02	1.22E+02	1.20E+02	1.22E+02	1.27E+02
1835	1.15E+02	1.13E+02	1.13E+02	1.12E+02	1.12E+02	1.13E+02	1.14E+02
1836	1.32E+02	1.24E+02	1.22E+02	1.21E+02	1.19E+02	1.20E+02	1.21E+02
1837	1.39E+02	1.28E+02	1.25E+02	1.23E+02	1.21E+02	1.22E+02	1.23E+02
1838	1.18E+02	1.16E+02	1.15E+02	1.14E+02	1.13E+02	1.13E+02	1.15E+02
1839	1.23E+02	1.26E+02	1.29E+02	1.35E+02	1.40E+02	1.48E+02	1.31E+02
1840	1.18E+02	1.16E+02	1.15E+02	1.14E+02	1.13E+02	1.14E+02	1.14E+02
1851	1.16E+02	1.16E+02	1.16E+02	1.17E+02	1.17E+02	1.15E+02	1.17E+02
1852	1.18E+02	1.18E+02	1.18E+02	1.18E+02	1.18E+02	1.17E+02	1.18E+02
Biased Statistics							
Average Biased	1.23E+02	1.18E+02	1.18E+02	1.18E+02	1.17E+02	1.18E+02	1.20E+02
Std Dev Biased	7.65E+00	4.02E+00	3.97E+00	3.71E+00	3.37E+00	3.90E+00	5.38E+00
Ps90%/90% (+KTL) Biased	1.44E+02	1.29E+02	1.29E+02	1.28E+02	1.26E+02	1.28E+02	1.35E+02
Ps90%/90% (-KTL) Biased	1.02E+02	1.07E+02	1.07E+02	1.07E+02	1.07E+02	1.07E+02	1.06E+02
Un-Biased Statistics							
Average Un-Biased	1.26E+02	1.22E+02	1.21E+02	1.22E+02	1.21E+02	1.23E+02	1.21E+02
Std Dev Un-Biased	9.34E+00	5.79E+00	6.32E+00	8.63E+00	1.12E+01	1.42E+01	6.64E+00
Ps90%/90% (+KTL) Un-Biased	1.51E+02	1.38E+02	1.39E+02	1.45E+02	1.52E+02	1.62E+02	1.39E+02
Ps90%/90% (-KTL) Un-Biased	1.00E+02	1.06E+02	1.04E+02	9.79E+01	9.05E+01	8.43E+01	1.03E+02
Specification MIN	9.70E+01	9.70E+01	9.70E+01	9.70E+01	9.40E+01	9.40E+01	9.40E+01
Status	PASS	PASS	PASS	PASS	PASS	PASS	PASS

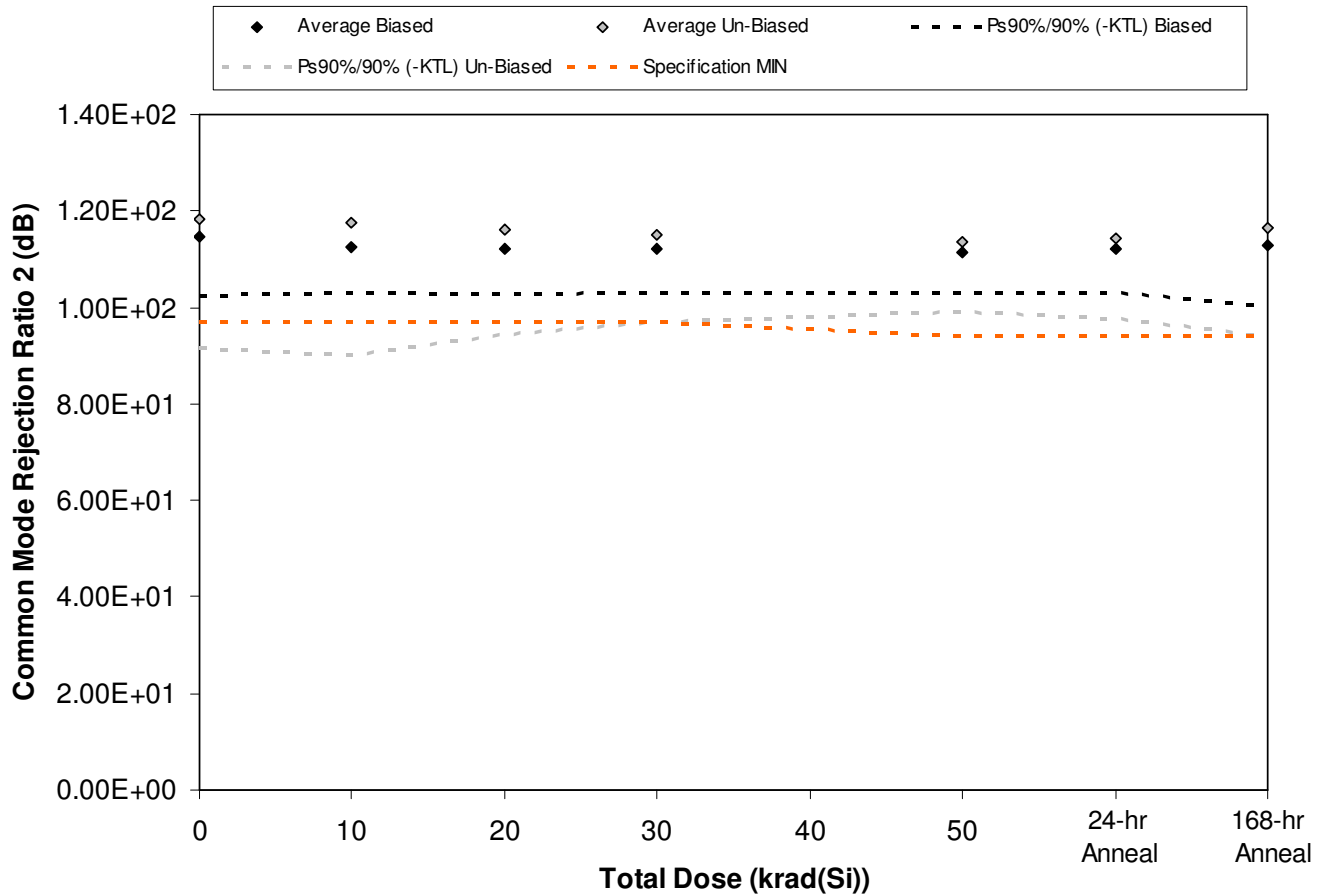

Figure 5.20. Plot of Common Mode Rejection Ratio 2 (dB) versus total dose. The solid diamonds are the average of the measured data points for the samples irradiated under electrical bias while the shaded diamonds are the average of the measured data points for the samples irradiated with all pins tied to ground. The black lines (solid and/or dashed) are the average of the data points after application of the KTL statistics on the samples irradiated under electrical bias while the gray lines (solid and/or dashed) are the average of the data points after application of the KTL statistics on the samples irradiated in the unbiased condition. The red dotted line(s) are the pre- and/or post-irradiation minimum and/or maximum specification value as defined in the datasheet and/or test plan.



**TID Report
11-572 R1.0**

**Aeroflex RAD
5017 N. 30th Street
Colorado Springs, CO 80919
(719) 531-0800**

Table 5.20. Raw data for Common Mode Rejection Ratio 2 (dB) versus total dose, including the statistical analysis, specification and the status of the testing (pass/fail).

Common Mode Rejection Ratio 2 (dB)	Total Dose (krad(Si))					24 hr Anneal	168 hr Anneal
	0	10	20	30	50		
Device	10/20/2011	11/3/2011	11/3/2011	11/3/2011	11/3/2011	11/4/2011	11/11/2011
1831	1.16E+02	1.15E+02	1.15E+02	1.14E+02	1.14E+02	1.15E+02	1.16E+02
1832	1.10E+02	1.09E+02	1.08E+02	1.08E+02	1.08E+02	1.09E+02	1.08E+02
1833	1.11E+02	1.10E+02	1.09E+02	1.09E+02	1.09E+02	1.09E+02	1.10E+02
1834	1.21E+02	1.17E+02	1.17E+02	1.16E+02	1.15E+02	1.16E+02	1.19E+02
1835	1.15E+02	1.13E+02	1.12E+02	1.12E+02	1.12E+02	1.12E+02	1.13E+02
1836	1.36E+02	1.36E+02	1.30E+02	1.26E+02	1.23E+02	1.25E+02	1.31E+02
1837	1.17E+02	1.16E+02	1.15E+02	1.14E+02	1.13E+02	1.14E+02	1.15E+02
1838	1.13E+02	1.12E+02	1.12E+02	1.11E+02	1.10E+02	1.11E+02	1.12E+02
1839	1.14E+02	1.14E+02	1.13E+02	1.13E+02	1.12E+02	1.12E+02	1.13E+02
1840	1.13E+02	1.12E+02	1.11E+02	1.10E+02	1.10E+02	1.10E+02	1.11E+02
1851	1.28E+02	1.28E+02	1.29E+02	1.29E+02	1.29E+02	1.28E+02	1.28E+02
1852	1.12E+02	1.12E+02	1.12E+02	1.12E+02	1.12E+02	1.12E+02	1.12E+02
Biased Statistics							
Average Biased	1.15E+02	1.12E+02	1.12E+02	1.12E+02	1.12E+02	1.12E+02	1.13E+02
Std Dev Biased	4.46E+00	3.46E+00	3.41E+00	3.32E+00	3.12E+00	3.37E+00	4.61E+00
Ps90%/90% (+KTL) Biased	1.27E+02	1.22E+02	1.22E+02	1.21E+02	1.20E+02	1.22E+02	1.26E+02
Ps90%/90% (-KTL) Biased	1.02E+02	1.03E+02	1.03E+02	1.03E+02	1.03E+02	1.03E+02	1.00E+02
Un-Biased Statistics							
Average Un-Biased	1.18E+02	1.18E+02	1.16E+02	1.15E+02	1.14E+02	1.14E+02	1.17E+02
Std Dev Un-Biased	9.81E+00	1.01E+01	7.90E+00	6.58E+00	5.28E+00	6.04E+00	8.18E+00
Ps90%/90% (+KTL) Un-Biased	1.45E+02	1.45E+02	1.38E+02	1.33E+02	1.28E+02	1.31E+02	1.39E+02
Ps90%/90% (-KTL) Un-Biased	9.16E+01	9.00E+01	9.44E+01	9.69E+01	9.91E+01	9.77E+01	9.41E+01
Specification MIN	9.70E+01	9.70E+01	9.70E+01	9.70E+01	9.40E+01	9.40E+01	9.40E+01
Status	PASS	PASS	PASS	PASS	PASS	PASS	PASS

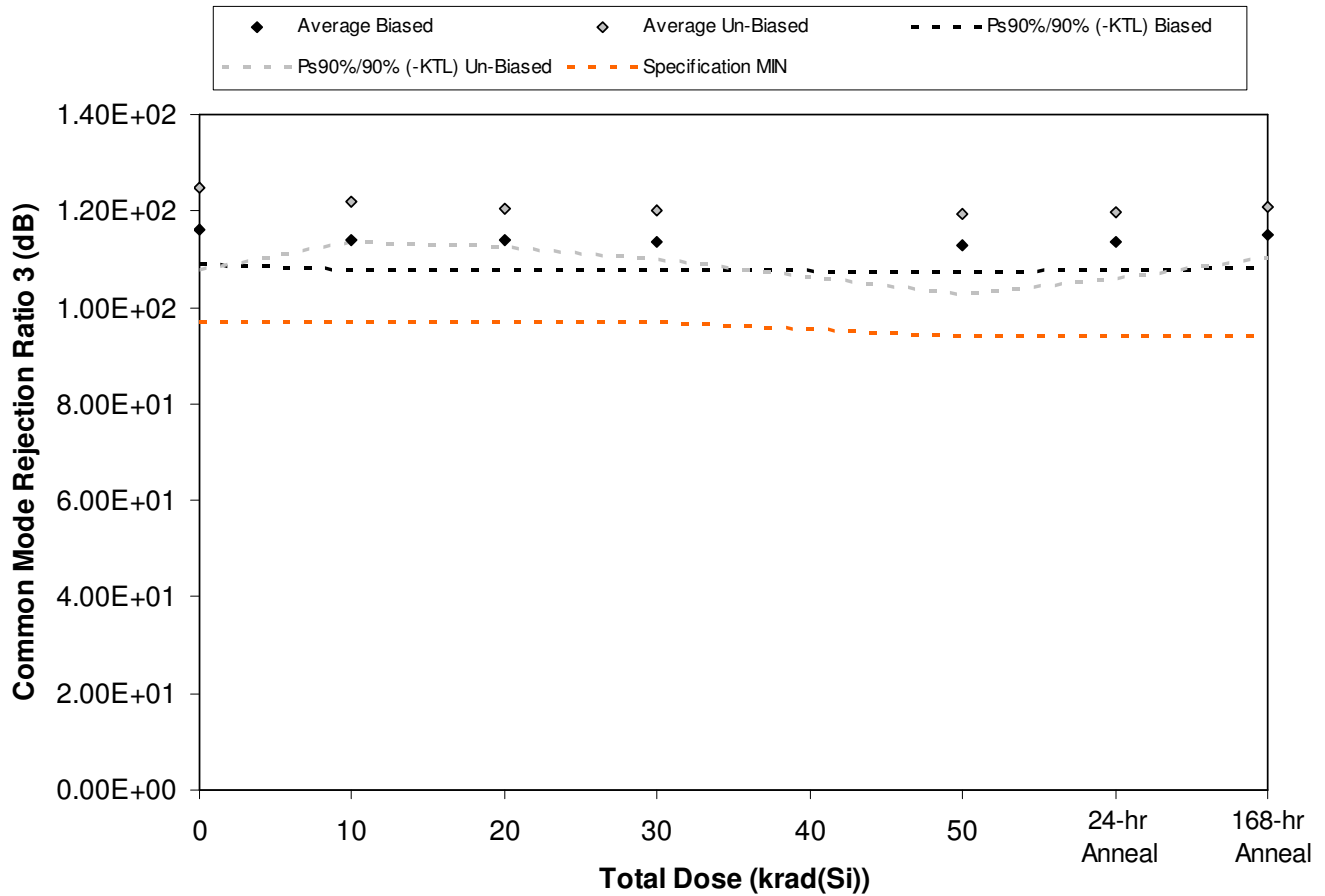

Figure 5.21. Plot of Common Mode Rejection Ratio 3 (dB) versus total dose. The solid diamonds are the average of the measured data points for the samples irradiated under electrical bias while the shaded diamonds are the average of the measured data points for the samples irradiated with all pins tied to ground. The black lines (solid and/or dashed) are the average of the data points after application of the KTL statistics on the samples irradiated under electrical bias while the gray lines (solid and/or dashed) are the average of the data points after application of the KTL statistics on the samples irradiated in the unbiased condition. The red dotted line(s) are the pre- and/or post-irradiation minimum and/or maximum specification value as defined in the datasheet and/or test plan.



Table 5.21. Raw data for Common Mode Rejection Ratio 3 (dB) versus total dose, including the statistical analysis, specification and the status of the testing (pass/fail).

Common Mode Rejection Ratio 3 (dB)	Total Dose (krad(Si))					24 hr Anneal	168 hr Anneal
	0	10	20	30	50		
Device	10/20/2011	11/3/2011	11/3/2011	11/3/2011	11/3/2011	11/4/2011	11/11/2011
1831	1.20E+02	1.17E+02	1.17E+02	1.16E+02	1.16E+02	1.16E+02	1.18E+02
1832	1.13E+02	1.12E+02	1.12E+02	1.11E+02	1.11E+02	1.11E+02	1.13E+02
1833	1.17E+02	1.15E+02	1.15E+02	1.14E+02	1.13E+02	1.14E+02	1.16E+02
1834	1.14E+02	1.12E+02	1.12E+02	1.11E+02	1.11E+02	1.11E+02	1.12E+02
1835	1.17E+02	1.15E+02	1.14E+02	1.14E+02	1.14E+02	1.14E+02	1.17E+02
1836	1.19E+02	1.22E+02	1.24E+02	1.26E+02	1.30E+02	1.28E+02	1.25E+02
1837	1.20E+02	1.18E+02	1.16E+02	1.16E+02	1.14E+02	1.15E+02	1.16E+02
1838	1.25E+02	1.22E+02	1.20E+02	1.19E+02	1.17E+02	1.18E+02	1.20E+02
1839	1.27E+02	1.22E+02	1.20E+02	1.19E+02	1.17E+02	1.18E+02	1.19E+02
1840	1.34E+02	1.26E+02	1.23E+02	1.21E+02	1.19E+02	1.20E+02	1.25E+02
1851	1.38E+02	1.37E+02	1.36E+02	1.38E+02	1.36E+02	1.35E+02	1.37E+02
1852	1.20E+02	1.20E+02	1.20E+02	1.20E+02	1.20E+02	1.20E+02	1.20E+02
Biased Statistics							
Average Biased	1.16E+02	1.14E+02	1.14E+02	1.13E+02	1.13E+02	1.13E+02	1.15E+02
Std Dev Biased	2.74E+00	2.25E+00	2.18E+00	2.10E+00	2.00E+00	2.05E+00	2.55E+00
Ps90%/90% (+KTL) Biased	1.24E+02	1.20E+02	1.20E+02	1.19E+02	1.18E+02	1.19E+02	1.22E+02
Ps90%/90% (-KTL) Biased	1.09E+02	1.08E+02	1.08E+02	1.08E+02	1.07E+02	1.08E+02	1.08E+02
Un-Biased Statistics							
Average Un-Biased	1.25E+02	1.22E+02	1.21E+02	1.20E+02	1.19E+02	1.20E+02	1.21E+02
Std Dev Un-Biased	6.29E+00	2.93E+00	2.96E+00	3.67E+00	6.07E+00	5.04E+00	3.85E+00
Ps90%/90% (+KTL) Un-Biased	1.42E+02	1.30E+02	1.29E+02	1.30E+02	1.36E+02	1.34E+02	1.32E+02
Ps90%/90% (-KTL) Un-Biased	1.08E+02	1.14E+02	1.12E+02	1.10E+02	1.03E+02	1.06E+02	1.10E+02
Specification MIN	9.70E+01	9.70E+01	9.70E+01	9.70E+01	9.40E+01	9.40E+01	9.40E+01
Status	PASS	PASS	PASS	PASS	PASS	PASS	PASS

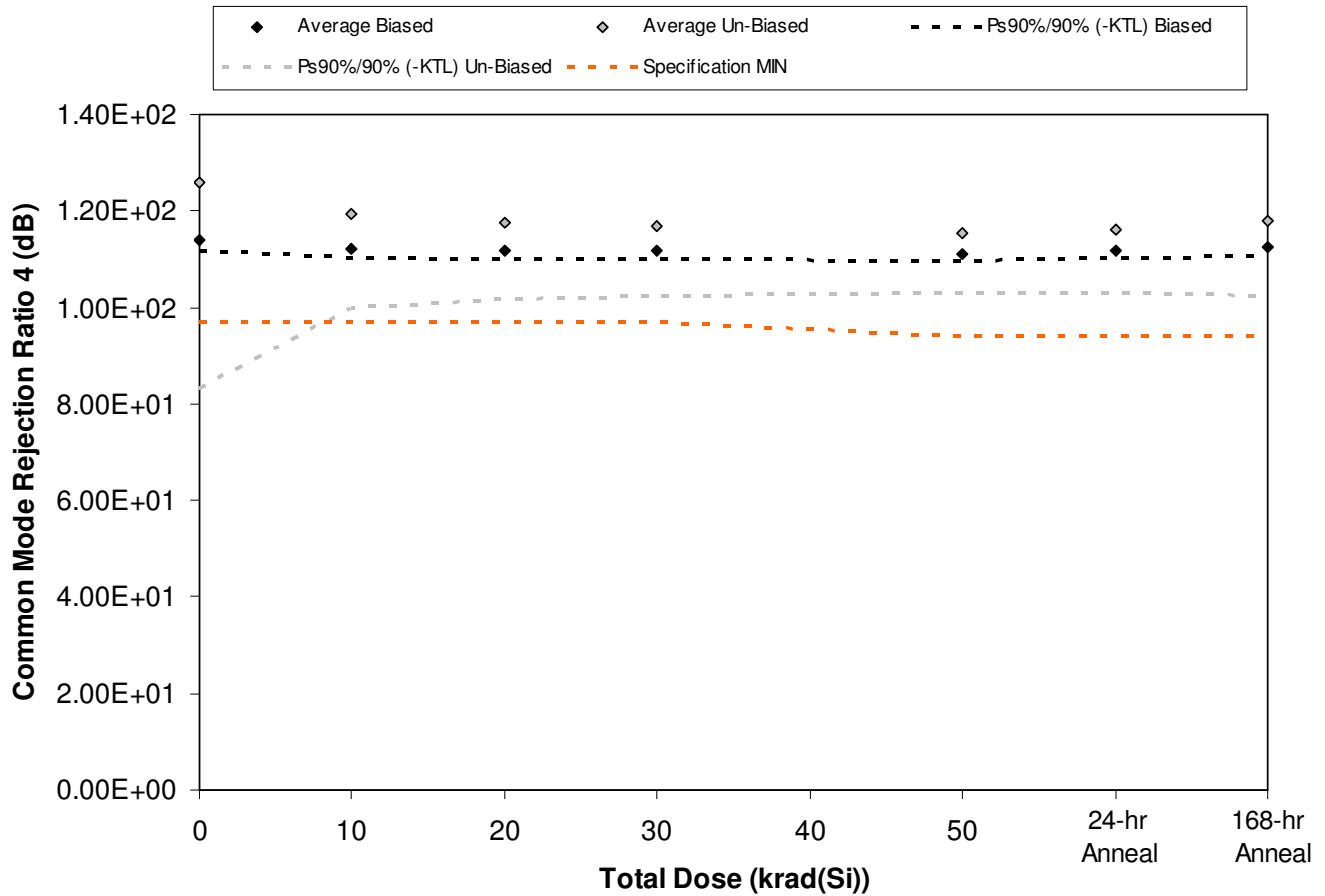

Figure 5.22. Plot of Common Mode Rejection Ratio 4 (dB) versus total dose. The solid diamonds are the average of the measured data points for the samples irradiated under electrical bias while the shaded diamonds are the average of the measured data points for the samples irradiated with all pins tied to ground. The black lines (solid and/or dashed) are the average of the data points after application of the KTL statistics on the samples irradiated under electrical bias while the gray lines (solid and/or dashed) are the average of the data points after application of the KTL statistics on the samples irradiated in the unbiased condition. The red dotted line(s) are the pre- and/or post-irradiation minimum and/or maximum specification value as defined in the datasheet and/or test plan.



Table 5.22. Raw data for Common Mode Rejection Ratio 4 (dB) versus total dose, including the statistical analysis, specification and the status of the testing (pass/fail).

Common Mode Rejection Ratio 4 (dB)	Total Dose (krad(Si))					24 hr Anneal	168 hr Anneal
	0	10	20	30	50		
Device	10/20/2011	11/3/2011	11/3/2011	11/3/2011	11/3/2011	11/4/2011	11/11/2011
1831	1.15E+02	1.13E+02	1.13E+02	1.12E+02	1.12E+02	1.12E+02	1.13E+02
1832	1.14E+02	1.12E+02	1.12E+02	1.12E+02	1.11E+02	1.12E+02	1.13E+02
1833	1.13E+02	1.13E+02	1.12E+02	1.12E+02	1.12E+02	1.12E+02	1.12E+02
1834	1.13E+02	1.12E+02	1.11E+02	1.11E+02	1.11E+02	1.11E+02	1.13E+02
1835	1.13E+02	1.11E+02	1.11E+02	1.11E+02	1.11E+02	1.11E+02	1.12E+02
1836	1.24E+02	1.21E+02	1.19E+02	1.18E+02	1.17E+02	1.18E+02	1.20E+02
1837	1.27E+02	1.23E+02	1.21E+02	1.20E+02	1.18E+02	1.19E+02	1.20E+02
1838	1.13E+02	1.12E+02	1.11E+02	1.11E+02	1.10E+02	1.11E+02	1.11E+02
1839	1.14E+02	1.13E+02	1.12E+02	1.12E+02	1.11E+02	1.11E+02	1.13E+02
1840	1.51E+02	1.29E+02	1.25E+02	1.23E+02	1.21E+02	1.22E+02	1.25E+02
1851	1.19E+02	1.19E+02	1.19E+02	1.20E+02	1.20E+02	1.19E+02	1.19E+02
1852	1.29E+02	1.29E+02	1.30E+02	1.29E+02	1.29E+02	1.29E+02	1.29E+02
Biased Statistics							
Average Biased	1.14E+02	1.12E+02	1.12E+02	1.12E+02	1.11E+02	1.12E+02	1.13E+02
Std Dev Biased	7.55E-01	6.38E-01	6.54E-01	5.62E-01	5.40E-01	5.52E-01	6.29E-01
Ps90%/90% (+KTL) Biased	1.16E+02	1.14E+02	1.14E+02	1.13E+02	1.13E+02	1.13E+02	1.14E+02
Ps90%/90% (-KTL) Biased	1.12E+02	1.10E+02	1.10E+02	1.10E+02	1.10E+02	1.10E+02	1.11E+02
Un-Biased Statistics							
Average Un-Biased	1.26E+02	1.19E+02	1.18E+02	1.17E+02	1.15E+02	1.16E+02	1.18E+02
Std Dev Un-Biased	1.56E+01	7.18E+00	5.90E+00	5.22E+00	4.49E+00	4.77E+00	5.65E+00
Ps90%/90% (+KTL) Un-Biased	1.69E+02	1.39E+02	1.34E+02	1.31E+02	1.28E+02	1.29E+02	1.33E+02
Ps90%/90% (-KTL) Un-Biased	8.32E+01	9.98E+01	1.02E+02	1.03E+02	1.03E+02	1.03E+02	1.02E+02
Specification MIN	9.70E+01	9.70E+01	9.70E+01	9.70E+01	9.40E+01	9.40E+01	9.40E+01
Status	PASS	PASS	PASS	PASS	PASS	PASS	PASS

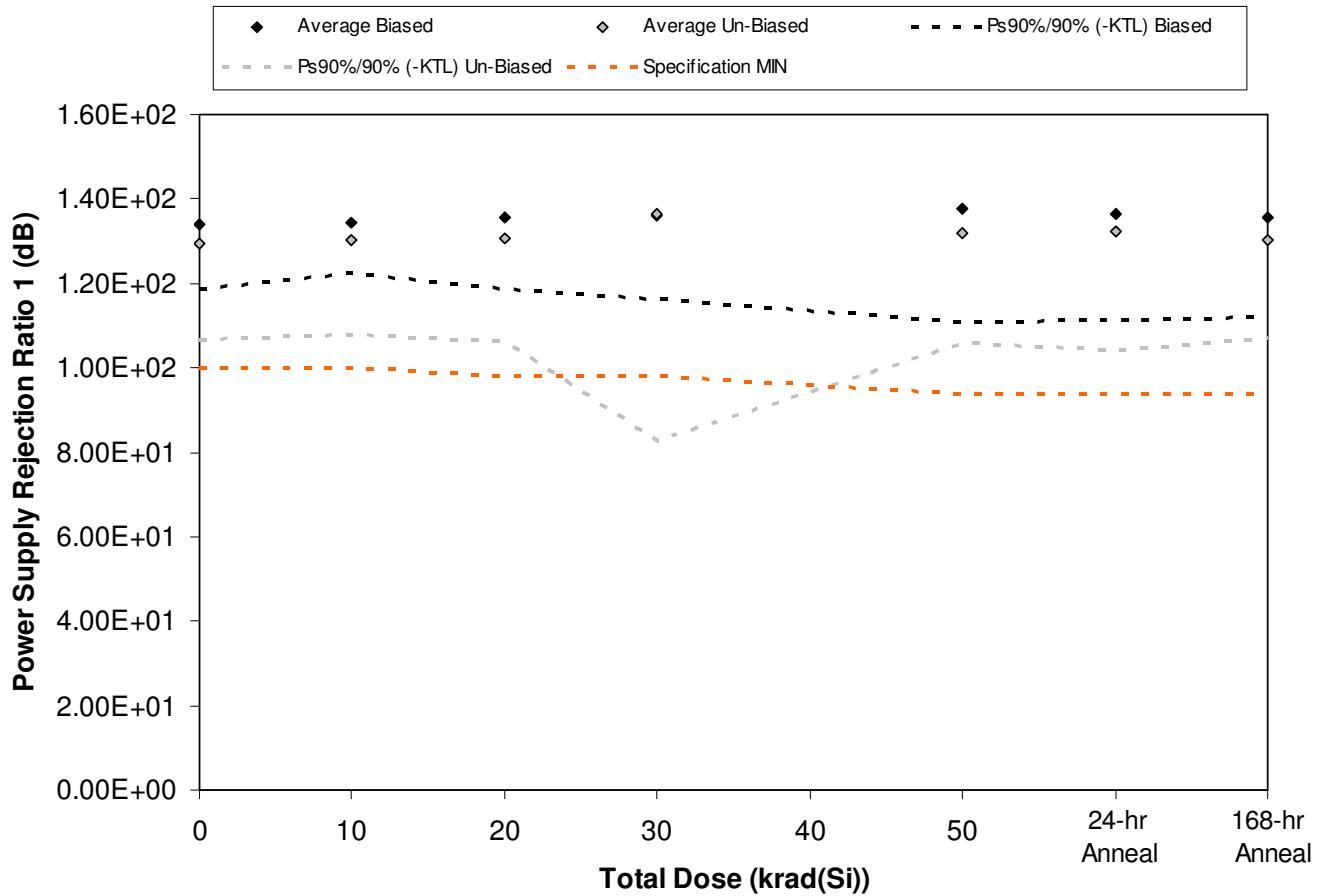

Figure 5.23. Plot of Power Supply Rejection Ratio 1 (dB) versus total dose. The solid diamonds are the average of the measured data points for the samples irradiated under electrical bias while the shaded diamonds are the average of the measured data points for the samples irradiated with all pins tied to ground. The black lines (solid and/or dashed) are the average of the data points after application of the KTL statistics on the samples irradiated under electrical bias while the gray lines (solid and/or dashed) are the average of the data points after application of the KTL statistics on the samples irradiated in the unbiased condition. The red dotted line(s) are the pre- and/or post-irradiation minimum and/or maximum specification value as defined in the datasheet and/or test plan.



Table 5.23. Raw data for Power Supply Rejection Ratio 1 (dB) versus total dose, including the statistical analysis, specification and the status of the testing (pass/fail).

Power Supply Rejection Ratio 1 (dB)	Total Dose (krad(Si))					24 hr Anneal	168 hr Anneal
	0	10	20	30	50		
Device	10/20/2011	11/3/2011	11/3/2011	11/3/2011	11/3/2011	11/4/2011	11/11/2011
1831	1.33E+02	1.32E+02	1.31E+02	1.30E+02	1.30E+02	1.30E+02	1.35E+02
1832	1.42E+02	1.37E+02	1.39E+02	1.36E+02	1.35E+02	1.35E+02	1.49E+02
1833	1.36E+02	1.40E+02	1.45E+02	1.48E+02	1.54E+02	1.52E+02	1.38E+02
1834	1.27E+02	1.29E+02	1.29E+02	1.30E+02	1.30E+02	1.30E+02	1.27E+02
1835	1.32E+02	1.33E+02	1.35E+02	1.35E+02	1.41E+02	1.35E+02	1.30E+02
1836	1.36E+02	1.38E+02	1.42E+02	1.70E+02	1.42E+02	1.47E+02	1.36E+02
1837	1.25E+02	1.26E+02	1.26E+02	1.27E+02	1.28E+02	1.29E+02	1.26E+02
1838	1.38E+02	1.37E+02	1.35E+02	1.33E+02	1.31E+02	1.33E+02	1.38E+02
1839	1.18E+02	1.18E+02	1.18E+02	1.19E+02	1.19E+02	1.19E+02	1.18E+02
1840	1.30E+02	1.32E+02	1.31E+02	1.33E+02	1.40E+02	1.35E+02	1.34E+02
1851	1.25E+02	1.26E+02	1.26E+02	1.26E+02	1.26E+02	1.25E+02	1.26E+02
1852	1.27E+02	1.26E+02	1.25E+02	1.26E+02	1.26E+02	1.26E+02	1.26E+02
Biased Statistics							
Average Biased	1.34E+02	1.34E+02	1.36E+02	1.36E+02	1.38E+02	1.36E+02	1.36E+02
Std Dev Biased	5.54E+00	4.39E+00	6.28E+00	7.23E+00	9.88E+00	9.15E+00	8.66E+00
Ps90%/90% (+KTL) Biased	1.49E+02	1.46E+02	1.53E+02	1.56E+02	1.65E+02	1.61E+02	1.60E+02
Ps90%/90% (-KTL) Biased	1.19E+02	1.22E+02	1.19E+02	1.16E+02	1.11E+02	1.11E+02	1.12E+02
Un-Biased Statistics							
Average Un-Biased	1.29E+02	1.30E+02	1.30E+02	1.36E+02	1.32E+02	1.32E+02	1.30E+02
Std Dev Un-Biased	8.19E+00	8.17E+00	8.77E+00	1.96E+01	9.53E+00	1.03E+01	8.54E+00
Ps90%/90% (+KTL) Un-Biased	1.52E+02	1.53E+02	1.55E+02	1.90E+02	1.58E+02	1.61E+02	1.54E+02
Ps90%/90% (-KTL) Un-Biased	1.07E+02	1.08E+02	1.06E+02	8.27E+01	1.06E+02	1.04E+02	1.07E+02
Specification MIN	1.00E+02	1.00E+02	9.80E+01	9.80E+01	9.40E+01	9.40E+01	9.40E+01
Status	PASS	PASS	PASS	PASS	PASS	PASS	PASS

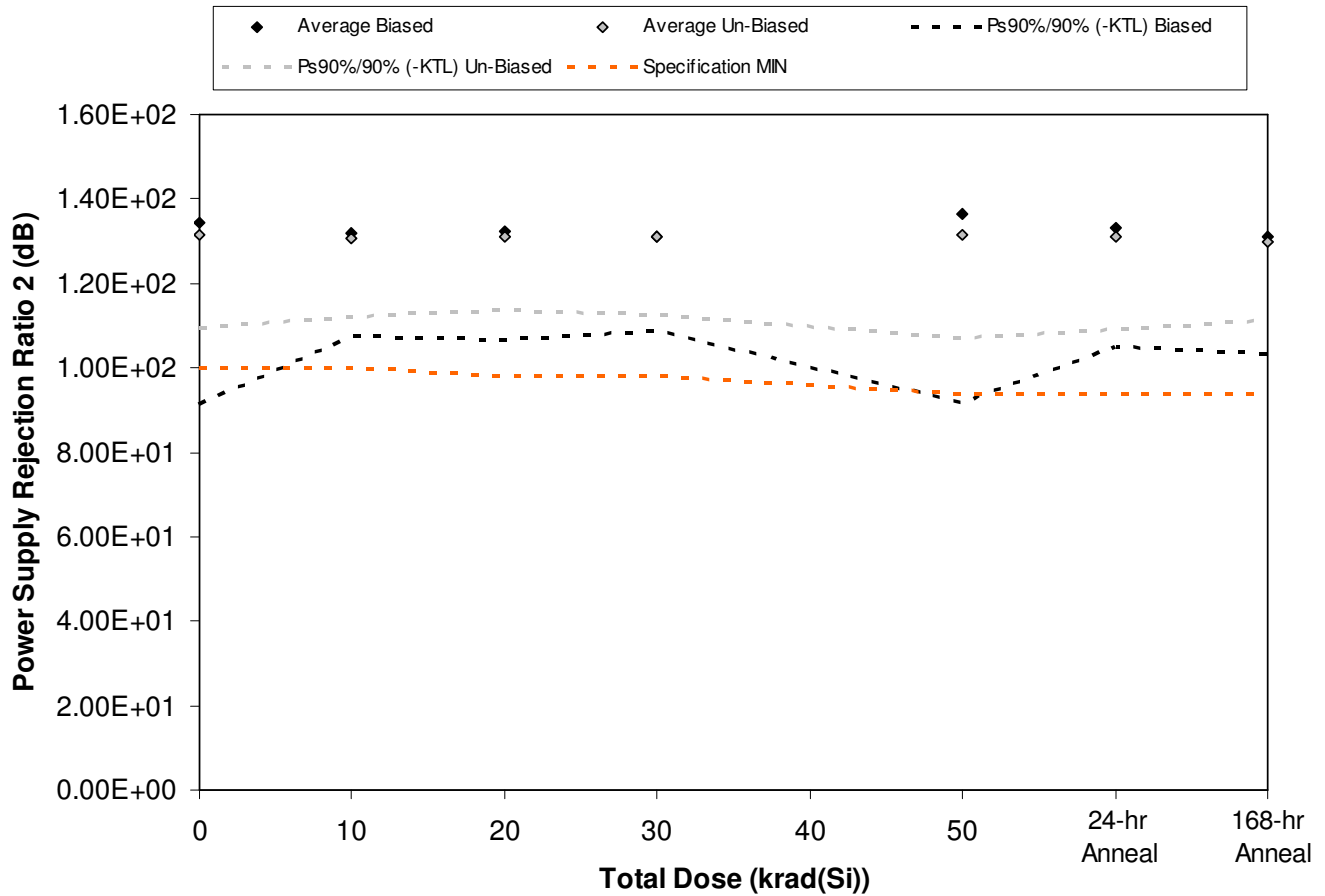

Figure 5.24. Plot of Power Supply Rejection Ratio 2 (dB) versus total dose. The solid diamonds are the average of the measured data points for the samples irradiated under electrical bias while the shaded diamonds are the average of the measured data points for the samples irradiated with all pins tied to ground. The black lines (solid and/or dashed) are the average of the data points after application of the KTL statistics on the samples irradiated under electrical bias while the gray lines (solid and/or dashed) are the average of the data points after application of the KTL statistics on the samples irradiated in the unbiased condition. The red dotted line(s) are the pre- and/or post-irradiation minimum and/or maximum specification value as defined in the datasheet and/or test plan.



**TID Report
11-572 R1.0**

**Aeroflex RAD
5017 N. 30th Street
Colorado Springs, CO 80919
(719) 531-0800**

Table 5.24. Raw data for Power Supply Rejection Ratio 2 (dB) versus total dose, including the statistical analysis, specification and the status of the testing (pass/fail).

Power Supply Rejection Ratio 2 (dB)	Total Dose (krad(Si))					24 hr Anneal	168 hr Anneal
	0	10	20	30	50		
Device	10/20/2011	11/3/2011	11/3/2011	11/3/2011	11/3/2011	11/4/2011	11/11/2011
1831	1.31E+02	1.34E+02	1.35E+02	1.34E+02	1.39E+02	1.36E+02	1.30E+02
1832	1.26E+02	1.24E+02	1.24E+02	1.24E+02	1.23E+02	1.24E+02	1.23E+02
1833	1.61E+02	1.40E+02	1.43E+02	1.39E+02	1.35E+02	1.39E+02	1.46E+02
1834	1.34E+02	1.41E+02	1.39E+02	1.39E+02	1.63E+02	1.45E+02	1.35E+02
1835	1.20E+02	1.22E+02	1.22E+02	1.21E+02	1.22E+02	1.22E+02	1.21E+02
1836	1.22E+02	1.23E+02	1.23E+02	1.23E+02	1.24E+02	1.24E+02	1.21E+02
1837	1.34E+02	1.32E+02	1.37E+02	1.40E+02	1.46E+02	1.44E+02	1.34E+02
1838	1.41E+02	1.37E+02	1.36E+02	1.35E+02	1.31E+02	1.30E+02	1.35E+02
1839	1.25E+02	1.25E+02	1.26E+02	1.26E+02	1.27E+02	1.26E+02	1.24E+02
1840	1.36E+02	1.37E+02	1.33E+02	1.32E+02	1.29E+02	1.30E+02	1.35E+02
1851	1.20E+02	1.21E+02	1.20E+02	1.21E+02	1.21E+02	1.21E+02	1.21E+02
1852	1.26E+02	1.26E+02	1.25E+02	1.26E+02	1.26E+02	1.26E+02	1.26E+02
Biased Statistics							
Average Biased	1.35E+02	1.32E+02	1.32E+02	1.31E+02	1.36E+02	1.33E+02	1.31E+02
Std Dev Biased	1.58E+01	8.86E+00	9.39E+00	8.19E+00	1.63E+01	1.02E+01	1.00E+01
Ps90%/90% (+KTL) Biased	1.78E+02	1.56E+02	1.58E+02	1.54E+02	1.81E+02	1.61E+02	1.58E+02
Ps90%/90% (-KTL) Biased	9.13E+01	1.08E+02	1.07E+02	1.09E+02	9.17E+01	1.05E+02	1.03E+02
Un-Biased Statistics							
Average Un-Biased	1.31E+02	1.31E+02	1.31E+02	1.31E+02	1.31E+02	1.31E+02	1.30E+02
Std Dev Un-Biased	7.93E+00	6.83E+00	6.35E+00	6.87E+00	8.83E+00	8.00E+00	6.68E+00
Ps90%/90% (+KTL) Un-Biased	1.53E+02	1.50E+02	1.49E+02	1.50E+02	1.56E+02	1.53E+02	1.48E+02
Ps90%/90% (-KTL) Un-Biased	1.10E+02	1.12E+02	1.14E+02	1.12E+02	1.07E+02	1.09E+02	1.11E+02
Specification MIN	1.00E+02	1.00E+02	9.80E+01	9.80E+01	9.40E+01	9.40E+01	9.40E+01
Status	PASS	PASS	PASS	PASS	PASS	PASS	PASS

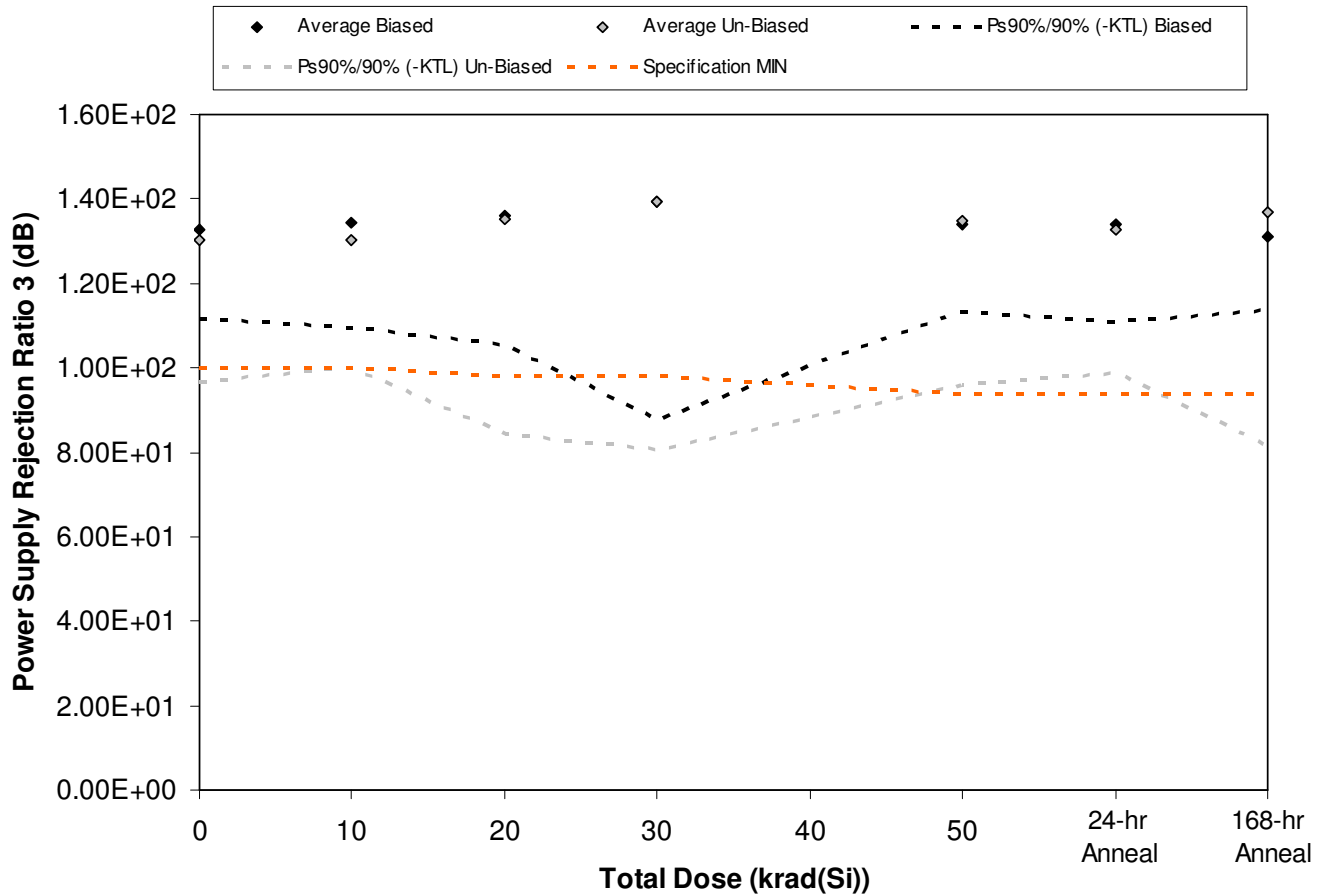

Figure 5.25. Plot of Power Supply Rejection Ratio 3 (dB) versus total dose. The solid diamonds are the average of the measured data points for the samples irradiated under electrical bias while the shaded diamonds are the average of the measured data points for the samples irradiated with all pins tied to ground. The black lines (solid and/or dashed) are the average of the data points after application of the KTL statistics on the samples irradiated under electrical bias while the gray lines (solid and/or dashed) are the average of the data points after application of the KTL statistics on the samples irradiated in the unbiased condition. The red dotted line(s) are the pre- and/or post-irradiation minimum and/or maximum specification value as defined in the datasheet and/or test plan.



Table 5.25. Raw data for Power Supply Rejection Ratio 3 (dB) versus total dose, including the statistical analysis, specification and the status of the testing (pass/fail).

Power Supply Rejection Ratio 3 (dB)	Total Dose (krad(Si))					24 hr Anneal	168 hr Anneal
	0	10	20	30	50		
Device	10/20/2011	11/3/2011	11/3/2011	11/3/2011	11/3/2011	11/4/2011	11/11/2011
1831	1.26E+02	1.27E+02	1.27E+02	1.27E+02	1.28E+02	1.26E+02	1.26E+02
1832	1.37E+02	1.41E+02	1.52E+02	1.72E+02	1.43E+02	1.45E+02	1.34E+02
1833	1.28E+02	1.26E+02	1.26E+02	1.25E+02	1.25E+02	1.25E+02	1.27E+02
1834	1.44E+02	1.47E+02	1.43E+02	1.40E+02	1.37E+02	1.40E+02	1.41E+02
1835	1.29E+02	1.32E+02	1.32E+02	1.34E+02	1.35E+02	1.33E+02	1.28E+02
1836	1.17E+02	1.17E+02	1.17E+02	1.17E+02	1.18E+02	1.18E+02	1.18E+02
1837	1.46E+02	1.43E+02	1.63E+02	1.57E+02	1.39E+02	1.38E+02	1.68E+02
1838	1.38E+02	1.38E+02	1.42E+02	1.66E+02	1.48E+02	1.47E+02	1.43E+02
1839	1.30E+02	1.33E+02	1.32E+02	1.35E+02	1.47E+02	1.39E+02	1.34E+02
1840	1.20E+02	1.20E+02	1.21E+02	1.21E+02	1.22E+02	1.22E+02	1.21E+02
1851	1.31E+02	1.35E+02	1.34E+02	1.34E+02	1.32E+02	1.33E+02	1.32E+02
1852	1.28E+02	1.27E+02	1.27E+02	1.27E+02	1.27E+02	1.28E+02	1.27E+02
Biased Statistics							
Average Biased	1.33E+02	1.35E+02	1.36E+02	1.39E+02	1.34E+02	1.34E+02	1.31E+02
Std Dev Biased	7.66E+00	9.18E+00	1.11E+01	1.89E+01	7.50E+00	8.42E+00	6.34E+00
Ps90%/90% (+KTL) Biased	1.54E+02	1.60E+02	1.66E+02	1.91E+02	1.54E+02	1.57E+02	1.49E+02
Ps90%/90% (-KTL) Biased	1.12E+02	1.09E+02	1.05E+02	8.76E+01	1.13E+02	1.11E+02	1.14E+02
Un-Biased Statistics							
Average Un-Biased	1.30E+02	1.30E+02	1.35E+02	1.39E+02	1.35E+02	1.33E+02	1.37E+02
Std Dev Un-Biased	1.21E+01	1.11E+01	1.86E+01	2.15E+01	1.42E+01	1.23E+01	2.01E+01
Ps90%/90% (+KTL) Un-Biased	1.63E+02	1.61E+02	1.86E+02	1.98E+02	1.74E+02	1.66E+02	1.92E+02
Ps90%/90% (-KTL) Un-Biased	9.69E+01	1.00E+02	8.43E+01	8.05E+01	9.58E+01	9.90E+01	8.14E+01
Specification MIN	1.00E+02	1.00E+02	9.80E+01	9.80E+01	9.40E+01	9.40E+01	9.40E+01
Status	PASS	PASS	PASS	PASS	PASS	PASS	PASS

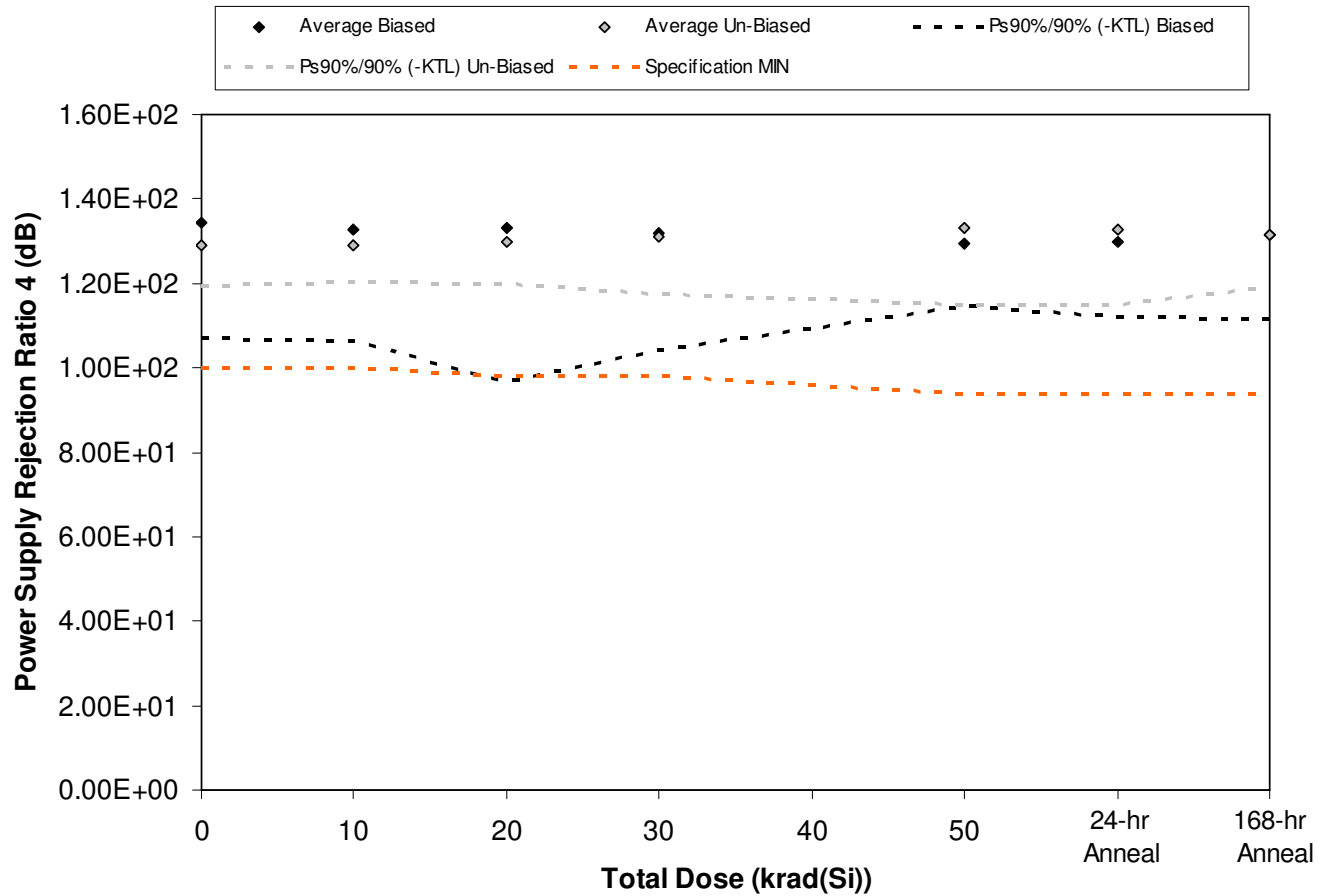

Figure 5.26. Plot of Power Supply Rejection Ratio 4 (dB) versus total dose. The solid diamonds are the average of the measured data points for the samples irradiated under electrical bias while the shaded diamonds are the average of the measured data points for the samples irradiated with all pins tied to ground. The black lines (solid and/or dashed) are the average of the data points after application of the KTL statistics on the samples irradiated under electrical bias while the gray lines (solid and/or dashed) are the average of the data points after application of the KTL statistics on the samples irradiated in the unbiased condition. The red dotted line(s) are the pre- and/or post-irradiation minimum and/or maximum specification value as defined in the datasheet and/or test plan.



Table 5.26. Raw data for Power Supply Rejection Ratio 4 (dB) versus total dose, including the statistical analysis, specification and the status of the testing (pass/fail).

Power Supply Rejection Ratio 4 (dB)	Total Dose (krad(Si))					24 hr Anneal	168 hr Anneal
	0	10	20	30	50		
Device	10/20/2011	11/3/2011	11/3/2011	11/3/2011	11/3/2011	11/4/2011	11/11/2011
1831	1.29E+02	1.26E+02	1.27E+02	1.25E+02	1.25E+02	1.25E+02	1.27E+02
1832	1.36E+02	1.33E+02	1.31E+02	1.32E+02	1.30E+02	1.30E+02	1.33E+02
1833	1.26E+02	1.27E+02	1.26E+02	1.27E+02	1.29E+02	1.28E+02	1.28E+02
1834	1.51E+02	1.49E+02	1.57E+02	1.49E+02	1.38E+02	1.41E+02	1.43E+02
1835	1.30E+02	1.27E+02	1.26E+02	1.26E+02	1.25E+02	1.26E+02	1.27E+02
1836	1.32E+02	1.31E+02	1.33E+02	1.34E+02	1.40E+02	1.38E+02	1.33E+02
1837	1.23E+02	1.24E+02	1.24E+02	1.24E+02	1.26E+02	1.25E+02	1.25E+02
1838	1.31E+02	1.30E+02	1.28E+02	1.28E+02	1.26E+02	1.26E+02	1.29E+02
1839	1.29E+02	1.29E+02	1.31E+02	1.33E+02	1.35E+02	1.38E+02	1.32E+02
1840	1.31E+02	1.32E+02	1.33E+02	1.36E+02	1.38E+02	1.37E+02	1.37E+02
1851	1.26E+02	1.26E+02	1.26E+02	1.26E+02	1.26E+02	1.26E+02	1.26E+02
1852	1.22E+02	1.22E+02	1.22E+02	1.22E+02	1.22E+02	1.22E+02	1.22E+02
Biased Statistics							
Average Biased	1.34E+02	1.33E+02	1.33E+02	1.32E+02	1.29E+02	1.30E+02	1.31E+02
Std Dev Biased	9.93E+00	9.55E+00	1.33E+01	9.98E+00	5.37E+00	6.49E+00	7.15E+00
Ps90%/90% (+KTL) Biased	1.62E+02	1.59E+02	1.70E+02	1.59E+02	1.44E+02	1.48E+02	1.51E+02
Ps90%/90% (-KTL) Biased	1.07E+02	1.06E+02	9.67E+01	1.04E+02	1.15E+02	1.12E+02	1.12E+02
Un-Biased Statistics							
Average Un-Biased	1.29E+02	1.29E+02	1.30E+02	1.31E+02	1.33E+02	1.33E+02	1.31E+02
Std Dev Un-Biased	3.54E+00	3.28E+00	3.58E+00	4.98E+00	6.51E+00	6.51E+00	4.50E+00
Ps90%/90% (+KTL) Un-Biased	1.39E+02	1.38E+02	1.40E+02	1.45E+02	1.51E+02	1.51E+02	1.44E+02
Ps90%/90% (-KTL) Un-Biased	1.19E+02	1.20E+02	1.20E+02	1.17E+02	1.15E+02	1.15E+02	1.19E+02
Specification MIN	1.00E+02	1.00E+02	9.80E+01	9.80E+01	9.40E+01	9.40E+01	9.40E+01
Status	PASS	PASS	PASS	PASS	PASS	PASS	PASS

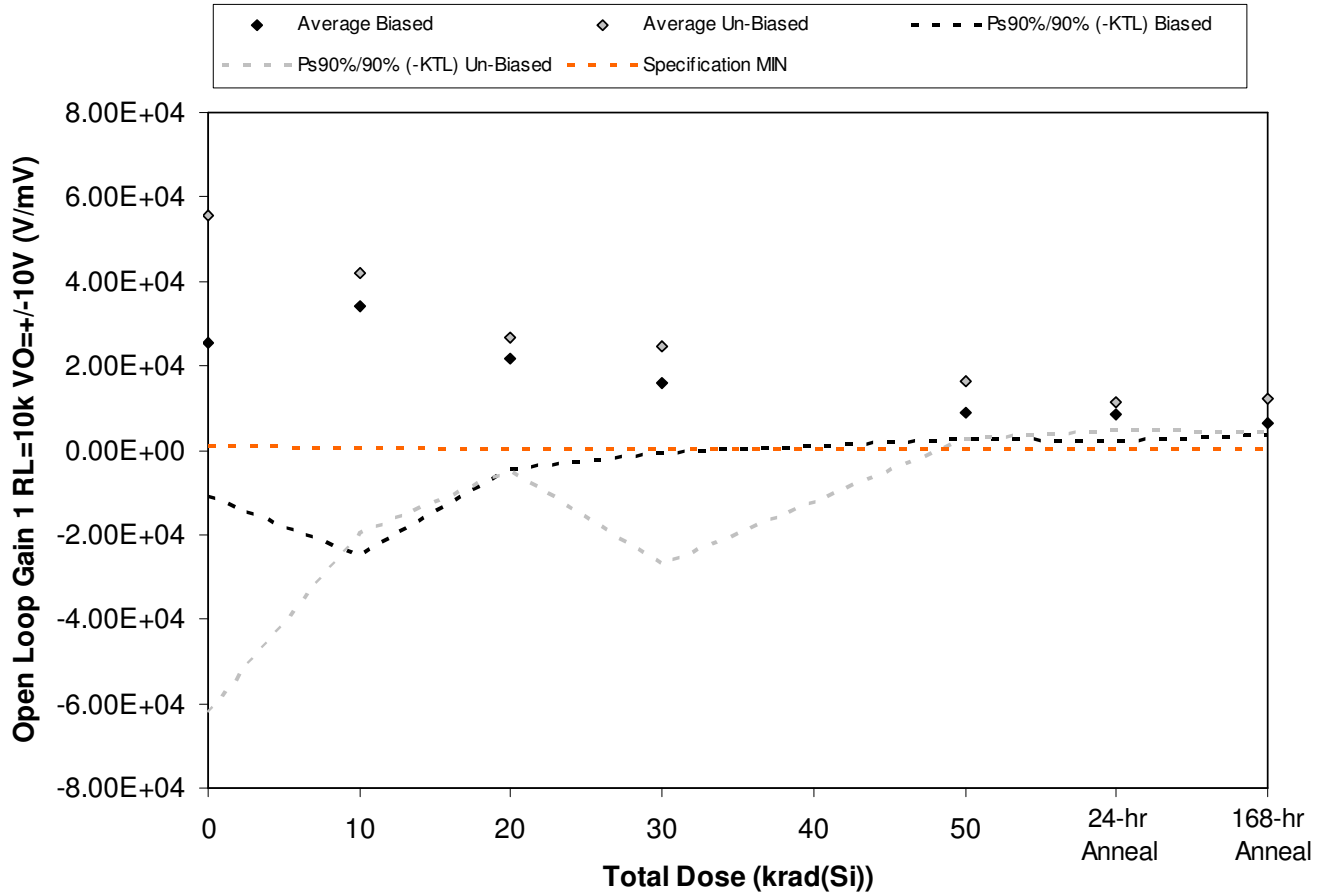

Figure 5.27. Plot of Open Loop Gain 1 RL=10k VO=+/-10V (V/mV) versus total dose. The solid diamonds are the average of the measured data points for the samples irradiated under electrical bias while the shaded diamonds are the average of the measured data points for the samples irradiated with all pins tied to ground. The black lines (solid and/or dashed) are the average of the data points after application of the KTL statistics on the samples irradiated under electrical bias while the gray lines (solid and/or dashed) are the average of the data points after application of the KTL statistics on the samples irradiated in the unbiased condition. The red dotted line(s) are the pre- and/or post-irradiation minimum and/or maximum specification value as defined in the datasheet and/or test plan.



Table 5.27. Raw data for Open Loop Gain 1 RL=10k VO=+/-10V (V/mV) versus total dose, including the statistical analysis, specification and the status of the testing (pass/fail).

Open Loop Gain 1 RL=10k VO=+/-10V (V/mV)	Total Dose (krad(Si))					24 hr	168 hr
	0	10	20	30	50	Anneal	Anneal
Device							
	10/20/2011	11/3/2011	11/3/2011	11/3/2011	11/3/2011	11/4/2011	11/11/2011
1831	1.66E+04	1.91E+04	1.61E+04	1.21E+04	7.70E+03	7.06E+03	5.29E+03
1832	1.85E+04	2.20E+04	2.05E+04	1.40E+04	8.73E+03	7.93E+03	5.81E+03
1833	4.54E+04	6.68E+04	2.90E+04	2.45E+04	1.11E+04	1.20E+04	7.54E+03
1834	3.32E+04	4.53E+04	3.36E+04	1.87E+04	1.13E+04	9.36E+03	7.29E+03
1835	1.41E+04	1.73E+04	9.85E+03	9.50E+03	6.01E+03	6.23E+03	5.43E+03
1836	3.14E+04	2.81E+04	2.20E+04	1.21E+04	1.06E+04	9.99E+03	1.14E+04
1837	3.82E+04	7.53E+04	4.49E+04	3.11E+04	1.84E+04	1.03E+04	1.24E+04
1838	1.63E+04	1.84E+04	1.40E+04	1.07E+04	1.16E+04	9.41E+03	8.28E+03
1839	1.25E+05	3.50E+04	2.82E+04	1.42E+04	1.84E+04	1.27E+04	1.35E+04
1840	6.70E+04	5.29E+04	2.39E+04	5.50E+04	2.21E+04	1.52E+04	1.61E+04
1851	1.95E+04	2.09E+04	2.21E+04	2.33E+04	2.45E+04	1.90E+04	2.13E+04
1852	2.16E+04	2.24E+04	2.13E+04	2.27E+04	2.48E+04	2.18E+04	2.48E+04
Biased Statistics							
Average Biased	2.56E+04	3.41E+04	2.18E+04	1.58E+04	8.96E+03	8.51E+03	6.27E+03
Std Dev Biased	1.34E+04	2.15E+04	9.60E+03	5.93E+03	2.25E+03	2.25E+03	1.06E+03
Ps90%/90% (+KTL) Biased	6.22E+04	9.30E+04	4.81E+04	3.20E+04	1.51E+04	1.47E+04	9.18E+03
Ps90%/90% (-KTL) Biased	-1.11E+04	-2.48E+04	-4.53E+03	-5.09E+02	2.79E+03	2.34E+03	3.36E+03
Un-Biased Statistics							
Average Un-Biased	5.56E+04	4.19E+04	2.66E+04	2.46E+04	1.62E+04	1.15E+04	1.23E+04
Std Dev Un-Biased	4.30E+04	2.25E+04	1.15E+04	1.88E+04	4.93E+03	2.39E+03	2.86E+03
Ps90%/90% (+KTL) Un-Biased	1.74E+05	1.04E+05	5.81E+04	7.63E+04	2.97E+04	1.81E+04	2.02E+04
Ps90%/90% (-KTL) Un-Biased	-6.23E+04	-1.97E+04	-4.85E+03	-2.71E+04	2.67E+03	4.93E+03	4.51E+03
Specification MIN	1.20E+03	5.00E+02	2.00E+02	2.00E+02	1.00E+02	1.00E+02	1.00E+02
Status	PASS	PASS	PASS	PASS	PASS	PASS	PASS

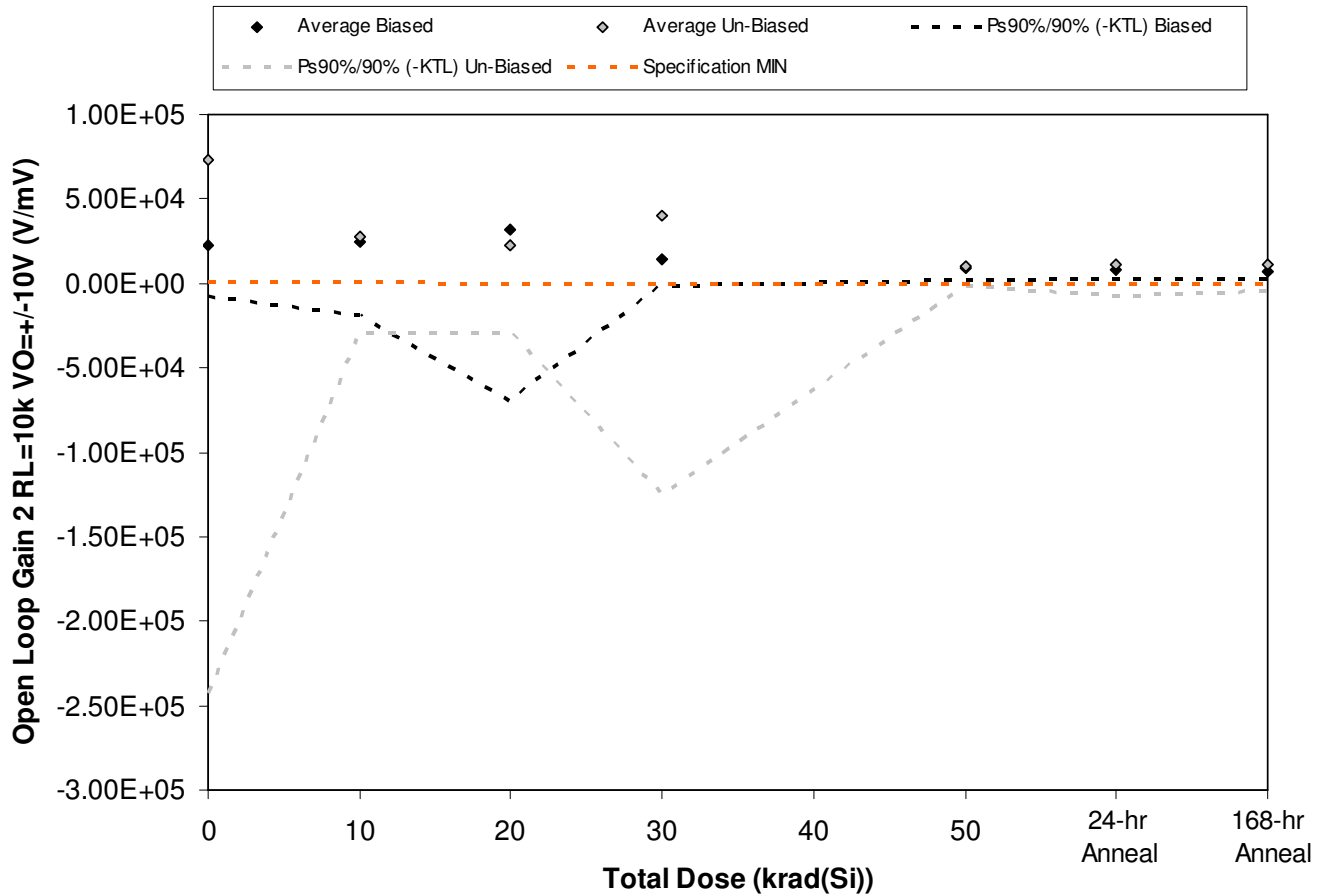

Figure 5.28. Plot of Open Loop Gain 2 RL=10k VO=+-10V (V/mV) versus total dose. The solid diamonds are the average of the measured data points for the samples irradiated under electrical bias while the shaded diamonds are the average of the measured data points for the samples irradiated with all pins tied to ground. The black lines (solid and/or dashed) are the average of the data points after application of the KTL statistics on the samples irradiated under electrical bias while the gray lines (solid and/or dashed) are the average of the data points after application of the KTL statistics on the samples irradiated in the unbiased condition. The red dotted line(s) are the pre- and/or post-irradiation minimum and/or maximum specification value as defined in the datasheet and/or test plan.



**TID Report
11-572 R1.0**

**Aeroflex RAD
5017 N. 30th Street
Colorado Springs, CO 80919
(719) 531-0800**

Table 5.28. Raw data for Open Loop Gain 2 RL=10k VO=+/-10V (V/mV) versus total dose, including the statistical analysis, specification and the status of the testing (pass/fail).

Open Loop Gain 2 RL=10k VO=+/-10V (V/mV)	Total Dose (krad(Si))					24 hr	168 hr
	0	10	20	30	50	Anneal	Anneal
Device	10/20/2011	11/3/2011	11/3/2011	11/3/2011	11/3/2011	11/4/2011	11/11/2011
1831	2.72E+04	2.78E+04	2.06E+04	2.10E+04	1.11E+04	9.51E+03	7.44E+03
1832	1.66E+04	1.38E+04	1.04E+04	9.20E+03	6.81E+03	6.67E+03	5.23E+03
1833	1.79E+04	1.94E+04	1.91E+04	1.13E+04	7.77E+03	7.17E+03	6.13E+03
1834	3.93E+04	5.15E+04	9.82E+04	1.82E+04	1.28E+04	1.05E+04	8.73E+03
1835	1.13E+04	1.23E+04	1.21E+04	9.27E+03	7.70E+03	6.14E+03	5.36E+03
1836	2.79E+05	6.45E+04	5.58E+04	1.47E+05	1.77E+04	2.26E+04	2.15E+04
1837	2.76E+04	2.12E+04	2.00E+04	1.82E+04	9.07E+03	8.84E+03	1.01E+04
1838	1.86E+04	1.94E+04	1.58E+04	1.21E+04	7.63E+03	7.32E+03	8.72E+03
1839	1.41E+04	1.16E+04	9.82E+03	7.70E+03	6.81E+03	5.95E+03	7.20E+03
1840	2.42E+04	2.40E+04	1.19E+04	1.30E+04	9.65E+03	9.32E+03	1.03E+04
1851	7.09E+04	5.45E+04	5.19E+04	7.07E+04	4.11E+04	3.28E+04	8.01E+04
1852	3.32E+04	3.34E+04	3.63E+04	4.42E+04	3.97E+04	4.06E+04	2.71E+04
Biased Statistics							
Average Biased	2.24E+04	2.50E+04	3.21E+04	1.38E+04	9.24E+03	8.00E+03	6.58E+03
Std Dev Biased	1.10E+04	1.60E+04	3.72E+04	5.45E+03	2.59E+03	1.90E+03	1.49E+03
Ps90%/90% (+KTL) Biased	5.27E+04	6.89E+04	1.34E+05	2.87E+04	1.63E+04	1.32E+04	1.07E+04
Ps90%/90% (-KTL) Biased	-7.79E+03	-1.90E+04	-7.00E+04	-1.14E+03	2.14E+03	2.79E+03	2.49E+03
Un-Biased Statistics							
Average Un-Biased	7.26E+04	2.81E+04	2.27E+04	3.96E+04	1.02E+04	1.08E+04	1.15E+04
Std Dev Un-Biased	1.15E+05	2.08E+04	1.89E+04	6.02E+04	4.35E+03	6.74E+03	5.68E+03
Ps90%/90% (+KTL) Un-Biased	3.89E+05	8.53E+04	7.46E+04	2.05E+05	2.21E+04	2.93E+04	2.71E+04
Ps90%/90% (-KTL) Un-Biased	-2.44E+05	-2.90E+04	-2.93E+04	-1.25E+05	-1.76E+03	-7.68E+03	-4.01E+03
Specification MIN	1.20E+03	5.00E+02	2.00E+02	2.00E+02	1.00E+02	1.00E+02	1.00E+02
Status	PASS	PASS	PASS	PASS	PASS	PASS	PASS

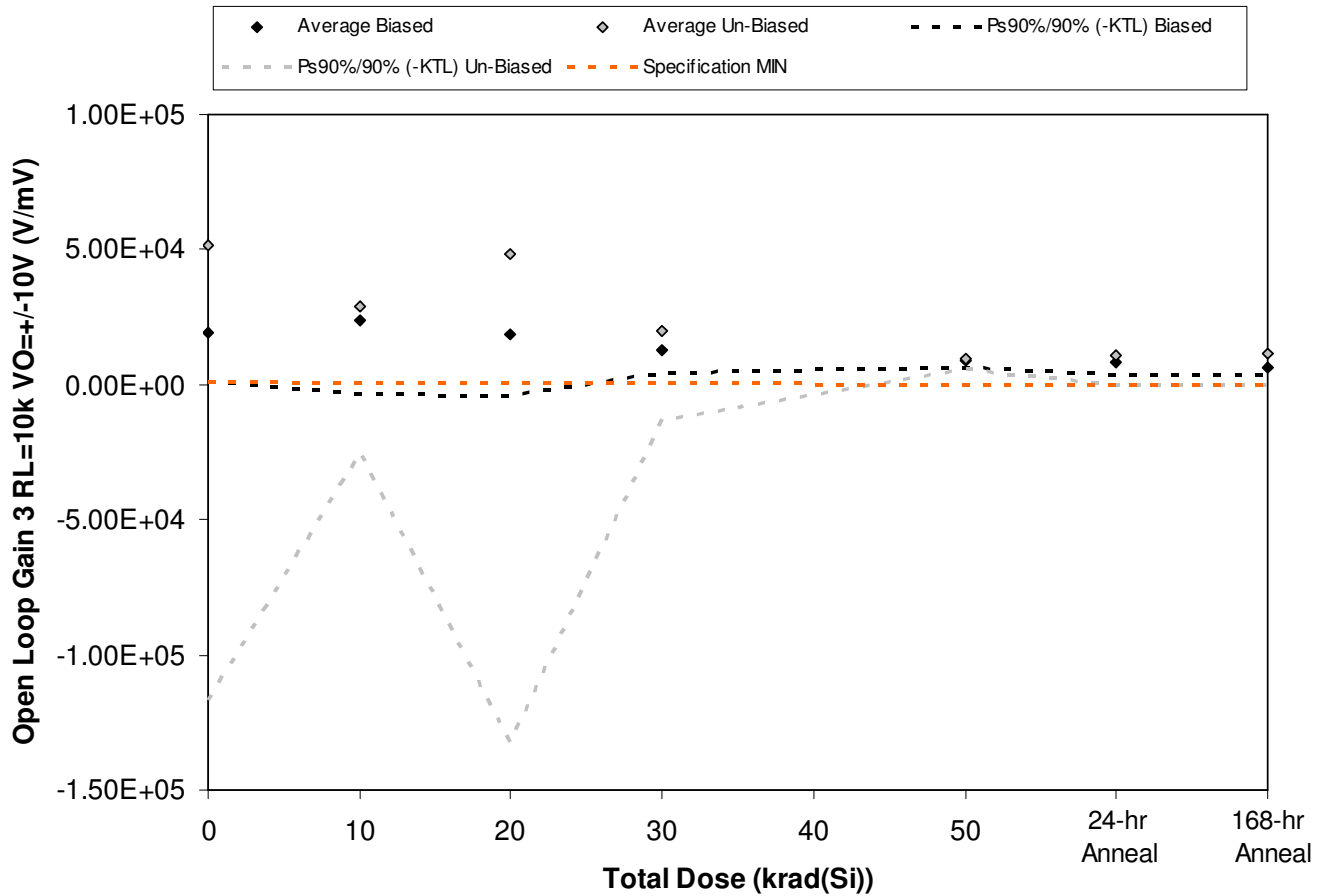

Figure 5.29. Plot of Open Loop Gain 3 RL=10k VO=+/-10V (V/mV) versus total dose. The solid diamonds are the average of the measured data points for the samples irradiated under electrical bias while the shaded diamonds are the average of the measured data points for the samples irradiated with all pins tied to ground. The black lines (solid and/or dashed) are the average of the data points after application of the KTL statistics on the samples irradiated under electrical bias while the gray lines (solid and/or dashed) are the average of the data points after application of the KTL statistics on the samples irradiated in the unbiased condition. The red dotted line(s) are the pre- and/or post-irradiation minimum and/or maximum specification value as defined in the datasheet and/or test plan.



Table 5.29. Raw data for Open Loop Gain 3 RL=10k VO=+/-10V (V/mV) versus total dose, including the statistical analysis, specification and the status of the testing (pass/fail).

Open Loop Gain 3 RL=10k VO=+/-10V (V/mV)	Total Dose (krad(Si))					24 hr	168 hr
	0	10	20	30	50	Anneal	Anneal
Device	10/20/2011	11/3/2011	11/3/2011	11/3/2011	11/3/2011	11/4/2011	11/11/2011
1831	2.01E+04	3.99E+04	2.59E+04	1.58E+04	9.47E+03	9.05E+03	6.48E+03
1832	1.34E+04	1.36E+04	1.18E+04	9.37E+03	7.73E+03	6.27E+03	5.41E+03
1833	2.98E+04	2.38E+04	2.97E+04	1.63E+04	9.78E+03	9.40E+03	7.67E+03
1834	1.78E+04	2.14E+04	1.32E+04	1.15E+04	8.31E+03	9.29E+03	6.31E+03
1835	1.48E+04	1.98E+04	1.34E+04	1.12E+04	8.02E+03	6.82E+03	5.86E+03
1836	1.61E+05	6.40E+04	1.66E+05	4.01E+04	1.12E+04	1.72E+04	1.80E+04
1837	2.24E+04	2.11E+04	2.74E+04	1.39E+04	9.04E+03	8.11E+03	9.21E+03
1838	1.85E+04	1.52E+04	1.59E+04	1.15E+04	7.55E+03	8.14E+03	8.49E+03
1839	2.34E+04	2.11E+04	1.43E+04	1.20E+04	9.44E+03	8.83E+03	8.47E+03
1840	3.25E+04	2.34E+04	1.80E+04	2.31E+04	1.05E+04	1.12E+04	1.36E+04
1851	5.78E+04	4.81E+04	5.26E+04	6.88E+04	5.95E+04	5.03E+04	7.23E+04
1852	1.94E+04	1.67E+04	1.85E+04	2.07E+04	1.89E+04	1.70E+04	1.65E+04
Biased Statistics							
Average Biased	1.92E+04	2.37E+04	1.88E+04	1.28E+04	8.66E+03	8.16E+03	6.35E+03
Std Dev Biased	6.46E+03	9.81E+03	8.37E+03	3.03E+03	9.09E+02	1.50E+03	8.49E+02
Ps90%/90% (+KTL) Biased	3.69E+04	5.06E+04	4.17E+04	2.11E+04	1.12E+04	1.23E+04	8.67E+03
Ps90%/90% (-KTL) Biased	1.45E+03	-3.23E+03	-4.18E+03	4.52E+03	6.17E+03	4.06E+03	4.02E+03
Un-Biased Statistics							
Average Un-Biased	5.16E+04	2.90E+04	4.83E+04	2.01E+04	9.54E+03	1.07E+04	1.16E+04
Std Dev Un-Biased	6.15E+04	1.98E+04	6.58E+04	1.21E+04	1.40E+03	3.84E+03	4.19E+03
Ps90%/90% (+KTL) Un-Biased	2.20E+05	8.33E+04	2.29E+05	5.33E+04	1.34E+04	2.12E+04	2.31E+04
Ps90%/90% (-KTL) Un-Biased	-1.17E+05	-2.54E+04	-1.32E+05	-1.30E+04	5.70E+03	1.58E+02	6.20E+01
Specification MIN	1.20E+03	5.00E+02	2.00E+02	2.00E+02	1.00E+02	1.00E+02	1.00E+02
Status	PASS	PASS	PASS	PASS	PASS	PASS	PASS

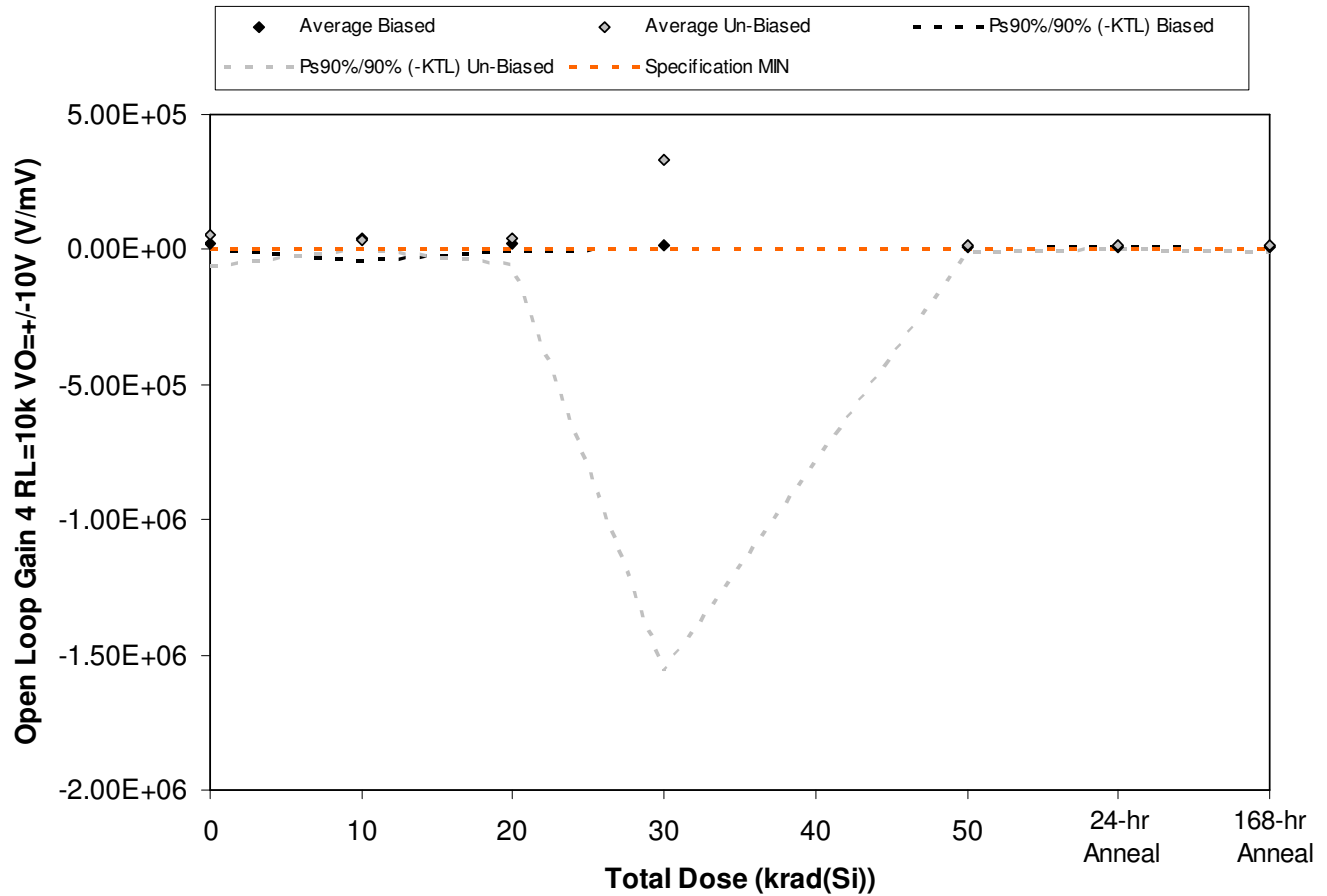

Figure 5.30. Plot of Open Loop Gain 4 RL=10k VO=+/-10V (V/mV) versus total dose. The solid diamonds are the average of the measured data points for the samples irradiated under electrical bias while the shaded diamonds are the average of the measured data points for the samples irradiated with all pins tied to ground. The black lines (solid and/or dashed) are the average of the data points after application of the KTL statistics on the samples irradiated under electrical bias while the gray lines (solid and/or dashed) are the average of the data points after application of the KTL statistics on the samples irradiated in the unbiased condition. The red dotted line(s) are the pre- and/or post-irradiation minimum and/or maximum specification value as defined in the datasheet and/or test plan.



**TID Report
11-572 R1.0**

**Aeroflex RAD
5017 N. 30th Street
Colorado Springs, CO 80919
(719) 531-0800**

Table 5.30. Raw data for Open Loop Gain 4 RL=10k VO=+/-10V (V/mV) versus total dose, including the statistical analysis, specification and the status of the testing (pass/fail).

Open Loop Gain 4 RL=10k VO=+/-10V (V/mV)	Total Dose (krad(Si))					24 hr	168 hr
	0	10	20	30	50	Anneal	Anneal
Device							
	10/20/2011	11/3/2011	11/3/2011	11/3/2011	11/3/2011	11/4/2011	11/11/2011
1831	1.66E+04	2.60E+04	2.61E+04	1.29E+04	9.86E+03	7.46E+03	5.57E+03
1832	1.50E+04	2.44E+04	1.52E+04	1.42E+04	7.94E+03	7.78E+03	5.82E+03
1833	2.82E+04	1.80E+04	1.52E+04	1.18E+04	7.87E+03	7.96E+03	6.87E+03
1834	2.62E+04	9.05E+04	2.36E+04	2.35E+04	1.11E+04	9.02E+03	7.66E+03
1835	3.22E+04	3.92E+04	4.18E+04	1.71E+04	8.82E+03	8.43E+03	7.15E+03
1836	2.68E+04	3.87E+04	1.75E+04	2.03E+04	9.07E+03	1.27E+04	1.05E+04
1837	2.38E+04	2.12E+04	1.47E+04	1.79E+04	1.07E+04	1.01E+04	1.13E+04
1838	2.32E+04	2.53E+04	1.63E+04	1.45E+04	9.67E+03	8.19E+03	8.87E+03
1839	9.43E+04	3.61E+04	9.67E+04	4.13E+04	2.33E+04	1.93E+04	3.39E+04
1840	1.07E+05	4.73E+04	5.76E+04	1.56E+06	2.84E+04	1.50E+04	1.74E+04
1851	1.86E+04	2.09E+04	2.28E+04	2.05E+04	1.70E+04	1.98E+04	1.97E+04
1852	8.30E+04	8.50E+04	8.08E+04	2.06E+05	1.68E+05	6.16E+04	1.13E+05
Biased Statistics							
Average Biased	2.36E+04	3.96E+04	2.44E+04	1.59E+04	9.12E+03	8.13E+03	6.61E+03
Std Dev Biased	7.49E+03	2.95E+04	1.09E+04	4.67E+03	1.37E+03	6.09E+02	8.89E+02
Ps90%/90% (+KTL) Biased	4.42E+04	1.20E+05	5.43E+04	2.87E+04	1.29E+04	9.80E+03	9.05E+03
Ps90%/90% (-KTL) Biased	3.11E+03	-4.12E+04	-5.55E+03	3.10E+03	5.36E+03	6.46E+03	4.17E+03
Un-Biased Statistics							
Average Un-Biased	5.50E+04	3.37E+04	4.05E+04	3.32E+05	1.62E+04	1.31E+04	1.64E+04
Std Dev Un-Biased	4.19E+04	1.05E+04	3.62E+04	6.89E+05	8.97E+03	4.34E+03	1.03E+04
Ps90%/90% (+KTL) Un-Biased	1.70E+05	6.26E+04	1.40E+05	2.22E+06	4.08E+04	2.49E+04	4.47E+04
Ps90%/90% (-KTL) Un-Biased	-5.99E+04	4.87E+03	-5.86E+04	-1.56E+06	-8.39E+03	1.16E+03	-1.19E+04
Specification MIN	1.20E+03	5.00E+02	2.00E+02	2.00E+02	1.00E+02	1.00E+02	1.00E+02
Status	PASS	PASS	PASS	PASS	PASS	PASS	PASS

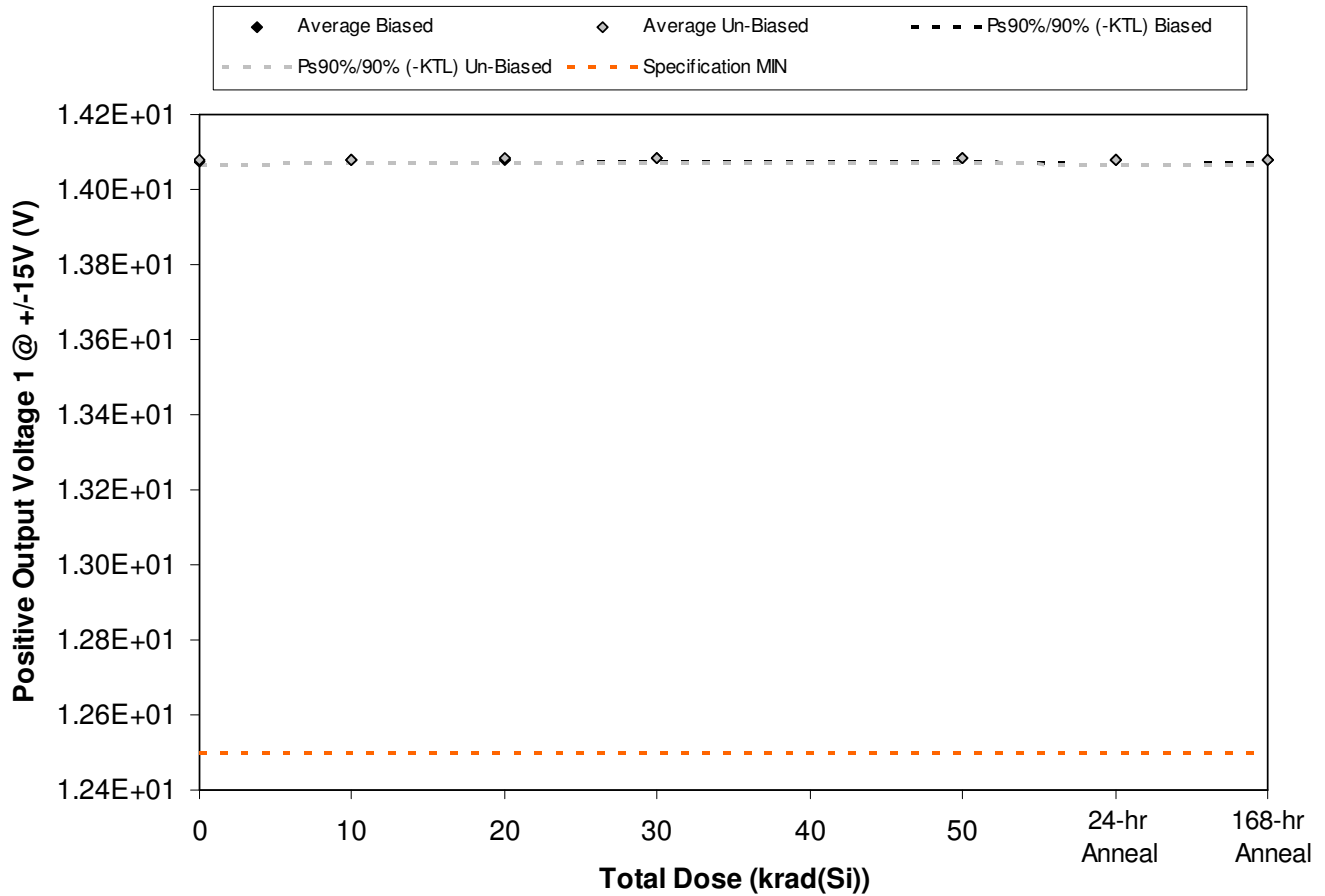

Figure 5.31. Plot of Positive Output Voltage 1 @ +/-15V (V) versus total dose. The solid diamonds are the average of the measured data points for the samples irradiated under electrical bias while the shaded diamonds are the average of the measured data points for the samples irradiated with all pins tied to ground. The black lines (solid and/or dashed) are the average of the data points after application of the KTL statistics on the samples irradiated under electrical bias while the gray lines (solid and/or dashed) are the average of the data points after application of the KTL statistics on the samples irradiated in the unbiased condition. The red dotted line(s) are the pre- and/or post-irradiation minimum and/or maximum specification value as defined in the datasheet and/or test plan.



**TID Report
11-572 R1.0**

**Aeroflex RAD
5017 N. 30th Street
Colorado Springs, CO 80919
(719) 531-0800**

Table 5.31. Raw data for Positive Output Voltage 1 @ +/-15V (V) versus total dose, including the statistical analysis, specification and the status of the testing (pass/fail).

Positive Output Voltage 1 @ +/-15V (V)	Total Dose (krad(Si))					24 hr Anneal	168 hr Anneal
	0	10	20	30	50		
Device	10/20/2011	11/3/2011	11/3/2011	11/3/2011	11/3/2011	11/4/2011	11/11/2011
1831	1.41E+01	1.41E+01	1.41E+01	1.41E+01	1.41E+01	1.41E+01	1.41E+01
1832	1.41E+01	1.41E+01	1.41E+01	1.41E+01	1.41E+01	1.41E+01	1.41E+01
1833	1.41E+01	1.41E+01	1.41E+01	1.41E+01	1.41E+01	1.41E+01	1.41E+01
1834	1.41E+01	1.41E+01	1.41E+01	1.41E+01	1.41E+01	1.41E+01	1.41E+01
1835	1.41E+01	1.41E+01	1.41E+01	1.41E+01	1.41E+01	1.41E+01	1.41E+01
1836	1.41E+01	1.41E+01	1.41E+01	1.41E+01	1.41E+01	1.41E+01	1.41E+01
1837	1.41E+01	1.41E+01	1.41E+01	1.41E+01	1.41E+01	1.41E+01	1.41E+01
1838	1.41E+01	1.41E+01	1.41E+01	1.41E+01	1.41E+01	1.41E+01	1.41E+01
1839	1.41E+01	1.41E+01	1.41E+01	1.41E+01	1.41E+01	1.41E+01	1.41E+01
1840	1.41E+01	1.41E+01	1.41E+01	1.41E+01	1.41E+01	1.41E+01	1.41E+01
1851	1.41E+01	1.41E+01	1.41E+01	1.41E+01	1.41E+01	1.41E+01	1.41E+01
1852	1.41E+01	1.41E+01	1.41E+01	1.41E+01	1.41E+01	1.41E+01	1.41E+01
Biased Statistics							
Average Biased	1.41E+01	1.41E+01	1.41E+01	1.41E+01	1.41E+01	1.41E+01	1.41E+01
Std Dev Biased	3.78E-03	3.39E-03	3.35E-03	3.32E-03	2.74E-03	3.61E-03	3.65E-03
Ps90%/90% (+KTL) Biased	1.41E+01	1.41E+01	1.41E+01	1.41E+01	1.41E+01	1.41E+01	1.41E+01
Ps90%/90% (-KTL) Biased	1.41E+01	1.41E+01	1.41E+01	1.41E+01	1.41E+01	1.41E+01	1.41E+01
Un-Biased Statistics							
Average Un-Biased	1.41E+01	1.41E+01	1.41E+01	1.41E+01	1.41E+01	1.41E+01	1.41E+01
Std Dev Un-Biased	4.38E-03	4.82E-03	4.64E-03	4.12E-03	4.15E-03	4.36E-03	4.92E-03
Ps90%/90% (+KTL) Un-Biased	1.41E+01	1.41E+01	1.41E+01	1.41E+01	1.41E+01	1.41E+01	1.41E+01
Ps90%/90% (-KTL) Un-Biased	1.41E+01	1.41E+01	1.41E+01	1.41E+01	1.41E+01	1.41E+01	1.41E+01
Specification MIN	1.25E+01	1.25E+01	1.25E+01	1.25E+01	1.25E+01	1.25E+01	1.25E+01
Status	PASS	PASS	PASS	PASS	PASS	PASS	PASS

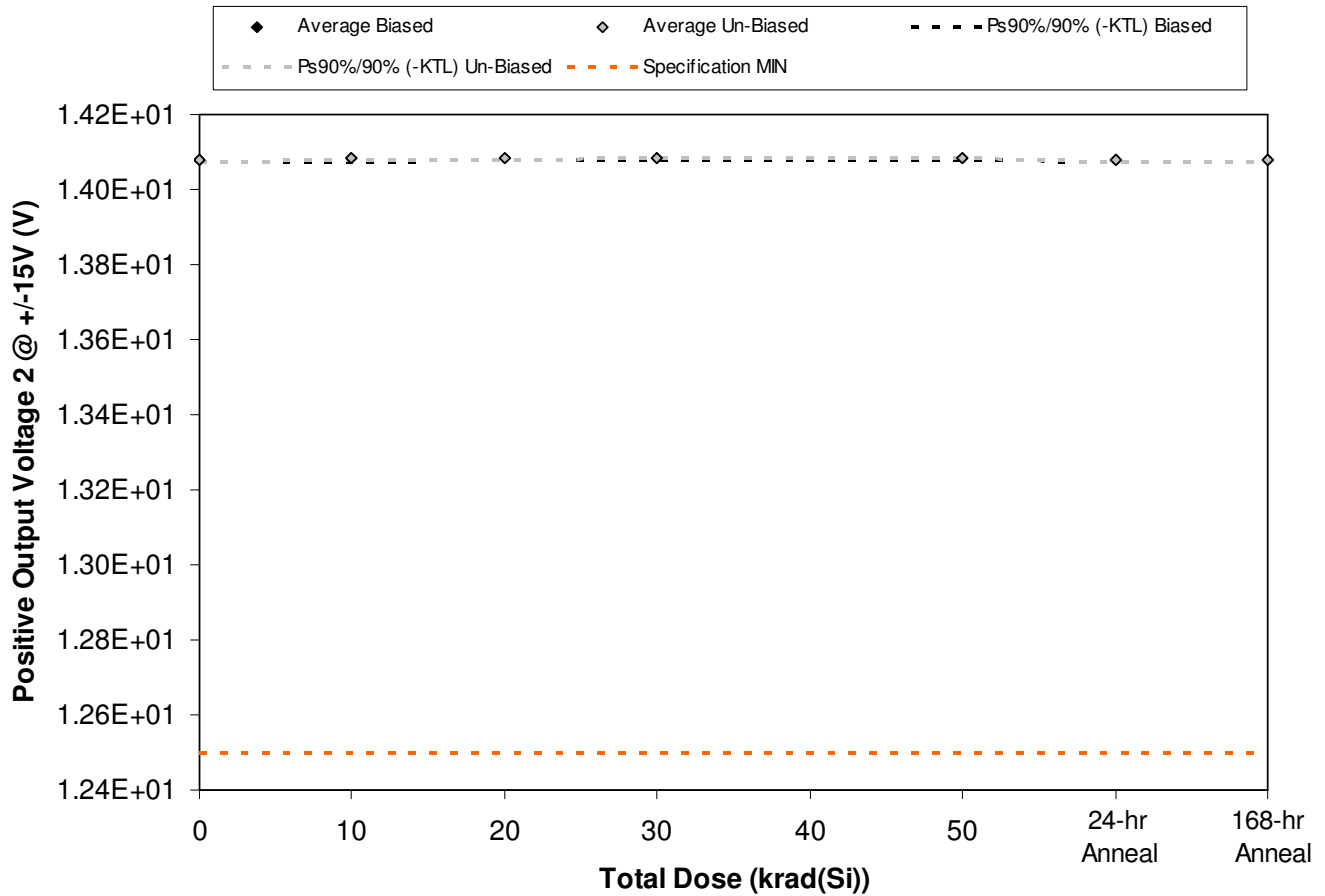

Figure 5.32. Plot of Positive Output Voltage 2 @ +/-15V (V) versus total dose. The solid diamonds are the average of the measured data points for the samples irradiated under electrical bias while the shaded diamonds are the average of the measured data points for the samples irradiated with all pins tied to ground. The black lines (solid and/or dashed) are the average of the data points after application of the KTL statistics on the samples irradiated under electrical bias while the gray lines (solid and/or dashed) are the average of the data points after application of the KTL statistics on the samples irradiated in the unbiased condition. The red dotted line(s) are the pre- and/or post-irradiation minimum and/or maximum specification value as defined in the datasheet and/or test plan.



**TID Report
11-572 R1.0**

**Aeroflex RAD
5017 N. 30th Street
Colorado Springs, CO 80919
(719) 531-0800**

Table 5.32. Raw data for Positive Output Voltage 2 @ +/-15V (V) versus total dose, including the statistical analysis, specification and the status of the testing (pass/fail).

Positive Output Voltage 2 @ +/-15V (V)	Total Dose (krad(Si))					24 hr Anneal	168 hr Anneal
	0	10	20	30	50		
Device	10/20/2011	11/3/2011	11/3/2011	11/3/2011	11/3/2011	11/4/2011	11/11/2011
1831	1.41E+01	1.41E+01	1.41E+01	1.41E+01	1.41E+01	1.41E+01	1.41E+01
1832	1.41E+01	1.41E+01	1.41E+01	1.41E+01	1.41E+01	1.41E+01	1.41E+01
1833	1.41E+01	1.41E+01	1.41E+01	1.41E+01	1.41E+01	1.41E+01	1.41E+01
1834	1.41E+01	1.41E+01	1.41E+01	1.41E+01	1.41E+01	1.41E+01	1.41E+01
1835	1.41E+01	1.41E+01	1.41E+01	1.41E+01	1.41E+01	1.41E+01	1.41E+01
1836	1.41E+01	1.41E+01	1.41E+01	1.41E+01	1.41E+01	1.41E+01	1.41E+01
1837	1.41E+01	1.41E+01	1.41E+01	1.41E+01	1.41E+01	1.41E+01	1.41E+01
1838	1.41E+01	1.41E+01	1.41E+01	1.41E+01	1.41E+01	1.41E+01	1.41E+01
1839	1.41E+01	1.41E+01	1.41E+01	1.41E+01	1.41E+01	1.41E+01	1.41E+01
1840	1.41E+01	1.41E+01	1.41E+01	1.41E+01	1.41E+01	1.41E+01	1.41E+01
1851	1.41E+01	1.41E+01	1.41E+01	1.41E+01	1.41E+01	1.41E+01	1.41E+01
1852	1.41E+01	1.41E+01	1.41E+01	1.41E+01	1.41E+01	1.41E+01	1.41E+01
Biased Statistics							
Average Biased	1.41E+01	1.41E+01	1.41E+01	1.41E+01	1.41E+01	1.41E+01	1.41E+01
Std Dev Biased	1.67E-03	2.28E-03	1.48E-03	1.79E-03	2.17E-03	2.12E-03	2.28E-03
Ps90%/90% (+KTL) Biased	1.41E+01	1.41E+01	1.41E+01	1.41E+01	1.41E+01	1.41E+01	1.41E+01
Ps90%/90% (-KTL) Biased	1.41E+01	1.41E+01	1.41E+01	1.41E+01	1.41E+01	1.41E+01	1.41E+01
Un-Biased Statistics							
Average Un-Biased	1.41E+01	1.41E+01	1.41E+01	1.41E+01	1.41E+01	1.41E+01	1.41E+01
Std Dev Un-Biased	1.52E-03	1.41E-03	1.67E-03	1.41E-03	1.52E-03	1.79E-03	1.73E-03
Ps90%/90% (+KTL) Un-Biased	1.41E+01	1.41E+01	1.41E+01	1.41E+01	1.41E+01	1.41E+01	1.41E+01
Ps90%/90% (-KTL) Un-Biased	1.41E+01	1.41E+01	1.41E+01	1.41E+01	1.41E+01	1.41E+01	1.41E+01
Specification MIN	1.25E+01	1.25E+01	1.25E+01	1.25E+01	1.25E+01	1.25E+01	1.25E+01
Status	PASS	PASS	PASS	PASS	PASS	PASS	PASS

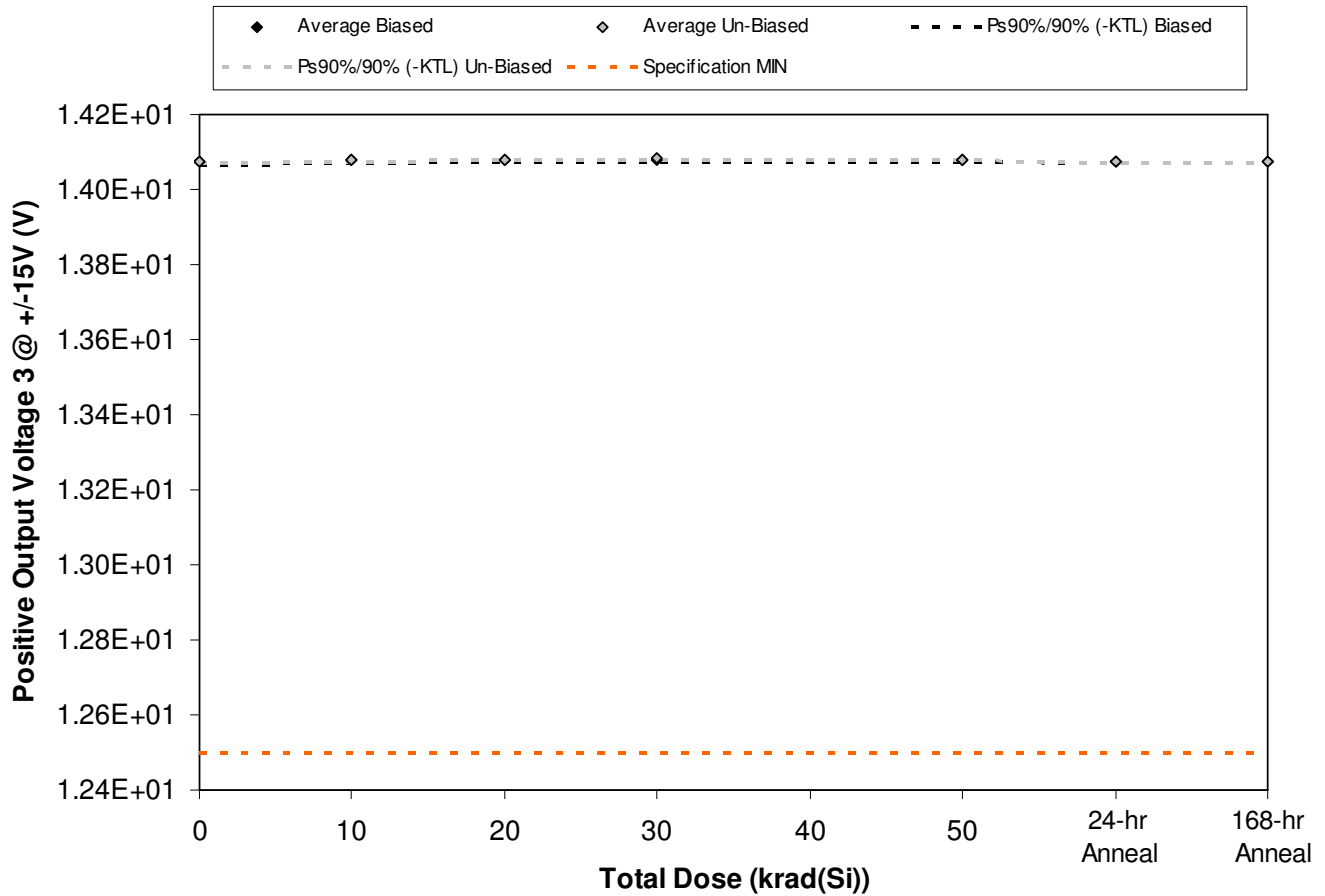

Figure 5.33. Plot of Positive Output Voltage 3 @ +/-15V (V) versus total dose. The solid diamonds are the average of the measured data points for the samples irradiated under electrical bias while the shaded diamonds are the average of the measured data points for the samples irradiated with all pins tied to ground. The black lines (solid and/or dashed) are the average of the data points after application of the KTL statistics on the samples irradiated under electrical bias while the gray lines (solid and/or dashed) are the average of the data points after application of the KTL statistics on the samples irradiated in the unbiased condition. The red dotted line(s) are the pre- and/or post-irradiation minimum and/or maximum specification value as defined in the datasheet and/or test plan.



**TID Report
11-572 R1.0**

**Aeroflex RAD
5017 N. 30th Street
Colorado Springs, CO 80919
(719) 531-0800**

Table 5.33. Raw data for Positive Output Voltage 3 @ +/-15V (V) versus total dose, including the statistical analysis, specification and the status of the testing (pass/fail).

Positive Output Voltage 3 @ +/-15V (V)	Total Dose (krad(Si))					24 hr Anneal	168 hr Anneal
	0	10	20	30	50		
Device	10/20/2011	11/3/2011	11/3/2011	11/3/2011	11/3/2011	11/4/2011	11/11/2011
1831	1.41E+01	1.41E+01	1.41E+01	1.41E+01	1.41E+01	1.41E+01	1.41E+01
1832	1.41E+01	1.41E+01	1.41E+01	1.41E+01	1.41E+01	1.41E+01	1.41E+01
1833	1.41E+01	1.41E+01	1.41E+01	1.41E+01	1.41E+01	1.41E+01	1.41E+01
1834	1.41E+01	1.41E+01	1.41E+01	1.41E+01	1.41E+01	1.41E+01	1.41E+01
1835	1.41E+01	1.41E+01	1.41E+01	1.41E+01	1.41E+01	1.41E+01	1.41E+01
1836	1.41E+01	1.41E+01	1.41E+01	1.41E+01	1.41E+01	1.41E+01	1.41E+01
1837	1.41E+01	1.41E+01	1.41E+01	1.41E+01	1.41E+01	1.41E+01	1.41E+01
1838	1.41E+01	1.41E+01	1.41E+01	1.41E+01	1.41E+01	1.41E+01	1.41E+01
1839	1.41E+01	1.41E+01	1.41E+01	1.41E+01	1.41E+01	1.41E+01	1.41E+01
1840	1.41E+01	1.41E+01	1.41E+01	1.41E+01	1.41E+01	1.41E+01	1.41E+01
1851	1.41E+01	1.41E+01	1.41E+01	1.41E+01	1.41E+01	1.41E+01	1.41E+01
1852	1.41E+01	1.41E+01	1.41E+01	1.41E+01	1.41E+01	1.41E+01	1.41E+01
Biased Statistics							
Average Biased	1.41E+01	1.41E+01	1.41E+01	1.41E+01	1.41E+01	1.41E+01	1.41E+01
Std Dev Biased	2.30E-03	2.45E-03	1.67E-03	2.17E-03	2.39E-03	2.28E-03	2.35E-03
Ps90%/90% (+KTL) Biased	1.41E+01	1.41E+01	1.41E+01	1.41E+01	1.41E+01	1.41E+01	1.41E+01
Ps90%/90% (-KTL) Biased	1.41E+01	1.41E+01	1.41E+01	1.41E+01	1.41E+01	1.41E+01	1.41E+01
Un-Biased Statistics							
Average Un-Biased	1.41E+01	1.41E+01	1.41E+01	1.41E+01	1.41E+01	1.41E+01	1.41E+01
Std Dev Un-Biased	1.79E-03	1.22E-03	1.10E-03	8.94E-04	1.10E-03	1.79E-03	1.95E-03
Ps90%/90% (+KTL) Un-Biased	1.41E+01	1.41E+01	1.41E+01	1.41E+01	1.41E+01	1.41E+01	1.41E+01
Ps90%/90% (-KTL) Un-Biased	1.41E+01	1.41E+01	1.41E+01	1.41E+01	1.41E+01	1.41E+01	1.41E+01
Specification MIN	1.25E+01	1.25E+01	1.25E+01	1.25E+01	1.25E+01	1.25E+01	1.25E+01
Status	PASS	PASS	PASS	PASS	PASS	PASS	PASS

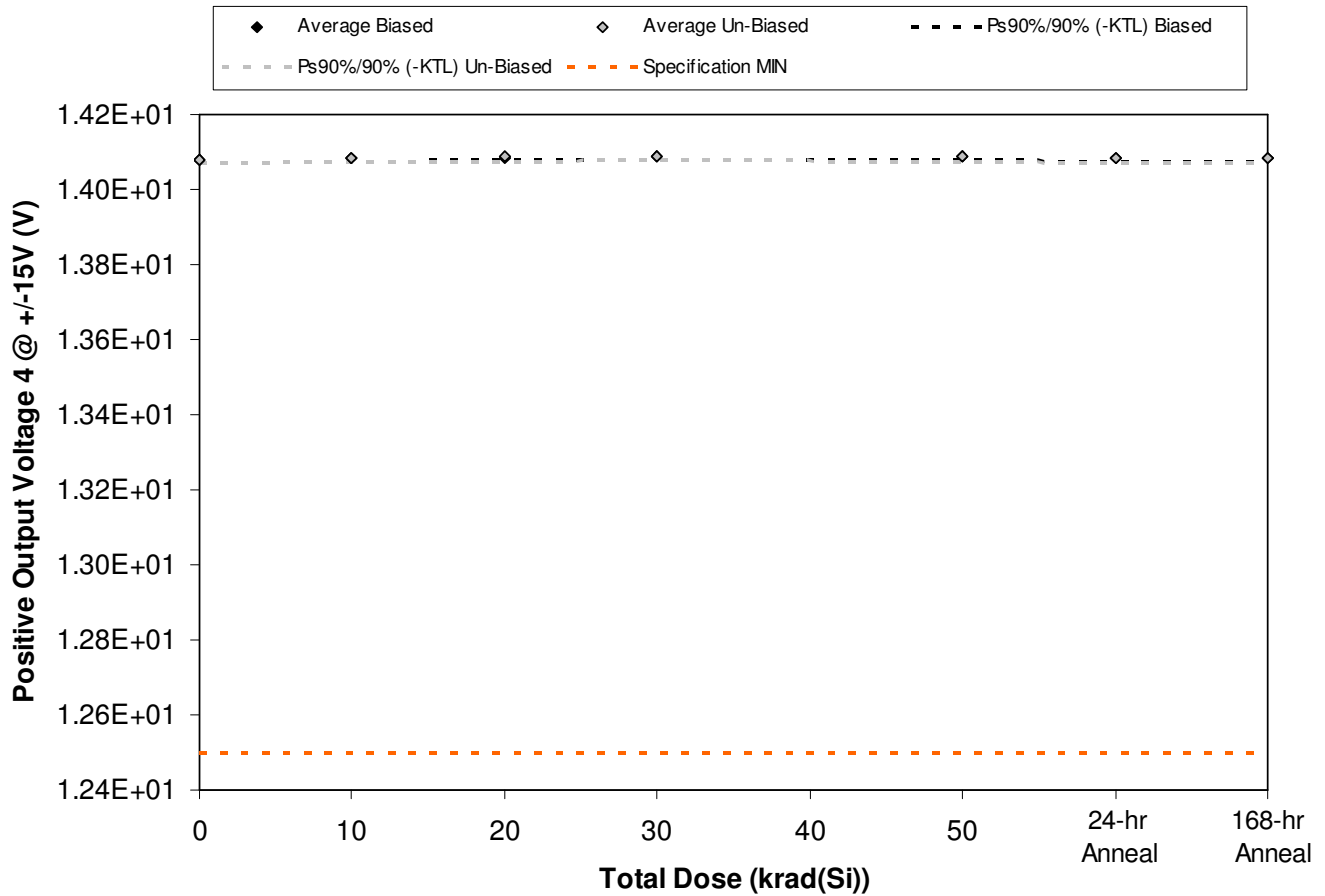

Figure 5.34. Plot of Positive Output Voltage 4 @ +/-15V (V) versus total dose. The solid diamonds are the average of the measured data points for the samples irradiated under electrical bias while the shaded diamonds are the average of the measured data points for the samples irradiated with all pins tied to ground. The black lines (solid and/or dashed) are the average of the data points after application of the KTL statistics on the samples irradiated under electrical bias while the gray lines (solid and/or dashed) are the average of the data points after application of the KTL statistics on the samples irradiated in the unbiased condition. The red dotted line(s) are the pre- and/or post-irradiation minimum and/or maximum specification value as defined in the datasheet and/or test plan.



**TID Report
11-572 R1.0**

**Aeroflex RAD
5017 N. 30th Street
Colorado Springs, CO 80919
(719) 531-0800**

Table 5.34. Raw data for Positive Output Voltage 4 @ +/-15V (V) versus total dose, including the statistical analysis, specification and the status of the testing (pass/fail).

Positive Output Voltage 4 @ +/-15V (V)	Total Dose (krad(Si))					24 hr Anneal	168 hr Anneal
	0	10	20	30	50		
Device	10/20/2011	11/3/2011	11/3/2011	11/3/2011	11/3/2011	11/4/2011	11/11/2011
1831	1.41E+01	1.41E+01	1.41E+01	1.41E+01	1.41E+01	1.41E+01	1.41E+01
1832	1.41E+01	1.41E+01	1.41E+01	1.41E+01	1.41E+01	1.41E+01	1.41E+01
1833	1.41E+01	1.41E+01	1.41E+01	1.41E+01	1.41E+01	1.41E+01	1.41E+01
1834	1.41E+01	1.41E+01	1.41E+01	1.41E+01	1.41E+01	1.41E+01	1.41E+01
1835	1.41E+01	1.41E+01	1.41E+01	1.41E+01	1.41E+01	1.41E+01	1.41E+01
1836	1.41E+01	1.41E+01	1.41E+01	1.41E+01	1.41E+01	1.41E+01	1.41E+01
1837	1.41E+01	1.41E+01	1.41E+01	1.41E+01	1.41E+01	1.41E+01	1.41E+01
1838	1.41E+01	1.41E+01	1.41E+01	1.41E+01	1.41E+01	1.41E+01	1.41E+01
1839	1.41E+01	1.41E+01	1.41E+01	1.41E+01	1.41E+01	1.41E+01	1.41E+01
1840	1.41E+01	1.41E+01	1.41E+01	1.41E+01	1.41E+01	1.41E+01	1.41E+01
1851	1.41E+01	1.41E+01	1.41E+01	1.41E+01	1.41E+01	1.41E+01	1.41E+01
1852	1.41E+01	1.41E+01	1.41E+01	1.41E+01	1.41E+01	1.41E+01	1.41E+01
Biased Statistics							
Average Biased	1.41E+01	1.41E+01	1.41E+01	1.41E+01	1.41E+01	1.41E+01	1.41E+01
Std Dev Biased	3.35E-03	2.95E-03	2.49E-03	3.27E-03	2.61E-03	3.16E-03	2.65E-03
Ps90%/90% (+KTL) Biased	1.41E+01	1.41E+01	1.41E+01	1.41E+01	1.41E+01	1.41E+01	1.41E+01
Ps90%/90% (-KTL) Biased	1.41E+01	1.41E+01	1.41E+01	1.41E+01	1.41E+01	1.41E+01	1.41E+01
Un-Biased Statistics							
Average Un-Biased	1.41E+01	1.41E+01	1.41E+01	1.41E+01	1.41E+01	1.41E+01	1.41E+01
Std Dev Un-Biased	4.15E-03	3.90E-03	4.44E-03	3.90E-03	4.15E-03	3.90E-03	4.04E-03
Ps90%/90% (+KTL) Un-Biased	1.41E+01	1.41E+01	1.41E+01	1.41E+01	1.41E+01	1.41E+01	1.41E+01
Ps90%/90% (-KTL) Un-Biased	1.41E+01	1.41E+01	1.41E+01	1.41E+01	1.41E+01	1.41E+01	1.41E+01
Specification MIN	1.25E+01	1.25E+01	1.25E+01	1.25E+01	1.25E+01	1.25E+01	1.25E+01
Status	PASS	PASS	PASS	PASS	PASS	PASS	PASS

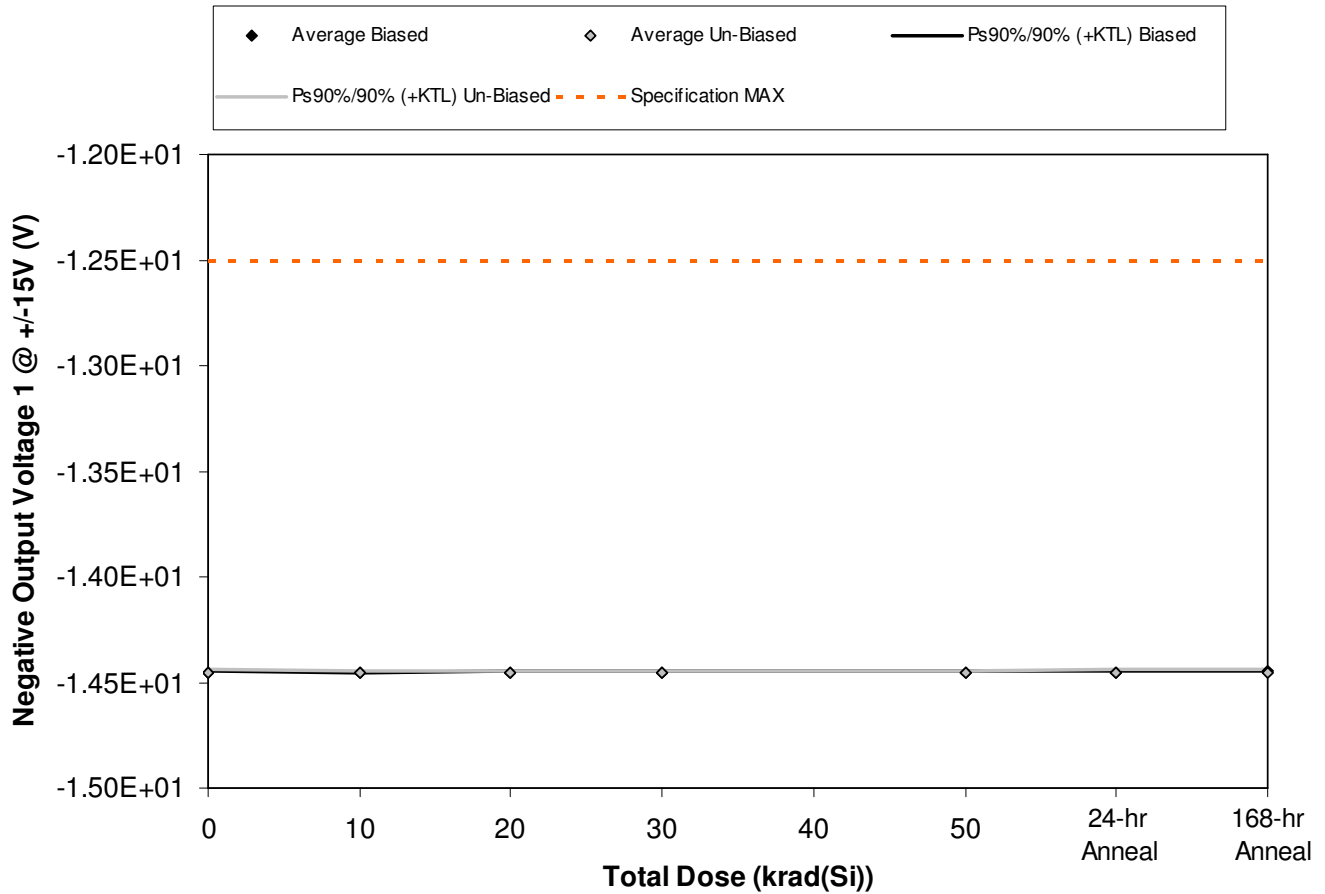

Figure 5.35. Plot of Negative Output Voltage 1 @ +/-15V (V) versus total dose. The solid diamonds are the average of the measured data points for the samples irradiated under electrical bias while the shaded diamonds are the average of the measured data points for the samples irradiated with all pins tied to ground. The black lines (solid and/or dashed) are the average of the data points after application of the KTL statistics on the samples irradiated under electrical bias while the gray lines (solid and/or dashed) are the average of the data points after application of the KTL statistics on the samples irradiated in the unbiased condition. The red dotted line(s) are the pre- and/or post-irradiation minimum and/or maximum specification value as defined in the datasheet and/or test plan.



Table 5.35. Raw data for Negative Output Voltage 1 @ +/-15V (V) versus total dose, including the statistical analysis, specification and the status of the testing (pass/fail).

Negative Output Voltage 1 @ +/-15V (V)	Total Dose (krad(Si))					24 hr Anneal	168 hr Anneal
	0	10	20	30	50		
Device	10/20/2011	11/3/2011	11/3/2011	11/3/2011	11/3/2011	11/4/2011	11/11/2011
1831	-1.45E+01	-1.45E+01	-1.45E+01	-1.45E+01	-1.45E+01	-1.45E+01	-1.44E+01
1832	-1.45E+01	-1.45E+01	-1.45E+01	-1.45E+01	-1.45E+01	-1.45E+01	-1.44E+01
1833	-1.45E+01	-1.45E+01	-1.45E+01	-1.45E+01	-1.45E+01	-1.45E+01	-1.45E+01
1834	-1.45E+01	-1.45E+01	-1.45E+01	-1.45E+01	-1.45E+01	-1.45E+01	-1.44E+01
1835	-1.45E+01	-1.45E+01	-1.45E+01	-1.45E+01	-1.45E+01	-1.45E+01	-1.44E+01
1836	-1.45E+01	-1.45E+01	-1.45E+01	-1.45E+01	-1.45E+01	-1.45E+01	-1.45E+01
1837	-1.45E+01	-1.45E+01	-1.45E+01	-1.45E+01	-1.45E+01	-1.45E+01	-1.45E+01
1838	-1.45E+01	-1.45E+01	-1.45E+01	-1.45E+01	-1.45E+01	-1.45E+01	-1.45E+01
1839	-1.44E+01	-1.45E+01	-1.45E+01	-1.45E+01	-1.45E+01	-1.45E+01	-1.44E+01
1840	-1.45E+01	-1.45E+01	-1.45E+01	-1.45E+01	-1.45E+01	-1.45E+01	-1.45E+01
1851	-1.45E+01	-1.45E+01	-1.45E+01	-1.45E+01	-1.45E+01	-1.45E+01	-1.45E+01
1852	-1.45E+01	-1.45E+01	-1.45E+01	-1.45E+01	-1.45E+01	-1.45E+01	-1.45E+01
Biased Statistics							
Average Biased	-1.45E+01	-1.45E+01	-1.45E+01	-1.45E+01	-1.45E+01	-1.45E+01	-1.44E+01
Std Dev Biased	2.12E-03	1.58E-03	1.79E-03	2.07E-03	2.41E-03	1.95E-03	1.41E-03
Ps90%/90% (+KTL) Biased	-1.44E+01	-1.45E+01	-1.45E+01	-1.44E+01	-1.44E+01	-1.44E+01	-1.44E+01
Ps90%/90% (-KTL) Biased	-1.45E+01	-1.45E+01	-1.45E+01	-1.45E+01	-1.45E+01	-1.45E+01	-1.45E+01
Un-Biased Statistics							
Average Un-Biased	-1.45E+01	-1.45E+01	-1.45E+01	-1.45E+01	-1.45E+01	-1.45E+01	-1.45E+01
Std Dev Un-Biased	4.62E-03	5.40E-03	5.08E-03	5.46E-03	4.49E-03	5.10E-03	5.40E-03
Ps90%/90% (+KTL) Un-Biased	-1.44E+01	-1.44E+01	-1.44E+01	-1.44E+01	-1.44E+01	-1.44E+01	-1.44E+01
Ps90%/90% (-KTL) Un-Biased	-1.45E+01	-1.45E+01	-1.45E+01	-1.45E+01	-1.45E+01	-1.45E+01	-1.45E+01
Specification MAX	-1.25E+01	-1.25E+01	-1.25E+01	-1.25E+01	-1.25E+01	-1.25E+01	-1.25E+01
Status	PASS	PASS	PASS	PASS	PASS	PASS	PASS

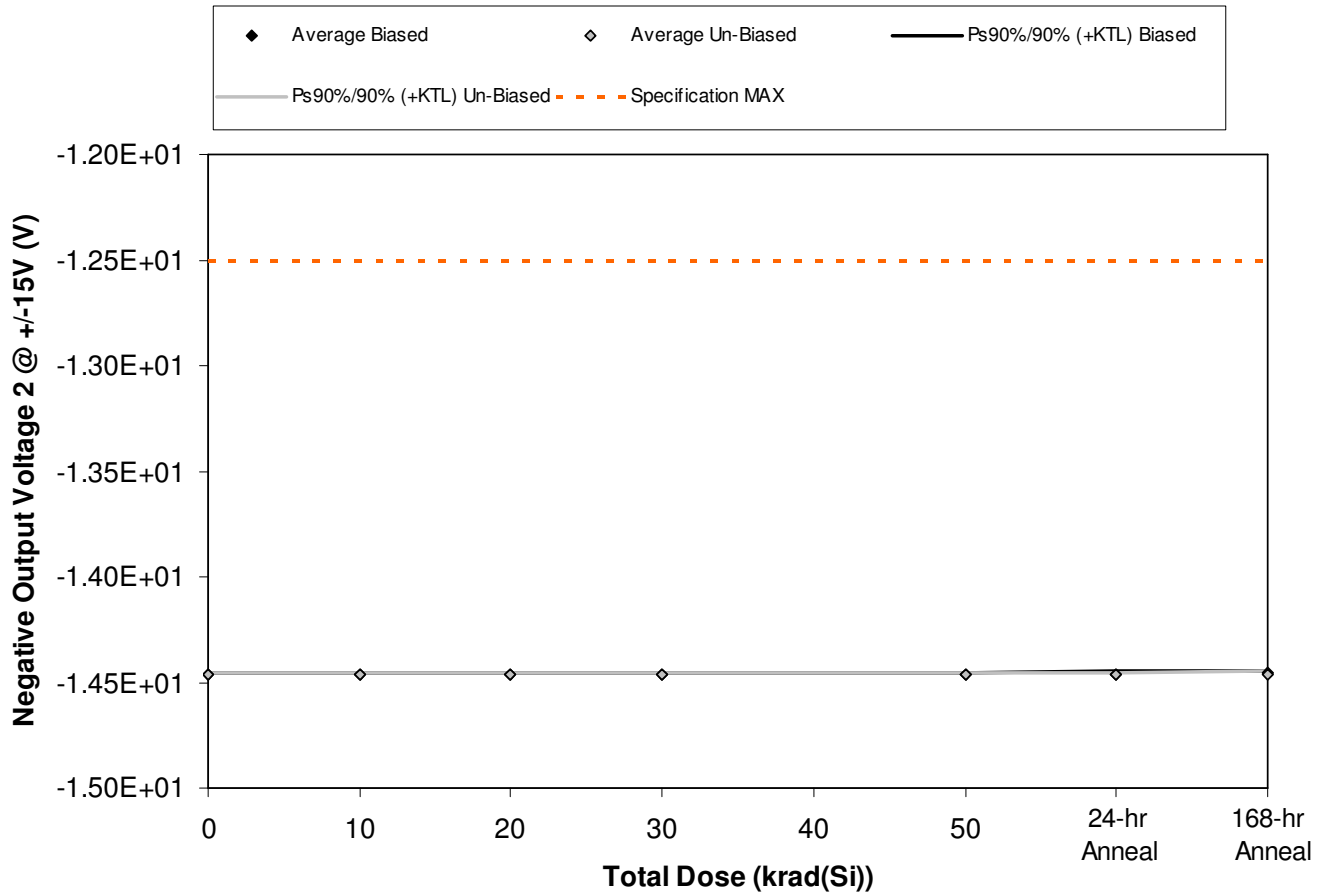

Figure 5.36. Plot of Negative Output Voltage 2 @ +/-15V (V) versus total dose. The solid diamonds are the average of the measured data points for the samples irradiated under electrical bias while the shaded diamonds are the average of the measured data points for the samples irradiated with all pins tied to ground. The black lines (solid and/or dashed) are the average of the data points after application of the KTL statistics on the samples irradiated under electrical bias while the gray lines (solid and/or dashed) are the average of the data points after application of the KTL statistics on the samples irradiated in the unbiased condition. The red dotted line(s) are the pre- and/or post-irradiation minimum and/or maximum specification value as defined in the datasheet and/or test plan.



Table 5.36. Raw data for Negative Output Voltage 2 @ +/-15V (V) versus total dose, including the statistical analysis, specification and the status of the testing (pass/fail).

Negative Output Voltage 2 @ +/-15V (V)	Total Dose (krad(Si))					24 hr Anneal	168 hr Anneal
	0	10	20	30	50		
Device	10/20/2011	11/3/2011	11/3/2011	11/3/2011	11/3/2011	11/4/2011	11/11/2011
1831	-1.45E+01	-1.45E+01	-1.45E+01	-1.45E+01	-1.45E+01	-1.45E+01	-1.45E+01
1832	-1.45E+01	-1.45E+01	-1.45E+01	-1.45E+01	-1.45E+01	-1.45E+01	-1.45E+01
1833	-1.45E+01	-1.45E+01	-1.45E+01	-1.45E+01	-1.45E+01	-1.45E+01	-1.45E+01
1834	-1.45E+01	-1.45E+01	-1.45E+01	-1.45E+01	-1.45E+01	-1.45E+01	-1.45E+01
1835	-1.45E+01	-1.45E+01	-1.45E+01	-1.45E+01	-1.45E+01	-1.45E+01	-1.45E+01
1836	-1.45E+01	-1.45E+01	-1.45E+01	-1.45E+01	-1.45E+01	-1.45E+01	-1.45E+01
1837	-1.45E+01	-1.45E+01	-1.45E+01	-1.45E+01	-1.45E+01	-1.45E+01	-1.45E+01
1838	-1.45E+01	-1.45E+01	-1.45E+01	-1.45E+01	-1.45E+01	-1.45E+01	-1.45E+01
1839	-1.45E+01	-1.45E+01	-1.45E+01	-1.45E+01	-1.45E+01	-1.45E+01	-1.45E+01
1840	-1.45E+01	-1.45E+01	-1.45E+01	-1.45E+01	-1.45E+01	-1.45E+01	-1.45E+01
1851	-1.45E+01	-1.45E+01	-1.45E+01	-1.45E+01	-1.45E+01	-1.45E+01	-1.45E+01
1852	-1.45E+01	-1.45E+01	-1.45E+01	-1.45E+01	-1.45E+01	-1.45E+01	-1.45E+01
Biased Statistics							
Average Biased	-1.45E+01	-1.45E+01	-1.45E+01	-1.45E+01	-1.45E+01	-1.45E+01	-1.45E+01
Std Dev Biased	3.70E-03	3.90E-03	3.74E-03	4.02E-03	3.29E-03	3.91E-03	3.74E-03
Ps90%/90% (+KTL) Biased	-1.45E+01	-1.45E+01	-1.45E+01	-1.45E+01	-1.45E+01	-1.44E+01	-1.44E+01
Ps90%/90% (-KTL) Biased	-1.45E+01	-1.45E+01	-1.45E+01	-1.45E+01	-1.45E+01	-1.45E+01	-1.45E+01
Un-Biased Statistics							
Average Un-Biased	-1.45E+01	-1.45E+01	-1.45E+01	-1.45E+01	-1.45E+01	-1.45E+01	-1.45E+01
Std Dev Un-Biased	3.29E-03	3.91E-03	3.58E-03	4.00E-03	3.44E-03	3.58E-03	3.44E-03
Ps90%/90% (+KTL) Un-Biased	-1.45E+01	-1.45E+01	-1.45E+01	-1.45E+01	-1.45E+01	-1.45E+01	-1.45E+01
Ps90%/90% (-KTL) Un-Biased	-1.45E+01	-1.45E+01	-1.45E+01	-1.45E+01	-1.45E+01	-1.45E+01	-1.45E+01
Specification MAX	-1.25E+01	-1.25E+01	-1.25E+01	-1.25E+01	-1.25E+01	-1.25E+01	-1.25E+01
Status	PASS	PASS	PASS	PASS	PASS	PASS	PASS

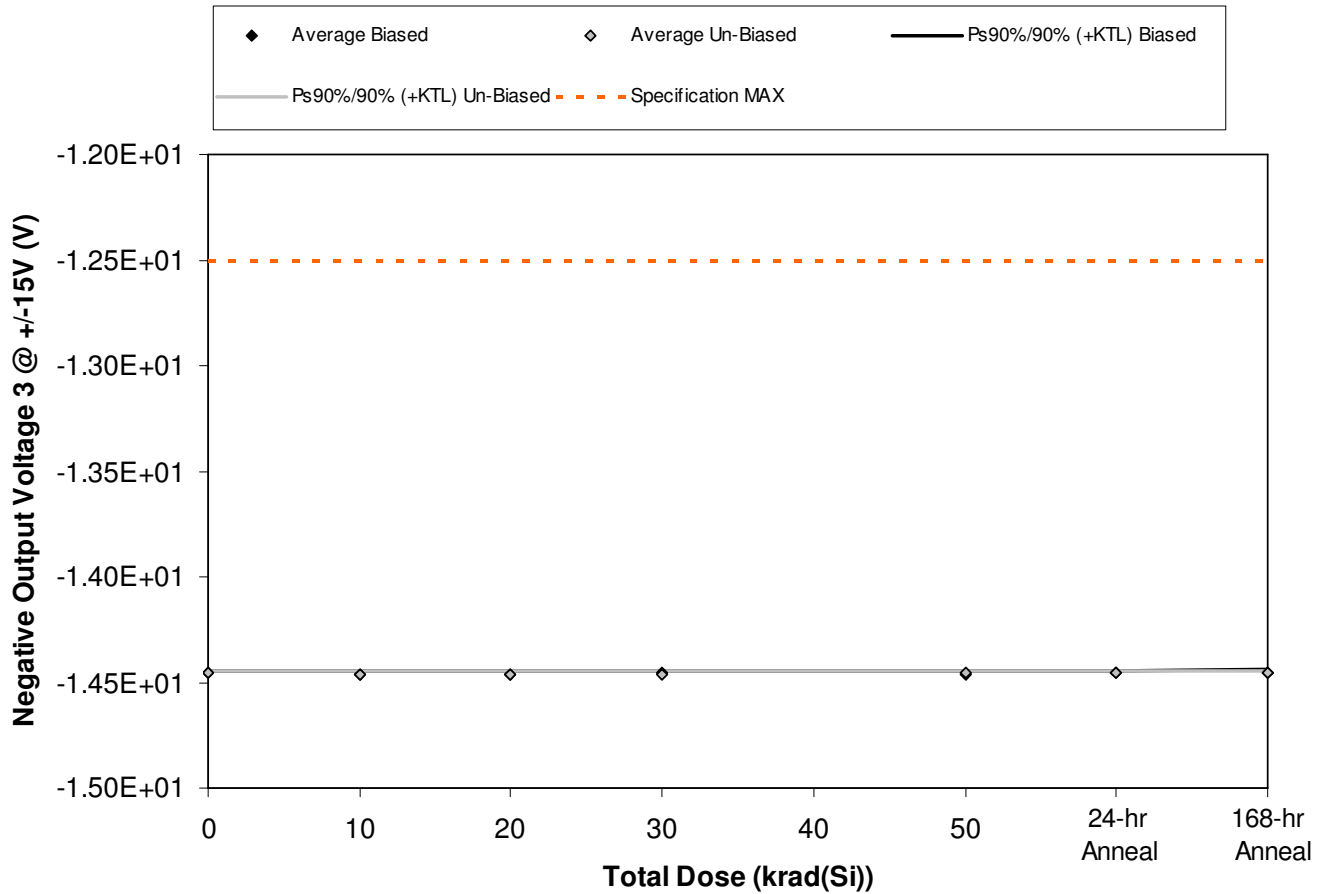

Figure 5.37. Plot of Negative Output Voltage 3 @ +/-15V (V) versus total dose. The solid diamonds are the average of the measured data points for the samples irradiated under electrical bias while the shaded diamonds are the average of the measured data points for the samples irradiated with all pins tied to ground. The black lines (solid and/or dashed) are the average of the data points after application of the KTL statistics on the samples irradiated under electrical bias while the gray lines (solid and/or dashed) are the average of the data points after application of the KTL statistics on the samples irradiated in the unbiased condition. The red dotted line(s) are the pre- and/or post-irradiation minimum and/or maximum specification value as defined in the datasheet and/or test plan.



Table 5.37. Raw data for Negative Output Voltage 3 @ +/-15V (V) versus total dose, including the statistical analysis, specification and the status of the testing (pass/fail).

Negative Output Voltage 3 @ +/-15V (V)	Total Dose (krad(Si))					24 hr Anneal	168 hr Anneal
	0	10	20	30	50		
Device	10/20/2011	11/3/2011	11/3/2011	11/3/2011	11/3/2011	11/4/2011	11/11/2011
1831	-1.45E+01	-1.45E+01	-1.45E+01	-1.45E+01	-1.45E+01	-1.45E+01	-1.45E+01
1832	-1.45E+01	-1.45E+01	-1.45E+01	-1.45E+01	-1.45E+01	-1.45E+01	-1.44E+01
1833	-1.45E+01	-1.45E+01	-1.45E+01	-1.45E+01	-1.45E+01	-1.45E+01	-1.45E+01
1834	-1.45E+01	-1.45E+01	-1.45E+01	-1.45E+01	-1.45E+01	-1.45E+01	-1.45E+01
1835	-1.45E+01	-1.45E+01	-1.45E+01	-1.45E+01	-1.45E+01	-1.45E+01	-1.44E+01
1836	-1.45E+01	-1.45E+01	-1.45E+01	-1.45E+01	-1.45E+01	-1.45E+01	-1.45E+01
1837	-1.45E+01	-1.45E+01	-1.45E+01	-1.45E+01	-1.45E+01	-1.45E+01	-1.45E+01
1838	-1.45E+01	-1.45E+01	-1.45E+01	-1.45E+01	-1.45E+01	-1.45E+01	-1.45E+01
1839	-1.45E+01	-1.45E+01	-1.45E+01	-1.45E+01	-1.45E+01	-1.45E+01	-1.45E+01
1840	-1.45E+01	-1.45E+01	-1.45E+01	-1.45E+01	-1.45E+01	-1.45E+01	-1.45E+01
1851	-1.45E+01	-1.45E+01	-1.45E+01	-1.45E+01	-1.45E+01	-1.45E+01	-1.45E+01
1852	-1.45E+01	-1.45E+01	-1.45E+01	-1.45E+01	-1.45E+01	-1.45E+01	-1.45E+01
Biased Statistics							
Average Biased	-1.45E+01	-1.45E+01	-1.45E+01	-1.45E+01	-1.45E+01	-1.45E+01	-1.45E+01
Std Dev Biased	3.85E-03	3.90E-03	3.90E-03	4.16E-03	3.74E-03	4.02E-03	4.22E-03
Ps90%/90% (+KTL) Biased	-1.44E+01	-1.44E+01	-1.44E+01	-1.44E+01	-1.44E+01	-1.44E+01	-1.44E+01
Ps90%/90% (-KTL) Biased	-1.45E+01	-1.45E+01	-1.45E+01	-1.45E+01	-1.45E+01	-1.45E+01	-1.45E+01
Un-Biased Statistics							
Average Un-Biased	-1.45E+01	-1.45E+01	-1.45E+01	-1.45E+01	-1.45E+01	-1.45E+01	-1.45E+01
Std Dev Un-Biased	3.97E-03	4.09E-03	4.53E-03	4.30E-03	4.28E-03	4.66E-03	4.24E-03
Ps90%/90% (+KTL) Un-Biased	-1.44E+01	-1.44E+01	-1.44E+01	-1.44E+01	-1.44E+01	-1.44E+01	-1.44E+01
Ps90%/90% (-KTL) Un-Biased	-1.45E+01	-1.45E+01	-1.45E+01	-1.45E+01	-1.45E+01	-1.45E+01	-1.45E+01
Specification MAX	-1.25E+01	-1.25E+01	-1.25E+01	-1.25E+01	-1.25E+01	-1.25E+01	-1.25E+01
Status	PASS	PASS	PASS	PASS	PASS	PASS	PASS

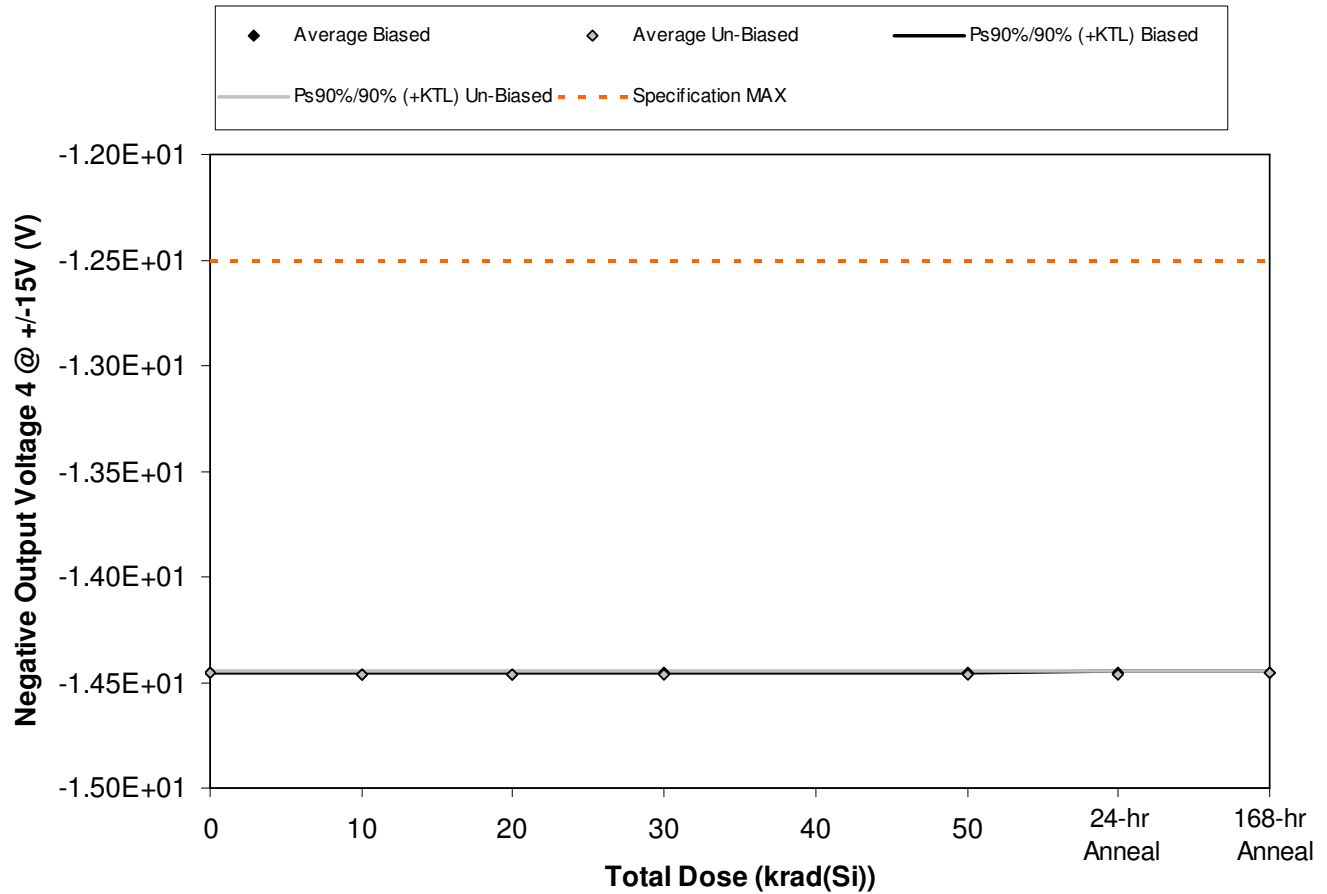

Figure 5.38. Plot of Negative Output Voltage 4 @ +/-15V (V) versus total dose. The solid diamonds are the average of the measured data points for the samples irradiated under electrical bias while the shaded diamonds are the average of the measured data points for the samples irradiated with all pins tied to ground. The black lines (solid and/or dashed) are the average of the data points after application of the KTL statistics on the samples irradiated under electrical bias while the gray lines (solid and/or dashed) are the average of the data points after application of the KTL statistics on the samples irradiated in the unbiased condition. The red dotted line(s) are the pre- and/or post-irradiation minimum and/or maximum specification value as defined in the datasheet and/or test plan.



Table 5.38. Raw data for Negative Output Voltage 4 @ +/-15V (V) versus total dose, including the statistical analysis, specification and the status of the testing (pass/fail).

Negative Output Voltage 4 @ +/-15V (V)	Total Dose (krad(Si))					24 hr Anneal	168 hr Anneal
	0	10	20	30	50		
Device	10/20/2011	11/3/2011	11/3/2011	11/3/2011	11/3/2011	11/4/2011	11/11/2011
1831	-1.45E+01	-1.45E+01	-1.45E+01	-1.45E+01	-1.45E+01	-1.45E+01	-1.45E+01
1832	-1.45E+01	-1.45E+01	-1.45E+01	-1.45E+01	-1.45E+01	-1.45E+01	-1.45E+01
1833	-1.45E+01	-1.45E+01	-1.45E+01	-1.45E+01	-1.45E+01	-1.45E+01	-1.45E+01
1834	-1.45E+01	-1.45E+01	-1.45E+01	-1.45E+01	-1.45E+01	-1.45E+01	-1.45E+01
1835	-1.45E+01	-1.45E+01	-1.45E+01	-1.45E+01	-1.45E+01	-1.45E+01	-1.45E+01
1836	-1.45E+01	-1.45E+01	-1.45E+01	-1.45E+01	-1.45E+01	-1.45E+01	-1.45E+01
1837	-1.45E+01	-1.45E+01	-1.45E+01	-1.45E+01	-1.45E+01	-1.45E+01	-1.45E+01
1838	-1.45E+01	-1.45E+01	-1.45E+01	-1.45E+01	-1.45E+01	-1.45E+01	-1.45E+01
1839	-1.45E+01	-1.45E+01	-1.45E+01	-1.45E+01	-1.45E+01	-1.45E+01	-1.45E+01
1840	-1.45E+01	-1.45E+01	-1.45E+01	-1.45E+01	-1.45E+01	-1.45E+01	-1.45E+01
1851	-1.45E+01	-1.45E+01	-1.45E+01	-1.45E+01	-1.45E+01	-1.45E+01	-1.45E+01
1852	-1.45E+01	-1.45E+01	-1.45E+01	-1.45E+01	-1.45E+01	-1.45E+01	-1.45E+01
Biased Statistics							
Average Biased	-1.45E+01	-1.45E+01	-1.45E+01	-1.45E+01	-1.45E+01	-1.45E+01	-1.45E+01
Std Dev Biased	1.67E-03	1.64E-03	1.87E-03	2.30E-03	2.17E-03	2.17E-03	1.10E-03
Ps90%/90% (+KTL) Biased	-1.45E+01	-1.45E+01	-1.45E+01	-1.45E+01	-1.45E+01	-1.45E+01	-1.44E+01
Ps90%/90% (-KTL) Biased	-1.45E+01	-1.45E+01	-1.45E+01	-1.45E+01	-1.45E+01	-1.45E+01	-1.45E+01
Un-Biased Statistics							
Average Un-Biased	-1.45E+01	-1.45E+01	-1.45E+01	-1.45E+01	-1.45E+01	-1.45E+01	-1.45E+01
Std Dev Un-Biased	4.77E-03	5.39E-03	5.27E-03	5.18E-03	4.82E-03	4.77E-03	4.77E-03
Ps90%/90% (+KTL) Un-Biased	-1.44E+01	-1.44E+01	-1.44E+01	-1.44E+01	-1.44E+01	-1.44E+01	-1.44E+01
Ps90%/90% (-KTL) Un-Biased	-1.45E+01	-1.45E+01	-1.45E+01	-1.45E+01	-1.45E+01	-1.45E+01	-1.45E+01
Specification MAX	-1.25E+01	-1.25E+01	-1.25E+01	-1.25E+01	-1.25E+01	-1.25E+01	-1.25E+01
Status	PASS	PASS	PASS	PASS	PASS	PASS	PASS

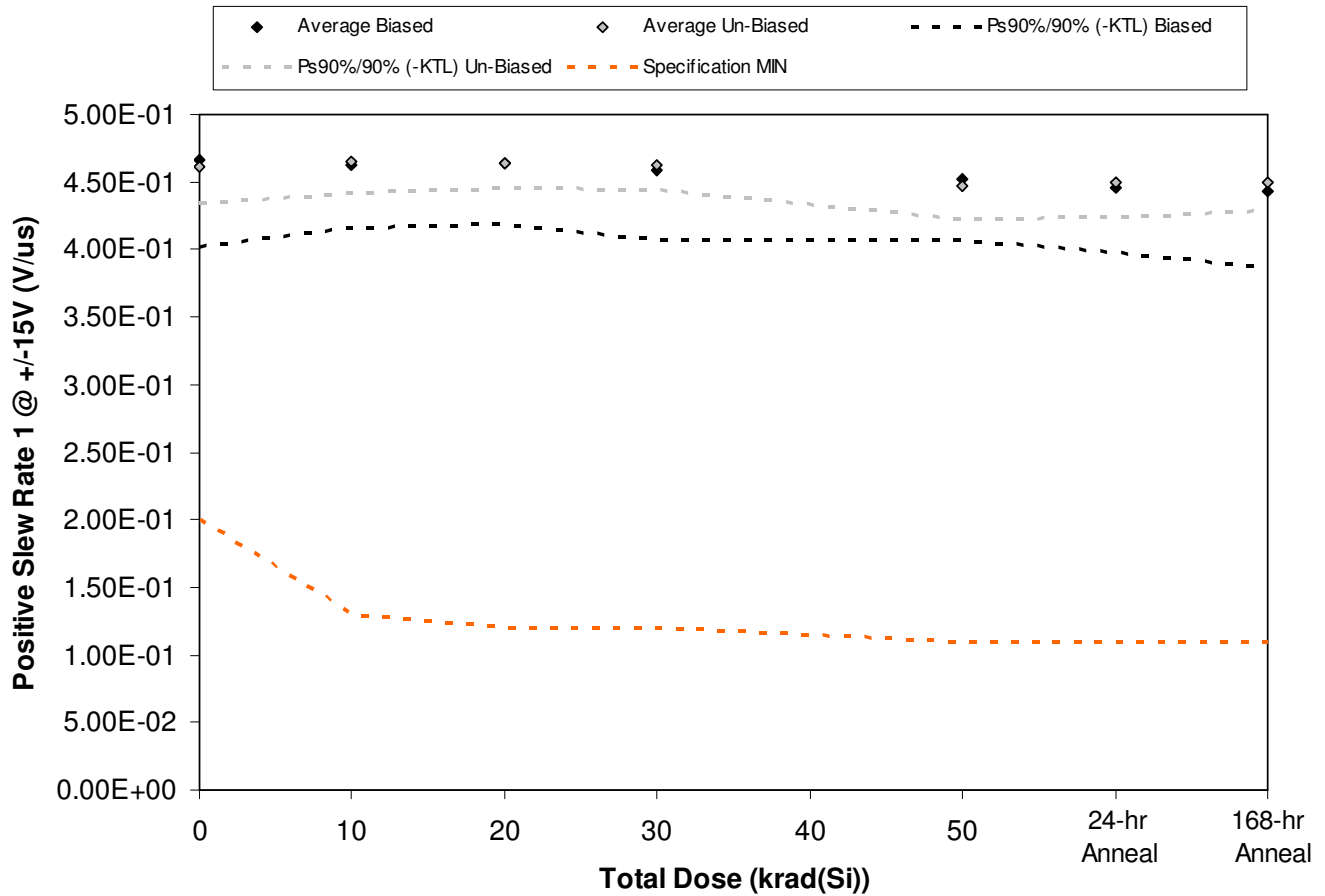

Figure 5.39. Plot of Positive Slew Rate 1 @ +/-15V (V/us) versus total dose. The solid diamonds are the average of the measured data points for the samples irradiated under electrical bias while the shaded diamonds are the average of the measured data points for the samples irradiated with all pins tied to ground. The black lines (solid and/or dashed) are the average of the data points after application of the KTL statistics on the samples irradiated under electrical bias while the gray lines (solid and/or dashed) are the average of the data points after application of the KTL statistics on the samples irradiated in the unbiased condition. The red dotted line(s) are the pre- and/or post-irradiation minimum and/or maximum specification value as defined in the datasheet and/or test plan.



Table 5.39. Raw data for Positive Slew Rate 1 @ +/-15V (V/us) versus total dose, including the statistical analysis, specification and the status of the testing (pass/fail).

Positive Slew Rate 1 @ +/-15V (V/us)	Total Dose (krad(Si))					24 hr	168 hr
	0	10	20	30	50	Anneal	Anneal
Device							
	10/20/2011	11/3/2011	11/3/2011	11/3/2011	11/3/2011	11/4/2011	11/11/2011
1831	4.35E-01	4.41E-01	4.45E-01	4.38E-01	4.34E-01	4.26E-01	4.22E-01
1832	4.62E-01	4.66E-01	4.70E-01	4.62E-01	4.53E-01	4.47E-01	4.42E-01
1833	4.56E-01	4.49E-01	4.47E-01	4.41E-01	4.38E-01	4.30E-01	4.24E-01
1834	4.92E-01	4.79E-01	4.81E-01	4.81E-01	4.73E-01	4.61E-01	4.65E-01
1835	4.87E-01	4.78E-01	4.73E-01	4.72E-01	4.61E-01	4.63E-01	4.64E-01
1836	4.51E-01	4.59E-01	4.62E-01	4.53E-01	4.36E-01	4.34E-01	4.38E-01
1837	4.52E-01	4.59E-01	4.53E-01	4.68E-01	4.41E-01	4.48E-01	4.54E-01
1838	4.73E-01	4.60E-01	4.70E-01	4.66E-01	4.60E-01	4.55E-01	4.47E-01
1839	4.64E-01	4.72E-01	4.67E-01	4.58E-01	4.50E-01	4.54E-01	4.55E-01
1840	4.69E-01	4.77E-01	4.68E-01	4.66E-01	4.51E-01	4.57E-01	4.57E-01
1851	4.68E-01	4.66E-01	4.68E-01	4.70E-01	4.67E-01	4.68E-01	4.60E-01
1852	4.84E-01	4.80E-01	4.73E-01	4.83E-01	4.76E-01	4.84E-01	4.78E-01
Biased Statistics							
Average Biased	4.66E-01	4.63E-01	4.63E-01	4.59E-01	4.52E-01	4.45E-01	4.43E-01
Std Dev Biased	2.34E-02	1.71E-02	1.62E-02	1.89E-02	1.61E-02	1.71E-02	2.08E-02
Ps90%/90% (+KTL) Biased	5.31E-01	5.09E-01	5.08E-01	5.11E-01	4.96E-01	4.92E-01	5.00E-01
Ps90%/90% (-KTL) Biased	4.02E-01	4.16E-01	4.19E-01	4.07E-01	4.08E-01	3.99E-01	3.86E-01
Un-Biased Statistics							
Average Un-Biased	4.62E-01	4.65E-01	4.64E-01	4.62E-01	4.48E-01	4.50E-01	4.50E-01
Std Dev Un-Biased	9.93E-03	8.50E-03	6.82E-03	6.42E-03	9.34E-03	9.34E-03	7.79E-03
Ps90%/90% (+KTL) Un-Biased	4.89E-01	4.89E-01	4.83E-01	4.80E-01	4.73E-01	4.75E-01	4.72E-01
Ps90%/90% (-KTL) Un-Biased	4.35E-01	4.42E-01	4.45E-01	4.45E-01	4.22E-01	4.24E-01	4.29E-01
Specification MIN	2.00E-01	1.30E-01	1.20E-01	1.20E-01	1.10E-01	1.10E-01	1.10E-01
Status	PASS	PASS	PASS	PASS	PASS	PASS	PASS

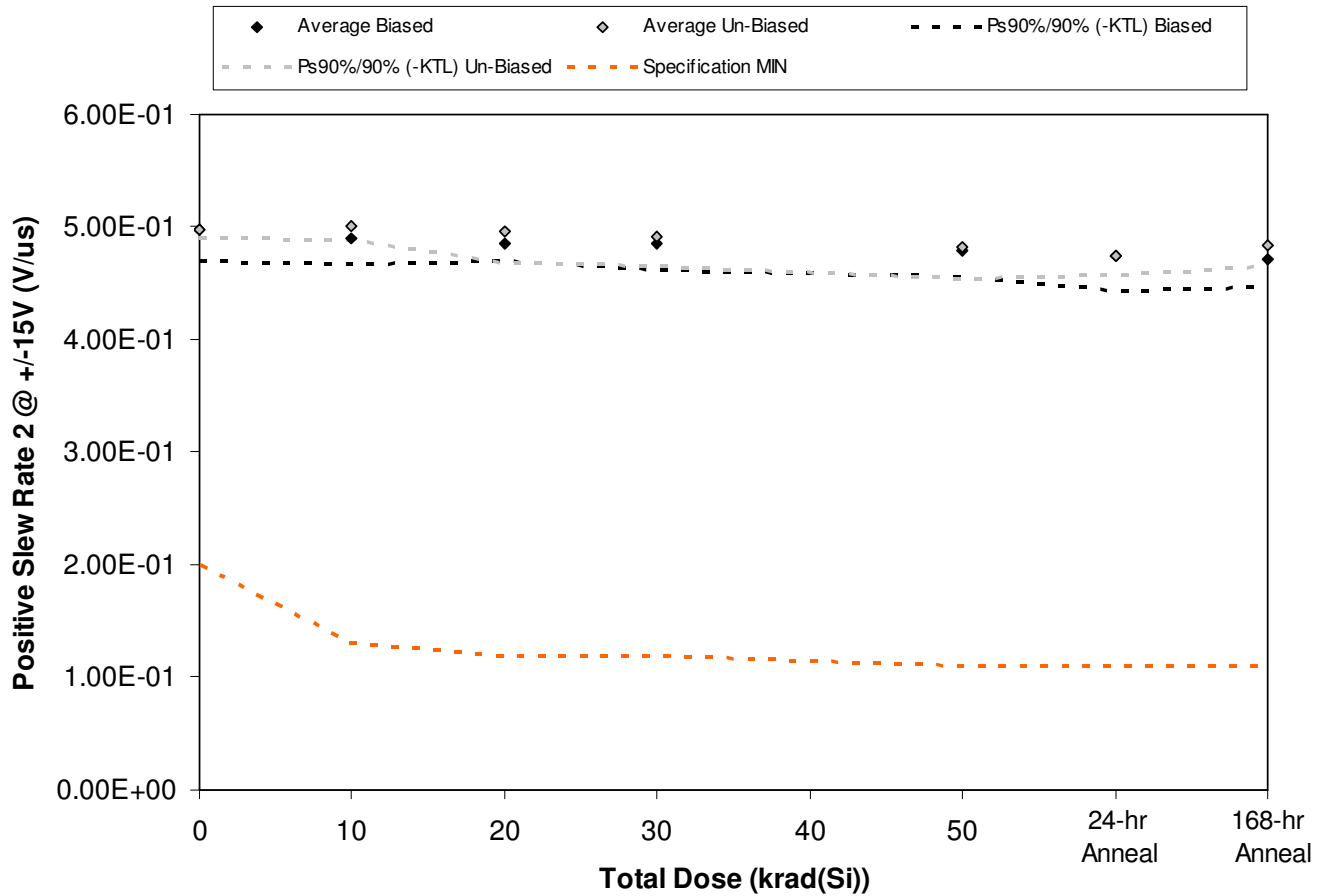

Figure 5.40. Plot of Positive Slew Rate 2 @ +/-15V (V/us) versus total dose. The solid diamonds are the average of the measured data points for the samples irradiated under electrical bias while the shaded diamonds are the average of the measured data points for the samples irradiated with all pins tied to ground. The black lines (solid and/or dashed) are the average of the data points after application of the KTL statistics on the samples irradiated under electrical bias while the gray lines (solid and/or dashed) are the average of the data points after application of the KTL statistics on the samples irradiated in the unbiased condition. The red dotted line(s) are the pre- and/or post-irradiation minimum and/or maximum specification value as defined in the datasheet and/or test plan.



Table 5.40. Raw data for Positive Slew Rate 2 @ +/-15V (V/us) versus total dose, including the statistical analysis, specification and the status of the testing (pass/fail).

Positive Slew Rate 2 @ +/-15V (V/us)	Total Dose (krad(Si))					24 hr	168 hr
	0	10	20	30	50	Anneal	Anneal
Device							
	10/20/2011	11/3/2011	11/3/2011	11/3/2011	11/3/2011	11/4/2011	11/11/2011
1831	5.08E-01	5.02E-01	4.89E-01	4.89E-01	4.89E-01	4.85E-01	4.78E-01
1832	5.08E-01	4.89E-01	4.89E-01	4.88E-01	4.83E-01	4.87E-01	4.74E-01
1833	5.00E-01	4.91E-01	4.85E-01	4.91E-01	4.75E-01	4.75E-01	4.76E-01
1834	4.91E-01	4.88E-01	4.85E-01	4.85E-01	4.78E-01	4.69E-01	4.69E-01
1835	4.85E-01	4.78E-01	4.76E-01	4.70E-01	4.67E-01	4.59E-01	4.56E-01
1836	4.98E-01	5.03E-01	4.82E-01	4.82E-01	4.83E-01	4.78E-01	4.86E-01
1837	4.94E-01	4.94E-01	4.92E-01	4.87E-01	4.67E-01	4.67E-01	4.72E-01
1838	4.98E-01	5.04E-01	4.95E-01	4.86E-01	4.79E-01	4.69E-01	4.82E-01
1839	4.97E-01	5.06E-01	5.09E-01	4.97E-01	4.91E-01	4.76E-01	4.86E-01
1840	5.02E-01	5.00E-01	5.02E-01	5.06E-01	4.94E-01	4.81E-01	4.89E-01
1851	4.94E-01	4.88E-01	4.87E-01	4.94E-01	4.90E-01	4.96E-01	4.96E-01
1852	4.78E-01	4.76E-01	4.83E-01	4.77E-01	4.84E-01	4.75E-01	4.71E-01
Biased Statistics							
Average Biased	4.98E-01	4.90E-01	4.85E-01	4.85E-01	4.78E-01	4.75E-01	4.71E-01
Std Dev Biased	1.03E-02	8.56E-03	5.31E-03	8.44E-03	8.29E-03	1.16E-02	8.82E-03
Ps90%/90% (+KTL) Biased	5.27E-01	5.13E-01	4.99E-01	5.08E-01	5.01E-01	5.07E-01	4.95E-01
Ps90%/90% (-KTL) Biased	4.70E-01	4.66E-01	4.70E-01	4.61E-01	4.56E-01	4.43E-01	4.46E-01
Un-Biased Statistics							
Average Un-Biased	4.98E-01	5.01E-01	4.96E-01	4.92E-01	4.83E-01	4.74E-01	4.83E-01
Std Dev Un-Biased	2.86E-03	4.67E-03	1.02E-02	9.76E-03	1.07E-02	5.97E-03	6.63E-03
Ps90%/90% (+KTL) Un-Biased	5.06E-01	5.14E-01	5.24E-01	5.18E-01	5.12E-01	4.91E-01	5.01E-01
Ps90%/90% (-KTL) Un-Biased	4.90E-01	4.89E-01	4.68E-01	4.65E-01	4.53E-01	4.58E-01	4.65E-01
Specification MIN	2.00E-01	1.30E-01	1.20E-01	1.20E-01	1.10E-01	1.10E-01	1.10E-01
Status	PASS	PASS	PASS	PASS	PASS	PASS	PASS

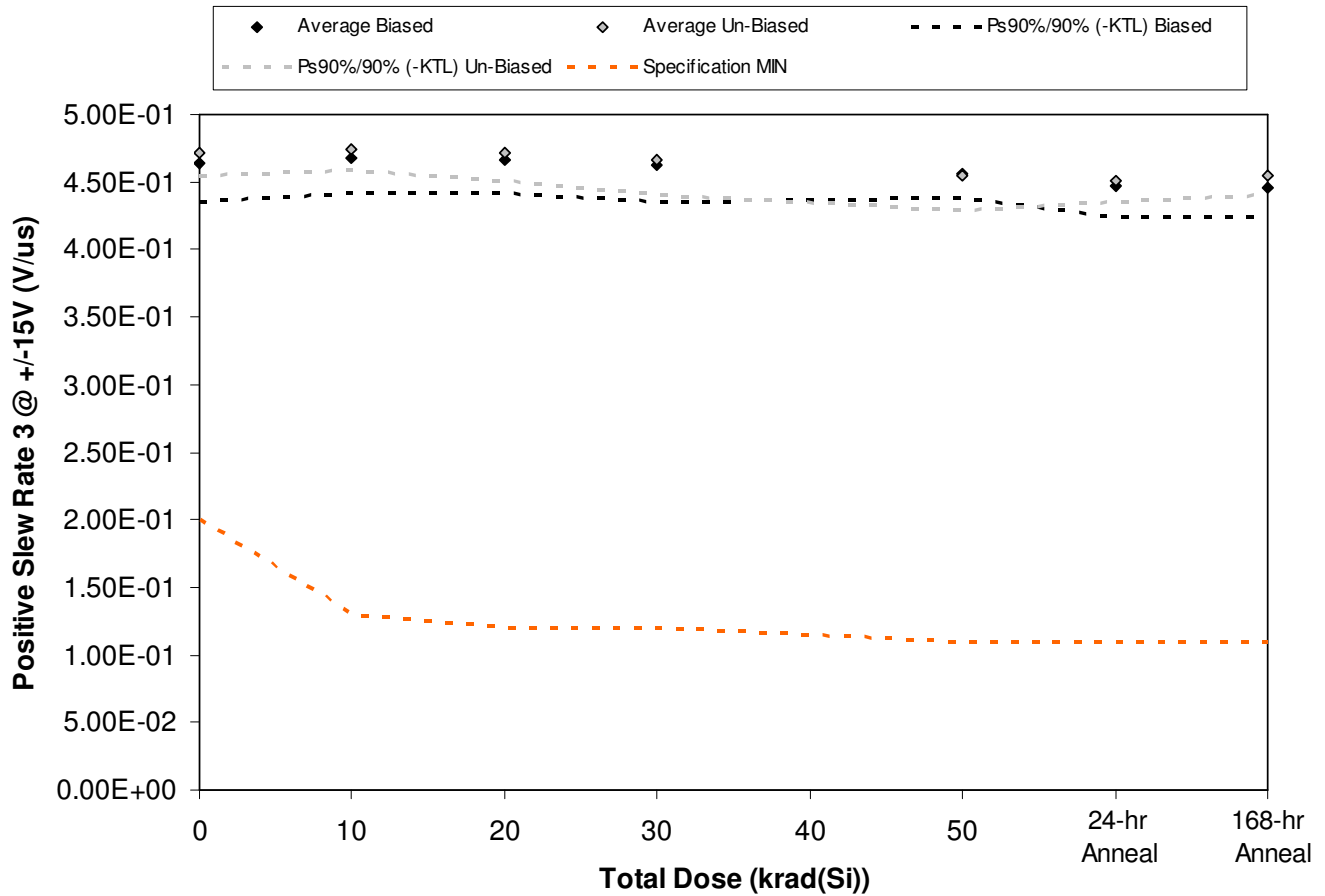

Figure 5.41. Plot of Positive Slew Rate 3 @ +/-15V (V/us) versus total dose. The solid diamonds are the average of the measured data points for the samples irradiated under electrical bias while the shaded diamonds are the average of the measured data points for the samples irradiated with all pins tied to ground. The black lines (solid and/or dashed) are the average of the data points after application of the KTL statistics on the samples irradiated under electrical bias while the gray lines (solid and/or dashed) are the average of the data points after application of the KTL statistics on the samples irradiated in the unbiased condition. The red dotted line(s) are the pre- and/or post-irradiation minimum and/or maximum specification value as defined in the datasheet and/or test plan.



Table 5.41. Raw data for Positive Slew Rate 3 @ +/-15V (V/us) versus total dose, including the statistical analysis, specification and the status of the testing (pass/fail).

Positive Slew Rate 3 @ +/-15V (V/us)	Total Dose (krad(Si))					24 hr	168 hr
	0	10	20	30	50	Anneal	Anneal
Device							
	10/20/2011	11/3/2011	11/3/2011	11/3/2011	11/3/2011	11/4/2011	11/11/2011
1831	4.74E-01	4.76E-01	4.72E-01	4.72E-01	4.56E-01	4.55E-01	4.52E-01
1832	4.73E-01	4.69E-01	4.65E-01	4.70E-01	4.62E-01	4.51E-01	4.48E-01
1833	4.62E-01	4.76E-01	4.71E-01	4.59E-01	4.60E-01	4.45E-01	4.49E-01
1834	4.64E-01	4.64E-01	4.70E-01	4.64E-01	4.54E-01	4.51E-01	4.49E-01
1835	4.48E-01	4.53E-01	4.51E-01	4.47E-01	4.46E-01	4.33E-01	4.32E-01
1836	4.77E-01	4.72E-01	4.69E-01	4.74E-01	4.58E-01	4.60E-01	4.53E-01
1837	4.64E-01	4.66E-01	4.61E-01	4.51E-01	4.42E-01	4.49E-01	4.51E-01
1838	4.69E-01	4.76E-01	4.69E-01	4.65E-01	4.49E-01	4.48E-01	4.51E-01
1839	4.71E-01	4.75E-01	4.76E-01	4.71E-01	4.61E-01	4.45E-01	4.62E-01
1840	4.79E-01	4.81E-01	4.80E-01	4.73E-01	4.65E-01	4.54E-01	4.60E-01
1851	4.71E-01	4.73E-01	4.70E-01	4.74E-01	4.77E-01	4.67E-01	4.77E-01
1852	4.55E-01	4.55E-01	4.62E-01	4.67E-01	4.67E-01	4.52E-01	4.48E-01
Biased Statistics							
Average Biased	4.64E-01	4.68E-01	4.66E-01	4.62E-01	4.56E-01	4.47E-01	4.46E-01
Std Dev Biased	1.05E-02	9.61E-03	8.70E-03	1.00E-02	6.23E-03	8.60E-03	7.97E-03
Ps90%/90% (+KTL) Biased	4.93E-01	4.94E-01	4.90E-01	4.90E-01	4.73E-01	4.71E-01	4.68E-01
Ps90%/90% (-KTL) Biased	4.35E-01	4.41E-01	4.42E-01	4.35E-01	4.39E-01	4.23E-01	4.24E-01
Un-Biased Statistics							
Average Un-Biased	4.72E-01	4.74E-01	4.71E-01	4.67E-01	4.55E-01	4.51E-01	4.55E-01
Std Dev Un-Biased	6.08E-03	5.52E-03	7.31E-03	9.50E-03	9.35E-03	5.89E-03	5.22E-03
Ps90%/90% (+KTL) Un-Biased	4.89E-01	4.89E-01	4.91E-01	4.93E-01	4.81E-01	4.67E-01	4.70E-01
Ps90%/90% (-KTL) Un-Biased	4.55E-01	4.59E-01	4.51E-01	4.41E-01	4.29E-01	4.35E-01	4.41E-01
Specification MIN	2.00E-01	1.30E-01	1.20E-01	1.20E-01	1.10E-01	1.10E-01	1.10E-01
Status	PASS	PASS	PASS	PASS	PASS	PASS	PASS

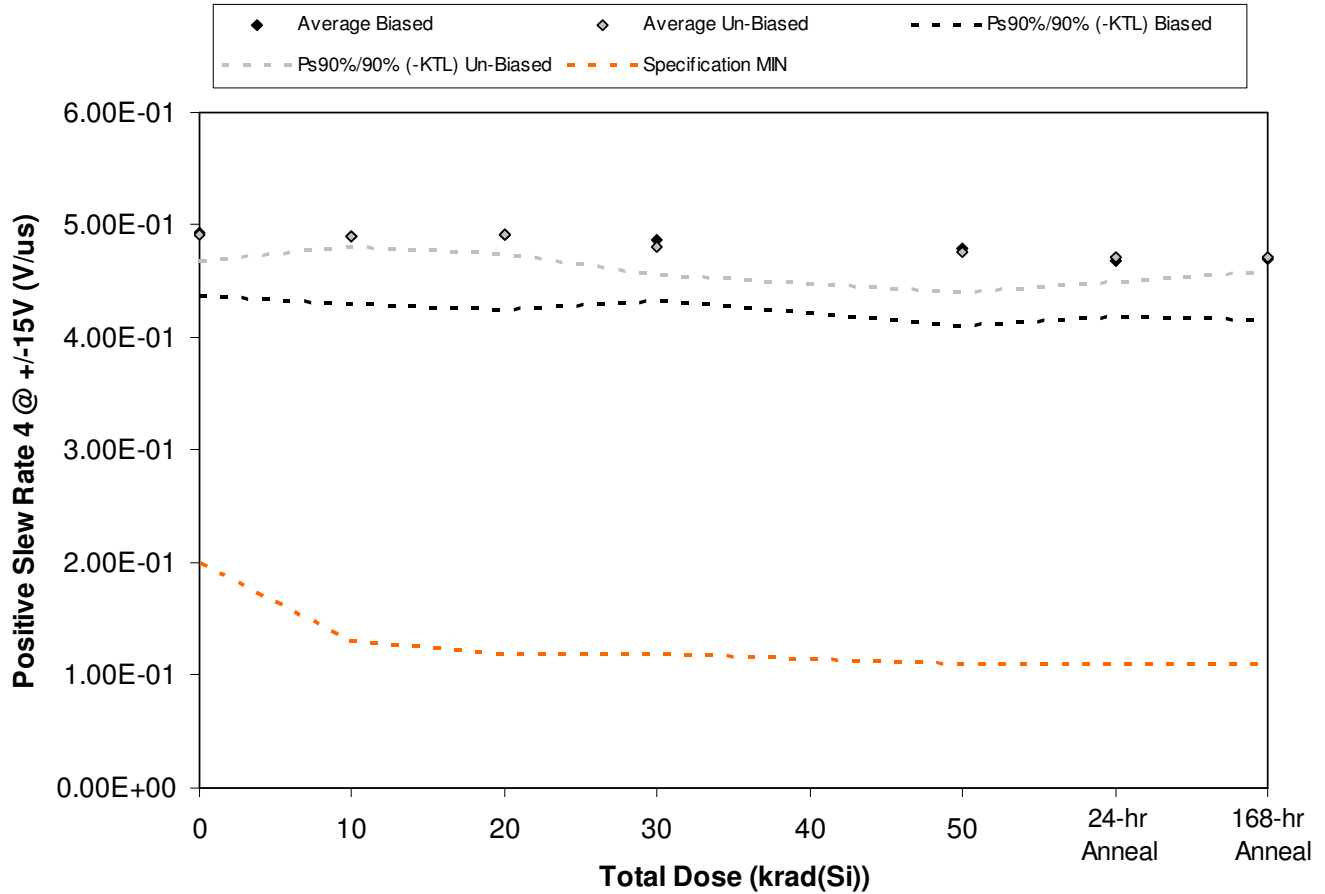

Figure 5.42. Plot of Positive Slew Rate 4 @ +/-15V (V/us) versus total dose. The solid diamonds are the average of the measured data points for the samples irradiated under electrical bias while the shaded diamonds are the average of the measured data points for the samples irradiated with all pins tied to ground. The black lines (solid and/or dashed) are the average of the data points after application of the KTL statistics on the samples irradiated under electrical bias while the gray lines (solid and/or dashed) are the average of the data points after application of the KTL statistics on the samples irradiated in the unbiased condition. The red dotted line(s) are the pre- and/or post-irradiation minimum and/or maximum specification value as defined in the datasheet and/or test plan.



**TID Report
11-572 R1.0**

**Aeroflex RAD
5017 N. 30th Street
Colorado Springs, CO 80919
(719) 531-0800**

Table 5.42. Raw data for Positive Slew Rate 4 @ +/-15V (V/us) versus total dose, including the statistical analysis, specification and the status of the testing (pass/fail).

Positive Slew Rate 4 @ +/-15V (V/us)	Total Dose (krad(Si))					24 hr	168 hr
	0	10	20	30	50	Anneal	Anneal
Device							
	10/20/2011	11/3/2011	11/3/2011	11/3/2011	11/3/2011	11/4/2011	11/11/2011
1831	4.67E-01	4.61E-01	4.68E-01	4.61E-01	4.52E-01	4.51E-01	4.44E-01
1832	4.95E-01	4.86E-01	4.85E-01	4.84E-01	4.76E-01	4.65E-01	4.71E-01
1833	4.78E-01	4.79E-01	4.73E-01	4.77E-01	4.59E-01	4.52E-01	4.60E-01
1834	5.15E-01	5.15E-01	5.28E-01	5.14E-01	5.11E-01	4.89E-01	4.96E-01
1835	5.07E-01	5.09E-01	5.01E-01	4.95E-01	4.95E-01	4.87E-01	4.81E-01
1836	4.80E-01	4.86E-01	4.86E-01	4.81E-01	4.59E-01	4.62E-01	4.65E-01
1837	4.86E-01	4.89E-01	4.83E-01	4.67E-01	4.67E-01	4.67E-01	4.68E-01
1838	5.00E-01	4.88E-01	4.97E-01	4.91E-01	4.90E-01	4.83E-01	4.74E-01
1839	4.93E-01	4.91E-01	4.95E-01	4.85E-01	4.85E-01	4.71E-01	4.75E-01
1840	4.99E-01	4.94E-01	4.93E-01	4.78E-01	4.82E-01	4.70E-01	4.75E-01
1851	5.02E-01	4.92E-01	4.88E-01	4.93E-01	4.92E-01	4.86E-01	4.88E-01
1852	5.11E-01	4.99E-01	5.01E-01	5.11E-01	5.01E-01	5.05E-01	5.05E-01
Biased Statistics							
Average Biased	4.92E-01	4.90E-01	4.91E-01	4.86E-01	4.79E-01	4.69E-01	4.70E-01
Std Dev Biased	1.99E-02	2.22E-02	2.43E-02	1.98E-02	2.46E-02	1.84E-02	1.98E-02
Ps90%/90% (+KTL) Biased	5.47E-01	5.51E-01	5.58E-01	5.41E-01	5.46E-01	5.19E-01	5.25E-01
Ps90%/90% (-KTL) Biased	4.38E-01	4.29E-01	4.24E-01	4.32E-01	4.11E-01	4.18E-01	4.16E-01
Un-Biased Statistics							
Average Un-Biased	4.92E-01	4.90E-01	4.91E-01	4.80E-01	4.77E-01	4.71E-01	4.71E-01
Std Dev Un-Biased	8.56E-03	3.05E-03	6.02E-03	8.93E-03	1.30E-02	7.77E-03	4.62E-03
Ps90%/90% (+KTL) Un-Biased	5.15E-01	4.98E-01	5.07E-01	5.05E-01	5.12E-01	4.92E-01	4.84E-01
Ps90%/90% (-KTL) Un-Biased	4.68E-01	4.81E-01	4.74E-01	4.56E-01	4.41E-01	4.49E-01	4.59E-01
Specification MIN	2.00E-01	1.30E-01	1.20E-01	1.20E-01	1.10E-01	1.10E-01	1.10E-01
Status	PASS	PASS	PASS	PASS	PASS	PASS	PASS

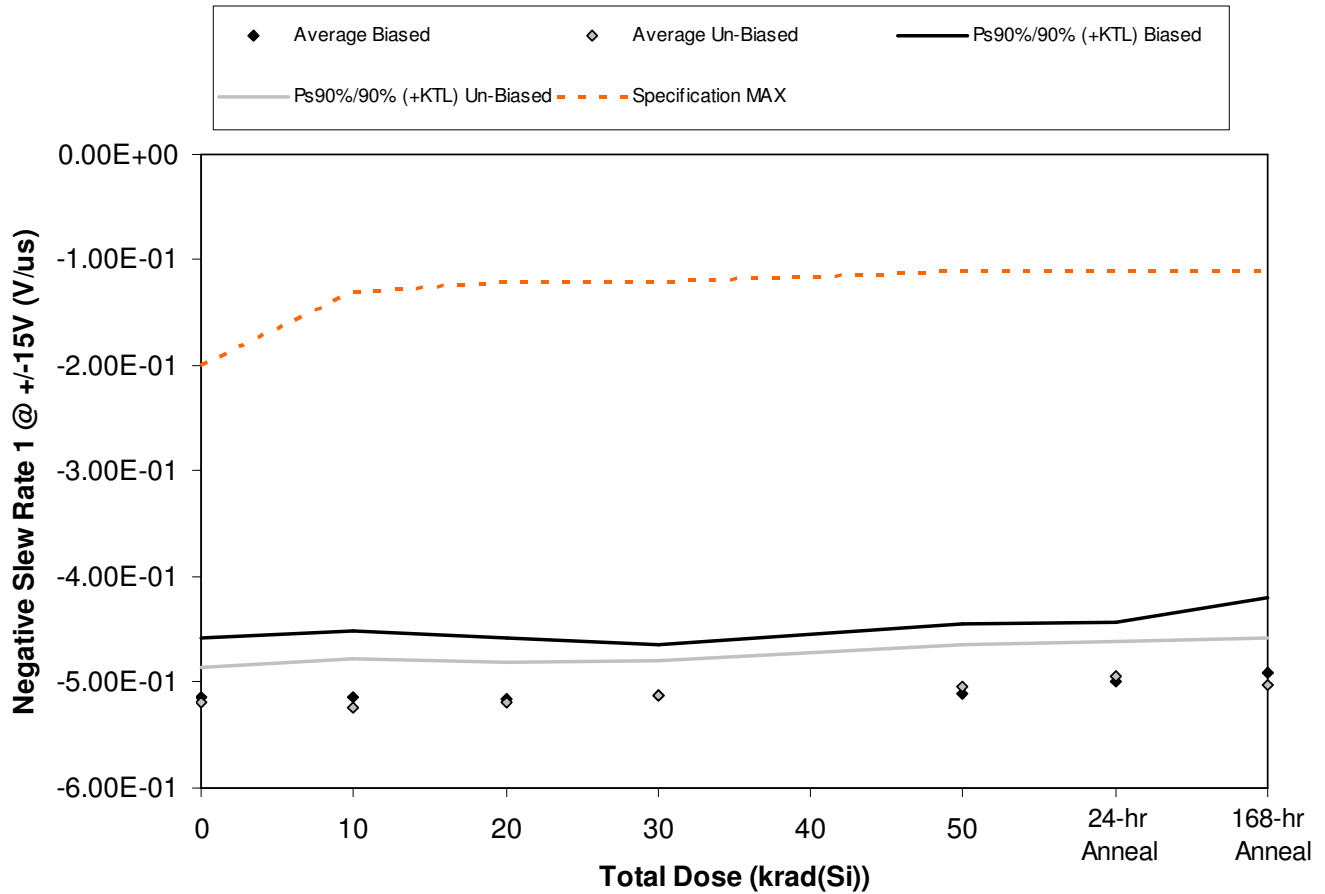

Figure 5.43. Plot of Negative Slew Rate 1 @ +/-15V (V/us) versus total dose. The solid diamonds are the average of the measured data points for the samples irradiated under electrical bias while the shaded diamonds are the average of the measured data points for the samples irradiated with all pins tied to ground. The black lines (solid and/or dashed) are the average of the data points after application of the KTL statistics on the samples irradiated under electrical bias while the gray lines (solid and/or dashed) are the average of the data points after application of the KTL statistics on the samples irradiated in the unbiased condition. The red dotted line(s) are the pre- and/or post-irradiation minimum and/or maximum specification value as defined in the datasheet and/or test plan.



**TID Report
11-572 R1.0**

**Aeroflex RAD
5017 N. 30th Street
Colorado Springs, CO 80919
(719) 531-0800**

Table 5.43. Raw data for Negative Slew Rate 1 @ +/-15V (V/us) versus total dose, including the statistical analysis, specification and the status of the testing (pass/fail).

Negative Slew Rate 1 @ +/-15V (V/us)	Total Dose (krad(Si))					24 hr Anneal	168 hr Anneal
	0	10	20	30	50		
Device							
	10/20/2011	11/3/2011	11/3/2011	11/3/2011	11/3/2011	11/4/2011	11/11/2011
1831	-4.91E-01	-4.92E-01	-4.87E-01	-4.95E-01	-4.82E-01	-4.75E-01	-4.59E-01
1832	-5.06E-01	-5.12E-01	-5.20E-01	-5.20E-01	-5.07E-01	-5.01E-01	-4.91E-01
1833	-5.08E-01	-4.93E-01	-5.01E-01	-4.93E-01	-4.95E-01	-4.81E-01	-4.72E-01
1834	-5.45E-01	-5.42E-01	-5.33E-01	-5.31E-01	-5.39E-01	-5.19E-01	-5.19E-01
1835	-5.22E-01	-5.33E-01	-5.37E-01	-5.26E-01	-5.31E-01	-5.17E-01	-5.14E-01
1836	-5.09E-01	-4.96E-01	-4.95E-01	-4.95E-01	-4.90E-01	-4.86E-01	-4.87E-01
1837	-5.04E-01	-5.30E-01	-5.20E-01	-5.23E-01	-4.89E-01	-4.79E-01	-4.85E-01
1838	-5.32E-01	-5.41E-01	-5.28E-01	-5.05E-01	-5.13E-01	-5.10E-01	-5.22E-01
1839	-5.26E-01	-5.22E-01	-5.26E-01	-5.21E-01	-5.09E-01	-4.98E-01	-5.04E-01
1840	-5.20E-01	-5.29E-01	-5.26E-01	-5.21E-01	-5.22E-01	-4.98E-01	-5.11E-01
1851	-4.97E-01	-5.36E-01	-5.22E-01	-5.23E-01	-5.10E-01	-5.17E-01	-5.24E-01
1852	-5.25E-01	-5.32E-01	-5.32E-01	-5.29E-01	-5.29E-01	-5.34E-01	-5.20E-01
Biased Statistics							
Average Biased	-5.14E-01	-5.14E-01	-5.16E-01	-5.13E-01	-5.11E-01	-4.99E-01	-4.91E-01
Std Dev Biased	2.03E-02	2.28E-02	2.13E-02	1.78E-02	2.40E-02	2.02E-02	2.60E-02
Ps90%/90% (+KTL) Biased	-4.59E-01	-4.52E-01	-4.57E-01	-4.64E-01	-4.45E-01	-4.43E-01	-4.20E-01
Ps90%/90% (-KTL) Biased	-5.70E-01	-5.77E-01	-5.74E-01	-5.62E-01	-5.77E-01	-5.54E-01	-5.62E-01
Un-Biased Statistics							
Average Un-Biased	-5.18E-01	-5.24E-01	-5.19E-01	-5.13E-01	-5.05E-01	-4.94E-01	-5.02E-01
Std Dev Un-Biased	1.16E-02	1.69E-02	1.37E-02	1.24E-02	1.46E-02	1.20E-02	1.58E-02
Ps90%/90% (+KTL) Un-Biased	-4.86E-01	-4.77E-01	-4.81E-01	-4.79E-01	-4.65E-01	-4.61E-01	-4.58E-01
Ps90%/90% (-KTL) Un-Biased	-5.50E-01	-5.70E-01	-5.57E-01	-5.47E-01	-5.45E-01	-5.27E-01	-5.45E-01
Specification MAX	-2.00E-01	-1.30E-01	-1.20E-01	-1.20E-01	-1.10E-01	-1.10E-01	-1.10E-01
Status	PASS	PASS	PASS	PASS	PASS	PASS	PASS

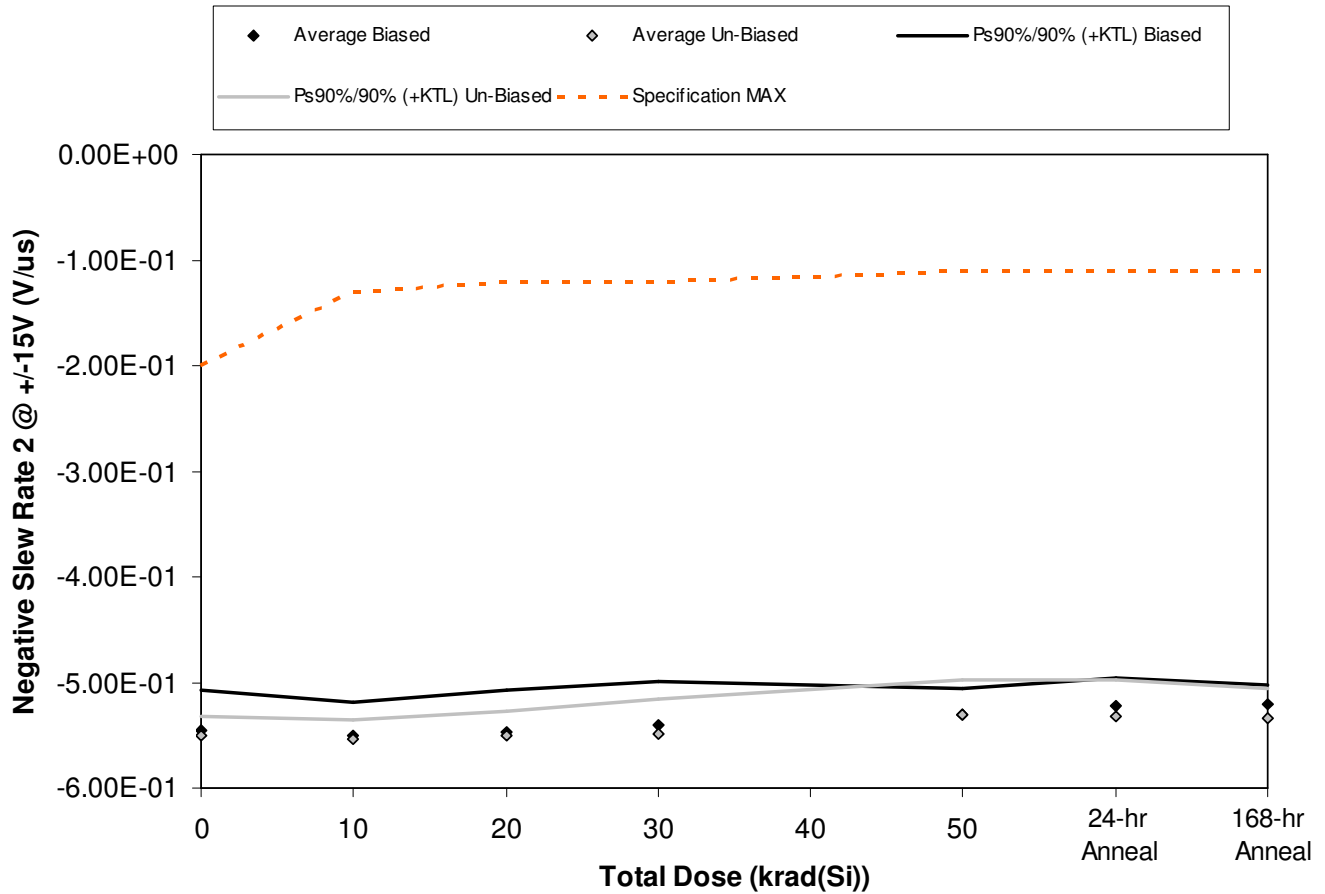

Figure 5.44. Plot of Negative Slew Rate 2 @ +/-15V (V/us) versus total dose. The solid diamonds are the average of the measured data points for the samples irradiated under electrical bias while the shaded diamonds are the average of the measured data points for the samples irradiated with all pins tied to ground. The black lines (solid and/or dashed) are the average of the data points after application of the KTL statistics on the samples irradiated under electrical bias while the gray lines (solid and/or dashed) are the average of the data points after application of the KTL statistics on the samples irradiated in the unbiased condition. The red dotted line(s) are the pre- and/or post-irradiation minimum and/or maximum specification value as defined in the datasheet and/or test plan.



Table 5.44. Raw data for Negative Slew Rate 2 @ +/-15V (V/us) versus total dose, including the statistical analysis, specification and the status of the testing (pass/fail).

Negative Slew Rate 2 @ +/-15V (V/us)	Total Dose (krad(Si))					24 hr Anneal	168 hr Anneal
	0	10	20	30	50		
Device	10/20/2011	11/3/2011	11/3/2011	11/3/2011	11/3/2011	11/4/2011	11/11/2011
1831	-5.55E-01	-5.52E-01	-5.64E-01	-5.45E-01	-5.39E-01	-5.37E-01	-5.25E-01
1832	-5.49E-01	-5.55E-01	-5.47E-01	-5.43E-01	-5.33E-01	-5.21E-01	-5.26E-01
1833	-5.56E-01	-5.48E-01	-5.52E-01	-5.59E-01	-5.32E-01	-5.12E-01	-5.24E-01
1834	-5.47E-01	-5.65E-01	-5.51E-01	-5.35E-01	-5.30E-01	-5.23E-01	-5.23E-01
1835	-5.22E-01	-5.33E-01	-5.24E-01	-5.18E-01	-5.15E-01	-5.17E-01	-5.09E-01
1836	-5.54E-01	-5.55E-01	-5.56E-01	-5.53E-01	-5.30E-01	-5.24E-01	-5.36E-01
1837	-5.46E-01	-5.45E-01	-5.43E-01	-5.38E-01	-5.17E-01	-5.15E-01	-5.23E-01
1838	-5.48E-01	-5.50E-01	-5.63E-01	-5.36E-01	-5.21E-01	-5.41E-01	-5.29E-01
1839	-5.61E-01	-5.53E-01	-5.44E-01	-5.51E-01	-5.39E-01	-5.44E-01	-5.31E-01
1840	-5.45E-01	-5.62E-01	-5.46E-01	-5.66E-01	-5.45E-01	-5.40E-01	-5.50E-01
1851	-5.60E-01	-5.47E-01	-5.53E-01	-5.51E-01	-5.54E-01	-5.47E-01	-5.48E-01
1852	-5.41E-01	-5.23E-01	-5.34E-01	-5.39E-01	-5.26E-01	-5.13E-01	-5.44E-01
Biased Statistics							
Average Biased	-5.46E-01	-5.51E-01	-5.48E-01	-5.40E-01	-5.30E-01	-5.22E-01	-5.21E-01
Std Dev Biased	1.38E-02	1.17E-02	1.46E-02	1.50E-02	8.93E-03	9.38E-03	7.02E-03
Ps90%/90% (+KTL) Biased	-5.08E-01	-5.19E-01	-5.07E-01	-4.99E-01	-5.05E-01	-4.96E-01	-5.02E-01
Ps90%/90% (-KTL) Biased	-5.84E-01	-5.83E-01	-5.88E-01	-5.81E-01	-5.54E-01	-5.48E-01	-5.41E-01
Un-Biased Statistics							
Average Un-Biased	-5.51E-01	-5.53E-01	-5.50E-01	-5.49E-01	-5.30E-01	-5.33E-01	-5.34E-01
Std Dev Un-Biased	6.69E-03	6.28E-03	8.73E-03	1.22E-02	1.18E-02	1.26E-02	1.02E-02
Ps90%/90% (+KTL) Un-Biased	-5.32E-01	-5.36E-01	-5.26E-01	-5.15E-01	-4.98E-01	-4.98E-01	-5.06E-01
Ps90%/90% (-KTL) Un-Biased	-5.69E-01	-5.70E-01	-5.74E-01	-5.82E-01	-5.63E-01	-5.67E-01	-5.62E-01
Specification MAX	-2.00E-01	-1.30E-01	-1.20E-01	-1.20E-01	-1.10E-01	-1.10E-01	-1.10E-01
Status	PASS	PASS	PASS	PASS	PASS	PASS	PASS

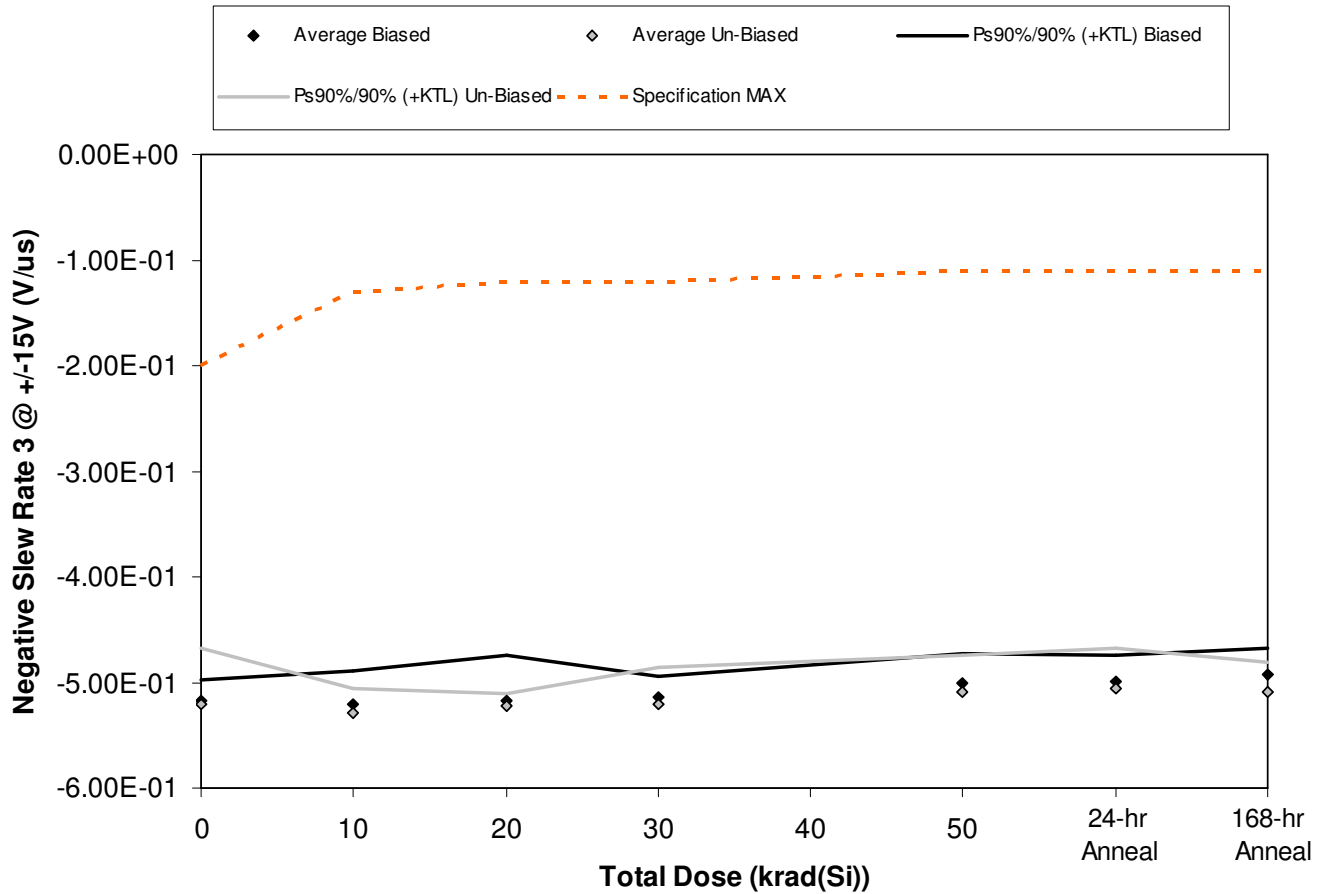

Figure 5.45. Plot of Negative Slew Rate 3 @ +/-15V (V/us) versus total dose. The solid diamonds are the average of the measured data points for the samples irradiated under electrical bias while the shaded diamonds are the average of the measured data points for the samples irradiated with all pins tied to ground. The black lines (solid and/or dashed) are the average of the data points after application of the KTL statistics on the samples irradiated under electrical bias while the gray lines (solid and/or dashed) are the average of the data points after application of the KTL statistics on the samples irradiated in the unbiased condition. The red dotted line(s) are the pre- and/or post-irradiation minimum and/or maximum specification value as defined in the datasheet and/or test plan.



**TID Report
11-572 R1.0**

**Aeroflex RAD
5017 N. 30th Street
Colorado Springs, CO 80919
(719) 531-0800**

Table 5.45. Raw data for Negative Slew Rate 3 @ +/-15V (V/us) versus total dose, including the statistical analysis, specification and the status of the testing (pass/fail).

Negative Slew Rate 3 @ +/-15V (V/us)	Total Dose (krad(Si))					24 hr Anneal	168 hr Anneal
	0	10	20	30	50		
Device							
	10/20/2011	11/3/2011	11/3/2011	11/3/2011	11/3/2011	11/4/2011	11/11/2011
1831	-5.23E-01	-5.39E-01	-5.23E-01	-5.15E-01	-5.05E-01	-5.02E-01	-4.96E-01
1832	-5.19E-01	-5.14E-01	-5.32E-01	-5.12E-01	-5.07E-01	-5.05E-01	-4.92E-01
1833	-5.17E-01	-5.24E-01	-5.15E-01	-5.16E-01	-5.12E-01	-5.00E-01	-5.07E-01
1834	-5.20E-01	-5.16E-01	-5.23E-01	-5.26E-01	-4.95E-01	-5.06E-01	-4.82E-01
1835	-5.05E-01	-5.10E-01	-4.91E-01	-5.05E-01	-4.86E-01	-4.84E-01	-4.88E-01
1836	-5.20E-01	-5.34E-01	-5.19E-01	-5.21E-01	-5.12E-01	-5.06E-01	-5.22E-01
1837	-4.90E-01	-5.17E-01	-5.18E-01	-5.06E-01	-4.90E-01	-4.96E-01	-4.96E-01
1838	-5.28E-01	-5.26E-01	-5.28E-01	-5.22E-01	-5.25E-01	-4.90E-01	-5.03E-01
1839	-5.26E-01	-5.29E-01	-5.22E-01	-5.15E-01	-5.06E-01	-5.14E-01	-5.08E-01
1840	-5.43E-01	-5.40E-01	-5.26E-01	-5.40E-01	-5.10E-01	-5.26E-01	-5.15E-01
1851	-5.24E-01	-5.20E-01	-5.18E-01	-5.17E-01	-5.28E-01	-5.18E-01	-5.21E-01
1852	-5.04E-01	-4.94E-01	-5.05E-01	-4.90E-01	-5.20E-01	-5.11E-01	-5.02E-01
Biased Statistics							
Average Biased	-5.17E-01	-5.21E-01	-5.17E-01	-5.15E-01	-5.01E-01	-4.99E-01	-4.93E-01
Std Dev Biased	6.94E-03	1.15E-02	1.56E-02	7.60E-03	1.04E-02	8.93E-03	9.38E-03
Ps90%/90% (+KTL) Biased	-4.98E-01	-4.89E-01	-4.74E-01	-4.94E-01	-4.72E-01	-4.75E-01	-4.67E-01
Ps90%/90% (-KTL) Biased	-5.36E-01	-5.52E-01	-5.60E-01	-5.36E-01	-5.30E-01	-5.24E-01	-5.19E-01
Un-Biased Statistics							
Average Un-Biased	-5.21E-01	-5.29E-01	-5.23E-01	-5.21E-01	-5.09E-01	-5.06E-01	-5.09E-01
Std Dev Un-Biased	1.95E-02	8.64E-03	4.34E-03	1.25E-02	1.26E-02	1.43E-02	1.01E-02
Ps90%/90% (+KTL) Un-Biased	-4.68E-01	-5.06E-01	-5.11E-01	-4.87E-01	-4.74E-01	-4.67E-01	-4.81E-01
Ps90%/90% (-KTL) Un-Biased	-5.75E-01	-5.53E-01	-5.34E-01	-5.55E-01	-5.43E-01	-5.46E-01	-5.37E-01
Specification MAX	-2.00E-01	-1.30E-01	-1.20E-01	-1.20E-01	-1.10E-01	-1.10E-01	-1.10E-01
Status	PASS	PASS	PASS	PASS	PASS	PASS	PASS

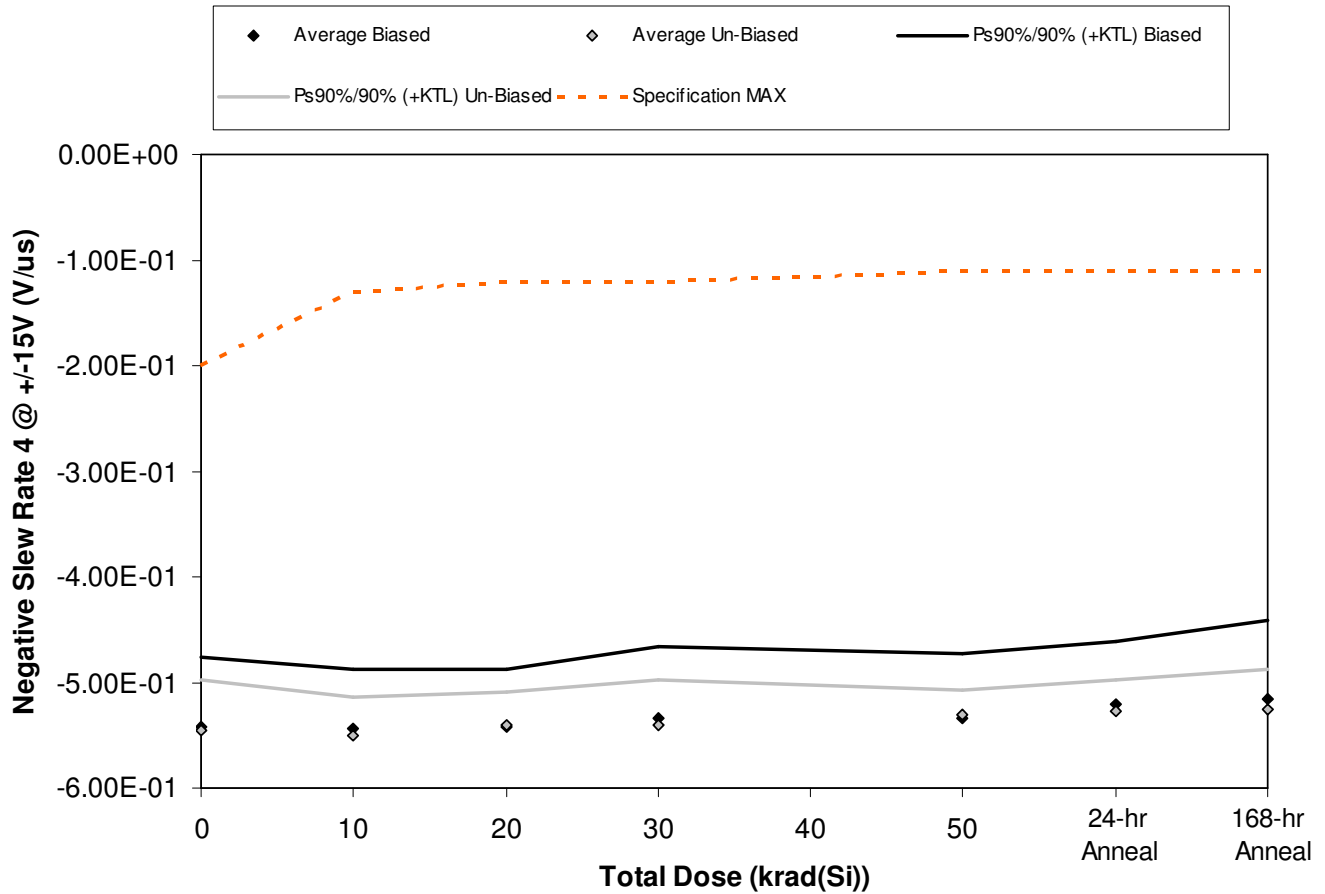

Figure 5.46. Plot of Negative Slew Rate 4 @ +/-15V (V/us) versus total dose. The solid diamonds are the average of the measured data points for the samples irradiated under electrical bias while the shaded diamonds are the average of the measured data points for the samples irradiated with all pins tied to ground. The black lines (solid and/or dashed) are the average of the data points after application of the KTL statistics on the samples irradiated under electrical bias while the gray lines (solid and/or dashed) are the average of the data points after application of the KTL statistics on the samples irradiated in the unbiased condition. The red dotted line(s) are the pre- and/or post-irradiation minimum and/or maximum specification value as defined in the datasheet and/or test plan.



**TID Report
11-572 R1.0**

**Aeroflex RAD
5017 N. 30th Street
Colorado Springs, CO 80919
(719) 531-0800**

Table 5.46. Raw data for Negative Slew Rate 4 @ +/-15V (V/us) versus total dose, including the statistical analysis, specification and the status of the testing (pass/fail).

Negative Slew Rate 4 @ +/-15V (V/us)	Total Dose (krad(Si))					24 hr Anneal	168 hr Anneal
	0	10	20	30	50		
Device							
	10/20/2011	11/3/2011	11/3/2011	11/3/2011	11/3/2011	11/4/2011	11/11/2011
1831	-5.15E-01	-5.24E-01	-5.27E-01	-5.04E-01	-5.14E-01	-4.93E-01	-4.89E-01
1832	-5.35E-01	-5.44E-01	-5.48E-01	-5.38E-01	-5.28E-01	-5.31E-01	-5.24E-01
1833	-5.28E-01	-5.23E-01	-5.18E-01	-5.13E-01	-5.14E-01	-5.05E-01	-4.85E-01
1834	-5.75E-01	-5.57E-01	-5.68E-01	-5.61E-01	-5.65E-01	-5.48E-01	-5.42E-01
1835	-5.55E-01	-5.70E-01	-5.53E-01	-5.53E-01	-5.50E-01	-5.29E-01	-5.39E-01
1836	-5.24E-01	-5.43E-01	-5.29E-01	-5.20E-01	-5.21E-01	-5.18E-01	-5.11E-01
1837	-5.37E-01	-5.33E-01	-5.36E-01	-5.32E-01	-5.23E-01	-5.18E-01	-5.12E-01
1838	-5.50E-01	-5.58E-01	-5.41E-01	-5.47E-01	-5.36E-01	-5.42E-01	-5.41E-01
1839	-5.43E-01	-5.52E-01	-5.39E-01	-5.43E-01	-5.32E-01	-5.21E-01	-5.28E-01
1840	-5.71E-01	-5.67E-01	-5.60E-01	-5.61E-01	-5.40E-01	-5.34E-01	-5.38E-01
1851	-5.57E-01	-5.56E-01	-5.47E-01	-5.46E-01	-5.49E-01	-5.40E-01	-5.54E-01
1852	-5.62E-01	-5.74E-01	-5.64E-01	-5.80E-01	-5.70E-01	-5.68E-01	-5.71E-01
Biased Statistics							
Average Biased	-5.42E-01	-5.44E-01	-5.43E-01	-5.34E-01	-5.34E-01	-5.21E-01	-5.16E-01
Std Dev Biased	2.36E-02	2.05E-02	2.02E-02	2.47E-02	2.27E-02	2.20E-02	2.72E-02
Ps90%/90% (+KTL) Biased	-4.77E-01	-4.87E-01	-4.87E-01	-4.66E-01	-4.72E-01	-4.61E-01	-4.41E-01
Ps90%/90% (-KTL) Biased	-6.06E-01	-6.00E-01	-5.98E-01	-6.02E-01	-5.96E-01	-5.81E-01	-5.90E-01
Un-Biased Statistics							
Average Un-Biased	-5.45E-01	-5.51E-01	-5.41E-01	-5.41E-01	-5.30E-01	-5.27E-01	-5.26E-01
Std Dev Un-Biased	1.74E-02	1.32E-02	1.16E-02	1.55E-02	8.20E-03	1.09E-02	1.41E-02
Ps90%/90% (+KTL) Un-Biased	-4.97E-01	-5.15E-01	-5.09E-01	-4.98E-01	-5.08E-01	-4.97E-01	-4.87E-01
Ps90%/90% (-KTL) Un-Biased	-5.93E-01	-5.87E-01	-5.73E-01	-5.83E-01	-5.53E-01	-5.56E-01	-5.65E-01
Specification MAX	-2.00E-01	-1.30E-01	-1.20E-01	-1.20E-01	-1.10E-01	-1.10E-01	-1.10E-01
Status	PASS	PASS	PASS	PASS	PASS	PASS	PASS

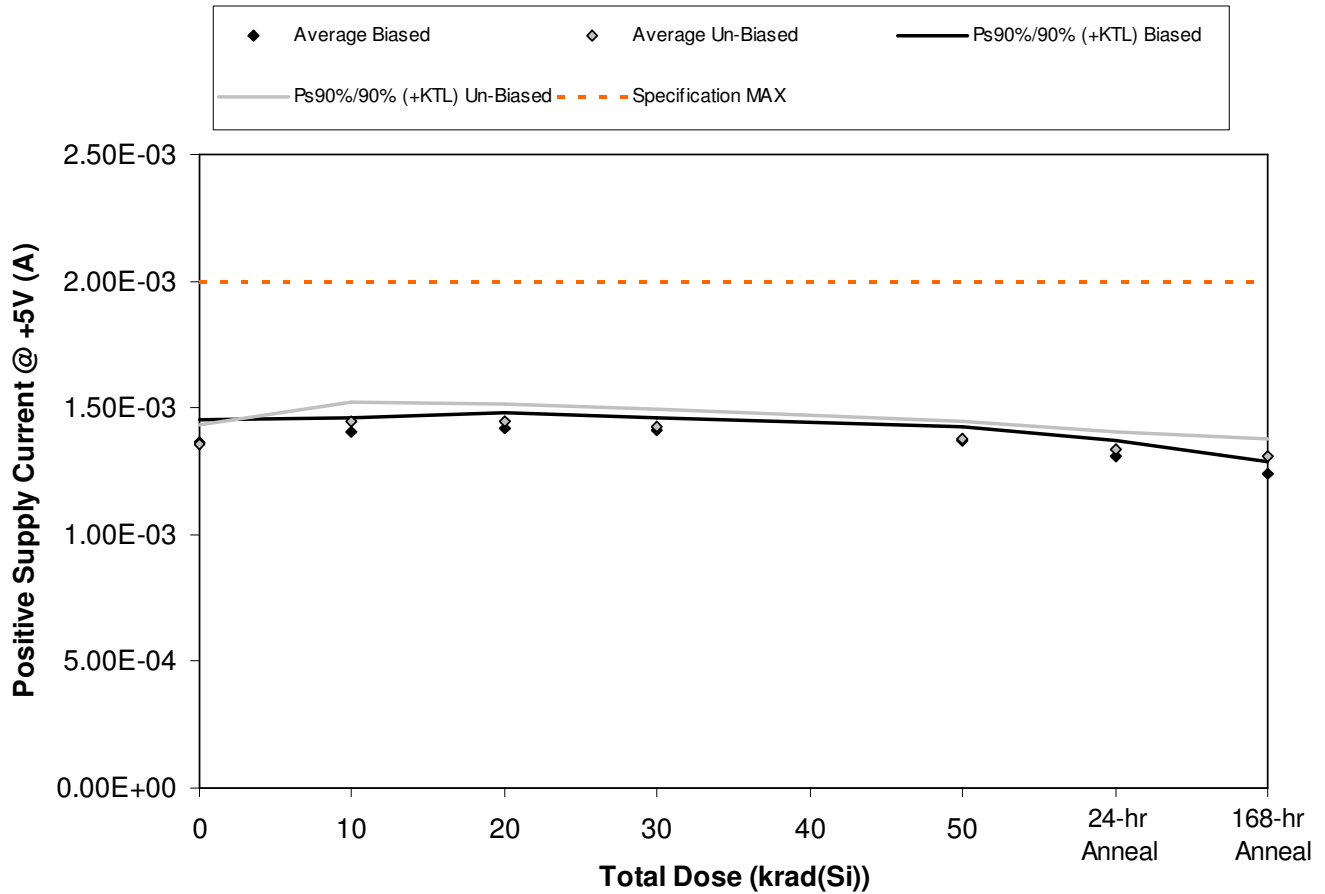

Figure 5.47. Plot of Positive Supply Current @ +5V (A) versus total dose. The solid diamonds are the average of the measured data points for the samples irradiated under electrical bias while the shaded diamonds are the average of the measured data points for the samples irradiated with all pins tied to ground. The black lines (solid and/or dashed) are the average of the data points after application of the KTL statistics on the samples irradiated under electrical bias while the gray lines (solid and/or dashed) are the average of the data points after application of the KTL statistics on the samples irradiated in the unbiased condition. The red dotted line(s) are the pre- and/or post-irradiation minimum and/or maximum specification value as defined in the datasheet and/or test plan.



Table 5.47. Raw data for Positive Supply Current @ +5V (A) versus total dose, including the statistical analysis, specification and the status of the testing (pass/fail).

Positive Supply Current @ +5V (A)	Total Dose (krad(Si))					24 hr	168 hr
	0	10	20	30	50	Anneal	Anneal
Device	10/20/2011	11/3/2011	11/3/2011	11/3/2011	11/3/2011	11/4/2011	11/11/2011
1831	1.33E-03	1.40E-03	1.42E-03	1.40E-03	1.36E-03	1.30E-03	1.23E-03
1832	1.40E-03	1.39E-03	1.43E-03	1.43E-03	1.39E-03	1.34E-03	1.26E-03
1833	1.33E-03	1.37E-03	1.39E-03	1.39E-03	1.34E-03	1.28E-03	1.22E-03
1834	1.39E-03	1.42E-03	1.45E-03	1.43E-03	1.38E-03	1.33E-03	1.26E-03
1835	1.37E-03	1.42E-03	1.43E-03	1.41E-03	1.37E-03	1.32E-03	1.25E-03
1836	1.32E-03	1.42E-03	1.41E-03	1.40E-03	1.36E-03	1.31E-03	1.28E-03
1837	1.34E-03	1.44E-03	1.44E-03	1.42E-03	1.37E-03	1.33E-03	1.29E-03
1838	1.39E-03	1.49E-03	1.48E-03	1.47E-03	1.42E-03	1.38E-03	1.35E-03
1839	1.36E-03	1.45E-03	1.44E-03	1.42E-03	1.37E-03	1.33E-03	1.31E-03
1840	1.36E-03	1.45E-03	1.45E-03	1.43E-03	1.38E-03	1.34E-03	1.31E-03
1851	1.33E-03	1.34E-03	1.34E-03	1.34E-03	1.34E-03	1.33E-03	1.34E-03
1852	1.42E-03	1.42E-03	1.42E-03	1.43E-03	1.43E-03	1.41E-03	1.42E-03
Biased Statistics							
Average Biased	1.36E-03	1.40E-03	1.42E-03	1.41E-03	1.37E-03	1.31E-03	1.24E-03
Std Dev Biased	3.31E-05	2.13E-05	2.13E-05	1.79E-05	2.03E-05	2.24E-05	1.74E-05
Ps90%/90% (+KTL) Biased	1.45E-03	1.46E-03	1.48E-03	1.46E-03	1.43E-03	1.37E-03	1.29E-03
Ps90%/90% (-KTL) Biased	1.27E-03	1.34E-03	1.36E-03	1.36E-03	1.31E-03	1.25E-03	1.19E-03
Un-Biased Statistics							
Average Un-Biased	1.35E-03	1.45E-03	1.44E-03	1.43E-03	1.38E-03	1.34E-03	1.31E-03
Std Dev Un-Biased	2.84E-05	2.75E-05	2.57E-05	2.53E-05	2.29E-05	2.42E-05	2.66E-05
Ps90%/90% (+KTL) Un-Biased	1.43E-03	1.52E-03	1.51E-03	1.50E-03	1.44E-03	1.40E-03	1.38E-03
Ps90%/90% (-KTL) Un-Biased	1.28E-03	1.37E-03	1.37E-03	1.36E-03	1.32E-03	1.27E-03	1.23E-03
Specification MAX	2.00E-03	2.00E-03	2.00E-03	2.00E-03	2.00E-03	2.00E-03	2.00E-03
Status	PASS	PASS	PASS	PASS	PASS	PASS	PASS

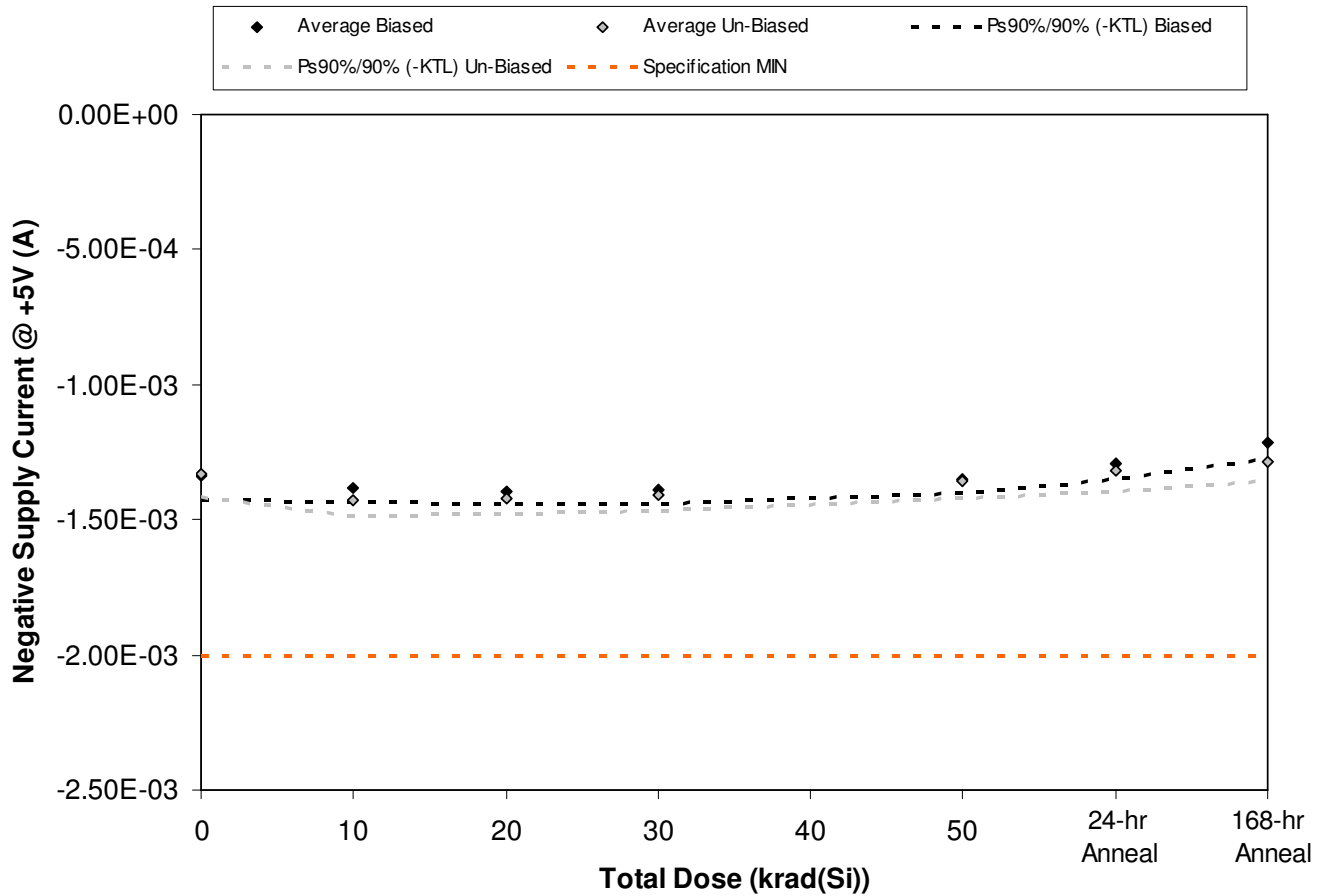

Figure 5.48. Plot of Negative Supply Current @ +5V (A) versus total dose. The solid diamonds are the average of the measured data points for the samples irradiated under electrical bias while the shaded diamonds are the average of the measured data points for the samples irradiated with all pins tied to ground. The black lines (solid and/or dashed) are the average of the data points after application of the KTL statistics on the samples irradiated under electrical bias while the gray lines (solid and/or dashed) are the average of the data points after application of the KTL statistics on the samples irradiated in the unbiased condition. The red dotted line(s) are the pre- and/or post-irradiation minimum and/or maximum specification value as defined in the datasheet and/or test plan.



Table 5.48. Raw data for Negative Supply Current @ +5V (A) versus total dose, including the statistical analysis, specification and the status of the testing (pass/fail).

Negative Supply Current @ +5V (A)	Total Dose (krad(Si))					24 hr	168 hr
	0	10	20	30	50	Anneal	Anneal
Device							
	10/20/2011	11/3/2011	11/3/2011	11/3/2011	11/3/2011	11/4/2011	11/11/2011
1831	-1.31E-03	-1.38E-03	-1.38E-03	-1.38E-03	-1.34E-03	-1.28E-03	-1.20E-03
1832	-1.38E-03	-1.37E-03	-1.40E-03	-1.41E-03	-1.37E-03	-1.31E-03	-1.23E-03
1833	-1.31E-03	-1.35E-03	-1.37E-03	-1.37E-03	-1.32E-03	-1.26E-03	-1.19E-03
1834	-1.36E-03	-1.40E-03	-1.41E-03	-1.40E-03	-1.36E-03	-1.30E-03	-1.24E-03
1835	-1.34E-03	-1.40E-03	-1.40E-03	-1.39E-03	-1.35E-03	-1.30E-03	-1.23E-03
1836	-1.30E-03	-1.40E-03	-1.40E-03	-1.38E-03	-1.33E-03	-1.28E-03	-1.26E-03
1837	-1.31E-03	-1.42E-03	-1.41E-03	-1.40E-03	-1.35E-03	-1.31E-03	-1.27E-03
1838	-1.37E-03	-1.46E-03	-1.45E-03	-1.44E-03	-1.39E-03	-1.36E-03	-1.33E-03
1839	-1.34E-03	-1.43E-03	-1.42E-03	-1.40E-03	-1.35E-03	-1.31E-03	-1.28E-03
1840	-1.34E-03	-1.42E-03	-1.43E-03	-1.41E-03	-1.36E-03	-1.32E-03	-1.29E-03
1851	-1.31E-03	-1.32E-03	-1.31E-03	-1.32E-03	-1.31E-03	-1.31E-03	-1.31E-03
1852	-1.40E-03	-1.40E-03	-1.40E-03	-1.40E-03	-1.40E-03	-1.40E-03	-1.39E-03
Biased Statistics							
Average Biased	-1.34E-03	-1.38E-03	-1.40E-03	-1.39E-03	-1.35E-03	-1.29E-03	-1.22E-03
Std Dev Biased	3.16E-05	2.03E-05	1.65E-05	1.71E-05	2.00E-05	2.28E-05	2.05E-05
Ps90%/90% (+KTL) Biased	-1.25E-03	-1.32E-03	-1.35E-03	-1.34E-03	-1.29E-03	-1.23E-03	-1.16E-03
Ps90%/90% (-KTL) Biased	-1.43E-03	-1.44E-03	-1.44E-03	-1.44E-03	-1.40E-03	-1.35E-03	-1.27E-03
Un-Biased Statistics							
Average Un-Biased	-1.33E-03	-1.43E-03	-1.42E-03	-1.41E-03	-1.36E-03	-1.32E-03	-1.28E-03
Std Dev Un-Biased	3.05E-05	2.10E-05	2.11E-05	2.15E-05	2.31E-05	2.91E-05	2.69E-05
Ps90%/90% (+KTL) Un-Biased	-1.25E-03	-1.37E-03	-1.36E-03	-1.35E-03	-1.29E-03	-1.24E-03	-1.21E-03
Ps90%/90% (-KTL) Un-Biased	-1.41E-03	-1.49E-03	-1.48E-03	-1.47E-03	-1.42E-03	-1.39E-03	-1.36E-03
Specification MIN	-2.00E-03	-2.00E-03	-2.00E-03	-2.00E-03	-2.00E-03	-2.00E-03	-2.00E-03
Status	PASS	PASS	PASS	PASS	PASS	PASS	PASS

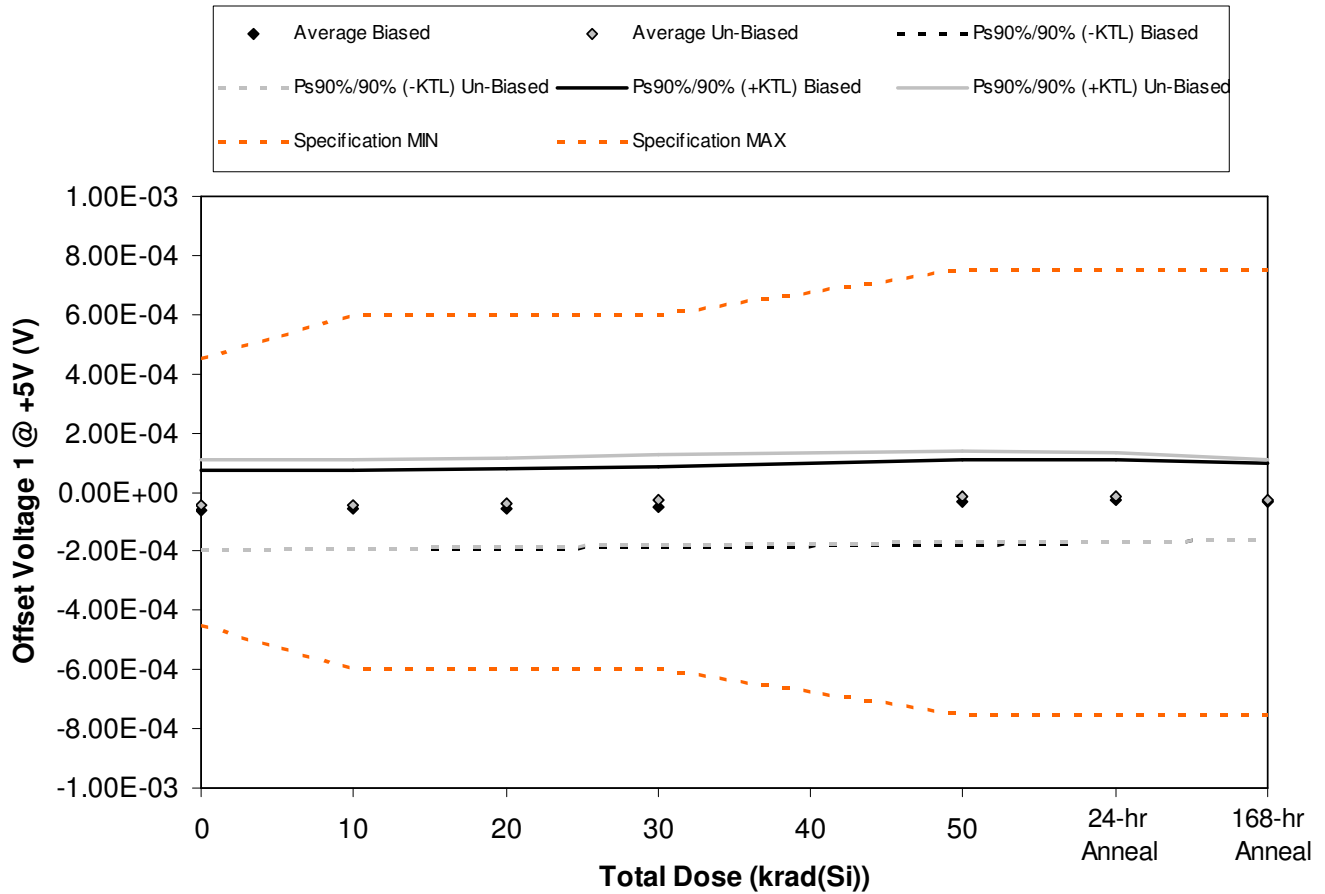

Figure 5.49. Plot of Offset Voltage 1 @ +5V (V) versus total dose. The solid diamonds are the average of the measured data points for the samples irradiated under electrical bias while the shaded diamonds are the average of the measured data points for the samples irradiated with all pins tied to ground. The black lines (solid and/or dashed) are the average of the data points after application of the KTL statistics on the samples irradiated under electrical bias while the gray lines (solid and/or dashed) are the average of the data points after application of the KTL statistics on the samples irradiated in the unbiased condition. The red dotted line(s) are the pre- and/or post-irradiation minimum and/or maximum specification value as defined in the datasheet and/or test plan.



**TID Report
11-572 R1.0**

**Aeroflex RAD
5017 N. 30th Street
Colorado Springs, CO 80919
(719) 531-0800**

Table 5.49. Raw data for Offset Voltage 1 @ +5V (V) versus total dose, including the statistical analysis, specification and the status of the testing (pass/fail).

Offset Voltage 1 @ +5V (V)	Total Dose (krad(Si))					24 hr Anneal	168 hr Anneal
	0	10	20	30	50		
Device	0	10	20	30	50		
	10/20/2011	11/3/2011	11/3/2011	11/3/2011	11/3/2011	11/4/2011	11/11/2011
1831	-8.71E-05	-5.99E-05	-5.80E-05	-5.23E-05	-3.68E-05	-3.05E-05	-4.84E-05
1832	-6.56E-05	-6.73E-05	-6.42E-05	-5.86E-05	-4.61E-05	-4.09E-05	-4.85E-05
1833	1.31E-05	1.67E-05	2.23E-05	2.77E-05	4.53E-05	4.74E-05	4.04E-05
1834	-5.91E-05	-5.84E-05	-5.62E-05	-4.98E-05	-3.53E-05	-2.65E-05	-2.65E-05
1835	-1.20E-04	-1.20E-04	-1.15E-04	-1.09E-04	-1.00E-04	-9.56E-05	-8.81E-05
1836	3.23E-05	3.39E-05	4.36E-05	5.35E-05	6.84E-05	6.48E-05	3.83E-05
1837	-9.17E-05	-8.69E-05	-8.08E-05	-7.52E-05	-6.10E-05	-6.12E-05	-5.22E-05
1838	-1.01E-04	-9.91E-05	-9.23E-05	-8.36E-05	-6.73E-05	-6.77E-05	-8.52E-05
1839	-9.36E-06	-8.03E-06	-8.15E-06	-3.93E-06	6.33E-06	4.63E-06	5.61E-06
1840	-4.98E-05	-4.82E-05	-4.24E-05	-3.37E-05	-2.20E-05	-2.55E-05	-4.81E-05
1851	-2.42E-05	-2.32E-05	-2.42E-05	-2.36E-05	-2.37E-05	-2.45E-05	-2.32E-05
1852	2.71E-06	3.32E-06	2.71E-06	3.31E-06	3.31E-06	2.70E-06	3.92E-06
Biased Statistics							
Average Biased	-6.37E-05	-5.79E-05	-5.42E-05	-4.85E-05	-3.46E-05	-2.92E-05	-3.42E-05
Std Dev Biased	4.91E-05	4.89E-05	4.92E-05	4.91E-05	5.21E-05	5.10E-05	4.72E-05
Ps90%/90% (+KTL) Biased	7.08E-05	7.63E-05	8.06E-05	8.61E-05	1.08E-04	1.11E-04	9.53E-05
Ps90%/90% (-KTL) Biased	-1.98E-04	-1.92E-04	-1.89E-04	-1.83E-04	-1.77E-04	-1.69E-04	-1.64E-04
Un-Biased Statistics							
Average Un-Biased	-4.40E-05	-4.17E-05	-3.60E-05	-2.86E-05	-1.51E-05	-1.70E-05	-2.83E-05
Std Dev Un-Biased	5.62E-05	5.53E-05	5.55E-05	5.61E-05	5.55E-05	5.42E-05	4.95E-05
Ps90%/90% (+KTL) Un-Biased	1.10E-04	1.10E-04	1.16E-04	1.25E-04	1.37E-04	1.32E-04	1.07E-04
Ps90%/90% (-KTL) Un-Biased	-1.98E-04	-1.93E-04	-1.88E-04	-1.82E-04	-1.67E-04	-1.66E-04	-1.64E-04
Specification MIN	-4.50E-04	-6.00E-04	-6.00E-04	-6.00E-04	-7.50E-04	-7.50E-04	-7.50E-04
Status	PASS	PASS	PASS	PASS	PASS	PASS	PASS
Specification MAX	4.50E-04	6.00E-04	6.00E-04	6.00E-04	7.50E-04	7.50E-04	7.50E-04
Status	PASS	PASS	PASS	PASS	PASS	PASS	PASS

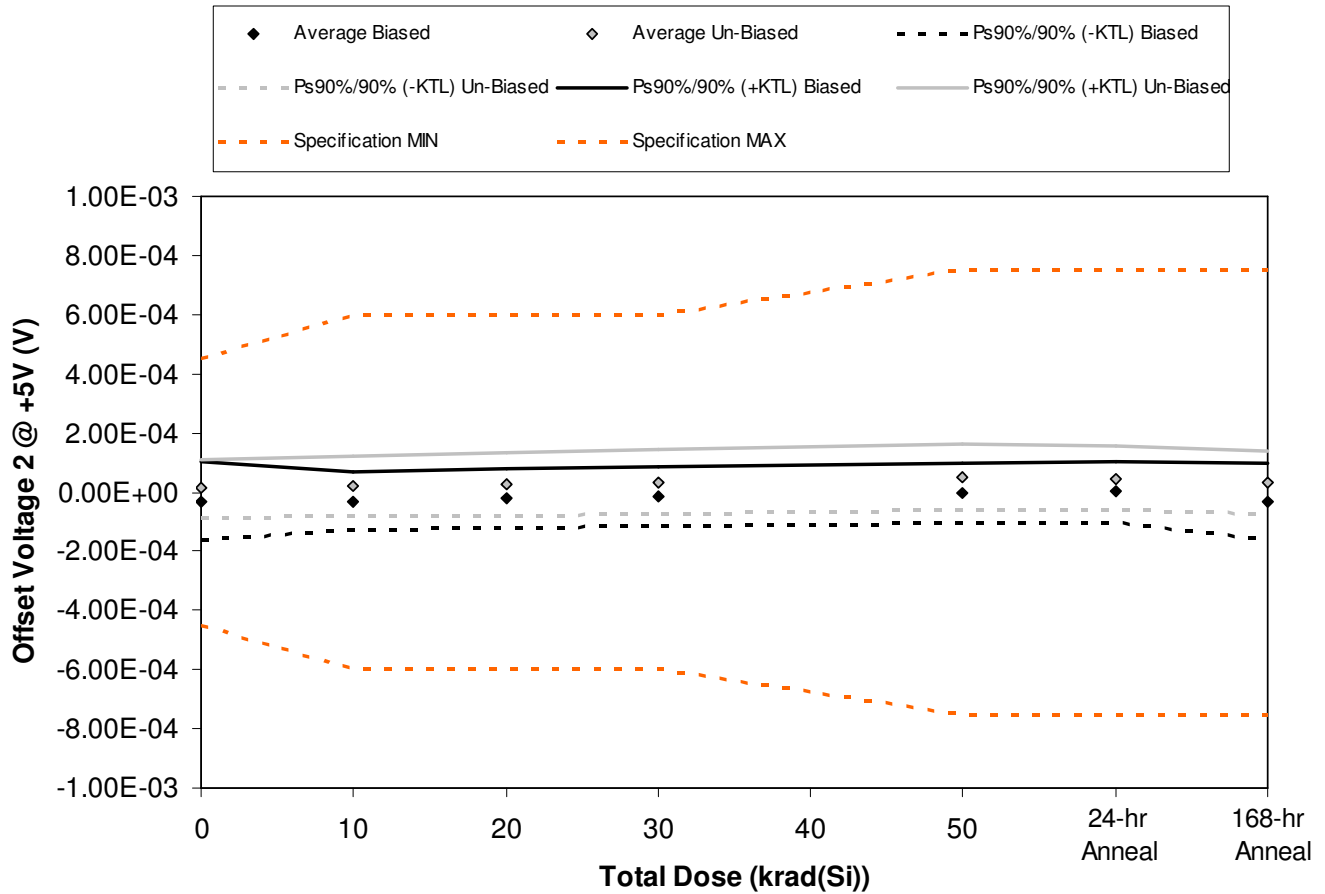

Figure 5.50. Plot of Offset Voltage 2 @ +5V (V) versus total dose. The solid diamonds are the average of the measured data points for the samples irradiated under electrical bias while the shaded diamonds are the average of the measured data points for the samples irradiated with all pins tied to ground. The black lines (solid and/or dashed) are the average of the data points after application of the KTL statistics on the samples irradiated under electrical bias while the gray lines (solid and/or dashed) are the average of the data points after application of the KTL statistics on the samples irradiated in the unbiased condition. The red dotted line(s) are the pre- and/or post-irradiation minimum and/or maximum specification value as defined in the datasheet and/or test plan.



**TID Report
11-572 R1.0**

**Aeroflex RAD
5017 N. 30th Street
Colorado Springs, CO 80919
(719) 531-0800**

Table 5.50. Raw data for Offset Voltage 2 @ +5V (V) versus total dose, including the statistical analysis, specification and the status of the testing (pass/fail).

Offset Voltage 2 @ +5V (V)	Total Dose (krad(Si))					24 hr	168 hr
	0	10	20	30	50	Anneal	Anneal
Device	0	10	20	30	50		
	10/20/2011	11/3/2011	11/3/2011	11/3/2011	11/3/2011	11/4/2011	11/11/2011
1831	-1.13E-04	-8.58E-05	-7.81E-05	-7.31E-05	-6.18E-05	-6.01E-05	-8.03E-05
1832	-4.05E-06	-2.43E-05	-1.46E-05	-8.40E-06	2.23E-06	1.03E-05	-8.63E-05
1833	-3.92E-05	-3.87E-05	-3.37E-05	-2.66E-05	-1.24E-05	-9.73E-06	-1.77E-05
1834	-2.24E-06	-3.20E-06	8.27E-06	1.49E-05	2.69E-05	2.89E-05	5.61E-06
1835	2.59E-06	4.04E-06	1.04E-05	1.71E-05	2.92E-05	3.30E-05	1.32E-05
1836	-4.49E-05	-3.98E-05	-3.68E-05	-2.89E-05	-1.49E-05	-1.63E-05	-2.60E-05
1837	4.07E-05	4.39E-05	5.10E-05	5.96E-05	8.06E-05	7.63E-05	7.56E-05
1838	3.64E-05	3.87E-05	4.52E-05	5.12E-05	7.02E-05	6.61E-05	4.97E-05
1839	2.76E-05	4.46E-05	5.79E-05	6.74E-05	8.37E-05	7.65E-05	4.90E-05
1840	5.49E-06	8.99E-06	1.48E-05	2.09E-05	3.43E-05	3.06E-05	2.14E-05
1851	3.80E-06	4.52E-06	4.76E-06	3.92E-06	4.40E-06	4.39E-06	4.16E-06
1852	-4.45E-05	-4.49E-05	-4.45E-05	-4.51E-05	-4.50E-05	-4.39E-05	-4.41E-05
Biased Statistics							
Average Biased	-3.11E-05	-2.96E-05	-2.15E-05	-1.52E-05	-3.18E-06	4.82E-07	-3.31E-05
Std Dev Biased	4.86E-05	3.57E-05	3.64E-05	3.70E-05	3.71E-05	3.79E-05	4.73E-05
Ps90%/90% (+KTL) Biased	1.02E-04	6.83E-05	7.83E-05	8.62E-05	9.84E-05	1.04E-04	9.65E-05
Ps90%/90% (-KTL) Biased	-1.64E-04	-1.27E-04	-1.21E-04	-1.17E-04	-1.05E-04	-1.03E-04	-1.63E-04
Un-Biased Statistics							
Average Un-Biased	1.31E-05	1.93E-05	2.64E-05	3.41E-05	5.08E-05	4.66E-05	3.39E-05
Std Dev Un-Biased	3.51E-05	3.61E-05	3.90E-05	3.94E-05	4.16E-05	3.99E-05	3.86E-05
Ps90%/90% (+KTL) Un-Biased	1.09E-04	1.18E-04	1.33E-04	1.42E-04	1.65E-04	1.56E-04	1.40E-04
Ps90%/90% (-KTL) Un-Biased	-8.32E-05	-7.98E-05	-8.04E-05	-7.39E-05	-6.34E-05	-6.27E-05	-7.19E-05
Specification MIN	-4.50E-04	-6.00E-04	-6.00E-04	-6.00E-04	-7.50E-04	-7.50E-04	-7.50E-04
Status	PASS	PASS	PASS	PASS	PASS	PASS	PASS
Specification MAX	4.50E-04	6.00E-04	6.00E-04	6.00E-04	7.50E-04	7.50E-04	7.50E-04
Status	PASS	PASS	PASS	PASS	PASS	PASS	PASS

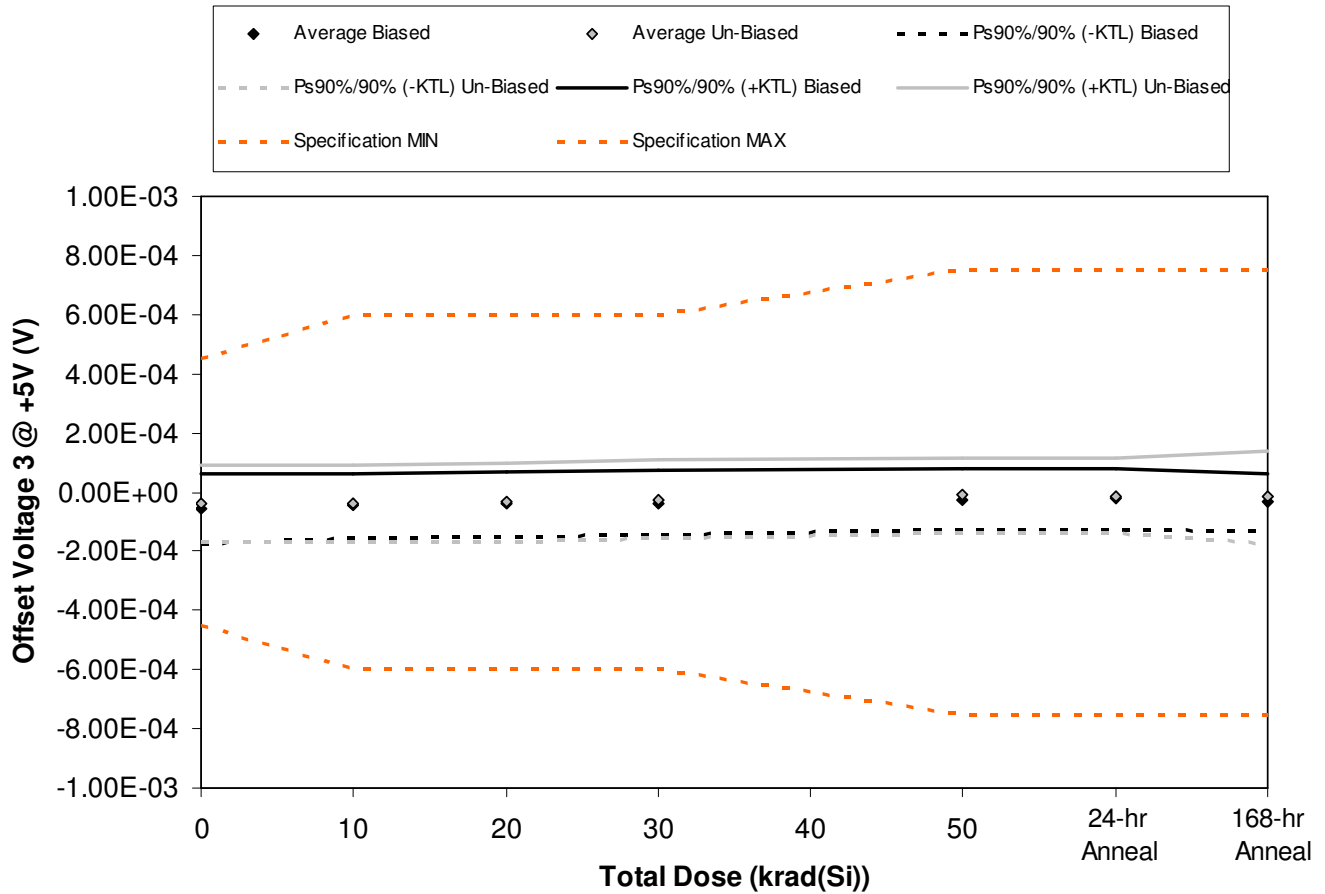

Figure 5.51. Plot of Offset Voltage 3 @ +5V (V) versus total dose. The solid diamonds are the average of the measured data points for the samples irradiated under electrical bias while the shaded diamonds are the average of the measured data points for the samples irradiated with all pins tied to ground. The black lines (solid and/or dashed) are the average of the data points after application of the KTL statistics on the samples irradiated under electrical bias while the gray lines (solid and/or dashed) are the average of the data points after application of the KTL statistics on the samples irradiated in the unbiased condition. The red dotted line(s) are the pre- and/or post-irradiation minimum and/or maximum specification value as defined in the datasheet and/or test plan.



**TID Report
11-572 R1.0**

**Aeroflex RAD
5017 N. 30th Street
Colorado Springs, CO 80919
(719) 531-0800**

Table 5.51. Raw data for Offset Voltage 3 @ +5V (V) versus total dose, including the statistical analysis, specification and the status of the testing (pass/fail).

Offset Voltage 3 @ +5V (V)	Total Dose (krad(Si))					24 hr	168 hr
	0	10	20	30	50	Anneal	Anneal
Device	10/20/2011	11/3/2011	11/3/2011	11/3/2011	11/3/2011	11/4/2011	11/11/2011
1831	-1.01E-04	-6.85E-05	-6.16E-05	-5.73E-05	-4.62E-05	-4.61E-05	-6.13E-05
1832	-7.73E-05	-7.76E-05	-7.31E-05	-7.07E-05	-5.99E-05	-5.87E-05	-6.14E-05
1833	-8.12E-05	-8.00E-05	-7.29E-05	-6.55E-05	-4.91E-05	-4.85E-05	-5.84E-05
1834	-9.48E-06	-4.29E-06	1.50E-06	6.94E-06	1.78E-05	2.03E-05	6.60E-07
1835	-8.39E-06	-2.60E-06	1.26E-06	7.54E-06	1.70E-05	1.68E-05	9.59E-06
1836	-4.58E-05	-4.16E-05	-3.69E-05	-3.02E-05	-1.82E-05	-1.96E-05	-1.96E-05
1837	-1.10E-04	-1.08E-04	-1.04E-04	-9.64E-05	-7.93E-05	-8.11E-05	-1.01E-04
1838	-1.93E-05	-1.67E-05	-9.36E-06	5.38E-07	1.77E-05	1.69E-05	2.20E-05
1839	-4.99E-05	-4.85E-05	-4.21E-05	-3.33E-05	-1.50E-05	-1.65E-05	-3.12E-05
1840	1.95E-05	2.21E-05	2.76E-05	3.48E-05	4.28E-05	4.02E-05	4.80E-05
1851	-6.33E-05	-6.32E-05	-6.36E-05	-6.34E-05	-6.43E-05	-6.29E-05	-6.33E-05
1852	-3.50E-05	-3.57E-05	-3.57E-05	-3.60E-05	-3.65E-05	-3.48E-05	-3.56E-05
Biased Statistics							
Average Biased	-5.55E-05	-4.66E-05	-4.10E-05	-3.58E-05	-2.41E-05	-2.32E-05	-3.42E-05
Std Dev Biased	4.35E-05	3.96E-05	3.89E-05	3.96E-05	3.82E-05	3.85E-05	3.60E-05
Ps90%/90% (+KTL) Biased	6.37E-05	6.21E-05	6.58E-05	7.27E-05	8.07E-05	8.23E-05	6.46E-05
Ps90%/90% (-KTL) Biased	-1.75E-04	-1.55E-04	-1.48E-04	-1.44E-04	-1.29E-04	-1.29E-04	-1.33E-04
Un-Biased Statistics							
Average Un-Biased	-4.11E-05	-3.85E-05	-3.30E-05	-2.49E-05	-1.04E-05	-1.20E-05	-1.64E-05
Std Dev Un-Biased	4.74E-05	4.77E-05	4.86E-05	4.85E-05	4.59E-05	4.59E-05	5.72E-05
Ps90%/90% (+KTL) Un-Biased	8.89E-05	9.22E-05	1.00E-04	1.08E-04	1.16E-04	1.14E-04	1.40E-04
Ps90%/90% (-KTL) Un-Biased	-1.71E-04	-1.69E-04	-1.66E-04	-1.58E-04	-1.36E-04	-1.38E-04	-1.73E-04
Specification MIN	-4.50E-04	-6.00E-04	-6.00E-04	-6.00E-04	-7.50E-04	-7.50E-04	-7.50E-04
Status	PASS	PASS	PASS	PASS	PASS	PASS	PASS
Specification MAX	4.50E-04	6.00E-04	6.00E-04	6.00E-04	7.50E-04	7.50E-04	7.50E-04
Status	PASS	PASS	PASS	PASS	PASS	PASS	PASS

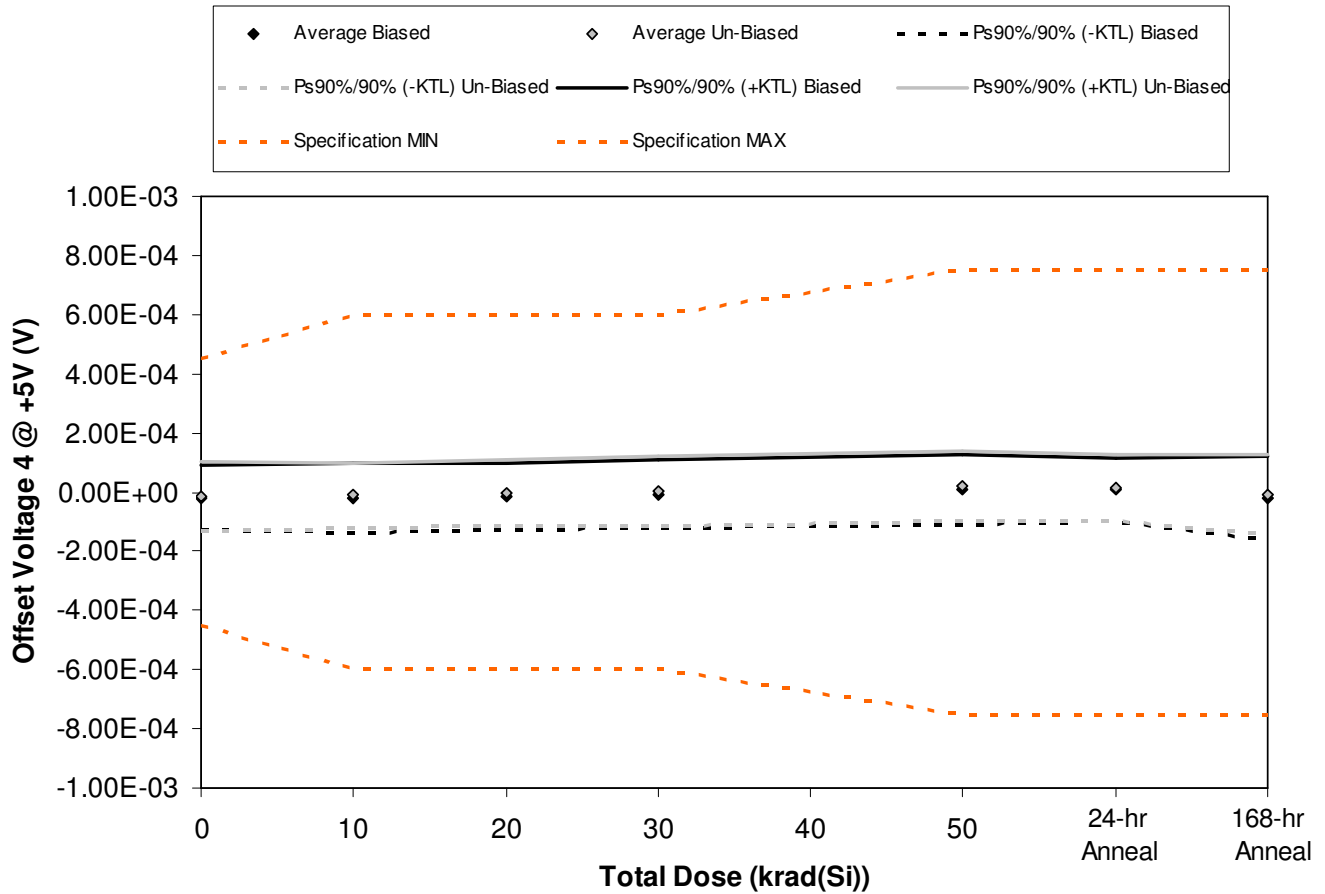

Figure 5.52. Plot of Offset Voltage 4 @ +5V (V) versus total dose. The solid diamonds are the average of the measured data points for the samples irradiated under electrical bias while the shaded diamonds are the average of the measured data points for the samples irradiated with all pins tied to ground. The black lines (solid and/or dashed) are the average of the data points after application of the KTL statistics on the samples irradiated under electrical bias while the gray lines (solid and/or dashed) are the average of the data points after application of the KTL statistics on the samples irradiated in the unbiased condition. The red dotted line(s) are the pre- and/or post-irradiation minimum and/or maximum specification value as defined in the datasheet and/or test plan.



**TID Report
11-572 R1.0**

**Aeroflex RAD
5017 N. 30th Street
Colorado Springs, CO 80919
(719) 531-0800**

Table 5.52. Raw data for Offset Voltage 4 @ +5V (V) versus total dose, including the statistical analysis, specification and the status of the testing (pass/fail).

Offset Voltage 4 @ +5V (V)	Total Dose (krad(Si))					24 hr	168 hr
	0	10	20	30	50	Anneal	Anneal
Device	0	10	20	30	50		
	10/20/2011	11/3/2011	11/3/2011	11/3/2011	11/3/2011	11/4/2011	11/11/2011
1831	-5.09E-05	-3.75E-05	-2.70E-05	-1.90E-05	-1.52E-06	1.68E-07	-2.10E-05
1832	4.77E-05	5.29E-05	5.58E-05	6.43E-05	8.03E-05	7.63E-05	6.60E-05
1833	-1.15E-05	-2.32E-05	-1.37E-05	-6.71E-06	8.14E-06	6.33E-06	-5.77E-05
1834	-3.92E-05	-4.08E-05	-3.50E-05	-2.69E-05	-1.79E-05	-1.43E-05	-1.54E-05
1835	-3.58E-05	-5.91E-05	-5.05E-05	-4.15E-05	-2.53E-05	-2.48E-05	-6.26E-05
1836	-5.91E-05	-5.54E-05	-4.90E-05	-4.00E-05	-2.01E-05	-2.60E-05	-4.67E-05
1837	9.47E-06	1.39E-05	1.90E-05	2.78E-05	4.93E-05	4.11E-05	6.94E-06
1838	-9.96E-06	-4.29E-06	4.89E-06	1.26E-05	2.84E-05	2.43E-05	-1.52E-05
1839	4.22E-05	3.72E-05	4.69E-05	5.46E-05	7.27E-05	6.50E-05	6.40E-05
1840	-5.37E-05	-4.86E-05	-4.41E-05	-4.00E-05	-2.43E-05	-2.77E-05	-6.18E-05
1851	5.02E-05	5.12E-05	5.15E-05	5.10E-05	5.10E-05	5.00E-05	5.15E-05
1852	8.07E-05	8.06E-05	8.07E-05	8.00E-05	8.02E-05	7.94E-05	8.05E-05
Biased Statistics							
Average Biased	-1.79E-05	-2.15E-05	-1.41E-05	-5.96E-06	8.75E-06	8.74E-06	-1.81E-05
Std Dev Biased	3.94E-05	4.35E-05	4.13E-05	4.12E-05	4.21E-05	3.97E-05	5.15E-05
Ps90%/90% (+KTL) Biased	9.01E-05	9.79E-05	9.91E-05	1.07E-04	1.24E-04	1.18E-04	1.23E-04
Ps90%/90% (-KTL) Biased	-1.26E-04	-1.41E-04	-1.27E-04	-1.19E-04	-1.07E-04	-1.00E-04	-1.59E-04
Un-Biased Statistics							
Average Un-Biased	-1.42E-05	-1.14E-05	-4.46E-06	3.00E-06	2.12E-05	1.53E-05	-1.05E-05
Std Dev Un-Biased	4.28E-05	3.99E-05	4.13E-05	4.21E-05	4.27E-05	4.12E-05	4.95E-05
Ps90%/90% (+KTL) Un-Biased	1.03E-04	9.80E-05	1.09E-04	1.18E-04	1.38E-04	1.28E-04	1.25E-04
Ps90%/90% (-KTL) Un-Biased	-1.32E-04	-1.21E-04	-1.18E-04	-1.12E-04	-9.58E-05	-9.75E-05	-1.46E-04
Specification MIN	-4.50E-04	-6.00E-04	-6.00E-04	-6.00E-04	-7.50E-04	-7.50E-04	-7.50E-04
Status	PASS	PASS	PASS	PASS	PASS	PASS	PASS
Specification MAX	4.50E-04	6.00E-04	6.00E-04	6.00E-04	7.50E-04	7.50E-04	7.50E-04
Status	PASS	PASS	PASS	PASS	PASS	PASS	PASS

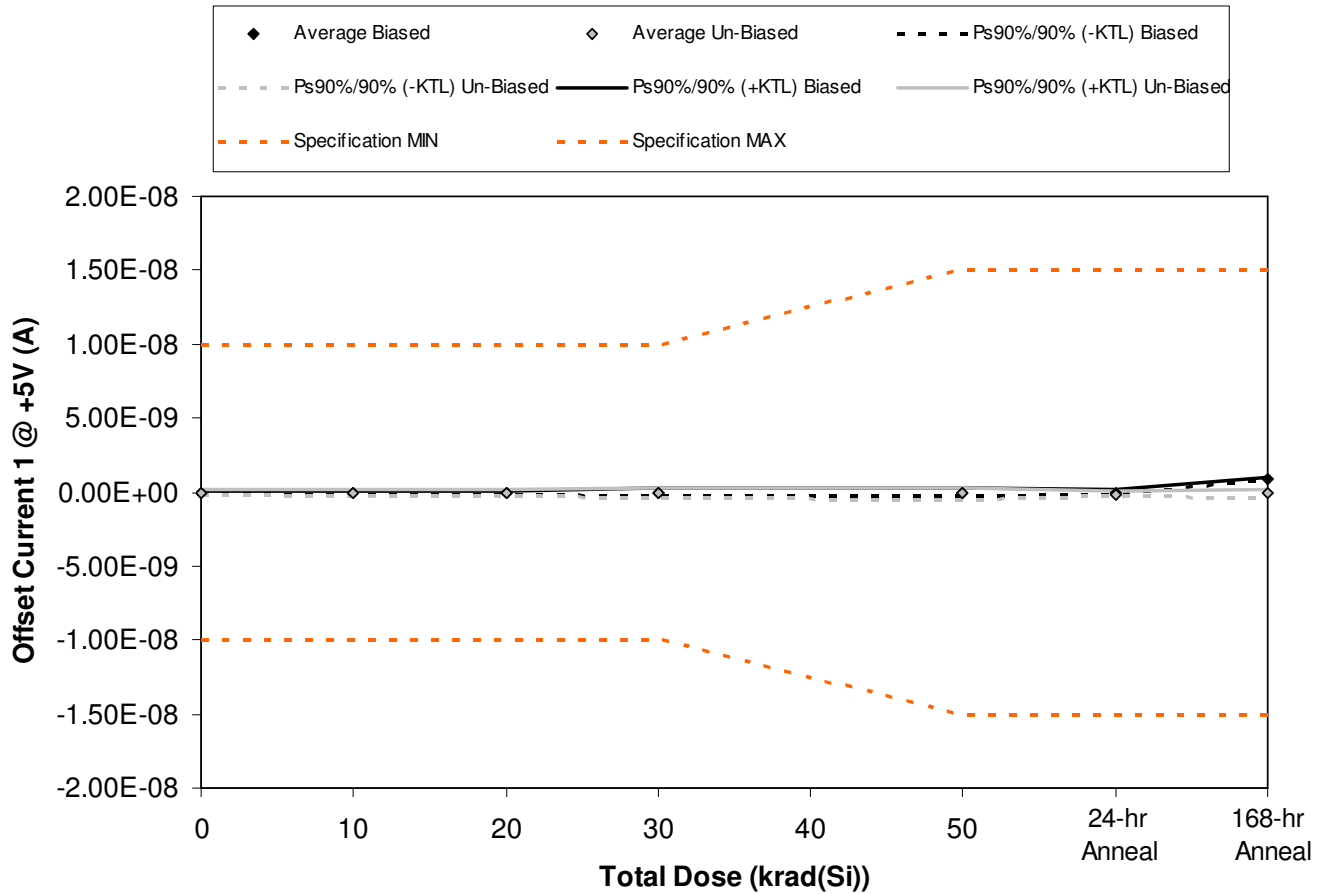

Figure 5.53. Plot of Offset Current 1 @ +5V (A) versus total dose. The solid diamonds are the average of the measured data points for the samples irradiated under electrical bias while the shaded diamonds are the average of the measured data points for the samples irradiated with all pins tied to ground. The black lines (solid and/or dashed) are the average of the data points after application of the KTL statistics on the samples irradiated under electrical bias while the gray lines (solid and/or dashed) are the average of the data points after application of the KTL statistics on the samples irradiated in the unbiased condition. The red dotted line(s) are the pre- and/or post-irradiation minimum and/or maximum specification value as defined in the datasheet and/or test plan.



**TID Report
11-572 R1.0**

**Aeroflex RAD
5017 N. 30th Street
Colorado Springs, CO 80919
(719) 531-0800**

Table 5.53. Raw data for Offset Current 1 @ +5V (A) versus total dose, including the statistical analysis, specification and the status of the testing (pass/fail).

Offset Current 1 @ +5V (A)	Total Dose (krad(Si))					24 hr Anneal	168 hr Anneal
	0	10	20	30	50		
Device	10/20/2011	11/3/2011	11/3/2011	11/3/2011	11/3/2011	11/4/2011	11/11/2011
1831	-2.80E-11	-6.10E-11	3.00E-12	1.00E-10	4.50E-11	-3.30E-11	9.11E-10
1832	-7.00E-11	-8.20E-11	-7.80E-11	-2.07E-10	-1.57E-10	-8.50E-11	1.00E-09
1833	-2.00E-12	-5.10E-11	-5.70E-11	-3.50E-11	-1.74E-10	-5.00E-11	9.36E-10
1834	1.40E-11	-1.60E-11	-5.80E-11	1.70E-11	7.00E-12	1.90E-11	9.38E-10
1835	-1.20E-11	1.70E-11	-6.80E-11	2.50E-11	5.20E-11	5.40E-11	9.15E-10
1836	-9.10E-11	-1.10E-10	-1.65E-10	-2.38E-10	-1.50E-10	-9.70E-11	-1.13E-10
1837	1.90E-11	3.00E-12	-2.90E-11	-3.60E-11	-1.97E-10	-1.67E-10	-1.47E-10
1838	-3.20E-11	1.70E-11	-4.40E-11	-1.21E-10	-7.60E-11	-1.85E-10	-2.00E-12
1839	4.00E-12	-6.30E-11	-7.10E-11	-4.40E-11	-1.50E-10	-1.60E-10	-1.89E-10
1840	6.80E-11	1.16E-10	1.11E-10	1.48E-10	1.74E-10	-4.00E-11	5.40E-11
1851	-1.00E-12	4.30E-11	4.20E-11	4.20E-11	2.10E-11	4.90E-11	4.70E-11
1852	-3.00E-12	-2.10E-11	-1.40E-11	-2.10E-11	-5.00E-12	0.00E+00	-2.30E-11
Biased Statistics							
Average Biased	-1.96E-11	-3.86E-11	-5.16E-11	-2.00E-11	-4.54E-11	-1.90E-11	9.41E-10
Std Dev Biased	3.20E-11	3.92E-11	3.17E-11	1.15E-10	1.11E-10	5.54E-11	3.69E-11
Ps90%/90% (+KTL) Biased	6.83E-11	6.88E-11	3.53E-11	2.96E-10	2.59E-10	1.33E-10	1.04E-09
Ps90%/90% (-KTL) Biased	-1.07E-10	-1.46E-10	-1.38E-10	-3.36E-10	-3.50E-10	-1.71E-10	8.39E-10
Un-Biased Statistics							
Average Un-Biased	-6.40E-12	-7.40E-12	-3.96E-11	-5.82E-11	-7.98E-11	-1.30E-10	-7.94E-11
Std Dev Un-Biased	5.94E-11	8.59E-11	9.94E-11	1.41E-10	1.48E-10	6.02E-11	1.02E-10
Ps90%/90% (+KTL) Un-Biased	1.56E-10	2.28E-10	2.33E-10	3.28E-10	3.27E-10	3.52E-11	2.00E-10
Ps90%/90% (-KTL) Un-Biased	-1.69E-10	-2.43E-10	-3.12E-10	-4.45E-10	-4.87E-10	-2.95E-10	-3.59E-10
Specification MIN	-1.00E-08	-1.00E-08	-1.00E-08	-1.00E-08	-1.50E-08	-1.50E-08	-1.50E-08
Status	PASS	PASS	PASS	PASS	PASS	PASS	PASS
Specification MAX	1.00E-08	1.00E-08	1.00E-08	1.00E-08	1.50E-08	1.50E-08	1.50E-08
Status	PASS	PASS	PASS	PASS	PASS	PASS	PASS

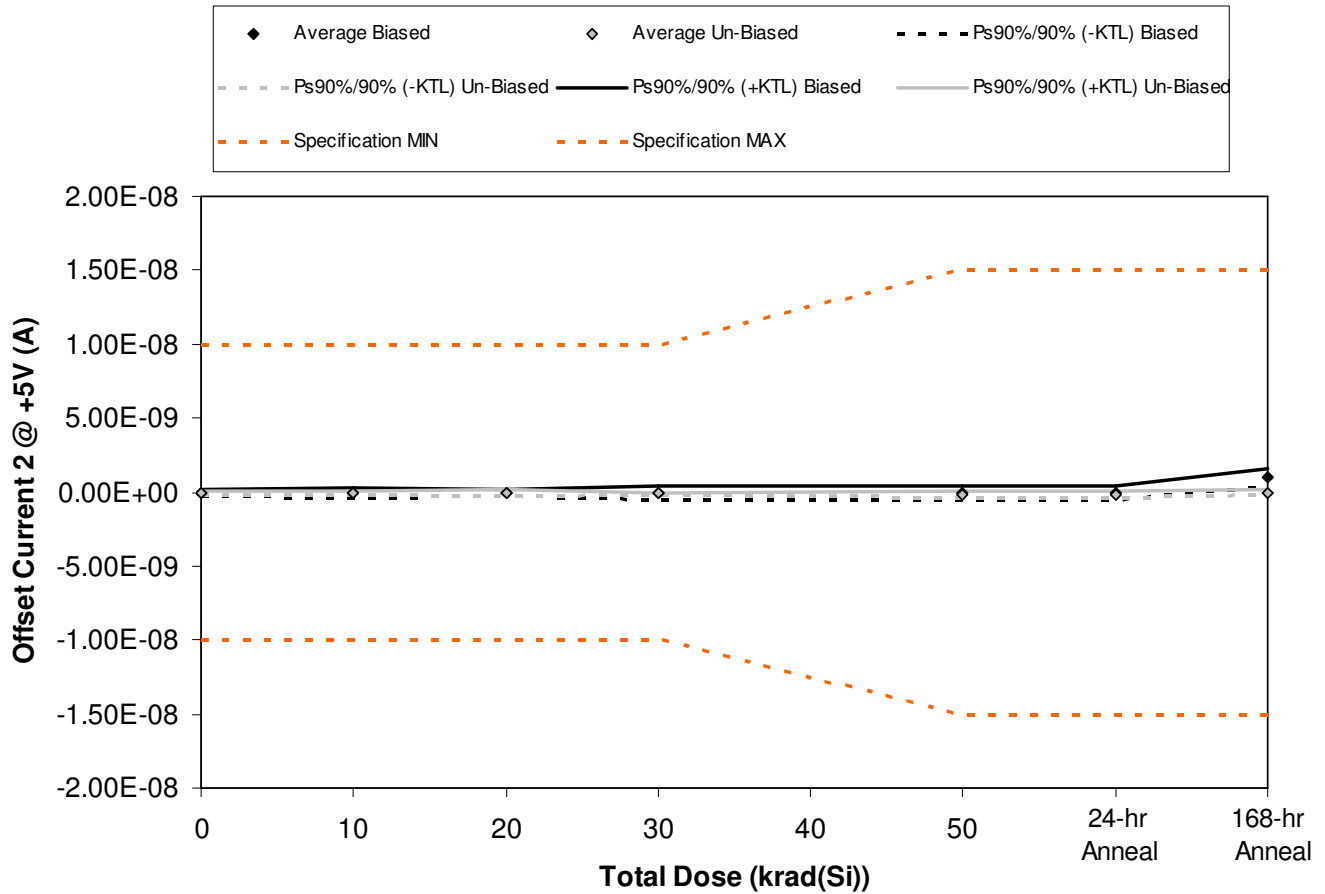

Figure 5.54. Plot of Offset Current 2 @ +5V (A) versus total dose. The solid diamonds are the average of the measured data points for the samples irradiated under electrical bias while the shaded diamonds are the average of the measured data points for the samples irradiated with all pins tied to ground. The black lines (solid and/or dashed) are the average of the data points after application of the KTL statistics on the samples irradiated under electrical bias while the gray lines (solid and/or dashed) are the average of the data points after application of the KTL statistics on the samples irradiated in the unbiased condition. The red dotted line(s) are the pre- and/or post-irradiation minimum and/or maximum specification value as defined in the datasheet and/or test plan.



**TID Report
11-572 R1.0**

**Aeroflex RAD
5017 N. 30th Street
Colorado Springs, CO 80919
(719) 531-0800**

Table 5.54. Raw data for Offset Current 2 @ +5V (A) versus total dose, including the statistical analysis, specification and the status of the testing (pass/fail).

Offset Current 2 @ +5V (A)	Total Dose (krad(Si))					24 hr	168 hr
	0	10	20	30	50	Anneal	Anneal
Device	10/20/2011	11/3/2011	11/3/2011	11/3/2011	11/3/2011	11/4/2011	11/11/2011
1831	4.70E-11	5.20E-11	9.00E-12	9.40E-11	1.09E-10	1.54E-10	1.19E-09
1832	-1.76E-10	-2.55E-10	-2.08E-10	-2.79E-10	-2.48E-10	-2.25E-10	8.56E-10
1833	-5.80E-11	-7.60E-11	-1.07E-10	-1.36E-10	-1.56E-10	-1.64E-10	9.65E-10
1834	-3.00E-12	-4.00E-12	-3.00E-12	-4.00E-12	1.15E-10	1.11E-10	1.31E-09
1835	-3.70E-11	-5.90E-11	1.60E-11	6.10E-11	-5.10E-11	-5.00E-11	7.86E-10
1836	-4.40E-11	-6.70E-11	2.70E-11	-4.50E-11	-1.12E-10	-1.07E-10	-3.60E-11
1837	-2.40E-11	-5.70E-11	-2.70E-11	-7.30E-11	-2.06E-10	-2.02E-10	-9.40E-11
1838	-8.10E-11	-8.30E-11	-1.07E-10	-1.11E-10	-1.97E-10	-2.31E-10	-2.50E-11
1839	-1.05E-10	-1.17E-10	-1.50E-10	-1.04E-10	-2.61E-10	-1.86E-10	7.20E-11
1840	1.10E-11	1.10E-11	-4.10E-11	-6.90E-11	-1.11E-10	-4.20E-11	1.50E-11
1851	-1.77E-10	-1.81E-10	-1.64E-10	-1.55E-10	-1.37E-10	-1.54E-10	-1.72E-10
1852	-2.24E-10	-2.21E-10	-2.21E-10	-2.07E-10	-2.25E-10	-2.20E-10	-2.14E-10
Biased Statistics							
Average Biased	-4.54E-11	-6.84E-11	-5.86E-11	-5.28E-11	-4.62E-11	-3.48E-11	1.02E-09
Std Dev Biased	8.31E-11	1.16E-10	9.73E-11	1.54E-10	1.60E-10	1.66E-10	2.22E-10
Ps90%/90% (+KTL) Biased	1.82E-10	2.49E-10	2.08E-10	3.70E-10	3.94E-10	4.20E-10	1.63E-09
Ps90%/90% (-KTL) Biased	-2.73E-10	-3.86E-10	-3.25E-10	-4.75E-10	-4.86E-10	-4.90E-10	4.12E-10
Un-Biased Statistics							
Average Un-Biased	-4.86E-11	-6.26E-11	-5.96E-11	-8.04E-11	-1.77E-10	-1.54E-10	-1.36E-11
Std Dev Un-Biased	4.59E-11	4.70E-11	6.95E-11	2.71E-11	6.50E-11	7.75E-11	6.17E-11
Ps90%/90% (+KTL) Un-Biased	7.71E-11	6.63E-11	1.31E-10	-6.17E-12	7.10E-13	5.88E-11	1.56E-10
Ps90%/90% (-KTL) Un-Biased	-1.74E-10	-1.92E-10	-2.50E-10	-1.55E-10	-3.56E-10	-3.66E-10	-1.83E-10
Specification MIN	-1.00E-08	-1.00E-08	-1.00E-08	-1.00E-08	-1.50E-08	-1.50E-08	-1.50E-08
Status	PASS	PASS	PASS	PASS	PASS	PASS	PASS
Specification MAX	1.00E-08	1.00E-08	1.00E-08	1.00E-08	1.50E-08	1.50E-08	1.50E-08
Status	PASS	PASS	PASS	PASS	PASS	PASS	PASS

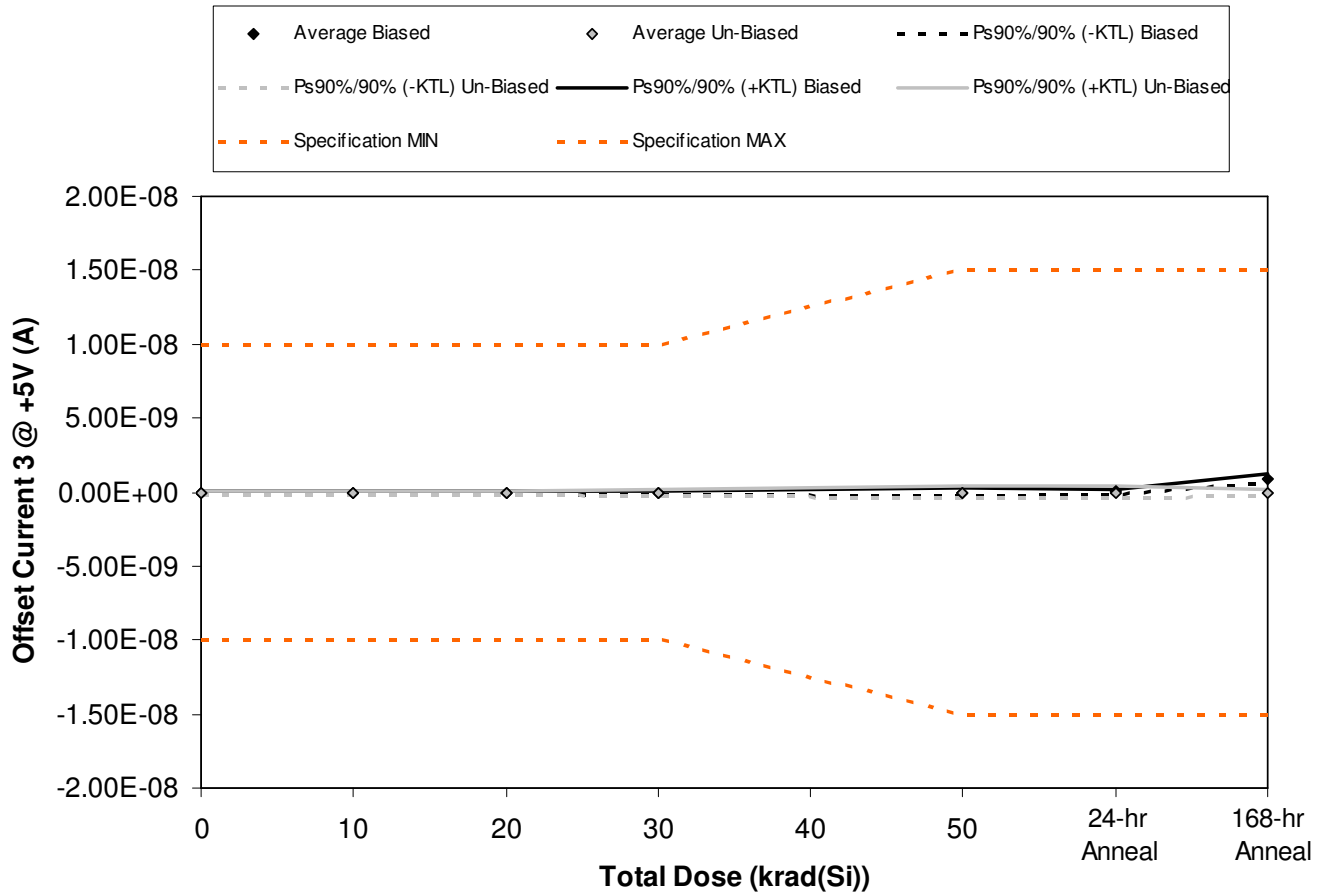

Figure 5.55. Plot of Offset Current 3 @ +5V (A) versus total dose. The solid diamonds are the average of the measured data points for the samples irradiated under electrical bias while the shaded diamonds are the average of the measured data points for the samples irradiated with all pins tied to ground. The black lines (solid and/or dashed) are the average of the data points after application of the KTL statistics on the samples irradiated under electrical bias while the gray lines (solid and/or dashed) are the average of the data points after application of the KTL statistics on the samples irradiated in the unbiased condition. The red dotted line(s) are the pre- and/or post-irradiation minimum and/or maximum specification value as defined in the datasheet and/or test plan.



**TID Report
11-572 R1.0**

**Aeroflex RAD
5017 N. 30th Street
Colorado Springs, CO 80919
(719) 531-0800**

Table 5.55. Raw data for Offset Current 3 @ +5V (A) versus total dose, including the statistical analysis, specification and the status of the testing (pass/fail).

Offset Current 3 @ +5V (A)	Total Dose (krad(Si))					24 hr	168 hr
	0	10	20	30	50	Anneal	Anneal
Device	10/20/2011	11/3/2011	11/3/2011	11/3/2011	11/3/2011	11/4/2011	11/11/2011
1831	1.10E-11	-1.00E-11	-3.00E-11	-5.60E-11	5.00E-12	3.00E-11	1.03E-09
1832	-4.00E-12	-7.90E-11	-7.00E-11	-5.30E-11	-1.10E-10	-5.00E-11	8.49E-10
1833	-1.20E-11	-9.90E-11	-1.21E-10	-1.35E-10	-1.29E-10	-6.90E-11	7.54E-10
1834	-3.20E-11	-4.60E-11	-1.30E-11	-9.00E-12	8.40E-11	7.50E-11	1.03E-09
1835	-9.90E-11	-9.80E-11	-7.50E-11	-1.39E-10	6.00E-11	5.80E-11	9.62E-10
1836	1.70E-11	-2.00E-12	-3.40E-11	1.20E-11	4.90E-11	1.11E-10	3.90E-11
1837	-5.80E-11	-1.38E-10	-1.14E-10	3.00E-11	-3.10E-11	-1.25E-10	2.60E-11
1838	-9.60E-11	-1.18E-10	-1.05E-10	-1.79E-10	-2.77E-10	-2.10E-10	-1.60E-10
1839	-6.00E-11	-2.70E-11	-3.20E-11	9.00E-12	-1.20E-11	-3.70E-11	-1.70E-11
1840	-8.40E-11	-8.20E-11	-3.00E-12	-1.00E-11	1.45E-10	1.80E-10	6.00E-12
1851	-1.76E-10	-1.65E-10	-1.54E-10	-1.42E-10	-1.78E-10	-1.26E-10	-1.80E-10
1852	1.15E-10	1.03E-10	1.04E-10	1.13E-10	9.30E-11	1.32E-10	7.00E-11
Biased Statistics							
Average Biased	-2.72E-11	-6.64E-11	-6.18E-11	-7.84E-11	-1.80E-11	8.80E-12	9.24E-10
Std Dev Biased	4.30E-11	3.81E-11	4.22E-11	5.67E-11	9.72E-11	6.47E-11	1.20E-10
Ps90%/90% (+KTL) Biased	9.08E-11	3.82E-11	5.40E-11	7.69E-11	2.49E-10	1.86E-10	1.25E-09
Ps90%/90% (-KTL) Biased	-1.45E-10	-1.71E-10	-1.78E-10	-2.34E-10	-2.85E-10	-1.69E-10	5.95E-10
Un-Biased Statistics							
Average Un-Biased	-5.62E-11	-7.34E-11	-5.76E-11	-2.76E-11	-2.52E-11	-1.62E-11	-2.12E-11
Std Dev Un-Biased	4.40E-11	5.81E-11	4.90E-11	8.58E-11	1.57E-10	1.62E-10	8.04E-11
Ps90%/90% (+KTL) Un-Biased	6.44E-11	8.58E-11	7.69E-11	2.08E-10	4.04E-10	4.27E-10	1.99E-10
Ps90%/90% (-KTL) Un-Biased	-1.77E-10	-2.33E-10	-1.92E-10	-2.63E-10	-4.55E-10	-4.59E-10	-2.42E-10
Specification MIN	-1.00E-08	-1.00E-08	-1.00E-08	-1.00E-08	-1.50E-08	-1.50E-08	-1.50E-08
Status	PASS	PASS	PASS	PASS	PASS	PASS	PASS
Specification MAX	1.00E-08	1.00E-08	1.00E-08	1.00E-08	1.50E-08	1.50E-08	1.50E-08
Status	PASS	PASS	PASS	PASS	PASS	PASS	PASS

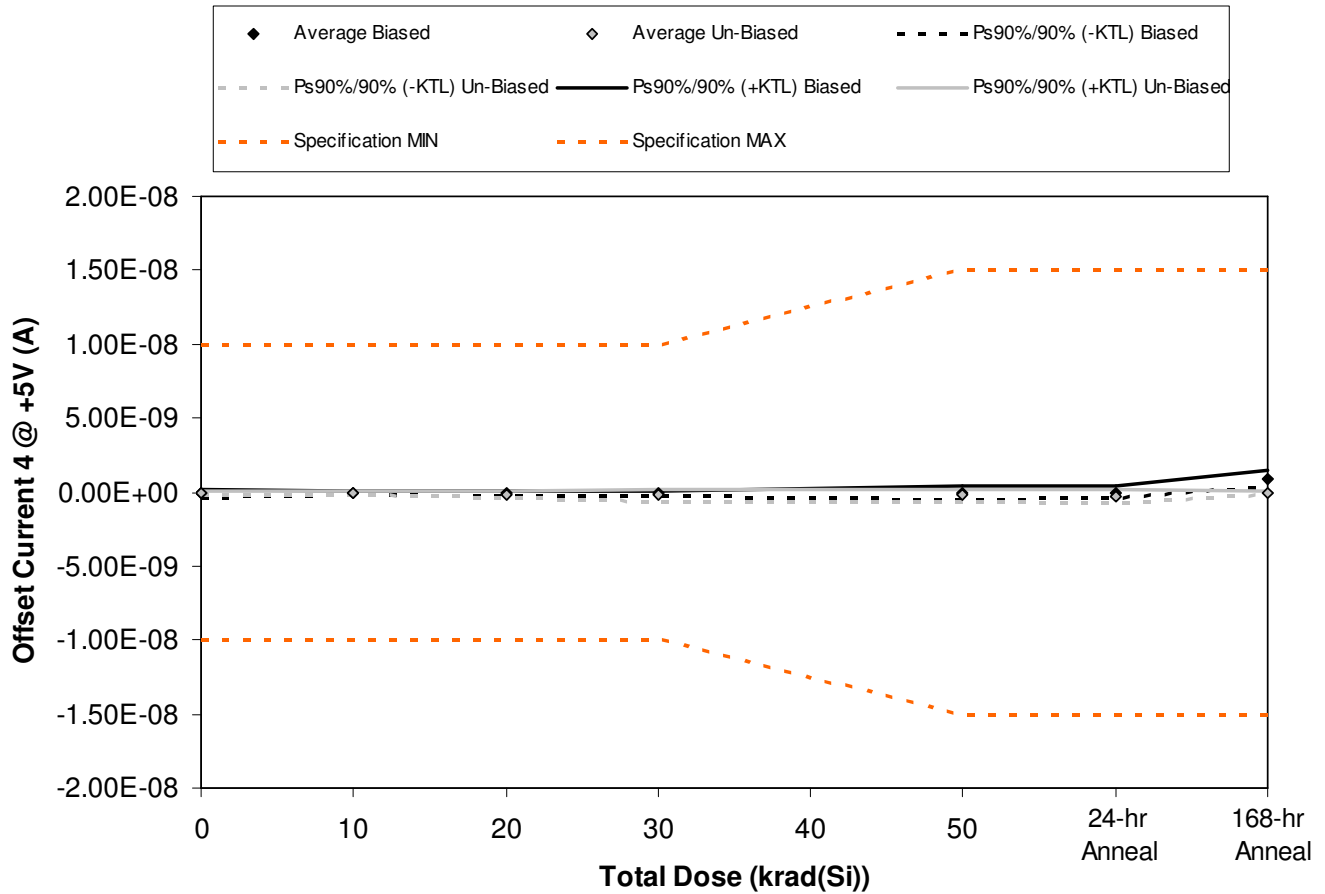

Figure 5.56. Plot of Offset Current 4 @ +5V (A) versus total dose. The solid diamonds are the average of the measured data points for the samples irradiated under electrical bias while the shaded diamonds are the average of the measured data points for the samples irradiated with all pins tied to ground. The black lines (solid and/or dashed) are the average of the data points after application of the KTL statistics on the samples irradiated under electrical bias while the gray lines (solid and/or dashed) are the average of the data points after application of the KTL statistics on the samples irradiated in the unbiased condition. The red dotted line(s) are the pre- and/or post-irradiation minimum and/or maximum specification value as defined in the datasheet and/or test plan.



**TID Report
11-572 R1.0**

**Aeroflex RAD
5017 N. 30th Street
Colorado Springs, CO 80919
(719) 531-0800**

Table 5.56. Raw data for Offset Current 4 @ +5V (A) versus total dose, including the statistical analysis, specification and the status of the testing (pass/fail).

Offset Current 4 @ +5V (A)	Total Dose (krad(Si))					24 hr	168 hr
	0	10	20	30	50	Anneal	Anneal
Device	0	10	20	30	50		
	10/20/2011	11/3/2011	11/3/2011	11/3/2011	11/3/2011	11/4/2011	11/11/2011
1831	-1.03E-10	-6.90E-11	-1.51E-10	-1.75E-10	-1.73E-10	-2.06E-10	8.60E-10
1832	-2.60E-11	-4.90E-11	-9.50E-11	-4.40E-11	8.20E-11	1.43E-10	1.06E-09
1833	-1.75E-10	-5.40E-11	-1.70E-11	-1.25E-10	9.30E-11	5.10E-11	8.32E-10
1834	2.80E-11	1.00E-12	-4.60E-11	-6.10E-11	3.10E-11	9.50E-11	1.17E-09
1835	-2.82E-10	-1.50E-10	-1.80E-10	-1.72E-10	-2.48E-10	-1.73E-10	7.02E-10
1836	-1.09E-10	-9.60E-11	-1.95E-10	-3.00E-10	-2.49E-10	-4.87E-10	-4.40E-11
1837	-5.30E-11	-4.00E-12	-2.70E-11	-2.90E-11	-5.40E-11	-1.38E-10	1.10E-11
1838	-2.10E-11	-6.40E-11	-2.29E-10	-2.73E-10	-3.71E-10	-3.65E-10	-1.90E-11
1839	-7.50E-11	-1.34E-10	-2.57E-10	-3.46E-10	-3.73E-10	-4.19E-10	-7.10E-11
1840	-7.00E-12	-8.40E-11	-1.52E-10	-5.40E-11	-4.40E-11	-1.26E-10	-7.90E-11
1851	-6.00E-12	-4.00E-12	-3.00E-12	-3.00E-12	-1.30E-11	1.50E-11	3.00E-12
1852	2.00E-12	-1.00E-12	-1.20E-11	9.00E-12	6.00E-12	2.20E-11	0.00E+00
Biased Statistics							
Average Biased	-1.12E-10	-6.42E-11	-9.78E-11	-1.15E-10	-4.30E-11	-1.80E-11	9.24E-10
Std Dev Biased	1.22E-10	5.47E-11	6.86E-11	6.10E-11	1.57E-10	1.60E-10	1.87E-10
Ps90%/90% (+KTL) Biased	2.24E-10	8.58E-11	9.02E-11	5.20E-11	3.87E-10	4.22E-10	1.44E-09
Ps90%/90% (-KTL) Biased	-4.47E-10	-2.14E-10	-2.86E-10	-2.83E-10	-4.73E-10	-4.58E-10	4.12E-10
Un-Biased Statistics							
Average Un-Biased	-5.30E-11	-7.64E-11	-1.72E-10	-2.00E-10	-2.18E-10	-3.07E-10	-4.04E-11
Std Dev Un-Biased	4.11E-11	4.78E-11	9.00E-11	1.48E-10	1.62E-10	1.66E-10	3.72E-11
Ps90%/90% (+KTL) Un-Biased	5.97E-11	5.48E-11	7.49E-11	2.04E-10	2.27E-10	1.47E-10	6.16E-11
Ps90%/90% (-KTL) Un-Biased	-1.66E-10	-2.08E-10	-4.19E-10	-6.05E-10	-6.64E-10	-7.61E-10	-1.42E-10
Specification MIN	-1.00E-08	-1.00E-08	-1.00E-08	-1.00E-08	-1.50E-08	-1.50E-08	-1.50E-08
Status	PASS	PASS	PASS	PASS	PASS	PASS	PASS
Specification MAX	1.00E-08	1.00E-08	1.00E-08	1.00E-08	1.50E-08	1.50E-08	1.50E-08
Status	PASS	PASS	PASS	PASS	PASS	PASS	PASS

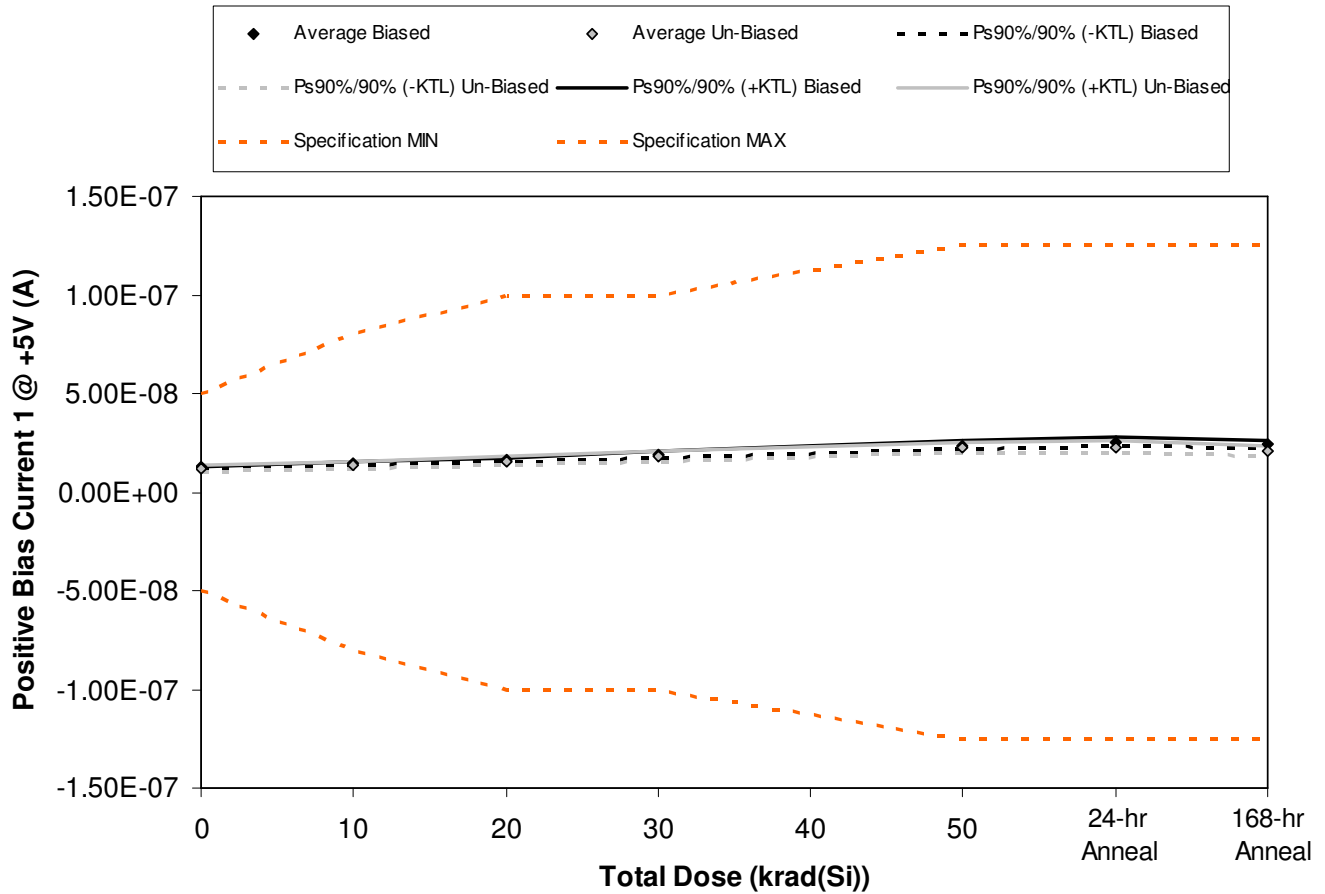

Figure 5.57. Plot of Positive Bias Current 1 @ +5V (A) versus total dose. The solid diamonds are the average of the measured data points for the samples irradiated under electrical bias while the shaded diamonds are the average of the measured data points for the samples irradiated with all pins tied to ground. The black lines (solid and/or dashed) are the average of the data points after application of the KTL statistics on the samples irradiated under electrical bias while the gray lines (solid and/or dashed) are the average of the data points after application of the KTL statistics on the samples irradiated in the unbiased condition. The red dotted line(s) are the pre- and/or post-irradiation minimum and/or maximum specification value as defined in the datasheet and/or test plan.



Table 5.57. Raw data for Positive Bias Current 1 @ +5V (A) versus total dose, including the statistical analysis, specification and the status of the testing (pass/fail).

Positive Bias Current 1 @ +5V (A)	Total Dose (krad(Si))					24 hr	168 hr
	0	10	20	30	50	Anneal	Anneal
Device	10/20/2011	11/3/2011	11/3/2011	11/3/2011	11/3/2011	11/4/2011	11/11/2011
1831	1.25E-08	1.42E-08	1.63E-08	1.87E-08	2.31E-08	2.50E-08	2.39E-08
1832	1.27E-08	1.43E-08	1.65E-08	1.91E-08	2.38E-08	2.57E-08	2.45E-08
1833	1.21E-08	1.38E-08	1.58E-08	1.83E-08	2.34E-08	2.51E-08	2.38E-08
1834	1.27E-08	1.46E-08	1.70E-08	1.97E-08	2.51E-08	2.69E-08	2.52E-08
1835	1.22E-08	1.40E-08	1.63E-08	1.88E-08	2.37E-08	2.54E-08	2.40E-08
1836	1.27E-08	1.44E-08	1.64E-08	1.89E-08	2.36E-08	2.39E-08	2.18E-08
1837	1.18E-08	1.35E-08	1.55E-08	1.77E-08	2.26E-08	2.27E-08	2.06E-08
1838	1.28E-08	1.46E-08	1.67E-08	1.92E-08	2.37E-08	2.39E-08	2.16E-08
1839	1.13E-08	1.30E-08	1.53E-08	1.79E-08	2.28E-08	2.26E-08	2.01E-08
1840	1.16E-08	1.32E-08	1.50E-08	1.71E-08	2.13E-08	2.14E-08	1.94E-08
1851	1.15E-08	1.16E-08	1.16E-08	1.16E-08	1.16E-08	1.15E-08	1.16E-08
1852	1.19E-08	1.19E-08	1.19E-08	1.19E-08	1.19E-08	1.19E-08	1.19E-08
Biased Statistics							
Average Biased	1.25E-08	1.42E-08	1.64E-08	1.89E-08	2.38E-08	2.56E-08	2.43E-08
Std Dev Biased	2.82E-10	3.29E-10	4.32E-10	5.36E-10	7.93E-10	7.59E-10	5.65E-10
Ps90%/90% (+KTL) Biased	1.32E-08	1.51E-08	1.76E-08	2.04E-08	2.60E-08	2.77E-08	2.58E-08
Ps90%/90% (-KTL) Biased	1.17E-08	1.33E-08	1.52E-08	1.75E-08	2.17E-08	2.35E-08	2.27E-08
Un-Biased Statistics							
Average Un-Biased	1.20E-08	1.37E-08	1.58E-08	1.82E-08	2.28E-08	2.29E-08	2.07E-08
Std Dev Un-Biased	6.75E-10	7.09E-10	7.25E-10	8.64E-10	9.73E-10	1.06E-09	1.01E-09
Ps90%/90% (+KTL) Un-Biased	1.39E-08	1.57E-08	1.78E-08	2.05E-08	2.55E-08	2.58E-08	2.35E-08
Ps90%/90% (-KTL) Un-Biased	1.02E-08	1.18E-08	1.38E-08	1.58E-08	2.01E-08	2.00E-08	1.79E-08
Specification MIN	-5.00E-08	-8.00E-08	-1.00E-07	-1.00E-07	-1.25E-07	-1.25E-07	-1.25E-07
Status	PASS	PASS	PASS	PASS	PASS	PASS	PASS
Specification MAX	5.00E-08	8.00E-08	1.00E-07	1.00E-07	1.25E-07	1.25E-07	1.25E-07
Status	PASS	PASS	PASS	PASS	PASS	PASS	PASS

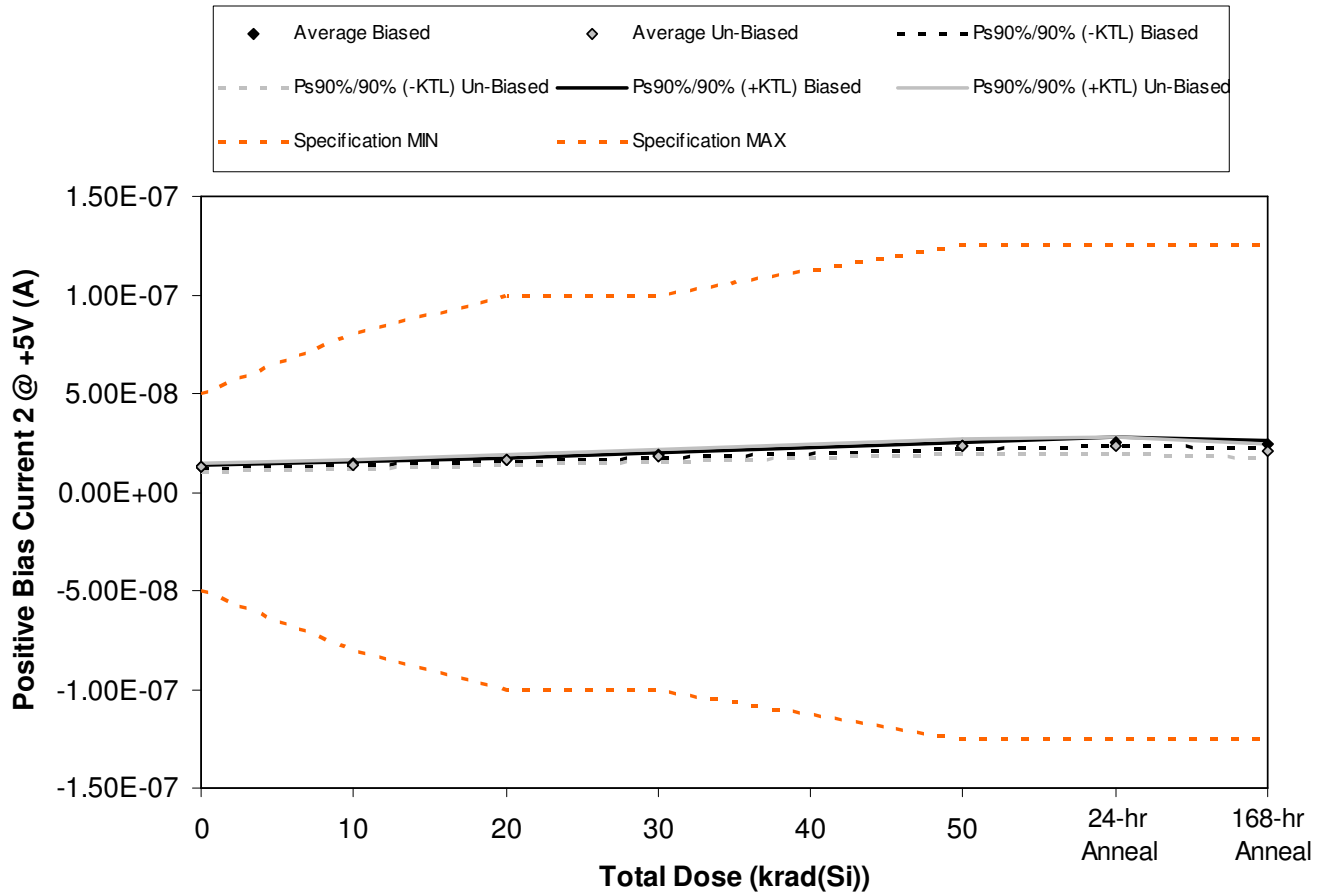

Figure 5.58. Plot of Positive Bias Current 2 @ +5V (A) versus total dose. The solid diamonds are the average of the measured data points for the samples irradiated under electrical bias while the shaded diamonds are the average of the measured data points for the samples irradiated with all pins tied to ground. The black lines (solid and/or dashed) are the average of the data points after application of the KTL statistics on the samples irradiated under electrical bias while the gray lines (solid and/or dashed) are the average of the data points after application of the KTL statistics on the samples irradiated in the unbiased condition. The red dotted line(s) are the pre- and/or post-irradiation minimum and/or maximum specification value as defined in the datasheet and/or test plan.



Table 5.58. Raw data for Positive Bias Current 2 @ +5V (A) versus total dose, including the statistical analysis, specification and the status of the testing (pass/fail).

Positive Bias Current 2 @ +5V (A)	Total Dose (krad(Si))					24 hr	168 hr
	0	10	20	30	50	Anneal	Anneal
Device	10/20/2011	11/3/2011	11/3/2011	11/3/2011	11/3/2011	11/4/2011	11/11/2011
1831	1.25E-08	1.43E-08	1.63E-08	1.86E-08	2.31E-08	2.48E-08	2.37E-08
1832	1.26E-08	1.41E-08	1.62E-08	1.87E-08	2.35E-08	2.52E-08	2.38E-08
1833	1.30E-08	1.48E-08	1.71E-08	1.96E-08	2.49E-08	2.67E-08	2.52E-08
1834	1.23E-08	1.39E-08	1.60E-08	1.84E-08	2.32E-08	2.48E-08	2.35E-08
1835	1.23E-08	1.41E-08	1.63E-08	1.88E-08	2.36E-08	2.52E-08	2.40E-08
1836	1.19E-08	1.36E-08	1.54E-08	1.78E-08	2.23E-08	2.26E-08	2.03E-08
1837	1.29E-08	1.46E-08	1.67E-08	1.91E-08	2.42E-08	2.45E-08	2.22E-08
1838	1.33E-08	1.51E-08	1.73E-08	1.98E-08	2.45E-08	2.47E-08	2.24E-08
1839	1.30E-08	1.43E-08	1.66E-08	1.92E-08	2.41E-08	2.40E-08	2.15E-08
1840	1.14E-08	1.30E-08	1.49E-08	1.70E-08	2.11E-08	2.11E-08	1.93E-08
1851	1.27E-08	1.27E-08	1.27E-08	1.27E-08	1.27E-08	1.26E-08	1.27E-08
1852	1.35E-08	1.36E-08	1.36E-08	1.36E-08	1.36E-08	1.35E-08	1.35E-08
Biased Statistics							
Average Biased	1.26E-08	1.42E-08	1.64E-08	1.88E-08	2.36E-08	2.54E-08	2.41E-08
Std Dev Biased	2.72E-10	3.22E-10	4.12E-10	4.74E-10	7.13E-10	7.60E-10	6.86E-10
Ps90%/90% (+KTL) Biased	1.33E-08	1.51E-08	1.75E-08	2.01E-08	2.56E-08	2.74E-08	2.59E-08
Ps90%/90% (-KTL) Biased	1.18E-08	1.33E-08	1.52E-08	1.75E-08	2.17E-08	2.33E-08	2.22E-08
Un-Biased Statistics							
Average Un-Biased	1.25E-08	1.41E-08	1.62E-08	1.86E-08	2.32E-08	2.34E-08	2.11E-08
Std Dev Un-Biased	8.01E-10	8.60E-10	1.00E-09	1.14E-09	1.48E-09	1.51E-09	1.31E-09
Ps90%/90% (+KTL) Un-Biased	1.47E-08	1.65E-08	1.89E-08	2.17E-08	2.73E-08	2.75E-08	2.47E-08
Ps90%/90% (-KTL) Un-Biased	1.03E-08	1.18E-08	1.34E-08	1.54E-08	1.92E-08	1.92E-08	1.75E-08
Specification MIN	-5.00E-08	-8.00E-08	-1.00E-07	-1.00E-07	-1.25E-07	-1.25E-07	-1.25E-07
Status	PASS	PASS	PASS	PASS	PASS	PASS	PASS
Specification MAX	5.00E-08	8.00E-08	1.00E-07	1.00E-07	1.25E-07	1.25E-07	1.25E-07
Status	PASS	PASS	PASS	PASS	PASS	PASS	PASS

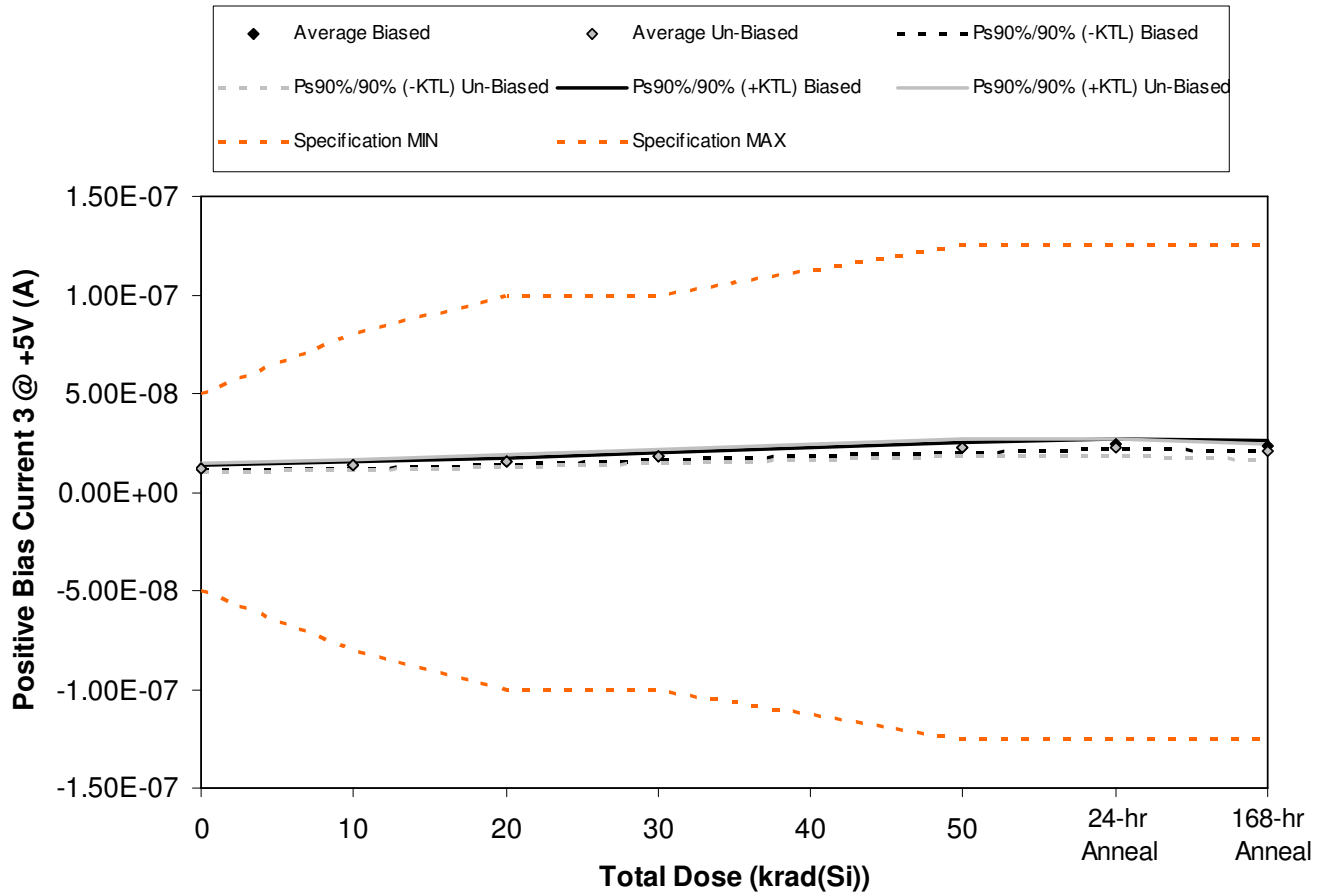

Figure 5.59. Plot of Positive Bias Current 3 @ +5V (A) versus total dose. The solid diamonds are the average of the measured data points for the samples irradiated under electrical bias while the shaded diamonds are the average of the measured data points for the samples irradiated with all pins tied to ground. The black lines (solid and/or dashed) are the average of the data points after application of the KTL statistics on the samples irradiated under electrical bias while the gray lines (solid and/or dashed) are the average of the data points after application of the KTL statistics on the samples irradiated in the unbiased condition. The red dotted line(s) are the pre- and/or post-irradiation minimum and/or maximum specification value as defined in the datasheet and/or test plan.



Table 5.59. Raw data for Positive Bias Current 3 @ +5V (A) versus total dose, including the statistical analysis, specification and the status of the testing (pass/fail).

Positive Bias Current 3 @ +5V (A)	Total Dose (krad(Si))					24 hr	168 hr
	0	10	20	30	50	Anneal	Anneal
Device							
	10/20/2011	11/3/2011	11/3/2011	11/3/2011	11/3/2011	11/4/2011	11/11/2011
1831	1.22E-08	1.39E-08	1.59E-08	1.83E-08	2.27E-08	2.43E-08	2.31E-08
1832	1.21E-08	1.35E-08	1.56E-08	1.79E-08	2.27E-08	2.43E-08	2.30E-08
1833	1.26E-08	1.43E-08	1.66E-08	1.91E-08	2.41E-08	2.60E-08	2.45E-08
1834	1.13E-08	1.28E-08	1.47E-08	1.70E-08	2.15E-08	2.30E-08	2.17E-08
1835	1.19E-08	1.37E-08	1.59E-08	1.84E-08	2.30E-08	2.47E-08	2.34E-08
1836	1.15E-08	1.30E-08	1.48E-08	1.71E-08	2.13E-08	2.15E-08	1.94E-08
1837	1.25E-08	1.42E-08	1.63E-08	1.86E-08	2.35E-08	2.37E-08	2.14E-08
1838	1.28E-08	1.46E-08	1.67E-08	1.91E-08	2.37E-08	2.39E-08	2.17E-08
1839	1.27E-08	1.44E-08	1.67E-08	1.94E-08	2.43E-08	2.43E-08	2.18E-08
1840	1.12E-08	1.27E-08	1.45E-08	1.66E-08	2.06E-08	2.05E-08	1.87E-08
1851	1.23E-08	1.23E-08	1.24E-08	1.23E-08	1.24E-08	1.23E-08	1.23E-08
1852	1.17E-08	1.18E-08	1.19E-08	1.19E-08	1.18E-08	1.18E-08	1.18E-08
Biased Statistics							
Average Biased	1.20E-08	1.37E-08	1.57E-08	1.82E-08	2.28E-08	2.44E-08	2.31E-08
Std Dev Biased	4.85E-10	5.49E-10	6.92E-10	7.68E-10	9.52E-10	1.06E-09	1.00E-09
Ps90%/90% (+KTL) Biased	1.33E-08	1.52E-08	1.76E-08	2.03E-08	2.54E-08	2.73E-08	2.59E-08
Ps90%/90% (-KTL) Biased	1.07E-08	1.21E-08	1.38E-08	1.61E-08	2.02E-08	2.15E-08	2.04E-08
Un-Biased Statistics							
Average Un-Biased	1.21E-08	1.38E-08	1.58E-08	1.82E-08	2.27E-08	2.28E-08	2.06E-08
Std Dev Un-Biased	7.45E-10	8.61E-10	1.06E-09	1.24E-09	1.61E-09	1.67E-09	1.45E-09
Ps90%/90% (+KTL) Un-Biased	1.42E-08	1.62E-08	1.87E-08	2.16E-08	2.71E-08	2.73E-08	2.46E-08
Ps90%/90% (-KTL) Un-Biased	1.01E-08	1.14E-08	1.29E-08	1.47E-08	1.83E-08	1.82E-08	1.66E-08
Specification MIN	-5.00E-08	-8.00E-08	-1.00E-07	-1.00E-07	-1.25E-07	-1.25E-07	-1.25E-07
Status	PASS	PASS	PASS	PASS	PASS	PASS	PASS
Specification MAX	5.00E-08	8.00E-08	1.00E-07	1.00E-07	1.25E-07	1.25E-07	1.25E-07
Status	PASS	PASS	PASS	PASS	PASS	PASS	PASS

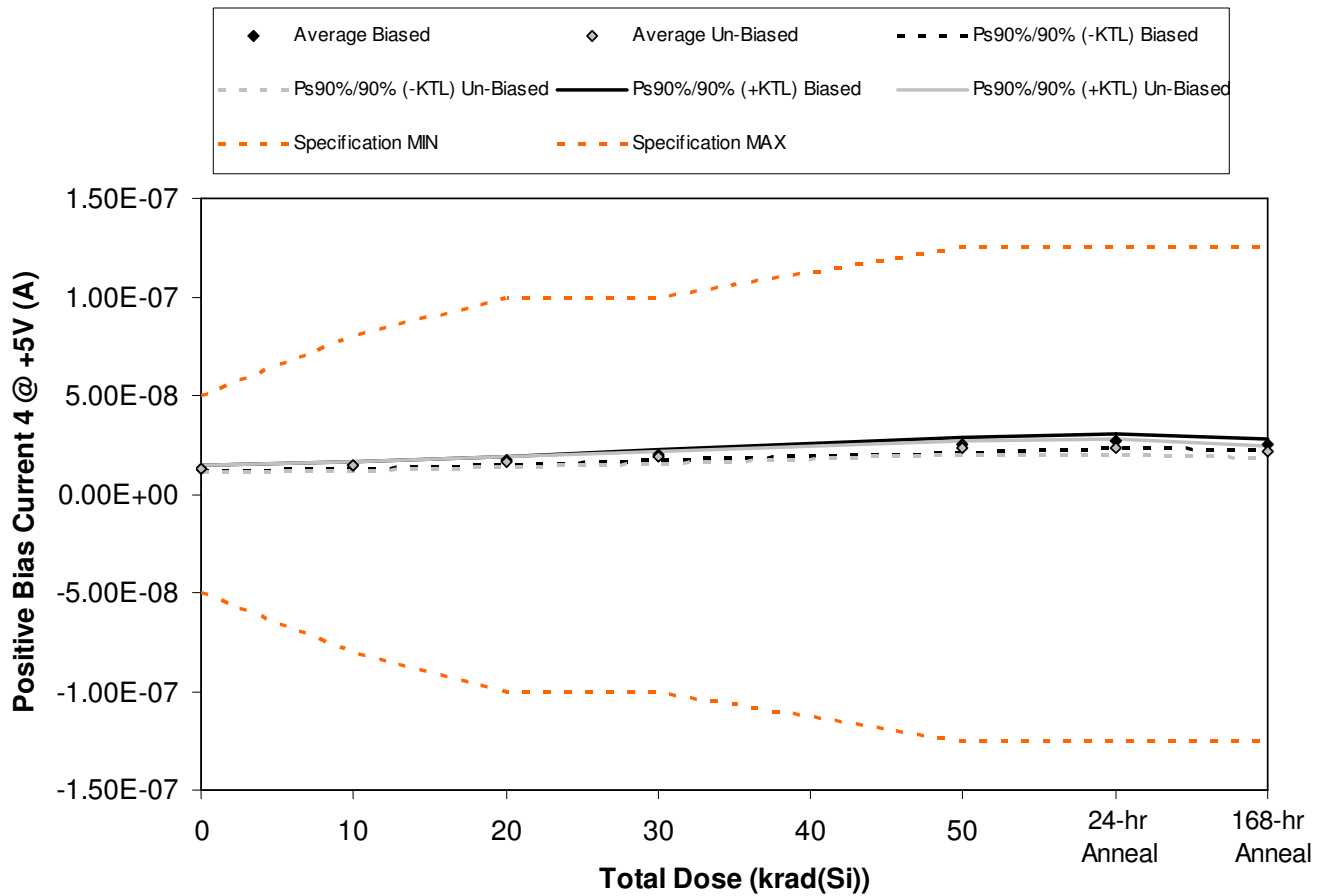

Figure 5.60. Plot of Positive Bias Current 4 @ +5V (A) versus total dose. The solid diamonds are the average of the measured data points for the samples irradiated under electrical bias while the shaded diamonds are the average of the measured data points for the samples irradiated with all pins tied to ground. The black lines (solid and/or dashed) are the average of the data points after application of the KTL statistics on the samples irradiated under electrical bias while the gray lines (solid and/or dashed) are the average of the data points after application of the KTL statistics on the samples irradiated in the unbiased condition. The red dotted line(s) are the pre- and/or post-irradiation minimum and/or maximum specification value as defined in the datasheet and/or test plan.



Table 5.60. Raw data for Positive Bias Current 4 @ +5V (A) versus total dose, including the statistical analysis, specification and the status of the testing (pass/fail).

Positive Bias Current 4 @ +5V (A)	Total Dose (krad(Si))					24 hr	168 hr
	0	10	20	30	50	Anneal	Anneal
Device	10/20/2011	11/3/2011	11/3/2011	11/3/2011	11/3/2011	11/4/2011	11/11/2011
1831	1.31E-08	1.49E-08	1.70E-08	1.95E-08	2.40E-08	2.59E-08	2.48E-08
1832	1.31E-08	1.48E-08	1.71E-08	1.96E-08	2.45E-08	2.64E-08	2.53E-08
1833	1.27E-08	1.38E-08	1.59E-08	1.83E-08	2.31E-08	2.50E-08	2.37E-08
1834	1.32E-08	1.53E-08	1.77E-08	2.07E-08	2.63E-08	2.80E-08	2.63E-08
1835	1.39E-08	1.54E-08	1.79E-08	2.08E-08	2.60E-08	2.78E-08	2.63E-08
1836	1.31E-08	1.49E-08	1.69E-08	1.94E-08	2.44E-08	2.49E-08	2.24E-08
1837	1.17E-08	1.33E-08	1.53E-08	1.75E-08	2.22E-08	2.26E-08	2.04E-08
1838	1.32E-08	1.50E-08	1.72E-08	1.99E-08	2.46E-08	2.49E-08	2.23E-08
1839	1.23E-08	1.42E-08	1.67E-08	1.96E-08	2.48E-08	2.46E-08	2.17E-08
1840	1.20E-08	1.36E-08	1.55E-08	1.77E-08	2.19E-08	2.19E-08	1.99E-08
1851	1.19E-08	1.19E-08	1.19E-08	1.19E-08	1.19E-08	1.18E-08	1.19E-08
1852	1.29E-08	1.30E-08	1.30E-08	1.30E-08	1.29E-08	1.29E-08	1.29E-08
Biased Statistics							
Average Biased	1.32E-08	1.48E-08	1.71E-08	1.98E-08	2.48E-08	2.66E-08	2.53E-08
Std Dev Biased	4.46E-10	6.43E-10	8.09E-10	1.01E-09	1.32E-09	1.29E-09	1.10E-09
Ps90%/90% (+KTL) Biased	1.44E-08	1.66E-08	1.93E-08	2.26E-08	2.84E-08	3.02E-08	2.83E-08
Ps90%/90% (-KTL) Biased	1.20E-08	1.30E-08	1.49E-08	1.70E-08	2.12E-08	2.31E-08	2.23E-08
Un-Biased Statistics							
Average Un-Biased	1.25E-08	1.42E-08	1.63E-08	1.88E-08	2.36E-08	2.38E-08	2.13E-08
Std Dev Un-Biased	6.52E-10	7.51E-10	8.80E-10	1.15E-09	1.39E-09	1.41E-09	1.14E-09
Ps90%/90% (+KTL) Un-Biased	1.42E-08	1.63E-08	1.87E-08	2.20E-08	2.74E-08	2.76E-08	2.45E-08
Ps90%/90% (-KTL) Un-Biased	1.07E-08	1.22E-08	1.39E-08	1.57E-08	1.97E-08	1.99E-08	1.82E-08
Specification MIN	-5.00E-08	-8.00E-08	-1.00E-07	-1.00E-07	-1.25E-07	-1.25E-07	-1.25E-07
Status	PASS	PASS	PASS	PASS	PASS	PASS	PASS
Specification MAX	5.00E-08	8.00E-08	1.00E-07	1.00E-07	1.25E-07	1.25E-07	1.25E-07
Status	PASS	PASS	PASS	PASS	PASS	PASS	PASS

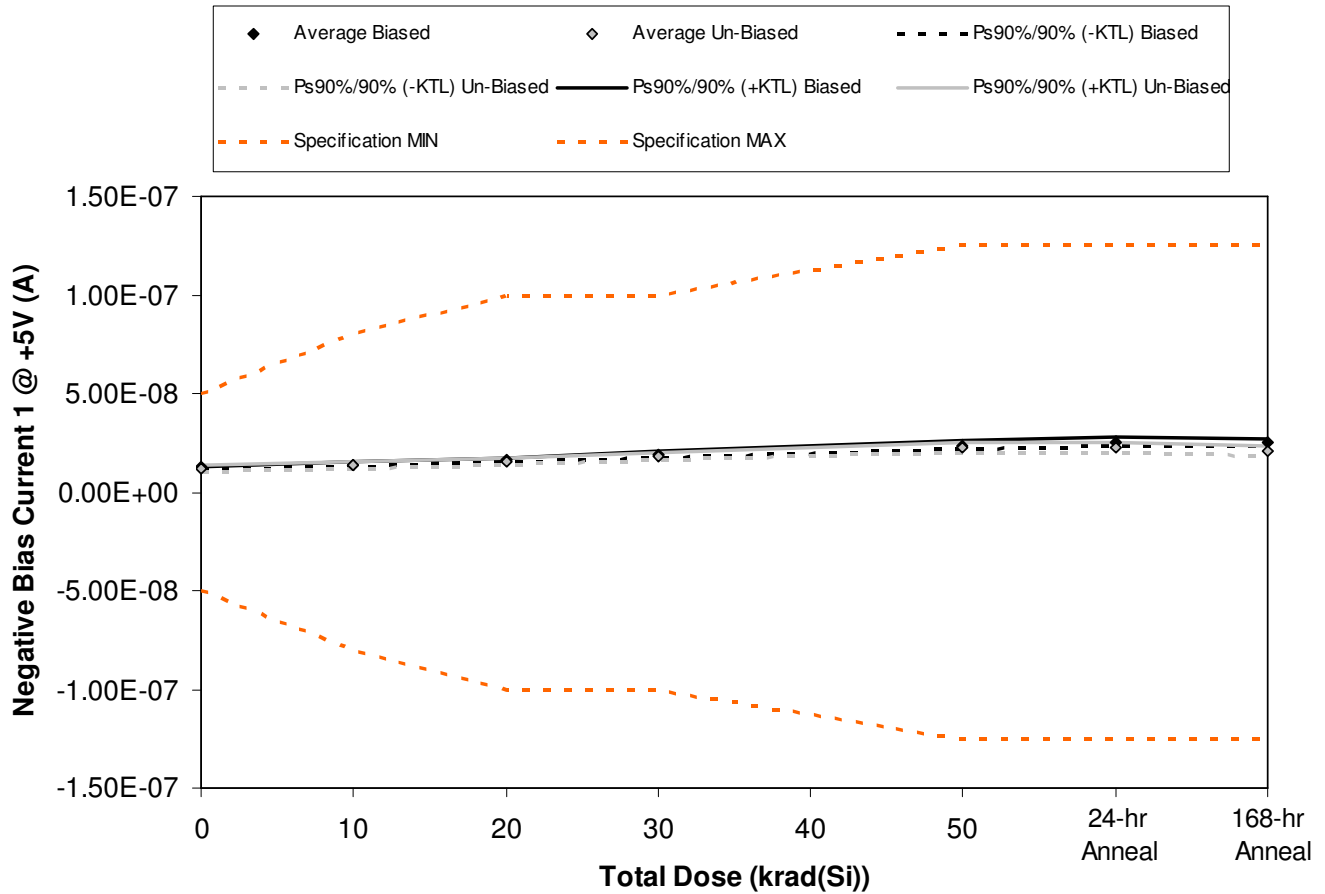

Figure 5.61. Plot of Negative Bias Current 1 @ +5V (A) versus total dose. The solid diamonds are the average of the measured data points for the samples irradiated under electrical bias while the shaded diamonds are the average of the measured data points for the samples irradiated with all pins tied to ground. The black lines (solid and/or dashed) are the average of the data points after application of the KTL statistics on the samples irradiated under electrical bias while the gray lines (solid and/or dashed) are the average of the data points after application of the KTL statistics on the samples irradiated in the unbiased condition. The red dotted line(s) are the pre- and/or post-irradiation minimum and/or maximum specification value as defined in the datasheet and/or test plan.



Table 5.61. Raw data for Negative Bias Current 1 @ +5V (A) versus total dose, including the statistical analysis, specification and the status of the testing (pass/fail).

Negative Bias Current 1 @ +5V (A)	Total Dose (krad(Si))					24 hr	168 hr
	0	10	20	30	50	Anneal	Anneal
Device	10/20/2011	11/3/2011	11/3/2011	11/3/2011	11/3/2011	11/4/2011	11/11/2011
1831	1.25E-08	1.41E-08	1.63E-08	1.87E-08	2.32E-08	2.50E-08	2.48E-08
1832	1.27E-08	1.43E-08	1.64E-08	1.89E-08	2.37E-08	2.57E-08	2.55E-08
1833	1.20E-08	1.37E-08	1.58E-08	1.82E-08	2.32E-08	2.51E-08	2.47E-08
1834	1.28E-08	1.46E-08	1.70E-08	1.97E-08	2.52E-08	2.69E-08	2.61E-08
1835	1.23E-08	1.40E-08	1.62E-08	1.89E-08	2.37E-08	2.55E-08	2.49E-08
1836	1.25E-08	1.43E-08	1.62E-08	1.87E-08	2.35E-08	2.38E-08	2.17E-08
1837	1.18E-08	1.35E-08	1.55E-08	1.76E-08	2.24E-08	2.26E-08	2.04E-08
1838	1.28E-08	1.46E-08	1.66E-08	1.91E-08	2.36E-08	2.37E-08	2.16E-08
1839	1.13E-08	1.30E-08	1.52E-08	1.78E-08	2.26E-08	2.24E-08	1.99E-08
1840	1.17E-08	1.33E-08	1.51E-08	1.73E-08	2.14E-08	2.13E-08	1.95E-08
1851	1.15E-08	1.16E-08	1.16E-08	1.16E-08	1.16E-08	1.16E-08	1.16E-08
1852	1.18E-08	1.19E-08	1.19E-08	1.19E-08	1.19E-08	1.18E-08	1.18E-08
Biased Statistics							
Average Biased	1.25E-08	1.41E-08	1.63E-08	1.89E-08	2.38E-08	2.56E-08	2.52E-08
Std Dev Biased	2.94E-10	3.53E-10	4.42E-10	5.43E-10	8.02E-10	7.62E-10	5.96E-10
Ps90%/90% (+KTL) Biased	1.33E-08	1.51E-08	1.76E-08	2.04E-08	2.60E-08	2.77E-08	2.68E-08
Ps90%/90% (-KTL) Biased	1.16E-08	1.32E-08	1.51E-08	1.74E-08	2.16E-08	2.35E-08	2.36E-08
Un-Biased Statistics							
Average Un-Biased	1.20E-08	1.37E-08	1.57E-08	1.81E-08	2.27E-08	2.28E-08	2.06E-08
Std Dev Un-Biased	6.25E-10	7.02E-10	6.49E-10	7.48E-10	8.87E-10	1.02E-09	9.90E-10
Ps90%/90% (+KTL) Un-Biased	1.37E-08	1.57E-08	1.75E-08	2.02E-08	2.51E-08	2.56E-08	2.34E-08
Ps90%/90% (-KTL) Un-Biased	1.03E-08	1.18E-08	1.40E-08	1.60E-08	2.03E-08	2.00E-08	1.79E-08
Specification MIN	-5.00E-08	-8.00E-08	-1.00E-07	-1.00E-07	-1.25E-07	-1.25E-07	-1.25E-07
Status	PASS	PASS	PASS	PASS	PASS	PASS	PASS
Specification MAX	5.00E-08	8.00E-08	1.00E-07	1.00E-07	1.25E-07	1.25E-07	1.25E-07
Status	PASS	PASS	PASS	PASS	PASS	PASS	PASS

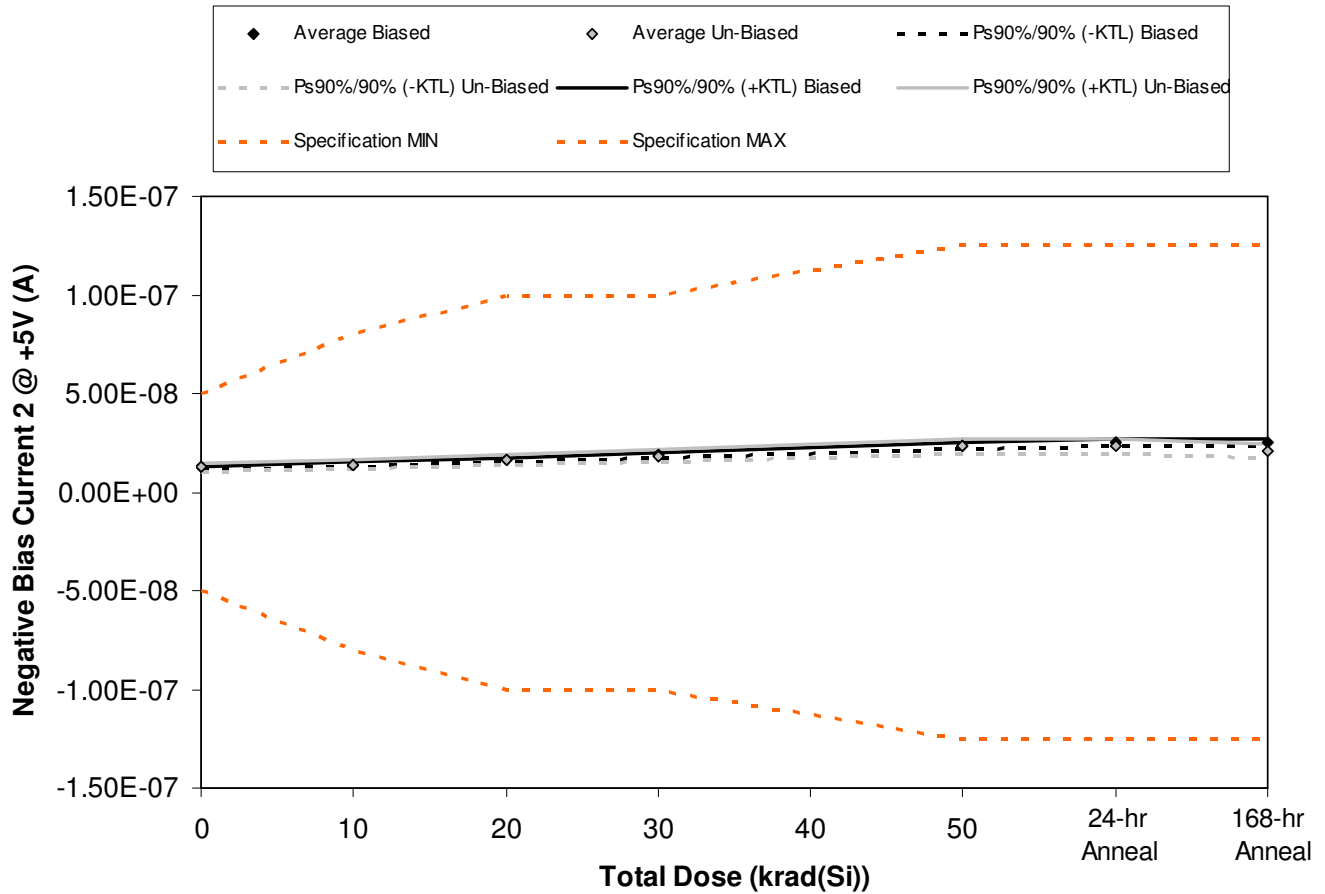

Figure 5.62. Plot of Negative Bias Current 2 @ +5V (A) versus total dose. The solid diamonds are the average of the measured data points for the samples irradiated under electrical bias while the shaded diamonds are the average of the measured data points for the samples irradiated with all pins tied to ground. The black lines (solid and/or dashed) are the average of the data points after application of the KTL statistics on the samples irradiated under electrical bias while the gray lines (solid and/or dashed) are the average of the data points after application of the KTL statistics on the samples irradiated in the unbiased condition. The red dotted line(s) are the pre- and/or post-irradiation minimum and/or maximum specification value as defined in the datasheet and/or test plan.



Table 5.62. Raw data for Negative Bias Current 2 @ +5V (A) versus total dose, including the statistical analysis, specification and the status of the testing (pass/fail).

Negative Bias Current 2 @ +5V (A)	Total Dose (krad(Si))					24 hr	168 hr
	0	10	20	30	50	Anneal	Anneal
Device	10/20/2011	11/3/2011	11/3/2011	11/3/2011	11/3/2011	11/4/2011	11/11/2011
1831	1.26E-08	1.44E-08	1.63E-08	1.87E-08	2.32E-08	2.50E-08	2.48E-08
1832	1.24E-08	1.38E-08	1.60E-08	1.84E-08	2.32E-08	2.51E-08	2.47E-08
1833	1.29E-08	1.47E-08	1.69E-08	1.95E-08	2.47E-08	2.65E-08	2.62E-08
1834	1.23E-08	1.39E-08	1.60E-08	1.84E-08	2.33E-08	2.50E-08	2.49E-08
1835	1.22E-08	1.40E-08	1.63E-08	1.88E-08	2.35E-08	2.53E-08	2.48E-08
1836	1.19E-08	1.35E-08	1.54E-08	1.78E-08	2.23E-08	2.25E-08	2.02E-08
1837	1.28E-08	1.45E-08	1.66E-08	1.90E-08	2.39E-08	2.42E-08	2.21E-08
1838	1.32E-08	1.50E-08	1.72E-08	1.97E-08	2.43E-08	2.44E-08	2.23E-08
1839	1.29E-08	1.41E-08	1.64E-08	1.90E-08	2.39E-08	2.39E-08	2.16E-08
1840	1.14E-08	1.30E-08	1.48E-08	1.69E-08	2.10E-08	2.10E-08	1.93E-08
1851	1.25E-08	1.25E-08	1.25E-08	1.25E-08	1.26E-08	1.25E-08	1.25E-08
1852	1.33E-08	1.33E-08	1.33E-08	1.34E-08	1.33E-08	1.33E-08	1.33E-08
Biased Statistics							
Average Biased	1.25E-08	1.41E-08	1.63E-08	1.88E-08	2.36E-08	2.54E-08	2.51E-08
Std Dev Biased	2.79E-10	3.81E-10	3.64E-10	4.31E-10	6.35E-10	6.48E-10	6.24E-10
Ps90%/90% (+KTL) Biased	1.32E-08	1.52E-08	1.73E-08	2.00E-08	2.53E-08	2.71E-08	2.68E-08
Ps90%/90% (-KTL) Biased	1.17E-08	1.31E-08	1.53E-08	1.76E-08	2.18E-08	2.36E-08	2.33E-08
Un-Biased Statistics							
Average Un-Biased	1.24E-08	1.40E-08	1.61E-08	1.85E-08	2.31E-08	2.32E-08	2.11E-08
Std Dev Un-Biased	7.46E-10	8.08E-10	9.49E-10	1.14E-09	1.39E-09	1.43E-09	1.31E-09
Ps90%/90% (+KTL) Un-Biased	1.45E-08	1.62E-08	1.87E-08	2.16E-08	2.69E-08	2.71E-08	2.47E-08
Ps90%/90% (-KTL) Un-Biased	1.04E-08	1.18E-08	1.35E-08	1.53E-08	1.93E-08	1.93E-08	1.75E-08
Specification MIN	-5.00E-08	-8.00E-08	-1.00E-07	-1.00E-07	-1.25E-07	-1.25E-07	-1.25E-07
Status	PASS	PASS	PASS	PASS	PASS	PASS	PASS
Specification MAX	5.00E-08	8.00E-08	1.00E-07	1.00E-07	1.25E-07	1.25E-07	1.25E-07
Status	PASS	PASS	PASS	PASS	PASS	PASS	PASS

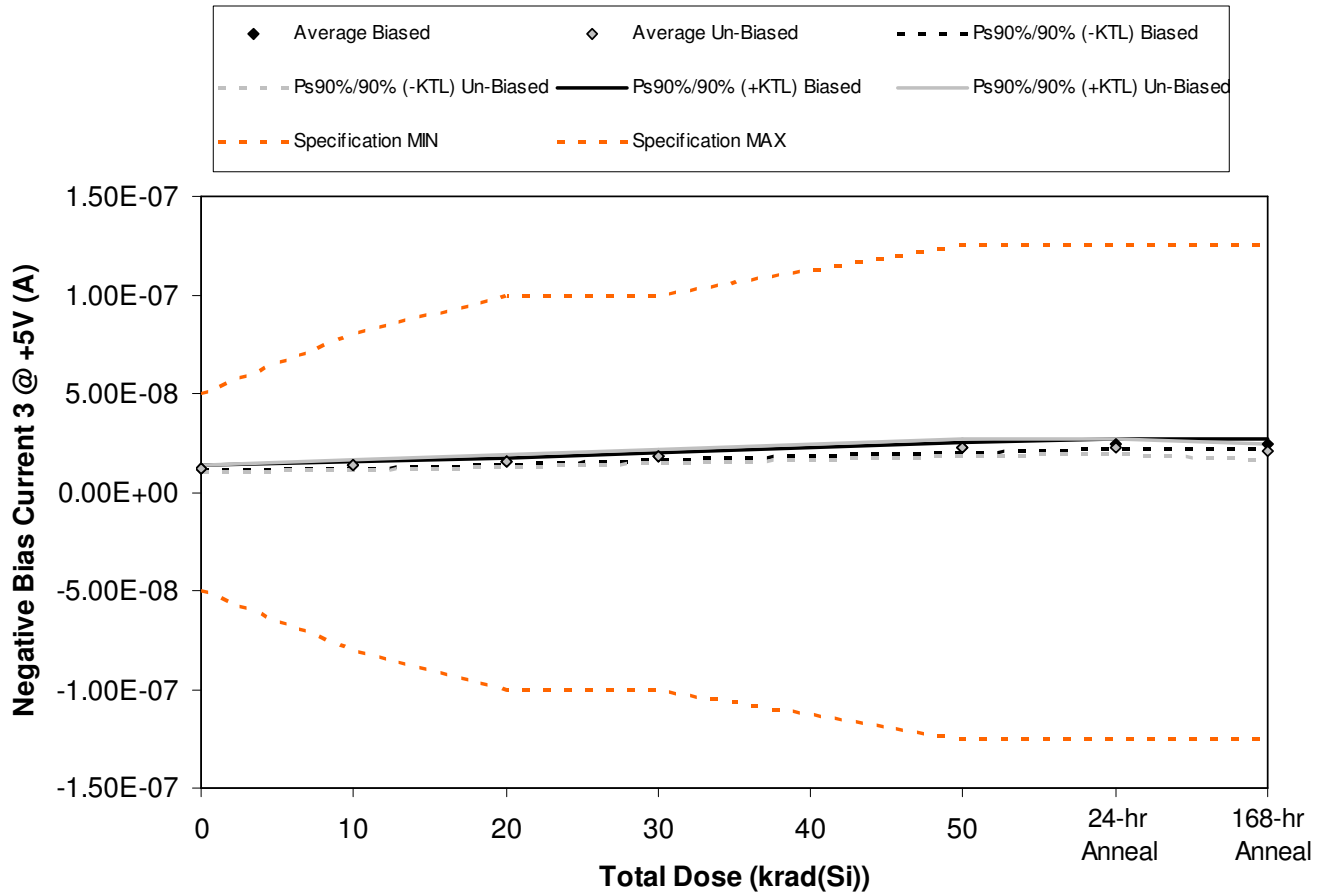

Figure 5.63. Plot of Negative Bias Current 3 @ +5V (A) versus total dose. The solid diamonds are the average of the measured data points for the samples irradiated under electrical bias while the shaded diamonds are the average of the measured data points for the samples irradiated with all pins tied to ground. The black lines (solid and/or dashed) are the average of the data points after application of the KTL statistics on the samples irradiated under electrical bias while the gray lines (solid and/or dashed) are the average of the data points after application of the KTL statistics on the samples irradiated in the unbiased condition. The red dotted line(s) are the pre- and/or post-irradiation minimum and/or maximum specification value as defined in the datasheet and/or test plan.



Table 5.63. Raw data for Negative Bias Current 3 @ +5V (A) versus total dose, including the statistical analysis, specification and the status of the testing (pass/fail).

Negative Bias Current 3 @ +5V (A)	Total Dose (krad(Si))					24 hr	168 hr
	0	10	20	30	50	Anneal	Anneal
Device	10/20/2011	11/3/2011	11/3/2011	11/3/2011	11/3/2011	11/4/2011	11/11/2011
1831	1.22E-08	1.39E-08	1.59E-08	1.82E-08	2.27E-08	2.43E-08	2.42E-08
1832	1.21E-08	1.34E-08	1.55E-08	1.78E-08	2.25E-08	2.42E-08	2.39E-08
1833	1.25E-08	1.42E-08	1.65E-08	1.89E-08	2.41E-08	2.59E-08	2.52E-08
1834	1.12E-08	1.27E-08	1.46E-08	1.69E-08	2.16E-08	2.31E-08	2.27E-08
1835	1.18E-08	1.36E-08	1.58E-08	1.83E-08	2.31E-08	2.47E-08	2.44E-08
1836	1.14E-08	1.30E-08	1.47E-08	1.70E-08	2.14E-08	2.17E-08	1.95E-08
1837	1.24E-08	1.41E-08	1.62E-08	1.85E-08	2.34E-08	2.36E-08	2.14E-08
1838	1.27E-08	1.44E-08	1.66E-08	1.90E-08	2.35E-08	2.37E-08	2.15E-08
1839	1.26E-08	1.44E-08	1.67E-08	1.94E-08	2.43E-08	2.43E-08	2.18E-08
1840	1.11E-08	1.27E-08	1.45E-08	1.66E-08	2.08E-08	2.07E-08	1.87E-08
1851	1.21E-08	1.22E-08	1.22E-08	1.22E-08	1.22E-08	1.21E-08	1.21E-08
1852	1.18E-08	1.19E-08	1.19E-08	1.19E-08	1.19E-08	1.19E-08	1.19E-08
Biased Statistics							
Average Biased	1.20E-08	1.36E-08	1.57E-08	1.80E-08	2.28E-08	2.45E-08	2.41E-08
Std Dev Biased	4.80E-10	5.88E-10	6.77E-10	7.31E-10	9.09E-10	1.01E-09	9.36E-10
Ps90%/90% (+KTL) Biased	1.33E-08	1.52E-08	1.75E-08	2.01E-08	2.53E-08	2.72E-08	2.66E-08
Ps90%/90% (-KTL) Biased	1.06E-08	1.19E-08	1.38E-08	1.60E-08	2.03E-08	2.17E-08	2.15E-08
Un-Biased Statistics							
Average Un-Biased	1.20E-08	1.37E-08	1.57E-08	1.81E-08	2.27E-08	2.28E-08	2.06E-08
Std Dev Un-Biased	7.53E-10	8.23E-10	1.05E-09	1.24E-09	1.50E-09	1.52E-09	1.40E-09
Ps90%/90% (+KTL) Un-Biased	1.41E-08	1.60E-08	1.86E-08	2.15E-08	2.68E-08	2.70E-08	2.44E-08
Ps90%/90% (-KTL) Un-Biased	9.96E-09	1.14E-08	1.28E-08	1.47E-08	1.86E-08	1.86E-08	1.67E-08
Specification MIN	-5.00E-08	-8.00E-08	-1.00E-07	-1.00E-07	-1.25E-07	-1.25E-07	-1.25E-07
Status	PASS	PASS	PASS	PASS	PASS	PASS	PASS
Specification MAX	5.00E-08	8.00E-08	1.00E-07	1.00E-07	1.25E-07	1.25E-07	1.25E-07
Status	PASS	PASS	PASS	PASS	PASS	PASS	PASS

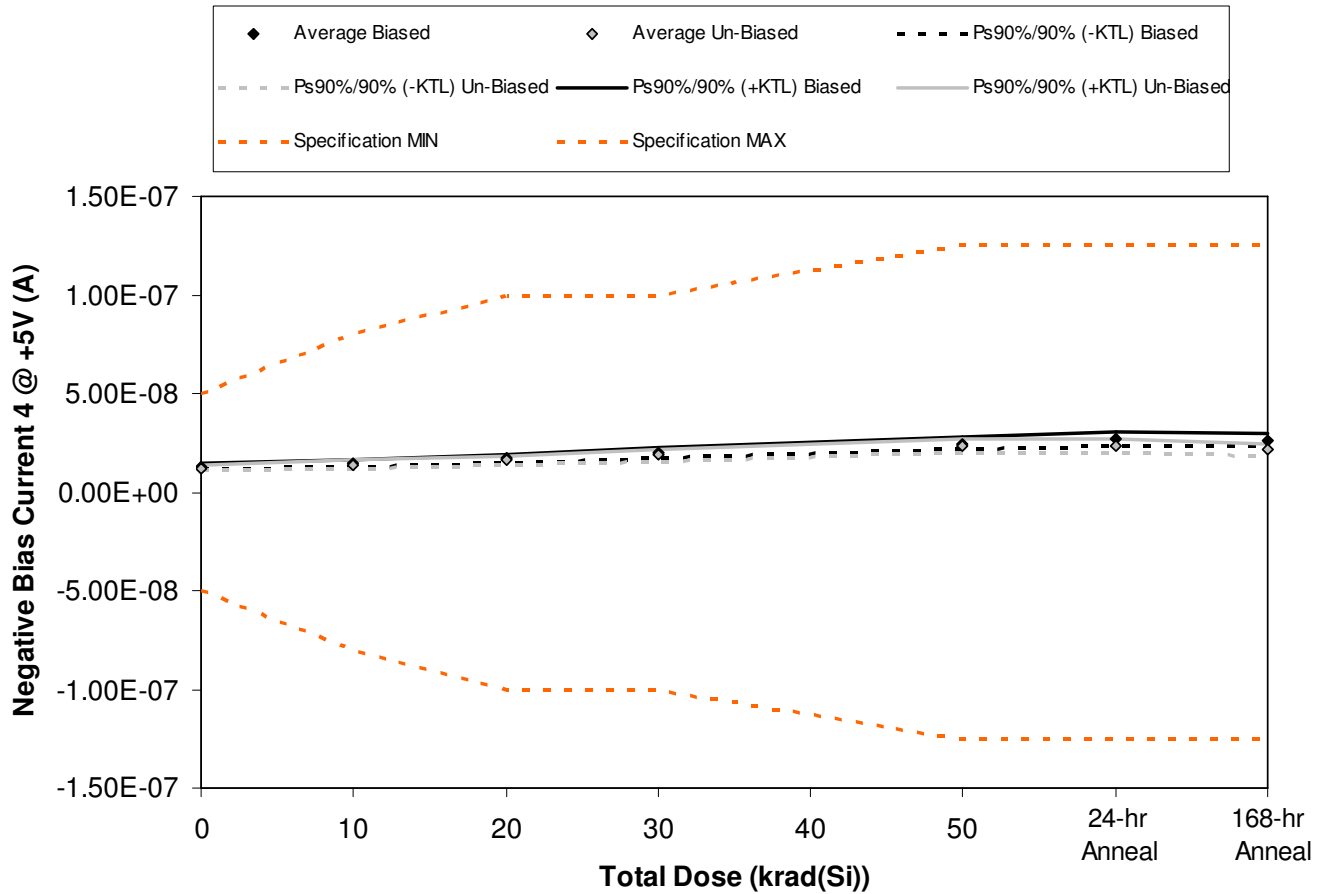

Figure 5.64. Plot of Negative Bias Current 4 @ +5V (A) versus total dose. The solid diamonds are the average of the measured data points for the samples irradiated under electrical bias while the shaded diamonds are the average of the measured data points for the samples irradiated with all pins tied to ground. The black lines (solid and/or dashed) are the average of the data points after application of the KTL statistics on the samples irradiated under electrical bias while the gray lines (solid and/or dashed) are the average of the data points after application of the KTL statistics on the samples irradiated in the unbiased condition. The red dotted line(s) are the pre- and/or post-irradiation minimum and/or maximum specification value as defined in the datasheet and/or test plan.



Table 5.64. Raw data for Negative Bias Current 4 @ +5V (A) versus total dose, including the statistical analysis, specification and the status of the testing (pass/fail).

Negative Bias Current 4 @ +5V (A)	Total Dose (krad(Si))					24 hr	168 hr
	0	10	20	30	50	Anneal	Anneal
Device	10/20/2011	11/3/2011	11/3/2011	11/3/2011	11/3/2011	11/4/2011	11/11/2011
1831	1.30E-08	1.47E-08	1.68E-08	1.93E-08	2.39E-08	2.57E-08	2.57E-08
1832	1.30E-08	1.47E-08	1.70E-08	1.96E-08	2.47E-08	2.66E-08	2.64E-08
1833	1.25E-08	1.37E-08	1.58E-08	1.81E-08	2.32E-08	2.50E-08	2.46E-08
1834	1.32E-08	1.53E-08	1.77E-08	2.06E-08	2.63E-08	2.81E-08	2.75E-08
1835	1.36E-08	1.52E-08	1.77E-08	2.06E-08	2.57E-08	2.76E-08	2.71E-08
1836	1.29E-08	1.47E-08	1.67E-08	1.92E-08	2.41E-08	2.44E-08	2.24E-08
1837	1.17E-08	1.33E-08	1.53E-08	1.74E-08	2.22E-08	2.25E-08	2.03E-08
1838	1.32E-08	1.50E-08	1.70E-08	1.96E-08	2.42E-08	2.44E-08	2.23E-08
1839	1.22E-08	1.40E-08	1.64E-08	1.92E-08	2.43E-08	2.42E-08	2.16E-08
1840	1.20E-08	1.35E-08	1.53E-08	1.76E-08	2.18E-08	2.18E-08	1.98E-08
1851	1.18E-08	1.19E-08	1.19E-08	1.19E-08	1.19E-08	1.18E-08	1.19E-08
1852	1.29E-08	1.29E-08	1.29E-08	1.30E-08	1.29E-08	1.29E-08	1.29E-08
Biased Statistics							
Average Biased	1.31E-08	1.47E-08	1.70E-08	1.96E-08	2.48E-08	2.66E-08	2.62E-08
Std Dev Biased	4.26E-10	6.58E-10	8.01E-10	1.02E-09	1.26E-09	1.29E-09	1.16E-09
Ps90%/90% (+KTL) Biased	1.42E-08	1.65E-08	1.92E-08	2.24E-08	2.82E-08	3.01E-08	2.94E-08
Ps90%/90% (-KTL) Biased	1.19E-08	1.29E-08	1.48E-08	1.68E-08	2.13E-08	2.31E-08	2.31E-08
Un-Biased Statistics							
Average Un-Biased	1.24E-08	1.41E-08	1.61E-08	1.86E-08	2.33E-08	2.35E-08	2.13E-08
Std Dev Un-Biased	6.36E-10	7.28E-10	7.90E-10	1.01E-09	1.22E-09	1.24E-09	1.14E-09
Ps90%/90% (+KTL) Un-Biased	1.41E-08	1.61E-08	1.83E-08	2.14E-08	2.67E-08	2.69E-08	2.44E-08
Ps90%/90% (-KTL) Un-Biased	1.06E-08	1.21E-08	1.40E-08	1.58E-08	2.00E-08	2.01E-08	1.82E-08
Specification MIN	-5.00E-08	-8.00E-08	-1.00E-07	-1.00E-07	-1.25E-07	-1.25E-07	-1.25E-07
Status	PASS	PASS	PASS	PASS	PASS	PASS	PASS
Specification MAX	5.00E-08	8.00E-08	1.00E-07	1.00E-07	1.25E-07	1.25E-07	1.25E-07
Status	PASS	PASS	PASS	PASS	PASS	PASS	PASS

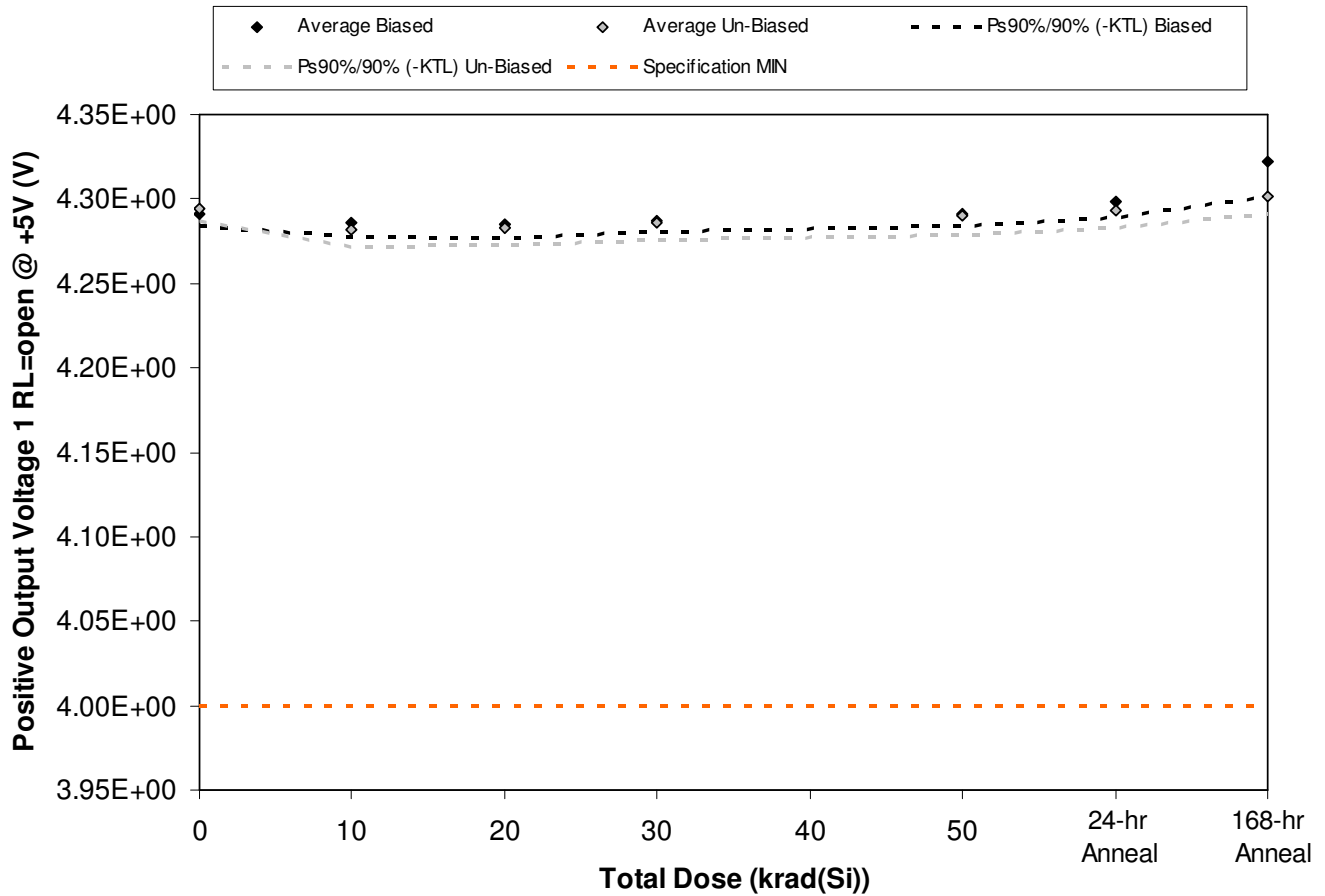

Figure 5.65. Plot of Positive Output Voltage 1 RL=open @ +5V (V) versus total dose. The solid diamonds are the average of the measured data points for the samples irradiated under electrical bias while the shaded diamonds are the average of the measured data points for the samples irradiated with all pins tied to ground. The black lines (solid and/or dashed) are the average of the data points after application of the KTL statistics on the samples irradiated under electrical bias while the gray lines (solid and/or dashed) are the average of the data points after application of the KTL statistics on the samples irradiated in the unbiased condition. The red dotted line(s) are the pre- and/or post-irradiation minimum and/or maximum specification value as defined in the datasheet and/or test plan.



**TID Report
11-572 R1.0**

**Aeroflex RAD
5017 N. 30th Street
Colorado Springs, CO 80919
(719) 531-0800**

Table 5.65. Raw data for Positive Output Voltage 1 RL=open @ +5V (V) versus total dose, including the statistical analysis, specification and the status of the testing (pass/fail).

Positive Output Voltage 1 RL=open @ +5V (V)	Total Dose (krad(Si))					24 hr	168 hr
	0	10	20	30	50	Anneal	Anneal
Device							
	10/20/2011	11/3/2011	11/3/2011	11/3/2011	11/3/2011	11/4/2011	11/11/2011
1831	4.29E+00	4.28E+00	4.28E+00	4.29E+00	4.29E+00	4.30E+00	4.32E+00
1832	4.29E+00	4.29E+00	4.28E+00	4.29E+00	4.29E+00	4.30E+00	4.32E+00
1833	4.30E+00	4.29E+00	4.29E+00	4.29E+00	4.30E+00	4.30E+00	4.33E+00
1834	4.29E+00	4.29E+00	4.29E+00	4.29E+00	4.29E+00	4.30E+00	4.32E+00
1835	4.29E+00	4.28E+00	4.28E+00	4.29E+00	4.29E+00	4.30E+00	4.32E+00
1836	4.30E+00	4.28E+00	4.28E+00	4.28E+00	4.29E+00	4.29E+00	4.30E+00
1837	4.29E+00	4.28E+00	4.28E+00	4.28E+00	4.29E+00	4.29E+00	4.30E+00
1838	4.29E+00	4.28E+00	4.28E+00	4.28E+00	4.29E+00	4.29E+00	4.30E+00
1839	4.30E+00	4.29E+00	4.29E+00	4.29E+00	4.30E+00	4.30E+00	4.31E+00
1840	4.30E+00	4.28E+00	4.28E+00	4.29E+00	4.29E+00	4.29E+00	4.30E+00
1851	4.30E+00	4.30E+00	4.30E+00	4.30E+00	4.30E+00	4.30E+00	4.30E+00
1852	4.28E+00	4.29E+00	4.29E+00	4.29E+00	4.29E+00	4.28E+00	4.28E+00
Biased Statistics							
Average Biased	4.29E+00	4.29E+00	4.28E+00	4.29E+00	4.29E+00	4.30E+00	4.32E+00
Std Dev Biased	2.68E-03	3.21E-03	2.97E-03	2.17E-03	2.86E-03	3.56E-03	7.46E-03
Ps90%/90% (+KTL) Biased	4.30E+00	4.30E+00	4.29E+00	4.29E+00	4.30E+00	4.31E+00	4.34E+00
Ps90%/90% (-KTL) Biased	4.28E+00	4.28E+00	4.28E+00	4.28E+00	4.28E+00	4.29E+00	4.30E+00
Un-Biased Statistics							
Average Un-Biased	4.29E+00	4.28E+00	4.28E+00	4.29E+00	4.29E+00	4.29E+00	4.30E+00
Std Dev Un-Biased	2.97E-03	3.63E-03	3.74E-03	3.78E-03	4.09E-03	3.97E-03	3.77E-03
Ps90%/90% (+KTL) Un-Biased	4.30E+00	4.29E+00	4.29E+00	4.30E+00	4.30E+00	4.30E+00	4.31E+00
Ps90%/90% (-KTL) Un-Biased	4.29E+00	4.27E+00	4.27E+00	4.28E+00	4.28E+00	4.28E+00	4.29E+00
Specification MIN	4.00E+00	4.00E+00	4.00E+00	4.00E+00	4.00E+00	4.00E+00	4.00E+00
Status	PASS	PASS	PASS	PASS	PASS	PASS	PASS

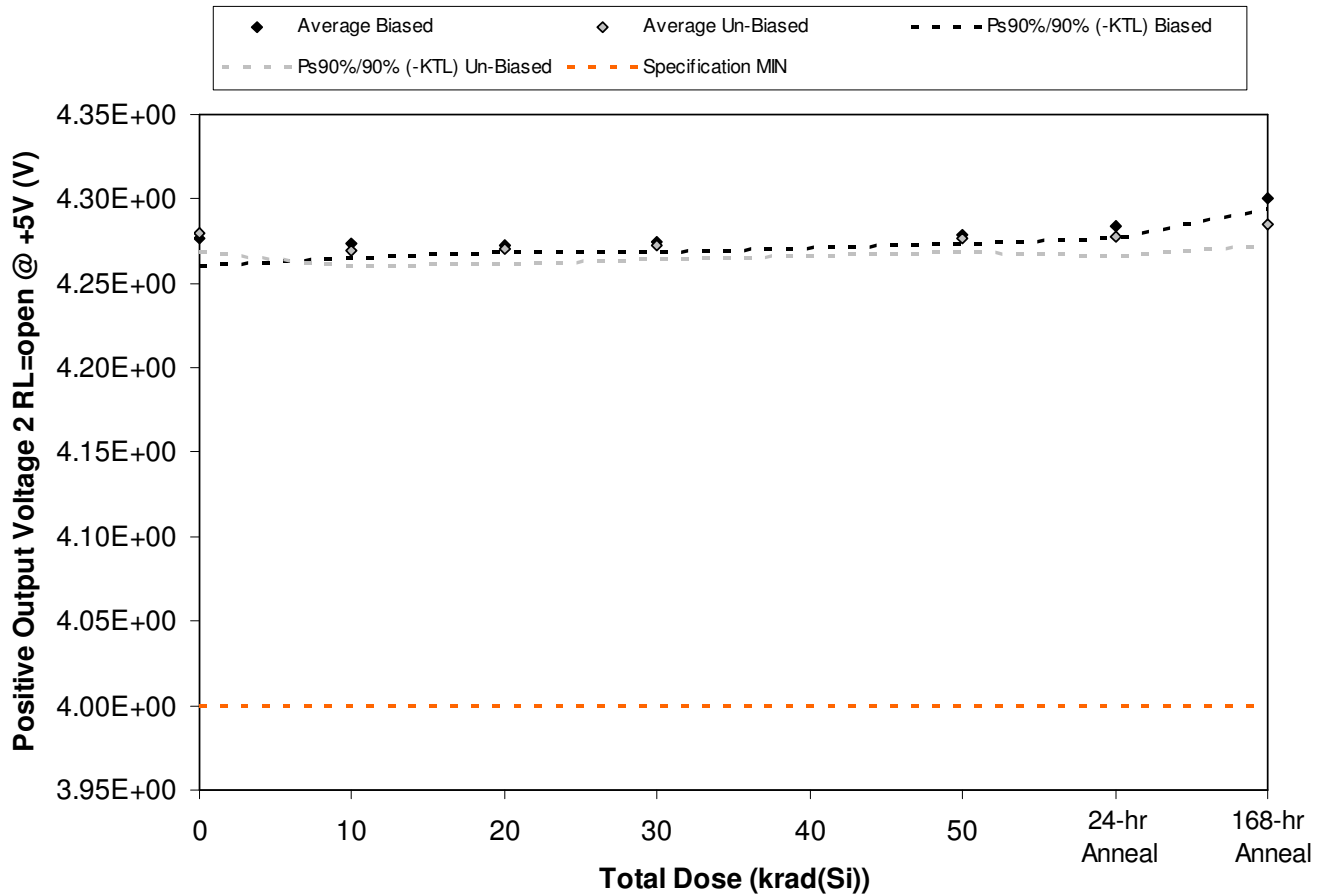

Figure 5.66. Plot of Positive Output Voltage 2 RL=open @ +5V (V) versus total dose. The solid diamonds are the average of the measured data points for the samples irradiated under electrical bias while the shaded diamonds are the average of the measured data points for the samples irradiated with all pins tied to ground. The black lines (solid and/or dashed) are the average of the data points after application of the KTL statistics on the samples irradiated under electrical bias while the gray lines (solid and/or dashed) are the average of the data points after application of the KTL statistics on the samples irradiated in the unbiased condition. The red dotted line(s) are the pre- and/or post-irradiation minimum and/or maximum specification value as defined in the datasheet and/or test plan.



**TID Report
11-572 R1.0**

**Aeroflex RAD
5017 N. 30th Street
Colorado Springs, CO 80919
(719) 531-0800**

Table 5.66. Raw data for Positive Output Voltage 2 RL=open @ +5V (V) versus total dose, including the statistical analysis, specification and the status of the testing (pass/fail).

Positive Output Voltage 2 RL=open @ +5V (V)	Total Dose (krad(Si))					24 hr	168 hr
	0	10	20	30	50	Anneal	Anneal
Device							
	10/20/2011	11/3/2011	11/3/2011	11/3/2011	11/3/2011	11/4/2011	11/11/2011
1831	4.28E+00	4.27E+00	4.27E+00	4.27E+00	4.28E+00	4.28E+00	4.30E+00
1832	4.27E+00	4.28E+00	4.27E+00	4.27E+00	4.28E+00	4.28E+00	4.30E+00
1833	4.28E+00	4.27E+00	4.27E+00	4.27E+00	4.28E+00	4.28E+00	4.30E+00
1834	4.28E+00	4.28E+00	4.27E+00	4.28E+00	4.28E+00	4.29E+00	4.30E+00
1835	4.28E+00	4.28E+00	4.28E+00	4.28E+00	4.28E+00	4.29E+00	4.30E+00
1836	4.29E+00	4.28E+00	4.28E+00	4.28E+00	4.28E+00	4.28E+00	4.29E+00
1837	4.28E+00	4.27E+00	4.27E+00	4.27E+00	4.27E+00	4.28E+00	4.28E+00
1838	4.28E+00	4.27E+00	4.27E+00	4.27E+00	4.28E+00	4.28E+00	4.28E+00
1839	4.28E+00	4.27E+00	4.27E+00	4.27E+00	4.27E+00	4.28E+00	4.28E+00
1840	4.28E+00	4.27E+00	4.27E+00	4.27E+00	4.28E+00	4.28E+00	4.29E+00
1851	4.28E+00	4.28E+00	4.29E+00	4.29E+00	4.29E+00	4.28E+00	4.28E+00
1852	4.27E+00	4.27E+00	4.27E+00	4.27E+00	4.27E+00	4.27E+00	4.27E+00
Biased Statistics							
Average Biased	4.28E+00	4.27E+00	4.27E+00	4.27E+00	4.28E+00	4.28E+00	4.30E+00
Std Dev Biased	6.12E-03	3.08E-03	1.67E-03	2.19E-03	2.00E-03	2.77E-03	2.28E-03
Ps90%/90% (+KTL) Biased	4.29E+00	4.28E+00	4.28E+00	4.28E+00	4.28E+00	4.29E+00	4.31E+00
Ps90%/90% (-KTL) Biased	4.26E+00	4.27E+00	4.27E+00	4.27E+00	4.27E+00	4.28E+00	4.29E+00
Un-Biased Statistics							
Average Un-Biased	4.28E+00	4.27E+00	4.27E+00	4.27E+00	4.28E+00	4.28E+00	4.28E+00
Std Dev Un-Biased	4.09E-03	3.58E-03	3.39E-03	3.13E-03	3.05E-03	3.91E-03	4.16E-03
Ps90%/90% (+KTL) Un-Biased	4.29E+00	4.28E+00	4.28E+00	4.28E+00	4.28E+00	4.29E+00	4.30E+00
Ps90%/90% (-KTL) Un-Biased	4.27E+00	4.26E+00	4.26E+00	4.26E+00	4.27E+00	4.27E+00	4.27E+00
Specification MIN	4.00E+00	4.00E+00	4.00E+00	4.00E+00	4.00E+00	4.00E+00	4.00E+00
Status	PASS	PASS	PASS	PASS	PASS	PASS	PASS

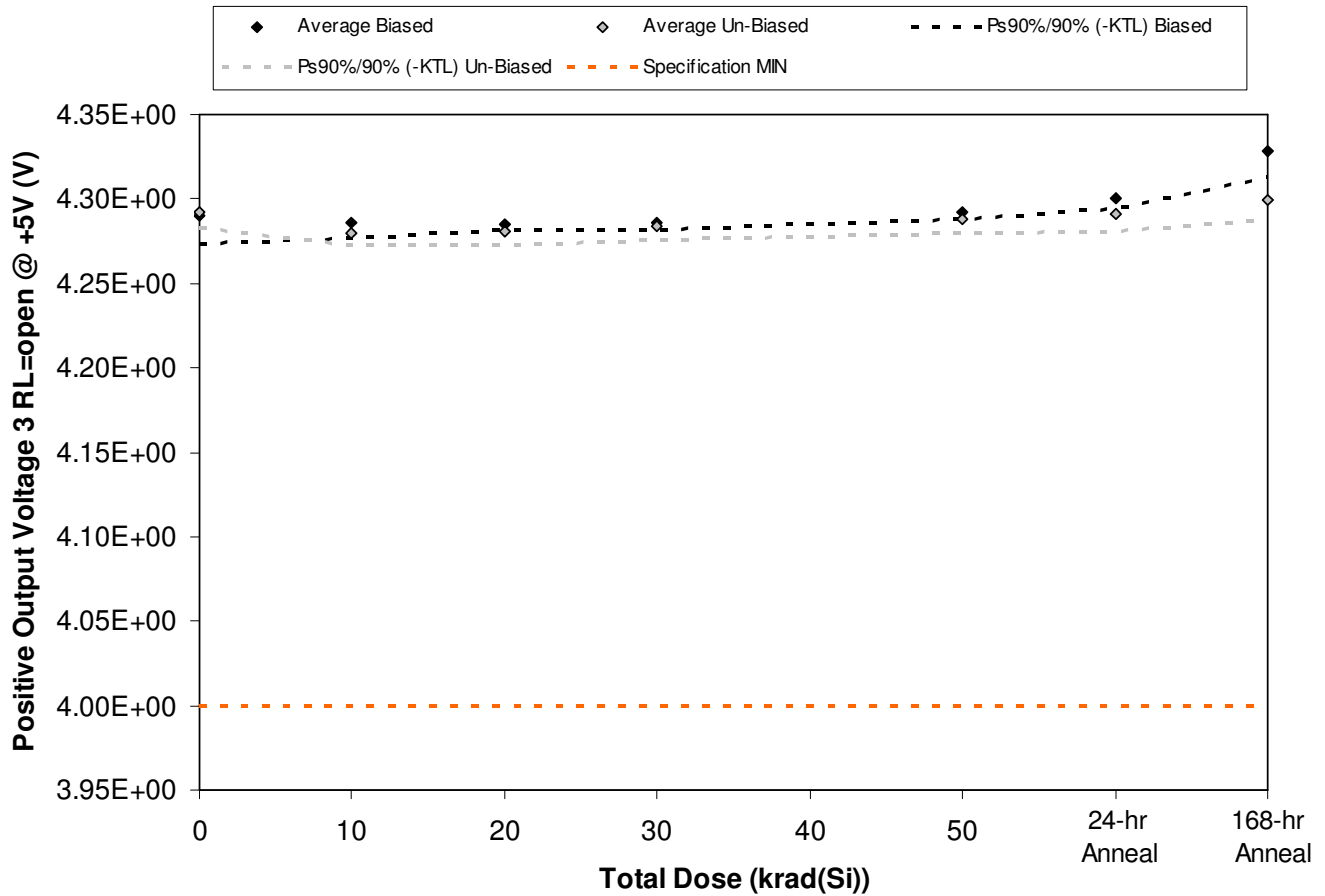

Figure 5.67. Plot of Positive Output Voltage 3 RL=open @ +5V (V) versus total dose. The solid diamonds are the average of the measured data points for the samples irradiated under electrical bias while the shaded diamonds are the average of the measured data points for the samples irradiated with all pins tied to ground. The black lines (solid and/or dashed) are the average of the data points after application of the KTL statistics on the samples irradiated under electrical bias while the gray lines (solid and/or dashed) are the average of the data points after application of the KTL statistics on the samples irradiated in the unbiased condition. The red dotted line(s) are the pre- and/or post-irradiation minimum and/or maximum specification value as defined in the datasheet and/or test plan.



**TID Report
11-572 R1.0**

**Aeroflex RAD
5017 N. 30th Street
Colorado Springs, CO 80919
(719) 531-0800**

Table 5.67. Raw data for Positive Output Voltage 3 RL=open @ +5V (V) versus total dose, including the statistical analysis, specification and the status of the testing (pass/fail).

Positive Output Voltage 3 RL=open @ +5V (V)	Total Dose (krad(Si))					24 hr Anneal	168 hr Anneal
	0	10	20	30	50		
Device	10/20/2011	11/3/2011	11/3/2011	11/3/2011	11/3/2011	11/4/2011	11/11/2011
1831	4.29E+00	4.28E+00	4.28E+00	4.29E+00	4.29E+00	4.30E+00	4.32E+00
1832	4.28E+00	4.29E+00	4.29E+00	4.29E+00	4.29E+00	4.30E+00	4.33E+00
1833	4.29E+00	4.29E+00	4.28E+00	4.29E+00	4.29E+00	4.30E+00	4.32E+00
1834	4.29E+00	4.29E+00	4.28E+00	4.29E+00	4.29E+00	4.30E+00	4.33E+00
1835	4.30E+00	4.29E+00	4.29E+00	4.29E+00	4.30E+00	4.30E+00	4.33E+00
1836	4.30E+00	4.29E+00	4.29E+00	4.29E+00	4.29E+00	4.30E+00	4.31E+00
1837	4.29E+00	4.28E+00	4.28E+00	4.28E+00	4.29E+00	4.29E+00	4.30E+00
1838	4.29E+00	4.28E+00	4.28E+00	4.28E+00	4.29E+00	4.29E+00	4.30E+00
1839	4.29E+00	4.28E+00	4.28E+00	4.28E+00	4.29E+00	4.29E+00	4.30E+00
1840	4.29E+00	4.28E+00	4.28E+00	4.28E+00	4.29E+00	4.29E+00	4.30E+00
1851	4.30E+00	4.30E+00	4.30E+00	4.30E+00	4.30E+00	4.30E+00	4.30E+00
1852	4.28E+00	4.28E+00	4.28E+00	4.28E+00	4.28E+00	4.28E+00	4.28E+00
Biased Statistics							
Average Biased	4.29E+00	4.29E+00	4.28E+00	4.29E+00	4.29E+00	4.30E+00	4.33E+00
Std Dev Biased	6.00E-03	3.63E-03	1.14E-03	1.52E-03	1.67E-03	2.41E-03	5.31E-03
Ps90%/90% (+KTL) Biased	4.31E+00	4.30E+00	4.29E+00	4.29E+00	4.30E+00	4.31E+00	4.34E+00
Ps90%/90% (-KTL) Biased	4.27E+00	4.28E+00	4.28E+00	4.28E+00	4.29E+00	4.29E+00	4.31E+00
Un-Biased Statistics							
Average Un-Biased	4.29E+00	4.28E+00	4.28E+00	4.28E+00	4.29E+00	4.29E+00	4.30E+00
Std Dev Un-Biased	3.27E-03	2.92E-03	2.95E-03	3.11E-03	2.92E-03	3.91E-03	4.32E-03
Ps90%/90% (+KTL) Un-Biased	4.30E+00	4.29E+00	4.29E+00	4.29E+00	4.30E+00	4.30E+00	4.31E+00
Ps90%/90% (-KTL) Un-Biased	4.28E+00	4.27E+00	4.27E+00	4.28E+00	4.28E+00	4.28E+00	4.29E+00
Specification MIN	4.00E+00	4.00E+00	4.00E+00	4.00E+00	4.00E+00	4.00E+00	4.00E+00
Status	PASS	PASS	PASS	PASS	PASS	PASS	PASS

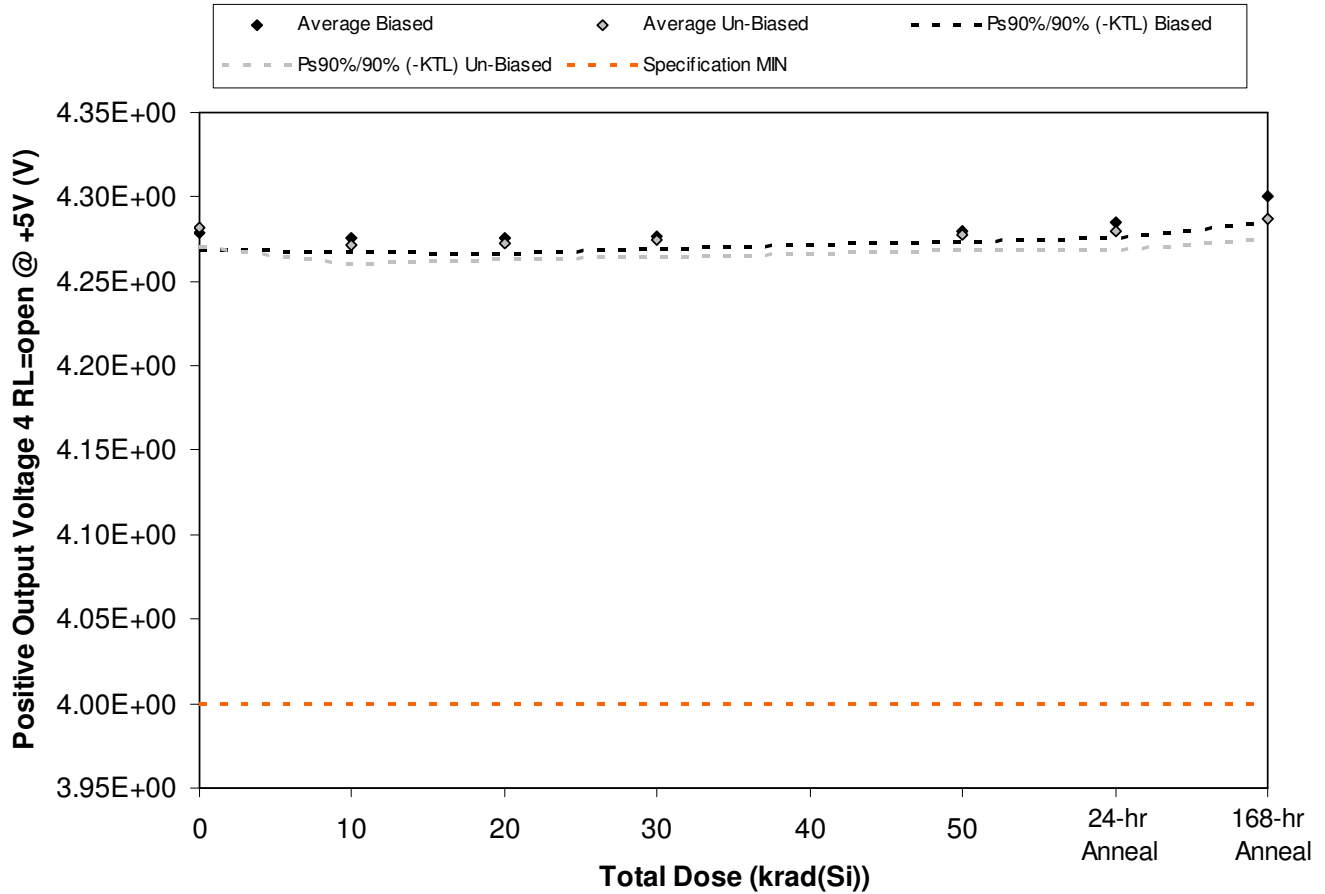

Figure 5.68. Plot of Positive Output Voltage 4 RL=open @ +5V (V) versus total dose. The solid diamonds are the average of the measured data points for the samples irradiated under electrical bias while the shaded diamonds are the average of the measured data points for the samples irradiated with all pins tied to ground. The black lines (solid and/or dashed) are the average of the data points after application of the KTL statistics on the samples irradiated under electrical bias while the gray lines (solid and/or dashed) are the average of the data points after application of the KTL statistics on the samples irradiated in the unbiased condition. The red dotted line(s) are the pre- and/or post-irradiation minimum and/or maximum specification value as defined in the datasheet and/or test plan.



**TID Report
11-572 R1.0**

**Aeroflex RAD
5017 N. 30th Street
Colorado Springs, CO 80919
(719) 531-0800**

Table 5.68. Raw data for Positive Output Voltage 4 RL=open @ +5V (V) versus total dose, including the statistical analysis, specification and the status of the testing (pass/fail).

Positive Output Voltage 4 RL=open @ +5V (V)	Total Dose (krad(Si))					24 hr	168 hr
	0	10	20	30	50	Anneal	Anneal
Device							
	10/20/2011	11/3/2011	11/3/2011	11/3/2011	11/3/2011	11/4/2011	11/11/2011
1831	4.28E+00	4.28E+00	4.28E+00	4.28E+00	4.28E+00	4.28E+00	4.30E+00
1832	4.28E+00	4.28E+00	4.27E+00	4.28E+00	4.28E+00	4.28E+00	4.30E+00
1833	4.29E+00	4.28E+00	4.28E+00	4.28E+00	4.28E+00	4.29E+00	4.31E+00
1834	4.28E+00	4.28E+00	4.28E+00	4.28E+00	4.28E+00	4.29E+00	4.30E+00
1835	4.28E+00	4.27E+00	4.27E+00	4.27E+00	4.28E+00	4.28E+00	4.29E+00
1836	4.28E+00	4.27E+00	4.27E+00	4.27E+00	4.28E+00	4.28E+00	4.29E+00
1837	4.28E+00	4.27E+00	4.27E+00	4.28E+00	4.28E+00	4.28E+00	4.29E+00
1838	4.28E+00	4.27E+00	4.27E+00	4.27E+00	4.27E+00	4.28E+00	4.28E+00
1839	4.29E+00	4.28E+00	4.28E+00	4.28E+00	4.28E+00	4.29E+00	4.29E+00
1840	4.28E+00	4.27E+00	4.27E+00	4.27E+00	4.28E+00	4.28E+00	4.29E+00
1851	4.28E+00	4.28E+00	4.29E+00	4.29E+00	4.29E+00	4.28E+00	4.28E+00
1852	4.27E+00	4.27E+00	4.28E+00	4.28E+00	4.28E+00	4.27E+00	4.27E+00
Biased Statistics							
Average Biased	4.28E+00	4.28E+00	4.28E+00	4.28E+00	4.28E+00	4.29E+00	4.30E+00
Std Dev Biased	3.94E-03	3.27E-03	3.11E-03	2.70E-03	2.59E-03	3.56E-03	5.52E-03
Ps90%/90% (+KTL) Biased	4.29E+00	4.28E+00	4.28E+00	4.28E+00	4.29E+00	4.29E+00	4.32E+00
Ps90%/90% (-KTL) Biased	4.27E+00	4.27E+00	4.27E+00	4.27E+00	4.27E+00	4.28E+00	4.28E+00
Un-Biased Statistics							
Average Un-Biased	4.28E+00	4.27E+00	4.27E+00	4.27E+00	4.28E+00	4.28E+00	4.29E+00
Std Dev Un-Biased	4.36E-03	4.28E-03	3.58E-03	3.96E-03	3.67E-03	4.06E-03	4.30E-03
Ps90%/90% (+KTL) Un-Biased	4.29E+00	4.28E+00	4.28E+00	4.29E+00	4.29E+00	4.29E+00	4.30E+00
Ps90%/90% (-KTL) Un-Biased	4.27E+00	4.26E+00	4.26E+00	4.26E+00	4.27E+00	4.27E+00	4.28E+00
Specification MIN	4.00E+00	4.00E+00	4.00E+00	4.00E+00	4.00E+00	4.00E+00	4.00E+00
Status	PASS	PASS	PASS	PASS	PASS	PASS	PASS

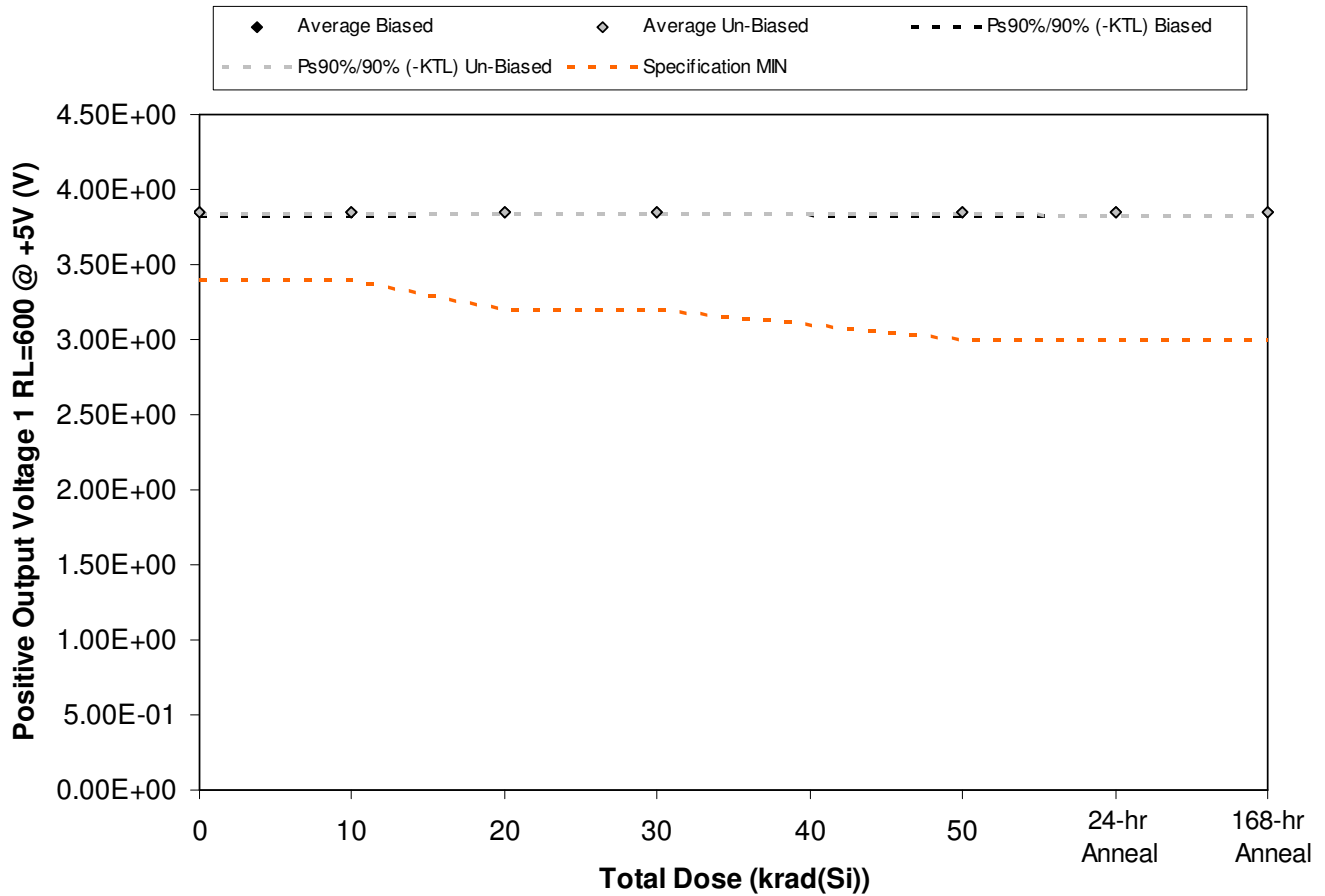

Figure 5.69. Plot of Positive Output Voltage 1 RL=600 @ +5V (V) versus total dose. The solid diamonds are the average of the measured data points for the samples irradiated under electrical bias while the shaded diamonds are the average of the measured data points for the samples irradiated with all pins tied to ground. The black lines (solid and/or dashed) are the average of the data points after application of the KTL statistics on the samples irradiated under electrical bias while the gray lines (solid and/or dashed) are the average of the data points after application of the KTL statistics on the samples irradiated in the unbiased condition. The red dotted line(s) are the pre- and/or post-irradiation minimum and/or maximum specification value as defined in the datasheet and/or test plan.



**TID Report
11-572 R1.0**

**Aeroflex RAD
5017 N. 30th Street
Colorado Springs, CO 80919
(719) 531-0800**

Table 5.69. Raw data for Positive Output Voltage 1 RL=600 @ +5V (V) versus total dose, including the statistical analysis, specification and the status of the testing (pass/fail).

Positive Output Voltage 1 RL=600 @ +5V (V)	Total Dose (krad(Si))					24 hr	168 hr
	0	10	20	30	50	Anneal	Anneal
Device							
	10/20/2011	11/3/2011	11/3/2011	11/3/2011	11/3/2011	11/4/2011	11/11/2011
1831	3.84E+00	3.84E+00	3.84E+00	3.84E+00	3.84E+00	3.84E+00	3.84E+00
1832	3.84E+00	3.84E+00	3.84E+00	3.84E+00	3.84E+00	3.84E+00	3.84E+00
1833	3.84E+00	3.85E+00	3.85E+00	3.85E+00	3.85E+00	3.84E+00	3.84E+00
1834	3.85E+00	3.85E+00	3.85E+00	3.85E+00	3.85E+00	3.85E+00	3.85E+00
1835	3.85E+00	3.85E+00	3.85E+00	3.85E+00	3.85E+00	3.85E+00	3.85E+00
1836	3.85E+00	3.85E+00	3.85E+00	3.85E+00	3.84E+00	3.84E+00	3.84E+00
1837	3.84E+00	3.85E+00	3.85E+00	3.85E+00	3.85E+00	3.84E+00	3.84E+00
1838	3.84E+00	3.85E+00	3.85E+00	3.84E+00	3.84E+00	3.84E+00	3.84E+00
1839	3.86E+00	3.86E+00	3.86E+00	3.86E+00	3.86E+00	3.85E+00	3.85E+00
1840	3.85E+00	3.85E+00	3.85E+00	3.85E+00	3.85E+00	3.84E+00	3.84E+00
1851	3.85E+00	3.85E+00	3.85E+00	3.85E+00	3.85E+00	3.85E+00	3.85E+00
1852	3.85E+00	3.85E+00	3.85E+00	3.85E+00	3.85E+00	3.85E+00	3.85E+00
Biased Statistics							
Average Biased	3.84E+00	3.85E+00	3.85E+00	3.85E+00	3.85E+00	3.84E+00	3.84E+00
Std Dev Biased	5.87E-03	5.74E-03	5.41E-03	5.26E-03	5.55E-03	5.86E-03	5.27E-03
Ps90%/90% (+KTL) Biased	3.86E+00	3.86E+00	3.86E+00	3.86E+00	3.86E+00	3.86E+00	3.86E+00
Ps90%/90% (-KTL) Biased	3.83E+00	3.83E+00	3.83E+00	3.83E+00	3.83E+00	3.83E+00	3.83E+00
Un-Biased Statistics							
Average Un-Biased	3.85E+00	3.85E+00	3.85E+00	3.85E+00	3.85E+00	3.84E+00	3.84E+00
Std Dev Un-Biased	5.26E-03	4.88E-03	4.88E-03	5.59E-03	5.32E-03	5.22E-03	4.98E-03
Ps90%/90% (+KTL) Un-Biased	3.86E+00	3.86E+00	3.86E+00	3.86E+00	3.86E+00	3.86E+00	3.86E+00
Ps90%/90% (-KTL) Un-Biased	3.83E+00	3.84E+00	3.84E+00	3.83E+00	3.83E+00	3.83E+00	3.83E+00
Specification MIN	3.40E+00	3.40E+00	3.20E+00	3.20E+00	3.00E+00	3.00E+00	3.00E+00
Status	PASS	PASS	PASS	PASS	PASS	PASS	PASS

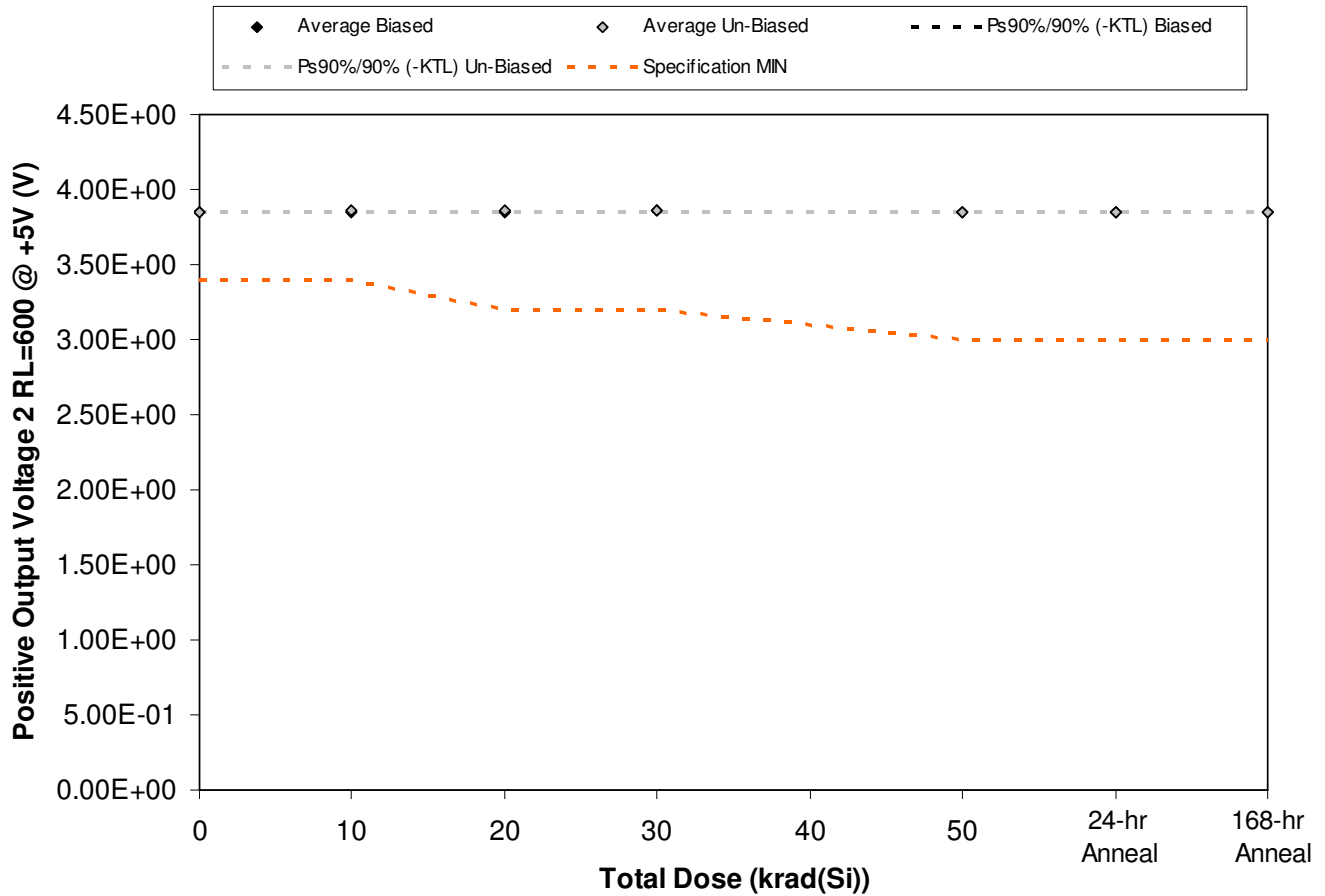

Figure 5.70. Plot of Positive Output Voltage 2 RL=600 @ +5V (V) versus total dose. The solid diamonds are the average of the measured data points for the samples irradiated under electrical bias while the shaded diamonds are the average of the measured data points for the samples irradiated with all pins tied to ground. The black lines (solid and/or dashed) are the average of the data points after application of the KTL statistics on the samples irradiated under electrical bias while the gray lines (solid and/or dashed) are the average of the data points after application of the KTL statistics on the samples irradiated in the unbiased condition. The red dotted line(s) are the pre- and/or post-irradiation minimum and/or maximum specification value as defined in the datasheet and/or test plan.



**TID Report
11-572 R1.0**

**Aeroflex RAD
5017 N. 30th Street
Colorado Springs, CO 80919
(719) 531-0800**

Table 5.70. Raw data for Positive Output Voltage 2 RL=600 @ +5V (V) versus total dose, including the statistical analysis, specification and the status of the testing (pass/fail).

Positive Output Voltage 2 RL=600 @ +5V (V)	Total Dose (krad(Si))					24 hr	168 hr
	0	10	20	30	50	Anneal	Anneal
Device							
	10/20/2011	11/3/2011	11/3/2011	11/3/2011	11/3/2011	11/4/2011	11/11/2011
1831	3.85E+00	3.86E+00	3.86E+00	3.86E+00	3.86E+00	3.85E+00	3.85E+00
1832	3.85E+00	3.86E+00	3.86E+00	3.86E+00	3.86E+00	3.85E+00	3.85E+00
1833	3.85E+00	3.85E+00	3.85E+00	3.85E+00	3.85E+00	3.85E+00	3.85E+00
1834	3.85E+00	3.85E+00	3.85E+00	3.85E+00	3.85E+00	3.85E+00	3.85E+00
1835	3.85E+00	3.86E+00	3.86E+00	3.86E+00	3.85E+00	3.85E+00	3.85E+00
1836	3.86E+00	3.86E+00	3.86E+00	3.86E+00	3.86E+00	3.86E+00	3.86E+00
1837	3.85E+00	3.85E+00	3.85E+00	3.85E+00	3.85E+00	3.85E+00	3.85E+00
1838	3.85E+00	3.86E+00	3.86E+00	3.86E+00	3.85E+00	3.85E+00	3.85E+00
1839	3.85E+00	3.86E+00	3.86E+00	3.86E+00	3.85E+00	3.85E+00	3.85E+00
1840	3.86E+00	3.86E+00	3.86E+00	3.86E+00	3.86E+00	3.85E+00	3.85E+00
1851	3.86E+00	3.86E+00	3.86E+00	3.86E+00	3.86E+00	3.86E+00	3.86E+00
1852	3.85E+00	3.85E+00	3.85E+00	3.85E+00	3.85E+00	3.85E+00	3.85E+00
Biased Statistics							
Average Biased	3.85E+00	3.85E+00	3.85E+00	3.85E+00	3.85E+00	3.85E+00	3.85E+00
Std Dev Biased	1.58E-03	1.41E-03	1.52E-03	1.48E-03	2.07E-03	1.30E-03	1.58E-03
Ps90%/90% (+KTL) Biased	3.86E+00	3.86E+00	3.86E+00	3.86E+00	3.86E+00	3.86E+00	3.86E+00
Ps90%/90% (-KTL) Biased	3.85E+00	3.85E+00	3.85E+00	3.85E+00	3.85E+00	3.85E+00	3.85E+00
Un-Biased Statistics							
Average Un-Biased	3.85E+00	3.86E+00	3.86E+00	3.86E+00	3.85E+00	3.85E+00	3.85E+00
Std Dev Un-Biased	2.59E-03	2.59E-03	2.59E-03	2.59E-03	2.59E-03	2.77E-03	2.35E-03
Ps90%/90% (+KTL) Un-Biased	3.86E+00	3.86E+00	3.86E+00	3.86E+00	3.86E+00	3.86E+00	3.86E+00
Ps90%/90% (-KTL) Un-Biased	3.85E+00	3.85E+00	3.85E+00	3.85E+00	3.85E+00	3.84E+00	3.85E+00
Specification MIN	3.40E+00	3.40E+00	3.20E+00	3.20E+00	3.00E+00	3.00E+00	3.00E+00
Status	PASS	PASS	PASS	PASS	PASS	PASS	PASS

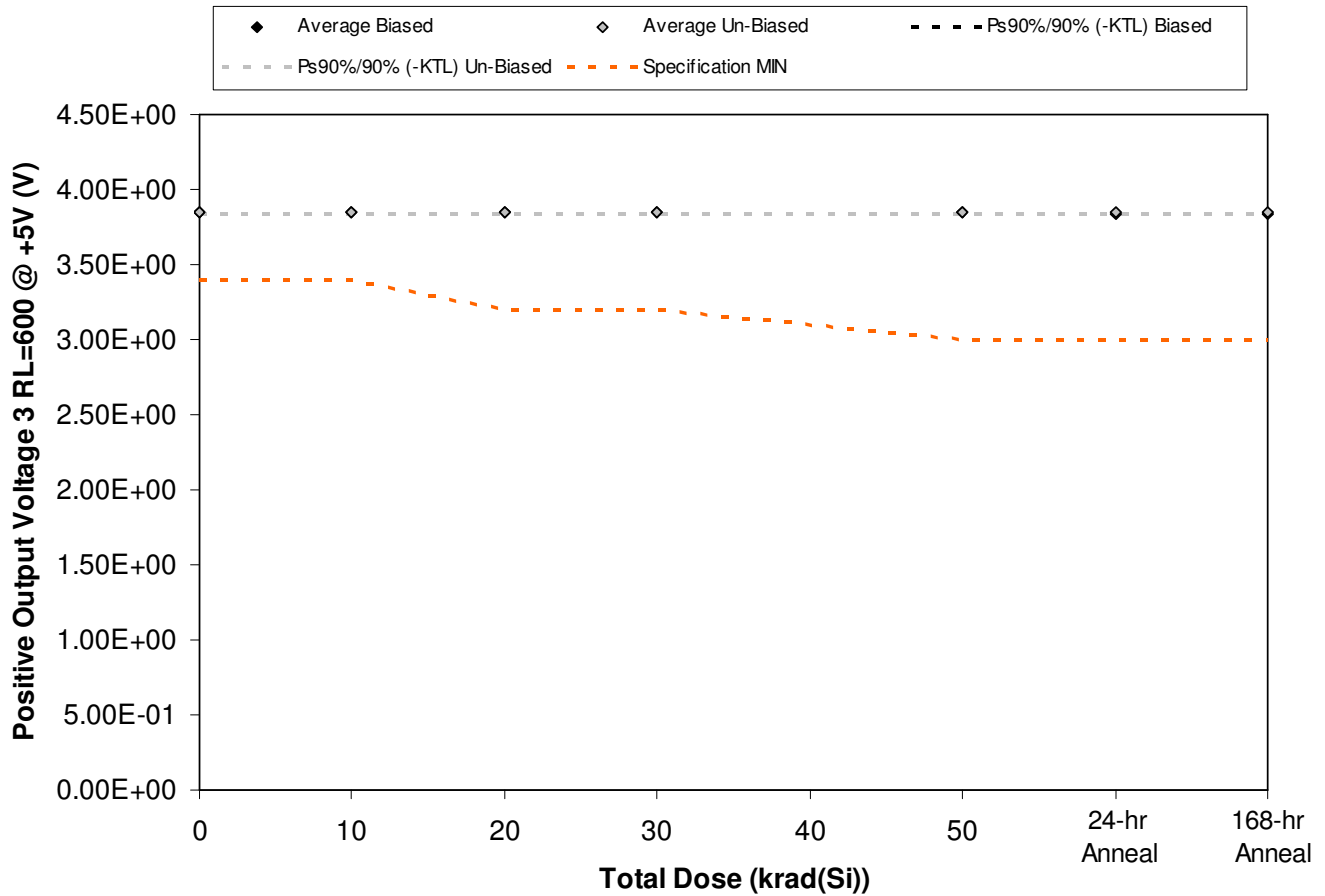

Figure 5.71. Plot of Positive Output Voltage 3 RL=600 @ +5V (V) versus total dose. The solid diamonds are the average of the measured data points for the samples irradiated under electrical bias while the shaded diamonds are the average of the measured data points for the samples irradiated with all pins tied to ground. The black lines (solid and/or dashed) are the average of the data points after application of the KTL statistics on the samples irradiated under electrical bias while the gray lines (solid and/or dashed) are the average of the data points after application of the KTL statistics on the samples irradiated in the unbiased condition. The red dotted line(s) are the pre- and/or post-irradiation minimum and/or maximum specification value as defined in the datasheet and/or test plan.



**TID Report
11-572 R1.0**

**Aeroflex RAD
5017 N. 30th Street
Colorado Springs, CO 80919
(719) 531-0800**

Table 5.71. Raw data for Positive Output Voltage 3 RL=600 @ +5V (V) versus total dose, including the statistical analysis, specification and the status of the testing (pass/fail).

Positive Output Voltage 3 RL=600 @ +5V (V)	Total Dose (krad(Si))					24 hr	168 hr
	0	10	20	30	50	Anneal	Anneal
Device							
	10/20/2011	11/3/2011	11/3/2011	11/3/2011	11/3/2011	11/4/2011	11/11/2011
1831	3.84E+00	3.84E+00	3.84E+00	3.84E+00	3.84E+00	3.84E+00	3.84E+00
1832	3.85E+00	3.85E+00	3.85E+00	3.85E+00	3.85E+00	3.84E+00	3.84E+00
1833	3.84E+00	3.84E+00	3.85E+00	3.85E+00	3.84E+00	3.84E+00	3.84E+00
1834	3.84E+00	3.85E+00	3.85E+00	3.85E+00	3.85E+00	3.84E+00	3.84E+00
1835	3.85E+00	3.85E+00	3.85E+00	3.85E+00	3.85E+00	3.84E+00	3.84E+00
1836	3.85E+00	3.85E+00	3.85E+00	3.85E+00	3.85E+00	3.85E+00	3.85E+00
1837	3.84E+00	3.85E+00	3.85E+00	3.85E+00	3.84E+00	3.84E+00	3.84E+00
1838	3.84E+00	3.85E+00	3.85E+00	3.85E+00	3.84E+00	3.84E+00	3.84E+00
1839	3.85E+00	3.85E+00	3.85E+00	3.85E+00	3.85E+00	3.84E+00	3.84E+00
1840	3.85E+00	3.85E+00	3.85E+00	3.85E+00	3.85E+00	3.84E+00	3.85E+00
1851	3.85E+00	3.85E+00	3.85E+00	3.85E+00	3.85E+00	3.85E+00	3.85E+00
1852	3.84E+00	3.84E+00	3.84E+00	3.84E+00	3.84E+00	3.84E+00	3.84E+00
Biased Statistics							
Average Biased	3.84E+00	3.85E+00	3.85E+00	3.85E+00	3.84E+00	3.84E+00	3.84E+00
Std Dev Biased	1.82E-03	1.58E-03	1.34E-03	1.22E-03	1.30E-03	1.52E-03	1.14E-03
Ps90%/90% (+KTL) Biased	3.85E+00	3.85E+00	3.85E+00	3.85E+00	3.85E+00	3.85E+00	3.85E+00
Ps90%/90% (-KTL) Biased	3.84E+00	3.84E+00	3.84E+00	3.84E+00	3.84E+00	3.84E+00	3.84E+00
Un-Biased Statistics							
Average Un-Biased	3.85E+00	3.85E+00	3.85E+00	3.85E+00	3.85E+00	3.84E+00	3.84E+00
Std Dev Un-Biased	2.95E-03	2.49E-03	2.49E-03	2.61E-03	2.61E-03	3.11E-03	3.21E-03
Ps90%/90% (+KTL) Un-Biased	3.85E+00	3.85E+00	3.85E+00	3.85E+00	3.85E+00	3.85E+00	3.85E+00
Ps90%/90% (-KTL) Un-Biased	3.84E+00	3.84E+00	3.84E+00	3.84E+00	3.84E+00	3.83E+00	3.83E+00
Specification MIN	3.40E+00	3.40E+00	3.20E+00	3.20E+00	3.00E+00	3.00E+00	3.00E+00
Status	PASS	PASS	PASS	PASS	PASS	PASS	PASS

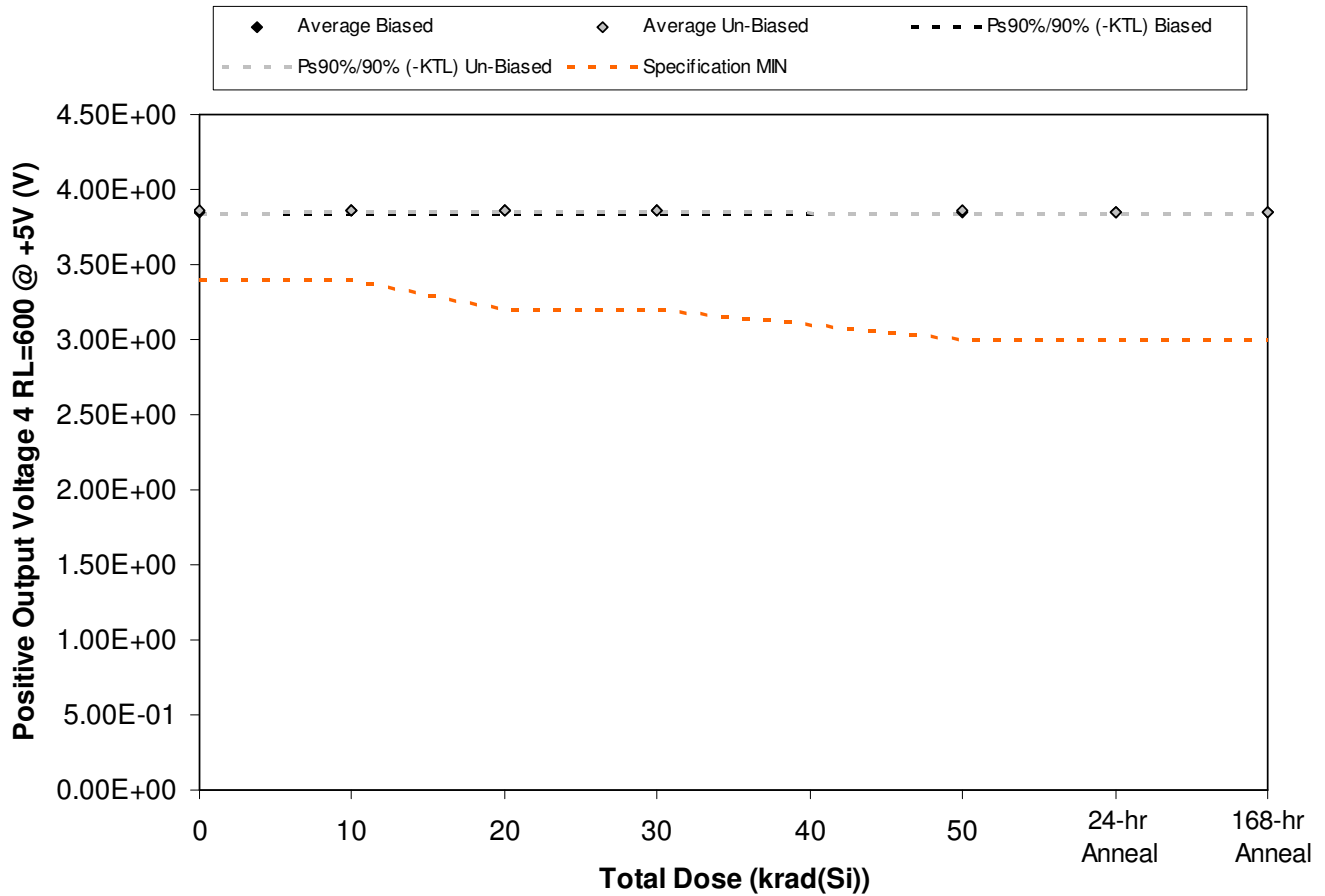

Figure 5.72. Plot of Positive Output Voltage 4 RL=600 @ +5V (V) versus total dose. The solid diamonds are the average of the measured data points for the samples irradiated under electrical bias while the shaded diamonds are the average of the measured data points for the samples irradiated with all pins tied to ground. The black lines (solid and/or dashed) are the average of the data points after application of the KTL statistics on the samples irradiated under electrical bias while the gray lines (solid and/or dashed) are the average of the data points after application of the KTL statistics on the samples irradiated in the unbiased condition. The red dotted line(s) are the pre- and/or post-irradiation minimum and/or maximum specification value as defined in the datasheet and/or test plan.



**TID Report
11-572 R1.0**

**Aeroflex RAD
5017 N. 30th Street
Colorado Springs, CO 80919
(719) 531-0800**

Table 5.72. Raw data for Positive Output Voltage 4 RL=600 @ +5V (V) versus total dose, including the statistical analysis, specification and the status of the testing (pass/fail).

Positive Output Voltage 4 RL=600 @ +5V (V)	Total Dose (krad(Si))					24 hr	168 hr
	0	10	20	30	50	Anneal	Anneal
Device							
	10/20/2011	11/3/2011	11/3/2011	11/3/2011	11/3/2011	11/4/2011	11/11/2011
1831	3.85E+00	3.85E+00	3.85E+00	3.85E+00	3.85E+00	3.85E+00	3.85E+00
1832	3.85E+00	3.85E+00	3.85E+00	3.85E+00	3.85E+00	3.85E+00	3.85E+00
1833	3.85E+00	3.85E+00	3.85E+00	3.86E+00	3.85E+00	3.85E+00	3.85E+00
1834	3.86E+00	3.86E+00	3.86E+00	3.86E+00	3.86E+00	3.86E+00	3.86E+00
1835	3.86E+00	3.86E+00	3.86E+00	3.86E+00	3.86E+00	3.86E+00	3.86E+00
1836	3.85E+00	3.85E+00	3.85E+00	3.85E+00	3.85E+00	3.85E+00	3.85E+00
1837	3.85E+00	3.85E+00	3.85E+00	3.85E+00	3.85E+00	3.85E+00	3.85E+00
1838	3.85E+00	3.85E+00	3.85E+00	3.85E+00	3.85E+00	3.85E+00	3.85E+00
1839	3.86E+00	3.87E+00	3.86E+00	3.87E+00	3.86E+00	3.86E+00	3.86E+00
1840	3.86E+00	3.86E+00	3.86E+00	3.86E+00	3.86E+00	3.85E+00	3.85E+00
1851	3.86E+00	3.86E+00	3.86E+00	3.86E+00	3.86E+00	3.86E+00	3.86E+00
1852	3.86E+00	3.86E+00	3.86E+00	3.86E+00	3.86E+00	3.86E+00	3.86E+00
Biased Statistics							
Average Biased	3.85E+00	3.85E+00	3.85E+00	3.86E+00	3.85E+00	3.85E+00	3.85E+00
Std Dev Biased	4.95E-03	4.76E-03	4.76E-03	4.77E-03	4.64E-03	4.82E-03	4.28E-03
Ps90%/90% (+KTL) Biased	3.87E+00	3.87E+00	3.87E+00	3.87E+00	3.87E+00	3.87E+00	3.86E+00
Ps90%/90% (-KTL) Biased	3.84E+00	3.84E+00	3.84E+00	3.84E+00	3.84E+00	3.84E+00	3.84E+00
Un-Biased Statistics							
Average Un-Biased	3.85E+00	3.86E+00	3.86E+00	3.86E+00	3.86E+00	3.85E+00	3.85E+00
Std Dev Un-Biased	4.82E-03	4.77E-03	4.49E-03	4.76E-03	4.64E-03	4.49E-03	4.34E-03
Ps90%/90% (+KTL) Un-Biased	3.87E+00	3.87E+00	3.87E+00	3.87E+00	3.87E+00	3.86E+00	3.86E+00
Ps90%/90% (-KTL) Un-Biased	3.84E+00	3.84E+00	3.84E+00	3.84E+00	3.84E+00	3.84E+00	3.84E+00
Specification MIN	3.40E+00	3.40E+00	3.20E+00	3.20E+00	3.00E+00	3.00E+00	3.00E+00
Status	PASS	PASS	PASS	PASS	PASS	PASS	PASS

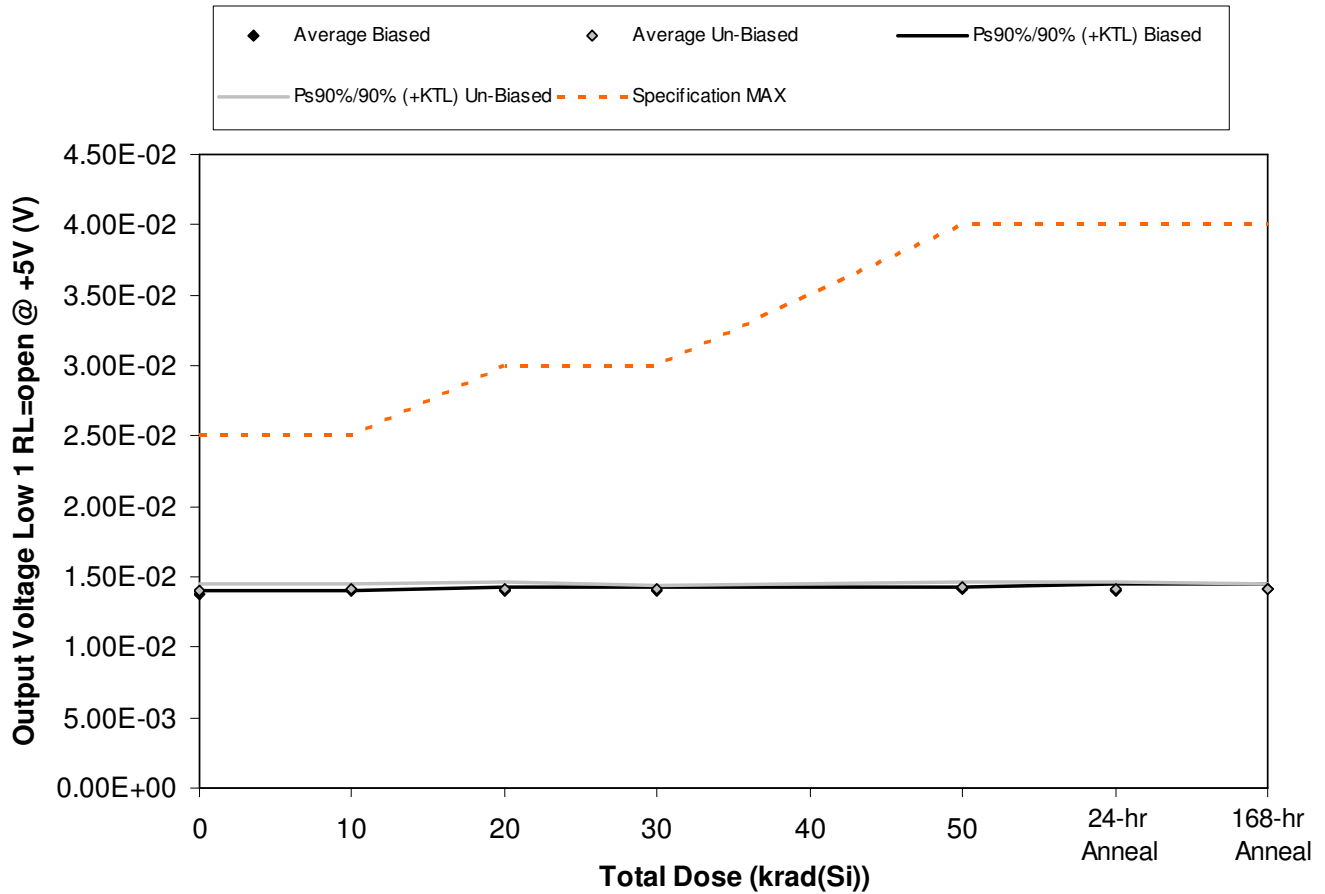

Figure 5.73. Plot of Output Voltage Low 1 RL=open @ +5V (V) versus total dose. The solid diamonds are the average of the measured data points for the samples irradiated under electrical bias while the shaded diamonds are the average of the measured data points for the samples irradiated with all pins tied to ground. The black lines (solid and/or dashed) are the average of the data points after application of the KTL statistics on the samples irradiated under electrical bias while the gray lines (solid and/or dashed) are the average of the data points after application of the KTL statistics on the samples irradiated in the unbiased condition. The red dotted line(s) are the pre- and/or post-irradiation minimum and/or maximum specification value as defined in the datasheet and/or test plan.



Table 5.73. Raw data for Output Voltage Low 1 RL=open @ +5V (V) versus total dose, including the statistical analysis, specification and the status of the testing (pass/fail).

Output Voltage Low 1 RL=open @ +5V (V)	Total Dose (krad(Si))					24 hr	168 hr
	0	10	20	30	50	Anneal	Anneal
Device							
	10/20/2011	11/3/2011	11/3/2011	11/3/2011	11/3/2011	11/4/2011	11/11/2011
1831	1.38E-02	1.40E-02	1.41E-02	1.41E-02	1.41E-02	1.41E-02	1.41E-02
1832	1.37E-02	1.40E-02	1.40E-02	1.39E-02	1.41E-02	1.38E-02	1.40E-02
1833	1.39E-02	1.40E-02	1.41E-02	1.41E-02	1.42E-02	1.42E-02	1.43E-02
1834	1.38E-02	1.40E-02	1.41E-02	1.41E-02	1.40E-02	1.41E-02	1.41E-02
1835	1.38E-02	1.40E-02	1.39E-02	1.40E-02	1.40E-02	1.38E-02	1.39E-02
1836	1.39E-02	1.42E-02	1.42E-02	1.41E-02	1.42E-02	1.41E-02	1.41E-02
1837	1.39E-02	1.40E-02	1.41E-02	1.42E-02	1.42E-02	1.41E-02	1.40E-02
1838	1.38E-02	1.39E-02	1.39E-02	1.41E-02	1.41E-02	1.40E-02	1.39E-02
1839	1.43E-02	1.43E-02	1.44E-02	1.43E-02	1.45E-02	1.44E-02	1.43E-02
1840	1.40E-02	1.40E-02	1.41E-02	1.41E-02	1.42E-02	1.40E-02	1.41E-02
1851	1.39E-02	1.41E-02	1.41E-02	1.41E-02	1.41E-02	1.39E-02	1.40E-02
1852	1.39E-02	1.40E-02	1.41E-02	1.39E-02	1.41E-02	1.40E-02	1.39E-02
Biased Statistics							
Average Biased	1.38E-02	1.40E-02	1.40E-02	1.40E-02	1.41E-02	1.40E-02	1.41E-02
Std Dev Biased	7.07E-05	1.94E-18	8.94E-05	8.94E-05	8.37E-05	1.87E-04	1.48E-04
Ps90%/90% (+KTL) Biased	1.40E-02	1.40E-02	1.43E-02	1.43E-02	1.43E-02	1.45E-02	1.45E-02
Ps90%/90% (-KTL) Biased	1.36E-02	1.40E-02	1.38E-02	1.38E-02	1.39E-02	1.35E-02	1.37E-02
Un-Biased Statistics							
Average Un-Biased	1.40E-02	1.41E-02	1.41E-02	1.42E-02	1.42E-02	1.41E-02	1.41E-02
Std Dev Un-Biased	1.92E-04	1.64E-04	1.82E-04	8.94E-05	1.52E-04	1.64E-04	1.48E-04
Ps90%/90% (+KTL) Un-Biased	1.45E-02	1.45E-02	1.46E-02	1.44E-02	1.47E-02	1.46E-02	1.45E-02
Ps90%/90% (-KTL) Un-Biased	1.35E-02	1.36E-02	1.36E-02	1.39E-02	1.38E-02	1.37E-02	1.37E-02
Specification MAX	2.50E-02	2.50E-02	3.00E-02	3.00E-02	4.00E-02	4.00E-02	4.00E-02
Status	PASS	PASS	PASS	PASS	PASS	PASS	PASS

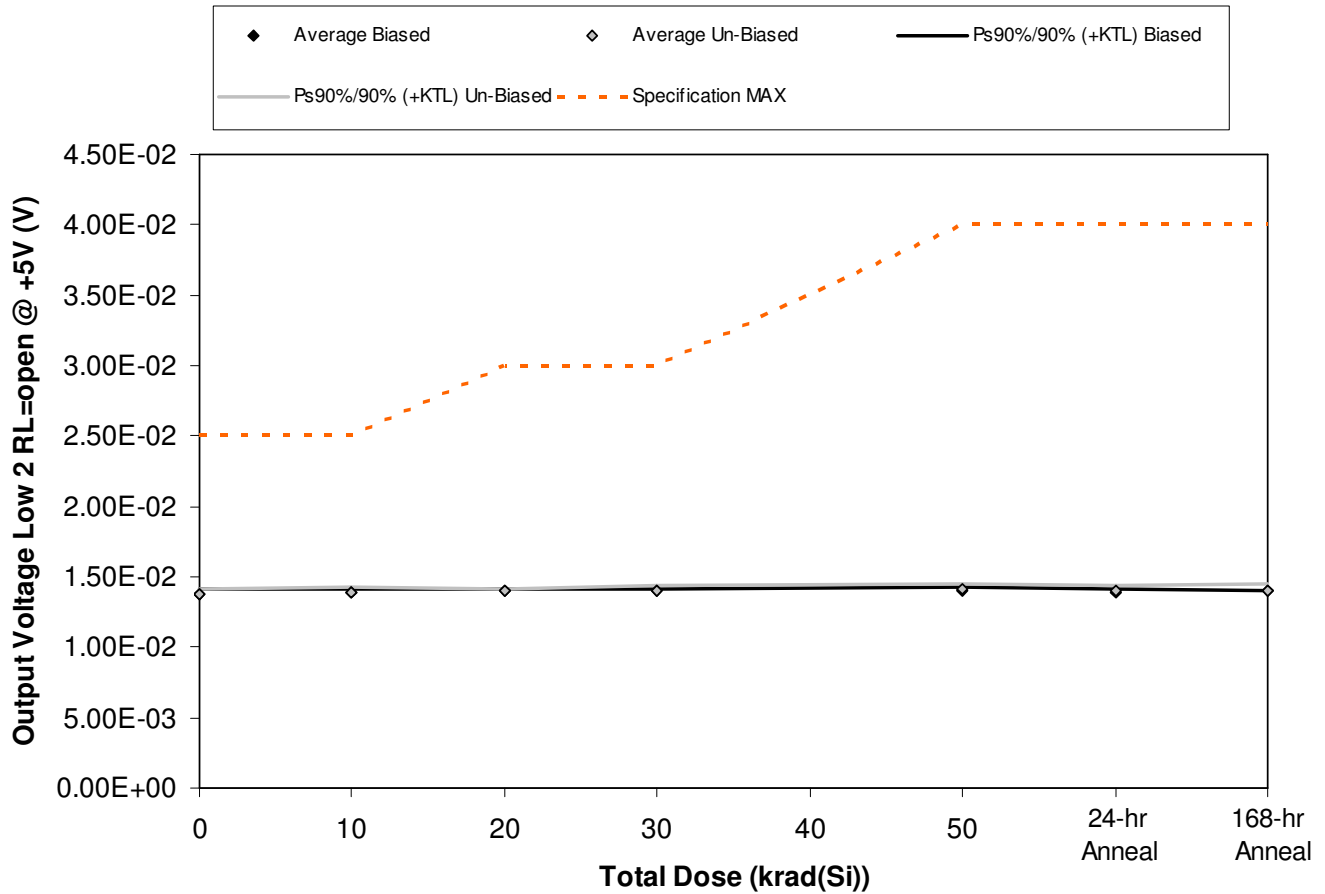

Figure 5.74. Plot of Output Voltage Low 2 RL=open @ +5V (V) versus total dose. The solid diamonds are the average of the measured data points for the samples irradiated under electrical bias while the shaded diamonds are the average of the measured data points for the samples irradiated with all pins tied to ground. The black lines (solid and/or dashed) are the average of the data points after application of the KTL statistics on the samples irradiated under electrical bias while the gray lines (solid and/or dashed) are the average of the data points after application of the KTL statistics on the samples irradiated in the unbiased condition. The red dotted line(s) are the pre- and/or post-irradiation minimum and/or maximum specification value as defined in the datasheet and/or test plan.



**TID Report
11-572 R1.0**

**Aeroflex RAD
5017 N. 30th Street
Colorado Springs, CO 80919
(719) 531-0800**

Table 5.74. Raw data for Output Voltage Low 2 RL=open @ +5V (V) versus total dose, including the statistical analysis, specification and the status of the testing (pass/fail).

Output Voltage Low 2 RL=open @ +5V (V)	Total Dose (krad(Si))					24 hr	168 hr
	0	10	20	30	50	Anneal	Anneal
Device							
	10/20/2011	11/3/2011	11/3/2011	11/3/2011	11/3/2011	11/4/2011	11/11/2011
1831	1.37E-02	1.40E-02	1.39E-02	1.40E-02	1.41E-02	1.40E-02	1.40E-02
1832	1.37E-02	1.39E-02	1.40E-02	1.40E-02	1.40E-02	1.39E-02	1.40E-02
1833	1.37E-02	1.38E-02	1.40E-02	1.40E-02	1.40E-02	1.38E-02	1.40E-02
1834	1.39E-02	1.39E-02	1.40E-02	1.40E-02	1.40E-02	1.40E-02	1.40E-02
1835	1.39E-02	1.40E-02	1.40E-02	1.41E-02	1.42E-02	1.40E-02	1.40E-02
1836	1.40E-02	1.40E-02	1.40E-02	1.42E-02	1.43E-02	1.42E-02	1.42E-02
1837	1.37E-02	1.39E-02	1.40E-02	1.39E-02	1.40E-02	1.39E-02	1.38E-02
1838	1.37E-02	1.38E-02	1.40E-02	1.40E-02	1.40E-02	1.39E-02	1.39E-02
1839	1.38E-02	1.38E-02	1.39E-02	1.40E-02	1.40E-02	1.38E-02	1.39E-02
1840	1.39E-02	1.41E-02	1.41E-02	1.40E-02	1.42E-02	1.40E-02	1.42E-02
1851	1.40E-02	1.41E-02	1.41E-02	1.41E-02	1.40E-02	1.41E-02	1.39E-02
1852	1.38E-02	1.39E-02	1.40E-02	1.39E-02	1.39E-02	1.39E-02	1.39E-02
Biased Statistics							
Average Biased	1.38E-02	1.39E-02	1.40E-02	1.40E-02	1.41E-02	1.39E-02	1.40E-02
Std Dev Biased	1.10E-04	8.37E-05	4.47E-05	4.47E-05	8.94E-05	8.94E-05	1.94E-18
Ps90%/90% (+KTL) Biased	1.41E-02	1.41E-02	1.41E-02	1.41E-02	1.43E-02	1.42E-02	1.40E-02
Ps90%/90% (-KTL) Biased	1.35E-02	1.37E-02	1.39E-02	1.39E-02	1.38E-02	1.37E-02	1.40E-02
Un-Biased Statistics							
Average Un-Biased	1.38E-02	1.39E-02	1.40E-02	1.40E-02	1.41E-02	1.40E-02	1.40E-02
Std Dev Un-Biased	1.30E-04	1.30E-04	7.07E-05	1.10E-04	1.41E-04	1.52E-04	1.87E-04
Ps90%/90% (+KTL) Un-Biased	1.42E-02	1.43E-02	1.42E-02	1.43E-02	1.45E-02	1.44E-02	1.45E-02
Ps90%/90% (-KTL) Un-Biased	1.35E-02	1.36E-02	1.38E-02	1.37E-02	1.37E-02	1.35E-02	1.35E-02
Specification MAX	2.50E-02	2.50E-02	3.00E-02	3.00E-02	4.00E-02	4.00E-02	4.00E-02
Status	PASS	PASS	PASS	PASS	PASS	PASS	PASS

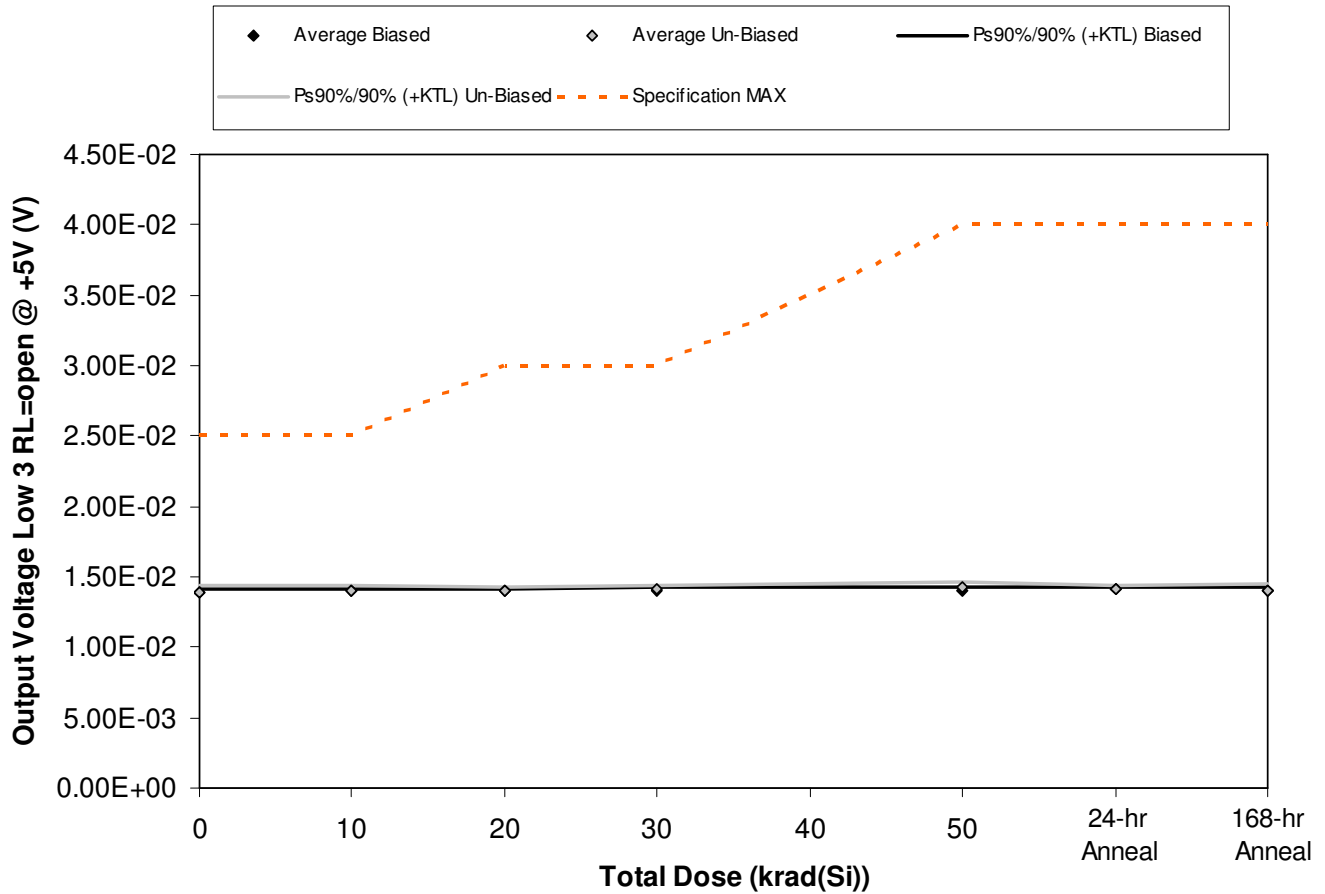

Figure 5.75. Plot of Output Voltage Low 3 RL=open @ +5V (V) versus total dose. The solid diamonds are the average of the measured data points for the samples irradiated under electrical bias while the shaded diamonds are the average of the measured data points for the samples irradiated with all pins tied to ground. The black lines (solid and/or dashed) are the average of the data points after application of the KTL statistics on the samples irradiated under electrical bias while the gray lines (solid and/or dashed) are the average of the data points after application of the KTL statistics on the samples irradiated in the unbiased condition. The red dotted line(s) are the pre- and/or post-irradiation minimum and/or maximum specification value as defined in the datasheet and/or test plan.



Table 5.75. Raw data for Output Voltage Low 3 RL=open @ +5V (V) versus total dose, including the statistical analysis, specification and the status of the testing (pass/fail).

Output Voltage Low 3 RL=open @ +5V (V)	Total Dose (krad(Si))					24 hr	168 hr
	0	10	20	30	50	Anneal	Anneal
Device							
	10/20/2011	11/3/2011	11/3/2011	11/3/2011	11/3/2011	11/4/2011	11/11/2011
1831	1.39E-02	1.40E-02	1.41E-02	1.41E-02	1.41E-02	1.41E-02	1.41E-02
1832	1.38E-02	1.40E-02	1.40E-02	1.40E-02	1.40E-02	1.40E-02	1.41E-02
1833	1.39E-02	1.40E-02	1.40E-02	1.41E-02	1.40E-02	1.40E-02	1.39E-02
1834	1.39E-02	1.41E-02	1.40E-02	1.40E-02	1.41E-02	1.41E-02	1.40E-02
1835	1.40E-02	1.40E-02	1.41E-02	1.41E-02	1.41E-02	1.42E-02	1.41E-02
1836	1.40E-02	1.42E-02	1.41E-02	1.43E-02	1.44E-02	1.42E-02	1.43E-02
1837	1.40E-02	1.40E-02	1.40E-02	1.40E-02	1.42E-02	1.42E-02	1.40E-02
1838	1.37E-02	1.39E-02	1.39E-02	1.40E-02	1.41E-02	1.41E-02	1.39E-02
1839	1.39E-02	1.38E-02	1.41E-02	1.40E-02	1.41E-02	1.40E-02	1.40E-02
1840	1.41E-02	1.39E-02	1.40E-02	1.41E-02	1.43E-02	1.40E-02	1.41E-02
1851	1.40E-02	1.41E-02	1.41E-02	1.41E-02	1.41E-02	1.41E-02	1.40E-02
1852	1.38E-02	1.40E-02	1.38E-02	1.39E-02	1.39E-02	1.38E-02	1.40E-02
Biased Statistics							
Average Biased	1.39E-02	1.40E-02	1.40E-02	1.41E-02	1.41E-02	1.41E-02	1.40E-02
Std Dev Biased	7.07E-05	4.47E-05	5.48E-05	5.48E-05	5.48E-05	8.37E-05	8.94E-05
Ps90%/90% (+KTL) Biased	1.41E-02	1.41E-02	1.42E-02	1.42E-02	1.42E-02	1.43E-02	1.43E-02
Ps90%/90% (-KTL) Biased	1.37E-02	1.39E-02	1.39E-02	1.39E-02	1.39E-02	1.39E-02	1.38E-02
Un-Biased Statistics							
Average Un-Biased	1.39E-02	1.40E-02	1.40E-02	1.41E-02	1.42E-02	1.41E-02	1.41E-02
Std Dev Un-Biased	1.52E-04	1.52E-04	8.37E-05	1.30E-04	1.30E-04	1.00E-04	1.52E-04
Ps90%/90% (+KTL) Un-Biased	1.44E-02	1.44E-02	1.42E-02	1.44E-02	1.46E-02	1.44E-02	1.45E-02
Ps90%/90% (-KTL) Un-Biased	1.35E-02	1.35E-02	1.38E-02	1.37E-02	1.39E-02	1.38E-02	1.36E-02
Specification MAX	2.50E-02	2.50E-02	3.00E-02	3.00E-02	4.00E-02	4.00E-02	4.00E-02
Status	PASS	PASS	PASS	PASS	PASS	PASS	PASS

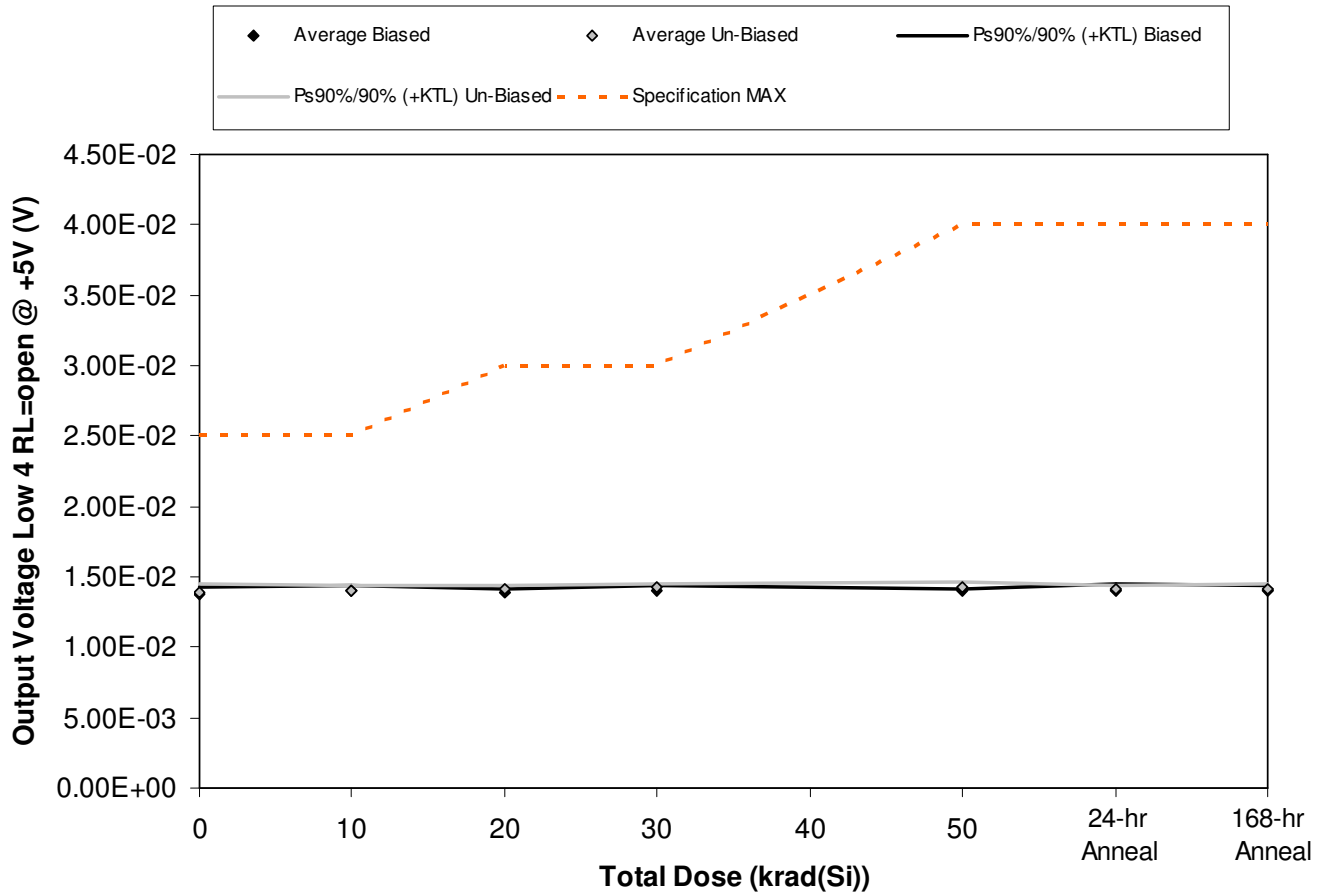

Figure 5.76. Plot of Output Voltage Low 4 RL=open @ +5V (V) versus total dose. The solid diamonds are the average of the measured data points for the samples irradiated under electrical bias while the shaded diamonds are the average of the measured data points for the samples irradiated with all pins tied to ground. The black lines (solid and/or dashed) are the average of the data points after application of the KTL statistics on the samples irradiated under electrical bias while the gray lines (solid and/or dashed) are the average of the data points after application of the KTL statistics on the samples irradiated in the unbiased condition. The red dotted line(s) are the pre- and/or post-irradiation minimum and/or maximum specification value as defined in the datasheet and/or test plan.



**TID Report
11-572 R1.0**

**Aeroflex RAD
5017 N. 30th Street
Colorado Springs, CO 80919
(719) 531-0800**

Table 5.76. Raw data for Output Voltage Low 4 RL=open @ +5V (V) versus total dose, including the statistical analysis, specification and the status of the testing (pass/fail).

Output Voltage Low 4 RL=open @ +5V (V)	Total Dose (krad(Si))					24 hr	168 hr
	0	10	20	30	50	Anneal	Anneal
Device							
	10/20/2011	11/3/2011	11/3/2011	11/3/2011	11/3/2011	11/4/2011	11/11/2011
1831	1.39E-02	1.41E-02	1.39E-02	1.40E-02	1.40E-02	1.39E-02	1.38E-02
1832	1.38E-02	1.39E-02	1.38E-02	1.39E-02	1.39E-02	1.39E-02	1.39E-02
1833	1.40E-02	1.41E-02	1.40E-02	1.42E-02	1.41E-02	1.43E-02	1.42E-02
1834	1.37E-02	1.38E-02	1.39E-02	1.41E-02	1.40E-02	1.39E-02	1.41E-02
1835	1.36E-02	1.39E-02	1.39E-02	1.41E-02	1.40E-02	1.39E-02	1.40E-02
1836	1.38E-02	1.39E-02	1.42E-02	1.43E-02	1.44E-02	1.40E-02	1.42E-02
1837	1.41E-02	1.40E-02	1.40E-02	1.42E-02	1.43E-02	1.40E-02	1.42E-02
1838	1.37E-02	1.38E-02	1.40E-02	1.41E-02	1.42E-02	1.40E-02	1.39E-02
1839	1.42E-02	1.42E-02	1.42E-02	1.43E-02	1.44E-02	1.43E-02	1.42E-02
1840	1.39E-02	1.40E-02	1.41E-02	1.41E-02	1.41E-02	1.41E-02	1.42E-02
1851	1.40E-02	1.39E-02	1.41E-02	1.40E-02	1.41E-02	1.38E-02	1.40E-02
1852	1.39E-02	1.40E-02	1.40E-02	1.39E-02	1.39E-02	1.39E-02	1.40E-02
Biased Statistics							
Average Biased	1.38E-02	1.40E-02	1.39E-02	1.41E-02	1.40E-02	1.40E-02	1.40E-02
Std Dev Biased	1.58E-04	1.34E-04	7.07E-05	1.14E-04	7.07E-05	1.79E-04	1.58E-04
Ps90%/90% (+KTL) Biased	1.42E-02	1.43E-02	1.41E-02	1.44E-02	1.42E-02	1.45E-02	1.44E-02
Ps90%/90% (-KTL) Biased	1.34E-02	1.36E-02	1.37E-02	1.37E-02	1.38E-02	1.35E-02	1.36E-02
Un-Biased Statistics							
Average Un-Biased	1.39E-02	1.40E-02	1.41E-02	1.42E-02	1.43E-02	1.41E-02	1.41E-02
Std Dev Un-Biased	2.07E-04	1.48E-04	1.00E-04	1.00E-04	1.30E-04	1.30E-04	1.34E-04
Ps90%/90% (+KTL) Un-Biased	1.45E-02	1.44E-02	1.44E-02	1.45E-02	1.46E-02	1.44E-02	1.45E-02
Ps90%/90% (-KTL) Un-Biased	1.34E-02	1.36E-02	1.38E-02	1.39E-02	1.39E-02	1.37E-02	1.38E-02
Specification MAX	2.50E-02	2.50E-02	3.00E-02	3.00E-02	4.00E-02	4.00E-02	4.00E-02
Status	PASS	PASS	PASS	PASS	PASS	PASS	PASS

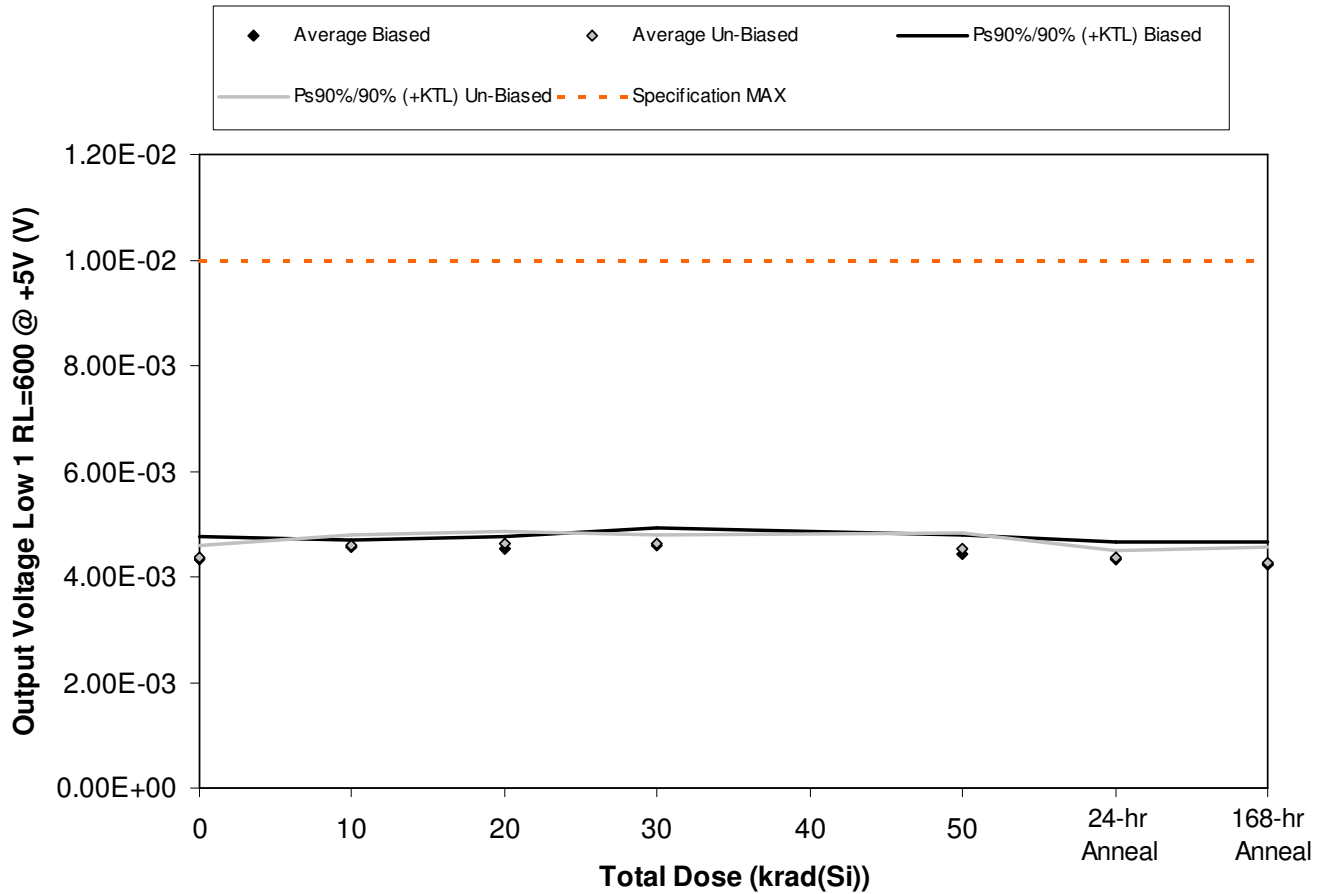

Figure 5.77. Plot of Output Voltage Low 1 RL=600 @ +5V (V) versus total dose. The solid diamonds are the average of the measured data points for the samples irradiated under electrical bias while the shaded diamonds are the average of the measured data points for the samples irradiated with all pins tied to ground. The black lines (solid and/or dashed) are the average of the data points after application of the KTL statistics on the samples irradiated under electrical bias while the gray lines (solid and/or dashed) are the average of the data points after application of the KTL statistics on the samples irradiated in the unbiased condition. The red dotted line(s) are the pre- and/or post-irradiation minimum and/or maximum specification value as defined in the datasheet and/or test plan.



**TID Report
11-572 R1.0**

**Aeroflex RAD
5017 N. 30th Street
Colorado Springs, CO 80919
(719) 531-0800**

Table 5.77. Raw data for Output Voltage Low 1 RL=600 @ +5V (V) versus total dose, including the statistical analysis, specification and the status of the testing (pass/fail).

Output Voltage Low 1 RL=600 @ +5V (V)	Total Dose (krad(Si))					24 hr	168 hr
	0	10	20	30	50	Anneal	Anneal
Device	10/20/2011	11/3/2011	11/3/2011	11/3/2011	11/3/2011	11/4/2011	11/11/2011
1831	4.10E-03	4.60E-03	4.40E-03	4.50E-03	4.30E-03	4.20E-03	4.00E-03
1832	4.40E-03	4.50E-03	4.50E-03	4.60E-03	4.50E-03	4.30E-03	4.30E-03
1833	4.20E-03	4.50E-03	4.50E-03	4.40E-03	4.30E-03	4.20E-03	4.10E-03
1834	4.50E-03	4.60E-03	4.60E-03	4.70E-03	4.60E-03	4.50E-03	4.30E-03
1835	4.40E-03	4.60E-03	4.60E-03	4.70E-03	4.50E-03	4.40E-03	4.40E-03
1836	4.30E-03	4.50E-03	4.60E-03	4.60E-03	4.40E-03	4.40E-03	4.10E-03
1837	4.30E-03	4.50E-03	4.70E-03	4.60E-03	4.60E-03	4.30E-03	4.40E-03
1838	4.40E-03	4.60E-03	4.50E-03	4.60E-03	4.60E-03	4.40E-03	4.20E-03
1839	4.50E-03	4.60E-03	4.60E-03	4.70E-03	4.40E-03	4.40E-03	4.30E-03
1840	4.40E-03	4.70E-03	4.70E-03	4.70E-03	4.60E-03	4.40E-03	4.30E-03
1851	4.50E-03	4.40E-03	4.60E-03	4.50E-03	4.50E-03	4.40E-03	4.40E-03
1852	4.50E-03	4.50E-03	4.60E-03	4.80E-03	4.70E-03	4.50E-03	4.60E-03
Biased Statistics							
Average Biased	4.32E-03	4.56E-03	4.52E-03	4.58E-03	4.44E-03	4.32E-03	4.22E-03
Std Dev Biased	1.64E-04	5.48E-05	8.37E-05	1.30E-04	1.34E-04	1.30E-04	1.64E-04
Ps90%/90% (+KTL) Biased	4.77E-03	4.71E-03	4.75E-03	4.94E-03	4.81E-03	4.68E-03	4.67E-03
Ps90%/90% (-KTL) Biased	3.87E-03	4.41E-03	4.29E-03	4.22E-03	4.07E-03	3.96E-03	3.77E-03
Un-Biased Statistics							
Average Un-Biased	4.38E-03	4.58E-03	4.62E-03	4.64E-03	4.52E-03	4.38E-03	4.26E-03
Std Dev Un-Biased	8.37E-05	8.37E-05	8.37E-05	5.48E-05	1.10E-04	4.47E-05	1.14E-04
Ps90%/90% (+KTL) Un-Biased	4.61E-03	4.81E-03	4.85E-03	4.79E-03	4.82E-03	4.50E-03	4.57E-03
Ps90%/90% (-KTL) Un-Biased	4.15E-03	4.35E-03	4.39E-03	4.49E-03	4.22E-03	4.26E-03	3.95E-03
Specification MAX	1.00E-02	1.00E-02	1.00E-02	1.00E-02	1.00E-02	1.00E-02	1.00E-02
Status	PASS	PASS	PASS	PASS	PASS	PASS	PASS

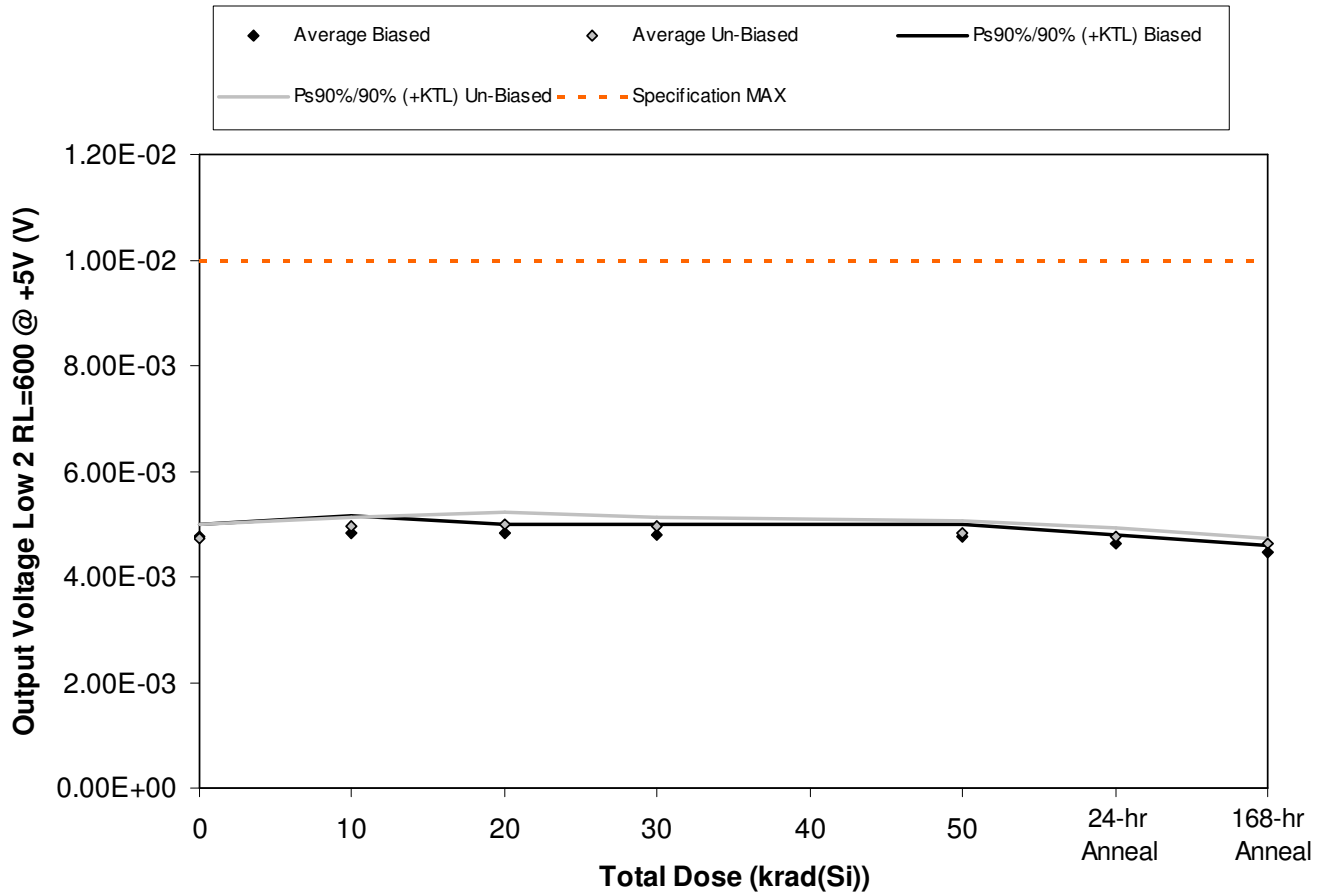

Figure 5.78. Plot of Output Voltage Low 2 RL=600 @ +5V (V) versus total dose. The solid diamonds are the average of the measured data points for the samples irradiated under electrical bias while the shaded diamonds are the average of the measured data points for the samples irradiated with all pins tied to ground. The black lines (solid and/or dashed) are the average of the data points after application of the KTL statistics on the samples irradiated under electrical bias while the gray lines (solid and/or dashed) are the average of the data points after application of the KTL statistics on the samples irradiated in the unbiased condition. The red dotted line(s) are the pre- and/or post-irradiation minimum and/or maximum specification value as defined in the datasheet and/or test plan.



**TID Report
11-572 R1.0**

**Aeroflex RAD
5017 N. 30th Street
Colorado Springs, CO 80919
(719) 531-0800**

Table 5.78. Raw data for Output Voltage Low 2 RL=600 @ +5V (V) versus total dose, including the statistical analysis, specification and the status of the testing (pass/fail).

Output Voltage Low 2 RL=600 @ +5V (V)	Total Dose (krad(Si))					24 hr Anneal	168 hr Anneal
	0	10	20	30	50		
Device	10/20/2011	11/3/2011	11/3/2011	11/3/2011	11/3/2011	11/4/2011	11/11/2011
1831	4.80E-03	5.00E-03	4.80E-03	4.80E-03	4.90E-03	4.70E-03	4.50E-03
1832	4.90E-03	4.80E-03	4.90E-03	4.80E-03	4.70E-03	4.60E-03	4.40E-03
1833	4.70E-03	4.90E-03	4.80E-03	4.80E-03	4.80E-03	4.70E-03	4.50E-03
1834	4.70E-03	4.80E-03	4.90E-03	4.90E-03	4.70E-03	4.60E-03	4.50E-03
1835	4.70E-03	4.70E-03	4.80E-03	4.70E-03	4.70E-03	4.60E-03	4.40E-03
1836	4.60E-03	4.90E-03	4.90E-03	4.90E-03	4.90E-03	4.80E-03	4.60E-03
1837	4.80E-03	4.90E-03	5.00E-03	4.90E-03	4.70E-03	4.70E-03	4.60E-03
1838	4.70E-03	5.00E-03	4.90E-03	5.00E-03	4.80E-03	4.80E-03	4.60E-03
1839	4.80E-03	5.00E-03	5.00E-03	5.00E-03	4.80E-03	4.70E-03	4.60E-03
1840	4.80E-03	5.00E-03	5.10E-03	5.00E-03	4.90E-03	4.80E-03	4.70E-03
1851	4.90E-03	4.70E-03	4.90E-03	4.90E-03	4.90E-03	4.80E-03	4.80E-03
1852	4.80E-03	4.80E-03	4.80E-03	4.90E-03	4.80E-03	4.80E-03	4.80E-03
Biased Statistics							
Average Biased	4.76E-03	4.84E-03	4.84E-03	4.80E-03	4.76E-03	4.64E-03	4.46E-03
Std Dev Biased	8.94E-05	1.14E-04	5.48E-05	7.07E-05	8.94E-05	5.48E-05	5.48E-05
Ps90%/90% (+KTL) Biased	5.01E-03	5.15E-03	4.99E-03	4.99E-03	5.01E-03	4.79E-03	4.61E-03
Ps90%/90% (-KTL) Biased	4.51E-03	4.53E-03	4.69E-03	4.61E-03	4.51E-03	4.49E-03	4.31E-03
Un-Biased Statistics							
Average Un-Biased	4.74E-03	4.96E-03	4.98E-03	4.96E-03	4.82E-03	4.76E-03	4.62E-03
Std Dev Un-Biased	8.94E-05	5.48E-05	8.37E-05	5.48E-05	8.37E-05	5.48E-05	4.47E-05
Ps90%/90% (+KTL) Un-Biased	4.99E-03	5.11E-03	5.21E-03	5.11E-03	5.05E-03	4.91E-03	4.74E-03
Ps90%/90% (-KTL) Un-Biased	4.49E-03	4.81E-03	4.75E-03	4.81E-03	4.59E-03	4.61E-03	4.50E-03
Specification MAX	1.00E-02	1.00E-02	1.00E-02	1.00E-02	1.00E-02	1.00E-02	1.00E-02
Status	PASS	PASS	PASS	PASS	PASS	PASS	PASS

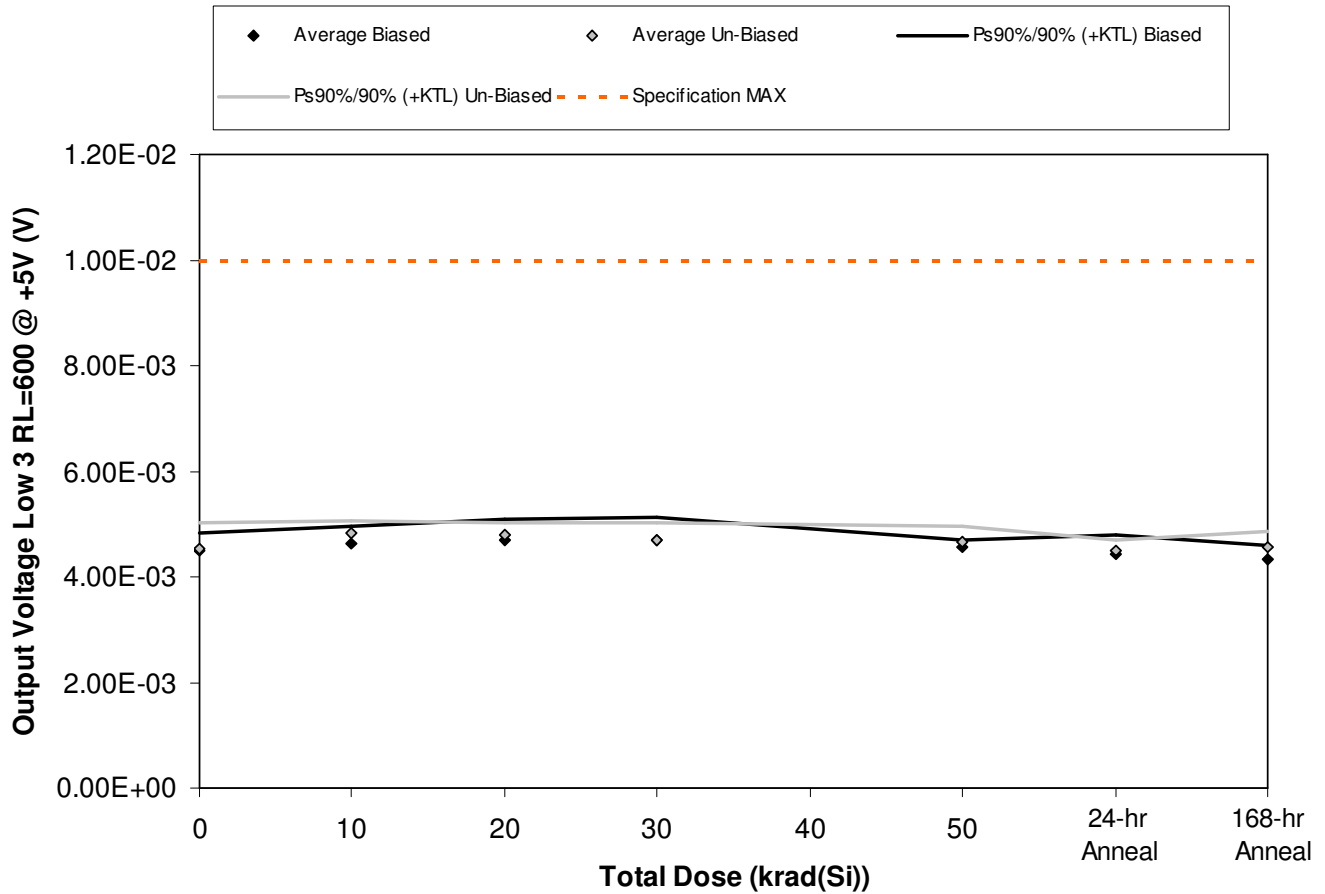

Figure 5.79. Plot of Output Voltage Low 3 RL=600 @ +5V (V) versus total dose. The solid diamonds are the average of the measured data points for the samples irradiated under electrical bias while the shaded diamonds are the average of the measured data points for the samples irradiated with all pins tied to ground. The black lines (solid and/or dashed) are the average of the data points after application of the KTL statistics on the samples irradiated under electrical bias while the gray lines (solid and/or dashed) are the average of the data points after application of the KTL statistics on the samples irradiated in the unbiased condition. The red dotted line(s) are the pre- and/or post-irradiation minimum and/or maximum specification value as defined in the datasheet and/or test plan.



**TID Report
11-572 R1.0**

**Aeroflex RAD
5017 N. 30th Street
Colorado Springs, CO 80919
(719) 531-0800**

Table 5.79. Raw data for Output Voltage Low 3 RL=600 @ +5V (V) versus total dose, including the statistical analysis, specification and the status of the testing (pass/fail).

Output Voltage Low 3 RL=600 @ +5V (V)	Total Dose (krad(Si))					24 hr	168 hr
	0	10	20	30	50	Anneal	Anneal
Device	10/20/2011	11/3/2011	11/3/2011	11/3/2011	11/3/2011	11/4/2011	11/11/2011
1831	4.50E-03	4.80E-03	4.90E-03	4.70E-03	4.50E-03	4.50E-03	4.40E-03
1832	4.70E-03	4.70E-03	4.70E-03	4.90E-03	4.60E-03	4.50E-03	4.40E-03
1833	4.50E-03	4.60E-03	4.70E-03	4.80E-03	4.60E-03	4.40E-03	4.40E-03
1834	4.40E-03	4.60E-03	4.70E-03	4.60E-03	4.60E-03	4.50E-03	4.30E-03
1835	4.40E-03	4.50E-03	4.50E-03	4.50E-03	4.50E-03	4.20E-03	4.20E-03
1836	4.50E-03	4.80E-03	4.70E-03	4.50E-03	4.70E-03	4.50E-03	4.50E-03
1837	4.30E-03	4.80E-03	4.70E-03	4.60E-03	4.60E-03	4.40E-03	4.40E-03
1838	4.50E-03	4.90E-03	4.80E-03	4.80E-03	4.50E-03	4.40E-03	4.60E-03
1839	4.50E-03	4.70E-03	4.80E-03	4.70E-03	4.70E-03	4.60E-03	4.60E-03
1840	4.80E-03	4.90E-03	4.90E-03	4.80E-03	4.80E-03	4.50E-03	4.70E-03
1851	4.40E-03	4.60E-03	4.60E-03	4.50E-03	4.60E-03	4.50E-03	4.60E-03
1852	4.50E-03	4.70E-03	4.60E-03	4.60E-03	4.80E-03	4.60E-03	4.60E-03
Biased Statistics							
Average Biased	4.50E-03	4.64E-03	4.70E-03	4.70E-03	4.56E-03	4.42E-03	4.34E-03
Std Dev Biased	1.22E-04	1.14E-04	1.41E-04	1.58E-04	5.48E-05	1.30E-04	8.94E-05
Ps90%/90% (+KTL) Biased	4.84E-03	4.95E-03	5.09E-03	5.13E-03	4.71E-03	4.78E-03	4.59E-03
Ps90%/90% (-KTL) Biased	4.16E-03	4.33E-03	4.31E-03	4.27E-03	4.41E-03	4.06E-03	4.09E-03
Un-Biased Statistics							
Average Un-Biased	4.52E-03	4.82E-03	4.78E-03	4.68E-03	4.66E-03	4.48E-03	4.56E-03
Std Dev Un-Biased	1.79E-04	8.37E-05	8.37E-05	1.30E-04	1.14E-04	8.37E-05	1.14E-04
Ps90%/90% (+KTL) Un-Biased	5.01E-03	5.05E-03	5.01E-03	5.04E-03	4.97E-03	4.71E-03	4.87E-03
Ps90%/90% (-KTL) Un-Biased	4.03E-03	4.59E-03	4.55E-03	4.32E-03	4.35E-03	4.25E-03	4.25E-03
Specification MAX	1.00E-02	1.00E-02	1.00E-02	1.00E-02	1.00E-02	1.00E-02	1.00E-02
Status	PASS	PASS	PASS	PASS	PASS	PASS	PASS

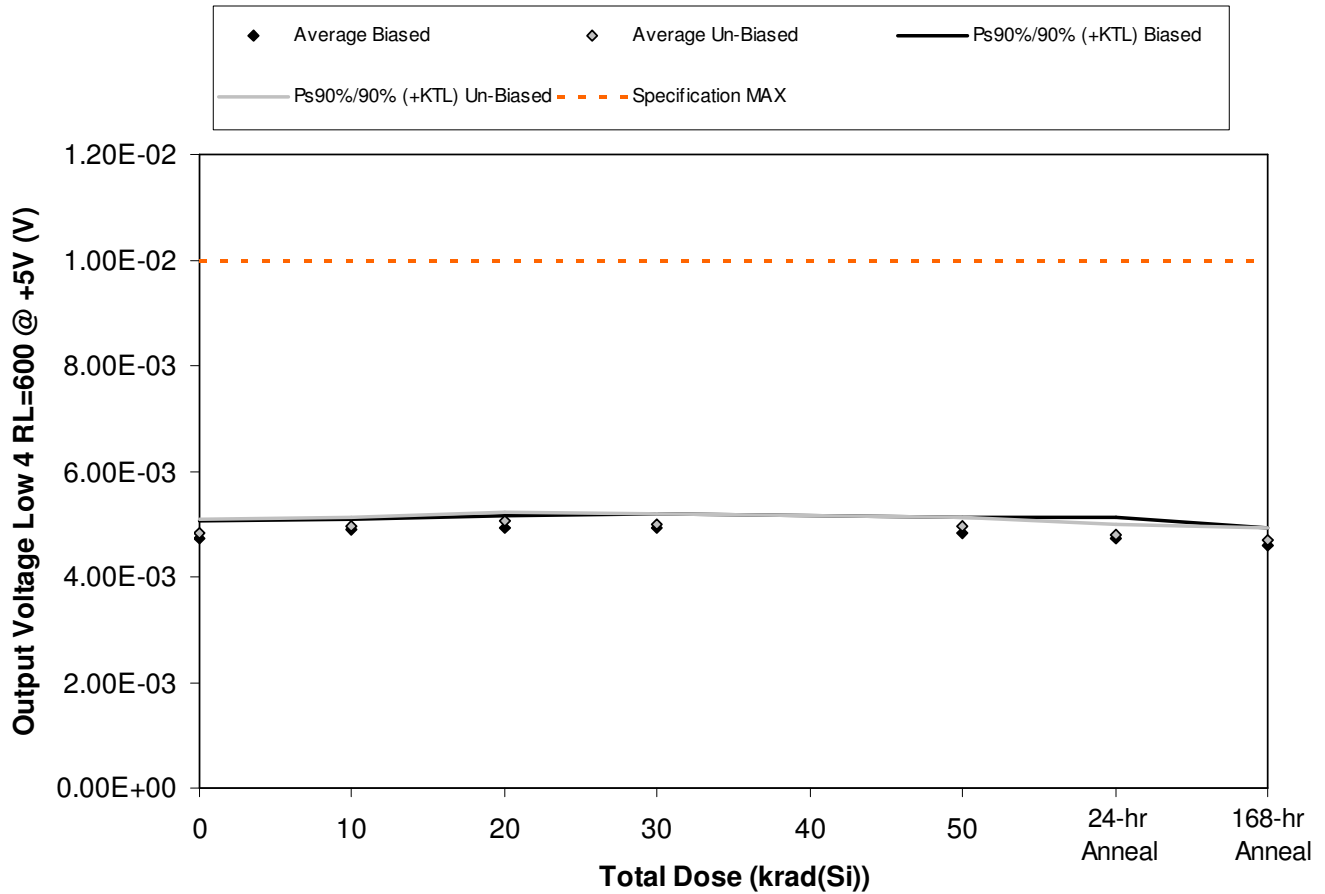

Figure 5.80. Plot of Output Voltage Low 4 RL=600 @ +5V (V) versus total dose. The solid diamonds are the average of the measured data points for the samples irradiated under electrical bias while the shaded diamonds are the average of the measured data points for the samples irradiated with all pins tied to ground. The black lines (solid and/or dashed) are the average of the data points after application of the KTL statistics on the samples irradiated under electrical bias while the gray lines (solid and/or dashed) are the average of the data points after application of the KTL statistics on the samples irradiated in the unbiased condition. The red dotted line(s) are the pre- and/or post-irradiation minimum and/or maximum specification value as defined in the datasheet and/or test plan.



**TID Report
11-572 R1.0**

**Aeroflex RAD
5017 N. 30th Street
Colorado Springs, CO 80919
(719) 531-0800**

Table 5.80. Raw data for Output Voltage Low 4 RL=600 @ +5V (V) versus total dose, including the statistical analysis, specification and the status of the testing (pass/fail).

Output Voltage Low 4 RL=600 @ +5V (V)	Total Dose (krad(Si))					24 hr Anneal	168 hr Anneal
	0	10	20	30	50		
Device	10/20/2011	11/3/2011	11/3/2011	11/3/2011	11/3/2011	11/4/2011	11/11/2011
1831	4.60E-03	4.90E-03	4.80E-03	4.80E-03	4.70E-03	4.70E-03	4.50E-03
1832	4.80E-03	4.90E-03	4.90E-03	5.00E-03	4.90E-03	4.70E-03	4.60E-03
1833	4.70E-03	4.80E-03	4.90E-03	4.90E-03	4.70E-03	4.50E-03	4.50E-03
1834	4.90E-03	4.90E-03	5.00E-03	5.00E-03	4.90E-03	4.80E-03	4.80E-03
1835	4.70E-03	5.00E-03	5.00E-03	5.00E-03	4.90E-03	4.90E-03	4.60E-03
1836	4.80E-03	5.00E-03	5.00E-03	4.90E-03	4.90E-03	4.80E-03	4.70E-03
1837	4.70E-03	4.90E-03	5.00E-03	5.00E-03	5.00E-03	4.70E-03	4.60E-03
1838	4.90E-03	4.90E-03	5.10E-03	5.10E-03	5.00E-03	4.90E-03	4.80E-03
1839	4.90E-03	5.00E-03	5.10E-03	5.00E-03	5.00E-03	4.80E-03	4.70E-03
1840	4.90E-03	5.00E-03	5.10E-03	5.00E-03	4.90E-03	4.80E-03	4.60E-03
1851	4.80E-03	4.90E-03	4.90E-03	4.90E-03	5.10E-03	4.60E-03	4.70E-03
1852	5.00E-03	5.00E-03	5.10E-03	5.00E-03	4.90E-03	4.90E-03	4.90E-03
Biased Statistics							
Average Biased	4.74E-03	4.90E-03	4.92E-03	4.94E-03	4.82E-03	4.72E-03	4.60E-03
Std Dev Biased	1.14E-04	7.07E-05	8.37E-05	8.94E-05	1.10E-04	1.48E-04	1.22E-04
Ps90%/90% (+KTL) Biased	5.05E-03	5.09E-03	5.15E-03	5.19E-03	5.12E-03	5.13E-03	4.94E-03
Ps90%/90% (-KTL) Biased	4.43E-03	4.71E-03	4.69E-03	4.69E-03	4.52E-03	4.31E-03	4.26E-03
Un-Biased Statistics							
Average Un-Biased	4.84E-03	4.96E-03	5.06E-03	5.00E-03	4.96E-03	4.80E-03	4.68E-03
Std Dev Un-Biased	8.94E-05	5.48E-05	5.48E-05	7.07E-05	5.48E-05	7.07E-05	8.37E-05
Ps90%/90% (+KTL) Un-Biased	5.09E-03	5.11E-03	5.21E-03	5.19E-03	5.11E-03	4.99E-03	4.91E-03
Ps90%/90% (-KTL) Un-Biased	4.59E-03	4.81E-03	4.91E-03	4.81E-03	4.81E-03	4.61E-03	4.45E-03
Specification MAX	1.00E-02	1.00E-02	1.00E-02	1.00E-02	1.00E-02	1.00E-02	1.00E-02
Status	PASS	PASS	PASS	PASS	PASS	PASS	PASS

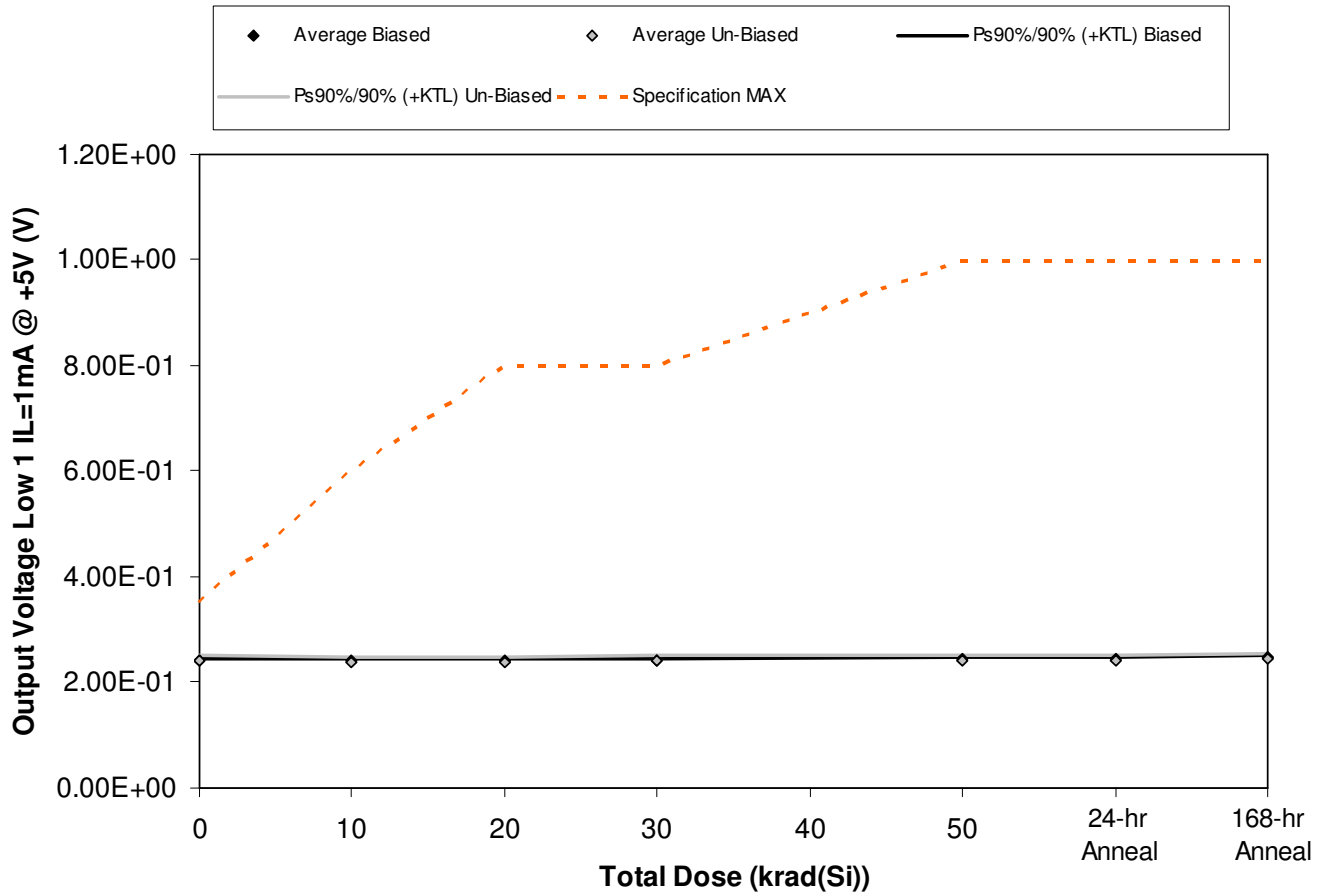

Figure 5.81. Plot of Output Voltage Low 1 IL=1mA @ +5V (V) versus total dose. The solid diamonds are the average of the measured data points for the samples irradiated under electrical bias while the shaded diamonds are the average of the measured data points for the samples irradiated with all pins tied to ground. The black lines (solid and/or dashed) are the average of the data points after application of the KTL statistics on the samples irradiated under electrical bias while the gray lines (solid and/or dashed) are the average of the data points after application of the KTL statistics on the samples irradiated in the unbiased condition. The red dotted line(s) are the pre- and/or post-irradiation minimum and/or maximum specification value as defined in the datasheet and/or test plan.



Table 5.81. Raw data for Output Voltage Low 1 IL=1mA @ +5V (V) versus total dose, including the statistical analysis, specification and the status of the testing (pass/fail).

Output Voltage Low 1 IL=1mA @ +5V (V)	Total Dose (krad(Si))					24 hr	168 hr
	0	10	20	30	50	Anneal	Anneal
Device	10/20/2011	11/3/2011	11/3/2011	11/3/2011	11/3/2011	11/4/2011	11/11/2011
1831	2.43E-01	2.42E-01	2.42E-01	2.43E-01	2.45E-01	2.44E-01	2.49E-01
1832	2.41E-01	2.41E-01	2.41E-01	2.41E-01	2.43E-01	2.43E-01	2.49E-01
1833	2.42E-01	2.41E-01	2.41E-01	2.41E-01	2.43E-01	2.44E-01	2.49E-01
1834	2.44E-01	2.42E-01	2.42E-01	2.44E-01	2.46E-01	2.46E-01	2.51E-01
1835	2.43E-01	2.42E-01	2.42E-01	2.43E-01	2.44E-01	2.44E-01	2.49E-01
1836	2.44E-01	2.40E-01	2.41E-01	2.42E-01	2.44E-01	2.43E-01	2.46E-01
1837	2.40E-01	2.37E-01	2.37E-01	2.39E-01	2.40E-01	2.39E-01	2.42E-01
1838	2.42E-01	2.38E-01	2.40E-01	2.41E-01	2.43E-01	2.41E-01	2.44E-01
1839	2.47E-01	2.43E-01	2.44E-01	2.46E-01	2.47E-01	2.45E-01	2.49E-01
1840	2.38E-01	2.34E-01	2.35E-01	2.37E-01	2.38E-01	2.37E-01	2.40E-01
1851	2.41E-01	2.42E-01	2.42E-01	2.44E-01	2.43E-01	2.40E-01	2.43E-01
1852	2.38E-01	2.38E-01	2.39E-01	2.40E-01	2.40E-01	2.37E-01	2.39E-01
Biased Statistics							
Average Biased	2.43E-01	2.42E-01	2.42E-01	2.42E-01	2.44E-01	2.44E-01	2.49E-01
Std Dev Biased	1.14E-03	5.48E-04	5.48E-04	1.34E-03	1.30E-03	1.10E-03	8.94E-04
Ps90%/90% (+KTL) Biased	2.46E-01	2.43E-01	2.43E-01	2.46E-01	2.48E-01	2.47E-01	2.52E-01
Ps90%/90% (-KTL) Biased	2.39E-01	2.40E-01	2.40E-01	2.39E-01	2.41E-01	2.41E-01	2.47E-01
Un-Biased Statistics							
Average Un-Biased	2.42E-01	2.38E-01	2.39E-01	2.41E-01	2.42E-01	2.41E-01	2.44E-01
Std Dev Un-Biased	3.49E-03	3.36E-03	3.51E-03	3.39E-03	3.51E-03	3.16E-03	3.49E-03
Ps90%/90% (+KTL) Un-Biased	2.52E-01	2.48E-01	2.49E-01	2.50E-01	2.52E-01	2.50E-01	2.54E-01
Ps90%/90% (-KTL) Un-Biased	2.33E-01	2.29E-01	2.30E-01	2.32E-01	2.33E-01	2.32E-01	2.35E-01
Specification MAX	3.50E-01	6.00E-01	8.00E-01	8.00E-01	1.00E+00	1.00E+00	1.00E+00
Status	PASS	PASS	PASS	PASS	PASS	PASS	PASS

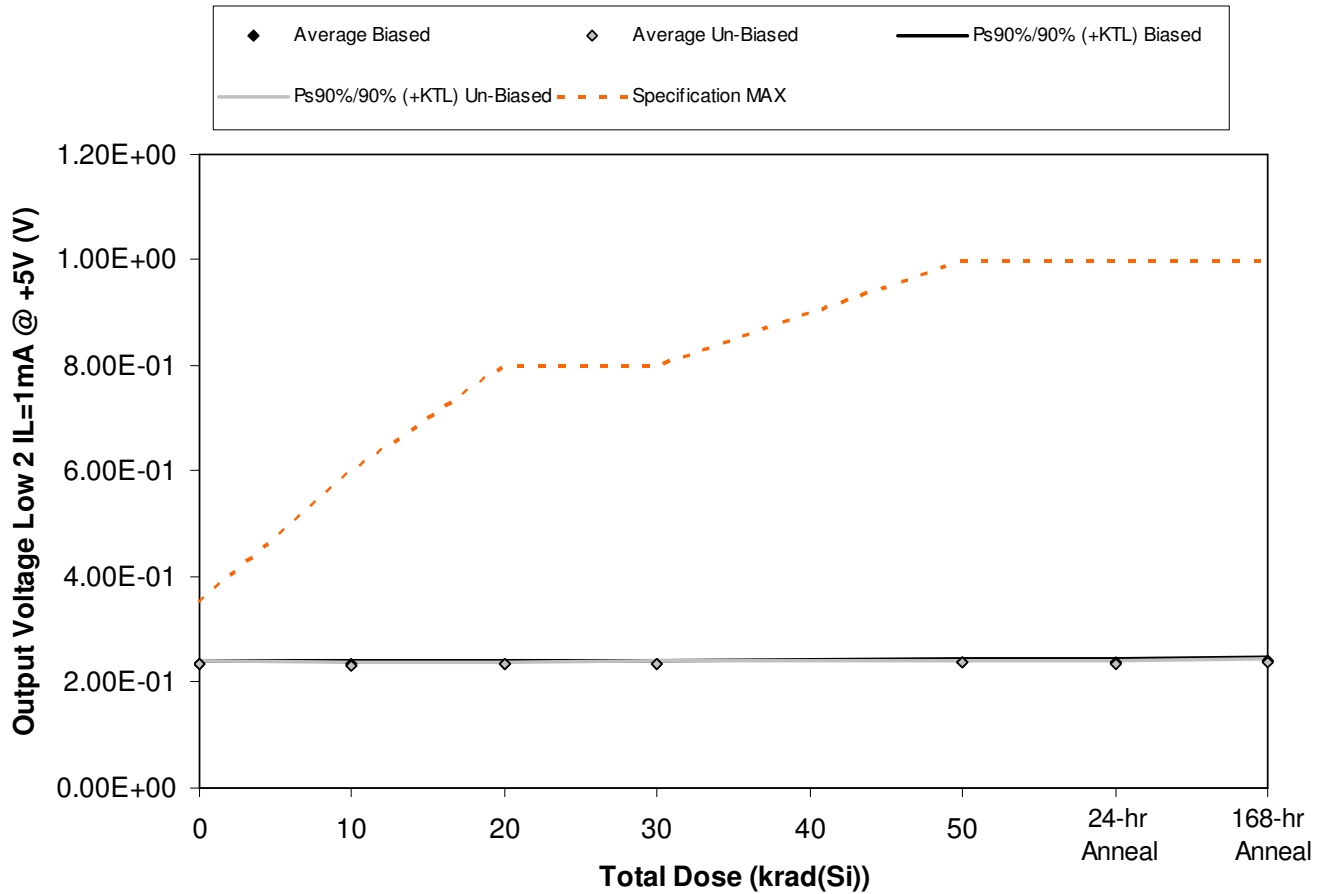

Figure 5.82. Plot of Output Voltage Low 2 IL=1mA @ +5V (V) versus total dose. The solid diamonds are the average of the measured data points for the samples irradiated under electrical bias while the shaded diamonds are the average of the measured data points for the samples irradiated with all pins tied to ground. The black lines (solid and/or dashed) are the average of the data points after application of the KTL statistics on the samples irradiated under electrical bias while the gray lines (solid and/or dashed) are the average of the data points after application of the KTL statistics on the samples irradiated in the unbiased condition. The red dotted line(s) are the pre- and/or post-irradiation minimum and/or maximum specification value as defined in the datasheet and/or test plan.



**TID Report
11-572 R1.0**

**Aeroflex RAD
5017 N. 30th Street
Colorado Springs, CO 80919
(719) 531-0800**

Table 5.82. Raw data for Output Voltage Low 2 IL=1mA @ +5V (V) versus total dose, including the statistical analysis, specification and the status of the testing (pass/fail).

Output Voltage Low 2 IL=1mA @ +5V (V)	Total Dose (krad(Si))					24 hr	168 hr
	0	10	20	30	50	Anneal	Anneal
Device	10/20/2011	11/3/2011	11/3/2011	11/3/2011	11/3/2011	11/4/2011	11/11/2011
1831	2.33E-01	2.31E-01	2.32E-01	2.33E-01	2.35E-01	2.34E-01	2.39E-01
1832	2.34E-01	2.36E-01	2.35E-01	2.35E-01	2.38E-01	2.38E-01	2.43E-01
1833	2.36E-01	2.34E-01	2.35E-01	2.36E-01	2.38E-01	2.37E-01	2.42E-01
1834	2.34E-01	2.32E-01	2.32E-01	2.33E-01	2.35E-01	2.35E-01	2.40E-01
1835	2.39E-01	2.37E-01	2.37E-01	2.38E-01	2.40E-01	2.40E-01	2.44E-01
1836	2.35E-01	2.32E-01	2.33E-01	2.34E-01	2.35E-01	2.34E-01	2.38E-01
1837	2.37E-01	2.34E-01	2.34E-01	2.37E-01	2.38E-01	2.36E-01	2.39E-01
1838	2.37E-01	2.34E-01	2.34E-01	2.36E-01	2.38E-01	2.36E-01	2.39E-01
1839	2.38E-01	2.34E-01	2.35E-01	2.36E-01	2.38E-01	2.36E-01	2.39E-01
1840	2.33E-01	2.30E-01	2.31E-01	2.32E-01	2.34E-01	2.31E-01	2.34E-01
1851	2.36E-01	2.36E-01	2.37E-01	2.38E-01	2.38E-01	2.35E-01	2.37E-01
1852	2.34E-01	2.34E-01	2.35E-01	2.36E-01	2.36E-01	2.33E-01	2.35E-01
Biased Statistics							
Average Biased	2.35E-01	2.34E-01	2.34E-01	2.35E-01	2.37E-01	2.37E-01	2.42E-01
Std Dev Biased	2.39E-03	2.55E-03	2.17E-03	2.12E-03	2.17E-03	2.39E-03	2.07E-03
Ps90%/90% (+KTL) Biased	2.42E-01	2.41E-01	2.40E-01	2.41E-01	2.43E-01	2.43E-01	2.47E-01
Ps90%/90% (-KTL) Biased	2.29E-01	2.27E-01	2.28E-01	2.29E-01	2.31E-01	2.30E-01	2.36E-01
Un-Biased Statistics							
Average Un-Biased	2.36E-01	2.33E-01	2.33E-01	2.35E-01	2.37E-01	2.35E-01	2.38E-01
Std Dev Un-Biased	2.00E-03	1.79E-03	1.52E-03	2.00E-03	1.95E-03	2.19E-03	2.17E-03
Ps90%/90% (+KTL) Un-Biased	2.41E-01	2.38E-01	2.38E-01	2.40E-01	2.42E-01	2.41E-01	2.44E-01
Ps90%/90% (-KTL) Un-Biased	2.31E-01	2.28E-01	2.29E-01	2.30E-01	2.31E-01	2.29E-01	2.32E-01
Specification MAX	3.50E-01	6.00E-01	8.00E-01	8.00E-01	1.00E+00	1.00E+00	1.00E+00
Status	PASS	PASS	PASS	PASS	PASS	PASS	PASS

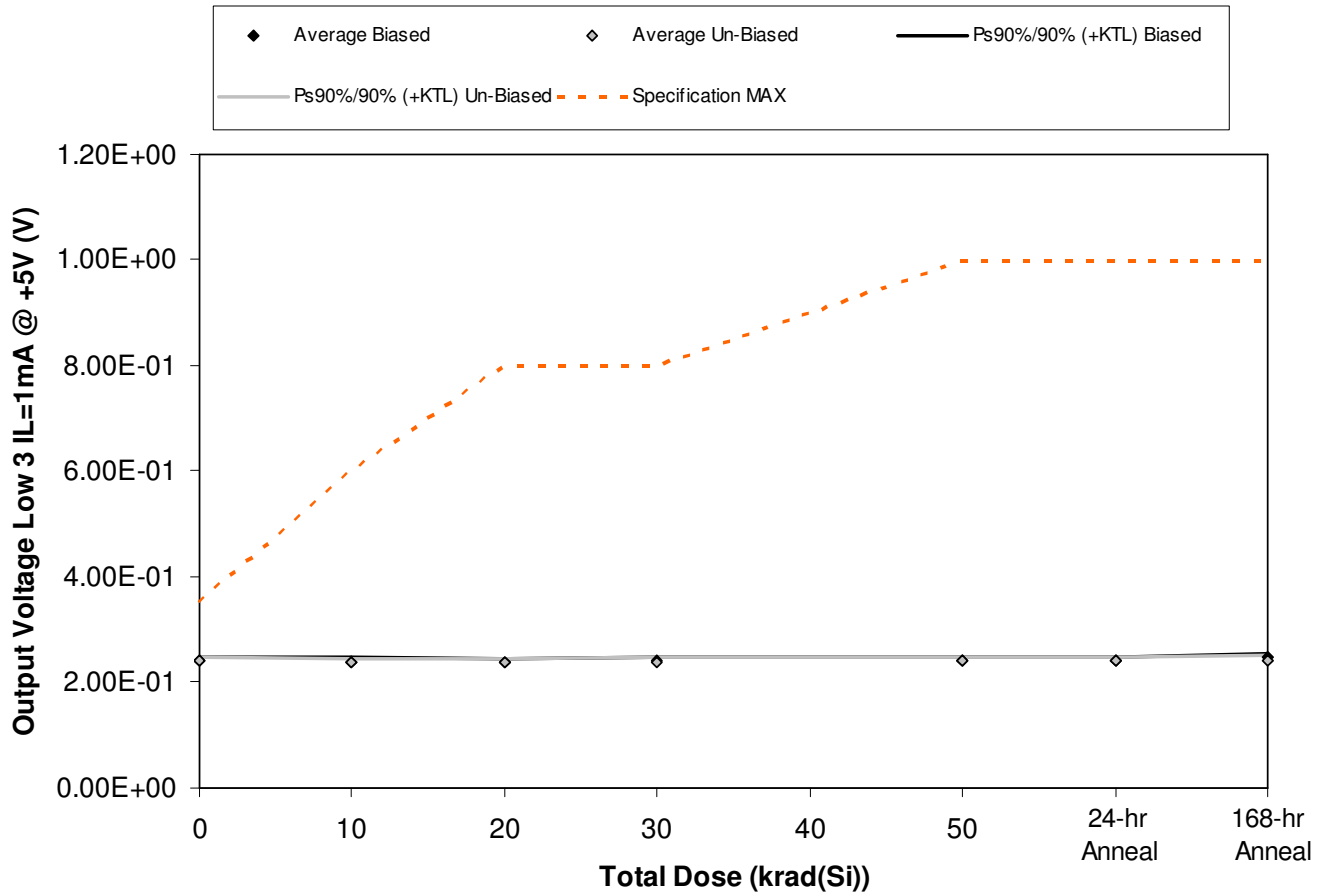

Figure 5.83. Plot of Output Voltage Low 3 IL=1mA @ +5V (V) versus total dose. The solid diamonds are the average of the measured data points for the samples irradiated under electrical bias while the shaded diamonds are the average of the measured data points for the samples irradiated with all pins tied to ground. The black lines (solid and/or dashed) are the average of the data points after application of the KTL statistics on the samples irradiated under electrical bias while the gray lines (solid and/or dashed) are the average of the data points after application of the KTL statistics on the samples irradiated in the unbiased condition. The red dotted line(s) are the pre- and/or post-irradiation minimum and/or maximum specification value as defined in the datasheet and/or test plan.



**TID Report
11-572 R1.0**

**Aeroflex RAD
5017 N. 30th Street
Colorado Springs, CO 80919
(719) 531-0800**

Table 5.83. Raw data for Output Voltage Low 3 IL=1mA @ +5V (V) versus total dose, including the statistical analysis, specification and the status of the testing (pass/fail).

Output Voltage Low 3 IL=1mA @ +5V (V)	Total Dose (krad(Si))					24 hr	168 hr
	0	10	20	30	50	Anneal	Anneal
Device	10/20/2011	11/3/2011	11/3/2011	11/3/2011	11/3/2011	11/4/2011	11/11/2011
1831	2.38E-01	2.36E-01	2.37E-01	2.37E-01	2.40E-01	2.39E-01	2.44E-01
1832	2.39E-01	2.42E-01	2.40E-01	2.41E-01	2.43E-01	2.43E-01	2.49E-01
1833	2.41E-01	2.40E-01	2.40E-01	2.41E-01	2.43E-01	2.43E-01	2.49E-01
1834	2.38E-01	2.37E-01	2.37E-01	2.38E-01	2.40E-01	2.40E-01	2.45E-01
1835	2.44E-01	2.41E-01	2.42E-01	2.43E-01	2.45E-01	2.45E-01	2.50E-01
1836	2.39E-01	2.36E-01	2.37E-01	2.38E-01	2.40E-01	2.40E-01	2.42E-01
1837	2.42E-01	2.39E-01	2.40E-01	2.42E-01	2.43E-01	2.42E-01	2.45E-01
1838	2.42E-01	2.38E-01	2.39E-01	2.41E-01	2.42E-01	2.41E-01	2.44E-01
1839	2.42E-01	2.39E-01	2.40E-01	2.42E-01	2.44E-01	2.42E-01	2.44E-01
1840	2.37E-01	2.33E-01	2.34E-01	2.35E-01	2.37E-01	2.35E-01	2.38E-01
1851	2.42E-01	2.41E-01	2.42E-01	2.43E-01	2.43E-01	2.40E-01	2.42E-01
1852	2.39E-01	2.39E-01	2.39E-01	2.40E-01	2.41E-01	2.37E-01	2.39E-01
Biased Statistics							
Average Biased	2.40E-01	2.39E-01	2.39E-01	2.40E-01	2.42E-01	2.42E-01	2.47E-01
Std Dev Biased	2.55E-03	2.59E-03	2.17E-03	2.45E-03	2.17E-03	2.45E-03	2.70E-03
Ps90%/90% (+KTL) Biased	2.47E-01	2.46E-01	2.45E-01	2.47E-01	2.48E-01	2.49E-01	2.55E-01
Ps90%/90% (-KTL) Biased	2.33E-01	2.32E-01	2.33E-01	2.33E-01	2.36E-01	2.35E-01	2.40E-01
Un-Biased Statistics							
Average Un-Biased	2.40E-01	2.37E-01	2.38E-01	2.40E-01	2.41E-01	2.40E-01	2.43E-01
Std Dev Un-Biased	2.30E-03	2.55E-03	2.55E-03	3.05E-03	2.77E-03	2.92E-03	2.79E-03
Ps90%/90% (+KTL) Un-Biased	2.47E-01	2.44E-01	2.45E-01	2.48E-01	2.49E-01	2.48E-01	2.50E-01
Ps90%/90% (-KTL) Un-Biased	2.34E-01	2.30E-01	2.31E-01	2.31E-01	2.34E-01	2.32E-01	2.35E-01
Specification MAX	3.50E-01	6.00E-01	8.00E-01	8.00E-01	1.00E+00	1.00E+00	1.00E+00
Status	PASS	PASS	PASS	PASS	PASS	PASS	PASS

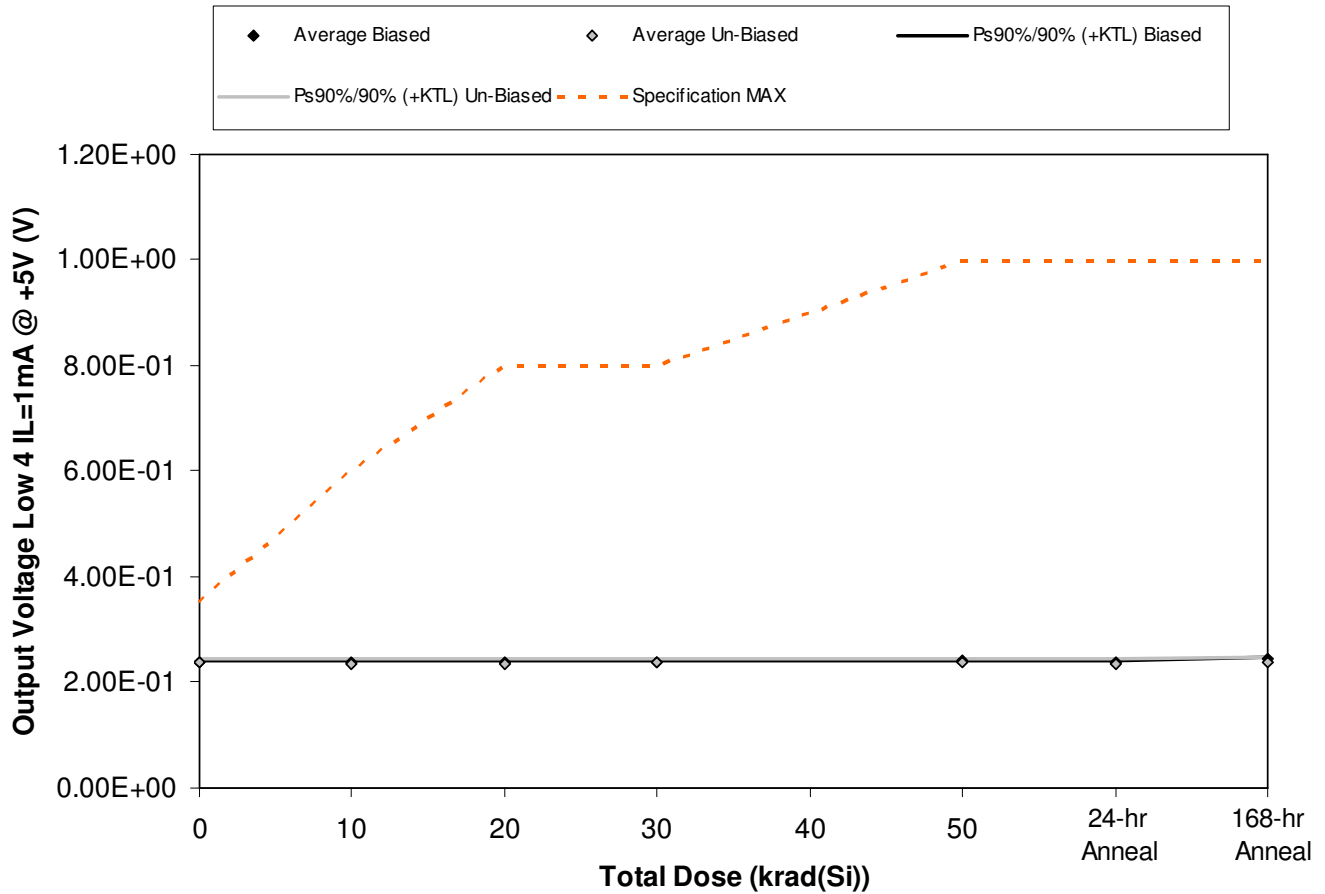

Figure 5.84. Plot of Output Voltage Low 4 IL=1mA @ +5V (V) versus total dose. The solid diamonds are the average of the measured data points for the samples irradiated under electrical bias while the shaded diamonds are the average of the measured data points for the samples irradiated with all pins tied to ground. The black lines (solid and/or dashed) are the average of the data points after application of the KTL statistics on the samples irradiated under electrical bias while the gray lines (solid and/or dashed) are the average of the data points after application of the KTL statistics on the samples irradiated in the unbiased condition. The red dotted line(s) are the pre- and/or post-irradiation minimum and/or maximum specification value as defined in the datasheet and/or test plan.



**TID Report
11-572 R1.0**

**Aeroflex RAD
5017 N. 30th Street
Colorado Springs, CO 80919
(719) 531-0800**

Table 5.84. Raw data for Output Voltage Low 4 IL=1mA @ +5V (V) versus total dose, including the statistical analysis, specification and the status of the testing (pass/fail).

Output Voltage Low 4 IL=1mA @ +5V (V)	Total Dose (krad(Si))					24 hr Anneal	168 hr Anneal
	0	10	20	30	50		
Device	10/20/2011	11/3/2011	11/3/2011	11/3/2011	11/3/2011	11/4/2011	11/11/2011
1831	2.39E-01	2.38E-01	2.38E-01	2.39E-01	2.41E-01	2.40E-01	2.45E-01
1832	2.37E-01	2.36E-01	2.36E-01	2.37E-01	2.39E-01	2.38E-01	2.43E-01
1833	2.38E-01	2.37E-01	2.36E-01	2.37E-01	2.39E-01	2.39E-01	2.45E-01
1834	2.39E-01	2.38E-01	2.39E-01	2.39E-01	2.41E-01	2.41E-01	2.45E-01
1835	2.37E-01	2.36E-01	2.37E-01	2.38E-01	2.40E-01	2.39E-01	2.43E-01
1836	2.39E-01	2.36E-01	2.37E-01	2.37E-01	2.39E-01	2.38E-01	2.41E-01
1837	2.36E-01	2.33E-01	2.33E-01	2.35E-01	2.36E-01	2.35E-01	2.38E-01
1838	2.36E-01	2.33E-01	2.34E-01	2.37E-01	2.37E-01	2.36E-01	2.39E-01
1839	2.41E-01	2.39E-01	2.39E-01	2.41E-01	2.42E-01	2.40E-01	2.43E-01
1840	2.34E-01	2.30E-01	2.31E-01	2.32E-01	2.34E-01	2.32E-01	2.35E-01
1851	2.37E-01	2.37E-01	2.37E-01	2.38E-01	2.38E-01	2.35E-01	2.37E-01
1852	2.33E-01	2.34E-01	2.34E-01	2.35E-01	2.36E-01	2.32E-01	2.34E-01
Biased Statistics							
Average Biased	2.38E-01	2.37E-01	2.37E-01	2.38E-01	2.40E-01	2.39E-01	2.44E-01
Std Dev Biased	1.00E-03	1.00E-03	1.30E-03	1.00E-03	1.00E-03	1.14E-03	1.10E-03
Ps90%/90% (+KTL) Biased	2.41E-01	2.40E-01	2.41E-01	2.41E-01	2.43E-01	2.43E-01	2.47E-01
Ps90%/90% (-KTL) Biased	2.35E-01	2.34E-01	2.34E-01	2.35E-01	2.37E-01	2.36E-01	2.41E-01
Un-Biased Statistics							
Average Un-Biased	2.37E-01	2.34E-01	2.35E-01	2.36E-01	2.38E-01	2.36E-01	2.39E-01
Std Dev Un-Biased	2.77E-03	3.42E-03	3.19E-03	3.29E-03	3.05E-03	3.03E-03	3.03E-03
Ps90%/90% (+KTL) Un-Biased	2.45E-01	2.44E-01	2.44E-01	2.45E-01	2.46E-01	2.45E-01	2.48E-01
Ps90%/90% (-KTL) Un-Biased	2.30E-01	2.25E-01	2.26E-01	2.27E-01	2.29E-01	2.28E-01	2.31E-01
Specification MAX	3.50E-01	6.00E-01	8.00E-01	8.00E-01	1.00E+00	1.00E+00	1.00E+00
Status	PASS	PASS	PASS	PASS	PASS	PASS	PASS



6.0. Summary / Conclusions

The total ionizing dose testing described in this final report was performed using the facilities at Aeroflex RAD's Longmire Laboratories in Colorado Springs, CO. The high dose rate total ionizing dose (TID) source is a JLSA 81-24 irradiator modified to provide a panoramic exposure. The Co-60 rods are held in the base of the irradiator heavily shielded by lead, during the radiation exposures the rod is raised by an electronic timer/controller and the exposure is performed in air. The dose rate for this irradiator in this configuration ranges from <math><1\text{rad(Si)/s}</math> to a maximum of approximately

The parametric data was obtained as "read and record" and all the raw data plus an attributes summary are contained in this report as well as in a separate Excel file. The attributes data contains the average, standard deviation and the average with the KTL values applied. The KTL value used in this work is 2.742 per MIL-HDBK-814 using one sided tolerance limits of 90/90 and a 5-piece sample size. The 90/90 KTL values were selected to match the statistical levels specified in the MIL-PRF-38535 sampling plan for the qualification of a radiation hardness assured (RHA) component. Note that the following criteria must be met for a device to pass the total ionizing dose test: following the radiation exposure each of the 5 pieces irradiated under electrical bias shall pass the specification value. The units irradiated without electrical bias and the KTL statistics are included in this report for reference only. If any of the 5 pieces irradiated under electrical bias exceed the device post radiation data sheet specification limits, then the lot could be logged as a failure.

Based on this criterion the RH1014MW Quad Precision Operational Amplifier (from the lot date code identified on the first page of this test report) PASSED the total ionizing dose test to the maximum tested dose level of



Appendix A: Photograph of a Sample Unit-Under-Test to Show Part Traceability

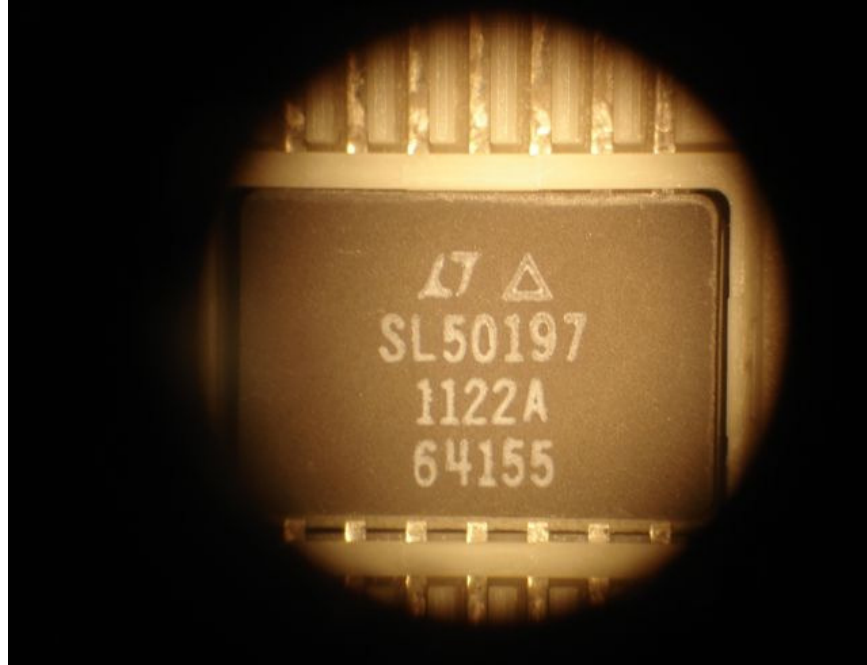



Appendix B: Radiation Bias Connections and Absolute Maximum Ratings

TID Radiation Biased Conditions: Extracted from Linear Technology RH1014M datasheet.

Pin	Function	Connection / Bias
1	OUT A	To Pin 2 Via 10kΩ Resistor
2	-IN A	To Pin 1 Via 10kΩ Resistor
3	+IN A	8V Via 10kΩ Resistor
4	V+	+15V Decoupled to GND W/ 0.1μF
5	+IN B	8V Via 10kΩ Resistor
6	-IN B	To Pin 7 Via 10kΩ Resistor
7	OUT B	To Pin 6 Via 10kΩ Resistor
8	OUT C	To Pin 9 Via 10kΩ Resistor
9	-IN C	To Pin 8 Via 10kΩ Resistor
10	+IN C	8V Via 10kΩ Resistor
11	V-	-15V Decoupled to GND W/ 0.1μF
12	+IN D	8V Via 10kΩ Resistor
13	-IN D	To Pin 14 Via 10kΩ Resistor
14	OUT D	To Pin 13 Via 10kΩ Resistor



**TID Report
11-572 R1.0**

**Aeroflex RAD
5017 N. 30th Street
Colorado Springs, CO 80919
(719) 531-0800**

TID Radiation Unbiased Conditions:

Pin	Function	Connection / Bias
1	OUT A	GND
2	-IN A	GND
3	+IN A	GND
4	V+	GND
5	+IN B	GND
6	-IN B	GND
7	OUT B	GND
8	OUT C	GND
9	-IN C	GND
10	+IN C	GND
11	V-	GND
12	+IN D	GND
13	-IN D	GND
14	OUT D	GND

An ISO 9001:2008 and DSCC Certified Company

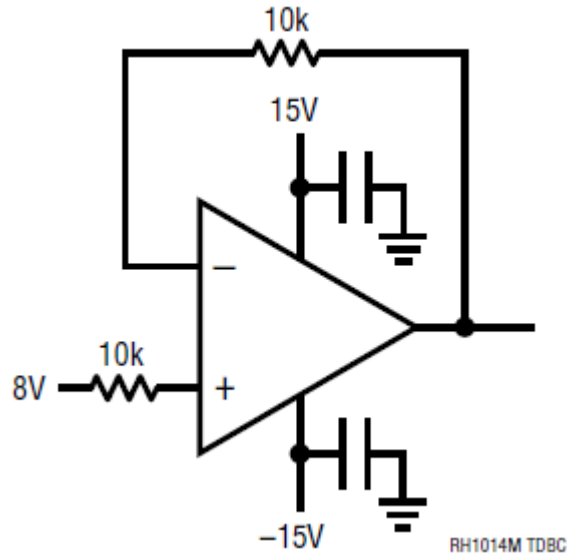

Figure B.1. Irradiation bias circuit for the units to be irradiated under electrical bias. This figure was extracted from Linear Technology RH1014M Quad Precision Operational Amplifier Datasheet.

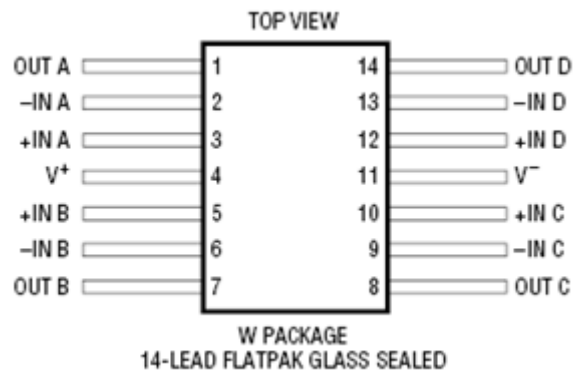

Figure B.2. Package drawing (for reference only). This figure was extracted from Linear Technology RH1014M Quad Precision Operational Amplifier Datasheet.



Appendix C: Electrical Test Parameters and Conditions

The expected ranges of values as well as the measurement conditions are taken from Linear Technology RH1014M datasheet. All electrical tests for this device are performed on one of Aeroflex RAD's LTS2020 Test Systems. The LTS2020 Test System is a programmable parametric tester that provides parameter measurements for a variety of digital, analog and mixed signal products including voltage regulators, voltage comparators, D to A and A to D converters. The LTS2020 Test System achieves accuracy and sensitivity through the use of software self-calibration and an internal relay matrix with separate family boards and custom personality adapter boards. The tester uses this relay matrix to connect the required test circuits, select the appropriate voltage / current sources and establish the needed measurement loops for all the tests performed. The measured parameters and test conditions are shown in Table C.1.

A listing of the measurement precision/resolution for each parameter is shown in Table C.2. The precision/resolution values were obtained from test data or from the DAC resolution of the LTS-2020 for the particular test shown, whichever is greater. To generate the precision/resolution shown in Table C.2, one of the units-under-test was tested repetitively (a total of 10-times with re-insertion between tests) to obtain the average test value and standard deviation. Using this test data MIL-HDBK-814 90/90 KTL statistics were applied to the measured standard deviation to generate the final measurement range. This value encompasses the precision/resolution of all aspects of the test system, including the LTS2020 mainframe, family board, socket assembly and DUT board as well as insertion error. In some cases, the measurement resolution is limited by the internal DACs, which results in a measured standard deviation of zero. In these instances the precision/resolution will be reported back as the LSB of the DAC.

Note that the testing and statistics used in this document are based on an “analysis of variables” technique, which relies on small sample sizes to qualify much larger lot sizes (see MIL-HDBK-814, p. 91 for a discussion of statistical treatments). Not all measured parameters are well suited to this approach due to inherent large variations. If necessary, larger samples sizes could be used to qualify these parameters using an “attributes” approach.



Table C.1. Measured parameters and test conditions for the RH1014MW Quad Precision Operational Amplifier.

Parameter	Test Conditions
Positive Supply Current (ICC+)	$V_S = \pm 15V$
Negative Supply Current (IEE-)	$V_S = \pm 15V$
Input Offset Voltage ($V_{OS1} - V_{OS4}$)	$V_S = \pm 15V$
Input Offset Current ($I_{OS1} - I_{OS4}$)	$V_S = \pm 15V$
+ Input Bias Current ($I_{B+1} - I_{B+4}$)	$V_S = \pm 15V$
- Input Bias Current ($I_{B-1} - I_{B-4}$)	$V_S = \pm 15V$
Common Mode Rejection Ratio (CMRR1-CMRR4)	$V_{CM} = 13.5V, -15V$
Power Supply Rejection Ratio (PSRR1-PSRR4)	$V_S = \pm 10V$ to $\pm 18V$
Large Signal Voltage Gain ($A_{VOL9} - A_{VOL12}$)	$V_S = \pm 15V, V_O = \pm 10V, R_L = 10k\Omega$
Positive Output Voltage Swing ($V_{OUT+1} - V_{OUT+4}$)	$V_S = \pm 15V, R_L = 10k\Omega$
Negative Output Voltage Swing ($V_{OUT-1} - V_{OUT-4}$)	$V_S = \pm 15V, R_L = 10k\Omega$
Positive Slew Rate (SlewRate+1 – SlewRate+4)	$V_S = \pm 15V, R_L = 10k\Omega$
Negative Slew Rate (SlewRate-1 – SlewRate-4)	$V_S = \pm 15V, R_L = 10k\Omega$
Positive Supply Current (ICC+2)	$V_S = +5V$
Negative Supply Current (IEE-2)	$V_S = +5V$
Input Offset Voltage ($V_{OS5} - V_{OS8}$)	$V_S = +5V$
Input Offset Current ($I_{OS5} - I_{OS8}$)	$V_S = +5V$
+ Input Bias Current ($I_{B+5} - I_{B+8}$)	$V_S = +5V$
- Input Bias Current ($I_{B-5} - I_{B-8}$)	$V_S = +5V$
Positive Output Voltage Swing ($V_{OUT+5} - V_{OUT+8}$)	$V_S = +5V, \text{No Load}$
Positive Output Voltage Swing ($V_{OUT+9} - V_{OUT+12}$)	$V_S = +5V, R_L = 600\Omega$
Output Voltage Low ($V_{OUT-5} - V_{OUT-8}$)	$V_S = +5V, \text{No Load}$
Output Voltage Low ($V_{OUT-9} - V_{OUT-12}$)	$V_S = +5V, R_L = 600\Omega$
Output Voltage Low ($V_{OUT-13} - V_{OUT-16}$)	$V_S = +5V, I_{SINK} = 1mA$



Table C.2. Measured parameters, pre-irradiation specifications and measurement precision for the RH1014MW Quad Precision Operational Amplifier.

Parameter	Pre-Irradiation Specification		Measurement Precision/Resolution
	MIN	MAX	
Positive Supply Current (ICC+)		2.20E-03 A	±5.26E-06 A
Negative Supply Current (IEE-)	-2.20E-03 A		±5.55E-06 A
Input Offset Voltage (V _{OS1} -V _{OS4})	-3.00E-04 V	3.00E-04 V	±3.40E-06 V
Input Offset Current (I _{OS1} -I _{OS4})	-1.00E-08 A	+1.00E-08 A	±3.04E-11 A
+ Input Bias Current (I _{B+1} -I _{B+4})	-3.00E-08 A	3.00E-08 A	±6.02E-11 A
- Input Bias Current (I _{B-1} -I _{B-4})	-3.00E-08 A	3.00E-08 A	±6.48E-11 A
Common Mode Rejection Ratio (CMRR1-CMRR4)	97 dB		±4.79E-01 dB
Power Supply Rejection Ratio (PSRR1-PSRR4)	100 dB		±3.23E+00 dB
Large Signal Voltage Gain (A _{VOL9} -A _{VOL12})	1.20E+03 V/mV		±1.72E+04 V/mV
Positive Output Voltage Swing (V _{OUT+1} -V _{OUT+4})	12.5 V		±1.90E-03 V
Negative Output Voltage Swing (V _{OUT-1} -V _{OUT-4})		-12.5 V	±8.71E-04 V
Positive Slew Rate (SlewRate+1-SlewRate+4)	0.2 V/μs		±1.26E-02 V/μs
Negative Slew Rate (SlewRate-1-SlewRate-4)		-0.2 V/μs	±2.34E-02 V/μs
Positive Supply Current (ICC+2)		2.00E-03 A	±3.87E-06 A
Negative Supply Current (IEE-2)	-2.00E-03 A		±5.08E-06 A
Input Offset Voltage (V _{OS5} -V _{OS8})	-4.50E-04 V	4.50E-04 V	±1.00E-06 V
Input Offset Current (I _{OS5} -I _{OS8})	-1.00E-08 A	1.00E-08 A	±3.61E-11 A
+ Input Bias Current (I _{B+5} -I _{B+8})	-5.00E-08 A	5.00E-08 A	±8.80E-11 A
- Input Bias Current (I _{B-5} -I _{B-8})	-5.00E-08 A	5.00E-08 A	±7.13E-11 A
Positive Output Voltage Swing (V _{OUT+5} -V _{OUT+8})	4.0 V		±1.17E-03 V
Positive Output Voltage Swing (V _{OUT+9} -V _{OUT+12})	3.4 V		±1.38E-03 V
Output Voltage Low (V _{OUT-5} -V _{OUT-8})		2.50E-02 V	±1.70E-04 V
Output Voltage Low (V _{OUT-9} -V _{OUT-12})		1.00E-02 V	±2.27E-04 V
Output Voltage Low (V _{OUT-13} -V _{OUT-16})		0.35 V	±1.09E-03 V



Appendix D: List of Figures Used in the Results Section (Section 5)

- 5.1. Positive Supply Current @ +/-15V (A)
- 5.2. Negative Supply Current @ +/-15V (A)
- 5.3. Offset Voltage 1 @ +/-15V (V)
- 5.4. Offset Voltage 2 @ +/-15V (V)
- 5.5. Offset Voltage 3 @ +/-15V (V)
- 5.6. Offset Voltage 4 @ +/-15V (V)
- 5.7. Offset Current 1 @ +/-15V (A)
- 5.8. Offset Current 2 @ +/-15V (A)
- 5.9. Offset Current 3 @ +/-15V (A)
- 5.10. Offset Current 4 @ +/-15V (A)
- 5.11. Positive Bias Current 1 @ +/-15V (A)
- 5.12. Positive Bias Current 2 @ +/-15V (A)
- 5.13. Positive Bias Current 3 @ +/-15V (A)
- 5.14. Positive Bias Current 4 @ +/-15V (A)
- 5.15. Negative Bias Current 1 @ +/-15V (A)
- 5.16. Negative Bias Current 2 @ +/-15V (A)
- 5.17. Negative Bias Current 3 @ +/-15V (A)
- 5.18. Negative Bias Current 4 @ +/-15V (A)
- 5.19. Common Mode Rejection Ratio 1 (dB)
- 5.20. Common Mode Rejection Ratio 2 (dB)
- 5.21. Common Mode Rejection Ratio 3 (dB)
- 5.22. Common Mode Rejection Ratio 4 (dB)
- 5.23. Power Supply Rejection Ratio 1 (dB)
- 5.24. Power Supply Rejection Ratio 2 (dB)
- 5.25. Power Supply Rejection Ratio 3 (dB)
- 5.26. Power Supply Rejection Ratio 4 (dB)
- 5.27. Open Loop Gain 1 $RL=10k$ $VO=\pm 10V$ (V/mV)
- 5.28. Open Loop Gain 2 $RL=10k$ $VO=\pm 10V$ (V/mV)
- 5.29. Open Loop Gain 3 $RL=10k$ $VO=\pm 10V$ (V/mV)
- 5.30. Open Loop Gain 4 $RL=10k$ $VO=\pm 10V$ (V/mV)
- 5.31. Positive Output Voltage 1 @ +/-15V (V)
- 5.32. Positive Output Voltage 2 @ +/-15V (V)
- 5.33. Positive Output Voltage 3 @ +/-15V (V)
- 5.34. Positive Output Voltage 4 @ +/-15V (V)
- 5.35. Negative Output Voltage 1 @ +/-15V (V)
- 5.36. Negative Output Voltage 2 @ +/-15V (V)
- 5.37. Negative Output Voltage 3 @ +/-15V (V)
- 5.38. Negative Output Voltage 4 @ +/-15V (V)



- 5.39. Positive Slew Rate 1 @ +/-15V (V/us)
- 5.40. Positive Slew Rate 2 @ +/-15V (V/us)
- 5.41. Positive Slew Rate 3 @ +/-15V (V/us)
- 5.42. Positive Slew Rate 4 @ +/-15V (V/us)
- 5.43. Negative Slew Rate 1 @ +/-15V (V/us)
- 5.44. Negative Slew Rate 2 @ +/-15V (V/us)
- 5.45. Negative Slew Rate 3 @ +/-15V (V/us)
- 5.46. Negative Slew Rate 4 @ +/-15V (V/us)
- 5.47. Positive Supply Current @ +5V (A)
- 5.48. Negative Supply Current @ +5V (A)
- 5.49. Offset Voltage 1 @ +5V (V)
- 5.50. Offset Voltage 2 @ +5V (V)
- 5.51. Offset Voltage 3 @ +5V (V)
- 5.52. Offset Voltage 4 @ +5V (V)
- 5.53. Offset Current 1 @ +5V (A)
- 5.54. Offset Current 2 @ +5V (A)
- 5.55. Offset Current 3 @ +5V (A)
- 5.56. Offset Current 4 @ +5V (A)
- 5.57. Positive Bias Current 1 @ +5V (A)
- 5.58. Positive Bias Current 2 @ +5V (A)
- 5.59. Positive Bias Current 3 @ +5V (A)
- 5.60. Positive Bias Current 4 @ +5V (A)
- 5.61. Negative Bias Current 1 @ +5V (A)
- 5.62. Negative Bias Current 2 @ +5V (A)
- 5.63. Negative Bias Current 3 @ +5V (A)
- 5.64. Negative Bias Current 4 @ +5V (A)
- 5.65. Positive Output Voltage 1 RL=open @ +5V (V)
- 5.66. Positive Output Voltage 2 RL=open @ +5V (V)
- 5.67. Positive Output Voltage 3 RL=open @ +5V (V)
- 5.68. Positive Output Voltage 4 RL=open @ +5V (V)
- 5.69. Positive Output Voltage 1 RL=600 @ +5V (V)
- 5.70. Positive Output Voltage 2 RL=600 @ +5V (V)
- 5.71. Positive Output Voltage 3 RL=600 @ +5V (V)
- 5.72. Positive Output Voltage 4 RL=600 @ +5V (V)
- 5.73. Output Voltage Low 1 RL=open @ +5V (V)
- 5.74. Output Voltage Low 2 RL=open @ +5V (V)
- 5.75. Output Voltage Low 3 RL=open @ +5V (V)
- 5.76. Output Voltage Low 4 RL=open @ +5V (V)
- 5.77. Output Voltage Low 1 RL=600 @ +5V (V)
- 5.78. Output Voltage Low 2 RL=600 @ +5V (V)
- 5.79. Output Voltage Low 3 RL=600 @ +5V (V)
- 5.80. Output Voltage Low 4 RL=600 @ +5V (V)



**TID Report
11-572 R1.0**

**Aeroflex RAD
5017 N. 30th Street
Colorado Springs, CO 80919
(719) 531-0800**

- 5.81. Output Voltage Low 1 IL=1mA @ +5V (V)
- 5.82. Output Voltage Low 2 IL=1mA @ +5V (V)
- 5.83. Output Voltage Low 3 IL=1mA @ +5V (V)
- 5.84. Output Voltage Low 4 IL=1mA @ +5V (V)