



**TID Report
12-086 120506 R1.0**

**Aeroflex RAD
5017 N. 30th Street
Colorado Springs, CO 80919
(719) 531-0800**

Products contained in this shipment may be subject to ITAR regulations.

Warning:

The export of these commodity(ies), technology, or software are subject either to the U.S. Commerce Department Export Administration Regulations (E.A.R.), or to the U.S. State Department International Traffic In Arms Regulations (I.T.A.R.). Diversion, the shipment to unauthorized locations or entities, or the disclosure of related technical data or software to unauthorized foreign nationals is contrary to U.S. law and is prohibited. If export is authorized to a specific country or end-users, compliance with the U.S. export laws is required prior to transfer, transshipment on a non-continuous voyage, or disposal in any other country, or to any other end-user of these commodities, either in their original form or after being incorporated into other end-items.



Total Ionizing Dose (TID) Radiation Testing of the RH137K Negative Adjustable Regulator for Linear Technology

Customer: Linear Technology, PO# 4255J

RAD Job Number: 12-086

Part Type Tested: RH137K Negative Adjustable Regulator.

Traceability Information: Fab Lot Number: W1001716.1, Wafer Number: 10, Assembly Lot Number: 644953.1, Date Code: 1140A. See photograph of unit under test in Appendix A.

Quantity of Units: 12 units received, 5 units for biased irradiation, 5 units for unbiased irradiation and 2 units for control. Serial numbers 81, 82, 83, 84 and 85 were biased during irradiation, serial numbers 86, 117, 118, 119 and 120 were unbiased during irradiation and serial numbers 164 and 165 were used as control. See Appendix B for the radiation bias connection table. Note that control units were shared with 12-087.

Radiation and Electrical Test Increments: 50-300rad(Si)/s ionizing radiation with electrical test increments: pre-irradiation, 10krad(Si), 20krad(Si), 30krad(Si) and 50krad(Si).

Pre-Irradiation Burn-In: Burn-In performed by Linear Technology prior to receipt by RAD

Overtest and Post-Irradiation Anneal: No overtest. 24-hour room temperature anneal followed by a 168-hour 100°C anneal. Both anneals shall be performed in the same electrical bias condition as the irradiations. Electrical measurements shall be made following each anneal increment.

Radiation Test Standard: MIL-STD-750E TM1019 and/or MIL-STD-883H TM1019 Condition A.

Test Hardware and Software: LTS2020 Automated Tester, Entity ID TS03, Calibration Date: 4/28/2011, Calibration Due: 4/28/2012. LTS2100 Family Board, Entity ID FB01. LTS0606 Test Fixture, Entity ID TF05. RH137 DUT Board. Test Program: RH137K.SRC

Facility and Radiation Source: Aeroflex RAD's Longmire Laboratories, Colorado Springs, CO. Gamma rays provided by JLSA 81-24 Co60 source. Dosimetry performed by Air Ionization Chamber (AIC) traceable to NIST. Aeroflex RAD's dosimetry has been audited by DSCC and Aeroflex RAD has been awarded Laboratory Suitability for MIL-STD-750 and MIL-STD-883 TM 1019.

Irradiation and Test Temperature: Room temperature controlled to 24°C±6°C per MIL-STD-883 and MIL-STD-750.

High Dose Rate Test Result: PASSED the total ionizing dose characterization test to the maximum tested dose level of 50krad(Si) with all parameters remaining within their datasheet specifications. Further the units do not exhibit ELDRS as defined in the current test method.



1.0. Overview and Background

It is well known that total dose ionizing radiation can cause parametric degradation and ultimately functional failure in electronic devices. The damage occurs via electron-hole pair production, transport and trapping in the dielectric and interface regions. In discrete devices the bulk of the damage is frequently manifested as a reduction in the gain and/or breakdown voltage of the device. The damage will usually anneal with time following the end of the radiation exposure. Due to this annealing, and to ensure a worst-case test condition MIL-STD-883 TM1019.8 calls out a dose rate of 50 to 300rad(Si)/s as Condition A and further specifies that the time from the end of an incremental radiation exposure and electrical testing shall be 1-hour or less and the total time from the end of one incremental irradiation to the beginning of the next incremental radiation step should be 2-hours or less. The work described in this report was performed to meet MIL-STD-883 TM1019.8 Condition A.

2.0. Radiation Test Apparatus

The total ionizing dose testing described in this final report was performed using the facilities at Aeroflex RAD's Longmire Laboratories in Colorado Springs, CO. The high dose rate total ionizing dose (TID) source is a JLSA 81-24 irradiator modified to provide a panoramic exposure. The Co-60 rods are held in the base of the irradiator heavily shielded by lead. During the radiation exposures the rod is raised by an electronic timer/controller and the exposure is performed in air. The dose rate for this irradiator in this configuration ranges from <1rad(Si)/s to a maximum of approximately 120rad(Si)/s, determined by the distance from the source. For high-dose rate experiments the bias boards are placed in a radial fashion equidistant from the raised Co-60 rods with the distance adjusted to provide the required dose rate. The irradiator calibration is maintained by Aeroflex RAD Longmire Laboratories using air ionization chamber (AIC) equipment calibrated with traceability to the National Institute of Standards and Technology (NIST). Figure 2.1 shows a photograph of the JLSA 81-24 Co-60 irradiator at Aeroflex RAD's Longmire Laboratory facility.

Aeroflex RAD is currently certified by the Defense Supply Center Columbus (DSCC) for Laboratory Suitability under MIL STD 750 and MIL-STD-883. Additional details regarding Aeroflex RAD dosimetry for TM1019 Condition A testing are available in Aeroflex RAD's report to DSCC entitled: "Dose Rate Mapping of the J.L. Shepherd and Associates Model 81 Irradiator Installed by Radiation Assured Devices".



Figure 2.1. Aeroflex RAD's high dose rate Co-60 irradiator. The dose rate is obtained by positioning the device-under-test at a fixed distance from the gamma cell. The dose rate for this irradiator varies from approximately 120rad(Si)/s close to the rods down to 1rad(Si)/s at a distance of approximately 2-feet.



3.0. Radiation Test Conditions

The RH137K Negative Adjustable Regulator described in this final report were irradiated under two different bias conditions, one when biased with a split 15V supply, and one when unbiased with all pins tied to ground. See the TID Bias Table in Appendix B for the full bias circuits. In our opinion, this bias circuit satisfies the requirements of MIL-STD-883H TM1019.8 Section 3.9.3 Bias and Loading Conditions which states "The bias applied to the test devices shall be selected to produce the greatest radiation induced damage or the worst-case damage for the intended application, if known. While maximum voltage is often worst case some bipolar linear device parameters (e.g. input bias current or maximum output load current) exhibit more degradation with 0 V bias."

The devices were irradiated to a maximum total ionizing dose level of 50krad(Si) with incremental readings at 10krad(Si), 20krad(Si) and 30krad(Si). Electrical testing occurred within one hour following the end of each irradiation segment. For intermediate irradiations, the parts were tested and returned to total dose exposure within two hours from the end of the previous radiation increment.

The TID bias board was positioned in the Co-60 cell to provide the required minimum of 50rad(Si)/s and was located inside a lead-aluminum enclosure. The lead-aluminum enclosure is required under MIL-STD-883H TM1019.8 Section 3.4 that reads as follows: "Lead/Aluminum (Pb/Al) container. Test specimens shall be enclosed in a Pb/Al container to minimize dose enhancement effects caused by low-energy, scattered radiation. A minimum of 1.5 mm Pb, surrounding an inner shield of at least 0.7 mm Al, is required. This Pb/Al container produces an approximate charged particle equilibrium for Si and for TLDs such as CaF₂. The radiation field intensity shall be measured inside the Pb/Al container (1) initially, (2) when the source is changed, or (3) when the orientation or configuration of the source, container, or test-fixture is changed. This measurement shall be performed by placing a dosimeter (e.g., a TLD) in the device-irradiation container at the approximate test-device position. If it can be demonstrated that low energy scattered radiation is small enough that it will not cause dosimetry errors due to dose enhancement, the Pb/Al container may be omitted."

The final dose rate within the high dose rate lead-aluminum enclosure was determined using calibration calculations based on air ionization chamber (AIC) dosimetry performed just prior to beginning the total dose irradiations. The final dose rate for this work was 50.40rad(Si)/s with a precision of $\pm 5\%$.



4.0. Tested Parameters

During the total ionizing dose characterization testing the following electrical parameters were measured pre- and post-irradiation:

1. Reference Voltage1 (V) @ VDIFF=5V, IOU=10mA
2. Reference Voltage2 (V) @ VDIFF=3V, IOU=10mA
3. Reference Voltage3 (V) @ VDIFF=30V, IOU=10mA
4. Reference Voltage4 (V) @ VDIFF=3V, IOU=1.5A
5. Reference Voltage5 (V) @ VDIFF=30V, IOU=0.5A
6. Line Regulation (%/V) @ VDIFF=3V to 30V, IOU=10mA
7. Load Regulation1 (V) @ VOUT<=5V, IOU=10mA to 0.5A
8. Load Regulation2 (%) @ VOUT>=5V, IOU=10mA to 1.5A
9. Adjust Pin Current1 (A) @ VDIFF=3V, IOU=10mA
10. Adjust Pin Current2 (A) @ VDIFF=5V, IOU=10mA
11. Adjust Pin Current3 (A) @ VDIFF=30V, IOU=10mA
12. Adjust Pin Current Change1 (A) @ VDIFF=5V, IOU=10mA to 1.5A
13. Adjust Pin Current Change2 (A) @ VDIFF=3V to 30V, IOU=10mA
14. Minimum Load Current1 (A) @ VDIFF=30V
15. Minimum Load Current2 (A) @ VDIFF=10V
16. Current Limit1 (A) @ VDIFF=15V
17. Current Limit2 (A) @ VDIFF=30V

Appendix C details the measured parameters, test conditions, pre-irradiation specification and measurement resolution for each of the measurements.

The parametric data was obtained as "read and record" and all the raw data plus an attributes summary are contained in this report as well as in a separate Excel file. The attributes data contains the average, standard deviation and the average with the KTL values applied. The KTL value used in this work is 2.742 per MIL-HDBK-814 using one sided tolerance limits of 90/90 and a 5-piece sample size. The 90/90 KTL values were selected to match the statistical levels specified in the MIL-PRF-38535 sampling plan for the qualification of a radiation hardness assured (RHA) component. Note that the following criteria must be met for a device to pass the total ionizing dose test: following the radiation exposure each of the 5 pieces irradiated under electrical bias shall pass the specification value. The units irradiated without electrical bias and the KTL statistics are included in this report for reference only. If any of the 5 pieces irradiated under electrical bias exceed the device post radiation data sheet specification limits, then the lot could be logged as a failure.

Further, MIL-STD-883H, TM 1019.8 Section 3.13.1.1 Characterization test to determine if a part exhibits ELDRS' states the following: Select a minimum random sample of 21 devices from a population representative of recent production runs. Smaller sample sizes may be used if agreed upon between the parties to the test. All of the selected devices shall have undergone appropriate elevated



**TID Report
12-086 120506 R1.0**

**Aeroflex RAD
5017 N. 30th Street
Colorado Springs, CO 80919
(719) 531-0800**

temperature reliability screens, e.g. burn-in and high temperature storage life. Divide the samples into four groups of 5 each and use the remaining part for a control. Perform pre-irradiation electrical characterization on all parts assuring that they meet the Group A electrical tests. Irradiate 5 samples under a 0 volt bias and another 5 under the irradiation bias given in the acquisition specification at 50-300 rad(Si)/s and room temperature. Irradiate 5 samples under a 0 volt bias and another 5 under irradiation bias given in the acquisition specification at < 10mrad(Si)/s and room temperature. Irradiate all samples to the same dose levels, including 0.5 and 1.0 times the anticipated specification dose, and repeat the electrical characterization on each part at each dose level. Post irradiation electrical measurements shall be performed per paragraph 3.10 where the low dose rate test is considered Condition D. Calculate the radiation induced change in each electrical parameter (Δ para) for each sample at each radiation level. Calculate the ratio of the median Δ para at low dose rate to the median Δ para at high dose rate for each irradiation bias group at each total dose level. If this ratio exceeds 1.5 for any of the most sensitive parameters then the part is considered to be ELDRS susceptible. This test does not apply to parameters which exhibit changes that are within experimental error or whose values are below the pre-irradiation electrical specification limits at low dose rate at the specification dose.

Therefore, the data in this report can be analyzed along with the low dose rate report titled "Enhanced Low Dose Rate Sensitivity (ELDRS) Radiation Testing of the RH137K Negative Adjustable Regulator for Linear Technology" to demonstrate that these parts do not exhibit ELDRS as defined in the current test method.



5.0. Total Ionizing Dose Test Results

Based on this criterion the RH137K Negative Adjustable Regulator (from the lot traceability information provided on the first page of this test report) PASSED the total ionizing dose test to the maximum tested dose level of 50krad(Si) with all parameters remaining within their datasheet specifications.

Figures 5.1 through 5.17 show plots of all the measured parameters versus total ionizing dose while Tables 5.1 - 5.17 show the corresponding raw data for each of these parameters. In the data plots the solid diamonds are the average of the measured data points for the sample irradiated under electrical bias while the shaded diamonds are the average of the measured data points for the units irradiated with all pins tied to ground. The black lines (solid or dashed) are the average of the data points after application of the KTL statistics on the sample irradiated in the biased condition while the shaded lines (solid or dashed) are the average of the data points after application of the KTL statistics on the sample irradiated in the unbiased condition. The red dotted line(s) are the pre- and/or post-irradiation minimum and/or maximum specification value as defined in the datasheet and/or test plan.

In addition to the radiation test results, the data plots and tables described above contain anneal data. The anneals are performed to better understand the underlying physical mechanisms responsible for radiation-induced parametric shifts and are not part of the criteria used to establish whether or not the lot passes or fails the low dose rate test. In all cases the parts either improved or exhibited no change during the anneal.

The control units, as expected, show no significant changes to any of the parameters. Therefore we can conclude that the electrical testing remained in control throughout the duration of the tests and the observed degradation was due to the radiation exposure. Appendix D lists the figures used in this section to facilitate the location of a particular parameter.

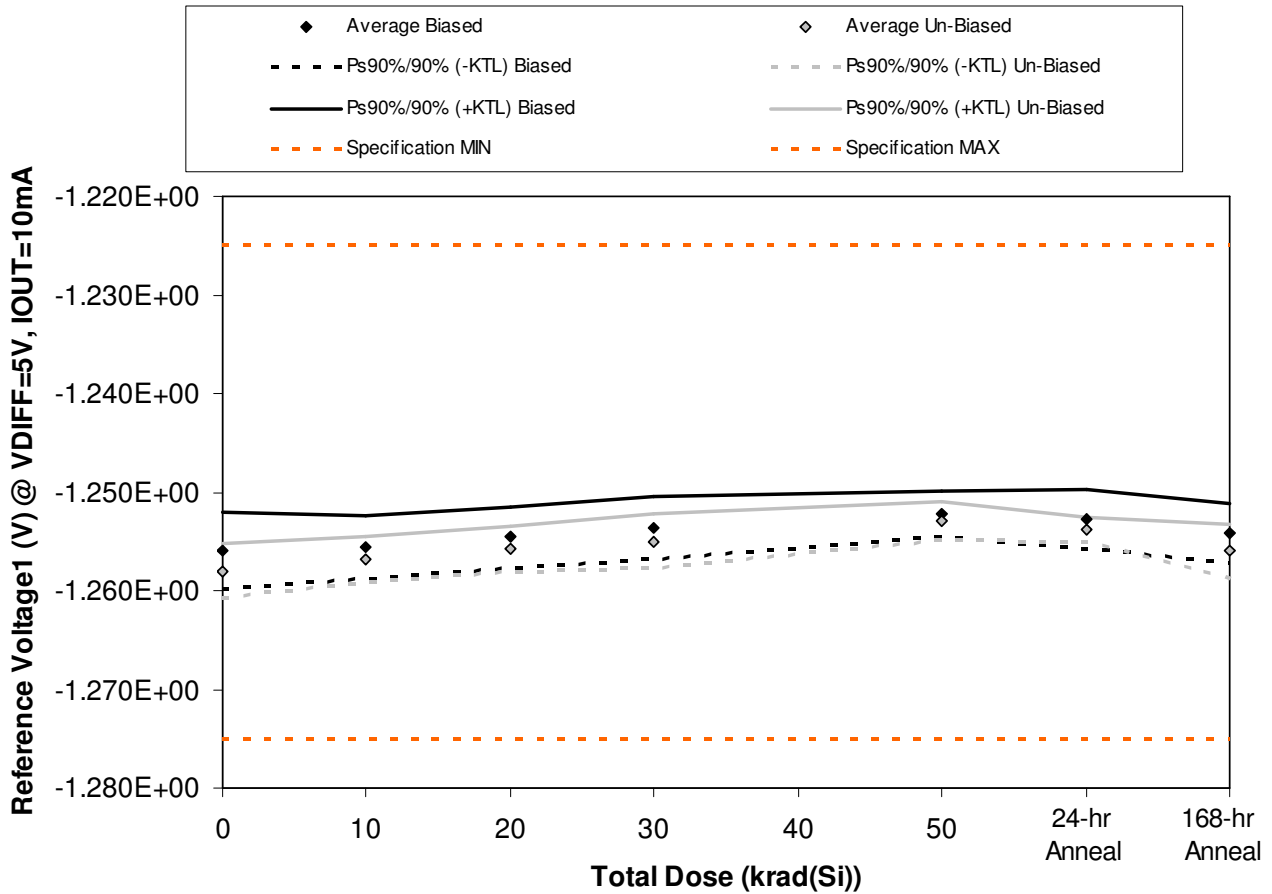

Figure 5.1. Plot of Reference Voltage1 (V) @ VDIFF=5V, IOU=10mA versus total dose. The solid diamonds are the average of the measured data points for the samples irradiated under electrical bias while the shaded diamonds are the average of the measured data points for the samples irradiated with all pins tied to ground. The black lines (solid and/or dashed) are the average of the data points after application of the KTL statistics on the samples irradiated under electrical bias while the gray lines (solid and/or dashed) are the average of the data points after application of the KTL statistics on the samples irradiated in the unbiased condition. The red dotted line(s) are the pre- and/or post-irradiation minimum and/or maximum specification value as defined in the datasheet and/or test plan.



**TID Report
12-086 120506 R1.0**

**Aeroflex RAD
5017 N. 30th Street
Colorado Springs, CO 80919
(719) 531-0800**

Table 5.1. Raw data for Reference Voltage1 (V) @ VDIFF=5V, IOU=10mA versus total dose, including the statistical analysis, specification and the status of the testing (pass/fail).

Reference Voltage1 (V) @ VDIFF=5V, IOU=10mA	Total Dose (krad(Si))					24-hr Anneal	168-hr Anneal
	0	10	20	30	50		
Device							
81	-1.256E+00	-1.255E+00	-1.254E+00	-1.253E+00	-1.252E+00	-1.253E+00	-1.254E+00
82	-1.258E+00	-1.257E+00	-1.256E+00	-1.255E+00	-1.253E+00	-1.254E+00	-1.256E+00
83	-1.256E+00	-1.256E+00	-1.255E+00	-1.254E+00	-1.252E+00	-1.253E+00	-1.254E+00
84	-1.254E+00	-1.254E+00	-1.253E+00	-1.252E+00	-1.251E+00	-1.251E+00	-1.253E+00
85	-1.256E+00	-1.256E+00	-1.255E+00	-1.254E+00	-1.253E+00	-1.253E+00	-1.254E+00
86	-1.259E+00	-1.258E+00	-1.257E+00	-1.256E+00	-1.254E+00	-1.254E+00	-1.257E+00
117	-1.257E+00	-1.256E+00	-1.255E+00	-1.254E+00	-1.253E+00	-1.254E+00	-1.255E+00
118	-1.259E+00	-1.257E+00	-1.256E+00	-1.255E+00	-1.253E+00	-1.254E+00	-1.256E+00
119	-1.258E+00	-1.257E+00	-1.256E+00	-1.256E+00	-1.253E+00	-1.254E+00	-1.257E+00
120	-1.257E+00	-1.256E+00	-1.255E+00	-1.254E+00	-1.252E+00	-1.253E+00	-1.255E+00
164	-1.256E+00	-1.256E+00	-1.256E+00	-1.256E+00	-1.256E+00	-1.256E+00	-1.256E+00
165	-1.255E+00	-1.255E+00	-1.255E+00	-1.255E+00	-1.255E+00	-1.255E+00	-1.255E+00
Biased Statistics							
Average Biased	-1.256E+00	-1.256E+00	-1.255E+00	-1.254E+00	-1.252E+00	-1.253E+00	-1.254E+00
Std Dev Biased	1.41E-03	1.14E-03	1.14E-03	1.14E-03	8.37E-04	1.10E-03	1.10E-03
Ps90%/90% (+KTL) Biased	-1.252E+00	-1.252E+00	-1.251E+00	-1.250E+00	-1.250E+00	-1.250E+00	-1.251E+00
Ps90%/90% (-KTL) Biased	-1.260E+00	-1.259E+00	-1.258E+00	-1.257E+00	-1.254E+00	-1.256E+00	-1.257E+00
Un-Biased Statistics							
Average Un-Biased	-1.258E+00	-1.257E+00	-1.256E+00	-1.255E+00	-1.253E+00	-1.254E+00	-1.256E+00
Std Dev Un-Biased	1.00E-03	8.37E-04	8.37E-04	1.00E-03	7.07E-04	4.47E-04	1.00E-03
Ps90%/90% (+KTL) Un-Biased	-1.255E+00	-1.255E+00	-1.254E+00	-1.252E+00	-1.251E+00	-1.253E+00	-1.253E+00
Ps90%/90% (-KTL) Un-Biased	-1.261E+00	-1.259E+00	-1.258E+00	-1.258E+00	-1.255E+00	-1.255E+00	-1.259E+00
Specification MIN	-1.275E+00	-1.275E+00	-1.275E+00	-1.275E+00	-1.275E+00	-1.275E+00	-1.275E+00
Status	PASS	PASS	PASS	PASS	PASS	PASS	PASS
Specification MAX	-1.225E+00	-1.225E+00	-1.225E+00	-1.225E+00	-1.225E+00	-1.225E+00	-1.225E+00
Status	PASS	PASS	PASS	PASS	PASS	PASS	PASS

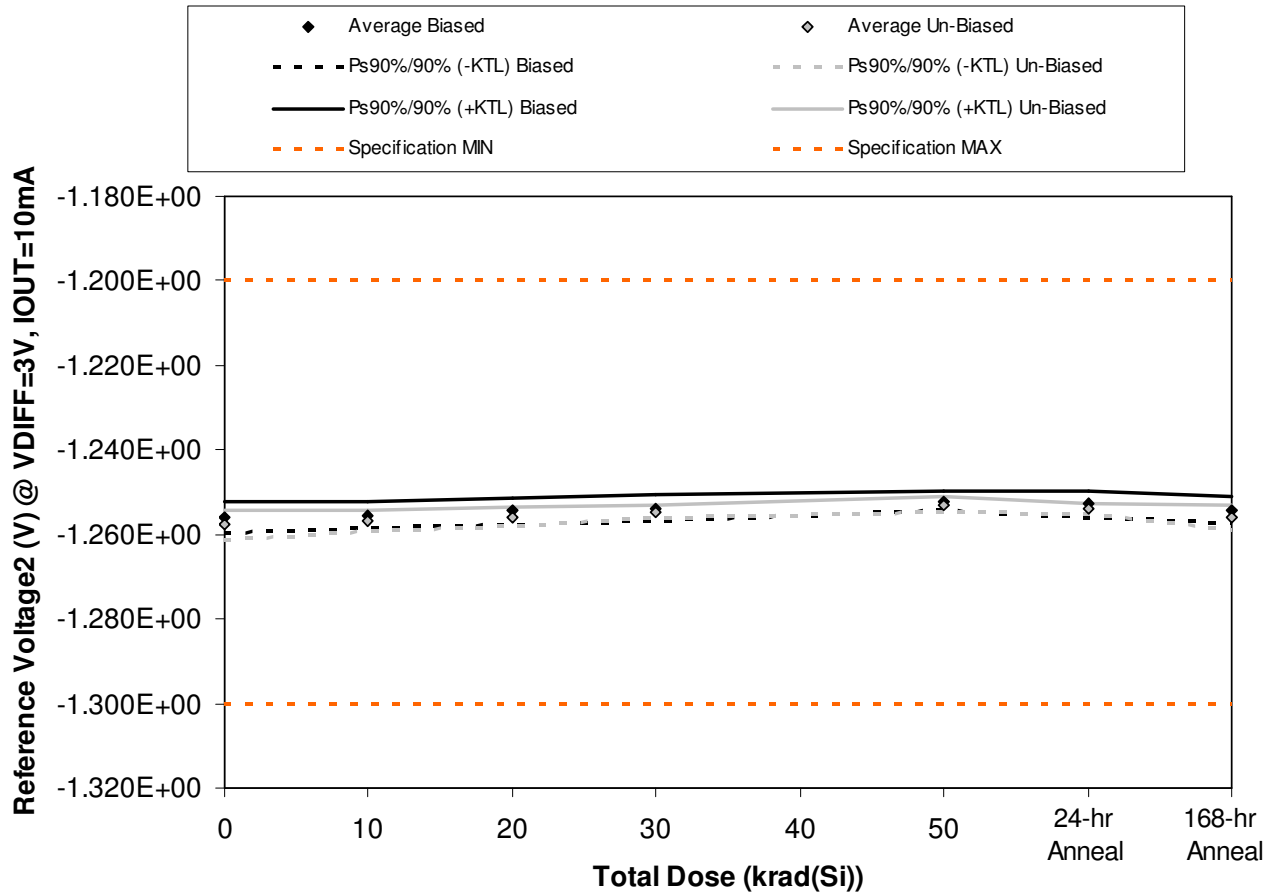

Figure 5.2. Plot of Reference Voltage2 (V) @ VDIFF=3V, IOU=10mA versus total dose. The solid diamonds are the average of the measured data points for the samples irradiated under electrical bias while the shaded diamonds are the average of the measured data points for the samples irradiated with all pins tied to ground. The black lines (solid and/or dashed) are the average of the data points after application of the KTL statistics on the samples irradiated under electrical bias while the gray lines (solid and/or dashed) are the average of the data points after application of the KTL statistics on the samples irradiated in the unbiased condition. The red dotted line(s) are the pre- and/or post-irradiation minimum and/or maximum specification value as defined in the datasheet and/or test plan.



TID Report
12-086 120506 R1.0

Aeroflex RAD
5017 N. 30th Street
Colorado Springs, CO 80919
(719) 531-0800

Table 5.2. Raw data for Reference Voltage2 (V) @ VDIFF=3V, IOU=10mA versus total dose, including the statistical analysis, specification and the status of the testing (pass/fail).

Reference Voltage2 (V) @ VDIFF=3V, IOU=10mA	Total Dose (krad(Si))					24-hr Anneal	168-hr Anneal
	0	10	20	30	50		
Device							
81	-1.256E+00	-1.255E+00	-1.254E+00	-1.254E+00	-1.252E+00	-1.253E+00	-1.254E+00
82	-1.258E+00	-1.257E+00	-1.256E+00	-1.255E+00	-1.253E+00	-1.254E+00	-1.256E+00
83	-1.256E+00	-1.255E+00	-1.254E+00	-1.254E+00	-1.252E+00	-1.253E+00	-1.254E+00
84	-1.254E+00	-1.254E+00	-1.253E+00	-1.252E+00	-1.251E+00	-1.251E+00	-1.253E+00
85	-1.256E+00	-1.256E+00	-1.255E+00	-1.254E+00	-1.253E+00	-1.253E+00	-1.254E+00
86	-1.259E+00	-1.258E+00	-1.257E+00	-1.255E+00	-1.254E+00	-1.254E+00	-1.257E+00
117	-1.256E+00	-1.256E+00	-1.255E+00	-1.254E+00	-1.253E+00	-1.254E+00	-1.255E+00
118	-1.259E+00	-1.257E+00	-1.256E+00	-1.255E+00	-1.253E+00	-1.254E+00	-1.256E+00
119	-1.258E+00	-1.257E+00	-1.256E+00	-1.255E+00	-1.253E+00	-1.254E+00	-1.257E+00
120	-1.257E+00	-1.256E+00	-1.255E+00	-1.254E+00	-1.252E+00	-1.253E+00	-1.255E+00
164	-1.256E+00	-1.256E+00	-1.256E+00	-1.256E+00	-1.256E+00	-1.256E+00	-1.256E+00
165	-1.255E+00	-1.255E+00	-1.255E+00	-1.255E+00	-1.255E+00	-1.255E+00	-1.255E+00
Biased Statistics							
Average Biased	-1.256E+00	-1.255E+00	-1.254E+00	-1.254E+00	-1.252E+00	-1.253E+00	-1.254E+00
Std Dev Biased	1.41E-03	1.14E-03	1.14E-03	1.10E-03	8.37E-04	1.10E-03	1.10E-03
Ps90%/90% (+KTL) Biased	-1.252E+00	-1.252E+00	-1.251E+00	-1.251E+00	-1.250E+00	-1.250E+00	-1.251E+00
Ps90%/90% (-KTL) Biased	-1.260E+00	-1.259E+00	-1.258E+00	-1.257E+00	-1.254E+00	-1.256E+00	-1.257E+00
Un-Biased Statistics							
Average Un-Biased	-1.258E+00	-1.257E+00	-1.256E+00	-1.255E+00	-1.253E+00	-1.254E+00	-1.256E+00
Std Dev Un-Biased	1.30E-03	8.37E-04	8.37E-04	5.48E-04	7.07E-04	4.47E-04	1.00E-03
Ps90%/90% (+KTL) Un-Biased	-1.254E+00	-1.255E+00	-1.254E+00	-1.253E+00	-1.251E+00	-1.253E+00	-1.253E+00
Ps90%/90% (-KTL) Un-Biased	-1.261E+00	-1.259E+00	-1.258E+00	-1.256E+00	-1.255E+00	-1.255E+00	-1.259E+00
Specification MIN	-1.30E+00	-1.30E+00	-1.30E+00	-1.30E+00	-1.30E+00	-1.30E+00	-1.30E+00
Status	PASS	PASS	PASS	PASS	PASS	PASS	PASS
Specification MAX	-1.20E+00	-1.20E+00	-1.20E+00	-1.20E+00	-1.20E+00	-1.20E+00	-1.20E+00
Status	PASS	PASS	PASS	PASS	PASS	PASS	PASS

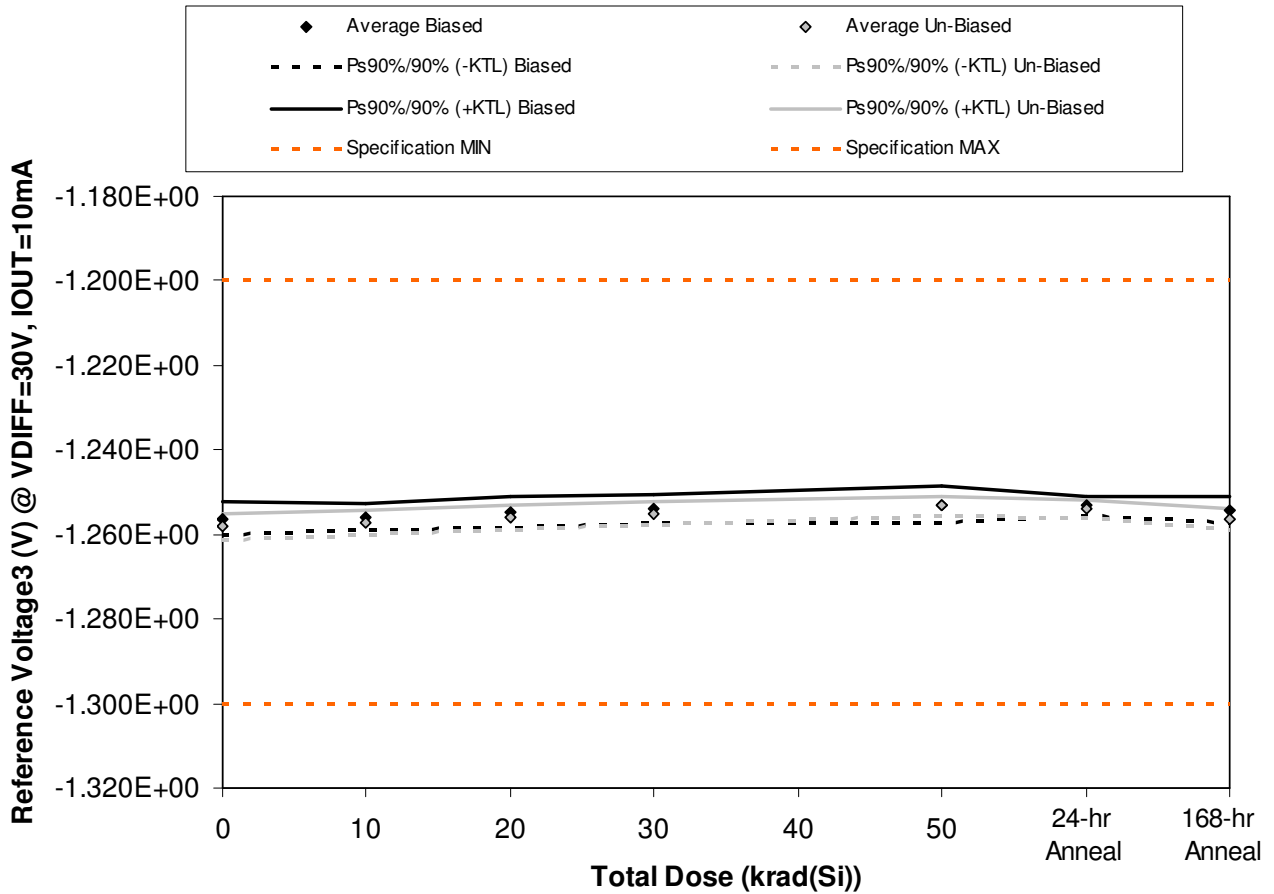

Figure 5.3. Plot of Reference Voltage3 (V) @ VDIFF=30V, IOU=10mA versus total dose. The solid diamonds are the average of the measured data points for the samples irradiated under electrical bias while the shaded diamonds are the average of the measured data points for the samples irradiated with all pins tied to ground. The black lines (solid and/or dashed) are the average of the data points after application of the KTL statistics on the samples irradiated under electrical bias while the gray lines (solid and/or dashed) are the average of the data points after application of the KTL statistics on the samples irradiated in the unbiased condition. The red dotted line(s) are the pre- and/or post-irradiation minimum and/or maximum specification value as defined in the datasheet and/or test plan.



TID Report
12-086 120506 R1.0

Aeroflex RAD
5017 N. 30th Street
Colorado Springs, CO 80919
(719) 531-0800

Table 5.3. Raw data for Reference Voltage3 (V) @ VDIFF=30V, IOUT=10mA versus total dose, including the statistical analysis, specification and the status of the testing (pass/fail).

Reference Voltage3 (V) @ VDIFF=30V, IOUT=10mA	Total Dose (krad(Si))					24-hr Anneal	168-hr Anneal
	0	10	20	30	50		
Device							
81	-1.256E+00	-1.256E+00	-1.254E+00	-1.254E+00	-1.252E+00	-1.253E+00	-1.254E+00
82	-1.258E+00	-1.257E+00	-1.256E+00	-1.255E+00	-1.254E+00	-1.254E+00	-1.256E+00
83	-1.256E+00	-1.256E+00	-1.255E+00	-1.254E+00	-1.253E+00	-1.253E+00	-1.254E+00
84	-1.254E+00	-1.254E+00	-1.253E+00	-1.252E+00	-1.251E+00	-1.252E+00	-1.253E+00
85	-1.257E+00	-1.256E+00	-1.256E+00	-1.255E+00	-1.255E+00	-1.254E+00	-1.254E+00
86	-1.259E+00	-1.258E+00	-1.257E+00	-1.256E+00	-1.254E+00	-1.255E+00	-1.257E+00
117	-1.257E+00	-1.256E+00	-1.255E+00	-1.254E+00	-1.253E+00	-1.254E+00	-1.256E+00
118	-1.259E+00	-1.258E+00	-1.256E+00	-1.255E+00	-1.253E+00	-1.254E+00	-1.257E+00
119	-1.259E+00	-1.258E+00	-1.257E+00	-1.256E+00	-1.254E+00	-1.254E+00	-1.257E+00
120	-1.257E+00	-1.256E+00	-1.255E+00	-1.254E+00	-1.252E+00	-1.253E+00	-1.255E+00
164	-1.256E+00	-1.257E+00	-1.256E+00	-1.256E+00	-1.256E+00	-1.256E+00	-1.256E+00
165	-1.255E+00	-1.256E+00	-1.255E+00	-1.256E+00	-1.255E+00	-1.255E+00	-1.255E+00
Biased Statistics							
Average Biased	-1.256E+00	-1.256E+00	-1.255E+00	-1.254E+00	-1.253E+00	-1.253E+00	-1.254E+00
Std Dev Biased	1.48E-03	1.10E-03	1.30E-03	1.22E-03	1.58E-03	8.37E-04	1.10E-03
Ps90%/90% (+KTL) Biased	-1.252E+00	-1.253E+00	-1.251E+00	-1.251E+00	-1.249E+00	-1.251E+00	-1.251E+00
Ps90%/90% (-KTL) Biased	-1.260E+00	-1.259E+00	-1.258E+00	-1.257E+00	-1.257E+00	-1.255E+00	-1.257E+00
Un-Biased Statistics							
Average Un-Biased	-1.258E+00	-1.257E+00	-1.256E+00	-1.255E+00	-1.253E+00	-1.254E+00	-1.256E+00
Std Dev Un-Biased	1.10E-03	1.10E-03	1.00E-03	1.00E-03	8.37E-04	7.07E-04	8.94E-04
Ps90%/90% (+KTL) Un-Biased	-1.255E+00	-1.254E+00	-1.253E+00	-1.252E+00	-1.251E+00	-1.252E+00	-1.254E+00
Ps90%/90% (-KTL) Un-Biased	-1.261E+00	-1.260E+00	-1.259E+00	-1.258E+00	-1.255E+00	-1.256E+00	-1.259E+00
Specification MIN	-1.30E+00	-1.30E+00	-1.30E+00	-1.30E+00	-1.30E+00	-1.30E+00	-1.30E+00
Status	PASS	PASS	PASS	PASS	PASS	PASS	PASS
Specification MAX	-1.20E+00	-1.20E+00	-1.20E+00	-1.20E+00	-1.20E+00	-1.20E+00	-1.20E+00
Status	PASS	PASS	PASS	PASS	PASS	PASS	PASS

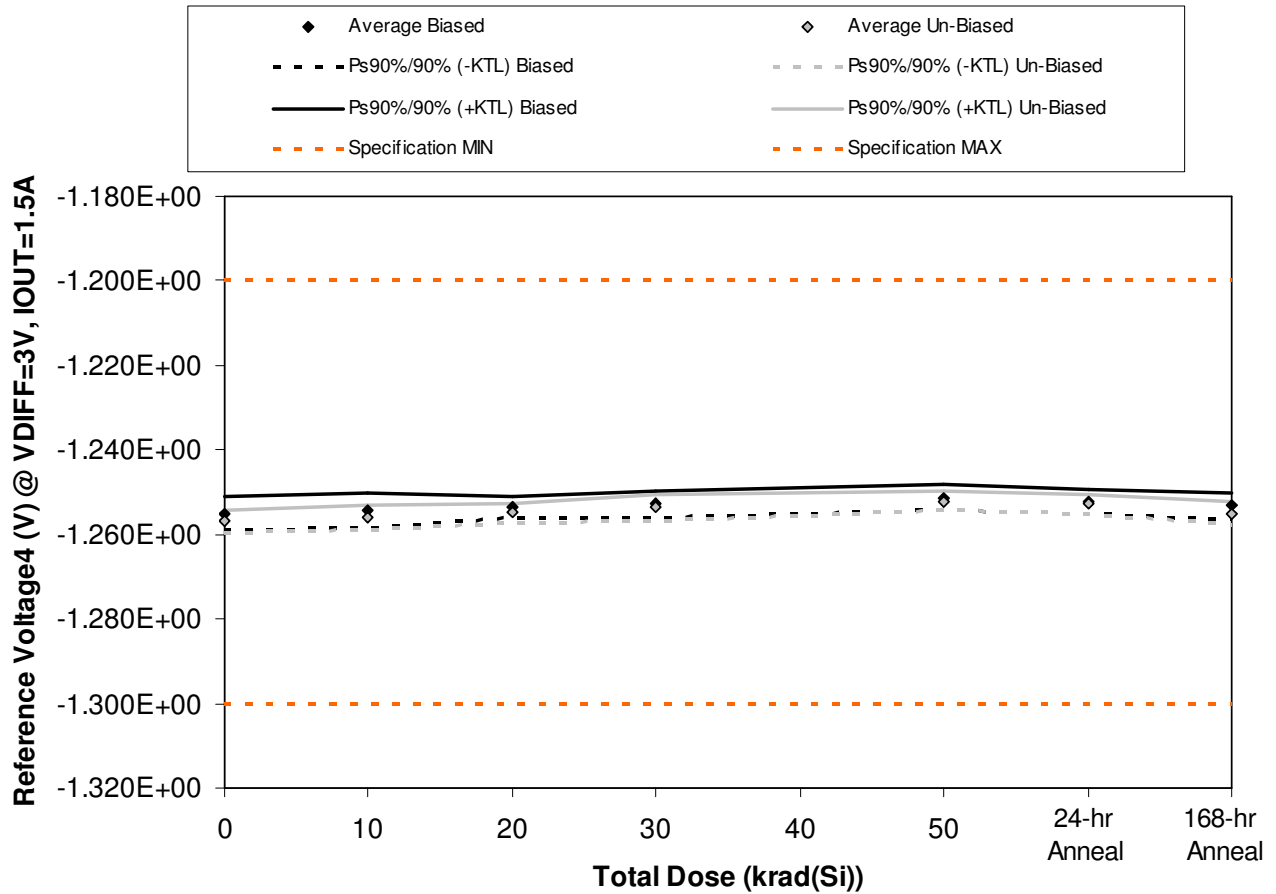

Figure 5.4. Plot of Reference Voltage4 (V) @ VDIFF=3V, IOU=1.5A versus total dose. The solid diamonds are the average of the measured data points for the samples irradiated under electrical bias while the shaded diamonds are the average of the measured data points for the samples irradiated with all pins tied to ground. The black lines (solid and/or dashed) are the average of the data points after application of the KTL statistics on the samples irradiated under electrical bias while the gray lines (solid and/or dashed) are the average of the data points after application of the KTL statistics on the samples irradiated in the unbiased condition. The red dotted line(s) are the pre- and/or post-irradiation minimum and/or maximum specification value as defined in the datasheet and/or test plan.



TID Report
12-086 120506 R1.0

Aeroflex RAD
5017 N. 30th Street
Colorado Springs, CO 80919
(719) 531-0800

Table 5.4. Raw data for Reference Voltage4 (V) @ VDIFF=3V, IOU=1.5A versus total dose, including the statistical analysis, specification and the status of the testing (pass/fail).

Reference Voltage4 (V) @ VDIFF=3V, IOU=1.5A	Total Dose (krad(Si))					24-hr Anneal	168-hr Anneal
	0	10	20	30	50		
Device							
81	-1.255E+00	-1.255E+00	-1.254E+00	-1.253E+00	-1.251E+00	-1.252E+00	-1.253E+00
82	-1.257E+00	-1.256E+00	-1.254E+00	-1.254E+00	-1.252E+00	-1.254E+00	-1.255E+00
83	-1.255E+00	-1.254E+00	-1.254E+00	-1.253E+00	-1.251E+00	-1.252E+00	-1.253E+00
84	-1.253E+00	-1.252E+00	-1.252E+00	-1.251E+00	-1.250E+00	-1.251E+00	-1.252E+00
85	-1.255E+00	-1.255E+00	-1.254E+00	-1.253E+00	-1.253E+00	-1.252E+00	-1.253E+00
86	-1.258E+00	-1.257E+00	-1.255E+00	-1.255E+00	-1.253E+00	-1.254E+00	-1.256E+00
117	-1.256E+00	-1.255E+00	-1.254E+00	-1.252E+00	-1.252E+00	-1.252E+00	-1.254E+00
118	-1.257E+00	-1.256E+00	-1.255E+00	-1.254E+00	-1.252E+00	-1.253E+00	-1.255E+00
119	-1.258E+00	-1.257E+00	-1.256E+00	-1.254E+00	-1.253E+00	-1.253E+00	-1.256E+00
120	-1.256E+00	-1.255E+00	-1.254E+00	-1.253E+00	-1.251E+00	-1.252E+00	-1.254E+00
164	-1.255E+00	-1.256E+00	-1.255E+00	-1.255E+00	-1.256E+00	-1.256E+00	-1.255E+00
165	-1.254E+00	-1.254E+00	-1.254E+00	-1.255E+00	-1.255E+00	-1.255E+00	-1.254E+00
Biased Statistics							
Average Biased	-1.255E+00	-1.254E+00	-1.254E+00	-1.253E+00	-1.251E+00	-1.252E+00	-1.253E+00
Std Dev Biased	1.41E-03	1.52E-03	8.94E-04	1.10E-03	1.14E-03	1.10E-03	1.10E-03
Ps90%/90% (+KTL) Biased	-1.251E+00	-1.250E+00	-1.251E+00	-1.250E+00	-1.248E+00	-1.249E+00	-1.250E+00
Ps90%/90% (-KTL) Biased	-1.259E+00	-1.259E+00	-1.256E+00	-1.256E+00	-1.255E+00	-1.255E+00	-1.256E+00
Un-Biased Statistics							
Average Un-Biased	-1.257E+00	-1.256E+00	-1.255E+00	-1.254E+00	-1.252E+00	-1.253E+00	-1.255E+00
Std Dev Un-Biased	1.00E-03	1.00E-03	8.37E-04	1.14E-03	8.37E-04	8.37E-04	1.00E-03
Ps90%/90% (+KTL) Un-Biased	-1.254E+00	-1.253E+00	-1.253E+00	-1.250E+00	-1.250E+00	-1.251E+00	-1.252E+00
Ps90%/90% (-KTL) Un-Biased	-1.260E+00	-1.259E+00	-1.257E+00	-1.257E+00	-1.254E+00	-1.255E+00	-1.258E+00
Specification MIN	-1.30E+00	-1.30E+00	-1.30E+00	-1.30E+00	-1.30E+00	-1.30E+00	-1.30E+00
Status	PASS	PASS	PASS	PASS	PASS	PASS	PASS
Specification MAX	-1.20E+00	-1.20E+00	-1.20E+00	-1.20E+00	-1.20E+00	-1.20E+00	-1.20E+00
Status	PASS	PASS	PASS	PASS	PASS	PASS	PASS

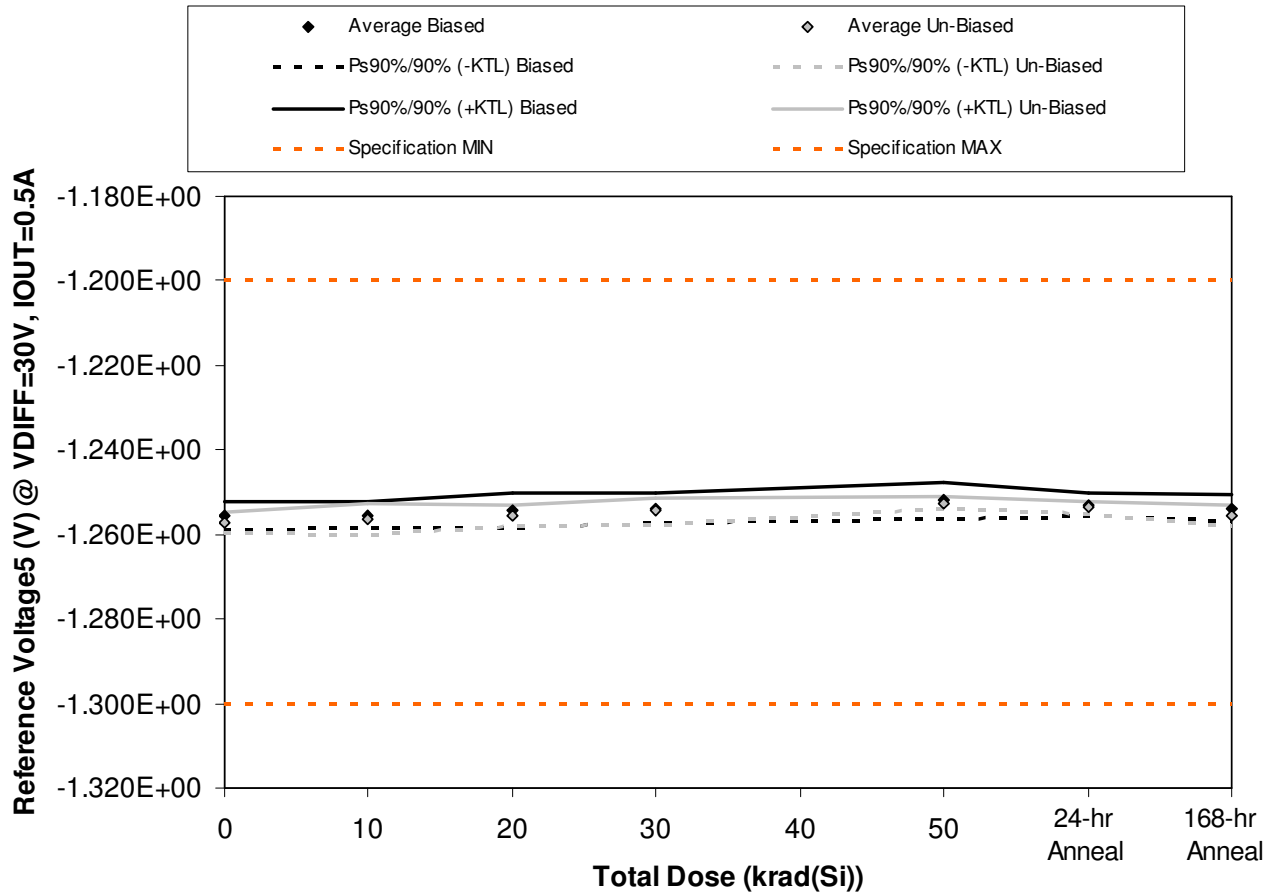

Figure 5.5. Plot of Reference Voltage5 (V) @ VDIFF=30V, IOU=0.5A versus total dose. The solid diamonds are the average of the measured data points for the samples irradiated under electrical bias while the shaded diamonds are the average of the measured data points for the samples irradiated with all pins tied to ground. The black lines (solid and/or dashed) are the average of the data points after application of the KTL statistics on the samples irradiated under electrical bias while the gray lines (solid and/or dashed) are the average of the data points after application of the KTL statistics on the samples irradiated in the unbiased condition. The red dotted line(s) are the pre- and/or post-irradiation minimum and/or maximum specification value as defined in the datasheet and/or test plan.



TID Report
12-086 120506 R1.0

Aeroflex RAD
5017 N. 30th Street
Colorado Springs, CO 80919
(719) 531-0800

Table 5.5. Raw data for Reference Voltage5 (V) @ VDIFF=30V, IOUT=0.5A versus total dose, including the statistical analysis, specification and the status of the testing (pass/fail).

Reference Voltage5 (V) @ VDIFF=30V, IOUT=0.5A	Total Dose (krad(Si))					24-hr Anneal	168-hr Anneal
	0	10	20	30	50		
Device							
81	-1.255E+00	-1.255E+00	-1.254E+00	-1.253E+00	-1.251E+00	-1.252E+00	-1.254E+00
82	-1.257E+00	-1.257E+00	-1.256E+00	-1.255E+00	-1.253E+00	-1.254E+00	-1.255E+00
83	-1.256E+00	-1.255E+00	-1.254E+00	-1.254E+00	-1.252E+00	-1.253E+00	-1.254E+00
84	-1.254E+00	-1.254E+00	-1.252E+00	-1.252E+00	-1.250E+00	-1.252E+00	-1.252E+00
85	-1.256E+00	-1.256E+00	-1.255E+00	-1.255E+00	-1.254E+00	-1.254E+00	-1.254E+00
86	-1.258E+00	-1.258E+00	-1.256E+00	-1.255E+00	-1.253E+00	-1.254E+00	-1.256E+00
117	-1.256E+00	-1.255E+00	-1.255E+00	-1.254E+00	-1.253E+00	-1.253E+00	-1.255E+00
118	-1.258E+00	-1.257E+00	-1.256E+00	-1.254E+00	-1.252E+00	-1.254E+00	-1.256E+00
119	-1.258E+00	-1.257E+00	-1.256E+00	-1.256E+00	-1.253E+00	-1.254E+00	-1.256E+00
120	-1.257E+00	-1.255E+00	-1.254E+00	-1.253E+00	-1.252E+00	-1.253E+00	-1.254E+00
164	-1.256E+00	-1.256E+00	-1.256E+00	-1.256E+00	-1.256E+00	-1.256E+00	-1.256E+00
165	-1.255E+00	-1.255E+00	-1.255E+00	-1.255E+00	-1.255E+00	-1.255E+00	-1.255E+00
Biased Statistics							
Average Biased	-1.256E+00	-1.255E+00	-1.254E+00	-1.254E+00	-1.252E+00	-1.253E+00	-1.254E+00
Std Dev Biased	1.14E-03	1.14E-03	1.48E-03	1.30E-03	1.58E-03	1.00E-03	1.10E-03
Ps90%/90% (+KTL) Biased	-1.252E+00	-1.252E+00	-1.250E+00	-1.250E+00	-1.248E+00	-1.250E+00	-1.251E+00
Ps90%/90% (-KTL) Biased	-1.259E+00	-1.259E+00	-1.258E+00	-1.257E+00	-1.256E+00	-1.256E+00	-1.257E+00
Un-Biased Statistics							
Average Un-Biased	-1.257E+00	-1.256E+00	-1.255E+00	-1.254E+00	-1.253E+00	-1.254E+00	-1.255E+00
Std Dev Un-Biased	8.94E-04	1.34E-03	8.94E-04	1.14E-03	5.48E-04	5.48E-04	8.94E-04
Ps90%/90% (+KTL) Un-Biased	-1.255E+00	-1.253E+00	-1.253E+00	-1.251E+00	-1.251E+00	-1.252E+00	-1.253E+00
Ps90%/90% (-KTL) Un-Biased	-1.260E+00	-1.260E+00	-1.258E+00	-1.258E+00	-1.254E+00	-1.255E+00	-1.258E+00
Specification MIN	-1.30E+00	-1.30E+00	-1.30E+00	-1.30E+00	-1.30E+00	-1.30E+00	-1.30E+00
Status	PASS	PASS	PASS	PASS	PASS	PASS	PASS
Specification MAX	-1.20E+00	-1.20E+00	-1.20E+00	-1.20E+00	-1.20E+00	-1.20E+00	-1.20E+00
Status	PASS	PASS	PASS	PASS	PASS	PASS	PASS

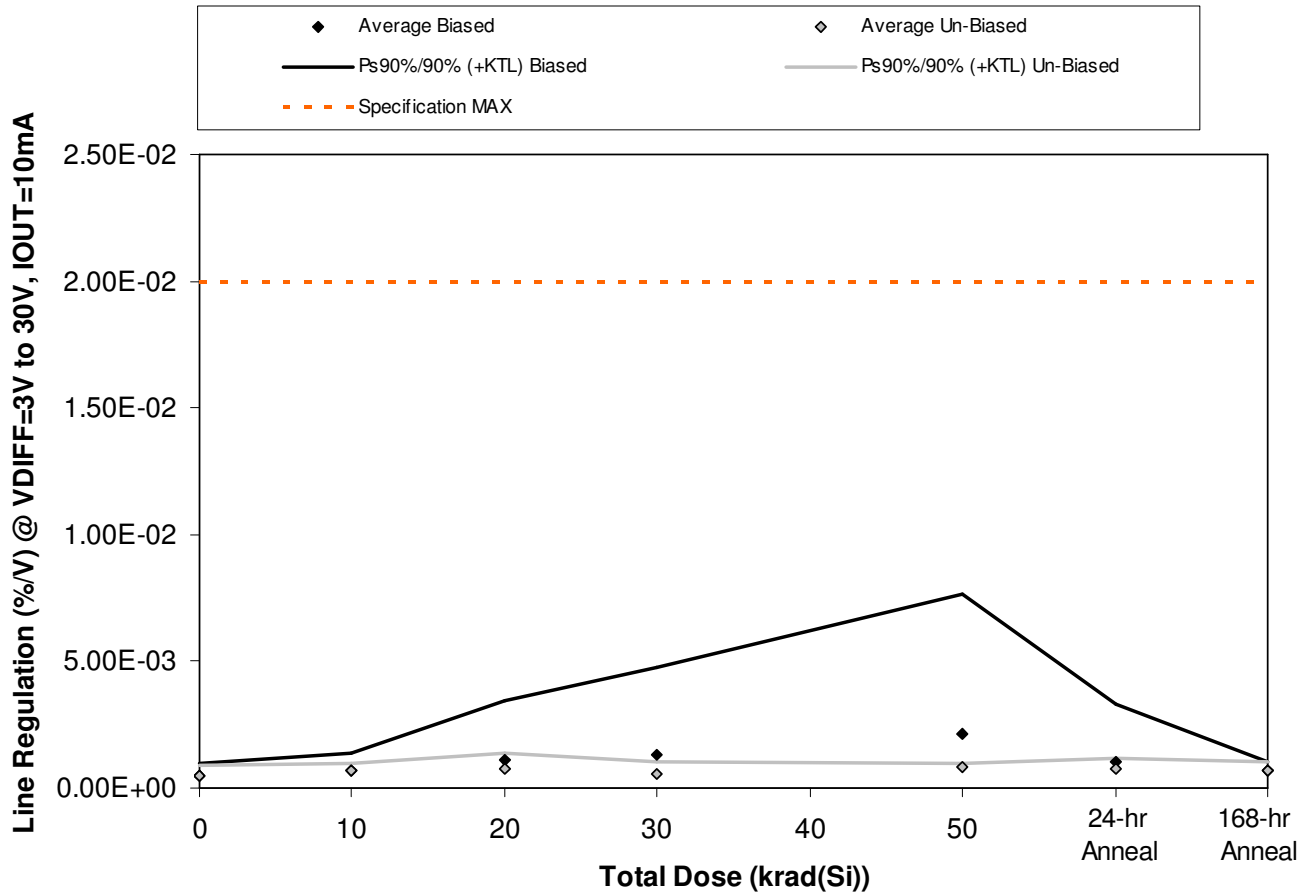

Figure 5.6. Plot of Line Regulation (%/V) @ VDIFF=3V to 30V, IOU=10mA versus total dose. The solid diamonds are the average of the measured data points for the samples irradiated under electrical bias while the shaded diamonds are the average of the measured data points for the samples irradiated with all pins tied to ground. The black lines (solid and/or dashed) are the average of the data points after application of the KTL statistics on the samples irradiated under electrical bias while the gray lines (solid and/or dashed) are the average of the data points after application of the KTL statistics on the samples irradiated in the unbiased condition. The red dotted line(s) are the pre- and/or post-irradiation minimum and/or maximum specification value as defined in the datasheet and/or test plan.



TID Report
12-086 120506 R1.0

Aeroflex RAD
5017 N. 30th Street
Colorado Springs, CO 80919
(719) 531-0800

Table 5.6. Raw data for Line Regulation (%/V) @ VDIFF=3V to 30V, IOU=10mA versus total dose, including the statistical analysis, specification and the status of the testing (pass/fail).

Line Regulation (%/V) @ VDIFF=3V to 30V, IOU=10mA	Total Dose (krad(Si))					24-hr Anneal	168-hr Anneal
	0	10	20	30	50		
Device							
81	7.00E-04	6.00E-04	7.00E-04	6.00E-04	1.30E-03	8.00E-04	8.00E-04
82	3.00E-04	6.00E-04	8.00E-04	9.00E-04	1.30E-03	5.00E-04	5.00E-04
83	4.00E-04	5.00E-04	7.00E-04	9.00E-04	1.30E-03	8.00E-04	6.00E-04
84	4.00E-04	8.00E-04	6.00E-04	5.00E-04	1.00E-03	6.00E-04	8.00E-04
85	6.00E-04	1.10E-03	2.60E-03	3.50E-03	5.70E-03	2.50E-03	6.00E-04
86	3.00E-04	6.00E-04	1.10E-03	6.00E-04	8.00E-04	7.00E-04	8.00E-04
117	4.00E-04	7.00E-04	6.00E-04	3.00E-04	9.00E-04	6.00E-04	6.00E-04
118	6.00E-04	8.00E-04	5.00E-04	5.00E-04	7.00E-04	9.00E-04	5.00E-04
119	6.00E-04	7.00E-04	7.00E-04	7.00E-04	8.00E-04	6.00E-04	6.00E-04
120	6.00E-04	8.00E-04	8.00E-04	7.00E-04	8.00E-04	9.00E-04	8.00E-04
164	6.00E-04	3.00E-04	2.00E-04	5.00E-04	4.00E-04	7.00E-04	5.00E-04
165	2.00E-04	7.00E-04	8.00E-04	3.00E-04	4.00E-04	5.00E-04	6.00E-04
Biased Statistics							
Average Biased	4.80E-04	7.20E-04	1.08E-03	1.28E-03	2.12E-03	1.04E-03	6.60E-04
Std Dev Biased	1.64E-04	2.39E-04	8.53E-04	1.25E-03	2.01E-03	8.26E-04	1.34E-04
Ps90%/90% (+KTL) Biased	9.31E-04	1.37E-03	3.42E-03	4.72E-03	7.62E-03	3.31E-03	1.03E-03
Ps90%/90% (-KTL) Biased	2.94E-05	6.54E-05	-1.26E-03	-2.16E-03	-3.38E-03	-1.23E-03	2.92E-04
Un-Biased Statistics							
Average Un-Biased	5.00E-04	7.20E-04	7.40E-04	5.60E-04	8.00E-04	7.40E-04	6.60E-04
Std Dev Un-Biased	1.41E-04	8.37E-05	2.30E-04	1.67E-04	7.07E-05	1.52E-04	1.34E-04
Ps90%/90% (+KTL) Un-Biased	8.88E-04	9.49E-04	1.37E-03	1.02E-03	9.94E-04	1.16E-03	1.03E-03
Ps90%/90% (-KTL) Un-Biased	1.12E-04	4.91E-04	1.09E-04	1.01E-04	6.06E-04	3.24E-04	2.92E-04
Specification MAX	2.00E-02	2.00E-02	2.00E-02	2.00E-02	2.00E-02	2.00E-02	2.00E-02
Status	PASS	PASS	PASS	PASS	PASS	PASS	PASS

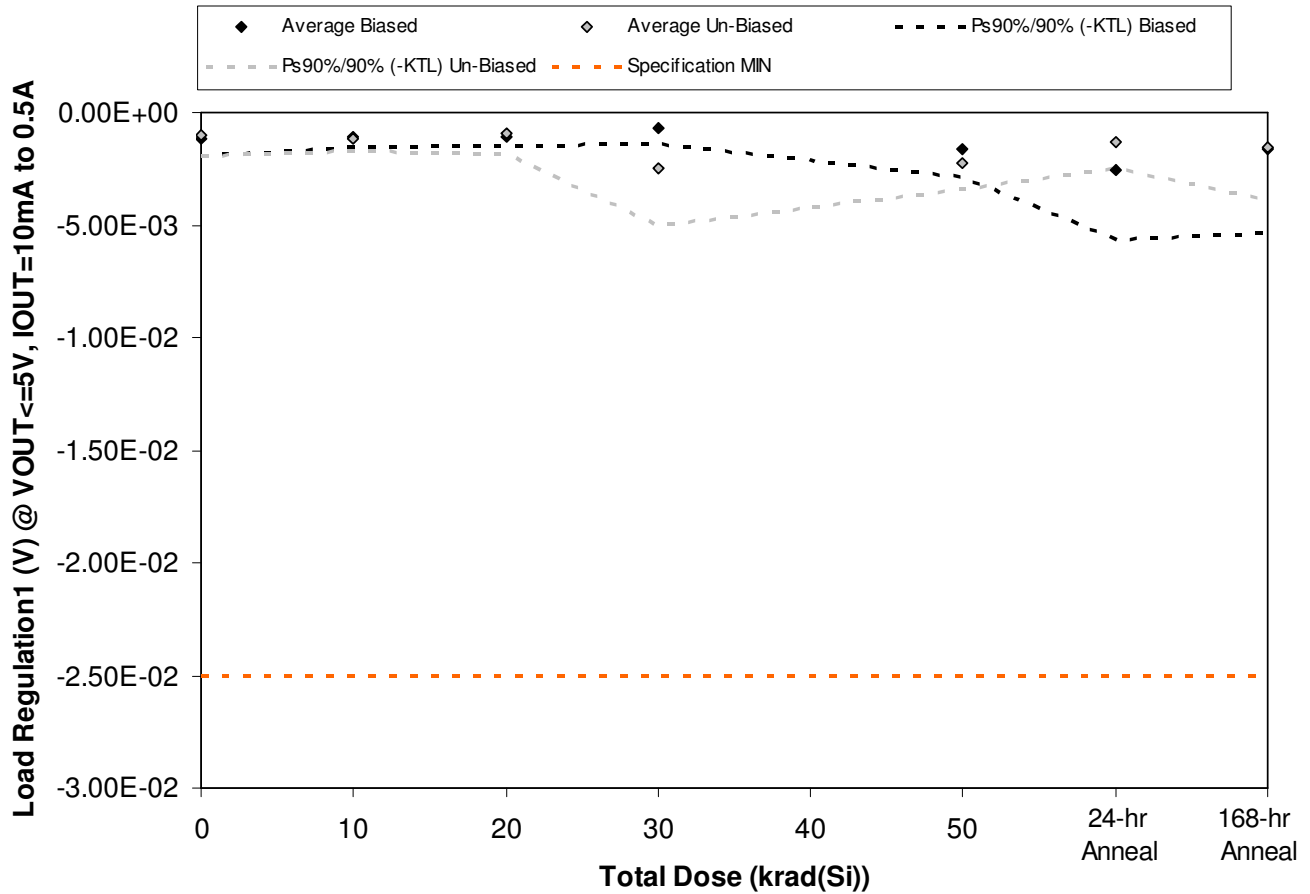

Figure 5.7. Plot of Load Regulation1 (V) @ VOUT<=5V, IOU=10mA to 0.5A versus total dose. The solid diamonds are the average of the measured data points for the samples irradiated under electrical bias while the shaded diamonds are the average of the measured data points for the samples irradiated with all pins tied to ground. The black lines (solid and/or dashed) are the average of the data points after application of the KTL statistics on the samples irradiated under electrical bias while the gray lines (solid and/or dashed) are the average of the data points after application of the KTL statistics on the samples irradiated in the unbiased condition. The red dotted line(s) are the pre- and/or post-irradiation minimum and/or maximum specification value as defined in the datasheet and/or test plan.



TID Report
12-086 120506 R1.0

Aeroflex RAD
5017 N. 30th Street
Colorado Springs, CO 80919
(719) 531-0800

Table 5.7. Raw data for Load Regulation1 (V) @ VOUT<=5V, IOU=10mA to 0.5A versus total dose, including the statistical analysis, specification and the status of the testing (pass/fail).

Load Regulation1 (V) @ VOUT<=5V, IOU=10mA to 0.5A	Total Dose (krad(Si))					24-hr Anneal	168-hr Anneal
	0	10	20	30	50		
Device							
81	-1.33E-03	-9.87E-04	-9.70E-04	-1.05E-03	-1.05E-03	-2.41E-03	-9.11E-04
82	-9.95E-04	-9.87E-04	-9.13E-04	-9.03E-04	-1.78E-03	-3.64E-03	-7.66E-04
83	-7.04E-04	-1.12E-03	-9.18E-04	-4.97E-04	-2.08E-03	-2.95E-03	-4.02E-03
84	-1.49E-03	-1.35E-03	-1.18E-03	-5.24E-04	-1.25E-03	-3.13E-03	-1.28E-03
85	-1.15E-03	-9.82E-04	-1.28E-03	-6.52E-04	-2.02E-03	-7.04E-04	-1.18E-03
86	-1.45E-03	-1.41E-03	-1.19E-03	-2.52E-03	-2.66E-03	-1.67E-03	-1.12E-03
117	-8.72E-04	-1.33E-03	-1.18E-03	-2.01E-03	-2.74E-03	-1.79E-03	-1.24E-03
118	-1.27E-03	-1.07E-03	-4.08E-04	-3.36E-03	-1.97E-03	-8.32E-04	-7.36E-04
119	-9.04E-04	-1.05E-03	-8.47E-04	-1.27E-03	-1.80E-03	-9.23E-04	-1.84E-03
120	-5.61E-04	-9.82E-04	-1.14E-03	-3.44E-03	-1.93E-03	-1.33E-03	-2.92E-03
164	-8.54E-04	-7.48E-04	-9.65E-04	-7.14E-04	-3.36E-03	-1.10E-03	-1.98E-03
165	-1.19E-03	-9.95E-04	-5.76E-04	-4.56E-04	-2.35E-03	-2.31E-03	-2.11E-03
Biased Statistics							
Average Biased	-1.13E-03	-1.09E-03	-1.05E-03	-7.24E-04	-1.63E-03	-2.57E-03	-1.63E-03
Std Dev Biased	3.04E-04	1.61E-04	1.66E-04	2.41E-04	4.63E-04	1.13E-03	1.35E-03
Ps90%/90% (+KTL) Biased	-3.01E-04	-6.45E-04	-5.96E-04	-6.34E-05	-3.64E-04	5.35E-04	2.07E-03
Ps90%/90% (-KTL) Biased	-1.97E-03	-1.53E-03	-1.51E-03	-1.39E-03	-2.90E-03	-5.67E-03	-5.33E-03
Un-Biased Statistics							
Average Un-Biased	-1.01E-03	-1.17E-03	-9.52E-04	-2.52E-03	-2.22E-03	-1.31E-03	-1.57E-03
Std Dev Un-Biased	3.51E-04	1.91E-04	3.35E-04	9.18E-04	4.44E-04	4.30E-04	8.52E-04
Ps90%/90% (+KTL) Un-Biased	-4.91E-05	-6.46E-04	-3.34E-05	2.90E-07	-1.00E-03	-1.29E-04	7.62E-04
Ps90%/90% (-KTL) Un-Biased	-1.97E-03	-1.69E-03	-1.87E-03	-5.04E-03	-3.44E-03	-2.49E-03	-3.91E-03
Specification MIN	-2.50E-02	-2.50E-02	-2.50E-02	-2.50E-02	-2.50E-02	-2.50E-02	-2.50E-02
Status	PASS	PASS	PASS	PASS	PASS	PASS	PASS

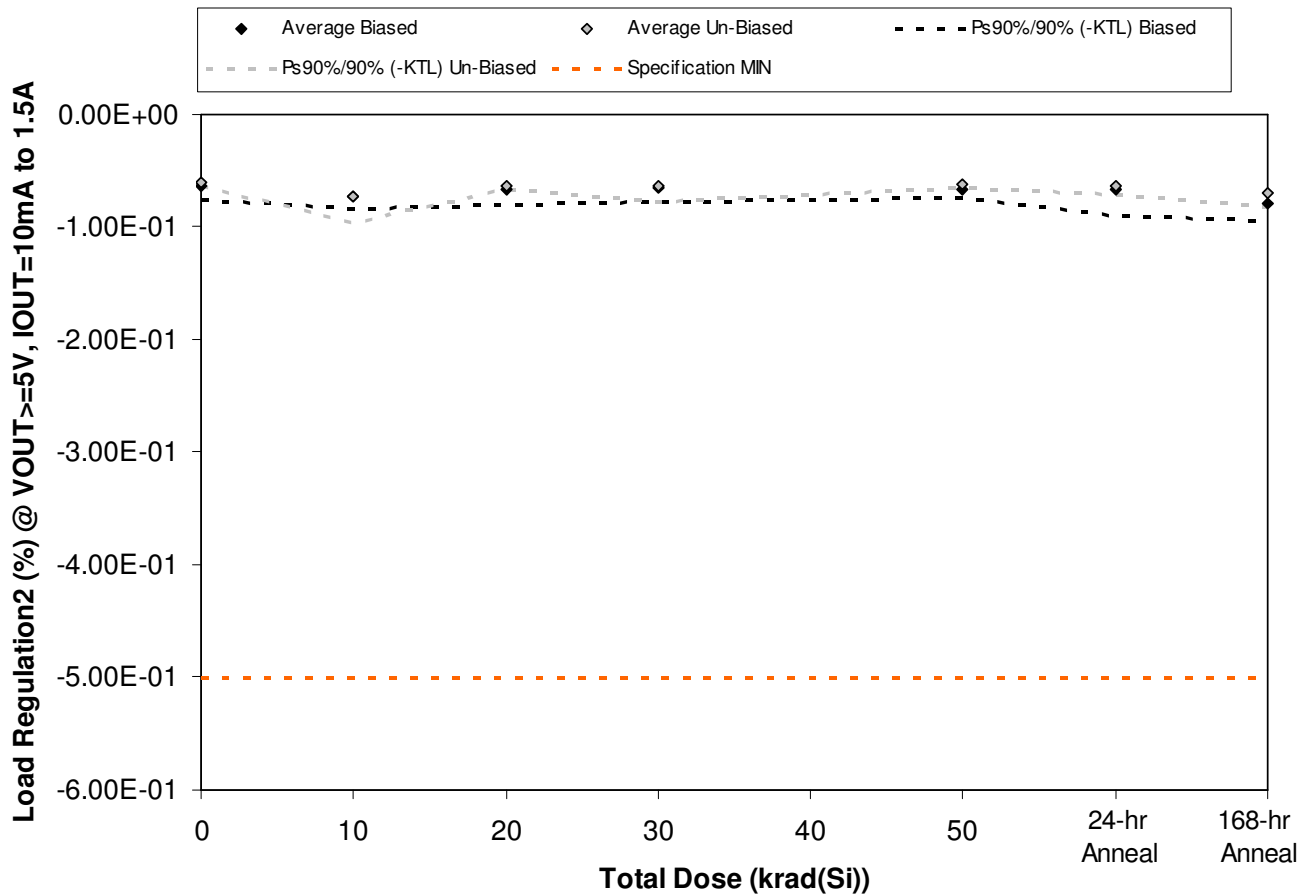

Figure 5.8. Plot of Load Regulation2 (%) @ VOUT>=5V, IOU=10mA to 1.5A versus total dose. The solid diamonds are the average of the measured data points for the samples irradiated under electrical bias while the shaded diamonds are the average of the measured data points for the samples irradiated with all pins tied to ground. The black lines (solid and/or dashed) are the average of the data points after application of the KTL statistics on the samples irradiated under electrical bias while the gray lines (solid and/or dashed) are the average of the data points after application of the KTL statistics on the samples irradiated in the unbiased condition. The red dotted line(s) are the pre- and/or post-irradiation minimum and/or maximum specification value as defined in the datasheet and/or test plan.



TID Report
12-086 120506 R1.0

Aeroflex RAD
5017 N. 30th Street
Colorado Springs, CO 80919
(719) 531-0800

Table 5.8. Raw data for Load Regulation2 (%) @ VOUT>=5V, IOU=10mA to 1.5A versus total dose, including the statistical analysis, specification and the status of the testing (pass/fail).

Load Regulation2 (%) @ VOUT>=5V, IOU=10mA to 1.5A	Total Dose (krad(Si))					24-hr Anneal	168-hr Anneal
	0	10	20	30	50		
Device							
81	-7.00E-02	-7.40E-02	-6.50E-02	-6.30E-02	-6.80E-02	-7.70E-02	-8.70E-02
82	-6.10E-02	-7.90E-02	-7.20E-02	-7.20E-02	-6.80E-02	-7.20E-02	-8.20E-02
83	-6.50E-02	-7.20E-02	-6.40E-02	-6.20E-02	-6.90E-02	-6.90E-02	-7.30E-02
84	-6.10E-02	-6.80E-02	-7.20E-02	-6.60E-02	-6.20E-02	-6.10E-02	-7.40E-02
85	-5.90E-02	-7.20E-02	-6.20E-02	-6.10E-02	-6.40E-02	-5.60E-02	-7.90E-02
86	-6.10E-02	-7.80E-02	-6.50E-02	-6.80E-02	-6.30E-02	-6.40E-02	-6.40E-02
117	-5.80E-02	-7.10E-02	-6.40E-02	-6.10E-02	-6.20E-02	-5.90E-02	-6.60E-02
118	-5.90E-02	-8.50E-02	-6.40E-02	-6.30E-02	-6.30E-02	-6.60E-02	-7.20E-02
119	-6.10E-02	-6.60E-02	-6.20E-02	-5.90E-02	-6.10E-02	-6.10E-02	-7.20E-02
120	-6.10E-02	-6.50E-02	-6.20E-02	-7.00E-02	-6.30E-02	-6.50E-02	-7.50E-02
164	-5.80E-02	-6.20E-02	-6.10E-02	-6.40E-02	-6.50E-02	-6.00E-02	-7.60E-02
165	-6.20E-02	-6.70E-02	-6.30E-02	-5.90E-02	-6.30E-02	-6.10E-02	-6.80E-02
Biased Statistics							
Average Biased	-6.32E-02	-7.30E-02	-6.70E-02	-6.48E-02	-6.62E-02	-6.70E-02	-7.90E-02
Std Dev Biased	4.38E-03	4.00E-03	4.69E-03	4.44E-03	3.03E-03	8.46E-03	5.79E-03
Ps90%/90% (+KTL) Biased	-5.12E-02	-6.20E-02	-5.41E-02	-5.26E-02	-5.79E-02	-4.38E-02	-6.31E-02
Ps90%/90% (-KTL) Biased	-7.52E-02	-8.40E-02	-7.99E-02	-7.70E-02	-7.45E-02	-9.02E-02	-9.49E-02
Un-Biased Statistics							
Average Un-Biased	-6.00E-02	-7.30E-02	-6.34E-02	-6.42E-02	-6.24E-02	-6.30E-02	-6.98E-02
Std Dev Un-Biased	1.41E-03	8.46E-03	1.34E-03	4.66E-03	8.94E-04	2.92E-03	4.60E-03
Ps90%/90% (+KTL) Un-Biased	-5.61E-02	-4.98E-02	-5.97E-02	-5.14E-02	-5.99E-02	-5.50E-02	-5.72E-02
Ps90%/90% (-KTL) Un-Biased	-6.39E-02	-9.62E-02	-6.71E-02	-7.70E-02	-6.49E-02	-7.10E-02	-8.24E-02
Specification MIN	-5.00E-01	-5.00E-01	-5.00E-01	-5.00E-01	-5.00E-01	-5.00E-01	-5.00E-01
Status	PASS	PASS	PASS	PASS	PASS	PASS	PASS

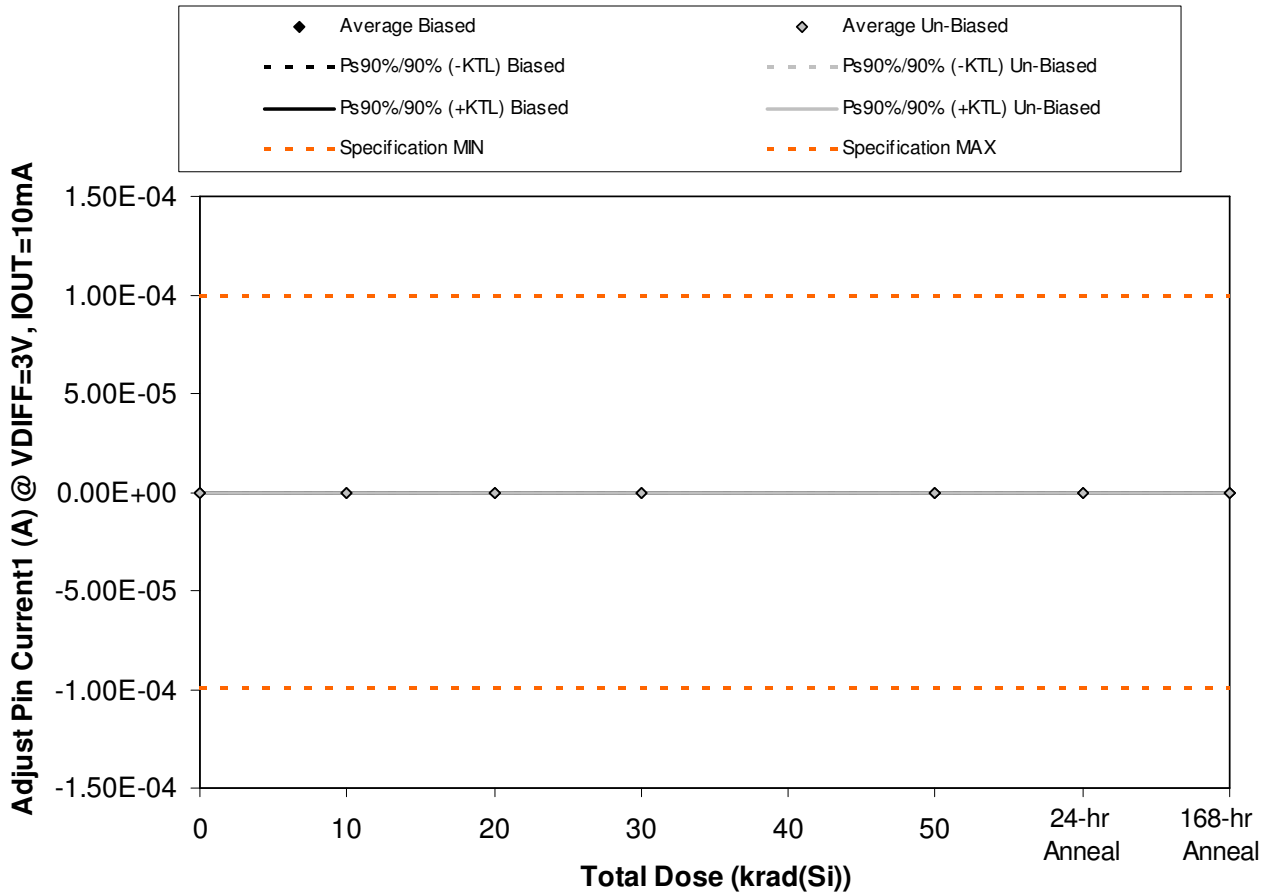

Figure 5.9. Plot of Adjust Pin Current1 (A) @ VDIFF=3V, IOU=10mA versus total dose. The solid diamonds are the average of the measured data points for the samples irradiated under electrical bias while the shaded diamonds are the average of the measured data points for the samples irradiated with all pins tied to ground. The black lines (solid and/or dashed) are the average of the data points after application of the KTL statistics on the samples irradiated under electrical bias while the gray lines (solid and/or dashed) are the average of the data points after application of the KTL statistics on the samples irradiated in the unbiased condition. The red dotted line(s) are the pre- and/or post-irradiation minimum and/or maximum specification value as defined in the datasheet and/or test plan.



TID Report
12-086 120506 R1.0

Aeroflex RAD
5017 N. 30th Street
Colorado Springs, CO 80919
(719) 531-0800

Table 5.9. Raw data for Adjust Pin Current1 (A) @ VDIFF=3V, IOU=10mA versus total dose, including the statistical analysis, specification and the status of the testing (pass/fail).

Adjust Pin Current1 (A) @ VDIFF=3V, IOU=10mA	Total Dose (krad(Si))					24-hr Anneal	168-hr Anneal
	0	10	20	30	50		
Device							
81	-2.00E-08	-1.90E-08	-2.00E-08	-2.00E-08	-2.00E-08	-2.00E-08	-2.00E-08
82	-2.00E-08	-1.90E-08	-1.90E-08	-1.90E-08	-2.00E-08	-2.00E-08	-2.00E-08
83	-2.10E-08	-2.00E-08	-2.00E-08	-2.00E-08	-2.00E-08	-2.00E-08	-2.00E-08
84	-2.10E-08	-2.00E-08	-2.00E-08	-2.00E-08	-2.00E-08	-2.10E-08	-2.10E-08
85	-2.10E-08	-2.00E-08	-2.10E-08	-2.10E-08	-2.10E-08	-2.10E-08	-2.10E-08
86	-2.00E-08	-1.90E-08	-2.00E-08	-1.90E-08	-2.00E-08	-2.00E-08	-2.00E-08
117	-2.00E-08	-2.00E-08	-2.00E-08	-2.00E-08	-1.90E-08	-2.00E-08	-2.00E-08
118	-2.00E-08	-1.90E-08	-1.90E-08	-1.90E-08	-2.00E-08	-1.90E-08	-2.00E-08
119	-2.00E-08	-2.00E-08	-2.00E-08	-2.00E-08	-2.00E-08	-2.00E-08	-2.00E-08
120	-2.00E-08	-2.00E-08	-2.00E-08	-2.00E-08	-2.00E-08	-2.00E-08	-2.00E-08
164	-2.00E-08	-2.00E-08	-2.00E-08	-2.00E-08	-2.00E-08	-2.10E-08	-2.00E-08
165	-2.00E-08	-2.00E-08	-2.00E-08	-2.00E-08	-2.00E-08	-2.10E-08	-2.00E-08
Biased Statistics							
Average Biased	-2.06E-08	-1.96E-08	-2.00E-08	-2.00E-08	-2.02E-08	-2.04E-08	-2.04E-08
Std Dev Biased	5.48E-10	5.48E-10	7.07E-10	7.07E-10	4.47E-10	5.48E-10	5.48E-10
Ps90%/90% (+KTL) Biased	-1.91E-08	-1.81E-08	-1.81E-08	-1.81E-08	-1.90E-08	-1.89E-08	-1.89E-08
Ps90%/90% (-KTL) Biased	-2.21E-08	-2.11E-08	-2.19E-08	-2.19E-08	-2.14E-08	-2.19E-08	-2.19E-08
Un-Biased Statistics							
Average Un-Biased	-2.00E-08	-1.96E-08	-1.98E-08	-1.96E-08	-1.98E-08	-1.98E-08	-2.00E-08
Std Dev Un-Biased	0.00E+00	5.48E-10	4.47E-10	5.48E-10	4.47E-10	4.47E-10	0.00E+00
Ps90%/90% (+KTL) Un-Biased	-2.00E-08	-1.81E-08	-1.86E-08	-1.81E-08	-1.86E-08	-1.86E-08	-2.00E-08
Ps90%/90% (-KTL) Un-Biased	-2.00E-08	-2.11E-08	-2.10E-08	-2.11E-08	-2.10E-08	-2.10E-08	-2.00E-08
Specification MIN	-1.00E-04	-1.00E-04	-1.00E-04	-1.00E-04	-1.00E-04	-1.00E-04	-1.00E-04
Status	PASS	PASS	PASS	PASS	PASS	PASS	PASS
Specification MAX	1.00E-04	1.00E-04	1.00E-04	1.00E-04	1.00E-04	1.00E-04	1.00E-04
Status	PASS	PASS	PASS	PASS	PASS	PASS	PASS

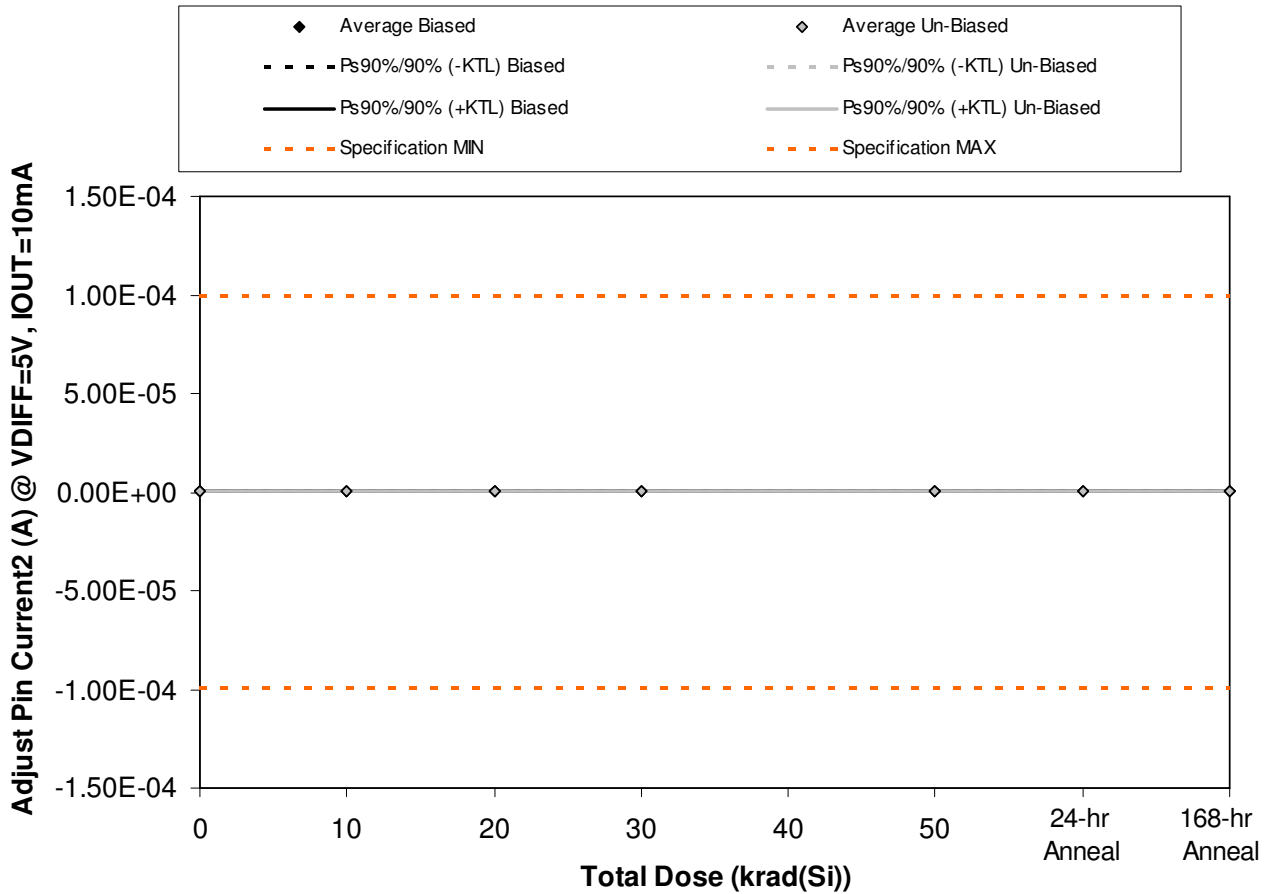

Figure 5.10. Plot of Adjust Pin Current2 (A) @ VDIFF=5V, IOU=10mA versus total dose. The solid diamonds are the average of the measured data points for the samples irradiated under electrical bias while the shaded diamonds are the average of the measured data points for the samples irradiated with all pins tied to ground. The black lines (solid and/or dashed) are the average of the data points after application of the KTL statistics on the samples irradiated under electrical bias while the gray lines (solid and/or dashed) are the average of the data points after application of the KTL statistics on the samples irradiated in the unbiased condition. The red dotted line(s) are the pre- and/or post-irradiation minimum and/or maximum specification value as defined in the datasheet and/or test plan.



TID Report
12-086 120506 R1.0

Aeroflex RAD
5017 N. 30th Street
Colorado Springs, CO 80919
(719) 531-0800

Table 5.10. Raw data for Adjust Pin Current2 (A) @ VDIFF=5V, IOU=10mA versus total dose, including the statistical analysis, specification and the status of the testing (pass/fail).

Adjust Pin Current2 (A) @ VDIFF=5V, IOU=10mA	Total Dose (krad(Si))					24-hr Anneal	168-hr Anneal
	0	10	20	30	50		
Device							
81	8.40E-08	8.50E-08	8.40E-08	8.40E-08	8.40E-08	8.40E-08	8.40E-08
82	8.40E-08	8.50E-08	8.40E-08	8.40E-08	8.40E-08	8.40E-08	8.40E-08
83	8.40E-08	8.50E-08	8.40E-08	8.40E-08	8.40E-08	8.40E-08	8.40E-08
84	8.40E-08	8.50E-08	8.40E-08	8.40E-08	8.40E-08	8.40E-08	8.40E-08
85	8.40E-08	8.50E-08	8.40E-08	8.40E-08	8.40E-08	8.40E-08	8.40E-08
86	8.40E-08	8.50E-08	8.40E-08	8.40E-08	8.40E-08	8.40E-08	8.40E-08
117	8.40E-08	8.50E-08	8.40E-08	8.40E-08	8.40E-08	8.40E-08	8.40E-08
118	8.40E-08	8.50E-08	8.40E-08	8.40E-08	8.40E-08	8.40E-08	8.40E-08
119	8.40E-08	8.50E-08	8.40E-08	8.40E-08	8.40E-08	8.40E-08	8.40E-08
120	8.40E-08	8.50E-08	8.40E-08	8.40E-08	8.40E-08	8.40E-08	8.40E-08
164	8.50E-08	8.50E-08	8.40E-08	8.40E-08	8.40E-08	8.40E-08	8.40E-08
165	8.50E-08	8.50E-08	8.40E-08	8.40E-08	8.40E-08	8.40E-08	8.40E-08
Biased Statistics							
Average Biased	8.40E-08	8.50E-08	8.40E-08	8.40E-08	8.40E-08	8.40E-08	8.40E-08
Std Dev Biased	0.00E+00	0.00E+00	0.00E+00	0.00E+00	0.00E+00	0.00E+00	0.00E+00
Ps90%/90% (+KTL) Biased	8.40E-08	8.50E-08	8.40E-08	8.40E-08	8.40E-08	8.40E-08	8.40E-08
Ps90%/90% (-KTL) Biased	8.40E-08	8.50E-08	8.40E-08	8.40E-08	8.40E-08	8.40E-08	8.40E-08
Un-Biased Statistics							
Average Un-Biased	8.40E-08	8.50E-08	8.40E-08	8.40E-08	8.40E-08	8.40E-08	8.40E-08
Std Dev Un-Biased	0.00E+00	0.00E+00	0.00E+00	0.00E+00	0.00E+00	0.00E+00	0.00E+00
Ps90%/90% (+KTL) Un-Biased	8.40E-08	8.50E-08	8.40E-08	8.40E-08	8.40E-08	8.40E-08	8.40E-08
Ps90%/90% (-KTL) Un-Biased	8.40E-08	8.50E-08	8.40E-08	8.40E-08	8.40E-08	8.40E-08	8.40E-08
Specification MIN	-1.00E-04	-1.00E-04	-1.00E-04	-1.00E-04	-1.00E-04	-1.00E-04	-1.00E-04
Status	PASS	PASS	PASS	PASS	PASS	PASS	PASS
Specification MAX	1.00E-04	1.00E-04	1.00E-04	1.00E-04	1.00E-04	1.00E-04	1.00E-04
Status	PASS	PASS	PASS	PASS	PASS	PASS	PASS

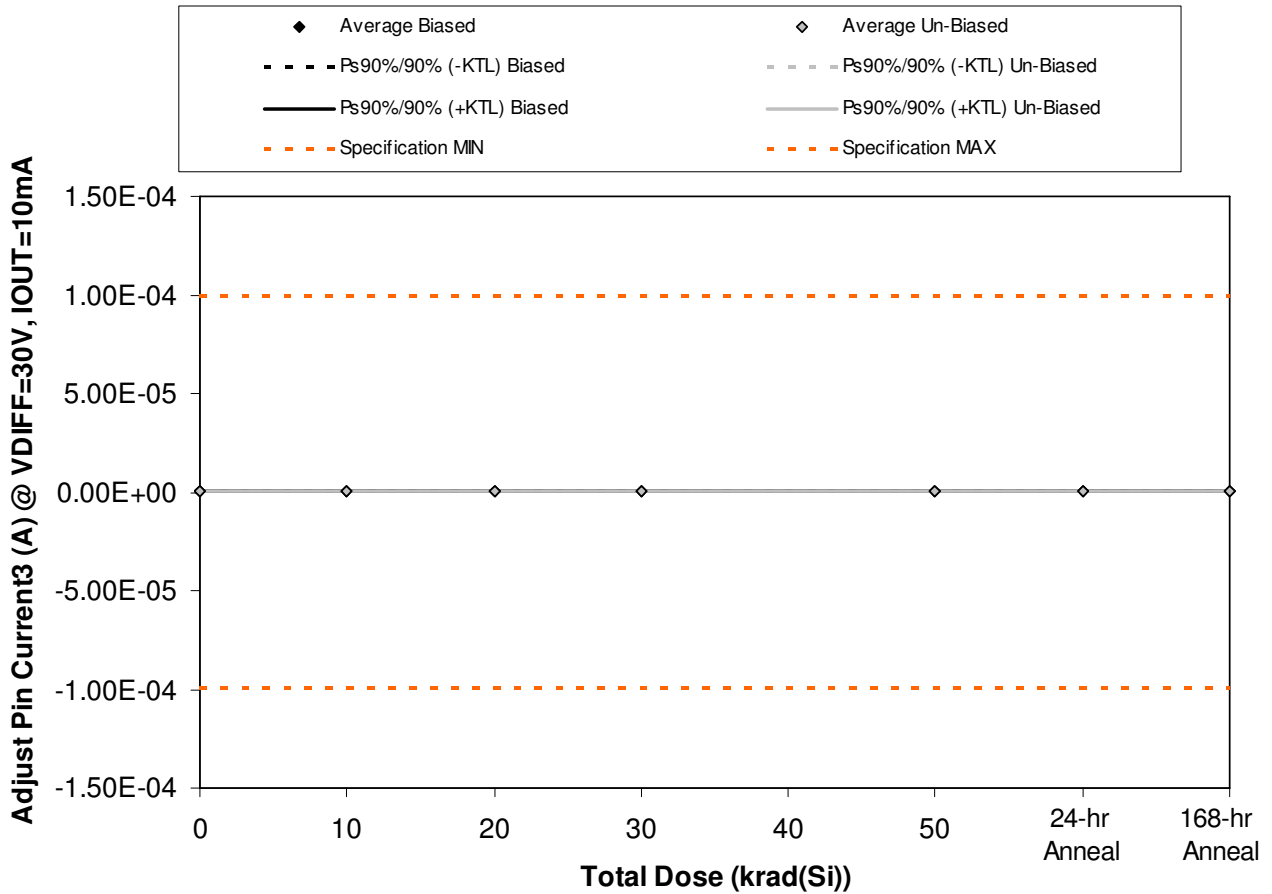

Figure 5.11. Plot of Adjust Pin Current3 (A) @ VDIFF=30V, IOU=10mA versus total dose. The solid diamonds are the average of the measured data points for the samples irradiated under electrical bias while the shaded diamonds are the average of the measured data points for the samples irradiated with all pins tied to ground. The black lines (solid and/or dashed) are the average of the data points after application of the KTL statistics on the samples irradiated under electrical bias while the gray lines (solid and/or dashed) are the average of the data points after application of the KTL statistics on the samples irradiated in the unbiased condition. The red dotted line(s) are the pre- and/or post-irradiation minimum and/or maximum specification value as defined in the datasheet and/or test plan.



TID Report
12-086 120506 R1.0

Aeroflex RAD
5017 N. 30th Street
Colorado Springs, CO 80919
(719) 531-0800

Table 5.11. Raw data for Adjust Pin Current3 (A) @ VDIFF=30V, IOU=10mA versus total dose, including the statistical analysis, specification and the status of the testing (pass/fail).

Adjust Pin Current3 (A) @ VDIFF=30V, IOU=10mA	Total Dose (krad(Si))					24-hr Anneal	168-hr Anneal
	0	10	20	30	50		
Device							
81	8.40E-08	8.50E-08	8.40E-08	8.40E-08	8.40E-08	8.40E-08	8.40E-08
82	8.40E-08	8.50E-08	8.40E-08	8.40E-08	8.40E-08	8.40E-08	8.40E-08
83	8.40E-08	8.50E-08	8.40E-08	8.40E-08	8.40E-08	8.40E-08	8.40E-08
84	8.40E-08	8.50E-08	8.40E-08	8.40E-08	8.40E-08	8.40E-08	8.40E-08
85	8.40E-08	8.50E-08	8.40E-08	8.40E-08	8.40E-08	8.40E-08	8.40E-08
86	8.40E-08	8.50E-08	8.40E-08	8.40E-08	8.40E-08	8.40E-08	8.40E-08
117	8.40E-08	8.50E-08	8.40E-08	8.40E-08	8.40E-08	8.40E-08	8.40E-08
118	8.40E-08	8.50E-08	8.40E-08	8.40E-08	8.40E-08	8.40E-08	8.40E-08
119	8.40E-08	8.50E-08	8.40E-08	8.40E-08	8.40E-08	8.40E-08	8.40E-08
120	8.40E-08	8.50E-08	8.40E-08	8.40E-08	8.40E-08	8.40E-08	8.40E-08
164	8.50E-08	8.50E-08	8.40E-08	8.40E-08	8.40E-08	8.40E-08	8.40E-08
165	8.50E-08	8.50E-08	8.40E-08	8.40E-08	8.40E-08	8.40E-08	8.40E-08
Biased Statistics							
Average Biased	8.40E-08	8.50E-08	8.40E-08	8.40E-08	8.40E-08	8.40E-08	8.40E-08
Std Dev Biased	0.00E+00	0.00E+00	0.00E+00	0.00E+00	0.00E+00	0.00E+00	0.00E+00
Ps90%/90% (+KTL) Biased	8.40E-08	8.50E-08	8.40E-08	8.40E-08	8.40E-08	8.40E-08	8.40E-08
Ps90%/90% (-KTL) Biased	8.40E-08	8.50E-08	8.40E-08	8.40E-08	8.40E-08	8.40E-08	8.40E-08
Un-Biased Statistics							
Average Un-Biased	8.40E-08	8.50E-08	8.40E-08	8.40E-08	8.40E-08	8.40E-08	8.40E-08
Std Dev Un-Biased	0.00E+00	0.00E+00	0.00E+00	0.00E+00	0.00E+00	0.00E+00	0.00E+00
Ps90%/90% (+KTL) Un-Biased	8.40E-08	8.50E-08	8.40E-08	8.40E-08	8.40E-08	8.40E-08	8.40E-08
Ps90%/90% (-KTL) Un-Biased	8.40E-08	8.50E-08	8.40E-08	8.40E-08	8.40E-08	8.40E-08	8.40E-08
Specification MIN	-1.00E-04	-1.00E-04	-1.00E-04	-1.00E-04	-1.00E-04	-1.00E-04	-1.00E-04
Status	PASS	PASS	PASS	PASS	PASS	PASS	PASS
Specification MAX	1.00E-04	1.00E-04	1.00E-04	1.00E-04	1.00E-04	1.00E-04	1.00E-04
Status	PASS	PASS	PASS	PASS	PASS	PASS	PASS

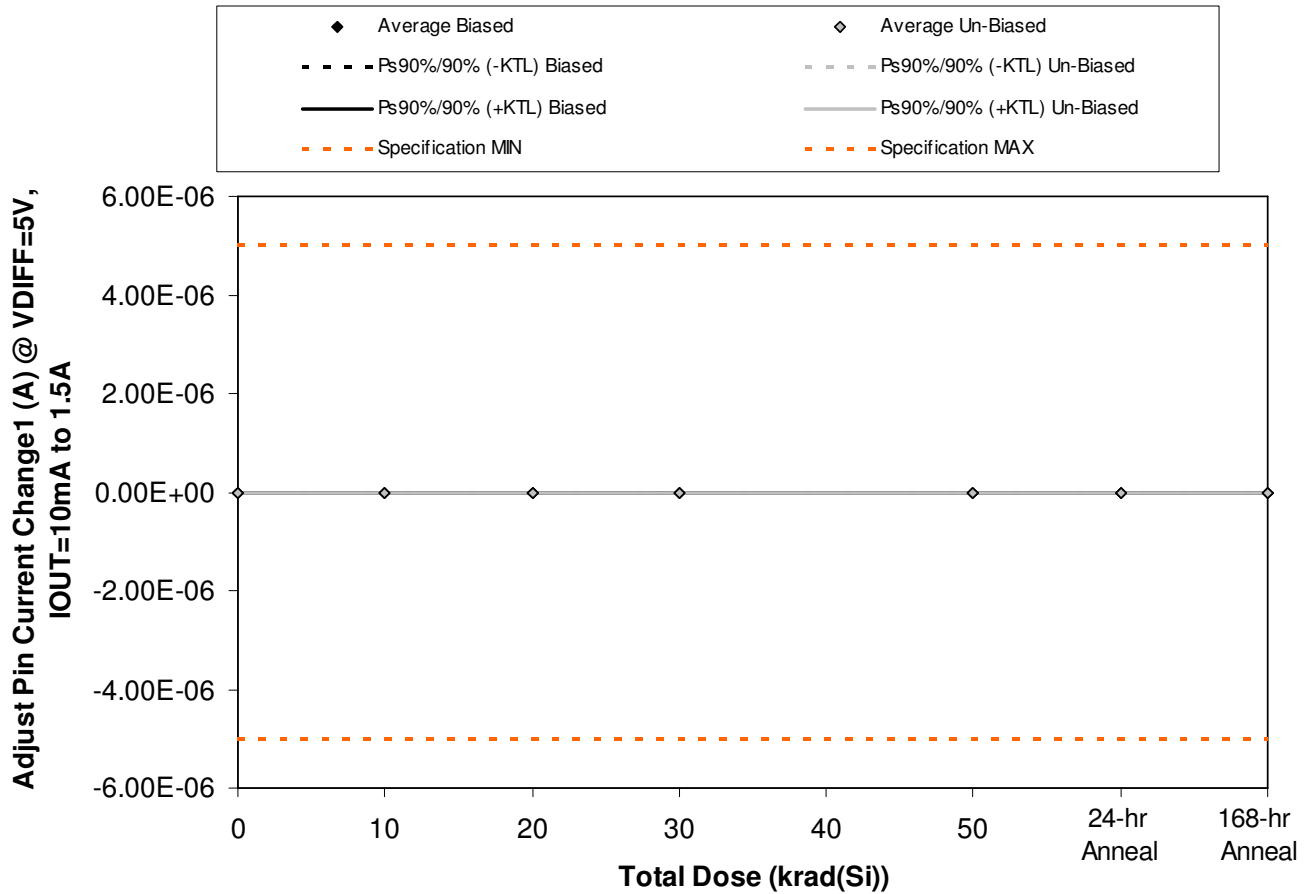

Figure 5.12. Plot of Adjust Pin Current Change1 (A) @ VDIFF=5V, IOU=10mA to 1.5A versus total dose. The solid diamonds are the average of the measured data points for the samples irradiated under electrical bias while the shaded diamonds are the average of the measured data points for the samples irradiated with all pins tied to ground. The black lines (solid and/or dashed) are the average of the data points after application of the KTL statistics on the samples irradiated under electrical bias while the gray lines (solid and/or dashed) are the average of the data points after application of the KTL statistics on the samples irradiated in the unbiased condition. The red dotted line(s) are the pre- and/or post-irradiation minimum and/or maximum specification value as defined in the datasheet and/or test plan.



TID Report
12-086 120506 R1.0

Aeroflex RAD
5017 N. 30th Street
Colorado Springs, CO 80919
(719) 531-0800

Table 5.12. Raw data for Adjust Pin Current Change1 (A) @ VDIFF=5V, IOU=10mA to 1.5A versus total dose, including the statistical analysis, specification and the status of the testing (pass/fail).

Adjust Pin Current Change1 (A) @ VDIFF=5V, IOU=10mA to 1.5A	Total Dose (krad(Si))					24-hr Anneal	168-hr Anneal
	0	10	20	30	50		
Device							
81	0.00E+00	0.00E+00	0.00E+00	0.00E+00	0.00E+00	0.00E+00	0.00E+00
82	0.00E+00	0.00E+00	0.00E+00	0.00E+00	0.00E+00	0.00E+00	0.00E+00
83	0.00E+00	0.00E+00	0.00E+00	0.00E+00	0.00E+00	0.00E+00	0.00E+00
84	0.00E+00	0.00E+00	0.00E+00	0.00E+00	0.00E+00	0.00E+00	0.00E+00
85	0.00E+00	0.00E+00	0.00E+00	0.00E+00	0.00E+00	0.00E+00	0.00E+00
86	0.00E+00	0.00E+00	0.00E+00	0.00E+00	0.00E+00	0.00E+00	0.00E+00
117	0.00E+00	0.00E+00	0.00E+00	0.00E+00	0.00E+00	0.00E+00	0.00E+00
118	0.00E+00	0.00E+00	0.00E+00	0.00E+00	0.00E+00	0.00E+00	0.00E+00
119	0.00E+00	0.00E+00	0.00E+00	0.00E+00	0.00E+00	0.00E+00	0.00E+00
120	0.00E+00	0.00E+00	0.00E+00	0.00E+00	0.00E+00	0.00E+00	0.00E+00
164	0.00E+00	0.00E+00	0.00E+00	0.00E+00	0.00E+00	0.00E+00	0.00E+00
165	0.00E+00	0.00E+00	0.00E+00	0.00E+00	0.00E+00	0.00E+00	0.00E+00
Biased Statistics							
Average Biased	0.00E+00	0.00E+00	0.00E+00	0.00E+00	0.00E+00	0.00E+00	0.00E+00
Std Dev Biased	0.00E+00	0.00E+00	0.00E+00	0.00E+00	0.00E+00	0.00E+00	0.00E+00
Ps90%/90% (+KTL) Biased	0.00E+00	0.00E+00	0.00E+00	0.00E+00	0.00E+00	0.00E+00	0.00E+00
Ps90%/90% (-KTL) Biased	0.00E+00	0.00E+00	0.00E+00	0.00E+00	0.00E+00	0.00E+00	0.00E+00
Un-Biased Statistics							
Average Un-Biased	0.00E+00	0.00E+00	0.00E+00	0.00E+00	0.00E+00	0.00E+00	0.00E+00
Std Dev Un-Biased	0.00E+00	0.00E+00	0.00E+00	0.00E+00	0.00E+00	0.00E+00	0.00E+00
Ps90%/90% (+KTL) Un-Biased	0.00E+00	0.00E+00	0.00E+00	0.00E+00	0.00E+00	0.00E+00	0.00E+00
Ps90%/90% (-KTL) Un-Biased	0.00E+00	0.00E+00	0.00E+00	0.00E+00	0.00E+00	0.00E+00	0.00E+00
Specification MIN	-5.00E-06	-5.00E-06	-5.00E-06	-5.00E-06	-5.00E-06	-5.00E-06	-5.00E-06
Status	PASS	PASS	PASS	PASS	PASS	PASS	PASS
Specification MAX	5.00E-06	5.00E-06	5.00E-06	5.00E-06	5.00E-06	5.00E-06	5.00E-06
Status	PASS	PASS	PASS	PASS	PASS	PASS	PASS

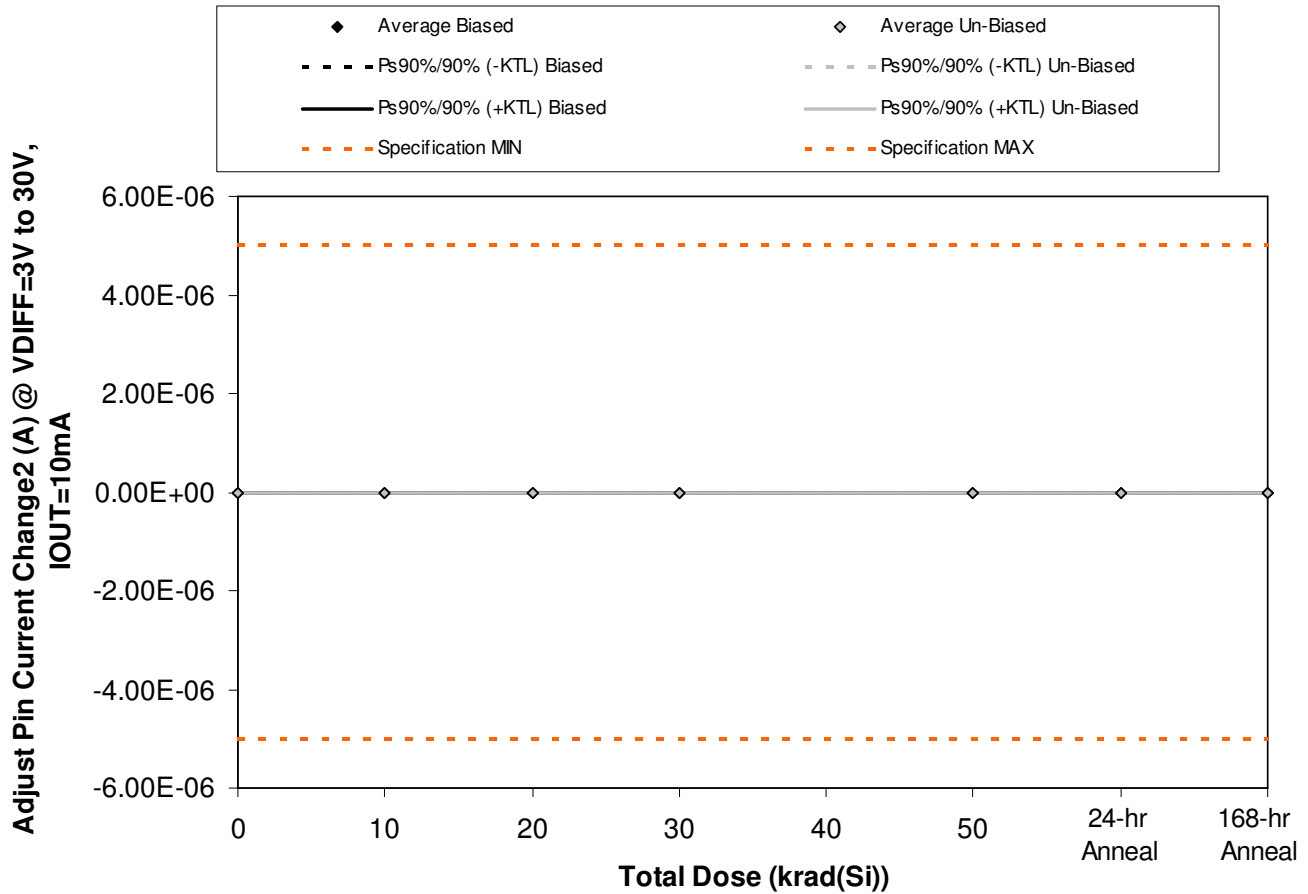

Figure 5.13. Plot of Adjust Pin Current Change2 (A) @ VDIFF=3V to 30V, IOU=10mA versus total dose. The solid diamonds are the average of the measured data points for the samples irradiated under electrical bias while the shaded diamonds are the average of the measured data points for the samples irradiated with all pins tied to ground. The black lines (solid and/or dashed) are the average of the data points after application of the KTL statistics on the samples irradiated under electrical bias while the gray lines (solid and/or dashed) are the average of the data points after application of the KTL statistics on the samples irradiated in the unbiased condition. The red dotted line(s) are the pre- and/or post-irradiation minimum and/or maximum specification value as defined in the datasheet and/or test plan.



TID Report
12-086 120506 R1.0

Aeroflex RAD
5017 N. 30th Street
Colorado Springs, CO 80919
(719) 531-0800

Table 5.13. Raw data for Adjust Pin Current Change2 (A) @ VDIFF=3V to 30V, IOU=10mA versus total dose, including the statistical analysis, specification and the status of the testing (pass/fail).

Adjust Pin Current Change2 (A) @ VDIFF=3V to 30V, IOU=10mA	Total Dose (krad(Si))					24-hr Anneal	168-hr Anneal
	0	10	20	30	50		
Device							
81	0.00E+00	0.00E+00	0.00E+00	0.00E+00	0.00E+00	0.00E+00	0.00E+00
82	0.00E+00	0.00E+00	0.00E+00	0.00E+00	0.00E+00	0.00E+00	0.00E+00
83	0.00E+00	0.00E+00	0.00E+00	0.00E+00	0.00E+00	0.00E+00	0.00E+00
84	0.00E+00	0.00E+00	0.00E+00	0.00E+00	0.00E+00	0.00E+00	0.00E+00
85	0.00E+00	0.00E+00	0.00E+00	0.00E+00	0.00E+00	0.00E+00	0.00E+00
86	0.00E+00	0.00E+00	0.00E+00	0.00E+00	0.00E+00	0.00E+00	0.00E+00
117	0.00E+00	0.00E+00	0.00E+00	0.00E+00	0.00E+00	0.00E+00	0.00E+00
118	0.00E+00	0.00E+00	0.00E+00	0.00E+00	0.00E+00	0.00E+00	0.00E+00
119	0.00E+00	0.00E+00	0.00E+00	0.00E+00	0.00E+00	0.00E+00	0.00E+00
120	0.00E+00	0.00E+00	0.00E+00	0.00E+00	0.00E+00	0.00E+00	0.00E+00
164	0.00E+00	0.00E+00	0.00E+00	0.00E+00	0.00E+00	0.00E+00	0.00E+00
165	0.00E+00	0.00E+00	0.00E+00	0.00E+00	0.00E+00	0.00E+00	0.00E+00
Biased Statistics							
Average Biased	0.00E+00	0.00E+00	0.00E+00	0.00E+00	0.00E+00	0.00E+00	0.00E+00
Std Dev Biased	0.00E+00	0.00E+00	0.00E+00	0.00E+00	0.00E+00	0.00E+00	0.00E+00
Ps90%/90% (+KTL) Biased	0.00E+00	0.00E+00	0.00E+00	0.00E+00	0.00E+00	0.00E+00	0.00E+00
Ps90%/90% (-KTL) Biased	0.00E+00	0.00E+00	0.00E+00	0.00E+00	0.00E+00	0.00E+00	0.00E+00
Un-Biased Statistics							
Average Un-Biased	0.00E+00	0.00E+00	0.00E+00	0.00E+00	0.00E+00	0.00E+00	0.00E+00
Std Dev Un-Biased	0.00E+00	0.00E+00	0.00E+00	0.00E+00	0.00E+00	0.00E+00	0.00E+00
Ps90%/90% (+KTL) Un-Biased	0.00E+00	0.00E+00	0.00E+00	0.00E+00	0.00E+00	0.00E+00	0.00E+00
Ps90%/90% (-KTL) Un-Biased	0.00E+00	0.00E+00	0.00E+00	0.00E+00	0.00E+00	0.00E+00	0.00E+00
Specification MIN	-5.00E-06	-5.00E-06	-5.00E-06	-5.00E-06	-5.00E-06	-5.00E-06	-5.00E-06
Status	PASS	PASS	PASS	PASS	PASS	PASS	PASS
Specification MAX	5.00E-06	5.00E-06	5.00E-06	5.00E-06	5.00E-06	5.00E-06	5.00E-06
Status	PASS	PASS	PASS	PASS	PASS	PASS	PASS

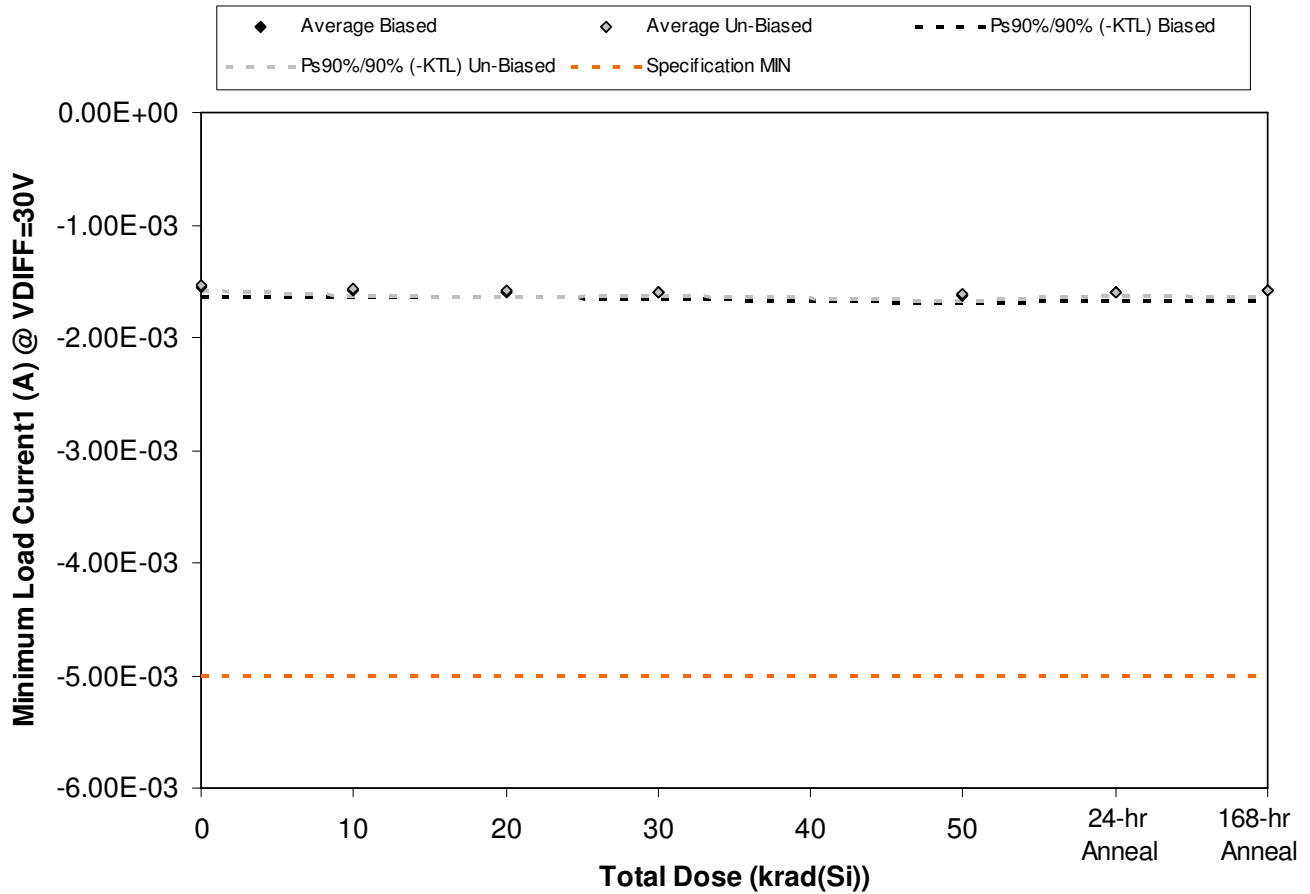

Figure 5.14. Plot of Minimum Load Current1 (A) @ VDIFF=30V versus total dose. The solid diamonds are the average of the measured data points for the samples irradiated under electrical bias while the shaded diamonds are the average of the measured data points for the samples irradiated with all pins tied to ground. The black lines (solid and/or dashed) are the average of the data points after application of the KTL statistics on the samples irradiated under electrical bias while the gray lines (solid and/or dashed) are the average of the data points after application of the KTL statistics on the samples irradiated in the unbiased condition. The red dotted line(s) are the pre- and/or post-irradiation minimum and/or maximum specification value as defined in the datasheet and/or test plan.



TID Report
12-086 120506 R1.0

Aeroflex RAD
5017 N. 30th Street
Colorado Springs, CO 80919
(719) 531-0800

Table 5.14. Raw data for Minimum Load Current1 (A) @ VDIFF=30V versus total dose, including the statistical analysis, specification and the status of the testing (pass/fail).

Minimum Load Current1 (A) @ VDIFF=30V	Total Dose (krad(Si))					24-hr Anneal	168-hr Anneal
	0	10	20	30	50		
Device							
81	-1.53E-03	-1.55E-03	-1.57E-03	-1.57E-03	-1.59E-03	-1.57E-03	-1.57E-03
82	-1.51E-03	-1.59E-03	-1.61E-03	-1.63E-03	-1.65E-03	-1.59E-03	-1.55E-03
83	-1.55E-03	-1.57E-03	-1.59E-03	-1.59E-03	-1.61E-03	-1.59E-03	-1.59E-03
84	-1.57E-03	-1.57E-03	-1.59E-03	-1.59E-03	-1.61E-03	-1.59E-03	-1.59E-03
85	-1.59E-03	-1.61E-03	-1.61E-03	-1.61E-03	-1.63E-03	-1.65E-03	-1.63E-03
86	-1.51E-03	-1.57E-03	-1.59E-03	-1.59E-03	-1.61E-03	-1.59E-03	-1.57E-03
117	-1.53E-03	-1.55E-03	-1.55E-03	-1.57E-03	-1.59E-03	-1.57E-03	-1.55E-03
118	-1.51E-03	-1.55E-03	-1.57E-03	-1.57E-03	-1.57E-03	-1.57E-03	-1.55E-03
119	-1.55E-03	-1.59E-03	-1.59E-03	-1.59E-03	-1.61E-03	-1.59E-03	-1.61E-03
120	-1.55E-03	-1.59E-03	-1.61E-03	-1.61E-03	-1.63E-03	-1.61E-03	-1.59E-03
164	-1.53E-03	-1.53E-03	-1.53E-03	-1.53E-03	-1.53E-03	-1.51E-03	-1.53E-03
165	-1.55E-03	-1.55E-03	-1.55E-03	-1.55E-03	-1.55E-03	-1.55E-03	-1.57E-03
Biased Statistics							
Average Biased	-1.55E-03	-1.58E-03	-1.60E-03	-1.60E-03	-1.62E-03	-1.60E-03	-1.59E-03
Std Dev Biased	3.16E-05	2.25E-05	1.64E-05	2.25E-05	2.28E-05	2.84E-05	2.97E-05
Ps90%/90% (+KTL) Biased	-1.47E-03	-1.52E-03	-1.55E-03	-1.54E-03	-1.56E-03	-1.52E-03	-1.51E-03
Ps90%/90% (-KTL) Biased	-1.64E-03	-1.64E-03	-1.64E-03	-1.66E-03	-1.68E-03	-1.68E-03	-1.67E-03
Un-Biased Statistics							
Average Un-Biased	-1.53E-03	-1.57E-03	-1.59E-03	-1.59E-03	-1.61E-03	-1.59E-03	-1.58E-03
Std Dev Un-Biased	2.00E-05	1.95E-05	2.23E-05	1.63E-05	2.28E-05	1.69E-05	2.62E-05
Ps90%/90% (+KTL) Un-Biased	-1.48E-03	-1.52E-03	-1.52E-03	-1.54E-03	-1.54E-03	-1.54E-03	-1.50E-03
Ps90%/90% (-KTL) Un-Biased	-1.59E-03	-1.63E-03	-1.65E-03	-1.63E-03	-1.67E-03	-1.64E-03	-1.65E-03
Specification MIN	-5.00E-03	-5.00E-03	-5.00E-03	-5.00E-03	-5.00E-03	-5.00E-03	-5.00E-03
Status	PASS	PASS	PASS	PASS	PASS	PASS	PASS

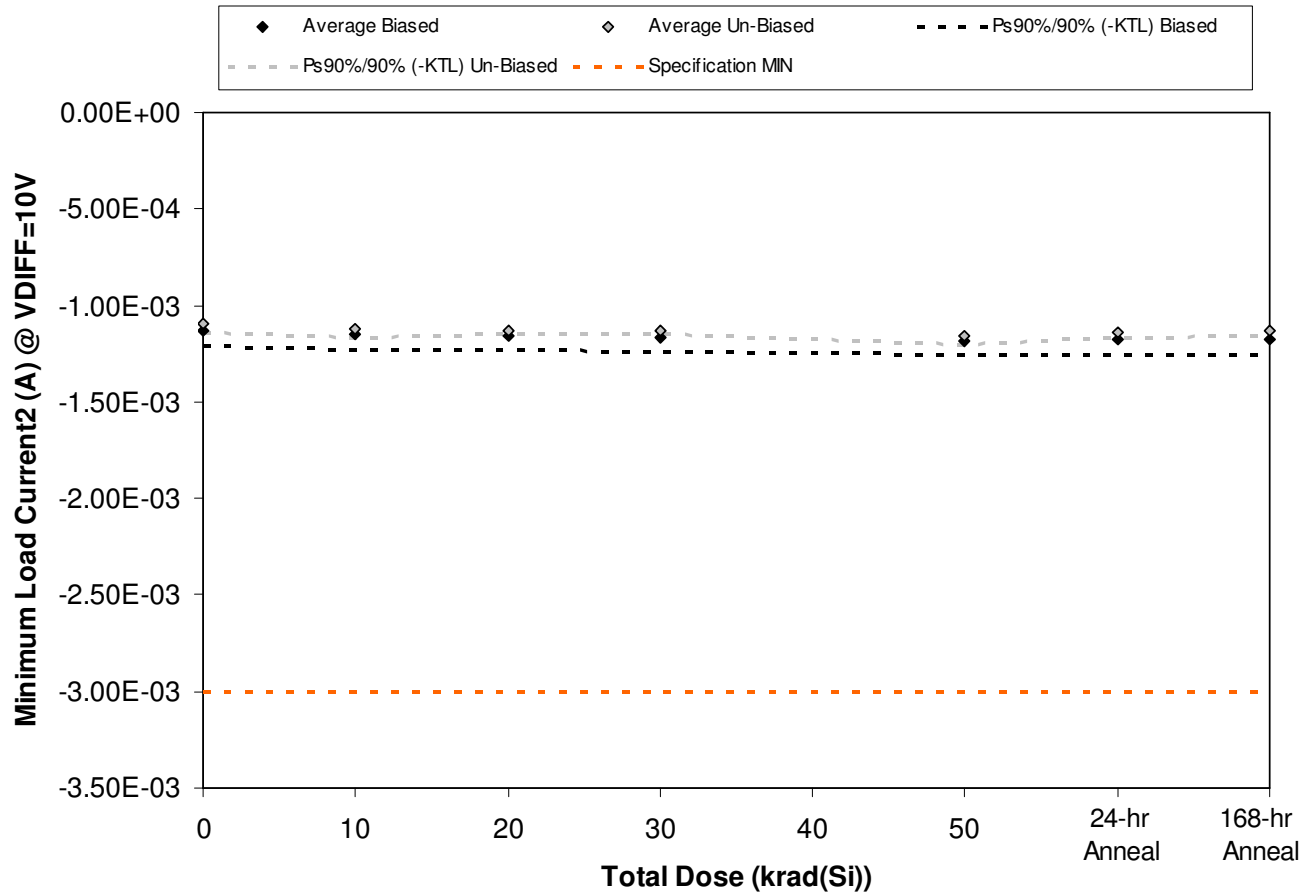

Figure 5.15. Plot of Minimum Load Current2 (A) @ VDIFF=10V versus total dose. The solid diamonds are the average of the measured data points for the samples irradiated under electrical bias while the shaded diamonds are the average of the measured data points for the samples irradiated with all pins tied to ground. The black lines (solid and/or dashed) are the average of the data points after application of the KTL statistics on the samples irradiated under electrical bias while the gray lines (solid and/or dashed) are the average of the data points after application of the KTL statistics on the samples irradiated in the unbiased condition. The red dotted line(s) are the pre- and/or post-irradiation minimum and/or maximum specification value as defined in the datasheet and/or test plan.



TID Report
12-086 120506 R1.0

Aeroflex RAD
5017 N. 30th Street
Colorado Springs, CO 80919
(719) 531-0800

Table 5.15. Raw data for Minimum Load Current2 (A) @ VDIFF=10V versus total dose, including the statistical analysis, specification and the status of the testing (pass/fail).

Minimum Load Current2 (A) @ VDIFF=10V	Total Dose (krad(Si))					24-hr Anneal	168-hr Anneal
	0	10	20	30	50		
Device							
81	-1.12E-03	-1.14E-03	-1.14E-03	-1.16E-03	-1.18E-03	-1.16E-03	-1.16E-03
82	-1.08E-03	-1.10E-03	-1.12E-03	-1.12E-03	-1.14E-03	-1.14E-03	-1.14E-03
83	-1.12E-03	-1.14E-03	-1.16E-03	-1.16E-03	-1.18E-03	-1.16E-03	-1.16E-03
84	-1.14E-03	-1.16E-03	-1.16E-03	-1.18E-03	-1.18E-03	-1.18E-03	-1.18E-03
85	-1.16E-03	-1.18E-03	-1.20E-03	-1.20E-03	-1.22E-03	-1.22E-03	-1.22E-03
86	-1.08E-03	-1.10E-03	-1.12E-03	-1.12E-03	-1.14E-03	-1.14E-03	-1.12E-03
117	-1.10E-03	-1.12E-03	-1.14E-03	-1.14E-03	-1.14E-03	-1.14E-03	-1.14E-03
118	-1.08E-03	-1.12E-03	-1.12E-03	-1.12E-03	-1.16E-03	-1.14E-03	-1.12E-03
119	-1.08E-03	-1.10E-03	-1.12E-03	-1.12E-03	-1.14E-03	-1.14E-03	-1.12E-03
120	-1.12E-03	-1.14E-03	-1.14E-03	-1.14E-03	-1.18E-03	-1.16E-03	-1.14E-03
164	-1.10E-03	-1.10E-03	-1.11E-03	-1.11E-03	-1.10E-03	-1.11E-03	-1.10E-03
165	-1.14E-03	-1.14E-03	-1.14E-03	-1.12E-03	-1.14E-03	-1.12E-03	-1.14E-03
Biased Statistics							
Average Biased	-1.13E-03	-1.15E-03	-1.16E-03	-1.16E-03	-1.18E-03	-1.17E-03	-1.18E-03
Std Dev Biased	2.98E-05	2.96E-05	2.83E-05	2.78E-05	2.66E-05	3.01E-05	3.03E-05
Ps90%/90% (+KTL) Biased	-1.05E-03	-1.07E-03	-1.08E-03	-1.09E-03	-1.11E-03	-1.09E-03	-1.09E-03
Ps90%/90% (-KTL) Biased	-1.21E-03	-1.23E-03	-1.23E-03	-1.24E-03	-1.26E-03	-1.25E-03	-1.26E-03
Un-Biased Statistics							
Average Un-Biased	-1.10E-03	-1.12E-03	-1.13E-03	-1.13E-03	-1.16E-03	-1.14E-03	-1.13E-03
Std Dev Un-Biased	1.79E-05	1.71E-05	8.22E-06	8.22E-06	1.79E-05	9.39E-06	1.10E-05
Ps90%/90% (+KTL) Un-Biased	-1.05E-03	-1.07E-03	-1.11E-03	-1.11E-03	-1.11E-03	-1.12E-03	-1.10E-03
Ps90%/90% (-KTL) Un-Biased	-1.14E-03	-1.17E-03	-1.15E-03	-1.15E-03	-1.21E-03	-1.17E-03	-1.16E-03
Specification MIN	-3.00E-03	-3.00E-03	-3.00E-03	-3.00E-03	-3.00E-03	-3.00E-03	-3.00E-03
Status	PASS	PASS	PASS	PASS	PASS	PASS	PASS

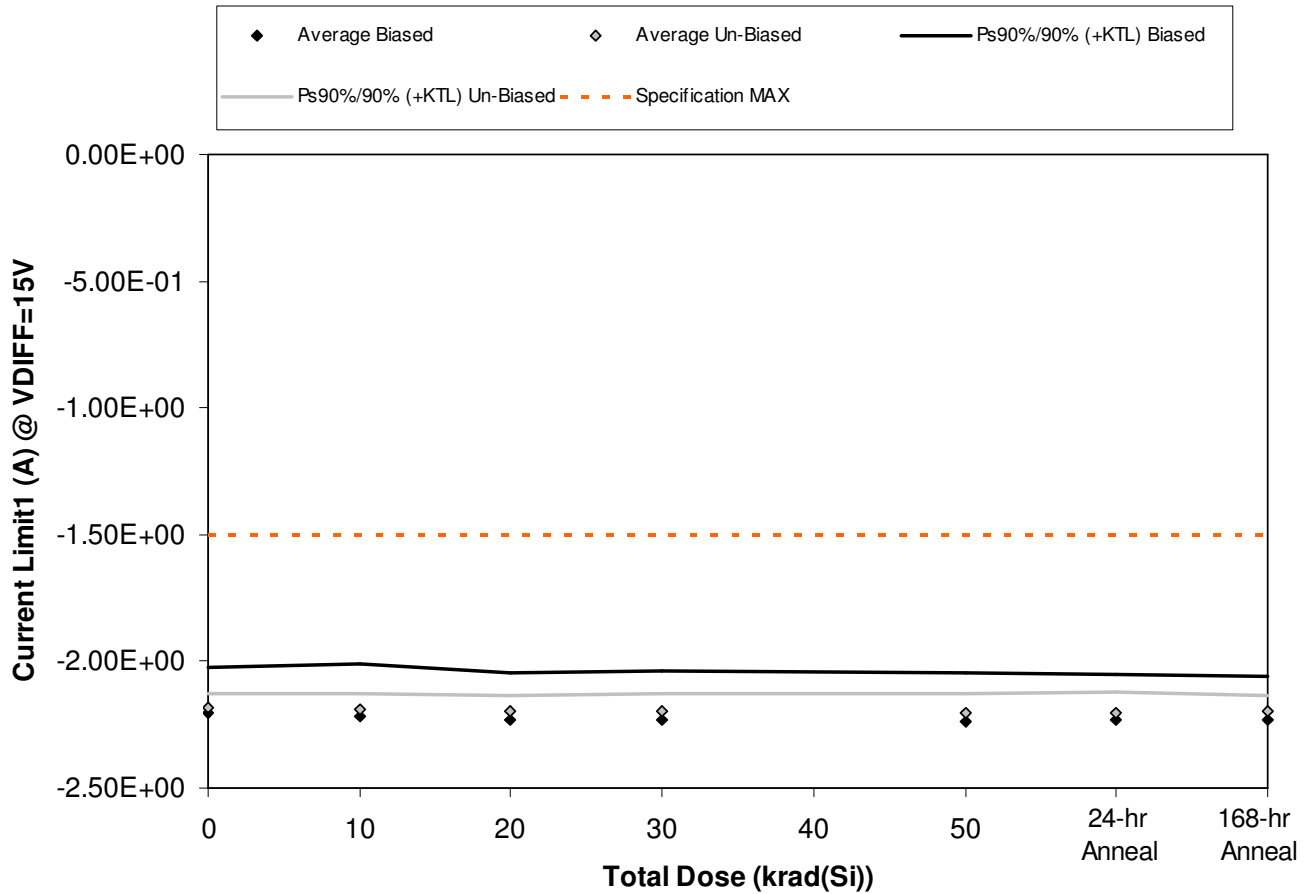

Figure 5.16. Plot of Current Limit1 (A) @ VDIFF=15V versus total dose. The solid diamonds are the average of the measured data points for the samples irradiated under electrical bias while the shaded diamonds are the average of the measured data points for the samples irradiated with all pins tied to ground. The black lines (solid and/or dashed) are the average of the data points after application of the KTL statistics on the samples irradiated under electrical bias while the gray lines (solid and/or dashed) are the average of the data points after application of the KTL statistics on the samples irradiated in the unbiased condition. The red dotted line(s) are the pre- and/or post-irradiation minimum and/or maximum specification value as defined in the datasheet and/or test plan.



**TID Report
12-086 120506 R1.0**

**Aeroflex RAD
5017 N. 30th Street
Colorado Springs, CO 80919
(719) 531-0800**

Table 5.16. Raw data for Current Limit1 (A) @ VDIFF=15V versus total dose, including the statistical analysis, specification and the status of the testing (pass/fail).

Current Limit1 (A) @ VDIFF=15V Device	Total Dose (krad(Si))					24-hr Anneal	168-hr Anneal
	0	10	20	30	50		
81	-2.24E+00	-2.24E+00	-2.25E+00	-2.25E+00	-2.25E+00	-2.25E+00	-2.25E+00
82	-2.16E+00	-2.16E+00	-2.19E+00	-2.19E+00	-2.19E+00	-2.19E+00	-2.19E+00
83	-2.22E+00	-2.24E+00	-2.25E+00	-2.25E+00	-2.26E+00	-2.25E+00	-2.25E+00
84	-2.29E+00	-2.31E+00	-2.32E+00	-2.33E+00	-2.34E+00	-2.32E+00	-2.32E+00
85	-2.12E+00	-2.12E+00	-2.15E+00	-2.15E+00	-2.15E+00	-2.15E+00	-2.16E+00
86	-2.16E+00	-2.18E+00	-2.19E+00	-2.19E+00	-2.19E+00	-2.19E+00	-2.19E+00
117	-2.21E+00	-2.22E+00	-2.24E+00	-2.24E+00	-2.19E+00	-2.24E+00	-2.24E+00
118	-2.17E+00	-2.18E+00	-2.19E+00	-2.19E+00	-2.24E+00	-2.19E+00	-2.19E+00
119	-2.19E+00	-2.20E+00	-2.20E+00	-2.21E+00	-2.22E+00	-2.24E+00	-2.21E+00
120	-2.16E+00	-2.16E+00	-2.18E+00	-2.18E+00	-2.17E+00	-2.17E+00	-2.18E+00
164	-2.21E+00	-2.21E+00	-2.21E+00	-2.21E+00	-2.21E+00	-2.21E+00	-2.21E+00
165	-2.26E+00	-2.25E+00	-2.25E+00	-2.25E+00	-2.25E+00	-2.25E+00	-2.25E+00
Biased Statistics							
Average Biased	-2.20E+00	-2.21E+00	-2.23E+00	-2.23E+00	-2.24E+00	-2.23E+00	-2.23E+00
Std Dev Biased	6.45E-02	7.40E-02	6.65E-02	7.02E-02	7.04E-02	6.46E-02	6.28E-02
Ps90%/90% (+KTL) Biased	-2.03E+00	-2.01E+00	-2.05E+00	-2.04E+00	-2.05E+00	-2.05E+00	-2.06E+00
Ps90%/90% (-KTL) Biased	-2.38E+00	-2.42E+00	-2.41E+00	-2.43E+00	-2.43E+00	-2.41E+00	-2.40E+00
Un-Biased Statistics							
Average Un-Biased	-2.18E+00	-2.19E+00	-2.20E+00	-2.20E+00	-2.20E+00	-2.20E+00	-2.20E+00
Std Dev Un-Biased	1.95E-02	2.12E-02	2.22E-02	2.52E-02	2.79E-02	3.14E-02	2.43E-02
Ps90%/90% (+KTL) Un-Biased	-2.13E+00	-2.13E+00	-2.14E+00	-2.13E+00	-2.12E+00	-2.12E+00	-2.13E+00
Ps90%/90% (-KTL) Un-Biased	-2.23E+00	-2.25E+00	-2.26E+00	-2.27E+00	-2.28E+00	-2.29E+00	-2.26E+00
Specification MAX	-1.50E+00	-1.50E+00	-1.50E+00	-1.50E+00	-1.50E+00	-1.50E+00	-1.50E+00
Status	PASS	PASS	PASS	PASS	PASS	PASS	PASS

An ISO 9001:2008 and DSCC Certified Company

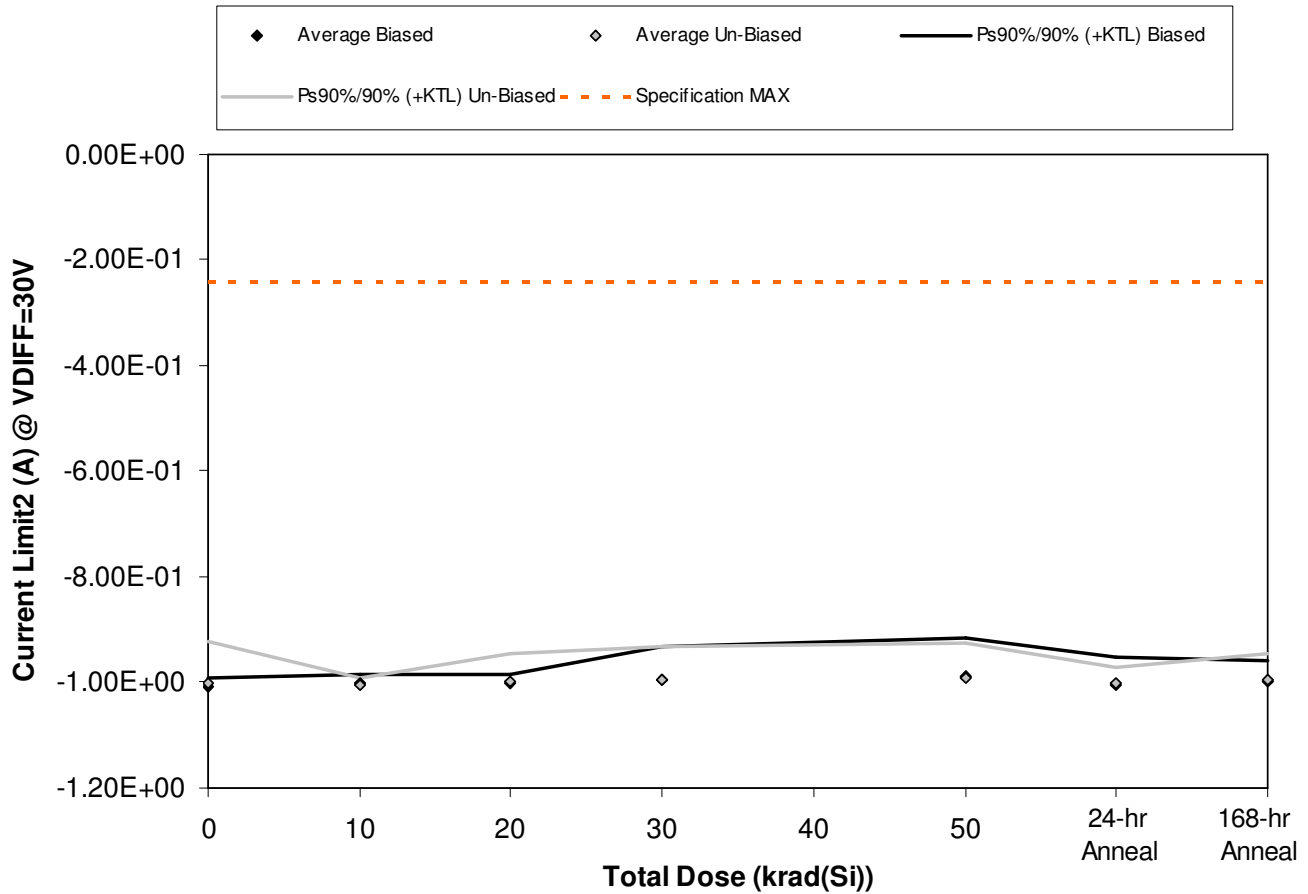

Figure 5.17. Plot of Current Limit2 (A) @ VDIFF=30V versus total dose. The solid diamonds are the average of the measured data points for the samples irradiated under electrical bias while the shaded diamonds are the average of the measured data points for the samples irradiated with all pins tied to ground. The black lines (solid and/or dashed) are the average of the data points after application of the KTL statistics on the samples irradiated under electrical bias while the gray lines (solid and/or dashed) are the average of the data points after application of the KTL statistics on the samples irradiated in the unbiased condition. The red dotted line(s) are the pre- and/or post-irradiation minimum and/or maximum specification value as defined in the datasheet and/or test plan.



**TID Report
12-086 120506 R1.0**

**Aeroflex RAD
5017 N. 30th Street
Colorado Springs, CO 80919
(719) 531-0800**

Table 5.17. Raw data for Current Limit2 (A) @ VDIFF=30V versus total dose, including the statistical analysis, specification and the status of the testing (pass/fail).

Current Limit2 (A) @ VDIFF=30V Device	Total Dose (krad(Si))					24-hr Anneal	168-hr Anneal
	0	10	20	30	50		
81	-1.00E+00	-9.97E-01	-1.01E+00	-1.01E+00	-9.91E-01	-1.03E+00	-1.01E+00
82	-1.01E+00	-1.01E+00	-9.97E-01	-9.58E-01	-9.64E-01	-1.02E+00	-9.91E-01
83	-1.02E+00	-1.01E+00	-1.01E+00	-9.97E-01	-9.58E-01	-9.86E-01	-9.97E-01
84	-1.01E+00	-9.97E-01	-9.97E-01	-9.97E-01	-1.02E+00	-9.86E-01	-9.80E-01
85	-1.01E+00	-9.97E-01	-9.97E-01	-1.02E+00	-1.01E+00	-1.01E+00	-1.02E+00
86	-1.01E+00	-1.00E+00	-9.97E-01	-1.02E+00	-1.01E+00	-9.97E-01	-1.00E+00
117	-9.52E-01	-1.01E+00	-9.64E-01	-9.97E-01	-9.86E-01	-1.02E+00	-9.97E-01
118	-1.03E+00	-9.97E-01	-1.01E+00	-1.00E+00	-1.01E+00	-9.97E-01	-1.02E+00
119	-1.01E+00	-1.01E+00	-1.01E+00	-9.58E-01	-9.52E-01	-9.91E-01	-9.75E-01
120	-1.01E+00	-1.01E+00	-1.01E+00	-9.91E-01	-1.00E+00	-1.01E+00	-9.80E-01
164	-1.02E+00	-1.01E+00	-1.01E+00	-1.02E+00	-9.58E-01	-1.02E+00	-9.86E-01
165	-9.91E-01	-9.97E-01	-1.01E+00	-1.02E+00	-9.52E-01	-1.03E+00	-1.01E+00
Biased Statistics							
Average Biased	-1.01E+00	-1.00E+00	-1.00E+00	-9.96E-01	-9.88E-01	-1.01E+00	-9.99E-01
Std Dev Biased	6.16E-03	6.02E-03	6.02E-03	2.30E-02	2.67E-02	1.97E-02	1.51E-02
Ps90%/90% (+KTL) Biased	-9.92E-01	-9.85E-01	-9.85E-01	-9.33E-01	-9.15E-01	-9.52E-01	-9.58E-01
Ps90%/90% (-KTL) Biased	-1.03E+00	-1.02E+00	-1.02E+00	-1.06E+00	-1.06E+00	-1.06E+00	-1.04E+00
Un-Biased Statistics							
Average Un-Biased	-1.00E+00	-1.00E+00	-9.97E-01	-9.94E-01	-9.91E-01	-1.00E+00	-9.95E-01
Std Dev Un-Biased	2.91E-02	4.87E-03	1.91E-02	2.25E-02	2.37E-02	1.11E-02	1.78E-02
Ps90%/90% (+KTL) Un-Biased	-9.21E-01	-9.91E-01	-9.45E-01	-9.32E-01	-9.26E-01	-9.72E-01	-9.46E-01
Ps90%/90% (-KTL) Un-Biased	-1.08E+00	-1.02E+00	-1.05E+00	-1.06E+00	-1.06E+00	-1.03E+00	-1.04E+00
Specification MAX	-2.40E-01	-2.40E-01	-2.40E-01	-2.40E-01	-2.40E-01	-2.40E-01	-2.40E-01
Status	PASS	PASS	PASS	PASS	PASS	PASS	PASS

An ISO 9001:2008 and DSCC Certified Company



6.0. Summary / Conclusions

The total ionizing dose testing described in this final report was performed using the facilities at Aeroflex RAD's Longmire Laboratories in Colorado Springs, CO. The high dose rate total ionizing dose (TID) source is a JLSA 81-24 irradiator modified to provide a panoramic exposure. The Co-60 rods are held in the base of the irradiator heavily shielded by lead, during the radiation exposures the rod is raised by an electronic timer/controller and the exposure is performed in air. The dose rate for this irradiator in this configuration ranges from 1rad(Si)/s to a maximum of approximately 120rad(Si)/s , determined by the distance from the source.

The parametric data was obtained as "read and record" and all the raw data plus an attributes summary are contained in this report as well as in a separate Excel file. The attributes data contains the average, standard deviation and the average with the KTL values applied. The KTL value used in this work is 2.742 per MIL-HDBK-814 using one sided tolerance limits of 90/90 and a 5-piece sample size. The 90/90 KTL values were selected to match the statistical levels specified in the MIL-PRF-38535 sampling plan for the qualification of a radiation hardness assured (RHA) component. Note that the following criteria must be met for a device to pass the total ionizing dose test: following the radiation exposure each of the 5 pieces irradiated under electrical bias shall pass the specification value. The units irradiated without electrical bias and the KTL statistics are included in this report for reference only. If any of the 5 pieces irradiated under electrical bias exceed the device post radiation data sheet specification limits, then the lot could be logged as a failure.

Based on this criterion the RH137K Negative Adjustable Regulator (from the lot date code identified on the first page of this test report) PASSED the total ionizing dose test to the maximum tested dose level of 50krad(Si) with all parameters remaining within their datasheet specifications. Further, the data in this report can be analyzed along with the low dose rate report titled "Enhanced Low Dose Rate Sensitivity (ELDRS) Radiation Testing of the RH137K Negative Adjustable Regulator for Linear Technology" to demonstrate that these parts do not exhibit ELDRS as defined in the current test method.



Appendix A: Photograph of a Sample Unit-Under-Test to Show Part Traceability



Appendix B: Radiation Bias Connections and Absolute Maximum Ratings

TID Radiation Biased Conditions: Extracted from Linear Technology RH137 Datasheet.

Pin	Function	Connection / Bias
1	ADJ	To +15V via 2kΩ Resistor
2	VOUT	To +15V via 243Ω Resistor 0.1uF Decoupling from +15V to GND
3 (Case)	VIN	To -15V 0.1uF Decoupling from -15V to GND

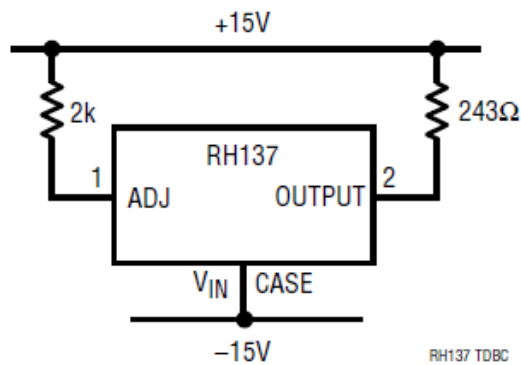

Figure B.1. Irradiation bias circuit. This figure was extracted from Linear Technology RH137 Datasheet.

TID Radiation Unbiased Conditions:

Pin	Function	Connection / Bias
1	ADJ	GND
2	VOUT	GND
3 (Case)	VIN	GND

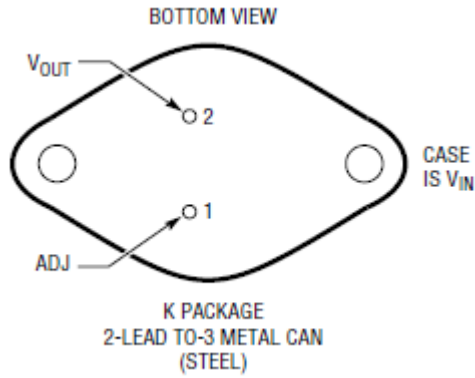

Figure B.2. K package drawing (for reference only). This figure was extracted from Linear Technology RH137 Datasheet.

Absolute Maximum Ratings:

Parameter	Max Rating
Power Dissipation	Internally Limited
Input-to-Output Voltage Differential	30V



Appendix C: Electrical Test Parameters and Conditions

The expected ranges of values as well as the measurement conditions are taken from Linear Technology RH137 Datasheet. All electrical tests for this device are performed on one of Aeroflex RAD's LTS2020 Test Systems. The LTS2020 Test System is a programmable parametric tester that provides parameter measurements for a variety of digital, analog and mixed signal products including voltage regulators, voltage comparators, D to A and A to D converters. The LTS2020 Test System achieves accuracy and sensitivity through the use of software self-calibration and an internal relay matrix with separate family boards and custom personality adapter boards. The tester uses this relay matrix to connect the required test circuits, select the appropriate voltage / current sources and establish the needed measurement loops for all the tests performed. The measured parameters and test conditions are shown in Table C.1.

A listing of the measurement precision/resolution for each parameter is shown in Table C.2. The precision/resolution values were obtained from test data or from the DAC resolution of the LTS-2020 for the particular test shown, whichever is greater. To generate the precision/resolution shown in Table C.2, one of the units-under-test was tested repetitively (a total of 10-times with re-insertion between tests) to obtain the average test value and standard deviation. Using this test data MIL-HDBK-814 90/90 KTL statistics were applied to the measured standard deviation to generate the final measurement range. This value encompasses the precision/resolution of all aspects of the test system, including the LTS2020 mainframe, family board, socket assembly and DUT board as well as insertion error. In some cases, the measurement resolution is limited by the internal DACs, which results in a measured standard deviation of zero. In these instances the precision/resolution will be reported back as the LSB of the DAC.

Note that the testing and statistics used in this document are based on an "analysis of variables" technique, which relies on small sample sizes to qualify much larger lot sizes (see MIL-HDBK-814, p. 91 for a discussion of statistical treatments). Not all measured parameters are well suited to this approach due to inherent large variations. If necessary, larger samples sizes could be used to qualify these parameters using an "attributes" approach.



Table C.1. Measured parameters and test conditions for the RH137K Negative Adjustable Regulator.

Parameter	Symbol	Test Conditions
Reference Voltage1 (V)	Vref1	VDIFF=5V, IOU=10mA
Reference Voltage2 (V)	Vref2	VDIFF=3V, IOU=10mA
Reference Voltage3 (V)	Vref3	VDIFF=30V, IOU=10mA
Reference Voltage4 (V)	Vref4	VDIFF=3V, IOU=1.5A
Reference Voltage5 (V)	Vref5	VDIFF=30V, IOU=0.5A
Line Regulation (%/V)	LINE REG	VDIFF=3V to 30V, IOU=10mA
Load Regulation1 (V)	LOAD REG 1	VOU<=5V, IOU=10mA to 0.5A
Load Regulation2 (%)	LOAD REG 2	VOU>=5V, IOU=10mA to 1.5A
Adjust Pin Current1 (A)	IADJ1	VDIFF=3V, IOU=10mA
Adjust Pin Current2 (A)	IADJ2	VDIFF=5V, IOU=10mA
Adjust Pin Current3 (A)	IADJ3	VDIFF=30V, IOU=10mA
Adjust Pin Current Change1 (A)	DIADJ1	VDIFF=5V, IOU=10mA to 1.5A
Adjust Pin Current Change2 (A)	DIADJ2	VDIFF=3V to 30V, IOU=10mA
Minimum Load Current1 (A)	IMIN1	VDIFF=30V
Minimum Load Current2 (A)	IMIN2	VDIFF=10V
Current Limit1 (A)	ISC1	VDIFF=15V
Current Limit2 (A)	ISC2	VDIFF=30V



TID Report
12-086 120506 R1.0

Aeroflex RAD
5017 N. 30th Street
Colorado Springs, CO 80919
(719) 531-0800

Table C.2. Measured parameters, pre-irradiation specifications and measurement precision for the RH137K Negative Adjustable Regulator.

Parameter	Pre-Irradiation Specification		Measurement Precision/Resolution
	MIN	MAX	
Reference Voltage1 (V)	-1.275E+00	-1.225E+00	±9.00E-04
Reference Voltage2 (V)	-1.30E+00	-1.20E+00	±9.00E-04
Reference Voltage3 (V)	-1.30E+00	-1.20E+00	±9.00E-04
Reference Voltage4 (V)	-1.30E+00	-1.20E+00	±9.00E-04
Reference Voltage5 (V)	-1.30E+00	-1.20E+00	±9.00E-04
Line Regulation (%/V)		2.00E-02	±4.00E-04
Load Regulation1 (V)	-2.50E-02		±4.00E-04
Load Regulation2 (%)	-5.00E-01		±7.00E-03
Adjust Pin Current1 (A)	-1.00E-04	1.00E-04	±2.00E-09
Adjust Pin Current2 (A)	-1.00E-04	1.00E-04	±2.00E-09
Adjust Pin Current3 (A)	-1.00E-04	1.00E-04	±2.00E-09
Adjust Pin Current Change1 (A)	-5.00E-06	5.00E-06	±4.00E-08
Adjust Pin Current Change2 (A)	-5.00E-06	5.00E-06	±4.00E-08
Minimum Load Current1 (A)	-5.00E-03		±2.00E-05
Minimum Load Current2 (A)	-3.00E-03		±2.00E-05
Current Limit1 (A)		-1.50E+00	±1.00E-02
Current Limit2 (A)		-2.40E-01	±1.00E-02



Appendix D: List of Figures Used in the Results Section (Section 5)

- 5.1. Reference Voltage1 (V) @ VDIFF=5V, IOU=10mA
- 5.2. Reference Voltage2 (V) @ VDIFF=3V, IOU=10mA
- 5.3. Reference Voltage3 (V) @ VDIFF=30V, IOU=10mA
- 5.4. Reference Voltage4 (V) @ VDIFF=3V, IOU=1.5A
- 5.5. Reference Voltage5 (V) @ VDIFF=30V, IOU=0.5A
- 5.6. Line Regulation (%/V) @ VDIFF=3V to 30V, IOU=10mA
- 5.7. Load Regulation1 (V) @ VOUT<=5V, IOU=10mA to 0.5A
- 5.8. Load Regulation2 (%) @ VOUT>=5V, IOU=10mA to 1.5A
- 5.9. Adjust Pin Current1 (A) @ VDIFF=3V, IOU=10mA
- 5.10. Adjust Pin Current2 (A) @ VDIFF=5V, IOU=10mA
- 5.11. Adjust Pin Current3 (A) @ VDIFF=30V, IOU=10mA
- 5.12. Adjust Pin Current Change1 (A) @ VDIFF=5V, IOU=10mA to 1.5A
- 5.13. Adjust Pin Current Change2 (A) @ VDIFF=3V to 30V, IOU=10mA
- 5.14. Minimum Load Current1 (A) @ VDIFF=30V
- 5.15. Minimum Load Current2 (A) @ VDIFF=10V
- 5.16. Current Limit1 (A) @ VDIFF=15V
- 5.17. Current Limit2 (A) @ VDIFF=30V