

FEATURES

- Very Low Input Noise Voltage 3.5nV/√Hz Typ
- Wide Small-Signal Bandwidth 10MHz Typ
- High Current Drive Capability
(10V_{RMS} into 600Ω @ V_S = ±18V)
- High Slew Rate 13V/μs Typ
- Wide Power Bandwidth 200kHz Typ
- High Open-Loop Gain 200V/mV Typ
- Extended Industrial
Temperature Range -40°C to +85°C
- Direct Replacement for Industry Standard 5534AN

GENERAL DESCRIPTION

The SSM-2134 is a high performance low noise operational amplifier which offers exceptionally low voltage noise of 3.5nV/√Hz, outstanding output drive capability, and very high small-signal and power bandwidth. This makes the SSM-2134 an ideal choice for use in high quality and professional audio equipment, instrumentation, and control circuits.

The SSM-2134 is internally compensated for A_v ≥ 3. However, the frequency response can be optimized with an external compensation capacitor to enable the SSM-2134 to operate at unity-gain or drive large capacitive loads.

The SSM-2134 is offered in an 8-pin plastic DIP and its performance and characteristics are guaranteed over the extended industrial temperature range of -40°C to +85°C.

APPLICATIONS

- High Quality Audio Amplifiers
- Telephone Channel Amplifiers
- Active Filter Designs
- Microphone Preamplifiers
- Audio Line Drivers
- Low-Level Signal Detection
- Servo Control Systems

PIN CONNECTIONS

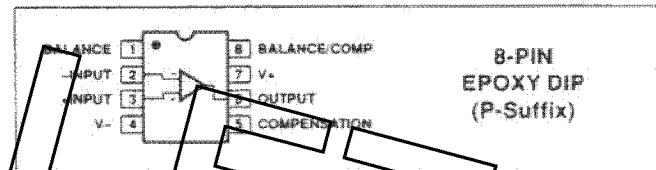

SIMPLIFIED SCHEMATIC

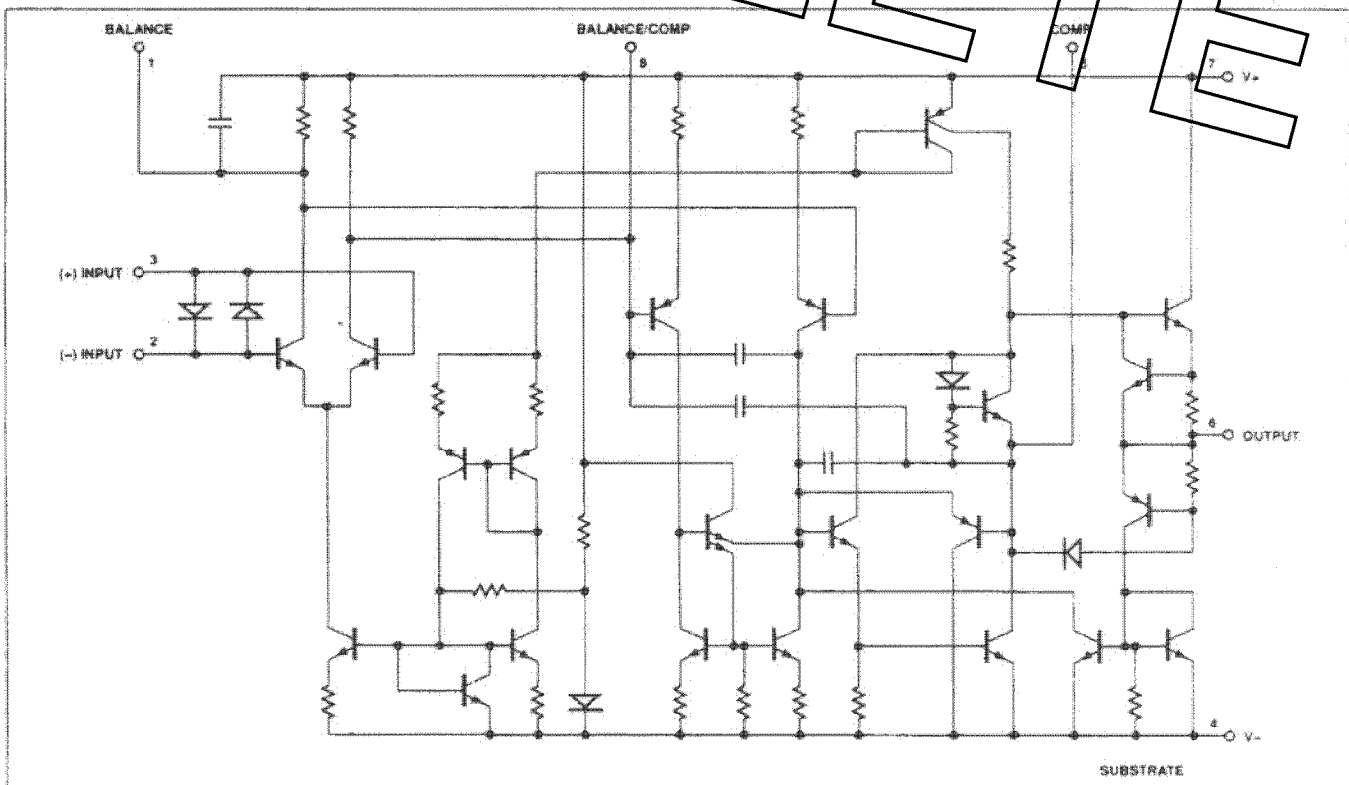

SSM-2134

ORDERING INFORMATION

PACKAGE	OPERATING TEMPERATURE RANGE
SSM2134P 8-Pin Plastic	-40°C to +85°C

ABSOLUTE MAXIMUM RATINGS

Supply Voltage	±22V
Differential Input Voltage (Note 1)	±0.5V
Input Voltage (Note 2)	±22V

Power Dissipation	300mW
Derate Above +24°C	2.5mW/°C
Short-Circuit Duration (Note 3)	Indefinite
Operating Temperature Range	-40°C to +85°C
Storage Temperature	-60°C to +150°C

NOTES:

- The SSM-2134's inputs are protected by diodes. Current limiting resistors are not used in order to achieve low noise. If differential input voltage exceeds ±0.5V, the input current should be limited to 10mA.
- For supply voltages less than ±22V, the absolute maximum input voltage is equal to the supply voltage.
- Output may be shorted to ground at $V_S = \pm 15V$, $T_A = +25^\circ C$. Temperature and/or supply voltages must be limited to ensure dissipation rating is not exceeded.

ELECTRICAL CHARACTERISTICS at $V_S = \pm 15V$ and $T_A = +25^\circ C$, unless otherwise noted.

PARAMETER	SYMBOL	CONDITIONS	SSM-2134P			UNITS
			MIN	TYP	MAX	
Input Offset Voltage	V_{OS}	$-40^\circ C \leq T_A \leq +85^\circ C$	-	0.3 0.4	2 3	mV
Input Offset Current	I_{OS}	$-40^\circ C \leq T_A \leq +85^\circ C$	-	15 25	300 400	nA
Input Bias Current	I_B	$-40^\circ C \leq T_A \leq +85^\circ C$	-	350 500	1500 2000	nA
Large Signal Voltage Gain	A_{VO}	$R_L \geq 600\Omega$, $V_O = \pm 10V$	25	200	-	V/mV
		$R_L \geq 600\Omega$, $V_O = \pm 10V$, $-40^\circ C \leq T_A \leq +85^\circ C$	±5	150	-	
Supply Current	I_{SY}	No Load	-	4.5	6.5	mA
Output Voltage Swing	V_O	$V_S = \pm 15V$, $R_L \geq 600\Omega$ $V_S = \pm 18V$, $R_L \geq 600\Omega$	±12 ±15	±14 ±16	-	V
Output Short-Circuit Current	I_{SC}	(Note 1)	-	65	-	mA
Input Resistance-Differential-Mode	R_{IN}	(Note 2)	30	100	-	Ω
Input Voltage Range	IVR		±12	±13	-	V
Common-Mode Rejection	CMR	$V_{CM} = \pm 12V$	70	114	-	dB
Power Supply Rejection Ratio	PSRR		-	6	100	μV/V
Rise Time	t_r	$R_L \geq 600\Omega$, $C_C = 22pF$	-	20	-	ns
Overshoot	OS	$C_L = 100pF$	-	20	-	%
AC Gain		$C_C = 0$, $f_O = 10kHz$	-	6	-	V/mV
		$C_C = 22pF$, $f_O = 10kHz$	-	2.2	-	
Unity-Gain Bandwidth	GBW	$C_C = 22pF$, $C_L = 100 pF$	-	10	-	MHz
Slew Rate	SR	$C_C = 0$	-	13	-	V/μs
		$C_C = 22pF$	-	6	-	
Full Power Bandwidth	BW_p	$V_O = \pm 10V$, $C_C = 22pF$	-	95	-	kHz
		$C_C = 0$	-	200	-	
Input Noise Voltage Density	e_n	$f_O = 30Hz$	-	5.5	7.0	nV/√Hz
		$f_O = 1kHz$	-	3.5	4.5	
Input Noise Current Density	i_n	$f_O = 30Hz$	-	2.5	-	pA/√Hz
		$f_O = 1kHz$	-	0.6	-	
Broadband Noise Figure	F_N	$R_S = 5k\Omega$, $f = 10Hz$ to $20kHz$	-	0.7	-	dB
Total Harmonic Distortion	THD	$V_{IN} = 3V_{RMS}$, $A_V = +1000$, $R_L = 2k\Omega$	-	0.025	-	%

NOTES:

- Output may be shorted to ground at $V_S = \pm 15V$, $T_A = +25^\circ C$. Temperature and/or supply voltages must be limited to ensure dissipation rating is not exceeded.
- Guaranteed by design.

Specifications subject to change. Consult latest data sheet.

TYPICAL PERFORMANCE CHARACTERISTICS *Continued*

CURRENT NOISE DENSITY vs FREQUENCY

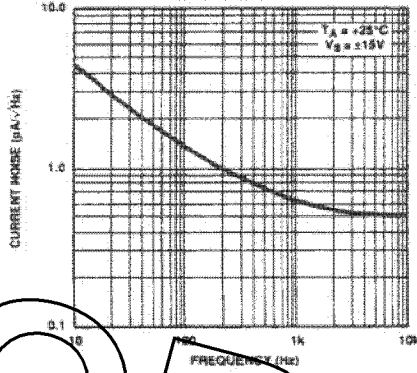

VOLTAGE NOISE DENSITY vs FREQUENCY

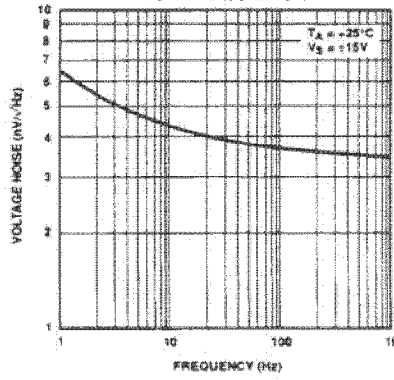

BROADBAND INPUT NOISE VOLTAGE

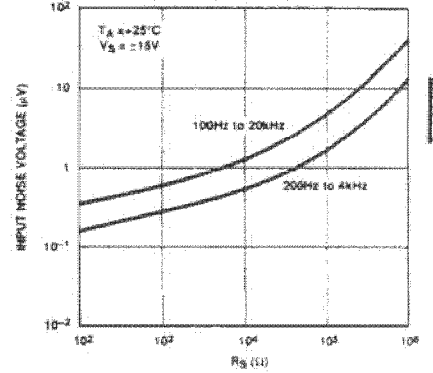

TOTAL INPUT NOISE DENSITY

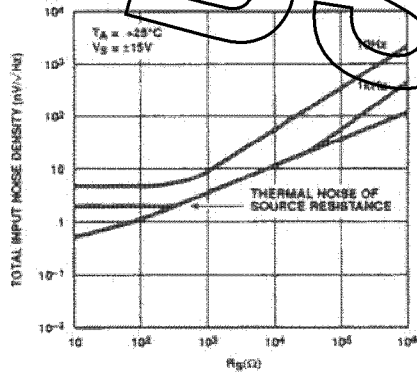

OPEN-LOOP GAIN vs FREQUENCY

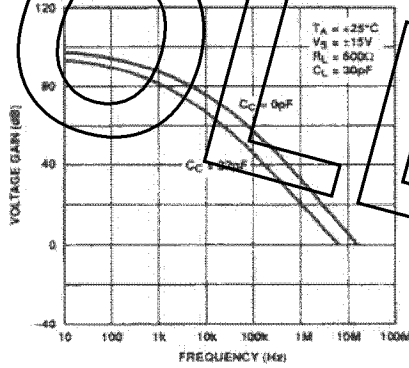

CLOSED-LOOP GAIN vs FREQUENCY

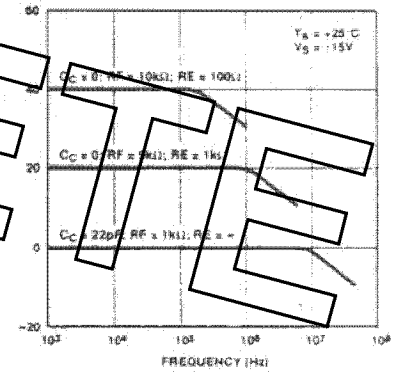

OUTPUT VOLTAGE SWING vs FREQUENCY

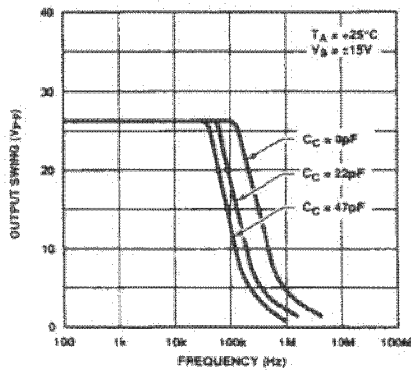

CMR vs FREQUENCY

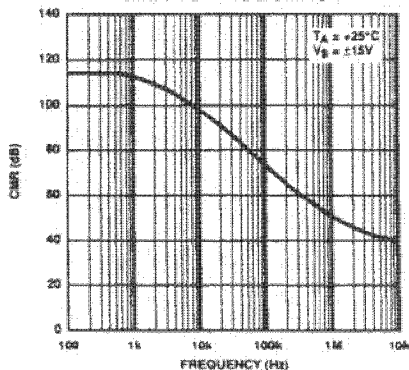

PSR vs FREQUENCY

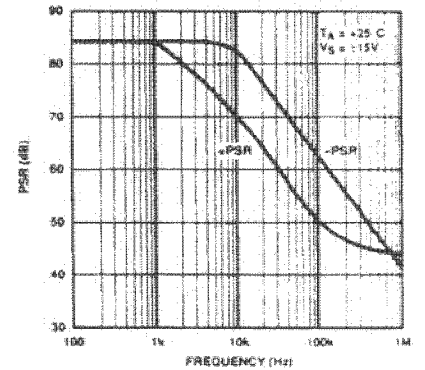

OBSOLETE

SLEW RATE vs
COMPENSATION CAPACITOR

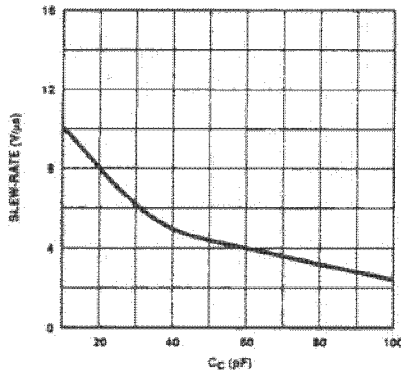

TOTAL HARMONIC DISTORTION vs FREQUENCY

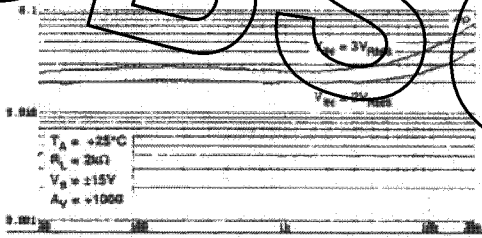

TOTAL HARMONIC DISTORTION vs FREQUENCY

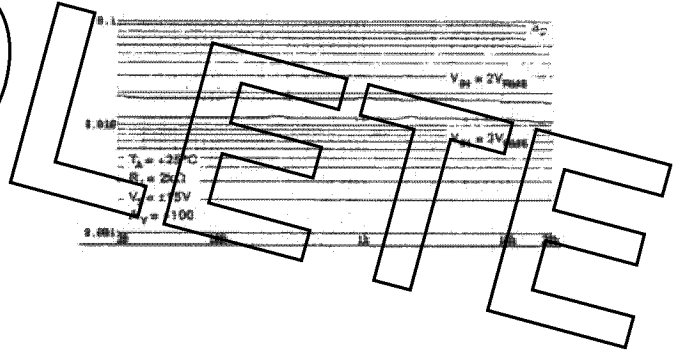

TOTAL HARMONIC DISTORTION vs FREQUENCY

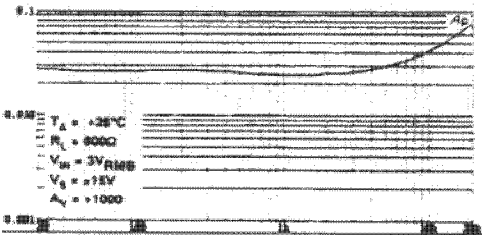

TOTAL HARMONIC DISTORTION vs FREQUENCY

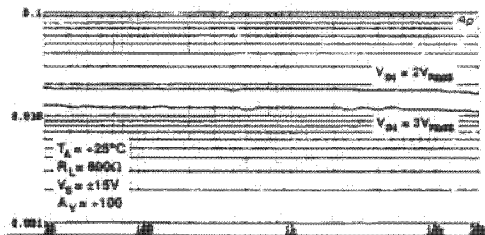

TYPICAL PERFORMANCE CHARACTERISTICS *Continued*

OUTPUT VOLTAGE SWING vs LOAD RESISTANCE

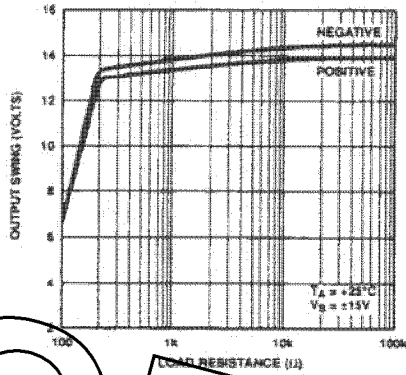

INPUT COMMON-MODE VOLTAGE vs SUPPLY VOLTAGE

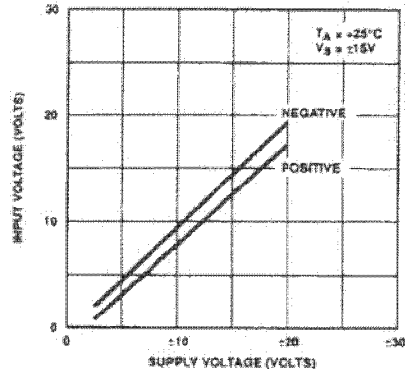

SUPPLY CURRENT vs SUPPLY VOLTAGE

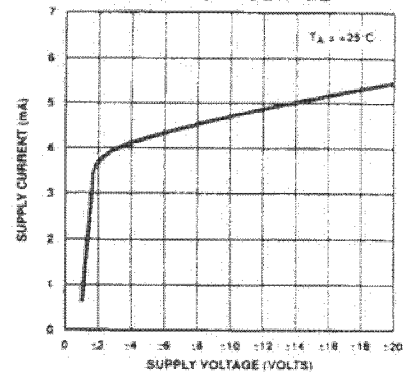

INPUT OFFSET VOLTAGE vs TEMPERATURE

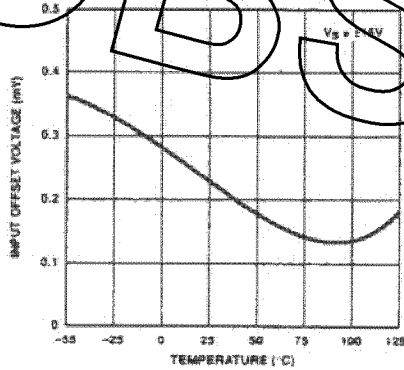

INPUT BIAS CURRENT vs TEMPERATURE

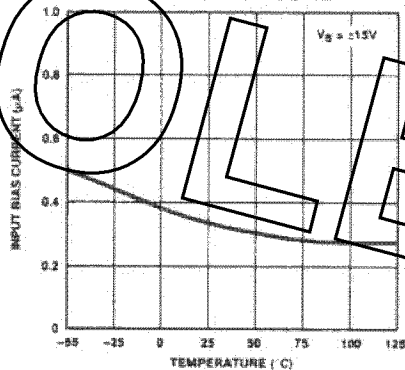

CMR vs TEMPERATURE

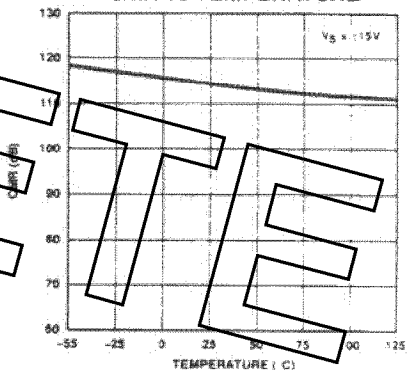

PSR vs TEMPERATURE

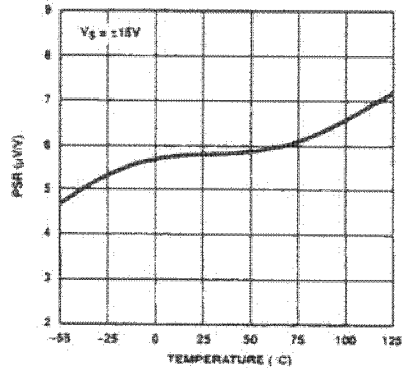

SUPPLY CURRENT vs TEMPERATURE

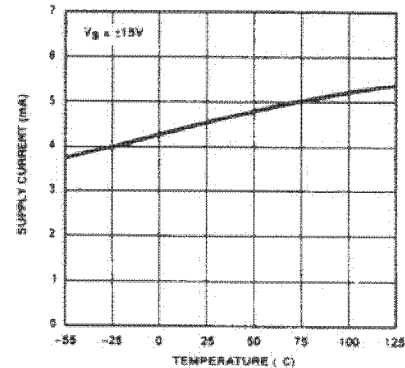

SHORT-CIRCUIT CURRENT vs TEMPERATURE

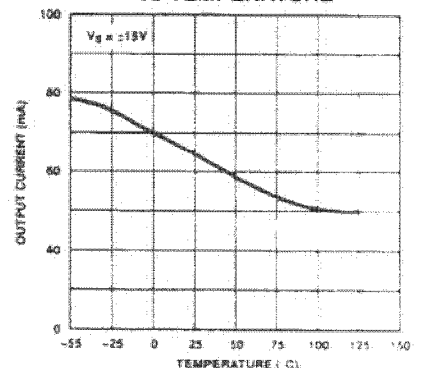

OBSOLETE

SSM-2134

APPLICATIONS INFORMATION

PREAMPLIFIER-RIAA/NAB COMPENSATION

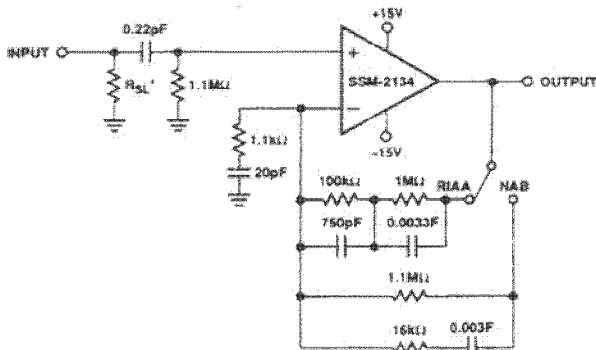

*SELECT TO PROVIDE SPECIFIED TRANSDUCER LOADING
OUTPUT NOISE 0.8mV_{RMS} (WITH INPUT SHORTED)

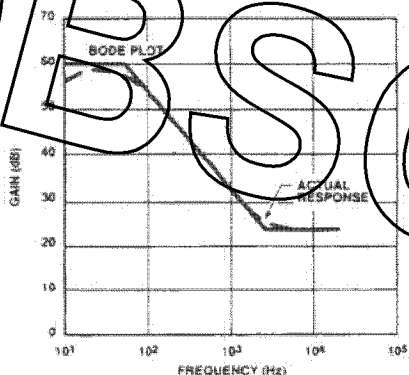

BODE PLOT OF RIAA EQUALIZATION AND THE RESPONSE REALIZED IN AN ACTUAL CIRCUIT USING THE SSM-2134

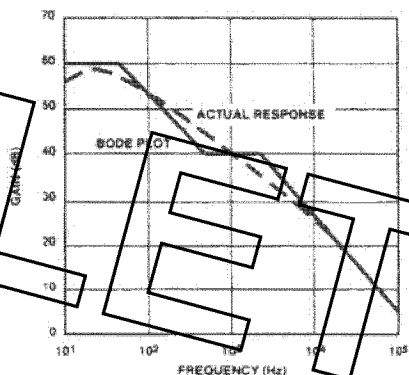

BODE PLOT OF NAB EQUALIZATION AND THE RESPONSE REALIZED IN THE ACTUAL CIRCUIT USING THE SSM-2134

TEST CIRCUIT

FREQUENCY COMPENSATION AND OFFSET VOLTAGE ADJUSTMENT CIRCUIT

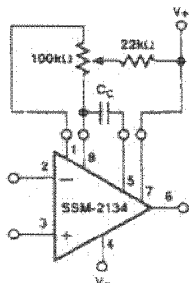

CLOSED-LOOP FREQUENCY RESPONSE

