

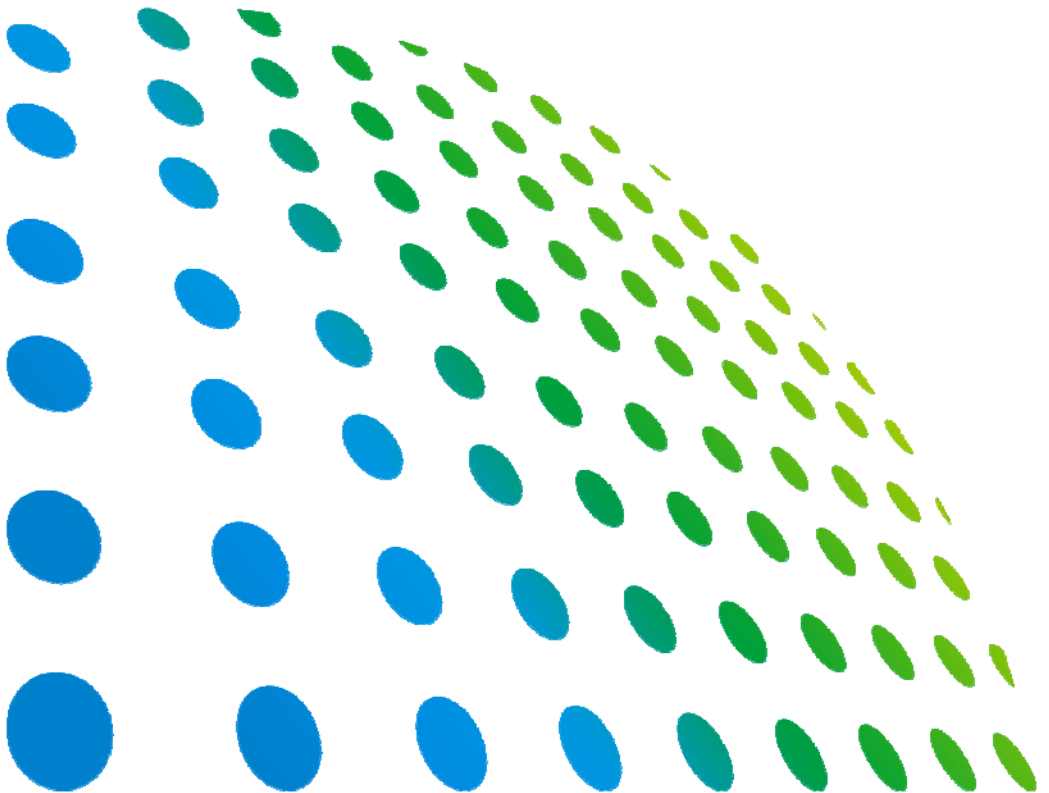

High Power DC Electronic Load

63200 Series

Quick Start Guide



High Power DC Electronic Load 63200 Series Quick Start Guide



Version 1.2
June 2013
P/N A11 001362

Legal Notices

The information in this document is subject to change without notice.

Chroma ATE INC. makes no warranty of any kind with regard to this manual, including, but not limited to, the implied warranties of merchantability and fitness for a particular purpose. Chroma ATE INC. shall not be held liable for errors contained herein or direct, indirect, special, incidental or consequential damages in connection with the furnishing, performance, or use of this material.

CHROMA ATE INC.

66 Hwaya 1st Rd., Kueishan Hwaya Technology Park, Taoyuan County 33383, Taiwan

Copyright Notices. Copyright 2012 Chroma ATE INC., all rights reserved. Reproduction, adaptation, or translation of this document without prior written permission is prohibited, except as allowed under the copyright laws.

Warranty

All of Chroma's instruments are warranted against defects in material and workmanship for a period of one year from date of shipment. Chroma agrees to repair or replace any assembly or component found to be defective, under normal use during this period. Chroma's obligation under this warranty is limited solely to repairing any such instrument, which in Chroma's sole opinion proves to be defective within the scope of the warranty when returned to the factory or to an authorized service center. Purchaser is responsible for the shipping and cost of the service item to Chroma factory or service center. Shipment should not be made without prior authorization by Chroma.

This warranty does not apply to any products repaired or altered by persons not authorized by Chroma, or not in accordance with instructions furnished by Chroma. If the instrument is defective as a result of misuse, improper repair, or abnormal conditions or operations, repairs will be billed at cost.

Chroma assumes no responsibility for its product being used in a hazardous or dangerous manner either alone or in conjunction with other equipment. High voltage used in some instruments may be dangerous if misused. Special disclaimers apply to these instruments. Chroma assumes no liability for secondary charges or consequential damages and in any event, Chroma's liability for breach of warranty under any contract or otherwise, shall not exceed the purchase price of the specific instrument shipped and against which a claim is made.

Any recommendations made by Chroma regarding the use of its products are based upon tests believed to be reliable; Chroma makes no warranty of the results to be obtained. This warranty is in lieu of all other warranties, expressed or implied, and no representative or person is authorized to represent or assume for Chroma any liability in connection with the sale of our products other than set forth herein.

CHROMA ATE INC.

66 Hwaya 1st Rd., Kueishan Hwaya Technology Park,
Taoyuan County 33383, Taiwan

Tel: 886-3-327-9999

Fax: 886-3-327-2886

e-mail: info@chromaate.com

www: <http://www.chromaate.com/>

Material Contents Declaration

The recycling label shown on the product indicates the Hazardous Substances contained in the product as the table listed below.



: See <Table 1>.



: See <Table 2>.

<Table 1>

Part Name	Hazardous Substances					
	Lead	Mercury	Cadmium	Hexavalent Chromium	Polybrominated Biphenyls	Polybromodiphenyl Ethers
	Pb	Hg	Cd	Cr ⁶⁺	PBB	PBDE
PCBA	O	O	O	O	O	O
CHASSIS	O	O	O	O	O	O
ACCESSORY	O	O	O	O	O	O
PACKAGE	O	O	O	O	O	O

“O” indicates that the level of the specified chemical substance is less than the threshold level specified in the standards of SJ/T-11363-2006 and EU 2005/618/EC.

“x” indicates that the level of the specified chemical substance exceeds the threshold level specified in the standards of SJ/T-11363-2006 and EU 2005/618/EC.

Disposal

Do not dispose of electrical appliances as unsorted municipal waste, use separate collection facilities. Contact your local government for information regarding the collection systems available. If electrical appliances are disposed of in landfills or dumps, hazardous substances can leak into the groundwater and get into the food chain, damaging your health and well-being. When replacing old appliances with new one, the retailer is legally obligated to take back your old appliances for disposal at least for free of charge.



<Table 2>

Part Name	Hazardous Substances					
	Lead	Mercury	Cadmium	Hexavalent Chromium	Polybrominated Biphenyls	Polybromodiphenyl Ethers
	Pb	Hg	Cd	Cr ⁶⁺	PBB	PBDE
PCBA	×	○	○	○	○	○
CHASSIS	×	○	○	○	○	○
ACCESSORY	×	○	○	○	○	○
PACKAGE	○	○	○	○	○	○

“○” indicates that the level of the specified chemical substance is less than the threshold level specified in the standards of SJ/T-11363-2006 and EU 2005/618/EC.

“×” indicates that the level of the specified chemical substance exceeds the threshold level specified in the standards of SJ/T-11363-2006 and EU 2005/618/EC.

1. Chroma is not fully transitioned to lead-free solder assembly at this moment; however, most of the components used are RoHS compliant.
2. The environment-friendly usage period of the product is assumed under the operating environment specified in each product's specification.

Disposal

Do not dispose of electrical appliances as unsorted municipal waste, use separate collection facilities. Contact your local government for information regarding the collection systems available. If electrical appliances are disposed of in landfills or dumps, hazardous substances can leak into the groundwater and get into the food chain, damaging your health and well-being. When replacing old appliances with new one, the retailer is legally obligated to take back your old appliances for disposal at least for free of charge.





Declaration of Conformity

For the following equipment :

DC Electronic Load

(Product Name/ Trade Name)

63201~ 63210

(Model Designation)

CHROMA ATE INC.

(Manufacturer Name)

66, Hwaya 1st Rd., Kueishan Hwaya Technology Park, Taoyuan County 33383, Taiwan

(Manufacturer Address)

Is herewith confirmed to comply with the requirements set out in the Council Directive on the Approximation of the Laws of the Member States relating to Electromagnetic Compatibility (2004/108/EC) and Low Voltage Directive (2006/95/EC). For the evaluation regarding the Directives, the following standards were applied :

EN 61326-1:2006 Class A

EN 61326-1:2006 (Industrial Locations)

EN 61000-4-2:2009, EN 61000-4-3:2006+A1:2008+A2:2010,

EN 61000-4-4:2004+A1:2010, EN 61000-4-5:2006, EN 61000-4-6:2009,

EN 61000-4-8:2010, EN 61000-4-11:2004

EN 61010-1:2010 (Third Edition)

The following importer/manufacturer or authorized representative established within the EUT is responsible for this declaration :

CHROMA ATE INC.

(Company Name)

66, Hwaya 1st Rd., Kueishan Hwaya Technology Park, Taoyuan County 33383, Taiwan

(Company Address)

Person responsible for this declaration:

Mr. Benjamin Huang

(Name, Surname)

Division Vice President

(Position/Title)

Taiwan

2013.05.15

(Place)

(Date)

Benjamin Huang
(Legal Signature)



Declaration of Conformity

For the following equipment :

DC Electronic Load

(Product Name/ Trade Name)

63211

(Model Designation)

CHROMA ATE INC.

(Manufacturer Name)

66, Hwaya 1st Rd., Kueishan Hwaya Technology Park, Taoyuan County 33383, Taiwan

(Manufacturer Address)

Is herewith confirmed to comply with the requirements set out in the Council Directive on the Approximation of the Laws of the Member States relating to Electromagnetic Compatibility (2004/108/EC) and Low Voltage Directive (2006/95/EC). For the evaluation regarding the Directives, the following standards were applied :

EN 61326-1:2006 Class A

EN 61000-3-2:2006+A1:2009+A2:2009, EN 61000-3-3:2008

EN 61326-1:2006 (Industrial Locations)

EN 61000-4-2:2009, EN 61000-4-3:2006+A1:2008+A2:2010, EN 61000-4-4:2004+A1:2010

EN 61000-4-5:2006, EN 61000-4-6:2009, EN 61000-4-8:2010, EN 61000-4-11:2004

EN 61010-1:2010(Third Edition) and EN 61010-2-030:2010(First Edition)

The following importer/manufacturer or authorized representative established within the EUT is responsible for this declaration :

CHROMA ATE INC.

(Company Name)

66, Hwaya 1st Rd., Kueishan Hwaya Technology Park, Taoyuan County 33383, Taiwan

(Company Address)

Person responsible for this declaration:

Mr. Benjamin Huang

(Name, Surname)

Division Vice President

(Position/Title)

Taiwan

2013.05.15

(Place)

(Date)

Benjamin Huang
(Legal Signature)

Safety Summary

The following general safety precautions must be observed during all phases of operation, service, and repair of this instrument. Failure to comply with these precautions or specific WARNINGS given elsewhere in this manual will violate safety standards of design, manufacture, and intended use of the instrument. *Chroma* assumes no liability for the customer's failure to comply with these requirements.



BEFORE APPLYING POWER

Verify that the power is set to match the rated input of this power supply.



PROTECTIVE GROUNDING

Make sure to connect the protective grounding to prevent an electric shock before turning on the power.



NECESSITY OF PROTECTIVE GROUNDING

Never cut off the internal or external protective grounding wire, or disconnect the wiring of protective grounding terminal. Doing so will cause a potential shock hazard that may bring injury to a person.



FUSES

Only fuses with the required rated current, voltage, and specified type (normal blow, time delay, etc.) should be used. Do not use repaired fuses or short-circuited fuse holders. To do so could cause a shock or fire hazard.



DO NOT OPERATE IN AN EXPLOSIVE ATMOSPHERE

Do not operate the instrument in the presence of flammable gases or fumes.



DO NOT REMOVE THE COVER OF THE INSTRUMENT

Operating personnel must not remove the cover of the instrument. Component replacement and internal adjustment can be done only by qualified service personnel.

Safety Symbols



DANGER – High voltage.



Explanation: To avoid injury, death of personnel, or damage to the instrument, the operator must refer to an explanation in the instruction manual.



High temperature: This symbol indicates the temperature is now higher than the acceptable range of human. Do not touch it to avoid any personal injury.



Protective grounding terminal: To protect against electrical shock in case of a fault. This symbol indicates that the terminal must be connected to ground before operation of equipment.



The **WARNING** sign denotes a hazard. It calls attention to a procedure, practice, or the like, which, if not correctly performed or adhered to, could result in personal injury. Do not proceed beyond a **WARNING** sign until the indicated conditions are fully understood and met.



The **CAUTION** sign denotes a hazard. It may result in personal injury or death if not noticed timely. It calls attention to procedures, practices and conditions.



The **Notice** sign denotes important information in procedures, applications or the areas that require special attention. Be sure to read it carefully.

Precautions before Use

1. The Electronic Load is for indoor use only.
2. The altitude up to 2000 meters is allowed to use the Electronic Load.
3. All specifications are tested under 20°C ~ 30°C except stated otherwise.
4. The range of operating temperature is 0°C ~ 40°C.
5. The range of storage temperature is -5°C ~ 60°C.
6. The operating relative humidity is from 30% to 90%.
7. The storage relative humidity is from 10% to 95%.
8. The transient overvoltage at Mains supply is 250V.
9. To meet the safety requirements, load wires must be thick enough not to overheat while carrying the short-circuit output current of the device connected to the electronic load.
10. The load module can be damaged by electronic discharge (static electricity). Use standard anti-static work practices when handling and installing the modules. Avoid touching the connectors and the circuit board.
11. Ensure the load always receives adequate ambient cooling air at all times and air filters, ducts, etc are maintained regularly. If loads are used with a cabinet, precautions should be taken to minimize heating within the cabinet.
12. If the UUT may be damaged or an unsafe condition may occur in the event of a load short circuit (e.g. certain types of batteries), or if there is no means of de-energizing the UUT in the event of a load failure, user may consider including a suitably rated circuit breaker, fuse or other means of disconnecting the load from the UUT under emergency conditions.
13. When using Model 63208, 63209, 63210 and 63211 the distance should be 1 meter for chassis front and 2.5 meters for rear without any foreign object blocking the vents or the hardware temperature may rise and cause OTP.
14. The electronic load can operate with a 115/230 Vac input as indicated on the left of the Electronic Load. The 100/200 Vac line voltage input model is used in Japan only. If the factory set switch on this label that does not correspond to the local nominal line voltage, turn off the Mainframe power and disconnect the power cord.
15. When connecting the load cable to the load module, do not use a load cable to connect a load module and short circuit other load modules, or it may cause the load cable to burn out when loading larger current.
16. This equipment is not intended for performing measurements on

CAT I, II, III or IV.

- * CAT IV – is for measurements performed at the source of the low-voltage installation.
- * CAT III – is for measurements performed in the building installation.
- * CAT II – is for measurements performed on circuits directly connected to the low-voltage installation.
- * CAT I – is for measurements performed on circuits directly connected to mains.

Table of Contents

1.	Key Features	1
2.	Installation	4
2.1	Inspection	4
2.2	Installing	6
2.2.1	Changing Line Voltage.....	6
2.2.2	Turn-On Self-Test	7
2.3	Application Connection	8
2.3.1	Load Connections	8
2.3.2	Remote Sensing Connections	9
2.3.3	Parallel Connections	10
2.3.4	RS-485 Parallel Connection Diagram.....	11
2.3.5	Parallel Setting	12
2.4	Remote Control Connection.....	16
3.	Panel Description.....	17
3.1	Front Panel Description.....	17
3.1.1	Selecting the Operation Mode	20
3.2	Rear Panel Description	21
3.3	Local/Remote Control	26

1. Key Features

- Local operation on front panel keypad.
- Remote control via GPIB, RS-232C interface or remote controller (optional).
- Photo-couple isolation supplies true floating Load.
- Automatic fan speed control to reduce audio noise.
- Constant current (CC), constant resistance (CR), constant voltage (CV) and constant power (CP) operation modes.
- Programmable slew rate, load level, load period and conduct voltage (Von).
- Programmable dynamic loading with speed up to 20kHz.
- Minimum input resistance allows load to sink high current even with low input voltage.
- Selective voltage and current ranges.
- Remote sensing capability.
- 100 sets of memories to save/recall user-definable setups.
- 10 sets of programs to link files for automatic test.
- 15-bit A/D converter with precision measurement.
- Short circuit simulation.
- Automatic GO/NG inspection to confirm UUT within spec.
- Isolated voltage and current monitoring waveforms output.
- Isolated external Vdc reference input to control the load current.

Rack mount note for model 63207:

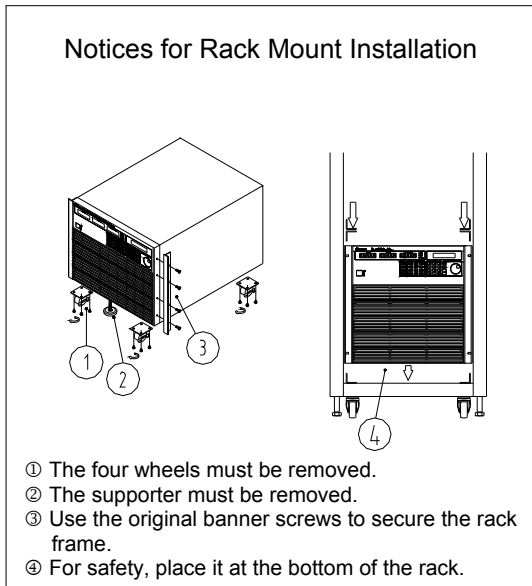

Installing the 63200 Protective Cover:

- Step 1: Insert the cable into protective cover.
- Step 2: Socket the Bakelite into the positive/negative copper plate until it touches the chassis and then secure the M6x20L screw and M6 screw nut to block the Bakelite.
- Step 3: Place a washer on the M6x20L screw and let it go through the positive/negative copper plate. Connect the two cables with an insulator to secure the cables on the positive/negative copper plate.
- Step 4: Cover the positive/negative copper plate with protective cover on the rear panel.
- Step 5: Use the attached M6x10L screw to secure the protective cover.
- Step 6: Complete installation.

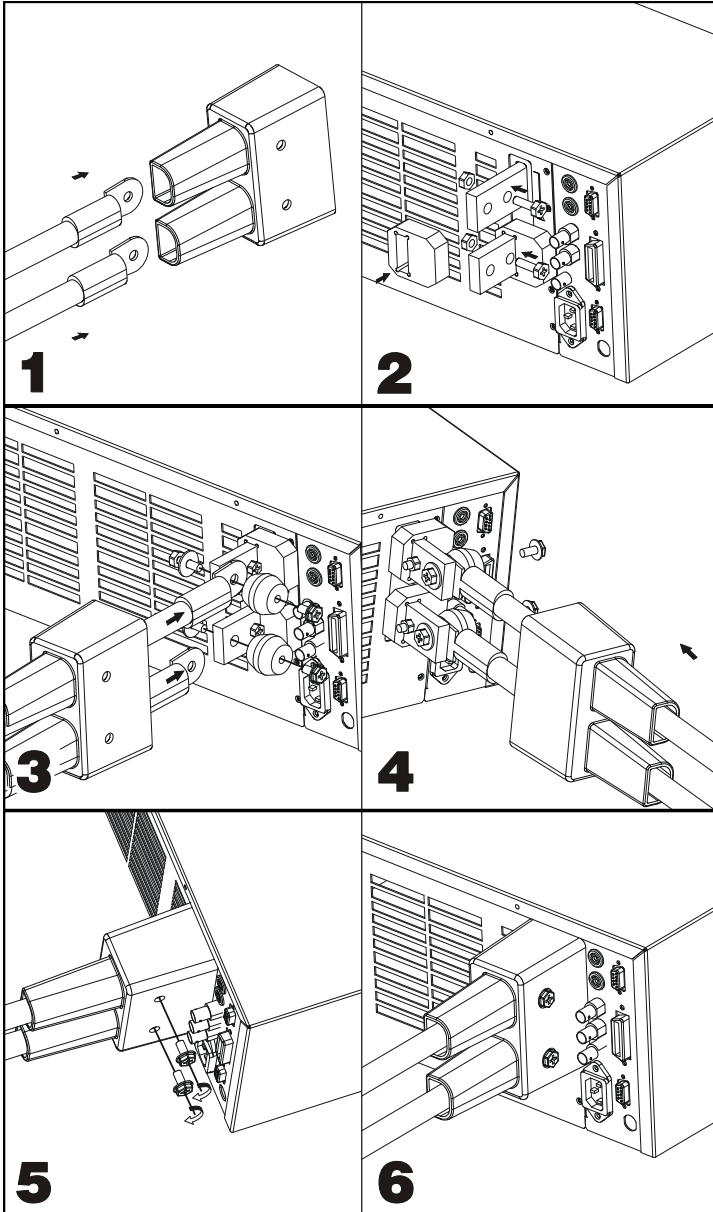

2. Installation













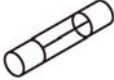

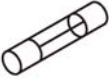



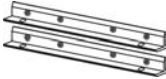

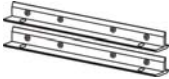



2.1 Inspection



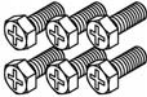

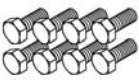
As soon as the instrument is unpacked, inspect any damage that might have occurred in shipping. Keep all packing materials in case that the instrument has to be returned. If any damage is found, please file a claim to the carrier immediately. Do not return the instrument to Chroma without prior approval.

Please ensure the following items are received correctly.

Item	Name	Quantity for Each Model										
		63201	63202	63203	63204	63205	63206	63207	63208	63209	63210	63211
1	Quick Start Guide Chinese version	1	1	1	1	1	1	1	1	1	1	1
2	Quick Start Guide English version	1	1	1	1	1	1	1	1	1	1	1
3	Fuse (2A/250V)	1	1	-	-	-	-	-	-	-	-	-
4	Fuse (2.5A/250V)	-	-	1	1	1	-	-	1	1	1	-
5	Fuse (3.15A/250V)	-	-	-	-	-	1	1	-	-	-	-
6	User's Manual CD	1	1	1	1	1	1	1	1	1	1	1
7	Installing kit for Rack	-	-	2	2	-	-	-	-	-	-	-
8	Handlebar	2	2	-	-	-	-	-	-	-	-	-
9	Installing kit for Rack	2	2	-	-	-	-	-	-	-	-	-
10	Installing kit for Rack	-	-	-	-	-	2	2	-	-	-	-
11	Installing kit for Rack	-	-	-	-	2	-	-	-	-	-	-
12	Insulating rubber cover	1	1	1	1	1	1	1	-	-	-	-
13	Insulated bakelite	2	2	2	2	2	2	2	-	-	-	-
14	Insulator	2	2	2	2	2	2	2	-	-	-	-
15	Wrench	-	-	-	-	-	-	-	1	1	1	1
16	Sleeve wrench	-	-	-	-	-	-	-	1	1	1	1
17	Screw M4x10L	4	4	-	-	-	8	8	-	-	-	-
18	Screw M6x10L	2	2	2	2	2	2	2	-	-	-	-
19	Screw M6x20L	6	6	6	6	6	6	6	-	-	-	-
20	Screw M6x25	4	4	4	4	4	4	4	-	-	-	-
21	Screw M8x20L	-	-	-	-	-	-	-	8	8	8	8
22	Hexagonal Nut M6	4	4	4	4	4	4	4	-	-	-	-
23	Hexagonal Nut M8	-	-	-	-	-	-	-	8	8	8	8
24	Washer	4	4	4	4	8	8	8	-	-	-	-
25	RS485 Cable	1	1	1	1	1	1	1	1	1	1	1
26	Test Wire	1	1	1	1	1	1	1	1	1	1	1
27	Power Cord 110V	1	1	1	1	1	1	1	1	1	1	1
28	Fuse (5A/250V)	-	-	-	-	-	-	-	-	-	-	1

High Power DC Electronic Load 63200 Series Quick Start Guide

Standard Accessories				
Item	1	2	3	4
				
Name	Quick Start Guide Chinese Version	Quick Start Guide English Version	Fuse (2A/250V)	Fuse (2.5A/250V)
Item	5	6	7	8
				
Name	Fuse (3.15A/250V)	User's Manual CD	Installing kit for Rack	Handlebar
Item	9	10	11	12
				
Name	Installing kit for Rack	Installing kit for Rack	Installing kit for Rack	Insulating rubber cover
Item	13	14	15	16
				
Name	Insulated bakelite	Insulator	wrench	Sleeve wrench
Item	17	18	19	20
				
Name	Screw M4x10L	Screw M6x10L	Screw M6x20L	Screw M6x25
Item	21	22	23	24
				
Name	Screw M8x20L	Hexagonal Nut M6	Hexagonal Nut M8	Washer

Item	25	26	27	28
				
Name	RS232 CABLE	Test wire	Power Cable 110V	Fuse (5A/250V)

2.2 Installing

The Electric Loads can operate well within the temperature range from 0 °C to 40 °C. However, the Electric Load must be installed in an area with enough space around the unit for adequate air flowing through and escaping from the back.

2.2.1 Changing Line Voltage

The Electronic Load can operate with a 115/230 Vac input as indicated on the left hand side of the unit (facing the unit). If the factory set voltage does not correspond to your nominal line voltage, set the switch to the correct line voltage as shown in Figure 2-1 before plugging in the power cord and turning on the power.

⚡ CAUTION Line fuses do not need to be changed when the line voltage is changed. The line fuses will protect the Electronic Load for incorrect voltage setting.

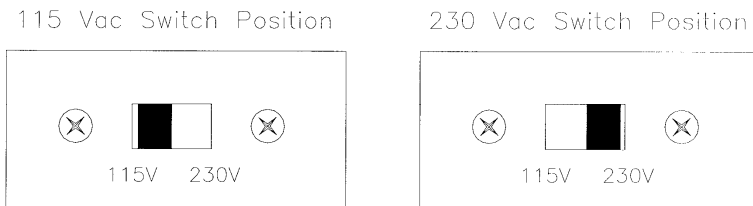



Figure 2-1 Line Voltage Switch

2.2.2 Turn-On Self-Test

Check the following before turning on the Load.

1. The unit has been set to the correct line voltage by factory. Refer to the line voltage indicated on the left hand side of the panel.
2. The power cord is connected to the AC input socket.

 **CAUTION** ■ The power supplies a chassis ground through a third connector. Be sure that your outlet is of three-conductor type with the correct pin connected to ground.

Turn on the Load by the power switch on the front panel and observe the display. Immediately after turning on, the Electronic Load executes a self-test to check the RS-232C, GPIB interface board and the system.

The LCD displays:

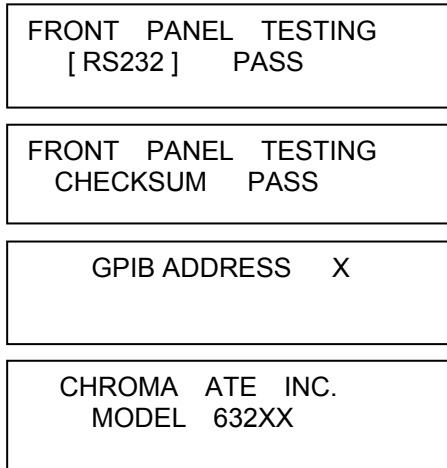

and then it goes to the output mode setting display.

All of the 7-segment LEDs which display the measuring V, I, P (or R) will be activated when the self-test completes. If any error is found in self-test, the display will stop here.

In case of failure, return the Load to Chroma sales or service office for repair.

2.3 Application Connection

2.3.1 Load Connections

⚡ CAUTION To satisfy safety requirements, load wires must be heavy enough not to overheat while carrying the short-circuit output current of the device connected to the Electronic Load.

Input connections are made to the + and – terminal block on the rear of the Load. The major considerations in making input connections are the wire size, length and polarity. The minimum wire size required to avoid overheating may not be enough to maintain good regulation. The wires should be large enough to limit the voltage drop to less than 0.5V per lead. The wires should be as short as possible, and bundled or tied together to minimize inductance and noise. Connect the wire from the PLUS (+) terminal to the HIGH potential output terminal of the power supply (UUT). Connect the wire from the MINUS (–) terminal to the LOW potential output terminal of the power supply (UUT). Figure 2-2 illustrates the typical setup of the Load to the UUT. When using Model 63208, 63209, 63210 and 63211 the distance should be 1 meter for chassis front and 2.5 meters for rear without any foreign object blocking the vents or the hardware temperature may rise and cause OTP.

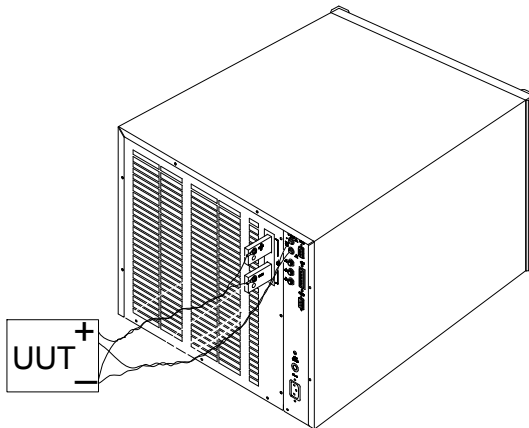

Figure 2-2 Load & Remote Sensing Connection

⚠ WARNING

In case the MOSFETs in the electronic load fail in the short circuit status, there is no internal means of interrupting the current that is flowing from the Unit Under Test (UUT). User should consider added external circuit elements for protection as described below. MOSFET failures are rare when instruments are used within their rated voltage/current/power and temperature ranges.

Recommended safety precautions:

Ensure wiring, external circuit elements, etc are sized to the maximum rating of the LOAD even if intended UUTs are smaller. This provides protection in the event that users inadvertently apply full rated voltage, current or power or larger UUTs are tested in the future.

User should take into account the power dissipated in the output cable under worse case conditions to ensure the wire the gauge and cooling is adequate.

Ensure the load always receives adequate ambient cooling air at all times and air filters, ducts, etc are maintained regularly. If loads are used with a cabinet, precautions should be taken to minimize heating within the cabinet.

If the UUT may be damaged or an unsafe condition may occur in the event of a load short circuit (e.g. certain types of batteries), or if there is no means of de-energizing the UUT in the event of a load failure, user may consider including a suitably rated circuit breaker, fuse or other means of disconnecting the load from the UUT under emergency conditions.

📌 Notice

If there are any questions regarding safe operation of the equipment or adding external protection circuits, please contact Chroma's service personnel.

2.3.2 Remote Sensing Connections

There are two sensing points for the Electronic Load. One is measurement at Load terminal, and another is measurement at Vsense. The Load will automatically switch to Vsense when Vsense terminals are connected to UUT, otherwise it will measure at Load terminals. Remote

sensing compensates for voltage drop in applications that require long lead lengths. It is useful when the load is operating in CV or CR mode, or when it needs precise measurement. Figure 2-2 also illustrates a typical setup for remote sensing operation.

 **CAUTION** ■ The potential of V-sense red connector must be higher than that of V-sense black connector.

2.3.3 Parallel Connections

The 63200 Series DC Electronic Load with same voltage specification can be paralleled to increase the loading power range. The Electronic Load can be paralleled for static and dynamic operation in CC mode; however, only static operation is available for CR, CV and CP modes.

The Loads is linked via RS-485 cable to RS485 port (see 2.3.4 RS-485 Parallel Connection Diagram). RS485 address represents the ID of each Load in the parallel group as the figure shown below. It enables the MASTER controller to connect to the Slave models correctly via the settings of RS485 ADDRESS and control the parallel load. There is only one Master in the parallel group, the rest are slaves. For 63200 Series, it can parallel up to 6 models and these Electronic Loads can be operated simultaneously via Master in static or dynamic mode.

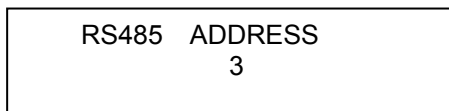

There are two operation modes in this parallel function:

The first is MASTER mode. The master gets the total setting commands from the remote control or front panel and then informs the slaves what setting current they should do according to their model. (The slave model has to be ready first.) So the only one needs to programmed is the master.

The second is MASTER SYNC mode. Each Load gets the current setting from its own remote control or front panel, the master controls the loads H/W synchronization action so that all loads can be operated with same action at the same time no matter in static or dynamic mode.

2.3.4 RS-485 Parallel Connection Diagram

2.3.4.1 Pin Assignment

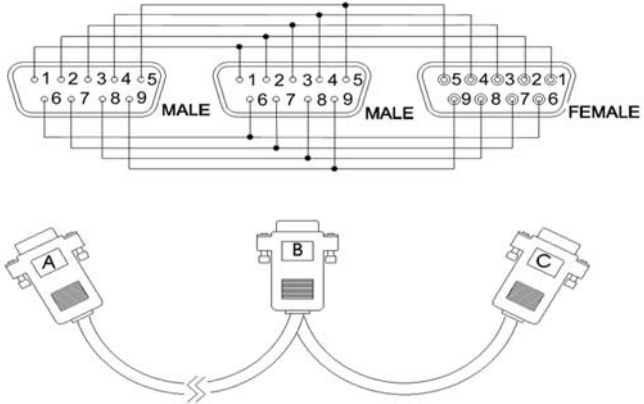

2.3.4.2 Master & Slave Connecting Diagram

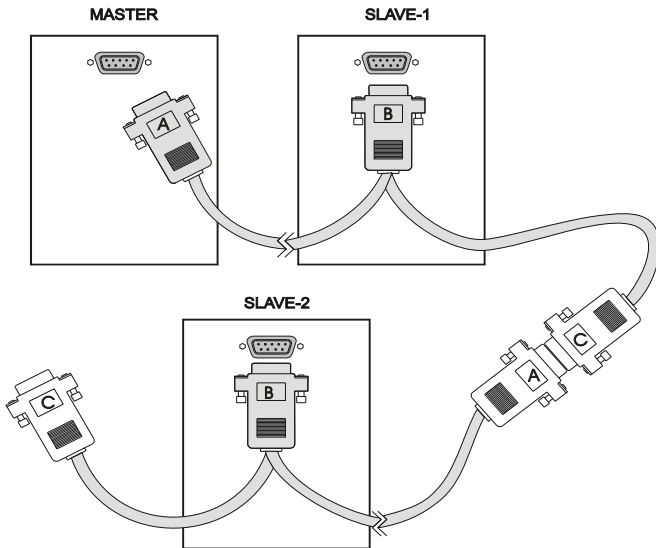

2.3.5 Parallel Setting

Power on the Electronic Load and it will start self test to check the system as well as the RS-232C and GPIB Interface. The LCD shows:

```
FRONT PANEL TESTING
[ RS232 ] PASS
```

```
FRONT PANEL TESTING
CHECKSUM PASS
```

```
GPIB ADDRESS X
```

```
CHROMA ATE INC.
MODEL 632XX
```

Next, it will show the CC mode settings.

```
CCHA:          0.0000A
CCHB:          0.0000A
```

Press **SYS** to set the RS485 address of Slave so that it can be followed when setting the attribute of Master.

First it will prompt the default GPIB address.

```
GPIB ADDRESS
X
```

Next, press **↓→** to RS485 ADDRESS setting mode. The setting of RS485 ADDRESS maps to the slave number, for instance if RS485 ADDRESS = 2, the slave number is SLAVE 2. Press **1**, **ENTER** to set the RS485 ADDRESS to 1.

RS485 ADDRESS
1

When the setting is done, it will show several RS-232 parameter setting modes

Press to skip these modes until PARALLEL setting mode appears.

(Note1):

PARALLEL = NONE
PRESS 0 → 3 TO SELECT

Set the Electronic Load to slave and press , .

PARALLEL = SLAVE
PRESS 0 → 3 TO SELECT

When the slave setting is done, it will prompt setting automatically as shown below:

SLAVE1 OFFLINE

Set the Master as follows:

Connect the A port of RS485 cable to the selected Master. The start screen is same as the CC mode settings.

CCHA: 0.0000A
CCHB: 0.0000A

Press to enter into system setting mode. Since the Master setting is not related to RS485 ADDRESS, press directly to go to PARALLEL setting screen.

PARALLEL = NONE
PRESS 0 → 3 TO SELECT

Press **1**, **ENTER** to select MASTER:

PARALLEL = MASTER
PRESS 0 → 3 TO SELECT

It goes to Measurement Display screen:

MEASUREMENT DISPLAY
1:SUM 2:SOLE

Select **1**, **ENTER**: SUM, the total current is set and displayed by MASTER. The current added to MASTER and SLAVE will divide evenly.

Select **2**, **ENTER**: It parallels the sole settings of each unit to show the added current.

When the above steps are done, it will go to Slave model selection screen:

SLAVE1 MODEL: NONE
PLS ROTATE TO SELECT

Switch the rotary knob on the panel following the slave no. (SLAVE1→6) until the screen shows the correct model.

SLAVE1 MODEL: 63202
PLS ROTATE TO SELECT

Press **↓→** or **↑←** to select other number to be paralleled for slave (SLAVE1→6) and repeat the above setting steps. If the number does not parallel to other slave, press **ENTER** to skip. NONE means does not exist. It ends when the setting is done. Select the mode to be tested can exit the screen to start testing.

Note 1 **PARALLEL:**

PARALLEL = NONE
PRESS 0 → 3 TO SELECT

Following are the selections of PARALLEL setting functions:

0: NONE: It disables the parallel mode function.

1: MASTER: It sets the Electronic Load as Master (main control unit.)

PARALLEL = MASTER
PRESS 0 → 3 TO SELECT

When setting the Electronic Load as the main control unit in the parallel group, only the front panel of Master or direct command from PC can control it. It not only can operate simultaneously but also can inform Slave the current for loading.

2: SLAVE: It sets the Electronic Load to Slave.

SLAVE1 OFFLINE

3: MASTER SYN: It performs parallel synchronization only. All Master, Slave loadings need to be inputted separately but the control movement and usage mode will be determined by the front panel on MASTER or PC input for synchronization.

PARALLEL = MST SYNC
PRESS 0 → 3 TO SELECT

 **Notice**

- The model 63201 to 63210 can be paralleled for use interactively, while the 63211 can only be paralleled with the same model.

2.4 Remote Control Connection

The remote operation of Load can be done through GPIB, RS-232C or remote controller. These connectors on the rear panel connect the Load to the controller or computer. The GPIB interface of the electronic load is standard. The remote controller is optional. The 63200 series Remote Controller can control the load via RS-232C port. Connect the Remote Controller to the Electronic Load before powering it on.

3. Panel Description

3.1 Front Panel Description

The front panel of the load includes a 20 × 2 characters LCD display, three segment LED, 9 led status indicators, and keypads. The LCD display will show which function is being performed when you use the keypads. One of the keys has two functions. Figure 3-2 shows the front panel of the loads.



Figure 3-1 Front Panel

To use the front panel keys to control the electronic load, local operation must be in effect. Immediately after the power is applied, local operation will be in effect. When local operation is in effect, you can use the display with keypad on the front panel to control the Load. The display can be used to view the programmed setting. The input voltage, current, power or resistance is displayed on the three 7-segment LEDs.

Notice When editing the settings, the display will blink to inform the user which setting is to be edited or has been selected.

In remote state, the keys on the front panel have no effect. Only remote controller can program the Load. The 7-segment will show the present input voltage and current readings. The Load LCD display will show REMOTE message.

Notice When setting the load level, the resolution of current, voltage, power, resistance and slew rate will be different from the entered values. The displayed value will remain as the one entered. But the output will be the

actual value D/A programmed in the load. These parameters except resistance will be degraded to low values when entered.

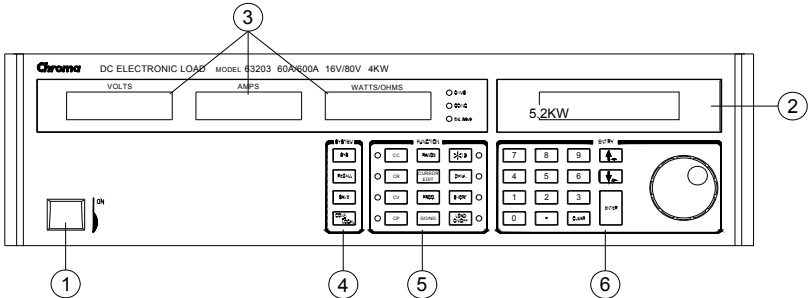
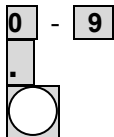

Figure 3-2 Detail of Electronic Load Front Panel

- 1. Line switch Turn the ac power on/off.
- 2. LCD display Display setting information normally.
- 3. 7-segment LEDs Show the V, I, P, R measured data.
- 4. System keys
 - SYS**
 - RECALL**
 - SAVE**
 - CONF**
- 5. Function keys To set the remote control status, ext. wave enable and Parallel function parameters.
- To recall the saved settings from EEPROM, and all settings from specified files (1 to 100). Recall 101 means to reset to the factory default.
- To save the present mode settings in the specified files (1 to 100). The save program is from 1 to 10. Saving DEFAULT is to save the status for the next time the Electronic Load is turned on. All saved settings are stored in EEPROM, and will not be lost when ac power is cycled.
- To select configuration data for editing.

- CC** To select the constant current mode for editing and the CC led aside this key will be on.
- CR** To select the constant resistance mode for editing and the CR LED aside this key will be on.
- CV** To select the constant voltage mode for editing and the CV LED aside this key will be on.
- CP** To select the constant power mode for editing and the CP LED aside this key will be on.
- RANGE** To select the setting level range for each mode.
- CURSOR EDIT** Enable to edit the digit by rotary knob under loading condition. This key is valid only when the Load is in on status.
- PROG.** To select a program for settings or running.
- GO/NG** To enable the SPEC. checking test. The GO/NG LED will turn red when any of the SPEC fails. It will turn green when the check is all right.
- A/B** To select one of the two static settings. The LED aside this key will be on when you choose A setting, and off when you choose B setting.
- DYNA.** Choose the dynamic current waveform and run the setting under Constant current mode. This key is only valid in CC mode and the LED aside this key will be on when in this status.
- SHORT** The Load can simulate a short circuit across the input. The short circuit can be enabled when this key is pressed. When the input is shorted, the LED aside this key will be active. The **SHORT** key can be set in configuration to toggle on/off, or active by pressing.
- LOAD ON/OFF** The input can be toggled on or off by pressing **LOAD**. The LED aside this key will be active when the input is turned on.
6. Entry keys
- ▲**, **▼** They let you scroll through the choices in a parameter list for a specific command. Parameter lists are circular. You can return to the starting position by pressing either key continuously.
- CLEAR** To clear the digit entered from keypad. This key lets you correct wrong digits before they are entered.
- ENTER** It executes the entered value or the parameter

for the command accessed presently. The parameters you have entered with other keys are displayed but not entered into the Load until you press this key. Before pressing **ENTER** you can change or abort anything entered into the display previously.



They are used for entering numeric values. It is a decimal point.

Rotary knob allows you to change the setting value continuously by turning this knob.

3.1.1 Selecting the Operation Mode

The **CC**, **CR**, **CV**, and **CP** keys are used to select the Load modes for local control.

The load levels and slew rates are common to CC, CR, and CP modes. CV mode sets voltage level and response speed. There are two level settings for CC, CR, CV, and CP modes. They can be switched by the **A/B** key.

Setting CC Values

There are four modes for CC operation: CCL, CCH, CCDL, CCDH. The current levels are programmed in Amps. The slew rate levels are programmed in Amps/ μ S. The timings are programmed in millisecond. The setting buffers of four CC modes are independent. Changing the operation range doesn't affect the settings of other ranges. The following examples show how to set the CC values for the Load model number 63203 channel.

Setting CR Values

The Load CR mode is programmed by pressing **CR**. The resistance values can be programmed in low voltage (CRL) or high voltage (CRH) range. The current is always in high range. All resistance levels are programmed in Ω . The slew rate is in A/ μ s.

Setting CV Values

The CV mode for the Load is programmed by pressing **CV**. The voltage values can be programmed in low voltage (CVL) or high voltage (CVH) range. The current is always in high range. All voltage levels are programmed in Volt.

Setting CP Values

The CP mode for the Load is programmed by pressing **CP**. The power values can be programmed in low current (CPL) or high current (CPH) range. All power levels are programmed in Watt. The slew rate is in A/ μ s.



Notice

For detail local operation, please refer to *Chapter 4* in “*High Power DC Electronic Load 63200 Series Operation & Programming Manual.*”

3.2 Rear Panel Description

The Mainframe rear panel includes ports of RS-232C, RS485, GPIB, two remote sense, three BNC connectors, a pair of input terminals, an AC LINE socket, and a fuse holder. Figure 3-3 to Figure 3-6 shows the rear panel of Mainframe 63200 Series.

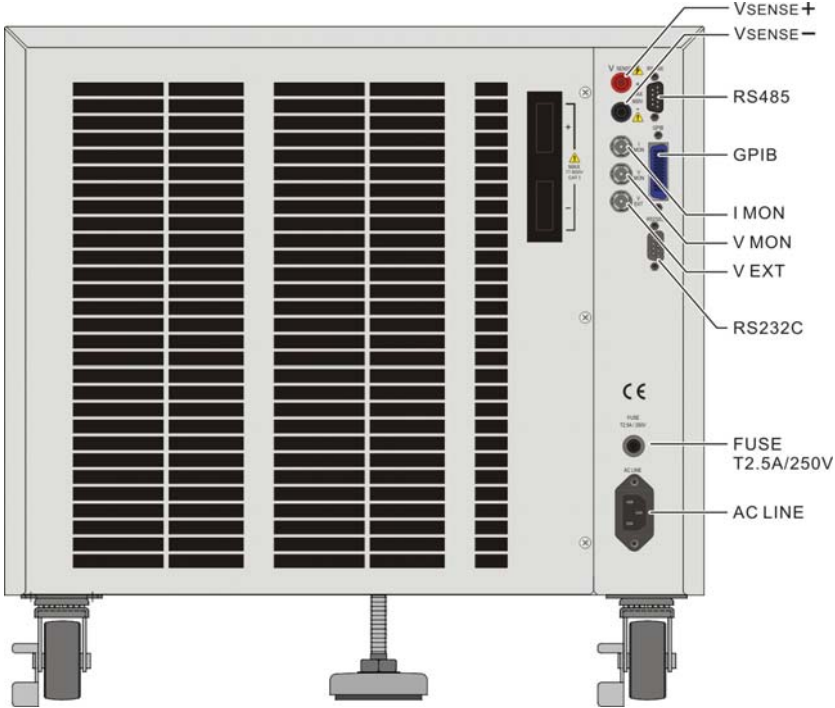

Figure 3-3 Rear Panel of Model 63201/63202/63203/63204

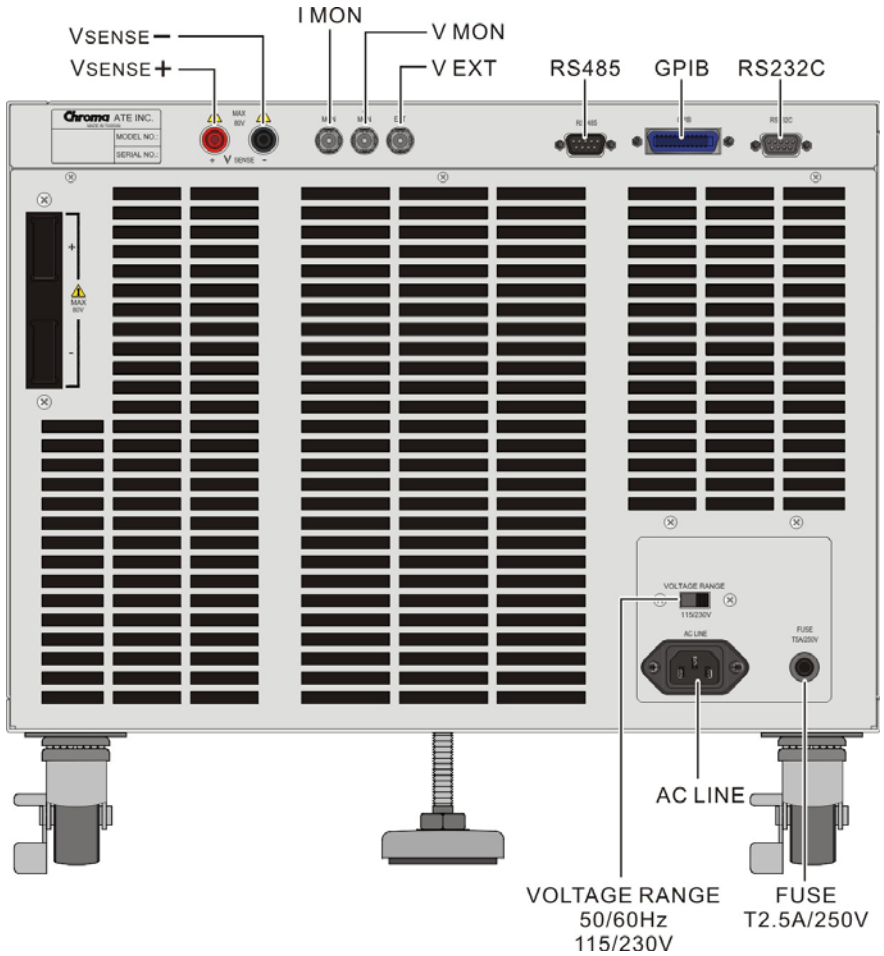

Figure 3-4 Rear Panel of Model 63205/63206/63207

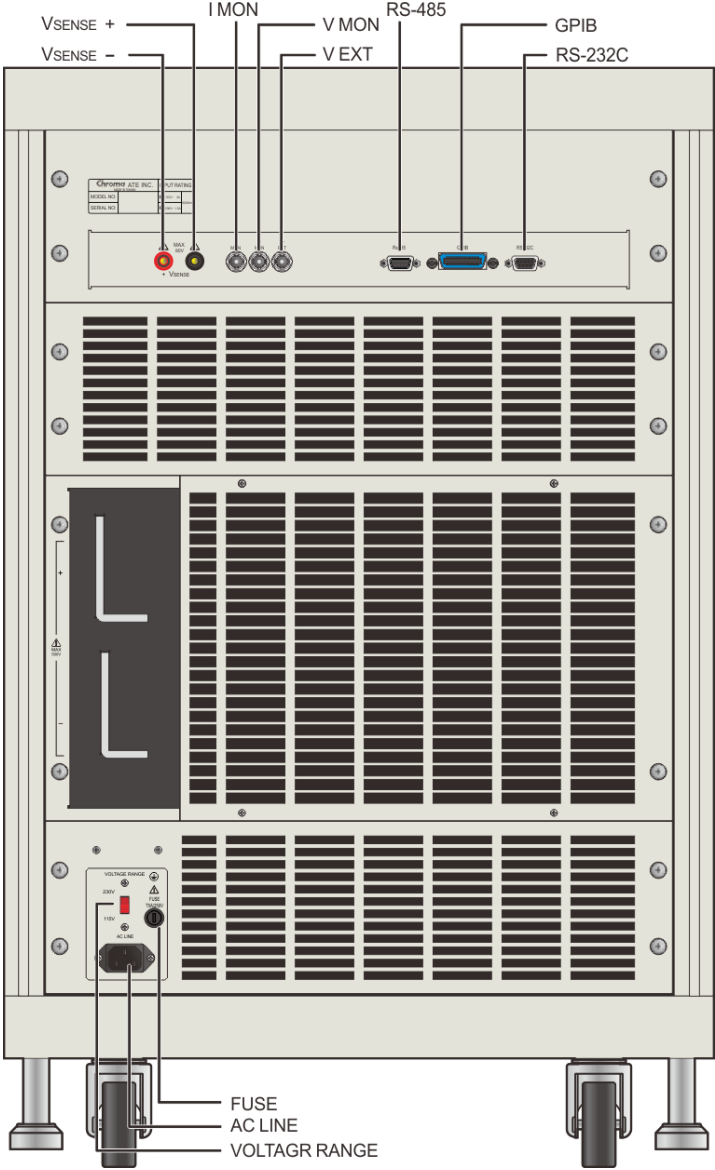

Figure 3-5 Rear Panel of Model 63208/63209/63210

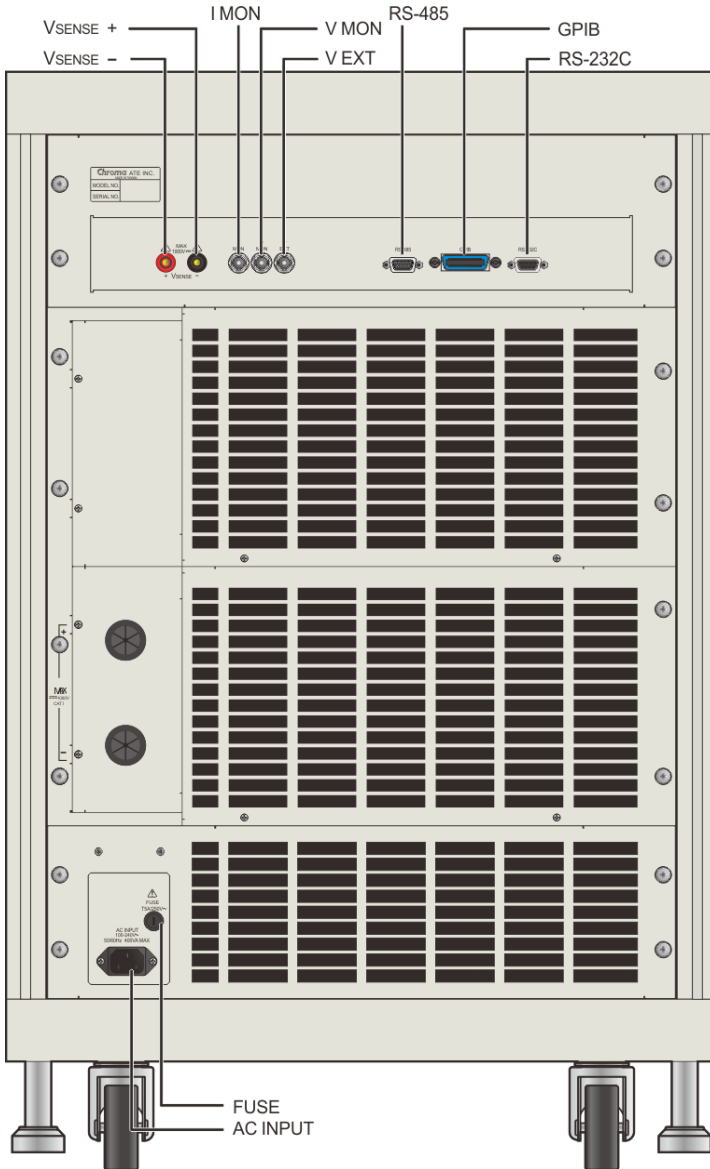

Figure 3-6 Rear Panel of Model 63211

3.3 Local/Remote Control

Local (front panel) control is in effect immediately after the power is applied. The front panel keypad and display allow manual control when Load is used in bench test applications. Remote control goes into effect as soon as the Load receives a command via GPIB, RS-232C or remote controller. When the remote control is in effect, only the computer can control the Load. The front panel keypad has no effect except the **LOCAL** key. The user can return to local control by pressing **LOCAL** key.



For detail local operation, please refer to *Chapter 3* in “*High Power DC Electronic Load 63200 Series Operation & Programming Manual.*”



CHROMA ATE INC.

致茂電子股份有限公司

66 Hwaya 1st Rd.

Kuei-shan Hwaya Technology Park

Taoyuan County 33383, Taiwan

33383 台灣桃園縣龜山鄉

華亞科技園區華亞一路 66 號

T +886-3-327-9999

F +886-3-327-8898

Mail: info@chromaate.com

<http://www.chromaate.com>