

# Warranty

All Chroma instruments are warranted against defects in material and workmanship for a period of one year after date of shipment. Chroma agrees to repair or replace any assembly or component found to be defective, under normal use during this period. Chroma's obligation under this warranty is limited solely to repairing any such instrument which in Chroma's sole opinion proves to be defective within the scope of the warranty when returned to the factory or to an authorized service center. Transportation to the factory or service center is to be prepaid by the purchaser. Shipment should not be made without prior authorization by Chroma.

This warranty does not apply to any products repaired or altered by persons not authorized by Chroma, or not in accordance with instructions furnished by Chroma. If the instrument is defective as a result of misuse, improper repair, or abnormal conditions or operations, repairs will be billed at cost.

Chroma assumes no responsibility for its product being used in a hazardous or dangerous manner either alone or in conjunction with other equipment. High voltage used in some instruments may be dangerous if misused. Special disclaimers apply to these instruments. Chroma assumes no liability for secondary charges or consequential damages and in any event, Chroma's liability for breach of warranty under any contract or otherwise, shall not exceed the purchase price of the specific instrument shipped and against which a claim is made.

Any recommendations made by Chroma for use of its products are based upon tests believed to be reliable, but Chroma makes no warranty of the results to be obtained. This warranty is in lieu of all other warranties, expressed or implied, and no representative or person is authorized to represent or assume for Chroma any liability in connection with the sale of our products other than set forth herein.

CHROMA ATE INC.

43 Wu-Chuan Road, Wu-Ku

Industrial Park, Taipei, Taiwan

Tel: 886 -2-2298-3855

Fax: 886-2-2298-3596

www:<http://www.chromaate.com>

E-mail:[chroma@serv.chroma.com.tw](mailto:chroma@serv.chroma.com.tw)

## **SAFETY SUMMARY**

The following general safety precautions must be observed during all phases of operation , service , and repair of this instrument. Failure to comply with these precautions or specific WARNINGS given elsewhere in this manual will violate safety standards of design , manufacture , and intended use of the instrument.

*Chroma* assumes no liability for the customer's failure to comply with these requirements.

### **BEFORE APPLYING POWER**

Verify that the product is set to match with the line voltage.

### **PROTECTIVE GROUNDING**

Make sure to connect the protective grounding to prevent an electric shock before turning on the power.

### **NECESSITY OF PROTECTIVE GROUNDING**

Never cut off the internal or external protective grounding wire, or disconnect the wiring of protective grounding terminal. Doing so will cause a potential shock hazard that may bring injury to a person.

### **FUSES**

Only fuses with the required rated current , voltage , and specified type ( normal blow , time delay , etc.) can be used. Do not use different fuses or short-circuited fuseholders. To do so might cause a shock or fire hazard.

### **DO NOT OPERATE IN AN EXPLOSIVE ATMOSPHERE**

Do not operate the instrument in the presence of flammable gases or fumes.

### **KEEP AWAY FROM LIVE CIRCUITS**



Operating personnel must not remove the covers of the instruments. Component replacement and internal adjustments must be only done by qualified personnel of service. Do not replace components with the power cable connected. Under some circumstances, dangerous voltage may exist in spite that the power cable has been removed. To avoid injuries the user has to disconnect power, discharge circuits, and remove external voltage source before he touches components.

### **DO NOT SUBSTITUTE PARTS OR MODIFY THE INSTRUMENT**

Because of the possibility of causing additional hazards, do not substitute parts, or modify the instrument without authorization. Return the wrong instrument to Chroma Sales and Service Office to ensure that safety features are maintained.

<b>WARNING</b>	<b><i>LETHAL VOLTAGES. Ac sources can supply 426 V peak at their output. DEATH on contact may result if the output terminals or circuits connected to the output are touched when power is applied.</i></b>
----------------	---

## SAFETY SYMBOLS

	<b>DANGER</b> - High voltage .
	<b>Explanation</b> : To avoid injury, death of personnel, or damage to the instrument, the operator must refer to an explanation in the instruction manual .
	<b>Protective grounding terminal</b> : To protect against electrical shock in case of a fault. This symbol indicates that the terminal must be connected to ground before operation of equipment.
<b>WARNING</b>	A <b>WARNING</b> sign denotes a hazard. It calls attention to a procedure, practice, condition or the like which may result in injury or death of personnel if it is not rightly observed.

# Table of Contents

---

<b>1. GENERAL INFORMATION .....</b>	<b>1-1</b>
1.1 Introduction .....	1-1
1.2 The Required Equipment for Test .....	1-2
<b>2. BASIC OPERATION .....</b>	<b>2-1</b>
2.1 Requirement of Input Power .....	2-1
2.2 Input Connection .....	2-1
<b>3. THE THEORY OF OPERATION .....</b>	<b>3-1</b>
3.1 General Information .....	3-1
3.2 Description of Overall System .....	3-1
3.3 AC/DC Power Stage Converter .....	3-4
3.4 DC/DC Power Stage .....	3-4
3.5 DC/AC Inverter .....	3-4
3.6 CPU .....	3-4
3.7 Measurement and Waveform Generator .....	3-5
3.8 Keyboard and Display .....	3-5
3.9 Mother Board .....	3-5
3.10 GPIB/RS-232C and I/O Interface .....	3-5
<b>4. ADJUSTMENT .....</b>	<b>4-1</b>
4.1 Introduction .....	4-1
4.2 Initial Setup .....	4-1
4.3 Reference Check & Adjustment of Voltage on BM Board .....	4-2

<b>4.4 Adjustment of Output .....</b>	<b>4-2</b>
4.4.1 Adjustment of Voltage .....	4-2
4.4.2 Adjustment of Power Measurement .....	4-3
4.4.3 Adjustment of Current Measurement .....	4-3
<b>4.5 Recovering the AC Source .....</b>	<b>4-4</b>
<b>5. TROUBLESHOOTING .....</b>	<b>5-1</b>
<b>5.1 Introduction .....</b>	<b>5-1</b>
<b>5.2 Guide of Troubleshooting .....</b>	<b>5-1</b>
<b>5.3 The Procedures of Troubleshooting .....</b>	<b>5-2</b>
5.3.1 Error Messages .....	5-2
5.3.2 Output Voltage Inaccuracy .....	5-2
5.3.3 The Protection of the Fan.....	5-3
5.3.4 The Problem of Turning On.....	5-3
5.3.5Set Model and Serial Number .....	5-3
<b>APPENDIX LOCATION OF COMPONENTS.....</b>	<b>1</b>



# **1. General Information**

## **1.1 Introduction**

This manual contains information on calibration, adjustment, basic maintenance, and troubleshooting of the 6430/6420/6415 programmable AC source. It is intended only for the well-trained personnel's use at service.

Detailed information on operation and programming is not included in the manual. For it the user can refer to the 6430/6420/6415 User's Manual.

### **WARNING**

The information in this manual is only provided for the qualified personnel at service.

To avoid electrical shock, do not take the instrument apart or repair it unless you are qualified to do so.

## 1.2 The Required Equipment for Test

Type	Required Characteristics	Use
DMM	5 1/2 digits or more	T, C
Current shunt	Accuracy with 0.01A (20A)	C
Load	44, 88 Ohm 300W 5.5, 8.5, 14 Ohm	T, C

T : Troubleshooting

C : Calibration

Load resistance of different models needs different value and power. Please refer to subsection 4.4.3 for the requirement.



## 2. Basic Operation

### 2.1 Requirement of Input Power

Model	Input Voltage Range	Input Frequency Range	Input Current
6430	190 – 250 V	47 – 63 Hz	25A Max.
6420	190 – 250 V	47 – 63 Hz	15A Max.
6415	190 – 250 V	47 – 63 Hz	12A Max.

#### CAUTION

The instrument may be damaged if it is operated at an input voltage that is outside the configured input range.

### 2.2 Input Connection

The input terminal block is located on the rear panel of the instrument. See Figure 2-1 (on next page). The instrument must be operated by a three-wired single phase AC power source. The power source must have a current rating greater than or equal to the fuse rating of the instrument. In order to protect the operating personnel, the wire connected to the GND terminal must be connected to an earth ground. Under no circumstances shall this instrument be operated without an adequate ground connection. Figure 2-2 (on page 2-3) shows the position of PCB in the AC source.

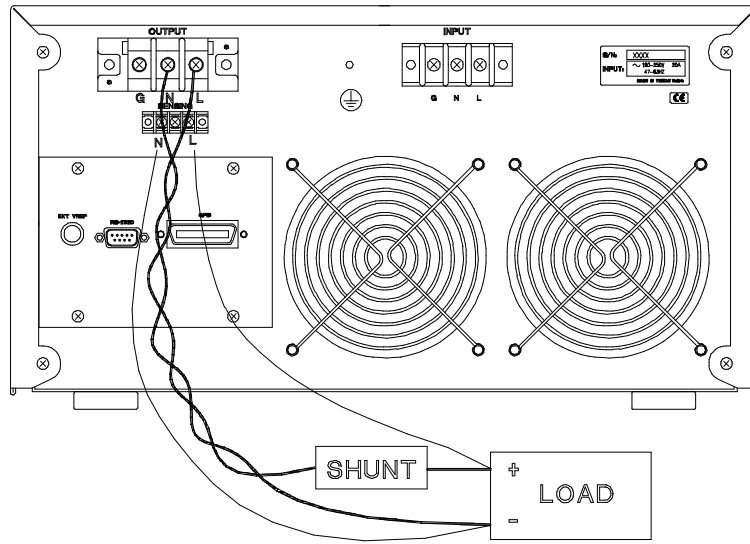

Figure 2-1 The Rear Panel of Load Connection

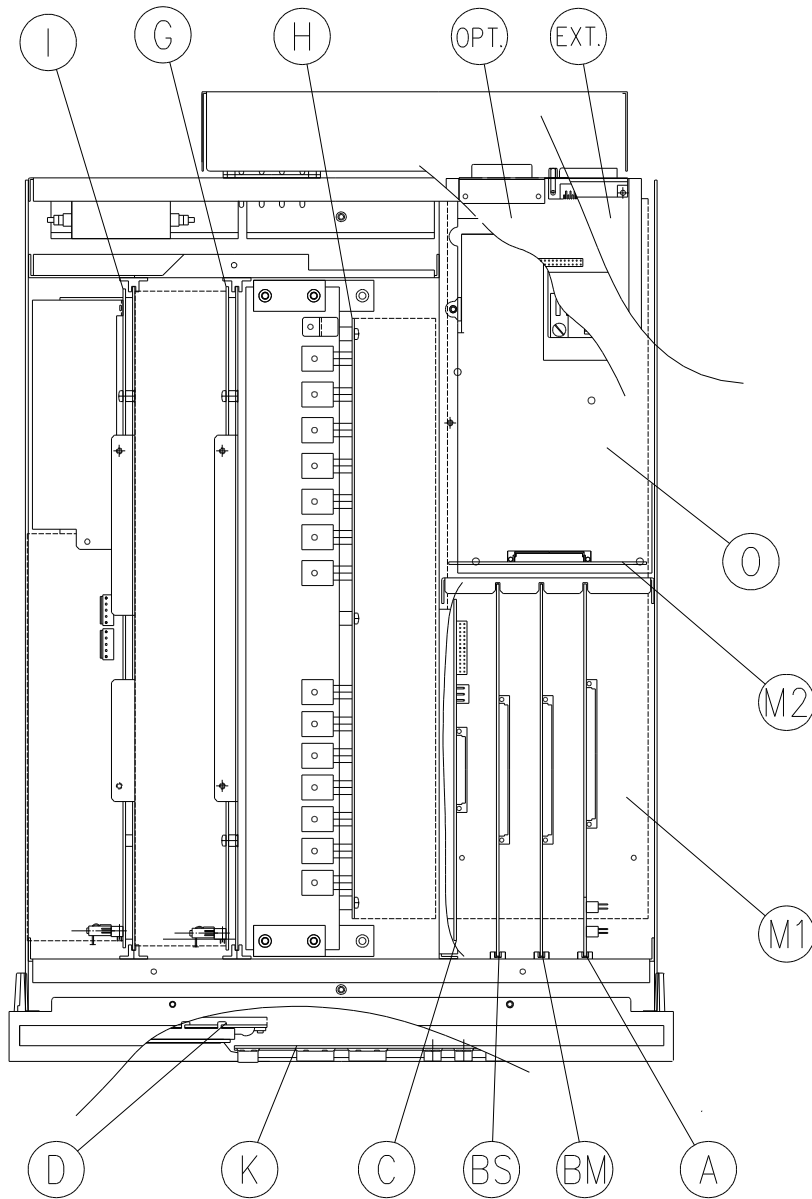

Figure 2-2 The Position of PCB in the AC Source

Apply the line power to the input terminals, and turn on the power switch on the front panel. No load shall be connected to the output terminal block. The instrument will do a series of self- tests whenever the user turns on the power switch. All LEDs on the front panel, including alphanumeric and indicator LEDs, are lighted for three seconds or so. Then, the seven-segment LEDs and alphanumeric LEDs will display “SELF TEST”. It means that the 6430, 6420 or 6415 is running a self-test.

Shortly afterwards, the seven-segment LEDs will display the model number like 6430, 6420 or 6415, and the firmware version number like ver 1.2 as below:

6430 ver 1.2
--------------

After the self-test is completed, the LEDs will show the current set values of V, F and the measured value of I, and indicate that the 6430, 6420 or 6415 is ready for use as below:

0.0 60.0 0.00
---------------

## 3. The Theory of Operation

### 3.1 General Information

This chapter includes the block diagrams and the related descriptions of the AC source. The 6430/6420/6415 AC source consists of 14 boards and some other discrete components. Each of them has its own specific function, which will be described in the following subsection.

### 3.2 Description of Overall System

Figure 3-1 (on page 3-3) shows the block diagram of overall system. Main power flows through I, G, H, and O boards. Other boards are control, measurement and user interface boards.

Main power flows as follows:

I board is identified as Input board. It converts input AC line into DC plus power factor correction circuits. Output voltage is about 380V DC.

G board is identified as DC to DC with isolation and stepping down of voltage. The output of I board is sent to G board, and that of G board to H board. Output voltage of G board is about 350V DC.

H board is identified as DC to AC board. The output of G board is sent to H board. Through H board the controlled full bridge converts DC to AC, and sends it to O board.

O board is identified as output board. Its main function is to control the range of the AC source. There are two relays controlling the output range of the AC source, 300V/150V.

Control, measurement and user interface boards:

A board is identified as CPU. The CPU of the 6430/6420/6415 AC source is used to perform remote control through GPIB, RS-232C, or EXT VREF interface on Optional board, to control output frequency and voltage through BS and C boards, to measure voltage, current and power through BM board, to display message and scan front panel key

through the module of LCD and K board, and to monitor all interrupts.

BM board is identified as measurement unit. All measurement functions are done here.

BS board is identified as waveform generator. It generates output waveforms that act as the reference input of C board.

C board is identified as the controller of DC to AC (H board). It controls DC to AC power stage in order to get low distorted waveform output.

K board is identified as keyboard including RPG—Rotary Pulse Generator. It is the interface between the user and the instrument when the latter is in local operation.

Extended and Optional boards are identified as input/output signals which include GPIB, RS-232C, EXT VREF, printer and other I/O control signals. Optional board is on Extended board.

M1 board is identified as mother board which includes system power supply, fan control and the interconnection of A, BM, BS as well as C boards. M2 board is only interconnected for M1, Extended and O boards.

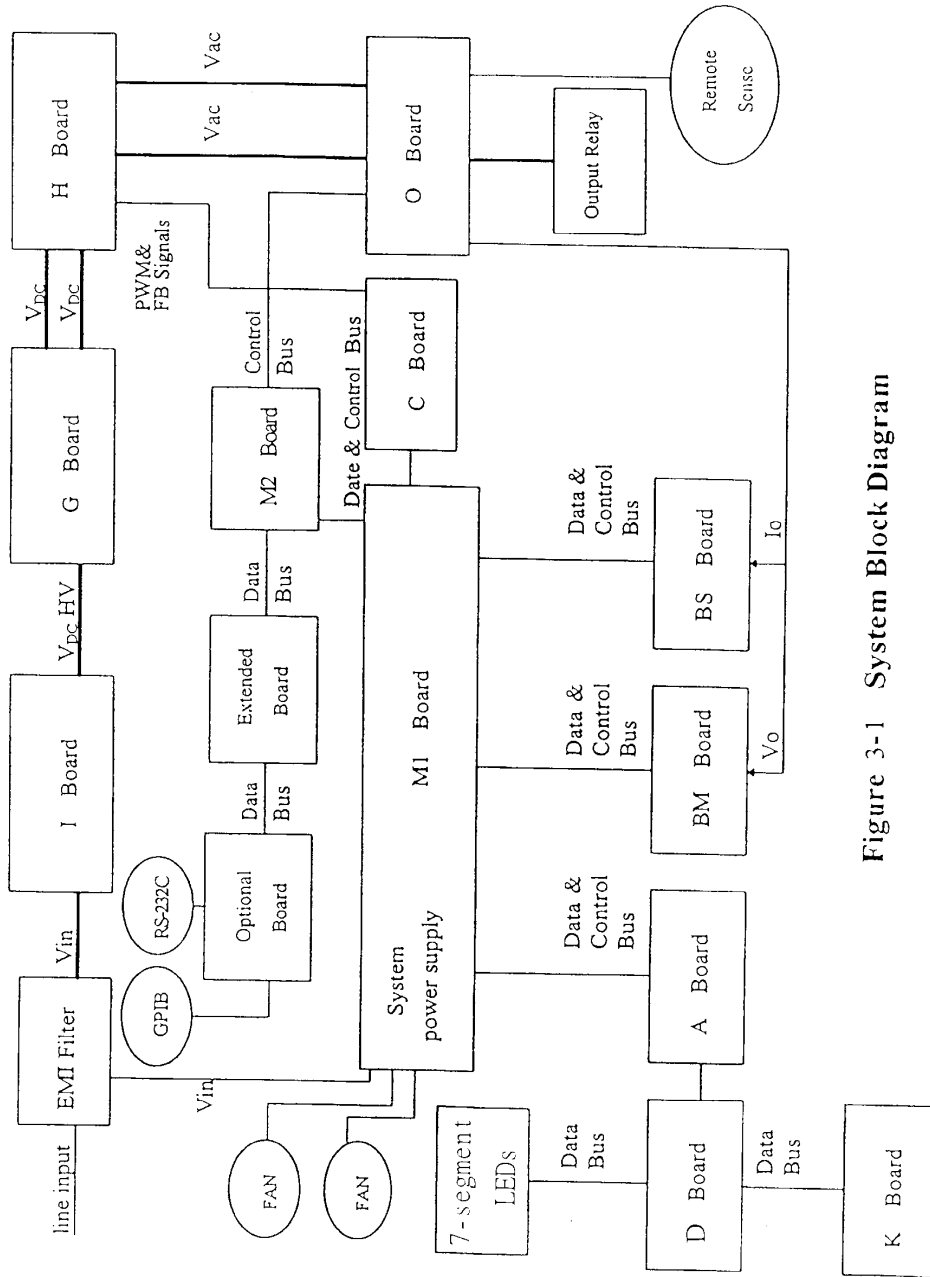

Figure 3-1 System Block Diagram

### **3.3 AC/DC Power Stage Converter**

This assembly is identified as I board which includes EMI filter, relays, rectifier bridge, and power factor correction circuits (PFC). The AC source through PFC is used to achieve a power factor of 0.98 or more. It generates high DC voltage for DC to DC stage.

### **3.4 DC/DC Power Stage**

This assembly is identified as G board which includes two transformers, PWM control circuit, full bridge MOSFET, and fast recovery diode. It generates two isolated DC voltages for DC/AC inverter.

### **3.5 DC/AC Inverter**

This assembly comprises H board, C board, and O board. It generates output waveforms for use.

C board is the controller of H board, which contains output protection like Over Load Protection (OLP), Short (SHT), and Over Temperature Protection (OTP).

H board is the power stage of the inverter. It is composed of two full bridges of MOSFET power components and two LC low pass filters so as to reject the switching frequency component. The PWM control signal from C board is applied to two full bridges to amplify the output. The output of H board is sent to O board.

O board consists of range relays, output relay, EMI filter and output sense circuits. Range relays connect the two sets of the output of H board together in parallel or series. Output relay can isolate the AC source from external source when any error occurs. EMI filter is to reject noise. Sense circuits are to send V, I signals to measurement/control unit.

### **3.6 CPU**

The CPU, that is, the A board, uses a 80188 CPU to control the AC source. A microprocessor circuit receives commands from GPIB, RS-232C controller, or the keyboard on the panel. It controls output parameters, receives data from measurement circuits, and reports to the display of LCD as well as remote controller. Parameters of setup are stored in battery backup ram whenever the user saves or recalls data. Data will not be lost when the instrument is powered off.



### **3.7 Measurement and Waveform Generator**

Measurement circuits on BM board monitor voltage, current, power, etc. Output voltage and current sensed by sense circuits on O board are scaled, and read by CPU through analog-to-digital converter. The true RMS measurement is made by RMS converter IC, and is so powered for true power measurement. The digital-to-analog converter on BM board sets the DC voltages that are used for the programmable voltage function.

Waveform generator on BS board generates output waveform. Data from waveform table are sent to digital-to-analog converter. Low pass filter is used to smooth the reference input signal.

### **3.8 Keyboard and Display**

The keyboard is designed as K board, which is connected through a flat ribbon cable to D board. It holds 16 key switches. The display is designed as D board. It is comprised of three 4-digit, 7-segment LEDs. The programming of AC voltage and frequency can be also done by turning the rotary knob on the front panel.

### **3.9 Mother Board**

This assembly is identified as M1 board, which includes system power supply, smart fan control circuits, and control/measurement interconnection. The power supply circuits generate the DC voltages of +5V, +15V, -15V, +12V, -24V for control/measurement circuits, and +13V for PFC power stage. Smart fan control circuits sense the internal temperature of the AC source so as to control fan speed, and get lower fan audio noise.

### **3.10 GPIB/RS-232C and I/O Interface**

The remote control is done by GPIB or RS-232C interface on Optional board which is connected through Extended board. External reference is for the use of DC reference to control the amplitude of the output of the AC source.



## 4. Adjustment

### 4.1 Introduction

This chapter provides the user with information on basic adjustment of the 6430/6420/6415 AC source. The verification tests of operation include a simple procedure which verify if the unit performs properly without testing all specified parameters. After troubleshooting and repair of a defective unit, the user can verify its operation with the procedure of adjustment in order to ensure a good performance.

### 4.2 Initial Setup

- A. Disconnect the line cable and all loads from the rear terminals.
- B. Remove the cover by taking away the screws on the rear panel and both sides of the AC source.
- C. Remove the inner top cover by taking away the top screws and four screws on the both sides of the AC source.
- D. Connect the line cable to the rear panel, and turn on AC power again.
- E. Turn off AC power after adjustment is finished, and then remove the connection to the power source.

Press **SHIFT** to enter into the setup function, and the green LED will be turned on. Then, press **3** **4** at the same time, and hold them for three seconds until the red 7-segment LEDs display as follows:



TEST PLAN 1

Press one of the numeric keys from **1** to **8** and **ENTER** to choose one of the following adjustment items as on the next page.

Numeric Key	Content	Display
[1]	Voltage Measurement and Control Gain Adjustment	1. <i>V MEAS 110.0</i>
[2]	Power Offset Adjustment	2. <i>P XXXX</i>
[3]	Load Test	3. <i>LOAD tEST</i>
[4]	Current Measurement	4. <i>I MEAS XXXX</i>
[5]	Overload Protection Test	5. <i>OLP PRO.XXXX</i>
[6]	Short Circuit Protection	6. <i>Sht PRO</i>
[7]	Rectified Load Test	7. <i>REC. tEST</i>
[8]	Extension Board Test	8. <i>Ext tEST</i>

When you like to stop an adjustment function or go back one level, press [OUT/QUIT].

### 4.3 Reference Check & Adjustment of Voltage on BM Board

Set DMM at DC range to measure the test pin on BM board of P4. DMM is low at AGND, and high at the test pin. Trim the VR5 to adjust the voltage of test pin P4 to the range of  $+ 10.240 \pm 0.0004V$ . Trim the VR6 to adjust the voltage of test pin P5 to the range of  $-5.120 \pm 0.0002V$ .

### 4.4 Adjustment of Output

This subsection is about the procedures of adjustment which verify the setting/measurement of the output voltage, current and power of the AC source. If the result of measurement is not accurate enough, the user can calibrate it again according to the following procedures.

#### 4.4.1 Adjustment of Voltage

In software test plan menu, press [1] and [ENTER] to go into voltage measurement adjustment function. Adjust the output voltage in the range of 150V.

- A. Set DMM at AC range to measure the output voltage. Trim the VR2 on C board to adjust the output voltage to the range of  $110 \pm 0.02V$ .
- B. Move DMM to BM board, and trim the VR2 to adjust P1 to the range of  $5.133 \pm 0.001V$ .

Press **ENTER** , and adjust the output voltage at the range of 300V.

A. The 7-segment LEDs will be

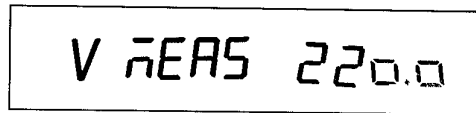

- B. Set DMM at AC range to measure the output voltage. Trim the VR2 on C board to adjust the output voltage to the range of  $220 \pm 0.04V$ .
- C. Move DMM to BM board, and trim the VR1 to adjust P1 to the range of  $5.133 \pm 0.001V$ .

Press **ENTER** , and adjust output voltage with feedback in the range of 300V.

Set DMM at AC range to measure the output voltage. Trim the VR2 on C board to adjust the output voltage to the range of  $220 \pm 0.04V$ .

Thus, the adjustment of output voltage accuracy and output measurement accuracy is completed.

#### 4.4.2 Adjustment of Power Measurement

Press **2** and **ENTER** to adjust the power measurement.

- A. Set DMM to DC range. Press **1** and measure P3 on BM board, and the data are V1. Press **2** and the data are V2.
- B. If  $V1 > V2$ , press **1** otherwise **2**.
- C. Trim VR4 on BM board to adjust P3 to the range of  $-0.3 \pm 0.3mV$ .

#### 4.4.3 Adjustment of Current Measurement

Press **4** and **ENTER** to adjust the current measurement.

- A. Connect shunt in series with the load, and press **RUN** to enable output.
- B. Different models have their own adjusted current respectively.

Model	Ishunt	Power (minimum)
6430	$20 \pm 1A$	2400 W
6420	$13 \pm 1A$	1500 W
6415	$10 \pm 1A$	1250 W

The reading of shunt current is Ishunt.

Trim VR4 on BS board is to make the reading of the AC source on LCD become the range of  $I = \text{Ishunt} \pm 0.01A$ . Thus, the adjustment of current measurement accuracy is completed.

## 4.5 Recovering the AC Source

After all adjustments are finished, turn off the power of the AC source, and disconnect all I/O connections. Put some glue on variable resistors in order to fix them. Replacing the inside and outside top covers.

## 5. Troubleshooting

### 5.1 Introduction

This chapter is concerning the procedures of troubleshooting on board level for the 6430/6420/6415 programmable AC source.

#### WARNING

Only personnel with knowledge of electronic circuiting and awareness of the hazards involved can test and repair the instrument.

#### CAUTION

To prevent static zap of ICs, always observe antistatic techniques when assemblies are handled or served.

### 5.2 Guide of Troubleshooting

Before repairing the instrument, the user has to know first what the problem is. Then, he can refer to the information in the following paragraphs for the defective assembly.

For all procedures of troubleshooting, the user has to check first if the power supply of +5V, +15V, -15V, +12V, -24V and +13V works properly. Then, he can take corrective action according to the following direction.

## 5.3 The Procedures of Troubleshooting

### 5.3.1 Error Messages

All possible error messages which may appear on the 7-segment LEDs are listed below. The list contains the cause of the problems and the corrective actions too.

Error Message	Cause	Action
ROM TEST ERR.	EPROM test fails.	The A11 of 27C020 on A board might be damaged. Replace it.
RAM1 ERROR RAM2 ERROR	System memory test fails.	Data of battery backup RAM might be lost. Press <input type="button" value="0"/> , <input type="button" value="8"/> simultaneously to initiate them, otherwise the A12 and/or A28 of 62256 on A board might be damaged. In that case replace it.
Waveform ERR.	Waveform table test fails.	Check B24, B25 of 6116 on BS board.
FRE. tEst ERR.	Frequency generator or measurement ckt fails.	Check TP1 frequency on A board. If TP1 F= 60 Hz, replace A18 of A board. If F is not 60 Hz, replace A board.

### 5.3.2 Output Voltage Inaccuracy

1. First, check if the sense cable is correctly connected.
2. If output voltage is out of specification, calibrate and adjust it (see Chapter 4).
3. If voltage accuracy cannot be adjusted to the expected range again, please check the following points.
4. Check points : range = 300V, V = 150V, F = 60 Hz, no load, output=RUN.

I board : TP + 365V to PG1 DC voltage =  $380 \pm 10$ Vdc.

G board : TP VO1 to PG2, VO2 to PG3 DC voltage =  $350 \pm 20$ Vdc.

O board : J\_ HO1 Pin1 to Pin7, J\_ HO2 Pin 1 to 7 AC voltage =  $150 \pm 1$ Vac.

TP1 to TP2 AC voltage =  $150 \pm 1$ Vac.

BS board : TP3 to AGND AC voltage =  $7.07 \pm 0.2$ V.

If the voltage of any point is out of its specification, please consult your dealer or inform Chroma directly.



### **5.3.3 The Protection of the Fan**

1. Check whether the connectors of the fan, CN3, CN4 on M1 board are loose or not.  
If they are loose, reconnect them firmly.
2. Check if the voltage of pin3 to pin4 at connector CN7 on M1 board is about  $12.5 \pm 1V$ .  
If it is not, replace M1 board.
3. Check if there is any wire or some other thing blocking the fan. If there is, remove it.

### **5.3.4 The Problem of Turning On**

1. First, check whether the input voltage is correct or not.
2. Check if the DIN connectors among A, BM, BS, C and M1 boards are loose. If they are, reconnect them firmly.
3. Check if the connector between A and K boards is loose. If it is, reconnect it firmly.

### **5.3.5 Set Model and Serial Number**

1. Press the SHIFT key.
2. Hold '0' and '9' keys down together for 2-3 seconds.
3. Use knob to select model.
4. Press the ENTER key.
5. Use knob to select unit serial number.
6. Press the ENTER key.
7. Cycle power.



# Appendix Location of Components

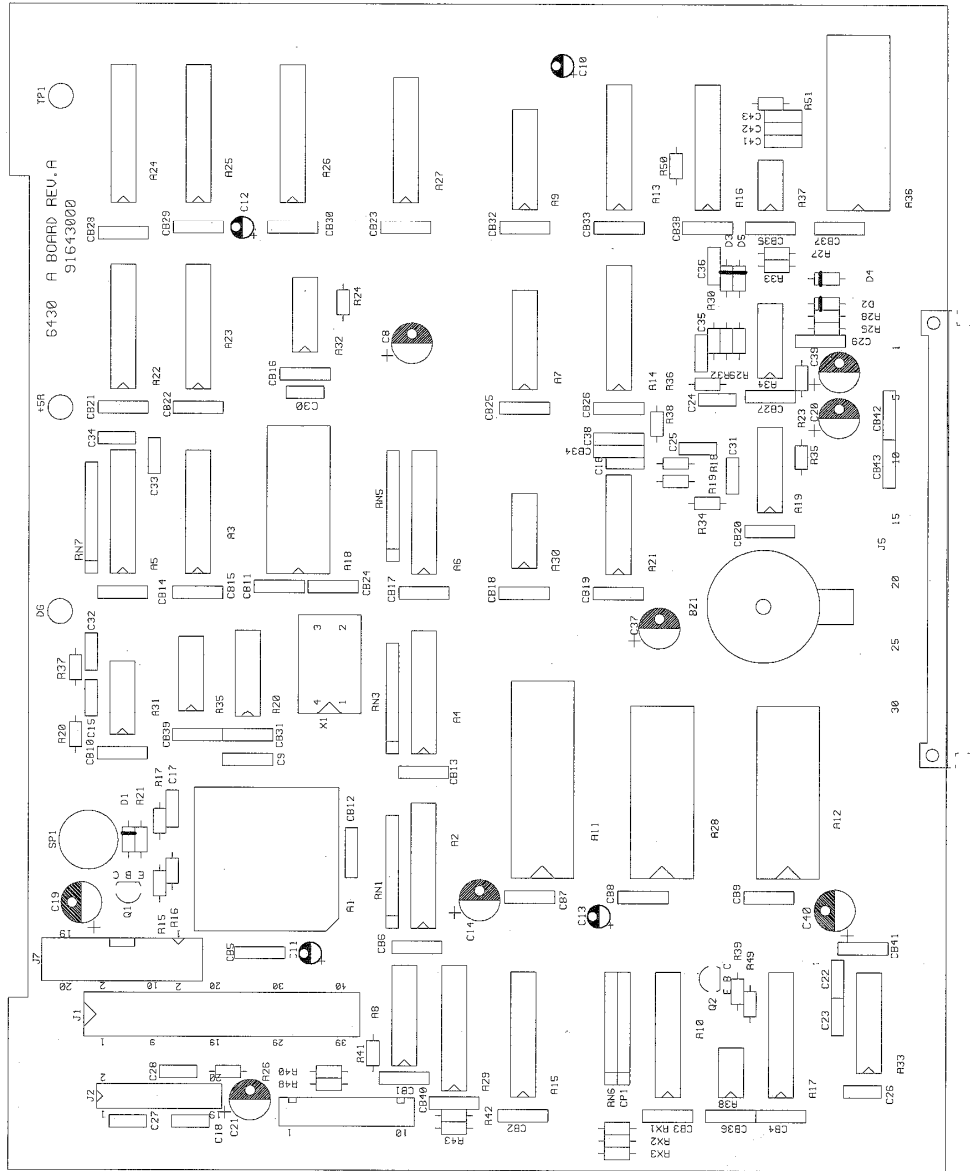

A Board

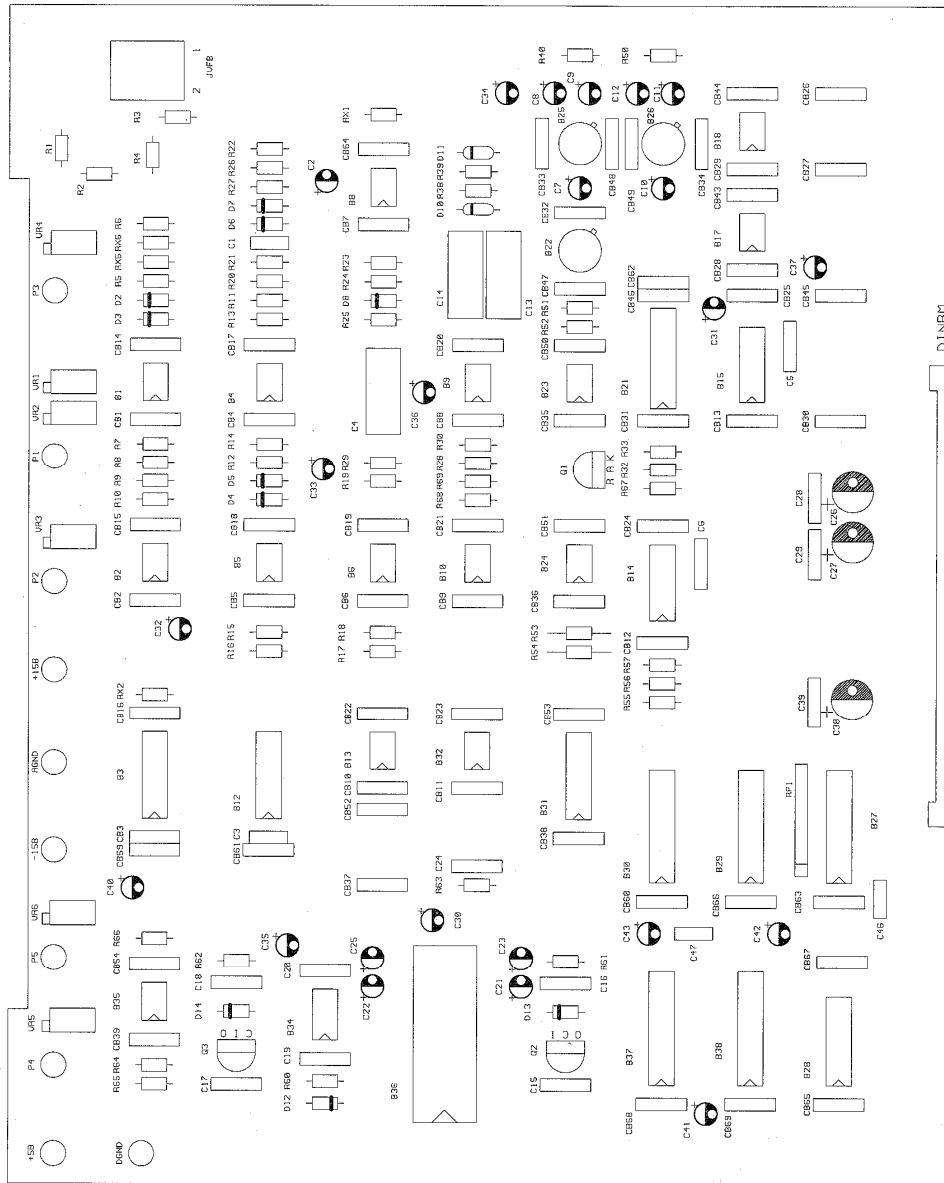

BM Board

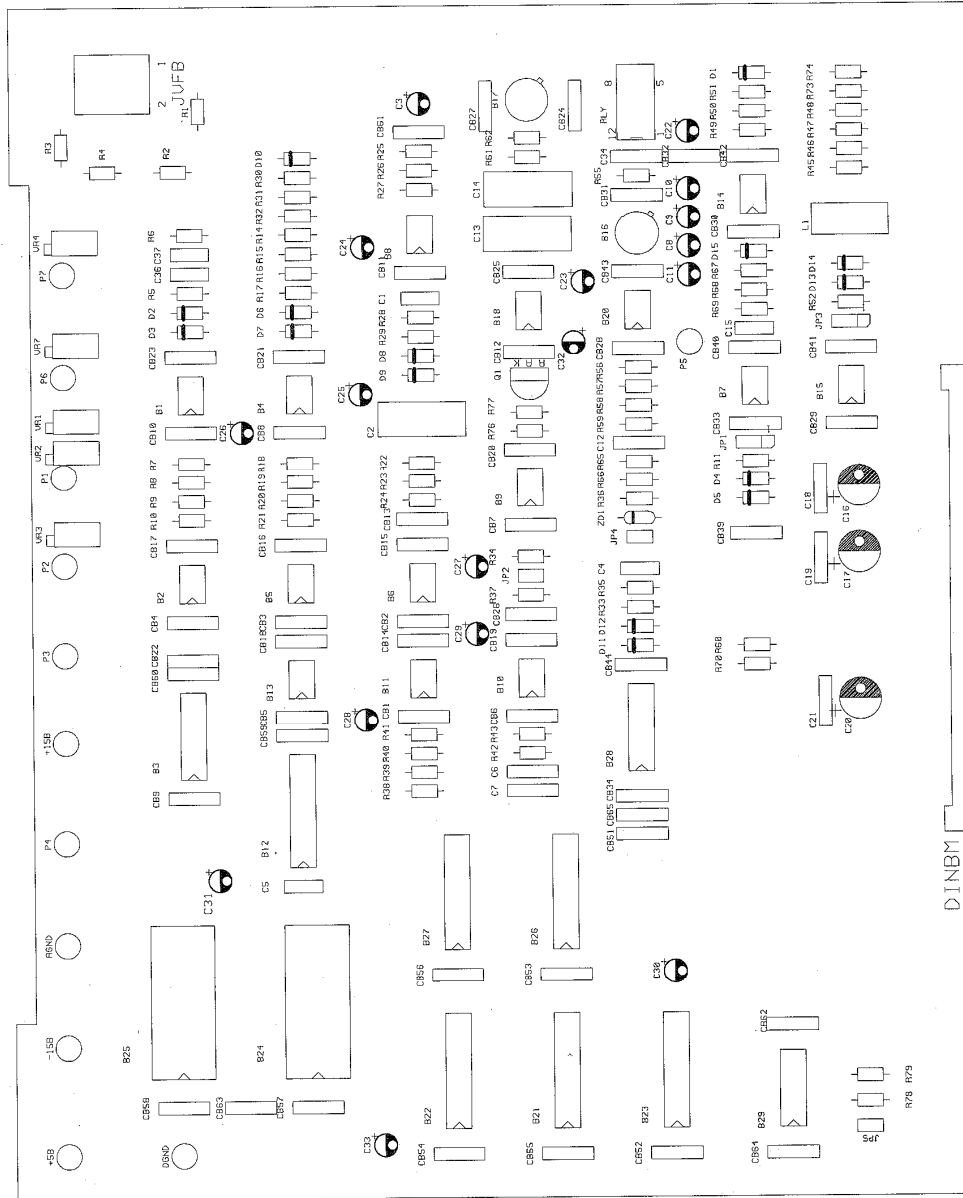

BS Board



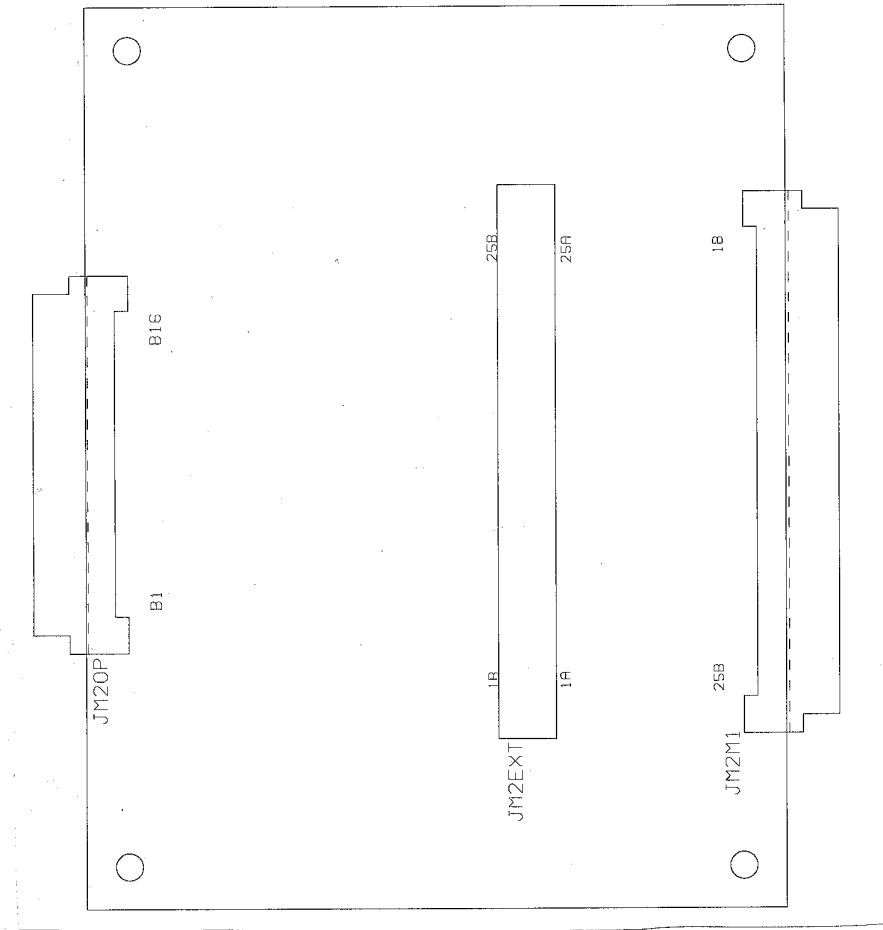

M2 Board

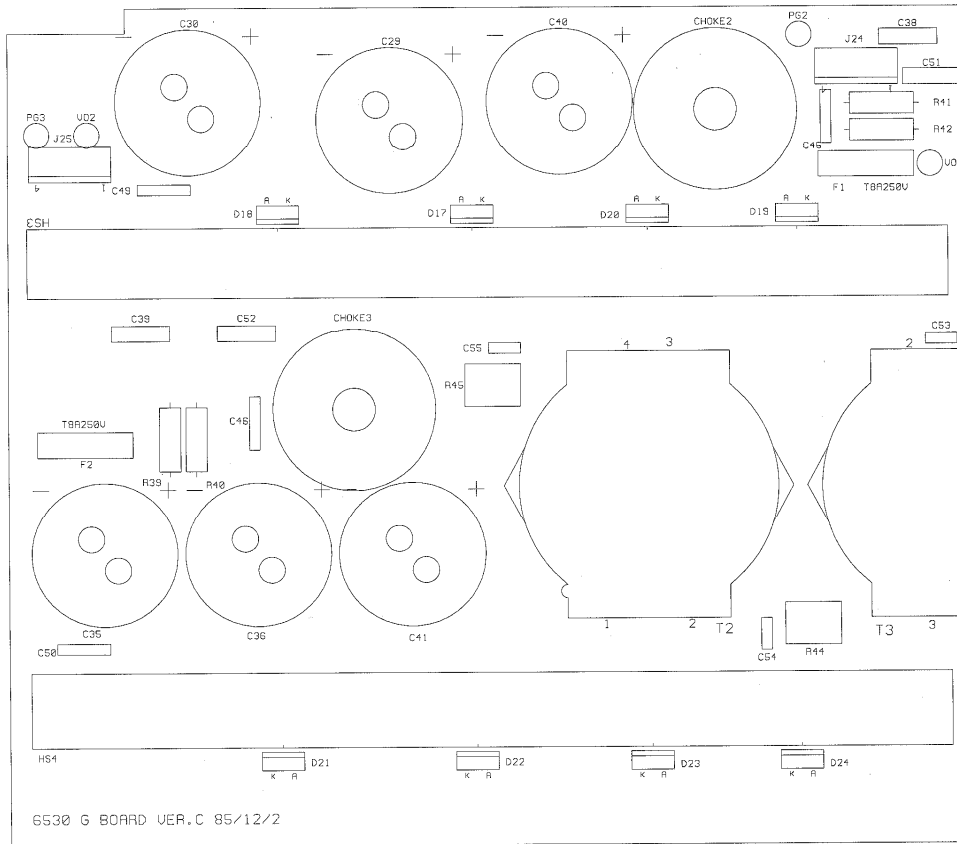

G Board-1



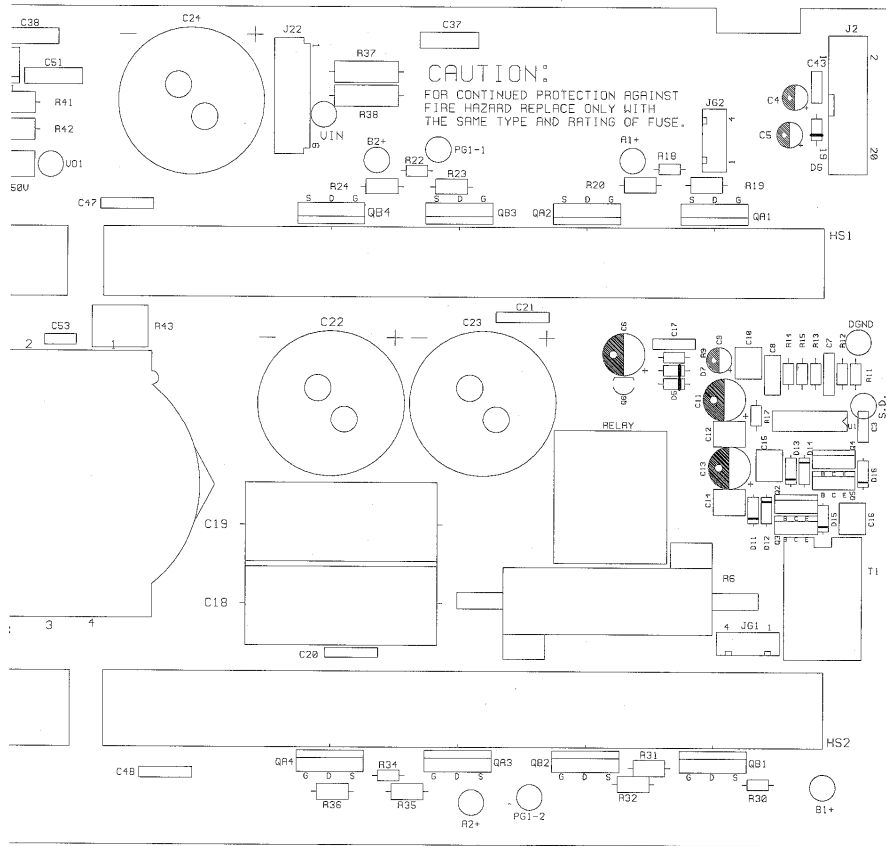

G Board-2



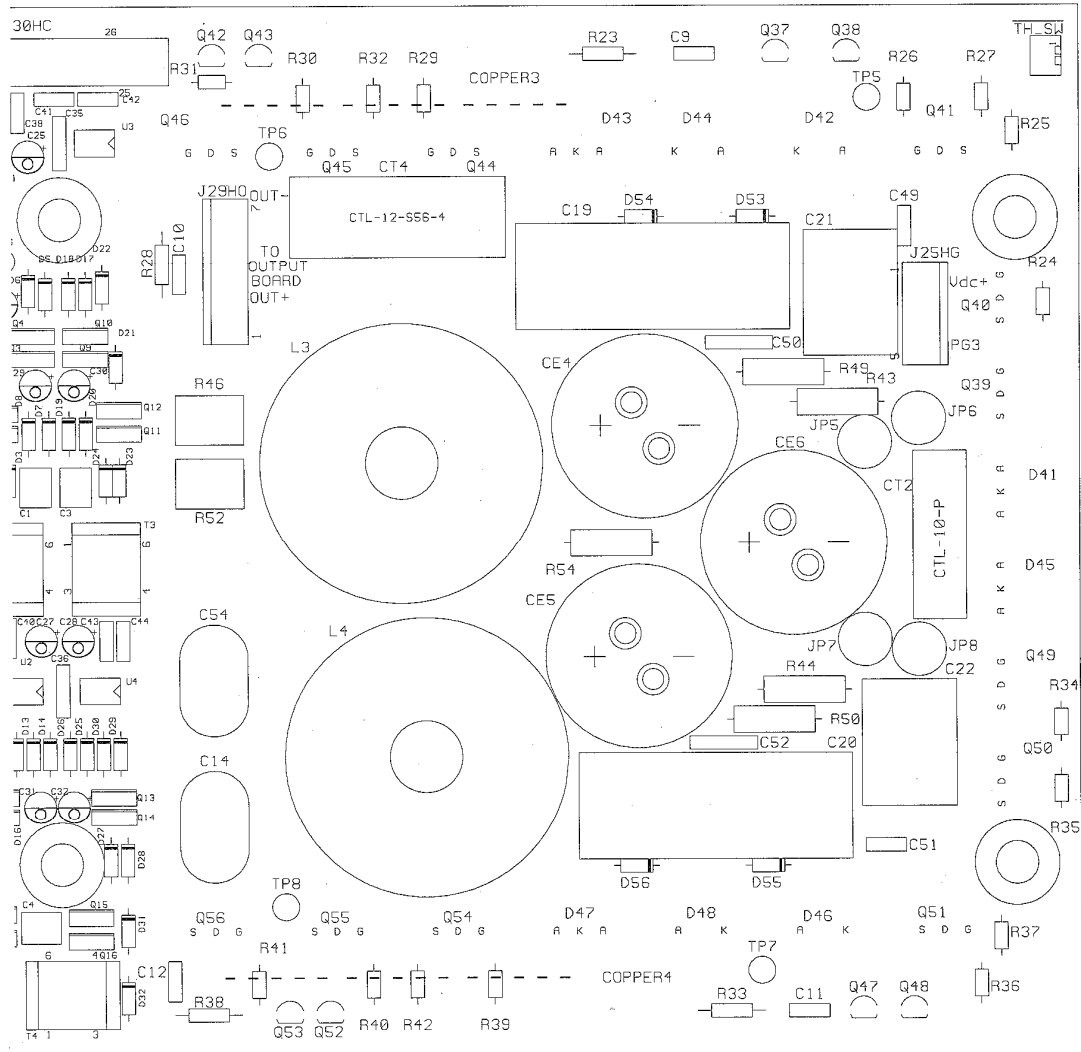

H Board-2

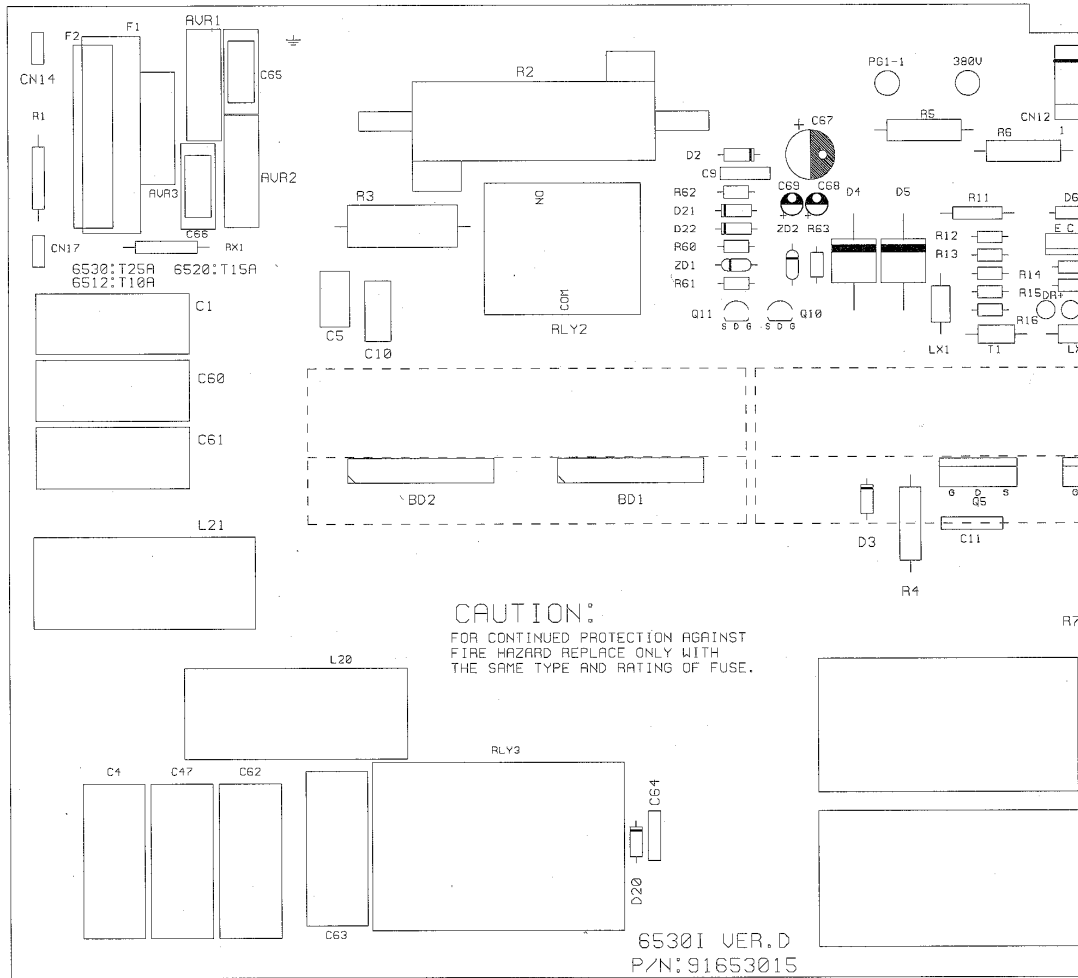

I Board-1

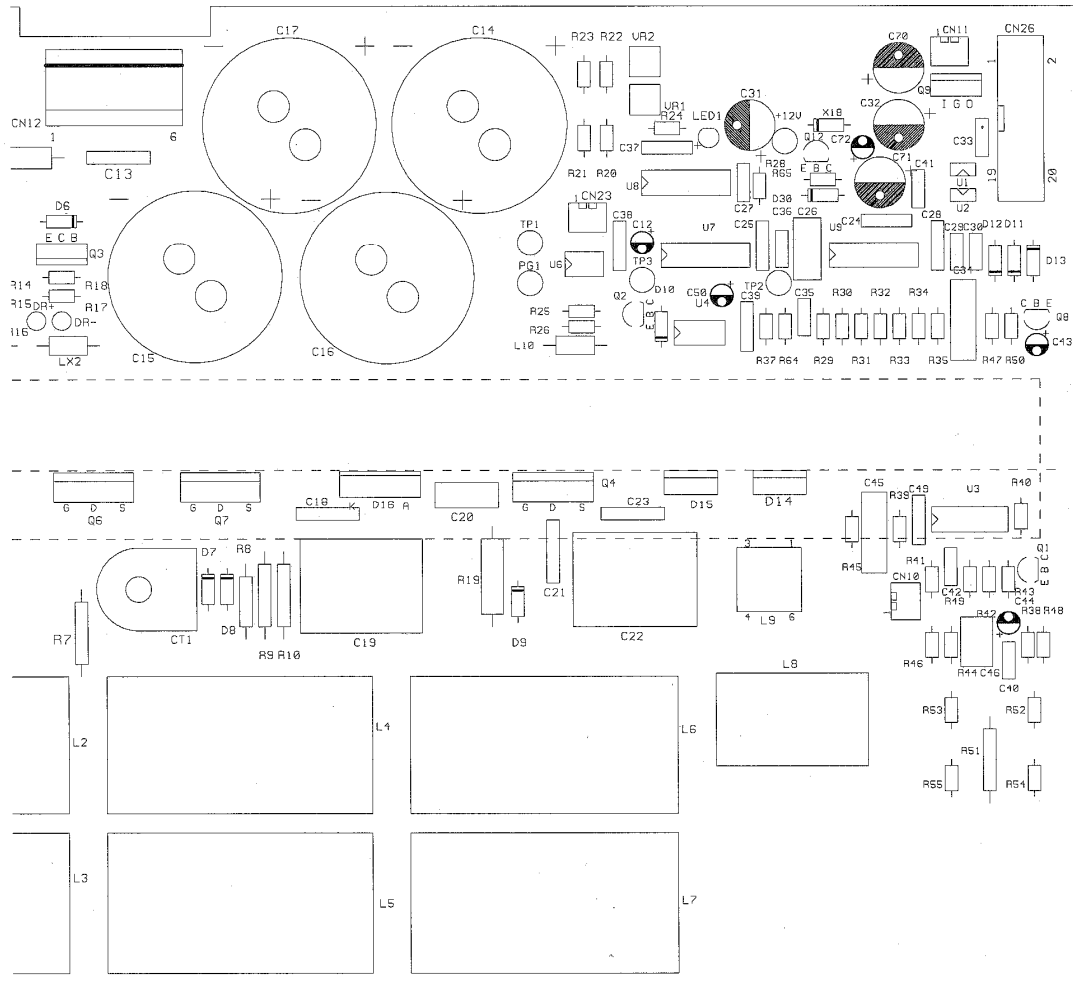

I Board-2

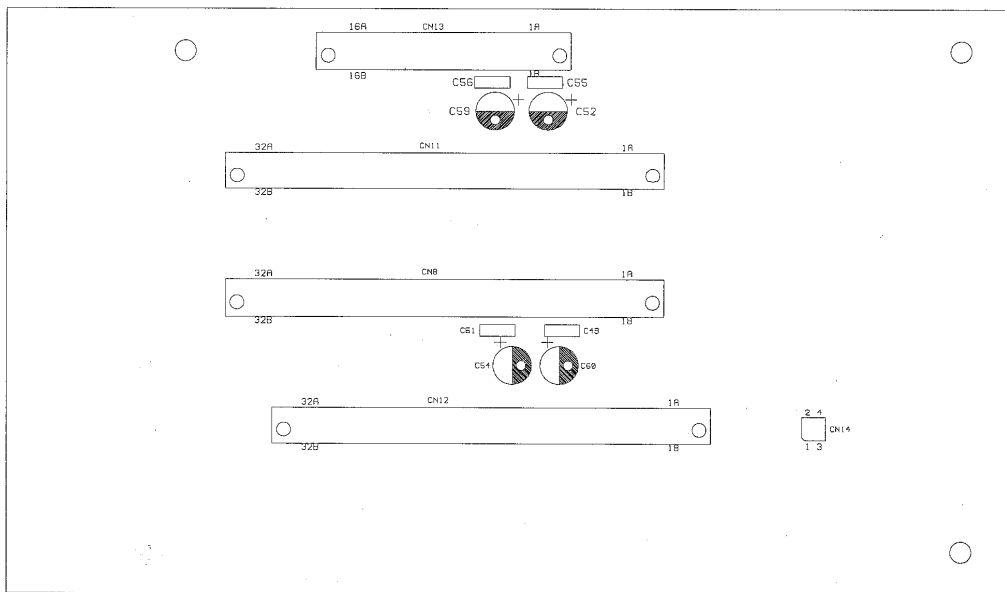

M1 Board-1

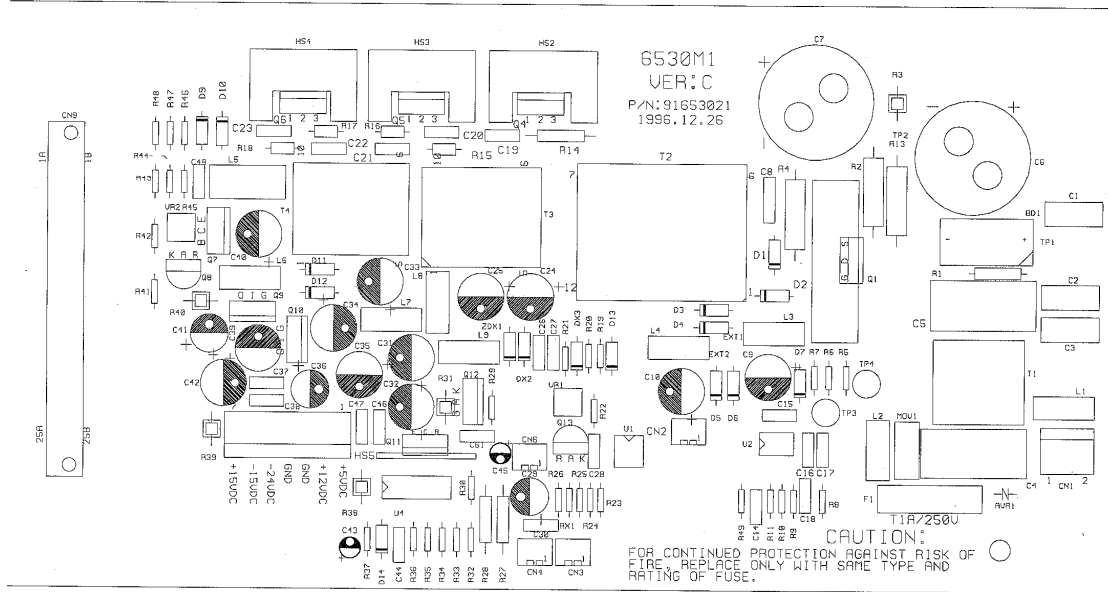

M1 Board-2

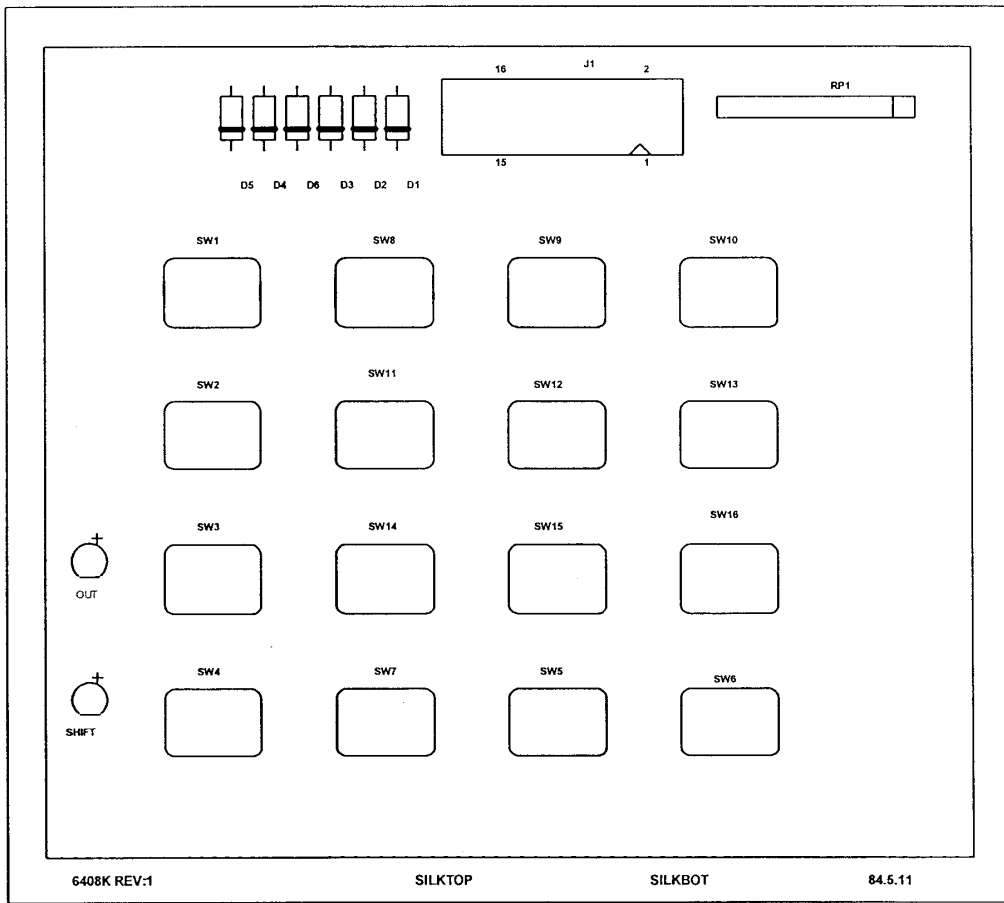

K Board-1



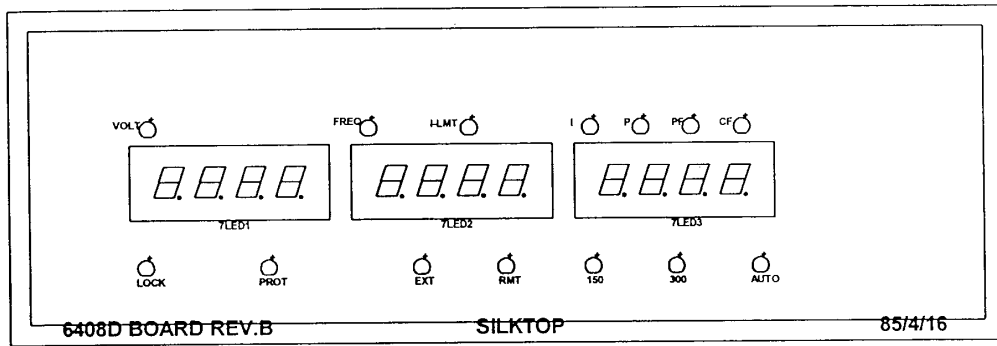

D Board (front)

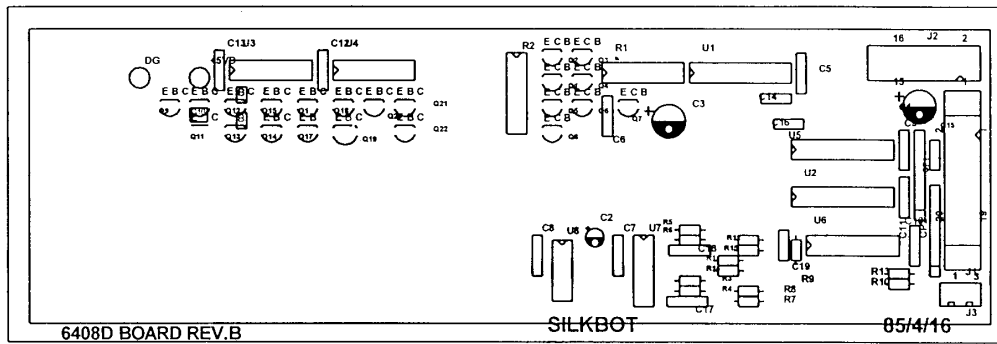

D Board (rear)

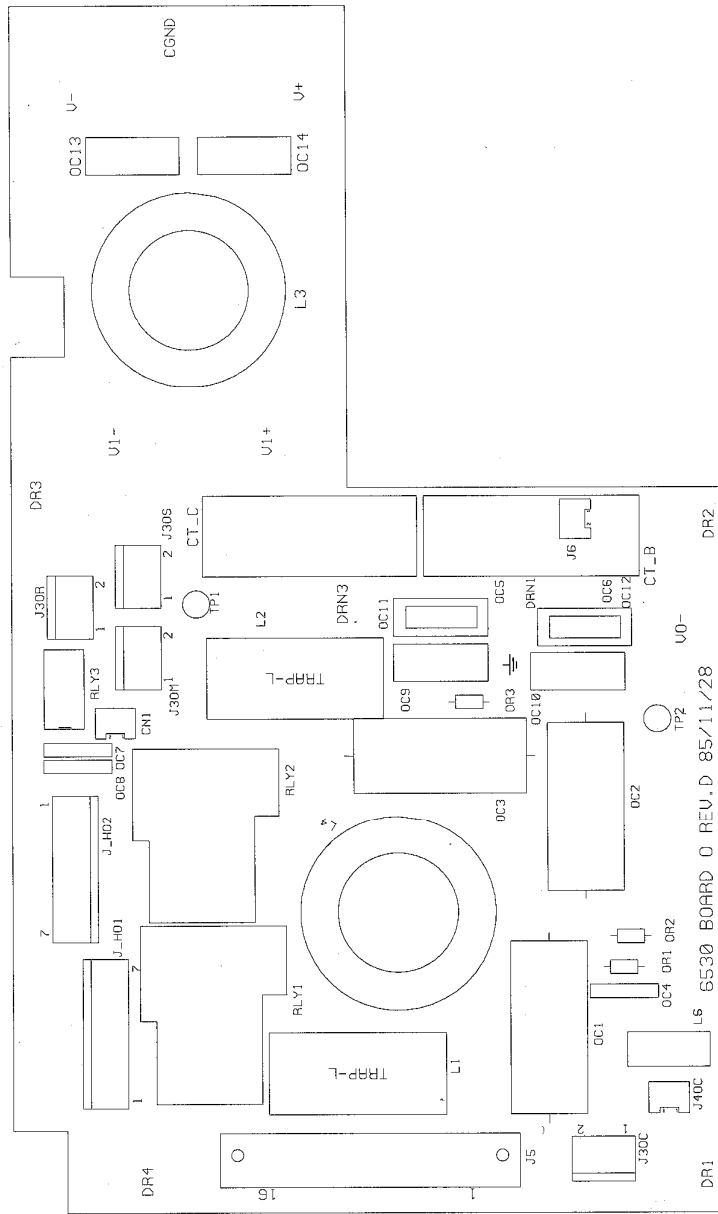

O Board

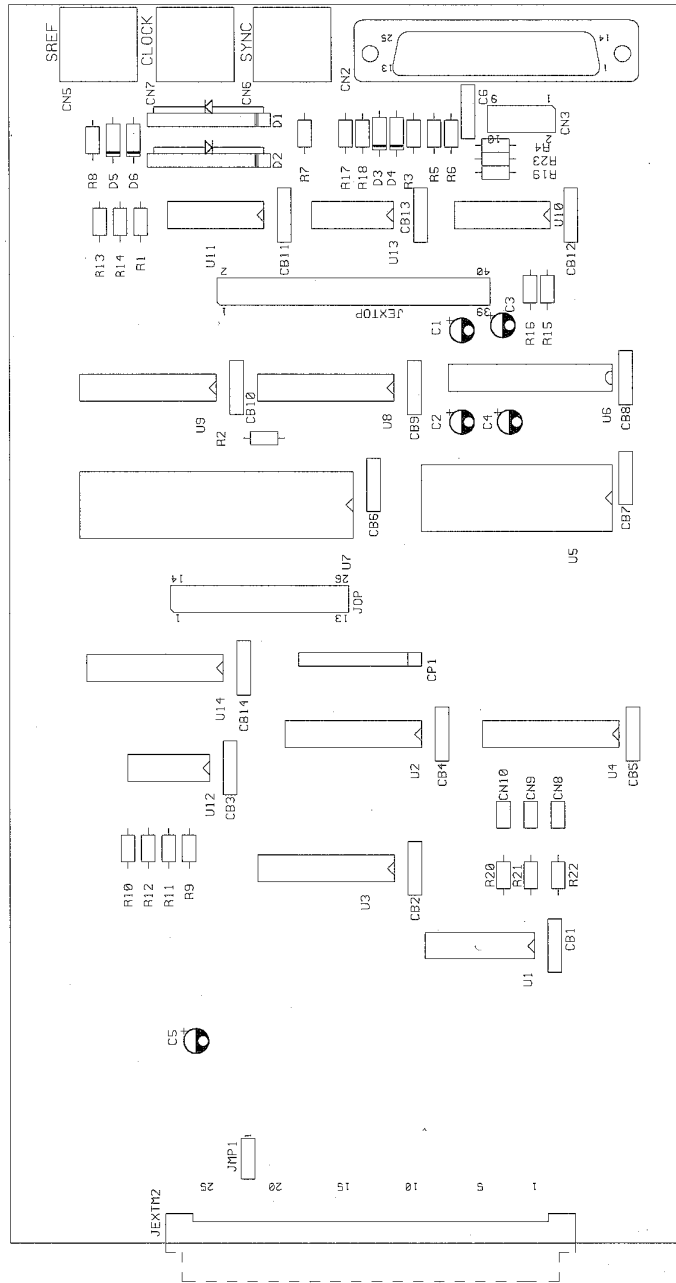

Extended Board

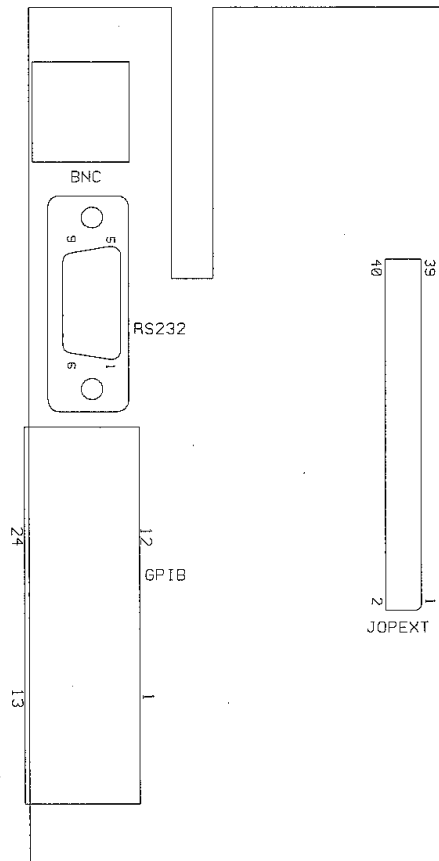

Optional Board