

**Chroma<sup>®</sup>**

**PROGRAMMABLE  
AC SOURCE  
6400 Series**

---

Service Manual

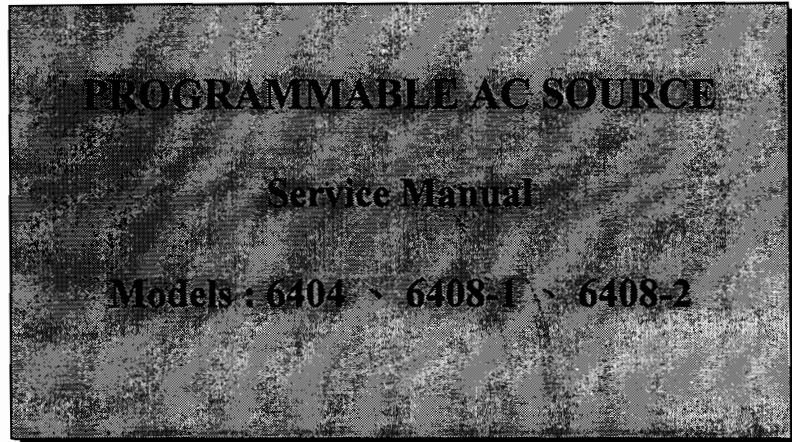

**CHROMA ATE INC.**

43 Wu-Chuan Rd., Wu-Ku Industrial Park , Wu-Ku , TAIPEI TAIWAN R.O.C.

TEL : ( 02 ) 298-3855

FAX : ( 02 ) 298-3596

# Warranty

All Chroma instruments are warranted against defects in material and workmanship for a period of one year after date of shipment. Chroma agrees to repair or replace any assembly or component found to be defective, under normal use during this period. Chroma's obligation under this warranty is limited solely to repairing any such instrument which in Chroma's sole opinion proves to be defective within the scope of the warranty when returned to the factory or to an authorized service center. Transportation to the factory or service center is to be prepaid by purchaser. Shipment should not be made without prior authorization by Chroma.

This warranty does not apply to any products repaired or altered by persons not authorized by Chroma, or not in accordance with instructions furnished by Chroma. If the instrument is defective as a result of misuse, improper repair, or abnormal conditions or operations, repairs will be billed at cost.

Chroma assumes no responsibility for its product being used in a hazardous or dangerous manner either alone or in conjunction with other equipment. High voltage used in some instruments may be dangerous if misused. Special disclaimers apply to these instruments. Chroma assumes no liability for secondary charges or consequential damages and in any event, Chroma's liability for breach of warranty under any contract or otherwise, shall not exceed the purchase price of the specific instrument shipped and against which a claim is made.

Any recommendations made by Chroma for use of its products are based upon tests believed to be reliable, but Chroma makes no warranty of the results to be obtained. This warranty is in lieu of all other warranties, expressed or implied, and no representative or person is authorized to represent or assume for Chroma any liability in connection with the sale of our products other than set forth herein.

CHROMA ATE INC.

43 Wu-Chuan Road, Wu-Ku,

Taipei, Taiwan

Tel: 886 -2-298-3855

Fax: 886-2-298-3596

## SAFETY SUMMARY

The following general safety precautions must be observed during all phases of operation , service , and repair of this instrument. Failure to comply with these precautions or with specific WARNINGS given elsewhere in this manual violates safety standards of design , manufacture , and intended use of the instrument.

Chroma Electric Corporation assumes no liability for the customer's failure to comply with these requirements.

### BEFORE APPLYING POWER

Verify that the product is set to match the line voltage.

### PROTECTIVE GROUNDING

Make sure to connect the protective grounding to prevent an electric shock before turning on the power.

### NECESSITY OF PROTECTIVE GROUNDING

Never cut off the internal or external protective grounding wire or disconnect the wiring of protective grounding terminal. Doing so will cause a potential shock hazard that could result in personal injury.

### FUSES

Fuses are contained inside the unit , and are not user-replaceable. Only trained service personnel should replace the required rated current , voltage and specified type (normal blow , time delay , etc) fuses , and only after identifying and correcting the problem which caused the fuse (s) to blow. Do not use different fuses or short-circuited fuseholders. To do so could cause a shock or fire hazard.

### DO NOT OPERATE IN AN EXPLOSIVE ATMOSPHERE

Do not operate the instrument in the presence of flammable gases or fumes.

### KEEP AWAY FROM LIVE CIRCUITS



Operating personnel must not remove instrument covers. Component replacement and internal adjustments must be made only by qualified service personnel. Do not replace components with the power cable connected. Under certain conditions , dangerous voltages may exist even with the power cable removed. To avoid injuries , always disconnect power , discharge circuits and remove external voltage sources before touching components.

### DO NOT SUBSTITUTE PARTS OR MODIFY INSTRUMENT

Because of the danger of introducing additional hazards , do not install substitute parts or perform any unauthorized modification to the instrument. Return the instrument to a Chroma Sales and Service Office for service and repair to ensure that safety features are maintained.

<b>WARNING</b>	<b>LETHAL VOLTAGES.</b> Ac sources can supply 426 V peak at their output. <b>DEATH</b> on contact may result if the output terminals or circuits connected to the output are touched when power is applied.
----------------	---

## SAFETY SYMBOLS

	<b>DANGER</b> - High voltage .
	<b>Explanation</b> : To avoid injury , death of personnel or damage to the instrument , you must refer to an explanation in the instruction manual .
	<b>Protective grounding terminal</b> : To protect against electrical shock in case of a fault. This symbol indicates that the terminal must be connected to ground before operation of equipment.
<b>WARNING</b>	A <b>WARNING</b> sign denotes a hazard. It calls attention to a procedure , practice , condition or the like , which , if not correctly performed or adhered to , could result in injury or death of personnel.

# Table of Contents

## **Chapter 1**

### **General Information**

- 1.1. Introduction
- 1.2. Test Equipment Required

## **Chapter 2**

### **Basic Operation Information**

- 2.1. Input Power Requirements
- 2.2. Input Connection
- 2.3. Power-on Procedure

## **Chapter 3**

### **Theory of Operation**

- 3.1. General
- 3.2. Overall System Description
- 3.3. AC/DC Power Stage Converter
- 3.4. DC/AC Inverter
- 3.5. CPU
- 3.6 Measurement and Sine wave Generator ( B board )
- 3.7. Keyboard and Display
- 3.8. GPIB/RS-232C/External reference

## **Chapter 4**

### **Adjustment**

- 4.1. Introduction
- 4.2. Initial Setup
- 4.3. Reference Voltage Check & Adjustment
- 4.4. Measurement Adjustment

## **Chapter 5**

### **Trouble shooting**

- 5.1. Introduction
- 5.2. Trouble shooting guide
- 5.3. Trouble shooting Procedure

## **Appendix**

Component Location

## **Chapter1**

### **General Information**

#### 1.1. Introduction

This manual has information to perform calibration , adjustment , basic maintenance and trouble shooting of the 6404/6408 programmable AC Power Source. This manual is intended for use by service trained personnel only.

Detailed information for operating and programming is excluded from this manual. Only sufficient information for service purposes is included. For more detailed operating and programming information , refer to the 6404/6408 user's manual.

#### **WARNING**

**The information in this manual is for the use of service trained personnel only.**

**To avoid electrical shock , do not perform any procedures in this manual or do any servicing to the 6404/6408 Ac power source , unless you are qualified to do so.**

1.2. Test Equipment Required :

TYPE	Required Characteristics	USE
DMM	5 1/2 digits	T 、 C
Current Shunt	Accuracy with 0.01A	C
Load	800W	C

T : Trouble shooting                      C : Calibration



## Chapter 2

### Basic Operation Information

#### 2.1. Input power requirements

Model	input voltage range	input frequency range	input current
6404	90-132V	47Hz-63Hz	7A Max
	180-250V	47Hz-63Hz	3.5A Max
6408-1	90-132V	47Hz-63Hz	12A Max
6408-2	180-250V	47Hz-63Hz	6A Max

**\*\* CAUTION \*\***

The instrument may be damaged if it is operated at an input voltage that is outside the configured input range.

#### 2.2. Input Connection

The input outlet is located on the rear panel of the instrument. Refer to Figure 2-1 on the following page. The instrument must be operated from a three-wire single phase AC power source. The power source must have a current rating greater than or equal to the instrument fuse rating.

**WARNING**

To protect operating personnel, the wire connected to the or GND terminal must be connected to an earth ground. In no event should this instrument be operated without an adequate ground connection.

### 2.3. Power-on Procedure

Apply the line power and turn on the front panel power switch. No loads should be connected to the output terminal block. The instrument performs a series of self tests each time when turning on the power-switch. All front panel LEDs , including alphanumeric and indicator LEDs , are turned on and holds about 3 seconds. Then , the seven segment LEDs , alphanumeric LEDs will show “SELF TEST” indicating that the 6408/6404 is running self-test routines.

Then , the seven segment LEDs display model number (6408 or 6404) , firmware version number ( e.g. “ ver 1.2 ” ) as below :

6408 ver 1.2
--------------

If any error is detected during the self-test routine , an error message will be displayed on the LED. For example.

RAM TEST ERR
--------------

The following table shows all the error messages and recommended actions :

Item	Error Message	Description	Action
1	RAM TEST ERR	System memory test failure.	refer to Trouble Shooting in Chapter 5
2	EEPROM ERR	System EEPROM test failure.	
3	DSP COMM ERR	CPU and DSP communication test failure.	

After the self-test routines are completed the LEDs turn to show the current setting values of V and F , and measured value of I , indicating the 6408/6404 is ready for use as below :

0.0 60.0 0.00
---------------

<p><b>** WARNING **</b></p> <p>Before the instrument is turned on , all protective earth terminals , extension cords , and devices connected to the instrument should be connected to a protective earth ground. Any interruption of the protective earth grounding will cause a potential shock hazard that could result in personal injury.</p>
---

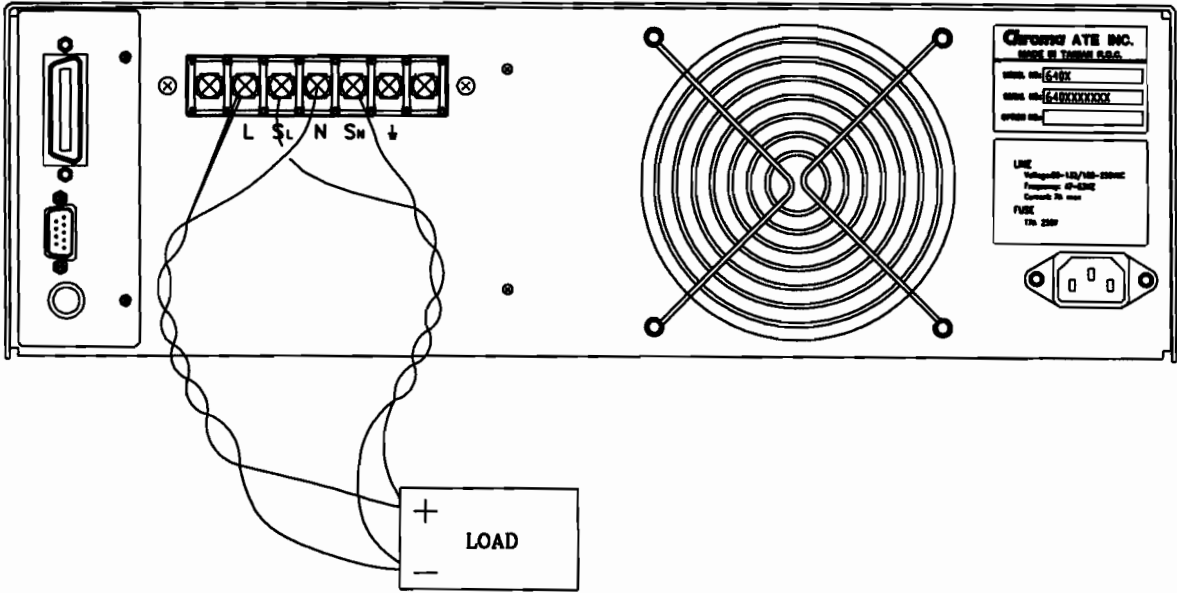

Figure 2-1 Rear Panel



## **Chapter3**

### **Theory Of Operation**

#### 3.1. General

The 6408/6404 AC power source consists of 8 main boards and other discrete components. Each has its specific function that will be described in the sections followed.

#### 3.2. Overall System Description

Figure 3-1. shows the overall system blocks. Main power flows through the A/D , D/A power stage converter. The A/D power stage is designated as **I board** and generates DC voltage from the line input. The DC voltage of the A/D output is applied to the input of the next power stage.

The **P board** of D/A stage take power from the A/D output , the fan speed control circuit is also on **P board**.

The isolated output transformer takes power from D/A output and transfer it to two sets at secondary , connected in parallel or serial at **O board** to obtain more current or higher voltage.

**A board** is identified as **CPU**. The 64180 CPU is used here to communicate with DSP at **B board** for programming variable output voltages and frequencies , to monitor or control the signal and interrupts , and to perform remote control through the GPIB or RS-232C interface on the optional board.

**B board** is identified as the sine wave generator , measurement unit , and D/A power stage controllers. It generates sine waves acting as the reference input of the D/A stage. All measurement functions are done here.

The seven-segment LEDs and keyboard are identified as **D board** and **K board** respectively , which makes the interfaces between the user and the instrument. Fan is used to remove extra heat from interior of the 6408/6404 AC Source.

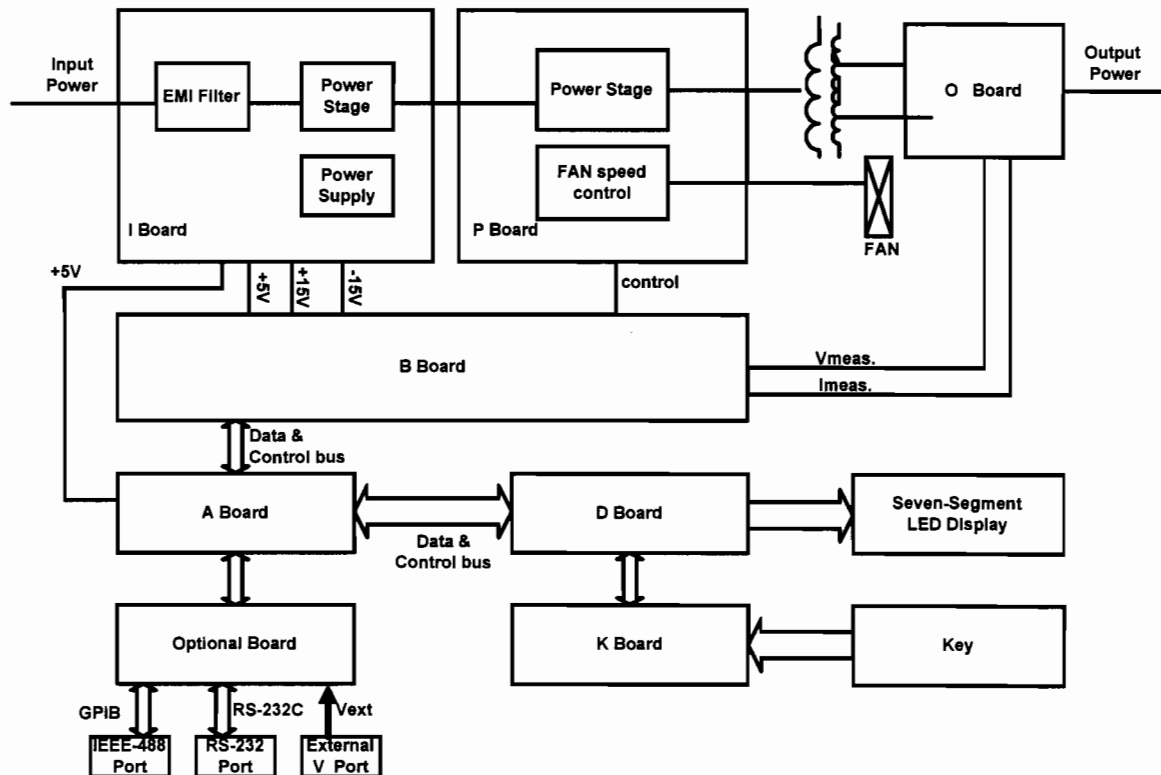

Figure 3-1 System Block Diagram

### 3.3. AC/DC Power Stage Converter

This assembly is identified as I board. It generates the high voltage  $V_{dc}$  supply. This power stage also include power supply circuits that generate the DC voltage identified as +15V , -15V , +5V. Power factor correction technology for 6408 is used to achieve a power factor of 0.98 or more.

### 3.4. DC/AC Inverter

This assembly comprises of control part at **B board** , **P board** , output transformer , **O board**. It generates an AC output sine wave.

Advanced PWM technology is applied to this system to obtain more stability. Maximum peak current is clamped to protect output power MOSFET. Overload protection (OLP) , which contains output protection against short circuit , is also implemented here.

**P board** is made up of the full bridge of MOSFET power components. The PWM control signal from controller is applied to the full bridge to amplify the output. The low pass filter can reject the switching frequency component.

**O board** consists of the range relays and output relays. Output relays can isolate the AC source from the external source when any error occurs. Range relays connect the two sets of the secondary of output transformer together in parallel or serial.

### 3.5. CPU

The CPU , A board , uses a 64180 CPU to control the circuit. A microprocessor circuit accepts commands from the GPIB or RS-232C controller , or from the front panel keyboard. It sends digital programming information to DSP controller to set the output parameters of the power source. Data from measurement circuits are accepted and reported to the display and GPIB. Setup parameters and one key operation data are stored in EEPROM.

### 3.6. Measurement and Sine wave Generator ( B board )

Measurement circuits on **B board** monitor voltage , current , power etc. Voltage from the output is scaled , and sent to the DSP processor by the analog-to-digital converter.

Current sensed by the current shunt is scaled , and sent to the DSP processor by the analog-to-digital converter.

The true-RMS measurement is made by software of the DSP processor , and so is the power.

The digital-to-analog converter on **B board** sets the DC voltages that are used for the programmable voltage function. Low pass filter is applied to smooth the reference input signal.

### 3.7. Keyboard and Display

The keyboard is designated as **K board** which is connected through a short flat ribbon cable. It holds 16 key switches and 2 LED indicators. The display is also connected from **B board** through a short flat ribbon cable. It comprises of three 4-digit seven-segment LEDs. Programming of V , F can also be done by rotary knob on the front panel.

### 3.8. GPIB/RS-232C/External reference

The remote control is done through the GPIB or RS-232C interface on the optional board which is connected through the flat ribbon cable from **A board**. External reference is for the user to use DC reference to control the amplitude of output AC voltage.



## Chapter4 Adjustment

### 4.1. Introduction

This section provides basic adjustment information for the 6408/6404 AC power source. The operation verification tests comprise a short procedure to verify that the unit is performing properly, without testing all specified parameters. After trouble shooting and repair of a defective unit you can usually verify proper operation with the adjustment procedure in order to ensure a proper performance.

### 4.2. Initial Setup

- a. Disconnect the line cable and all loads from rear terminals.
- b. Remove the top cover by removing the top screws.
- c. Reconnect line cable and turn on AC power.
- d. Turn off AC power when making or removing connections to the power source.

### 4.3. Reference voltage check & adjustment

Set DMM at DC range to measure the test pin of TPREF of B-board.(DMM Low at AG, High at the test pin)

Trim the VR6 to adjust the voltage of TPREF into the range :  $-5.1200 \pm 0.0004V$ .

### 4.4. Measurement adjustment

This section contains the adjustment procedure to verify the measurement of the output voltage and current of the AC Source.

If the measurement result is inaccurate enough, the user may recalibrate it according to following procedure.

Note : Before doing the adjustment, make sure the ext-prog LED is off.

4.4.1. Voltage Measurement adjustment :

press **< SHIFT >** key and make sure the shift LED “ ON ” , then keep pressing the **< 3 >** and **< 4 >** keys simultaneously about three seconds until the display shows :

TEST PLAN 1

press **< 4 >** , **< ENTER >** , and the display will show :

4. SYSTEM TEST

**Note :** you can exit from this adjustment by pressing **< OUT/QUIT >** key.

Use the DMM to measure the AC source output voltage.

press **< 1 >** and the display shows :

1. dA GAIN ADJ

Trim the RX20 of B-Board until DMM Reading =  $150.0 \pm 0.1V$  , then press **< 2 >** and the Display shows :

2. V REAS XXXX

XXXX is the measured value of the output voltage  $V_0$

adjust VR2 until  $XXXX = V_0 \pm 0.0V$  , then press **< ENTER >**

adjust VR1 until  $XXXX = V_0 \pm 0.0V$  , then press **< ENTER >**

adjust VR3 until DMM reading =  $150.0 \pm 0.1V$

Then the adjustment of output voltage accuracy and voltage measurement accuracy is completed through above procedures.

You can press **< OUT/QUIT >** key twice to exit from voltage measurement adjustment

#### 4.4.2. Current Measurement Adjustment

make sure the voltage range is in the 150V range.

1> Set  $V_{out} = 110V$  ,  $F = 60Hz$

2> Connect a current shunt and a linear load to the AC source output.

3> First , the load is  $1.25 \pm 0.05A$  for 6404  
 $2.50 \pm 0.10A$  for 6408

adjust VR5 of B-Board until AC source display

$I_{reading} = I_{shunt} \pm 0.00A$

Second , adjust load to  $2.50 \pm 0.10A$  for 6404  
 $5.00 \pm 0.20A$  for 6408

adjust VR4 of B-Board until  $I_{reading} = I_{shunt} \pm 0.00A$

then the current measurement accuracy is completed through above procedures.

#### 4.4.3. System Test

After finishing the recalibration of the measurement , you can check if the output voltage is within spec to the setting value , and the frequency measurement is checked as well at this test.

To enable the test , follow the procedures described below :

press the **<SHIFT>** key , the green LED turns on , then press the **<0>** key and hold it for 3 seconds , until the red 7-segment LEDs display the following :

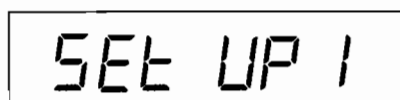

SET UP 1

**Note :** If the user see the red indicator LED of “ LOCK ” turning on before or during the **<0>** key , please release and press the **<0>** key again to switch it off. Then , press firmly the **<0>** key to wait for the setup screen.

1. Press **< 5 >** , and **< ENTER >** , then the display shows :

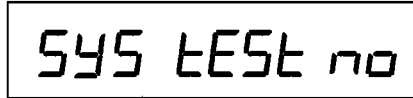

SYS tEST no

2. Trun  to change the option to be “ YES ” and press **< ENTER >**  
The 6408/6404 performs system test after pressing **< ENTER >** .  
Upon completion of test , the 6408/6404 displays test result showing “ PASS ” or  
“ FAIL ”. In case of failure , please refer to the trouble shooting in next chapter.
3. Press **< OUT/QUIT >** twice to exit from setup.

**Note :** Disconnect any output load when doing the system test.

## Chapter 5 Trouble shooting

### 5.1. Introduction

This section provides a technical description of board level trouble shooting procedures for the 6408/6404 programmable AC source.

#### **WARNING**

**Only personnel with knowledge of electronic circuiting and an awareness with the hazards involved should test and trouble shoot the instrument.**

#### **\*\* CAUTION \*\***

**To prevent static zap of ICs , always observe , antistatic techniques when assemblies are handled or serviced**

### 5.2. Trouble shooting guide

To trouble shoot the power source , first determine what the failure is. Then refer to the information in the following paragraphs to determine the defective assembly.

For all trouble shooting procedures , the first step is to check if the power supply of  $+5V_M$  ,  $+5V_D$  ,  $\pm 15V$  work properly. Then , start to take the corrective action according to following direction.

Failure Phenomenon	Go To	Suspect Board
1. Error Message	5.3.1.	
2. Voltage Inaccuracy	5.3.2.	
3. Fan no working	5.3.3.	P 、 I
4. Can not turn on	5.3.4.	I
5. OPP works abnormally		B
6. OLP works abnormally		B
7. Output waveform distorted when load applying		I 、 P

### 5.3. Trouble shooting Procedure

#### 5.3.1. Error Message

Belows are listed all the possible error messages which may appear on the LCD display. The cause and corrective action to be taken is also shown.

Error Message	Cause	Action
RAM TEST ERR	SYSTEM memory test failure	The UX3 of 62256 of A-board might be damaged , try to replace it.
EEPROM ERR	SYSTEM EEPROM test failure	The UX7 of X24C04 of A-board might be damaged , try to replaced it.
DSP COMM ERR	CPU and DSP communication test failure	The UX1 of 64180 of A-board or the UY1 of 2105 of B-board can't communicate with each other properly , check out which one is damaged and replace it.

### 5.3.2. Voltage Inaccuracy

- 1> First , check if the sense cable is correctly connected.
- 2> If voltage accuracy is in the range of  $V_{set} \pm 3V$  , then take the calibration & adjustment procedure to improve the accuracy. ( Refer to chapter 4 )
- 3> If the voltage accuracy is incapable to be readjusted into the expected range , please check the following points.

If any point's voltage is out of its spec , please consult your dealer or inform Chroma directly.

- 4> Checking points. ( 150V range  $V_{set}$  150V out ,  $F = 60\text{HZ}$  , no load )

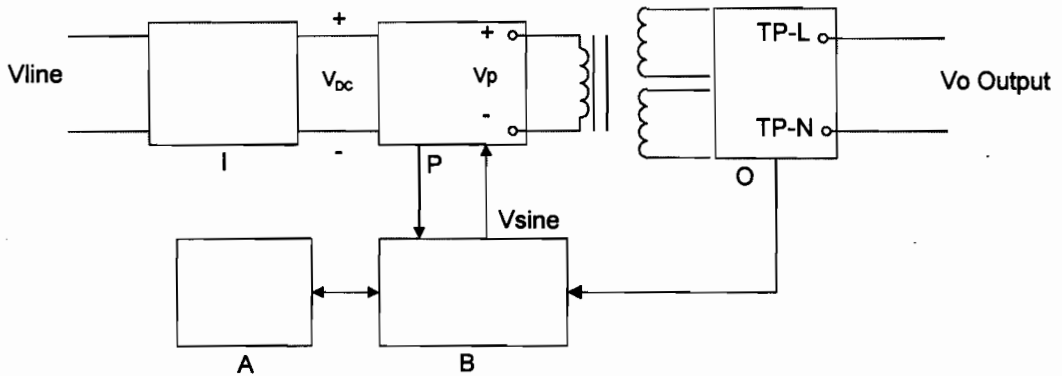

Test point	Range	Decription
$V_{dc}$	$2\sqrt{2} * V_{line}$ for 6404 with 110V input $\sqrt{2} * V_{line}$ for 6404 with 220V input $210 \pm 5 V_{dc}$ for 6408-1 $380 \pm 10 V_{dc}$ for 6408-2	Test pins of “+VDC” and “PG” of P-board.
$V_p$	$90 \pm 1\text{VAC}$ for 6404 $100 \pm 1\text{VAC}$ for 6408-1 $150 \pm 1.5\text{VAC}$ for 6408-2	Terminals of “ $V_o+$ ” and “ $V_-$ ” of P-board.
$V_o$	$150 \pm 3\text{VAC}$ for 6404 、 6408-1 、 6408-2	Test pins of “TP-L” and “TP-N” of O-board.
$V_{sine}$	$7.07 \pm 0.23\text{VAC}$ for all models	Test pins of “TP3” and “AG” of B-board

### 5.3.3. Fan No Working

- 1> Check the FAN connector "JFAN" on the P-board is loose or not.  
If loose , reconnect it firmly.
- 2> Check the voltage between the test pins "+15V" and "AG" on the B-board , is it about  $15\pm 1V$  , if not , try to replace the I-board.
- 3> Check the voltage between the test pins "V-FAN" and "CG" in the P-board ; is it about  $7\pm 1V$  , if not , try to replace the P-board.

### 5.3.4. Can Not Turn On

- 1> First , check if the input voltage is correct ?
- 2> Check the din connectors between I 、 P 、 O 、 A and B boards are loose , reconnect them firmly if loose.
- 3> Check if the FAN is working , if not , try to replace the I-board.



## Component Location

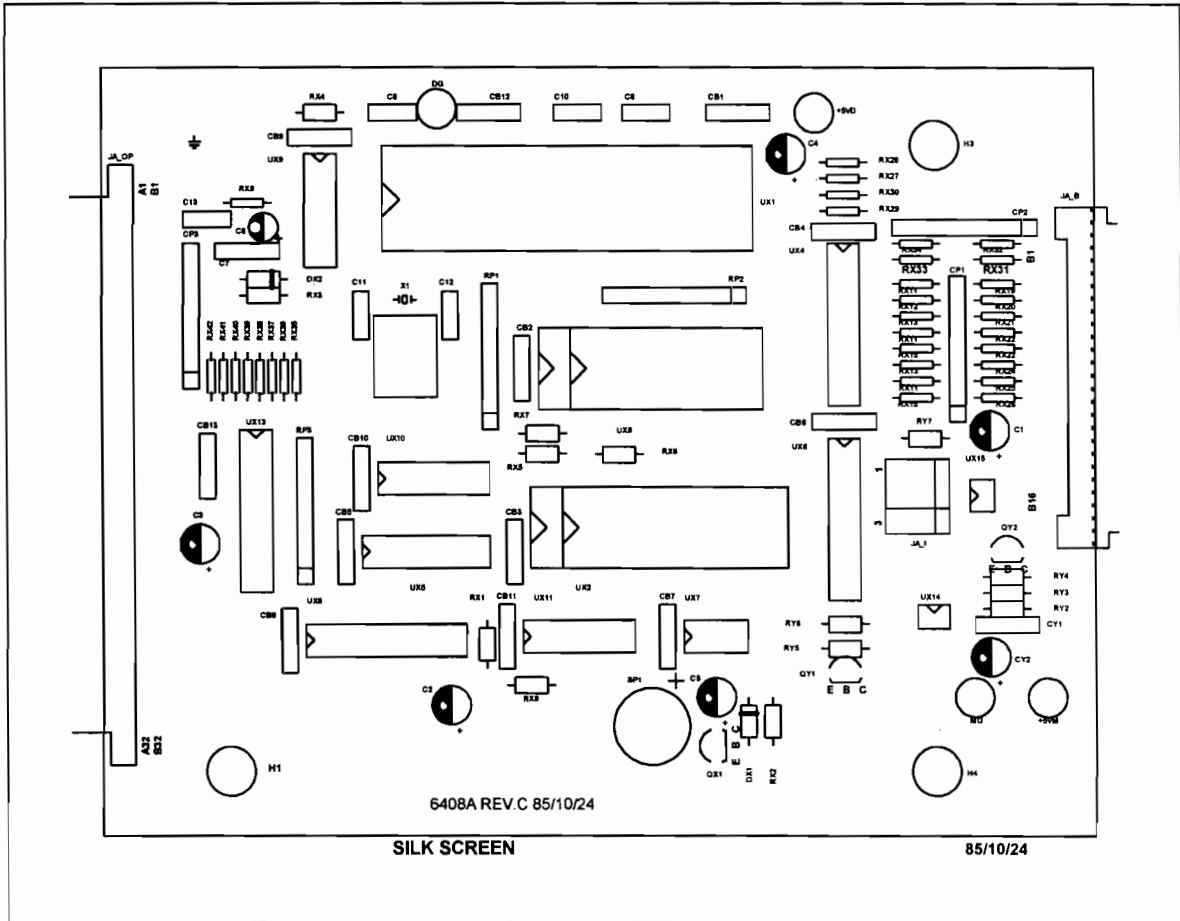

**CPU Board**

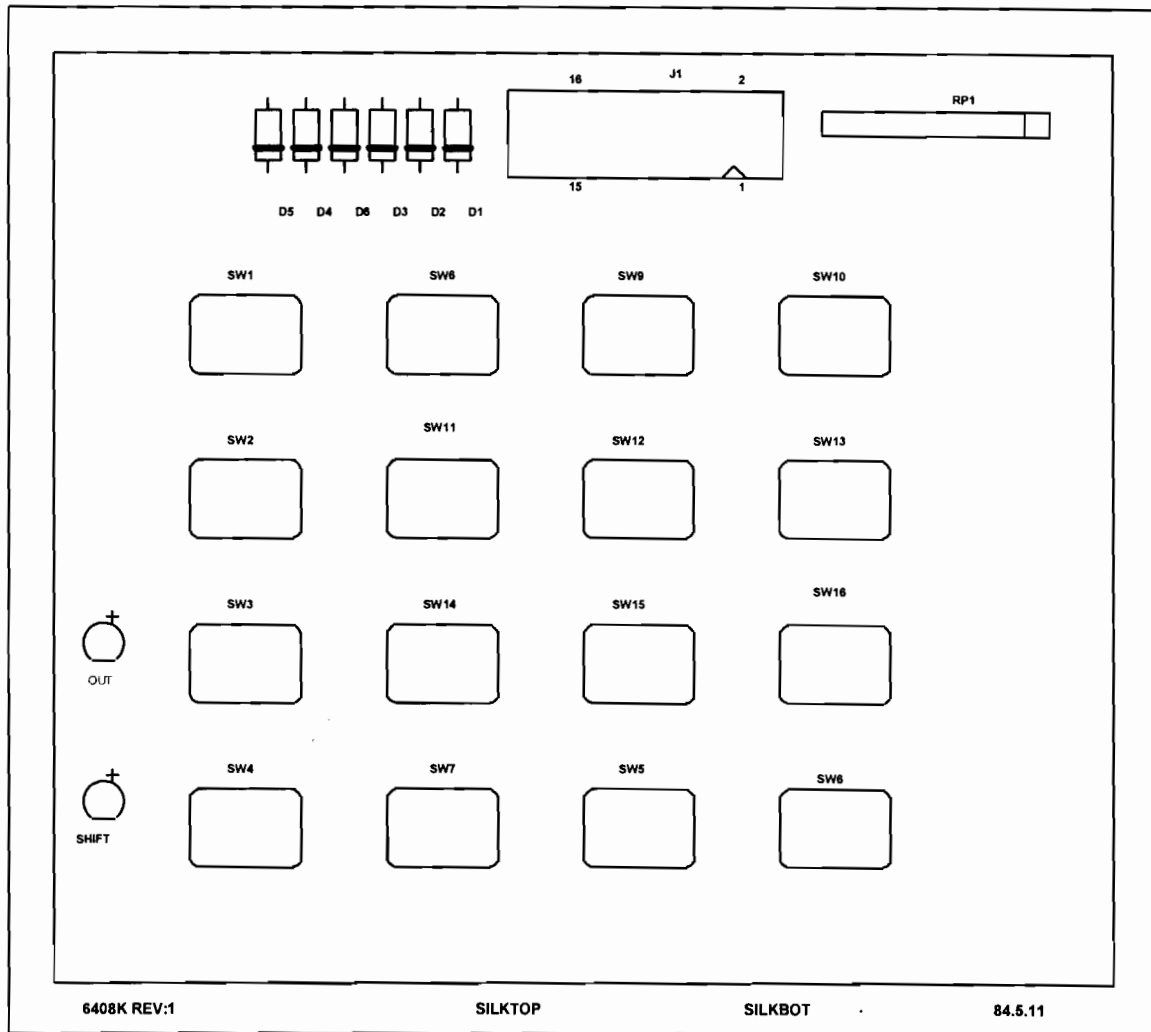

### Key Board

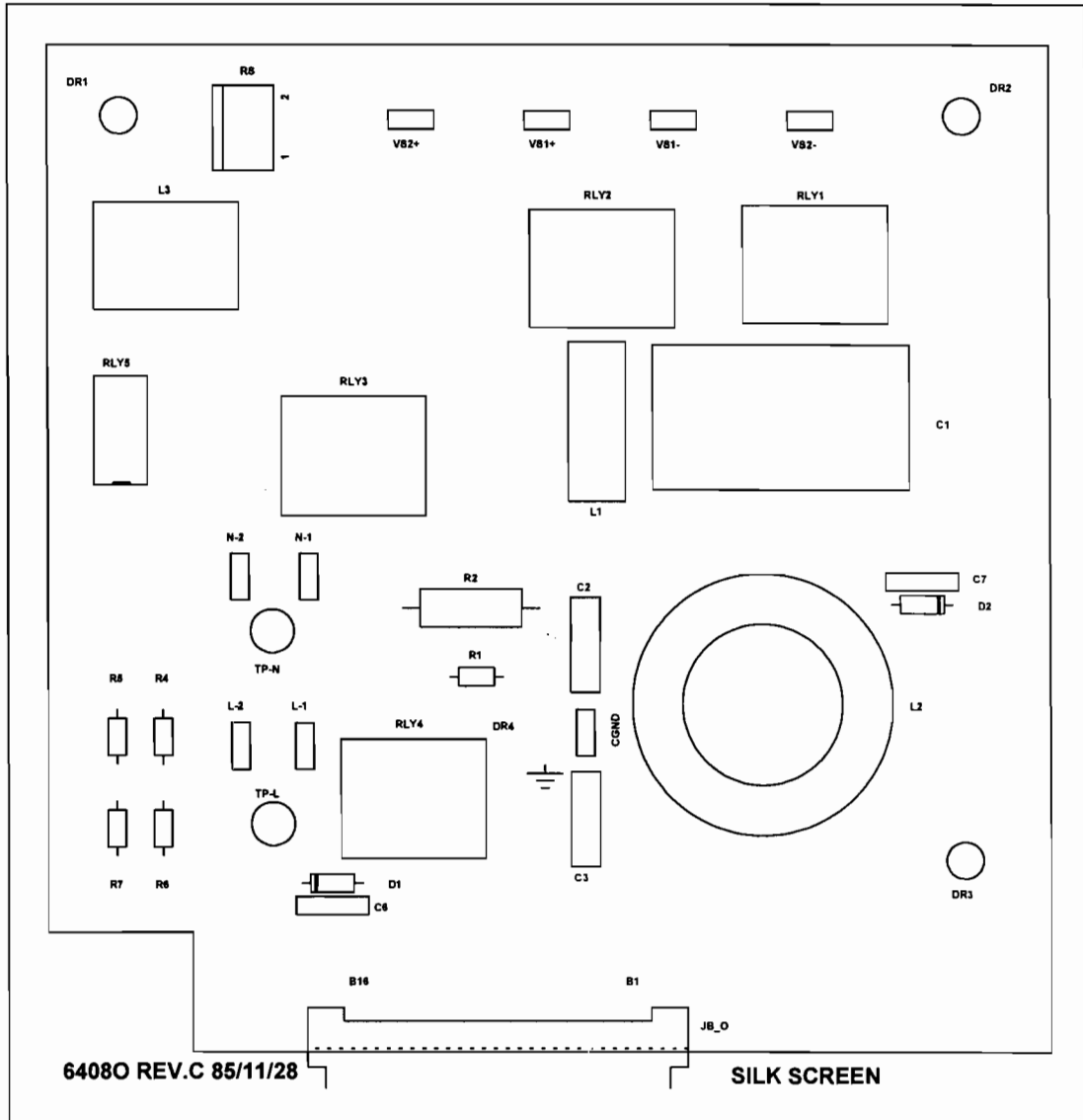

Output Board

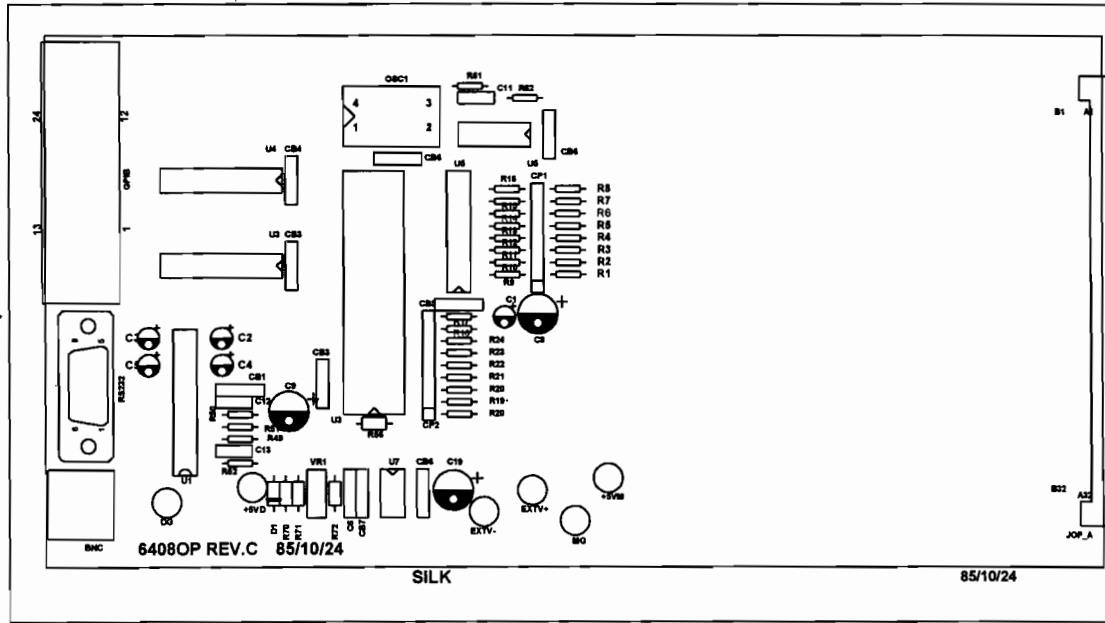

GPIB Board

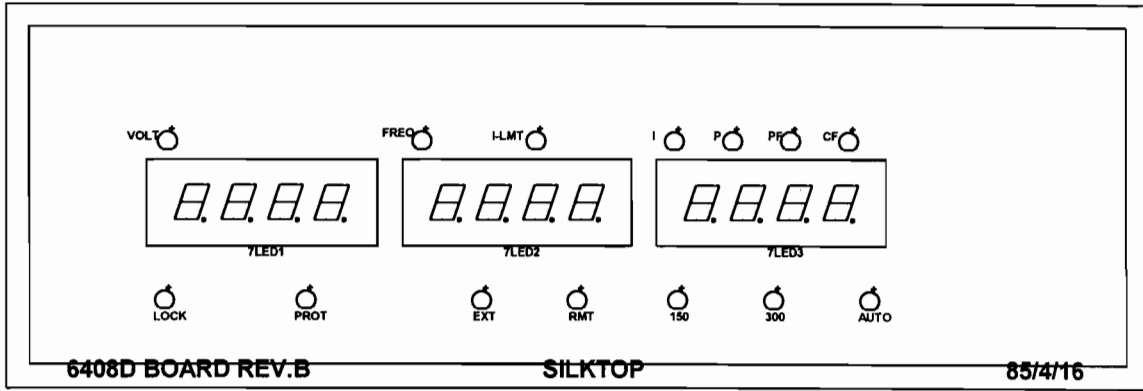

**Display Board**

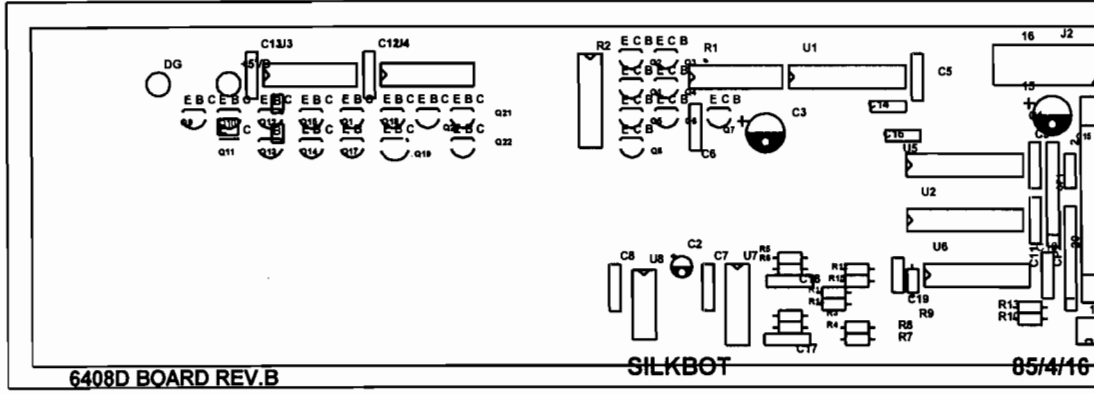

Display Board

# Measurement and Control Board

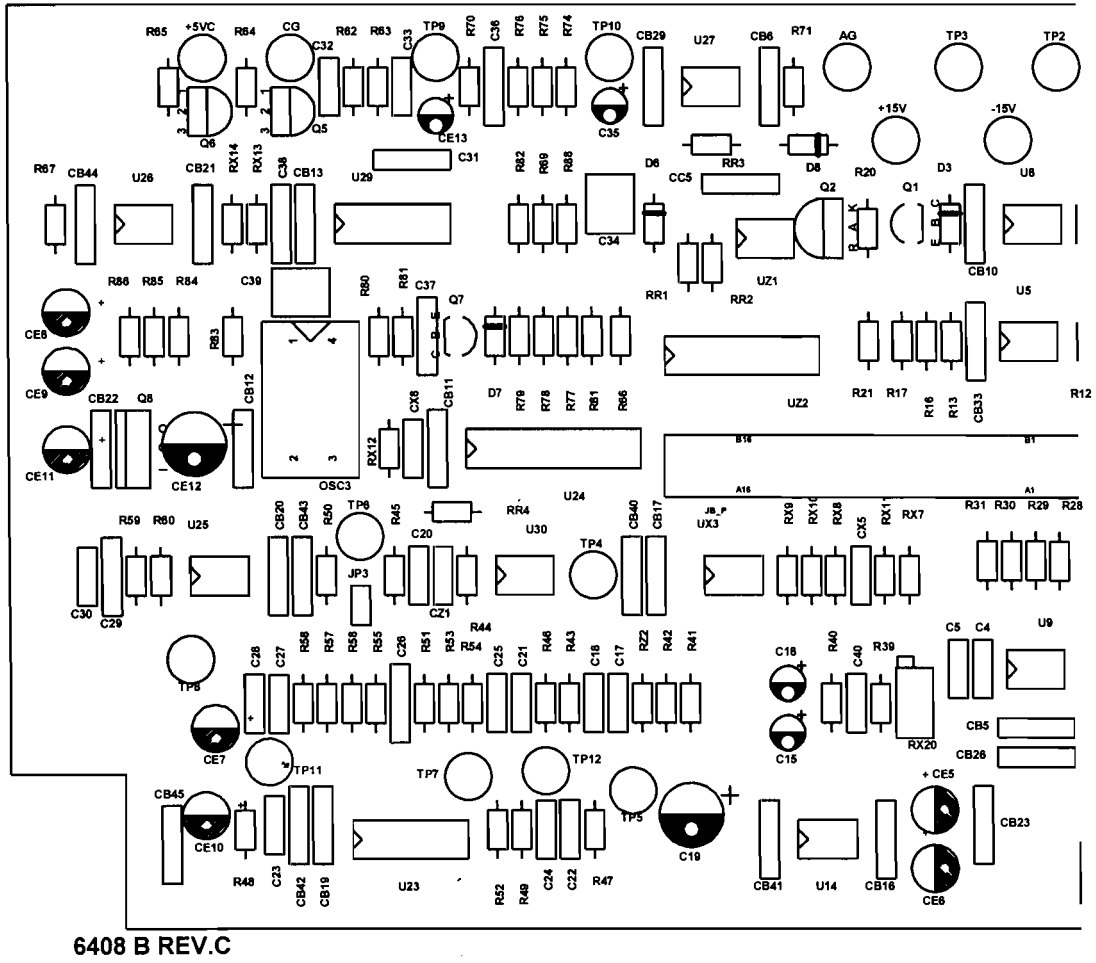

Fig-1

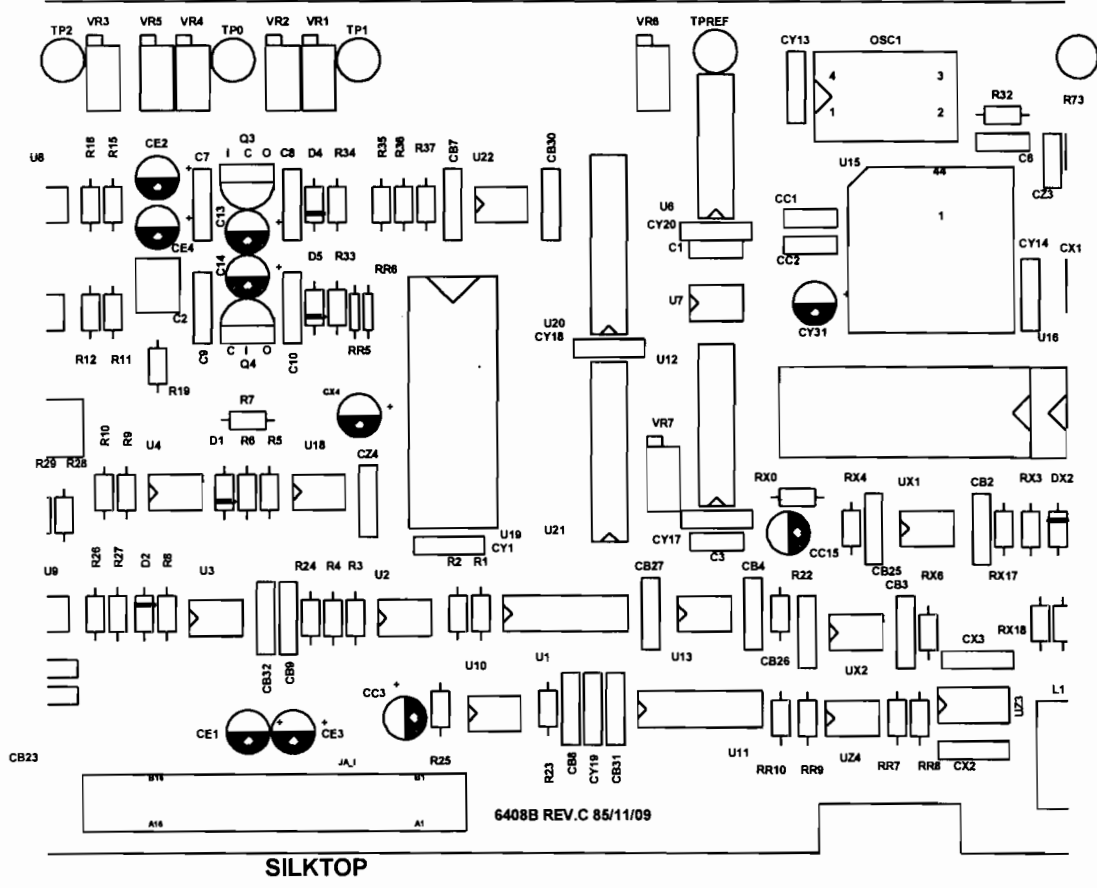
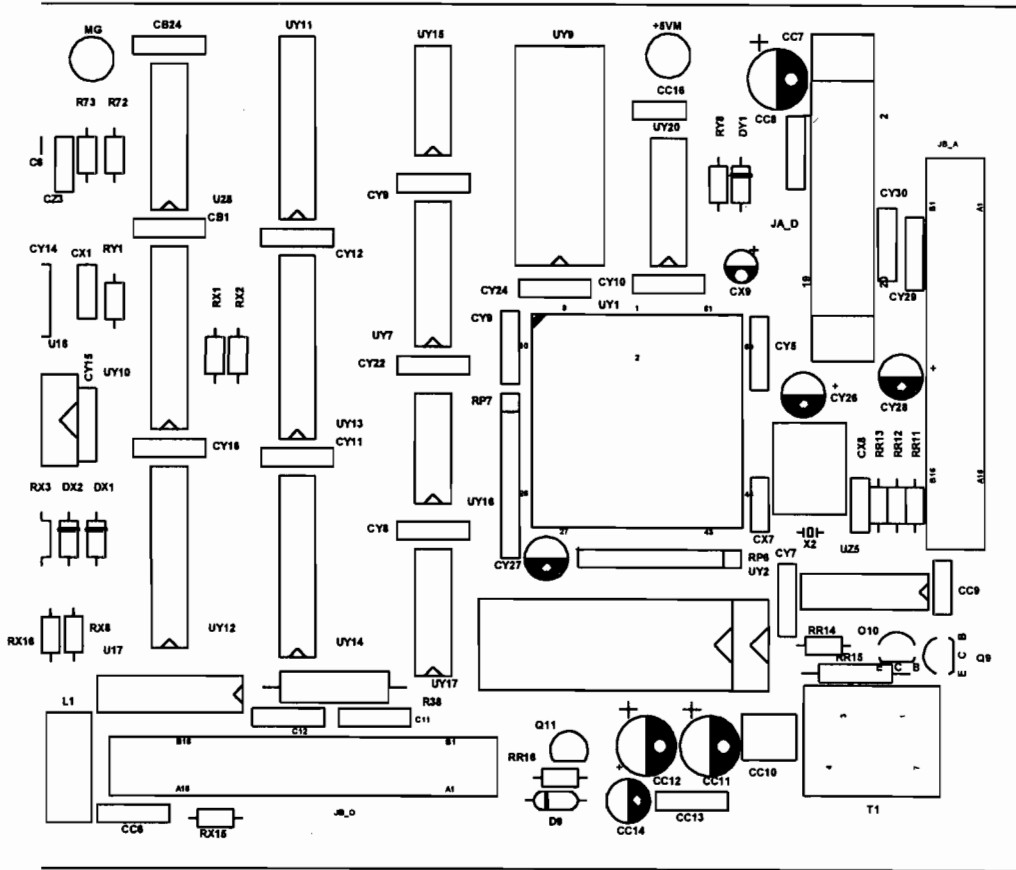

Fig-2





85.11.09

Fig-3

# Inverter Board

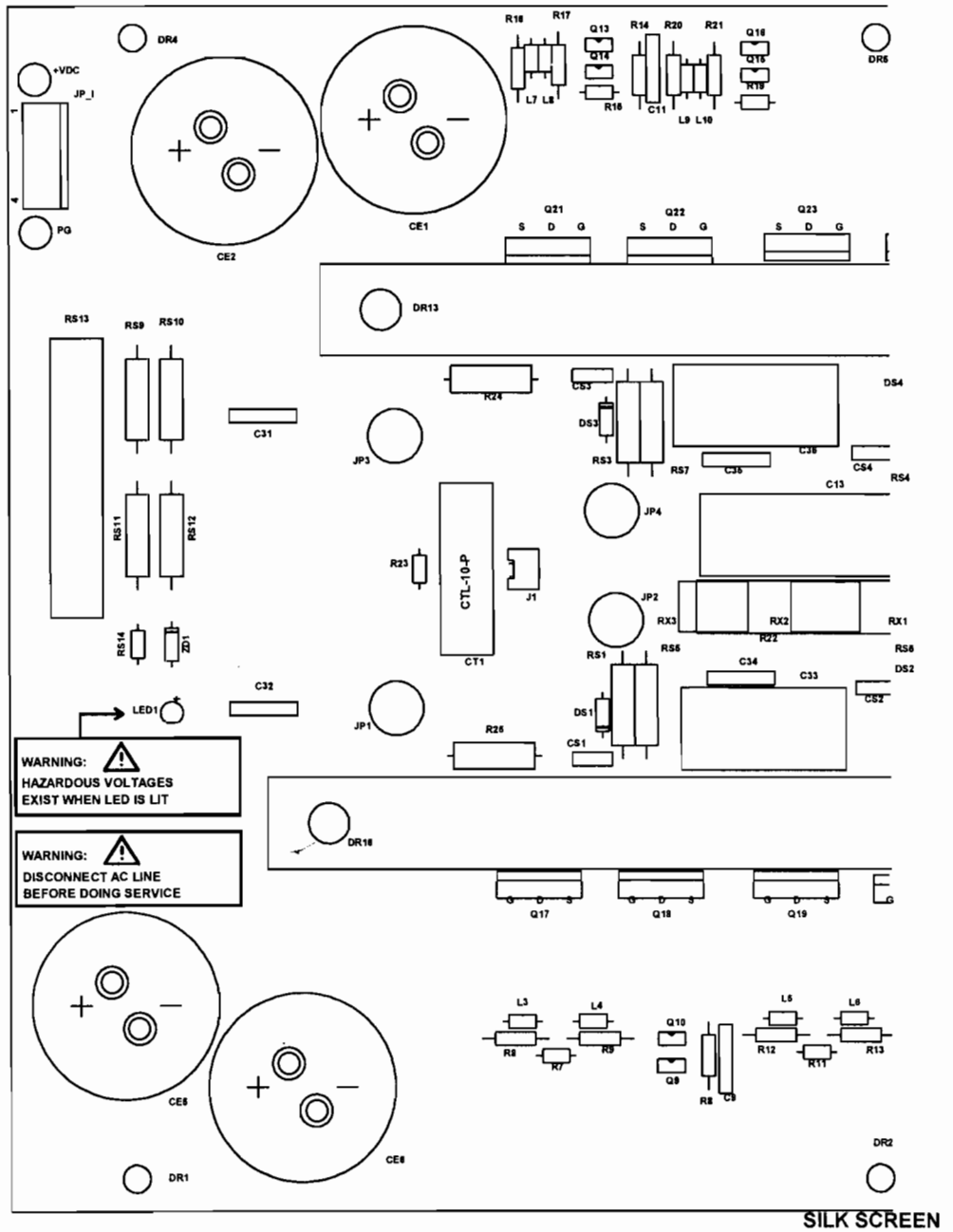

Fig-1

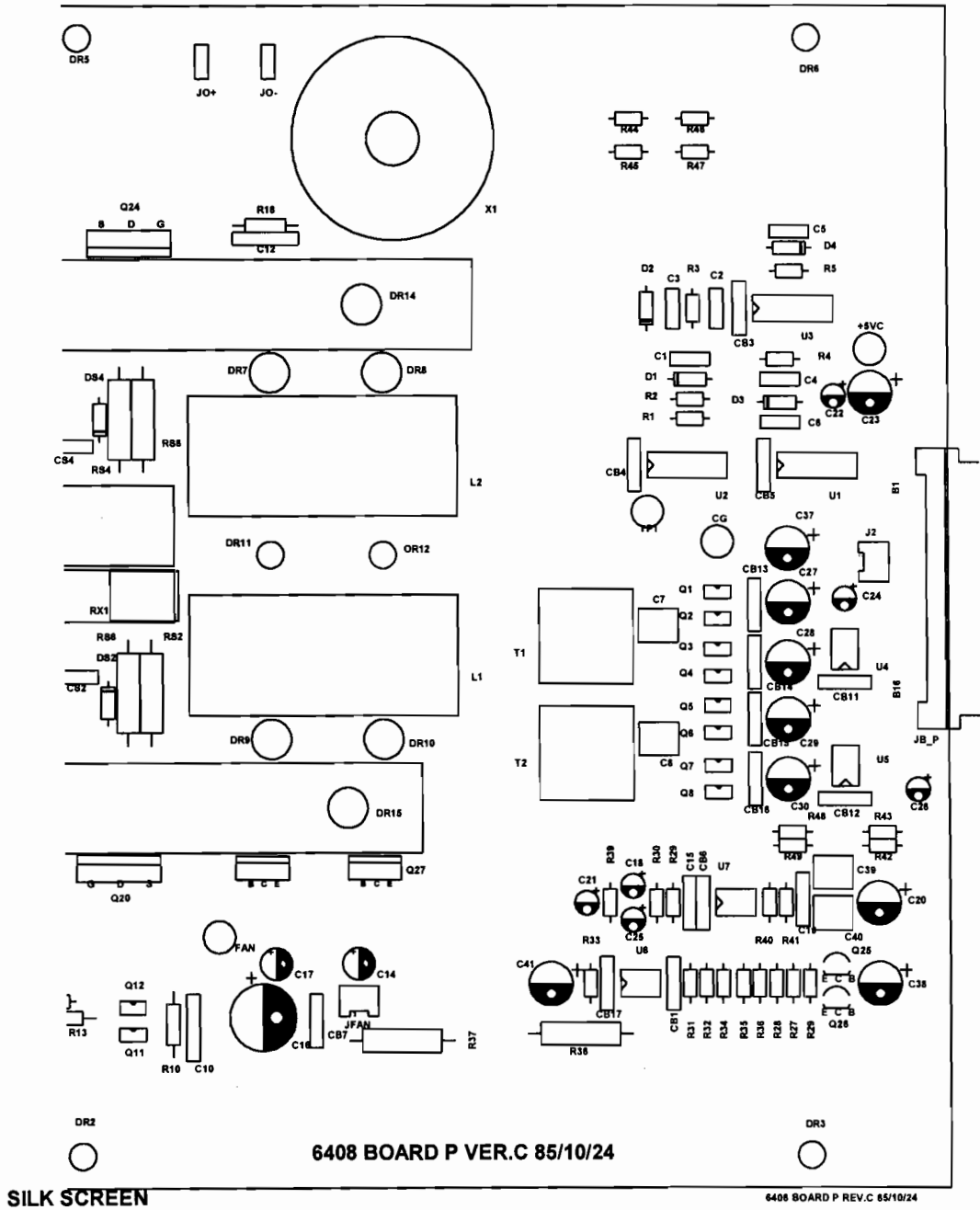

Fig-2

# 6404 A/D Board

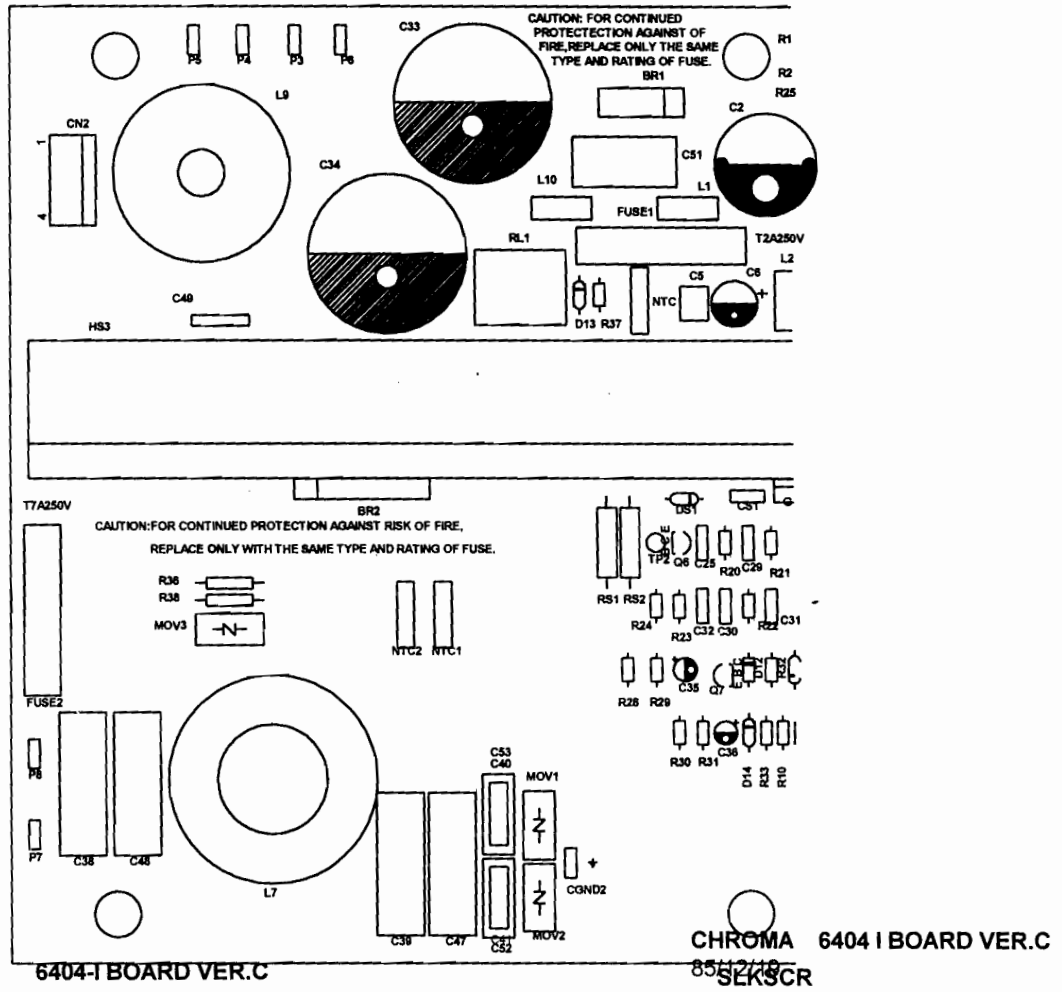

Fig-1

CAUTION: FOR CONTINUED PROTECTION AGAINST OF FIRE, REPLACE ONLY THE SAME TYPE AND RATING OF FUSE.

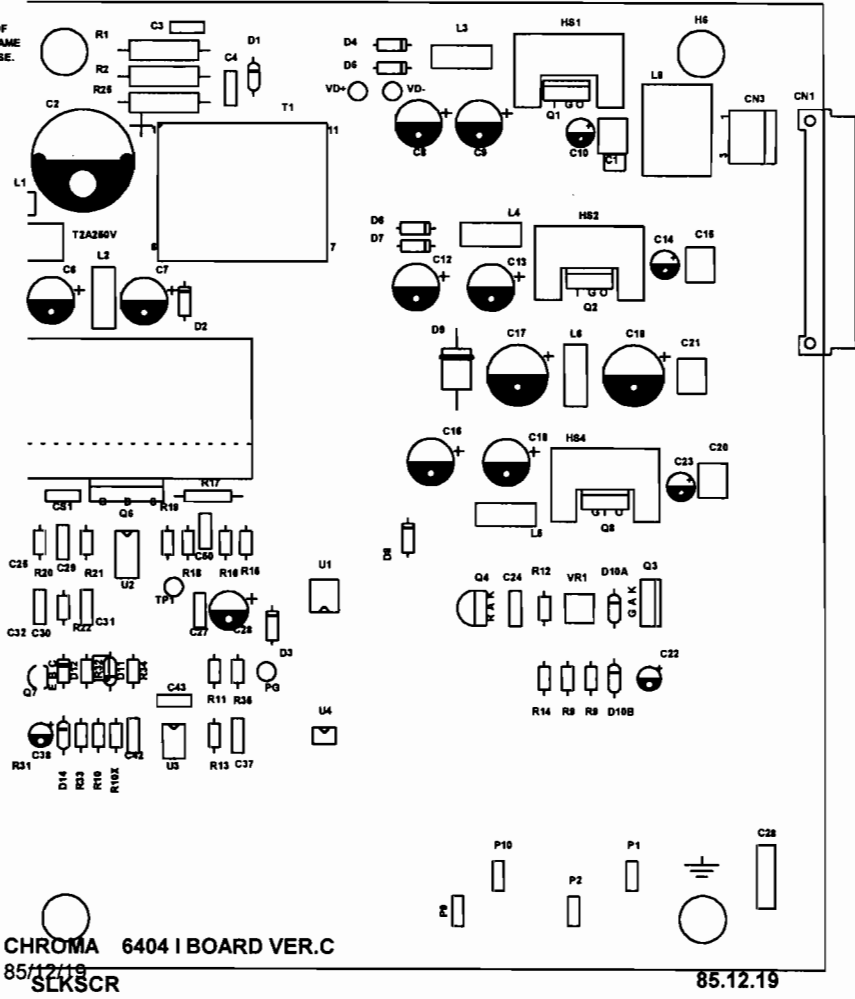

Fig-2



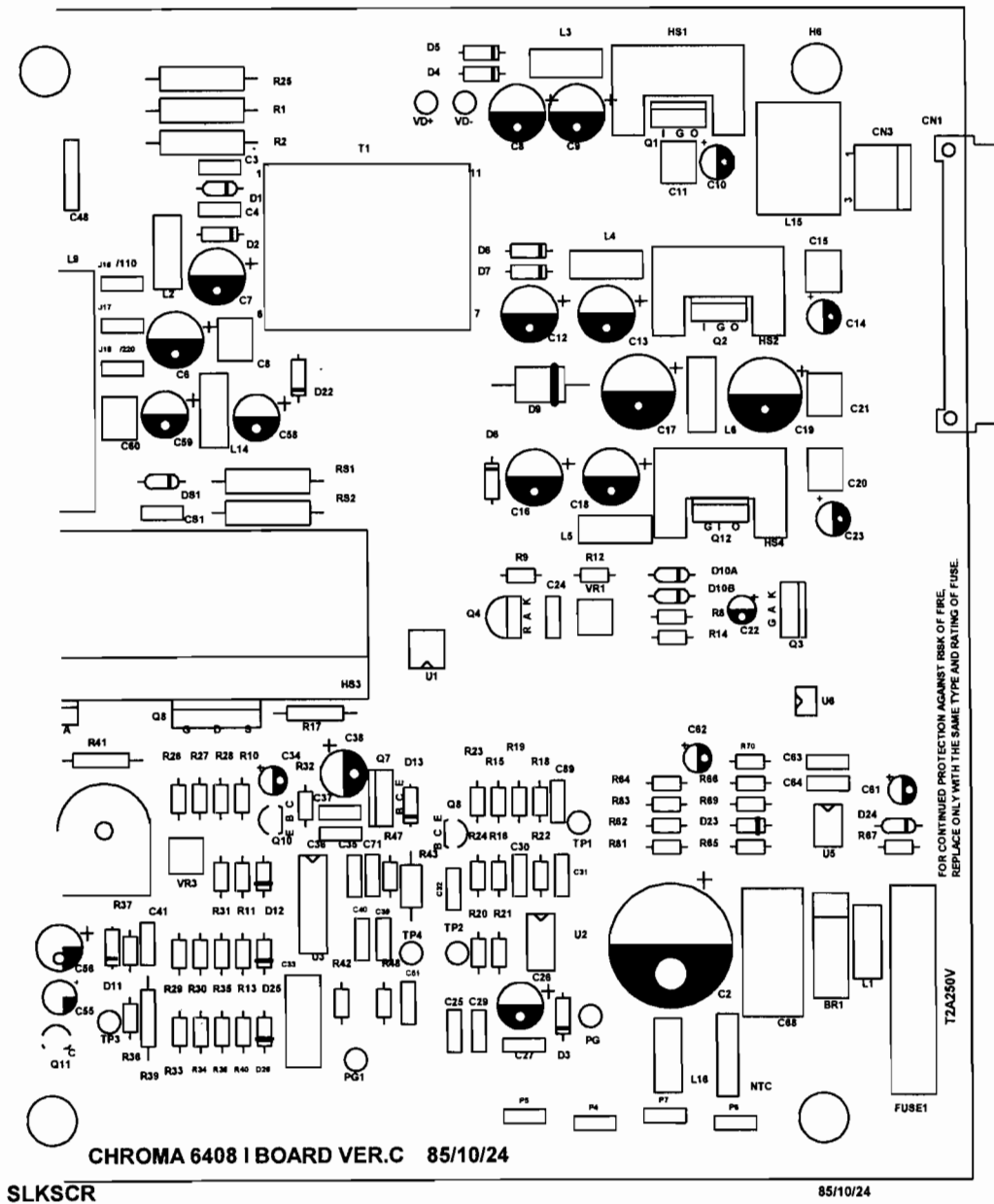

Fig-2

**Chroma**<sup>®</sup>  
**CHROMA ATE INC.**  
**致茂電子股份有限公司**

43, Wu-Chuan Road, Wu-Ku Ind. Park,  
Taipei Hsien, Taiwan, R.O.C.  
台北縣五股鄉五股工業區五權路43號  
TEL:886-2-298-3855  
FAX:886-2-298-3596