

USER'S  
HANDBOOK

**4800, 4805 & 4808**  
**Multifunction Calibrators**







**DANGER**  
**HIGH VOLTAGE**



**THIS INSTRUMENT IS CAPABLE  
OF DELIVERING  
A LETHAL ELECTRIC SHOCK !  
when connected to a high voltage source**

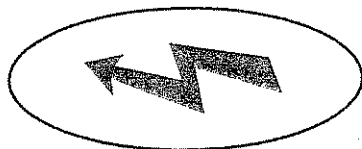

FRONT or REAR terminals  
carry the Full Input Voltage  
**THIS CAN KILL !**



Guard terminal is sensitive  
to over-voltage  
**It can damage  
your instrument !**

Unless **you** are **sure** that it is **safe** to do so,  
**DO NOT TOUCH**  
the **I+ I- Hi** or **Lo leads** and **terminals**

**DANGER**

# CONTENTS

	Page
<b>SECTION 1 THE DATRON 4800, 4805 and 4808 MULTIFUNCTION CALIBRATORS</b>	
Introduction	1-1
4800 Multifunction Calibrator Standard and Optional Facilities	1-1
SAFETY	1-2
Additional Documentation	1-3
Optional Facilities	1-4
Accessories	1-5
4805 Multifunction Calibrator Standard and Optional Facilities	1-5
SAFETY	1-6
Additional Documentation	1-7
Optional Facilities	1-8
Accessories	1-9
4808 Multifunction Calibrator Standard and Optional Facilities	1-9
SAFETY	1-10
Additional Documentation	1-11
Optional Facilities	1-12
Accessories	1-13
Principles of Operation	1-13
	1-15
<b>SECTION 2 INSTALLATION</b>	
Unpacking and Inspection	2-1
Preparation for Operation	2-1
Bench Mounting	2-1
Rack Mounting	2-4
Connectors and Pin Designations	2-4
	2-6
<b>SECTION 3 OPERATING CONTROLS</b>	
Front Panel	3-1
Front Panel Keys	3-1
Power Switch	3-1
Output Switching	3-2
Reset Key	3-3
Function Keys	3-4
Output Range Keys	3-5
Output Display and $\odot$ Keys	3-6
Frequency Control	3-8
Mode Selection Keys	3-14
Display Key	3-24
Front Panel Terminals	3-27
Rear Panel	3-28
	3-30

	Page
<b>SECTION 4 USING THE 4300, 4805 and 4808 CALIBRATORS</b>	<b>4-1</b>
SAFETY	4-1
Preliminaries	4-2
Limiting Characteristics	4-2
Interconnections	4-8
Typical Lead Connections	4-14
General Sequence of Operations	4-15
Display Messages	4-17
Operating Routines	4-18
DC Voltage Outputs	4-20
AC Voltage Outputs	4-23
DC Current	4-24
AC Current	4-25
Resistance	4-26
Additional Facilities	4-26
Frequency Store	4-28
Spot Frequency (4808 only)	4-31
'Spec' Mode	4-34
'Error' and 'Offset' Modes	4-40
Combining Offset and Error Modes	4-42
Test Key	4-46
Display Key	4-47
Warnings and Messages	4-47
<b>SECTION 5 SYSTEMS APPLICATION VIA THE IEEE 488 INTERFACE</b>	<b>5-1</b>
Introduction	5-1
Interface Capability	5-2
Bus Addresses	5-3
Interconnections	5-3
Typical System	5-4
Using the 4800, 4805 and 4808 Calibrators in a System	5-7
Programming Instructions	5-9
Programming of Operational Functions	5-14
Programming of Bus Transmissions	5-20
Service Requests	5-26
Activation of Commands	5-28
Multiple Commands	5-28
Universal and Addressed Commands	5-29
Clear Commands	5-30
Operational Sequence Guidelines	5-31

## CONTENTS (continued)

	Page
<b>SECTION 6.1 4800 SPECIFICATIONS</b>	<b>6.1-1</b>
General	6.1-1
DC Voltage	6.1-3
AC Voltage	6.1-4
Voltage/Frequency Constraints	6.1-6
Capacitive Loading Constraints	6.1-7
DC Current	6.1-8
AC Current	6.1-9
Resistance	6.1-10
<b>SECTION 6.2 4805 SPECIFICATIONS</b>	<b>6.2-1</b>
General	6.2-1
DC Voltage	6.2-3
AC Voltage	6.2-4
Voltage/Frequency Constraints	6.2-6
Capacitive Loading Constraints	6.2-7
DC Current	6.2-8
AC Current	6.2-9
Resistance	6.2-10
<b>SECTION 6.3 4808 SPECIFICATIONS</b>	<b>6.3-1</b>
General	6.3-1
DC Voltage	6.3-3
AC Voltage	6.3-4
Voltage/Frequency Constraints	6.3-6
Capacitive Loading Constraints	6.3-7
DC Current	6.3-8
AC Current	6.3-9
Resistance	6.3-10
<b>SECTION 7 SPECIFICATION VERIFICATION</b>	<b>7-1</b>
Introduction	7-1
DC Voltage Verification	7-4
DC Current Verification	7-10
AC Voltage Verification	7-14
AC Current Verification	7-28
Resistance Verification	7-32
Verification Report Sheet 4800 RS 1	7-39
Verification Report Sheet 4805 RS 1	7-49
Verification Report Sheet 4808 RS 1	7-59

**APPENDICES TO SECTION 7**

1. Validity Tolerance Limit Calculation	7-A1-1
2. Uncertainty and Traceability	7-A2-1
3. General Procedural Information	7-A3-1
4. Alternative AC Millivolt Verification	7-A4-1
5. Alternative AC Current Verification	7-A5-1
6. Harmonic Distortion Measurement	7-A6-1

**SECTION 8 ROUTINE CALIBRATION**

The 4800, 4805 and 4808 Autocal Feature	8-1
Latest and Shadow Calibration Memories	8-1
DC Calibration	8-2
Calibration Key Availability	8-4
Zero Calibration	8-5
Equipment Required for DC Calibration	8-6
Interconnections	8-7
DC Calibration Sequence	8-7
DC Voltage Calibration	8-8
DC Current Calibration	8-10
Resistance Calibration	8-16
Calibration Memory	8-19
2-wire/4-wire Calibration Limits	8-19
Resistance Calibration Sequence	8-20
Resistance Calibration	8-21
AC Calibration	8-24
AC Calibration Sequence	8-26
General Notes	8-28
AC Voltage Calibration (1V - 1000V)	8-30
AC Millivolts (LF) Calibration (1mV - 100mV)	8-32
AC Millivolts (HF) Calibration (1mV - 100mV)	8-34
AC Current Calibration (1mA - 1A)	8-40

**APPENDICES TO SECTION 8**

AC Current Calibration (100 $\mu$ A - 1A)	8-A1-1
---	--------

**DATRON SALES REPRESENTATIVES WORLDWIDE**

**Inside Rear Cover**





# SECTION 1 THE DATRON 4800, 4805 & 4808 MULTIFUNCTION CALIBRATORS

## Introduction

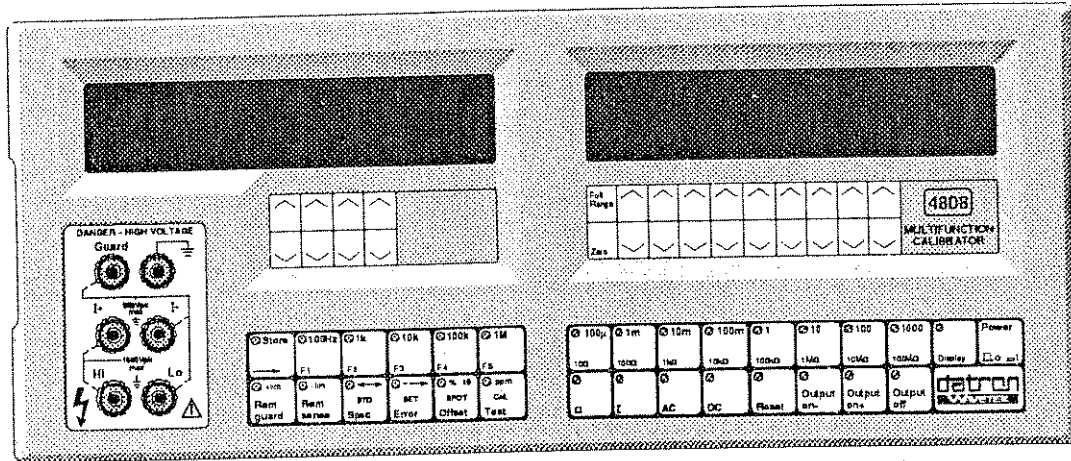

The Datron Models 4800, 4805 and 4808 are high-precision Multifunction Calibrators which feature exceptionally high stability and full systems capability. They are characterized by wide-range coverage of DC Voltage, AC Voltage, DC Current, AC Current and Resistance functions in a single unit.

The 4800 and 4808 calibrators consist of a mainframe to which various output options may be added. The 4808 has a higher specification than the 4800 and has an additional AC Voltage 'Spot Frequency' calibration facility. The 4805 is a fixed configuration instrument containing all the above functions as standard.

All three calibrators incorporate a reference module which maintains a high accuracy specification over the ambient temperature range of  $23^{\circ}\text{C} \pm 10^{\circ}\text{C}$ . A high level of stability is achieved by the use of specially selected and tested reference components and ultra-stable gain-defining resistors. The calibrators' 'Autocal' feature ensures that their 24-hour specifications are usable - not merely figures of merit - and all three models feature a 'Shadow Calibration' facility which allows new calibration data to be stored, but not implemented, until the integrity of the metrology standards used in the unit's calibration has been verified.

The 4800, 4805 and 4808 all feature microprocessor control for instrument management, simplifying their use during complex manual operations such as the calibration of high-quality digital multimeters. Their IEEE 488 interface provides a comprehensive remote programming capability, allowing fully automated instrument control, and programmed calibration of the calibrators themselves.

## **4800 Multifunction Calibrator Standard and Optional Facilities**

---

### **DC Voltage Ranges**

By fitting Option 10, the instrument provides DC Voltage calibration facilities in seven decade ranges from  $\pm 100\mu\text{V}$  to  $\pm 100\text{V}$ . By adding Option 30 and Option 10, a  $\pm 1000\text{V}$  range is also available. 100% overrange is incorporated, except on the optional  $\pm 1000\text{V}$  range, where the output is limited to  $\pm 1100\text{V}$ .

### **Resolution and Accuracy**

The maximum resolution is 7.5 digits with a facility for displaying the specified accuracy of any output voltage. The 4800 DC Voltage specifications are shown in *Section 6*.

### **AC Voltage Ranges**

By fitting Option 20, the instrument provides AC Voltage calibration facilities in six decade ranges from 1mV to 100V. By adding Option 30 and Option 20, a 1000V range is also available. 100% over-range is incorporated, except on the optional 1000V range, when the output is limited to 1100V.

### **Resolution and Accuracy**

The maximum resolution is 6.5 digits with a facility for displaying the specified accuracy of any output voltage. The 4800 AC Voltage specifications are shown in *Section 6*.

### **DC Current Ranges**

By fitting Option 40, in conjunction with Option 10, the instrument can be used to calibrate DC Current in five decade ranges from  $\pm 100\mu\text{A}$  to  $\pm 1\text{A}$ . Option 60 may be added to extend DC Current capability to  $\pm 11\text{A}$ .

### **Resolution and Accuracy**

The maximum resolution is 6.5 digits with a facility for displaying the specified accuracy of output current. The 4800 DC Current specifications are shown in *Section 6*.

### **AC Current Ranges**

By fitting Option 40, in conjunction with Option 20, the instrument can be used to calibrate AC Current in five decade ranges from  $100\mu\text{A}$  to 1A. Option 60 may be added to extend AC Current capability to 11A.

### **Resolution and Accuracy**

The maximum resolution is 6.5 digits with a facility for displaying the specified accuracy of output current. The 4800 AC Current specifications are shown in *Section 6*.

### **Resistance**

By fitting Option 50, in conjunction with Options 10 or 20, the instrument can be used to calibrate resistance in eight decade ranges from 10 ohm to 100M ohm.

### **Resolution and Accuracy**

The maximum resolution is 7.5 digits with a facility for displaying the specified accuracy of any output resistance. The 4800 Resistance specifications are shown in *Section 6*.

### Frequency

With Option 20 fitted, the output frequency bandwidth of the 4800 is 10Hz to 1MHz. This frequency span is covered in five overlapping decade ranges, at a resolution of 1% of nominal Frequency Range. Any five frequency values within the range of the instrument can be stored in and recalled from memory.

### Output Deviation

A user may deviate the output voltage from the output display value by introducing a gain 'Error' within the general range  $\pm 10\%$ . Additionally, for DC functions, the output may be 'offset' by up to  $\pm 2\%$  of the range in use, or  $200\mu\text{V}$ , whichever is greater.

### Remote Sense

The specified output voltage may be sensed at the load, using 4-wire connections. Remote or Local Sense is selectable from the front panel.

### Remote Guard

This facility allows the instrument's internal guard shields to be externally connected.

### Self-test

On power-up, the internal calibration memory is automatically checked. At any time when the output is off and not under remote control, a user may conduct a sequenced test of the displays, keyboard, safety circuitry and Reset function.

### Message Readout

Messages to the user are presented on the left-hand MODE display. The two main groups of message are:

- Fail** An internal fault condition has been detected.
- Error** A user has selected a task which is outside the instrument's capability.

### Safety

For protection of the user, safety trip circuits are incorporated to switch the OUTPUT OFF in the event of instrument failures which might generate dangerous output voltages.

**UNDER NO CIRCUMSTANCES SHOULD USERS TOUCH ANY OF THE OUTPUT, SENSE OR GUARD TERMINALS UNLESS THEY ARE FIRST SATISFIED THAT NO DANGEROUS VOLTAGE IS PRESENT.**

## **4800 Multifunction Calibrator Standard and Optional Facilities (continued)**

---

### **Autocal**

All Datron AUTOCAL instruments are designed to make the removal of the covers for calibration unnecessary, as full routine calibration of all ranges and functions can be carried out from the front panel or over the IEEE 488 bus.

Accidental or unauthorized use of the calibration routine is prevented by a key operated switch on the instrument rear panel. The procedure for calibrating the 4800 is contained in *Section 8*.

### **Systems Use**

The instrument can form part of an automated system by means of the IEEE 488 standard digital interface. The method of connecting to the system controller and the command codes are described in *Section 5*.

### **Additional Documentation**

The *Maintenance Handbook* and *Reference Handbook* contain information required to adjust and service the 4800. Together, they provide detailed descriptions of the circuits, troubleshooting and calibration procedures, parts lists, layout drawings and circuit diagrams.

### Optional Facilities

The available options for the 4800 are as follows:

- Option 10: DC Voltage function to  $\pm 200V$ .
- Option 20: AC Voltage function to 200V.
- Option 30: Integral 1000V amplifier for AC Voltage and/or DC Voltage functions. (Requires either Option 10, Option 20 or both.)
- Option 40: Current converter to provide DC Current and AC Current functions. (DC Current capability requires Option 10, AC Current capability requires Option 20.)
- Option 50: Resistance function. (Requires Option 10 or Option 20.)
- Option 60: DC Current and/or AC Current range extension to 11A. This option includes the Datron 4600 Transconductance Amplifier and all necessary cabling. (Requires Option 40.)
- Option 90: Rack mounting kit.

### Accessories:

The instrument is supplied with the following accessories:

Description	Part Number
Power Cable	920012
Set of Calibration keys	700068
User's Handbook	850267

### Optional Accessories:

The following accessories can be purchased for use with the 4800:

Description	Part Number
Model 1510: General Purpose Lead Kit.	
Model 1516: Shrouded 6-pin Calibrator Connector with leads to five 4mm banana plugs.	
Maintenance Handbook	850268
Reference Handbook	850269

## 4805 Multifunction Calibrator Standard and Optional Facilities

---

### DC Voltage Ranges

The instrument provides DC Voltage calibration facilities in eight decade ranges from  $\pm 100\mu\text{V}$  to  $\pm 1000\text{V}$ . 100% overrange is incorporated, except on the  $\pm 1000\text{V}$  range, when the output is limited to  $\pm 1100\text{V}$ .

### Resolution and Accuracy

The maximum resolution is 6.5 digits with a facility for displaying the specified accuracy of any output voltage. The 4805 DC Voltage specifications are shown in *Section 6*.

### AC Voltage Ranges

The instrument provides AC Voltage calibration facilities in six decade ranges from 1mV to 1000V. 100% overrange is incorporated, except on the 1000V range, when the output is limited to 1100V.

### Resolution and Accuracy

The maximum resolution is 5.5 digits with a facility for displaying the specified accuracy of any output voltage. The 4805 AC Voltage specifications are shown in *Section 6*.

### DC Current Ranges

The instrument can be used to calibrate DC Current in five decade ranges from  $\pm 100\mu\text{A}$  to  $\pm 1\text{A}$ . Option 60 (the Datron 4600 Transconductance Amplifier) may be used to extend DC Current capability to  $\pm 11\text{A}$ .

### Resolution and Accuracy

The maximum resolution is 5.5 digits with a facility for displaying the specified accuracy of output current. The 4805 DC Current specifications are shown in *Section 6*.

### AC Current Ranges

The instrument can be used to calibrate AC Current in five decade ranges from  $100\mu\text{A}$  to 1A. Option 60 (the Datron 4600 Transconductance Amplifier) may be used to extend AC Current capability to 11A.

### Resolution and Accuracy

The maximum resolution is 5.5 digits with a facility for displaying the specified accuracy of output current. The 4805 AC Current specifications are shown in *Section 6*.

### Resistance

The instrument can be used to calibrate resistance in eight decade ranges from 10 ohm to 100M ohm.

### Resolution and Accuracy

The maximum resolution is 6.5 digits with a facility for displaying the specified accuracy of any output resistance. The 4805 Resistance specifications are shown in *Section 6*.

### Frequency

The output frequency bandwidth of the 4805 extends from 10 Hz to 100 kHz in four overlapping decade ranges, at a resolution of 1% of nominal Frequency Range. Any five frequency values within the range of the instrument can be stored in and recalled from memory.

### Output Deviation

A user may deviate the output voltage from the output display value by introducing a gain 'Error' within the general range  $\pm 10\%$ . Additionally, for DC functions, the output may be 'offset' by up to  $\pm 2\%$  of the range in use, or 200  $\mu\text{V}$ , whichever is greater.

### Remote Sense

The specified output voltage may be sensed at the load, using 4-wire connections. Remote or Local Sense is selectable from the front panel.

### Remote Guard

This facility allows the instrument's internal guard shields to be externally connected.

### Self-test

On power-up, the internal calibration memory is automatically checked. At any time when the output is off and not under remote control, a user may conduct a sequenced test of the displays, keyboard, safety circuitry and Reset function.

### Message Readout

Messages to the user are presented on the left-hand MODE display. The two main groups of message are:

- Fail** An internal fault condition has been detected.
- Error** A user has selected a task which is outside the instrument's capability.

### Safety

For protection of the user, safety trip circuits are incorporated to switch the OUTPUT OFF in the event of instrument failures which might generate dangerous output voltages.

**UNDER NO CIRCUMSTANCES SHOULD USERS TOUCH ANY OF THE OUTPUT, SENSE OR GUARD TERMINALS UNLESS THEY ARE FIRST SATISFIED THAT NO DANGEROUS VOLTAGE IS PRESENT.**

## **4805 Multifunction Calibrator Standard and Optional Facilities (continued)**

---

### **Autocal**

All Datron AUTOCAL instruments are designed to make the removal of the covers for calibration unnecessary, as full routine calibration of all ranges and functions can be carried out from the front panel or over the IEEE 488 bus.

Accidental or unauthorized use of the calibration routine is prevented by a key operated switch on the instrument rear panel. The procedure for calibrating the 4805 is contained in *Section 8*.

### **Systems Use**

The instrument can form part of an automated system by means of the IEEE 488 standard digital interface. The method of connecting to the system controller and the command codes are described in *Section 5*.

### **Additional Documentation**

The *Maintenance Handbook and Servicing Handbook* contain information required to adjust and service the 4805. Together, they provide detailed descriptions of the circuits, trouble shooting and calibration procedures, parts lists, layout drawings and circuit diagrams.



---

### Optional Facilities

The available options for the 4805 are as follows:

Option 60: DC Current and/or AC Current range extension to 11A. This option includes the Datron 4600 Transconductance Amplifier and all necessary cabling.

Option 90: Rack mounting kit.

### Accessories:

The instrument is supplied with the following accessories:

Description	Part Number
Power Cable	920012
Set of Calibration keys	700068
User's Handbook	850267

### Optional Accessories:

The following accessories can be purchased for use with the 4805:

#### Description

Model 1510: General Purpose Lead Kit.  
Model 1516: Shrouded 6-pin Calibrator Connector with leads to five 4mm banana plugs.

Description	Part Number
Maintenance Handbook	850275
Reference Handbook	850276

## 4808 Multifunction Calibrator Standard and Optional Facilities

---

### DC Voltage Ranges

By fitting Option 10, the instrument provides DC Voltage calibration facilities in seven decade ranges from  $\pm 100\mu\text{V}$  to  $\pm 100\text{V}$ . By adding Option 30 and Option 10, a  $\pm 1000\text{V}$  range is also available. 100% overrange is incorporated, except on the optional  $\pm 1000\text{V}$  range, where the output is limited to  $\pm 1100\text{V}$ .

### Resolution and Accuracy

The maximum resolution is 7.5 digits with a facility for displaying the specified accuracy of any output voltage. The 4808 DC Voltage specifications are shown in *Section 6*.

### AC Voltage Ranges

By fitting Option 20, the instrument provides AC Voltage calibration facilities in six decade ranges from  $1\text{mV}$  to  $100\text{V}$ . By adding Option 30 and Option 20, a  $1000\text{V}$  range is also available. 100% over-range is incorporated, except on the optional  $1000\text{V}$  range, when the output is limited to  $1100\text{V}$ .

### Resolution and Accuracy

The maximum resolution is 6.5 digits with a facility for displaying the specified accuracy of any output voltage. The 4808 AC Voltage specifications are shown in *Section 6*.

### DC Current Ranges

By fitting Option 40, in conjunction with Option 10, the instrument can be used to calibrate DC Current in five decade ranges from  $\pm 100\mu\text{A}$  to  $\pm 1\text{A}$ . Option 60 may be added to extend DC Current capability to  $\pm 11\text{A}$ .

### Resolution and Accuracy

The maximum resolution is 6.5 digits with a facility for displaying the specified accuracy of output current. The 4808 DC Current specifications are shown in *Section 6*.

### AC Current Ranges

By fitting Option 40, in conjunction with Option 20, the instrument can be used to calibrate AC Current in five decade ranges from  $100\mu\text{A}$  to  $1\text{A}$ . Option 60 may be added to extend AC Current capability to  $11\text{A}$ .

### Resolution and Accuracy

The maximum resolution is 6.5 digits with a facility for displaying the specified accuracy of output current. The 4808 AC Current specifications are shown in *Section 6*.

### Resistance

By fitting Option 50, in conjunction with Options 10 or 20, the instrument can be used to calibrate resistance in eight decade ranges from  $10\text{ ohm}$  to  $100\text{M ohm}$ .

### Resolution and Accuracy

The maximum resolution is 7.5 digits with a facility for displaying the specified accuracy of any output resistance. The 4808 Resistance specifications are shown in *Section 6*.

### Frequency

With Option 20 fitted, the output frequency bandwidth of the 4808 is 10Hz to 1MHz. This frequency span is covered in five overlapping decade ranges, at a resolution of 1% of nominal Frequency Range. Any five frequency values within the range of the instrument can be stored in and recalled from memory. For higher accuracy, five 'Spot Calibrated' frequency values per Output Range can be recalled from non-volatile memory.

### Output Deviation

A user may deviate the output voltage from the output display value by introducing a gain 'Error' within the general range  $\pm 10\%$ . Additionally, for DC functions, the output may be 'offset' by up to  $\pm 2\%$  of the range in use, or  $200\mu\text{V}$ , whichever is greater.

### Remote Sense

The specified output voltage may be sensed at the load, using 4-wire connections. Remote or Local Sense is selectable from the front panel.

### Remote Guard

This facility allows the instrument's internal guard shields to be externally connected.

### Self-test

On power-up, the internal calibration memory is automatically checked. At any time when the output is off and not under remote control, a user may conduct a sequenced test of the displays, keyboard, safety circuitry and Reset function.

### Message Readout

Messages to the user are presented on the left-hand MODE display. The two main groups of message are:

- Fail** An internal fault condition has been detected.
- Error** A user has selected a task which is outside the instrument's capability.

### Safety

For protection of the user, safety trip circuits are incorporated to switch the OUTPUT OFF in the event of instrument failures which might generate dangerous output voltages.

**UNDER NO CIRCUMSTANCES SHOULD USERS TOUCH ANY OF THE OUTPUT, SENSE OR GUARD TERMINALS UNLESS THEY ARE FIRST SATISFIED THAT NO DANGEROUS VOLTAGE IS PRESENT.**

## **4808 Multifunction Calibrator Standard and Optional Facilities (continued)**

---

### **Autocal**

All Datron AUTOCAL instruments are designed to make the removal of the covers for calibration unnecessary, as full routine calibration of all ranges and functions can be carried out from the front panel or over the IEEE 488 bus.

Accidental or unauthorized use of the calibration routine is prevented by a key operated switch on the instrument rear panel. The procedure for calibrating the 4808 is contained in *Section 8*.

### **Systems Use**

The instrument can form part of an automated system by means of the IEEE 488 standard digital interface. The method of connecting to the system controller and the command codes are described in *Section 5*.

### **Additional Documentation**

The *Maintenance Handbook and Servicing Handbook* contain information required to adjust and service the 4808. Together, they provide descriptions of the circuits, trouble shooting and calibration procedures, parts lists, layout drawings and circuit diagrams.

**Optional Facilities**

The available options for the 4808 are as follows:

- Option 10: DC Voltage function to  $\pm 200V$ .
- Option 20: AC Voltage function to 200V.
- Option 30: Integral 1000V amplifier for AC Voltage and/or DC Voltage functions. (Requires either Option 10, Option 20 or both.)
- Option 40: Current converter to provide DC Current and AC Current functions. (DC Current capability requires Option 10, AC Current capability requires Option 20.)
- Option 50: Resistance function. (Requires Option 10 or Option 20.)
- Option 60: DC Current and/or AC Current range extension to 11A. This option includes the Datron 4600 Transconductance Amplifier and all necessary cabling. (Requires Option 40.)
- Option 90: Rack mounting kit.

**Accessories:**

The instrument is supplied with the following accessories:

Description	Part Number
Power Cable	920012
Set of Calibration keys	700068
User's Handbook	850267

**Optional Accessories:**

The following accessories can be purchased for use with the 4808:

**Description**

- Model 1510: General Purpose Lead Kit.
- Model 1516: Shrouded 6-pin Calibrator Connector with leads to five 4mm banana plugs.

**Description**

Description	Part Number
Maintenance Handbook	850277
Reference Handbook	850278

Section 1 - Introduction and General Description

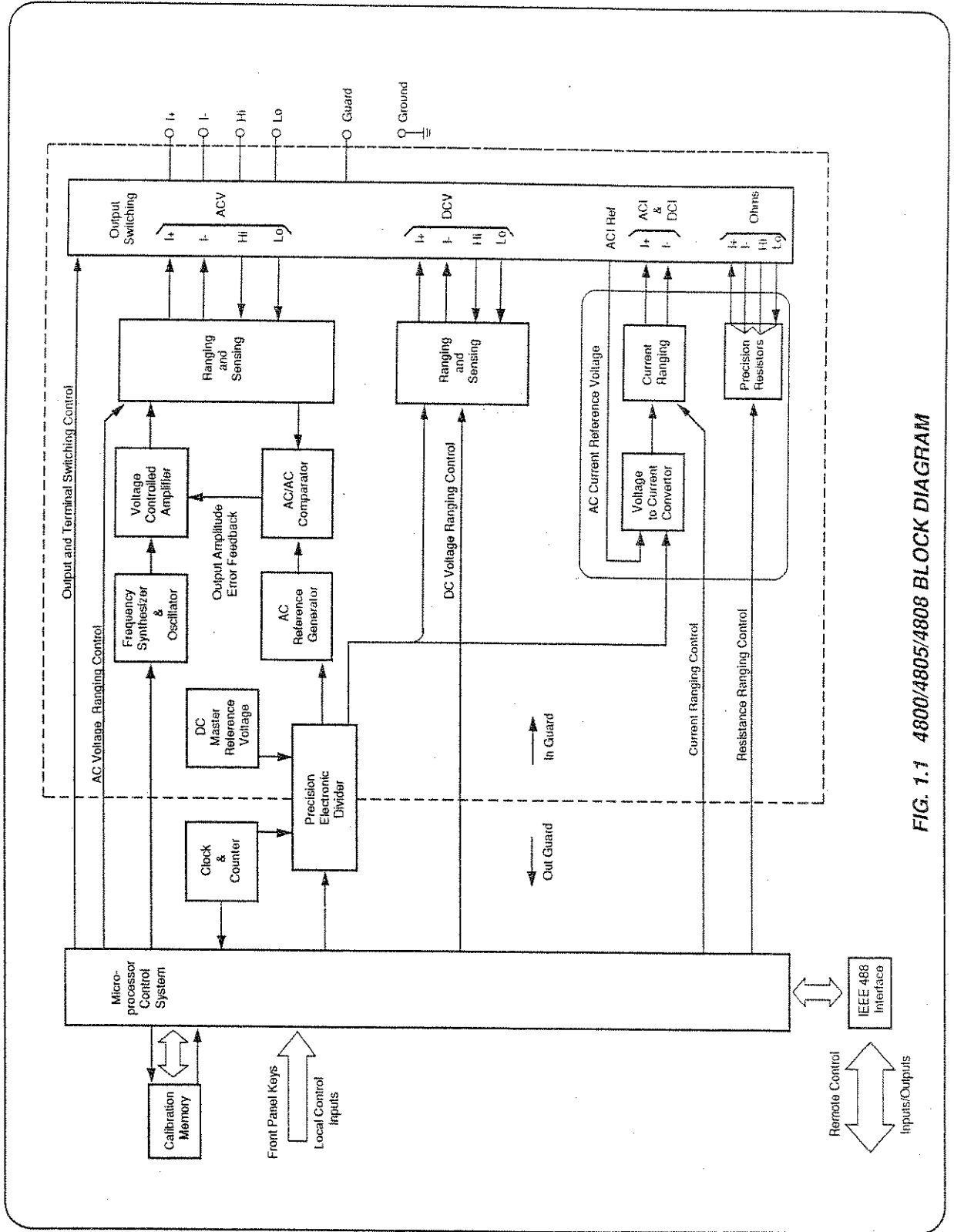

FIG. 1.1 4800/4805/4808 BLOCK DIAGRAM

## Principles of Operation

### Inputs

The calibrator's 6802 microprocessor controls the calibrator output in response to three main inputs:

- i) Front panel keys when used under front-panel control
- ii) IEEE 488 bus messages when used in 'Remote' operation
- iii) Corrections placed in non-volatile memory during 'Autocalibration'. These modify the values which control the output.

After processing, the computing system changes the output of the instrument to respond to the input instructions.

### Reference Voltages

A 20V DC 'Master' Voltage Reference establishes the fundamental accuracy of the instrument. From this 20V reference, a precision electronic divider derives an adjustable 'Working' reference voltage between 0V and 20V, whose value depends on digital inputs from front panel keys and calibration memory.

### Precision Electronic Divider

In the out-guard section (see Figure 1.1. opposite) the selected output value, including calibration corrections, is set into a digital comparator as a 25-bit number. This number is counted out by a crystal controlled binary counter, resulting in a 125Hz square wave whose mark:period ratio accurately represents the output value selection. When transferred into guard, it chops the Master Reference voltage. A 7-pole active low-pass filter integrates the chopped reference, to generate the ripple-free DC Working Reference Voltage.

### Output Switching.

In addition to switching between functions, the output switching circuits isolate the calibrator terminals in the OUTPUT OFF condition. Remote/Local Sense and Guard switching is incorporated.

## DC Voltage Output

The working reference for DC Voltage Output is a stable DC voltage, accurately variable at high resolution between 0 and +20V.

### DC Voltage Ranging

#### Low Voltage Ranges (100 $\mu$ V - 10V Full Range)

The basic range of the calibrator is  $\pm 10$ V Full Range ( $\pm 19.999999$ V Full Scale for the 4800 and 4808;  $\pm 19.99999$  for the 4805), derived directly from the working reference. The 1V and 100mV ranges are achieved by attenuation.

The 100mV range attenuator is also used for 10mV, 1mV and 100 $\mu$ V ranges, and the digital input to the precision divider is scaled to provide the correct working reference values.

Range	Working reference values
10mV	-2V to +2V
1mV	-200mV to +200mV
100 $\mu$ V	-20mV to +20mV

#### High Voltage Ranges (100V and 1000V)

The 100V range is a direct amplification of the working reference. The 1000V range (optional in the 4800 and 4808) employs step-up AC transformation.

## AC Voltage Output

The working reference for AC Voltage Output is a stable DC voltage, accurately variable at high resolution between +0.1V and +2V DC.

### AC Reference Generator

The higher accuracy of AC/AC comparison (compared to AC/DC comparison) is exploited by converting the DC Working Reference into a stepped waveform whose characteristics match those of a sinewave. The amplitude of this 'Quasi-sinewave' is precisely controlled by the DC Working Reference value.

### Sinewave Source - Frequency Synthesizer

From the frequency value set into the calibrator's left-hand MODE display, the processor controls the frequency synthesizer using an encoded 9-bit command. The synthesizer translates the command into a pulse train at a crystal-derived frequency between 240kHz and 4MHz, to be divided down for use as a phase-reference for the Quadrature Oscillator.

**N.B.** If required, the Frequency Synthesizer, can be locked to an externally supplied 1MHz or 10MHz frequency, input via J53 on the rear panel.



## AC Voltage Output (continued)

### Sinewave Source - Quadrature Oscillator

The oscillator's output frequency is set close to the demanded frequency, between 10Hz and 1MHz, by selecting the RC time constants of its dual integrators; and then by correcting to the actual demand by phase-comparison with the output from the synthesizer. The output sinewave purity and constant amplitude are precisely defined by a sophisticated control loop, and the RMS value of the sinewave is adjusted to be roughly proportional to the demanded output voltage or current. Timing data is output from the sinewave source to synchronize the actions of the AC Reference Generator and AC/AC Comparator.

### Voltage-Controlled Amplifier (VCA)

This has variable gain, amplifying the output from the Sinewave Source and providing a buffered drive to the output circuits. Its gain is determined by the measured difference between the RMS values of the sensed calibrator output and the AC Reference; so the VCA provides the correcting fine adjustment for the output amplitude loop.

### AC Voltage Ranging

#### 1V Range

This is the basic AC voltage range of the calibrator. As the AC working reference is variable between 0.1V and 2V RMS, it is compared in a 1:1 ratio with the sensed output. The 1V Buffer output is thus passed directly to the output I+ and I- terminals.

#### 100mV, 10mV and 1mV Ranges

The 1V Buffer output is reduced by precision attenuators before being connected to the terminals, the level being sensed before attenuation.

#### 10V, 100V and 1000V Ranges

The 1V Buffer output is amplified on each of these ranges. A separate amplifier is provided for the 10V range, the output sense signal being obtained at the terminals and attenuated before comparison with the reference. A common power amplifier is used for both the 100V and 1000V ranges. On the 100V Range the output is fed directly to the terminals, on the 1000V Range (optional on the 4800 and 4808) the output is stepped up by a transformer. On both ranges, the sensed terminal voltage is reduced to the reference level by precision attenuators.

## AC Voltage Output (continued)

### Output Sensing

On the 1V range and above, the output is sensed at the front panel Hi and Lo terminals. With Remote Sense selected, these are isolated from I+ and I-, but in Local Sense Hi is internally connected to I+, and Lo to I-. As described above, the 10V, 100V and 1000V range sense signal is attenuated before comparison with the reference.

### AC/AC Comparator

The comparator generates an error voltage proportional to the difference between the RMS values of the AC reference and the sensed output. It alternately samples a number of cycles from its 'Ref' and 'Sense' inputs, computes and integrates the squares of their instantaneous values, and uses a 'Sample and Hold' technique to subtract one from the other, this being the 'error' voltage to control the VCA. The loop thus controls the calibrator output so that the RMS value of the comparator's sense input equates to that of its reference input.

## DC Current Output

On changing function to DC Current, the Working Reference voltage is switched to drive a voltage-to-current converter, and the right-hand OUTPUT display legend is changed to  $\mu\text{A}$ , mA or A as appropriate. Over-voltage protection is provided, and the Output lines are fused.

## AC Current Output

An AC Current output is produced by the voltage-to-current converter. The  $100\mu\text{A}$  and 1A ranges are driven directly from the basic 1V range, and the others from the 10V range. Range selection is achieved by switching internal shunts. Output protection against over-voltage is provided, and the output lines are fused. The right-hand OUTPUT display legend is altered to  $\mu\text{A}$ , mA or A.

## Resistance

### Remote Sense

One of a set of eight precision resistors is internally 4-wire connected to the **I+**, **I-**, **Hi** and **Lo** terminals by operation of each **RANGE** key. Simultaneously the 4-wire calibrated value of the resistor is displayed on the right-hand display. Pressing the **Zero** key connects a true 4-wire short to the terminals, and the right-hand **OUTPUT** display indicates zero. This zero display value cannot be recalibrated.

### Local Sense (Remote Sense LED Unlit)

The connections to the resistor remain the same, but the display value includes the resistance of the connections from the **Hi** and **Lo** terminals to the resistor. The arrangement provides a calibrated 2-wire facility with external connection to the **Hi** and **Lo** terminals. The **Zero** key shorts the **Hi** and **Lo** terminals, and in this case the resistance between the terminals is displayed and may be recalibrated. When  $\Omega$  is selected from any other function, the calibrator is forced into **Remote Sense**, but this may be deselected for 2-wire operation.

## Autocalibration

By setting the **CAL ENABLE** security keyswitch on the rear panel to **ENABLE**, the calibrator can be calibrated. (Refer to *Section 8*). The output value is measured and the microprocessor is activated to add any new corrections to factors already retained in non-volatile memory. The updated correction factors are applied in the normal **RUN** mode.

The 4800, 4805 and 4808 calibrators also feature 'Shadow' calibration memory. Using this non-volatile memory the calibrator can be recalibrated and the new calibration constants temporarily retained, but not implemented, until the integrity of the calibration standards used to calibrate the calibrator have been verified. (For example, by return to a National Bureau of Standards.)

## Section 1 - Introduction and General Description

---

### **Processor**

A 6802-series microprocessor controls internal management of the instrument, employing 52k bytes of program memory.

2k bytes of memory are used for stack and work space, and 8k bytes are made non-volatile by a battery-powered back-up supply, storing calibration correction factors.

With the exception of the **Power** on/off switch and **Display** pushbutton, each front and rear panel control provides an input to the microprocessor system, which translates the information to command the calibrator's analog and calibration functions.

The processor also controls the display, the IEEE 488 Interface Bus and the operation of the restart and error circuitry.

## SECTION 2 INSTALLATION

This section contains information and instructions for unpacking and installing the Datron 4800, 4805 and 4808 calibrators.

### Unpacking and Inspection

Every care is taken in the choice of packing materials to ensure that your equipment will reach you in perfect condition.

If the equipment has been subject to excessive mishandling in transit, the fact will probably be visible as external damage to the shipping carton. In the event of damage, the shipping container and cushioning material should be kept for the carrier's inspection.

Unpack the equipment and check for external damage to the case, sockets, keys, etc. If damage is found, notify the carrier and your sales representative immediately.

Standard accessories supplied with the instrument are as described in *Section 1*.

### Preparation for Operation

Before preparing the 4800, 4805 or 4808 calibrator for operation, note the following danger warning.



#### **DANGER** **SYMBOL**

**THIS INSTRUMENT IS CAPABLE OF DELIVERING A LETHAL ELECTRIC SHOCK.**

**THE I+, I-, Hi and Lo TERMINALS ARE MARKED WITH THE ABOVE 'FLASH' SYMBOL TO WARN USERS OF THIS DANGER.**

**UNDER NO CIRCUMSTANCES TOUCH ANY INSTRUMENT TERMINAL UNLESS YOU ARE FIRST SATISFIED THAT NO DANGEROUS VOLTAGE IS PRESENT.**

### Power Input

The recessed **POWER INPUT** plug, **POWER FUSE** and **LINE VOLTAGE SELECTOR** are contained in an integral filtered module at the center of the rear panel.

The protective window allows the fuse rating and line voltage selection to be inspected with the power socket connected. This window slides to the left once the socket has been disconnected, for access to the fuse and voltage selector printed circuit board.

### Power Cable

The detachable supply cable, comprising two meters of 3-core PVC sheath cable permanently moulded to a fully-shrouded 3-pin socket, fits in the **POWER INPUT** plug recess, and should be pushed firmly home.

The supply lead should be connected to a grounded outlet ensuring that the ground lead is connected. Connect Black lead to Line, White lead to Neutral and Green lead to Ground. (European: Brown lead to Line, Blue lead to Neutral, and Green/Yellow lead to Ground).

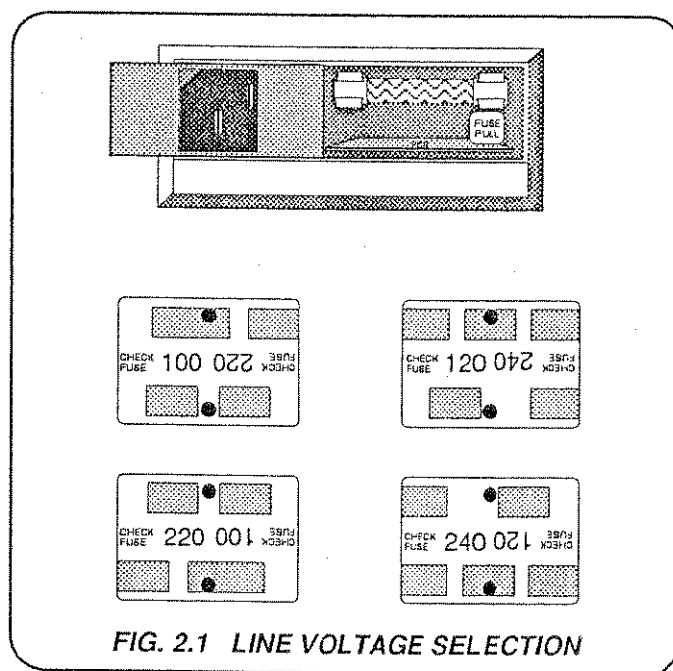

FIG. 2.1 LINE VOLTAGE SELECTION

## Line Voltage

The 4800, 4805 and 4808 calibrators are operative within the line voltage ranges 100/115/120/220/230/240V  $\pm 10\%$ , 50 or 60Hz. To accommodate these ranges, a small PC selector board is housed beneath the **POWER FUSE**.

## Operating Voltage Selection

1. Ensure that the **POWER CABLE** is removed. Slide the window to the left to reveal the fuse and PC selector board.
2. Draw the fuse-extractor to the left and remove the fuse.
3. Remove the PC selector board and rotate until the desired voltage is on the left of the upper surface — see *Figure 2.1 opposite*.
4. Reinsert the selector board firmly into its slot in the Power Input Module.
5. Check that the desired voltage is visible in the cutout below the fuse.
6. Return the fuse extractor to the normal position.
7. Insert the appropriate **POWER FUSE** (see following section 'Power Fuse').
8. Slide the window to the right and insert the **POWER CABLE**.

## Power Fuse

The fuse rating is:

- 3.15A for 220/240V line supply
- 6.25A for 100/120V line supply

It is located behind the window in the **POWER INPUT** module on the rear panel, and should be of the anti-surge or SLO BLO type.

## WARNING

**MAKE SURE THAT ONLY FUSES WITH THE REQUIRED RATED CURRENT AND OF THE SPECIFIED TYPE ARE USED FOR REPLACEMENT. THE USE OF MENDED FUSES AND THE SHORT CIRCUITING OF FUSE-HOLDERS SHALL BE AVOIDED, AND RENDERS THE WARRANTY VOID.**

## Bench Mounting

The instrument is fitted with six plastic feet. It is intended to stand flat on a bench, positioned so that the cooling-air inlet and exhaust apertures on its rear panel are not obstructed. It is recommended that at least 30cm (12 inches) of free space is allowed at the rear.

## Rack Mounting

Option 90 permits the instrument to be mounted in a standard 19-inch cabinet.

### CAUTION

**NOTE THAT THE 4800/4805/4808 IS DESIGNED TO BE SUPPORTED AT THE FRONT AND REAR. AT NO TIME SHOULD THE INSTRUMENT BE SUPPORTED ONLY BY THE FRONT BRACKETS. ON NO ACCOUNT SHOULD THE UPPER AND LOWER COVERS BE REMOVED.**

## Option 90 Fitting Procedure

1. Remove the two rear spacers from the case sides by releasing the six retaining screws.
2. Remove the six screws located in the holes marked 'A' in Figure 2.2 opposite.
3. Fit the two front rack-mounting ears to the case sides of the calibrator, using six of the shorter screws in the option kit. Add the cover plates and handles to the ears if required.
4. Fit the two rack-mounting slides to the rear of the case sides and secure using the remaining six of the shorter screws in the option kit. **N.B.** The slides may be reversed to give rearward extension.
5. Fit the two rear rack-mounting ears to the rear of the cabinet, with tongues facing forward. In shallow cabinets it may be necessary to trim the tongue.
6. **CAUTION:** Assistance is required to fit the 4800/4805/4808 into the cabinet.  
Lift the instrument into position in the cabinet, locate the tongues in the slides, and carefully slide backwards until the front ears butt up against the cabinet front.
7. Secure the front ears to the cabinet.
8. Ensure clear ventilation for fan cooling to operate properly.



**Suitable Rack Depths**

DEPTH		NOTES
mm	Inches	
<675	<26.5	Shorten the Rear Rack Mounting Ears
675 to 775	26.5 to 30.5	Fit as shown
775 to 840	30.5 to 33	Reverse Rack Mounting Slides to extend past the Rear Panel

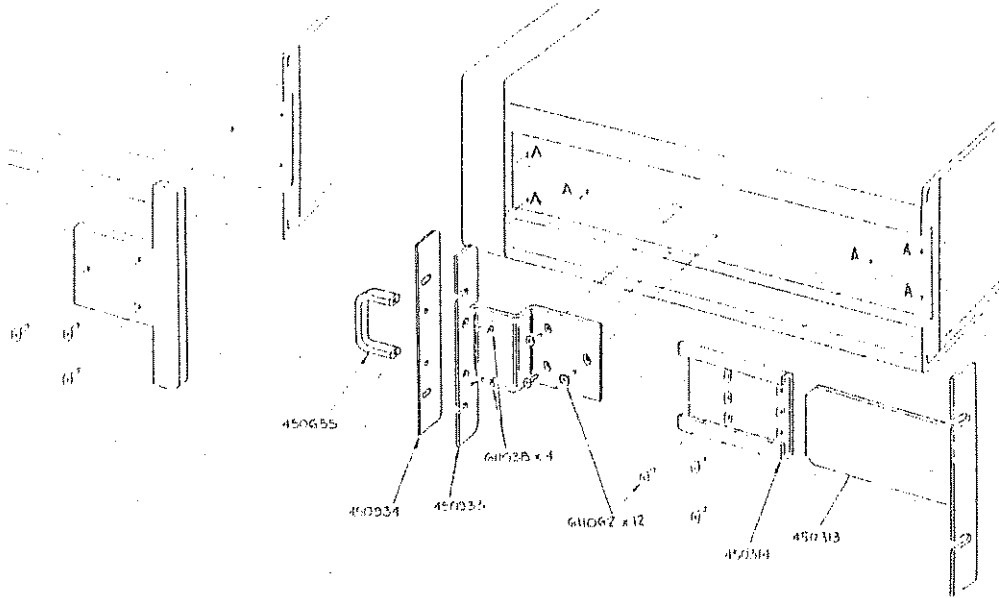

**FIG. 2.2 RACK MOUNTING DETAILS**

## Connectors and Pin Designations

### IEEE-488 Input/Output Socket J27

The IEEE-488 input/output is a 24-way connector that is directly compatible with the IEEE-488 and IEC-625 Interface Bus standards.

#### Pin Layout

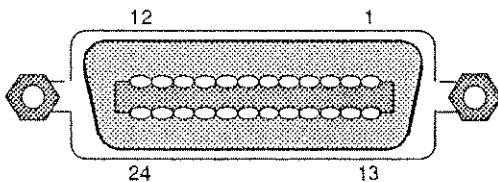

### Pin Designations

Pin No.	Name	Description
1	DIO 1	Data Input Output Line 1
2	DIO 2	Data Input Output Line 2
3	DIO 3	Data Input Output Line 3
4	DIO 4	Data Input Output Line 4
5	EOI	End or Identify
6	DAV	Data Valid
7	NRFD	Not ready for Data
8	NDAC	Not Data Accepted
9	IFC	Interface Clear
10	SRQ	Service Request
11	ATN	Attention
12	SHIELD	Screening on cable (connected to Safety Ground)
13	DIO 5	Data Input Output Line 5
14	DIO 6	Data Input Output Line 6
15	DIO 7	Data Input Output Line 7
16	DIO 8	Data Input Output Line 8
17	REN	Remote Enable
18	GND 6	Ground wire of twisted pair with DAV
19	GND 7	Ground wire of twisted pair with NRFD
20	GND 8	Ground wire of twisted pair with NDAC
21	GND 9	Ground wire of twisted pair with IFC
22	GND 10	Ground wire of twisted pair with SRQ
23	GND 11	Ground wire of twisted pair with ATN
24	GND	Logic Ground (Internally connected to Safety Ground)

### External Reset Socket & 4600 Transconductance Amplifier Digital Connector J54

#### Pin Layout

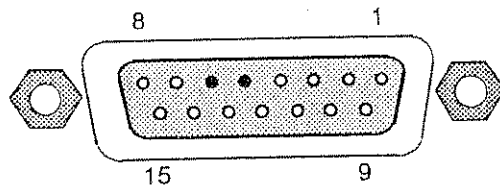

#### Pin Designation

Pin	Name	Function
1	SHIELD	Case Ground
2	0V_6	Digital Common
3	IWR_R	Write Strobe (Rising Edge)
4	0V_6	Digital Common
5	0V_6	Digital Common
6	ICAL_RST_L	Not used on 4600
7	IA_H_D_L	Address/Data select on AD0-AD4
8	IRD_L	Read Strobe (Active Low)
9	IDIGBUSON_H	+5V ( $R_{source} = 1k\Omega$ ) when unit is on.
10	0V_6	Digital Common
11	IAD0	Bi-directional Address/Data Lines, controlled by Strobes and IA_H_D_L
12	IAD1	
13	IAD2	
14	IAD3	
15	IAD4	

### External Reset Switch Wiring

Pins 6 and 5 of J54 may be used to input an external reset to restore the calibrator to its power-up state. (4805: DCV, 1V Range. 4800 and 4808: DCV or ACV, 1V Range depending on options fitted).

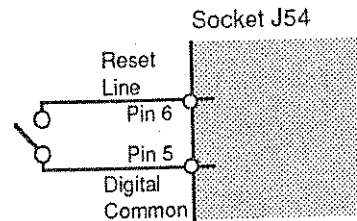

### 4600 Transconductance Amplifier Analog Connector J56 Pin Layout and Designations

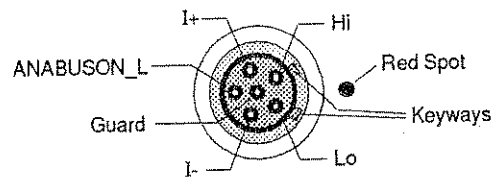

## *Section 2 - Installation*

---

### **External Reference Frequency Input Socket J53.**

This BNC socket is located next to the cooling air intake filter. It enables the frequency synthesizer to be locked to a customer's own frequency standard provided that it meets the following criteria:

Voltage: 500mV to 15V peak-to-peak  
Frequency: 1MHz  $\pm$  1% or 10MHz  $\pm$  1%

N.B. The socket has an input resistance of approximately 50 $\Omega$ .



Section 3 - Operating Controls

**POWER SWITCH**

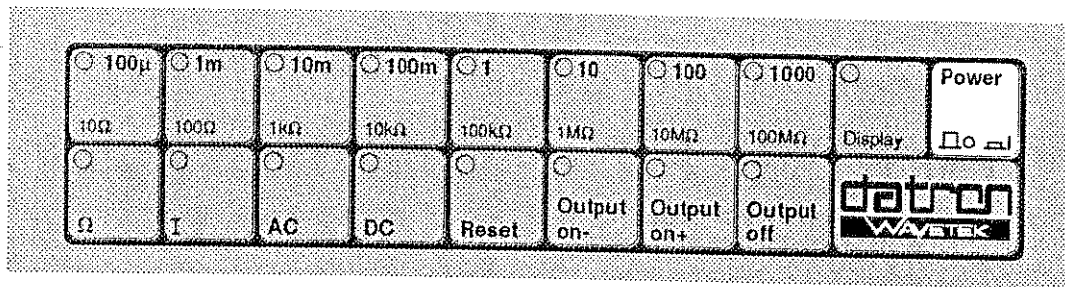

**WARNING**

**THE POWER SWITCH SHOULD NOT BE SET TO ON UNTIL THE LINE VOLTAGE AND POWER FUSE RATING HAVE BEEN SELECTED AS DETAILED IN SECTION 2.**

When set to the OFF (□○) position, the Power switch isolates the instrument from the supply.

When switched to the ON (▣) position, the instrument powers up, runs a self-test program and configures itself into the following state:

FUNCTION	DC if the calibrator has a DC Voltage function. AC if the calibrator has an AC Voltage function and no DC Voltage function. N.B. This only applies to the 4800 and 4808.
OUTPUT RANGE	1
OUTPUT	OFF
OUTPUT DISPLAY	For a 4800 or 4808: .000,000,0V      For a 4805: .000,000V
FREQUENCY RANGE	None selected
MODE/FREQUENCY DISPLAY	Blank
MODE	None selected Rem guard LED unlit (local guard) Rem sense LED unlit (local sense)
Key LEDs Lit	Output off, DC, 1

## OUTPUT SWITCHING

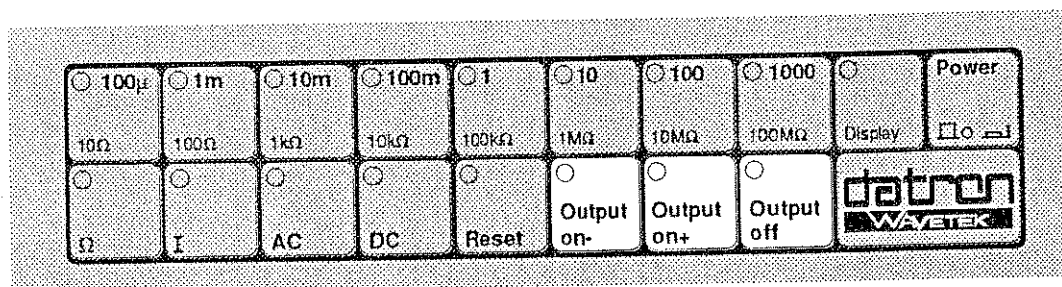

### OUTPUT ON/OFF

The calibrator should normally be connected and set up with its output OFF. This isolates the **I+**, **I-**, **Hi** and **Lo** terminals from their internal circuitry regardless of RANGE, FUNCTION, FREQUENCY or MODE selections. The **Output off** LED is lit.

Pressing the **Output on+** or **Output on-** keys connects the **I+**, **I-**, **Hi** and **Lo** terminals to their energized internal circuits.

### OUTPUT OFF Default

Certain instrument states are prohibited, and some transfers between states are restricted by program firmware. For safety reasons some of these transfers result in the output being switched off. Refer to *Section 4, Operating Routines*.

### OUTPUT ON +/ON -

On DC Voltage or Current, the polarity at the Output terminals is determined by the Key used to switch the output on, as labelled. In addition, polarity may be reversed by using the  $\diamond$  keys to step the output across zero value. The **Output on+** and **Output on-** LEDs describe the polarity AT THE OUTPUT TERMINALS, not on the OUTPUT display. (In "error" and "offset" modes these two could be opposite).

In the AC Voltage, AC Current and Resistance functions, the **Output on+** key will cause the selected outputs to appear at the output terminals. The **Output on-** key will cause the error buzzer to sound and **Error 8** to appear in the left-hand MODE/FREQUENCY display.

## RESET KEY

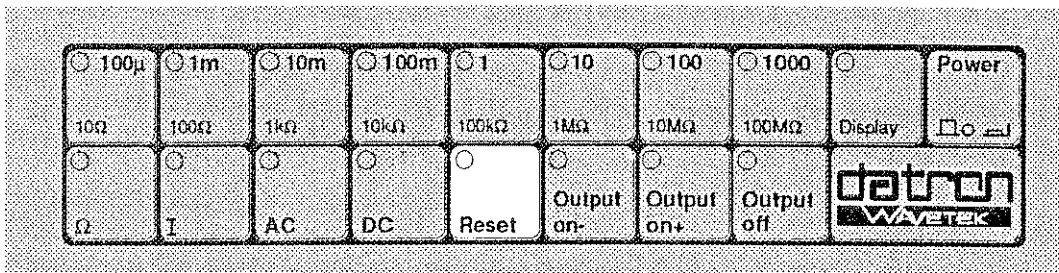

### Reset Key

Under certain abnormal conditions which might compromise safety, the calibrator output will trip off, accompanied by a **FAIL 5** message on the left-hand **MODE** display. Control is removed from the front panel keys.

If the **FAIL 5** message is present, there is **NO** automatic recovery from the tripped state irrespective of whether internal conditions have, or have not, returned to normal.

(A full list of **FAIL** and other types of message appears in *Section 4*. The fault conditions which generate **FAIL** messages are analyzed in the relevant *Maintenance Handbook*.)

The Reset key has two functions:

1. It allows the user to reset the safety trip to test whether conditions have returned to normal. If they have, the **FAIL** message will disappear, the previous instrument state will be restored but with the **OUTPUT OFF**, and front panel control will be returned to the user. If conditions are still abnormal the **FAIL** state will persist, and a further attempt may be made after a suitable interval. The **Reset** LED is inoperative except in "TEST" mode.
2. It returns the instrument to power-up conditions in all cases except the following:
  - Self-test mode
  - **FAIL** conditions
  - In remote control mode (where it is inoperative).



## FUNCTION KEYS

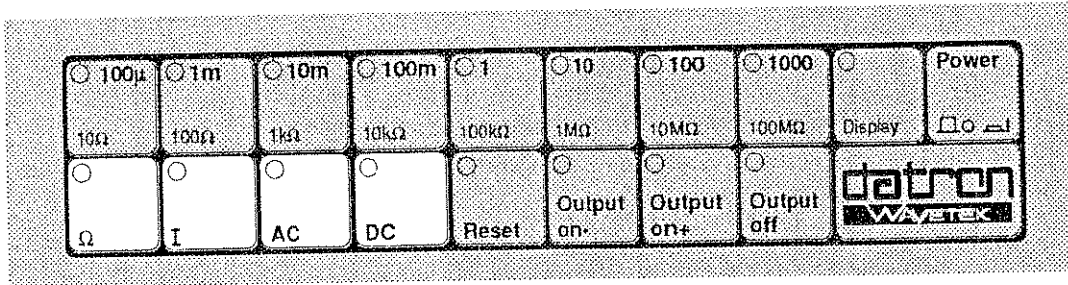

When changing from one function to another the output is automatically set to OFF. When changing from  $\Omega$ , to AC or DC, the OUTPUT value is automatically set to zero. If the corresponding OUTPUT RANGE or value is not available on the new function, the calibrator displays Error 8 and sounds its error buzzer.

$\Omega$  selection forces the calibrator into Remote Sense for 4-wire operation.

Selected Function	Specified Output	Notes
DC AC $\Omega$ DC and I AC and I	DC Voltage AC Voltage Resistance DC Current AC Current	For the 4800 or 4808 Error 9 is displayed and the buzzer sounds if the relevant option is not fitted.

## OUTPUT RANGE KEYS

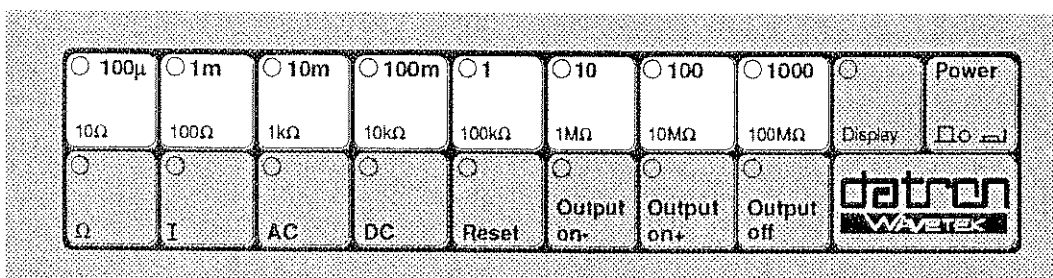

Each OUTPUT RANGE key scales the output as selected by the user, setting the legend and decimal point on the right-hand OUTPUT display to match. Full range values for voltage and current are marked in bold-face type on the keys. Nominal values of each precision resistor for the  $\Omega$  function are marked in light-face type on the keys.

Voltage and current ranges are selectable as follows, the actual output value being selected by use of the OUTPUT display  $\odot$  keys. (N.B. For the 4800 and 4808 this depends on the appropriate options being fitted)

DC Voltage	100 $\mu$ V to 1000V
AC Voltage	1mV to 1000V RMS
DC Current	100 $\mu$ A to 1A
AC Current	100 $\mu$ A to 1A RMS
Resistance	10 $\Omega$ to 100M $\Omega$

If the output is ON when changing ranges, it remains ON unless the change is to a 1000V range, or the ranging is to a value greater than 75V RMS on the AC 100V range or greater than 110V on the DC 100V range. In these cases the output defaults to OFF. Any range selection which would exceed the internally defined voltage-frequency limit is automatically inhibited. These limits are described on pages 3-16 to 3-19.

### 4800 and 4808 Range Selection

Key Selections	<input checked="" type="radio"/> 100 $\mu$	<input checked="" type="radio"/> 1m	<input checked="" type="radio"/> 10m	<input checked="" type="radio"/> 100m	<input checked="" type="radio"/> 1	<input checked="" type="radio"/> 10	<input checked="" type="radio"/> 100	<input checked="" type="radio"/> 1000
	10 $\Omega$	100 $\Omega$	1k $\Omega$	10k $\Omega$	100k $\Omega$	1M $\Omega$	10M $\Omega$	100M $\Omega$
DC Voltage	100 $\mu$ V	1mV	10mV	100mV	1V	10V	100V	1000V <sup>[2]</sup>
AC Voltage	*	1mV	10mV	100mV	1V	10V	100V	1000V <sup>[2]</sup>
DC Current	100 $\mu$ A	1mA	10mA	100mA	1A	10A <sup>[1]</sup>	*	*
AC Current	100 $\mu$ A	1mA	10mA	100mA	1A	10A <sup>[1]</sup>	*	*
Resistance	10 $\Omega$	100 $\Omega$	1k $\Omega$	10k $\Omega$	100k $\Omega$	1M $\Omega$	10M $\Omega$	100M $\Omega$

\*Error 8

[1] Error 8 if 4600 not connected in slave mode configuration

[2] Error 9 if Option 30 not fitted

### 4805 Range Selection

Key Selections	<input checked="" type="radio"/> 100 $\mu$	<input checked="" type="radio"/> 1m	<input checked="" type="radio"/> 10m	<input checked="" type="radio"/> 100m	<input checked="" type="radio"/> 1	<input checked="" type="radio"/> 10	<input checked="" type="radio"/> 100	<input checked="" type="radio"/> 1000
	10 $\Omega$	100 $\Omega$	1k $\Omega$	10k $\Omega$	100k $\Omega$	1M $\Omega$	10M $\Omega$	100M $\Omega$
DC Voltage	100 $\mu$ V	1mV	10mV	100mV	1V	10V	100V	1000V
AC Voltage	*	1mV	10mV	100mV	1V	10V	100V	1000V
DC Current	100 $\mu$ A	1mA	10mA	100mA	1A	10A <sup>[1]</sup>	*	*
AC Current	100 $\mu$ A	1mA	10mA	100mA	1A	10A <sup>[1]</sup>	*	*
Resistance	10 $\Omega$	100 $\Omega$	1k $\Omega$	10k $\Omega$	100k $\Omega$	1M $\Omega$	10M $\Omega$	100M $\Omega$

\*Error 8

[1] Error 8 if 4600 not connected in slave mode configuration



Section 3 - Operating Controls

OUTPUT DISPLAY AND  $\diamond$  KEYS

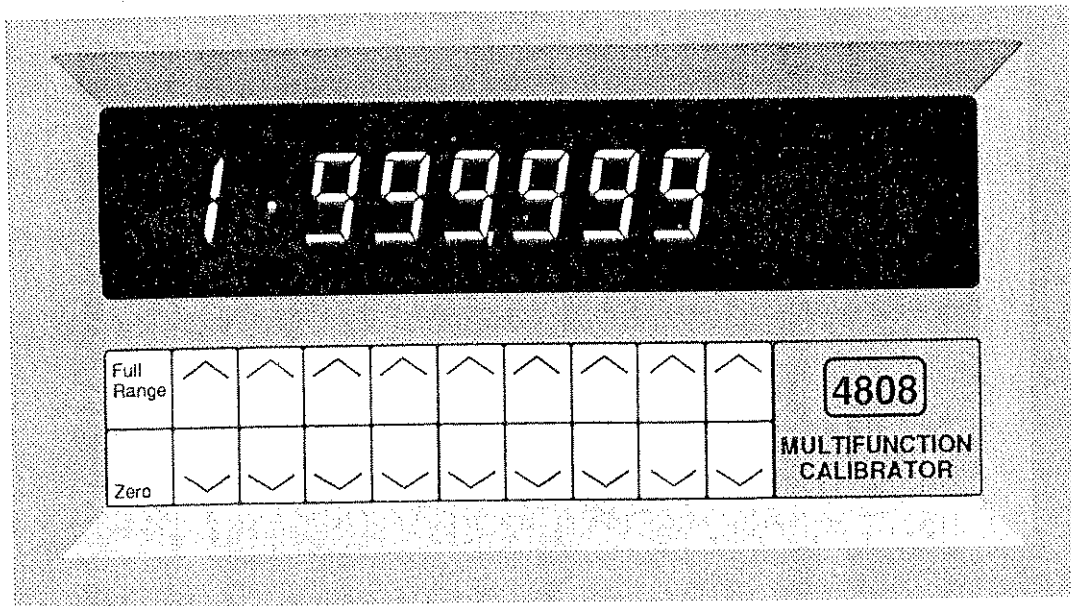

**Output Resolution**

The 4800, 4805 and 4808 output and output display resolutions are shown in the tables opposite.



## 4800 and 4808 Output and Display Resolution

Range	<input checked="" type="radio"/> 100 $\mu$	<input checked="" type="radio"/> 1m	<input checked="" type="radio"/> 10m	<input checked="" type="radio"/> 100m	<input checked="" type="radio"/> 1	<input checked="" type="radio"/> 10	<input checked="" type="radio"/> 100	<input checked="" type="radio"/> 1000
	10 $\Omega$	100 $\Omega$	1k $\Omega$	10k $\Omega$	100k $\Omega$	1M $\Omega$	10M $\Omega$	100M $\Omega$
DCV	4.5	5.5	6.5	7.5	7.5	7.5	7.5	7.5
ACV	-	4.5	5.5	6.5	6.5	6.5	6.5	6.5
DCI	6.5	6.5	6.5	6.5	6.5	6.5 <sup>[1]</sup>	-	-
ACI	6.5	6.5	6.5	6.5	6.5	6.5 <sup>[1]</sup>	-	-
$\Omega$ (2-wire)	4.5	5.5	6.5	7.5	7.5	7.5	7.5	7.5
$\Omega$ (4-wire)	7.5	7.5	7.5	7.5	7.5	7.5	7.5	7.5

[1] Not applicable unless 4600 Transconductance Amplifier is fitted.

## 4805 Output and Display Resolution

Range	<input checked="" type="radio"/> 100 $\mu$	<input checked="" type="radio"/> 1m	<input checked="" type="radio"/> 10m	<input checked="" type="radio"/> 100m	<input checked="" type="radio"/> 1	<input checked="" type="radio"/> 10	<input checked="" type="radio"/> 100	<input checked="" type="radio"/> 1000
	10 $\Omega$	100 $\Omega$	1k $\Omega$	10k $\Omega$	100k $\Omega$	1M $\Omega$	10M $\Omega$	100M $\Omega$
DCV	3.5	4.5	5.5	6.5	6.5	6.5	6.5	6.5
ACV	-	3.5	4.5	5.5	5.5	5.5	5.5	5.5
DCI	5.5	5.5	5.5	5.5	5.5	5.5 <sup>[1]</sup>	-	-
ACI	5.5	5.5	5.5	5.5	5.5	5.5 <sup>[1]</sup>	-	-
$\Omega$ (2-wire)	3.5	4.5	5.5	6.5	6.5	6.5	6.5	6.5
$\Omega$ (4-wire)	6.5	6.5	6.5	6.5	6.5	6.5	6.5	6.5

[1] Not applicable unless 4600 Transconductance Amplifier is fitted.





OUTPUT AND DISPLAY CONTROL

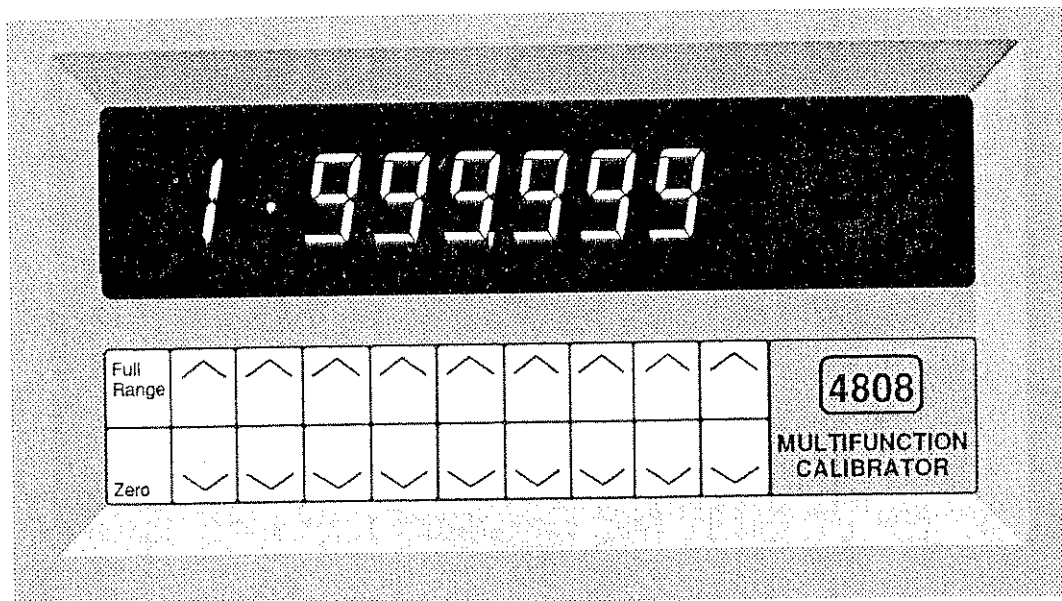

Each vertical pair of  $\wedge$  keys is assigned to the display digit above it. Thus the value registered on the display may be set within the range permitted by the selected function. Each momentary press of the  $\wedge$  key adds 1 to the corresponding digit. Each momentary press of the  $\vee$  key subtracts 1. If the output is ON, the output at the calibrator's terminals changes by the same increment/decrement as the display (subject to the instrument interlocks).

On  $\Omega$  ranges, only the overrange (leftmost pair of)  $\wedge$  keys are operative. These duplicate the action of the Full Range/Zero Keys.

The Resistance value displayed is the calibrated value of the standard internal resistor selected (not the nominal value). This value may be updated during periodic calibration. The value displayed depends on the selection of Local (2-wire) or Remote (4-wire) Sense, and should be recalibrated in the correct Sense mode (See Section 8).

The right-hand OUTPUT display is supplemented by legends, which always indicate the correct units for the RANGE and FUNCTION selected



### Auto-Increment/Decrement

When a  $\odot$  key is pressed for more than 0.5 seconds, its digit is increased or decreased at a rate of approximately 3 digits per second until the key is released.

### Overflow and Underflow

As a digit is stepped from 9 to 0, the value of the next higher-order digit is increased by 1. Stepping from 0 to 9 decreases the value by 1. The whole display therefore acts as a counter, with full 'carry' and 'borrow' action.

### Range of Adjustment for DC Functions

The  $\odot$  keys adjust the readings between a minimum of 0000000 and 1999999 full scale (000000 and 199999 for the 4805) on the 100mV to 100V ranges, and between 000000 and 199999 (00000 and 19999 for the 4805) on Current Ranges. The 1000V Range (optional on the 4800 and 4805) has a Full Scale of 1100.0000 (1100.000 for the 4805). On the 100 $\mu$ V, 1mV and 10mV ranges the resolution is truncated.

### Range of Adjustment for AC Functions

The  $\odot$  keys adjust the reading between a minimum of 0090000 (009000 for the 4805), and a maximum of 1999999 full scale (199999 for the 4805) on the 100mV to 100V AC Voltage ranges and on all AC Current Ranges. The 1000V Range (optional on the 4800 and 4808) has a Full Scale of 1100.000 (1100.00 for the 4805). In the 1mV and 10mV ranges the resolution is truncated.

### Range of Adjustment for Resistance Function

There is no range of adjustment on Resistance functions.

## **OUTPUT AND DISPLAY CONTROL (continued)**

### **Leading Zeros**

For fractional readings, a leading zero is inserted to the left of the decimal point in order to emphasise the decimal point position. This is not done for the **1m** and **1** range selections.

### **DC Zero and Polarity.**

On DC Voltage and DC Current functions, a polarity sign is displayed for all outputs except zero. The numeric value of the display represents the magnitude of the output.

As the display value is stepped to zero the polarity sign disappears, and the opposite sign appears as stepping continues in the same direction. If the output is ON during the sequence, the change in output polarity is signalled by a changeover from the **Output on+** to the **Output on-** LED or visa versa.

**N.B.** If the calibrator is in **Offset Mode**, with an offset present, the display and output zeros do not coincide. It is therefore possible to have a + sign on the display, and the **Output 0n-** LED lit, or vice-versa.

When using the  $\curvearrowright$  keys or **Zero** key to obtain a zero, the polarity is not changed over and the same **Output on (+ or -)** LED remains lit. The polarity LEDs change over only when there is a change of polarity at the output terminals.

### **Full Range Key**

When the **Full Range** key is pressed, the display reverts to the nominal value of the range selected. If the output is already ON, the terminal value follows the display value unless:

1. The combination of output voltage and frequency would exceed the instrument's volt.hertz limits. (Refer to *Section 6*).
2. **OFFSET** or **ERROR** Mode is selected. In these modes the user-input offset or gain error is not cancelled from the output.

### Zero Key

This reduces the display value to zero. If the output is ON, the terminal value is also set to zero as follows:

- DC Voltage — an active zero is presented to the output terminals.
- AC Voltage — an internal short circuit is connected across the output terminals.
- DC and AC Current — the output terminals are open-circuited.

On  $\Omega$  ranges in REMOTE SENSE with the output ON, the Zero key connects a true 4-wire internal short circuit to the output terminals as shown below. With the Rem sense LED unlit, the same short is connected, but the actual resistive value of this short may be calibrated (See Section 8 and Figure 3.1 below).

### Deselection of Zero in AC Functions

The size of the characters on the 'Zero' display is significant. A half-size '0' above any  $\wedge$  key indicates that it cannot be used to deselection Zero, because it increments values which are less than 10% of nominal range. Any  $\wedge$  key with a full size '0' above it (and any key to its left) deselection Zero and adds its increment.

### Selection of High Voltage Outputs

The 4800, 4805 and 4808 calibrators are capable of delivering LETHAL output voltages. Program interlocks are therefore used to ensure that users do not inadvertently select outputs in excess of 110V in DC or 75V RMS in AC. Details of the High Voltage selection procedure are given in Section 4.

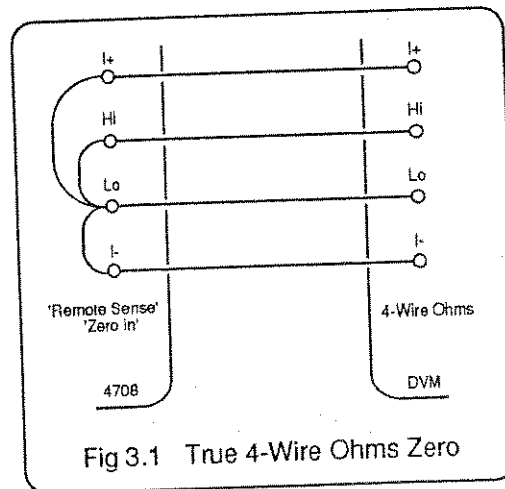

## FREQUENCY CONTROL

The AC Voltage output of the 4800 and 4808 calibrators extends from 10Hz to 1MHz in five overlapping decade ranges. The AC Voltage output of the 4805 calibrator extends from 10Hz to 100kHz in four overlapping decade ranges. Frequency setting resolution is 1% of nominal Frequency Range. In addition, any five frequency values within the range of the instrument can be stored in and recalled from volatile memory.

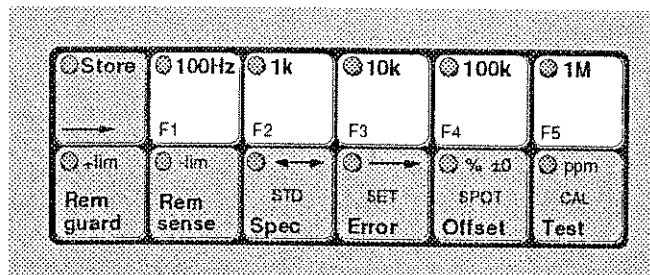

### Decade Ranging

Generally, selection of a new range changes the frequency by an integral number of decades. However, ranging down to a frequency less than 10Hz, or ranging-up to a frequency greater than 1MHz in the case of the 4800 or 4808, or 100kHz in the case of the 4805, causes **Error 7** to be displayed and the buzzer to sound.

### Selection of Nominal Range Value

Once a Frequency Range has been selected, the frequency can be set to the nominal value of the range by re-pressing the same range key.

## Frequency Display

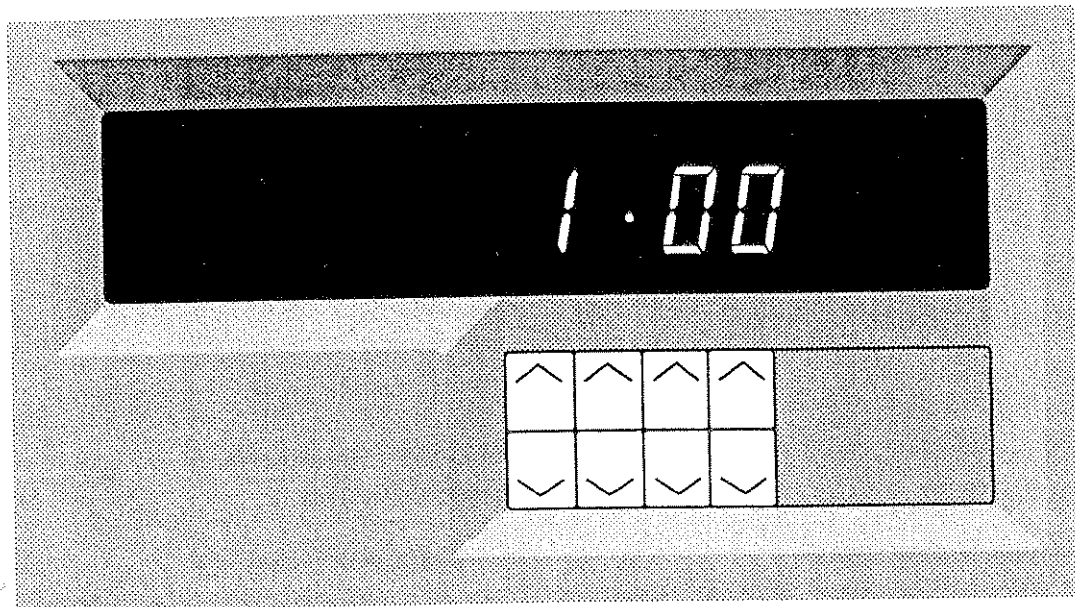

### Resolution

- The output frequency is adjustable in steps of 1% of the selected FREQUENCY RANGE's nominal value, matching the display resolution. Appropriate range legends are displayed, and a leading zero is presented to the left of the decimal point for fractional values.

### Frequency $\diamond$ Control Keys

Each vertical pair of  $\diamond$  keys is assigned to the display digit above it. The frequency registered on the display is adjusted by manipulation of

these keys. Each momentary press of the  $\wedge$  key adds 1 to its digit, and each  $\vee$  key subtracts 1. If the output is ON, the output frequency is also changed by the same increments as the display (subject to the instrument interlocks). The  $\diamond$  keys below decimal points are inactive.

### Auto-Increment/Decrement

When a  $\diamond$  key is pressed for more than 0.5 seconds, its digit is increased or decreased at a rate of approximately 3 digits per second until the key is released.

## FREQUENCY CONTROL (continued)

### Overflow and Underflow

As a digit is stepped from 9 to 0, the value of the next higher-order digit is increased by 1. Stepping from 0 to 9 decreases the value by 1. The whole display therefore acts as a counter, with full 'carry' and 'borrow' action.

### Autoranging

Stepping the frequency beyond the span of the selected range automatically switches the frequency range up or down, but further steps are inhibited until the  $\wedge$  or  $\vee$  key is released (the key could be below a decimal point). When the range-change occurs, the alarm buzzer sounds and the FREQUENCY display is blanked for approximately 1 second.

When the display is reinstated, the calibrator recalls from memory the last frequency on the old range, and sets the new range to the next frequency increment in the original direction. After releasing the original key, stepping can be continued to any increments of the new range.

### Autorange Limits

The calibrator displays an Error 7 and sounds its buzzer when any attempted frequency increment or decrement is made which would produce an invalid combination of FUNCTION, OUTPUT RANGE or FREQUENCY. In addition, it will not increment or decrement to a frequency beyond the limits of the next frequency range up or down.

## OUTPUT/FREQUENCY CONSTRAINTS

### AC Voltage and Frequency

Under most conditions, the output amplitude and frequency are adjustable throughout their full scales:

Voltages — from 90 $\mu$ V to 1100V RMS  
Frequencies — 4800 and 4808: from 10Hz  
to 1MHz,  
4805: from 10Hz to 100kHz.

On the 100V and 1000V Ranges, certain combinations of voltage and frequency cannot be selected.

The diagrams on pages 3-17, 3-18 and 3-19 illustrate the boundaries for the 4800, 4805 and 4808 respectively. The 10V Range span is also shown for comparison.

The 4800, 4805 and 4808 calibrators refuse to select any Voltage/Frequency combination outside these constraints. The temporary message Error 7 is displayed for approximately 1 second before reverting to the original display.

### AC Current and Frequency

AC Current is adjustable between 9 $\mu$ A and 2A RMS at frequencies from 10Hz to 5kHz. With Option 60 fitted, currents from 2A to 11A are available (10Hz - 20kHz). Error 7 indicates an invalid Current/Frequency selection.



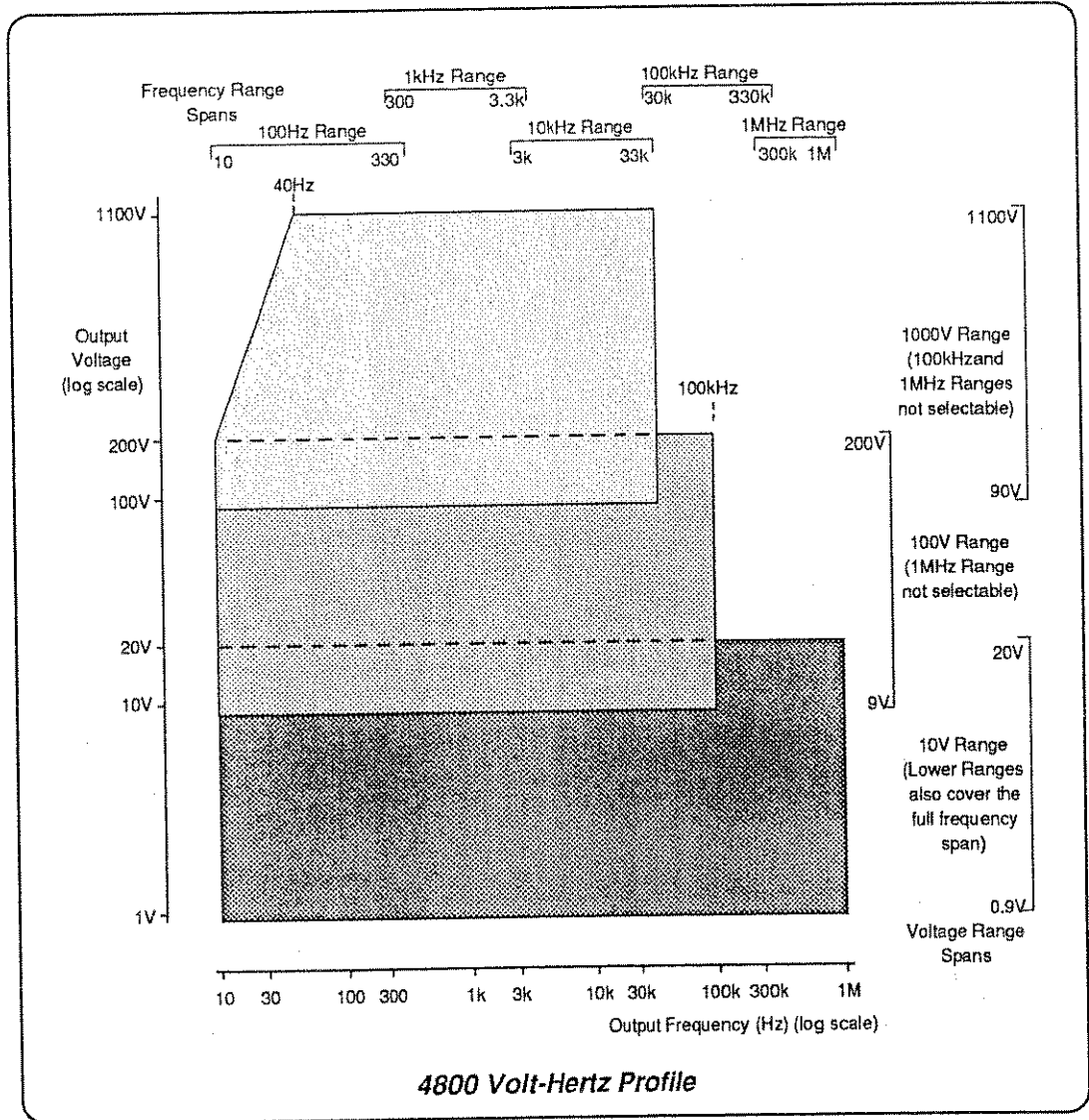

Section 3 - Operating Controls

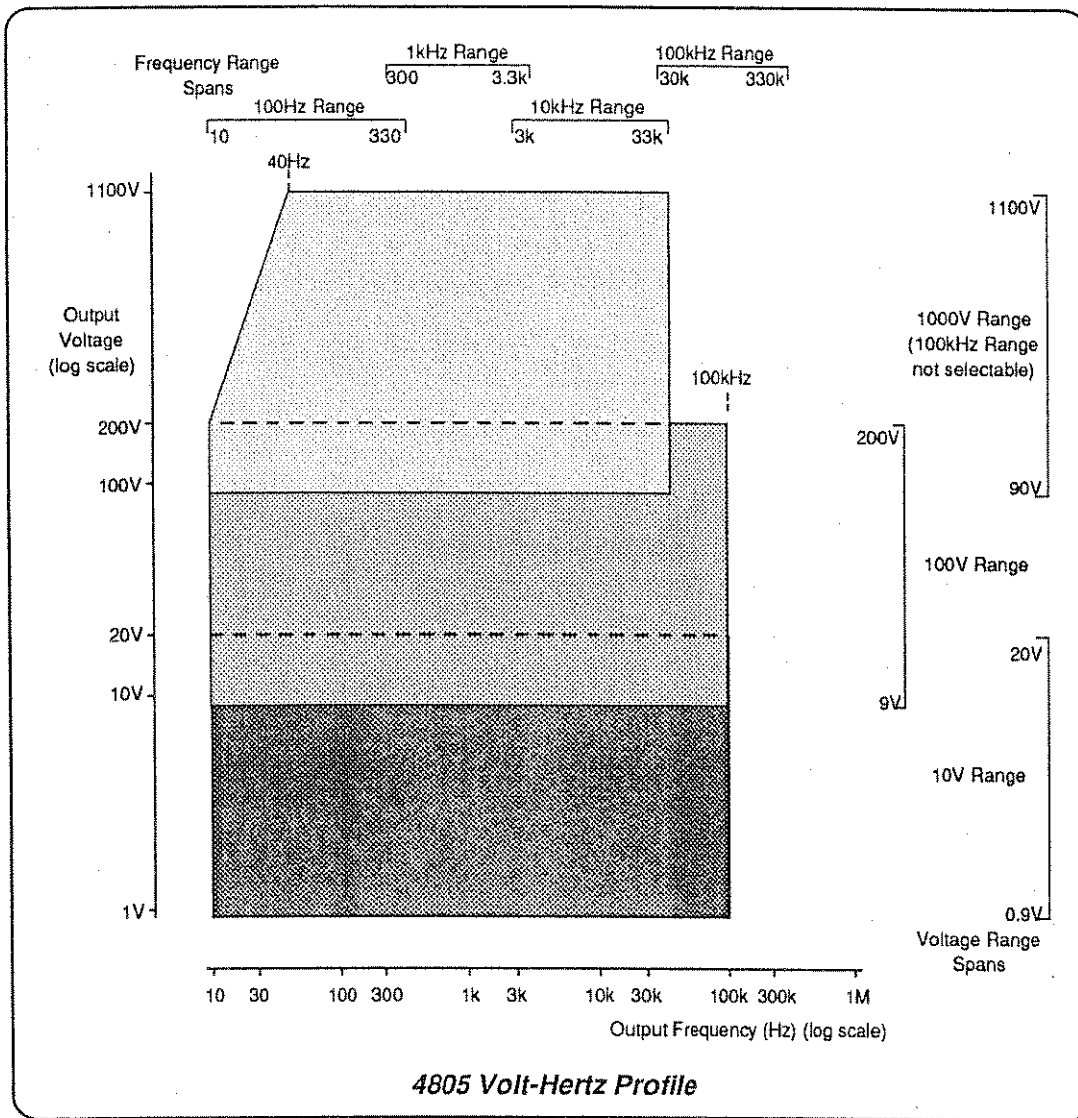

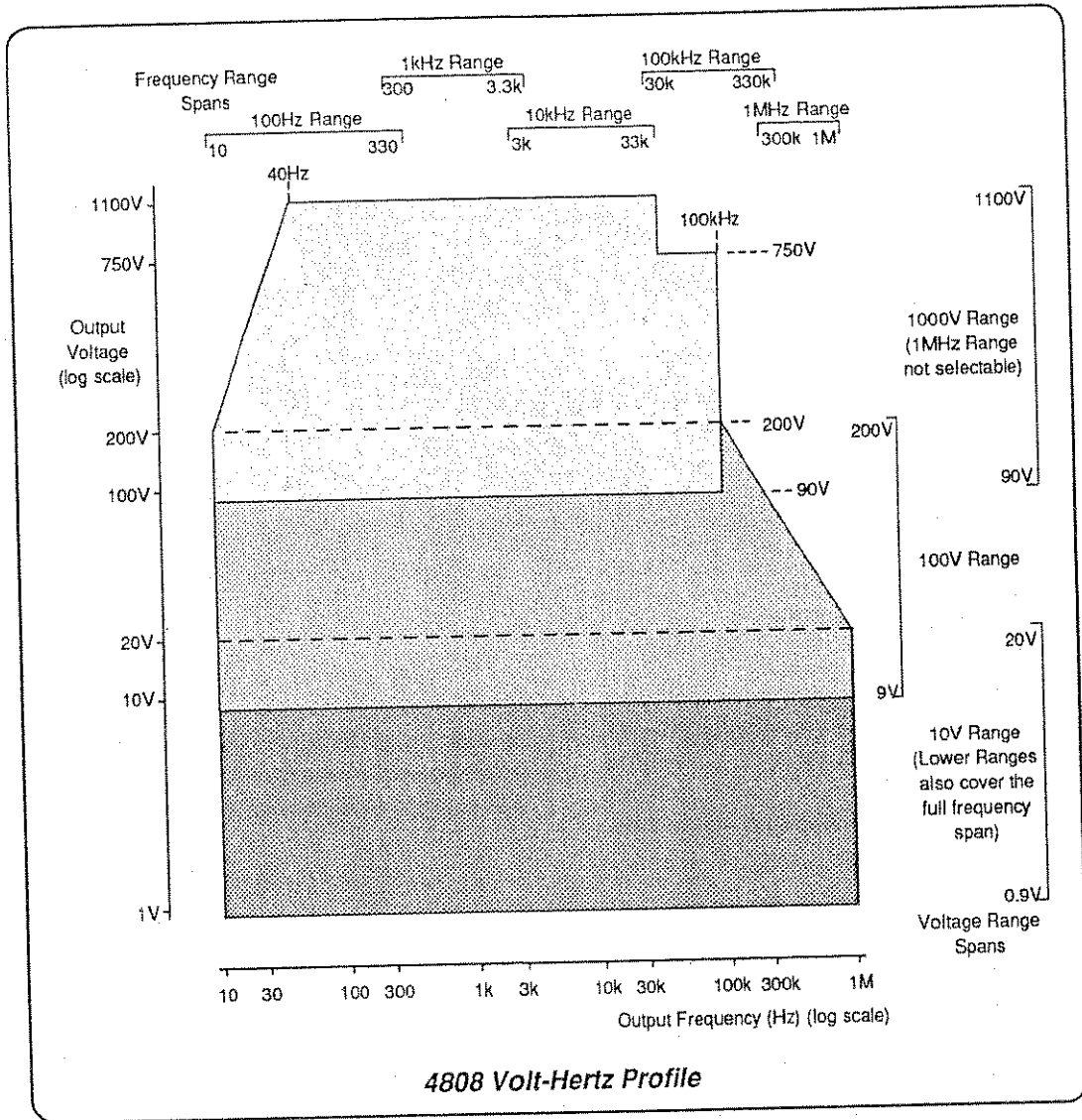

## FREQUENCY MEMORY

This facility allows storage of up to five user-selected frequencies. Once stored, each can easily be retrieved or changed from the front panel. They are retained until power is removed from the instrument or the **Reset** key is depressed.

### Store Key

Only five of the FREQUENCY RANGE keys select ranges. The first press of the sixth key, **Store**, reassigns the other five as frequency memories. It has a toggle action: a second press deselecting the memory function.

### F1-F5 Memory Keys

When the Store LED is ON, these keys select individual memory locations.

N.B. Although the FREQUENCY RANGE keys double as memory selectors, this does not imply that a particular memory can only accept frequencies from its key's range. It is emphasized that any displayable frequency can be stored in any of the five locations.

### Power-up Default

Because the stores are volatile, the following default frequencies are stored in the five memory locations each time the calibrator is powered-up:

F1	30Hz
F2	300Hz
F3	3kHz
F4	30kHz
F5	300kHz

Details of storage and retrieval procedures are described in *Section 4*.

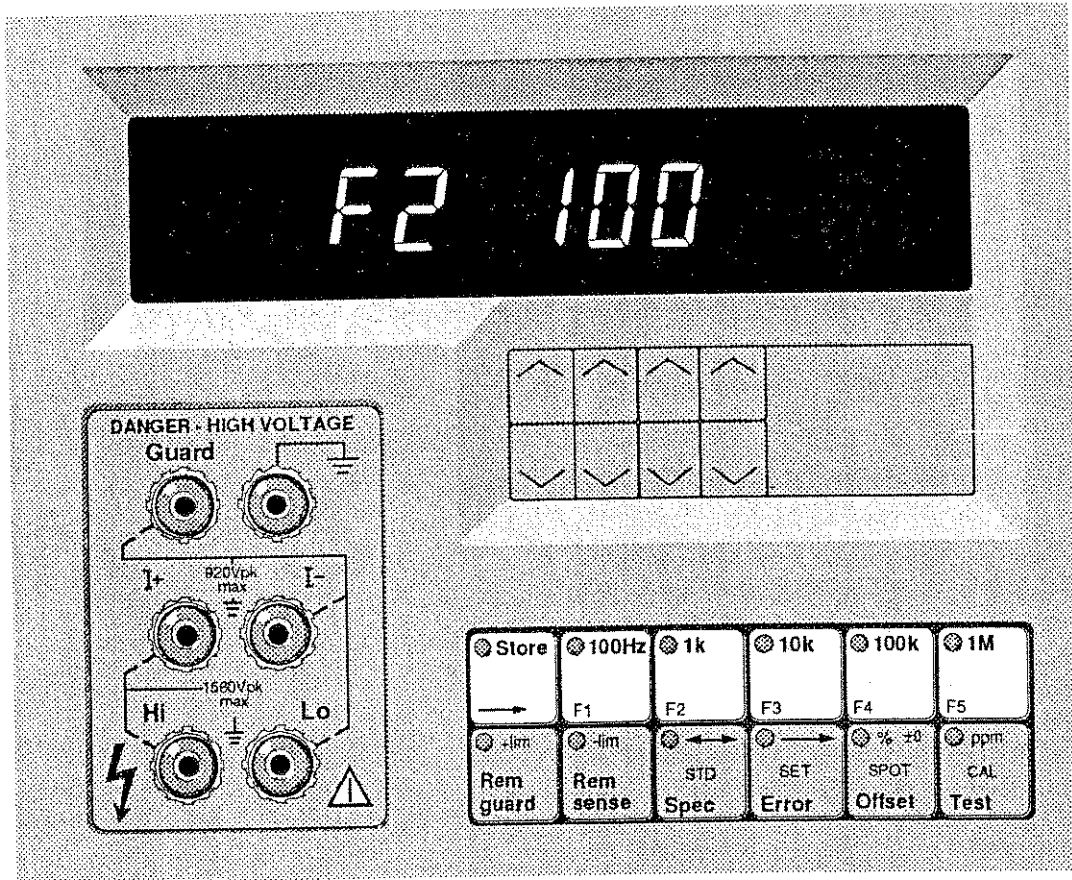

## **SPOT FREQUENCY MEMORY (4808 Only)**

When in CALIBRATION MODE, five user-selected 'Spot' calibrated frequencies can be stored in non-volatile calibration memory for each of the seven OUTPUT RANGES. At these frequencies the calibrator output can be specially Auto-calibrated. Each spot calibrated frequency can then be subsequently recalled when in RUN MODE by two key depressions.

### **Spot Key**

This is used to reassign the F1-F5 memory keys so that they access the non-volatile memory.

'Recall' procedures are detailed in *Section 4*.  
'Store' procedures are detailed in *Section 8*.

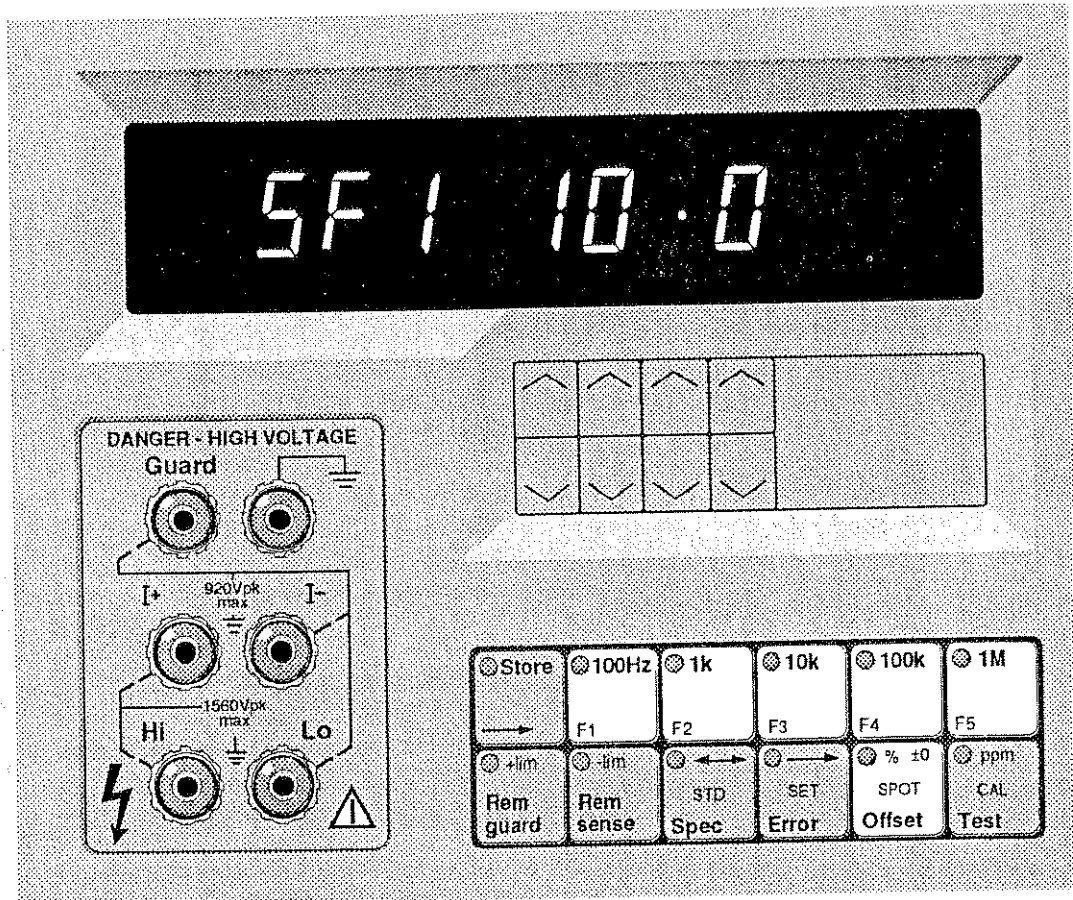

## MODE SELECTION KEYS

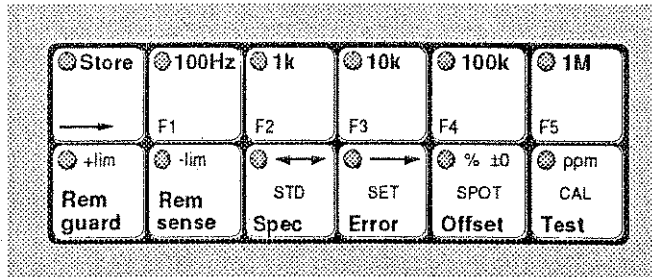

The MODE selection keys are located on the lower left of the front panel. The **Rem guard** and **Rem sense** keys are described in the section titled 'Front Panel Terminals' on page 3-28. **STD**, **SET**, **±0** and **CAL** are calibration modes, printed in green and described in Section 8.

### Spec Mode

The **Spec** key controls the toggle-action SPECIFICATION function. By pressing the key, the 4800, 4805 or 4808 specification tolerances as applicable are displayed on the MODE display, referred to its current FUNCTION, OUTPUT and FREQUENCY, and to the CALIBRATION INTERVAL set on the rear-panel CALIBRATION INTERVAL switch — see Figure 3.2. A second press of the **Spec** key cancels the function. For 24-hour calibration intervals, the 'accuracy relative to calibration standards' figures are displayed, but for 90 days and 1 year intervals they are 'Traceable' accuracy figures which include Datron's Calibration Uncertainty.

While in SPECIFICATION mode, all primary functions of the other MODE keys are cancelled (although the selected Guard and Sense connections remain). The keys are reassigned to their secondary functions: **+lim**, **-lim**, **%** and **ppm**. When SPECIFICATION mode is initiated, the magnitude of the specification tolerance itself determines whether ppm or % is selected. The double-ended arrow above the **Spec** key shows that all four secondary modes are available.

Full details of the operation of Specification mode are given in Section 4.

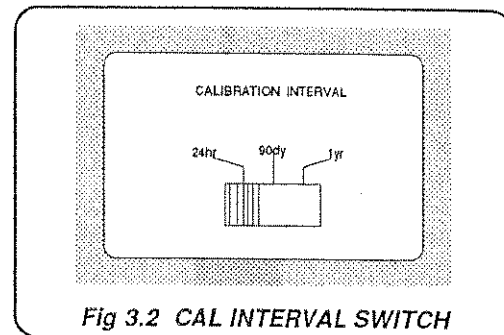

Fig 3.2 CAL INTERVAL SWITCH



### Error and Offset Modes

These keys are used to deviate the output at the terminals from the value shown on the OUTPUT display. The two modes may be selected together. Fuller details of the operation of Error, Offset and the combined mode are given in *Section 4*.

#### Error and Offset Modes NOT Selected

The terminal value is a linear function of the OUTPUT DISPLAY value:

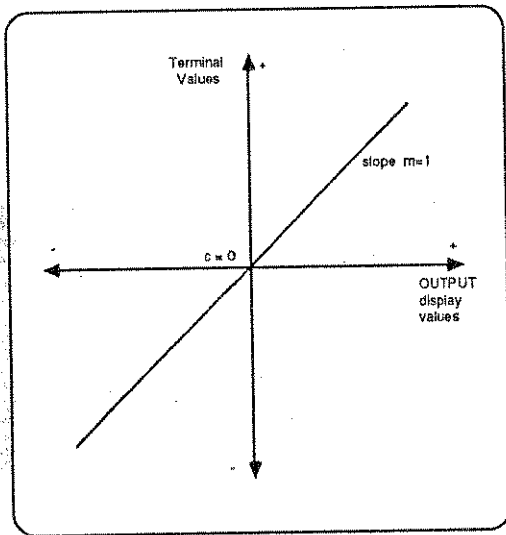

#### Error Mode Selected

This mode allows a gain error deviation of up to  $\pm 10\%$  of the displayed value to be applied to the terminals. Full details are given in *Section 4*.

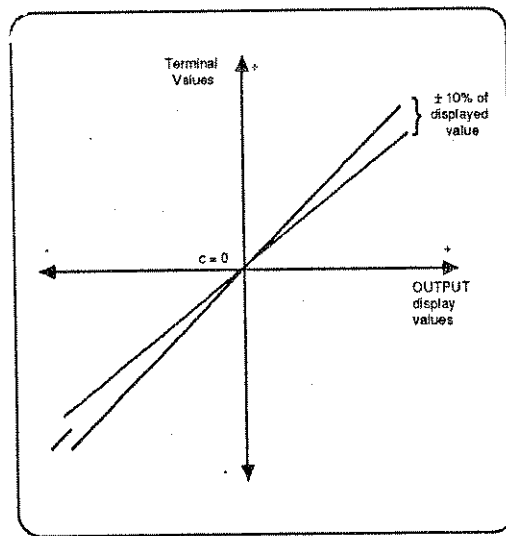

### Error and Offset Modes (continued)

#### Offset Mode Selected (DC Functions Only)

In OFFSET mode, the intercept (c) may be adjusted to any value within the offset limit listed below.

#### Offset Limits:

100 $\mu$ V and 1mV Ranges:  $\pm 200\mu$ V

Other Ranges:  $\pm 2\%$  of the Full Range value.

#### Offset and Error Mode Combination

The OFFSET mode cannot be selected or deselected when the calibrator is already in ERROR Mode.

The intercept (c) is established first in OFFSET mode, then the slope (m) is adjusted in ERROR mode.

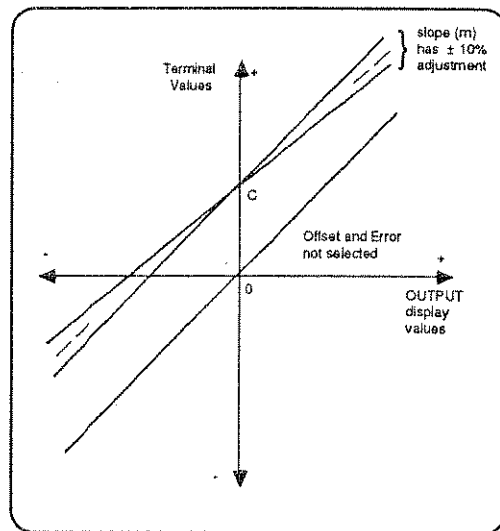
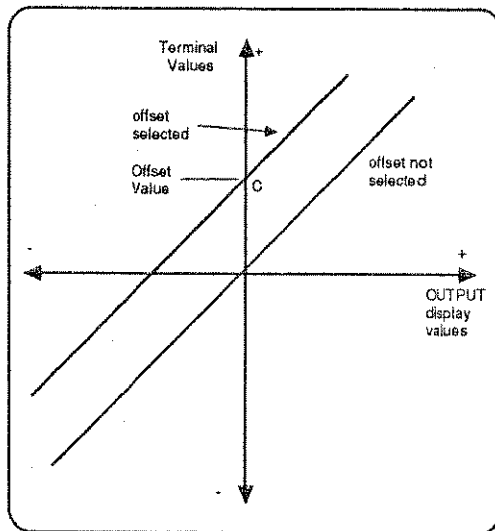

#### Test Mode

Full details of the operations in Test mode are given in *Section 4*.

## DISPLAY KEY

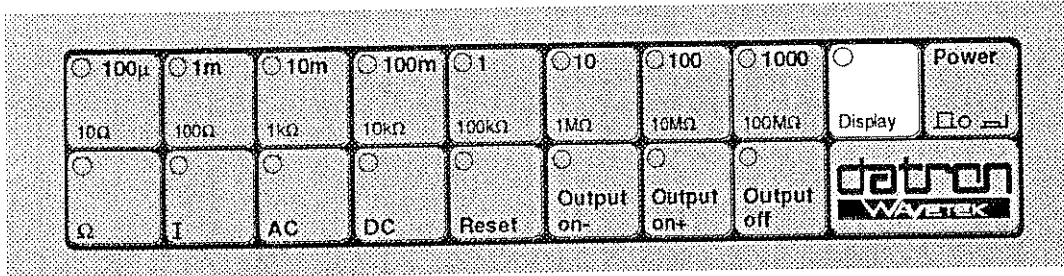

With the calibrator output OFF, pressing the **Display** key illuminates all the segments of the calibrator's left-hand MODE/FREQUENCY display and right-hand OUTPUT display, allowing a visual check of display operation. If carried out periodically, this check will also help to maintain the displays in optimum condition.

## FRONT PANEL TERMINALS

These terminals are located on the lower left of the Front Panel.

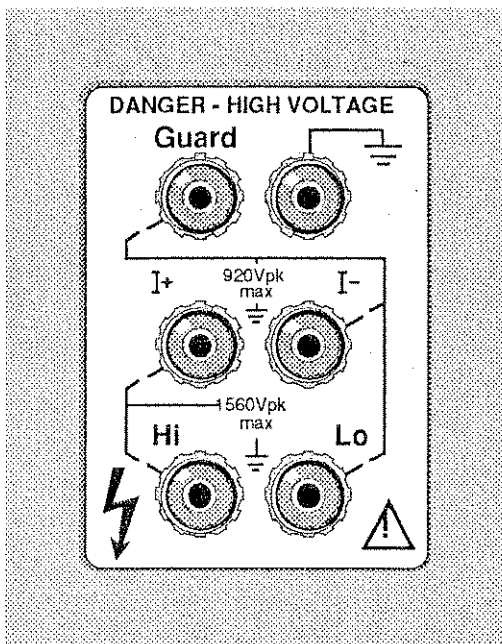

### I+ and I- Terminals

The output from the internal power circuits is delivered to the I+ terminal, I- being its return to Analog Common.

### Hi and Lo Terminals

These terminals provide a differential input to the amplitude sensing circuitry.

### Remote Sensing

The Rem sense key has a 'toggle' action. Successive presses alternate between ON and OFF.

**N.B. Sense connections can only be switched with the OUTPUT OFF.**

The specified voltage output of the calibrator may be produced either at its output terminals (Local Sense for high impedance loads) or at the load terminals (Remote Sense for cases in which lead resistance and load impedance produce a significant effect).

With REMOTE SENSE OFF, the I+ terminal is isolated, and the voltage output is fed to the Hi terminal.

With REMOTE SENSE ON, the output voltage is fed across the I+ and I- terminals only, and must be sensed externally, using leads connected to the Hi and Lo terminals.

REMOTE SENSE is not available on the 100 $\mu$ V to 100mV ranges. It is not applicable to Current outputs.

On OHMS ranges, LOCAL SENSE is used for 2-wire connections, and REMOTE SENSE for 4-wire. (Changing FUNCTION into  $\Omega$  forces the calibrator into REMOTE SENSE, but this may be deselected for 2-wire operation). The Rem sense LED always indicates the true connection:

Lit = Remote    Unlit = Local

### Guard Terminal

The **Guard** terminal is permanently connected to the internal guard shields:

### Remote Guard

The **Rem guard** key has a 'toggle' action. Successive presses alternate between ON and OFF.

With REMOTE GUARD OFF, Guard is internally connected to the **I-** terminal.

With REMOTE GUARD ON, the internal link to **I-** is removed. The **Guard** terminal can then be connected externally to reduce common mode interference.

### Ground Terminal $\perp$

The **Ground** terminal connects directly to the calibrator's internal ground shields and to **Safety Ground** via the power cable.

### Output Connections

Connections to the output terminals may be made either with leads or via a shrouded connector.

For **Voltage** outputs in local sense the two leads should be attached to the Hi and Lo terminals.

Various configurations of the calibrator load connections are detailed in *Section 4*.

## REAR PANEL

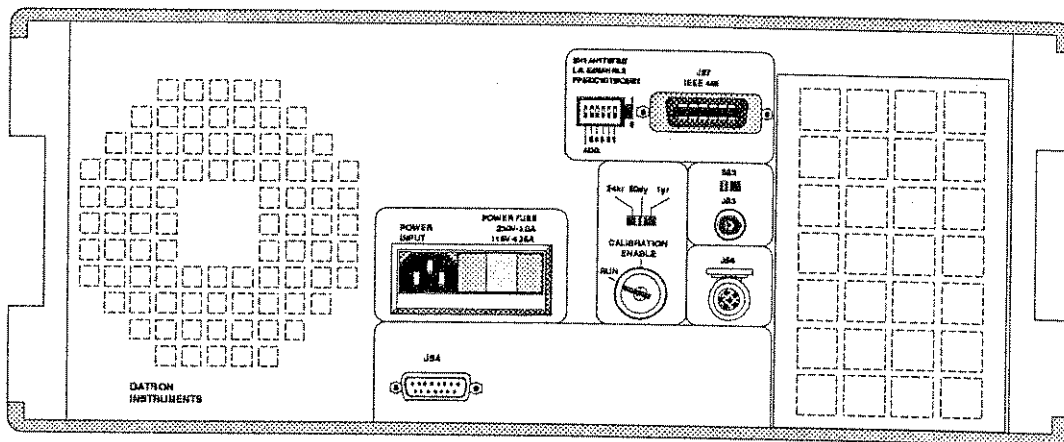

### POWER INPUT

The recessed **POWER INPUT** plug, **POWER FUSE** and **LINE VOLTAGE SELECTOR** are located in the center of the rear panel, contained within a single moulded unit. Details of connections, selection of line voltage and fuse are given in *Section 2*.

### SOCKET J53 (External Reference Frequency Input)

This BNC socket is located next to the cooling air intake filter. It may be used to lock the calibrator's internal frequency synthesizer to an external frequency standard. Voltage and frequency criteria are given in *Section 2*. An on-off switch, S53, located above this socket is provided to enable this facility. If the switch is ON and an external frequency is not present, error message 'Error EF' is displayed.

### SOCKET J54 (External Reset & 4600 Transconductance Amplifier Digital Connector)

This D-type socket provides digital control signals between the calibrator and a 4600 Transconductance Amplifier. It may also be used to input an external reset to restore the calibrator to its power-up state. Pin Layout, Pin Designation and Switch Wiring details are given in *Section 2*.

This connector is specifically designed to accept the digital control cable supplied as part of Option 60.

### SOCKET J56 (4600 Transconductance Amplifier Analog Connector)

J56 provides analog connections between the 4800, 4805 or 4808 calibrator and a 4600 Transconductance Amplifier. This connector is specifically designed to accept the analog control cable supplied as part of Option 60.

### SOCKET J27 (IEEE 488 Input/Output)

The IEEE 488 Input/Output (D-type) socket J27 is a 24-way micro-ribbon connector that is directly compatible with the IEEE-488 and the IEC-625 Interface Bus standards.

J27 is located at the top of the rear panel, outlined with the IEEE-488 address switch. The pin layout and designations appear in *Sections 2* and *Section 5*.

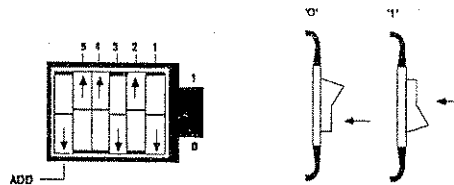

### IEEE-488 Address Switch

The 4800, 4805 and 4808 calibrators may be addressed for use on the IEEE-488 interface bus. The address settings are given in *Section 5*.



**DANGER  
HIGH VOLTAGE**



**THIS INSTRUMENT IS CAPABLE  
OF DELIVERING  
A LETHAL ELECTRIC SHOCK !  
when connected to a high voltage source**

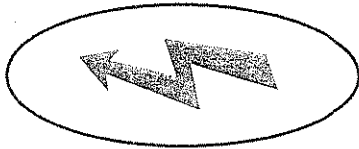

FRONT or REAR terminals  
carry the Full Input Voltage  
**THIS CAN KILL !**

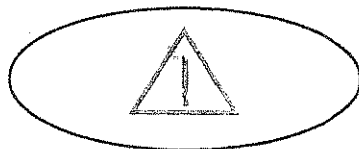

Guard terminal is sensitive  
to over-voltage  
It can damage  
your instrument !

Unless **you** are **sure** that it is **safe** to do so,  
**DO NOT TOUCH**  
the **I+ I- Hi** or **Lo** leads and terminals

**DANGER**



## SECTION 4 USING THE 4800, 4805 and 4808 CALIBRATORS

### Safety

The 4800, 4805 and 4808 calibrators are designed to be Class 1 equipment as defined in IEC Publication 348 and UL 1244, concerning safety requirements.

Protection is provided by a direct connection via the power cable from ground to exposed metal parts and internal ground screens.

The line connection must only be inserted in a socket outlet provided with a protective ground contact, and continuity of the ground conductor must be assured between the socket and the instrument.

#### WARNING

ANY INTERRUPTION OF THE PROTECTIVE GROUND CONDUCTOR INSIDE OR OUTSIDE THE INSTRUMENT, OR DISCONNECTION OF THE PROTECTIVE GROUND TERMINAL MAY MAKE THE APPARATUS DANGEROUS. INTENTIONAL INTERRUPTION IS PROHIBITED.



#### DANGER SYMBOL

THE TERMINALS MARKED WITH THE ABOVE 'FLASH' SYMBOL CARRY THE OUTPUT OF THE CALIBRATOR. THESE TERMINALS AND ANY OTHER CONNECTIONS TO THE LOAD UNDER TEST COULD CARRY LETHAL VOLTAGES.

UNDER NO CIRCUMSTANCES SHOULD USERS TOUCH ANY OF THE FRONT OR REAR PANEL TERMINALS UNLESS THEY ARE FIRST SATISFIED THAT NO DANGEROUS VOLTAGE IS PRESENT.

#### CAUTION

THE  SYMBOL IS USED TO REMIND THE USER OF SPECIAL PRECAUTIONS DETAILED IN THIS HANDBOOK AND IS PLACED ADJACENT TO TERMINALS THAT ARE SENSITIVE TO OVERVOLTAGE CONDITIONS. REFER TO SECTION 6.

## Preliminaries

Before using the instrument it is important that it has been correctly installed as detailed in *Section 2*.

## Limiting Characteristics

The following details are given in *Section 6*:

Function	Characteristics
All functions	Peak terminal voltages.
DC Voltage	Output resistance and current limit.
AC Voltage	Output resistance and current limit. Capacitive loading limits.
DC Current	Maximum load resistance and maximum compliance.
AC Current	Maximum load resistance and maximum compliance.
Resistance	Maximum currents and accuracy de-rating factors.

## Interconnections

### Importance of Correct Connections

The 4800, 4805 and 4808 calibrators have been designed for use as accurate sources for precision calibration. To match the external circuitry to their superior specifications, it is essential to take great care in making connections to the load.

## Sources of Error

### Thermal EMFs

Thermal EMFs can give rise to series (normal) mode interference, particularly for low voltage outputs or in situations where large currents have a heating effect at thermo-electric junctions. Draughts can also cause unbalanced cooling in an otherwise thermo-electrically balanced measuring circuit.

### E-M Interference

Noisy or intense electric, magnetic or electromagnetic fields in the vicinity of the calibration set-up can disturb the measurement circuit.

Some typical sources are:

- Proximity of large electric fields
- Fluorescent lighting
- Inadequate screening, filtering or grounding of power lines
- Transients from local switching
- Induction and radiation fields of local E-M transmitters
- Excessive common mode voltages between source and load

The disturbances may be magnified by the user's hand capacitance. Electrical interference has greatest effect in high impedance circuits. Separation of leads and creation of loops in the circuit can intensify the disturbances.

### Lead Impedance

The impedance of the connecting leads can cause significant voltage drops between the source and load, and generate adverse phasing effects, particularly if the leads are long or the current in them is high.

### Lead Insulation Leakage

Leakage currents in lead insulation can cause significant errors in measurement circuits at high voltages. Some insulating materials suffer greater losses than others e.g. PVC has more leakage than PTFE.

## Interconnections (continued)

### Avoidance Tactics

#### Thermal EMFs

Screen thermal junctions from draughts.

Allow time for thermal equilibrium to be reached before taking readings.

Use conductors, joints and terminals with a good margin of current-carrying capacity.

Avoid thermo-electric junctions where possible.

e.g. Use untinned single-strand copper wire of high purity. Avoid making connections through Nickel, Tin, Brass and Aluminum. If oxidation is a problem use gold-plated copper terminals, and replace the terminals before the plating wears off. If joints must be soldered, low-thermal solders are available, but crimped joints are preferred. Use low-thermal switches and relays where they form part of the measuring circuits.

Balance one thermal EMF against another in opposition, where possible (switch and relay contacts, terminals, etc.).

#### E-M Interference

Choose a site as 'electrically quiet' as possible (a screened cage may be necessary if interference is heavy).

Suppress as many sources as possible.

Always keep interconnecting leads as short as possible, especially unscreened lengths.

Run leads together as twisted pairs in a common screen to reduce loop pick-up area, but beware of leakage problems and excessive capacitance.

Where both source and load are floating, connect 1- to ground at the source to reduce common mode voltages.

#### Lead Impedance

Keep all leads as short as possible.

Use conductors with a good margin of current-carrying capacity.

Use Remote Sense and 4-wire connections where necessary to establish the calibrator's output specification at the load. Always use 4-wire connections for values of resistance below  $1k\Omega$ .

#### Lead Insulation Leakage

Choose low-loss insulated leads - PTFE is preferable to PVC.

When running leads together in screened pairs, avoid large voltages between leads in the same screen, especially if using PVC insulation.

## Remote/Local Sense Configurations

The calibrator terminals are configured as follows:

Voltage ranges 100 $\mu$ V, 1mV, 10mV and 100mV  
- Local sense only.

Voltage ranges 1V, 10V, 100V and 1000V  
- user selects Local or Remote sense

Current ranges - Local sense only.

Resistance ranges - Remote Sense gives 4-wire connection  
- Local Sense provides 2-wire connection capability.

The Rem sense key LED indicates the true connection:

Lit = Remote    Unlit = Local

**N.B.** When changing to  $\Omega$  function, the calibrator is automatically forced into **Remote Sense** for 4-wire operation.

## Connections to the Load

### General Considerations

The choice of connection method is influenced by several factors:

#### a. Loading Effects

4-wire connections should be used for low load impedances. For high impedance loads, 2-wire connections can be employed.

The ratio : 
$$\frac{\text{Total Lead Resistance}}{\text{Load Resistance}}$$

gives the approximate error for 2-wire connection at low frequencies.

e.g. Two  $0.5\Omega$  leads with a load of  $100k\Omega$  produce an error of approximately 10ppm.

At frequencies higher than about 100kHz, the error is also modified by reactive effects.

#### b. Noise and Output Level

Providing the E-M environment is reasonably quiet, interference due to noise pickup in the load connection is insignificant for outputs of more than about 100mV, so unscreened leads can be used. But at lower signal levels, or in noisier environments, it is advisable to use screened cable.

#### c. High Frequency Effects

##### i. Voltage.

Up to about 100kHz, for outputs above 100mV, it is possible to use pairs of unscreened wires, provided that the E-M environment is quiet. Twist or run leads together; keep length less than 1 meter.

Above 100kHz, both lead and load capacitances reduce the load impedance. Similarly, lead and load inductances combine to increase the load impedance with frequency (heavily reactive loads should be avoided). It is therefore advisable to make leads from low-capacitance coaxial or twin-axial cable. To avoid mutual coupling, sense and power leads should not run together in the same screen.

##### ii. Current

Above about 1kHz, with low output currents, high lead capacitance can introduce shunt errors. To reduce these errors, the leads should be kept as short as possible, and be of low-capacitance.

**d. Common Mode Disturbances**

When in Local Guard, the guard shields and tracks for the sense circuitry are connected internally to 'I-', the low impedance terminal of the calibrator's output power source. This classical connection effectively guards out internal common mode disturbances. To reduce external disturbances it is advisable to make only one ground connection to the measurement circuit, and in the case of a guarded DMM, to make use of its external guard facilities. Also, where a line-powered load (such as a DMM being calibrated) has a ground connection, it should be to the same line ground as the calibrator.

**DANGER**

**THE 4800, 4805 and 4808's OUTPUT CIRCUITS ARE NOT INTERNALLY CONNECTED TO GROUND. USERS ARE STRONGLY ADVISED TO CONNECT Lo OR I- EXTERNALLY TO GROUND (PREFERABLY AT THEIR COMMON JUNCTION), WHEN THE CALIBRATORS ARE TO BE USED ON THE 100V OR 1000V RANGE. THIS ELIMINATES THE RISK OF Lo AND I- FLOATING TO HIGH VOLTAGE.**

**Suggested Lead Connections**

Because of:

- a. the variety of environmental conditions and loads likely to be encountered when using the calibrator
- b. the extensive set of combinations of outputs from the instrument
- c. the accuracy required

it is unrealistic to describe a definitive 'best' general method of connection to the load.

Combinations of the above factors can lead to conflicting requirements, and users may be faced with a choice between methods. In these cases it is sometimes necessary to arrive at a compromise solution by setting priorities.

Six suggestions for connecting the 4800, 4805 or 4808 calibrators to a load are illustrated on the following pages 4-8 to 4-13. Each has found use with the combination of factors described, and together they cover the majority of predicted requirements.

## Typical Lead Connections

### Voltage\* and Resistance Outputs

#### Simple 2-wire Connection

Use for many applications where:

The voltage drop in the leads is insignificant.  
 The E-M environment is 'quiet'.  
 External common-mode voltages are insignificant.

Use for measurements in the following ranges:

Voltage	DCV $\geq 100\text{mV}$ ACV $\geq 100\text{mV}$
Frequency	$F < 100\text{kHz}$
Resistance	$1\text{k}\Omega \leq R < 1\text{M}\Omega$

Select Local Sense and Local Guard.

(N.B. After selecting  $\Omega$ , Remote Sense must be cancelled for 2-wire operation.)

Keep leads as short as possible (no longer than 1 meter). Twisted pair is preferable.

#### \* CAUTION

ALL LEADS AND CABLES MUST BE PROOFED TO AT LEAST 2kV.

ON 100V/1000V RANGES, GROUND THE Lo LINE FOR SAFETY

#### Calibrator Terminals

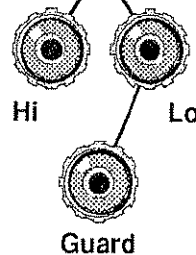
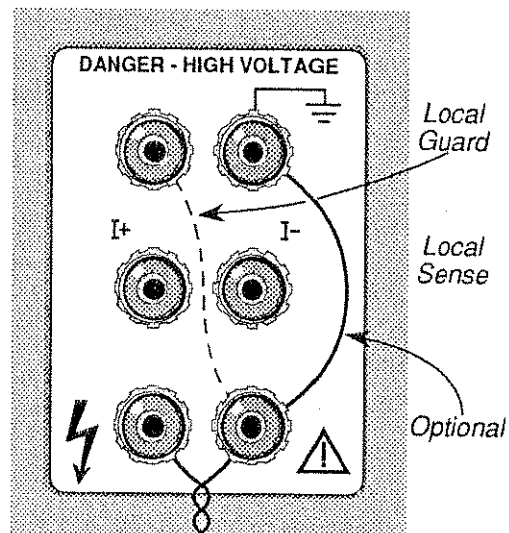

#### Load Terminals



### Screened 2-wire Connection

Use where:

Sensitive measurements are being made.  
 The E-M environment is relatively 'noisy'.  
 External common-mode voltages are significant.

Use for measurements in the following ranges:

Voltage	DCV $\geq 10\mu\text{V}$
	ACV $> 90\mu\text{V}$
Frequency	$F \leq 1\text{MHz}$
Resistance	$1\text{k}\Omega \leq R < 1\text{M}\Omega$

Select Local Sense and Local Guard.  
 (N.B. After selecting  $\Omega$ , Remote Sense must be cancelled for 2-wire operation.)

Keep leads as short as possible (no longer than 1 meter).

**\* CAUTION**

**ALL LEADS AND CABLES MUST BE PROOFED TO AT LEAST 2kV.**

**ON 100V/1000V RANGES, GROUND THE Lo LINE FOR SAFETY**

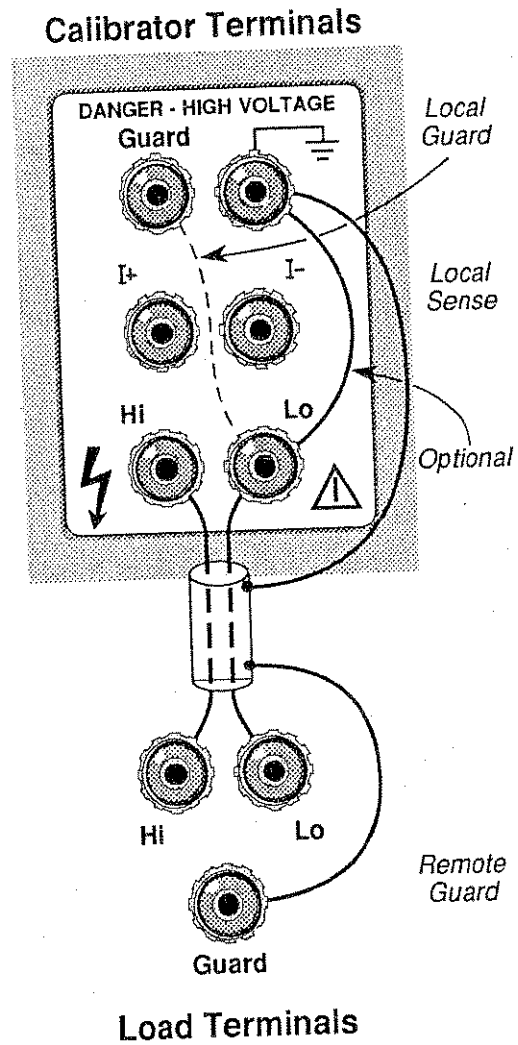

### Voltage and Resistance Outputs (continued)

#### Screened 4-wire Connection Using Coaxial Cable.

Use where:

The load resistance is low enough to cause a significant voltage drop in the output connection.  
 Sensitive measurements are being made.  
 The E-M environment is relatively noisy.  
 External common-mode voltages are significant.

Use for measurements in the following ranges:

Voltage	DCV $\geq 90\text{mV}$
	ACV $\geq 90\text{mV}$
Frequency	$F \leq 1\text{MHz}$
Resistance	Not appropriate

Select Remote Sense and Local Guard.

Keep leads as short as possible (no longer than 1 meter).

**\* CAUTION**

**ALL LEADS AND CABLES MUST BE PROOFED TO AT LEAST 2kV.**

**ON 100V/1000V RANGES, GROUND THE Lo LINE FOR SAFETY**

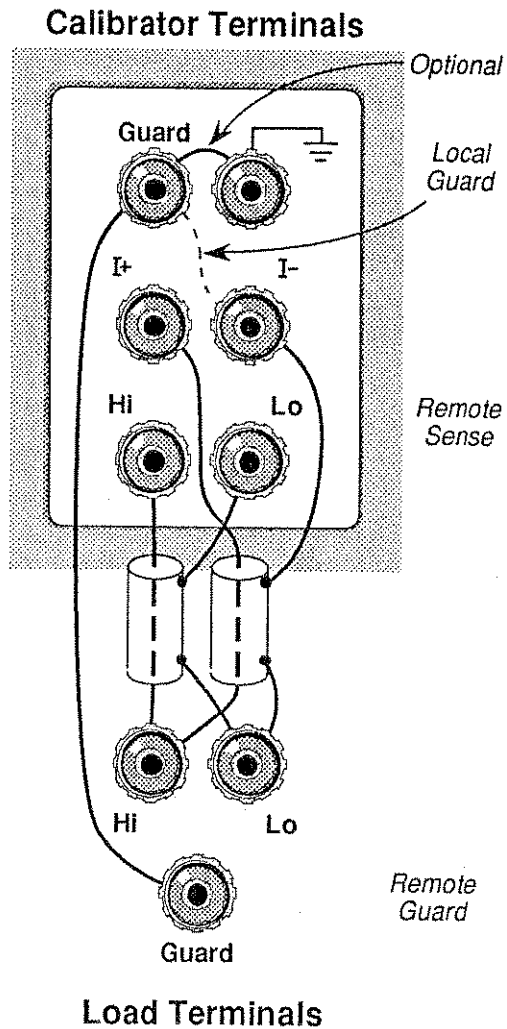

**Alternative Screened 4-wire Connection Using Twin-axial Cable.**

Use where:

- The load resistance is low enough to cause a significant voltage drop in the output connection.
- Sensitive measurements are being made.
- The E-M environment is relatively noisy.
- External common-mode voltages are significant.

Use for measurements in the following ranges:

Voltage	DCV $\geq 90\text{mV}$
	ACV $\geq 90\text{mV}$
Frequency	$F \leq 1\text{MHz}$
Resistance	Not appropriate

Select Remote Sense and Local Guard.

Keep leads as short as possible (no longer than 1 meter).

**\* CAUTION**

**ALL LEADS AND CABLES MUST BE PROOFED TO AT LEAST 2kV.**  
**ON 100V/1000V RANGES, GROUND THE Lo LINE FOR SAFETY**

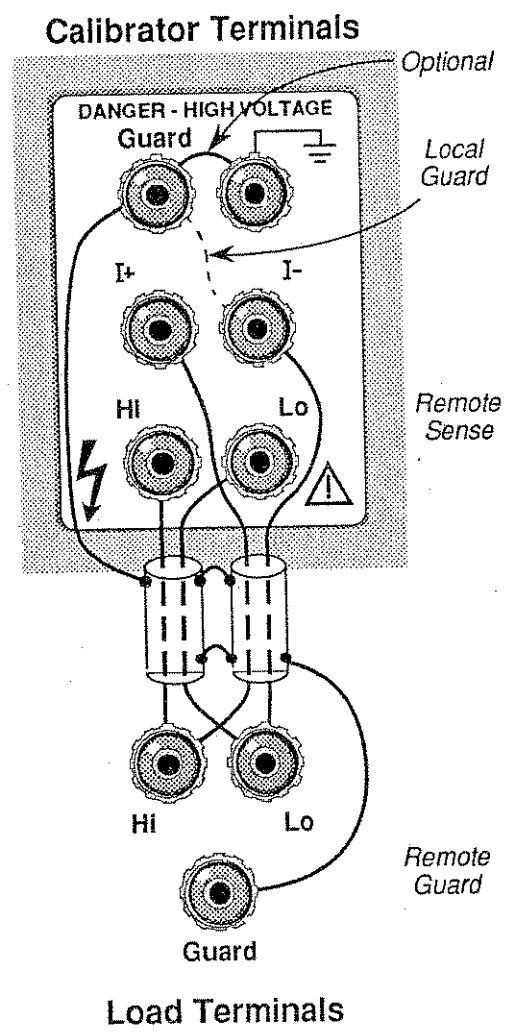

## Current Outputs

### Simple 2-wire Connection

Use for the majority of applications where:

The E-M environment is 'quiet'.  
External common-mode is insignificant.

Use for measurements in the following ranges:

Current      DCI > 1mA  
                 ACI > 100mA  
Frequency    F < 5kHz

Local Sense selected automatically.

Select Local Guard.

Keep leads as short as possible (no longer than 1 meter). Twisted pair is preferable.

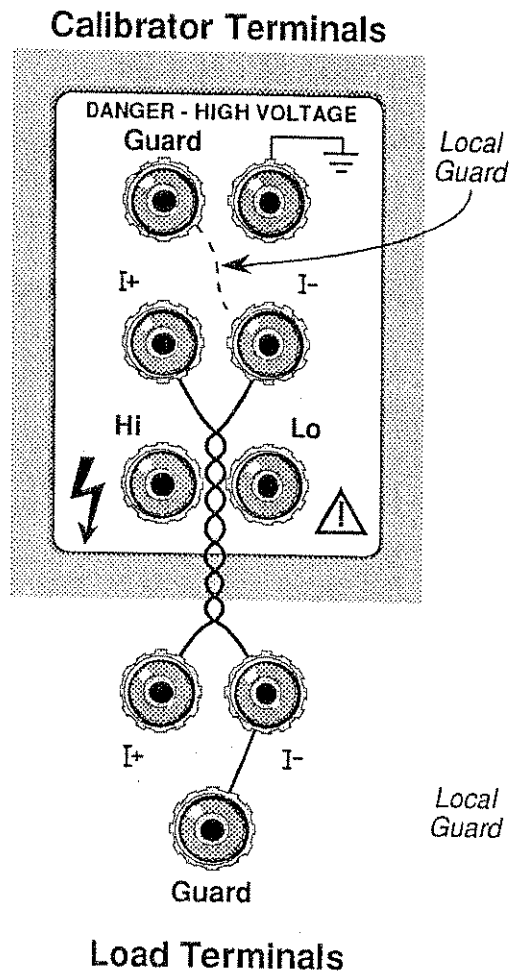



**DANGER**  
**HIGH VOLTAGE**



**THIS INSTRUMENT IS CAPABLE  
OF DELIVERING  
A LETHAL ELECTRIC SHOCK !**

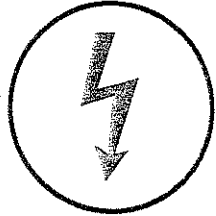

I+, I-, Hi and Lo Terminals carry the  
Full Output Voltage  
**THIS CAN KILL !**

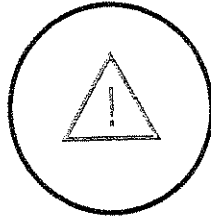

Guard terminal is sensitive  
to over-voltage  
It can damage your  
instrument !

Unless you are sure that it is safe to do so,  
**DO NOT TOUCH**  
the I+ I- Hi or Lo leads and terminals

**DANGER**

### Screened 2-wire Connection

Use where:

- Sensitive measurements are being made.
- The E-M environment is relatively 'noisy'.
- External common-mode is significant.

Use for measurements in the following ranges:

- Current DCI > 9 $\mu$ A  
ACI > 9 $\mu$ A
- Frequency F < 5kHz

Local Sense selected automatically.

Select Local Guard.

Keep leads as short as possible (no longer than 1 meter). Co-axial or Twin-axial is preferable.

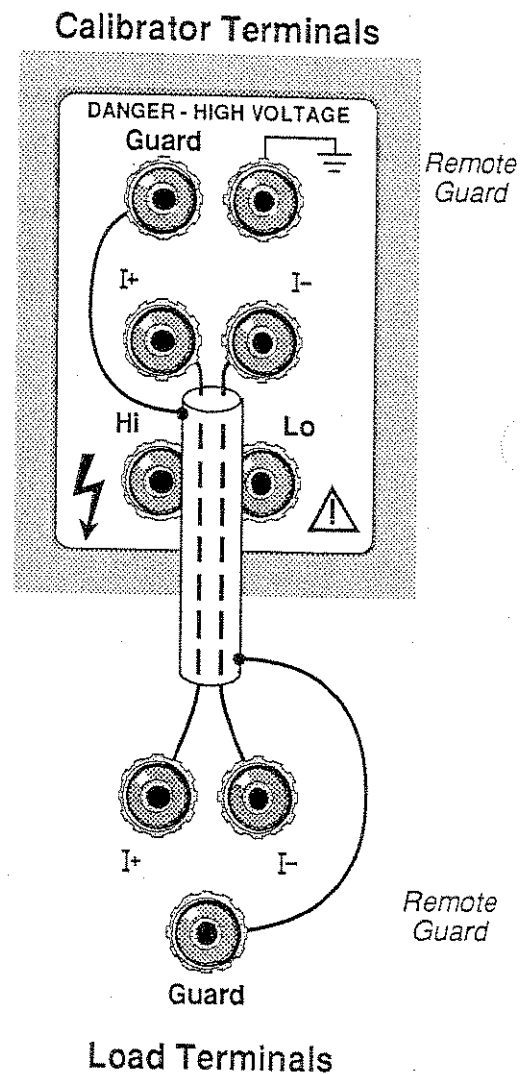

## 4800/4805/4808 General Sequence of Operations

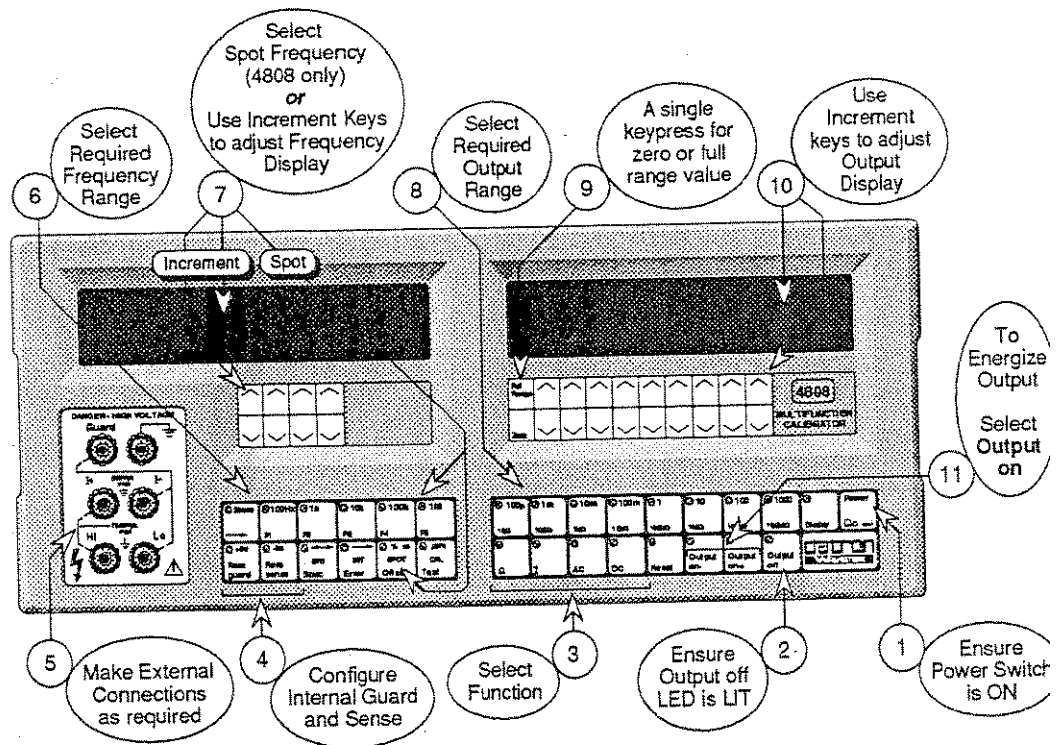





## Display Messages

(For a full list of display messages pages 4-47 to 4-50)

### Error Messages

Message	Message Type	Error
Error 1	Spec. % mode error Spec. $\pm$ lim error	Uncertainty > 100% Off-scale limit
Error 2	Cal. mode error	Output not ON.
Error 3	Cal. mode error	Incorrect range or function for mode.
Error 4	Cal. mode error	Correction exceeds store capacity.
Error 5	Offset or Error mode error	Requested output would have been off-scale.
Error 6	Cal. mode error	Resistance exceeded.
Error 7	100V/1000V range error	Selected output exceeds voltage/frequency constraints.
Error 8	Select error	The operation requested by the user is not possible in present machine configuration.
Error 9	Option not fitted error	The requested range or function option is not fitted.
Error EF	External frequency error	The external frequency is not present. The calibrator performance will be out of specification.
Error OL	Voltage/Current limit error	Output is either current-limited (Voltage outputs) or compliance limited (Current outputs).

*Section 4 - Using the 4800, 4805 and 4808 Calibrators*

---

**Fail Messages**

Message	Failure
FAIL 1	Excessive internal temperature.
FAIL 2	Over-voltage.
FAIL 3	Control data corrupted.
FAIL 4	Precision divider fault.
FAIL 5	Safety circuits tripped.
FAIL 6	Calibration store fault.
FAIL 7	400V power supply overload. Automatically resets except where hard fault occurs.
FAIL 8	38V power supply overload.
FAIL 9	15V in-guard power supply overload.
FAIL 10	Model 4600 communication fault.

**Test Mode Messages**

Message	Indication
SAFETY	Forced safety watchdog trip.
running	Indicates test in progress.
PASS	Calibration memory, over- voltage detector and 400V switching checked.

**Other Messages**

Message	Indication
'B'	Processor busy (keyboard inoperative).

## **Operating Routines**

The following operating routines are subdivided into two main types:

- Standard Operating Sequences
  - Additional Facilities
- 

### **Standard Operating Sequences**

There are many common elements in the selection routines for both Voltage and Current operation. The fold-out diagram on *page 4-14* shows the general sequence of operations. It should be used as the basis of any operating procedure, in conjunction with the individual selections detailed in the following pages.

## DC Voltage Outputs

There are two overlapping voltage states with a 20V overlap which allows  $\pm 10\%$  adjustment either side of 100V without changing state.

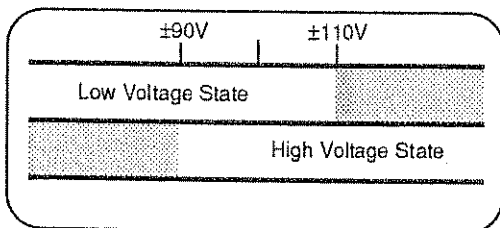

In the Low Voltage state, the output may be switched ON directly, but to transfer from Low to High Voltage state deliberate user-actions are required. (N.B. The 4800, 4805 and 4808 calibrators switch their output voltage OFF every time the 1000V RANGE is selected and when the 1000V RANGE polarity is reversed.

### Low Voltage Selections (up to $\pm 110V$ )

Use the general sequence:

At operation (3):

- Select DC

At operation (4) and (5):

- No Remote Sense on 100 $\mu$ V, 1mV, 10mV and 100mV ranges.

### High Voltage Selections (above $\pm 110V$ )

Use the general sequence:

At operation (3):

Select DC

At operation (9) or (10):

- the appropriate RANGE LED flashes for selections above  $\pm 110V$

At operation (11):

- Audible warning - 5 pulses/sec for 3 secs.
- After 3 second warning calibrator switches its output ON.

While the output is ON audible reminder pulses are sounded at approx. 1 sec. intervals, and the appropriate RANGE LED continues flashing.

If the Output off, Output on+ or Output on- keys are pressed during the 3 sec. delay the calibrator reverts to the output OFF condition.

### Transfer into High Voltage State with the Output ON.

#### By changing RANGE

Select 100V or greater range:

- the output is switched OFF
- selected RANGE LED flashes

User reselects **Output on+** or **Output on-**:

- 3 sec audible warning
- the calibrator switches its output ON
- audible reminder while the output is ON
- the appropriate RANGE LED flashes

#### By use of $\wedge$ keys in the 100V or 1000V range

Increment output above 110V:

- the output remains ON at previous voltage
- the output display shows selected (High Voltage) value
- the appropriate RANGE and **Output on (+ or -)** LEDs flash.

User reselects **Output on+** or **Output on-**:

- 3 sec audible warning
- the calibrator increases its output voltage to the value on the OUTPUT display
- audible reminder while in High Voltage state
- the appropriate RANGE LED flashes
- the appropriate **Output on** LED is lit continuously

### Transfer out of High Voltage state with the Output ON

#### By pressing the Output off key

Press **Output off** key:

- **Output on+** or **Output on-** LED remains lit until the output voltage has decayed into the Low Voltage State (Approx. 1 second from 1000V).

#### By use of $\sim$ keys or by changing to a lower RANGE:

Decrement output or switch to lower range:

- Transfer to Low Voltage State is automatic when the output voltage falls below 90V.
- the RANGE LED stops flashing and remains continuously lit
- the appropriate **Output on** LED stays lit
- Audible reminder is silent

### Changing Voltage State when in Error or Offset Mode

For safety reasons, the thresholds are always defined with respect to voltage levels at the output terminals. Therefore, if the instrument is in Error or Offset mode, the threshold indications may not coincide with 110V and 90V on the OUTPUT display.

## AC Voltage Outputs

### Zero Output

Zero AC Voltage output from the 4800, 4805 or 4808 calibrator can be obtained only by pressing the Zero key. Internal relay contacts short I+ to I-, and Hi to Lo.

### Increment from Zero

The smallest AC output available on any range is 9% of full range. Any attempt to reduce the output below 9% is ignored by the calibrator. Thus the smallest possible increment from Zero is to 10% of full range, using the appropriate key (any key to the right of this would attempt to increment to 1% or less, and be ignored, causing 'Error 8' and buzzer to sound). Half-size zeroes on the Zero display show which keys cannot be used to increment from Zero; full-size zeroes show those which can.

When the display is correctly incremented with the output ON, the output terminals are internally reconnected to the voltage output circuitry.

### 4800 and 4808 Zero Displays

Range	Zero Display
1mV	.000,0 mV
10mV	0.000,0 mV
100mV	00.000,0 mV
1V	.000,000 V
10V	0.000,000 V
100V	00.000,000 V
1000V	000.0000 V

### 4805 Zero Displays

Range	Zero Display
1mV	.000 mV
10mV	0.000 mV
100mV	00.000 mV
1V	.000,00 V
10V	0.000,0 V
100V	00.000 V
1000V	000.00 V

### Output Voltage Selection

There are two overlapping AC voltage states. The 15V overlap between these states allows some adjustment without changing state.

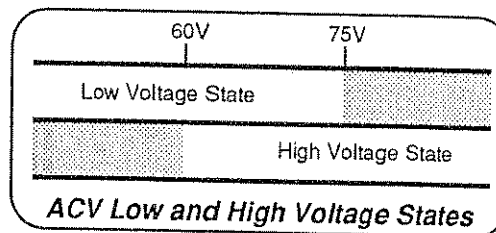

In the Low Voltage state, the output can be switched ON directly, but deliberate user-actions are required to transfer from the Low to High Voltage state.

N.B. The 4800, 4805 and 4808 calibrators automatically switch their output voltage OFF each time the 1000V RANGE is selected.

### Low Voltage Selections (up to 75V RMS)

Use the general sequence:

At operation (3):

- Select AC

At operations (4) and (5):

- No Remote Sense on the 1mV, 10mV and 100mV ranges.

### High Voltage Selections (above 75V RMS).

Use the general sequence:

At operation (3):

- Select AC

At operation (9) or (10):

- the appropriate output RANGE LED flashes for selections above 75V RMS.

At operation (11):

- **Audible warning** - 5 pulses/sec for 3 secs.
- **After the 3 sec. warning** the calibrator sets its output ON.

While the output is ON the audible reminder pulses continue at approx. 1 sec. intervals, and the appropriate RANGE LED continues flashing.

If selection of **Output on+**, **Output on-** or **Output off** is attempted during the 3 sec. delay the calibrator reverts to the output OFF state.

### Output ON Transfers

If the output is already switched ON in Low Voltage State when an attempt is made to select a voltage in excess of 75V RMS, the calibrator safety interlocks prevent the selection. Certain deliberate actions, detailed below, are then required by the operator to effect the selection.

### Transfer from Low into High Voltage State, by Manual Upgrading

Select the 100V or greater range:

- calibrator switches its output OFF
- Selected RANGE LED flashes

User reselects **Output on+** or **Output on-**:

- 3 sec **audible warning**
- calibrator switches its output ON
- audible reminder while the output is ON
- the appropriate RANGE LED continues flashing
- the **Output on** LED is lit continuously.

### AC Voltage Outputs (continued)

#### Transfer from Low into High Voltage State, by Incrementing the OUTPUT Display

Increment output above 75V:

- the output remains ON at previous voltage
- the OUTPUT display shows selected value
- the appropriate RANGE and Output on LEDs flash.

User reselects Output on+ or Output on-:

- 3 sec audible warning
- the calibrator increases the output voltage to the value displayed on the OUTPUT display
- audible reminder while the output is ON
- the appropriate RANGE LED flashes
- the Output on LED is lit continuously.

#### Transfer from High into Low Voltage State, by Pressing the Output Off Key

Press the Output off key:

- the Output on LED remains lit until the output voltage has decayed (approx. 1 second from 1kV).

#### Transfer from High into Low Voltage State by Decrementing the OUTPUT Display, or by Manual Downranging

Decrement the output or select lower range:

- Transfer to Low Voltage State is automatic when the output voltage falls below 60V RMS.
- the appropriate RANGE LED stops flashing and remains continuously lit
- the Output on LED stays lit
- audible reminder is silent

#### Changing Voltage State when in Error Mode

For safety reasons, the thresholds are always defined with respect to the **actual voltage at the output terminals**. When the instrument is in Error mode the displayed output voltage is modified by the gain error, so the threshold indications may **not** coincide exactly with 75V and 60V on the OUTPUT display.

#### Frequency Control

Refer to pages 3-14 to 3-21.



## DC Current Outputs

Use the General Sequence:

At operation (3):

- Select **DC** followed by **I**

At operations (4) and (5):

- Remote Sense not available

**N.B.** The maximum output compliance is 3V on all ranges unless the Model 4600 Transconductance Amplifier is being used when the compliance is limited to 2V.

## AC Current Outputs

### Zero Output

Zero AC Current output from the 4800, 4805 and 4808 calibrators can be obtained by pressing the Zero key. This causes the internal software to isolate the I+ and I- terminals from the internal circuitry, physically interrupting the output current.

### 4800 and 4808 Zero Displays

Range	Zero Display
100 $\mu$ A	0 0 . 0 0 0 , 0 $\mu$ A
1mA	. 0 0 0 , 0 0 0 mA
10mA	0 . 0 0 0 , 0 0 mA
100mA	0 0 . 0 0 0 , 0 mA
1A	. 0 0 0 , 0 0 0 mA
10A	0 . 0 0 0 , 0 0 mA

### 4805 Zero Displays

Range	Zero Display
100 $\mu$ A	0 0 . 0 0 0 $\mu$ A
1mA	. 0 0 0 , 0 0 mA
10mA	0 . 0 0 0 , 0 mA
100mA	0 0 . 0 0 0 mA
1A	. 0 0 0 , 0 0 mA
10A	0 . 0 0 0 , 0 mA

### Increment from Zero

The smallest AC output available on any range is 9% of full range, so any attempt to reduce the output below 9% is ignored. Thus the smallest possible increment from Zero is to 10% of full range, using the appropriate key (any key to the right of this would attempt to increment to 1% or less, and be ignored). Half-size zeroes on the Zero display show which keys cannot be used to increment from Zero; full-size zeroes show those which can.

When the display is correctly incremented with the output ON, the I+ and I- terminals are internally reconnected to the Current output circuits.

### Current Outputs

To generate AC output currents, use the General Sequence:

At operation (3):

- select AC followed by I

At operations (4) and (5):

- no Remote Sense

N.B. The maximum output compliance is 3V on all ranges unless the Model 4600 Transconductance Amplifier is being used when the compliance is limited to 2V. Changing function switches the output OFF.

## Resistance

Use the General Sequence:

At operation (3):

- Select  $\Omega$
- **Rem** sense LED lights as the calibrator is forced into 4-wire mode

At operation (4):

- If 2-wire Ohms is required, press **Rem** sense to deselect 4-wire mode

At operation (5):

- In 4-wire Ohms use the **I+** and **I-** terminals to drive current into the resistance and use the **Hi** and **Lo** terminals to measure the voltage developed across the resistance
- In 2-wire Ohms only use the **Hi** and **Lo** terminals.

(On the  $\Omega$  function, the **I+** and **I-** terminals are internally fused at 1.0A, and the **Hi** and **Lo** terminals are fused at 375mA).

At operation (8):

- the **RANGE** key value is the **nominal** value selected.
- The **OUTPUT** display value is the previously calibrated value (Full Range value for 4-wire; Full Range and Zero value for 2-wire) of the calibrator's internal resistor.

At operation (10):

- Left hand (overrange) pair of  $\diamond$  keys have the same functions as the **Full Range/Zero** keys.
- The other  $\diamond$  keys are inoperative except in the Calibration function (See Section 8).



## Additional Facilities

### Frequency Store

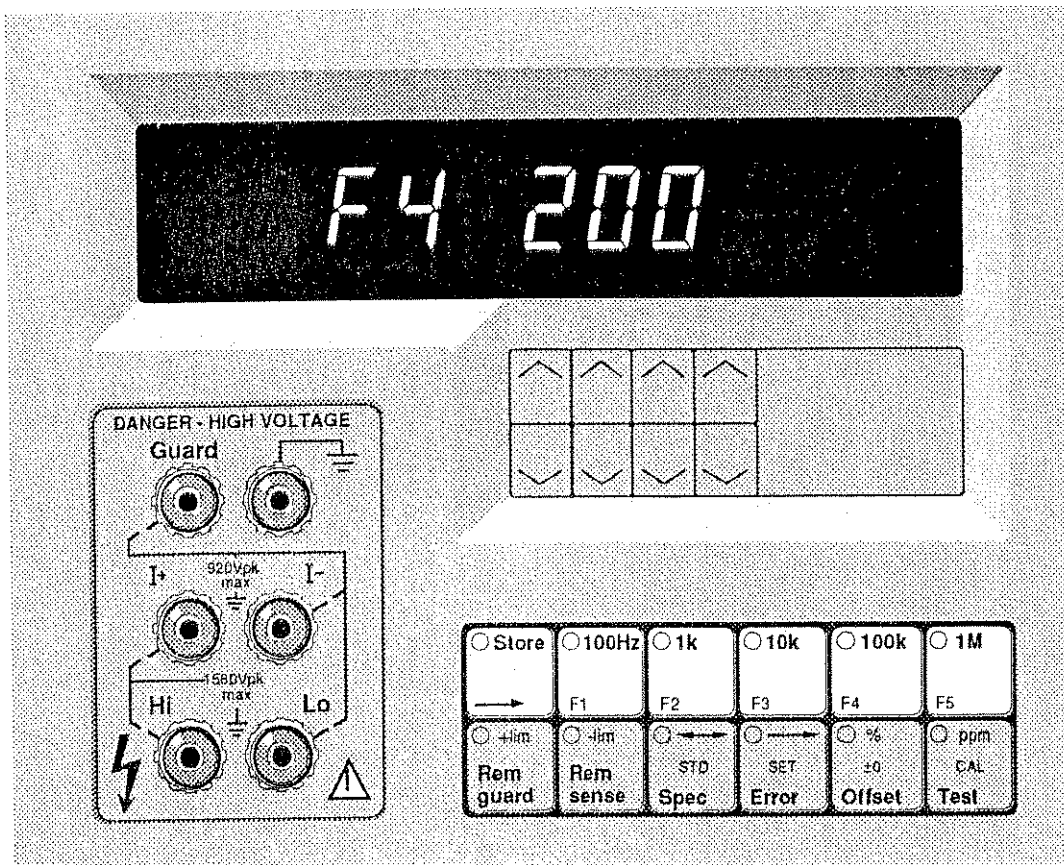



### Store Key

This key controls the storage and recall of five user-selected frequencies. The frequency memories are volatile in that their contents are lost when the calibrator is powered-down. At power-up, the following five decade frequencies are stored automatically.

Store	Frequency
F1	30Hz
F2	300Hz
F3	3kHz
F4	30kHz
F5	300kHz

### Recall of a Stored Frequency

To set the 4800, 4805 or 4808 calibrator to one of the five stored frequencies:

Press and release the **Store** key:

- Its green LED lights

Press and release the desired **F1-F5** key:

- Its LED lights
- The **Store** LED remains lit
- The stored frequency is presented on the **FREQUENCY** display, accompanied by its store location (see illustration opposite).

### Recall from a Different Memory

To switch to a different stored frequency:

- Press and release the desired **F1-F5** key:
- The displayed indications change as appropriate.

### Store Mode Deselection

To revert to normal frequency selection:

Press the **Store** key again:

- Its LED goes out
- The **F1-F5** LED goes out
- The stored frequency remains unchanged

### Stored Frequency Re-programming

The following procedure stores any displayable frequency in any of the five frequency memories:

Select the required **FREQUENCY RANGE**:

Use the **FREQUENCY** display  $\hat{\curvearrowright}$  keys to set the new frequency on the display:

Press and hold the **Store** key:

- Its green LED lights

While the **Store** key is depressed, press and release the desired **F1-F5** key:

- Its LED lights
- The store location appears on the display

Release the **Store** key:

- Its LED remains lit

If desired, deselect **Store** as above.





Spot Frequency (4808 only)

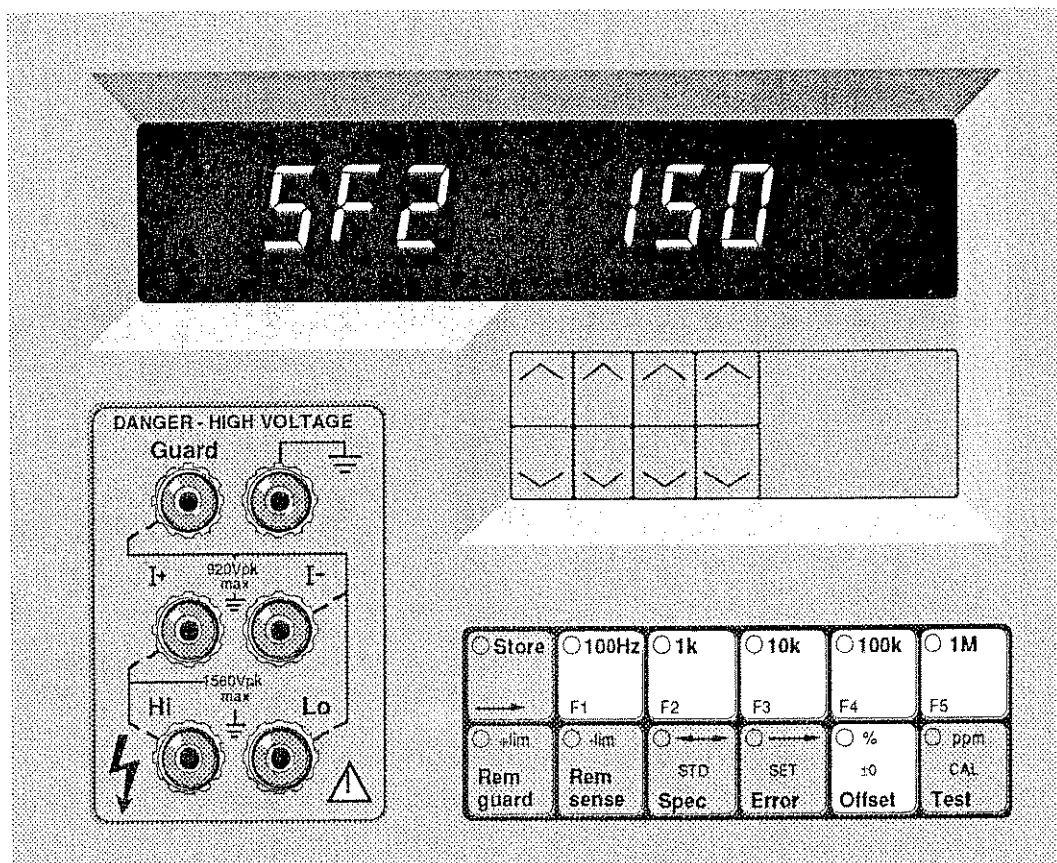



This facility exists to provide rapid access to five user-selected spot calibrated frequencies on each AC Voltage and AC Current range. As there are seven Voltage ranges, and five Current ranges, this makes a total of sixty spot frequencies in all. Selecting a new output RANGE also calls up its five spot frequencies, ready for selection.

The calibrator output can be calibrated at each spot frequency, thus achieving ultra-high accuracy by eliminating the 'Flatness' error component.

By using non-volatile memory, these frequencies and their associated calibration constants are retained in store, even when the calibrator is powered-down.

In order to change the frequency setting of a spot frequency and to recalibrate at this new frequency, it is necessary to enter 'cal' mode (with the rear panel CALIBRATION key-switch set to 'ENABLE').

The output level span available for calibration of Spot frequencies is restricted to within 10% of nominal full range.

The calibration procedure is described, together with other routine calibrations, in *Section 8*.

### Spot Key

This reassigns the use of the F1-F5 keys to provide read-access to the non-volatile Spot Frequency memories.

### Recall

To set the 4800, 4805 or 4808 calibrators to one of the existing spot frequencies, with the output as previously calibrated:

Press and release the **Spot** key:

- Its LED lights
- The **Store** LED lights

Press and release the desired **F1-F5** key:

- Its LED lights
- The **Store** and **Spot** LEDs remain lit
- The spot frequency is presented on the **FREQUENCY** display, accompanied by its store location (see illustration opposite).

### Recall from a Different Memory

To switch to a different spot frequency.

Press and release the desired **F1-F5** key:

- The displayed indications change as appropriate.

If the spot has not previously been calibrated, the message 'SFX——' is displayed (X is the store number). The most recent frequency setting is retained.

## **Spot Frequency (continued)**

### **Output and Frequency Constraints**

If the combination of voltage and frequency, or current and frequency, is outside the defined constraints of the calibrator, the command to change spot, output range or output value will be ignored.

### **Deselection of Spot Frequency**

To revert to the calibrator's normal frequency facility:

Press either **Spot** or **Store**:

- **Spot** LED goes out
- **Store** LED goes out
- The selected **F1-F5** LED goes out
- the **1k** FREQUENCY RANGE LED lights
- the FREQUENCY display reverts to 1kHz
- the output frequency reverts to 1kHz
- the stored spot frequency remains unchanged

### **Re-programming a Frequency Memory Store**

To change the frequency of a spot frequency memory store, the calibrator must be placed into 'cal' mode. This procedure is detailed in *Section 8*.

## Spec Mode

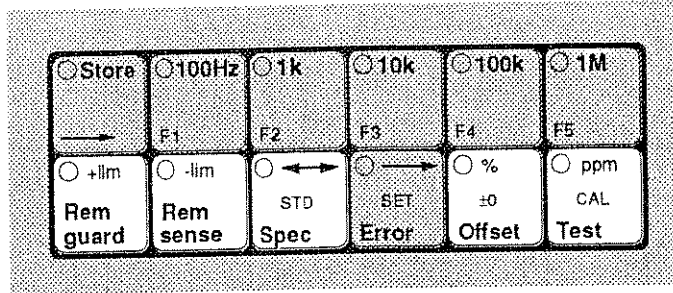

### Spec Key

The **Spec** key allows a user to avoid constantly referring to the data sheet specifications when it is necessary to determine the uncertainty for any set output value.

### Uncertainty Data Selection

The 4800, 4805 and 4808's specification uncertainties are held in their respective internal memories. **Spec** mode selects the stored data appropriate to the current settings of FUNCTION, RANGE, OUTPUT VALUE, FREQUENCY and CALIBRATION INTERVAL; then calculates and displays the overall uncertainty.

### Initiation

To transfer into **Spec** mode:

Select the required CALIBRATION INTERVAL (Rear Panel switch):

Press the **Spec** key

- **Spec** LED lights green
- The **Error** key action is inhibited
- The **Rem guard**, **Rem sense**, **Offset** and **Test** keys assume their secondary functions **+lim**, **-lim**, **%** and **ppm** respectively. (The calibrator's actual guard and sense conditions remain as previously selected.)
- the uncertainty appears on the MODE/FREQUENCY display, displacing the frequency readout. (except for **Store** frequencies, frequency cannot be changed when in **Spec** mode).

Initially the presentation is as shown in the following table:

Uncertainty	Display
≤ 1,999ppm of set value	ppm
> 1,999ppm of set value	%
Not displayable or > 100%	Error 1

## Spec Mode (continued)

### Secondary Spec Modes

Once the **Spec** key has been pressed, the other **MODE** keys become reassigned to give a choice of four display modes:

**ppm   %   +lim   -lim**

### ppm or %

From 1ppm to 1999ppm, the uncertainty can be displayed in **ppm** of displayed value. From 0.001% to 100%, it can be displayed in **%** of displayed value. When the uncertainty is not defined, the message **Error 1** is displayed and the buzzer sounds.

### Example of Error 1 Condition (Any Cal interval)

Output Range	- 1V
Setting	- <b>Zero</b> key pressed
Frequency	- Any frequency
Uncertainty	- Not defined at Zero

Under these conditions the **MODE/FREQUENCY** display is **Error 1**.

### +Limit or -Limit

To obtain a reading of an absolute limit of uncertainty:

Press the **+lim** or **-lim** key:

The **MODE/FREQUENCY** display will switch to the same resolution as the **OUTPUT** display and its reading will be the positive or negative absolute limit of uncertainty (i.e. the **OUTPUT** reading plus or minus the absolute uncertainty error limit for that output).

As the reading approaches full scale, its positive limit may exceed full scale. If **+lim** is selected, **Error 1** is displayed and the buzzer sounds.

### FUNCTION and RANGE Control in Spec Mode

The **FUNCTION**, **OUTPUT RANGE** and **OUTPUT** keys can be operated normally. The calibrator will adjust its **MODE/FREQUENCY** display to display the uncertainty figure appropriate to each new selection.

### Frequency Selection in Spec Mode

The MODE/FREQUENCY display is assigned to its 'Uncertainty' presentation. Consequently the use of the FREQUENCY RANGE, FREQUENCY  $\hat{C}$  and Store keys is inhibited.

Nevertheless, by pressing the Store key followed by one of the F1-F5 keys before pressing Spec, all five 'Stored' frequencies can still be accessed.

In this case the MODE/FREQUENCY display normally presents the appropriate uncertainty figure. However, a readout of the Stored frequency can be obtained by pressing and releasing the F1-F5 key which has its LED lit. The store location and frequency will appear for about 1 second before changing back to the uncertainty figure.

### Specification Data

Section 6 breaks down the 4800, 4805 and 4808's specifications into:

- a) Stability
- b) Accuracy Relative to Standards
- c) Datron's Calibration Uncertainty

The CALIBRATION INTERVAL switch on the rear panel is labelled:

24 hr, 90 dy, and 1 yr.

The stored uncertainty data is selected from (b) and (c) above, as follows:

24hr :	(b), $23^{\circ}\text{C} \pm 1^{\circ}\text{C}$
90dy :	(b) + (c), $23^{\circ}\text{C} \pm 1^{\circ}\text{C}$
1yr :	(b) + (c), $23^{\circ}\text{C} \pm 5^{\circ}\text{C}$

Thus the accuracy figures displayed for 90 dy and 1 yr are traceable to National Standards.

In verifying the unit's specification on receipt of a 4800, 4805 or 4808 calibrator, users are able to display the 90-day limits to check against the instrument's specified traceable accuracy. After calibration, the '24 hour interval' limits should be used to verify against the same standards used for calibration.

Refer to Section 7, 'Specification Verification', for further information.

### 'Error' and 'Offset' Modes (Voltage and Current Only)

The specification of a high accuracy DMM (and of other electrical measurement equipment) relates its display readings to its input values. A perfectly calibrated DMM would have an exact 1:1 correspondence, and the specification lays down acceptable tolerances of deviation from this direct relationship. Plotted as a graph, the ideal case is a straight line at 45° through the origin. The tolerances, plotted on the graph, enclose an area on both sides of this line.

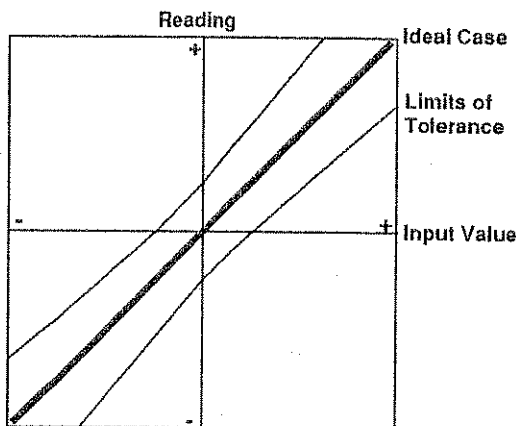

There are three major causes of deviation from the ideal case:

**Zero offset** - the line does not pass through the origin. Most DMMs have a front panel adjustment to correct this.

**Gain Error** - the slope of the line is not 45°

**Linearity Error** - the slope of the line varies. (A common variation is a "dog leg" at zero).

Each of these elements could cause large enough deviations to place the instrument out of tolerance, sometimes a combination of elements being responsible.

The **Error** and **Offset** modes allow a user to deviate the output of the calibrator in specific ways, so as to identify directly the causes of excessive deviation in a measuring instrument's input versus displayed reading response.



## Error Mode

### Error Key

The **Error** key is used to initiate the ERROR mode. The calibrator terminal value can then be deviated from the OUTPUT display value by known gain factors as entered on the MODE/FREQUENCY display.

### Error Mode Display

Pressing the **Error** key changes the MODE/FREQUENCY display from 'Frequency' readout to 'Error Mode' readout. The initial reading is always '0.0 ppm', indicating that the terminal value has not yet been deviated.

### MODE/FREQUENCY $\diamond$ Keys

The terminal value is changed, without altering the OUTPUT display, by pressing the  $\diamond$  keys beneath the MODE/FREQUENCY display. The gain compensation being applied is displayed as a % or ppm of the OUTPUT display value; with positive polarity for an increase of terminal value, and negative for a decrease.

The gain-compensation factor has a maximum possible resolution of 0.1ppm of Full Range (DCV).

An example of the use of Error Mode is shown overleaf.

### Full Scale Limiting.

The OUTPUT display cannot be raised to a value which sets its overrange digit to greater than 1, and the ERROR MODE display cannot be raised above 9.9999% in % mode or 999.9ppm in ppm mode.

Nevertheless, a combination of OUTPUT display value and gain error could result in an off-scale value. The calibrator prevents this by ignoring any demand for an error-corrected output voltage in excess of full scale. The user is informed by **Error 5** message on the MODE/FREQUENCY display with no change to the OUTPUT display.

### Deselection of Error Mode

Deselection clears the MODE/FREQUENCY display, turns the green **Error** LED OFF and restores the calibrator gain factor to unity. Normally the mode is deselected by repressing the **Error** key, but it is also turned off by changing FUNCTION or RANGE.

## Error Mode (continued)

### Example of the use of "Error" mode

To measure the linearity of a DMM, a user needs to:

- Remove any zero offset.
- Detect and measure any inherent gain error ratio (usually from its response to a full range input).
- Calculate compensating deviations for each of the inputs for the linearity measurement, based on the measured ratio.
- Compensate each input to the DMM so that the linearity errors may be measured.

In "Error" mode, once the gain error has been measured, the calibrator automatically calculates and applies the compensating deviation to all its outputs on that range and function; whilst displaying both the nominal (uncompensated) value of output and the compensation ratio. Only if the DMM response is linear, will each DMM reading agree with the corresponding calibrator OUTPUT display value.

The procedure detailed opposite shows how the calibrator can be adjusted to compensate for a +100ppm gain error in a DMM before checking the DMM's linearity.

After carrying out this procedure, the calibrator automatically compensates for the gain error of the DMM. All selected output values will be compensated in the same ratio on this range and function until either the ratio is changed or the Error mode is deselected. The MODE/FREQUENCY display presents the compensation ratio directly. Note that the compensation polarity is shown, not the error polarity, therefore the true output is the sum of both displayed values; in this case +10.00000(0)V - 100ppm = +9.99900(0)V.

The linearity of the DMM may now be checked by directly comparing its reading with the OUTPUT display settings. e.g. at +5V on this range, both the calibrator and DMM read +5.000000V, although the terminal voltages are +4.995000V.

Other linearity check values could be:

Nominal Check Point	Calibrator Set Value	DMM Reading	Terminal Voltages
- 0.5V	- 0.500000V	- 0.500000V	- 0.499950V
+0.1V	+0.100000V	+0.100000V	+0.099990V
+0.01V	+0.010000V	+0.010000V	+0.009999V

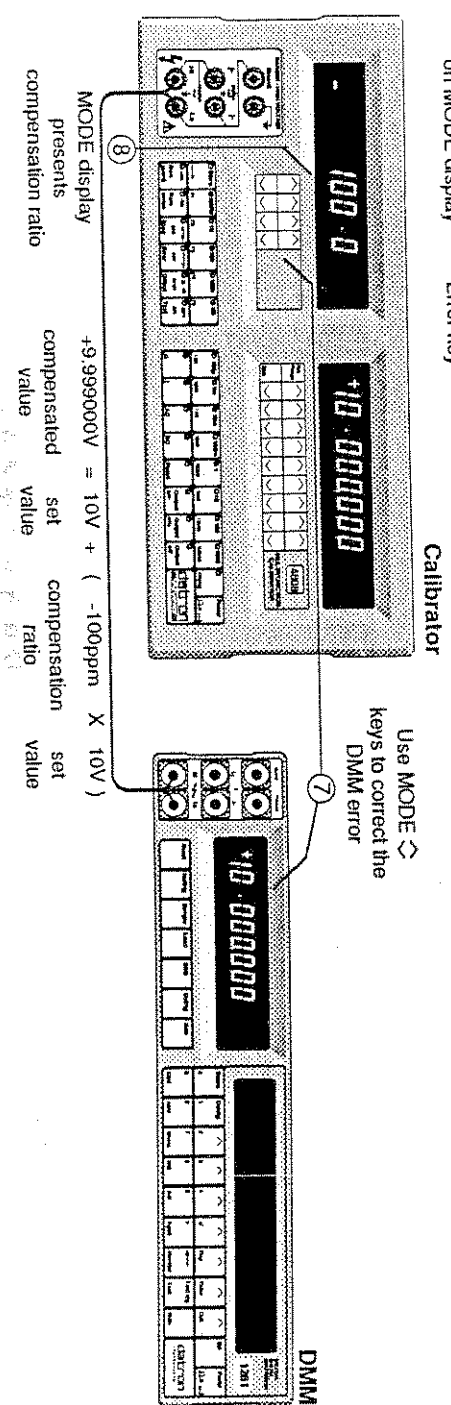
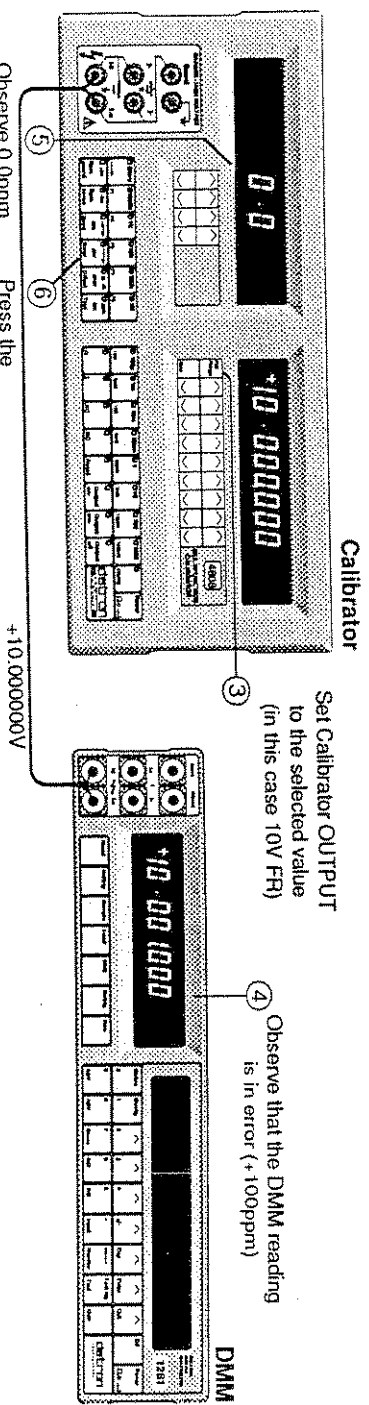
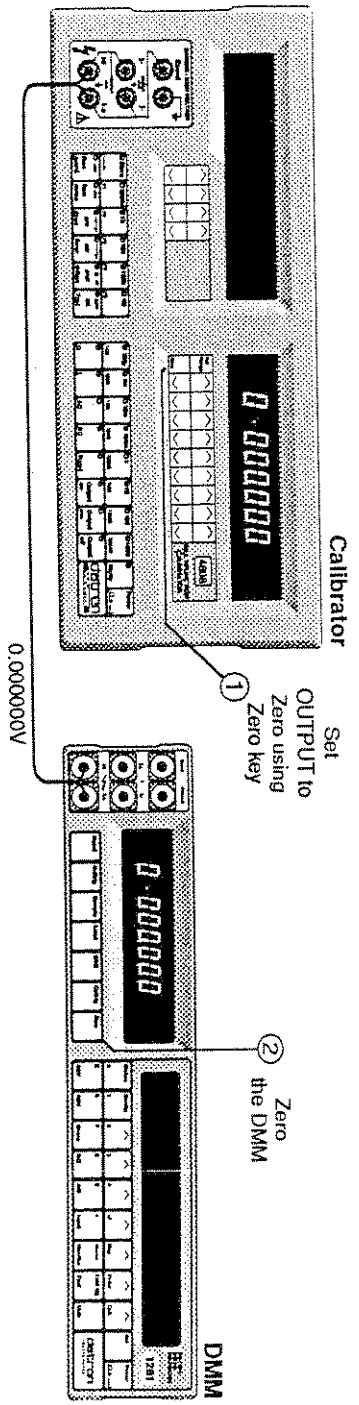

## Offset Mode (DC Functions only)

### Offset key

A device being checked against the calibrator (say a DMM) may have an inherent zero offset error. Nevertheless, a user may wish to perform other measurements before removing the offset error. The 4800, 4805 and 4808's OFFSET mode is used for this purpose.

The value output at the calibrator's output terminals is now the sum of the OUTPUT display value and the MODE/FREQUENCY display offset value.

The example illustrated opposite generates an offset of  $-100\mu\text{V}$  on the 10V range of a DMM, for all set values (unless the calibrator is driven off-scale).

Connect the DMM to the calibrator, both set to their 10V range, ensuring that calibrator's Error and Offset LEDs are OFF.

Note that the negative polarity of the Offset value shown on the MODE/FREQUENCY display indicates that the Output voltage is more negative than the value on the OUTPUT display, i.e. the calibrator offset polarity is displayed, not the polarity of the DMM offset error.

### Full Scale Limiting

The 4800, 4805 and 4808 calibrators will reject any combination of set value and zero offset which would result in an off-scale output.

e.g. if  $-19.99995(0)\text{V}$  is set together with a  $100\mu\text{V}$  offset, the user is requesting an offscale output of  $-20.00005(0)\text{V}$  and the combination is invalid. The calibrator causes Error 5 to appear on the MODE/FREQUENCY display as a signal to the user, and continues to output its previous (valid) value.

The OUTPUT display cannot be set to a value greater than Full Scale. The OFFSET MODE display cannot be set to a value greater than the Offset span for the Range in use.

i.e.  $100\mu\text{V}$  and  $1\text{mV}$  Ranges:  $<200\mu\text{V}$   
Other Ranges:  $<2\%$  of Full Range value

### Deselection of Offset Mode

This clears the MODE/FREQUENCY display, turns the red Offset LED OFF and reduces the calibrator offset to zero. Normally the mode is deselected by depressing the Offset key, but it is also turned off by changing FUNCTION or RANGE.

## Combining Offset and Error Modes (DC Functions only)

By combining OFFSET and ERROR modes it is possible to carry out a rapid analysis of a measuring instrument's linearity (e.g. for a DMM or A-D converter) without the need to correct its zero offset and gain errors.

This is done by using OFFSET mode to compensate the calibrator's output for the DMM's zero offset, and then using ERROR mode to compensate for the DMM's gain error with the offset compensation still present.

In this condition, any residual deviations in DMM readings from the calibrator's OUTPUT display settings represent non-linearities which would still be present if the DMM were corrected for offset and gain errors.

This facility also permits a user to quantify the linear response of the instrument to its input values in the form:

$$y = mx + c$$

in which  $y$  = instrument reading  
 $x$  = input value  
 $m$  = gain ratio  
 $c$  = zero offset value

e.g. for a DMM on its 10V range:

$$\text{if } y = 9.999956 \text{ and } x = 0.000084$$

then the DMM needs a gain compensation of +4.4ppm and a zero offset compensation of +84 $\mu$ V.

These compensation figures can be read directly from the calibrator's MODE/FREQUENCY display, during the following procedure.

### Combination procedure

1. Use the calibrator's OFFSET mode to compensate for the DMM's input offset error as shown in steps 1 to 6 on the diagrams on page 4-39. Record the calibrator's MODE/FREQUENCY display value ( $\gamma$ ) obtained at step 6 on page 4-39.
2. With the OFFSET LED still lit, press the Error key and set the OUTPUT display to the required value (full range in the example illustrated). Use the calibrator's ERROR mode to compensate for the instrument's gain error as shown in steps 7 and 8 on the diagrams on page 4-37. Record the calibrator's MODE/FREQUENCY display value in ppm or % ( $\mu$  or  $\delta$  respectively) obtained at step 8 on page 4-37.

Section 4 - Using the 4800, 4805 and 4808 Calibrators

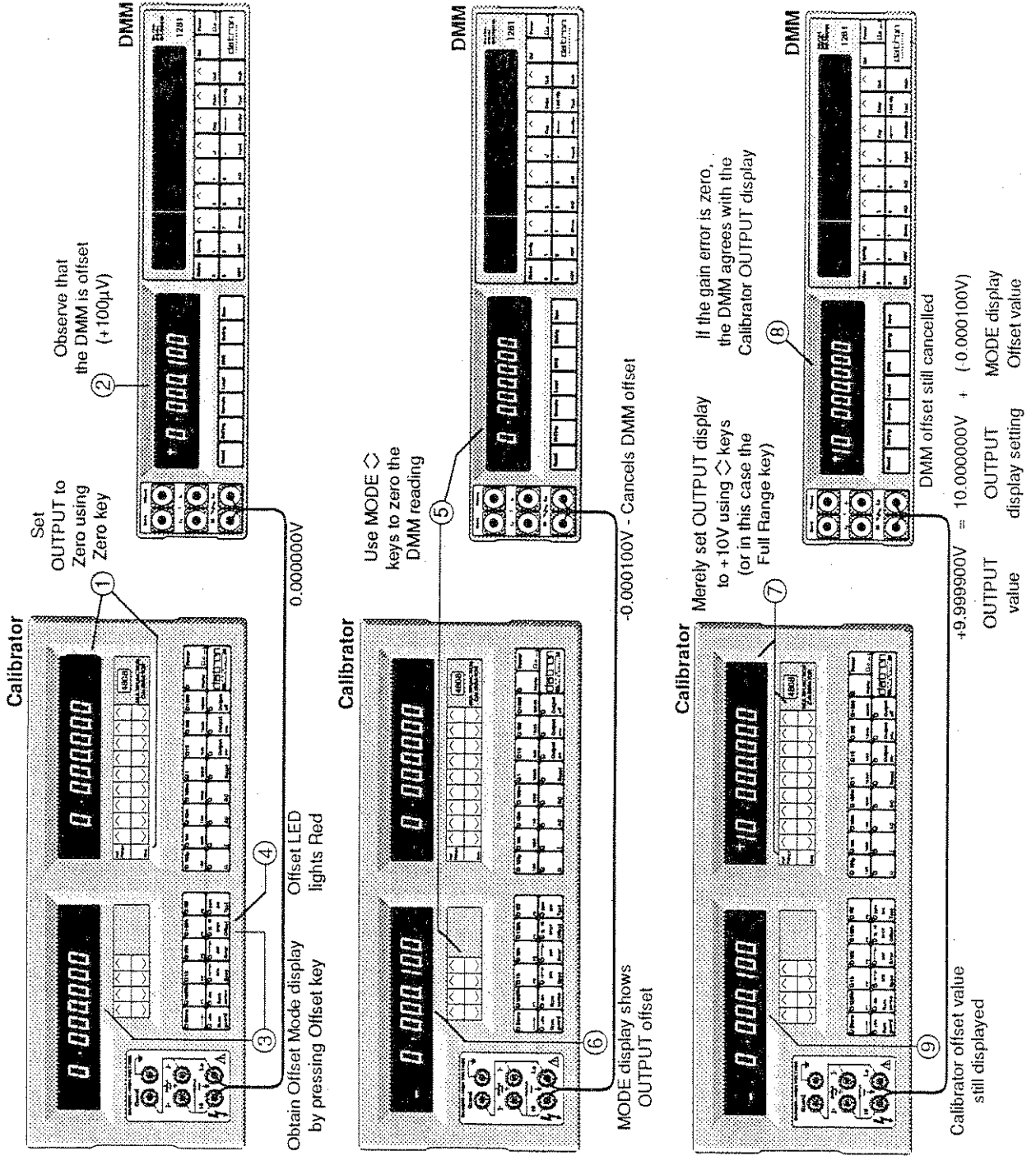

- Use suitable values of the OUTPUT display setting to check the linearity of the instrument under test. If the instrument has perfect linear response, then its readings will agree with those of the calibrator's OUTPUT display and its linear transfer function is either:

Instrument Reading =

$$\left[ 1 - \frac{\mu}{10^6} \right] \times \text{Input value} - \gamma \equiv y = mx + c$$

$$\left[ 1 - \frac{\delta}{100} \right] \times \text{Input value} - \gamma \equiv y = mx + c$$

- Deselect ERROR and OFFSET in reverse sequence.

**NOTE:** For these equations to be valid, the procedure must follow the above sequence. Therefore the 4800, 4805 and 4808 calibrators have been designed to inhibit any other sequence.

i.e. OFFSET mode cannot be selected or deselected when the Error LED is lit and the Offset key is operating in its secondary function of %.

## **Test Key**

### **Tests available**

There are two stages of 'Test' mode. The first stage, Safety and Memory checks, cannot be omitted from any 'Test' sequence.

### **Safety and Memory Checks**

On first pressing the **Test** key, the 4800, 4805 and 4808 calibrators carry out three checks:

1. Operation of the Safety trip, buzzer and reset circuitry.
2. Calibration Memory integrity.
3. Over-voltage check. (High voltage when not in HV state).

Messages appear on the MODE/FREQUENCY display, and completion is signalled by the **Test** LED going OFF. The second stage key checks may be omitted by pressing any key other than **Test**.

### **Key Checks**

If, after the Safety and Memory Checks are completed, the **Test** key is re-pressed before pressing any other Key, an operator-interactive sequence is initiated which allows the front-panel keys to be tested.

This sequence contains the following steps:

1. Key LED tests
2. Key contact tests

The calibrator remains in the key-contact mode until TEST mode is deselected by pressing the **Test** key. It may then be used normally.

- N.B.**
1. The **Test** key may be used to abort the test at any point in the sequence.
  2. During self-test the instrument reset facility is not available.

### **Test Sequence**

The Front or Rear panel terminals are not energized during the Test sequence.



## Warnings and Messages

### High Pitch Audible Warning

- (a) Sounds at approx 5 pulses per second during the 3 second delay between selection of **Output on** or **Output on-** and the High Voltage being connected to the terminals, when the **OUTPUT TERMINAL VOLTAGE WILL EXCEED 110V DC or 75V RMS**
- (b) Sounds at approx 1 second intervals with the output ON in **High Voltage State**.
- (c) Sounds for 1 second with blank FREQUENCY display when frequency auto-ranges up or down
- (d) Sounds continuously when **SAFETY** message is present on MODE/FREQUENCY display during self test.

### Low Pitch Audible Warning

- (a) Sounds when any message is displayed on the MODE/FREQUENCY display (except recall messages).
- (b) Sounds when any invalid bus command is received.

## arnings and Messages (continued)

### FREQUENCY/MODE Display Messages

- |       |                                      |  |
|-------|--------------------------------------|--|
| or 1  | - Spec Mode: [%]<br>- [+Lim, -Lim]   | - Tolerance exceeds 100%.<br>- The selected limit is off-scale.  |
| or 2  | - Calibrate Mode                     | - OUTPUT OFF.  |
| or 3  | - Calibrate Mode                     | - Incorrect FUNCTION, OUTPUT or FREQUENCY RANGE for this calibration mode.   |
| or 4  | - Calibrate Mode                     | - Correction out of limits.  |
| or 5  | - Offset or<br>Error Mode            | - Temporary message. The selected deviation would exceed the full scale value. <b>Activation has been prevented.</b>   |
| or 6  | - Calibrate Mode<br>(Resistance)     | - The resistance value selected exceeds the calibration value.   |
| or 7  | - 100V and<br>1000V Ranges           | - Temporary message. The selected Voltage and Frequency exceeds the calibrator's internal constraints. <b>Activation has been prevented.</b>   |
| or 8  | - Selection error                    | - Temporary message. The operation requested by the user is not possible in present machine configuration.   |
| or 9  | - Option not fitted                  | - Temporary message. The requested range or function option is not fitted.   |
| or EF | - External<br>Frequency              | - The external frequency is not present, machine will perform out of specification.  |
| or OL | - Voltage Ranges<br>- Current Ranges | - The output has been current-limited by an overload. (If in 100V or 1000V range, <b>OUTPUT</b> is automatically switched <b>OFF</b> ).<br>- The terminal voltage has been <b>compliance-limited</b> to 3V. (Load impedance too high). |

## Warnings and Messages (continued)

### Warning LEDs

#### Warning Indications:

Warning lit

Warning and Error Keys Lit

Warning key Lit

- The labelled facility is selected and active.
- The labelled facility is not selected.
- Other MODE key facilities are reassigned to the secondary modes, printed alongside the key LEDs, as directed by the arrows.
- FREQUENCY RANGE keys are reassigned to select F1-F5 memory stores.

#### Warnings with Function DC or AC Selected:

OUTPUT RANGE 100V or 1000V LED flashing

- A voltage in excess of 110V DC or 75V RMS AC has been selected (OUTPUT ON or OFF).

Output on+ or Output on- LED flashing while in Low Voltage State with OUTPUT ON

- An attempt to select output in excess of 110V DC or 75V RMS AC has been prevented.
- Repressing the Output on+ or Output on- key will switch the HIGH VOLTAGE ON.



**FREQUENCY/MODE Display Messages (continued)**

- FAIL 1** - Excessive internal temperature.
- FAIL 2** - Over-voltage
- FAIL 3** - Control data corrupted
- FAIL 4** - Precision divider fault
- FAIL 5** - Safety circuits tripped
- FAIL 6** - Calibration memory sumcheck non-parity
- FAIL 7** - 400V power supply fault - this 'trip' may reset itself if no hardware fault exists and the Fail message is temporary.
- FAIL 8** - 38V power supply fault
- FAIL 9** - 15V in-guard power supply fault
- FAIL 10** - Model 4600 Transconductance Amplifier communication fault

- SAFETY** - Test Mode - Safety circuits tested by tripping: Press **Reset** key to continue
- running** - Test Mode - Indicates test in progress.
- PASS** - Test Mode - **FAIL 6** did not occur during test of calibration memory parity and **FAIL 2** did not occur during test of over-voltage threshold

**Recalled Messages**

- LAteSt** - Indicates latest calibration data is operative (selected by pressing **Error** then **↔** key)
- SHAdO** - Indicates shadow calibration data is operative (selected by pressing **Error** then **↔** key)
- ISS XX.XX** - Firmware issue number (selected by pressing **Error** then **-Lim**).
- Addr XX** - IEEE 488 Bus address as set on Address switch (selected by pressing **Error** then **+Li**)

**Processor 'Busy' (Keyboard Unreceptive)**

The calibrator will not respond to commands while legend 'B' is present on the MODE/FREQUEN and OUTPUT displays except to override during safety delay.



### Guard and Sense

These are configured into Local or Remote by **G** or **S** codes respectively:

- G0** - Local Guard
- G1** - Remote Guard
- S0** - Local Sense (forced when F2 or F3 has been commanded and when F0, R1, R2, R3 and R4 or F1, R2, R3 and R4 have been commanded). Programs for 2-wire resistance in F4.
- S1** - Remote Sense (available only when F0 or F1 have been selected together with R5, R6, R7 and R8 or when F4 has been selected in all ranges). Programs for 4-wire resistance in F4.

These bus commands are subject to the constraints of the calibrator firmware. The instrument will reject and ignore invalid commands, such as **Remote Sense** when in **100mV** range.

### Calibration Enable and Calibration Commands (W and C codes)

These are available for automatic calibration of the calibrator, under remote control via the **II** bus. Refer to the *Maintenance Handbook*.

- W0** - Calibration disable
- W1** - Calibration enable (only if **CALIBRATION ENABLE** keyswitch set **ENABLE**).
- C0** - Calibration Trigger - equivalent to **CAL** key
- C1** - As **SET** key
- C2** - As **STD** key
- C3** - (DC) As  $\pm 0$  key
- C3** - (AC) "Precal"
- C4** - DC Coarse linearity calibration
- C5** - DC linearity calibration
- C6** - Copies calibration data in the **LA** store into the **SH** store
- C7** - Selects the **SH** store
- C8** - Selects the **LA** store

Ref  
to  
Sect  
8





## Programming of Bus Transmissions

### Output String Formation

800, 4805 and 4808 calibrators can be programmed to output 'internal' information to the system via the IEEE-488 bus, by sending one or more specified 'recall' messages.

Each recall command should be included in a delimited string.

As well as the information it contains, the string must be formatted correctly for acceptance by the system. Many variations of format are possible; these can be programmed for the type of item in use.

The length and construction of the string both depend upon the type of information to be transmitted, and thus upon the codes used to program the calibrator. The purpose of this explanation is to describe the effects of these codes on the output string format.

Figure 5.4 illustrates the construction of a typical string, such as the calibrator output value. Notice that numerical data is reduced to a standard form, and scaled by means of an exponent in base 10. All device dependent messages use the ASCII code.

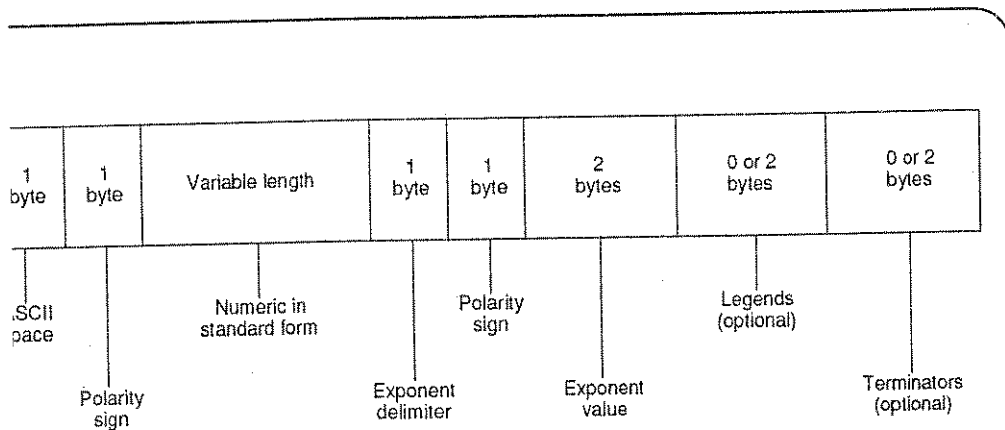

FIGURE 5.4 BREAKDOWN OF A TYPICAL OUTPUT STRING



**ASCII 'Space'**

A format character to denote the beginning of an output string - not present for recall command X8.

**Polarity Sign**

Replaced by an ASCII space in AC Functions. For DC functions, the appropriate polarity sign is presented.

**Numeric Sub-string**

Length depends on the resolution of the information to be transmitted, and form depends on the notation programmed by 'L' code.

**Exponent Delimiter 'E'**

Signifies that the numeric has finished and the next three bytes form the exponent.

**Exponent Value**

The first of the three bytes is always '+' or '-'. Because the value is never greater than 9, the second byte is always 0, and the third is a single decimal digit.

**Legends**

Inclusion is optional, but if they are programmed in, two bytes are always present. The characters are appropriate to the programmed state of the calibrator.

**Terminators**

Two terminating characters are available and programmed by 'K' code. The EOI bus management line can optionally be programmed for simultaneous transmission with the last byte of the string.

## Format Codes

The following pages list and describe the programming codes which determine the formation of the output string. The codes on this page select specific types of ASCII strings for retrieval.

### Call/Verify (V code)

When sending a V code the controller interrogates the calibrator to obtain information about its present status. Unless otherwise stated, the output strings are formatted as programmed by K and L codes. The V codes are as follows:

- V0 - The present OUTPUT value
- V1 - The present FREQUENCY setting
- V2 - The present functional status.  
The response to V2 is a standard ASCII string: (space R\*F\*O\*G\*S\*W\*Q\*D\*L\*K terminator). The functions are represented by the same numerics as for programming. In addition, the OUTPUT RANGE is identified by a lower case 'r' if the calibrator is programmed in autorange.

- V3 - Software status  
The software status is the part number and issue number of the internal program. This is formatted as follows, in response to command code V3:

(space 89\*\*\*\* - numeric terminator)

↑  
Part No.

↑  
Issue No.

(This status report is also available manually by pressing the Error key followed by the -lim key. The firmware issue number is presented on the MODE/FREQUENCY display).

- V4-V8 - 'Stored' Frequencies

Codes V4 to V8 recall each of the five frequencies held in volatile memory locations F1 to F5. These can only be set or selected manually. (Refer to Page 3-20).

The range of legends transmitted by the calibrator is listed under 'String Formatting Commands (K and L Codes)'.

### Safety and Memory Checks

#### 1. Initial Conditions

Ensure that the **Output off** LED is lit and the **Error** and **Spec** LEDs are unlit. Check that the **Test** LED is unlit.

#### 2. Press Test Key:

**Test** LED lights as the checks begin.

#### 3. Safety Trip Check

The calibrator tests the safety trip circuits. The **SAFETY** message appears on the **MODE/FREQUENCY** display and the buzzer will sound continuously when the trips have operated, and the **Reset** LED flashes.

#### 4. Reset Check

The program ensures that user tests the **Reset** action.

Press **Reset** Key:

The **SAFETY** message is replaced by the **running** message and the buzzer stops sounding. Relay operation can be heard during the automatic checks which follow.

#### 5. Calibration Memory Check

This is a sum-check of the calibrator's non-volatile RAM. If the check fails, the Message **FAIL 6** appears, otherwise no message.

#### 6. Over-Voltage Checks

The calibrator automatically tests the over-voltage detector threshold levels in **Lc Voltage** state.

If the check fails, the message **Fail 2** appears otherwise a **PASS** message indicates both tests completed successfully.

#### 7. The Test LED goes OFF.

The following table summarizes the **MOI** display messages:

Message	Reason
<b>SAFETY running</b>	First stage of 'test' operative.
<b>PASS</b>	No failure discovered
<b>FAIL 6 only</b>	Parity error Calibration Memo Check.
<b>FAIL 2 only</b>	High voltage found be present in <b>Lc Voltage</b> state.

Any combination of these two **FAIL** messages can appear in sequence, replacing the **running** message.

#### 8. To terminate the TEST mode before the LE and key checks, press any key other than **T** — the calibrator returns to prior condition

## D and Key Checks

### / Checks

#### ⌂ Keys

Each ^ key should light the upper half of the digit immediately above it.

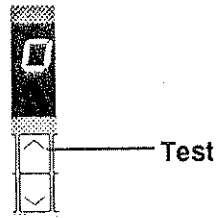

Note that the OUTPUT display overrange digit ^ key lights the upper half of the overrange digit.

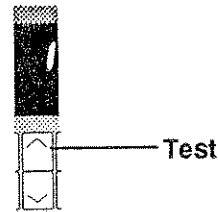

Each v key should light the lower half of the digit immediately above it.

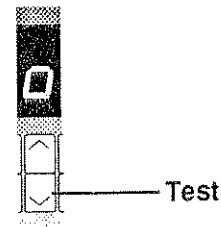

Note that the OUTPUT display overrange digit v key lights the lower half of the overrange digit and the ± legends.

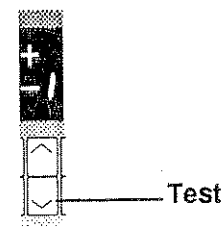

(b) Full Range and Zero Keys

The **Full Range** key should light the three upper half-zeros at the left of the OUTPUT display.

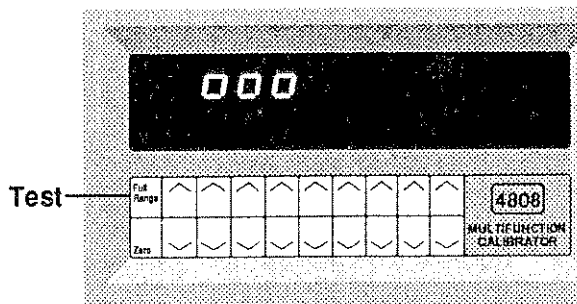

The **Zero** key should light the three lower half-zeros at the left of the OUTPUT display.

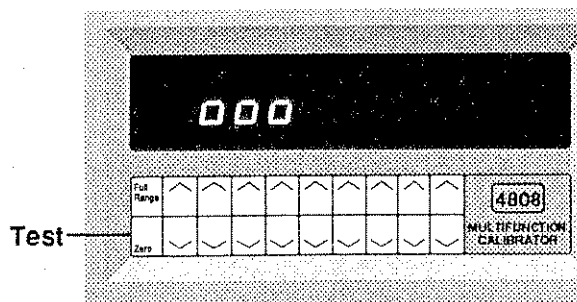

(c) FREQUENCY RANGE, MODE, OUTPUT RANGE, FUNCTION and OUTPUT keys should cause their LEDs to light, except:

- (i) the **Reset** key, which is inoperative.
- (ii) the **Test** key, which aborts the test.
- (iii) the **Display** key.

In these tests the key-press operates a latch so that the display or LED remains lit until another key is pressed. Only one key-press at a time is recognized.

(d) **To Terminate the Test Sequence:**

Press the **Test** key again.

- calibrator reverts to initial condition
- **Test** LED goes OFF.

(e) Operate the calibrator normally.

### Display Key

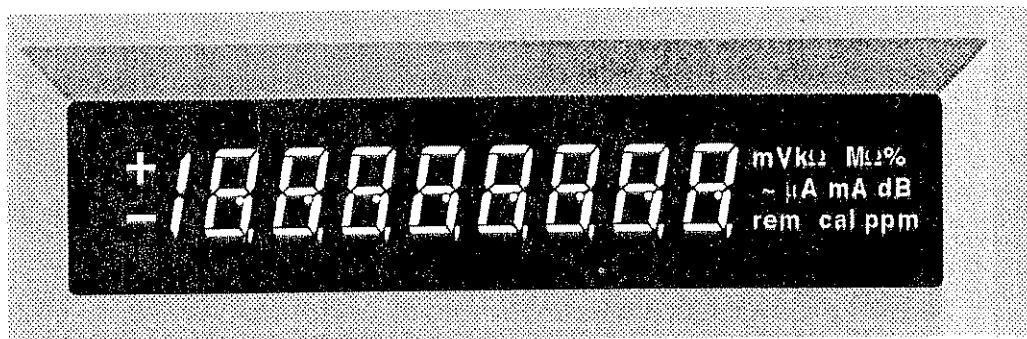

Pressing the **Display** key while the calibrator output is OFF causes all the display segments (7-segment digits, decimal points, commas and dashes) to illuminate on the left-hand MODE/FREQUENCY display and the right-hand OUTPUT display. The Display key LED also illuminates. This allows a visual check to be made of display operation.

The key is inoperative if the calibrator output is ON (**Output on+** or **Output on-** LED lit).

In addition, leaving the displays in the fully illuminated DISPLAY TEST condition for a few minutes each week will maintain them in optimum condition.



## SECTION 5 SYSTEMS APPLICATION via the IEEE-488 INTERFACE

### Introduction

This section gives the information necessary to put the 4800, 4805 or 4808 calibrator into operation on the IEEE 488 bus. As some operators will be first time users of the bus, the

text provides introductory level information. For more detailed information, refer to standard specification, which appears in publication ANSI/IEEE Std. 488-1978.

---

### Section Contents

The section is divided so as to group certain types of information together. These divisions are:

**Interface Capability** - the permitted IEEE-488 options which have been implemented in the 4800, 4805 and 4808 calibrators.

**Typical System** - a brief view of a typical system using the 4800, 4805 or 4808 calibrator to check a DMM's calibration.

**Using the 4800, 4805 and 4808 Calibrators in a System** - implications of bus operation.

**Programming Instructions** - how the calibrator facilities have been transposed into remote commands.

**Programming of Operational Function** - more detail about the codes which control calibrator operation.

**Programming of Bus Transmissions** - how to program the 4800, 4805 and 4808 calibrator to obtain specific types of readout.

**Service Request** - why the calibrator needs controller's attention and how it gets it.

**Activation of Commands** - what the calibrator does with the commands it receives.

**Operational Sequence Guidelines** - general help with programming sequences.

## **Interface Capability**

### **IEEE-488 Standard**

4800, 4805 and 4808 calibrators conform to Standard specification IEEE 488-1978 - 'IEEE Standard Digital Interface for Programmable Instrumentation'.

Calibrators can be connected to the IEEE 488 Interface Bus and set into programmed communication with other bus-connected devices under the direction of a system controller.

### **Programming Options**

The instrument can be programmed via the IEEE 488 Interface, to:

- Change its operational state (Range, Function, Frequency, Mode, Output, etc.)
- Transmit its own status data to other devices on the bus.
- Request service from the system controller.

### **Capability Codes**

To conform to the standard specification, it is not essential for a compatible device to encompass the full range of bus capabilities.

The IEEE 488 document describes and codes each of the standard bus features, so that manufacturers can provide brief coded descriptions of their own interfaces' overall capability. A code string is often printed on the product itself.

The codes which apply to the 4800, 4805 and 4808 calibrators are given in Table 5.1, together with short descriptions. They also appear on the rear of the instrument next to the interface connector.

Appendix C of the IEEE 488 document contains a fuller description of each code.

## Using the 4800, 4805 and 4808 Calibrators in a System

### Addressing the 4800, 4805 and 4808 Calibrators

#### Bus Address

The instrument address is set manually using a six-way miniature switch near the interface connector on the rear panel. Five of the switches are used to set any address in the range 0 to 30, using a binary code.

The sixth switch is provided for possible future variants. In the 4800, 4805 and 4808 calibrators, the position of the ADD switch is immaterial, as the normal bus addresses can be selected at either setting.

#### Addresses 0-30

With an address selected in the range 0 to 30 the instrument may be controlled manually, or remotely as part of a system on the Bus. The address selected must be the same as that used in the controller program to activate the calibrator. **N.B.** The selected address can be temporarily displayed on the front panel when in manual control, by pressing the **Error** key followed by the **Rem guard** key.

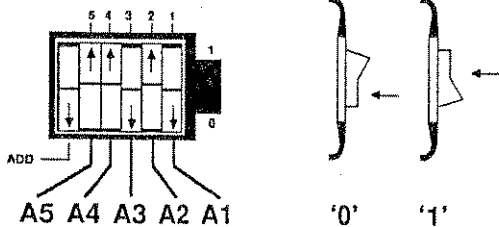

A5	A4	A3	A2	A1	Deci Co
0	0	0	0	0	00
0	0	0	0	1	01
0	0	0	1	0	02
0	0	0	1	1	03
0	0	1	0	0	04
0	0	1	0	1	05
0	0	1	1	0	06
0	0	1	1	1	07
0	1	0	0	0	08
0	1	0	0	1	09
0	1	0	1	0	10
0	1	0	1	1	11
0	1	1	0	0	12
0	1	1	0	1	13
0	1	1	1	0	14
0	1	1	1	1	15
1	0	0	0	0	16
1	0	0	0	1	17
1	0	0	1	0	18
1	0	0	1	1	19
1	0	1	0	0	20
1	0	1	0	1	21
1	0	1	1	0	22
1	0	1	1	1	23
1	1	0	0	0	24
1	1	0	0	1	25
1	1	0	1	0	26
1	1	0	1	1	27
1	1	1	0	0	28
1	1	1	0	1	29
1	1	1	1	0	30

TABLE 5.3 ADDRESS SELECTI

### **ote Operation**

the 4800, 4805 and 4808 calibrators are ting under the direction of the controller, egend rem appears on the MODE/ QUENCY display, and all front panel ols are disabled except Power.

ntering the remote state, any earlier ual) selection of Error mode is cancelled. g remote operation, the calibrator's Error is disabled, as it can easily be programmed re controller. Spec mode is also cancelled, 'spec' information can be obtained by bus and. There is no Spec mode display on the panel during remote operation.

calibrator's power-up sequence is rmed as for manual operation. After r-up, and on recovery from a power failure, liberator generates an SRQ and prepares an ' Status Byte' for transmission to the ollder as a response to its subsequent serial

### **ibration Enable**

'ibration Enable' command via the bus is ed to set the instrument into its Remote ration mode (the CALIBRATION BLE keyswitch on the rear panel must ly be set to ENABLE). Selection of any ss in the range 0-30 inhibits manual ation from the front panel. In remote, ation may be initiated with any address in nge 0 - 30 selected.

### **Address 31 (Illegal bus address)**

This address configures manual operation only, inhibiting remote facilities. Address 31 must be selected (with CAL key set to ENABLE), for manual calibration to be carried out.

### **Temporary Transfer to Local Operation (GTL)**

The calibrator can be programmed to switch into 'Local' operation (Command GTL), permitting a user to take manual control from the front panel. The system controller regains 'Remote' control by sending the following overriding commands:

### **LAD with REN True**

The controller addresses the calibrator as a listener with the Remote Enable management line true (Low). This returns the calibrator from local to remote control. Any commands which had been sent during the period under local control will then be executed.

### **SDC**

Specific 'Device Clear' commands are sent over the bus, returning the calibrator to a predetermined state (described later in this section).

### Interconnections

Instruments fitted with an IEEE 488 interface normally communicate through a set of interconnecting cables, specified in the IEEE 488-1978 Standard document.

The calibrator interface connector, J27, is fitted on its rear panel. It accepts the specified IEEE-488 connector, for which pin designations are shown in *Fig. 5.1* and *Table 5.2*.

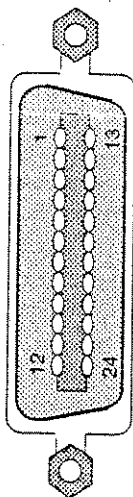

FIG 5.1 J27 PIN LAYOUT

Code	Interface Function
SHI	Source Handshake Capability
AHI	Acceptor Handshake Capability
T6	Talker (basic talker, serial poll, unaddressed to talk if addressed to listen)
TEØ	No Address Extension Talker Mode
L4	Listener (basic listener, unaddressed to listen if addressed to talk)
LEØ	No Address Extension Listener Mode
SR1	Service Request Capability
RL2	Remote/Local Capability (without Local Lockout)
PPØ	No Parallel Poll Capability
DC1	Device Clear Capability
DTØ	No Device Trigger Capability
CØ	No Controller Capability
E1	Open-Collector Drivers

TABLE 5.1 IEEE-488 INTERFACE CAPABILITY

### Bus Addresses

When an IEEE 488 system comprises several instruments, a unique 'Address' is assigned to each to enable the controller to communicate with them individually.

One address is sufficient for a Datron instrument, as the controller can add information to it to define either 'talk' or 'listen'.

J27 Pin No.	Name	Description
1	DIO 1	Data Input Output Line 1
2	DIO 2	Data Input Output Line 2
3	DIO 3	Data Input Output Line 3
4	DIO 4	Data Input Output Line 4
5	EOI	End of Identify
6	DAV	Data Valid
7	NRFD	Not ready for Data
8	NDAC	Not Data Accepted
9	IFC	Interface Clear
10	SRQ	Service Request
11	ATN	Attention
12	SHIELD	Screening on cable (connected to Safety Ground)
13	DIO 5	Data Input Output Line 5
14	DIO 6	Data Input Output Line 6
15	DIO 7	Data Input Output Line 7
16	DIO 8	Data Input Output Line 8
17	REN	Remote Enable
18	GND 6	Ground wire of twisted pair with DAV
19	GND 7	Ground wire of twisted pair with NRFD
20	GND 8	Ground wire of twisted pair with NDAC
21	GND 9	Ground wire of twisted pair with IFC
22	GND 10	Ground wire of twisted pair with SRQ
23	GND 11	Ground wire of twisted pair with ATN
24	GND	THE CALIBRATOR Logic Ground (Internally connected to the calibrator's Safety Ground)

Table 5.2 IEEE 488-1978 Connector - Pin Designations

## Typical System

A typical system is shown in Fig. 5.2. The system is directed by a controlling device able to:

- (a) 'Control' (Issue commands)
- (b) 'Listen' (Receive data)
- (c) 'Talk' (Transmit data)

## Example of a System in Operation

In the system example (Fig. 5.2) the programme task could be to check the DMM calibration against a 4800, 4805 or 4808 calibrator, and print out the results. The following is a typical sequence of events:

- (1) The controller needs to instruct the calibrator to set its output to a calibration point for the DMM. These commands must not be received by the DMM or the printer and so the controller sends the general bus message 'Unlisten'. When sending general messages, the controller makes all bus devices interpret any DIO-line data as configuration or data-flow commands, by holding the ATN line true.
- (2) The controller then sends the calibrator listen address to force it to receive, followed by the calibrator configuration commands (including the Output Disable message, to prevent the DMM receiving an inappropriate analog input). The instructions are passed along the DIO (data input-output) lines as coded messages (bytes). The data coding is ASCII (American Standard Code for Information Interchange).
- (3) Although the calibrator accepts the instructions as they are passed, their implementation takes a short time. The controller would perform other tasks during this period. In the example, it would pass configuring commands to the DMM, after the Unlisten and DMM listen address have been sent.
- (4) The DMM also needs time to settle into stable operation, so the controller performs other tasks while waiting, such as configuring the printer.
- (5) The controller next generates Unlisten, re-addresses the calibrator as listener, and reconfigures its Analog Output On by an Output Enable message. If the calibrator has executed its previous instructions, it sets OUTPUT ON immediately, otherwise the OUTPUT is set ON as soon as they have been executed. In either case, the calibrator sends a message back to the controller via the SRQ (Service Request) management line, if programmed to do so.
- (6) As the SRQ facility is available to all bus devices (Wired-OR function), the controller needs to discover which one sent the 'SRQ'. It therefore asks all devices one-by-one by conducting a 'serial poll', and finds out that the calibrator is the SRQ source and that its OUTPUT is ON.

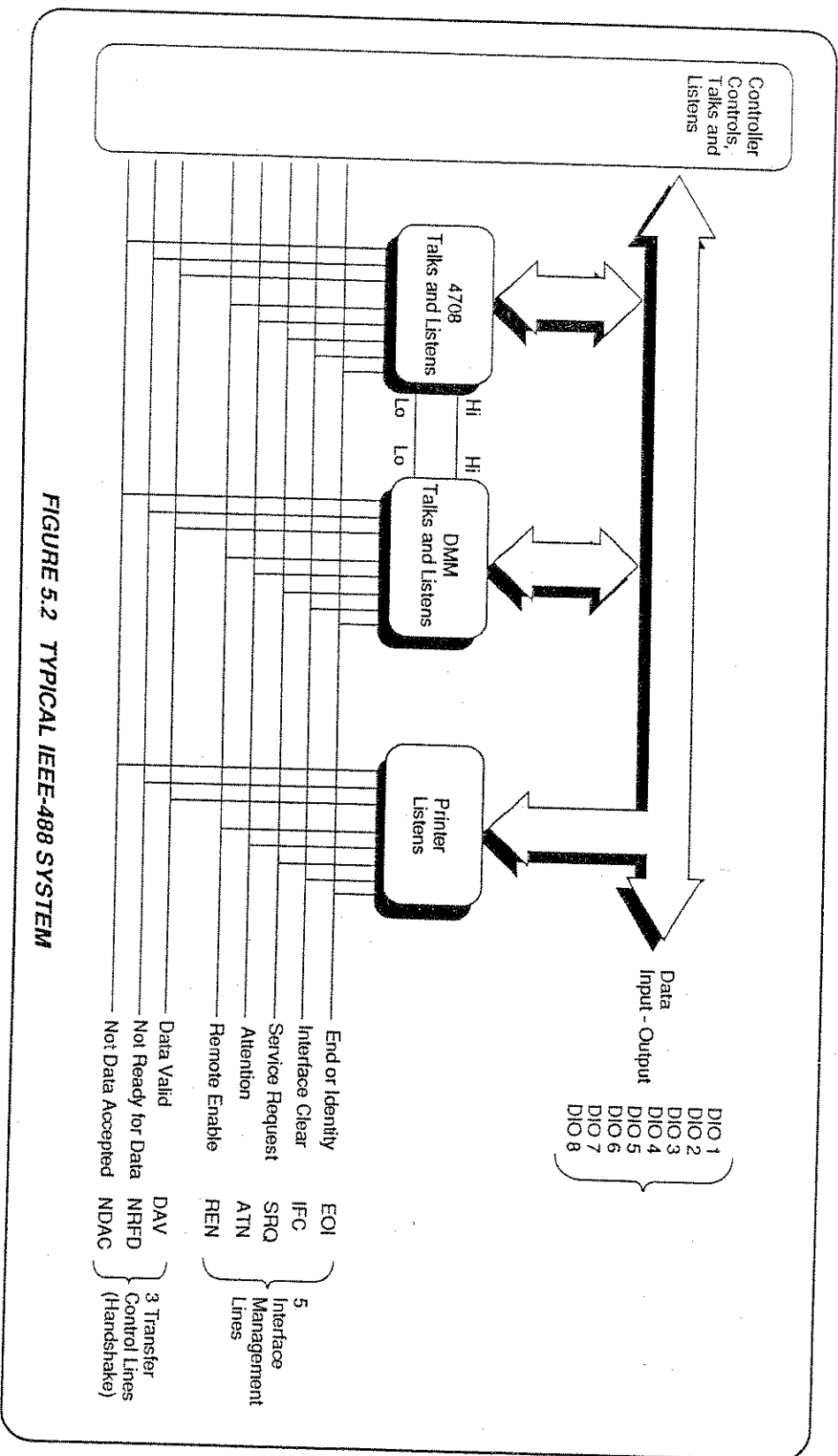

FIGURE 5.2 TYPICAL IEEE-488 SYSTEM

- (7) The controller addresses the DMM as a listener, and sends the GET message (Group Execute Trigger) via the DIO lines to initiate the reading. After a short delay for measurement, the DMM prepares output data and SRQ's the controller when it is ready for transfer.
- (8) The controller identifies the DMM by a serial poll. Finding that the reading is available, it sends the DMM's talk address, and printer's listen address, to activate both devices.
- (9) The controller sets the ATN line false, thus releasing both devices to start the transfer. The DMM sends its data, byte by byte, via the DIO lines to the printer. This data must be in a form acceptable to the printer, and to ensure orderly transfer, each byte is transferred by 'Handshake', using the three Transfer-Control lines.

## Typical System (continued)

- (10) Usually the controller is also listening to this data transfer to determine when it is complete. As an aid to the controller and printer, the DMM can send another message with the last byte to be transferred (EOI 'end or identify' using another bus management line).
- (11) The sequence is complete, and the controller can start again at another calibration point.

The controller holds the **REN** line true when taking remote control. It can send an addressed command **GTL**, or some controllers can set **REN** false, to permit temporary manual control of a device. The **IFC** line is used at the discretion of the controller, to clear any activity off the bus.

Sequences such as this are often assembled into programs to check DMMs at many calibration points; changing functions, ranges and output levels as designed by the user. The program would also include 'display' messages to complete the printout in a recognizable form for the user's convenience. Programs must also cater for **FAIL** and **ERROR SRQs**.

Note that many of the individual steps detailed above will be transparent to the programmer. The level of transparency will be dependent on the controller. Refer to the relevant documentation for further information.

With a Datron Autocal DMM, other sequences can cause the DMM calibration errors to be reduced until they are within specification, using its 'calibrate' mode.



## Programming of Operational Functions

### Output ON/OFF

analog OUTPUT is switched off by command **D0** (output disable), and switched on to the selected value by **D1** (output enable). The amplitude and frequency of the output are derived from the 'M' code and 'H' code data used to set OUTPUT and MODE/FREQUENCY registers respectively.

### Safety Delay

High Voltage Safety delay (3 seconds) is normally active (**D0**). It can be overridden by command **D1**, but the use of this command **up potentially dangerous situations**. **D0** is enforced by any FUNCTION or RANGE change (including Autorange changes).

#### WARNING

**DO NOT USE D1 UNLESS IT IS ESSENTIAL FOR HIGH SPEED OPERATION. TAKE SAFETY PRECAUTIONS TO PROTECT PERSONNEL IN THE VICINITY.**

### Function

**F0** (DC voltage), **F1** (AC voltage), **F2** (DC Current), **F3** (AC Current) and **F4** (Resistance) configure the instrument to the required function.

### Output Range

**R1** through to **R9** configure the calibrator to specific ranges as shown earlier in *Table 5.4*. **R0** puts the instrument in auto-range function, allowing the output value to be specified as a number without setting the actual range. Ranging down occurs at 20% of range, i.e. Full Scale value of next lower range. Ranging up occurs at Full Scale. In autorange, commands **A0**, **A1** and **A2** are invalid.

### Output Display Value (Main Register)

In remote programming, the incremental  $\Delta$  method of setting the output value is not used. Instead, Code **M±\*\*\*** is used to set the output value explicitly, either in numeric, scientific or engineering notation (see examples below). If the resolution is too high, the value is truncated to the correct resolution and the controller is informed by **SRQ** and **RQS** Status Byte (see **RQS** Status Byte formats later in this section).

TABLE 5.4 IEEE 488 COMMAND CODES (continued)

CONTROL	CODE	DESCRIPTION
Value Notation	L0	Scientific with legends
	L1	Scientific with no legends
	L2	Engineering with legends
	L3	Engineering without legends
Main Register Value	M±***	Numeric value of 'Output' display
Output	O0	Output OFF
	O1	Output ON
Specification Tolerance	P0	24 hours
	P1	90 days
	P2	1 year
Service Request	Q0	SRQ on all specified states
	Q1	SRQ on Overload/Fail only
	Q2	No SRQs
Output Range	R0	Autorange
	R1	100μ —
	R2	1m 10Ω
	R3	10m 100Ω
	R4	100m 1kΩ
	R5	1 10kΩ
	R6	10 100kΩ
	R7	100 1MΩ
	R8	1000 10MΩ
	R9	— 100MΩ
Sense	S0	Local Sense
	S1	Remote sense

CONTROL	CODE	DESCRIPTION
Spot Frequencies (4808 only)	T0	Cancel Spot Frequency
	T1	SF1
	T2	SF2
	T3	SF3
	T4	SF4
	T5	SF5
Specification Tolerance (Absolute Limits of Uncertainty)	U0	24 hours
	U1	90 days
	U2	1 year
	U3	24 hours
	U4	90 days
	U5	1 year
Recall/Verify	V0	'OUTPUT' Value
	V1	'Frequency Setting'
	V2	Calibrator Status
	V3	Software Status (Part No/Issue)
	V4	F1
	V5	F2
	V6	F3
	V7	F4
	V8	F5
Calibration	W0	Calibration Mode Disal
	W1	Calibration Mode Enab
Diagnostic (The cal-store values relate to the function set at the time.)	X0	Zero Cal Store
	X1	Gain Cal Store
	X2	STD Cal Gain Factor
	X3	Zero offset
	X4	Gain Offset
	X5	Linearity (not AC)
	X6	Reference Divider Set
	X7	Not Used
	X8	User Message Recall
X9	Recall Cal Store Selec	

## Programming Instructions

### Programming Strings

From the example given earlier in this section it is evident that the calibrator requires an address code followed by a series of device-dependent messages or commands to alter its configuration. A series of these commands can be sent together as a 'program string', each programming instruction being position-dependent.

Each string will contain at least one programming instruction (detailed later in this section), but the calibrator must receive the string 'terminator' before it can activate any instructions. The required terminator for the 4800, 4805 and 4808 calibrators is either the ASCII character '=' or EOI asserted coincident with the line feed character (decimal 10).

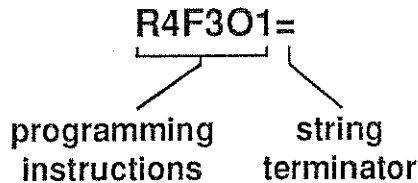

To assist in eliminating incorrect programming instructions, the 4800, 4805 and 4808 calibrators check for errors in the string, and generate a

service request (SRQ) if a syntax error occurs if an option is called for but not fitted. To ensure that the programming string does not set a prohibited state, it also checks the whole string for validity. If it finds any errors in this phase the whole command string is ignored.

**For Example:** With the calibrator set to 10 Range, a string is received which contains an unacceptable command to switch Se connection ('S' command). The user needs to set up a completely new, valid string: so the whole string is discarded.

### Device-dependent commands

To give maximum scope for system programming, the bus operation of the 4800, 4805 and 4808 calibrators differs in detail from manual operation, which is organized for easy front panel use. Some functions of the 4800, 4805 and 4808 calibrators' firmware are dedicated for bus operation, as they are easily programmed into the system controller; and extra functions have been made available to take advantage of the controller's added computing power.

## rogramming Instructions (continued)

The following Alphabetic codes are used to establish the required functioning of the 4800, or 4808 calibrator as a calibration source:

Full Range/Zero:	A
Frequency Delay Override:	D
Output ON/OFF:	O
Function DCV, ACV, DCI, ACI, $\Omega$ :	F
Output Range in all Functions:	R
Output Value:	M
Frequency:	H
Output of Frequencies:	T
Phase:	S
Guard:	G
Calibrate' trigger:	C
Calibration Mode Enable:	W

The following Alphabetic codes are used to select and configure the messages to be passed by the 4800, 4805 and 4808 calibrators over the IEEE Bus:

User memory:	I
Output string terminators:	K
Notation of output values:	L
Specification tolerances (relative: per unit):	P
Specification tolerances (absolute limits):	U
Recall/Verify (relative):	V
Service request origination:	Q
Diagnostic information:	X

Table 5.4 lists the range of device-dependent command codes available.

Figure 5.3 summarises the way that front panel functions are transferred to system operation.



**DANGER**  
**HIGH VOLTAGE**



I+, I-, Hi and Lo Terminals carry the Full Output Voltage

**THIS CAN KILL!**

**READ THIS:** For manual operation, High Voltage Interlocks ensure that users employ deliberate actions before selecting voltages in excess of 100V DC or 75V RMS at the Calibrator's output terminals.

- In system applications, the interlocks also require deliberate commands to be received from the system controller. (But see Safety Delay Override command D1 in the text).
- In manual operation users who are exposed to danger from high voltage also have direct control of the Calibrator output, but it is not possible to give the same degree of built-in protection to exposed users when the instrument is under remote programming.
- It is therefore **ESSENTIAL** that **WHENEVER THE CALIBRATOR IS BEING USED IN A SYSTEM TO GENERATE VOLTAGES IN EXCESS OF 75V, THERE MUST BE NO ACCESS TO THE CALIBRATOR'S OUTPUT TERMINALS.**

Unless you are sure that it is safe to do so,  
**DO NOT TOUCH**  
the I+ I- Hi or Lo leads and terminals

**DANGER**

Table 5.4 IEEE 488 Command Codes

CONTROL	CODE	DESCRIPTION
Full Range/Zero	A0	Zero
	A1	+Full Range
	A2	- Full Range
Calibration Mode (see Section 8)	C0	"CAL" Calibration Trigger
	C1	"SET"
	C2	"STD"
	C3	"±0" (in DC)
Safety Delay	D0	"Precal" (in AC)
	D1	DC Coarse Linearity
	F0	DC Linearity
	F1	Copy LAEST cal memory to SHAdO cal memory
	F2	Select SHAdO cal memory
	F3	Select LAEST cal memory
	F4	Safety delay Active
	D1	Safety delay Over-Ridden
Function	V	(DC Voltage)
	V~	(AC Voltage)
	A	(DC Current)
	A~	(AC Current)
Guard	G0	Local Guard
	G1	Remote Guard
Frequency	H****	Numeric value of frequency
	I	Store next 16 ASCII Characters (Aide-Memoire)
Output String Terminators	K0	Cr followed by Ll with EOI
	K1	Cr followed by Ll
	K2	Cr with EOI
	K3	Cr
	K4	Ll with EOI
	K5	Ll
	K6	EOI with last character
K7	No terminator	

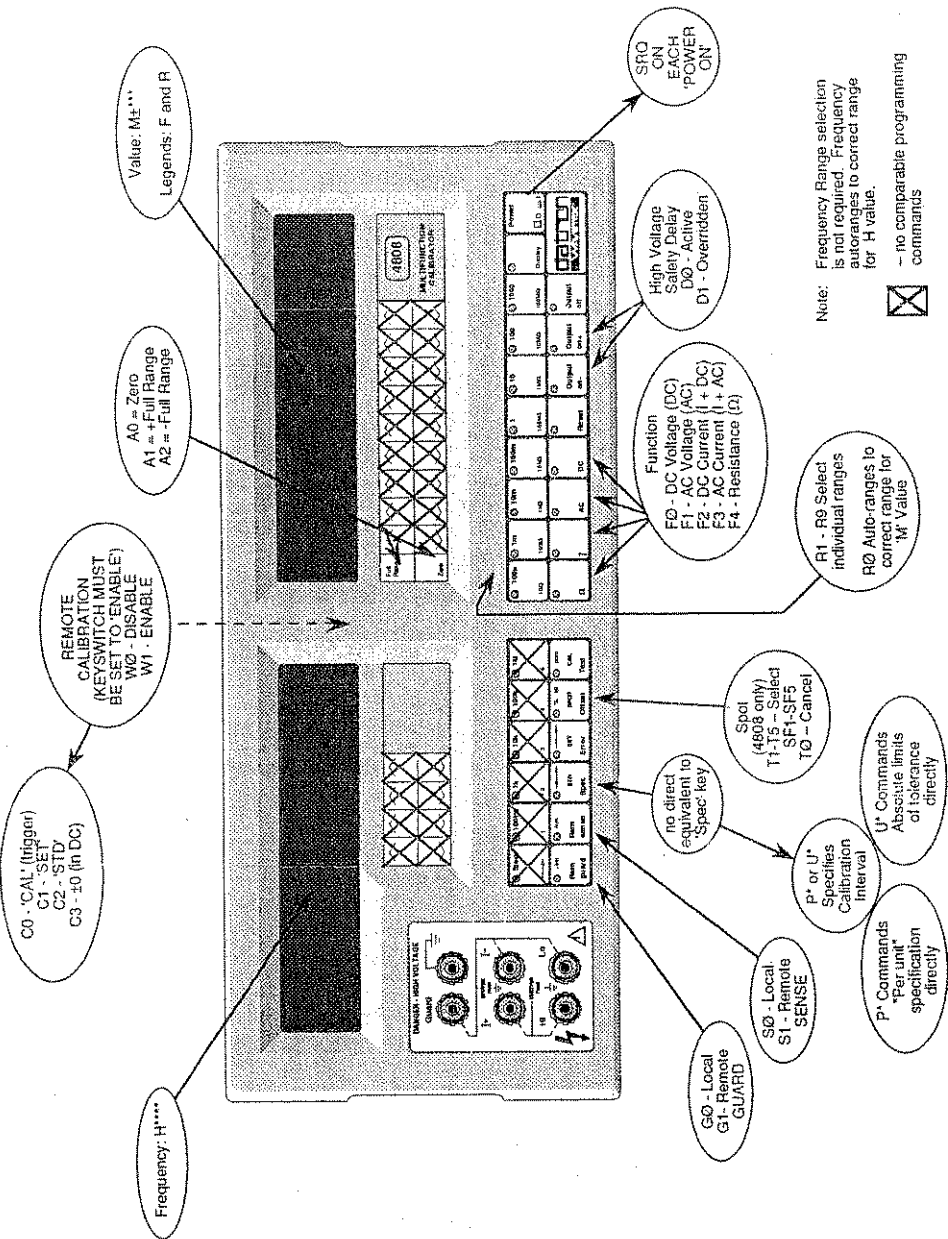

FIG 5.3 TRANSFER OF FRONT PANEL CONTROLS TO SYSTEM OPERATION

## High Voltage Outputs

The change from Low to High voltage state is controlled by the same interlocks which govern the manual changeover (Refer to *Section 4*). To effect the changeover, the command string:

**'M (followed by voltage) 01 ='**

should be used if OUTPUT is already ON and a range change is not involved. If a range change is programmed to set the output into high voltage state (for instance in RØ), the '01' should be sent as a separate string.

If the M code alone is attempted (M\*\*\*...=) with OUTPUT already enabled (01), the new value is set in the Main Register (OUTPUT display); but the output voltage will not ramp to high voltage state until the enabling string '01 =' is received.

If the attempt had been made with OUTPUT disabled (0Ø), the 01 would be required in a case.

It should also be remembered that the output circuitry needs time to settle to its final value especially if a range-change is incurred. Delay should be included in the controller program allow for this.

During these processes, the front panel warning of flashing LEDs and pulsing tones operate as if manual operation.

**NEVERTHELESS, ACCESS TO THE FRONT PANEL SHOULD BE RESTRICTED BECAUSE THE HIGH SPEED OF PROGRAMMING IN THE IEEE INTERFACE ADDS TO THE SAFETY HAZARD.**

### Examples of valid M codes:

Required Output Value	Function	Range	M Code	Output Display
-153V	FØ	R7	M-153	- 153.000,0V
+1.6212574V	FØ	R5	M+1.6212574	+1.621,257,4V
1.621257V RMS	F1	R5	M1621257E-6	1.621,257V ~
1.621257V RMS	F1	RØ	M1621.257E-03	1.621,257V ~ (Autorange to R5 =1V)
0.002563 RMS	F3	RØ	M.002563	2.56300mA ~ (Autorange to R3 =10mA)







### Frequency Display Value (Auxiliary Register)

Remote programming, the incremental method of setting the frequency is not used. Instead, each auxiliary register value is input directly by Code **H\*\*\*\*** in numeric, scientific engineering notation.

Manual frequency 'Store' memories cannot be set via the bus, although their contents can be changed using 'V' codes.

### Frequency Resolution

Frequency is resolved to three significant digits (to 100ppm accuracy). On the display this occupies four digit spaces, to accommodate the decimal point. If the significance is greater than three digits, the value is truncated and the controller is informed by SRQ Status Byte (see SRQ Status Byte formats later in this section).

### Frequency and Voltage Constraints

For 100V and 1000V output ranges, the calibrator will refuse any command for an output which exceeds the limits defined on pages 3-17 to 3-19. The controller is informed by 'Error 7' SRQ Status Byte (see SRQ Status Byte formats later in this section).

### Spot Frequency Selection (4808 only)

Codes **T1-T5** select the spot frequencies stored in SF1-SF5 non-volatile memories. Sixty unique memory locations exist. Thirty five are allocated to the seven AC Voltage output ranges and twenty five to the five AC Current ranges: five for each range. The value of the frequency called up by any **T** command is therefore dependent on the preselected **F** and **R** codes.

With Spot active, sending a new **R** code selects the corresponding spot frequency in the new range. A new **F** code, sent to change function, cancels the **T** command: the calibrator frequency reverts to 1kHz.

The controller is able to command an uncalibrated spot. The 'uncalibrated' message is displayed as in manual operation, the calibrator frequency remaining as previously set. But in addition, the calibrator generates an SRQ to notify the controller. Code **T0** cancels any earlier spot frequency selection: the calibrator frequency reverts to 1kHz.

**N.B.** The Spot Frequency facility is included to provide separate, ultra-accurately calibrated points in the calibrator output spectrum. Therefore, frequencies set into the 'spot frequency' memories can only be changed during the calibration routine (See Section 8).

**I-code (Aide Memoire)**

This allows the user to identify a specific calibrator with a designator up to 16 characters in length, stored in non-volatile memory. The calibrator must first be placed in the CAL mode by turning the CAL key to ENABLE and sending the W1 command. Sending the I command will store the subsequent 16 character string in memory. This string can be recalled using the X8 command.

N.B. The I command and the W1 command must not be sent in the same string.

**Specification Tolerance - Per Unit (P codes)**

The P commands give access to Spec mode over the bus, also setting the calibration interval:

P0 - 24 hour; P1 - 90 day; P2 - 1 year

On being commanded by a P code, the calibrator calculates the Output Uncertainty of its current state (as a 'per unit' fraction of the output value) and generates an output string formatted by K and L codes. Legends are transmitted as pu (per unit).

**Specification Tolerance - Absolute Limits**

In this case, the U commands cause the calibrator to calculate the high or low absolute limit of uncertainty of its output value against the nominated calibration interval.

- U0 - Low limit 24 hour
- U1 - Low limit 90 day
- U2 - Low limit 1 year
- U3 - High limit 24 hour
- U4 - High limit 90 day
- U5 - High limit 1 year

On being commanded, the calculated value output by the calibrator in an output string formatted by K and L codes.

**Diagnostic Information**

The X commands recall the contents of certain non-volatile calibration memory locations. The values recalled are calibration constants stored the most recent Autocalibration. They are used in the computations which establish the calibrator output level, as corrections for long-term drift in the analog circuitry.

- X0 - Zero Cal. Store
- X1 - Gain Cal. Store in DC, LF gain HF calibration in AC
- X2 - 'STD' calibration gain factor
- X3 - Zero offset
- X4 - Gain error
- X5 - Linearity (not AC)
- X6 - Reference Divider setting
- X7 - Not used
- X8 - Recall message which was memorised earlier by the operator using Code I.
- X9 - Recall Cal Store Selection.

### Activating the Recall Transmission

The calibrator assembles the appropriate output string in its output registers in response to the V, U or X command. The string can subsequently be released onto the bus by addressing the calibrator as a talker.

### String Formatting Commands (K and L codes)

The output string can be formatted and terminated to adapt to user's requirements. Scientific Engineering notation can be programmed, with or without descriptive legends. Two examples are given below.

Codes L0 to L3 configure the output string notation:

- L0 - Scientific notation with legends
- L1 - Scientific notation, no legends
- L2 - Engineering notation with legends
- L3 - Engineering notation, no legends

Two sorts of terminator are available:

One or two bytes can be added to the end of the string. These contain either Carriage Return (Cr) or Line Feed (Lf); or both in the order: Cr followed by Lf.

The EOI bus management line can be programmed to set true simultaneously with the last byte of the string. EOI can be used even if both Cr and Lf are suppressed.

The 4800, 4805 and 4808 calibrators can also be programmed to transmit strings without terminators. To accommodate these variations, the system programmer uses the K codes:

- K0 - No suppression  
(Cr, Lf and EOI all present as terminators)
- K1 - Suppress EOI  
(Terminator Cr followed by Lf)
- K2 - Suppress Lf  
(Terminator Cr with EOI)
- K3 - Suppress Lf and EOI  
(Terminator Cr)
- K4 - Suppress Cr  
(Terminator Lf with EOI)
- K5 - Suppress Cr and EOI  
(Terminator Lf)
- K6 - Suppress Cr and Lf  
(Terminator EOI with last character)
- K7 - Suppress Cr, Lf and EOI  
(No terminators)

**Descriptive Legends**

The following Legends will be fitted into the string after the exponent, if programmed by codes L0 or L2:

Recall	Function	Legend	Meaning
VØ) UØ-U5	F0	V	DC Volts
VØ) UØ-U5	F1	V	AC Volts
VØ) UØ-U5	F2	A	DC Amps
VØ) UØ-U5	F3	A	AC Amps
VØ) UØ-U5	F4	R	Resistance
PØ-P2	Frequency	pu	per unit
		Hz	frequency

**1. Scientific Notation (Codes L0 and L1).**

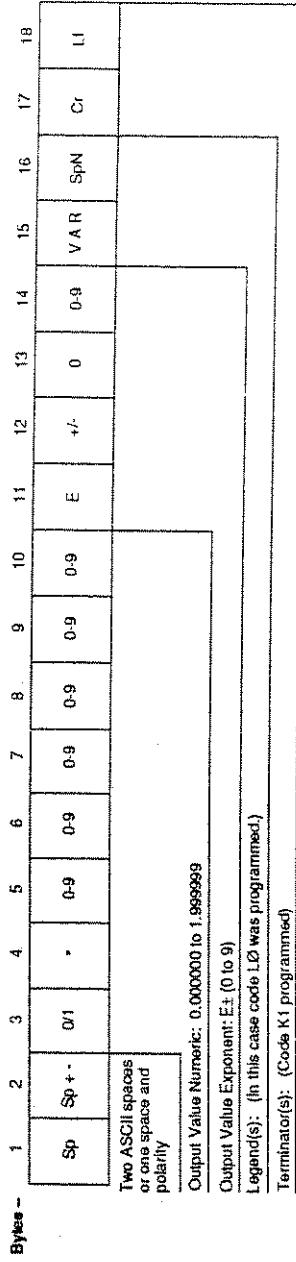

**1. Engineering Notation (Codes L2 and L3).**

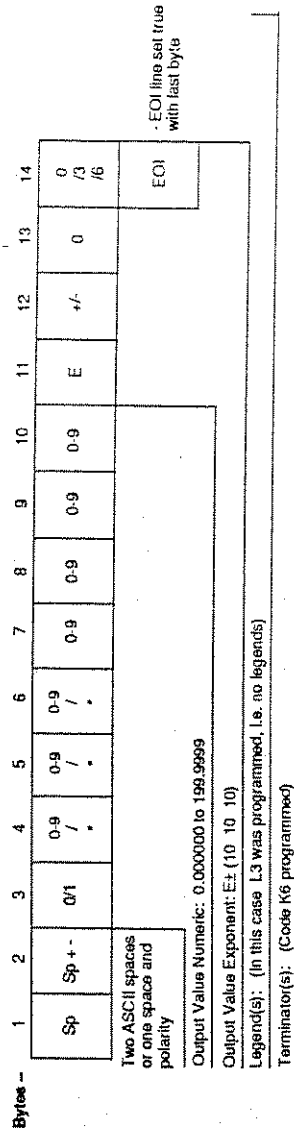

**FIGURE 5-5 OUTPUT STRING FORMATS**

## Service Requests

The 4800, 4805 and 4808 calibrators can asynchronously request service from the controller by putting the SRQ line true (low).

SRQ is always generated by the action of switching the calibrator power ON, as the power-up default mode is Q0.

A user can program the calibrator to generate SRQs (or not) using command code Q:

- Q0 - SRQ on any of the states in *Table 5.5*
- Q1 - SRQ on overload and any FAIL state in *Table 5.5* (but not in Error states).
- Q2 - No SRQs generated

### Serial Poll and RQS Status Byte

If programmed for SRQ response, the bus controller will pause in its operation to attend to the service request. It first conducts a serial or parallel poll to determine which device initiated the SRQ. The calibrator does not react to parallel poll, but only to serial poll, during which each device is addressed in turn. The instrument responds to its serial poll address by releasing a prepared 'RQS Status Byte' onto the bus. The RQS Request Bit (bit B7 of its status byte) is asserted only if the calibrator has generated the SRQ. This validates the remainder of the byte, which describes the causal condition by the state codes listed in *Table 5.5*.

### RQS Status Byte Composition

- bit b8: Indicates a syntax or option error when true.
- bit b7: The RQS request bit, when true, confirms that the calibrator was the SRQ originator. The RQS status byte is not valid unless bit b7 is true.
- bit b6 true: Each combination of bits b5-b1 represents a single state as listed in *Table 5.5*.
- bit b6 false: Bits b5-b1 each represent separate functional states within the calibrator and the RQS byte represents several states as listed in *Table 5.5*.

### Example with bit 'b6' false:

RQS status byte 01000001 represents:

- 0 - No option or Syntax error
- 1 - This instrument originated the SRQ
- 0 - The following bits each represent separate states
- 0 - This bit is not used in the calibrator
- 0 - No High Voltage warning
- 0 - Auxiliary register not at limit
- 0 - Main register not at limit
- 1 - Output is ON

The RQS Status Byte should not be confused with other status messages (e.g. 'calibrator' or 'software' status, described earlier under 'Recall/Verify') which are called up by the system controller's program.

TABLE 5.5 STATUS BYTE CODING

This table lists the possible RQS Status Bytes which the 4800, 4805 and 4808 calibrators can generate. Note that the information in the byte is valid only if bit 7 (request bit) is true.

Bits	b8	b7	b6	b5	b4	b3	b2	b1	
<b>Combination Status Messages</b>									
X	1	0	X	X	X	X	X	1	Output ON
X	1	0	X	X	X	X	1	X	Main Register limit reached
X	1	0	X	X	X	1	X	X	Auxiliary Register limit reached
X	1	0	X	X	X	1	X	X	High Voltage Warning
X	1	0	X	1	1	X	X	X	
<b>Individual Status Messages</b>									
X	1	1	0	0	0	0	0	0	Recall message available
X	1	1	0	0	0	0	0	1	Error 1 Specification not displayable
X	1	1	0	0	0	0	1	0	Error 2 CAL mode: Output not ON
X	1	1	0	0	0	0	1	1	Error 3 CAL mode: Incorrect Range/Function
X	1	1	0	0	0	1	0	0	Error 4 CAL mode: Insufficient store span
X	1	1	0	0	0	1	0	1	Error 5 Error or Offset mode: Overscale output requested
X	1	1	0	0	0	1	1	0	Error 6 CAL mode: Resistance selected exceeds cal. limits
X	1	1	0	0	0	1	1	1	Error 7 AC Functions: Output has been limited by internal frequency constraints
X	1	1	0	0	1	0	0	0	Error 8 General selection error
X	1	1	0	1	0	0	0	1	Error 9 Option not fitted
X	1	1	1	0	0	0	0	0	Fail 0 Fault condition rectified
X	1	1	1	0	0	0	0	1	Fail 1 Over-temperature
X	1	1	1	1	0	0	0	0	Fail 2 Over-voltage
X	1	1	1	1	0	0	1	0	Fail 3 Control data corrupted
X	1	1	1	1	0	1	1	1	Fail 4 Precision divider fault
X	1	1	1	1	0	1	0	0	Fail 5 Safety alarm
X	1	1	1	1	0	1	1	0	Fail 6 Cal. store sum check non-parity
X	1	1	1	1	0	1	1	1	Fail 7 400V power supply fault (automatically resets if temporary)
X	1	1	1	1	1	0	0	0	Fail 8 38V power supply fault
X	1	1	1	1	1	0	0	1	Fail 9 15V In-guard power supply fault
X	1	1	1	1	1	0	1	0	Fail 10 Model 4600 communication fault
X	1	1	1	1	1	1	0	0	Reset - Instrument reset to power-up state
X	1	1	1	1	1	1	0	1	Error EE External frequency not present
X	1	1	1	1	1	1	1	0	Spot Frequency not calibrated
X	1	1	1	1	1	1	1	1	Overload - Current or Voltage Limit
X	1	1	1	1	1	1	1	1	Power-on

Notes:

- (1) Power-up condition: D0 F0 G0 K0 L0 M0 O0 Q0 R0(UV) S0 T0 W0 Device clear condition as power-up but K = and L = continue unchanged
- (2) Program string terminator: "-" activates preceding string.

Key:

- 1 = True
- 0 = False
- X = True or False (1 or 0)

**Fail Messages**

The calibrator needs to react quickly to internally-generated FAIL messages and is programmed to take rapid protective action. A fault condition may generate a train of such internal messages, which occur too quickly for some controllers to detect.

Such a train may be terminated by a FAIL 5 message, which is detected by the controller. Thus the receipt of FAIL 5 by a controller should be taken as a final default condition, and not as indicating the origin of the fault. The FAIL 5 message can be cleared, if the calibrator has recovered, by pressing the Reset key on the instrument front panel. As FAIL 5 is related to safety, it cannot be reset by remote control.

**DIO Line Transmissions**

Providing Q0 or Q1 has been selected, when the calibrator has a message to transmit over the DIO lines, it sets the SRQ line true and prepares the 'Recall' RQS Status Byte (x1100000) ready for the subsequent serial poll. On receiving the status byte, the controller can address any device required to receive the data as a listener, and address the calibrator as a talker. Then the message is sent via DIO lines to the programmed listener(s).

## Activation of Commands

### Use of Terminator

The calibrator activates single or multiple commands only on receipt of the recognised terminator. This is either the ASCII character '=' or EOI coincident with the Lf character.

Commands or command strings may be received while the instrument is in Local control, but will not be activated even if a terminator is present, until the instrument is set to Remote control. The two 'Clear' messages (DCL and SDC) will be activated even when in Local control.

## Multiple Commands

### Activation Sequence

The input buffer has a capacity of 128 characters. Commands in a multiple string may be entered in any order, provided correct character syntax is observed. They are extracted from the buffer in received sequence and stored by alpha character into command stores. Any existing commands in the store are over-written and lost.

When a string terminator is received, the commands in the store are validated. Validation ensures that the proposed instrument state (consisting of those changes programmed and those current states not reprogrammed) is valid. Any

error results in the string being ignored and a syntax error generated.

New commands are executed in this sequence:

- K Output terminator format
- L Output notation
- Q SRQ Mode
- W Remote Calibration Enable
- I User Message Input
- OØ OUTPUT OFF
- G Guard
- D Safety Delay override
- F Function
- R Range
- M Main Register Value (Output)
- A Full Range/Zero
- S Sense
- H Auxiliary Register Value (Frequency)
- T Spot Frequency
- OI OUTPUT ON
- C Calibrate Mode
- P Specification tolerance
- U Specification limits
- V Recall/Verify
- X Diagnostic information

A programmer may elect to change the sequence by inserting terminators between commands, but the basic constraints of the calibrator will still be imposed. For example, if the function is changed as a single command (e.g. F3=) the main program firmware will set OUTPUT OFF as a result, and it must then be re-programmed ON by the user.



### Successions of Multiple Commands

If the input buffer is not full, new commands are accepted to await their turn for processing, and are extracted string by string. The input system design makes it extremely unlikely that the buffer will overflow, unless the calibrator is in Local Control and the command input is excessive. If this does cause the buffer to fill up, the calibrator places a hold on the IEEE bus handshake sequence. The command **IFC** can be used to release the hold, followed by **DCL** to clear the calibrator input buffer; but as a general principle, this situation should be avoided by suitable reprogramming.

### Input Errors

Some unwanted commands are ignored. Others enter the input buffer and are rejected later.

### Read Commands

Before addressing the calibrator as a talker, it is essential that it has been programmed by a **P**, **U**, **V** or **X** command. Otherwise it will have no data to transmit.

## Universal Commands

- LLO** (Local Lockout) - ignored, no capability.
- PPU** (Parallel Poll Unconfigure) - ignore no capability for parallel poll.
- SPE** (Serial Poll Enable) - sets the calibrator to serial poll state, which when addressed responds with the F Status Byte. This byte contains condition of the request service (bit 7). If the calibrator is request service; bit 7 will be true, the 0 bits describing the service required.
- SPD** (Serial Poll Disable) - returns the instrument to Serial Poll Idle state.

## Addressed Commands

- PPC** (Parallel Poll Configure) - ignore no capability.
- GET** (Group Execute Trigger) - ignore no capability.
- TCT** (Take Control) - ignored, no capability.
- GTL** (Go To Local) - instrument returns Manual Control. The controller gains remote control by addressing the calibrator as a listener with F line true.

## ear Commands (DCL and SDC)

When the calibrator receives either of the two 'ear' messages, (DCL is universal and SDC is addressed to a selected device) it will default to a predetermined state defined below. During the time taken to default, the IEEE interface handshake is held. These commands are effective even in 'Local' control.

A?	Not Active (see M code)
FØ	DC Volts
RØ	Autorange 1V default
MØ	Where value is zero
TØ	Cancel Spot Frequency
H (value)	Where value is 1kHz
GØ	Local guard
SØ	Local sense
OØ	OUTPUT OFF state
QØ	SRQ on all specified states
DØ	Safety delay active
WØ	Calibration disabled
C?	Not active - disabled by WØ
P?	Not active
U?	Not active
V?	Not active
X?	Not active
K*	Unchanged
L*	Unchanged

Frequency values held in 'Store' volatile memory locations F1-F5 are reset to the default value described on page 3-20.

## Operational Sequence Guidelines

Most interface communication tasks require sequences of coded messages to be sent over the interface. Many controllers assign a single programming instruction to a complete sequence, so it is advisable to study the available controller capabilities carefully before attempting to program a system. Because the IEEE Std 488 (1978) allows a certain latitude in bus protocol, considerable differences may be found between programming instructions and operating sequences from one make of controller to another. Consequently, the following sequences are recommendations only.

### Data Transfer

UNL	Inhibits all current listeners
LAD <sub>1</sub>	Each address sent enables a specific device to receive future data bytes.
:	
:	
LAD <sub>n</sub>	More than one address may be sent if multiple listeners desired.
TAD	The address sent enables a specific device to send data. The calibrator must be already programmed to prepare data.
DAB <sub>1</sub>	Data bytes sent by currently-enabled talkers to all currently enabled listeners.
:	
:	
DAB <sub>n</sub>	
UNT	Disables the talker on receipt of the last character.

### Serial Poll

UNL	Inhibits all current listener
SPE	Puts interface into serial poll mode during which all devices send status instead data when addressed.
TAD <sub>n</sub>	Enables a specific device send status. Within this loc device should be sequential enabled.
SBN or SBA	Status Byte sent by enable device:- - If SBN, loop should be repeated. - If SBA sent, enabled device is identified as having sent the SRQ and automatically removes it
SPD	Disables Serial Poll Mode
UNT	Disable last talker

### Untalk

It is recommended that any sequence which addresses a device as a talker should be terminated by an 'untalk' command.

#### Key:

UNL	=	unlisten
LAD	=	listen address of specific device
TAD	=	talk address of specific device
DAB	=	data bytes
UNT	=	untalk
SPE	=	Serial poll enable
SPD	=	Serial poll disable
SBN	=	Status byte negative where bit 7 = 0
SBA	=	Status byte affirmative where bit 7 =



# SECTION 6.1 4800 SPECIFICATIONS

## General

### Power Supply

Voltage (single phase)	: 100V/120V/220V/240V selectable from rear panel
Line Frequency	: 48Hz to 62Hz
Consumption	: 370VA normal 660VA full power
Fuses 220/240V	: 3.15A
100/120V	: 6.25A

### Mechanical

Dimensions	: Height: 178mm (7 inches) Width: 455mm (17.9 inches) Depth: 563mm (22.2 inches)
Weight	: 36kg (80lbs)

<b>SAFETY</b>	: Designed to UL1244, IEC348, IEC1010, BS4743
---------------	--

### Peak Terminal Voltages

Guard to Ground	: 920V
Lo to Guard	: 920V
Lo to Ground	: 920V
Hi to Guard	: 1556V
Hi to Ground	: 1556V

### Rear Panel Digital Inputs:

to Hi	: 1556V
to Lo	: 920V
to Guard	: 920V
to Ground	: 0V to +5V

N.B.

Digital Common is internally connected to Ground

### Environmental Conditions

Operating Temperature	: 0°C to 50°C
-----------------------	---------------

### Caution

Above 30°C on 1kV Range max output power is der

Storage Temperature	: -40°C to +70°C
Max. Relative Humidity	: 75% at 40°C, non-condensing
Warm-up Time	: Two hours to meet specifications

### Operating Indications

Indication	: Symbols lit on displ and illuminated key:
------------	--

### Scale Lengths

Output Display	: 7.5 digits maximum
Frequency Display	: 3 digits plus store location
Mode Display	: 7.5 digits maximum

### Option Summary

Option 10 : DCV function to 200V.

Option 20 : ACV function to 200V.

Option 30 : Integral 1000V Amplifier for:  
DCV (requires Option 10); or  
ACV (requires Option 20); or both.

Option 40 : Current Converter for:  
DCI (requires Option 10); or  
ACI (requires Option 20); or both.

Option 50 : Resistance function.

Option 60 : Current Range Extender to 11A for:  
DCI (requires Options 10 & 40); or  
ACI (requires Option 20 & 40); or both.  
Includes Model 4600 Transconductanc  
Amplifier and all necessary cabling.

Option 90 : Rack Mount Kit.

## **Accuracy Specifications**

### **Absolute Uncertainty**

Calculate the absolute uncertainty in a measurement made with a factory-calibrated 4800, using the 4800 'Performance Relative to Calibration Standards' with the relevant 'Calibration Uncertainty'.

When different calibration standards are used, simply substitute their uncertainties in place of the column headed 'Calibration Uncertainty' and combine them with the 4800 'Performance Relative to Calibration Standards'.

## DCV Accuracy Specifications

Option 10 - DC Voltage (Requires Option 30 for 1000V Range)

Voltage Range	Accuracy Relative to Calibration Standards $\pm$ (ppm OUTPUT + ppmFS) [1]			Calibration Uncertainty ( $\pm$ ppm Output)	Temperature Coefficient ( $\pm$ ppm/ $^{\circ}$ C)
	24 Hours Stability [2]	90 Days Tcert [3] $\pm$ 1 $^{\circ}$ C	1 Year Tcert [3] $\pm$ 5 $^{\circ}$ C		
100 $\mu$ V	1.2 + 0.6 $\mu$ V	5 + 1 $\mu$ V	10 + 1 $\mu$ V	4	2
1mV	1.2 + 0.6 $\mu$ V	5 + 1 $\mu$ V	10 + 1 $\mu$ V	4	2
10mV	1.2 + 0.6 $\mu$ V	5 + 1 $\mu$ V	10 + 1 $\mu$ V	4	2
100mV	1.2 + 0.6 $\mu$ V	5 + 1 $\mu$ V	10 + 1 $\mu$ V	4	2
1V	1 + 0.5	4 + 1	8 + 1	2	1
10V	0.6 + 0.1	3 + 0.5	6.5 + 0.5	1.5	0.5
100V	1 + 0.3	4 + 1	8 + 1	2	1
1000V	1 + 0.3	5 + 1	10 + 1	2	1

### Other DCV Specifications

Scale Length	100 $\mu$ V to 100V ranges: 0 to $\pm$ 200% of nominal range 1000V range: 0 to $\pm$ 110% of nominal range
Settling Time	<1second to 10ppm of step size
Setting Resolution	0.1ppm or 10nV
Maximum Load	1V to 1000V ranges: 25mA 100 $\mu$ V to 100mV ranges: Output impedance 100 $\Omega$

NOTES: [1] FS = 2 x Nominal Range Value (e.g. 20V on 10V range).

[2] For same conditions between 18 $^{\circ}$ C and 28 $^{\circ}$ C.

[3] Tcert = temperature at certification. Factory certification temperature = 23 $^{\circ}$ C

## ACV Accuracy Specifications

### General ACV Specifications

Scale Length	1mV to 100V ranges: 9% to 200% of nominal range 1000V range: 9% to 110% of nominal range
Settling Time	To 10ppm of step size: 10Hz to 32Hz: <10 seconds 33Hz to 330Hz: <3 seconds >330Hz: <1 second Range change: Double the above times
Setting Resolution	1ppm or 100nV
Frequency Accuracy	$\pm 100$ ppm for life
Maximum Resistive Load	100 $\mu$ V to 100mV ranges: Output impedance 30 $\Omega$ 1V range: 50mA rms 10V range: 60mA rms 100V range: 120mA rms 1000V range; <3kHz: 15mA rms 1000V range; >3kHz: 65mA rms
Maximum Capacitive Load	1V to 100V ranges: 1000pF 1000V range: 300pF

- NOTES: [1] FS = 2 x Nominal Range Value (e.g. 20V on 10V range).  
 [2] For same conditions between 18°C and 28°C.  
 [3] Tcert = temperature at certification. Factory certification temperature = 23°C  
 [4] Valid over load range: 0-50mA rms. Above 50mA add:  $\frac{F(\text{kHz}) \times [I(\text{mA}) - 50]}{150}$  ppmFS  
 [5] Figures indicate pure THD only, excluding noise, which is included in the main specification. THD is predominantly second harmonic (negligible error on mean-sensing equipment).



Option 20 - AC Voltage (Requires Option 30 for 1000V Range)

Voltage Range	Frequency (Hz)	Accuracy Relative to Calibration Standards ± (ppm OUTPUT + ppmFS)[1]			Calibration Uncertainty (±ppm Output)	Temperature Coefficient (±ppm/°C)	Total Harmonic Distortion (%) [5]	
		24 Hour Stability[2]	90 day Tcert[3] ± 1°C	1 Year Tcert[3] ± 5°C				
1mV-100mV	10 - 31	120 + 10 + 7µV	250 + 30 + 7µV	340 + 30 + 7µV	30 + 1µV	10	0.1	
	32 - 330	60 + 10 + 7µV	200 + 30 + 7µV	220 + 30 + 7µV	30 + 1µV	5	0.04	
	300 - 10k	60 + 10 + 5µV	150 + 20 + 5µV	170 + 20 + 5µV	30 + 1µV	5	0.04	
	10k - 33k	60 + 10 + 7µV	160 + 30 + 7µV	180 + 30 + 7µV	170 + 1µV	5	0.04	
	30k - 100k	60 + 10 + 9µV	480 + 40 + 9µV	550 + 40 + 9µV	350 + 1µV	10	0.1	
	100k - 330k	160 + 20 + 20µV	0.12% + 100 + 20µV	0.15% + 100 + 20µV	450 + 1µV	20	0.3	
	300k - 1M	260 + 20 + 20µV	0.23% + 0.1% + 20µV	0.3% + 0.1% + 20µV	450 + 1µV	50	1.0	
	1V	10 - 31	80 + 20	210 + 50	230 + 50	20	5	0.1
		32 - 330	40 + 10	140 + 30	160 + 30	20	5	0.04
		300 - 33k	40 + 10	80 + 20	90 + 20	20	3	0.04
30k - 100k		40 + 10	130 + 20	150 + 20	50	5	0.1	
100k - 330k		100 + 20	320 + 60	400 + 60	100	15	0.3	
300k - 1M		240 + 20	0.2% + 500	0.27% + 500	300	100	1.0	
10V		10 - 31	80 + 20	210 + 50	230 + 50	20	5	0.1
		32 - 330	40 + 10	140 + 30	160 + 30	20	5	0.04
		300 - 33k	40 + 10	80 + 20	90 + 20	20	3	0.04
		30k - 100k	40 + 10	130 + 20	150 + 20	50	5	0.1
	100k - 330k	100 + 20	320 + 60	400 + 60	100	15	0.3	
	300k - 1M	240 + 20	0.2% + 500	0.27% + 500	300	100	1.0	
	100V	10 - 31	80 + 20	210 + 50	230 + 50	20	5	0.1
		32 - 330	40 + 10	140 + 30	160 + 30	20	5	0.04
		300 - 10k	40 + 10	80 + 20	90 + 20	20	3	0.04
		10k - 33k	40 + 10	80 + 20	90 + 20	20	3	0.04
30k - 100k		40 + 10	250 + 40	300 + 40	50	10	0.2	
1000V		10 - 330	100 + 20	210 + 30	220 + 30	30	5	0.2
		300 - 3.3k	60 + 20	160 + 20	180 + 20	30	5	0.1
		3k - 10k	60 + 20	160 + 20	180 + 20	30	5	0.1
		10k - 33k	100 + 30	200 + 20	210 + 20	50	5	0.1

NOTES: [1] FS = 2 x Nominal Range Value (e.g. 20V on 10V range).

[2] For same conditions between 18°C and 28°C.

[3] Tcert = temperature at certification. Factory certification temperature = 23°C

[5] Figures indicate pure THD only, excluding noise, which is included in the main specification. THD is predominantly second harmonic (negligible error on mean-sensing equipment)

ACV Accuracy Specifications (Contd.)

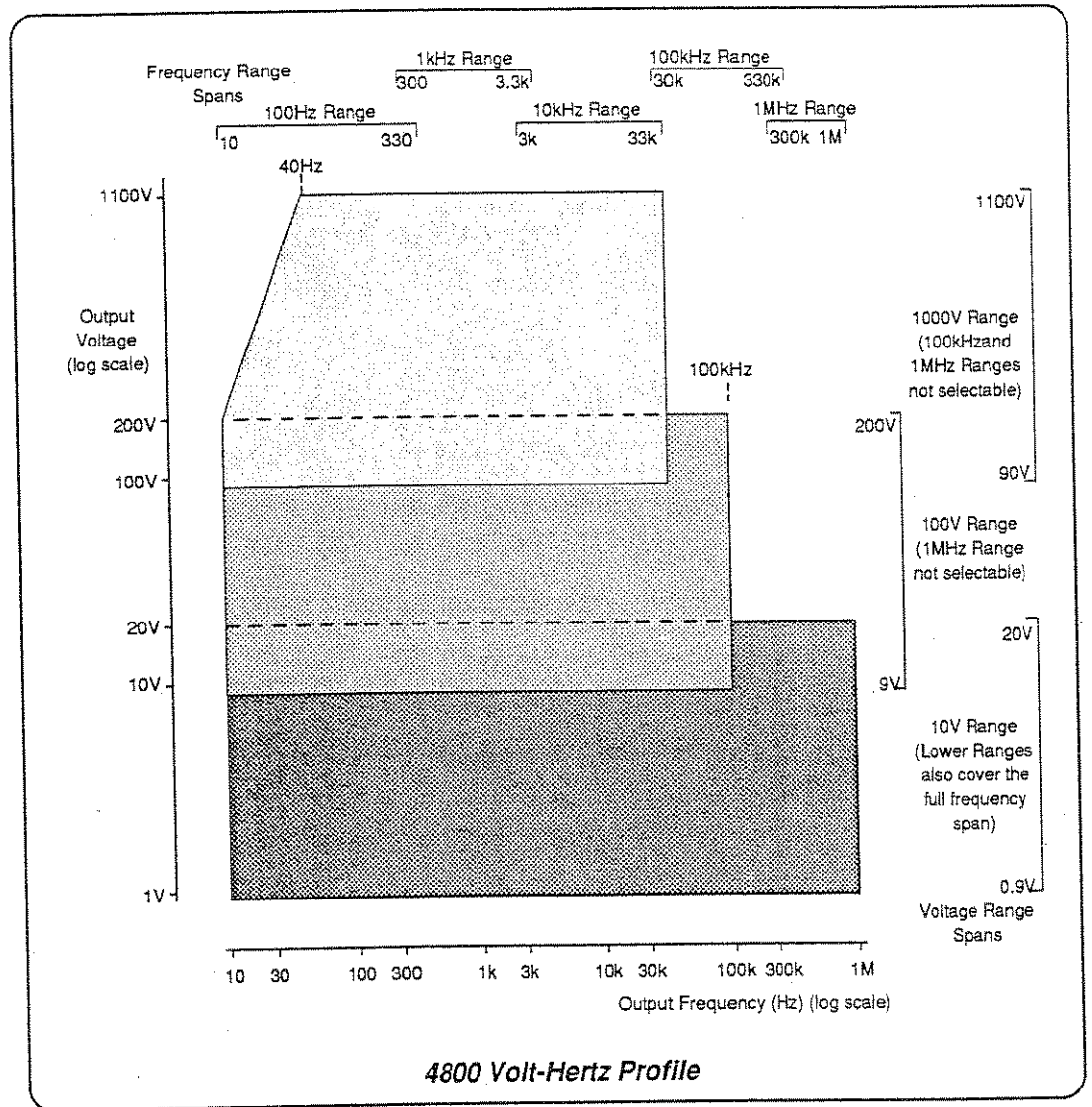

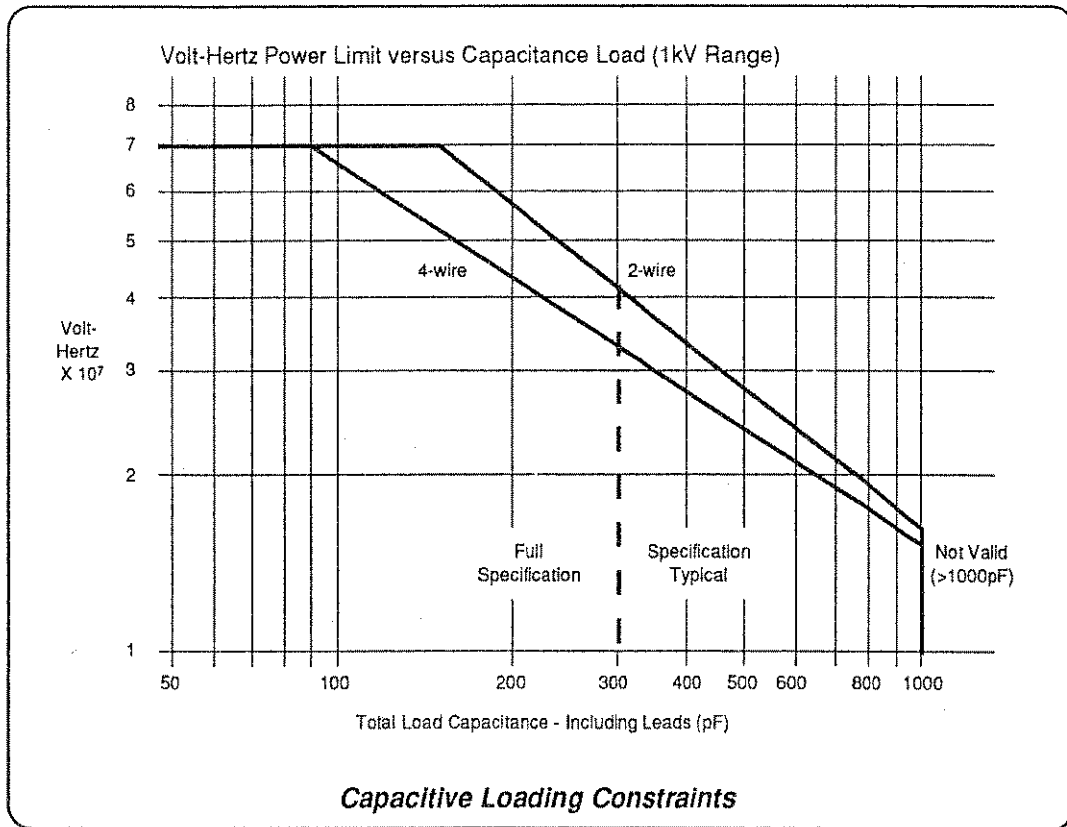

Section 6.1 - 4800 Specifications

### DCI and ACI Accuracy Specifications

Option 40 with Option 10 - DC Current (Requires Option 60 for 10A Range)

Current Range	Accuracy Relative to Calibration Standards ± (ppm OUTPUT + ppmFS) [1]			Calibration Uncertainty (±ppm Output)	Temperature Coefficient (±ppm/°C)
	24 Hours Stability [2]	90 Days Tcert [3] ± 1°C	1 Year Tcert [3] ± 5°C		
100µA	7 + 10	50 + 10	100 + 10	10	20
1mA	7 + 5	35 + 10	65 + 10	10	10
10mA	7 + 5	35 + 10	65 + 10	10	10
100mA	7 + 5	35 + 10	65 + 10	10	10
1A	15 + 10	60 + 15	125 + 15	25	20
10A	15 + 10	70 + 25	160 + 25	30	20

#### Other DCI Specifications

Scale Length	100µA to 1A ranges: 0 to ±200% of nominal range 10A range: 0 to ±100% of nominal range
Settling Time	100µA to 1A ranges: <1second to full specification 10A range: <1second to 40ppm of step size
Setting Resolution	1ppm
Compliance Voltage	100µA to 1A ranges: 3V 10A range: 2V

NOTES: [1] FS = 2 x Nominal Range Value (e.g. 20mA on 10mA range).

[2] For same conditions between 18°C and 28°C.

[3] Tcert = temperature at certification. Factory certification temperature = 23°C

## Resistance Accuracy Specifications

### Option 50 - Resistance

Resistor Nominal Value	4-Wire Accuracy Relative to Calibration Standards ± (ppm OUTPUT + ppmFS) [1]			Calibration Uncertainty (±ppm Output)	Temperature Coefficient (±ppm/°C)
	24 Hours Stability [2]	90 Days Tcert [3] ± 1°C	1 Year Tcert [3] ± 5°C		
10Ω	6	15	35	10	6
100Ω	2.5	6	15	5	2
1kΩ	2.5	6	15	5	2
10kΩ	2.5	6	15	4	2
100kΩ	2.5	7	19	6	2
1MΩ	6	16	38	12	6
10MΩ	15	40	78	17	10
100MΩ	30	80	150	50	20

Resistor Nominal Value	2-Wire Accuracy Relative to 4-Wire Accuracy		
	24 Hours Stability [2]	90 Days Tcert [3] ± 1°C	1 Year Tcert [3] ± 5°C
10Ω	±5mΩ	±5mΩ	±10mΩ
100Ω	±10mΩ	±10mΩ	±20mΩ
1kΩ to 100MΩ	±100mΩ	±100mΩ	±200mΩ

### Other Resistance Specifications

Display Resolution	0.1ppm
Connections	Programmable 2-wire/4-wire sense Programmable remote/local guard
Fuse Protection	To 120V rms

NOTES: [1] FS = 2 x Nominal Range Value (e.g. 20Ω for 10Ω resistor).

[2] For same conditions between 18°C and 28°C.

[3] Tcert = temperature at certification. Factory certification temperature = 23°C.

### ACI Accuracy Specifications

Option 40 with Option 20 - AC Current (Requires Option 60 for 10A Range)

Current Range	Frequency (Hz)	Accuracy Relative to Calibration Standards ± (ppm OUTPUT + ppmFS) <sup>[1]</sup>			Calibration Uncertainty (±ppm Output)	Temperature Coefficient (±ppm/°C)	Total Harmonic Distortion (%) <sup>[5]</sup>
		24 Hour Stability <sup>[2]</sup>	90 day T <sub>cert</sub> <sup>[3]</sup> ± 1°C	1 Year T <sub>cert</sub> <sup>[3]</sup> ± 5°C			
100µA	10 - 1k 1k - 5k	50 + 20 70 + 30	120 + 30 250 + 40	150 + 50 300 + 70	100 100	10 20	0.2 0.5
1mA-100mA	10 - 1k 1k - 5k	30 + 10 40 + 10	70 + 30 120 + 30	100 + 50 200 + 50	100 100	10 10	0.2 0.2
1A	10 - 1k 1k - 5k	50 + 20 70 + 30	250 + 30 400 + 40	300 + 50 450 + 70	100 100	20 25	0.2 0.2
10A	10 - 1k 1k - 5k 5k - 10k 10k - 20k	40 + 20 75 + 30 400 + 60 0.2% + 150	300 + 100 750 + 100 0.15% + 300 0.55% + 0.16%	400 + 100 900 + 100 0.22% + 300 0.72% + 0.16%	110 110 130 250	13 13 28 50	0.2 0.2 0.2 1.0

### Other ACI Specifications

Scale Length	100µA to 1A ranges: 10A range:	9% to 200% of nominal range 9% to 110% of nominal range
Settling Time	To 10ppm of step size:  Range change:	10Hz to 32Hz: <10 seconds 33Hz to 330Hz: <3 seconds >330Hz: <1 second  Double the above times
Setting Resolution	1ppm	<±100ppm for life
Frequency Accuracy	10nF, 1mH (time constant <1µs)	
Maximum Reactive Load	100µA to 1A ranges: 10A range:	3V rms 2V rms
Compliance Voltage		

NOTES: [1] FS = 2 x Nominal Range Value (e.g. 20mA on 10mA range).

[2] For same conditions between 18°C and 28°C.

[3] T<sub>cert</sub> = temperature at certification. Factory certification temperature = 23°C

[5] Predominantly second harmonic (negligible error on mean-sensing equipment)

# SECTION 6.2 4805 SPECIFICATIONS

## General

### Power Supply

Voltage (single phase)	: 100V/120V/220V/240V selectable from rear panel
Line Frequency	: 48Hz to 62Hz
Consumption	: 370VA normal 660VA full power
Fuses 220/240V	: 3.15A
100/120V	: 6.25A

### Mechanical

Dimensions	: Height: 178mm (7 inches) Width: 455mm (17.9 inches) Depth: 563mm (22.2 inches)
Weight	: 36kg (80lbs)

<b>SAFETY</b>	: Designed to UL1244, IEC348, IEC1010, BS4743
---------------	--

### Peak Terminal Voltages

Guard to Ground	: 920V
Lo to Guard	: 920V
Lo to Ground	: 920V
Hi to Guard	: 1556V
Hi to Ground	: 1556V

### Rear Panel Digital Inputs:

to Hi	: 1556V
to Lo	: 920V
to Guard	: 920V
to Ground	: 0V to +5V

N.B.

Digital Common is internally connected to Ground

### Environmental Conditions

Operating Temperature	: 0°C to 50°C
-----------------------	---------------

### Caution

Above 30°C on 1kV Range max output power is derated

Storage Temperature	: -40°C to +70°C
Max. Relative Humidity	: 75% at 40°C, non-condensing
Warm-up Time	: Two hours to meet all specifications

### Operating Indications

Indication	: Symbols lit on displays and illuminated keys
------------	---

### Scale Lengths

Output Display	: 6.5 digits maximum
Frequency Display	: 3 digits plus store location
Mode Display	: 6.5 digits maximum

### Standard Functions

DC Voltage: 100 $\mu$ V to 1100V.

AC Voltage: 1mV to 1100V; 10Hz to 100kHz.

DC Current: 100 $\mu$ A to 1.1A.

AC Current: 100 $\mu$ A to 1.1A; 10Hz to 5kHz.

Resistance: Decade Values: 10 $\Omega$  to 100M $\Omega$ .

### Option Summary

Option 60 : Current Range Extender to 11A for DCI and ACI.  
(ACI from 10Hz to 20kHz on 10A range).  
Includes Model 4600 Transconductance Amplifier and all necessary cabling.

Option 90 : Rack Mount Kit.

## **Accuracy Specifications**

### **Absolute Uncertainty**

To calculate the absolute uncertainty in a measurement made with a factory-calibrated 4805, combine the 4805 'Performance Relative to Calibration Standards' with the relevant 'Calibration Uncertainty'.

When different calibration standards are used, simply substitute their uncertainties in place of the column headed 'Calibration Uncertainty' and combine them with the 4805 'Performance Relative to Calibration Standards'.



## DCV Accuracy Specifications

### DC Voltage

Voltage Range	Accuracy Relative to Calibration Standards ± (ppm OUTPUT + ppmFS) (1)			Calibration Uncertainty (±ppm Output)	Temperature Coefficient (±ppm/°C)
	24 Hours Stability (2)	90 Days Tcert (3) ± 1°C	1 Year Tcert (3) ± 5°C		
100µV	2 + 1µV	15 + 1µV	35 + 5µV	9 + 1µV	2
1mV	2 + 1µV	15 + 1µV	35 + 5µV	9 + 1µV	2
10mV	2 + 1µV	15 + 1µV	35 + 5µV	9 + 1µV	2
100mV	2 + 1µV	15 + 1µV	35 + 5µV	9 + 1µV	2
1V	2 + 0.5	15 + 1	35 + 5	6	1.5
10V	1 + 0.5	15 + 1	35 + 5	4.5	1
100V	2 + 0.5	15 + 1	35 + 5	7	1.5
1000V	2 + 0.5	15 + 1	35 + 5	10	2

### Other DCV Specifications

Scale Length	100µV to 100V ranges: 0 to ±200% of nominal range 1000V range: 0 to ±110% of nominal range
Settling Time	<1second to 10ppm of step size
Setting Resolution	1ppm or 100nV
Maximum Load	1V to 1000V ranges: 25mA 100µV to 100mV ranges: Output impedance 100Ω

- NOTES:** [1] FS = 2 x Nominal Range Value (e.g. 20V on 10V range).  
 [2] For same conditions between 18°C and 28°C.  
 [3] Tcert = temperature at certification. Factory certification temperature = 23°C

## ACV Accuracy Specifications

### General ACV Specifications

Scale Length	1mV to 100V ranges: 9% to 200% of nominal range 1000V range: 9% to 110% of nominal range
Settling Time	To 10ppm of step size: 10Hz to 32Hz: <10 seconds 33Hz to 330Hz: <3 seconds >330Hz: <1 second Range change: Double the above times
Setting Resolution	1ppm or 100nV
Frequency Accuracy	<±100ppm for life
Maximum Resistive Load	100µV to 100mV ranges: Output impedance 30Ω 1V range: 50mA rms 10V range: 60mA rms 100V range: 120mA rms 1000V range; <3kHz: 15mA rms 1000V range; >3kHz: 65mA rms
Maximum Capacitive Load	1V to 100V ranges: 1000pF 1000V range: 300pF

NOTES: [1] FS = 2 x Nominal Range Value (e.g. 20V on 10V range).

[2] For same conditions between 18°C and 28°C.

[3] Tcert = temperature at certification. Factory certification temperature = 23°C

[5] Figures indicate pure THD only, excluding noise, which is included in the main specification. THD is predominantly second harmonic (negligible error on mean-sensing equipment).

AC Voltage

Voltage Range	Frequency (Hz)	Accuracy Relative to Calibration Standards ± (ppm OUTPUT + ppmFS) <sup>[1]</sup>			Calibration Uncertainty (±ppm Output)	Temperature Coefficient (±ppm/°C)	Total Harmonic Distortion (%) [5]
		24 Hour Stability <sup>[2]</sup>	90 day T <sub>cert</sub> <sup>[3]</sup> ± 1°C	1 Year T <sub>cert</sub> <sup>[3]</sup> ± 5°C			
1mV-100mV	10 - 31	170 + 10 + 10µV	300 + 60 + 10µV	400 + 60 + 10µV	80 + 12µV	10	0.1
	32 - 330	80 + 10 + 10µV	250 + 60 + 10µV	300 + 60 + 10µV	230 + 10µV	10	0.04
	300 - 10k	80 + 10 + 10µV	250 + 60 + 10µV	300 + 60 + 10µV	230 + 10µV	10	0.04
	10k - 33k	80 + 10 + 10µV	250 + 60 + 10µV	300 + 60 + 10µV	230 + 10µV	10	0.04
1V	30k - 100k	80 + 10 + 10µV	800 + 80 + 10µV	0.1% + 80 + 10µV	510 + 11µV	10	0.1
	10 - 31	150 + 20	300 + 60	400 + 60	130	6	0.1
	32 - 330	80 + 10	250 + 50	300 + 50	100	6	0.04
	300 - 33k	80 + 10	250 + 50	300 + 50	100	6	0.04
10V	30k - 100k	80 + 10	300 + 80	500 + 80	140	6	0.1
	10 - 31	150 + 20	300 + 60	400 + 60	130	6	0.1
	32 - 330	80 + 10	250 + 50	300 + 50	110	6	0.04
	300 - 10k	80 + 10	250 + 50	300 + 50	110	6	0.04
100V	10k - 33k	80 + 10	250 + 50	300 + 50	110	6	0.04
	30k - 100k	80 + 10	300 + 80	500 + 80	170	10	0.2
	10 - 31	150 + 20	300 + 60	400 + 60	130	6	0.1
	32 - 330	80 + 10	250 + 50	300 + 50	110	6	0.04
1000V	300 - 10k	80 + 10	250 + 50	300 + 50	110	6	0.04
	10k - 33k	80 + 10	250 + 50	300 + 50	110	6	0.04
	30k - 100k	80 + 10	300 + 80	500 + 80	170	10	0.2
	10 - 330	150 + 20	300 + 60	400 + 60	170	10	0.2
10000V	300 - 3.3k	80 + 10	250 + 50	300 + 50	140	10	0.1
	3k - 10k	80 + 10	250 + 50	300 + 50	140	10	0.1
	10k - 33k	150 + 30	300 + 80	500 + 80	180	10	0.1
	10 - 330	150 + 20	300 + 60	400 + 60	170	10	0.2

NOTES: [1] FS = 2 x Nominal Range Value (e.g. 20V on 10V range).

[2] For same conditions between 18°C and 28°C.

[3] T<sub>cert</sub> = temperature at certification. Factory certification temperature = 23°C

[5] Figures indicate pure THD only, excluding noise, which is included in the main specification.

THD is predominantly second harmonic (negligible error on mean-sensing equipment).

**ACV Accuracy Specifications (Contd.)**

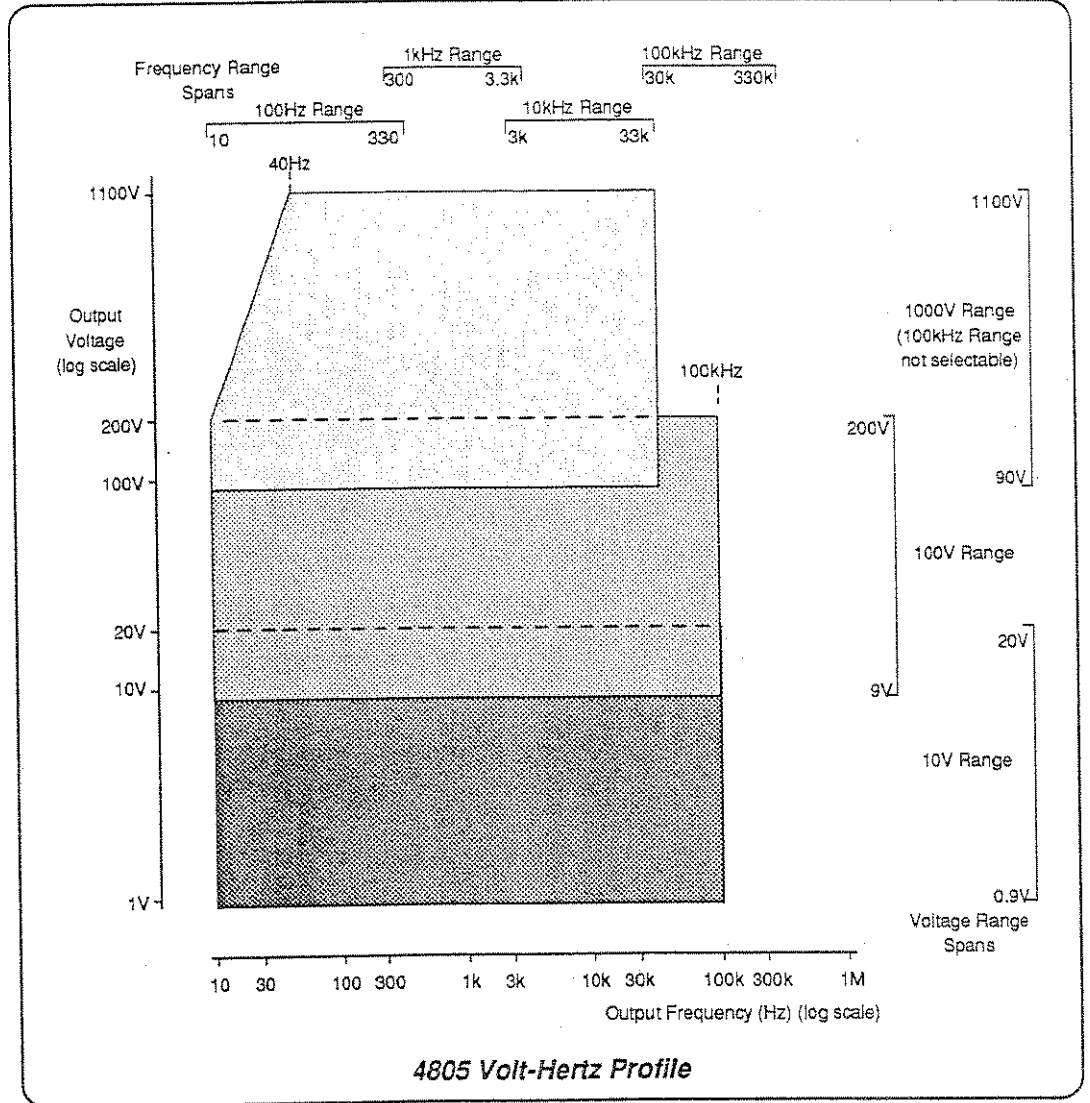

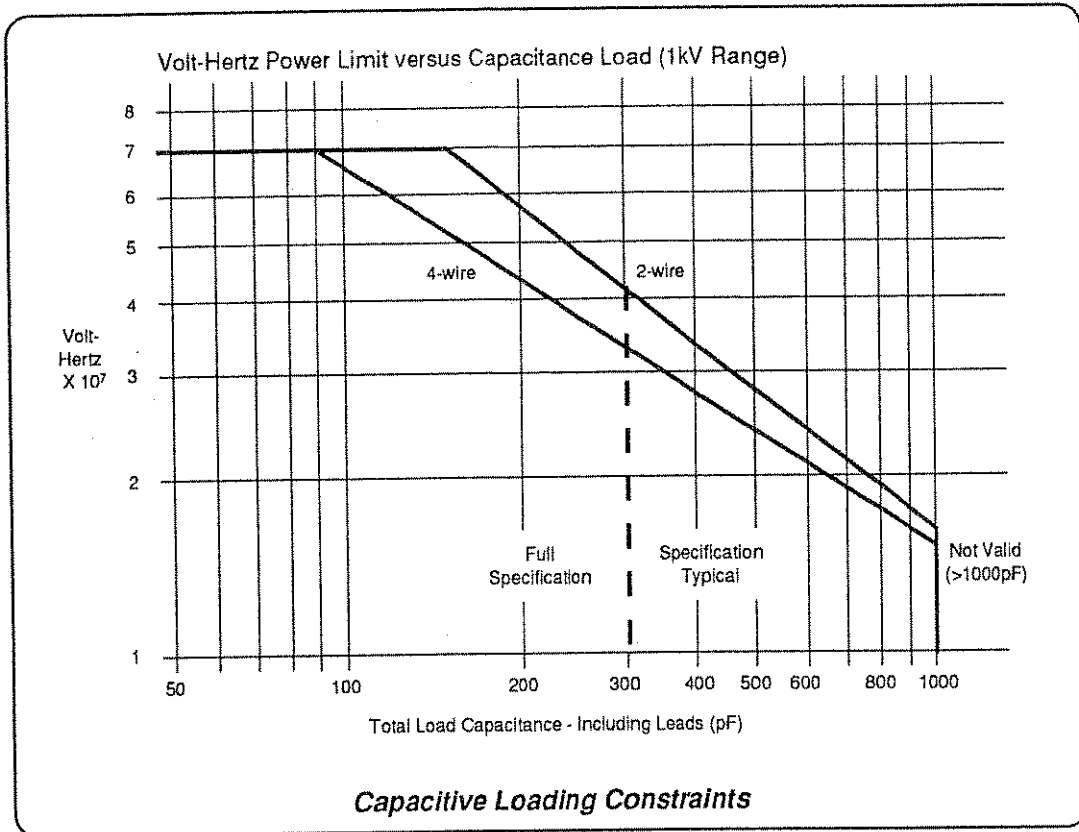

Section 6.2 - 4805 Specifications

### DCI and ACI Accuracy Specifications

DC Current (Requires Option 60 for 10A Range)

Current Range	Accuracy Relative to Calibration Standards ± (ppm OUTPUT + ppmFS) [1]			Calibration Uncertainty (±ppm Output)	Temperature Coefficient (±ppm/°C)
	24 Hours Stability [2]	90 Days Tcert [3] ± 1°C	1 Year Tcert [3] ± 5°C		
100µA	15 + 10	50 + 15	115 + 20	34	30
1mA	15 + 10	50 + 15	115 + 20	32	12
10mA	15 + 10	50 + 15	115 + 20	32	12
100mA	15 + 10	50 + 15	115 + 20	32	12
1A	15 + 15	115 + 20	250 + 30	76	30
10A	30 + 15	150 + 25	300 + 30	100	30

### Other DCI Specifications

Scale Length	100µA to 1A ranges: 0 to ±200% of nominal range 10A range: 0 to ±100% of nominal range
Settling Time	100µA to 1A ranges: <1second to full specification 10A range: <1second to 40ppm of step size
Setting Resolution	10ppm
Compliance Voltage	100µA to 1A ranges: 3V 10A range: 2V

NOTES: [1] FS = 2 x Nominal Range Value (e.g. 20mA on 10mA range).

[2] For same conditions between 18°C and 28°C.

[3] Tcert = temperature at certification. Factory certification temperature = 23°C

### ACI Accuracy Specifications

AC Current (Requires Option 60 for 10A Range)

Current Range	Frequency (Hz)	Accuracy Relative to Calibration Standards ± (ppm OUT/PUT + ppmFS) <sup>[1]</sup>			Calibration Uncertainty (±ppm Output)	Temperature Coefficient (±ppm/°C)	Total Harmonic Distortion (%) <sup>[5]</sup>
		24 Hour Stability <sup>[2]</sup>	90 day T <sub>cert</sub> ± 1°C	1 Year T <sub>cert</sub> ± 5°C			
100µA	10 - 1k	50 + 20	400 + 80	500 + 100	400	20	0.2
	1k - 5k	70 + 30	550 + 100	650 + 150	900	40	0.5
1mA-100mA	10 - 1k	50 + 20	220 + 80	350 + 100	255	20	0.2
	1k - 5k	50 + 20	350 + 80	450 + 100	255	20	0.2
1A	10 - 1k	50 + 20	400 + 80	500 + 100	290	40	0.2
	1k - 5k	70 + 30	550 + 100	650 + 150	440	40	0.2
10A	10 - 1k	60 + 20	500 + 100	600 + 100	300	40	0.2
	1k - 5k	80 + 30	0.1% + 100	0.12% + 100	450	40	0.2
	5k - 10k	500 + 80	0.2% + 300	0.25% + 300	550	70	0.2
	10k - 20k	0.25% + 200	0.6% + 0.2%	1% + 0.2%	700	150	1.0

### Other ACI Specifications

Scale Length	100µA to 1A ranges: 10A range: To 10ppm of step size:	9% to 200% of nominal range 9% to 110% of nominal range 10Hz to 32Hz: <10 seconds 33Hz to 330Hz: <3 seconds >330Hz: <1 second Double the above times
Settling Time	Range change: 1ppm	Double the above times
Setting Resolution	<±100ppm for life	
Frequency Accuracy	10nF, 1mH (time constant <1µs)	
Maximum Reactive Load	100µA to 1A ranges: 10A range:	3V rms 2V rms
Compliance Voltage		

NOTES: [1] FS = 2 x Nominal Range Value (e.g. 20mA on 10mA range).

[2] For same conditions between 18°C and 28°C.

[3] T<sub>cert</sub> = temperature at certification. Factory certification temperature = 23°C

[5] Predominantly second harmonic (negligible error on mean-sensing equipment).

## Resistance Accuracy Specifications

### Resistance

Resistor Nominal Value	4-Wire Accuracy Relative to Calibration Standards ± (ppm OUTPUT + ppmFS) [1]			Calibration Uncertainty (±ppm Output)	Temperature Coefficient (±ppm/°C)
	24 Hours Stability [2]	90 Days Tcert [3] ± 1°C	1 Year Tcert [3] ± 5°C		
10Ω	10	30	75	25	6
100Ω	2.5	6	20	10	2
1kΩ	2.5	6	20	10	2
10kΩ	2.5	6	20	9	2
100kΩ	2.5	6	25	18	2
1MΩ	8	25	60	37	6
10MΩ	30	100	200	62	10
100MΩ	40	125	500	200	20

Resistor Nominal Value	2-Wire Accuracy Relative to 4-Wire Accuracy		
	24 Hours Stability [2]	90 Days Tcert [3] ± 1°C	1 Year Tcert [3] ± 5°C
10Ω	±5mΩ	±5mΩ	±10mΩ
100Ω	±10mΩ	±10mΩ	±20mΩ
1kΩ to 100MΩ	±100mΩ	±100mΩ	±200mΩ

### Other Resistance Specifications

Display Resolution	1ppm
Connections	Programmable 2-wire/4-wire sense Programmable remote/local guard
Fuse Protection	To 120V rms

NOTES: [1] FS = 2 x Nominal Range Value (e.g. 20Ω for 10Ω resistor).

[2] For same conditions between 18°C and 28°C.

[3] Tcert = temperature at certification. Factory certification temperature = 23°C



# SECTION 6.3 4808 SPECIFICATIONS

## General

### Power Supply

Voltage (single phase)	: 100V/120V/220V/240V selectable from rear panel
Line Frequency	: 48Hz to 62Hz
Consumption	: 370VA normal 660VA full power
Fuses 220/240V	: 3.15A
100/120V	: 6.25A

### Mechanical

Dimensions	: Height: 178mm (7 inches) Width: 455mm (17.9 inches) Depth: 563mm (22.2 inches)
Weight	: 36kg (80lbs)

<b>SAFETY</b>	: Designed to UL1244, IEC348, IEC1010, BS4743
---------------	--

### Peak Terminal Voltages

Guard to Ground	: 920V
Lo to Guard	: 920V
Lo to Ground	: 920V
Hi to Guard	: 1556V
Hi to Ground	: 1556V

### Rear Panel Digital Inputs:

to Hi	: 1556V
to Lo	: 920V
to Guard	: 920V
to Ground	: 0V to +5V

N.B.

Digital Common is internally connected to Ground

### Environmental Conditions

Operating Temperature	: 0°C to 50°C
-----------------------	---------------

### Caution

Above 30°C on 1kV Range max output power is derated

Storage Temperature	: -40°C to +70°C
Max. Relative Humidity	: 75% at 40°C, non-condensing
Warm-up Time	: Two hours to meet all specifications

### Operating Indications

Indication	: Symbols lit on displays and illuminated keys
------------	---

### Scale Lengths

Output Display	: 7.5 digits maximum
Frequency Display	: 3 digits plus store location
Mode Display	: 7.5 digits maximum

### Option Summary

Option 10 : DCV function to 200V.

Option 20 : ACV function to 200V.

Option 30 : Integral 1000V Amplifier for:  
DCV (requires Option 10); or  
ACV (requires Option 20); or both.

Option 40 : Current Converter for:  
DCI (requires Option 10); or  
ACI (requires Option 20); or both.

Option 50 : Resistance function.

Option 60 : Current Range Extender to 11A for:  
DCI (requires Options 10 & 40); or  
ACI (requires Option 20 & 40); or both.  
Includes Model 4600 Transconductance  
Amplifier and all necessary cabling.

Option 90 : Rack Mount Kit.

## **Accuracy Specifications**

### **Absolute Uncertainty**

To calculate the absolute uncertainty in a measurement made with a factory-calibrated 4808, combine the 4808 'Performance Relative to Calibration Standards' with the relevant 'Calibration Uncertainty'.

When different calibration standards are used, simply substitute their uncertainties in place of the column headed 'Calibration Uncertainty' and combine them with the 4808 'Performance Relative to Calibration Standards'.

## DCV Accuracy Specifications

Option 10 - DC Voltage (Requires Option 30 for 1000V Range)

Voltage Range	Accuracy Relative to Calibration Standards ± (ppm OUTPUT + ppmFS) [1]			Calibration Uncertainty (±ppm Output)	Temperature Coefficient (±ppm/°C)
	24 Hours Stability [2]	90 Days Tcert [3] ± 1°C	1 Year Tcert [3] ± 5°C		
100µV	0.4 + 0.3µV	3 + 0.4µV	7 + 0.5µV	4	1
1mV	0.4 + 0.3µV	3 + 0.4µV	7 + 0.5µV	4	1
10mV	0.4 + 0.3µV	3 + 0.4µV	7 + 0.5µV	4	1
100mV	0.4 + 0.3µV	3 + 0.4µV	7 + 0.5µV	4	1
1V	0.3 + 0.25	2 + 0.4	5 + 0.5 <i>1µV</i>	2	0.5
10V	0.3 + 0.05	1 + 0.15	3 + 0.15 <i>3µV</i>	1.5	0.15
100V	0.5 + 0.1	2 + 0.25	5 + 0.25 <i>50µV</i>	2	0.5
1000V	0.5 + 0.1	3 + 0.25	7 + 0.25 <i>500µV</i>	2	0.5

### Other DCV Specifications

Scale Length	100µV to 100V ranges: 0 to ±200% of nominal range 1000V range: 0 to ±110% of nominal range
Settling Time	<1second to 10ppm of step size
Setting Resolution	0.1ppm or 10nV
Maximum Load	1V to 1000V ranges: 25mA 100µV to 100mV ranges: Output impedance 100Ω

- NOTES: [1] FS = 2 x Nominal Range Value (e.g. 20V on 10V range).  
 [2] For same conditions between 18°C and 28°C.  
 [3] Tcert = temperature at certification. Factory certification temperature = 23°C

## ACV Accuracy Specifications

### General ACV Specifications

Scale Length	1mV to 100V ranges: 9% to 200% of nominal range 1000V range: 9% to 110% of nominal range
Settling Time	To 10ppm of step size: 10Hz to 32Hz: <10 seconds 33Hz to 330Hz: <3 seconds >330Hz: <1 second Range change: Double the above times
Setting Resolution	1ppm or 100nV
Frequency Accuracy	±100ppm for life
Maximum Resistive Load	100µV to 100mV ranges: Output impedance 30Ω 1V range: 50mA rms 10V range: 60mA rms 100V range: 120mA rms 1000V range; <3kHz: 15mA rms 1000V range; >3kHz: 65mA rms
Maximum Capacitive Load	1V to 100V ranges: 1000pF 1000V range: 300pF

NOTES: [1] FS = 2 x Nominal Range Value (e.g. 20V on 10V range).

[2] For same conditions between 18°C and 28°C.

[3] Tcert = temperature at certification. Factory certification temperature = 23°C

[4] Valid over load range: 0-50mA rms. Above 50mA add:  $\frac{F(\text{kHz}) \times [I(\text{mA}) - 50]}{150}$  ppmFS

[5] Figures indicate pure THD only, excluding noise, which is included in the main specification. THD is predominantly second harmonic (negligible error on mean-sensing equipment).

Option 20 - AC Voltage (Requires Option 30 for 1000V Range)

Voltage Range	Frequency (Hz)	Accuracy Relative to Calibration Standards ± (ppm OUTPUT + ppmFS) <sup>(1)</sup>				Calibration Uncertainty (±ppm Output)	Temperature Coefficient (±ppm/°C)	Total Harmonic Distortion (%) <sup>(2)</sup>																																																			
		24 Hour Stability <sup>(2)</sup>	90 day T <sub>cert</sub> <sup>(3)</sup> ± 1°C		1 Year T <sub>cert</sub> <sup>(3)</sup> ± 5°C																																																						
			Spot	Broadband	Spot				Broadband																																																		
1mV-100mV	10 - 31 32 - 330 300 - 10k 10k - 33k 30k - 100k 100k - 330k 300k - 1M	60 + 5 + 5µV 30 + 5 + 5µV 20 + 5 + 5µV 20 + 5 + 5µV 30 + 5 + 5µV 80 + 10 + 5µV 130 + 10 + 5µV	90 + 5µV 40 + 5µV 30 + 5µV 40 + 5µV 60 + 5µV 280 + 5µV 850 + 5µV	110 + 20 + 5µV 60 + 20 + 5µV 50 + 20 + 5µV 60 + 20 + 5µV 250 + 20 + 5µV 750 + 50 + 10µV 0.15% + 500 + 20µV	100 + 5µV 50 + 5µV 40 + 5µV 50 + 5µV 80 + 5µV 350 + 5µV 0.1% + 5µV	120 + 20 + 5µV 70 + 20 + 5µV 60 + 20 + 5µV 70 + 20 + 5µV 300 + 20 + 5µV 0.1% + 50 + 5µV 0.2% + 500 + 5µV	30 + 1µV 30 + 1µV 30 + 1µV 170 + 1µV 350 + 1µV 450 + 1µV 450 + 1µV	5 5 5 5 5 20 50	0.1 0.04 0.04 0.04 0.1 0.3 1.0																																																		
										1V	10 - 31 32 - 330 300 - 33k 30k - 100k 100k - 330k 300k - 1M	30 + 10 10 + 5 7 + 2 15 + 5 30 + 10 100 + 10	70 20 15 35 120 800	80 + 15 40 + 10 30 + 5 60 + 10 180 + 50 0.11% + 200	80 30 20 50 150 0.1%	90 + 15 50 + 15 40 + 15 80 + 15 250 + 15 0.15% + 200	20 20 20 50 100 300	15 15 15 15 10 50	0.1 0.04 0.04 0.1 0.3 1.0																																								
																				10V	10 - 31 32 - 330 300 - 33k 30k - 100k 100k - 330k 300k - 1M	30 + 10 10 + 5 7 + 2 15 + 5 30 + 10 100 + 10	75 25 20 35 120 800	80 + 15 40 + 10 30 + 5 60 + 10 180 + 50 0.11% + 200	80 30 20 50 150 0.1%	90 + 15 50 + 15 40 + 15 80 + 15 250 + 15 0.15% + 200	20 20 20 50 100 300	15 15 15 15 10 50	0.1 0.04 0.04 0.1 0.3 1.0																														
																														100V	10 - 31 32 - 330 300 - 10k 10k - 33k 30k - 100k 100k - 330k 300k - 1M	30 + 10 10 + 5 10 + 2 10 + 2 15 + 5 160 + 20 600 + 75	75 25 25 35 45 230 0.57%	90 + 15 50 + 10 40 + 5 50 + 10 90 + 15 530 + 150 <sup>(4)</sup> 0.77% + 600 <sup>(4)</sup>	80 30 30 40 60 400 0.72%	100 + 15 60 + 10 50 + 5 60 + 10 120 + 15 700 + 150 <sup>(4)</sup> 0.95% + 600 <sup>(4)</sup>	20 20 20 20 50 200 300	3 3 3 3 5 30 90	0.1 0.04 0.04 0.04 0.2 0.3 1.0																				
																																								1000V	10 - 330 300 - 3.3k 3k - 10k 10k - 33k 30k - 100k	20 + 5 20 + 2 20 + 2 30 + 2 50 + 10	120 80 80 120 170	130 + 10 90 + 10 90 + 10 130 + 10 750 + 20	130 90 90 130 200	140 + 10 100 + 10 100 + 10 140 + 10 0.1% + 20	30 30 30 50 50	5 5 5 5 7	0.2 0.1 0.1 0.1 0.5										
																																																		(to 750V max)	10 - 330 300 - 3.3k 3k - 10k 10k - 33k 30k - 100k	20 + 5 20 + 2 20 + 2 30 + 2 50 + 10	120 80 80 120 170	130 + 10 90 + 10 90 + 10 130 + 10 750 + 20	130 90 90 130 200	140 + 10 100 + 10 100 + 10 140 + 10 0.1% + 20	30 30 30 50 50	5 5 5 5 7	0.2 0.1 0.1 0.1 0.5

**ACV Accuracy Specifications (Contd.)**

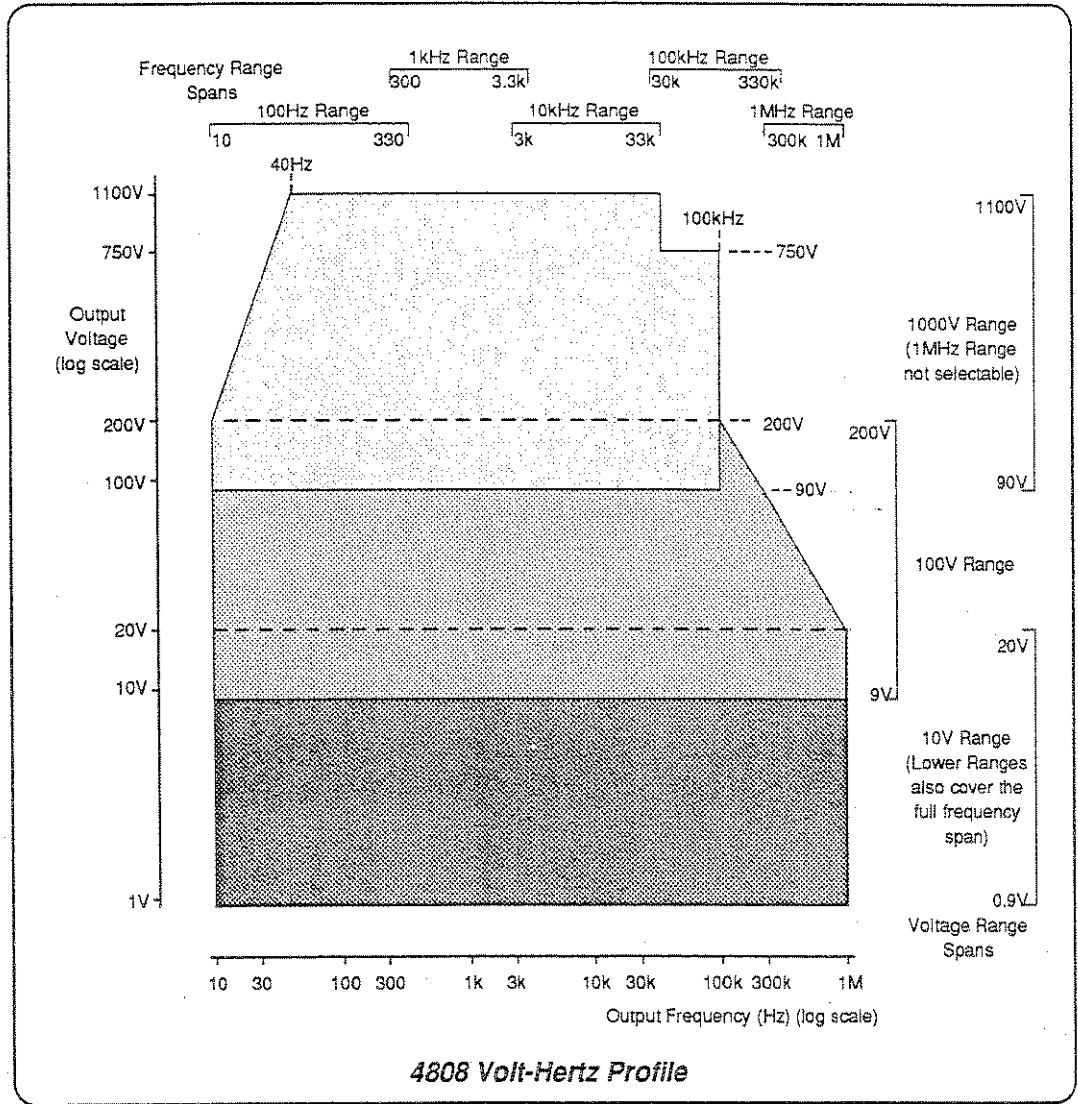

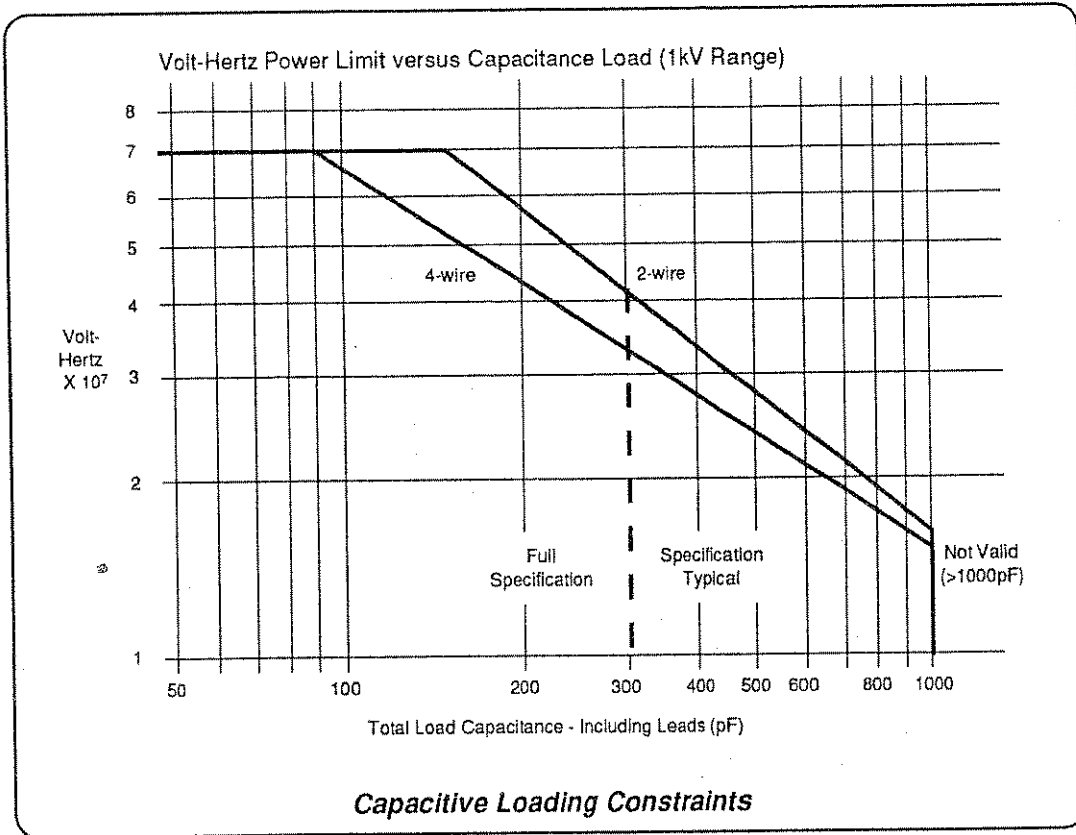

Section 6.3 - 4808 Specifications

**DCI and ACI Accuracy Specifications**

Option 40 with Option 10 - DC Current (Requires Option 60 for 10A Range)

Current Range	Accuracy Relative to Calibration Standards ± (ppm OUTPUT + ppmFS) [1]			Calibration Uncertainty (±ppm Output)	Temperature Coefficient (±ppm/°C)
	24 Hours Stability [2]	90 Days Tcert [3] ± 1°C	1Year Tcert [3] ± 5°C		
100µA	7 + 10	50 + 10	100 + 10	10	15
1mA	3 + 4	20 + 5	40 + 5	10	6
10mA	3 + 4	20 + 5	40 + 5	10	6
100mA	3 + 4	20 + 5	40 + 5	10	6
1A	7 + 10	50 + 10	100 + 10	25	15
10A	15 + 10	50 + 25	150 + 25	30	15

**Other DCI Specifications**

Scale Length	100µA to 1A ranges: 0 to ±200% of nominal range 10A range: 0 to ±100% of nominal range
Settling Time	100µA to 1A ranges: <1second to full specification 10A range: <1second to 40ppm of step size
Setting Resolution	1ppm
Compliance Voltage	100µA to 1A ranges: 3V 10A range: 2V

**NOTES:** [1] FS = 2 x Nominal Range Value (e.g. 20mA on 10mA range).

[2] For same conditions between 18°C and 28°C.

[3] Tcert = temperature at certification. Factory certification temperature = 23°C



### ACI Accuracy Specifications

Option 40 with Option 20 - AC Current (Requires Option 60 for 10A Range)

Current Range	Frequency (Hz)	Accuracy Relative to Calibration Standards ± (ppm OUTPUT + ppmFS) <sup>[1]</sup>				Calibration Uncertainty (±ppm Output)	Temperature Coefficient (±ppm/°C)	Total Harmonic Distortion (%) <sup>[5]</sup>	
		24 Hour Stability <sup>[2]</sup>	90 day T <sub>cert</sub> <sup>[3]</sup> ± 1°C		1 Year T <sub>cert</sub> <sup>[3]</sup> ± 5°C				
100µA	10 - 1k 1k - 5k	50 + 20 70 + 30	Spot	Broadband	Spot	Broadband	100 100	10 20	0.2 0.5
			100	120 + 30 250 + 40	130 220	150 + 50 300 + 70			
1mA - 100mA	10 - 1k 1k - 5k	30 + 10 40 + 10	Spot	Broadband	Spot	Broadband	100 100	10 10	0.2 0.2
			60 100	70 + 30 120 + 30	90 160	100 + 50 200 + 50			
1A	10 - 1k 1k - 5k	50 + 20 70 + 30	Spot	Broadband	Spot	Broadband	100 100	20 25	0.2 0.2
			170 270	250 + 30 400 + 40	200 320	300 + 50 450 + 70			
10A	10 - 1k 1k - 5k 5k - 10k 10k - 20k	40 + 20 75 + 30 400 + 60 0.2% + 150	Spot	Broadband	Spot	Broadband	110 110 130 250	13 13 28 50	0.2 0.2 0.2 1.0
			210 300 0.11% 0.4%	300 + 60 750 + 75 0.15% + 300 0.54% + 0.16%	270 480 0.14% 0.5%	400 + 65 850 + 80 0.22% + 300 0.72% + 0.16%			

### Other ACI Specifications

Scale Length	100µA to 1A ranges: 10A range:	9% to 200% of nominal range 9% to 110% of nominal range
Settling Time	To 10ppm of step size: Range change:	10Hz to 32Hz: <10 seconds 33Hz to 330Hz: <3 seconds >330Hz: <1 second Double the above times
Settling Resolution	1ppm	
Frequency Accuracy	<±100ppm for life	
Maximum Reactive Load	10nF, 1mH (time constant <1µs)	
Compliance Voltage	100µA to 1A ranges: 10A range:	3V rms 2V rms

NOTES: [1] FS = 2 x Nominal Range Value (e.g. 20mA on 10mA range).

[2] For same conditions between 18°C and 28°C.

[3] T<sub>cert</sub> = temperature at certification. Factory certification temperature = 23°C

[5] Predominantly second harmonic (negligible error on mean-sensing equipment).

## Resistance Accuracy Specifications

### Option 50 - Resistance

Resistor Nominal Value	4-Wire Accuracy Relative to Calibration Standards ± (ppm OUTPUT + ppmFS) [1]			Calibration Uncertainty (±ppm Output)	Temperature Coefficient (±ppm/°C)
	24 Hours Stability [2]	90 Days Tcert [3] ± 1°C	1 Year Tcert [3] ± 5°C		
10Ω	2	10	25	10	6
100Ω	1	3	9	5	2
1kΩ	1	3	9	5	2
10kΩ	1	3	9	4	2
100kΩ	1	3	10	6	2
1MΩ	2	10	25	12	6
10MΩ	2	25	50	17	10
100MΩ	3	30	70	50	20

Resistor Nominal Value	2-Wire Accuracy Relative to 4-Wire Accuracy		
	24 Hours Stability [2]	90 Days Tcert [3] ± 1°C	1 Year Tcert [3] ± 5°C
10Ω	±5mΩ	±5mΩ	±10mΩ
100Ω	±10mΩ	±10mΩ	±20mΩ
1kΩ to 100MΩ	±100mΩ	±100mΩ	±200mΩ

### Other Resistance Specifications

Display Resolution	0.1ppm
Connections	Programmable 2-wire/4-wire sense Programmable remote/local guard
Fuse Protection	To 120V rms

NOTES: [1] FS = 2 x Nominal Range Value (e.g. 20Ω for 10Ω resistor).

[2] For same conditions between 18°C and 28°C.

[3] Tcert = temperature at certification. Factory certification temperature = 23°C



