

FEATURES

- Low Offset Voltage: 0.5mV max (AD611K)
- Low Offset Voltage Drift: 10 μ V/ $^{\circ}$ C max (AD611K)
- Low Bias Current: 50pA max (AD611K)
- High Slew Rate: 8V/ μ s min
- Low Supply Current: 2.5mA max
- Fast Settling Time: 3 μ s

AD611 FUNCTIONAL BLOCK DIAGRAM

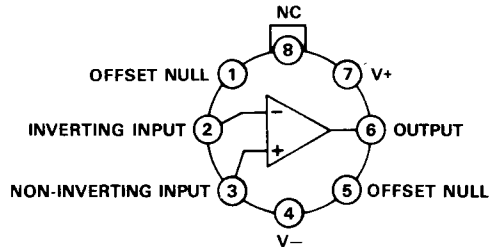

NOTE: PIN 4 CONNECTED TO CASE

TO-99
TOP VIEW

PRODUCT DESCRIPTION

The AD611 is a precision monolithic BIFET operational amplifier designed and manufactured to offer offset voltages of 0.5mV max and offset voltage drifts of 10 μ V/ $^{\circ}$ C max, yet is priced in the same range as lower performance devices. Analog Devices precision BIFET fabrication technology and proprietary laser wafer drift trimming process are combined with years of experience in manufacturing precision analog integrated circuits to insure consistently high performance at low cost. The offset voltage specifications mentioned above, coupled with the lowest input bias current of any general purpose BIFET amplifier, 100pA max guaranteed after five minutes of operation, make the AD611 the most precise BIFET amplifier in its price range.

In addition to the excellent dc specifications, the design of the AD611 is optimized to deliver 13V/ μ s slew rate, 2MHz unity gain bandwidth and a 0.01% settling time of 3 μ s. This combination of performance makes the AD611 ideal for any FET application where excellent performance at low cost is required. Its wide bandwidth, low offset voltage and fast settling time make this device ideal as an output amplifier for current output D/A converters of all types. 80dB of CMRR and 94dB of open loop gain ensure "12-bit" performance in high speed buffer circuits. The devices' excellent low frequency noise performance and low supply current requirements will benefit any general purpose BIFET application.

The AD611 is available in two grades rated over the 0 to +70 $^{\circ}$ C temperature range; the general purpose AD611J and the high precision AD611K. Both grades are available in hermetically sealed TO-99 packages. The AD611 is pinned out in standard operational amplifier configuration to facilitate low cost upgrading of existing designs using older, less accurate amplifiers.

PRODUCT HIGHLIGHTS

1. The AD611 is laser wafer drift trimmed to offer offset voltages of 0.5mV max and offset voltage drifts of 10 μ V/ $^{\circ}$ C.
2. Analog Devices BIFET processing results in maximum input bias currents of 50pA, guaranteed after 5 minutes of operation.
3. The high slew rate (8V/ μ s min.) and fast settling time (3 μ s to 0.01%) make the AD611 ideal for use in D/A, A/D, sample-and-hold circuits and precision high speed integrators.
4. Monolithic construction, along with advanced processing and manufacturing technologies result in extremely high performance at very low cost.

SPECIFICATIONS (typical @ +25°C and ±15V dc, unless otherwise noted)

Model	AD611J			AD611K			Units
	Min	Typ	Max	Min	Typ	Max	
OPEN LOOP GAIN¹ V _{OUT} = ±10V R _L ≥ 2kΩ T _A = min to max R _L ≥ 2kΩ	30,000 20,000	80,000 50,000		50,000 40,000	80,000 50,000		V/V V/V
FREQUENCY RESPONSE Unity Gain, Small Signal Full Power Response Slew Rate, Unity Gain Total Harmonic Distortion f = 1kHz	8	2 200 13 0.0025		8	2 200 13 0.0025		MHz kHz V/μs %
INPUT OFFSET VOLTAGE² vs. Temperature vs. Supply T _A = min to max		0.25 5 50 70	2.0 20 200 200		0.25 5 50 70	0.5 10 100 100	mV μV/°C μV/V μV/V
INPUT BIAS CURRENT Either Input ³ Input Offset Current		25 10	100 50		10 5	50 25	pA pA
INPUT IMPEDANCE Differential Common Mode		10 ¹² Ω 6pF 10 ¹² Ω 3pF			10 ¹² Ω 6pF 10 ¹² Ω 3pF		
INPUT VOLTAGE RANGE Differential ⁴ Common Mode Common-Mode Rejection, V _{IN} = ±10V	±10 74	±20 ±12		±10 80	±20 ±12		V V dB
POWER SUPPLY Operating Range Quiescent Current	±5	1.8	±18 2.5	±5	1.8	±18 2.5	V mA
VOLTAGE NOISE 0.1 – 10Hz 10Hz 100Hz 1kHz 10kHz		2.0 35 22 18 16			2.0 35 22 18 16		μV p-p nV/√Hz nV/√Hz nV/√Hz nV/√Hz
TEMPERATURE RANGE Operating, Rated Performance Storage	0 -65		+70 +150	0 -65		+70 +150	°C °C
PACKAGE OPTIONS⁵ TO-99		AD611JH			AD611KH		

NOTES

¹Open Loop Gain is specified with V_{OS} both nulled and unnullled.

²Input Offset Voltage specifications are guaranteed after 5 minutes of operation at T_A = +25°C.

³Bias Current specifications are guaranteed maximum at either input after 5 minutes of operation at T_A = +25°C. For higher temperatures, the current doubles every 10°C.

⁴Defined as voltage between inputs, such that neither exceeds ±10V from ground.

⁵See Section 19 for package outline information.

Specifications subject to change without notice.

Specifications shown in boldface are tested on all production units at final electrical test. Results from those tests are used to calculate outgoing quality levels. All min and max specifications are guaranteed, although only those shown in boldface are tested on all production units.

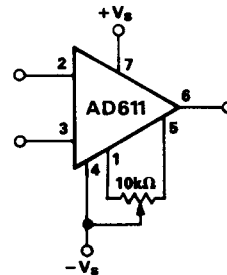

Standard Offset Null Circuit

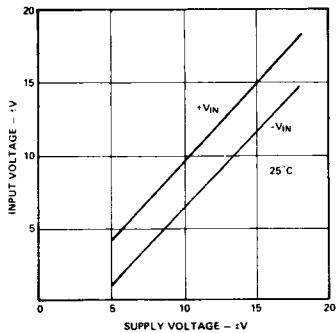

Figure 1. Input Voltage Range vs. Supply Voltage

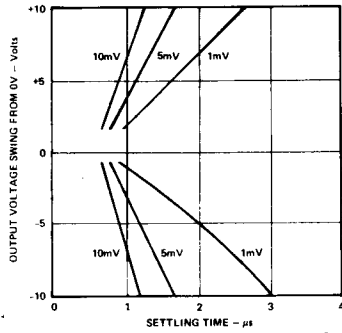

Figure 2. Output Settling Time vs. Output Swing and Error (Circuit of Figure 15a)

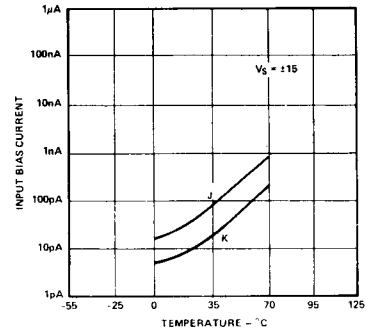

Figure 3. Input Bias Current vs. Temperature

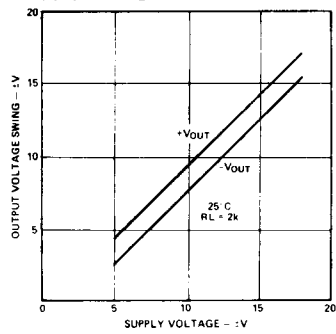

Figure 4. Output Voltage Swing vs. Supply Voltage

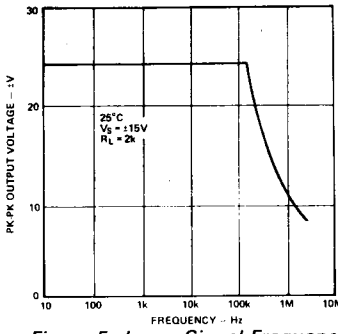

Figure 5. Large Signal Frequency Response

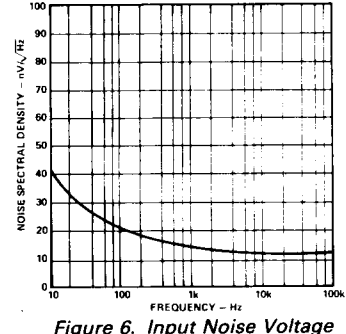

Figure 6. Input Noise Voltage Spectral Density

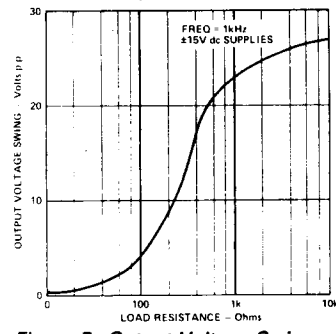

Figure 7. Output Voltage Swing vs. Resistive Load

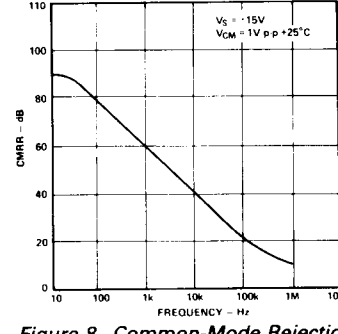

Figure 8. Common-Mode Rejection vs. Frequency

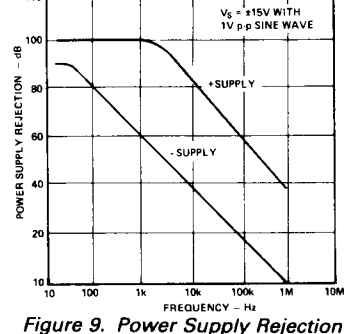

Figure 9. Power Supply Rejection vs. Frequency

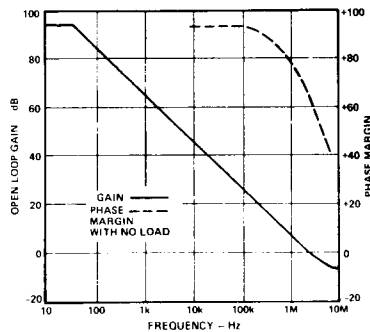

Figure 10. Open Loop Voltage Gain vs. Supply Voltage

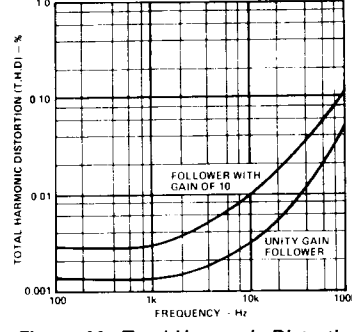

Figure 11. Total Harmonic Distortion vs. Frequency

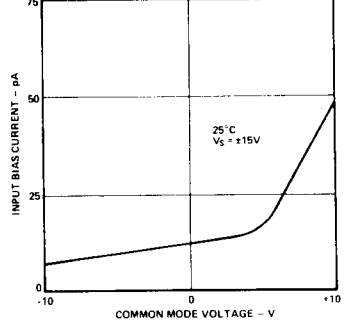

Figure 12. Input Bias Current vs. CMV

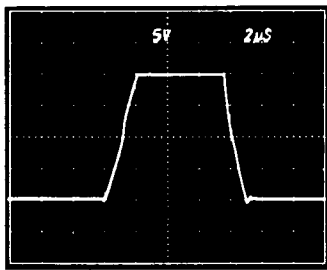

Figure 13a. Unity Gain Follower Pulse Response (Large Signal)

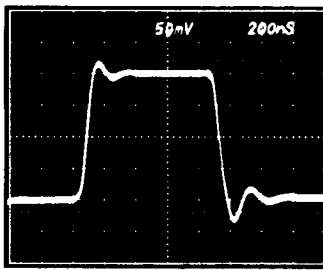

Figure 13b. Unity Gain Follower Pulse Response (Small Signal)

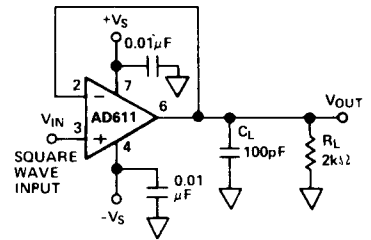

Figure 13c. Unity Gain Follower

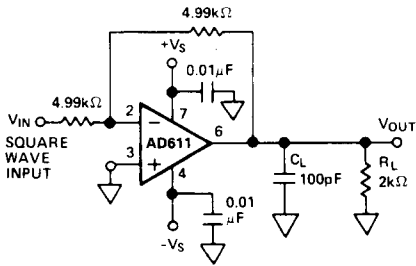

Figure 14a. Unity Gain Inverter

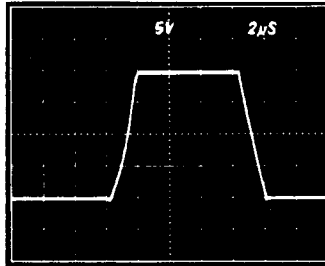

Figure 14b. Unity Gain Inverter Pulse Response (Large Signal)

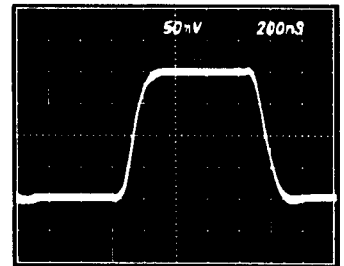

Figure 14c. Unity Gain Inverter Pulse Response (Small Signal)

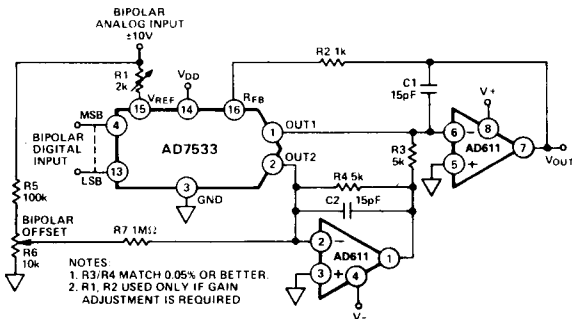

Figure 15a. AD611 Used as DAC Output Amplifiers

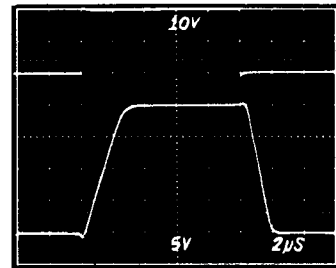

Figure 15b. Large Signal Response

Figure 15a illustrates the 10-bit digital-to-analog converter, AD7533, connected for bipolar operation. Since the digital input can accept bipolar numbers and V_{REF} can accept a bipolar analog input, the circuit can perform a 4-quadrant multiplying function. The photos exhibit the response to a step input at V_{REF} . Figure 15b is the large signal response and Figure 15c is the small signal response.

The output impedance of a CMOS DAC varies with the digital word thus changing the noise gain of the amplifier circuit. The effect will cause a nonlinearity the magnitude of which is dependent on the offset voltage of the amplifier. The AD611 with trimmed offset will minimize the effect. The Schottky protection diodes recommended for use with many CMOS DACs are not required when using the AD611.

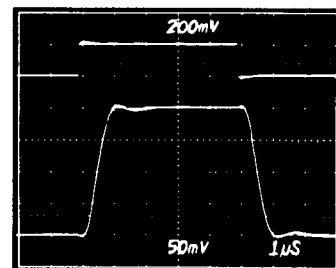

Figure 15c. Small Signal Response