

riešenia na presné meranie

[www.else.sk/Fluke-Calibration](http://www.else.sk/Fluke-Calibration)

**FLUKE**®



Electrical Calibration  
Temperature Calibration  
Time and Frequency Standards

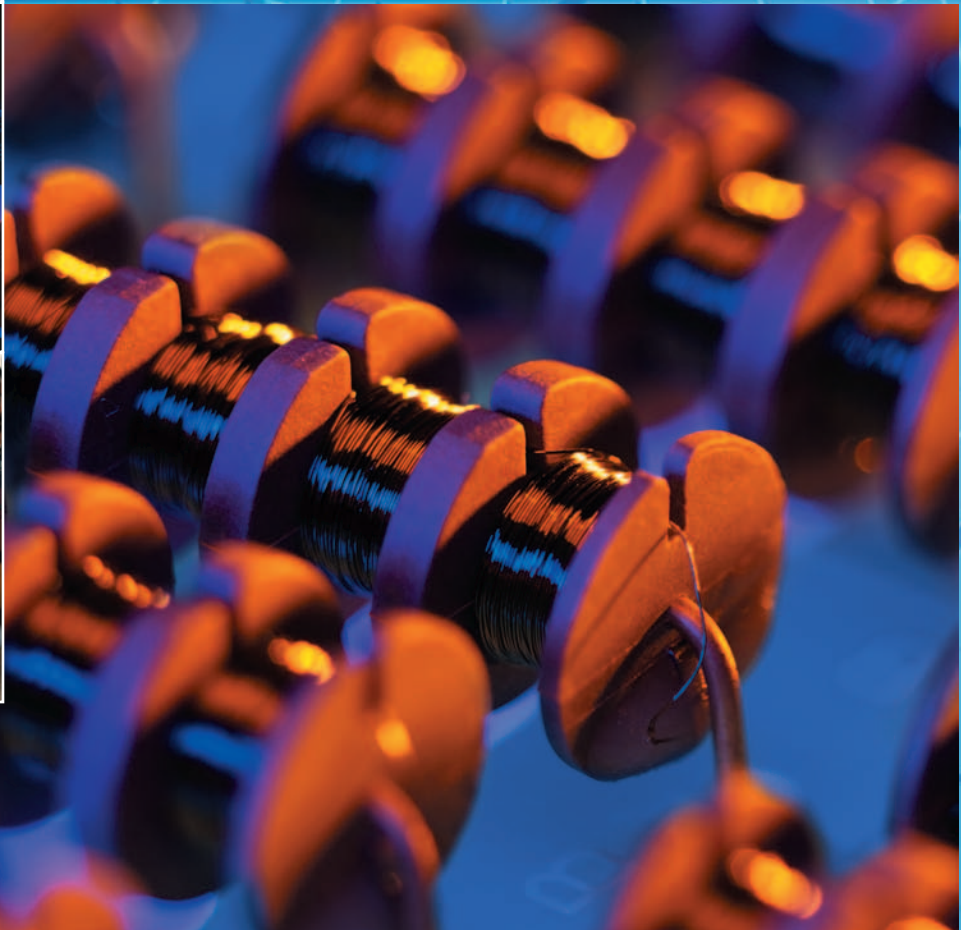

## Precision Measurement Solutions

**ELSO**

riešenia na presné meranie™

Elso Philips Service; tel: +421 32 6582410  
email: [else@else.sk](mailto:else@else.sk); web: [www.else.sk](http://www.else.sk)

Calibration Software

Data Acquisition

VXI Products

Signal Sources

Value-Added Services

Elso Philips Service, Trenčín

On the cover:

Wire wound resistors made in our Everett, WA facility are found in Fluke Corporation's most precise calibrators, references and standards. Constructed of one of two special alloys with offsetting temperature coefficients, they are individually characterized, hermetically sealed, precisely matched, then installed in sets to eliminate resistance changes over operating temperature ranges. The benefit of this painstaking process? Outstanding performance and stability characteristics. In a word: confidence.



Fluke Corporate Headquarters, Everett, Washington, U.S.A.

Since its founding in 1948, Fluke has helped define and grow a unique technology market, providing testing and troubleshooting capabilities that have grown to mission critical status in manufacturing and service industries. Fluke Precision Measurement (FPM) instruments help measurement professionals around the globe keep their organizations up and running.

Since its founding in 1948, Fluke has helped define and grow a unique technology market, providing testing and troubleshooting capabilities that have grown to mission critical status in manufacturing and service industries. Fluke Precision Measurement (FPM) instruments help measurement professionals around the globe keep their organizations up and running.

Fluke Precision Measurement instruments and software can be found in standards and calibration labs, and in industrial, plant and commercial facilities around the world. With factories in the United States and United Kingdom, we work hard to make sure you get the products you need, when you need them – wherever you work and make measurements.

But the FPM commitment to our customers doesn't end with producing great products. We operate electrical standards laboratories in

the United States and Germany, temperature standards laboratories in the United Kingdom and United States, and service facilities around the world. We do this so we can offer you accredited calibrations and comprehensive repair services to keep your equipment working the way you expect it to work. We also offer a variety of training courses to help you maximize the value of your investment in hardware and software.

We are committed to delighting our customers and finding innovative new ways to help them keep their world up and running. We also work hard to support our customers before and after the sale; provide efficient calibration services that add value to each purchase; and offer training to help customers maximize their investment.

**Put your trust in the leader.**



Fluke European Sales and Service Headquarters, Eindhoven, The Netherlands



UKAS-accredited temperature lab at Fluke Precision Measurement Ltd (formerly Wavetek-Datron), Norwich, United Kingdom



Josephson arrays in US and Germany. Fluke is only one of a handful of commercial organizations operating Josephson Array standards to represent the volt in their metrology operations. Fluke maintains two J-arrays, one at its corporate headquarters in Everett, Washington in the USA, and one in its standards laboratory in Kassel, Germany.



Fluke Hart Scientific Temperature Calibration Headquarters, American Fork, Utah, U.S.A.



8508A Reference Multimeter  
see page 4



9141 Field Dry-Well  
see page 152

## Electrical Calibration

### Bench Meters

Reference Multimeter ..... 4

### DC/LF Calibration

Calibrators selection guide ..... 11

Multi-Product Calibrators ..... 13

Universal Calibration System ..... 21

### Oscilloscope Calibration

Scope calibrator selection guide ..... 40

Oscilloscope Calibrators ..... 41

### Power Calibration

Power calibration selection guide ..... 55

Electrical Power Standard ..... 56

### Electrical Standards

AC Measurement Standard ..... 66

Current Shunts ..... 69

Reference & Transfer Standards ..... 70

Volt Maintenance System ..... 72

Multifunction Calibrators ..... 28

ATE System Source Upgrade ..... 32

Temperature/Pressure Calibrator ..... 36

Oscilloscope Cal Options ..... 49

Power Quality Options ..... 62

Power Calibration Options ..... 64

Resistance Standards ..... 74

Reference Divider ..... 75

Kelvin-Varley Divider ..... 76

AC/DC Transfer Standard ..... 77

## Temperature Calibration

### Primary Temperature Standards

Primary Standards Selection Guide ..... 79

Quartz-Sheath SPRTs ..... 80

Working Standard SPRT ..... 82

Working Standard Metal-Sheath SPRTs ..... 82

Extended Range Metal-Sheath SPRT ..... 82

Glass Capsule SPRTs ..... 83

Gold-Platinum Thermocouple ..... 84

Triple Point of Water Cells ..... 85

TPW Maintenance Bath ..... 86

ITS-90 Fixed-Point Cells ..... 88

Freeze-Point Furnaces ..... 90

Annealing Furnace ..... 92

Mini Fixed-Point Cells ..... 93

Mini Fixed-Point Maintenance Apparatus ..... 94

X Cells ..... 96

LN<sup>2</sup> Comparison Calibrators ..... 97

### Thermometer Readouts

Thermometer Readouts Selection Guide ..... 98

Handheld Thermometers ..... 99

"Tweeners" Thermometers ..... 101

Chub-E4 Standards Thermometer ..... 103

The Black Stack Thermometer ..... 105

Super-Thermometers ..... 109

### Thermometer Probes

Probes SPRT/PRT Selection Guide ..... 112

Secondary Standard PRTs ..... 113

Secondary Reference Temp Standards ..... 114

100 Ohm PRT ..... 116

Precision Industrial PRTs ..... 117

Fast Response PRTs ..... 118

Small Diameter Industrial PRT ..... 119

Freezer Probe ..... 120

Thermistor Standards Probes ..... 121

Secondary Reference Thermistor Probes ..... 122

Type S & R Thermocouple Standards ..... 123

### Baths

Baths Selection Guide ..... 124

Compact Baths ..... 126

Deep-Well Compact Baths ..... 128

Really Cold Baths ..... 130

Cold Baths ..... 132

Hot Baths ..... 134

Really Hot Baths ..... 136

Deep-Well Baths ..... 138

Resistor Baths ..... 140

Bath Fluids ..... 142

Bath Accessories ..... 144

## Industrial Temperature Calibrators

<i>Dry-Wells Selection Guide</i> .....	145	Zero-Point Dry-Well .....	157
Micro-Baths .....	147	High-Accuracy Duel-Well Calibrator .....	158
Handheld Dry-Wells .....	149	Portable IR Calibrators .....	160
Industrial Dual-Block Calibrator .....	151	Thermocouple Furnace .....	161
Field Dry-Wells .....	152	Thermocouple Calibration Furnace .....	162
High-Accuracy Dry-Wells .....	154		

## Temperature and Humidity Products

Thermo-Hygrometer .....	163	Recording Thermometers .....	166
Precision Humidity/Temp Data Logger .....	165	Benchtop Temp/Humidity Generator .....	167

## Time and Frequency Standards

<i>Time and Frequency Selection Guide</i> ..	169
--	-----

### Timer/Counters

Timer/Counter/Analyzers .....	170	Universal Frequency Counters .....	176
-------------------------------	-----	------------------------------------	-----

### Frequency Standards

Frequency References .....	180	GPS-Controlled Frequency Standards ..	181
----------------------------	-----	---------------------------------------	-----

## Calibration Software

MET/CAL® Plus .....	185	TableWare .....	196
Interface-it .....	193	LogWare .....	197
MET/TEMP II .....	194		

## Value-Added Services

Training .....	198	Temperature Calibration Services .....	201
Calibration Services .....	200	MET/SUPPORT Gold .....	202

## Data Acquisition

<i>Selection Guide</i> .....	203	NetDAQ® .....	212
Data Acquisition Systems .....	204	Trend Link for Fluke .....	216
Hydra Series .....	209		

## VXI Products

VXIbus Precision Digital Multimeter ..	217
--	-----

## Signal Sources

<i>Selection Guide</i> .....	219	Universal Waveform Generators .....	229
Function Generators .....	221		

## Handheld Industrial Test Tools .....

## Fluke Networks .....

## Fluke Biomedical .....

## Raytek .....

## Working with Fluke .....

## Index .....



6100 Electrical Power Standard  
see page 56



9500B Oscilloscope Calibrator  
see page 41

# 8508A Reference Multimeter

## Precision Multimeters

Reference standard accuracy and stability, in one functionally versatile, easy to use solution



- 8.5 digit resolution
- True Ohms measurement
- 20 Amp current measurement
- Reference-standard accuracy and stability
- Versatile: replaces multiple laboratory reference standards
- Dual channel ratio provides simple yet fast measurement transfer
- MET/CAL automation

### Tech Tip

The 8508A has the measurement functions, accuracy and stability of many metrology grade instruments. See the application note, "Maximizing your reference multimeter, minimizing measurement uncertainties" on the web at [www.fluke.com](http://www.fluke.com)

(Literature code 2090893)

The 8508A Reference Multimeter is designed specifically to address the measurement challenges faced by metrologists. Not only does it provide the performance required for complex measurement tasks, it is also extremely easy to use. Moreover, it is specified in a way that lets users really understand the uncertainties of the measurements they make.

#### Accuracy and stability

The 8508A features 8.5 digit resolution, exceptional linearity and extremely low noise and stability, producing superior accuracy specifications as low as 3 ppm over one year. But measurements need to be repeatable and the 8508A delivers that as well, with 24-hour stability as low as 0.5 ppm and a 20-minute stability of 0.16 ppm. This stability is maintained over a wide operating temperature range and achieved without requiring routine auto-cal or self-calibration, which can compromise measurement traceability and history.

#### Functional and versatile

The Fluke 8508A lets you handle a wide range of applications and achieve your measurement requirements with a single instrument, thus saving time and money. In addition to ac and dc voltage, ac and dc current, resistance and frequency, the 8508A also includes a host of other features designed to increase the range of measurements you can make. **True Ohms**

measurement using current reversal technique improves the accuracy of your resistance measurements. The **precision SPRT and PRT temperature readout** extends the 8508A's functionality into advanced temperature metrology. The **Lo Current Ohms** feature reduces measurement errors due to self-heating within the device being measured. A **dual input channel ratio** feature, under GPIB control, enables the 8508A/01 to be used as a simple, fast, automated transfer standard. **High current measurement** – up to 20 A – extends the operational range to address your multi-product calibrator workload. Up to **200 V compliance** on resistance ranges gives you greater scope to measure high resistances with greater accuracy.

#### Easy to use

A clear control structure with Dual Paramatrix™ LCD displays and context sensitive menus provides a transparent, logical and intuitive interface that makes the 8508A easy to use. The menu structures have been designed especially for metrology applications, so you can focus on getting the best possible measurements without needing to work through complex sequential or multi-instrument setups, or repeatedly reference supporting documentation. To make sure that total uncertainties of measurements are made clear, Fluke publishes 8508A uncertainties in both relative and absolute terms. For full and comprehensive specifications, refer to the extended specification data sheet available at [www.fluke.com](http://www.fluke.com).

## DC Voltage

DC Voltage <sup>[1] [2] [3]</sup>						
Range	Full Scale	Uncertainty Relative to Cal Stds			Absolute Uncertainties	
		± (ppm Reading + ppm Range) <sup>[4]</sup>				
		24 hour TCal ± 1 °C	90 day TCal ± 1 °C	365 day TCal ± 1 °C	365 day TCal ± 1 °C	365 day TCal ± 5 °C
<b>95 % Confidence Level</b>						
200 mV	199.999 999	0.7 + 0.5	1.4 + 0.5	2.7 + 0.5	4.5 + 0.5	5.0 + 0.5
2 V	1.999 999 99	0.5 + 0.2	1.4 + 0.2	2.7 + 0.2	3.0 + 0.2	3.5 + 0.2
20 V	19.999 999 9	0.5 + 0.2	1.4 + 0.2	2.7 + 0.2	3.0 + 0.2	3.5 + 0.2
200 V	199.999 999	1.0 + 0.2	2.6 + 0.2	4.0 + 0.2	4.5 + 0.2	5.5 + 0.2
1000 V	1050.000 00	1.0 + 0.5	2.6 + 0.5	4.0 + 0.5	4.5 + 0.5	5.5 + 0.5
<b>99 % Confidence Level</b>						
200 mV	199.999 999	0.8 + 0.6	2.0 + 0.6	3.5 + 0.6	6.0 + 0.6	6.5 + 0.6
2 V	1.999 999 99	0.6 + 0.25	1.8 + 0.25	3.5 + 0.25	4.0 + 0.25	4.5 + 0.25
20 V	19.999 999 9	0.6 + 0.25	1.8 + 0.25	3.5 + 0.25	4.0 + 0.25	4.5 + 0.25
200 V	199.999 999	1.2 + 0.25	3.5 + 0.25	5.2 + 0.25	6.0 + 0.25	7.0 + 0.25
1000 V	1050.000 00	1.2 + 0.6	3.5 + 0.6	5.2 + 0.6	6.0 + 0.6	7.0 + 0.6
DC Voltage (Secondary Specifications) <sup>[1] [2] [3]</sup>						
Range	Transfer Uncertainty 20 mins ± 1 °C ± (ppm Reading + ppm Range)	Temperature Coefficient				
		15 °C to 30 °C		5 °C to 15 °C 30 °C to 40 °C		
		± ppm Reading/°C				
200 mV	0.4 + 0.3	0.4		0.6		
2 V	0.12 + 0.1	0.3		0.5		
20 V	0.12 + 0.1	0.3		0.5		
200 V	0.4 + 0.1	0.7		1.0		
1000 V	0.4 + 0.3	0.7		1.0		

## Ratio Accuracy

<b>Range to Range</b>	± (Net Front Input Accuracy + Net Rear Input Accuracy)
<b>Within Range</b>	Apply 24 hour or 20 minute Transfer Uncertainty specifications Full details are in the extended specification data sheet available on <a href="http://www.fluke.com">www.fluke.com</a>

## DC Current

DC Current <sup>[1] [2] [3]</sup>						
Range	Full Scale	Uncertainty Relative to Cal Stds			Absolute Uncertainties	
		± (ppm Reading + ppm Range) <sup>[4]</sup>				
		24 hour TCal ± 1 °C	90 day TCal ± 1 °C	365 day TCal ± 1 °C	365 day TCal ± 1 °C	365 day TCal ± 5 °C
<b>95 % Confidence Level</b>						
200 µA	199.999 99	5.5 + 2.0	6.0 + 2.0	6.5 + 2.0	12 + 2.0	12 + 2.0
2 mA	1.999 999 9	5.5 + 2.0	6.0 + 2.0	6.5 + 2.0	12 + 2.0	12 + 2.0
20 mA	19.999 999	6.5 + 2.0	7.0 + 2.0	8.0 + 2.0	13 + 2.0	14 + 2.0
200 mA	199.999 99	28 + 4.0	30 + 4.0	33 + 4.0	36 + 4.0	48 + 4.0
2 A	1.999 999 9	80 + 8.0	125 + 8.0	170 + 8.0	170 + 8.0	185 + 8.0
20 A	19.999 999	200 + 20	290 + 20	380 + 20	380 + 20	400 + 20
<b>99 % Confidence Level</b>						
200 µA	199.999 99	7.0 + 2.0	7.5 + 2.0	8.0 + 2.0	15 + 2.0	16 + 2.0
2 mA	1.999 999 9	7.0 + 2.0	7.5 + 2.0	8.0 + 2.0	15 + 2.0	16 + 2.0
20 mA	19.999 999	8.0 + 2.0	9.0 + 2.0	10 + 2.0	16 + 2.0	18 + 2.0
200 mA	199.999 99	35 + 4.0	37 + 4.0	40 + 4.0	45 + 4.0	60 + 4.0
2 A	1.999 999 9	100 + 8.0	150 + 8.0	205 + 8.0	210 + 8.0	225 + 8.0
20 A	19.999 999	250 + 20	350 + 20	450 + 20	455 + 20	500 + 20

### Notes:

- <sup>[1]</sup> Specifications apply for max resolution in each function, normal mode.  
<sup>[2]</sup> Assumes 4-hour warm-up period.  
<sup>[3]</sup> Input zero or offset null required whenever the temperature moves more than ± 1 °C from the temperature at which the previous null/zero was performed.  
<sup>[4]</sup> TCal – Ambient calibration temperatures.

# 8508A Reference Multimeter

riešenia na presné meranie

www.elseo.sk/Fluke-Calibration

## Precision Multimeters

### AC Voltage

AC Voltage <sup>[1] [2] [6] [7]</sup>							
Range	Full Scale	Frequency (Hz)	Uncertainty Relative to Cal Stds			Absolute Uncertainties <sup>[9]</sup>	
			± (ppm Reading + ppm Range) <sup>[4]</sup>				
			24 hour TCal ± 1 °C	90 day TCal ± 1 °C	365 day TCal ± 1 °C	365 day TCal ± 1 °C	365 day TCal ± 5 °C
<b>95 % Confidence Level</b>							
200 mV	199.999 9	1 to 10	80 + 70	120 + 70	120 + 70	160 + 70	165 + 70
		10 to 40	80 + 20	120 + 20	120 + 20	130 + 20	140 + 20
		40 to 100	60 + 20	100 + 20	100 + 20	110 + 20	115 + 20
		100 to 2 k	40 + 10	100 + 10	100 + 10	105 + 10	110 + 10
		2 k to 10 k	60 + 20	100 + 20	100 + 20	105 + 20	135 + 20
		10 k to 30 k	250 + 30	300 + 40	300 + 40	305 + 40	340 + 40
		30 k to 100 k	400 + 100	700 + 100	700 + 100	705 + 100	765 + 100
2 V, 20 V, 200 V	1.999 999	1 to 10	70 + 60	100 + 60	100 + 60	140 + 60	150 + 60
	19.999 99	10 to 40	70 + 10	100 + 10	100 + 10	105 + 10	115 + 10
	199.999 9	40 to 100	50 + 10	80 + 10	80 + 10	85 + 10	90 + 10
		100 to 2 k	30 + 10	60 + 10	60 + 10	65 + 10	75 + 10
		2 k to 10 k	50 + 10	80 + 10	80 + 10	85 + 10	110 + 10
		10 k to 30 k	100 + 20	200 + 20	200 + 20	205 + 20	220 + 20
		30 k to 100 k	250 + 100	500 + 100	500 + 100	505 + 100	570 + 100
		100 k to 300 k	0.15 % + 0.1 %	0.3 % + 0.1 %	0.3 % + 0.1 %	0.3 % + 0.1 %	0.3 % + 0.1 %
300 k to 1 M	1 % + 0.5 %	1 % + 1 %	1 % + 1 %	1 % + 1 %	1 % + 1 %		
1000 V <sup>[8]</sup>	1050.000	1 to 10	70 + 70	100 + 70	100 + 70	140 + 70	150 + 70
		10 to 40	70 + 20	100 + 20	100 + 20	110 + 20	120 + 20
		40 to 10 k	50 + 20	80 + 20	80 + 20	95 + 20	115 + 20
		10 k to 30 k	100 + 40	200 + 40	200 + 40	205 + 40	225 + 40
		30 k to 100 k	250 + 200	500 + 200	500 + 200	510 + 200	580 + 200
<b>99 % Confidence Level</b>							
200 mV	199.999 9	1 to 10	90 + 80	140 + 80	140 + 80	200 + 80	210 + 80
		10 to 40	90 + 25	140 + 25	140 + 25	145 + 25	160 + 25
		40 to 100	70 + 25	115 + 25	115 + 25	125 + 25	135 + 25
		100 to 2 k	45 + 12	115 + 12	115 + 12	125 + 12	135 + 12
		2 k to 10 k	70 + 25	115 + 25	115 + 25	125 + 25	165 + 25
		10 k to 30 k	270 + 35	340 + 50	340 + 50	345 + 50	395 + 50
		30 k to 100 k	450 + 120	750 + 120	750 + 120	755 + 120	855 + 120
2 V, 20 V 200 V	1.999 999	1 to 10	80 + 70	115 + 70	115 + 70	180 + 70	190 + 70
	19.999 99	10 to 40	80 + 12	115 + 12	115 + 12	120 + 12	135 + 12
	199.999 9	40 to 100	60 + 12	90 + 12	90 + 12	95 + 12	110 + 12
		100 to 2 k	35 + 12	70 + 12	70 + 12	75 + 12	90 + 12
		2 k to 10 k	60 + 12	90 + 12	90 + 12	95 + 12	135 + 12
		10 k to 30 k	115 + 25	240 + 25	240 + 25	245 + 25	260 + 25
		30 k to 100 k	270 + 120	550 + 120	550 + 120	555 + 120	650 + 120
		100 k to 300 k	0.15 % + 0.12 %	0.3 % + 0.12 %	0.3 % + 0.12 %	0.3 % + 0.12 %	0.3 % + 0.12 %
300 k to 1 M	1 % + 0.6 %	1 % + 1.2 %	1 % + 1.2 %	1 % + 1.2 %	1 % + 1.2 %		
1000 V <sup>[8]</sup>	1050.000	1 to 10	80 + 80	115 + 80	115 + 80	180 + 80	190 + 80
		10 to 40	80 + 25	115 + 25	115 + 25	135 + 25	145 + 25
		40 to 10 k	60 + 25	90 + 25	90 + 25	110 + 25	140 + 25
		10 k to 30 k	115 + 50	240 + 50	240 + 50	250 + 50	265 + 50
		30 k to 100 k	270 + 250	600 + 250	600 + 250	615 + 250	700 + 250

- Notes:**
- <sup>[1]</sup> Specifications apply for max resolution in each function, normal mode.
  - <sup>[2]</sup> Assumes 4-hour warm-up period.
  - <sup>[3]</sup> Input zero or offset null required whenever the temperature moves more than ± 1 °C from the temperature at which the previous null/zero was performed.
  - <sup>[4]</sup> TCal – Ambient calibration temperatures.
  - <sup>[5]</sup> Integration time > 1 power line cycle.
  - <sup>[6]</sup> Valid for signals > 1 % full scale, transfer mode on. Signal must be dc coupled < 40 Hz. Readings invalid with transfer mode on and 1 Hz filter selected when using internal trigger mode.
  - <sup>[7]</sup> Max Volt.Hertz 3 x 10<sup>7</sup>.
  - <sup>[8]</sup> > 300 V, < 10 kHz add: ± 0.0004 (R-300)<sup>2</sup> ppm  
> 300 V, 10 kHz to 30 kHz add: ± (0.0004 + (F - 10000) \* IE-7) \* (R - 300)<sup>2</sup> ppm  
< 300 V, > 30 kHz add: ± 0.0024 (R-300)<sup>2</sup> ppm.
  - <sup>[9]</sup> Typical below 10 Hz for ac V, below 10 Hz, and above 10 kHz for ac I and above 2 GΩ for resistance.



## AC Current

AC Current <sup>[1]</sup> <sup>[2]</sup> <sup>[6]</sup> <sup>[9]</sup>							
Range	Full Scale	Frequency (Hz)	Uncertainty Relative to Cal Stds			Absolute Uncertainties <sup>[9]</sup>	
			± (ppm Reading + ppm Range) <sup>[4]</sup>				
			24 hour TCal ± 1 °C	90 day TCal ± 1 °C	365 day TCal ± 1 °C	365 day TCal ± 1 °C	365 day TCal ± 5 °C
<b>95 % Confidence Level</b>							
200 µA,	199.999 9	1 to 10	200 + 100	250 + 100	250 + 100	290 + 100	310 + 100
2 mA,	1.999 999	10 to 10 k	200 + 100	250 + 100	250 + 100	280 + 100	300 + 100
20 mA	19.999 99	10 k to 30 k	500 + 100	600 + 100	600 + 100	650 + 100	710 + 100
		30 k to 100 k	0.35 % + 100	0.4 % + 100	0.4 % + 100	0.4 % + 100	0.4 % + 100
200 mA	199.999 9	1 to 10	200 + 100	250 + 100	250 + 100	290 + 100	310 + 100
		10 to 10 k	200 + 100	250 + 100	250 + 100	250 + 100	290 + 100
		10 k to 30 k	500 + 100	600 + 100	600 + 100	600 + 100	625 + 100
2 A	1.999 999	10 to 2 k	500 + 100	600 + 100	600 + 100	600 + 100	620 + 100
		2 k to 10 k	600 + 100	700 + 100	700 + 100	700 + 100	725 + 100
		10 k to 30 k	0.25 % + 100	0.3 % + 100	0.3 % + 100	0.3 % + 100	0.3 % + 100
20 A	19.999 99	10 to 2 k	700 + 100	800 + 100	800 + 100	800 + 100	820 + 100
		2 k to 10 k	0.2 % + 100	0.25 % + 100	0.25 % + 100	0.25 % + 100	0.25 % + 100
<b>99 % Confidence Level</b>							
200 µA,	199.999 9	1 to 10	250 + 120	300 + 120	300 + 120	380 + 120	400 + 120
2 mA,	1.999 999	10 to 10 k	250 + 120	300 + 120	300 + 120	340 + 120	370 + 120
20 mA	19.999 99	10 k to 30 k	600 + 120	700 + 120	700 + 120	775 + 120	800 + 120
		30 k to 100 k	0.35 % + 120	0.4 % + 120	0.4 % + 120	0.4 % + 120	0.4 % + 120
200 mA	199.999 9	1 to 10	250 + 120	300 + 120	300 + 120	380 + 120	400 + 120
		10 to 10 k	250 + 120	300 + 120	300 + 120	305 + 120	360 + 120
		10 k to 30 k	600 + 120	700 + 120	700 + 120	700 + 120	740 + 120
2 A	1.999 999	10 to 2 k	600 + 120	700 + 120	700 + 120	705 + 120	725 + 120
		2 k to 10 k	700 + 120	800 + 120	800 + 120	815 + 120	860 + 120
		10 k to 30 k	0.25 % + 120	0.3 % + 120	0.3 % + 120	0.3 % + 120	0.3 % + 120
20 A	19.999 99	10 to 2 k	800 + 120	900 + 120	900 + 120	900 + 120	920 + 120
		2 k to 10 k	0.2 % + 120	0.25 % + 120	0.25 % + 120	0.25 % + 120	0.25 % + 120

### Notes:

- <sup>[1]</sup> Specifications apply for max resolution in each function, normal mode.
- <sup>[2]</sup> Assumes 4-hour warm-up period.
- <sup>[3]</sup> Input zero or offset null required whenever the temperature moves more than ± 1 °C from the temperature at which the previous null/zero was performed.
- <sup>[4]</sup> TCal – Ambient calibration temperatures.
- <sup>[5]</sup> Integration time > 1 power line cycle.
- <sup>[6]</sup> Valid for signals > 1 % full scale, transfer mode on. Signal must be dc coupled < 40 Hz. Readings invalid with transfer mode on and 1 Hz filter selected when using internal trigger mode.
- <sup>[7]</sup> Max Volt.Hertz 3 x 10<sup>7</sup>.
- <sup>[8]</sup> > 300 V, < 10 kHz add: ± 0.0004 (R-300)<sup>2</sup> ppm  
 > 300 V, 10 kHz to 30 kHz add: ± (0.0004 + (F - 10000) \* IE-7) \* (R - 300)<sup>2</sup> ppm  
 < 300 V, > 30 kHz add: ± 0.0024 (R-300)<sup>2</sup> ppm.
- <sup>[9]</sup> Typical below 10 Hz for ac V, below 10 Hz, and above 10 kHz for ac I and above 2 GΩ for resistance.

# 8508A Reference Multimeter

riešenia na presné meranie

www.elseo.sk/Fluke-Calibration

## Precision Multimeters

### Resistance

Resistance <sup>[1] [2] [3] [9]</sup>							
Range	Full Scale	Mode <sup>[10]</sup>	Uncertainty Relative to Cal Stds			Absolute Uncertainties	
			± (ppm Reading + ppm Range) <sup>[4]</sup>				
			24 hour TCal ± 1 °C	90 day TCal ± 1 °C	365 day TCal ± 1 °C	365 day TCal ± 1 °C	365 day TCal ± 5 °C
<b>95 % Confidence Level</b>							
2 Ω	1.999 999 99	Normal	5.0 + 2.0	8.0 + 2.0	10 + 2.0	15 + 2.0	17 + 2.0
20 Ω	19.999 999 9	Normal	2.5 + 0.7	4.5 + 0.7	7.0 + 0.7	9.0 + 0.7	9.5 + 0.7
200 Ω	199.999 999	Normal	1.5 + 0.25	4.0 + 0.25	7.0 + 0.25	7.5 + 0.25	8.0 + 0.25
2 kΩ	1.999 999 99	Normal	1.0 + 0.25	3.5 + 0.25	7.0 + 0.25	7.5 + 0.25	8.0 + 0.25
20 kΩ	19.999 999 9	Normal	1.0 + 0.25	3.5 + 0.25	7.0 + 0.25	7.5 + 0.25	8.0 + 0.25
200 kΩ	199.999 999	Normal	1.0 + 0.25	3.5 + 0.25	7.0 + 0.25	7.5 + 0.25	8.0 + 0.25
2 MΩ	1.999 999 99	Normal	2.0 + 0.5	4.0 + 0.5	7.0 + 0.5	8.5 + 0.5	9.0 + 0.5
20 MΩ	19.999 999 9	Normal	3.5 + 5.0	6.0 + 5.0	9.0 + 5.0	15 + 5.0	20 + 5.0
200 MΩ	199.999 999	Normal	20 + 50	25 + 50	30 + 50	60 + 50	120 + 50
2 GΩ	1.999 999 99	Normal	250 + 500	350 + 500	500 + 500	525 + 500	1510 + 500
2 Ω	1.999 999 99	Lo current	5.0 + 2.0	8.0 + 2.0	10 + 2.0	15 + 2.0	17 + 2.0
20 Ω	19.999 999 9	Lo current	2.5 + 0.7	4.5 + 0.7	7.0 + 0.7	9.0 + 0.7	9.5 + 0.7
200 Ω	199.999 999	Lo current	2.5 + 0.7	5.0 + 0.7	7.0 + 0.7	7.5 + 0.7	8.0 + 0.7
2 kΩ	1.999 999 99	Lo current	2.5 + 0.7	5.0 + 0.7	7.0 + 0.7	7.5 + 0.7	8.0 + 0.7
20 kΩ	19.999 999 9	Lo current	2.5 + 0.7	5.0 + 0.7	7.0 + 0.7	7.5 + 0.7	8.0 + 0.7
200 kΩ	199.999 999	Lo current	5.0 + 0.5	6.5 + 0.5	7.0 + 0.5	7.5 + 0.5	8.0 + 0.5
2 MΩ	1.999 999 99	Lo current	7.0 + 0.5	8.0 + 0.5	9.0 + 0.5	10 + 0.5	15 + 0.5
20 MΩ	19.999 999 9	Lo current	20 + 5.0	20 + 5.0	25 + 5.0	35 + 5.0	90 + 5.0
200 MΩ	199.999 999	Lo current	250 + 500	350 + 500	500 + 500	515 + 500	1505 + 500
2 GΩ	1.999 999 99	Lo current	250 + 500	350 + 500	500 + 500	525 + 500	1510 + 500
20 MΩ	19.999 999 9	High voltage	2.0 + 0.5	4.0 + 0.5	7.0 + 0.5	15 + 0.5	17 + 0.5
200 MΩ	199.999 999	High voltage	3.5 + 5.0	6.0 + 5.0	9.0 + 5.0	60 + 5.0	65 + 5.0
2 GΩ	1.999 999 99	High voltage	20 + 50	25 + 50	30 + 50	150 + 50	180 + 50
20 GΩ	19.999 999 9	High voltage	250 + 500	350 + 500	500 + 500	525 + 500	1510 + 500
<b>99 % Confidence Level</b>							
2 Ω	1.999 999 99	Normal	6.0 + 2.5	10 + 2.5	12 + 2.5	19 + 2.5	22 + 2.5
20 Ω	19.999 999 9	Normal	3.0 + 0.9	5.5 + 0.9	8.5 + 0.9	11.5 + 0.9	12.0 + 0.9
200 Ω	199.999 999	Normal	1.8 + 0.3	5.0 + 0.3	8.5 + 0.3	9.5 + 0.3	10.0 + 0.3
2 kΩ	1.999 999 99	Normal	1.2 + 0.3	4.5 + 0.3	8.5 + 0.3	9.5 + 0.3	10.0 + 0.3
20 kΩ	19.999 999 9	Normal	1.2 + 0.3	4.5 + 0.3	8.5 + 0.3	9.5 + 0.3	10.0 + 0.3
200 kΩ	199.999 999	Normal	1.2 + 0.3	4.5 + 0.3	8.5 + 0.3	9.5 + 0.3	10.0 + 0.3
2 MΩ	1.999 999 99	Normal	2.5 + 0.6	5.0 + 0.6	8.5 + 0.6	10.5 + 0.6	12.0 + 0.6
20 MΩ	19.999 999 9	Normal	4.5 + 6.0	7.5 + 6.0	12 + 6.0	20 + 6.0	25 + 6.0
200 MΩ	199.999 999	Normal	25 + 60	30 + 60	35 + 60	75 + 60	150 + 60
2 GΩ	1.999 999 99	Normal	325 + 600	450 + 600	650 + 600	675 + 600	1810 + 600
2 Ω	1.999 999 99	Lo current	6.0 + 2.5	10 + 2.5	12 + 2.5	19 + 2.5	22 + 2.5
20 Ω	19.999 999 9	Lo current	3.0 + 0.9	5.5 + 0.9	8.5 + 0.9	11.5 + 0.9	12.0 + 0.9
200 Ω	199.999 999	Lo current	3.0 + 0.9	6.5 + 0.9	8.5 + 0.9	9.5 + 0.9	10.0 + 0.9
2 kΩ	1.999 999 99	Lo current	3.0 + 0.9	6.5 + 0.9	8.5 + 0.9	9.5 + 0.9	10.0 + 0.9
20 kΩ	19.999 999 9	Lo current	3.0 + 0.9	6.5 + 0.9	8.5 + 0.9	9.5 + 0.9	10.0 + 0.9
200 kΩ	199.999 999	Lo current	6.0 + 0.6	8.0 + 0.6	9.0 + 0.6	9.5 + 0.6	10.0 + 0.6
2 MΩ	1.999 999 99	Lo current	8.0 + 0.6	10.0 + 0.6	12.0 + 0.6	13.0 + 0.6	17.0 + 0.6
20 MΩ	19.999 999 9	Lo current	25 + 6.0	25 + 6.0	30 + 6.0	45 + 6.0	110 + 6.0
200 MΩ	199.999 999	Lo current	325 + 600	450 + 600	650 + 600	670 + 600	1810 + 600
2 GΩ	1.999 999 99	Lo current	325 + 600	450 + 600	650 + 600	675 + 600	1810 + 600
20 MΩ	19.999 999 9	High voltage	2.5 + 0.6	5.0 + 0.6	8.5 + 0.6	19 + 0.6	20 + 0.6
200 MΩ	199.999 999	High voltage	4.5 + 6.0	7.5 + 6.0	12 + 6.0	75 + 6.0	80 + 6.0
2 GΩ	1.999 999 99	High voltage	25 + 60	30 + 60	35 + 60	195 + 60	230 + 60
20 GΩ	19.999 999 9	High voltage	325 + 600	450 + 600	650 + 600	675 + 600	1810 + 600

- Notes:**
- [1] Specifications apply for max resolution in each function, normal mode.
  - [2] Assumes 4-hour warm-up period.
  - [3] Input zero or offset null required whenever the temperature moves more than ± 1 °C from the temperature at which the previous null/zero was performed.
  - [4] TCal – Ambient calibration temperatures.
  - [9] Typical below 10 Hz for ac V, below 10 Hz, and above 10 kHz for ac I and above 2 GΩ for resistance.
  - [10] Tru Ohms mode available on 2 Ω to 20 kΩ ranges. Read rate reduced in Tru Ohms mode. Specification for Tru Ohms same as corresponding normal or lo current range.

Elso Philips Service, Trenčín

## Resistance

Resistance - Normal Mode (Secondary Specifications) <sup>[1] [2] [3] [10]</sup>				
Range	Measurement Current	Transfer Uncertainty 20 mins ± 1 °C ± (ppm Reading + ppm Range)	Temperature Coefficient	
			15 °C to 30 °C	5 °C to 15 °C 30 °C to 40 °C
			± ppm Reading/°C	
2 Ω	100 mA	2.0 + 2.0	1.5	2.5
20 Ω	10 mA	0.8 + 0.7	0.6	1.0
200 Ω	10 mA	0.2 + 0.15	0.5	0.8
2 kΩ	1 mA	0.2 + 0.15	0.5	0.8
20 kΩ	100 μA	0.2 + 0.15	0.5	0.8
200 kΩ	100 μA	0.2 + 0.15	0.5	0.8
2 MΩ	10 μA	0.5 + 0.5	0.6	1.0
20 MΩ	1 μA	2.5 + 5	2	3
200 MΩ	100 nA	15 + 50	20	30
2 GΩ	10 nA	200 + 500	200	300
Resistance - Lo Current Mode (Secondary Specifications) <sup>[1] [2] [3] [10]</sup>				
Range	Measurement Current	Transfer Uncertainty 20 mins ± 1 °C ± (ppm Reading + ppm Range)	Temperature Coefficient	
			15 °C to 30 °C	5 °C to 15 °C 30 °C to 40 °C
			± ppm Reading/°C	
2 Ω	100 mA	2.0 + 2.0	1.5	2.5
20 Ω	10 mA	0.8 + 0.7	0.6	1.0
200 Ω	1 mA	0.8 + 0.7	0.6	1.0
2 kΩ	100 μA	0.8 + 0.7	0.6	1.0
20 kΩ	10 μA	0.8 + 0.7	0.6	1.0
200 kΩ	10 μA	0.5 + 0.5	0.6	1.0
2 MΩ	1 μA	2.0 + 0.5	2	3
20 MΩ	100 nA	15 + 5	20	30
200 MΩ	10 nA	200 + 500	200	300
2 GΩ	10 nA	200 + 500	200	300
Resistance - High Voltage Mode (Secondary Specifications) <sup>[1] [2] [3]</sup>				
Range <sup>[9]</sup>	Measurement Current	Transfer Uncertainty 20 mins ± 1 °C ± (ppm Reading + ppm Range)	Temperature Coefficient	
			15 °C to 30 °C	5 °C to 15 °C 30 °C to 40 °C
			± ppm Reading/°C	
20 MΩ	10 μA	0.5 + 0.5	0.6	1.0
200 MΩ	1 μA	2.0 + 0.5	2.0	3
2 GΩ	100 nA	15 + 50	20	30
20 GΩ	10 nA	200 + 500	200	300
<b>Type</b>	True 4-wire with Ohms guard, 2-wire selectable			
<b>Ratio accuracy</b>	Range to Range: ± (Net Front Input Accuracy + Net Rear Input Accuracy) Within Range: Apply 24 hour or 20 minute Transfer Uncertainty specifications			

### Notes:

<sup>[1]</sup> Specifications apply for max resolution in each function, normal mode.

<sup>[2]</sup> Assumes 4-hour warm-up period.

<sup>[3]</sup> Input zero or offset null required whenever the temperature moves more than ± 1 °C from the temperature at which the previous null/zero was performed.

<sup>[9]</sup> Typical below 10 Hz for ac V, below 10 Hz, and above 10 kHz for ac I and above 2 GΩ for resistance.

<sup>[10]</sup> Tru Ohms mode available on 2 Ω to 20 kΩ ranges. Read rate reduced in Tru Ohms mode. Specification for Tru Ohms same as corresponding normal or lo current range.

# 8508A Reference Multimeter

riešenia na presné meranie

www.elseo.sk/Fluke-Calibration

## Precision Multimeters

### Temperature

Temperature Readout <sup>[1]</sup> <sup>[2]</sup> <sup>[3]</sup>					
Resistance	Absolute Resistance	Typical Equivalent Temperature Measurement Uncertainty <sup>[12]</sup>			
Range	Measurement Uncertainty 365 day Tcal ± 1 °C <sup>[4]</sup> ± (ppm Reading + mΩ) <sup>[11]</sup>	Probe Type	Nominal Temperature (°C)	Resistance (Ω)	Accuracy ± (°C)
<b>95 % Confidence Level</b>					
0 to 199.999 999 Ω	7.5 + 0.14	25 Ω PRT/SPRT	-200	5	0.0085
		25 Ω PRT/SPRT	0	25	0.0035
		25 Ω PRT/SPRT	660	84	0.0025
		100 Ω PRT/SPRT	-200	20	0.0035
		100 Ω PRT/SPRT	0	100	0.0025
		100 Ω PRT/SPRT	232	185	0.0020
200 to 1999.999 99 Ω	7.5 + 0.5	100 Ω PRT/SPRT	400	250	0.0025
<b>99 % Confidence Level</b>					
0 to 199.999 999 Ω	9.5 + 0.18	25 Ω PRT/SPRT	-200	5	0.0010
		25 Ω PRT/SPRT	0	25	0.0040
		25 Ω PRT/SPRT	660	84	0.0025
		100 Ω PRT/SPRT	-200	20	0.0040
		100 Ω PRT/SPRT	0	100	0.0025
		100 Ω PRT/SPRT	232	185	0.0020
200 to 1999.999 99 Ω	9.5 + 0.6	100 Ω PRT/SPRT	400	250	0.0025
<b>Type</b>	4-wire current reversal resistance measurement with readout of equivalent temperature. 2-wire and 3-wire selectable without current reversal. Refer to Resistance specifications for additional details.				
<b>Temperature range</b>	-200 °C to 660 °C, readout also available in °F or K.				
<b>Linearization</b>	ITS-90 or Callendar van Dusen. Entry and storage of coefficients and nominal resistance for up to 100 probes.				
<b>Current source</b>	1 mA				

#### Notes:

<sup>[1]</sup> Specifications apply for max resolution in each function, normal mode.

<sup>[2]</sup> Assumes 4-hour warm-up period.

<sup>[3]</sup> Input zero or offset null required whenever the temperature moves more than ± 1 °C from the temperature at which the previous null/zero was performed.

<sup>[4]</sup> TCal – Ambient calibration temperatures.

<sup>[11]</sup> Valid for 4-wire sensor.

<sup>[12]</sup> Not including sensor uncertainty.

### General Specifications

#### Power

115 V Setting: 100 V to 120 V rms  
± 10 %

230 V Setting: 200 V to 240 V rms  
± 10 %

**Frequency:** 47 Hz to 63 Hz

**Consumption:** < 80 VA

#### Dimensions

Height: 88 mm (3.5 in)

Width: 427 mm (16.8 in)

Depth: 487 mm (19.2 in)

Weight: 11.5 kg (25.5 lbs)

#### Environment temperature

Operating: 0 °C to 50 °C

Specified Operation: 5 °C to 40 °C

Calibration (TCal): 20 °C to 25 °C

Factory Cal Temp: 23 °C

Storage: -20 °C to 70 °C

Warm Up: 4 hours to full  
uncertainty specification

#### Relative humidity (non-condensing)

Operating: 5 °C to 40 °C < 90 %

Storage: 0 °C to 70 °C < 95 %

#### Altitude

Operating: < 2000 meters

Storage: < 12000 meters

#### Autorange

Range Up: 100 % of range

Range Down: 9 % of range

(18 % on 1000 V range)

#### Remote interface

IEEE 488.2

#### Warranty

One-year

#### Calibration

Standard Certificate: NPL-UK,  
traceable with data

Optional: NVLAP and UKAS,  
accredited with data

### Ordering Information Models

**8508A** Reference Multimeter

**8508A/01** Reference Multimeter  
with Front and Rear 4 mm binding  
posts and rear input ratio  
measurement

#### Options and Accessories

**8508A-LEAD** Lead kit including  
two pairs of 1 m six-wire ptfе cable  
terminated with gold flashed  
spades connectors and 4 mm plugs

**8508-7000K** Calibration Kit including  
one 1 GΩ resistor, one screened  
lead set, two 4-wire shorting P.C.B.  
and one carry case

**8508A-PRT** 100 Ohm Platinum  
Resistance Thermometer

**8508A-SPRT** Standard Platinum  
Resistance Thermometer

**Y8508** Rack Mount Kit

**Y8508S** Rack Mount Slide Kit

**1256990** NVLAP Accredited  
Calibration

**1883673** UKAS Accredited  
Calibration

#### Software

**MET/CAL® Plus** Automated  
Calibration Management Software

Elsø Philips Service, Trenčín

**For dc/lf, oscilloscope and power calibration, and time and frequency standards**

Workload	Product	Options	Software
DMMs < 5 digits	5500A 9100		MET/CAL Plus 5500/CAL
DMMs ≥ 5 digits	5720A 5700A 5520A	5700A/EP-UG	MET/CAL Plus 5500/CAL
DMMs ≥ 6½ to 8½ digits	5720A 5700A 5520A	5700A-03 5700A/EP-UG	MET/CAL Plus
Oscilloscopes ≤ 300 MHz	9500B/600 5820A 5520A/3 5500A/3 9100	9510 5800A-5 9100-250	MET/CAL Plus 5500/CAL
Oscilloscopes ≤ 600 MHz	9500B/600 5820A 5520A/6 5500A/6 9100	9510 5800A-5 9100-600	MET/CAL Plus 5500/CAL 5800A/TDP
Oscilloscopes up to 14 GHz	9500B/1100 9500B/3200  5820A	9510 9530 9550 9560 5820A-GHz 5820A-5	MET/CAL Plus 5500/CAL
Thermocouple/ RDT thermometers	5520A 5500A 9100 525A		MET/CAL Plus 5500/CAL
Analog volt/ohm/ amp meters	5520A 5500A 9100		MET/CAL Plus 5500/CAL
Watt meters	5520A 5500A 9100 6100A	6100/80/E 6100A/E 6100A/80	MET/CAL Plus 5500/CAL
Power harmonics analyzers	5520A/PQ 5520A 5500A 9100 6100A	9100A-PWR 6100A/80	MET/CAL Plus 5500/CAL
Process calibrators	5520A 5500A 9100, requires DMM 8508A 525A	700P Series  525A-P Series	MET/CAL Plus 5500/CAL
RF voltmeters	5720A/03 5700A/03		MET/CAL Plus
Chart/strip/ XY recorders	5520A 5500A 9100 525A		MET/CAL Plus 5500/CAL

continued on next page



The broad range of Fluke calibrators includes innovative solutions for wide workload coverage, dedicated oscilloscope calibration, high accuracy, and temperature and pressure calibration and measurement.

Of the multi-product calibrators, the 5520A calibrates the widest workload, including 6½ digit DMMs, oscilloscopes to 300 MHz, 600 MHz and 1.1 GHz, pressure sensors, and much more. The 9100 Universal Calibration System features options supporting power metering and insulation/continuity testers up to 2 GΩ.

For dedicated oscilloscope workloads, the 9500B offers the benefits of hands-free, fully automated, accurate calibration at a price and performance level that meets a wide range of needs and budgets, featuring leveled sine waves to 6.4 GHz and edges to 25 ps when used with the 9560 Active Head. The 5820A calibrates oscilloscopes up to 2.1 GHz for upgradeable entry-level performance.

In the high-accuracy calibrator class, the 5720A Multifunction Calibrator offers excellent precision, supporting 8½ digit DMMs.

Rounding out the calibrator line is the 525A Temperature and Pressure Calibrator, which provides high accuracy and broad functionality for temperature and pressure instrument calibration.

For dc/lf, oscilloscope and power calibration, and time and frequency standards cont.

Workload	Product	Options	Software
Data loggers	5520A 5500A 9100		MET/CAL® Plus 5500/Cal
Current clamps and clamp meters	5520A 5500A 9100		MET/CAL® Plus 5500/CAL
Insulation/continuity test	9100	9100-135	
Time and frequency	910/910R 908 909 PM 6681R PM 6685R	910-01 910-70 PM 9621 PM 9624 PM 9625B	

### Standards Selection Guide

Workload	Product	Options	Software
Artifact calibration standards	5700A-7002 732B  7001 742A-1 742A-10K	732B/H 732B/C	
Direct voltage reference	734A 7004N 7010N		7050 Software
Direct voltage transfer standards	732B 7004T 7010T		7050 Software
Resistance standards	742A Series		
Alternating voltage standards	5790A 792A	5790A-03	
Current standards	A40/A40A		
Ratio standards	720A 752A		

### Calibration Training Selection Guide

Classroom training	Principles of Metrology Cal Lab Management I Cal Lab Management II MET/CAL Database and Reports MET/CAL Procedure Writing Advanced MET/CAL Procedure Writing I Advanced MET/CAL Procedure Writing II
Product specific training	Web-based Training MET/CAL Database Web Training MET/CAL Procedure Writing Web Training
Computer-based (CBT) training	MET/CAL-CBT7 Computer Based Training
Other training	On-site training is available for most of the above classes
Calibration/metrology reference	<i>Calibration: Philosophy in Practice, Second Edition, Item #937529</i>

# 5500A/5520A Multi-Product Calibrators

riešenia na presné meranie

www.elseo.sk/Fluke-Calibration

FLUKE®

## DC/LF Calibration

Calibration solutions that match your workload and budget



5520A Calibrator



5500A Calibrator

- Widest workload coverage, including meters to 6.5 digits and oscilloscopes to 1.1 GHz (with options)
- Compliance with quality standards made easy
- Easy to use
- Versatile and flexible
- Portable and rugged



## Tech Tip

MET/CAL® *Plus* automated calibration software has over 640 UUT calibration procedures available using the 5520A as the calibrator.

The standard Fluke 5500A Multi-Product Calibrator calibrates digital and analog multimeters, thermometers (thermocouple and RTD), wattmeters, data loggers, current clamps, various types of recorders, panel meters, process calibrators, power harmonics analyzers and many other similar measurement tools.

The 5520A builds on the 5500A's capabilities, extending its workload coverage even further. Its improved accuracy, expanded ranges, and added features, including current to 20 A and pressure measurement, as well as its capability to calibrate 5½ and 6½ digit multimeters, means the 5520A can cover virtually all your high-performance workload.

### Options and accessories provide flexibility and value

The 5500A and 5520A offer several options to provide truly complete calibration solutions, including:

- Options to calibrate oscilloscopes to 300 MHz, 600 MHz, or 1.1 GHz.
- A power quality option for the 5520A that provides additional calibration functions for power quality instruments, including traceability for highly distorted sine wave signals.
- MET/CAL® *Plus* calibration and documentation software to help you automate calibration, plus collect and report results.

- A complete range of accessories that enable you to connect to virtually any instrument, measure relative humidity, temperature and pressure, as well as calibrate high current clamps and clamp meters and to store and transport your calibrator.

### Compliance with quality standards made easy

With standards such as ISO 17025, there is a lot more to calibration than just making measurements. You also have documentation, control and reporting requirements to meet.

Fluke's optional Microsoft Windows®-based MET/CAL® *Plus* software simplifies the documentation of your procedures, adequacy and traceability as required by ISO 17025 and other similar quality standards. It also collects and reports calibration data and helps consistently, quickly and efficiently calibrate a wide variety of instruments. 5500/CAL is a special version of Fluke's MET/CAL® *Plus*, designed to work with the 5500A and 5520A. Because it controls instruments via an RS-232 (serial port), no IEEE interfaces are required.

For full and comprehensive specifications, refer to the extended specification data sheet at [www.fluke.com](http://www.fluke.com).

# 5500A/5520A Multi-Product Calibrators

riešenia na presné meranie

www.elseo.sk/Fluke-Calibration

## DC/LF Calibration

### DC Voltage Specifications

Range	Absolute Uncertainty, tcal $\pm 5\text{ }^{\circ}\text{C}$ $\pm$ (ppm of output + mV) 1 year		Resolution $\mu\text{V}$
	5500A	5520A	
0 to 329.9999 mV	60 + 3	20 + 1	0.1
0 to 3.299999 V	50 + 5	11 + 2	1
0 to 32.99999 V	50 + 50	12 + 20	10
30 V to 329.9999 V	55 + 500	18 + 150	100
100 V to 1000.000 V	55 + 1500	18 + 1500	1000
<b>Auxiliary Output (dual output mode only)</b>			
0 to 329.999 mV	400 + 350	400 + 350	1
0.33 V to 3.29999 V	400 + 350	400 + 350	10
3.3 V to 7 V	N/A	400 + 350	100
<b>TC Simulate and Measure in Linear 10 mV/<math>^{\circ}\text{C}</math> and 1 mV/<math>^{\circ}\text{C}</math> Modes</b>			
0 to 329.999 mV	60 + 3	50 + 3	0.1

### DC Current Specifications

Range	Absolute Uncertainty, tcal $\pm 5\text{ }^{\circ}\text{C}$ $\pm$ (ppm of output + mA) 1 year		Resolution $\mu\text{A}$
	5500A	5520A	
0 to 329.999 mA	N/A	150 + 0.02	1
0 to 3.29999 mA	130 + 0.05	100 + 0.05	0.01
0 to 32.9999 mA	100 + 0.25	100 + 0.25	0.1
0 to 329.999 mA	100 + 3.3	100 + 2.5	1
0 to 1.09999 A	N/A	200 + 40	10
0 to 2.19999 A	300 + 44	N / A	10
0 to 10.9999 A	600 + 330	N / A	100
1.1 to 2.99999 A	N/A	380 + 40	10
0 to 10.9999 A (20 A Range)	N/A	500 + 500	100
11 to 20.5 A (20 A Range)	N/A	1000 + 750	100
<b>5500A with the 5725A Amplifier</b>			
0 to 10.9999 A	400 + 330	N/A	100

### Resistance Specifications

Range	Absolute Uncertainty, tcal $\pm 5\text{ }^{\circ}\text{C}$ $\pm$ (ppm of output + $\Omega$ ) 1 year		Resolution $\Omega$	
	5500A	5520A	5500A	5520A
0 to 10.9999 $\Omega$	120 + 0.008	40 + 0.001	0.001	0.0001
11 to 32.9999	120 + 0.015	30 + 0.0015	0.001	0.0001
33 to 109.9999	90 + 0.015	28 + 0.0014	0.001	0.0001
110 to 329.9999	90 + 0.015	28 + 0.002	0.001	0.0001
330 to 1.099999 k $\Omega$	90 + 0.06	28 + 0.002	0.01	0.001
1.1 k $\Omega$ to 3.299999 k $\Omega$	90 + 0.06	28 + 0.02	0.01	0.001
3.3 k $\Omega$ to 10.99999 k $\Omega$	90 + 0.6	28 + 0.02	0.1	0.01
11 k $\Omega$ to 32.99999 k $\Omega$	90 + 0.6	28 + 0.2	0.1	0.01
33 k $\Omega$ to 109.9999 k $\Omega$	110 + 6	28 + 0.2	1	0.1
110 k $\Omega$ to 329.9999 k $\Omega$	120 + 6	32 + 2	1	0.1
330 k $\Omega$ to 1.099999 M $\Omega$	150 + 55	32 + 2	10	1
1.1 M $\Omega$ to 3.299999 M $\Omega$	150 + 55	60 + 30	10	1
3.3 M $\Omega$ to 10.99999 M $\Omega$	600 + 550	130 + 50	100	10
11 M $\Omega$ to 32.99999 M $\Omega$	1000 + 550	250 + 2500	100	10
33 M $\Omega$ to 109.9999 M $\Omega$	5000 + 5500	500 + 3000	1000	100
110 M $\Omega$ to 329.9999 M $\Omega$	5000 + 16500	3000 + 100000	1000	1000
330 M $\Omega$ to 1100 M $\Omega$	N/A	15000 + 500000	N/A	10000



## AC Voltage (Sine Wave) Specifications

Range	Frequency	Absolute Uncertainty, $t_{cal} \pm 5^\circ\text{C}$ $\pm$ (% of output + $\mu\text{V}$ ) 1 year		Resolution
		5500A	5520A	
1.0 mV to 32.999 mV	10 Hz to 45 Hz	0.35 + 20	.08 + 6	1 $\mu\text{V}$
	45 Hz to 10 kHz	0.15 + 20	.015 + 6	
	10 kHz to 20 kHz	0.2 + 20	.02 + 6	
	20 kHz to 50 kHz	0.25 + 20	.1 + 6	
	50 kHz to 100 kHz	0.35 + 33	.35 + 12	
	100 kHz to 500 kHz	1 + 60	.8 + 50	
33 mV to 329.999 mV	10 Hz to 45 Hz	0.25 + 50	.05 + 8	1 $\mu\text{V}$
	45 Hz to 10 kHz	0.05 + 20	.0145 + 8	
	10 kHz to 20 kHz	0.1 + 20	.016 + 8	
	20 kHz to 50 kHz	0.16 + 40	.035 + 8	
	50 kHz to 100 kHz	0.24 + 170	.08 + 32	
	100 kHz to 500 kHz	0.7 + 333	.2 + 70	
0.33 V to 3.29999 V	10 Hz to 45 Hz	0.15 + 250	.03 + 50	10 $\mu\text{V}$
	45 Hz to 10 kHz	0.03 + 60	.015 + 60	
	10 kHz to 20 kHz	0.08 + 60	.019 + 60	
	20 kHz to 50 kHz	0.14 + 300	.03 + 50	
	50 kHz to 100 kHz	0.24 + 1700	.07 + 125	
	100 kHz to 500 kHz	0.5 + 3300	.24 + 600	
3.3 V to 32.9999 V	10 Hz to 45 Hz	0.15 + 2500	.03 + 650	100 $\mu\text{V}$
	45 Hz to 10 kHz	0.04 + 600	.015 + 600	
	10 kHz to 20 kHz	0.08 + 2600	.024 + 600	
	20 kHz to 50 kHz	0.19 + 5000	.035 + 600	
	50 kHz to 100 kHz	0.24 + 17000	.09 + 1600	
	100 kHz to 500 kHz	0.5 + 33000	.24 + 6000	
33 V to 329.999 V	45 Hz to 1 kHz	0.05 + 6600	.019 + 2000	1 mV
	1 kHz to 10 kHz	0.08 + 15000	.02 + 6000	
	10 kHz to 20 kHz	0.09 + 33000	.025 + 6000	
	20 kHz to 50 kHz	N/A	.03 + 6000	
	50 kHz to 100 kHz	N/A	.2 + 50000	
	100 kHz to 500 kHz	N/A	.2 + 50000	
330 V to 1020 V	45 Hz to 1 kHz	0.05 + 80000	.03 + 10000	10 mV
	1 kHz to 5 kHz	0.20 + 100000	.025 + 10000	
	5 kHz to 10 kHz	0.20 + 500000	.03 + 10000	
<b>5500A with the 5725A Amplifier</b>				
100 to 1020 V	45 Hz to 1 kHz	0.05 + 80000	N/A	10 mV
	1 kHz to 20 kHz	0.08 + 100000	N/A	
	20 kHz to 30 kHz	0.10 + 100000	N/A	
100 to 750 V	30 kHz to 100 kHz	0.5 + 500000	N/A	
<b>AUX (Auxiliary Output) [dual output mode only]</b>				
10 mV to 329.999 mV	10 Hz to 20 Hz	0.2 + 370	0.2 + 370	1 $\mu\text{V}$
	20 Hz to 45 Hz	0.1 + 370	0.1 + 370	
	45 Hz to 1 kHz	0.1 + 370	0.1 + 370	
	1 kHz to 5 kHz	0.2 + 450	0.2 + 450	
	5 kHz to 10 kHz	0.4 + 450	0.4 + 450	
	10 kHz to 30 kHz	N/A	5.0 + 900	
0.33 V to 3.29999 V	10 Hz to 20 Hz	0.2 + 450	0.2 + 450	10 $\mu\text{V}$
	20 Hz to 45 Hz	0.1 + 450	0.1 + 450	
	45 Hz to 1 kHz	0.09 + 450	0.09 + 450	
	1 kHz to 5 kHz	0.2 + 1400	0.2 + 1400	
	5 kHz to 10 kHz	0.4 + 1400	0.4 + 1400	
	10 kHz to 30 kHz	N/A	5.0 + 2800	
3.3 V to 5 V	10 Hz to 20 Hz	N/A	0.2 + 450	100 $\mu\text{V}$
	20 Hz to 45 Hz	N/A	0.1 + 450	
	45 Hz to 1 kHz	N/A	0.09 + 450	
	1 kHz to 5 kHz	N/A	0.2 + 1400	
	5 kHz to 10 kHz	N/A	0.4 + 1400	

# 5500A/5520A Multi-Product Calibrators

riešenia na presné meranie

www.elseo.sk/Fluke-Calibration

## DC/LF Calibration

### AC Current (Sine Wave) Specifications

Range	Frequency	Absolute Uncertainty, $t_{cal} \pm 5^\circ C$ $\pm$ (% of output + $\mu A$ ) 1 year		Resolution
		5500A	5520A	
29.00 $\mu A$ to 329.99 $\mu A$	10 Hz to 20 Hz	0.25 + 0.15	0.2 + 0.1	0.01 $\mu A$
	20 Hz to 45 Hz	0.125 + 0.15	0.15 + 0.1	
	45 Hz to 1 kHz	0.125 + 0.25	0.125 + 0.1	
	1 kHz to 5 kHz	0.4 + 0.15	0.3 + 0.15	
	5 kHz to 10 kHz	1.25 + 0.15	0.8 + 0.2	
	10 kHz to 30 kHz	N/A	1.6 + 0.4	
0.33 mA to 3.2999 mA	10 Hz to 20 Hz	0.2 + 0.3	0.2 + 0.15	0.01 $\mu A$
	20 Hz to 45 Hz	0.1 + 0.3	0.125 + 0.15	
	45 Hz to 1 kHz	0.1 + 0.3	0.1 + 0.15	
	1 kHz to 5 kHz	0.2 + 0.3	0.2 + 0.2	
	5 kHz to 10 kHz	0.6 + 0.3	0.5 + 0.3	
	10 kHz to 30 kHz	N/A	1.0 + 0.6	
3.3 mA to 32.999 mA	10 Hz to 20 Hz	0.2 + 3	0.18 + 2	0.1 $\mu A$
	20 Hz to 45 Hz	0.1 + 3	0.09 + 2	
	45 Hz to 1 kHz	0.09 + 3	0.04 + 2	
	1 kHz to 5 kHz	0.2 + 3	0.08 + 2	
	5 kHz to 10 kHz	0.6 + 3	0.2 + 3	
	10 kHz to 30 kHz	N/A	0.4 + 4	
33 mA to 329.99 mA	10 Hz to 20 Hz	0.2 + 30	0.18 + 20	1 $\mu A$
	20 Hz to 45 Hz	0.1 + 30	0.09 + 20	
	45 Hz to 1 kHz	0.09 + 30	0.04 + 20	
	1 kHz to 5 kHz	0.2 + 30	0.10 + 50	
	5 kHz to 10 kHz	0.6 + 30	0.2 + 100	
	10 kHz to 30 kHz	N/A	0.4 + 200	
0.33 A to 1.09999 A	10 Hz to 45 Hz	N/A	0.18 + 100	10 $\mu A$
	45 Hz to 1 kHz	N/A	0.05 + 100	
	1 kHz to 5 kHz	N/A	0.6 + 1000	
	5 kHz to 10 kHz	N/A	2.5 + 5000	
1.1 A to 2.99999 A	10 Hz to 45 Hz	N/A	0.18 + 100	10 $\mu A$
	45 Hz to 1 kHz	N/A	0.06 + 100	
	1 kHz to 5 kHz	N/A	0.6 + 1000	
	5 kHz to 10 kHz	N/A	2.5 + 5000	
3 A to 10.9999 A	45 Hz to 100 Hz	N/A	0.06 + 2000	100 $\mu A$
	100 kHz to 1 kHz	N/A	0.10 + 2000	
	1 kHz to 5 kHz	N/A	3.0 + 2000	
11 A to 20.5 A	45 Hz to 100 Hz	N/A	0.12 + 5000	100 $\mu A$
	100 Hz to 1 kHz	N/A	0.15 + 5000	
	1 kHz to 5 kHz	N/A	3.0 + 5000	
0.33 A to 2.19999 A	10 Hz to 45 Hz	0.2 + 300	N/A	10 $\mu A$
	45 Hz to 1 kHz	0.1 + 300	N/A	
	1 kHz to 5 kHz	0.75 + 300	N/A	
2.2 A to 11.9999 A	45 Hz to 65 Hz	0.06 + 2000	N/A	100 $\mu A$
	65 Hz to 500 Hz	0.10 + 2000	N/A	
	500 Hz to 1 kHz	0.33 + 2000	N/A	
<b>5500A with the 5725A Amplifier</b>				
1.5 A to 11 A	45 kHz to 1 kHz	0.1 + 100	N/A	100 $\mu A$
	1 kHz to 5 kHz	0.25 + 5000	N/A	
	5 kHz to 10 kHz	1 + 10000	N/A	

## Capacitance Specifications

Range	Absolute Uncertainty, tcal $\pm 5$ °C $\pm$ (% of output + floor) 1 year		Resolution
	5500A	5520A	
0.19 nF to 0.3999 nF		0.5 + 0.01 nF	0.1 pF
0.4 nF to 1.0999 nF		0.5 + 0.01 nF	0.1 pF
1.1 nF to 3.2999 nF		0.5 + 0.01 nF	0.1 pF
3.3 nF to 10.9999 nF		0.25 + 0.01 nF	0.1 pF
11 nF to 32.9999 nF		0.25 + 0.1 nF	0.1 pF
33 nF to 109.999 nF		0.25 + 0.1 nF	1 pF
110 nF to 329.999 nF		0.25 + 0.3 nF	1 pF
0.33 $\mu$ F to 1.09999 $\mu$ F		0.25 + 1 nF	10 pF
1.1 $\mu$ F to 3.29999 $\mu$ F		0.25 + 3 nF	10 pF
3.3 $\mu$ F to 10.9999 $\mu$ F		0.25 + 10 nF	100 pF
11 $\mu$ F to 32.9999 $\mu$ F		0.40 + 30 nF	100 pF
33 $\mu$ F to 109.999 $\mu$ F		0.45 + 100 nF	1 nF
110 $\mu$ F to 329.999 $\mu$ F		0.45 + 300 nF	1 nF
0.33 $\mu$ F to 1.09999mF		0.45 + 1 $\mu$ F	10 nF
1.1 mF to 3.2999 mF		0.45 + 3 $\mu$ F	10 nF
3.3 mF to 10.9999 mF		0.45 + 10 $\mu$ F	100 nF
11 mF to 32.9999 mF		0.75 + 30 $\mu$ F	100 nF
33 mF to 110 mF		1.1 + 100 $\mu$ F	10 mF
0.33 nF to 0.4999 nF	0.5 + 0.01 nF		0.1 pF
0.5 nF to 1.0999 nF	0.5 + 0.01 nF		0.1 pF
1.1 nF to 3.2999 nF	0.5 + 0.01 nF		0.1 pF
3.3 nF to 10.999 nF	0.5 + 0.01 nF		1 pF
11 nF to 32.999 nF	0.25 + 0.1 nF		1 pF
33 nF to 109.99 nF	0.25 + 0.1 nF		10 pF
110 nF to 329.99 nF	0.25 + 0.3 nF		10 pF
0.33 $\mu$ F to 1.0999 $\mu$ F	0.25 + 1 nF		100 pF
1.1 $\mu$ F to 3.2999 $\mu$ F	0.35 + 3 nF		100 pF
3.3 $\mu$ F to 10.999 $\mu$ F	0.35 + 10 nF		1 nF
11 $\mu$ F to 32.999 $\mu$ F	0.40 + 30 nF		1 nF
33 $\mu$ F to 109.99 $\mu$ F	0.50 + 100 nF		10 nF
110 $\mu$ F to 329.99 $\mu$ F	0.70 + 300 nF		10 nF
330 mF to 1.1 mF	1 + 300 nF		100 nF

## Temperature Calibration (Thermocouple Source/Measure) Specifications

TC Type	Range °C	Absolute Uncertainty, tcal $\pm 5$ °C $\pm$ °C 1 year
B	600 to 800	0.44
	800 to 1000	0.34
	1000 to 1550	0.30
	1550 to 1820	0.33
C	0 to 150	0.30
	150 to 650	0.26
	650 to 1000	0.31
	1000 to 1800	0.50
	1800 to 2316	0.84
E	-250 to -100	0.50
	-100 to -25	0.16
	-25 to 350	0.14
	350 to 650	0.16
	650 to 1000	0.21
J	-210 to -100	0.27
	-100 to -30	0.16
	-30 to 150	0.14
	150 to 760	0.17
	760 to 1200	0.23
K	-200 to -100	0.33
	-100 to -25	0.18
	-25 to 120	0.16
	120 to 1000	0.26
	1000 to 1372	0.40
L	-200 to -100	0.37
	-100 to 800	0.26
	800 to 900	0.17
N	-200 to -100	0.40
	-100 to -25	0.22
	-25 to 120	0.19
	120 to 410	0.18
	410 to 1300	0.27
R	0 to 250	0.57
	250 to 400	0.35
	400 to 1000	0.33
	1000 to 1767	0.40
S	0 to 250	0.47
	250 to 1000	0.36
	1000 to 1400	0.37
	1400 to 1767	0.46
T	-250 to -150	0.63
	-150 to 0	0.24
	0 to 120	0.16
	120 to 400	0.14
U	-200 to 0	0.56
	0 to 600	0.27

- Resolution is 0.01 °C.
- The 10 mV/°C linear output mode has the same uncertainty as the 300 mV dc range.
- Applies to both simulated thermocouple output and thermocouple measurement.
- Temperature standard ITS-90 or IPTS-68 is selectable.

# 5500A/5520A Multi-Product Calibrators

riešenia na presné meranie

www.elseo.sk/Fluke-Calibration

## DC/LF Calibration

### Temperature Calibration (RTD) Specifications

RTD Type	Range °C	Absolute Uncertainty, tcal ±5 °C ± °C 1 year
Pt 395, 100 Ω	-200 to -80	0.05
	-80 to 0	0.05
	0 to 100	0.07
	100 to 300	0.09
	300 to 400	0.10
	400 to 630	0.12
	630 to 800	0.23
Pt 3926, 100 Ω	-200 to -80	0.05
	-80 to 0	0.05
	0 to 100	0.07
	100 to 300	0.09
	300 to 400	0.10
	400 to 630	0.12
	630 to 800	0.23
Pt 3916, 100 Ω	-200 to -190	0.25
	-190 to -80	0.04
	-80 to 0	0.05
	0 to 100	0.06
	100 to 260	0.07
	260 to 300	0.08
	300 to 400	0.09
	400 to 600	0.10
	600 to 630	0.23
Pt 385, 200 Ω	-200 to -80	0.04
	-80 to 0	0.04
	0 to 100	0.04
	100 to 260	0.05
	260 to 300	0.12
	300 to 400	0.13
	400 to 600	0.14
	600 to 630	0.16
Pt 385, 500 Ω	-200 to -80	0.04
	-80 to 0	0.05
	0 to 100	0.05
	100 to 260	0.06
	260 to 300	0.08
	300 to 400	0.08
	400 to 600	0.09
	600 to 630	0.11
Pt 385, 1000 Ω	-200 to -80	0.03
	-80 to 0	0.03
	0 to 100	0.04
	100 to 260	0.05
	260 to 300	0.06
	300 to 400	0.07
	400 to 600	0.07
	600 to 630	0.23
PtNi 385, 120 Ω (Ni120)	-80 to 0	0.08
	0 to 100	0.08
	100 to 260	0.14
Cu 427,10 Ω	-100 to 260	0.3

- Resolution is 0.003 °C.
- Temperature standard ITS-90 or IPTS-68 is selectable.

### DC Power Specification Summary

Voltage Range	Current Range	Absolute Uncertainty, tcal ± 5 °C ± (% of watts output) 1 year
33 mV to 1020 V	<b>5520A Calibrator</b>	
	0.33 mA to 329.99 mA	0.023 %
	0.33 A to 2.9999 A	0.022 %
	3 A to 20.5 A	0.07 %
	<b>5500A Calibrator</b>	
	3.3 to 8.999 mA	0.04 %
	9 to 32.999 mA	0.03 %
	33 to 89.99 mA	0.04 %
	90 to 329.99 mA	0.03 %
	0.33 to 0.8999 A	0.08 %
	0.9 to 2.1999 A	0.06 %
	2.2 to 4.4999 A	0.12 %
	4.5 to 11 A	0.09 %
	<b>5500A Calibrator with 5725A Current Amplifier</b>	
1.5 to 4.4999 A	0.10 %	
4.5 to 11 A	0.08 %	

## AC Power Specification Summary, shown for a frequency range of (45 Hz to 65 Hz) with a PF=1

Absolute Uncertainty,  $t_{cal} \pm 5\text{ }^{\circ}\text{C}$ ,  $\pm$  (% of watts output) 1 year

Current Range	5500A Calibrator Voltage Range	5725A Voltage Amplifier	
	33 to 329.999 mV	330 mV to 1020 V	100 to 1020 V
<b>5500A Calibrator</b>			
3.3 to 8.999 mA	0.40 %	0.25 %	0.25 %
9 to 32.999 mA	0.25 %	0.15 %	0.15 %
33 to 89.99 mA	0.35 %	0.25 %	0.25 %
90 to 329.99 mA	0.25 %	0.15 %	0.15 %
0.33 to 0.8999 A	0.35 %	0.25 %	0.25 %
0.9 to 2.1999 A	0.25 %	0.15 %	0.15 %
2.2 to 4.4999 A	0.35 %	0.20 %	0.20 %
4.5 to 11 A	0.25 %	0.15 %	0.15 %
<b>5725A Amplifier</b>			
1.5 to 4.4999 A	0.35 %	0.20 %	
4.5 to 11 A	0.25 %	0.15 %	

Current Range	5520A Voltage Range	
	33 to 329.999 mV	330 mV to 1020 V
<b>5520A</b>		
3.3 to 8.999 mA	0.14 %	0.12 %
9 to 32.999 mA	0.10 %	0.08 %
33 to 89.99 mA	0.14 %	0.12 %
90 to 329.99 mA	0.10 %	0.08 %
0.33 to 0.8999 A	0.13 %	0.11 %
0.9 to 2.9999 A	0.11 %	0.09 %
3.0 to 10.9999 A	0.13 %	0.12 %
11 to 20.5 A	0.11 %	0.10 %

**Note:** Other frequency and phase/power factor conditions can apply and the power specifications will change accordingly. For additional specification information refer to the Extended Specifications data sheet and the instrument manual.

## Phase Specifications

1-Year Absolute Uncertainty,  $t_{cal} \pm 5\text{ }^{\circ}\text{C}$ , ( $\Delta \Phi$  °)

Model	10 Hz to 65 Hz	65 Hz to 500 Hz	500 Hz to 1 kHz	1 kHz to 5 kHz	5 kHz to 10 kHz	10 kHz to 30 kHz
5500A	0.15 °	0.9 °	2.0 °	6 °	10 °	N/A
5520A	0.10 °	0.25 °	0.5 °	2.5 °	5 °	10 °

## Frequency Specifications

1-Year Absolute Uncertainty,  $t_{cal} \pm 5\text{ }^{\circ}$

Frequency Range	Resolution	Stability	
		5500A	5520A
0.01 Hz to 119.99 Hz	0.01 Hz	25 ppm $\pm$ 1 mHz	2.5 ppm $\pm$ 5 $\mu$ Hz
120.0 Hz to 1199.9 Hz	0.1 Hz		
1.200 kHz to 11.999 kHz	1.0 Hz		
12.00 kHz to 119.99 kHz	10 Hz		
120.0 kHz to 1199.9 kHz	100 Hz		
1.200 MHz to 2.000 MHz	1 kHz	25 ppm $\pm$ 15 mHz	

## Oscilloscope calibration

For specifications for the oscilloscope calibration options, please refer to the oscilloscope calibration section of this catalog.

### Calibration

Standard: NVLAP accredited certificate, traceable to NIST, including measurement data.

The oscilloscope calibration option's calibration certificate in non-accredited, but is traceable to NIST with measurement data. An accredited scope cal option calibration is available. Contact Fluke for details.

# 5500A/5520A Multi-Product Calibrators

riešenia na presné meranie

www.elseo.sk/Fluke-Calibration

## DC/LF Calibration

### Supplemental Function Specifications

For the following functions the detailed specifications can be found in the Extended Specifications data sheet or the instrument manual.

- Harmonics (2nd to 50th)
- AC voltage sine wave extended bandwidth of .01 Hz to 2 MHz
- AC voltage non-sine wave functions: Truncated sine wave, Triangle wave, Square wave
- AC voltage, dc offset
- AC current sine wave extended bandwidth .01 Hz to 10 Hz
- 5520 ac current (non-sine wave) specifications: Triangle wave, Truncated sine wave, Square wave

### General Specifications

#### Warmup time

Twice the time since last warmed up, to a maximum of 30 minutes

#### Settling time

Less than 5 seconds for all functions and ranges except as noted

#### Standard interfaces

IEEE-488 (GPIB), RS-232, 5725A (5500A only)

#### Temperature performance

Operating: 0 °C to 50 °C  
Calibration (tcal): 15 °C to 35 °C  
Storage: -20 °C to 70 °C

#### Temperature coefficient

5500A: Temperature coefficient for temperatures outside tcal  $\pm 5$  °C is 10 % of the 90-day specification (or 1-year, as applicable) per °C  
5520A: Temperature coefficient for temperatures outside tcal  $\pm 5$  °C is 10 % of the stated specification per °C for temperatures in the range of 0 °C to 35 °C. Above 35 °C, the temperature coefficient is 20% of the stated specification per °C.

#### Relative humidity

Operating: < 80 % to 30 °C, < 70 % to 40 °C, < 40 % to 50 °C  
Storage: < 95 %, noncondensing

Note: After long periods of storage at high humidity, a drying out period (with the power on) of at least one week may be required

#### Altitude

Operating: 3,050 m (10,000 ft) maximum  
Non-operating: 12,200 m (40,000 ft) maximum

#### Safety

Designed to comply with IEC 1010-1 (1992-1); ANSI/ISA-S82.01-1994; CAN/CSA-C22.2 No. 1010.1-92

### Analog low isolation

20 V

### EMC

5520A: Designed to comply with IEC 61326-1/1997

5500A: Designed to comply with FCC Rules Part 15

### Line power

Line Voltage (selectable): 100 V, 120 V, 220 V, 240 V

Line Frequency: 47 to 63 Hz  
Line Voltage Variation:  $\pm 10$  % about line voltage setting

Note: For optimal 5520A performance at full dual outputs (e.g. 1000 V, 20 A), choose a line voltage setting that is  $\pm 7.5$  % from nominal

### Power consumption

5520A: 600 VA  
5500A: 300 VA

### Dimensions

Height: 17.8 cm (7 in), standard rack increment, plus 1.5 cm (0.6 in) for feet on bottom of unit

Width: 43.2 cm (17 in), standard rack width

Depth: 47.3 cm (18.6 in) overall

### Weight (without options)

5520A: 22 kg (49 lb)  
5500A: 20 kg (44 lb)

### Absolute uncertainty definition

5500A and 5520A uncertainty specifications include stability, temperature coefficient, linearity, line and load regulation and the traceability of the external standards used for calibration.

You do not need to add anything to determine the total uncertainty of your calibrator for the temperature range indicated.

### Specification confidence interval

> 99 %

### Ordering Information

#### Models

**5520A** High Performance Multi-Product Calibrator

**5520A/3** 5520A Calibrator with 300 MHz Oscilloscope Calibration Option

**5520A/6** 5520A Calibrator with 600 MHz Oscilloscope Calibration Option

**5520A/1 GHz** 5520A Calibrator with 1.1 GHz Oscilloscope Calibration Option

**5500A** Multi-Product Calibrator

**5500A/3** 5500A Calibrator with 300 MHz Oscilloscope Calibration Option

**5500A/6** 5500A Calibrator with 600 MHz Oscilloscope Calibration Option

#### Options and Accessories

**5500A-SC300** 300 MHz Oscilloscope Calibration Option

**5500A-SC600** 600 MHz/300 ps Oscilloscope Calibration Option

**5520A-SC1100** 1.1 GHz Oscilloscope Calibration Option (5520A only)

**5500A/LEADS** Comprehensive Test Lead Kit

**5520A-525A/LEADS** Test Lead Set

**5800A/TDP** 125 ps Tunnel Diode Pulser

**5500A/COIL** 50-Turn Coil

**5500A/CASE** Transit Case with Wheels

**5725A** Amplifier (5500A only)

**5500A/HNDL** Side Handle

**700PCK** Pressure Calibration Kit

**Y5537** Rack Mount Kit (5500A/5520A)

**Y5735** Rack Mount Kit (5725A)

#### Software

**MET/CAL® Plus** Automated Calibration Management Software

**5500/CAL** Automated Calibration Software (RS-232 only)

# 9100 Universal Calibration System

## DC/LF Calibration

### Versatile entry-level performance



### Tech Tip

The lead mat supplied with the 9100 will automatically optimize the signal paths to the UUT.

- Unique insulation and continuity meter calibration
- AC current to 30 KHz
- AC/DC current to 20 amps
- Extensive range of available calibration procedures

The affordable and versatile 9100 is designed to calibrate an impressive range of portable meter workload including: handheld multimeters, bench multimeters, analog meters, panel meters, clamp meters, power meters, harmonic analyzers, oscilloscopes, ScopeMeter® Test Tools, insulation/continuity meters, counters, electronic thermometers, chart recorders, oscillograph recorders, XY recorders, and data loggers. With its easy-to-use front panel featuring a clear and informative LCD display, and its unique procedure-driven calibration routines, the 9100 is not only a versatile calibrator but also one that will increase calibration throughput significantly.

For full and comprehensive specifications, refer to the extended specification data sheet at [www.fluke.com](http://www.fluke.com).

### DC Voltage Accuracy

Voltage Output Polarities	Accuracy <sup>[1]</sup> ± (% of Output + Floor) 1 Year - Tcal ± °C <sup>[2]</sup>	Absolute Resolution
000.000 mV to 320.000 mV	0.006 % + 4.16 µV	1 µV
0.32001 V to 3.2000 V	0.006 % + 41.6 µV	10 µV
03.2001 V to 32.0000 V	0.0065 % to 416 µV	100 µV
032.001 V to 320.000 V	0.0065 % to 4.48 mV	1 mV
0320.01 V to 1050.00 V	0.006 % to 19.95 mV	10 mV

<sup>[1]</sup> = For loads < 1 MΩ: add load regulation error.

<sup>[2]</sup> Tcal = temperature at calibration. Factory calibration temperature = 23 °C

### AC Voltage Accuracy (Sinusoidal Waveshape)

Voltage Output	Frequency Band [2]	Accuracy [1] ± (% Output + Floor) 1 Year - Tcal [3] ± 5 °C	Absolute Resolution
000.000 mV to 010.000 mV	10 to 3 k	0.04 + 384 µV	1 µV
	3k to 10 k	0.04 + 512 µV	1 µV
	10 k to 30 k	0.06 + 960 µV	1 µV
	30 k to 50 k	0.09 + 1.92 mV	1 µV
	50 k to 100 k	0.20 + 5.12 mV	1 µV
010.001 mV to 032.000 mV	10 to 3 k	0.4 + 96.0 µV	1 µV
	3 k to 10 k	0.4 + 128 µV	1 µV
	10 k to 30 k	0.06 + 240 µV	1 µV
	30 k to 50 k	0.09 + 430 µV	1 µV
	50 k to 100 k	0.20 + 1.28 µV	1 µV
032.001 mV to 320.000 mV	10 to 3 k	0.4 + 19.2 µV	1 µV
	3 k to 10 k	0.4 + 25.6 µV	1 µV
	10 k to 30 k	0.06 + 48.0 µV	1 µV
	30 k to 50 k	0.09 + 960 µV	1 µV
	50 k to 100 k	0.20 + 256 µV	1 µV
0.32001 V to 3.20000 V	10 to 3 k	0.04 + 192 µV	10 µV
	3 k to 10 k	0.04 + 256 µV	10 µV
	10 k to 30 k	0.06 + 480 µV	10 µV
	30 k to 50 k	0.09 + 960 µV	10 µV
	50 k to 100 k	0.20 + 2.56 mV	10 µV
03.2001 V to 32.0000 V	10 to 3 k	0.04 + 1.92 mV	100 µV
	3 k to 10 k	0.06 + 2.56 mV	100 µV
	10 k to 30 k	0.08 + 4.80 mV	100 µV
	30 k to 50 k	0.15 + 9.60 mV	100 µV
	50 k to 100 k	0.35 + 32.0 mV	100 µV
032.001 V to 105.000 V	10 to 3 k	0.04 + 6.30 mV	1 mV
	3 k to 10 k	0.06 + 8.40 mV	1 mV
	10 k to 30 k	0.08 + 15.8 mV	1 mV
	30 k to 50 k	0.15 + 31.5 mV	1 mV
	50 k to 100 k	0.35 + 105 mV	1 mV
105.001 V to 320.000 V	40 to 100	0.05 + 19.2 mV	1 mV
	100 to 1 k	0.05 + 19.2 mV	1 mV
	1 k to 3 k	0.08 + 19.2 mV	1 mV
	3 k to 10 k	0.08 + 32.0 mV	1 mV
	10 k to 20 k	0.12 + 48.0 mV	1 mV
0320.01 V to 0800.00 V	20 k to 30 k	0.15 + 64.0 mV	1 mV
	40 to 100	0.05 + 63.0 mV	10 mV
	100 to 1 k	0.05 + 63.0 mV	10 mV
	1 k to 3 k	0.08 + 63.0 mV	10 mV
	3 k to 10 k	0.08 + 105 mV	10 mV
0800.01 V to 1050.00 V	10 k to 20 k <sup>[4]</sup>	0.12 + 158 mV	10 mV
	20 k to 30 k <sup>[4]</sup>	0.15 + 210 mV	10 mV
	40 to 100	0.05 + 126 mV	10 mV
	100 to 1 k	0.05 + 126 mV	10 mV
	1 k to 3 k	0.08 + 126 mV	10 mV
	3 k to 10 k	0.08 + 210 mV	10 mV
	10 k to 20 k <sup>[4]</sup>	0.12 + 315 mV	10 mV

[1] = For loads < |1MΩ|: add load regulation error.

[2] Frequency Accuracy: 25 ppm of output frequency.

[3] Tcal = temperature at calibration. Factory calibration temperature = 23 °C.

[4] = Availability of voltage and frequency combinations is subject to the Volt-Hertz limit (see V-Hz profile).



## DC Current Accuracy

Equivalent Current Output	Accuracy ± (% of Output + Floor) 1 Year - Tcal ± 5 °C [1]	Absolute Resolution
000.000 µA to 320.000 µA	0.014 + 11 nA	1 nA
0.32001 mA to 3.20000 mA	0.014 + 83 nA	10 nA
03.2001 mA to 32.0000 mA	0.014 + 900 nA	100 nA
032.001 mA to 320.000 mA	0.016 + 9.6 µA	1 µA
0.32001 A to 3.20000 A	0.060 + 118 µA	10 µA
03.2001 A to 10.5000 A	0.055 + 940 µA	100 µA
10.5001 A to 20.0000 A [2]	0.055 + 4.50 mA	100 µA

[1] Tcal = temperature at calibration. Factory calibration temperature = 23 °C.

[2] = With output 'ON', maximum duty cycle of (> 0.525FS : 0.525FS) is [1 : 4]. Continuous output > 0.525FS will automatically reduce to < 0.525FS after 2 Minutes.

## AC Current Accuracy (Sinusoidal Waveshape)

Current Output	Frequency Band [2] (Hz)	Accuracy [1] ± (% Output + Floor) 1 Year - Tcal [3] ± 5 °C	Absolute Resolution
000.000 µA to 032.000 µA	10 to 3 k	0.07 + 900 nA	1 nA
	3 k to 10 k	0.10 + 1.8 µA	1 nA
	10 k to 20 k	0.20 + 6.0 µA	1 nA
	20 k to 30 k	0.25 + 9.0 µA	1 nA
032.001 µA to 320.000 µA	10 to 3 k	0.07 + 300 nA	1 nA
	3 k to 10 k	0.10 + 600 nA	1 nA
	10 k to 20 k	0.20 + 2.0 µA	1 nA
	20 k to 30 k	0.25 + 3 µA	1 nA
0.32001 mA to 3.20000 mA	10 to 3 k	0.07 + 300 nA	10 nA
	3 k to 10 k	0.10 + 600 nA	10 nA
	10 k to 20 k	0.20 + 2.0 µA	10 nA
	20 k to 30 k	0.25 + 3.0 µA	10 nA
03.2001 mA to 32.0000 mA	10 to 3 k	0.07 + 3.2 µA	100 nA
	3 k to 10 k	0.10 + 6.4 µA	100 nA
	10 k to 20 k	0.20 + 12.8 µA	100 nA
	20 k to 30 k	0.25 + 22.4 µA	100 nA
032.001 mA to 320.000 mA	10 to 3 k	0.08 + 32.0 µA	1 µA
	3 k to 10 k	0.10 + 48.0 µA	1 µA
	10 k to 20 k	0.20 + 64.0 µA	1 µA
	20 k to 30 k	0.25 + 96.0 µA	1 µA
0.32001 A to 3.20000 A	10 to 3 k	0.10 + 480 µA	10 µA
	3 k to 10 k	0.25 + 2.56 mA	10 µA
03.2001 A to 10.5000 A	10 to 3 k	0.20 + 3.0 mA	100 µA
	3 k to 10 k	0.50 + 10.0 mA	100 µA
10.5001 A to 20.0000 A [4]	10 to 3 k	0.20 + 6.9 mA	100 µA
	3 k to 10 k	0.50 + 23.0 mA	100 µA
03.2001 A to 32.0000 A [5]	10 to 100	0.20 + 5.5 mA	100 µA
	100 to 440	0.78 + 27 mA	100 µA
032.001 A to 200.000 A [4][5]	10 to 100	0.21 + 90 mA	1 mA
	100 to 440	0.67 + 0.25 A	1 mA
016.001 A to 160.000 A [6]	10 to 100	0.20 + 28 mA	1 mA
0160.01 A to 1000.00 A [4][6]	10 to 100 [8]	0.21 + 0.45 A	10 mA

[1] = Total uncertainty includes compliance errors for voltage 0.5 Vrms. Above 0.5 V, add appropriate compliance error, except for outputs marked [4] and [6].

[2] Frequency Accuracy: 25 ppm of output frequency.

[3] Tcal = temperature at calibration. Factory calibration temperature = 23 °C.

[4] = With output 'ON', maximum duty cycle of (> 0.525FS : 0.525FS) is [1 : 4]. Continuous output > 0.525FS will automatically reduce to < 0.525FS after 2 minutes.

[5] = Accuracy at 9100 output terminals, option 200 10 turn coil connected. For the output from the coil, add ± 0.2 % of output from coil for uncertainty of coil.

[6] = Accuracy at 9100 output terminals, option 200 50 turn coil connected. For the output from the coil, add ± 0.2 % of output from coil for uncertainty of coil.

[7] = For frequencies < 40 Hz, compliance voltage is reduced by 0.5 Vrms.

[8] = These coils have been designed for optimum accuracy and inductance for use with the Model 9100. With some clamp meters, especially those using Hall effect, the increase in inductance due to the current clamp design will limit the obtainable 9100 Current/Hertz profile. In some cases, 1000 A cannot be reached at higher frequency.

### Resistance Accuracy

Resistance Output	Accuracy (Source UUTi Low) ± (% of Output + Floor) 1 Year - Tcal ± 5 °C [1]	Absolute Resolution
00.0000 Ω to 40.0000 Ω	0.025 + 10.0 mΩ	0.1 mΩ
040.001 Ω to 400.000 Ω	0.020 + 20.0 mΩ [2]	1 mΩ
0.40001 kΩ to 4.00000 kΩ	0.015 + 80.0 mΩ	10 mΩ
04.0001 kΩ to 40.0000 kΩ	0.020 + 800 mΩ	100 mΩ
040.001 kΩ to 400.000 kΩ	0.020 + 8.0 Ω	1 Ω
0.40001 MΩ to 4.00000 MΩ	0.050 + 100 Ω	10 Ω
04.0001 MΩ to 40.0000 MΩ	0.150 + 2.0 kΩ	100 Ω
040.001 MΩ to 400.000 MΩ	0.260 + 40.0 kΩ	1 kΩ

[1] Tcal = temperature at calibration. Factory calibration temperature = 23 °C.

[2] = Valid for UUTi ≥ 200 μA. Below 200 μA: new floor = (200 μA ÷ Actual UUTi) x 20 mΩ.

### Conductance Accuracy

Conductance Output	Accuracy ±(% Output) 1 Year - Tcal ± 5 °C [1] UUTi Low & High UUTi Super
2.5 nS to 25.0 nS	0.40
25.0 nS to 250.0 nS	0.20
250.0 nS to 2.5 μS	0.12
2.5 μS to 25.0 μS	0.05
25.0 μS to 250.0 μS	0.05
250.0 μS to 2.5 mS	0.04

[1] Tcal = temperature at calibration. Factory calibration temperature = 23 °C.

### Frequency Function Accuracy

Frequency Output	Accuracy ± (ppm of Output Frequency) 1 Year - Tcal ± 5 °C [1] Standard	Accuracy ± (ppm of Output Frequency) 5 Year - Tcal ± 5 °C [1] Option 100	Mark/Period Ratio (%)
0.5 Hz to 10.0 MHz	25.0	0.25	50

[1] Tcal = temperature at calibration. Factory calibration temperature = 23 °C.

### Capacitance Accuracy

Capacitance Output	Accuracy [1] Source UUTi Low ± (% of Output + Floor) 1 Year - Tcal ± 5 °C [2]		Absolute Resolution
	Stim Repetition Rate ≤ 350 Hz	Stim Repetition Rate 350 Hz to 1.5 kHz	
0.5000 nF to 4.0000 nF	0.3 + 15 pF	0.6 + 30.0 pF	0.1 pF
4.0001 nF to 40.000 nF	0.3 + 30 pF	0.6 + 60.0 pF	1 pF
40.001 nF to 400.00 nF	0.3 + 160 pF	0.6 + 320 pF	10 pF
400.01 nF to 4.0000 μF	0.4 + 1.6 nF	0.8 + 3.2 nF	100 pF
4.0001 μF to 40.000 μF	0.5 + 16.0 nF	1.0 + 32.0 nF	1 nF
40.001 μF to 400.00 μF	0.5 + 160 nF	1.0 + 320 nF	10 nF
400.01 μF to 4.0000 mF	0.5 + 1.6 μF	1.0 + 3.2 μF	100 nF
4.0001 mF to 40.000 mF	1.0 + 60 μF	2.0 + 120 μF	1 μF

[1] = Accuracy specifications apply both at the 9100 output terminals, and at the output leads of the Model 9105 lead set.

[2] Tcal = temperature at calibration. Factory calibration temperature = 23 °C.

## Thermocouple Temperature Accuracy

Thermocouple Type	Temperature Output (Screen Resolution Shown)	Accuracy <sup>[1][2][3]</sup> ( $\pm$ °C) 1 Year - Tcal $\pm$ 5 °C <sup>[4]</sup>
B	0500.0 °C to 0800.0 °C	0.55
	0800.0 °C to 1000.0 °C	0.41
	1000.0 °C to 1400.0 °C	0.34
	1400.0 °C to 1820.0 °C	0.37
C	0000.0 °C to 0600.0 °C	0.29
	0600.0 °C to 1000.0 °C	0.27
	1000.0 °C to 1800.0 °C	0.40
	1800.0 °C to 2320.0 °C	0.41
E	-0250.0 °C to -0200.0 °C	0.45
	-0200.0 °C to -0100.0 °C	0.22
	-0100.0 °C to 0100.0 °C	0.17
	0100.0 °C to 1000.0 °C	0.21
J	-0210.0 °C to -0100.0 °C	0.25
	-0100.0 °C to 0800.0 °C	0.19
	0800.0 °C to 1000.0 °C	0.21
	1000.0 °C to 1200.0 °C	0.23
K	-0250.0 °C to -0200.0 °C	0.57
	-0200.0 °C to -0100.0 °C	0.27
	-0100.0 °C to 0100.0 °C	0.19
	0100.0 °C to 0600.0 °C	0.23
	0600.0 °C to 1372.0 °C	0.27
L	-0200.0 °C to -0050.0 °C	0.26
	-0050.0 °C to 0200.0 °C	0.18
	0200.0 °C to 0700.0 °C	0.20
	0700.0 °C to 0900.0 °C	0.23
N	-0200.0 °C to -0100.0 °C	0.33
	-0100.0 °C to 0900.0 °C	0.23
	0900.0 °C to 1100.0 °C	0.22
	1100.0 °C to 1300.0 °C	0.24
R	0000.0 °C to 0100.0 °C	0.52
	0100.0 °C to 0200.0 °C	0.40
	0200.0 °C to 1600.0 °C	0.35
	1600.0 °C to 1767 °C	0.28
S	0000.0 °C to 0200.0 °C	0.49
	0200.0 °C to 1000.0 °C	0.37
	1000.0 °C to 1400.0 °C	0.35
	1400.0 °C to 1767.0 °C	0.36
T	-0250.0 °C to -0200.0 °C	0.59
	-0200.0 °C to -0100.0 °C	0.27
	-0100.0 °C to 0000.0 °C	0.22
	0000.0 °C to 0400.0 °C	0.17

<sup>[1]</sup> = Accuracy figures include CJC error.

<sup>[2]</sup> = Compensated output determined from pre-defined tables based on:  
 IPTS-68 Reference Table NIST Monograph 125 for Types: B, E, J, K, R, S and T.  
 ITS-90 Reference Table NIST Monograph 175 for Types: B, E, J, K, N, R, S and T.  
 IPTS-68 Reference Table DIN 43710 for Type L.  
 ITS-90 Reference Table DIN 43710 for Type L.

<sup>[3]</sup> = For loads < 1 M $\Omega$  add load regulation error.

<sup>[4]</sup> Tcal = temperature at calibration. Factory calibration temperature = 23 °C.

<sup>[5]</sup> = Types R & S adjusted above 1700 °C for IPTS-68 as per NIST monograph 175.

## Other Thermocouple Output Specifications

Settling time to within 10 % of accuracy	0.08 s
Load regulation	(200/R <sub>LOAD</sub> ) % of output
Maximum capacitance	1000 pF

### RTD Temperature Accuracy

Temperature Output	Accuracy <sup>[1]</sup> : ± (% of Output + Floor) 1 Year - Tcal ± 5 °C <sup>[2]</sup>		
	Resistance at 0 °C = 10 Ω to 60 Ω	Resistance at 0 °C = 60 Ω to 1 kΩ	Resistance at 0 °C = 1 kΩ to 2 kΩ
-200 °C to -100 °C	0.00 + 0.225 °C	0.00 + 0.15 °C	0.00 + 0.12 °C
-100 °C to 100 °C	0.00 + 0.15 °C	0.00 + 0.10 °C	0.00 + 0.08 °C
100 °C to 630 °C	0.00 + 0.30 °C	0.00 + 0.20 °C	0.00 + 0.16 °C
630 °C to 850 °C	0.00 + 0.45 °C	0.00 + 0.30 °C	0.00 + 0.24 °C

<sup>[1]</sup> = Accuracy figures apply to Output Temperature vs Resistance curves PT385 or PT392 and to Temperature Scales IPTS-68 or ITS-90 as selected by the user:

PT385, IPTS-68 as per IEC751.

PT392, IPTS-68 as per SAMA.

PT385, ITS-90 as per IEC751 amendment 2.

PT392, ITS-90 as per NIST monograph 175 corrections (90-68).

<sup>[2]</sup> Tcal = temperature at calibration. Factory calibration temperature = 23 °C.

### Insulation Specifications (Option 135)

Uncertainties are for 1 year, Tcal ± °C		
Function	Range	Best Uncertainty
<b>Insulation Resistance</b>		
Resistance	100 kΩ to 2 GΩ	0.1 %
Voltage (measured)	0 to 1350 V	0.6 %
Current (derived)	1 μA to 2.3 mA	1.5 %
<b>Continuity</b>		
Resistance	0 to 4 kΩ	0.035 %
Voltage	0 to 10 V	
Current (derived)	100 μA to 350 mA	1.0 %

### Power Option Specifications (Option PWR)

Voltage Output	Frequency Band (Hz)	Output Phase Uncertainty
0.30000 V to 105.000 V	10 to 65	0.07 °
	65 to 1 k	0.07 + 0.001 x (f - 65) °
105.001 V to 750.000 V	45 to 65	0.16 °
	65 to 1 k	0.16 + 0.0037 x (f - 65) °
<b>Current Output</b>		
0.00000 A to 20.0000 A	10 to 65	0.08 °
	65 to 1 k	0.08 + 0.0008 x (f - 65) °
	> 1 k	0.08 + 0.0012 x (f - 65) °
03.2000 A to 1000.00 A	10 to 65	0.23 °
	65 to 440	0.23 + 0.003 x (f - 65) °
<b>Auxiliary Channel Voltage Output</b>		
0.32 mV to 7.500 A	10 to 65	0.007 °
	65 to 1 k	0.07 + 0.001 x (f - 65) °
	< 1 k	0.07 + 0.0015 x (f - 65) °

### Oscilloscope calibration

For specifications for the oscilloscope calibration options, please refer to the oscilloscope calibration section of this catalog.

### Calibration

A certificate traceable to NPL-UK, including measurement data, is supplied. For additional certificate types, contact your local representation.

## General Specifications

### Line power supply

Voltage (single I): 100 V/200 V/  
220 V/240 V selectable from rear  
panel

Variation: < +10 % nominal voltage

Line Frequency: 48 Hz to 63 Hz

Consumption: 450 VA max 500 VA  
max with Option 250

Power Fuses: 220/240 V: T3, 15 A  
HBC, 250 V, IEC127

100/120 V: T5, 0 A HBC, 250 V,  
IEC 127

### Dimensions

Height: 3 U

Width: 427 mm (16.8 in)

Depth: 460 mm (18.1 in)

Weight: 18.5 kg (41 lbs)

19 kg (42 lbs) with Option 250

**Safety:** Designed to UL1244,  
IEC1010-1: Pollution degree 2;  
installation category II; Protection  
class I

## Environmental conditions

### Temperature

Operating: 5 °C to 40 °C

Transit: -20 °C to 60 °C < 100 hrs

Storage: 0 °C to 50 °C

Warm-up Time: 20 minutes

### Max. relative humidity (non-condensing)

Operating: + 5 °C to + 30 °C:

< 90 %; + 30 °C to + 40 °C: <75 %

Storage: 0 °C to + 50 °C: < 95 %

### Altitude

Operating: 0 to 2000 m (6.562 ft);

Non-operating: 0 to 12,00 m

(40,000 ft)

Shock: MIL-T-28800, type III, class

5, style E

Vibration: MIL-T-28800, type III,

class 5, style E

Enclosure: MIL-T-2880, type III,

class 5, style E

EMC: Designed to: Generic Emis-

sions: EN50081; Generic Immunity:

EN50082; FCC Rules part 15 sub-

part J class B

## Ordering Information

### Models

**9100** Multifunction Calibration  
Workstation

### Options and Accessories

**9100-600** 600 MHz Oscilloscope  
Calibration Module

**9100-250** 250 MHz Oscilloscope  
Calibration Module

**9100-200** 10/50 Turn Coil

**9100-PWR** Power Calibration

**9100-135** Insulation/Continuity  
Test

**9100-100** High Stability Crystal  
Ref.

**9100-90** Rack Mount Kit

**9500-65** Hard Transit Case  
(requires option 60)

**9100-60** Soft Carry Case

### Software

**MET/CAL® Plus** Automated  
Calibration Management  
Software

# 5700A/5720A Multifunction Calibrators

riešenia na presné meranie

www.elseo.sk/Fluke-Calibration

## DC/LF Calibration

Taking accuracy to a new level



5720A Calibrator



5700A Calibrator

- Fluke 5720A: The lowest uncertainties of any multifunction calibrator
- Simplified support with complete confidence through unique Artifact Cal and Cal Check concept
- Specifications available at both 99 % and 95 % confidence levels
- AC voltage wideband to 30 MHz to support RF voltmeters



## Tech Tip

Artifact Calibration lets you calibrate your 5700 series calibrator economically in your lab. Cal Check supports high confidence in the performance between formal calibrations. Refer to [www.fluke.com](http://www.fluke.com) for an assortment of application notes and technical papers on these unique capabilities.

The 5700A and 5720A are five-function calibrators designed to address the most accurate electrical calibration workload. They source direct and alternating voltage and current and resistance. A wideband voltage option extends over all ac bandwidth to 10 Hz to 30 MHz to cover RF voltmeters. Both are compatible with the 5725A, 5220A and 5205A/5215A amplifiers.

### 5720A: the lowest uncertainties of any multifunction calibrator

Since its introduction, the 5700A has earned a worldwide reputation for performance, dependability and quality, and as a result it is the calibrator of choice throughout government and industry.

Today, the 5720A offers even more. In addition to the dependability, simplified calibration, ease-of-use and worldwide support that has made the 5700A number one, the 5720A offers even tighter uncertainty specifications. Customers can get all the performance they need to calibrate their most demanding workload of multimeters up to 8½ digits quickly, easily and reliably. This improvement in performance results from factory testing to tighter tolerances, and from a variety of hardware and firmware improvements.

### 5700A Series II: the world standard

The 5700A has undergone continuous improvements to become the 5700A Series II, one of the most tested and reliable high precision calibrators Fluke has ever produced. Considered the calibration standard

worldwide, the 5700A delivers high value as well as accuracy covering 5½ to 7½ digit DMMs. Plus it offers the same ease of use, low cost of ownership, rugged design, simplified support and confidence building features as the 5720A.

### 5725A Amplifier

The 5720 and 5700 calibrators can increase their performance with the use of the 5725 boost amplifier. The 5725A amplifier increases maximum direct and alternating current to 11 A for calibrating the high current ranges of popular low-cost, handheld DMMs. It also extends the calibrator's alternating Volt-Hertz product to 1100 V at 30 kHz and 750 V at 100 kHz, to cover the calibration requirements of high accuracy bench and system meters.

### Specifications available at both 99 % and 95 % confidence levels

Specifications for both the 5700A and 5720A are stated with a choice of confidence levels. Now you can use the conservative 99 % specifications that Fluke traditionally publishes, or more aggressive 95 % specifications recommended in many international procedures. In addition to allowing you to trade a small amount of risk for better performance, 95 % confidence level specifications allow easier measurement inter-comparisons. Both specifications are available at a press of the SPEC key for any output. Specifications are also available on the web at [www.fluke.com](http://www.fluke.com).

## Understanding confidence levels

A critical factor in specified calibrator performance is the difference between the actual output value and the nominal output value. The confidence interval is a statistical expression of the likelihood that any output of any instrument will deviate beyond this specified difference or uncertainty.

At Fluke, we state calibrator specifications with better than 99 % confidence to minimize the risk for the user. However, because international metrology practices recommend using a 95 % confidence level in all measurements, the 5700A and 5720A now offer both 99 % and 95 % confidence level specifications. This makes it easier to make valid comparisons of measurements, and permits you to accept a slightly higher statistical risk that an instrument is out of tolerance in return for lower instrument uncertainty. In addition, both absolute and relative specifications are provided.

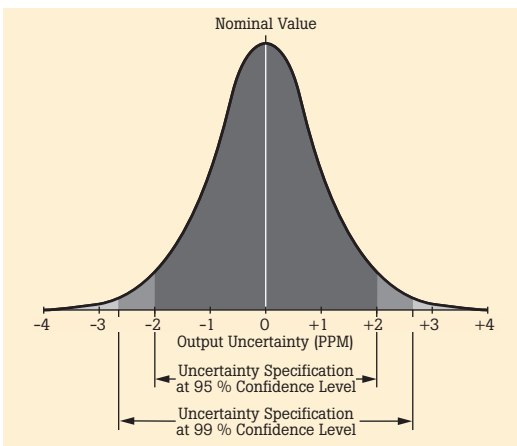

## Compatibility

Both the 5700A and 5720A can emulate, via the remote interface either a 5100B or 5200A calibrator, permitting them to replace those older calibrators in automated systems with little or no impact on software. In addition, it is compatible with the 5725A Amplifier, 5220A Transconductance Amplifier and 5205A or 5215A Precision Power Amplifiers.

## Simplified support with complete confidence

Like the 5700A, the 5720A features Artifact Calibration. Only three artifact standards – a 10 V dc reference and 1  $\Omega$  and 10 k $\Omega$  resistance references – are required to calibrate all ranges and functions to full specifications. Front panel instructions prompt the operator to make connections and inputs each step of the way. The calibrator controls the process, which takes only about an hour, compared to several hours using traditional methods.

During the process, assigned values of an external artifact are transferred to a large array of multi-dimensional parameters within the 5720A. The calibrator takes over the manual metrology functions of establishing ratios and making comparisons, as well as controlling the measurement process.

To assure confidence, the 5700A and 5720A can check themselves against their own internal standards to assure everything is working as expected. Those results can be printed out or downloaded to a computer.

Thousands of 5700A calibrators in service around the world prove Artifact Calibration delivers fast, easy and inexpensive calibration along with the confidence that your instrument is performing as expected between calibrations.

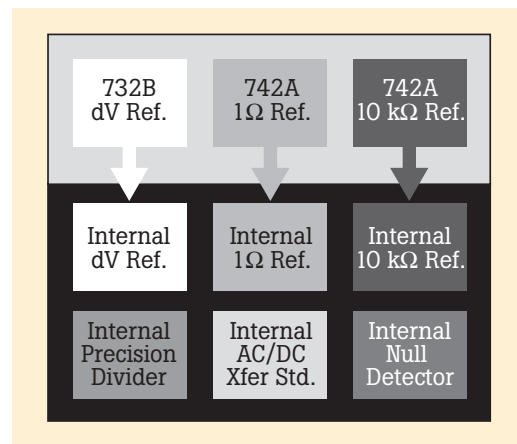

# 5700A/5720A Multifunction Calibrators

riešenia na presné meranie

www.elseo.sk/Fluke-Calibration

## DC/LF Calibration

### 5700A/5720A Capabilities

Function	Range
Direct voltage	0 to $\pm 1100$ V
Alternating voltage	220 $\mu$ V to 1100 V, 10 Hz to 1.2 MHz
Resistance	1 $\Omega$ to 100 M $\Omega$ in x1 and x1.9 values
Direct current	0 to $\pm 2.2$ A
Alternating current	9 $\mu$ A to 2.2 A, 10 Hz to 10 kHz

### 5720A Specifications at a Glance

Function	Output	Best Traceable Uncertainty (95 % 180 days)
Direct voltage	10 V	$\pm 3.25$ ppm
Alternating voltage	1 V	$\pm 55$ ppm
Resistance	10 k $\Omega$	$\pm 9$ ppm
Direct current	10 mA	$\pm 37$ ppm
Alternating current	100 mA	$\pm 140$ ppm

### 5700A Specifications at a Glance

Function	Output	Best Traceable Uncertainty (95 % 180 days)
Direct voltage	10 V	$\pm 6.4$ ppm
Alternating voltage	1 V	$\pm 87$ ppm
Resistance	10 k $\Omega$	$\pm 12$ ppm
Direct current	10 mA	$\pm 65$ ppm
Alternating current	100 mA	$\pm 190$ ppm

### General Specifications

#### Warm-up time

2x the time since last warmed up, to a maximum of 30 minutes

#### System installation

Rear output configuration and rack-mount kit available

#### Interfaces

IEEE-488, RS-232, 5725A, 5205A or 5215A, 5220A, phase lock in (BNC), phase reference out (BNC)

#### Temperature performance

Operating: 0 °C to 50 °C  
Calibration: 15 °C to 35 °C  
Storage: -40 °C to 75 °C

#### Relative humidity

Operating: < 80 % to 30 °C, < 70 % to 40 °C, < 40 % to 50 °C  
Storage: < 95 %, non-condensing. A power-on stabilization period of four days may be required after extended storage at high temperature and humidity.

#### Safety

Designed to comply with UL311; IEC 348-1978; IEC 66E (CO)4; CSA 556B

#### Guard isolation

20 volts

#### EMI/RFI

Designed to comply with FCC Rules Part 15, Subpart J, Class B; VDE 0871, Class B

#### Line power

47 to 63 Hz; + 10 % allowed about selectable nominal line voltage: 100 V, 110 V, 115 V, 120 V, 200 V, 220 V, 230 V, 240 V  
Maximum power: 5700A/5720A: 300 VA; 5725A, 750 VA

#### Dimensions

5700A/5720A: Height 17.8 cm (7 in), standard rack increment, plus 1.5 cm (0.6 in) for feet; width 43.2 cm (17 in), standard rack width; depth 63.0 cm (24.8 in) overall; 57.8 cm (22.7 in), rack depth  
5725A: Height 13.3 cm (5.25 in); width and depth same as 5700A/5720A  
Both units project 5.2 cm, (2 in) from rack front

#### Weight

5700A/5720A: 27 kg (62 lbs.)  
5725A: 32 kg (70 lbs.)

### Calibration

Standard: NVLAP accredited certificate, traceable to NIST, including measurement data.

The wideband option's calibration is not accredited, but is traceable to NIST and includes measurement data.

### Ordering Information

#### Models

5720A Multifunction Calibrator

5720A/3 Multifunction Calibrator with Wideband AC

5700A Series II Multifunction Calibrator

5700A/3 Series II Multifunction Calibrator with Wideband AC

#### Options and Accessories

5700A-03 Wideband AC Voltage (compatible with the 5720A too)

5725A Amplifier

5440-7002 Low Thermal Cable Set

5700A-7002 Portable Artifact Cal Package. Includes 732B DC Standard, 742A-1 and 742A-10K Resistance Standard, 732B-7001 External Battery and Charger, 52 Digital Thermometer, 5400A-7002 Test Leads in a rugged shipping case.

732B DC Voltage Reference Standard

742A-1 1  $\Omega$  Resistance Standard

742A-10k 10 k $\Omega$  Resistance Standard

Y5701 Cable for 5205A or 5215A

Y5702 Cable for 5220A

Y5737 Rack Mount Kit with 24-in slides for 5725A\*

Y8021 Shielded IEEE-488 Cable, 1 m

Y8022 Shielded IEEE-488 Cable, 2 m

\* These rack slides allow for side ventilation.

#### Upgrades

5700A/EP UG 5700A to 5720A Upgrade

#### Software

MET/CAL<sup>®</sup> Plus Automated Calibration Management

Software  
Eiso Philips Service, Trenčín



# 5700A/EP Upgrade

## DC/LF Calibration

Take your 5700A to a new level of performance



- 40 % improvement in uncertainty specifications
- Extensive upgrades and replacements
- Choice of 99 % or 95 % confidence levels on specifications
- Additional emulation of the 5200A AC Calibrator in automated systems



The 5700A/EP is an upgrade service that extends both the performance and service life of your existing 5700A Multifunction Calibrator. Through the installation of new hardware and software, your working 5700A, no matter how old, will be brought up to the performance equivalent of a state-of-the-art 5720A, at half of the cost of a new calibrator. All work is performed at the Fluke Corporation manufacturing facilities in Everett, Washington, USA, or Eindhoven, The Netherlands, with rigorous testing and verification performed on the actual 5720A production line.

### 40 % improvement in uncertainty specifications

Give your 5700A the performance you need to quickly, easily and reliably meet your most demanding dc and low frequency ac calibration workload, including dmm's up to 8½ digits.

### Extensive upgrades and replacements

Extensive hardware and firmware upgrades and replacements bring your 5700A up to the latest production configuration.

### Choice of 99 % or 95 % confidence levels on specifications

You can trade a small amount of risk for lower uncertainties, and simplify the inter-comparisons of measurements by using the internationally accepted and more aggressive 95 % confidence specifications. Or use the conservative 99 % specifications Fluke traditionally publishes. Both are available, after the upgrade, at the press of the SPEC key on the calibrator's front panel.

### Additional emulation of the 5200A AC Calibrator in automated systems

With the upgrade, you can replace the now obsolete 5200A in automated systems with minimal changes to your software.

### New front panel screen saver

A new screen saver for the front panel message display extends the display life.

### How the upgrade process works

Due to the rigorous stability testing required, normal turn-around time for the upgrade process is six to eight weeks. Upon placing your order, a Fluke service representative will contact you to schedule your 5700A into the upgrade facility. Approximately one week prior to your scheduled date, you will receive a shipping container for returning your 5700A to Fluke.

Once your calibrator arrives at Fluke, the upgrade proceeds in three phases:

1. All outstanding engineering changes (PCNs) are made. The upgraded hardware is installed, along with new firmware. Nearly one-third of the 5700A's modules are replaced, including the vacuum fluorescent displays and front panel key pad. A label indicating that the 5700A/EP upgrade has been installed is affixed to the calibrator rear panel.
2. Your unit is sent to the stability station where it is monitored for three weeks.
3. Final test calibration and verification is performed at the 5720A production line, and the unit is packaged for return shipment to you.

**Note:** If your 5700A is not in working condition, the cost of any required repairs will be estimated in advance.

### Ordering Information 5700A/EP UG 5700A Upgrade

# 57LFC ATE System Source

## DC/LF Calibration

A rugged, accurate source of traceable signals designed for ATE systems



- High burden and compliance output maintains specification to overcome loading from system connections and cables
- Emulates Fluke 5700 GPIB commands
- All external interface connectors conveniently located on the front panel for easy setup and cable connections
- Lightweight yet rugged design for easy system deployment and transportation
- Meets stringent storage and operating MIL specifications

### Tech Tip

Long cable lengths commonly associated with ATE systems require a precision source with high burden currents to maintain accuracy specifications at the test head.

The Fluke 57LFC is a precision system source designed specifically for the ATE systems environment. The 57LFC sources dc and ac voltage, dc and ac current, and resistance. This rugged, economical signal source has the highly accurate and traceable signals required in test systems for electronic products with low frequency analog signals.

The Fluke 57LFC is a valuable aid to system built-in test (BIT) diagnostics and routine maintenance. Use it as a stimulus or embedded traceable source to run routine diagnostics throughout your built-in test environment (BITE) strategy. The 57LFC, used as an embedded system source, will increase system up time and reduce the need for excess inventory, while improving system accuracy and confidence at the test

interface. System traceability, confidence and quality are transferred to equipment housed within the ATE system automatically, through use of user-developed diagnostic software routines. The 57LFC does not influence system downtime when removed for its periodic calibration.

The 57LFC is designed to meet the stringent demands of an ATE environment. Temperature sensors monitor and protect the 57LFC from adverse environmental conditions. All signal inputs and outputs are fully protected from reverse voltage and short circuiting and can be fully isolated from the system analog bus. The 57LFC features a rugged design, weighs less than 40 pounds, and fits into a standard system rack environment.

### DC Voltage Specifications

Ranges	Absolute Uncertainty, tcal + 5 °C + (% output + V) 1 Year		Resolution	Maximum Burden <sup>[1]</sup>
0 to 220 mV	0.004 %	3 µV	0.1 µV	50 Ω output impedance
0 to 2.2 V	0.0025 %	3 µV	1 µV	50 mA
0 to 11 V	0.0025 %	30 µV	10 µV	50 mA
0 to 22 V	0.0025 %	30 µV	10 µV	50 mA
0 to 220 V	0.004 %	300 µV	100 µV	20 mA

<sup>[1]</sup> Remote sensing provided on all but 220 mV range.

**Note:** minimum output 0 V for all ranges.

### DC Current Specifications

Ranges	Absolute Uncertainty, tcal + 5 °C + (% of output + A) 1 Year		Resolution	Maximum Compliance Voltage	Maximum Inductive Load
0 to 220 µA	0.05 %	0.02 µA	1 nA	10 V	300 µH
0 to 2.2 mA	0.05 %	0.05 µA	0.01 µA	10 V	300 µH
0 to 22 mA	0.05 %	0.25 µA	0.1 µA	10 V	300 µH
0 to 220 mA	0.05 %	2.5 µA	1 µA	10 V	300 µH
0 to 2.2 A	0.07 %	40 µA	10 µA	4 V	300 µH

## Resistance Specifications

Nominal Resistance Value <sup>[1]</sup>	Absolute Uncertainty of Characterized Value, tcal + 5 °C + (% of output) 1 Year	Full Specification Current <sup>[2]</sup>	Maximum Peak Current
0 Ω	0.001 Ω	8 to 200 mA	220 mA
1 Ω	0.001 Ω	8 to 100 mA	220 mA
1.9 Ω	0.002 Ω	8 to 100 mA	220 mA
10 Ω	0.004 Ω	8 to 11 mA	220 mA
19 Ω	0.008 Ω	8 to 11 mA	160 mA
100 Ω	0.01 Ω	8 to 11 mA	70 mA
190 Ω	0.02 Ω	8 to 11 mA	50 mA
1 kΩ	0.1 Ω	1 to 2 mA	22 mA
1.9 kΩ	0.2 Ω	1 to 1.5 mA	16 mA
10 kΩ	1 Ω	0.1 to 0.5 mA	3 mA
19 kΩ	2 Ω	0.05 to 0.25 mA	1.6 mA
100 kΩ	10 Ω	0.01 to 0.1 mA	0.3 mA
190 kΩ	20 Ω	5 to 50 μA	0.16 mA
1 MΩ	100 Ω	5 to 20 μA	30 μA
1.9 MΩ	200 Ω	2.5 to 10 μA	16 μA
10 MΩ	4 kΩ	0.5 to 2 μA	3 μA
19 MΩ	10 kΩ	0.25 to 1 μA	1.6 μA

<sup>[1]</sup> Discrete resistors with characterized values stored in non-volatile memory. Specifications apply to the characterized value using 4-wire connections.

<sup>[2]</sup> Active two-wire compensation may be selected for values up to 190 kΩ. Active compensation is 11 mA load and 2 V burden minimum.

## AC Voltage Specifications

Ranges	Frequency	Absolute Uncertainty, tcal + 5 °C + (% output + V) 1 year	Resolution	Maximum Burden <sup>[1][2]</sup>
10 mV to 22 mV	10 to 45 Hz	0.15 %	20 μV	50 Ω output impedance
	45 Hz to 20 kHz	0.08 %	20 μV	
	20 to 50 kHz	0.25 %	20 μV	
	50 to 100 kHz	0.5 %	50 μV	
22 mV to 220 mV	10 to 45 Hz	0.15 %	50 μV	50 Ω output impedance
	45 Hz to 20 kHz	0.05 %	50 μV	
	20 to 50 kHz	0.25 %	50 μV	
	50 to 100 kHz	0.4 %	200 μV	
0.22 V to 2.2 V	10 to 45 Hz	0.1 %	250 μV	50 mA
	45 Hz to 20 kHz	0.05 %	100 μV	
	20 to 50 kHz	0.1 %	320 μV	
	50 to 100 kHz	0.25 %	2000 μV	
2.2 V to 22 V	10 to 45 Hz	0.1 %	1 mV	50 mA
	45 Hz to 20 kHz	0.05 %	1 mV	
	20 to 50 kHz	0.1 %	1 mV	
	50 to 100 kHz	0.25 %	2 mV	
22 V to 220 V <sup>[2]</sup>	10 Hz to 45 Hz	0.1 %	10 mV	20 mA
	45 Hz to 20 kHz	0.05 %	10 mV	
	20 to 50 kHz	0.25 %	20 mV	
	50 to 100 kHz	0.5 %	50 mV	

<sup>[1]</sup> Remote sensing provided on all but 22 mV and 220 mV ranges. Maximum output current is reduced by 50 % above 40 °C. Maximum load capacitance is 500 pF.

<sup>[2]</sup> V x Hz limited to 11.8e6.

**Note:** frequency uncertainty is specified to be 0.01 % of frequency setting.

### AC Voltage Distortion

Ranges	Frequency	Max distortion and noise 10 Hz to 10 MHz Bandwidth ± (% output + V)	
10 mV to 22 mV	10 to 45 Hz	0.15 %	90 µV
	45 Hz to 20 kHz	0.035 %	90 µV
	20 kHz to 50 kHz	0.15 %	90 µV
	50 kHz to 100 kHz	0.25 %	90 µV
22 mV to 220 mV	10 to 45 Hz	0.15 %	90 µV
	45 Hz to 20 kHz	0.035 %	90 µV
	20 kHz to 50 kHz	0.15 %	90 µV
	50 kHz to 100 kHz	0.20 %	90 µV
0.22 V to 2.2 V	10 to 45 Hz	0.15 %	200 µV
	45 Hz to 20 kHz	0.035 %	200 µV
	20 kHz to 50 kHz	0.15 %	200 µV
	50 kHz to 100 kHz	0.20 %	200 µV
2.2 V to 22 V	10 to 45 Hz	0.15 %	2 mV
	45 Hz to 20 kHz	0.035 %	2 mV
	20 kHz to 50 kHz	0.2 %	2 mV
	50 kHz to 100 kHz	0.5 %	2 mV
22 V to 220 V	10 Hz to 45 Hz	0.15 %	10 mV
	45 Hz to 20 kHz	0.05 %	10 mV
	20 kHz to 50 kHz	0.8 %	10 mV
	50 kHz to 100 kHz	1.0 %	10 mV

### AC Current Specifications

Ranges [2]	Frequency	Absolute Uncertainty, tcal + 5 °C + (% of output + A) 1 year		Resolution	Maximum Compliance Voltage (rms)	Maximum Inductive Load [1]
30 µA to 220 µA	10 to 20 Hz	0.3 %	0.2 µA	0.01 µA	7 V	50 µH
	20 to 45 Hz	0.15 %	0.2 µA			
	45 Hz to 1 kHz	0.125 %	0.2 µA			
	1 to 5 kHz	0.4 %	0.3 µA			
0.22 mA to 2.2 mA	5 to 10 kHz	1.5 %	0.4 µA			
	10 to 20 Hz	0.2 %	0.3 µA	0.1 µA	7 V	50 µH
	20 to 45 Hz	0.15 %	0.3 µA			
	45 Hz to 1 kHz	0.1 %	0.3 µA			
2.2 mA to 22 mA	1 to 5 kHz	0.2 %	0.3 µA			
	5 to 10 kHz	0.8 %	0.5 µA			
	10 to 20 Hz	0.2 %	3 µA	1 µA	7 V	50 µH
	20 to 45 Hz	0.1 %	3 µA			
	45 Hz to 1 kHz	0.1 %	3 µA			
22 mA to 220 mA	1 to 5 kHz	0.2 %	3 µA			
	5 to 10 kHz	0.4 %	5 µA			
	10 to 20 kHz	0.8 %	5 µA			
	10 to 20 Hz	0.18 %	30 µA	10 µA	7 V	50 µH
	20 to 45 Hz	0.1 %	30 µA			
	45 Hz to 1 kHz	0.1 %	30 µA			
0.22 A to 2.2 A	1 to 5 kHz	0.3 %	50 µA			
	5 to 10 kHz	0.4 %	100 µA			
	10 to 20 kHz	0.8 %	200 µA			
	10 to 45 Hz	0.18 %	300 µA	100 µA	4 V	2.5 µH
	45 Hz to 1 kHz	0.1 %	300 µA			
0.22 A to 2.2 A	1 to 5 kHz	1 %	3000 µA			
	5 to 10 kHz	5 %	5000 µA			

[1] 400 µH with inductive compensation ON.

[2] I-guard, (as on the 5700A rear panel), required when sourcing low-level currents through a long cable.

**Note:** Frequency uncertainty is specified to be 0.01 % of frequency setting.

## General Specifications

### Warm-up time

Twice the time since last warmed up, to a maximum of 30 minutes

### Temperature performance

Operating: 0 to 50 °C

Calibration (tcal): 15 to 37.7 °C

Storage: -40 to 75 °C

### Temperature coefficient

Temperature coefficient for temperatures outside tcal +5 °C is 10 % of the 1-year spec per °C

### Relative humidity

Operating: < 80 % to 30 °C, < 70 % to 40 °C, < 40 % to 50 °C

Provide typical specification for 43 °C at 95 % non-condensing

Storage: < 95 %, non-condensing

### Altitude

Operating: 3,050 m (10,000 ft) maximum

Non-operating: 12,200 m (40,000 ft) max.

### Safety

Designed to comply with

IEC 61010-1 2000-1;

ANSI/ISA-S82.01-1994;

CAN/CSA-C22.2 No. 1010.1-92

### Analog low isolation

20 V

## EMC

Designed to comply with IEC 61326-1 2000-11 (EMC)

### Line power

Line voltage (selectable): 100 V, 120 V, 208 V, and 230 V

Line frequency: 47 to 63 Hz

Line voltage variation:  $\pm 7\%$  about line voltage setting

Maximum VA: 200

### Settling time

$\leq 3$  to 10 seconds, similar to 5700A

### Dimensions

7" x 17" x 18" maximum chassis

H x W x D

### Weight

Less than 40 pounds

(less than 18 kg)

### Electrical/signal interface

Fluke 5700A/LP\* equivalent signal interface, AC Mains, IEEE-488, and RS232 connectors, AC power switch, and Line Voltage selection on front panel

### Cooling

50 cubic feet per minute

\*Fluke 5700A/LP special build configuration for Navy CASS program

## Ordering Information

### Models

57LFC ATE System Source

### Options and

### Accessories

Y5537A Comprehensive Rack

Mount Kit

# 525A Temperature/ Pressure Calibrator

riešenia na presné meranie

www.elseo.sk/Fluke-Calibration

## DC/LF Calibration

Superior accuracy and functionality in an economical benchtop package



- Calibrates a wide variety of thermocouple instrumentation
- Highly accurate simulation and measurement of RTD probes
- Direct measurement of all Fluke 700 Series and 525A-P pressure modules
- Converts easily to any pressure unit
- Sources dc voltage to 100 V and current to 100 mA at 30 ppm



### Tech Tip

The 525A makes an excellent pressure readout standard using the 525A-P Pressure Modules.

The Fluke 525A Temperature/Pressure Calibrator gives you a workhorse combination of high accuracy and broad functionality for temperature and pressure instrument calibration. Compact and economical, the 525A has an interface for automated calibration, providing wide workload coverage in instrument shops and calibration labs, as well as in ATE applications. The 525A is the most accurate Fluke temperature calibrator, sourcing and measuring a complete range of

RTDs, thermocouples, and thermistors. It also measures pressure covering common ranges from 1 inch (6900 Pa) of water up to 10,000 PSI (69 MPa) using the Fluke 700 Series (0.05 %) pressure modules and the 525A-P (0.02 %) Series Pressure Modules. Plus, the dc voltage and current specifications of the 525A enable you to calibrate other process calibrators and a wide variety of other instruments with accuracy that rivals any calibrator in its price range.

### DC Voltage Specifications, Output

Ranges <sup>[1]</sup>	Absolute Uncertainty, tcal ± 5 °C ± (ppm of output + µV)				Stability 24 hours, ± 1 °C ± (ppm of output + µV)	Resolution	Maximum Burden <sup>[2]</sup>
	90 days	1 year					
0 to 100.000 mV	25	3 µV	30	3 µV	5 + 2	1 µV	10 mA
0 to 1.00000 V	25	20 µV	30	20 µV	4 + 20	10 µV	10 mA
0 to 10.0000 V	25	200 µV	30	200 µV	4 + 200	100 µV	10 mA
0 to 100.000 V	25	2 mV	30	2 mV	5 + 1 mV	1 mV	1 mA

<sup>[1]</sup> All outputs are positive only.

<sup>[2]</sup> Remote sensing is not provided. Output resistance is < 1 Ω.

### DC Current Specifications, Output

Ranges <sup>[1]</sup>	Absolute Uncertainty, tcal ± 5 °C ± (ppm of output + µA)				Resolution	Maximum Compliance Voltage	Maximum Inductive Load
	90 days	1 year					
0 to 100.000 mA	85	2	100	2	1 µA	10 V	100 µH

<sup>[1]</sup> All outputs are positive only.

## Resistance Specifications, Output

Ranges <sup>[1]</sup>	Absolute Uncertainty, $t_{cal} \pm 5\text{ }^{\circ}\text{C}$ $\pm$ (ppm of output + $\Omega$ )		Resolution	Allowable Current <sup>[2]</sup>
	90 days	1 year		
5 to 400.00 $\Omega$	0.025	0.03	0.01 $\Omega$	1 to 10 mA
5 to 4.0000 k $\Omega$	0.25	0.3	0.1 $\Omega$	250 $\mu\text{A}$ to 1 mA

<sup>[1]</sup> Continuously variable from 0 to 4 k $\Omega$ .

<sup>[2]</sup> For currents lower than shown, the floor adder increases by  $\text{Floor}(\text{new}) = \text{Floor}(\text{old}) \times I_{\text{min}}/I_{\text{actual}}$ . For example, a 500  $\mu\text{A}$  stimulus measuring 100  $\Omega$  has a floor uncertainty of  $0.025\text{ } \Omega \times 1\text{ mA}/500\text{ } \mu\text{A} = 0.05\text{ } \Omega$ .

## Resistance Specifications, Input

Ranges	Absolute Uncertainty, $t_{cal} \pm 5\text{ }^{\circ}\text{C}$ $\pm$ (ppm of output + $\Omega$ )				Resolution	Stimulus Current
	90 days		1 year			
0 to 400.00 $\Omega$	35	0.003	40	0.003	0.001 $\Omega$	1 mA
401 to 4001.00 $\Omega$	35	0.03	40	0.03	0.01 $\Omega$	0.1 mA

## Thermocouple Specification, Output and Input

TC Type <sup>[2]</sup>	Range ( $^{\circ}\text{C}$ )		Absolute Uncertainty, $t_{cal} \pm 5\text{ }^{\circ}\text{C}$ , $\pm$ ( $^{\circ}\text{C}$ ) <sup>[1]</sup>	
			Output/Input	
	Minimum	Maximum	90 days	1 year
B	600 $^{\circ}\text{C}$	1820 $^{\circ}\text{C}$	0.42 $^{\circ}\text{C}$	0.46 $^{\circ}\text{C}$
C	0 $^{\circ}\text{C}$	2316 $^{\circ}\text{C}$	0.25 $^{\circ}\text{C}$	0.84 $^{\circ}\text{C}$
E	-250 $^{\circ}\text{C}$ -100 $^{\circ}\text{C}$	-100 $^{\circ}\text{C}$ 1000 $^{\circ}\text{C}$	0.38 $^{\circ}\text{C}$ 0.16 $^{\circ}\text{C}$	0.50 $^{\circ}\text{C}$ 0.21 $^{\circ}\text{C}$
J	-210 $^{\circ}\text{C}$ -100 $^{\circ}\text{C}$	-100 $^{\circ}\text{C}$ 1200 $^{\circ}\text{C}$	0.20 $^{\circ}\text{C}$ 0.18 $^{\circ}\text{C}$	0.27 $^{\circ}\text{C}$ 0.23 $^{\circ}\text{C}$
K	-200 $^{\circ}\text{C}$ -100 $^{\circ}\text{C}$	-100 $^{\circ}\text{C}$ 1372 $^{\circ}\text{C}$	0.25 $^{\circ}\text{C}$ 0.19 $^{\circ}\text{C}$	0.33 $^{\circ}\text{C}$ 0.40 $^{\circ}\text{C}$
L	-200 $^{\circ}\text{C}$	900 $^{\circ}\text{C}$	0.37 $^{\circ}\text{C}$	0.17 $^{\circ}\text{C}$
N	-200 $^{\circ}\text{C}$	1300 $^{\circ}\text{C}$	0.33 $^{\circ}\text{C}$	0.27 $^{\circ}\text{C}$
R	0 $^{\circ}\text{C}$	1750 $^{\circ}\text{C}$	0.58 $^{\circ}\text{C}$	0.40 $^{\circ}\text{C}$
S	0 $^{\circ}\text{C}$	1750 $^{\circ}\text{C}$	0.56 $^{\circ}\text{C}$	0.46 $^{\circ}\text{C}$
T	-250 $^{\circ}\text{C}$ -150 $^{\circ}\text{C}$	-150 $^{\circ}\text{C}$ 400 $^{\circ}\text{C}$	0.51 $^{\circ}\text{C}$ 0.18 $^{\circ}\text{C}$	0.63 $^{\circ}\text{C}$ 0.14 $^{\circ}\text{C}$
U	-200 $^{\circ}\text{C}$ 0 $^{\circ}\text{C}$	0 $^{\circ}\text{C}$ 600 $^{\circ}\text{C}$	0.56 $^{\circ}\text{C}$ 0.27 $^{\circ}\text{C}$	0.56 $^{\circ}\text{C}$ 0.27 $^{\circ}\text{C}$
mV	-10 to 75.000 mV			

<sup>[1]</sup> Does not include thermocouple wire error.

<sup>[2]</sup> Also excludes type XP and BP.

## TC mV Specifications, Input and Output

Range (mV)	Absolute Uncertainty, $t_{cal} \pm 5\text{ }^{\circ}\text{C}$ $\pm$ (ppm of output + $\mu\text{V}$ )		Stability 24 hours, $\pm 1\text{ }^{\circ}\text{C}$ $\pm$ (ppm of output + $\mu\text{V}$ )	Resolution	Maximum Burden
	90 days	1 year			
-10 to 75.000	25 + 3 $\mu\text{V}$	30 + 3 $\mu\text{V}$	5 + 2 $\mu\text{V}$	1 $\mu\text{V}$	10 $\Omega$

### RTD and Thermistor Specification, Output

RTD Type	Range (°C)		Absolute Uncertainty, tcal ± 5 °C ± (°C) [1]	
	Minimum	Maximum	90 days	1 year
Pt 385, 100 Ω	-200 °C	800 °C	0.06 °C	0.10 °C
Pt 3926, 100 Ω	-200 °C	630 °C	0.06 °C	0.09 °C
Pt 3916, 100 Ω	-200 °C	630 °C	0.06 °C	0.09 °C
Pt 385, 200 Ω	-200 °C	630 °C	0.31 °C	0.50 °C
Pt 385, 500 Ω	-200 °C	630 °C	0.13 °C	0.19 °C
Pt 385, 1000 Ω	-200 °C	630 °C	0.06 °C	0.09 °C
PtNi 385, 120 Ω (Ni 120)	-80 °C	260 °C	0.04 °C	0.03 °C
Cu 427, 10 Ω [2]	-100 °C	260 °C	0.63 °C	0.75 °C
YSI 400	15 °C	50 °C	0.005 °C	0.007 °C

[1] 2-wire output

[2] Based on MINCO Application Aid No. 18.

### RTD and Thermistor Specification, Input

RTD Type	Range (°C)		Absolute Uncertainty, tcal ± 5 °C ± (°C) [1]	
	Minimum	Maximum	90 days	1 year
Pt 385, 100 Ω	-200 °C	80 °C	0.031 °C	0.012 °C
	0 °C	100 °C	0.018 °C	0.020 °C
	100 °C	630 °C	0.027 °C	0.047 °C
	630 °C	800 °C	0.050 °C	0.057 °C
Pt 3926, 100 Ω	-200 °C	100 °C	0.031 °C	0.019 °C
	0 °C	630 °C	0.018 °C	0.046 °C
	100 °C		0.026 °C	
Pt 3916, 100 Ω	-200 °C	630 °C	0.026 °C	0.047 °C
Pt 385, 200 Ω	-200 °C	630 °C	0.071 °C	0.106 °C
Pt 385, 500 Ω	-200 °C	630 °C	0.046 °C	0.076 °C
Pt 385, 1000 Ω	-200 °C	100 °C	0.031 °C	0.040 °C
	0 °C	630 °C	0.039 °C	0.047 °C
PtNi 385, 120 Ω (Ni120)	-80 °C	260 °C	0.209 °C	0.212 °C
Cu 427, 10 Ω [2]	-100 °C	260 °C	0.300 °C	0.069 °C
YSI 400	15 °C	50 °C	0.005 °C	0.304 °C
SPRT, 25 Ω	User Defined	User Defined	0.05 °C	0.06 °C

[1] 4-wire mode. Uncertainties listed do not include probe uncertainties.

[2] Based on MINCO Application Aid No. 18.

### General Specifications

Warm up time: Twice the time since last warmed up, to a maximum of 30 minutes

Settling time: Less than 5 seconds for all functions and ranges except as noted

Standard interface: RS-232

Optional interface: IEEE-488 (GPIB)

### Temperature performance

Operating: 0 °C to 50 °C

Calibration (tcal): 18 °C to 28 °C

Storage: -20 °C to 70 °C

Electromagnetic compatibility: CE, conforms to EN61326

Temperature coefficient: For temperatures outside tcal ± 5 °C is 10 % of the 90 day specification (or 1 year if applicable) per °C

### Relative humidity

Operating: < 80 % to 30 °C, < 70 % to 40 °C, < 40 % to 50 °C

Storage: < 95 % noncondensing

### Altitude

Operating: 3,050 m (10,000 ft) maximum

Nonoperating: 12,200 m (40,000 ft) maximum

### Safety

EN 61010 Second, ANSI/ISA-S82.01-1994, CAN/CSA-C22.2 No. 1010.1-92, NRTL

Analog low isolation : 20 V

### Line power

Line Voltage (selectable):

100 V/120 V or 220 V/240 V

Line Frequency: 47 to 63 Hz

Line Voltage Variation: ± 10 % about line voltage setting

Power consumption: 15 VA maximum

### Dimensions

Height: 13.3 cm (5.25 in) plus

1.5 cm (0.6 in) four feet on bottom

Width: 3/4 standard rack width

Depth: 47.3 cm (18.6 in) overall

Weight (without options): 4 kg (9 lb)

### Calibration

NIST traceable with data



## Ordering Information

### Models\*

**525A** Temperature/Pressure Calibrator

**525A-GPIB** Temperature/Pressure Calibrator with IEEE-488 interface

### Options and Accessories\*\*

**5520A-525A/Leads** Thermo-couple and Test Lead Set

**Y525** 19 in Rack Mount Kit

**Fluke 700PD3** Dual Pressure Module  $\pm 5$  psi/ $\pm 34$  kPa

**Fluke 700P31** High Pressure Module 10000 psi/69 M Pa

**Fluke 700P22** Differential Pressure Module 1 psi/6900 Pa

**Fluke 700P24** Differential Pressure Module 15 psi/103 kPa

**Fluke 700PD2** Dual Pressure Module  $\pm 1$  psi/ $\pm 6900$  Pa

**Fluke 700P08** Gage Pressure Module 1000 psi/6900 kPa

**Fluke 700PA4** Absolute Pressure Module 15 psi/103 kPa

**Fluke 700P30** High Pressure Module 5000 psi/34 M Pa

**Fluke 700PD7** Dual Pressure Module  $-15/200$  psi/ $-100/1380$  kPa

\*Specify 120 or 240 power

\*\*For specifications for 700 and 525A-P Pressure Modules, visit Fluke on the web at [www.fluke.com](http://www.fluke.com)

**Fluke 700P05** Gage Pressure Module 30 psi/207 kPa

**Fluke 700P06** Gage Pressure Module 100 psi/690 kPa

**Fluke 700P29** High Pressure Module 3000 psi/20.7 M Pa

**Fluke 700PD5** Dual Pressure Module  $-15/30$  psi/ $-100/207$  kPa

**Fluke 700PV3** Vacuum Pressure Module  $-5$  psi/ $-34$  kPa

**Fluke 700P23** Differential Pressure Module 5 psi/34 kPa

**Fluke 700PA5** Absolute Pressure Module 30 psi/207 kPa

**Fluke 700P03** Differential Pressure Module 5 psi/34 kPa

**Fluke 700PD6** Dual Pressure Module  $-15/100$  psi/ $-100/690$  kPa

**Fluke 700P04** Differential Pressure Module 15 psi/103 kPa

**Fluke 700PA6** Absolute Pressure Module 100 psi/6900 kPa

**Fluke 700P01** Differential Pressure Module 10.00 in. H<sub>2</sub>O/2.5 kPa

**Fluke 700PD4** Dual Pressure Module  $\pm 15$  psi/ $\pm 103$  kPa

**PV350** Pressure/Vacuum Module (0 to 350 PSI)

**Fluke 700P00** Differential Pressure Module 1.000 in H<sub>2</sub>O/0.25 kPa

**Fluke 700P07** Gage Pressure Module 500 psi/3400 kPa

**Fluke 700P09** Gage Pressure Module 1500 psi/10 MPa

**Fluke 700P02** Differential Pressure Module 1 psi/6900 Pa

**Fluke 700P27** High Pressure Module 300 psi/2070 kPa

**Fluke 700PV4** Vacuum Pressure Module  $-15$  psi/ $-103$  kPa

**Fluke 700PA3** Absolute Pressure Module 5 psi/34 kPa

**525A-P02** Differential 1 psi/6900 Pa

**525A-P05** Gage 30 psi/207 kPa

**525A-P06** Gage 100 psi/690 kPa

**525A-P07** Gage 500 psi/3400 kPa

**525A-P08** Gage 1000 psi/6900 kPa

**525A-P29** Gage 3000 psi/20.7 MPa

**525A-PA6** Absolute 100 psia/6900 kPa

**525A-PA7** Absolute 500 psia/3400 kPa

**525A-PA8** Absolute 1000 psia/6900 kPa

### Software

**MET/CAL® Plus** Automated Calibration Management Software

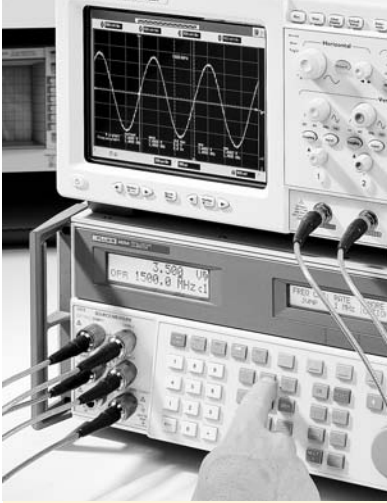

Fluke offers a variety of oscilloscope calibration solutions to match just about every workload and budget. For dedicated oscilloscope calibration workloads, the 9500B offers the highest performance, fully automated calibration with leveled sine waves to 6.4 GHz and edges to 25 ps. The 5820 calibrates oscilloscopes in the bandwidth range up to 2.1 GHz for upgradeable entry level performance.

If oscilloscopes are only part of your workload, your best solution might be in the scope cal options available for the 5520A or 5500A Multi-Product Calibrators, or the 9100 Universal Calibration System. These products calibrate a wide workload in addition to oscilloscopes.

Workload Maximum Bandwidth	Single Channel Calibration		
	Multi-Product Calibration		
	9100	5500A	5520A
< 300 MHz	add option 250	5500A/3	5520A/3
< 600 MHz	add option 600	5500A/6	5520A/6
< 1100 MHz	N/A	N/A	5520A/1 GHz
	Dedicated Scope Calibrator		
	5820A	9500B	
	< 300 MHz	5820A-1C	9500B/600 Active Head: 1x9510 FLK
< 600 MHz	5820A-1C	9500B/600 Active Head: 1x9510 FLK	
< 1100 MHz	5820A-1C-GHz	9500B/1100 Active Head: 1x9510 FLK	
< 2.1 GHz	5820A-1C-GHz	9500B/3200 Active Head: 1x9530 FLK	
< 3.2 GHz	N/A	9500B/3200 Active Head: 1x9530 FLK	
< 6.4 GHz	N/A	9500B/3200 Active Heads: 1x9530 FLK, 1x9560 FLK	
< 14 GHz	N/A	9500B/3200 Active Heads: 1x9530 FLK, 1x9560 FLK, 1x9550 FLK	
	Multi-Channel Calibration		
	Dedicated Scope Calibrator		
	5820A	9500B	
< 300 MHz	5820A-5C	9500B/600 Active Heads: 2x9510 FLK	
< 600 MHz	5820A-5C	9500B/600 Active Heads: 5x9510 FLK	
< 1100 MHz	5820A-5C-GHz	9500B/1100 Active Heads: 5x9510 FLK	
< 2.1 GHz	5820A-5C-GHz	9500B/3200 Active Heads: 5x9530 FLK	
< 3.2 GHz	N/A	9500B/3200 Active Heads: 5x9530 FLK	
< 6.4 GHz	N/A	9500B/3200 Active Heads: 5x9530 FLK, 1x9560 FLK	
< 14 GHz	N/A	9500B/3200 Active Heads: 5x9530 FLK, 1x9560 FLK, 1x9550 FLK	

# 9500B Oscilloscope Calibrator

riešenia na presné meranie

www.elseo.sk/Fluke-Calibration

FLUKE®

## Oscilloscope Calibration

The highest performance, fully automated, upgradeable  
oscilloscope calibration workstation



- Full automation provides totally hands-free oscilloscope calibration
- Continuous upgradeability helps you protect your investment
- Up to five channels simultaneous output
- Leveled sine waves to 6.4 GHz and edges to 25 ps
- Fluke's unique Active Head Technology generates calibration signals right at the oscilloscope input
- Software and procedures

### Tech Tip

9500 Active Heads can be calibrated away from the mainframe, so you can schedule calibrations of individual heads at different times. That way, you can keep the 9500 system available for use for a greater percentage of time.

The Fluke 9500B Oscilloscope Calibration Workstation brings the benefits of hands-free, fully-automated, accurate oscilloscope calibration to everyone at a price and performance level that your needs and budget can support, while ensuring that, through performance upgrades, future needs will be met when the time demands it.

#### Active Heads provide full automation

The Fluke 9500B provides true, full automation through the use of its unique Active Heads. With the 9500B, all the signals required to fully calibrate the oscilloscope are generated in detachable heads, remote from the calibrator mainframe. The heads are connected directly to the oscilloscope input without the need for additional cables. All control and switching of waveforms are performed under the control of the mainframe, yet within the head itself – typically only a matter of millimeters away from the oscilloscope input and amplifiers. With each 9500B mainframe able to control up to five heads, all the signals required to calibrate a four-channel oscilloscope with an external trigger can be supplied, controlled and switched without operator intervention or the need for external switching.

#### 9560 Active Head – for ultimate leveled sine performance to 6.4 GHz

The latest member of the Active Head family, 9560, allows existing users of the 9500 to upgrade their equipment to any 9500B status and take advantage of more recent product and performance enhancements. The 9560 is able to deliver 6.4 GHz leveled sine wave and pulse edges of 70 ps.

Unlike other oscilloscope calibrators, you're not restricted to fixed amplitude pulses. Active Head Technology™ lets you adjust output amplitude between 4.44 mV and 3.1 V, allowing you to check an oscilloscope's amplifiers right down to their most sensitive ranges. Whatever amplitude you choose, controlled wave shape filtering ensures that all high-speed edges have an accurately defined energy distribution.

#### Fully compatible with MET/CAL® Plus Calibration Management Software

The final link in the chain of full automation is software. The 9500B Oscilloscope Calibrator can be used with the powerful IEEE-488 (GPIB) based MET/CAL® Plus auto-mated calibration management software.

While allowing you to automate the calibration process, MET/CAL also documents results, manages your calibration inventory, and allows you to develop new oscilloscope calibration procedures. Running under Microsoft Windows® and supporting multi-user networking, the software implements advanced features such as ISO 9000 compliant traceability, custom certificate and report generation, and high-level procedure programming. The result is higher workload throughput, better calibration consistency, minimization of human error, and fewer requirements for operator training – in short, higher quality calibration at lower cost.

### Gold procedure support

Fluke's MET/SUPPORT Gold Software Support Program, available by annual subscription, gives you free access to all procedures written by the Fluke software support team, plus a host of additional benefits, including free software upgrades and discounts on custom procedure development. Even if you only use a few of the Gold Services in a year, you can easily recover more than the cost of your membership fee.

**Note:** For full and comprehensive specifications, refer to the Extended Specifications data sheet, available at [www.fluke.com](http://www.fluke.com)

All Specifications TCal  $\pm 5\text{ }^\circ\text{C}$ , 1 year, 99 % where Factory TCal =  $23\text{ }^\circ\text{C}$  (except frequency accuracies 5 years). Uncertainties are fully inclusive of instrument errors, resolution, stability, regulation and traceability to National Standards. In general, nothing further needs to be added to determine test uncertainty ratio against the equipment under calibration.

### Voltage Function (not available via 9550 Active Head)

	DC Into 1 M $\Omega$	DC Into 50 $\Omega$	Square Wave Into 1 M $\Omega$	Square Wave Into 50 $\Omega$
Amplitude	$\pm 1\text{ mV to } \pm 200\text{ V}$	$\pm 1\text{ mV to } \pm 5\text{ V}$	40 $\mu\text{V to } 200\text{ V pk-pk}$	40 $\mu\text{V to } 5\text{ V pk-pk}$
Accuracy	$\pm (0.025\% + 25\text{ }\mu\text{V})$		$\geq 1\text{ mV } (0.1\% + 10\text{ }\mu\text{V}),$ $< 1\text{ mV } (1\% + 10\text{ }\mu\text{V}) @ \leq 10\text{ KHz}$	
Ranging	Volt/div factors of 1, 2, 5 or 1, 2, 2.5, 4, 5; or continuously variable			
Deviation	$\pm 11.2\%$ (Including over and underrange)			
Rise/fall time	$< 100\text{ V pkpk } < 150\text{ ns}; \geq 100\text{ V pkpk } < 200\text{ ns}$			
Aberrations	$< 2\%$ peak for first 500 ns			
Frequency	10 Hz to 100 kHz			

DC into 1 M $\Omega$  available at all heads without specification degradation.

### Edge Function (9550 Active Head supports 25 ps Fast Edge only)

	500 ps Edge Pulse Into 50 $\Omega$ or 1 M $\Omega$	HV Edge Pulse Into 1 M $\Omega$	150 ps Fast-Edge (9530 Head Only) Into 50 $\Omega$	70 ps Fast-Edge (9560 Head Only) Into 50 $\Omega$	25 ps Fast-Edge (9550 Head Only) Into 50 $\Omega$
Amplitude	5 mV to 3 V pk-pk	1 mV to 200 V pk-pk <sup>(1)</sup>	5 mV to 3 V pk-pk	25 mV to 2 V pk-pk	425 mV to 575 mV pk-pk
Polarity	Rising and falling Return to ground	Rising and falling Return to ground	Rising and falling Return to ground	Rising Rising and falling	Rising and falling Return to ground
Rise/fall time (10 % to 90 %)	500 ps	$< 100\text{ V pk-pk } < 150\text{ ns}$ <sup>(2)</sup> $\geq 100\text{ V pk-pk } < 200\text{ ns}$ <sup>(2)</sup>	150 ps	70 ps	25 ps
Accuracy	+ 50 ps to 150 ps	N/A	$\pm 25\text{ ps}$	$\pm 12\text{ ps}$	$\pm 3\text{ ps}$
Accuracy (displayed value)	$\pm 35\text{ ps}$	N/A	$\pm 12\text{ ps}$	$\pm 8\text{ ps}$	$\pm 1.5\text{ ps}$
Duty cycle	10 %	50 %	10 %	10 %	10 %
Aberrations (Into VSWR 1.2:1)	$< \pm 2\%$ pk in 8 GHz $< \pm 1.5\%$ pk in 3 GHz (first 10 ns)	$< \pm 2\%$ pk (first 500 ns)	$< \pm 3\%$ pk in 8 GHz $< \pm 2\%$ pk in 3 GHz (first 1 ns)	$< \pm 4\%$ pk in 20 GHz $< \pm 3\%$ pk in 8 GHz $< \pm 1\%$ pk in 3 GHz (first 700 ps)	$< \pm 5\%$ pk in 20 GHz $< \pm 3\%$ pk in 10 GHz $< \pm 1\%$ pk in 3 GHz (first 200 ps)
Frequency	10 Hz to 2 MHz	10 Hz to 100 kHz	10 Hz to 2 MHz	10 Hz to 1 MHz	10 Hz to 1 MHz
Trigger to edge delay	25 ns (typical)				
Trigger to edge jitter	5 ps pk-pk				

<sup>(1)</sup> 1 mV to 5 V pk-pk into 50  $\Omega$ .

<sup>(2)</sup> Into 50  $\Omega$   $< 100\text{ ns}$ .

Edge speeds faster than 500 ps are not recommended for 1 M $\Omega$  input applications. 9560 and 9550 50  $\Omega$  only.

### Timing Marker Function (not available via 9550 Active Head)

Styles	Square	Sine	Pulse	Narrow Triangle
Period	9.0091 ns to 55 s	450.5 ps to 9.009 ns 9500/600 (909.1 ns min) 9560 (180.19 ps min)	900.91 ns to 55 s	900.91 ns to 55 s
Ranging	Time/div ranging 1, 2, 5 or 1, 2, 2.5, 4, 5 or continuously variable			
Deviation	± 45 % (including overrange)			
Rise/fall times	1 ns typical	N/A	1 ns typical	2.5 % of period
Timing accuracy	< 83 μs ± 0.25 ppm, ≥ 83 μs ± 3 ppm			
Amplitude	100 mV to 1 V pk-pk			
Sub-division	Every tenth marker can be set to higher amplitude for periods ≥ 1 μs for all waveshapes			

Line frequency timing markers are available in square waveform. Jitter wrt line zero crossing ± 20 μs pk-pk.  
Periods below 2 ns are not recommended for 1 MΩ input applications. 9560 50 Ω only.

### Leveled Sine Function (not available via 9550 Active Head)

	9500B/600	9500B/1100	9500B/3200 and 9530	9500B/3200 and 9560
Frequency range	0.1 Hz to 600 MHz	0.1 Hz to 1.1 GHz	0.1 Hz to 3.2 GHz	0.1 Hz to 6.4 GHz
Amplitude (pk-pk) (into 50 Ω)	0.1 Hz to 550 MHz 5 mV to 5 V	0.1 Hz to 550 MHz 5 mV to 5 V	0.1 Hz to 550 MHz 5 mV to 5 V	0.1 Hz to 550 MHz 5 mV to 5 V
	550 MHz to 600 MHz 5 mV to 3 V	550 MHz to 1.1 GHz 5 mV to 3 V	550 MHz to 2.5 GHz 5 mV to 3 V	550 MHz to 2.5 GHz 5 mV to 3 V
			2.5 GHz to 3.2 GHz 5 mV to 2 V	2.5 GHz to 3.2 GHz 5 mV to 2 V
				3.2 GHz to 6.4 GHz 25 mV to 2 V
Accuracy	± 1.5 % at single ref frequency (50 kHz to 10 MHz)			
Flatness wrt ref frequency	0.1 Hz to 300 MHz ± 2.0 %	0.1 Hz to 300 MHz ± 2.0 %	0.1 Hz to 300 MHz ± 2.0 %	0.1 Hz to 300 MHz ± 2.0 %
Into VSWR of 1.6:1 (1.2:1)	300 MHz to 550 MHz ± 3 % (± 2.5 %)	300 MHz to 550 MHz ± 3 % (± 2.5 %)	300 MHz to 550 MHz ± 3 % (± 2.5 %)	300 MHz to 550 MHz ± 2.5 % (± 2.5 %)
	550 MHz to 600 MHz ± 4 % (± 3.5 %)	550 MHz to 1.1 GHz ± 4 % (± 3.5 %)	550 MHz to 1.1 GHz ± 4 % (± 3.5 %)	550 MHz to 3.0 GHz ± 3.5 % (± 3.0 %)
			1.1 GHz to 3.2 GHz ± 5 % (± 4 %)	3.0 GHz to 6.4 GHz ± 5.0 % (± 4.0 %)
Harmonic purity	2nd Harmonic < -35 dBc, 3rd Harmonic < -40 dBc in 12 GHz			
Non and sub harmonic purity	< -40 dBc			< -35 dBc

Periods below 2 ns are not recommended for 1 MΩ input applications. 9560 50 Ω only.

### Dual Sine Function (not available via 9550 Active Head and specification limited to Heads of the same type)

	9500B/600	9500B/1100	9500B/3200 and 9530	9500B/3200 and 9560
Frequency range	0.1 Hz to 600 MHz	0.1 Hz to 1.1 GHz	0.1 Hz to 3.2 GHz	0.1 Hz to 3.2 GHz
Time alignment	± 25 ps any channel to any channel			

Periods below 2 ns are not recommended for 1 MΩ input applications. 9560 50 Ω only.

### Input Impedance Functions (not available via 9550 and 9560 Active Heads)

Resistance Measurement	10 Ω to 40 Ω	40 Ω to 90 Ω	90 Ω to 150 Ω	50 kΩ to 800 kΩ	800 kΩ to 1.2 MΩ	1.2 MΩ to 12 MΩ
Accuracy	± 0.5 %	± 0.1 %	± 0.5 %	± 0.5 %	± 0.1 %	± 0.5 %
<b>Not available via 9550 and 9560 Active Head</b>						
Capacitance measurement	1 pF to 35 pF	35 pF to 95 pF				
Accuracy	± 2 % ± 0.25 pF	± 3 % ± 0.25 pF				

### Pulse Width Function (not available via 9550 Active Head)

Pulse width	1 n to 100 ns
Accuracy	$< \pm 5 \% \pm 200 \text{ ps}$
Adjustment resolution	1 ns to 4 ns, $< 50 \text{ ps}$ 4 ns to 20 ns $< 250 \text{ ps}$ 20 ns to 100 ns $< 1 \text{ ns}$
Rise and fall time	$< 450 \text{ ps}$
Aberrations	$< \pm 5 \% \text{ pk (typical)}$
Width stability	$< 10 \text{ ps pk-pk 10 mins/1 } ^\circ\text{C}$
Pulse jitter (wrt trigger)	$< 5 \text{ ps pk-pk}$
Frequency	1 kHz to 1 MHz
Amplitude	1 V pk-pk into 50 $\Omega$

### Other Output Functions (not available via 9550 Active Head)

Current	DC	Square Wave
Amplitude	$\pm 100 \mu\text{A to } \pm 100 \text{ mA}$	$\pm 100 \mu\text{A to } \pm 100 \text{ mA pk-pk}$
Accuracy	$\pm (0.25 \% + 0.5 \mu\text{A})$	
Duty cycle and symmetry		50 %, symmetrical about ground
Rise time and aberrations		$< 150 \text{ ns and } < 2 \% \text{ pk}$
Requires 9530 or 9510 Head and BNC current adapter		
Composite Video Output		
Amplitude	1.0 V pk-pk	
Pattern (full raster)	White, grey or black	
Sync polarity	Positive or negative	
Standards	625-line 50 Hz, 525-line 60 Hz	
Trigger output	Composite sync or odd field start	
9560 50 $\Omega$ only		
Auxiliary Input		
Signal routing	Rear SMA input, passive and switched 50 $\Omega$ path to any Active Head	
Maximum input	$\pm 40 \text{ V pk-pk, } \pm 400 \text{ mA pk-pk}$	
Insertion loss (into 50 $\Omega$ )	to 100 MHz $< 2.5 \text{ dB}$ , to 500 MHz $< 4 \text{ dB}$ , to 1 GHz $< 6 \text{ dB}$	
Reference Frequency	Input (BNC)	Output (BNC)
Frequency range	1 MHz to 20 MHz in 1 MHz steps	1 MHz or 10 MHz
Level (typical)	90 mV to 1 V pk-pk	Into 50 $\Omega$ 1 V pk-pk, Into 1 M $\Omega$ 2 V pk-pk
Lock range	$\pm 50 \text{ ppm}$	

### Other Output Functions

Overload Pulse	
Amplitude	5 V to 20 V into 50 $\Omega$
Polarity	Positive/Negative
Duration	0.2 s to 100 s (subject to pulse energy limits)
Energy power in 50 $\Omega$	1.6 J to 50 J, 0.5 $\Omega$ to 8 $\Omega$
Trigger	Manual max. rep rate 0.3 Hz (internally limited)
Zero Skew	
Unadjusted skew	$< \pm 25 \text{ ps ch to ch}$
Adjusted skew	$< \pm 5 \text{ ps ch to ch}$
Skew temp coef	$< 0.2 \text{ ps/}^\circ\text{C}$
Rise and fall time	450 ps typical
Relative jitter	$< 7 \text{ ps pk-pk}$
Input Leakage Function	
Open circuit output	Leakage $< \pm 50 \text{ pA}$
Short circuit output	Offset $< \pm 15 \mu\text{V}$
LF Linear Ramp	
Waveforms	1 V pk-pk triangle symmetrical about ground
Linearity	$< \pm 0.1 \% \text{ deviation over 10 to 90 \%}$
Ramp time	1 ms, 10 ms, 100 ms or 1 s

## General Specifications

### Environmental

#### Temperature

Operating: 5 °C to 40 °C  
Storage: 0 °C to 50 °C, transit  
< 100 hours -20 °C to 60 °C

#### Humidity (non-condensing)

Operating: < 90 % 5 °C to 30 °C  
< 75 % 30 °C to 40 °C  
Storage: <95 % 0 °C to 50 °C

### Safety

Designed to and documented to  
EN61010-1-11993/  
A21995 CE and ETL marked

### EMC (including options)

Radiated Emissions: EN55011/22  
FCC Rules part 15 subpart J class B  
Radiated Immunity: EN50082-1

Conducted Emissions: EN55011  
1991 Class B  
Conducted Immunity: EN50082-1  
Harmonics: EN61000-3-2  
Shock and Vibration: MIL-T-28800  
type III, Class 5, style E

### Power

Line Voltage: 95 V to 132 V rms,  
209 V to 264 V rms installation  
CAT II  
Line Frequency: 48 Hz to 63 Hz  
Power Consumption: < 400 VA  
Warmup: 20 minutes

### Dimensions

9500 Base Unit: 133 H x 427 W x  
440 D mm (5.24 H x 16.8 W x  
17.3 D in)  
95xx Active Heads: 65 H x 31 W x  
140 D mm (2.56 H x 1.22 W x  
5.51 D in)

### Weight

9500 Base Unit: 12 kg (27 lbs)  
approx.  
95xx Active Heads: 0.45 kg (1 lb)  
approx.

### Warranty period

9500 Base Unit: One-year  
95xx Active Heads: Three-year  
Active Plus CarePlan

### Calibration

Standard: NPL-UK traceable  
calibration certificate with data.  
An accredited calibration certificate  
is available.

## Ordering Information

### Models

**9500B/600** 600 MHz  
High-Performance Oscilloscope  
Calibrator Workstation

**9500B/1100** 1100 MHz  
High-Performance Oscilloscope  
Calibrator Workstation

**9500B/3200** 3.2 GHz  
High-Performance Oscilloscope  
Calibrator Workstation

**9560 FLK** Active Head with  
6.4 GHz and 70 ps pulse  
capability

**9510 FLK** Active Head with  
1.1 GHz and 50 ps pulse  
capability

**9530 FLK** Active Head with  
3.2 GHz and 150 ps/500 ps  
pulse capability

**9550 FLK** Active Head with  
25 ps pulse capability

### Options and Accessories

**9500-60** Soft Carrying Case

**9500-65** Rugged Transit Case

**9500-90** Rack Mounting Kit

### 9500 Base Chassis Upgrades

**95/400-9500/600UG** Upgrade  
9500/400 to 9500/600

**95/400-9500/1100UG** Upgrade  
9500/400 to 9500/1100

**95/400-9500/3200UG** Upgrade  
9500/400 to 9500/3200  
firmware compatible with 9560  
modules, include upgrade to  
5 channels and simultaneous  
5-channel output functions

**95/600-9500/1100UG** Upgrade  
9500/600 to 9500/1100

**95/600-9500/3200UG** Upgrade  
9500/600 to 9500/3200  
firmware compatible with 9560  
modules, include upgrade to  
5 channels and simultaneous  
5 channel output functions

**95/1100-95/3200UG** Upgrade  
9500/1100 to 9500/3200  
firmware compatible with 9560  
modules, include upgrade to  
5 channels and simultaneous  
5 channel output functions

**95/3200-95/3200UG** Upgrade  
9500/3200 to 9500/3200  
firmware compatible with 9560  
modules, include upgrade to  
5 channels and simultaneous  
5 channel output functions

### Fluke 9500B Base Chassis Upgrades

**95B/600-95B/1100UG** Upgrade  
9500B/600 to 9500B/1100

**95B/600-95B/3200UG** Upgrade  
9500B/600 to 9500B/3200

**95B/1100-95B/3200U** Upgrade  
9500B/1100 to 9500B/3200

### Wavetek-Datron 9500 Upgrades

**95/400-95B/3200UG** Upgrade  
9500/400 to 9500B/3200,  
include upgrade to 5 channels,  
9560 capability, narrow pulse  
and simultaneous 5 channel  
output functions

**95/600-95B/3200UG** Upgrade  
9500/600 to 9500B/3200,  
include upgrade to 5 channels,  
9560 capability, narrow pulse  
and simultaneous 5 channel  
output functions

**95/1100-95B/3200UG** Upgrade  
9500/1100 to 9500B/3200,  
include upgrade to 5 channels,  
9560 capability, narrow pulse  
and simultaneous 5 channel  
output functions

**95/3200-95B/3200UG** Upgrade  
9500/3200 to 9500B/3200,  
include upgrade to 5 channels,  
9560 capability, narrow pulse  
and simultaneous 5 channel  
output functions

### Software

**MET/CAL® Plus** Automated  
Calibration Management  
Software

# 5820A Oscilloscope Calibrator

## Oscilloscope Calibration

Dedicated oscilloscope calibration that is flexible, powerful and affordable



- Excellent value for today's cal lab
- Compact, portable, easy to use and maintain
- Upgradeable to 2.1 GHz



### Tech Tip

Connecting to the scope is easy and reliable with the high quality coaxial cables of the 5820A. Intended for scopes with bandwidths up to 2.1 GHz, the calibrating signal's quality remains high, and the calibration technique is simple.

The Fluke 5820A Oscilloscope Calibrator is designed to calibrate all the ranges and functions of the majority of digital and analog oscilloscopes in use or being purchased today in the 500 MHz to 2.1 GHz bandwidth range. The 5820A connects to the unit under test via characterized cable interconnections, so it is easy to use and maintain.

The 5820's five-channel output option facilitates fast, hands-free automated calibration. Both the 2.1 GHz upgrade option and the five-channel output option can be added later, enabling the 5820A to keep up with your labs changing requirements.

**Note:** For full and comprehensive specifications, refer to the 5820A Oscilloscope Calibrator Specifications data sheet, available at [www.fluke.com](http://www.fluke.com).

### Voltage Function

Volt Function	DC Signal		Square Wave Signal <sup>[1]</sup>	
	into 50 Ω	into 1 MΩ	into 50 Ω	into 1 MΩ
Amplitude range	0 V to ± 6.6 V	0 V to ± 130 V	± 1 mV to ± 6.6 V p-p	± 1 mV to ± 130 V p-p
1-year absolute uncertainty, tcal ± 5 °C	± (0.25 % of output + 40 μV)	± (0.025 % of output + 25 μV)	± (0.25 % of output + 40 μV)	± (0.05 % of output + 5 μV)
Sequence	1-2-5 (e.g., 10 mV, 20 mV, 50 mV)			
Frequency range	10 Hz to 10 kHz			
1 year absolute uncertainty, tcal ± 5 °C	± (0.33 ppm of setting)			

<sup>[1]</sup> Positive or negative, zero referenced square wave.

### Edge Function

Edge Characteristics into 50 Ω	1-Year Absolute Uncertainty, tcal ± 5 °C	
Amplitude range (p-p)	± (2 % of output + 200 μV)	
Frequency range	± (0.33 ppm of setting)	
Rise time	+ 0/-100 ps	
Typical jitter, edge to trigger	•	
Leading edge aberrations	within 2 ns from 50 % of rising edge	< (3 % of output + 2 mV)
	2 ns to 5 ns	< 2 % of output + 2 mV)
	5 ns to 15 ns	< (1 % of output + 2 mV)
	after 15 ns	< (0.5 % of output + 2 mV)



### Fast Edge Function (2.1 GHz Option)

Edge Characteristics into 50 $\Omega$		1-Year Absolute Uncertainty, $t_{cal} \pm 5^\circ\text{C}$
Amplitude range (p-p)	250 mV	
Frequency range	1 kHz to 100 kHz	$\pm$ (0.33 ppm of setting)
Rise time	$\leq$ 150 ps	+ 0/-50 ps

### Leveled Sine Wave Function $\leq$ 600 MHz

Leveled Sine Wave Characteristics into 50 $\Omega$	Frequency Range				
	50 kHz (reference)	50 kHz to 100 MHz	100 MHz to 300 MHz	300 MHz to 500 MHz	500 MHz to 600 MHz
Amplitude range (p-p)	5 mV to 5.5 V				
1-year absolute amplitude uncertainty, $t_{cal} \pm 5^\circ\text{C}$	$\pm$ (2 % of output + 300 $\mu\text{V}$ )	$\pm$ (3.5 % of output + 300 $\mu\text{V}$ )	$\pm$ (4 % of output + 300 $\mu\text{V}$ )	$\pm$ (5.5 % of output + 300 $\mu\text{V}$ )	$\pm$ (6 % of output + 300 $\mu\text{V}$ )
Flatness (relative to 50 kHz)	N/A	$\pm$ (1.5 % of output + 100 $\mu\text{V}$ )	$\pm$ (2 % of output + 100 $\mu\text{V}$ )	$\pm$ (3.5 % of output + 100 $\mu\text{V}$ )	$\pm$ (4 % of output + 100 $\mu\text{V}$ )
Short-term amplitude stability	$\leq$ 1 % <sup>[1]</sup>				
Frequency resolution	10 kHz				
1-year absolute frequency uncertainty, $t_{cal} \pm 5^\circ\text{C}$	$\pm$ 0.33 ppm				
2nd harmonic	$\leq$ -33 dBc				
3rd and higher harmonics	$\leq$ -38 dBc				

<sup>[1]</sup> Within one hour after reference amplitude setting, provided temperature varies no more than  $\pm 5^\circ\text{C}$ .

### Leveled Sine Wave Function $>$ 600 MHz (2.1 GHz Option)

Leveled Sine Wave Characteristics into 50 $\Omega$	Frequency Range			
	10 MHz (reference)	600 MHz to 1.1 GHz	1.1 GHz to 1.6 GHz	1.6 GHz to 2.1 GHz
Amplitude range (p-p)	5 mV to 3.5 V			
1-year absolute amplitude uncertainty, $t_{cal} \pm 5^\circ\text{C}$	$\pm$ (2 % of output + 300 $\mu\text{V}$ )	$\pm$ (7 % of output + 300 $\mu\text{V}$ )	$\pm$ (7 % of output + 300 $\mu\text{V}$ )	$\pm$ (8 % of output + 300 $\mu\text{V}$ )
Flatness (relative to 50 kHz)	N/A	$\pm$ (5 % of output + 100 $\mu\text{V}$ )	$\pm$ (5 % of output + 100 $\mu\text{V}$ )	$\pm$ (6 % of output + 100 $\mu\text{V}$ )
Short-term amplitude stability	$\leq$ 1 % <sup>[1]</sup>			
Frequency resolution	100 kHz			
1-year absolute frequency, uncertainty, $t_{cal} \pm 5^\circ\text{C}$	$\pm$ 0.33 ppm			
2nd harmonic	$\leq$ -33 dBc			
3rd and higher harmonics	$\leq$ -38 dBc			

<sup>[1]</sup> Within one hour after reference amplitude setting, provided temperature varies no more than  $\pm 5^\circ\text{C}$ .

### Time Marker Function

Time Marker into 50 $\Omega$	5 s to 50 ms	20 ms to 100 ns (max)	50 ns to 20 ns	10 ns	5 ns to 2 ns	2 ns to 500 ps (2.1 GHz Option)
Wave shape	spike or square	spike, square, or 20 %-pulse	spike or square	square or sine	sine	sine
Sequence	5-2-1 from 5 s to 2 ns (e.g., 500 ms, 200 ms, 100 ms)					
Period resolution	4 digits					
1-year absolute uncertainty, $t_{cal} \pm 5^\circ\text{C}$	$\pm$ (2.5 ppm + 5 $\mu\text{Hz}$ )	$\pm$ 0.33 ppm	$\pm$ 0.33 ppm	$\pm$ 0.33 ppm	$\pm$ 0.33 ppm	$\pm$ 0.33 ppm

For specifications on other functions, including wave generator, 1 ns pulse generator, trigger function, tunnel diode drive, current output function, measurement functions and the auxiliary input, please refer to the 5820A Extended Specifications, available at [www.fluke.com](http://www.fluke.com).

# 5820A Oscilloscope Calibrator

riešenia na presné meranie

www.elseo.sk/Fluke-Calibration

## Oscilloscope Calibration

### General Specifications

#### Warmup time

Twice the time since last warmed up, to a maximum of 30 minutes

#### Settling time

5 seconds or faster for all functions and ranges

#### Standard interfaces

IEE488 (GPIB), RS-232

#### Temperature performance

Operating: 0 °C to 50 °C  
Calibration ( $T_{cal}$ ): 15 °C to 35 °C  
Storage: -20 °C to 70 °C

#### Electromagnetic compatibility

Designed to operate in Standard Laboratory environments where the Electromagnetic environment is highly controlled. If used in areas with Electromagnetic fields > 1 V/m, there could be errors in current output values.

#### Temperature coefficient

Temperature Coefficient for temperatures outside  $t_{cal} \pm 5$  °C: add 0.1 x 1-year specification/°C

#### Relative humidity

Operating: < 80 % to 30 °C,  
< 70 % to 40 °C, < 40 % to 50 °C  
Storage: < 95 %, non-condensing

#### Altitude

Operating: 3,050 m (10,000 ft) maximum  
Non-operating: 12,200 m (40,000 ft) maximum

#### Safety

Designed to comply with IEC 1010-1 (19921); ANSI/ISAS82.01-1994; CAN/CSA-C22.2 No. 1010, 1-92

#### Analog low isolation

20 V

#### EMC

Complies with EN 61326-1

#### Line power

Line Voltage (selectable): 100 V, 120 V, 220 V, 240 V  
Line Frequency: 47 to 63 Hz  
Line Voltage Variation:  $\pm 10$  % about line voltage setting

#### Power consumption

250 VA

#### Dimensions

Height: 17.8 cm (7 in), standard rack increment, plus 1.5 cm (0.6 in) for feet on bottom of unit  
Width: 43.2 cm (17 in), standard rack width  
Depth: 47.3 cm (18.6 in) overall

#### Weight

20 kg (44 lb)

#### Calibration

Standard: NIST traceable, non-accredited certificate with measurement data.  
No accredited calibration certificates are available.

### Ordering Information

#### Models

5820A Oscilloscope Calibrator

#### Options and Accessories

5800A/TDP 125 ps Tunnel Diode Pulser for the 5820A

5500A/CASE Transit case with wheels

5500A/HNDL Side Handle

Y5537 Rack Mount Kit

#### Upgrades

5800A-GHz UGK Upgrades existing 5800A to add 2.1 GHz capability

5820A-GHz UGK Upgrades existing 5820A to 2.1 GHz capability

5820A-5C UGK Upgrades existing 5820A to 2.1 GHz, five-channels

#### Software

MET/CAL<sup>®</sup> Plus Automated Calibration Management Software

# 5500A/5520A Oscilloscope Calibration Options

riešenia na presné meranie

www.else.sk/Fluke-Calibration

**FLUKE**®

## Oscilloscope Calibration

Fully calibrate oscilloscopes to 300 MHz or 600 MHz/300 ps, or to 1.1 GHz



5520A Calibrator



5500A Calibrator

- Oscilloscope calibration options extend the wide workload coverage of the multi-product calibrators
- More ways to match the right oscilloscope calibration tools with your workload and budget



### Tech Tip

Upgrades to add or improve the scope option to existing calibrators are easy and available. Contact Fluke for details.

The SC300 and SC600 options enable the versatile 5500A and the enhanced performance 5520A to calibrate the most widely used analog and digital oscilloscopes up to 300 MHz and 600 MHz, respectively. The SC1100 enables the 5520A to calibrate oscilloscopes up to 1.1 GHz with rise times to 300 ps – even 125 ps with the 5800A/TDP tunnel diode pulser option. That

represents what is likely the highest level of oscilloscopes in your workload – along with the other workload the 5520A addresses.

Each option is a plug-in module that fits inside the 5500A or 5520A Multi-Product Calibrator. It can be ordered factory installed with a new calibrator, or added later at a Fluke service center for an additional installation and calibration charge.

### Voltage Function Specifications for 5520A-SC1100 and 5500A-SC600

Volt Function	DC Signal		Square Wave Signal <sup>[1]</sup>	
	Into 50 Ω	Into 1 MΩ	Into 50 Ω	Into 1 MΩ
<b>Amplitude Characteristics</b>				
Range	0 V to ± 6.6 V	0 V to ± 130 V	± 1 mV to ± 6.6 V p-p	± 1 mV to ± 130 V p-p
	Resolution			
1 mV to 24.999 mV	1 μV			
25 mV to 109.99 mV	10 μV			
110 mV to 2.1999 V	100 μV			
2.2 V to 10.999 V	1 mV			
11 V to 130 V	10 mV			
Adjustment range	Continuously Adjustable			
1-year absolute uncertainty, tcal ± 5 °C	± (0.25 % of output + 40 μV)	± (0.05 % of output + 40 μV)	± (0.25 % of output + 40 μV)	± (0.1 % of output + 40 μV) <sup>[2]</sup>
Sequence	1-2-5 (e.g., 10 mV, 20 mV, 50 mV)			
<b>Square Wave Frequency Characteristics</b>				
Range	10 Hz to 10 kHz			
1-year absolute uncertainty, tcal ± 50 °C	± (2.5 ppm of setting)			
Typical aberration (from 50 % of leading/trailing edge)	< (0.5 % of output + 100 μV)			
25 mV to 130 V: within 4 μs				
10 mV to 25 mV: within 8 μs				
1 mV to 10 mV: within 14 μs				

<sup>[1]</sup> Positive or negative, zero referenced square wave.

<sup>[2]</sup> Above 1 kHz, ± (0.25 % of output + 40 μV). Assumes connectors and cables are in good condition.

# 5500A/5520A Oscilloscope Calibration Options

riešenia na presné meranie

www.elseo.sk/Fluke-Calibration

## Oscilloscope Calibration

**Note:** For full and comprehensive specifications, refer to the 5500A/5520A Multi-Product Calibrators Oscilloscope Options Extended Specifications data sheet, available at [www.fluke.com](http://www.fluke.com).

### Voltage Function for 5500A-SC300

Volt Function	DC Signal		Square Wave Signal <sup>[1]</sup>	
	Into 50 Ω	Into 1 MΩ	Into 50 Ω	Into 1 MΩ
Amplitude range	0 V to ± 2.2 V	0 V to ± 33 V	± 1.8 mV to 2.2 V p-p	1.8 mV to ± 105 V p-p
1-year absolute uncertainty, tcal ± 5 °C	± (0.25 % of output + 100 μV)			
Sequence	1-2-5 (e.g., 10 mV, 20 mV, 50 mV)			
Frequency range	10 Hz to 10 kHz			

<sup>[1]</sup> Positive or negative, zero referenced square wave.

### Edge Function for 5520A-SC1100 and 5500A-SC600

Edge Characteristics into 50 Ω		1-Year Absolute Uncertainty, tcal ± 5 °C
<b>Amplitude</b>		
Rise time	< 300 ps	+ 0/-100 ps
Range (p-p)	5.0 mV to 2.5 V	± (2 % of output + 200 μV)
Resolution	4 digits	
Adjustment range	± 10 % around each sequence value (indicated below)	
Sequence values	5 mV, 10 mV, 25 mV, 50 mV, 60 mV, 80 mV, 100 mV, 200 mV, 250 mV, 300 mV, 500 mV, 600 mV, 1 V, 2.5 V	
<b>Other Edge Characteristics</b>		
Frequency range	1 kHz to 10 MHz <sup>[1]</sup>	± (2.5 ppm of setting)
Frequency range	≤ 300 ps <sup>[1]</sup>	(+ 0 ps /-100 ps)
Typical jitter, edge to trigger	< 5 ps (p-p)	
Leading edge aberrations <sup>[2]</sup>	within 2 ns from 50 % of rising edge 2 ns to 5 ns 5 ns to 15 ns after 15 ns	< (3 % of output + 2 mV) < (2 % of output + 2 mV) < (1 % of output + 2 mV) < (0.5 % of output + 2 mV)
Typical duty cycle	45 % to 55 %	
Tunnel diode pulse drive	Square wave at 100 Hz to 100 kHz, with variable amplitude of 60 V to 1000 V p-p	
Tunnel diode option	≤ 125 ps @ 250 mV p-p	

<sup>[1]</sup> Frequency range above 2 MHz has rise time specification ≤ 350 ps.

<sup>[2]</sup> Below 250 mV aberrations are typical.

### Edge Function for 5500A-SC300

Edge Characteristics into 50 Ω		1-Year Absolute Uncertainty, tcal ± 5 °C
Amplitude range (p-p)	4.5 mV to 2.75 V	± (2 % of output + 200 μV)
Frequency range	1 kHz to 10 MHz	± (2.5 ppm of setting + 15 mHz)
Rise time	≤ 1 ns	
Leading edge aberrations	within 10 ns 10 ns to 30 ns after 30 ns	< (2 % of output + 2 mV) < (1 % of output + 2 mV) < (0.5 % of output + 2 mV)
Typical duty cycle	45 % to 55 %	

### Leveled Sine Wave Function for 5520A-SC1100 (> 600 MHz)

Characteristics into 50 Ω	Frequency Range	
	50 kHz (reference)	600 MHz to 1.1 GHz
<b>Amplitude Characteristics</b>		
Range	5 mV to 3.5 V	
Resolution	< 100 mV: 3 digits; ≥ 100 mV: 4 digits	
<b>Adjustment Range</b>		
Continuously Adjustable		
1-year absolute uncertainty, tcal ± 5 °C	± (2 % of output + 300 μV)	± (7 % of output + 300 μV)
Flatness (relative to 50 MHz) <sup>[1]</sup>	N/A	± (5 % of output + 100 μV)
Short-term amplitude stability	≤ 1 % <sup>[2]</sup>	
<b>Frequency Characteristics</b>		
Resolution	100 kHz	
1-year absolute uncertainty, tcal ± 5 °C	± 2.5 ppm	
<b>Distortion Characteristics</b>		
2nd harmonic	≤ -33 dBc	
3rd and higher harmonic	≤ -38 dBc	

<sup>[1]</sup> As measured near oscilloscope bandwidth frequency.

<sup>[2]</sup> Within one hour after reference amplitude setting, provided temperature varies no more than ± 5 °C.

### Leveled Sine Wave Function for 5520A-SC1100 and 5500A-SC600 (< 600 MHz)

Characteristics into 50 Ω	Frequency Range			
	50 kHz (reference)	50 kHz to 100 MHz	100 MHz to 300 MHz	300 MHz to 600 MHz
<b>Amplitude Characteristics</b>				
Range (p-p)	5 mV to 5.5 V			
1-year absolute uncertainty, tcal ± 5 °C	± (2 % of output + 300 μV)	± (3.5 % of output + 300 μV)	± (4 % of output + 300 μV)	± (6 % of output + 300 μV)
Flatness (relative to 50 kHz) <sup>[1]</sup>	N/A	± (1.5 % of output + 100 μV)	± 2 % of output + 100 μV)	± (4 % of output + 100 μV)
Short-term amplitude stability	≤ 1 % <sup>[2]</sup>			
<b>Frequency Characteristics</b>				
Resolution <sup>[3]</sup>	10 kHz			
1-year absolute uncertainty, tcal ± 5 °C	± 2.5 ppm			
<b>Distortion Characteristics</b>				
2nd harmonic	≤ -33 dBc			
3rd and higher harmonics	≤ -38 dBc			

<sup>[1]</sup> As measured near oscilloscope bandwidth frequency.

<sup>[2]</sup> Within one hour after reference amplitude setting, provided temperature varies no more than ± 5 °C.

<sup>[3]</sup> At frequencies less than 1 MHz, the resolution is 15 kHz.

### Leveled Sine Wave Function for 5500A-SC300

Characteristics into 50 Ω	Frequency Range		
	50 kHz (reference)	50 kHz to 100 MHz	100 MHz to 300 MHz <sup>[1]</sup>
<b>Amplitude Characteristics</b>			
Range (p-p)	5 mV to 5.5 V <sup>[1]</sup>		
1-year absolute uncertainty, tcal ± 5 °C	± (2 % of output + 200 μV)	± (3.5 % of output + 300 μV)	± (4 % of output + 300 μV)
Flatness (relative to 50 kHz) <sup>[1]</sup>	N/A	± (1.5 % of output + 100 μV)	± 2 % of output + 100 μV)
Short-term amplitude stability	≤ 1 % <sup>[2]</sup>		
<b>Frequency Characteristics</b>			
Resolution <sup>[3]</sup>	10 Hz	10 kHz	
1-year absolute uncertainty, tcal ± 5 °C	± (25 ppm + 15 mHz)	± 2.5 ppm	
<b>Distortion Characteristics</b>			
2nd harmonic	≤ -35 dBc		
3rd and higher harmonics	≤ -40 dBc		

<sup>[1]</sup> Extended frequency range to 350 MHz is provided, but flatness is not specified. Amplitude is limited to 3 V for frequencies above 250 MHz.

<sup>[2]</sup> Within one hour after reference amplitude setting, provided temperature varies no more than ± 5 °C.

<sup>[3]</sup> At frequencies less than 1 MHz, the resolution is 15 kHz.

### Time Marker Function for 5520A-SC1100 and 5500A-SC600

Time Marker into 50 Ω <sup>[1]</sup>	5 s to 50 ms	20 ms to 100 ns	50 ns to 20 ns	10 ns	5 ns to 2 ns
1-year absolute uncertainty, tcal ± 5 °C <sup>[2]</sup>	± (25 + t x 1000) ppm <sup>[3]</sup>	± 2.5 ppm	± 2.5 ppm	± 2.5 ppm	± 2.5 ppm
Wave shape	spike or square	spike, square, or 20 %-pulse	spike or square	square or sine	sine
Typical jitter (p-p)	< 10 ppm	< 1 ppm	< 1 ppm	< 1 ppm	< 1 ppm
Sequence <sup>[4]</sup>	5-2-1 from 5 s to 2 ns (e.g., 500 ms, 200 ms, 100 ms)				

<sup>[1]</sup> Output amplitude > 1 V pk.

<sup>[2]</sup> Time marker uncertainty is ± 50 ppm when measured off of cardinal points.

<sup>[3]</sup> t = time in seconds.

<sup>[4]</sup> Time marker extends to 1 ns on 5520A-SC1100.

### Time Marker Function for 5500A-SC300

Time Marker into 50 Ω <sup>[1]</sup>	5 s to 100 μs	50 μs to 2 μs	1 μs to 20 ns	10 ns to 2 ns
1-year absolute uncertainty, tcal ± 5 °C	± (25 + t x 1000) ppm <sup>[2]</sup>	± (25 + t x 1000) ppm <sup>[2]</sup>	± 2.5 ppm	± 2.5 ppm
Wave shape	pulsed sawtooth	pulsed sawtooth	pulsed sawtooth	sine
Sequence <sup>[4]</sup>	5-2-1 from 5 s to 2 ns (e.g., 500 ms, 200 ms, 100 ms)			

<sup>[1]</sup> Typical amplitude > 1 V.

<sup>[2]</sup> t = time in seconds.

### Additional functions

Refer to the Extended Specifications, available on [www.fluke.com](http://www.fluke.com), for performance details and calibrator model availability.

- Waveform generator
- Pulse generator
- Trigger signals – pulse, edge, time marker, square wave and TV signals
- Input resistance and capacitance measurement
- Overload measurement

### Calibration

Standard: For the oscilloscope calibration functions of the calibrator, a calibration certificate with measurement data traceable to NIST is standard.

Available: A2LA accredited calibrations with measurement.

### Ordering Information

#### Models

**5520A/3** High-Performance Multi-Product Calibrator with 300 MHz Scope Option

**5520A/6** High-Performance Multi-Product Calibrator with 600 MHz Scope Option

**5520A/1GHz** High-Performance Multi-Product Calibrator with 1100 MHz Scope Option

**5500A/3** Multi-Product Calibrator with 300 MHz Scope Option

**5500A/6** Multi-Product Calibrator with 600 MHz Scope Option

#### Options and Accessories

**5500A-SC300** 300 MHz Oscilloscope Calibration Option

**5500A-SC600** 600 MHz Oscilloscope Calibration Option

**5520A-SC1100** 1.1 GHz Oscilloscope Calibration Option

**5800A-TDP** Tunnel Diode Pulser

**5500A/LEADS** Test Lead Set

**5520A0-525A-LEADS** Test Lead Set

**5500A/CASE** Transit Case with wheels

**5500A/HNDL** Side Handle

**Y5537** Rack Mount Kit

#### Software

**MET/CAL® Plus** Automated Calibration Management Software

**5500/CAL** Automated Calibration Management Software (RS-232 only)

# 9100 Oscilloscope Calibration Options

riešenia na presné meranie

www.elseo.sk/Fluke-Calibration

FLUKE®

## Oscilloscope Calibration

Calibrate oscilloscopes up to 250 MHz or 600 MHz



- Two options expand the capabilities of the 9100 to calibrate oscilloscope up to 250 MHz or 600 MHz
- Precision dc levels and 1 kHz square waves up to 120 V
- Continuously variable leveled sine waves from 10 Hz to 250 MHz (option 250) or 10 Hz to 600 MHz (option 600) for bandwidth and ac flatness checks

## Tech Tip

Check out [www.fluke.com](http://www.fluke.com) for application note "Guide to Oscilloscope Calibration" (Literature code 1626187)

Adding one of the 9100 workstation's oscilloscope calibration options allows you to comprehensively calibrate oscilloscopes up to 250 MHz (Option 250) or 600 MHz (Option 600). All of the outputs required to calibrate the gain, linearity and bandwidth of vertical and horizontal deflection circuits, and the accuracy and linearity of timebase circuits, are delivered through a single pair of BNC cables (one for the calibration waveforms and one for the trigger signal), making complex lead changes a thing of the past. Full accuracy is maintained right up to the scope's BNC inputs.

These scope cal options provide precision dc levels and 1 kHz square waves up to 120 V for vertical and XY deflection calibration, plus continuously variable leveled sine waves from 10 Hz to 250 MHz (Option 250) or 10 Hz to 600 MHz (Option 600) for bandwidth and ac flatness checks.

Both options generate ultra-fast low-level edges at repetition rates high enough to allow even the shortest persistence traces to be examined for overshoot, undershoot and ringing. And they generate fast high-level edges so that you can check the ac performance of input attenuators.

Clearly visible timing markers at intervals as short as 2 ns or as far apart as five seconds calibrate timebase accuracy, while an optional high-stability crystal reference (Option 100) improves basic timing accuracy from 25 ppm to 0.25 ppm in order to calibrate high performance digital storage oscilloscopes.

### Specifications

Function	Range
<b>Voltage Amplitude <sup>[1]</sup></b>	
Into 1 M $\Omega$	5 mV to 120 V pk-pk dc and 1 kHz
Into 50 $\Omega$	5 mV to 3 V pk-pk at 1 kHz Up to $\pm 2.5$ V dc
Range sequence	1-2-5
Adjustment	$\pm 10$ %
<b>Low Edge <sup>[1]</sup></b>	
Amplitude into 50 $\Omega$	100 mV to 1.1 V pk-pk
Rise/fall time	< 1 ns
Period	100 ns to 10 ms
<b>High Edge <sup>[1]</sup></b>	
Amplitude into 1 M $\Omega$	1 V to 50 V pk-pk
Rise time	< 100 ns
Period	10 $\mu$ s to 10 ms
<b>Levelled Sine Wave <sup>[1]</sup></b>	
Frequency:	
Option 250	10 Hz to 250 MHz
Option 600	10 Hz to 600 MHz
Amplitude into 50 $\Omega$	4.5 mV up to 5.5 V pk-pk
Amplitude adjustment	$\pm 10$ %
<b>Markers <sup>[1]</sup></b>	
Period:	
Option 250	4 ns to 5 s
Option 600	2 ns to 5 s
Range sequence	1-2-5
Amplitude	Up to 1 V into 50 $\Omega$
<b>Timing Accuracy</b>	
Normal	25 ppm
With Option 100	0.25 ppm

<sup>[1]</sup> External trigger output provided.

**Note:** For full and comprehensive specifications, refer to the extended specifications available on the web at [www.fluke.com](http://www.fluke.com).

### Calibration

Standard: NPL-UK traceable calibration certificate with measurement data.

Available: UKAS accredited calibration certificate.

### Ordering Information

#### Models

9100 Multifunction Calibration Workstation

#### Options and Accessories

9100-250 250 MHz Oscilloscope Calibration Module

9100-600 600 MHz Oscilloscope Calibration Module

9100-100 High Stability Crystal Reference

9100-90 Rack Mount Kit

9100-60 Soft Carry Case

9100-65 Hard Transit Case (requires option 60)

Elsco Philips Service, Trenčín



# Power Calibration Selection Guide

riešenia na presné meranie

www.elseo.sk/Fluke-Calibration

**FLUKE**®

## Power Calibration

Fluke solutions for power include the 6100A – the first truly universal power standard – and a variety of solutions for power quality calibration. The 6100A Electrical Power Standard sources up to four phases of traceable sinusoidal and complex non-sinusoidal power, with up to 100 harmonic components, for compliance with IEC electrical

power standards. The 5520A/PQ single phase power quality instrumentation option increases the workload coverage of the 5520A calibrator and is retrofittable to existing 5520A calibrators. A basic range of power capabilities is standard on the Fluke 5520A and 5500A Multifunction Calibrators and optional with the 9100 Universal Calibration System.



Model	9100 - PWR	5500A	5520A	5520A-PQ	6100A
Description/configuration	PWR Option to 9100 Calibrator	Multi-Product Calibrator	Multi-Product Calibrator	PQ Option to 5520A Calibrator	Electrical Power Standard
<b>Power Specifications</b>					
Power range	0 to 21 kVA	0 to 11.2 kVA	0 to 20.9 kVA	0 to 20.9 kVA	0 to 80.8 kVA
AC frequency range	10 Hz to 3 kHz	.01 Hz to 10 kHz	.01 Hz to 30 kHz	10 Hz to 5 kHz	16 Hz to 850 Hz
<b>Voltage Specifications</b>					
AC amplitude range (RMS)	0 to 1050 V	0 to 1020 V	0 to 1020 V	0 to 1020 V	0 to 1008 V
Basic accuracy	0.04 %	0.02 %	0.0125 %	0.0125 %	0.0122 %
Maximum compliance current	6 mA to 20 mA	2 mA to 20 mA	2 mA to 20 mA	2 mA to 20 mA	71 mA to 1.13 A
DC amplitude range	0 to 1050 V	0 to 1020 V	0 to 1020 V	0 to 1020 V	0 to 504 V
<b>Current Specifications</b>					
AC amplitude range (RMS)	0 to 20 A	2.9 $\mu$ A to 11 A	29 $\mu$ A to 20.5 A	29 $\mu$ A to 20.5 A	10 mA to 21 A
Basic accuracy	0.08 %	0.07 %	0.035 %	0.035 %	0.013 %
Maximum compliance voltage	2.5 V to 4 V	2.0 V to 3.0 V	3.0 V to 7 V	3.0 V to 7 V rms	12.5 to 14 Vpk
DC amplitude range	0 to 20 A	0 to 11 A	0 to 20.5 A	0 to 20.5 A	0 to 10 A
<b>Phase Specifications</b>					
Settable V to I phase range	0 to $\pm 180^\circ$	0 to $\pm 180^\circ$	0 to $\pm 180^\circ$	0 to $\pm 180^\circ$	0 to $\pm 180^\circ$
Settable V to I phase resolution	0.01 $^\circ$	0.02 $^\circ$	0.01 $^\circ$	0.01 $^\circ$	0.0001 $^\circ$
Basic V to I phase accuracy	0.15 $^\circ$	0.15 $^\circ$	0.10 $^\circ$	0.07 $^\circ$	0.003 $^\circ$
Multi-phase power	yes	no	yes	yes	yes - up to 4 phases
<b>Power Quality Capabilities</b>					
Voltage harmonics	no	yes	yes	yes	yes
Current harmonics	yes	yes	yes	yes	yes
Max. number of simultaneous harmonics	1	1	1	15	100
Maximum harmonic frequency	3 kHz	10 kHz	10 kHz	5 kHz	6 kHz
Maximum harmonic value		50	50	50	100
Modulating harmonic amplitudes					yes
Programmable interharmonics					two interharmonics
Calibrates flicker meters				yes	yes
Programmable amplitude sags and swells				yes	yes
Fluctuating harmonics					yes
<b>Optional Capabilities</b>					
Extended current range					80 A ac
Calibrates watt hour meters					up to 3 phases
<b>Additional Capabilities</b>					
Dual channel voltage/voltage	yes	yes	yes	yes	yes
Predefined non-sine waveshapes	yes	yes	yes	yes	yes
Industry standard waveshapes				yes	yes
Test setup storage, external and internal					yes
<b>General</b>					
RS232 interface		yes	yes	yes	
GPIB interface	yes	yes	yes	yes	yes
MET/CAL compatible	yes	yes	yes	yes	yes
Local printer port	yes				

# 6100A Electrical Power Standard

riešenia na presné meranie

www.elseo.sk/Fluke-Calibration

## Power Calibration

### Measurement validation and calibration for electrical power applications



- Configurable from one to four independent phases
- Fully independent control of voltage and current on each phase
- 1 kV and 80 Amps available on each phase
- Up to 100 simultaneous harmonics
- Fluctuating harmonics and interharmonics to IEC 61000-4-7
- Flicker to IEC 61000-4-30 and 61000-4-15
- Energy option to EN61036



### Tech Tip

When calibrating power instruments at conditions with power factors less than one, phase accuracy errors can greatly increase the uncertainty of the calibrator compared to unity power factor conditions. The unmatched performance of the 6100's phase accuracy minimizes this concern.

The 6100A Electrical Power Standard delivers the electrical signals, quantities and phenomena you need to test, characterize, verify or calibrate power measurement, logging, recording or control equipment. Whether your environment is design, manufacturing, test, service or calibration, the 6100A provides you with the tools you need to get your job done – quickly, reliably and precisely.

The 6100A replicates power waveforms, distortions events and phenomena such as harmonic distortion, phase errors, flicker and dips and swells – simultaneously if required. This makes measurement verification much simpler, more reliable and ultimately lower cost.

#### Configurable from one to four phases

Start with a single-phase system and add to it later as your needs change. A single 6100A Master unit allows you to source single-phase voltage and current with all available distortions and phenomena. Phase angle between voltage and current can be adjusted to a maximum of  $\pm 180$  degrees, with accuracy to within as little as 0.01 of a degree.

As more phases are required, additional 6101A Auxiliary units can be added, up to a maximum of four phases. Each additional phase can also source all available distortions and phenomena and has equally flexible phase angle control. Each 6101A unit is controlled by the user interface in the 6100A Master, but is completely independent from all other phases.

#### 15 V compliance on all current outputs

All current outputs on both 6100A Master and 6101A Auxiliary units have a compliance of 14 V up to 20 A (optionally to 80 A), which guarantees resilience of the current output when faced with high burden or inconsistent loads. This feature is particularly important when you are testing a number of devices simultaneously to improve throughput, or when cables or connectors linking a remote source to a test station prevent delivery of required current.

#### User-selectable apparent power definitions

Fluke has built eight methods for calculating reactive power into the 6100A. So no matter how you define reactive power, you can match the 6100A's operation to your own way of making measurements.

#### User-friendly interface

The 6100A's system control program is based on the Microsoft Windows® graphical user interface. This easy-to-use program controls all of the functions of the 6100A calibrator and 6101A auxiliary units. Operate the 6100A using the calibrator's front panel, or use a keyboard and mouse (not supplied).

## Primary Specifications

Voltage/current amplitude setting resolution	6 digits
Range of fundamental frequency	16 Hz to 850 Hz
Frequency accuracy	50 ppm
Frequency setting resolution	0.1 Hz
Warm-up time to full accuracy	1 hour or twice the time since last warm up
Settling time	< 1.4 second
Nominal angle between voltage phases	120 °
Nominal angle between voltage and current of a phase	0 °
Phase angle setting	$\pm 180^\circ, \pm \pi$ radians
Phase angle setting resolution	0.001 °, 0.00001 radians

## Sinusoidal Voltage Output

Range	Frequency	Voltage	1 year accuracy, tcal $\pm 5^\circ\text{C}$ $\pm$ (ppm of output + mV)	
1.0 V to 16 V	16 Hz to 450 Hz	1.0 V to 6.4 V	122	1.0
		6.4 V to 16 V	112	1.0
	450 Hz to 850 Hz	1.0 V to 6.4 V	164	1.0
		6.4 V to 16 V	150	1.0
2.3 V to 33 V	16 Hz to 450 Hz	2.3 V to 13.2 V	122	2.0
		13.2 V to 33 V	112	1.5
	450 Hz to 850 Hz	2.3 V to 13.2 V	164	2.0
		13.2 V to 33 V	150	1.5
5.6 V to 78 V	16 Hz to 450 Hz	5.6 V to 31 V	122	2.0
		31 V to 78 V	112	2.0
	450 Hz to 850 Hz	5.6 V to 31 V	164	2.0
		31 V to 78 V	150	2.0
11 V to 168 V	16 Hz to 450 Hz	11 V to 67 V	122	4.4
		67 V to 168 V	112	4.4
	450 Hz to 850 Hz	11 V to 67 V	164	4.4
		67 V to 168 V	150	4.4
23 V to 336 V	16 Hz to 450 Hz	23 V to 134 V	122	8.8
		134 V to 336 V	112	8.8
	450 Hz to 850 Hz	23 V to 134 V	164	8.8
		134 V to 336 V	150	8.8
70 V to 1008 V	16 Hz to 450 Hz	70 V to 330 V	166	26
		330 V to 1008 V	158	26
	450 Hz to 850 Hz	70 V to 330 V	190	26
		330 V to 1008 V	175	26

## Voltage DC and Harmonic Amplitude

Range	Frequency	Voltage	1 year accuracy, tcal $\pm 5^\circ\text{C}$ $\pm$ (ppm of output + mV)	
1.0 V to 16 V	0 V to 8 V	dc	122	5.0
		16 Hz to 450 Hz	122	1.0
	0 V to 4.8 V	450 Hz to 850 Hz	164	1.0
		850 Hz to 6 kHz	512	1.0
2.3 V to 33 V	0 V to 16.5 V	dc	122	10
		16 Hz to 450 Hz	122	2.0
	0 V to 9.9 V	450 Hz to 850 Hz	164	2.0
		850 Hz to 6 kHz	512	2.0
5.6 V to 78 V	0 V to 39 V	dc	122	24
		16 Hz to 450 Hz	122	2.0
	0 V to 23 V	450 Hz to 850 Hz	164	2.0
		850 Hz to 6 kHz	512	2.0
11 V to 168 V	0 V to 84 V	dc	122	50
		16 Hz to 450 Hz	122	4.4
	0 V to 50 V	450 Hz to 850 Hz	164	4.4
		850 Hz to 6 kHz	512	4.4
23 V to 336 V	0 V to 168 V	dc	122	100
		16 Hz to 450 Hz	122	12.0
	0 V to 100 V	450 Hz to 850 Hz	164	12.0
		850 Hz to 6 kHz	512	12.0
70 V to 1008 V	0 V to 504 V	dc	166	300
		16 Hz to 450 Hz	166	33
	0 V to 302 V	450 Hz to 850 Hz	190	33
		850 Hz to 6 kHz	524	33

### Sinusoidal Current Output

Range	Frequency	Current	1 year accuracy, tcal ± 5 °C ± (ppm of output + µA)	
0.01 A to 0.25 A	16 Hz to 450 Hz	0.01 A to 0.1 A	139	6
		0.1 A to 0.25 A	130	6
	450 Hz to 850 Hz	0.01 A to 0.1 A	182	6
		0.1 A to 0.25 A	170	6
0.05 A to 0.5 A	16 Hz to 450 Hz	0.05 A to 0.2 A	139	12
		0.2 A to 0.5 A	130	12
	450 Hz to 850 Hz	0.05 A to 0.2 A	182	12
		0.2 A to 0.5 A	170	12
0.1 A to 1 A	16 Hz to 450 Hz	0.1 A to 0.4 A	139	24
		0.4 A to 1 A	130	24
	450 Hz to 850 Hz	0.1 A to 0.4 A	182	24
		0.4 A to 1 A	170	24
0.2 A to 2 A	16 Hz to 450 Hz	0.2 A to 0.8 A	139	48
		0.8 A to 2 A	130	48
	450 Hz to 850 Hz	0.2 A to 0.8 A	182	48
		0.8 A to 2 A	170	48
0.5 A to 5 A	16 Hz to 450 Hz	0.5 A to 2 A	139	120
		2 A to 5 A	130	120
	450 Hz to 850 Hz	0.5 A to 2 A	182	120
		2 A to 5 A	170	120
1 A to 10 A	16 Hz to 450 Hz	1 A to 4 A	191	240
		4 A to 10 A	164	240
	450 Hz to 850 Hz	1 A to 4 A	267	240
		4 A to 10 A	250	240
2 A to 21 A	16 Hz to 450 Hz	2 A to 8 A	213	720
		8 A to 21 A	189	720
	450 Hz to 850 Hz	2 A to 8 A	267	720
		8 A to 21 A	250	720
8 A to 80 A	40 Hz to 450 Hz	8 A to 32 A	265	2800
		32 A to 80 A	250	2800
	450 Hz to 850 Hz	8 A to 32 A	300	2800
		32 A to 80 A	280	2800

### Current DC and Harmonic Amplitude

Range	Output	Current	1 year accuracy, tcal ± 5 °C ± (ppm of output + µA)	
0.01 A to 0.25 A	0 A to 0.125 A	dc	139	75
		0 A to 0.75 A	139	6
	16 Hz to 450 Hz	450 Hz to 850 Hz	182	6
		850 Hz to 6 kHz	505	6
0.05 A to 0.5 A	0 A to 0.25 A	dc	139	150
		0 A to 0.15 A	139	12
	16 Hz to 450 Hz	450 Hz to 850 Hz	182	12
		850 Hz to 6 kHz	505	12
0.1 A to 1 A	0 A to 0.5 A	dc	139	300
		0 A to 0.3 A	139	24
	16 Hz to 450 Hz	450 Hz to 850 Hz	182	24
		850 Hz to 6 kHz	505	24
0.2 A to 2 A	0 A to 1 A	dc	139	600
		0 A to 0.6 A	139	48
	16 Hz to 450 Hz	450 Hz to 850 Hz	182	48
		850 Hz to 6 kHz	505	48
0.5 A - 5 A	0 A to 2.5 A	dc	139	1500
		0 A to 1.5 A	139	120
	16 Hz to 450 Hz	450 Hz to 850 Hz	182	120
		850 Hz to 6 kHz	505	120
1 A - 10 A	0 A to 5 A	dc	191	3000
		0 A to 3 A	191	240
	16 Hz to 450 Hz	450 Hz to 850 Hz	267	240
		850 Hz to 6 kHz	519	240
2 A - 21 A	0 A to 10 A	dc	213	6000
		0 A to 6 A	213	720
	16 Hz to 450 Hz	450 Hz to 850 Hz	267	720
		850 Hz to 6 kHz	665	720
8 A - 80 A	0 A to 24 A	40 Hz to 450 Hz	265	2800
		450 Hz to 850 Hz	300	2800
		850 Hz to 3 kHz	690	2800

### Phase Angle - Current to Voltage

For all voltage ranges (16 V to 1008 V)		Voltage and current components > 40 % of range		Voltage and current components 0.5 % to 40 % of range	
Current Range	Frequency	1 year accuracy TCal ± 5 °C	Stability per hour	1 year accuracy TCal ± 5 °C	Stability per hour
0.25 A to 5 A	16 Hz to 69 Hz	0.003 °	0.0002 °	0.010 °	0.001 °
	69 Hz to 180 Hz	0.005 °	0.0002 °	0.017 °	0.002 °
	180 Hz to 450 Hz	0.015 °	0.0005 °	0.050 °	0.005 °
	450 Hz to 850 Hz	0.030 °	0.0008 °	0.070 °	0.018 °
	850 Hz to 3 kHz	0.150 °	0.0010 °	0.200 °	0.100 °
	3 kHz to 6 kHz	0.300 °	0.0010 °	0.450 °	0.100 °
5 A to 21 A	16 Hz to 69 Hz	0.004 °	0.0003 °	0.013 °	0.002 °
	69 Hz to 180 Hz	0.007 °	0.0003 °	0.023 °	0.004 °
	180 Hz to 450 Hz	0.020 °	0.0005 °	0.065 °	0.010 °
	450 Hz to 850 Hz	0.040 °	0.0008 °	0.080 °	0.020 °
	850 Hz to 3 kHz	0.200 °	0.0015 °	0.250 °	0.100 °
	3 kHz to 6 kHz	0.400 °	0.0020 °	0.600 °	0.150 °
21 A to 80 A	16 Hz to 69 Hz	0.004 °	0.0005 °	0.016 °	0.003 °
	69 Hz to 180 Hz	0.008 °	0.0005 °	0.028 °	0.005 °
	180 Hz to 450 Hz	0.025 °	0.0010 °	0.080 °	0.015 °
	450 Hz to 850 Hz	0.050 °	0.0015 °	0.100 °	0.030 °
	850 Hz to 3 kHz	0.250 °	0.0020 °	0.300 °	0.150 °

■ Applicable only to the 6100A/80A and 6100A/E/80A

## Phase Angle – Voltage to Voltage (multiphase systems)

Frequency	Voltage and current components > 40 % of range		Voltage and current components 0.5 % to 40 % of range	
	1 year accuracy TCal $\pm 5$ °C	Stability per hour	1 year accuracy TCal $\pm 5$ °C	Stability per hour
16 Hz to 69 Hz	0.005 °	0.0002 °	0.010 °	0.001 °
69 Hz to 180 Hz	0.007 °	0.0002 °	0.018 °	0.002 °
180 Hz to 450 Hz	0.025 °	0.0005 °	0.052 °	0.005 °
450 Hz to 850 Hz	0.050 °	0.0008 °	0.075 °	0.018 °
850 Hz to 3 kHz	0.170 °	0.0010 °	0.220 °	0.100 °
3 kHz to 6 kHz	0.350 °	0.0015 °	0.400 °	0.150 °

## Sinusoidal VA

Current Range	V Range					
	16 V (6.4 V to 16 V)	33 V (13.2 V to 33 V)	78 V (31 V to 78 V)	168 V (67 V to 168 V)	336 V (134 V to 336 V)	1008 V (330 V to 1008 V)
0.1 A to 5 A	233 to 329	220 to 295	206 to 259	207 to 260	207 to 260	240 to 304
5.1 A to 10 A	256 to 341	245 to 309	233 to 275	233 to 276	233 to 276	263 to 317
10.1 A to 21 A	284 to 373	274 to 344	263 to 314	264 to 315	264 to 315	290 to 352
21.1 A to 80 A	347 to 485	339 to 463	330 to 441	330 to 442	330 to 442	352 to 469

Shown in parts per million the minimum to maximum power accuracy for specific voltage and current bands under sinusoidal conditions.

## Harmonics

Number of harmonics available	100 (simultaneously if required)
Maximum harmonic frequency available	6 kHz (100th harmonic of 60 Hz)
Maximum level of individual harmonic	30 % of full range
Setting method (user selectable)	% RMS, % fundamental, dB down from fundamental, absolute value

## Flicker

Setting range	$\pm 30$ % of set voltage or current within range values (60 % $\Delta V/V$ )
Flicker modulation depth accuracy	0.025 %
Modulation depth setting resolution	0.001 %
Shape	Rectangular or sinusoidal
Duty cycle (shape = rectangular)	0.01 % to 99.99 %
Modulating frequency range	0.0008 Hz to 40 Hz
Pst indication accuracy	0.25 % valid for voltage only between 220 V and 240 V

Although flicker is voltage phenomena the 6100A will provide flicker on its current output. Flicker is not available if fluctuating harmonics are already enabled on that channel.

## Fluctuating Harmonics

Number of harmonics to fluctuate	Any number from 0 to all set harmonics can fluctuate
Modulation depth setting range	0 % to 100 % of nominal harmonic voltage
Fluctuation accuracy (0 % to $\pm 30$ % modulation)	0.025 %
Modulation depth setting resolution	0.001 %
Shape	Rectangular or sinusoidal
Duty cycle (shape = rectangular)	0.1 % to 99.99 %
Modulating frequency range	0.008 Hz to 30 Hz

Not available on voltage or current channels if flicker is already enabled on that channel.

## Interharmonics

Frequency accuracy	500 ppm
Amplitude accuracy 16 Hz to < 6 kHz	1 %
Amplitude accuracy > 6 kHz	4 %
Maximum value of a single interharmonic	The maximum value for an interharmonic < 2850 Hz is 30 % of range
Frequency range of interharmonic	16 Hz to 9 kHz

■ Applicable only to the 6100A/80A and 6100A/E/80A

### Dips and Swells

Dip/swell minimum duration	1 $\mu$ s
Dip/swell maximum duration	1 minute
Dip minimum amplitude	0 % of the nominal output
Swell maximum amplitude	The least of full range value and 140 % of the nominal output
Ramp up/down period	Settable 100 $\mu$ s to 30 seconds
Optional repeat with delay	0 to 60 seconds $\pm$ 31 $\mu$ s
Starting level amplitude accuracy	$\pm$ 0.025 % of level
Dip/swell level amplitude accuracy	$\pm$ 0.25 % of level
Trigger out	TTL falling edge co-incident with end of trigger out delay, remaining low for 10 $\mu$ s to 31 $\mu$ s

### Pulse Inputs

Maximum frequency	5 MHz
Minimum pulse width	60 ns
Maximum counts per channel	$2^{32}-1$ (4,294,967,295)

### Pulse and Gate Inputs

Input low level maximum	1 V
Input high level minimum	3 V
Internal pull-up values	135 $\Omega$ and 940 $\Omega$ to 4.5 V nominal (approximately equivalent to 150 $\Omega$ /1 k $\Omega$ to 5 V nominal)
Maximum input voltage	28 V (clamped @ 30 V approximately)
Minimum input voltage	0 V (clamped @ -0.5 V approximately)

### Pulse Output

Drive	Open-collector with optional 470 $\Omega$ pull-up
Frequency range	0.011 Hz to 5 MHz
Frequency accuracy	$\pm$ ( 50 ppm + 107 nHz )
External pull-up voltage	30 V maximum (clamped)
Sink current	150 mA maximum

### Gate Output

Drive	Open-drain
Internal pull-up	As Gate-Input
External pull-up voltage	30 V maximum (clamped)
Sink current	1 A maximum

### Accuracy

Counted/timed timing accuracy	$\pm$ ( 50 ppm + 60 ns )
Packet mode accuracy (ppm)	$\pm$ ( output power (ppm) + 50 ppm + 101,000/test duration (secs) )

### Test Duration

Maximum test duration	2500 hours
-----------------------	------------

■ Applicable only to the 6100A/80A and 6100A/E/80A

## General Specifications

### Line Power

Voltage: 100 V to 240 V with up to  $\pm 10\%$  fluctuations  
 Transient Overvoltages: Impulse withstand (overvoltage) category II of IEC 60364-4-443  
 Frequency: 47 Hz to 63 Hz  
 Maximum Consumption: 1000 VA maximum from 100 V to 130 V, 1250 VA maximum from 130 V to 260 V

### Dimensions

#### 6100A, 6101A and 6100A/E

Height: 233 mm (9.17 in)  
 Height (without feet): 219 mm (8.6 in)  
 Width: 432 mm (17 in)  
 Depth: 630 mm (24.8 in)  
 Weight: 23 kg (51 lb)

#### 6100A/80 A, 6101A/80 A and 6101A/E/80 A

Height: 324 mm (12.8 in)

Height (without feet): 310 mm (12.2 in)  
 Width: 432 mm (17 in)  
 Depth: 630 mm (24.8 in)  
 Weight: 30 kg (66 lb)

### Environment

Operating Temperature: 5 °C to 35 °C  
 Calibration Temperature (TCal) Range: 16 °C to 30 °C  
 Storage Temperature: 0 °C to 50 °C  
 Transit Temperature: -20 °C to 60 °C < 100 hours  
 Warm Up Time: 1 hour  
 Safe Operating Maximum Relative Humidity: < 80 %  
 5 °C to 31 °C ramping linearly down to 50 % at 35 °C (non-condensing)  
 Storage Maximum Relative Humidity: < 95 % 0 °C to 50 °C (non-condensing)  
 Operating Altitude: 0 m to 2,000 m  
 Non-Operating Altitude: 0 m to 12,000 m

Shock: MIL-PRF-28800F class 3  
 Vibration: MIL-PRF-28800F class 3  
 Enclosure: MIL-PRF-28800F class 3

### Safety

Designed to EN61010-1: 2001, CAN/CSA 22.2, No 1010.1-92, UL61010A-1. Indoor use only, pollution degree 2; installation category II. CE marked and ETL listed.

### EMC

EN61326: 2002, class A<sup>[1]</sup>, FCC rules part 15, sub-part B, class A  
<sup>[1]</sup> (Class A equipment is suitable for use in establishments other than domestic, and those directly connected to a low voltage power supply network which supplies buildings used for domestic purposes).

### Calibration

Standard: NPL-UK traceable certificate  
 Available: UKAS accredited calibration certificate with data

## Ordering Information

### Models

**6100A** Electrical Power Standard Master, including: One phase (one voltage channel to 1000 V, one current channel to 21 A); user controls and display system; interfacing via GPIB/RS-232; interfacing to Auxiliary Unit; line cord; lead kit; user manual

**6101A** Auxiliary Power Standard, including: One phase (one voltage channel to 1000 V, one current channel to 21 A); cable and interfacing to connect to Master; line cord; lead kit

**6100A/80A** Electrical Power Standard Master, including: One phase (one voltage channel to 1000 V, one current channel to 80 A); user controls and display system; interfacing via GPIB/RS-232, interfacing to Auxiliary Unit, line cord, lead kit, user manual

**6101A/80A** Auxiliary Power Standard, including: One phase (one voltage channel to 1000 V, one current channel to 80 A); cable and interfacing to connect to Master; line cord; lead kit

**6100A/E** Electrical Power Standard Master, including: One phase (one voltage channel to 1000 V, one current channel to 21 A) with energy counting

option fitted; user controls and display system; interfacing via GPIB/RS-232; interfacing to Auxiliary Unit; line cord; lead kit; user manual

**6100A/E/80A** Electrical Power Standard, including: One phase (one voltage channel to 1000 V, one current channel to 80 A) with energy counting option fitted; cable and interfacing to connect to Master; line cord; lead kit; user manual

### Complete 6100A systems

**6120A** Complete 2-phase system, including: One 6100A; one 6101A

**6130A** Complete 3-phase system, including: One 6100A; two 6101As

**6140A** Complete 4-phase system, including: One 6100A; three 6101As

### Complete 6100A/80A systems

**6120A/80A** Complete 2-phase system, including: One 6100A/80A; One 6101A/80A

**6130A/80A** Complete 3-phase system, including: One 6100A/80A; two 6101A/80As

**6140A/80A** Complete 4-phase system, including: One 6100A/80A; three 6101A/80As

### Complete 6100A/E systems

**6120A/E** Complete 2-phase system, including: One 6100A/E; one 6101A

**6130A/E** Complete 3-phase system, including: One 6100A/E; two 6101As

**6140A/E** Complete 4-phase system, including: One 6100A/E; Three 6101As

### Complete 6100A/E/80A systems

**6120A/E/80A** Complete 2-phase system, including: One 6100A/E/80A; one 6101A/80A

**6130A/E/80A** Complete 3-phase system, including: One 6100A/E/80A/a; two 6101A/80As

**6140A/E/80A** Complete 4-phase system, including: One 6100A/E/80A; three 6101A/80As

### Accessories

**6100-CASE** 6100A/6101A Transit Case

**Y6100** 6100A/6101A Rack Mount Kit

### Software

**MET/CAL® Plus** Automated Calibration Management Software

### Upgrades

Upgrades to existing units to add 80 amps and/or energy options are available. Contact your Fluke representative for details.

Elseo Philips Service, Trenčín

# 5520A-PQ Power Quality Option

riešenia na presné meranie

www.elseo.sk/Fluke-Calibration

## Power Calibration

### Power Quality Option for the 5520A Multi-Product Calibrator



- Calibrate power quality to the most exacting standards
- Three power quality modes
- Composite harmonic, flicker simulation, sags and swells simulation modes

### Tech Tip

To learn more about 5520A-PQ functions, a five-minute power quality demo guide can be found on the 5520A product page at [www.fluke.com](http://www.fluke.com).

The 5520A-PQ option enables the Fluke 5520A Multi-Product Calibrator to calibrate power quality instrumentation to the standards of the IEC and other regulatory agencies. Three precision waveform modes provide traceability for power meters, disturbance analyzers, power quality monitors, recorders and other power quality related equipment.

The 5520A-PQ can be ordered factory installed with a new calibrator or added to your existing 5520A at a Fluke Service Center.

### Composite Harmonic Mode, General Specifications

Maximum number of harmonics in a user-defined waveform	15
Pre-loaded industry waveforms	IEC A, IEC D, NRC7030, NRC 2 to 5
Specified fundamental frequencies	10 to 20 Hz, 45-65 Hz, 400 Hz <sup>[1]</sup>
Highest harmonic frequency	5 kHz <sup>[2]</sup>
Harmonic amplitude resolution	0.1 % of fundamental
Harmonic phase range (relative to fundamental)	0 to 360 °
Harmonic phase resolution	0.1 ° relative to fundamental

<sup>[1]</sup> AC voltage outputs  $\geq 33$  V, and current outputs  $\geq 3$  A have low frequency limits of 45 Hz. Other fundamental frequencies within the output limits of the 5520A can be used, but are not specified.

<sup>[2]</sup> Current outputs with LCOMP ON have lower limits, as shown in the ac current table below. Current outputs  $> 3$  A LCOMP OFF have a 4 kHz limit. Voltage outputs  $> 33$  V have a 2 kHz limit.

### Composite Harmonic Mode, AC Voltage

Composite Waveform Range	Harmonic Amplitude Range (% of fundamental)	Best Harmonic Amplitude Uncertainty (% of harmonic + V)	Best Harmonic Phase Uncertainty (relative to fundamental)	Best Absolute RMS Uncertainty of Composite Waveform
1 mV to 32.999 mV	0 to 100 %	0.20 % + 30 $\mu$ V	0.3 °	0.20 % + 30 $\mu$ V
33 mV to 329.999 mV	0 to 100 %	0.20 % + 40 $\mu$ V	0.3 °	0.20 % + 40 $\mu$ V
0.33 V to 3.29999 V	0 to 100 %	0.20 % + 400 $\mu$ V	0.3 °	0.20 % + 400 $\mu$ V
3.3 V to 32.9999 V	0 to 100 %	0.20 % + 4 mV	0.3 °	0.20 % + 4 mV
33 V to 329.999 V	0 to 100 % <sup>[1]</sup>	0.25 % + 40 mV	0.5 °	0.25 % + 40 mV
330 V to 1020 V	0 to 100 % <sup>[1]</sup>	0.25 % + 160 mV	0.5 °	0.25 % + 160 mV

<sup>[1]</sup> 0 to 30 % for harmonics  $> 440$  Hz, 0 to 10 % for harmonics  $> 900$  Hz, and 0 to 5 % for harmonics up to 2 kHz

Elsio Philips Service, Trenčín



**Composite Harmonic Mode, AC Voltage Auxiliary Output** (dual output mode only)

Composite Waveform Range	Harmonic Amplitude Range	Harmonic Amplitude Uncertainty (% of harmonic + V)	Harmonic Phase Uncertainty (relative to fundamental)	Absolute Uncertainty of Composite Waveform
10 mV to 329.999 mV	0 to 100 %	0.20 % + 500 µV	0.5 °	0.25 % + 1 mV
.33 V to 5 V	0 to 100 %	0.20 % + 2 mV	0.5 °	0.25 % + 10 mV

**Composite Harmonic Mode, AC Current LCOMP OFF**

Composite Waveform Range	Harmonic Amplitude Range (% of RMS waveform)	Best Harmonic Amplitude Uncertainty (% of harmonic + A)	Best Harmonic Phase Uncertainty (relative to fundamental)	Best Absolute Uncertainty of Composite Waveform
29 µA to 329.99 µA	0 to 100 %	0.20 % + 1 µA	0.3 °	0.20 % + 1 µA
0.33 mA to 3.2999 mA	0 to 100 %	0.20 % + 1 µA	0.3 °	0.20 % + 10 µA
3.3 mA to 32.999 mA	0 to 100 %	0.20 % + 10 µA	0.3 °	0.20 % + 100 µA
33 mA to 329.99 mA	0 to 100 %	0.20 % + 100 µA	0.3 °	0.20 % + 1 mA
0.33 A to 2.99999 A	0 to 100 % <sup>[1]</sup>	0.20 % + 1 mA	0.5 °	0.5 % + 20 mA
3 A to 20.5 A	0 to 100 % <sup>[1]</sup>	0.3 % + 10 mA	0.5 °	0.5 % + 100 mA

<sup>[1]</sup> 0 to 20 % for harmonics > 900 Hz, 0 to 10 % for harmonics > 2 kHz

**Flicker Simulation Mode**

Voltage range	1 mV to 1020 V
Current range	29 µA to 20.5 A
Frequency of fundamental	50 and 60 Hz
Amplitude modulation range	± 100 %
Frequency of modulation	0.1 to 30 Hz
Type of modulation	Square or sine
Delta V/V settings for P <sub>st</sub> = 1	7 settings each for P <sub>st</sub> = 1, 230V 50 Hz and 120 V 60 Hz
Trigger event	2nd push of OPER key, or remote command

**Sags and Swells Simulation Mode**

Voltage range	1 mV to 1020 V
Current range	29 µA to 20.5 A
Frequency of fundamental	45 to 65 Hz
Amplitude modulation range	± 100 %
Duration of sag or swell	0.005 to 60 seconds
Trigger event	2nd Push of OPER key, or remote command

**Phase Specifications, Sinewave outputs**

Output Combination, 45 Hz to 65 Hz	1-Year Absolute Uncertainty
0.33 V to 329.999 V and 3.3 mA to 10.9999 A	0.07 °
0.33 V to 329.999 V and 10 mV to 3.299999	0.07 °

**Calibration**

Standard: NIST traceable, non-accredited calibration certificate with measurement data

**Ordering Information Models**

**5520A-PQ** 5520A Multi-Product Calibrator with Power Quality Option

**5520A-PQ/3** 5520A Multi-Product Calibrator with PQ and 300 MHz Scope Option

**5520A-PQ/6** 5520A Multi-Product Calibrator with PQ and 600 MHz Scope Option

**5520A-PQ/1G** 5520A Multi-Product Calibrator with PQ and 1 GHz Scope Option

**Options and Accessories**

**5520A-525A/LEADS** Test Lead Set

**5500A/COIL** 50 Turn Current Coil

**5500A/CASE** Transit case with wheels

**5500A/HNDL** Side Handle

**Y5537** Rack Mount Kit

**Software**

**MET/CAL® Plus** Automated Calibration Management Software

**5500/CAL** Automated Calibration Management Software (RS-232

only)  
Elseo Philips Service, Trenčín

# 5500A, 5520A and 9100 Power Calibration

## Power Calibration

### Power calibration performance extends workload coverage



5520A Calibrator



5500A Calibrator



9100 Calibration System

- Built-in or optional power calibration capabilities
- Calibrate wattmeters, power harmonics analyzers, and more



### Tech Tip

Electrically independent voltage and current sources let calibrators simulate power to the units being calibrated. These techniques permit high accuracy and provide for reliable calibrations.

Multi-product calibrators from Fluke feature either built-in or optional capabilities for power calibration. Power calibration uses the calibrator's dual precision outputs. These are capable of generating simultaneous voltage outputs or simultaneous voltage and current outputs with precision phase control to simulate either dc or ac power. The maximum voltage generated is over 1000 volts and depending upon the calibrator, the maximum current range is either 11 amps or 20 amps. Additionally, a 50-turn coil can be used to extend the effective current amplitude to a maximum of 1000 amps. These capabilities permit accurate calibration of power analyzers, and other power related measurement instrumentation.

In this group of calibrators, the Fluke 5520A Multi-Product Calibrator is the best alternative, offering the highest accuracy and widest range of power capabilities. For advanced requirements, it also has the 5520A-PQ Power Quality Option (page 62) that enables the 5520A to calibrate power quality instrumentation with precision complex harmonic distortion, when required to satisfy the standards of the IEC and other regulatory agencies.

Power calibration capability is also standard on the Fluke 5500A and optional with the 9100 Universal Calibration System. Refer to the table on the following page for a summary of the power calibration capabilities of all three calibrators.

	Models		
	9100 with PWR option	5500A	5520A
<b>Voltage Specifications</b>			
Frequency range	DC and 10 Hz to 3 kHz	DC and .01 Hz to 10 kHz	DC and .01 Hz to 30 kHz
AC amplitude range (RMS)	0 to 1050 V	0 to 1020 V	0 to 1020 V
Basic accuracy	0.04 %	0.02 %	0.0125 %
Maximum compliance current	6 mA to 20 mA	2 mA to 20 mA	2 mA to 20 mA
DC amplitude range	0 to 1050 V	0 to 1020 V	0 to 1020 V
<b>Current Specifications</b>			
AC amplitude range (RMS)	0 to 20A	2.9 $\mu$ A to 11 A	29 $\mu$ A to 20.5 A
Basic accuracy	0.08 %	0.07 %	0.035 %
Maximum compliance voltage	2.5 V to 4 V	2.0 V to 3.0 V	3.0 V to 7 V
DC amplitude range	0 to 20 A	0 to 11 A	0 to 20.5 A
<b>Phase Specifications</b>			
Settable V to I phase range	0 to $\pm 180^\circ$	0 to $\pm 180^\circ$	0 to $\pm 180^\circ$
Settable V to I phase resolution	0.01 $^\circ$	0.02 $^\circ$	0.01 $^\circ$
Basic V to I phase accuracy	0.15 $^\circ$	0.15 $^\circ$	0.10 $^\circ$
Multi-phase power	yes	no	yes
<b>Power Quality Capabilities</b>			
Voltage harmonics	no	yes	yes
Current harmonics	yes	yes	yes
Max. number of simultaneous harmonics	1	1	1
Maximum harmonic frequency	3 kHz	10 kHz	10 kHz
Maximum harmonic value		50	50
<b>Additional Capabilities</b>			
Dual channel voltage/voltage	yes	yes	yes
Predefined non-sine waveshapes	yes	yes	yes
<b>General</b>			
RS-232 interface		yes	yes
GPIB interface	yes	yes	yes
MET/CAL compatible	yes	yes	yes
Local printer port	yes		

### Ordering Information

5500A/5520A Multi-Product  
Calibrators: see page 13

9100 Universal Calibration  
System: see page 21

# 5790A AC Measurement Standard

## Electrical Standards

Automated ac measurement with precision that is easy to use



- Automated precision ac measurement
- Versatility that keeps you productive
- Designed with your support requirements in mind
- Traceable to national standards



### Tech Tip

Need to make precise ac/dc current transfer measurements? Simply pair the 5790A with Fluke A40 and A40A current shunts for precise measurements from 5 mA to 20 A.

The 5790A is a complete automated ac measurement standard designed for the most demanding calibration applications. It combines the accuracy you would expect from a thermal transfer standard with the ease-of-use of a digital multimeter. The 5790A is designed to meet the complete ac voltage and wideband verification requirements of the Fluke 5700 Series, 5500 Series and other calibrators, amplifiers like the Fluke 5725A and transfer standard and ac voltmeters.

The 5790A covers an ac voltage range from 700  $\mu$ V to 1000 V with frequencies from 10 Hz to 1 MHz. The wideband voltage option extends its frequency range to 30 MHz.

The 5790A may be used alone or as a transfer standard with an external dc source. In either case, the normally tedious switching and calculations are performed automatically by the 5790A and the resulting ad/dc difference displayed directly on its display.

Voltage Range	Frequency Range	Absolute Uncertainty Measurement Mode <sup>[1]</sup> ± (ppm of Reading + μV) 1 Year
2.2 mV	10 Hz to 20 Hz	1700 +1.3
	20 Hz to 40 Hz	740 +1.3
	40 Hz to 20 kHz	420 +1.3
	20 kHz to 50 kHz	810 +2.0
	50 kHz to 100 kHz	1200 +2.5
	100 kHz to 300 kHz	2300 +4.0
	300 kHz to 500 kHz	2400 +8.0
	500 kHz to 1 MHz	3500 +8.0
7 mV	10 Hz to 20 Hz	850 +1.3
	20 Hz to 40 Hz	370 +1.3
	40 Hz to 20 kHz	210 +1.3
	20 kHz to 50 kHz	400 +2.0
	50 kHz to 100 kHz	600 +2.5
	100 kHz to 300 kHz	1200 +4.0
	300 kHz to 500 kHz	1300 +8.0
	500 kHz to 1 MHz	2300 +8.0
22 mV	10 Hz to 20 Hz	290 +1.3
	20 Hz to 40 Hz	190 +1.3
	40 Hz to 20 kHz	110 +1.3
	20 kHz to 50 kHz	210 +2.0
	50 kHz to 100 kHz	310 +2.5
	100 kHz to 300 kHz	810 +4.0
	300 kHz to 500 kHz	890 +8.0
	500 kHz to 1 MHz	1700 +8.0
70 mV	10 Hz to 20 Hz	240 +1.5
	20 Hz to 40 Hz	120 +1.5
	40 Hz to 20 kHz	65 +1.5
	20 kHz to 50 kHz	130 +2.0
	50 kHz to 100 kHz	260 +2.5
	100 kHz to 300 kHz	510 +4.0
	300 kHz to 500 kHz	670 +8.0
	500 kHz to 1 MHz	1100 +8.0
220 mV	10 Hz to 20 Hz	10 +1.5
	20 Hz to 40 Hz	85 +1.5
	40 Hz to 20 kHz	38 +1.5
	20 kHz to 50 kHz	69 +2.0
	50 kHz to 100 kHz	160 +2.5
	100 kHz to 300 kHz	250 +4.0
	300 kHz to 500 kHz	380 +8.0
	500 kHz to 1 MHz	1000 +8.0
700 mV	10 Hz to 20 Hz	210 +1.5
	20 Hz to 40 Hz	76 +1.5
	40 Hz to 20 kHz	33 +1.5
	20 kHz to 50 kHz	51 +2.0
	50 kHz to 100 kHz	79 +2.5
	100 kHz to 300 kHz	180 +4.0
	300 kHz to 500 kHz	300 +8.0
	500 kHz to 1 MHz	960 +8.0

<sup>[1]</sup> ± 5 °C of calibration temperature.

Voltage Range	Frequency Range	Absolute Uncertainty Measurement Mode <sup>[1]</sup> ± (ppm of Reading + μV) 1 Year	
2.2 V	10 Hz to 20 Hz	200	
	20 Hz to 40 Hz	66	
	40 Hz to 20 kHz	24	
	20 kHz to 50 kHz	46	
	50 kHz to 100 kHz	71	
	100 kHz to 300 kHz	160	
	300 kHz to 500 kHz	260	
	500 kHz to 1 MHz	900	
7 V	10 Hz to 20 Hz	200	
	20 Hz to 40 Hz	67	
	40 Hz to 20 kHz	24	
	20 kHz to 50 kHz	48	
	50 kHz to 100 kHz	81	
	100 kHz to 300 kHz	190	
	300 kHz to 500 kHz	400	
	500 kHz to 1 MHz	1200	
22 V	10 Hz to 20 Hz	200	
	20 Hz to 40 Hz	67	
	40 Hz to 20 kHz	27	
	20 kHz to 50 kHz	48	
	50 kHz to 100 kHz	81	
	100 kHz to 300 kHz	190	
	300 kHz to 500 kHz	400	
	500 kHz to 1 MHz	1200	
70 V	10 Hz to 20 Hz	200	
	20 Hz to 40 Hz	68	
	40 Hz to 20 kHz	32	
	20 kHz to 50 kHz	57	
	50 kHz to 100 kHz	94	
	100 kHz to 300 kHz	200	
	300 kHz to 500 kHz	410	
	500 kHz to 1 MHz	1200	
220 V	10 Hz to 20 Hz	200	
	20 Hz to 40 Hz	68	
	40 Hz to 20 kHz	31	
	20 kHz to 50 kHz	69	
	50 kHz to 100 kHz	98	
	100 kHz to 300 kHz	210	
	300 kHz to 500 kHz	500	
	700 V	10 Hz to 20 Hz	200
20 Hz to 40 Hz		99	
40 Hz to 20 kHz		41	
20 kHz to 50 kHz		130	
50 kHz to 100 kHz		500	
1000 V		10 Hz to 20 Hz	200
		20 Hz to 40 Hz	99
		40 Hz to 20 kHz	38
	20 kHz to 50 kHz	130	
	50 kHz to 100 kHz	500	

<sup>[1]</sup> ± 5 °C of calibration temperature.

# 5790A AC Measurement Standard

riešenia na presné meranie

www.elseo.sk/Fluke-Calibration

## Electrical Standards

### General Specifications

Warm-up Time: 30 minutes

#### Relative humidity

Operating: 45 % to 50 °C, 75 % to 45 °C; 95 % to 30 °C  
Storage: < 95 % non-condensing

#### Altitude

Operating: 3,050 meters (10,000 feet)  
Non-Operating: 12,200 meters (40,000 feet)

#### Temperature

Operating: 0 °C to 50 °C  
Calibration: 15 °C to 35 °C  
Storage: -40 °C to 70 °C

### EMI/RFI

Complies with FCC Part 15 Subpart B, Class B; VDE 0871, Class B; ESD: EIA PN-1361

### Reliability

MIL-T-28800D, paragraph 3.13.3

### Line power

47 Hz to 63 Hz;  $\pm 10\%$  of selectable line voltages, 100 V, 110 V, 115 V, 120 V, 200 V, 220 V, 230 V, 240 V

### Safety

Designed to comply with UL3111; EN61010; CSA C22.2 No. 1010; ANSI/TSI S82.01-1994

### Remote interfaces

RS-232C, IEEE-488

### Dimensions

Height: 17.8 cm (7 in) standard rack mount + 1.5 cm (0.6 in)  
Width: 43.2 cm (17 in)  
Depth: 63 cm (24.8 in)  
Weight: 5790A: 24 kg (53 lb); with wideband: 24.5 kg (54 lb)

### Power

Maximum: 5790A: 95 VA; with wideband: 120 VA

### Calibration

Standard: NIST traceable certificate of calibration with data  
Available: NVLAP accredited calibrations are available on a limited number of measurement functions (excluding the wideband option and millivolt ranges)

## Ordering Information

### Models

5790A AC Measurement Standard

5790A/3 AC Measurement Standard with Wideband AC Measurement

### Options and Accessories

5790A-03 Wideband AC Measurement

Y5737 Rack Mount Kit

A40 and A40A Current Shunts

792A-7004 A40 Current Shunt Adapter

5440A-7002 Low Thermal Copper EMF Plug-In Cable

Elseo Philips Service, Trenčín

# A40/A40A Current Shunts

## Electrical Standards

Enables ac/dc current transfer measurements with the 792A Transfer Standard or 5790A Measurement Standard



A40

- AC current transfer measurements from 5 mA to 20A
- Frequency between 5 Hz to 100 kHz
- Compatible with 792A and 5790A



A40A

The A40 and A40A Current Shunt Series are used to measure ac currents through comparison to similar levels of dc currents. The comparisons measurements are intended to be made by either the 792A AC/DC Transfer Standard or 5790A AC Measurement Standard. The entire shunt series permit measuring currents from 5 mA to 20 A at frequencies from 5 Hz to 100 kHz. The A40 consists of 12 shunts rated from 10 mA up to 5 A. The A40A shunts add 10 A and 20 A ranges. Each shunt is commonly used from 50 % to 100 % of its nominal current rating.

The general ac/dc difference specification is the maximum allowable difference between similar amplitude ac and dc current measurements as done with uncertified shunts. This specification ranges from  $\pm 0.02\%$  to  $\pm 0.05\%$ . (See the specification table below.) However, once the ac/dc difference of each A40 series shunt is individually measured and certified traceable to a national laboratory, the result is a specific ac/dc difference with an associated uncertainty. These values are specific to each individual shunt, current amplitude, frequency parameter, and calibration laboratory.

The shunts require the use of special cables, terminators and adapters. The 792A-7004 is both a connector adaptor and a resistive termination. A 90 Ohm termination

resistor is required for proper usage of the shunts and is included in the 792A-7004 assembly. It also converts from the 1-inch spaced banana plugs of the shunts to the Type N connector inputs on the 792A and 5790A.

The higher current A40A shunts also require the A45-4004 output cable. It connects the A40A measurement output UHF connector to the banana plugs on the 792A-7004.

The A40A's current input connector is a female UHF connector. The UHF mating male connector must be used to connect to the 5 A or higher current source. The A40A-4003 input cable is a coaxial cable with the UHF male connectors on both ends and could be used if the current source for 5 A or higher has a similar UHF connector. Otherwise the user must supply the male UHF connector or modify the A40A-4003 cable.

The A40 and A40A shunts are supplied without any calibration certificates. Fluke can supply NVLAP accredited calibration certificates at the request of the customer for an extra charge. The customer should specify the various current levels and frequencies that are required. The 792A-7004 must be included with the current shunts, and in some cases the 792A or 5790A must be furnished to the Fluke laboratory in order to receive a proper calibration

### Tech Tip

AC/DC current difference calibrations are relative in nature, so the absolute value of the resistance is not necessary. Resistance stability and repeatability are needed to get the best measurement performance. That is why it is not necessary to know or certify the exact resistance of the A40 series shunts.

### AC/DC Difference Specifications ( % or ppm of Difference)

Shunt	Frequency	Max. Uncertified AC/DC Difference	Example Uncertainties using a certified A40 series shunt, taken within midrange and midband zones, as measured with the 792A
10 mA to 5 A	5 Hz to 20 kHz	$\pm 0.02\%$	$\pm 30$ ppm
	20 kHz to 50 kHz	$\pm 0.03\%$	$\pm 60$ ppm
	50 kHz to 100 kHz	$\pm 0.05\%$	$\pm 80$ ppm
10 A to 20 A	5 Hz to 20 kHz	$\pm 0.03\%$	$\pm 65$ ppm
	20 kHz to 50 kHz	$\pm 0.05\%$	$\pm 110$ ppm

### Ordering Information

#### Models: Ratings

- A40-010MA Current Shunt: 10 mA
- A40-020MA Current Shunt: 20 mA
- A40-030MA Current Shunt: 30 mA
- A40-050MA Current Shunt: 50 mA
- A40-100MA Current Shunt: 100 mA
- A40-200MA Current Shunt: 200 mA
- A40-300MA Current Shunt: 300 mA
- A40-500MA Current Shunt: 500 mA
- A40-1A Current Shunt: 1 A
- A40-2A Current Shunt: 2 A
- A40-3A Current Shunt: 3 A
- A40-5A Current Shunt: 5 A
- A40A-10A Current Shunt: 10 A
- A40A-20A Current Shunt: 20 A

#### Options and Accessories

- 792A-7004 Current Shunt Adapter for 792A and 5790A
- A45-4003 Input Cable for A40A Shunts
- A45-4004 Output Cable for A40A Shunts
- C41 Storage Case for A40/A40A Shunts

# 734A Reference Transfer and Standards

riešenia na presné meranie

[www.elseo.sk/Fluke-Calibration](http://www.elseo.sk/Fluke-Calibration)

## Electrical Standards

The simple and proven way to maintain and disseminate your volt



- Independence
- Small, portable and rugged
- Confidence
- Stability
- Support for Artifact Calibration

### Tech Tip

With three or more independent voltage references, a lab can use inter-comparison measurement techniques to track performance between certifications and to characterize the outputs and reduce uncertainties. Refer to the Fluke web site for application notes and technical articles.

The 732B is a direct voltage standard with 10 V and 1.018 V outputs. The 734A on the other hand, is a direct voltage reference standard that consists of four 732Bs that are each mechanically and electrically isolated and housed in a rack-mountable enclosure.

The 734A is designed to be a primary voltage standard for primary and secondary calibration and standard laboratories. Because it is made up of four independent standards, inter-comparisons of the standards and statistical methods can be used to significantly reduce the uncertainty of the reference over time.

#### Independence

The 734A offers complete mechanical and electrical independence of each of its four standards. Because each 732B is independent, it can be removed from the 734A and used as a portable standard to transfer a value from the primary 734A reference to remote service or production locations.

#### Small, portable and rugged

Each standard is small, light, rugged, and is ideal for shipment. The long 72-hour battery life allows the 732B to be transported over long distances while still under power. An optional external battery and charger extends battery life still further – for more than 130 hours.

#### Confidence

The 732B is based on the proven technology of the Fluke 732A. Thousands are now in service worldwide in a variety of applications – from maintaining an institutional reference to transferring values from national labs or Josephson Arrays.

#### Stability

Long term stability is optimized for the 10 V output with a stability of  $\pm 1.6$  ppm per year and .7 ppm per 90 days. The 1.018 V output is designed for shorter term usage, specified with a .8 ppm stability for 30 days. Each 10 V output can drive up to 12 mA of current to simplify use with instrumentation – like the 5700A – with low output impedance.

With the 734A, it is remarkably easy to establish a fractional part-per-million voltage reference in your laboratory. Over time, with frequent inter-comparisons and regular calibrations, you can reduce the uncertainty of your 734A by a factor of three or more.

#### Support for Artifact Calibration

Combined with the Fluke 742A-1 and 742A-10k Resistance Standards, a single 732B makes a tough and compact artifact calibration support package for instruments like the Fluke 5700A/5720A Calibrators or the Agilent Technologies 3458A Multimeter.



## Specifications

Absolute uncertainty: The 734A and 732B are normally delivered without absolute uncertainty specifications because to maintain traceability they must continue to receive uninterrupted operating voltage from the ac power lines or from the internal batteries. The 734A is normally shipped from the factory with the battery switches turned off. Upon receipt, the 734A must be powered up and allowed to stabilize for 24 hours before calibration against traceable standards. The absolute uncertainty specification for the standards must be related to the uncertainty specifications for the traceable standards used for calibration.

Output Voltage	Stability ( $\pm$ ppm)		
	30 Days	90 Days	1 Year
10 V	0.3	0.7	1.6
1.018 V	0.8	N/A	N/A

Model	732B	734A <sup>[1]</sup>
<b>10 V Output</b>		
Stability $\pm$ ( ppm), 90 days	0.7	0.7
Stability $\pm$ ( ppm), 1 year	1.6	1.2
<b>Predictability</b>		
After 5 points, 3 months apart	$\pm$ 0.4 ppm/year typical	$\pm$ 0.2 ppm/year typical
<b>Temperature Coefficient</b>		
15 to 35 °C	< 0.04 ppm	< 0.04 ppm
<b>Noise</b>		
0.01 to 10 Hz	< 0.06 ppm RMS	< 0.03 ppm RMS
Std. dev. of 90 days regression	< 0.065 ppm	< 0.04 ppm RMS
<b>Hysteresis Recovery</b>		
After battery discharge	0.2 ppm <sup>[2]</sup>	0.2 ppm <sup>[2]</sup>
<b>Output current</b>	12 mA	12 mA
<b>Output resistance</b>	< 1 m $\Omega$	< 1 m $\Omega$
<b>Battery</b>		
Battery type	Lead acid	Lead acid
Back-up period	72 hours	72 hours
Recharge time (typical)	24 hours	24 hours
<b>Temperature</b>		
Operating	+15 °C to 35 °C	+15 °C to 35 °C
Transit	-40 °C to 50 °C	-40 °C to 50 °C
Warm-up period	1 hour (power off for less than 1 hour)	1 hour (power off for less than 1 hour)
<b>Power</b>	< 10 W	< 40 W
<b>Mechanical dimensions (H x W x D)</b>	135 x 99 x 419 mm (5.3 x 3.9 x 16.5 in)	191 x 432 x 502 mm (7.5 x 17 x 19.75 in)
<b>Weight</b>	5.9 kg (13 lbs)	29.6 kg (65 lbs)
<b>General Specifications</b>		
Safety	UL1244; CE marked CSA C22.2 # 231 IEC 348; IEC 1010	UL1244; CE marked CSA C22.2 # 231 IEC 348; IEC 1010

Notes: All specifications, including 732B, are stated with 95 % confidence level

<sup>[1]</sup> 734A specifications are using a mathematical average of four cells.

<sup>[2]</sup> Conditioning not available. Specification assumes reference remains within a temp controlled environment.

## Calibration

Calibration certificates can be supplied with new 732Bs. The model 732B/H provides 732B with a calibration certificate and the unit is shipped under power from Fluke to the customer. Special shipping arrangements are necessary. Similarly the 732B/C is a 732B with a calibration certificate as well as a drift rate prediction for future output values up to one year in the future. This is also shipped under power and requires special shipment arrangements. NVLAP accredited calibration certificates are available under special conditions.

## Ordering Information

### Models

**734A** Reference Standard, including four 732Bs in a rack-width enclosure. Calibration of each 732B output optional.

**732B** DC Standard. Output calibration optional.

**732B/H** 10 V Output Voltage Calibration for one 732B, shipped under power

**732B/C** 10 V Output Voltage Calibration and Drift Rate Characterization for one 732B, shipped under power

### Options and Accessories

**732B-200** 10 V Output Voltage Calibration on site (U.S. only)

**732B-201** Additional 10 V Output Voltage Calibration at the same site (U.S. only)

**732A-7001** Enclosure, holds up to four 732Bs

**732B-7001** External Battery and Charger

**732B-7002** Transit Case. Holds one or two 732Bs or one 732B and one 732B-7001 External Battery and Charger

**5440B-7002** Low Thermal EMF Copper Plug-In Cables

**Y734A** Rack Mount Kit for 734A or 734A-7001

# 7000 Series Automated Volt Measurement System

## Electrical Standards

### Automated measurement for simplified use



7001 Stand-alone Reference



7004N Voltage Maintenance System



7004T Voltage Maintenance System

- Automated measurement intercomparisons
- Accommodates measurement of internal or external 10 V reference standards
- Simplify routine measurement analysis, prediction and trends using 7050 supporting software
- Latest conditioning technology removes need for hot shipment battery support during transportation between labs

### Tech Tip

The design of the 7000 series references permits powering down for shipping and storage with little to no added uncertainty to the 10 volt reference value.

The 7000 Series replaces traditional comparison systems with a fully integrated solution that includes all the hardware, switching, and software necessary to automate the inter-comparison process. Automation of volt maintenance ensures consistency and eliminates human error. Furthermore, with additional 7000S scan modules fitted, the system will enable you to automatically scan and measure one or more existing 10 V dc standards, including the Fluke 732B and 734A. Direct importation of captured data in a Microsoft Excel® spreadsheet program allows the 7000 system to produce sophisticated data reports and analysis, making 10 V maintenance as simple as possible.

### Automating the Volt

Complete automation of Volt maintenance significantly reduces the burden and risk of error in maintaining fully traceable standards for the Volt. Most of the Volt maintenance systems currently in use consist of equipment and software from a variety of manufacturers. This often leads to variability in setup, difficulties in the management of expanded uncertainty and obtaining support for the system all of which results in inefficient use of time.

### Patented technology

The heart of the Fluke 7000 Series is the fully isolated, compact 7000 solid state 10 V and 1.018 V direct Voltage standard. Designed to be robust and portable, its internal batteries support *hot shipment* and *plug-in*. However, should complete power be lost at any time, patented Reference Conditioning technology overcomes reference device hysteresis and restores the last powered value to the module. The 7000 modules also feature patented dc-dc converter technology, which achieves unparalleled isolation from the external ac-dc line power adapter. This makes the 7000 series particularly well suited to Josephson Junction direct comparison, as it speeds up intercomparison and reduces measurement uncertainty.

Ten, four and single housings are available for 7000 modules. The ten and four housings will accept either the Nanoscan or Transfer units. The Nanoscan provides hardware averaging, a 4-wire buffer and remote control of its scan and measurement functions. The Transfer provides a convenient hardware averaged output as well as the ability to access the output of individual modules using the Nanoscan System. The 70004T is an ideal product for support of transfers between single or multiple working standards at remote locations. Furthermore high isolation, low thermal EMF optical MOSFET technology is used to switch the output of each module through the housing backplane to the hardware average. Full reversal switching further ensures maximum rejection of thermal EMF offsets.

## Specifications

Model	7000/7001	7004N/T
<b>10 V Output</b>		
Stability ± ( ppm), 90 days	0.9	0.8
Stability ± ( ppm), 1 year	1.8	1.2
<b>Predictability</b>		
After 5 points, 3 months apart	± 0.5 ppm/year typical	± 0.2 ppm/year typical
<b>Temperature Coefficient</b>		
15 to 35 °C	< 0.05 ppm	< 0.03 ppm
<b>Noise</b>		
0.01 to 10 Hz	< 0.10 ppm RMS	< 0.05 ppm RM
Std. dev. of 90 days regression	< 0.10 ppm RMS	< 0.06 ppm
<b>Hysteresis Recovery</b>		
After battery discharge	< 0.1 ppm <sup>[1]</sup>	< 0.1 ppm <sup>[1]</sup>
<b>Output current</b>		
	12 mA	12 mA
<b>Output resistance</b>		
	< 10 mΩ	125 Ω
<b>10 V 4-wire Output (relative to average)</b>		
Output current	N/A	12 mA max
<b>Load Regulation</b>		
Zero to 2 mA	N/A	< 0.1 ppm
2 mA to 12 mA	N/A	< 0.5 ppm
<b>External Standard Input</b>		
Range	N/A	+9.990 to +10.010 V
Input impedance	N/A	100 MΩ + 10 pF
<b>Null Detector</b>		
Range	N/A	-9999.9 to +9999.9 μV
<b>Measurement Errors</b>		
Channel to average	N/A	± 0.3 % of difference
Channel to out of average	N/A	± 0.1 % of difference
External standard	N/A	± 0.001 %
Channel to channel	N/A	± 0.1 μV
<b>Oven Temperature Monitor</b>		
Accuracy	N/A	± 3 °C
Stability/repeatability	N/A	± 0.1 °C/year
<b>Battery</b>		
Battery type	NiMH	NiMH
Back-up period	16 hours	16 hours
Recharge time (typical)	2 hours	2 hours
Half life	5 years	5 years
Reference conditioning (power loss recovery)	yes	yes
<b>Temperature</b>		
Operating	+15 °C to 35 °C	+15 °C to 35 °C
Transit	-18 °C to 45 °C	-18 °C to 45 °C
Warm-up period	10 min. to ± 0.1 ppm of final output value	20 min to ± 0.2 ppm 2 hours to final value
<b>Power</b>		
	< 1 W	< 6 W
<b>Mechanical dimensions (H x W x D)</b>		
	137 x 85 x 290 mm (3.5 x 2.1 x 11.4 in)	133 x 449 x 355 mm (5.24 x 17.68 x 13.19 in)
<b>Weight</b>		
	2.1 kg (4.5 lbs)	9.6 kg (21.2 lbs)
<b>General Specifications</b>		
Safety	UL3111; CE marked EN61010-1-1;1993 /A2;1995 ; CETL	UL3111; CE marked EN61010-1-1;1993 /A2;1995 ; CETL

Notes: All specifications, including 732B, are stated with 95 % confidence level

<sup>[1]</sup> After conditioning cycle and maintained within environments down to 10 °C.

## Calibration

Standard: NPL-UK traceable calibration certificate with measurement data

Available: UKAS accredited calibration

## Ordering Information

### Models

**7000** 10 V Solid State DC Voltage Reference Module

**7001** Solid-State 10 V DC Voltage Reference

**7000S** 10 V External Reference Input Module

**7004N** 4-Reference Nanoscan Voltage Maintenance System

**7010N** 10-Reference Nanoscan Voltage Maintenance System

**7004T** 4-Reference 'transfer' Volt Maintenance System with 12 V DC Power Supply

**7010T** 10-Reference 'transfer' Volt Maintenance System with 12 V DC Power Supply

### Options and Accessories

**7004-65** Four module chassis ruggedized Transit Case

**7001-65** Single module ruggedized Transit Case

**7000-742A** Artifact Kit, includes a Model 7001, 742A-1 and 742A-10k resistance standards

### Software

**7050** PC Windows-based software for controlling 7004N/7010N nanoscan systems

# 742A Resistance Standards

## Electrical Standards

High accuracy working standards for on-site resistance calibration



- Compact and rugged
- No oil or air baths required
- 18 °C to 28 °C operating range
- Supplied with temperature characterization
- Six-month stability to 2.5 ppm
- Used for artifact calibration

### Tech Tip

A new 25 ohm value has been added to better support temperature traceability with ITS-90 PRT Reference Standards.

Fluke 742A Resistance Standards are high accuracy working standards for precision, resistance calibration. Their excellent temperature stability allows them to be used from 18 °C to 28 °C with typically less than 2 ppm degradation. Using the calibration table supplied with the standards, which lists corrections in 0.5 °C increments, this uncertainty can be reduced to near zero. Because the 742A is an “air resistor,” cumbersome oil baths are not required.

Model	Nominal Value (Ohms)	Deviation from Nominal (ppm)	Stability		Calibration Uncertainty 23 °C (ppm)	Max Change 18-28 °C (± ppm)	Max Voltage (volts)
			6 month (ppm)	12 month (ppm)			
742A-1	1.0	17	5.0	8.0	1.0	3.0	0.5
742A-1.9	1.9	17	5.0	8.0	1.0	3.0	0.38
742A-10	10.0	17	5.0	8.0	1.0	3.0	1.0
742A-25	25.0	17	5.0	8.0	1.0	3.0	1.0
742A-100	100.0	13	4.0	6.0	1.0	3.0	2.0
742A-1k	1.0 k	14	4.0	6.0	1.5	2.0	10.0
742A-10k	10.0 k	9	2.5	4.0	1.0	1.5	30.0
742A-19k	19.0 k	10	2.5	4.0	1.5	2.0	28.5
742A-100k	100.0 k	15	4.0	6.0	2.5	2.0	100.0
742A-1M	1.0 M	21	6.0	8.0	5.0	2.0	100.0
742A-10M	10.0 M	28	6.0	9.0	10.0	3.0	200.0
742A-19M	19.0 M	40	8.0	10.0	20.0	4.0	190.0

### General Specifications

Operating temperature range:  
18 °C to 28 °C  
Storage temperature: 0 °C to 40 °C  
**Retrace error (hysteresis)**  
23 °C to 18 °C to 23 °C cycle:  
Negligible resistance shift

23 °C to 0°C to 23 °C cycle:  
< 2 ppm resistance shift  
23 °C to 40 °C to 23 °C cycle:  
< 2 ppm resistance shift  
Size: 8.6 cm H x 10.5 cm W x  
12.7 cm D (3.4 in x 4.15 in x 5 in)  
Weight: 0.68 to 0.89 kg (1.5 to 2 lbs)  
depending on the model

### Ordering Information

#### Models

**742A-1** 1 Ω Resistance Standard

**742A-1.9** 1.9 Ω Resistance Standard

**742A-10** 10 Ω Resistance Standard

**742A-100** 100 Ω Resistance Standard

**742A-1k** 1 kΩ Resistance Standard

**742A-10k** 10 kΩ Resistance Standard

**742A-19k** 19 kΩ Resistance Standard

**742A-100k** 100 kΩ Resistance Standard

**742A-1M** 1 MΩ Resistance Standard

**742A-10M** 10 MΩ Resistance Standard

**742A-19M** 19 MΩ Resistance Standard

#### Options and Accessories

**742A-7002** Transit Case

**5440A-7002** Cable Set

# 752A Reference Divider

## Electrical Standards

### Setting the standard for ratio accuracy and ease of use



- 10:1 and 100:1 divider outputs
- Output uncertainty 0.2 ppm and 0.5 ppm
- Built-in calibration bridge
- Dynamic resistor matching
- System switching for ease of use

### Tech Tip

The 752A is the best precision divider available. Paired with a 10 V reference standard, it provides the best possible verification of decade voltages from 100 mV to 1000 V.

The 752A is a precision 10:1 and 100:1 divider designed primarily for comparing direct voltage levels of various sources to a 10 V standard such as a 732B. Internal switching allows calibration of the 100 mV, 1 V, 10 V, 100 V and 1000 V ranges of a voltage calibrator with a 10 V standard, without the need to change connections. Before each use, the 752A is easily calibrated with only a stable source and a null detector. The entire procedure takes only five minutes and does not require external standards.

### Specifications

These specifications apply for the lifetime of the instrument over the temperature range of 18 °C to 28 °C.

#### Ratio uncertainty

The Fluke 752A may be calibrated and operated in the normal temperature range of 18 °C to 28 °C. The following table describes the ratio uncertainty of the 752A that applies for a temperature variation of less than +1 °C from the calibration temperature for up to eight hours following calibration.

Range	Input Voltage	Ratio Uncertainty	Null Uncertainty*
10:1	100 V	0.2 ppm	± 0.5 µV
100:1	1000 V	0.5 ppm	± 1.0 µV

\*Null uncertainty refers to the required uncertainty of the null detector reading during calibration.

#### Temperature coefficient of ratio

Temperature coefficient of ratio is  $< \pm 1$  ppm / °C over the entire operating range. Typical performance from 15 °C to 30 °C is 0.1 ppm / °C.

### Temperature and humidity

Condition	Temperature	% Relative Humidity (Non-condensing)
Non-operating	-40 °C to +75 °C 0 °C to 50 °C	Not controlled 95 ± 5 % max
Operating	-0 °C to 40 °C 40 °C to 50 °C	75 ± 5 % max 45 ± 5 % max

#### Input resistance

10:1 ratio: 380 kΩ + 1 %  
100:1 ratio: Divider 4 MΩ  
Driver Guard 4 MΩ  
Total 2 MΩ ± 1 %

#### Maximum input voltage

10:1 ratio: 200 V. This specification applies to the safety of the unit only. The maximum voltage for best accuracy is 100 V.  
100:1 range: 1100 V

#### Power coefficient effect on ratio

10:1 ratio: < 0.05 ppm of output with 100 V applied  
100:1 ratio: < 0.3 ppm of output with 1000 V applied  
Note: these specifications are already included in the ratio uncertainty specifications.

#### Weight

Net: 8.4 kg (18.5 lb)  
Shipping: 13.6 kg (30 lb)  
Size: 60.3 cm L x 22.1 cm W x 19.1 cm H (23.75 in L x 8.69 in W x 7.53 in H)

#### Compliance with standards

ANSI C39.5, 1980, IEC 348, 2nd edition, 1978

#### Altitude

Non-operating: 0 to 12,000 m (40,000 ft)  
Operating: 0 to 3,050 m (10,000 ft)

#### Vibration

Per MIL-T-288800C, Type III, Class 5, Style E

#### Calibration

Calibration certificates are not supplied with the 752A. Because the 752A is a self-calibrating ratio device, calibration certificates are typically not required.

### Ordering Information

**Model**  
752A Reference Divider

**Options and Accessories**  
5440A-7002 Low Thermal Copper EMF Plug-In Cables

# 720A Kelvin-Varley Divider

## Electrical Standards

A primary standard for ratio measurements



- 0.1 ppm resolution, seven decades
- 0.1 ppm of input, absolute linearity
- Built-in self calibration bridge
- Front panel self-calibration

## Tech Tip

Ratio measurements are critical to metrology. A Kelvin-Varley Divider provides the best precision measurements which require variable ratios. Alternatively, reference multimeters like the 8508A can make similar ratio measurements, using much simpler operator techniques with only a small increase in uncertainty.

The 720 Kelvin-Varley Divider is a high-resolution primary ratio standard with absolute linearity of 0.1 ppm, temperature coefficient of linearity of 0.1 ppm/°C, and self-calibration capability.

### Specifications

Ratio range: 0 to 1.0 (1.0 input tap) and 0 to 1.1 (1.1 input tap)  
Resolution: 0.1 ppm of input with seven decades

### Linearity

Absolute linearity: (at calibration temperature and without the use of a correction chart)  $\pm 0.1$  ppm of input at dial settings of 1.1 to 0.1,  $\pm 0.1 (10S)^{1/3}$  of input at dial settings (S) of 0.1 to 0.

Absolute linearity stability: (without self-calibration)  $\pm 1.0$  ppm of input/yr at dial settings of 1.1 to 0.1,  $\pm 1.0 (10S)^{2/3}$  ppm of input/yr at dial setting (S) of 0.1 to 0

**Note:** Absolute linearity is defined as the linearity between max and min output voltages. The self-calibration procedure may be used at any time to reset absolute linearity to  $\pm 0.1$  ppm of input.

Temperature coefficient of linearity:  $\pm 0.1$  ppm of input/°C maximum at dial settings of 1.1 to 0.1

Short-term linearity stability: Under typical conditions in a standards laboratory environment (temperature maintained within  $\pm 1$  °C) and with an applied voltage of up to 100 V, stability of linearity is 0.1 ppm/30 days

### Power coefficient of linearity

$\pm 0.2$  ppm of input/W max at dial settings of 1.1 to 0.1  
 $\pm 0.2 (10S)^2$  ppm of input/W max at dial settings (S) of 0.1 to 0

### Maximum end errors

Zero error at output low: 0.004 ppm of input  
Zero error at input low: 0.05 ppm of input  
Full-scale error: 0.05 ppm of input  
Thermal voltages:  $\pm 0.5$   $\mu$ V max

### Maximum input voltage

1000 V on 1.0 input terminal  
1100 V on 1.1 input terminal

### Input resistance

100 k $\Omega$   $\pm 0.005$  % at 1.0 input terminal at 25 °C  
110 k $\Omega$   $\pm 0.005$  % at 1.1 input terminal at 25 °C

Temperature coefficient of input resistance:  $\pm 1$  ppm per °C max

### Dimensions

Size: 14 cm H x 48.2 cm W x 33 cm D, rack mounted  
(5.5 in H x 19 in W x 13 in D)  
Weight: 8.16 kg (18 lb)

### Calibration

Calibration certificates are not supplied with 720A dividers. They are typically not required because 720As are self-calibrating ratio devices.

### Ordering Information Models

720A\* Kelvin-Varley Voltage Divider

\*Not CE compliant. Not available in the European community.

# 792A AC/DC Transfer Standard

riešenia na presné meranie

www.elseo.sk/Fluke-Calibration

FLUKE®

Electrical  
Standards

Support for your most demanding ac traceability requirements



- Nine ranges from 22 mV to 1000 V (with external range resistor)
- Visual and audible alert warns of approaching overload condition
- Input connector located on rear panel
- Two volt (full scale) output permits the use of a high resolution digital multimeter to simplify transfer measurements
- External power supply makes bench use more convenient and simplifies shipping of the transfer unit for calibration

## Tech Tip

Need to maintain low ac V uncertainties but find it expensive to do? Fluke can provide NVLAP accredited calibrations for the 792A via its standards labs, with uncertainties rivaling national labs at a fraction of the cost.

The Fluke 792A is an ultra-high accuracy ac/dc thermal transfer standard, designed to meet the most demanding ac traceability requirements. The Fluke 792A is designed to support calibration of the most accurate ac instruments in the standards lab workload, including calibrators such as the Fluke 5700A/5720A; voltmeters like the Fluke 8508A, Wavetek-Datron 1281, or the Agilent 3458; and ac measurement standards including the Fluke 5790A.

### Patented RMS sensor offers exceptional accuracy

Using the patented Fluke RMS sensor and thin film range resistors, the 792A offers extraordinary transfer accuracy, with total uncertainties of as low as  $\pm 10$  ppm ( $\pm 5$  ppm better than some national laboratories). The 792A also provides a wide voltage range of 2 mV to 1000 V, and a wide frequency range of 10 Hz to 1 MHz.

### Accurate, fast and easy to use

At the heart of the Fluke 792A is the patented solid-state thermal RMS sensor, which has been proven in a variety of Fluke products since 1979. Its output voltage is 2 V, compared to the 7 to 10 mV output of traditional

thermocouples. That means the 792A exhibits excellent signal-to-noise characteristics and minimal reversal errors as low as 10 ppm relative to input voltage. The 2 V output also permits measurements with high resolution so you can use a digital voltmeter rather than a null meter detector to make transfers. Not only are measurements easier to make, they are more precise as well. And because it is small, the RMS sensor has very low thermal mass, so the 792A stabilizes in as little as 30 seconds and can be used over a wide temperature range of 11 °C to 35 °C. The RMS sensor is designed to be rugged and reliable. Each is built to exacting standards by the Fluke Microelectronics Operation to maintain quality and consistency, part after part.

### Fully traceable performance

Each 792A is shipped from Fluke with a certificate of calibration traceable to NIST. Also available is a calibration accredited by NVLAP. A table of correction factors for measured ac/dc differences is included. To achieve even higher performance, the transfer uncertainties of your 792A can be assigned directly by any national metrology institute.

# 792A AC/DC Transfer Standard

## Electrical Standards

### Summary Specifications

Function	Range
Voltage input	2 mV to 1000 V
Frequency	10 Hz to 1 MHz
Best ac/dc difference	± 10 ppm per year (traceable to NIST)

### Output characteristics

Impedance: < 30 milliohms

Current: up to 20 mA drive capability

Protection: Protected against damage due to high voltage up to 200 volts, provided the peak current does not exceed 50 mA. May be shorted indefinitely without damage to the instrument

Nominal output voltage is approximately 2 volts at any range's full scale, with tolerances below:

Voltage Range	Tolerance
22 mV	5 % + 5.3 mV
220 mV	5 % + 760 µV
700 mV	5 % + 500 µV
2.2 V	10 % + 300 µV
7 V	10 % + 300 µV
22 V	10 % + 300 µV
70 V	10 % + 300 µV
220 V	10 % + 300 µV
1000 V	10 % + 300 µV

### General Specifications

Temperature stabilization: Allow 12 hours stabilization time in the environment of use

Warm-up time: 15 minutes with power on, after stabilization time

### Temperature performance

Operating: 11 °C to 35 °C

Calibration: 18 °C to 28 °C

Storage: -40 °C to 50 °C

### Relative humidity

Operating: < 75 % to 30 °C,

< 70 % to 35 °C

Storage: < 95 %, non-condensing

### Altitude

Operating: to 3,050 m (10,000 ft)

Non-operating: to 12,200 m (40,000 ft)

### Safety

Designed to comply with

UL1244(198); IED 348-1978; IEC

66E(CO)4; and SCA556B

Input low isolation: 20 V to chassis

Guard isolation: 10 V to input LO or chassis

EMI/RFI: Designed to comply with

FCC Rules Part 15, Subpart J, Class

B; VDE 0871, Class B; VDE 0875,

Class K

Reliability: MIL-STD-28800D, para 3.13.3

Line power: 50 to 60 Hz ± 5 %

allowed about selectable nominal line voltages: 100 V, 120 V, 220 V, 240 V ± 10 %

Maximum power : 45 VA

### Dimensions

#### Transfer unit

Height 17.8 cm (7 in) plus 1.5 cm

(0.6 in) for feet;

Width 21.6 cm (8.5 in);

Depth 30.5 cm (12 in)

#### Power pack

Height 17.8 cm (17 in), plus 1.5 cm

(0.6 in) for feet;

Width 21.6 cm (8.5 in);

Depth 30.5 cm (12 in)

#### 1000 V range resistor

Height 7.6 cm (3 in)

Width 8.9 cm (3.5 in)

Depth 14.0 cm (5.5 in)

#### Transfer switch

Height 7.6 cm (3 in);

Width 8.9 cm (3.5 in)

Depth 14.0 cm (5.5 in)

#### Weight

Transfer unit: 8.4 kg (18.5 lbs)

Power pack: 8.9 kg (19.5 lbs)

1000 V range resistor: 1.6 kg (3.5 lbs)

Transfer switch: 1.6 kg (3.5 lbs)

### Calibration

Standard: NIST traceable certificate

of calibration with data

Available: NVLAP accredited

calibration certificates

### Ordering Information

#### Models

792A AC/DC Transfer Standard, including power pack, 1000 V range resistor, transfer switch

#### Options and Accessories

792A-7001 Power Pack

792A-7002 1000 V Range Resistor

792A-7003 Transfer Switch

792A-7004 A40 Current Shunt Adapter

A45-4004 Output cable for A40A current shunts; connects the output of the A40A to the 792A-7004 adapter



# Primary Temperature Standards Selection Guide

riešenia na presné meranie

www.elseo.sk/Fluke-Calibration

## Primary Temperature Standards

**FLUKE**

Hart Scientific

These primary temperature standards have been tested and proven by national laboratories around the world. The line includes high-stability quartz- and metal-sheath SPRTs covering temperatures from  $-260\text{ }^{\circ}\text{C}$  to

$1070\text{ }^{\circ}\text{C}$ ; ITS-90 fixed-point and triple point of water cells in traditional and mini sizes; and ultrastable metrology furnaces, fluid baths, and automated mini furnaces for maintaining fixed points from mercury to copper.



### Standard Platinum Resistance Thermometers and Noble-Metal Thermocouples

Model	RTPW	Range
5681	25.5 $\Omega$	$-200\text{ }^{\circ}\text{C}$ to $661\text{ }^{\circ}\text{C}$
5683	25.5 $\Omega$	$-200\text{ }^{\circ}\text{C}$ to $480\text{ }^{\circ}\text{C}$
5684	0.25 $\Omega$	$0\text{ }^{\circ}\text{C}$ to $1070\text{ }^{\circ}\text{C}$
5685	2.5 $\Omega$	$0\text{ }^{\circ}\text{C}$ to $1070\text{ }^{\circ}\text{C}$
5680	25.5 $\Omega$	$-200\text{ }^{\circ}\text{C}$ to $480\text{ }^{\circ}\text{C}$
5682	100 $\Omega$	$-200\text{ }^{\circ}\text{C}$ to $480\text{ }^{\circ}\text{C}$
5698	25.5 $\Omega$	$-200\text{ }^{\circ}\text{C}$ to $661\text{ }^{\circ}\text{C}$
5699	25.5 $\Omega$	$-200\text{ }^{\circ}\text{C}$ to $661\text{ }^{\circ}\text{C}$
5686	25.5 $\Omega$	$-260\text{ }^{\circ}\text{C}$ to $232\text{ }^{\circ}\text{C}$
5695	25.5 $\Omega$	$-200\text{ }^{\circ}\text{C}$ to $500\text{ }^{\circ}\text{C}$
5629	Au-Pt TC	$0\text{ }^{\circ}\text{C}$ to $1000\text{ }^{\circ}\text{C}$

### Primary Standards Maintenance Apparatus

Model	Features/Uses
7312	Maintains: two TPW cells. Compact size, runs quietly. Comparisons: $-5\text{ }^{\circ}\text{C}$ to $110\text{ }^{\circ}\text{C}$ .
9210	Maintains: mini triple point of water and mini gallium cells. Comparisons: $-10\text{ }^{\circ}\text{C}$ to $125\text{ }^{\circ}\text{C}$ .
9230	Maintains: stainless steel gallium cell. Comparisons: $15\text{ }^{\circ}\text{C}$ to $35\text{ }^{\circ}\text{C}$ .
9260	Maintains: indium, tin, zinc, and aluminum cells. Comparisons: $50\text{ }^{\circ}\text{C}$ to $680\text{ }^{\circ}\text{C}$ .
9114	Maintains: indium, tin, zinc, and aluminum cells. Comparisons: $100\text{ }^{\circ}\text{C}$ to $680\text{ }^{\circ}\text{C}$ .
9115	Maintains: aluminum and silver cells. Comparisons: $550\text{ }^{\circ}\text{C}$ to $1000\text{ }^{\circ}\text{C}$ .
9116	Maintains: aluminum, silver, gold, and copper cells. Comparisons: $400\text{ }^{\circ}\text{C}$ to $1100\text{ }^{\circ}\text{C}$ .
9117	Anneals SPRTs, HTPRTs, and thermocouples to $1100\text{ }^{\circ}\text{C}$ . Protects them against contamination from metal ions.
7196	Affordable substitute for a triple point of argon system. Provides for low-temperature comparison calibrations at approximately $-196\text{ }^{\circ}\text{C}$ with uncertainties of 2 mK.
742A	Excellent performance without oil or air baths. Values from 10 $\Omega$ to 100 M $\Omega$ .

### Fixed Points

Model	Description	Temperature
5900	Triple point of mercury	$-38.8344\text{ }^{\circ}\text{C}$
5901	Triple point of water (TPW)	$0.01\text{ }^{\circ}\text{C}$
5901A	TPW, NBS design	$0.01\text{ }^{\circ}\text{C}$
5901B	Mini triple point of water	$0.01\text{ }^{\circ}\text{C}$
5901C	TPW, 13.6 mm well	$0.01\text{ }^{\circ}\text{C}$
5903	Melting point of gallium	$29.7646\text{ }^{\circ}\text{C}$
5904	Freezing point of indium	$156.5985\text{ }^{\circ}\text{C}$
5905	Freezing point of tin	$231.928\text{ }^{\circ}\text{C}$
5906	Freezing point of zinc	$419.527\text{ }^{\circ}\text{C}$
5907	Freezing point of aluminum	$660.323\text{ }^{\circ}\text{C}$
5908	Freezing point of silver	$961.78\text{ }^{\circ}\text{C}$
5909	Freezing point of copper	$1084.62\text{ }^{\circ}\text{C}$
5914A	Mini freezing point of indium	$156.5985\text{ }^{\circ}\text{C}$
5915A	Mini freezing point of tin	$231.928\text{ }^{\circ}\text{C}$
5916A	Mini freezing point of zinc	$419.527\text{ }^{\circ}\text{C}$
5717A	Mini freezing point of aluminum	$660.323\text{ }^{\circ}\text{C}$
5918A	Mini freezing point of silver	$961.78\text{ }^{\circ}\text{C}$
5919A	Mini freezing point of copper	$1084.62\text{ }^{\circ}\text{C}$
5924	Open freezing point of indium	$156.5985\text{ }^{\circ}\text{C}$
5925	Open freezing point of tin	$231.928\text{ }^{\circ}\text{C}$
5926	Open freezing point of zinc	$419.527\text{ }^{\circ}\text{C}$
5927	Open freezing point of aluminum	$660.323\text{ }^{\circ}\text{C}$
5928	Open freezing point of silver	$961.78\text{ }^{\circ}\text{C}$
5929	Open freezing point of copper	$1084.62\text{ }^{\circ}\text{C}$
5931	Triple point of water X cell	$0.01\text{ }^{\circ}\text{C}$
5933	Melting point of gallium X cell	$29.7646\text{ }^{\circ}\text{C}$
5934	Freezing point of indium X cell	$156.5985\text{ }^{\circ}\text{C}$
5943	Melting point of gallium, SST	$29.7646\text{ }^{\circ}\text{C}$
5944	Mini freezing point of indium	$156.5985\text{ }^{\circ}\text{C}$
5945	Mini freezing point of tin	$231.928\text{ }^{\circ}\text{C}$
5946	Mini freezing point of zinc	$419.527\text{ }^{\circ}\text{C}$

# 5681, 5683, 5684, 5685, 5698 Quartz-Sheath SPRTs

riešenia na presné meranie

## Primary Temperature Standards

[www.else.sk/Fluke-Calibration](http://www.else.sk/Fluke-Calibration)

All the features you expect in world-class SPRTs

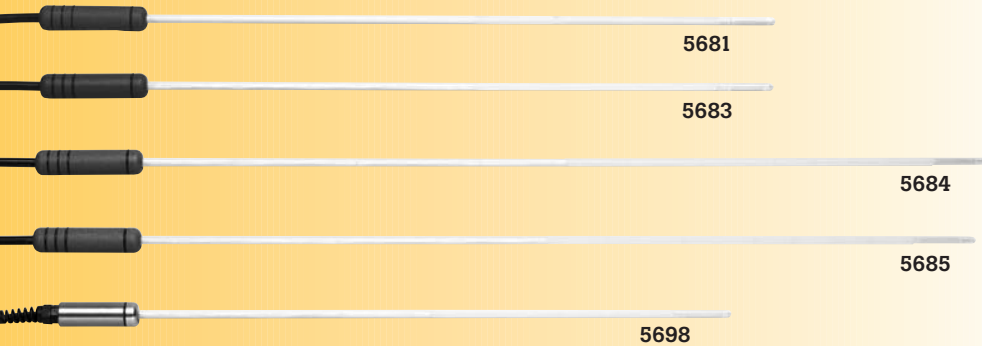

- Drift rates as low as 0.5 mK
- Fully conforms to ITS-90 SPRT guidelines
- Proprietary gas mixtures ensure high stability
- Multiple calibration options by fixed point

Five models of quartz-sheathed SPRTs cover the ITS-90 range of  $-200\text{ }^{\circ}\text{C}$  to  $1070\text{ }^{\circ}\text{C}$ . The 5681 is used from  $-200\text{ }^{\circ}\text{C}$  to the aluminum point at  $660.323\text{ }^{\circ}\text{C}$ . The 5683 is used from  $-200\text{ }^{\circ}\text{C}$  to  $480\text{ }^{\circ}\text{C}$  with greater long-term stability. The 5684 and the 5685 cover higher temperatures up to  $1070\text{ }^{\circ}\text{C}$  and can be calibrated at the silver point. The 25 ohm 5698 has a 485 mm quartz sheath and covers a temperature range from  $-200\text{ }^{\circ}\text{C}$  to  $661\text{ }^{\circ}\text{C}$ .

All include gold-plated spade lugs, a strain-relieved connection to the four-wire cable, convection prevention disks, the finest quartz glass available, delustered stems, and the purest platinum wire available.



A close-up of a 25  $\Omega$  spiral-wound helix SPRT element.

### 5681: $-200\text{ }^{\circ}\text{C}$ to $661\text{ }^{\circ}\text{C}$

This 25 ohm thermometer is the workhorse of the ITS-90 ranges. It can be calibrated for any of the subranges from the triple point of argon to the freezing point of aluminum.

### 5683: $-200\text{ }^{\circ}\text{C}$ to $480\text{ }^{\circ}\text{C}$

While SPRTs traditionally cover temperatures to the aluminum point ( $660\text{ }^{\circ}\text{C}$ ), most measurements occur between  $-100\text{ }^{\circ}\text{C}$  and  $420\text{ }^{\circ}\text{C}$ . The 5683 SPRT covers this range and more, from  $-200\text{ }^{\circ}\text{C}$  to  $480\text{ }^{\circ}\text{C}$ , and does so with long-term stabilities that extended range SPRTs can't match. Typical drift is less than 0.5 mK after 100 hours at  $480\text{ }^{\circ}\text{C}$ .

### 5684 and 5685: $0\text{ }^{\circ}\text{C}$ to $1070\text{ }^{\circ}\text{C}$

ITS-90 extended the use of the platinum thermometer from  $630\text{ }^{\circ}\text{C}$  to  $962\text{ }^{\circ}\text{C}$ . The 0.25 ohm HTPRT sensor uses a strip-shaped support made from high-purity quartz glass. The 2.5 ohm model uses a quartz glass cross frame. Stability after thermal cycling is excellent, and the design is reasonably tolerant of vibration. Choose from 0.25 ohm or 2.5 ohm nominal  $R_{TPW}$  values.

### 5698: $-200\text{ }^{\circ}\text{C}$ to $661\text{ }^{\circ}\text{C}$

This 25 ohm Working Standard SPRT is the perfect companion to a Super-Thermometer such as the 1590, which reads 25 ohm SPRTs to within 1 mK at  $0\text{ }^{\circ}\text{C}$ . Long term drift, defined as the change in output resistance at the triple point of water after 100 hours at  $661\text{ }^{\circ}\text{C}$ , is (after converting to temperature) less than 6 mK – typically less than 3 mK.

## Tech Tip

SPRTs may be calibrated in Hart's U.S.-based NVLAP-accredited lab or Hart's UK-based UKAS-accredited lab. Both offer world-class uncertainties.

## Specifications

	5681	5683	5684	5685	5698
Temperature range	-200 °C to 661 °C	-200 °C to 480 °C	0 °C to 1070 °C <sup>†</sup>	0 °C to 1070 °C <sup>†</sup>	-200 °C to 661 °C
Nominal $R_{TPW}$	25.5 Ω		0.25 Ω	2.5 Ω	25.5 Ω
Current	1 mA		14.14 mA	5 mA	1 mA
Resistance ratio	W(302.9146 K) ≥ 1.11807 and W(234.3156 K) ≤ 0.844235		W(302.9146 K) ≥ 1.11807 and W(1234.93 K) ≤ 4.2844		w(302.9146 K) ≥ 1.11807 and w(234.3156 K) ≤ 0.844235
Sensitivity	0.1 Ω/°C		0.001 Ω/°C	0.01 Ω/°C	0.1 Ω/°C
Drift rate	< 0.002 °C/100 hours at 661 °C (typically < 0.001 °C)	< 0.001 °C/100 hours at 480 °C (0.0005 °C typical)	< 0.003 °C/100 hours at 1070 °C (typically < 0.001 °C)		< 0.006 °C/100 hours at maximum temperature (typically < 0.003 °C)
Sensor support	Quartz glass cross		Quartz glass strip with notches	Quartz glass cross	Quartz glass cross
Diameter of sensor Pt wire	0.07 mm (0.003 in)		0.4 mm (0.016 in)	0.2 mm (0.008 in)	0.07 mm (0.003 in)
Protective sheath	Quartz glass, Diameter: 7 mm (0.28 in), Length: 520 mm (20.5 in)		Quartz glass, Diameter: 7 mm (0.28 in), Length: 680 mm (26.8 in)		Quartz glass, Diameter: 7 mm (0.28 in), Length: 485 mm (19.1 in)

<sup>†</sup> The official maximum temperature of an SPRT as a defining interpolation instrument of the ITS-90 is 961.78 °C, but these types of SPRTs were found to be stable up to at least 1070 °C. The annealing temperature during the stability test was 1085 °C. The lower temperature limit of these types of SPRTs can be as low as -200 °C. In general, it is suggested that a 25 Ω SPRT be used below 0 °C.

## Calibration

All SPRTs come without calibration unless ordered. Multiple calibration options by fixed point are available from Hart with either NVLAP or UKAS accreditation. We recommend our model 1911 with your desired temperature range.

## Ordering Information

### Models

**5681-S** SPRT 25.5 Ω, 661 °C<sup>†</sup>

**5683-S** SPRT 25.5 Ω, 480 °C<sup>†</sup>,  
Ultrastable

**5684-S** SPRT 0.25 Ω, 1070 °C<sup>†</sup>

**5685-S** SPRT 2.5 Ω, 1070 °C<sup>†</sup>

**5698-25** 25 Ω Working Standard  
SPRT<sup>†</sup>

<sup>†</sup> Maple carrying case included

### Calibration Options

**1911-4-7** -200 °C to 660 °C,  
by fixed point (5681)

**1911-6-0** °C to 962 °C, by fixed  
point (5684, 5685)

**1910-4-8** -200 °C to 420 °C,  
by fixed point (5683)

Other options available.

See [www.hartscientific.com](http://www.hartscientific.com) or  
Hart's complete printed catalog.

# 5680, 5682, 5699 Metal-Sheath SPRTs

riešenia na presné meranie

## Primary Temperature Standards

www.elso.sk/Fluke-Calibration

### Affordable working standard SPRTs



- Drift rate better than 8 mK/year
- Meet all ITS-90 requirements from -200 °C to 661 °C
- Multiple calibration options by fixed point available

While the temperature range of metal-sheath SPRTs is narrower than that of quartz-sheath SPRTs, they're perfect for salt baths, baths that require metal blocks for increased stability (Hart baths don't need metal blocks), and dry-wells. The price and performance of these standards allow you to use them in other situations, as well, that are inappropriate for quartz models.

The element in the 5680 and 5682 SPRTs is made from high-purity platinum with a unique ceramic shield for high-temperature work. The quality construction of these SPRTs produces drift rates typically less than 0.005 °C at 0 °C after 100 hours at 480 °C. This is excellent repeatability for an SPRT in this price range.

The 5699 Extended Range Metal-Sheath SPRT features protective sheathing materials that allow it to be used in virtually any furnace or bath with temperatures as high as 661 °C.

The strain-free sensing element in the 5699 meets all ITS-90 requirements for SPRTs and minimizes long-term drift. After one year of regular usage, drift is less than 8 mK (2-3 mK is typical). Even lower drift rates are possible depending on care and handling. A fifth wire for grounding is added to the four-wire sensor to help reduce electrical noise, particularly for ac measurements.

The 5699 is constructed with a 5.563 millimeter (0.219 inch) diameter Inconel™ sheath for high durability and fast response times. Inside the sheath, the sensing element is protected by a thin platinum housing that shields the sensor from contamination from free-floating metal ions found within metal environments at high temperatures. Reduced contamination means a low drift rate — even after hours of use in metal-block furnaces at high temperatures.

### Specifications

	5680	5682	5699
Temperature range	-200 °C to 480 °C		-200 °C to 661 °C
Nominal $R_{TPW}$	25.5 $\Omega$ ( $\pm 0.5 \Omega$ )	100 $\Omega$ ( $\pm 1.0 \Omega$ )	25.5 $\Omega$ ( $\pm 0.5 \Omega$ )
Current	1 mA	0.5 or 1.0 mA	1 mA
Resistance ratio	$W(234.315 \text{ K}) \leq 0.844235$ , $W(302.9146 \text{ K}) \geq 1.11807$		
Sensitivity	0.1 $\Omega/^\circ\text{C}$	0.4 $\Omega/^\circ\text{C}$	0.1 $\Omega/^\circ\text{C}$
Drift rate	< 0.01 °C/100 hours at 480 °C (typically < 0.005 °C)		< 8 mK/year (2-3 mK/year typical)
Repeatability	< 2 mK		< 1 mK
Diameter of Pt sensor wire	0.07 mm (0.003 in)	0.04 mm (0.0016 in)	0.07 mm (0.003 in)
Protective sheath	Inconel Diameter: 6.35 mm (0.25 in) Length: 485 mm (19.1 in)		Inconel Diameter: 5.56 mm $\pm 0.13$ mm (0.219 in $\pm 0.005$ in) Length: 482 mm (19 in)
Lead wires	Four sensor wires plus grounding wire		
Insulation resistance	> 100 M $\Omega$ at 661 °C > 1000 M $\Omega$ at 20 °C		

### Calibration

All SPRTs come without calibration unless ordered. Multiple calibration options by fixed point are available from Hart with either NVLAP or UKAS accreditation. We recommend our model 1912 with your desired temperature range.

### Tech Tip

Beware! Metal-sheathed SPRTs are no less susceptible to resistance shift from mechanical shock than are quartz-sheathed SPRTs.

### Ordering Information

#### Models

**5680-S** 25  $\Omega$  Working Standard Metal-Sheath SPRT\*

**5682-S** 100  $\Omega$  Working Standard Metal-Sheath SPRT\*

**5699-S** Extended Range Metal-Sheath SPRT\*

\*Maple carrying case included.

#### Calibration Options

**1912-4-8** -200 °C to 420 °C, by fixed point (5680, 5682)

**1911-4-7** -200 °C to 600 °C, by fixed point (5699)

Other options available. See [www.hartscientific.com](http://www.hartscientific.com) or Hart's complete printed catalog.

# 5686 and 5695 Glass Capsule SPRTs

riešenia na presné merania

www.elseo.sk/Fluke-Calibration

Primary  
Temperature  
Standards

FLUKE®

Hart Scientific

Designed for metrology work requiring small SPRTs

## Tech Tip

Be sure to understand the impact of stem-conduction effects on your measurements. Sensor construction, immersion, and temperature can all contribute to such effects.



- Temperatures from  $-260\text{ }^{\circ}\text{C}$  (13 K) to  $500\text{ }^{\circ}\text{C}$
- Stability typically  $0.001\text{ }^{\circ}\text{C}$  over a  $100\text{ }^{\circ}\text{C}$  range
- Miniature capsule package eliminates stem conduction

The 5686 and 5695 Glass Capsule SPRTs are perfect for cryogenics, calorimetry, and other metrology work requiring small SPRTs. Both models are true SPRTs. The high-purity platinum wire is hand-wound on a glass cross frame in a strain-free design. The glass capsule is designed to match the thermal expansion of the platinum wire to ensure a true seal at all operating temperatures. The capsules are pressure sealed and come protected in their own maple case. Both models comply completely with ITS-90.

The 5686 covers temperatures from  $-260\text{ }^{\circ}\text{C}$  to  $232\text{ }^{\circ}\text{C}$ , so it's perfect for cryogenic applications. It is 5.8 millimeters in diameter and 56 millimeters long. The 5695 is designed for high-temperature applications requiring a small SPRT. Its unmatched range is from  $-200\text{ }^{\circ}\text{C}$  to  $500\text{ }^{\circ}\text{C}$ , and its size is 5.2 millimeters by 68 millimeters.

These SPRTs are small but meet customary SPRT performance for reproducibility, reliability, and stability. They solve many of the problems associated with taking precision measurements in situations unsuitable for traditional-length SPRTs.

## Specifications

	5686	5695
Temperature range	$-260\text{ }^{\circ}\text{C}$ to $232\text{ }^{\circ}\text{C}$ (13 K to 505 K)	$-200\text{ }^{\circ}\text{C}$ to $500\text{ }^{\circ}\text{C}$ (73 K to 773 K)
Nominal $R_{TPW}$	25.5 $\Omega$	
Resistance ratio	$W(302.9146\text{K}) \geq 1.11807$ $W(234.3156\text{K}) \leq 0.844235$	
Drift rate	$< 0.01\text{ }^{\circ}\text{C}$ per year over the entire range; typically $0.001\text{ }^{\circ}\text{C}$ per year over a range of $100\text{ }^{\circ}\text{C}$	
Filling gas	helium	argon and oxygen
Lead wires	Four platinum wires, 3 cm long	
Size	5.8 mm dia. x 56 mm long (0.23 in x 2.2 in)	5.2 (+0.4) mm dia. x 68 mm long (0.2 in [+0.016 in] x 2.7 in)

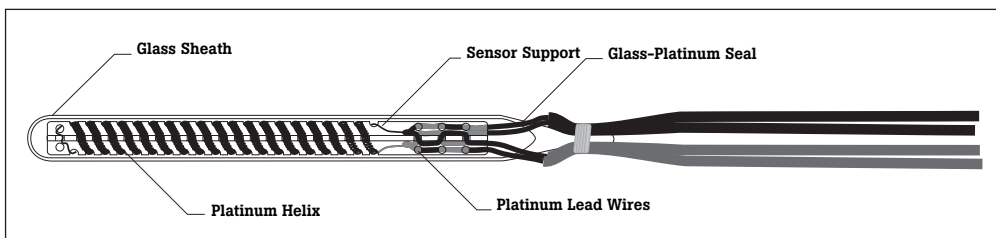

## Calibration

All SPRTs come without calibration unless ordered. Multiple calibration options by fixed point are available from Hart with either NVLAP or UKAS accreditation. We recommend our model 1911 with your desired temperature range.

## Ordering Information

### Models

**5686-B** Glass Capsule SPRT,  $-260\text{ }^{\circ}\text{C}$  to  $232\text{ }^{\circ}\text{C}$ <sup>†</sup>

**5695-B** Glass Capsule SPRT,  $-200\text{ }^{\circ}\text{C}$  to  $500\text{ }^{\circ}\text{C}$ <sup>†</sup>

<sup>†</sup>Maple carrying case included.

### Calibration Options

**1911-4-9**  $-200\text{ }^{\circ}\text{C}$  to  $232\text{ }^{\circ}\text{C}$ , by fixed point (5686)

**1911-4-8**  $-200\text{ }^{\circ}\text{C}$  to  $420\text{ }^{\circ}\text{C}$ , by fixed point (5695)

Other options available.

See [www.hartscientific.com](http://www.hartscientific.com) or Hart's complete printed catalog.

# 5629 Gold-Platinum Thermocouple

## Primary Temperature Standards

### Performance that rivals high-temperature SPRTs

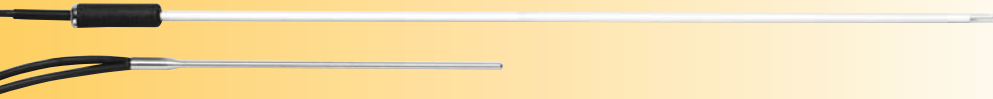

- Calibration uncertainty of  $\pm 0.02$  °C to 1000 °C
- Fixed-point calibration included
- Stability better than  $\pm 0.02$  °C

### Tech Tip

Gold-platinum thermocouples are less accurate and stable than HTPRTs; however, they are less expensive and less susceptible to contamination and mechanical shock.

Following the designs of NIST and NRC, the 5629 Gold-Platinum Thermocouple performs to a level that rivals most high-temperature SPRTs but is easier to use and more affordable.

Each thermocouple includes a NVLAP-accredited fixed-point calibration at the freezing points of tin, zinc, aluminum, and silver. From that, we derive two deviation coefficients that, in conjunction with the NIST function, provide maximum accuracy. With an expanded calibration uncertainty of  $\pm 0.02$  °C ( $k=2$ ), the gold-platinum thermocouple is a true laboratory standard.

Gold-platinum thermocouples are also exceptionally stable. The 5629 repeats within  $\pm 0.02$  °C after numerous repetitions throughout its range of 0 °C to 1000 °C.

Each 5629 includes a reference junction enclosed in stainless steel. Hart uses high-grade copper extension wires meticulously selected for low EMF characteristics. At 9 inches long, this reference junction is longer than average, to ensure sufficient immersion with low heat loss in a zero-point temperature source.

### Specifications

Temperature range	0 °C to 1000 °C
Thermocouple materials	99.999 % pure gold, 99.999 % pure platinum
Sheath materials	Measurement junction of quartz glass, reference junction of stainless steel
Calibration	Freezing points of tin, zinc, aluminum, and silver included; coefficient values included with certificate
Calibration uncertainty	$\pm 0.020$ °C (expanded uncertainty [ $k=2$ ] over entire range)
Stability	$\pm 0.020$ °C
Measurement junction sheath dimensions	Diameter: 7.0 mm (0.27 in) Length: 600 mm (23.62 in)
Reference junction sheath dimensions	Diameter: 5.56 mm (0.22 in) Length: 229 mm (9.01 in)
Minimum immersion	406 mm (16 in)
Accuracy	Accuracy will vary according to usage techniques and conditions Under reasonably good conditions, uncertainties of $\pm 0.02$ °C can be expected

### Ordering Information

#### Models

**5629-X** Gold-Platinum Thermocouple (four-point NVLAP-accredited calibration by fixed point and maple protective case included)

X = termination. Specify "B" (bare wire) or "W" (generic copper-to-copper TC connector).

Else Philips Service, Trenčín

# Triple Point of Water Cells

## Must-have, primary temperature standards



- Very accurate — uncertainty better than  $\pm 0.0001$  °C
- Five shapes and sizes to choose from

## Tech Tip

Ice mantles can be formed in triple point of water cells using dry ice, LN<sub>2</sub>, or a Hart Quick Stick. The mantles can be maintained in simple dewars for days or in a high stability bath for months!

The triple point of water (TPW) is an intrinsic standard that does not need recalibration. It is the most accurate standard you can use to make sure your thermometer standards are in tolerance.

The ITS-90 assigns the TPW a value of 0.01 °C (273.16 K). Our cells achieve this temperature with an expanded uncertainty of less than 0.0001 °C.

The 5901 cell is used by many national temperature labs around the world. It has a wide mouth for facilitating freezing of the mantle using crushed dry ice. The rubber foot lets you rest the cell on your ice bath or holding fixture for extra stability and protection while you're using it.

The 5901A is a full-size cell designed after the original NBS cell, which had a glass support arm. The arm can be used as a hook for supporting the cell in an ice bath. The handle is also used as a McLeod gauge for a qualitative check of trapped air in the cell.

The 5901B is a smaller cell that's easy to handle, accommodates shorter sensors, and can be maintained in an automatic maintenance device.

The 5901C is designed like the original 5901 cell with the exception of the well size, which is 13.6 millimeters rather than the standard 12 millimeters.

All these cells are cylindrical borosilicate glass filled with highly pure water.

## Specifications

	5901	5901A	5901B	5901C
Expanded Uncertainty (k=2)	< 0.0001 °C	< 0.0001 °C	< 0.0002 °C	< 0.0001 °C
Reproducibility	0.00002 °C	0.00002 °C	0.00005 °C	0.00002 °C
Dimensions: Outside diameter	60 mm	50 mm	30 mm	60 mm
Length	380 mm	450 mm	180 mm	380 mm
Inside diameter	12.6 mm	12.6 mm	8 mm	13.6 mm
Immersion Depth (water surface to well bottom)	260 mm (10.24 in)	260 mm (10.24 in)	117 mm (4.6 in)	260 mm (10.24 in)

## Ordering Information

### Models

5901 TPW, 12.6 mm I.D.

5901A TPW, 12.6 mm I.D., with handle

5901B TPW, mini quartz, 8 mm I.D.

5901C TPW, 13.6 mm I.D.

### Options and Accessories

INSU-5901 TPW Insurance, one year

2031 "Quick Stick" Immersion Freezer

1904-Tpw Accredited Cell Intercomparison

# 7312 TPW Maintenance Bath

## Primary Temperature Standards

Maintains two TPW cells for up to two months



- Includes “Quick Stick” immersion freezer for simple cell freezing
- Independent cutout circuit protects cells from breaking

### Tech Tip

No matter what device is used to maintain triple point of water cells, the cells should be periodically checked to ensure the ice mantles float freely and have not become attached to the glass.

The Model 7312 Triple Point of Water Maintenance Bath keeps your cells up and running reliably for weeks at a time – even during heavy usage. The 7312 accommodates two TPW cells and includes three pre-cool wells for properly cooling probes prior to measurements within the cells. Stability and uniformity are each better than  $\pm 0.006$  °C, so your cells stay usable for up to eight weeks. Whatever method you use for building your ice mantles, you can be assured they'll last in a 7312 bath.

An independent safety circuit protects your water cells from freezing and breaking by monitoring the temperature of the bath and shutting down its refrigeration system should the bath controller fail. Noise-reduction techniques in the manufacturing process ensure your bath doesn't add excessive noise to your lab.

With a temperature range from  $-5$  °C to  $110$  °C, this bath can also be used for comparison calibrations – particularly of long-stem probes – or maintenance of gallium cells. An optional gallium cell holding fixture fits two cells, which in a 7312 bath can maintain their melting plateaus for up to two weeks.

The 7312 comes with a time-saving Model 2031 Immersion Freezer so you can build your ice mantles quickly and hands-free. Just fill the 2031's condensing reservoir with dry-ice and alcohol, insert it into the cell, and your ice mantle forms in less than an hour. (Alternatively,  $LN_2$  may be used.)

### Specifications

Range	$-5$ °C to $110$ °C
Stability	$\pm 0.001$ °C at $0$ °C (alcohol-water mix), $\pm 0.004$ °C at $30$ °C (alcohol-water mix)
Uniformity	$\pm 0.003$ °C at $0$ °C (alcohol-water mix), $\pm 0.006$ °C at $30$ °C (alcohol-water mix)
TPW duration	Six weeks, typical (assumes correctly formed ice mantle)
Set-point accuracy	$\pm 0.05$ °C at $0$ °C
Set-point repeatability	$\pm 0.01$ °C
Display resolution	$\pm 0.01$ °C
Set-point resolution	$\pm 0.002$ °C; $0.00003$ °C in high-resolution mode
Access opening	121 x 97 mm (4.75 in x 3.8 in)
Immersion depth	496 mm (19.5 in)
Volume	19 liters (5 gallons)
Communications	RS-232 included
Power	115 V ( $\pm 10$ %), 60 Hz or 230 V ( $\pm 10$ %), 50 Hz, specify
Size	(HxWxD) 305 x 622 x 819 mm (12 in x 24.5 in x 32.25 in)
Weight	34 kg (75 lb)

### Ordering Information

#### Models

**7312** TPW Maintenance Bath (includes TPW Holding Fixture, Immersion Freezer, and RS-232 Interface)

#### Options and Accessories

**2001-IEEE** Interface, IEEE-488

**2029-5903** Gallium Cell Holding Fixture

**2031** “Quick Stick” Immersion Freezer

Elsco Philips Service, Trenčín



## ITS-90 Fixed Point Cells

Best cell uncertainties commercially available



- Every ITS-90 fixed point available from mercury to copper
- Plateaus last days (gallium for weeks and TPW for months)
- Manufactured and tested by Hart's primary standards scientists

## Tech Tip

The performance of a fixed point cell can be specified based on the theoretical uncertainty of the cell's components or on actual observed measurements. Hart's specifications rely on the latter.

## Traditional freeze-point cells

For true primary temperature standards capability, you need metal freeze-point cells that are very close to the theoretical freezing temperature and provide plateaus that are both stable and long lasting.

Hart's metal freeze-point cells are the culmination of more than 20 years of primary standards experience. Each cell is carefully constructed in an ultra-clean, state-of-the-art lab, using high-density, high-purity graphite crucibles containing metal samples with purity of at least 99.9999 % (six 9s) and in many cases 99.99999 % (seven 9s). The crucible is enclosed within a sealed quartz glass envelope that is evacuated and back-filled with high-purity argon gas. A special sealing technique is used to seal the cell at the freezing point. Hart scientists measure and record the precise pressure of the argon gas to ensure the most accurate corrections for pressure.

Once manufactured, all cells are tested and supplied with an assay of metal-sample purity. Every traditional size ITS-90 cell further undergoes more rigorous testing in Hart's primary standards lab where melt-freeze curves are realized and a detailed "slope analysis" is performed to confirm cell purity. An optional inter-comparison with Hart's own reference cells is available if you require more data.

## Gallium cells

Gallium cells are an excellent reference for validation of instruments subject to drift (like SPRTs) and they're important for calibrating sensors used near room or body temperatures, in environmental monitoring, and in life sciences applications.

Hart makes two traditional-size gallium cells. The 5943 Gallium Cell is sealed in a stainless steel envelope. High purity gallium (99.9999 %) is enclosed in a plastic and metal shell. The stainless steel container is

then filled with pure argon gas at one standard atmosphere at the melting-point temperature.

Gallium expands on freezing by 3.1 %, requiring the cell to have flexible walls. Unlike cells made from PTFE enclosure materials, Hart's cells don't need pumping and refilling, because they're not gas permeable. Realization and maintenance of the cell is automated with the 9230 Maintenance Apparatus. This apparatus provides melting plateaus up to eight days and a convenient control to automatically achieve a new melt plateau each week with an investment of just five minutes, making maintenance extremely easy.

The 5903 is sealed in a borosilicate glass envelope, uses similar manufacturing techniques, and provides similar low uncertainties; and when maintained in a Model 7012 or 7312 maintenance bath, your melting plateaus will last as long as 14 days.



# ITS-90 Fixed Point Cells

## Primary Temperature Standards

### Water cells

While simple ice baths are often used as a calibration point at 0 °C, their limitations include gradients, purity problems, repeatability issues, and variances in construction and measurement techniques. Triple point of water cells not only solve these problems, they represent the most used temperature on the ITS-90, and they're inexpensive to own and use.

Hart makes three traditional size TPW cells that have been proven repeatedly in national labs to surpass their published uncertainty specification of  $\pm 0.0001$  °C. Ice mantles may be formed using dry ice, LN<sub>2</sub>, or immersion freezers and can last for up to two months when maintained in Hart's 7012 or 7312 baths.

Because open cells allow users to measure the pressure within the cell, uncertainties due to pressure corrections may be minimized. Use of open cells is now being suggested by the CCT, and open cells can be used for demanding temperature-versus-pressure applications as well as precision SPRT calibrations.

The height of these cells has been extended to allow easy access to the gas valve while the cells are in use. Pure quartz-wool insulation and four high-purity graphite discs prevent heat loss from the metal sample to the pressure regulation system while optimizing vertical temperature gradients within the cell. Each cell has an outside diameter of 50 millimeter and a height of 600 millimeter (silver and copper cells are 700 millimeter tall).

The scope of Hart's accreditation includes the testing of ITS-90 fixed-point cells. Each cell may be purchased with this intercomparison option, which includes comparing the equilibrium value of your cell against that of a reference Hart cell.



### Open metal cells

Made from the same materials and with the same manufacturing techniques as their sealed counterparts, Hart's new series of "open" metal fixed-point cells include a high quality valve for connecting to a precision pressure-handling system within your lab. Using such a system, the cell can be evacuated, charged and purged several times with a pure inert gas, then charged again to a regulated pressure level while measurements are made with the cell. Once assembled and tested, each Hart ITS-90 open cell further undergoes more rigorous testing in Hart's lab.

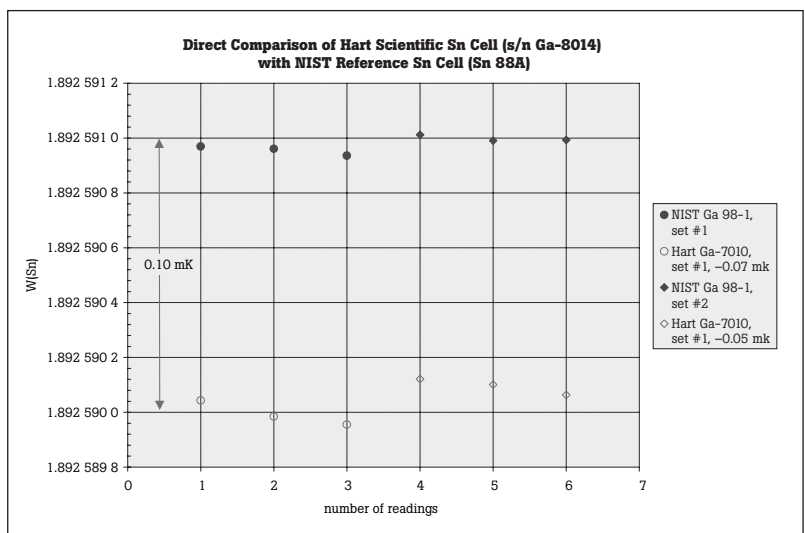
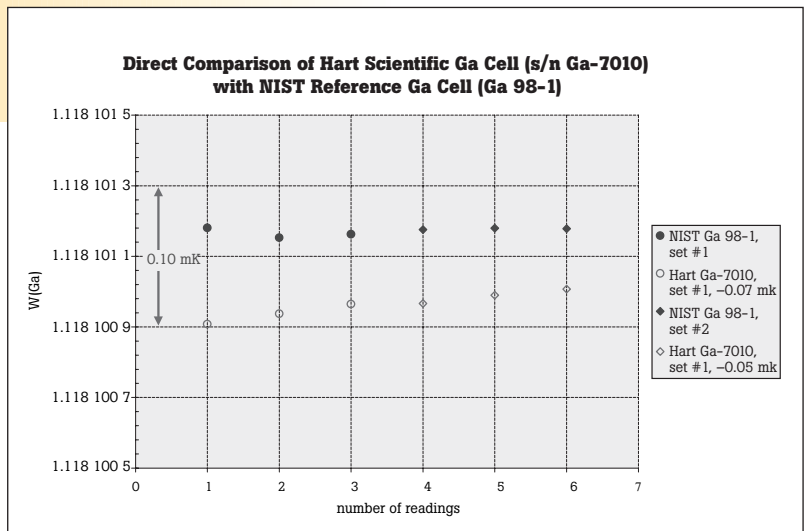

## Specifications

Model	Fixed Point	Style	Assigned Value (°C)	Outside Diameter	Inside Diameter	Total Outside Cell Height	Depth <sup>†</sup>	Cell Uncertainty (mK, k=2)	Certification (mK, k=2) <sup>‡</sup>
5900	Mercury	Stainless steel	-38.8344	31 mm	8.2 mm	470 mm	200 mm	0.2	0.25
5903	Gallium	Traditional quartz glass	29.7646	42 mm	8 mm	300 mm	150 mm	0.08	0.1
5904	Indium	Traditional quartz glass	156.5985	48 mm	8 mm	285 mm	195 mm	0.7	0.7
5905	Tin	Traditional quartz glass	231.928	48 mm	8 mm	285 mm	195 mm	0.5	0.8
5906	Zinc	Traditional quartz glass	419.527	48 mm	8 mm	285 mm	195 mm	0.9	1.0
5907	Aluminum	Traditional quartz glass	660.323	48 mm	8 mm	285 mm	195 mm	1.3	1.8
5908	Silver	Traditional quartz glass	961.78	48 mm	8 mm	285 mm	195 mm	2.4	4.5
5909	Copper	Traditional quartz glass	1084.62	48 mm	8 mm	285 mm	195 mm	10.1	12.0
5924	Indium	Open quartz glass	156.5985	50 mm	8 mm	596 mm	195 mm	0.7	0.7
5925	Tin	Open quartz glass	231.928	50 mm	8 mm	596 mm	195 mm	0.5	0.8
5926	Zinc	Open quartz glass	419.527	50 mm	8 mm	596 mm	195 mm	0.9	1.0
5927A-L	Aluminum	Open quartz glass (long)	660.323	50 mm	8 mm	696 mm	195 mm	1.3	1.8
5927A-S	Aluminum	Open quartz glass (short)	660.323	50 mm	8 mm	596 mm	195 mm	1.3	1.8
5928	Silver	Open quartz glass	961.78	50 mm	8 mm	696 mm	195 mm	2.4	4.5
5929	Copper	Open quartz glass	1084.62	50 mm	8 mm	696 mm	195 mm	10	12.0
5943	Gallium	Stainless steel	29.7646	38.1 mm	8.2 mm	250 mm	168 mm	0.1	0.1

<sup>‡</sup>Certifications at lower uncertainties are available for national laboratories.

<sup>†</sup>Depth is measured from the bottom of the thermometer well to the top of the pure reference material.

### Ordering Information

#### Models

**5900** Mercury Cell, Stainless Steel

**5903** Gallium Cell, Traditional Pyrex Glass

**5904** Indium Cell, Traditional Quartz Glass

**5905** Tin Cell, Traditional Quartz Glass

**5906** Zinc Cell, Traditional Quartz Glass

**5907** Aluminum Cell, Traditional Quartz Glass

**5908** Silver Cell, Traditional Quartz Glass

**5909** Copper Cell, Traditional Quartz Glass

**5924** Indium Cell, Open Quartz Glass

**5925** Tin Cell, Open Quartz Glass

**5926** Zinc Cell, Open Quartz Glass

**5927A-S** Aluminum Cell, Open Quartz Glass, Short

**5927A-L** Aluminum Cell, Open Quartz Glass, Long

**5928** Silver Cell, Open Quartz Glass

**5929** Copper Cell, Open Quartz Glass

**5943** Gallium Cell, Stainless Steel

**1904-X** Accredited Cell Intercomparison

**2931-LG** Protective Wood Case, Traditional Cells

# 9114, 9115, 9116 Freeze-Point Furnaces

## Primary Temperature Standards

Designed for maximum-length plateaus



9114

- Automated controllers, RS-232 included
- Top access to high-stability Hart controllers
- External cooling coils

Hart Scientific makes three freeze-point furnaces that, when combined with Hart freeze-point cells, produce the longest plateaus in the industry. A furnace and cell combination can establish plateaus that range from 24 to 40 hours or more. All of these furnaces have external cooling coils for circulation of tap water at less than 60 PSIG and approximately 0.4 GPM to reduce heat load to the lab. They also come with RS-232 ports and have equilibration blocks available for comparison calibrations. IEEE-488 interface packages are also available if that's your preference.

### 9114 Three-Zone Furnace

The Model 9114 is a three-zone furnace with the best in Hart's proprietary digital controller technology. This furnace has a range of 100 °C to 680 °C, which includes the indium, tin, zinc, and aluminum fixed points all in one furnace.

The freezing and melting process can be automated using eight preset, user-programmable temperature settings. The top and bottom zones are slaved to the primary zone using differential thermocouples. A high-temperature PRT acts as the main control sensor for the best accuracy, sensitivity, and repeatability.

### 9115 Sodium Heat Pipe Furnace

The 9115 Furnace is designed for maintenance of aluminum and silver freeze-point cells. It has a temperature range of 550 °C to 1000 °C with gradients of less than  $\pm 0.1$  °C throughout. The sodium heat-pipe design provides a simple yet uniform single heating zone that ensures very uniform changes in states during heating and cooling.

Melting, freeze initiation, and plateau control for a variety of freeze-point cells are possible by entering up to eight set-points and ramp and soak rates. The controller displays temperature in degrees C or F, and temperature feedback is done via a thermocouple. Freeze-point plateaus of 8 to 10 hours are typical, and 24 hours is possible under controlled conditions.

### 9116 Furnace

With a temperature range up to 1100 °C, covering the copper point, this furnace may also be optimized for zinc, aluminum, silver, and gold fixed points. The 9116 has all of the standard features found on other Hart freeze-point furnaces, including external cooling coils and an RS-232 port. The freezing and melting process may be automated using eight preset, user-programmable temperature settings.

## Specifications

	9114	9115	9116
Temperature range	100 °C to 680 °C	550 °C to 1000 °C	400 °C to 1100 °C
Temperature stability	± 0.03 °C	± 0.3 °C	± 0.5 °C
Temperature uniformity	± 0.05 °C (± 0.1 °C in the pre-heat well)	± 0.1 °C	less than ± 0.5 °C
Set-point accuracy	± 0.5 °C	± 3.0 °C	
Set-point resolution	0.01 °C	0.1 °C	
Display resolution	0.01 °C	0.1 °C below 1000 °C, 1 °C above 1000 °C	
Thermal safety Cutout accuracy	± 5 °C	± 10 °C	
Heater power	End Zones: 1000 W each (at 230 V nominal) Primary Zone: 1500 W	2500 W	End Zones: 800 W each (at 230 V nominal) Primary Zone: 900 W
Exterior dimensions	(HxWxD) 838 x 610 x 406 mm (33 in x 24 in x 16 in)		
Power requirements	230 V ac (± 10 %), 50/60 Hz, 1 Phase, 12 A maximum		
Weight	92 kg (203 lb)	82 kg (180 lb)	68 kg (150 lb)

## Ordering Information

### Models

**9114** Metrology Furnace (includes Cell Support Container)

**9115** Sodium Heat Pipe Furnace (includes Cell Support Container)

**9116** Three-Zone Freeze-Point Furnace (includes Cell Support Container)

### Options and Accessories

**2125** IEEE-488 Interface (9114 only)

**2126** Comparison Block (9114)

**2940-9114** Cell Support Container, 9114

**2127-9114** Alumina Block (9114)

**2941** Mini Freeze-Point Cell Basket Adapter

**2940-9115** Cell Support Container (9115)

**2127-9115** Alumina Block, (9115)

**2940-9116** Cell Support Container (9116)

**2127-9116** Alumina Block (9116)

# 9117 Annealing Furnace

## Primary Temperature Standards

Keep SPRTs and HTPRTs performing at their highest levels



- Guards against contamination
- Anneals both SPRTs and HTPRTs
- Fully programmable

### Tech Tip

Annealing is central for most thermometers immediately prior to calibration. Unnecessary annealing, however, can add undesirable thermal history and should be avoided.

All HTPRTs and SPRTs are subject to mechanical shock, no matter how carefully you handle them. Annealing relieves the stress on the platinum sensor caused by mechanical shock and is recommended prior to any calibration of an SPRT.

Annealing also removes the oxidation from sensors that have been used for long periods at temperatures between 200 °C and 500 °C. Oxidation impacts the purity of the element and therefore the accuracy of

temperature readings. Oxide is easily removed by annealing at 660 °C for one or two hours.

Annealing should only be done in a furnace that's designed to avoid emitting metal ions during its heating cycle. Hart solves this problem in its 9117 furnace by using an alumina block that is specially designed to guard against contamination. The furnace also has a programmable controller specifically designed for the annealing process.

### Specifications

Temperature range	300 °C to 1100 °C
Stability	± 0.5 °C
Uniformity	± 0.5 °C at 660 °C ± 1.0 °C at 1000 °C
Power	230 V ac (± 10 %), 50/60 Hz, 12 A, 2500 W
Display resolution	0.1 °C below 1000 °C, 1 °C above 1000 °C
Display accuracy	± 5 °C
Thermal wells	Five: 8 mm diameter x 430 mm long (0.31 in diameter x 16.93 in long)
Controller	PID, ramp and soak programmable, thermocouple sensor
Over-temp protection	Separate circuit protects furnace from exceeding rated temperature limit
Exterior dimensions	(HxWxD) 863 x 343 x 343 mm (34 in x 13.5 in x 13.5 in)
Weight	28 kg (61 lb)
Communications	RS-232

### Ordering Information

#### Models

**9117** Annealing Furnace (includes Model 2129 Alumina Block)

#### Options and Accessories

**2129** Spare Alumina Block, 5 wells (9117)

# Mini Fixed-Point Cells

Inexpensive, easy-to-use fixed-point standards



5901B

- Lower uncertainties than comparison calibrations
- All ITS-90 fixed points from TPW to copper
- Reduced equipment and annual recalibration costs

## Tech Tip

Mini cells offer slightly less performance than their traditional-size counterparts. However, they're less expensive, easier to transport, and easier to use.

Mini Fixed-Point Cells give you the least expensive, easiest-to-use fixed-point standards for your lab. These mini cells cover the triple point of water (0.01 °C) and every ITS-90 point from indium (156.5985 °C) to copper (1084.62 °C). They are made from the same materials and with the same procedures as their full-size counterparts. In fact, they can achieve nearly the same uncertainty levels as Hart's traditional fixed-point cells. Probes as short as nine inches work with these cells.

The 5944, 5945 and 5946 feature stainless-steel-cased cells that are easier to use and transport without risk of breakage. The metal cased cells are designed with more immersion depth to give even better uncertainty.

## Specifications

Model Number	Fixed-Point	Temp. (°C)	O.D.	I.D.	Total Cell Height	Immersion Depth (mm) <sup>1</sup>	Expanded Uncertainty (mK)	
							Cell Only <sup>2</sup>	Simple Realization <sup>2</sup>
5901B	Water T. P.	0.01	30 mm	9 mm	170 mm	117	0.2	0.5
5914A	Indium M. P.	156.5985	43 mm	8 mm	214 mm	140	1.0	2.0
5915A	Tin M. P.	231.928	43 mm	8 mm	214 mm	140	1.4	3.0
5916A	Zinc M. P.	419.527	43 mm	8 mm	214 mm	140	1.6	4.0
5917A	Aluminum M. P.	660.323	43 mm	8 mm	214 mm	140	4.0	10.0
5918A	Silver M. P.	961.78	43 mm	8 mm	214 mm	140	7.0	N/A
5919A	Copper M. P.	1084.62	43 mm	8 mm	214 mm	140	15.0	N/A
5944	Indium M. P.	156.5985	41.3 mm	7.8 mm	222 mm	156	0.7	1.4
5945	Tin M. P.	231.928	41.3 mm	7.8 mm	222 mm	156	0.8	1.6
5946	Zinc M. P.	419.527	41.3 mm	7.8 mm	222 mm	156	1.0	2.0

<sup>1</sup> Distance from the bottom of the central well to the surface of the pure metal.

<sup>2</sup> "Cell Only" refers to the expanded uncertainty of the cell when realized by traditional methods and maintained using traditional maintenance devices. "Simple Realization" refers to the expanded uncertainty of the cell when realized using practical methods (melting points instead of freezing points or slush ice instead of an ice mantle, for example) and maintained using Hart's models 9210 and 9260 mini cell maintenance apparatus.

## Ordering Information

### Models

- 5901B Mini Quartz TPW Cell
- 5914A Mini Quartz Indium Cell
- 5915A Mini Quartz Tin Cell
- 5916A Mini Quartz Zinc Cell
- 5917A Mini Quartz Aluminum Cell
- 5918A Mini Quartz Silver Cell
- 5919A Mini Quartz Copper Cell
- 5944 Mini Metal Cased Indium Cell
- 5945 Mini Metal Cased Tin Cell
- 5946 Mini Metal Cased Zinc Cell

### Options and Accessories

- 2931-SM Protective Wood Case, mini cells
- 1904-X Accredited Cell Intercomparison
- 1904-Tpw Accredited Cell Intercomparison
- 1904-GA Accredited Cell Intercomparison

Note: Each Mini Metal Cased Cell includes a 2942-9260 Mini Cell Basket. Indium, tin, zinc, and aluminum Mini Quartz Cells each include a 2940-9260 Mini Cell Basket. Both basket styles adapt the cell to Hart's 9260 Mini Fixed-Point Furnace.

# 9210, 9230, 9260 Mini Fixed-Point Maintenance Apparatus

riešenia na presné meranie [www.elseo.sk/Fluke-Calibration](http://www.elseo.sk/Fluke-Calibration)

## Primary Temperature Standards

Inexpensive, easy-to-use fixed-point maintenance apparatus



9260

- Preprogrammed controller makes realizing fixed points easy
- Half the cost (or less) of traditional fixed-point systems
- Training takes a few hours — not a few years

## Tech Tip

The ITS-90 calls for freezing points of indium, tin, zinc, and aluminum. Melting points, however, are easier to use and add only minimal contributions to total uncertainty.

### 9210 TPW Maintenance Apparatus

The 9210 TPW Maintenance Apparatus provides built-in programming for the simple supercool-and-shake realization and maintenance of the 5901B Mini TPW Cell. Simply insert the cell, enter the “freeze” mode through the front-panel buttons, and when the 9210 audibly alerts you, remove the Mini TPW Cell and give it a shake to initiate freezing a portion of the water. Re-insert the cell, change the program mode to “maintain,” and you’ve got 0.01 °C for the rest of the day with uncertainty of only  $\pm 0.0005$  °C.

Precision-machined thermal blocks can also be used to take advantage of the excellent stability and uniformity of the 9210 for performing comparison calibrations. Multi-hole and custom blocks are available with seven-inch depths.

### 9230 Gallium Maintenance System

The easy-to-use 9230 Gallium Maintenance System works with the 5943 Stainless Steel Gallium Cell to provide melting plateaus that last a week.

The 5943 Stainless Steel Gallium Cell holds a gallium sample that is 99.99999+ % pure. The gallium is sealed in a Teflon envelope in a high purity argon atmosphere, which is itself sealed inside a stainless steel housing. This double-sealing method reduces leaching into the gallium sample and ensures a life of ten years or longer for the cell.

### 9260 Mini Fixed-Point Cell Furnace

This furnace works with indium, tin, zinc, and aluminum cells to cover all ITS-90 fixed points from 156.5985 °C to 660.323 °C.

The 9260 makes using fixed points easy. Simply insert the cell at the end of the day and let it sit overnight. The next morning, initialize the built-in software routine for your specific cell. Come back in an hour, verify the stability of the cell, and you can take measurements for the rest of the day from a near-perfect temperature source.

The built-in software lets you choose between using melting-point curves or freezing-point curves for each metal. The ITS-90 calls for freezing points, but melting points are easier to realize, and the difference in uncertainty (less than 2 mK for most applications) is generally insignificant. In fact, the difference between using traditional cells at their freezing points and Hart’s mini cells at their melting points is not significant for most labs in most applications.

Comparison blocks are also available for the 9260 for high-precision comparison calibrations at high temperatures. Two blocks are available with a variety of pre-drilled wells in addition to blank or custom blocks. Well depth is 229 millimeters (9 inches).



## Specifications

	9210	9230	9260
Temperature range	-10 °C to 125 °C	15 °C to 35 °C	50 °C to 680 °C
Ambient operating range	5 °C to 45 °C	18 °C to 28 °C	5 °C to 45 °C
Stability	± 0.02 °C	± 0.02 °C ± 0.05 °C above 300 °C	± 0.03 °C to 300 °C
Vertical gradient	± 0.05 °C over 100 mm at 0 °C during cell maintenance	< 0.03 °C over six inches adjustable by offset	Top and bottom zones
Melting/freezing-point duration	6 to 10 hours, typical	Five days, typical	6 to 10 hours typical
Resolution	0.01 ° (0.001 ° in program mode)	0.01 ° (0.001 ° in program mode)	0.01 °
Display scale	°C or °F, switchable		
Immersion depth	171 mm (6.75 in) in optional comparison block	152 mm (6 in) in gallium cell	229 mm (9 in)
Stabilization time	15 minutes nominal	Preprogrammed	15 minutes nominal
Preheat wells	3 wells (for 3.18, 6.35, or 7.01 mm probes)	2	2
Fault protection	Adjustable software cutout using control probe, separate circuit thermocouple cutout for maximum instrument temperature	Heating/cooling rate cutout	Sensor burnout and short protection, over-temperature thermal cutout
Display accuracy	± 0.25 °C	± 0.05 °C at 29.76 °C	± 0.2 °C to 300 °C ± 0.3 °C to 450 °C ± 0.5 °C to 680 °C
Comparison block	Three multi-hole blocks, blanks, and custom blocks available	Contact Hart	Two multi-hole blocks, blanks, and custom blocks available
Well-to-well gradient (in comparison block)	± 0.02 °C	N/A	± 0.02 °C
Heating time	Ambient to 100 °C: 45 min.	Preprogrammed	1.25 hrs. from 25 °C to 680 °C
Cooling time	Ambient to -5 °C: 25 min.	Preprogrammed	10.5 hrs. from 680 °C to 100 °C
Communications		RS-232 included	
Power requirements	115 V ac (± 10 %), 60 Hz, 1.5 A, or 230 V ac (± 10 %), 50 Hz, 0.75 A, 170 W	115 V ac (± 10 %), 60 Hz, 1.5 A, or 230 V ac (± 10 %), 50 Hz, 0.75 A, 175 W	115 V ac (± 10 %), 60 Hz, 11 A, or 230 V ac (± 10 %), 50 Hz, 6 A, specify, 1200 W
Exterior dimensions	(HxWxD) 222 x 260 x 489 mm (8.75 in x 10.25 in x 19.25 in)		
Weight	7 kg (15.5 lb) with block	8.2 kg (18 lb) without cell	20.5 kg (45 lb) with block

### Ordering Information

#### Models

**9210** Mini TPW Maintenance Apparatus

**9230** Gallium Cell Maintenance System

**9260** Mini Fixed-Point Furnace (for In, Sn, Zn, Al cells )

#### Options and Accessories

**3110-1** Comparison Insert, blank (9210)

**3110-2** Comparison Insert A, holes at 1/16 in, 1/8 in, 3/16 in, 1/4 in, 3/8 in, and 1/2 in (9210)

**3110-3** Comparison Insert B, 2 holes at 3/16 in, 2 at 1/4 in, and 2 at 3/8 in (9210)

**3110-4** Comparison Insert C, 6 holes at 6 1/4 in (9210)

**3110-6** X Cell Adapter Sleeve, (9210)

**3160-1** Comparison Insert, blank (9260)

**3160-2** Comparison Insert, 7 holes at 1/4 in (9260)

**3160-3** Comparison Insert, 2 holes at 1/8 in, 2 at 3/16 in, 2 at 1/4 in, 2 at 9/32 in (9 mm), and 2 at 3/8 in (9260)

Call for other comparison insert options.

# 5931-5934 X Cells

## Primary Temperature Standards

Industrial cells that provide primary standards performance



- Stainless steel casings help protect cells from mishandling
- Accuracies similar to traditional-size quartz cells
- Can be maintained in fluid baths or dry-well calibrators

### Tech Tip

X cells allow for highly accurate checks of industrial probes at critical temperatures: 0 °C to check drift, 29 °C for body – and room-temperature probes, and 156 °C for probes involved with sterilization applications.

Hart Scientific's X Cells provide primary standards performance, are nearly unbreakable, and cost much less than traditional cell systems. The value of the water triple point X Cells is within 0.2 mK of traditional water triple point cells, and the gallium and indium cells include realized uncertainties less than 0.002 °C.

Gallium and indium X Cells are constructed using a Teflon crucible containing a sample with purity of at least 99.9999 %. The crucible is enclosed within a specially cleaned stainless steel envelope, which is evacuated and back-filled with high-purity argon.

Realizing these reference points could not be easier. Special X Cell maintenance baskets allow the cells to be used in both standard baths and Micro-Baths, and a special sleeve is available for maintaining X Cells in Model 9103 dry-well calibrators.

Simply place the cell in the heat source, select the melt temperature, and within 30 minutes you'll have an ITS-90 reference temperature all day long with stability of  $\pm 0.001$  °C. Once you finish using the cell, just set the freeze temperature and within minutes the cell is again ready for another realization.

### Specifications

Nominal temperature values	Water: 0.01 °C Gallium: 29.7646 °C Indium: 156.5985 °C
Expanded uncertainty (k=2)	Water: $\pm 1.0$ mK (0.5 typical) Gallium: $\pm 1.0$ mK (0.5 typical) Indium: $\pm 2.0$ mK (1.0 typical)
Metal sample purity	Gallium: 99.99999 % Indium: 99.9999 %
Immersion depth (in pure sample)	Water: 86.4 mm (3.4 in) Gallium: 76.2 mm (3.0 in) Indium: 76.2 mm (3.0 in)
Casing material	Stainless Steel
Well I.D.	6.35 mm (0.25 in)
Cell size	127mm H x 24 mm dia. (5 in x 1 in)

Comparison of a TPW X Cell (#31004) to a Standard TPW Cell (#1022)

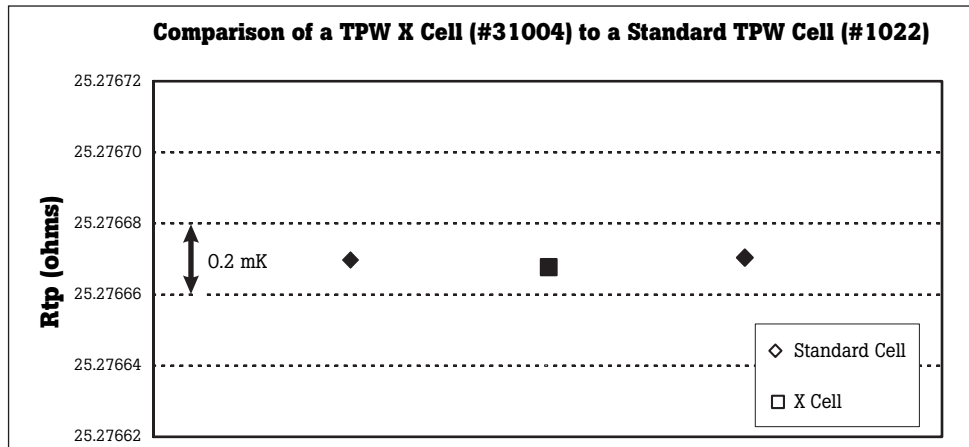

### Ordering Information

#### Models

5931 X Cell, Triple Point of Water

5933 X Cell, Gallium

5934 X Cell, Indium

#### Options and Accessories

2025 X Cell Basket, Standard Bath Fill Hole

2025-6102 X Cell Basket, 6102 or 7102

2025-7103 X Cell Basket, 7103

3103-5 X Cell Adapter Sleeve, 9103

3109-5 X Cell Adapter Sleeve, 9011 and 9127

3110-6 X Cell Adapter Sleeve, 9210

Elseo Philips Service, Trenčín

# 7196 LN<sub>2</sub> Comparison Calibrators

riešenia na presné merania

www.elseo.sk/Fluke-Calibration

Primary Temperature Standards

FLUKE®

Hart Scientific

## Low-cost calibration to -196 °C

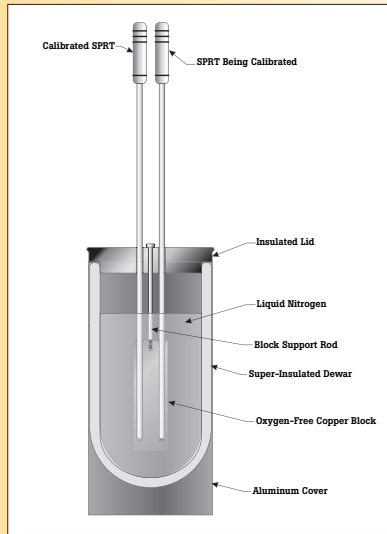

- Simple to use
- Uncertainty less than 2 mK
- Four-hole and thirteen-hole blocks available

## Tech Tip

Low-cost LN<sub>2</sub> comparators may effectively substitute for the high-priced, difficult-to-use Argon systems called for by the ITS-90.

If you need to do calibrations at the triple point of argon but don't want the complexity and cost of using an argon triple point cell, the Model 7196 LN<sub>2</sub> Comparison Calibrators will solve your problems – for less than half the price of other argon triple point simulators.

The nominal boiling point of nitrogen is -196 °C at one atmosphere of pressure. The defining triple point of argon is -189.3442 °C. While there is a difference between the nominal boiling point of nitrogen and the argon triple point, the difference can be corrected for mathematically, and an uncertainty of less than 2 mK from the actual argon triple point is achievable.

The 7196 LN<sub>2</sub> Comparison Calibrators consist of a super-insulated glass dewar, a high-purity copper block, and a precision-fit lid. The dewar is filled with LN<sub>2</sub> and the copper block is suspended in it; an SPRT is inserted into the block and a calibration is performed against your own calibrated SPRT. The 7196-4 includes four 8-millimeters (0.32 in) wells. The 7196-13 includes five 8-millimeters (0.32 in) wells and eight 6.35-millimeters (0.25 in) wells.

## Specifications

Temperature	Nominal -196 °C depending on atmospheric pressure
Thermal wells	7196-4: four 8 mm (0.32 in) I.D. wells 7196-13: five 8 mm (0.32 in) I.D. wells, eight 6.35 mm (0.25 in) I.D. wells Both blocks: 275 mm immersion from top of lid to bottom of well, 150 mm immersion into copper block
Dimensions	180 mm O.D. x 385 mm H
Stability	Typically better than 2 mK
Uniformity	< 0.4 mK between holes
Volume	3.5 liters of liquid nitrogen
Evaporation	Approximately 25 mm (1 in) per 45 minutes

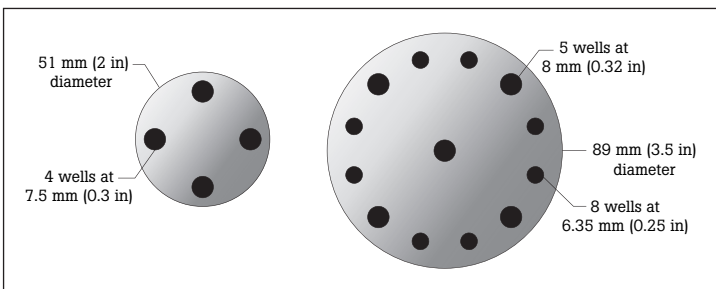

## Ordering Information

### Models

**7196-4** LN<sub>2</sub> Comparison Calibrator, 4 holes

**7196-13** LN<sub>2</sub> Comparison Calibrator, 13 holes

# Thermometer Readout Selection Guide

riešenia na presné meranie

www.elseo.sk/Fluke-Calibration

## Thermometer Readouts

These thermometer readouts offer unparalleled accuracy, versatility, and productivity – enhancing features, at great values. Super-Thermometers, recognized in metrology laboratories worldwide for their ease of use and reliable accuracy, are perfectly suited for SPRT calibrations. The Black Stack, Chub-E4, and Tweener

readouts provide unmatched versatility and value as reference thermometers, data acquisition systems, or in integrated automatic calibration systems. The 1521 and 1522 handheld thermometers read PRTs and thermistors with memory and data-logging features.



Model	Probe Types	Accuracy at 0 °C	Features
1521	PRTs, Thermistors	± 0.025 °C	Battery-powered, handheld thermometer; INFO-CON connector reads coefficients without programming.
1522	PRTs, Thermistors	± 0.025 °C	Stores up to 10,000 readings, plus 100 more on demand; reads PRTs and thermistors (calibrated or uncalibrated) interchangeably.
1502A	PRTs	± 0.006 °C	Resolution of 0.001 °C and accuracy to match; uses ITS-90, IPTS-68, CVD, or DIN (IEC 751) conversions.
1504	Thermistors	± 0.002 °C	Reads thermistors from 0 to 1Ω; uses Steinhart-Hart and CVD.
1529	PRTs, Thermistors, Thermocouples	± 0.006 °C (PRT)	Four channels can all be measured simultaneously; battery-powered; logs up to 8,000 readings; configurable display
1560			Accepts any combination of the eight modules below; all are easily added to and removed from the 1560 base
2560	PRTs	± 0.005 °C	2 channels of 25 Ω or 100 Ω PRTs.
2561	HTPRTs	± 0.013 °C	2 channels to 1200 °C.
2562	PRTs	± 0.01 °C	8 channels of 2-, 3-, or 4-wire RTDs.
2563	Thermistors	± 0.0013 °C	2 channels of resolution to 0.0001 °C.
2564	Thermistors	± 0.0025 °C	8 channels for data acquisition.
2565	Thermocouples	± 0.05 °C	Reads all TC types with 0.0001 mV resolution.
2566	Thermocouples	± 0.1 °C	Reads any combination up to 12 channels of any type of TC.
2567	1000 Ω PRTs	± 0.006 °C	2 channels at high resistance PRTs
2568	1000 Ω PRTs	± 0.01 °C	8 channels of high resistance PRTs
1575	SPRTs, Thermistors	± 0.001 °C	4 ppm accuracy; resolution to 0.0001 °C for SPRTs and 0.00001 °C for thermistors; 2 channels; add 10 more channels with 2575 max
1590	SPRTs, Thermistors	± 0.00025 °C	1 ppm accuracy; patented DWF connectors; color display; add up to 50 channels with 2590 max

# 1521 and 1522 Handheld Thermometers

riešenia na presné meranie

www.else.sk/Fluke-Calibration

Thermometer  
Readouts

FLUKE®

Hart Scientific

Highest precision available in a battery-powered, handheld thermometer



1521

- Read PRTs/RTDs to  $\pm 0.025$  °C and thermistors to  $\pm 0.005$  °C
- Model 1522 stores multiple data sets totaling 10,000 readings
- INFO-CON connector allows interchangeable use of calibrated probes
- INFO-CON eliminates errors from programming probe data

These handheld thermometers feature measurement accuracy to  $\pm 0.005$  °C and 0.001 °C resolution. They accept inputs from RTDs or thermistors and with the INFO-CON connector, there's no need to program probe coefficients into the meter. All probe information is stored in the INFO-CON and conveniently downloaded when connected to the 1521 and 1522. The 1522 is also a data logger. Log up to 10,000 readings. Download logged data via RS-232 using the 9934 LogWare software.



Handheld thermometers make excellent reference standards for field calibrations.



LogWare software can be used to graphically and statistically analyze data logged to the Model 1522 LLL. LogWare can also turn either Handheld Thermometer into a real-time datalogger.

## Tech Tip

### Readouts and probes should match.

Digital thermometer readouts measure resistance, voltage, and sometimes connector temperature (in the case of TCs). The displayed temperature is always a computed result – not a direct measurement! Pretty simple, right? The trouble is that the readout will perform the calculation even if all of the information upon which the calculation is based is wrong or missing. And the error may not always be obvious.

Before making a measurement, check the readout and ensure that the coefficients, excitation current, and reference junction settings are correct. While you're at it, check the sample timing, statistics, and filtering. You'll save yourself a lot of trouble and be much happier with the results. INFO-CON connectors used with 1521/1522 reduce the chance of this subtle error by storing correct probe coefficients.

# 1521 and 1522 Handheld Thermometers

riešenia na presné meranie

www.elseo.sk/Fluke-Calibration

## Thermometer Readouts

### Specifications

	1521 and 1522	
Sensor type	Pt 25 to Pt 100	Thermistor
Temperature range	-200 °C to 962 °C	-50 °C to 150 °C
Resistance range	0 Ω to 400 Ω	0 Ω to 500 KΩ
Characterizations	ITS-90, IEC-751 (DIN "385"), Callendar-Van Dusen	Steinhart-Hart thermistor polynomial, YSI 400 (2252 Ω)
Temperature accuracy (meter only)	-200 °C to 100 °C: ± 0.025 °C 100 °C to 400 °C: ± 0.05 °C 400 °C to 800 °C: ± 0.1 °C 800 °C to 962 °C: ± 0.15 °C	0 °C to 50 °C: ± 0.005 °C 50 °C to 75 °C: ± 0.01 °C 75 °C to 100 °C: ± 0.02 °C
Excitation current	0.5 mA	5 μA
Operating range	0 °C to 40 °C	
Temperature resolution	0.001 °	
Measurement period	1 second	
Digital filter	1- to 60-second exponential filter	
Probe connection	INFO-CON Connector	
Communications	RS-232 (Model 1522 also includes infrared interface)	
Memory	Stores 6 readings in "Hold" mode (1521)	Logs 10,000 readings in "Auto Logging" mode; logs 100 readings in "Demand Logging" mode. Memory holds up to 25 data labels that may be attached to Demand Log readings or Auto Log data sets. (1522)
Display	6-digit, 7-segment LCD with 16x1 alphanumeric	
Power	Rechargeable nickel-meta-hydride batteries (AC adapter included)	
Size	(HxWxD) 20 cm x 11cm x 4 cm (7.75 in x 4.2 in x 1.5 in)	
Weight	0.4 kg (1 lb)	
Probes from Hart	Contact Hart for a wide variety of precision PRTs and thermistors	
Calibration	Accredited 10-point, NIST-traceable resistance calibration provided	



The Model 9318 Hard Carrying Case protects your Handheld Thermometer, a probe and all your accessories.

### Ordering Information

#### Models

**1521-156** Thermometer, Handheld, 1 Channel, 110 V

**1521-256** Thermometer, Handheld, 1 Channel, 220 V

**1522-156** Thermometer, Handheld, 1 Channel Data Logger, 110 V

**1522-256** Thermometer, Handheld, 1 Channel Data Logger, 220 V

#### Options and Accessories

**9318** Probe Carrying Case (1521/1522) Included: Adapter/charger

#### Software

**9934-S** LogWare 1-channel, Single-User Software

#### Probes

See page 112 for optional probes

# 1502A and 1504 “Tweener” Thermometers

riešenia na presné meranie

www.elseo.sk/Fluke-Calibration

## Thermometer Readouts

**FLUKE**®

Hart Scientific

Best performance thermometers in their price range



1502A

- Two Tweeners to choose from—reading PRTs or thermistors
- Battery packs available
- Accepts ITS-90, ITS-68, CVD and Steinhart-Hart polynomial coefficients

### Tech Tip

Readouts and probes are calibrated individually. Tweeners accept probe constants from their calibration certificate. System calibration of the Tweener and a dedicated probe are also available.

The Tweener thermometer is one of our best selling readouts. It stands alone with performance and features not found elsewhere at its price point. Each 1502A and 1504 thermometer is easily programmable through front-panel keystrokes, to match a probe's constants for maximum accuracy. For convenience, the 1502A reads the IEC-751 or “385” ALPHA RTD without any programming. Temperature is displayed in °C, °F, K or resistance in ohms. Each thermometer comes complete with an RS-232 interface for automating temperature data collection, calibrations, or process control functions. An optional IEEE-488 interface is also available. 9934 LogWare software lets you use these readouts for real-time data acquisition. MET/TEMP II software lets you use them as an automated reference thermometer.



# 1502A and 1504 “Tweener” Thermometers

riešenia na presné meranie

www.elseo.sk/Fluke-Calibration

## Thermometer Readouts

### Specifications

	1502A	1504
Temperature range <sup>1</sup>	-200 °C to 962 °C (-328 °F to 1764 °F)	Any thermistor range
Resistance range	0 Ω to 400 Ω, auto-ranging	0 Ω to 1 MΩ, auto-ranging
Probe	Nominal R <sub>TPW</sub> : 10 Ω to 100 Ω RTD, PRT, or SPRT	Thermistors
Characterizations	ITS-90 subranges 4, 6, 7, 8, 9, 10, and 11 IPTS-68: R <sub>0</sub> , α, δ, a <sub>4</sub> , and c <sub>4</sub> Callendar-Van Dusen: R <sub>0</sub> , α, δ, and β	Steinhart-Hart thermistor polynomial Callendar-Van Dusen: R <sub>0</sub> , α, δ, and β
Resistance accuracy (ppm of reading)	0 Ω to 20 Ω: 0.0005 Ω 20 Ω to 400 Ω: 25 ppm	0 Ω to 5 kΩ: 0.5 Ω 5 kΩ to 200 kΩ: 100 ppm 200 kΩ to 1 MΩ: 300 ppm
Temperature accuracy <sup>1</sup> , (meter only)	± 0.004 °C at -100 °C ± 0.006 °C at 0 °C ± 0.009 °C at 100 °C ± 0.012 °C at 200 °C ± 0.018 °C at 400 °C ± 0.024 °C at 600 °C	± 0.002 °C at 0 °C ± 0.002 °C at 25 °C ± 0.004 °C at 50 °C ± 0.010 °C at 75 °C ± 0.020 °C at 100 °C (Using 10 kΩ thermistor sensor, α = 0.04. Does not include probe uncertainty or characterization errors.)
Operating temperature range	16 °C to 30 °C	13 °C to 33 °C
Resistance resolution	0 Ω to 20 Ω: 0.0001 Ω 20 Ω to 400 Ω: 0.001 Ω	0 Ω to 10 kΩ: 0.01 Ω 10 kΩ to 100 kΩ: 0.1 Ω 100 kΩ to 1 MΩ: 1 Ω
Temperature resolution	0.001 °	0.0001 °
Excitation current	0.5 and 1 mA, user selectable, 2 Hz	2 and 10 ΩA, automatically selected
Measurement period	1 second	
Digital filter	Exponential, 0 to 60 seconds time constant (user selectable)	
Probe connection	4-wire with shield, 5-pin DIN connector	
Communications	RS-232 serial standard, IEEE-488 (GPIB) optional	
Display	8-digit, 7-segment, yellow-green LED; 0.5-inch-high characters	
Power	115 V ac (± 10 %), 50/60 Hz, 1 A, nominal 230 V ac, 50/60 Hz, 1 A, (± 10 %)nominal, specify	
Size	(HxWxD) 143 mm x 181 mm x 61 mm (2.4 in x 5.6 in x 7.1 in)	
Weight	1.0 kg (2.2 lb)	
Calibration	Accredited NIST-traceable calibration provided	
Probes from Hart	See page 112	See page 112

<sup>1</sup>Temperature ranges and accuracy may be limited by the sensor you use.

### Ordering Information

#### Models

**1502A** “Tweener” PRT  
Thermometer

**1504** “Tweener” PRT  
Thermometer (specify voltage)

#### Options and Accessories

**2502** DC Power Option

**2505** Spare Connector

**2506** IEEE Option

**2507** Mini-Printer

**2508** Serial Cable Kit

**9313** Battery Pack

**9301** Carrying Case, fits Tweener  
and 12 in probe

**9308** Carrying Case, fits Tweener  
and 6 in probe

**1930-2** System Cal Report, RTDs

**1930-5** System Cal Report,  
Thermistors

#### Software

**9934-S** LogWare, Single  
Channel, Single User

**9934-M** LogWare, Single  
Channel, Multi-User

**9938-16** MET/TEMP II (includes  
CD-ROM, RS-232 multiplexer,  
adapter, and PC cable), (110 V)

**9938-25** MET/TEMP II (includes  
CD-ROM, RS-232 multiplexer,  
adapter, and PC cable), (220 V)

#### Probes

See page 112 for optional probes.



# 1529 Chub-E4 Thermometer

riešenia na presné meranie

www.elseo.sk/Fluke-Calibration

FLUKE®

## Thermometer Readouts

Hart Scientific

Lab-quality accuracy on four channels for PRTs, thermistors and thermocouples



- Four channels for PRTs, thermistors and thermocouples
- Displays eight user-selected data fields from any channel
- Logs up to 8,000 readings with date and time stamps
- Battery provides eight hours of continuous operation

### Tech Tip

Simultaneous measurement of all channels can help minimize heat source stability errors.

If you need multiple channels, battery power, outstanding accuracy, and the ability to read many different sensor types-but you don't need all the power of a 1560 Black Stack readout, the Chub-E4 Thermometer is the solution for you.

PRTs and thermistors connect easily to the 1529 using Hart's patented mini DWF connectors. Thermocouples connect using standard or miniature terminations. Measurements are taken either simultaneously or sequentially.

The versatile front panel displays measurements in °C, °F, K, ohms, or millivolts and lets you choose temperature resolution from 0.01 to 0.0001. Select and display any eight items from a long list of displayable data fields, including statistical functions, probe information, utility functions, and more. Pushing a single front-panel button brings up a simple menu to guide you through all the internal setup and memory options.

9935 LogWare II software lets you unload data quickly from the Chub-E4 to your PC for graphical and statistical analysis. With MET/TEMP II software, the Chub-E4 may be integrated into a completely automated calibration system. An RS-232 port is standard on every unit. An optional IEEE-488 port is also available.

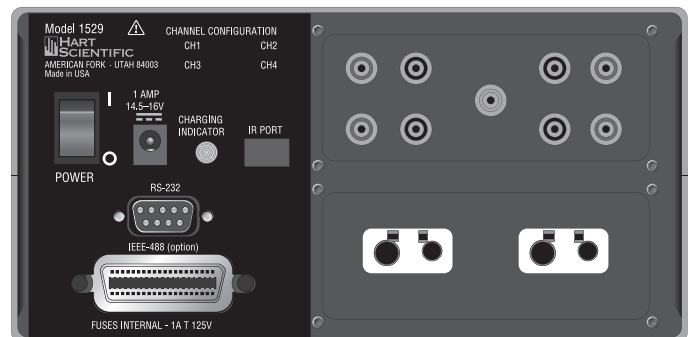

Choose from three combinations of inputs: 2 PRT/thermistor and 2 TC or 4 PRT/Thermistor or 4 TC.

PRTs and thermistors connect easily with Hart's patented mini-DWF connectors, which accept bare wire, spade lug, or banana plug terminations.

The Chub-E4 reads 2-, 3-, or 4-wire PRTs with 10- to 100-ohm nominal resistance values. A grounding terminal is also included.

Thermocouple receptacles accept both standard and miniature connectors. The Chub-E4 read thermocouple types B, E, J, K, N, R, S, T, and Au-PT.

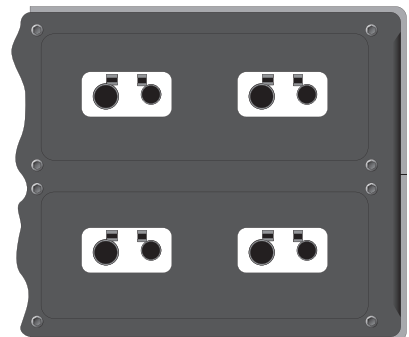
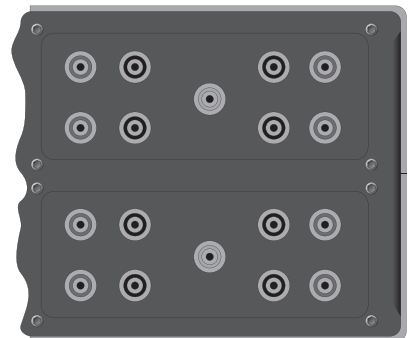

# 1529 Chub-E4 Thermometer

riešenia na presné meranie

www.elseo.sk/Fluke-Calibration

## Thermometer Readouts

### Specifications

	PRT/RTD	Thermistor	Thermocouple																											
Inputs	2 channels PRT/thermistor and 2 channels TC, or 4 channels PRT/thermistor, or 4 channels TC, specify when ordering; PRT/thermistor channels accept 2, 3, or 4 wires; TC inputs accept B, E, J, K, N, R, S, T, and Au-Pt TC types																													
Temperature range	-189 °C to 960 °C -308.2 °F to 1760 °F	-50 °C to 150 °C -58 °F to 302 °F	-270 °C to 1800 °C -454 °C to 3272 °C																											
Measurement range	0 to 400 Ω	0 to 500 KΩ	-10 to 100 mV																											
Characterizations	ITS-90, IEC-751 (DIN "385"), Callendar-Van Dusen	Steinhart-Hart, YSI-400	NIST Monograph 175, 3-point deviation function applied to NIST 175, 6th-order polynomial																											
Temperature accuracy (meter only)	± 0.004 °C at -100 °C ± 0.006 °C at 0 °C ± 0.009 °C at 100 °C ± 0.012 °C at 200 °C ± 0.018 °C at 400 °C ± 0.024 °C at 600 °C	± 0.0025 °C at 0 °C ± 0.0025 °C at 25 °C ± 0.004 °C at 50 °C ± 0.010 °C at 75 °C ± 0.025 °C at 100 °C	<table border="1"> <thead> <tr> <th></th> <th>Ext. RJC</th> <th>Int: RJC</th> </tr> </thead> <tbody> <tr> <td>B at 1000 °C</td> <td>± 0.6 °C</td> <td>± 0.6 °C</td> </tr> <tr> <td>E at 600 °C</td> <td>± 0.07 °C</td> <td>± 0.25 °C</td> </tr> <tr> <td>J at 600 °C</td> <td>± 0.1 °C</td> <td>± 0.35 °C</td> </tr> <tr> <td>K at 600 °C</td> <td>± 0.15 °C</td> <td>± 0.4 °C</td> </tr> <tr> <td>N at 600 °C</td> <td>± 0.15 °C</td> <td>± 0.3 °C</td> </tr> <tr> <td>R at 1000 °C</td> <td>± 0.4 °C</td> <td>± 0.5 °C</td> </tr> <tr> <td>S at 1000 °C</td> <td>± 0.5 °C</td> <td>± 0.6 °C</td> </tr> <tr> <td>T at 200 °C</td> <td>± 0.1 °C</td> <td>± 0.3 °C</td> </tr> </tbody> </table>		Ext. RJC	Int: RJC	B at 1000 °C	± 0.6 °C	± 0.6 °C	E at 600 °C	± 0.07 °C	± 0.25 °C	J at 600 °C	± 0.1 °C	± 0.35 °C	K at 600 °C	± 0.15 °C	± 0.4 °C	N at 600 °C	± 0.15 °C	± 0.3 °C	R at 1000 °C	± 0.4 °C	± 0.5 °C	S at 1000 °C	± 0.5 °C	± 0.6 °C	T at 200 °C	± 0.1 °C	± 0.3 °C
	Ext. RJC	Int: RJC																												
B at 1000 °C	± 0.6 °C	± 0.6 °C																												
E at 600 °C	± 0.07 °C	± 0.25 °C																												
J at 600 °C	± 0.1 °C	± 0.35 °C																												
K at 600 °C	± 0.15 °C	± 0.4 °C																												
N at 600 °C	± 0.15 °C	± 0.3 °C																												
R at 1000 °C	± 0.4 °C	± 0.5 °C																												
S at 1000 °C	± 0.5 °C	± 0.6 °C																												
T at 200 °C	± 0.1 °C	± 0.3 °C																												
Temperature resolution	0.001	0.0001	0.01 to 0.001																											
Resistance/voltage accuracy	0 Ω to 20 Ω: ± 0.0005 Ω 20 Ω to 400 Ω: ± 25 ppm of rdg.	0 Ω to 5 kΩ: ± 0.5 Ω 5 kΩ to 200 kΩ: ± 100 ppm of rdg. 200 kΩ to 500 kΩ ± 300 ppm of rdg.	-10 to 50 mV: ± 0.005 mV 50 to 100 mV: ± 100 ppm of rdg. (Internal RJC: ± 0.25°C)																											
Operating range	16 °C to 30 °C																													
Measurement interval	0.1 second to 1 hour; inputs may be read sequentially or simultaneously at 1 second or greater interval																													
Excitation current	1 mA, reversing	2 and 10 μA, automatically selected	N/A																											
Display	1.3 in x 5 in backlit LCD graphical display																													
Display units	°C, °F, K, Ω, kΩ, mV																													
Data logging	Up to 8,000 time-and date-stamped measurements can be logged																													
Logging intervals	0.1, 0.2, 0.5, 1, 2, 5, 10, 30, or 60 seconds; 2, 5, 10, 30, or 60 minutes																													
Averaging	Moving average of most recent 2 to 10 readings, user selectable																													
Probe connection	Patented DWF Connectors accept mini spade lug, bare-wire, or mini banana plug terminations	Universal receptacle accepts miniature and standard TC connectors																												
Communications	RS-232 and IR ports included, IEEE-488 (GPIB) optional																													
AC power	100 to 240 V ac, 50 to 60 Hz, 0.4 A																													
DC power	12 to 16 V dc, 0.5 A (battery charges during operation from 14.5 to 16 V dc, 1.0A)																													
Battery	NiMH, 8 hours of operation typical without backlight, 3 hours to charge, 500 cycles																													
Size	(HxWxD) 102 mm x 191 mm x 208 mm (4.0 in x 7.5 in x 8.2 in)																													
Weight	2 kg (4.5 lb)																													
Probes from Hart	See pages 112-123																													
Calibration	Accredited NIST-traceable resistance calibration and NIST-traceable voltage calibration provided																													

### Ordering Information

#### Models

- 1529-156** Chub-E4 Thermometer, 2 TC and 2 PRT/Thermistor Inputs (110 V)
- 1529-256** Chub-E4 Thermometer, 2 TC and 2 PRT/Thermistor Inputs (220 V)
- 1529-R-156** Chub-E4 Thermometer, 4 PRT/Thermistor Inputs (110 V)
- 1529-R-256T** Chub-E4 Thermometer, 4 PRT/Thermistor TC Inputs (220 V)
- 1529-T-156** Chub-E4 Thermometer, 4 TC Inputs (110 V)

- 1529-T-256** Chub-E4 Thermometer, 4 TC Inputs (220 V)

#### Options and Accessories

- 2506-1529** IEEE Option
- 9322** Rugged Carrying Case, holds 1529 and four probes up to 12 in long
- 9323** Soft Carrying Case
- 2513-1529** Rack-Mount Kit
- 2374** IR Dongle, for connection to PCs without IR interface
- 2375** Thermal Serial Printer, with paper, AC adapter, cable, battery pack
- 2362** Spare AC Adapter, 15 V

- 9322** Rugged Carry Case holds 1529 and four probes up to 12 in long

#### Software

- 9935-S** LogWare II, Multi-Channel, Single User
- 9935-M** LogWare II, Multi-Channel, Multi-User
- 9938-16** MET/TEMP II (includes CD-ROM, RS-232 multiplexer, adapter, and PC cable), (110 V)
- 9938-25** MET/TEMP II (includes CD-ROM, RS-232 multiplexer, adapter, and PC cable), (220 V)

#### Probes

- See page 112 for optional probes

# 1560 Black Stack Thermometer

riešenia na presné meranie

www.elseo.sk/Fluke-Calibration

FLUKE®

Thermometer  
Readouts

Hart Scientific

Accurate, expandable and configurable readout



- Reads SPRTs, RTDs, thermistors, and thermocouples
- Highly configurable with up to eight modules — 96 channels max
- High-accuracy reference thermometer (to  $\pm 0.0013$  °C)
- Automates precision data acquisition

The 1560 Black Stack works in three distinctive ways. It's a reference thermometer with a NIST traceable calibration; it's an automated calibration system, reading your reference probe and the sensors you're testing; or it's a high-accuracy data acquisition system.

The Stack consists of up to eight different modules that fit together to do any type of thermometry you choose. You can buy modules in any combination, and change the Stack and its functions anytime you want. Each module stacks behind the preceding one, and when you add a module, the Stack's software reconfigures itself automatically to include all of the new functions supplied by that module. There's nothing to take apart. No boards need to be installed. There's no software to load, and nothing has to be calibrated.

9935 LogWare II software provides graphical and statistical analysis of each channel you're measuring (up to 96). With alarms that can be customized, delayed start times, and selectable logging intervals, LogWare II turns the Black Stack into a powerful temperature data acquisition tool.

## The base unit

The Stack base module consists of two parts: a display with the main processor and a power supply. The base module supplies power, communication management, and software coordination for all of the other modules. It has the display, control buttons, and RS-232 port built in.

Each base module can handle eight thermometer modules stacked behind it, with a maximum of 96 sensor inputs. The base module never needs calibration and performs its own diagnostic self-test each time it powers up. The thermometer characteristics of each base module are defined by the thermometry modules stacked behind it.

## The modules

There are nine thermometry modules: an SPRT module, a high-temp PRT module, a PRT scanner module, a standards thermistor module, two 1000-ohm PRT modules, a thermistor scanner module, a precision

thermocouple module, and a thermocouple scanner module. Each module has its own processor and connects to the stack on a proprietary digital bus. Each retains its own calibration data and performs all analog measurement functions within the module.

## 2560 SPRT Module

The SPRT module reads 25-ohm and 100-ohm four-wire RTDs, PRTs, and SPRTs with very high accuracy. It turns the Stack into a first-rate reference thermometer, with an accuracy to  $\pm 0.005$  °C.

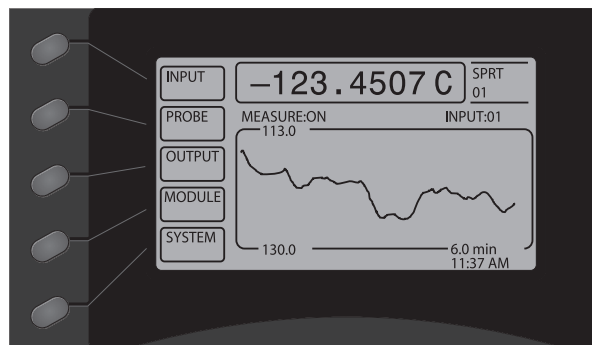

Elsó Philips Service, Trenčín

Temperature Calibration 105

# 1560 Black Stack Thermometer

riešenia na presné meranie

[www.elseo.sk/Fluke-Calibration](http://www.elseo.sk/Fluke-Calibration)

## Thermometer Readouts

It has two input channels, so you can collect data with two reference sensors, or you can do comparison calibrations of one sensor against a calibrated reference sensor.

Temperature conversion features include direct resistance measurement, ITS-90, W(T90), IPTS-68, Callendar-Van Dusen, or an RTD polynomial conversion. The user-changeable default values for the CVD conversion fit the 100-ohm, 0.00385 ALPHA sensor described by IEC-751.

The SPRT modules can be used one at a time or combined together in any combination, for reading up to 16 different reference thermometers. If you stack an SPRT module with a scanner module, you can test multiple sensors against your reference. The PRT Scanner Module operates with or without the two-channel SPRT module.

### 2561 High-Temp PRT Module

This module reads 2.5-ohm and 0.25-ohm four-wire HTPRTs and RTDs. The complete resistance range covers up to 5-ohm sensors with applications as high as 1200 °C. The temperature conversion features are the same as for the SPRT module, and, like the SPRT module, the connectors are gold plated.

### 2562 PRT Scanner

This module reads eight channels of two-, three-, or four-wire 100-ohm PRTs or RTDs. The accuracy is  $\pm 0.01$  °C at 0 °C for calibration of industrial sensors. The common industrial RTD can be read with the default values in the CVD temperature conversion for fast setup of industrial applications, or you can enter individual probe constants for higher accuracy data acquisition.

### 2563 Standards Thermistor Module

Special low-drift thermistors are becoming increasingly popular as reference probes in applications with modest temperature ranges up to 100 °C. This module has a temperature accuracy of  $\pm 0.0013$  °C at 0 °C with a resolution of 0.0001 °C.

The 2563 Thermistor Module has two input channels. It displays direct resistance in ohms or converts directly to a temperature readout using either the Steinhart-Hart equation or a higher-order polynomial.

### 2564 Thermistor Scanner Module

This module is usable with any type of thermistor, but has eight channels instead of the two found on the Standards Thermistor Module, and it operates with or without the Standards Thermistor Module. This module's accuracy is  $\pm 0.0025$  °C at 0 °C for all eight channels. The 2564 module makes an excellent data acquisition tool for research work or for verification of biomedical equipment, such as DNA sequencing apparatus.

### 2565 Precision Thermocouple Module

This precision thermocouple module reads any type of thermocouple, including type R and S platinum thermocouples and the new gold-platinum thermocouples for standards work. This two-channel module has internal

reference junction compensation, or you can use an external source for even greater accuracy.

All the standard ANSI thermocouple types are preprogrammed; however, you can choose a conversion method and then enter the probe characteristics of your sensor, creating a system-calibrated channel. The 2565 module accepts up to three calibration points for error adjustment in the individual sensor. A polynomial interpolation function calculates the points between your measurements.

Type R, type S, and gold-platinum conversions accept complete polynomial calibration coefficients. Additionally, a thermocouple conversion function calculates temperature by interpolating from a table. Enter the temperature in degrees C and the corresponding voltage for your specific sensor from 1 to 10 temperatures. Interpolation is performed between the entered points.

### 2566 Thermocouple Scanner Module

This module has 12 channels and reads K, J, T, S, R, B, E, and N thermocouples. Each channel can be set to read a different type of thermocouple. All temperature readings are performed in exactly the same manner as with the 2565 module. The connectors on the scanner module are special dual connectors that accept both the common miniature and standard thermocouple connectors. To use screw terminals, use the appropriately-sized connector with the hood removed.



Elsco Philips Service, Trenčín

### 1000-Ohm PRT Modules 2567 and 2568

For 1000-ohm PRTs, these modules provide the same features as the 2560 and 2562 Modules. The two-channel 2567 Module has a resistance range of 0 to 4000 ohms and is accurate to  $\pm 0.006^\circ\text{C}$  at  $0^\circ\text{C}$ . The 2568 Module reads up to eight 1000-ohm PRTs and at  $0^\circ\text{C}$  is accurate to  $\pm 0.01^\circ\text{C}$ .

### Extended Communications Module 3560

The 3560 module adds an IEEE-488 (GPIB) interface, a Centronics printer interface, and analog output via a DC signal ( $\pm 1.25\text{ V dc}$ ).

### Features common to all modules

Buy only the Black Stack modules you need for the work you are doing. If your work changes, simply order the modules with the functions you need and slip them

onto the back of the Stack. Your thermometer changes its software, display, and method of operation to match the new functions you've added. It's all automatic.

Each module stores its own calibration internally, so you can add or change modules without recalibrating the whole stack. Module calibration is digital and is performed manually through the base's front panel or over the RS-232 link.

The LCD screen has multiple methods of displaying data, including a graphical strip chart recorder. The graphical capability of the Black Stack makes testing temperature stability easier than ever. Vertical scaling and graph resolution are automatic.

Read data in ohms, millivolts, or temperature, according to your application and preference. This thermometer's calibration is traceable to NIST. Its accuracy is as high as  $\pm 0.0013^\circ\text{C}$ , depending on the module and sensor you're using.

## Specifications

### Model 1560 Base Unit

Power: 100 to 240 V ac, 50 or 60 Hz, nominal

Attachable Modules: up to 8

Display: 4.25 in x 2.25 in LCD graphics, LED backlight, adjustable contrast and brightness

Automatic Input Sequencing: 1 to 96 channels;

Communications: RS-232

Non-volatile Memory: channel sequence, probe coefficients

Minimum Sample Time: 2 seconds

## Resistance Modules

	Input Channels	Basic Resistance Range	Resistance Accuracy	Resistance Resolution	Equivalent Temperature Range	Temperature Accuracy†	Temperature Resolution	Excitation Current
SPRT Module 2560	2	0 $\Omega$ to 400 $\Omega$	$\pm 20$ ppm of reading (0.0005 $\Omega$ at 25 $\Omega$ , 0.002 $\Omega$ at 100 $\Omega$ )	0.0001 $\Omega$	-260 $^\circ\text{C}$ to 962 $^\circ\text{C}$	$\pm 0.005^\circ\text{C}$ at $0^\circ\text{C}$ $\pm 0.007^\circ\text{C}$ at $100^\circ\text{C}$	0.0001 $^\circ\text{C}$	1.0 mA, 1.4 mA
High-Temp PRT Module 2561	2	0 $\Omega$ to 25 $\Omega$	$\pm 50$ ppm of reading (0.00013 $\Omega$ at 2.5 $\Omega$ )	0.00001 $\Omega$	$0^\circ\text{C}$ to 1200 $^\circ\text{C}$	$\pm 0.013^\circ\text{C}$ at $0^\circ\text{C}$ $\pm 0.018^\circ\text{C}$ at $100^\circ\text{C}$	0.001 $^\circ\text{C}$	3.0 mA, 5.0 mA
PRT Scanner 2562	8	0 $\Omega$ to 400 $\Omega$	$\pm 40$ ppm of reading (0.004 $\Omega$ at 100 $\Omega$ )	0.0001 $\Omega$	-200 $^\circ\text{C}$ to 850 $^\circ\text{C}$	$\pm 0.01^\circ\text{C}$ at $0^\circ\text{C}$ $\pm 0.014^\circ\text{C}$ at $100^\circ\text{C}$	0.0001 $^\circ\text{C}$	1.0 mA, 1.4 mA
Standards Thermistor Module 2563	2	0 $\Omega$ to 1 M $\Omega$	$\pm 50$ ppm of reading (0.5 $\Omega$ at 10 K $\Omega$ )	0.1 $\Omega$	-60 $^\circ\text{C}$ to 260 $^\circ\text{C}$	$\pm 0.0013^\circ\text{C}$ at $0^\circ\text{C}$ $\pm 0.0015^\circ\text{C}$ Cat 75 $^\circ\text{C}$	0.0001 $^\circ\text{C}$	2 $\mu\text{A}$ , 10 $\mu\text{A}$
Thermistor Scanner 2564	8	0 $\Omega$ to 1 M $\Omega$	$\pm 100$ ppm of reading (1 $\Omega$ at 10 K $\Omega$ )	0.1 $\Omega$	-60 $^\circ\text{C}$ to 260 $^\circ\text{C}$	$\pm 0.0025^\circ\text{C}$ at $0^\circ\text{C}$ $\pm 0.003^\circ\text{C}$ at $75^\circ\text{C}$	0.0001 $^\circ\text{C}$	2 $\mu\text{A}$ , 10 $\mu\text{A}$
1000 $\Omega$ PRT Module 2567	2	0 $\Omega$ to 4 k $\Omega$	$\pm 25$ ppm of reading (0.025 $\Omega$ at 1 k $\Omega$ )	0.001 $\Omega$	-260 $^\circ\text{C}$ to 962 $^\circ\text{C}$	$\pm 0.006^\circ\text{C}$ at $0^\circ\text{C}$ $\pm 0.009^\circ\text{C}$ at $100^\circ\text{C}$	0.0001 $^\circ\text{C}$	0.1 mA, 0.05 mA
1000 $\Omega$ PRT Scanner 2568	8	0 $\Omega$ to 4 k $\Omega$	$\pm 40$ ppm of reading (0.04 $\Omega$ at 1 k $\Omega$ )	0.001 $\Omega$	-200 $^\circ\text{C}$ to 850 $^\circ\text{C}$	$\pm 0.01^\circ\text{C}$ at $0^\circ\text{C}$ $\pm 0.014^\circ\text{C}$ at $100^\circ\text{C}$	0.0001 $^\circ\text{C}$	0.1 mA, 0.05 mA
Calibration	Accredited NIST- traceable resistance calibration provided							

## Thermocouple Modules

	Input Channels	Millivolt Range	Millivolt Accuracy	Millivolt Resolution	Temperature Accuracy,† Ext. CJC	Temperature Accuracy,† Int. CJC	Temperature Resolution	
Precision Thermocouple Module 2565	2	-10 to 100 mV	$\pm 0.002$ mV	0.0001 mV	$\pm 0.05^\circ\text{C}$	$\pm 0.1^\circ\text{C}$	0.001 $^\circ\text{C}$	
Thermocouple Scanner 2566	12	-10 to 100 mV	$\pm 0.004$ mV	0.0001 mV	$\pm 0.1^\circ\text{C}$	$\pm 0.3^\circ\text{C}$	0.001 $^\circ\text{C}$	
Calibration	Accredited NIST-traceable voltage calibration provided							

†Temperature accuracy depends on probe type and temperature.

# 1560 Black Stack Thermometer

riešenia na presné meranie

www.elseo.sk/Fluke-Calibration

## Thermometer Readouts

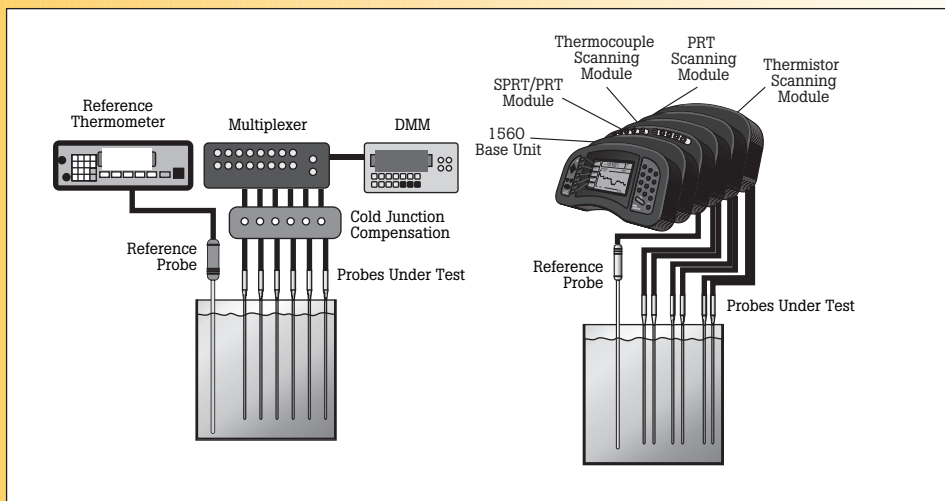

Black Stack as an automated calibration system.



Black Stack as a high accuracy reference thermometer.

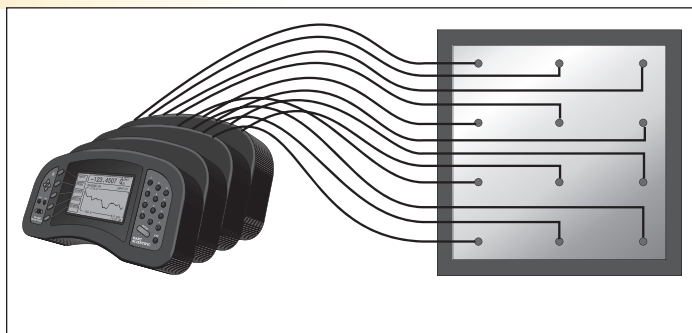

Black Stack as a high accuracy data acquisition system.

### Ordering Information Models

- 1560 Thermometer Base Unit
- 2560 SPRT Module, 25  $\Omega$  and 100  $\Omega$ , 2-channel
- 2561 High-Temp PRT Module, 0.25  $\Omega$  to 5  $\Omega$ , 2-channel
- 2562 PRT Scanner Module, 8-channel
- 2563 Standards Thermistor Module, 2-channel
- 2564 Thermistor Scanner Module, 8-channel
- 2565 Precision Thermocouple Module, 2-channel
- 2566 Thermocouple Scanner Module, 12-channel
- 2567 SPRT Module, 1000  $\Omega$ , 2-channel
- 2568 PRT Scanner Module, 8-channel, 1000  $\Omega$
- 3560 Extended Communications Module

### Options and Accessories

- 9302 Case (holds 1560 and up to five modules)

### Software

- 9935-S LogWare II, Multi-Channel, Single User
- 9935-M LogWare II, Multi-Channel, Multi-User

### Probes

- 5610-6-X Thermistor Probe (0.125 in dia x 6 in), 0  $^{\circ}$ C to 100  $^{\circ}$ C
- 5610-9-X Thermistor Probe (0.125 in dia x 9 in), 0  $^{\circ}$ C to 100  $^{\circ}$ C
- 5642-X Standards Thermistor Probe
- 5612-9-X Secondary Standard PRT (0.187 in dia x 9 in), to 420  $^{\circ}$ C
- 5613-6-X Secondary Standard PRT (0.187 in dia x 6 in), to 300  $^{\circ}$ C

- 5614-12-X Secondary Standard PRT (0.25 dia. x 12 in), to 420  $^{\circ}$ C
- 5626-12-X Secondary Standard PRT (0.25 dia. x 12 in), 100  $\Omega$ , -200  $^{\circ}$ C to 660  $^{\circ}$ C
- 5628-12-X Secondary Standard PRT (0.25 dia. x 12in) 25  $\Omega$ , -200  $^{\circ}$ C to 661  $^{\circ}$ C
- 5628-15-X Secondary Standard PRT (0.25 dia. x 15in), 25  $\Omega$ , -200  $^{\circ}$ C to 661  $^{\circ}$ C

X = termination. Specify "B" (bare wire), "D" (5-pin DIN for Tweener Thermometers), "G" (gold pins), "I" (INFO-CON for 1521 or 1522 Handheld Thermometers), "J" (banana jacks), "L" (mini spade lugs), "M" (mini banana jacks), or "S" (spade lugs).

### Spare Connector Kits

- 2380-X Miniature Thermocouple Connector, 12 pc. (X - TC type. Choose from K, T, J, E, R, S, N, or U)
- 2381-X Standard Thermocouple Connector, 12 pc. (X - TC type. Choose from K, T, J, E, R, S, N, or U)
- 2382 RTD/Thermistor Connector, 8 pcs. (Fits 2562, 2564, and 2568 modules)

# 1575A, 1590 Super-Thermometers

riešenia na presné meranie

www.elseo.sk/Fluke-Calibration

Thermometer  
Readouts

FLUKE®

Hart Scientific

Recognized worldwide for their ease of use and reliable accuracy



1590

- Accuracy to 4 ppm (0.001 °C) or 1 ppm (0.00025 °C)
- Bridge-level performance at less than half the cost
- Accepts 0.25 Ω through 100 Ω SPRTs plus thermistors
- Includes all temperature functions and stores setups

The 1575A Super-Thermometer is accurate to 0.001 °C. The 1590 Super-Thermometer II is accurate to 0.00025 °C, or 1 ppm. Both Super-Thermometers are perfectly suited for SPRT calibrations. These are the best lab instruments to take advantage of SPRT accuracy. They're easy to use, they read temperature directly, they have automated data collection, and they calculate constants for ITS-90 automatically.

## Bridges

Resistance bridges are one of the most expensive pieces of lab equipment you can buy. They are difficult to use. Their learning curve is long and complex. So why buy a bridge if you have a legitimate alternative? If 1 ppm accuracy gets the job done, the easiest and best value can be found in Hart's Super-Thermometers.

## 1575A Super-Thermometer

The 1575A Super-Thermometer features ease of use, high accuracy, built-in software, and a reasonable price. Temperature is read directly on the display in your choice of scales. There are no manual resistance-to-temperature conversions. Resistance is converted to temperature for you using the ITS-90 algorithm in any one of the instrument's ranges. Up to 16 independent sets of probe characterizations can be stored in the 1575A's memory. Switch SPRTs and simply call up its reference identification number. Forget the extensive, time-consuming setup required by resistance bridges.

## 1590 Super-Thermometer II

The 1590 Super-Thermometer II has all of the features of the 1575A, plus 1 ppm accuracy and a color screen that tilts to create the best viewing angles. With all of these features, it's still less than half the price of a bridge.

In many labs with standards that require the use of bridges, Super-Thermometers have been accepted as an alternative because they combine bridge technology and microprocessor-based solid-state electronics and they're much easier to use.

Both Super-Thermometers come with an accredited calibration.

## Accuracy

The typical benchtop thermometer has an error level 5 to 10 times larger than the Super-Thermometer, and 20 to 40 times higher than a Super-Thermometer II. With common 25- or 100-ohm SPRTs, the 1575A Super-Thermometer achieves ± 0.002 °C accuracy and ± 0.001 °C accuracy with a calibrated external standard resistor. The 1590 Super-Thermometer II is even better with ± 0.00025 °C accuracy.

ITS-90 specifies the use of 2.5-ohm and 0.25-ohm SPRTs as high-temperature standards up to the silver point (962 °C). This very small resistance is difficult to measure and is commonly done only with resistance bridges. The Super-Thermometers address ITS-90 problems directly and are the most cost-effective solution available.

# 1575A, 1590 Super-Thermometers

## Thermometer Readouts

In addition, resolution with a 25-ohm SPRT is 0.0001 °C. Comparison calibrations or calibrations against primary standard fixed points are performed easily. Both instruments have two channels for handling two probes at once. Display and record actual temperatures, or choose to read the difference between the two directly from the screen.

Both Super-Thermometers have their own on-board resistors. Each is a high-stability, low thermal coefficient, four-terminal resistor for each of the resistance ranges of the thermometer: 0.25 ohms, 2.5 ohms, 25 ohms, 100 ohms, and thermistor ranges. Resistors are housed in an internal temperature-controlled oven.

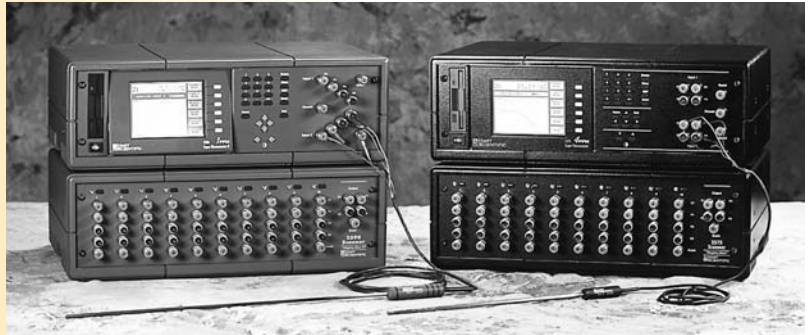

### DWF connectors

Hart's patented 2392 DWF Connector is unique (U.S. Patent 5,964,625). Each one is machined from solid brass and then plated with gold. DWF Connectors accept banana plugs, spade connectors, or bare wires. Banana plugs are inserted in the top. Bare wires go in one of the four side holes and are held in place by a spring-loaded pressure plate. Spade connectors are inserted between the top of the connector and pressure plate and are held in place the same as bare wire. The connections are solid and difficult to dislodge. Bare wire and spade connectors require nothing more than pushing the DWF Connector in. There's nothing to screw down or tighten.

### Other features

Super-Thermometers convert resistance to temperature using your choice of ITS-90 or IPTS-68. ITS-90 requires no conversions; just enter your coefficients directly. For IPTS-68 enter RO, ALPHA, DELTA, A4, and C4. Temperature can be converted from IPTS-68 to ITS-90 automatically at your request. Calendar-Van Dusen equations are also provided in an automated mode.

Thermistor probes are characterized by coefficients of a logarithmic polynomial. Use low-cost, rugged thermistor standards for  $\pm 0.001$  °C accuracy in the low-temperature regions. Other thermometers don't do all this.

Measurements can be displayed as temperatures in °C, K, or °F and as resistance in ohms or a ratio of probe resistance to reference resistance. The current source is controllable between 0.001 mA and 15 mA with a resolution of 0.2 %. Integration time and digital filtering are programmable to optimize resolution, stability, and response.

Data logging and memory functions store measurements, and each thermometer has its own 3.5-inch disc drive for archiving data. The display is a backlit LCD for visual display of information. It has an RS-232, an IEEE-488, and a parallel printer port.

These Super-Thermometers are based on dc electronics, thus eliminating the problems with national lab certification for ac bridges and the removal of quadrature interference from ac-heated fixed-point furnaces.

### Multiplexers

If two channels aren't enough, add 10 more with a Mighty-Mux featuring Hart's handy DWF connectors. Add up to 50 more channels to the 1590.

The 2575 provides 10 more channels for use with a 1575. For the 1590, the 2590 Mighty-Mux II has a cascading ability that lets you have up to 50 channels by chaining more than one Mux together, and you can now set continuous constant current levels on each channel to avoid self-heating effects. Whatever your application, a Mighty-Mux will make it easier and more efficient.

Both units have low thermal EMF relays that are hermetically sealed and magnetically shielded. You're making true four-wire measurements with a floating guard and support for up to 20 mA of drive current.

### Super-Thermometers vs. digital multimeters

Good eight-and-a-half-digit multimeters might provide accuracy to  $\pm 0.005$  °C in the resistance measurement. However, DMMs require separate high-stability current sources, and you have to make EMF offsets, worry about a scheme to switch between forward and reverse current during the measurement, and devise a switch to get a second channel for an external standard resistor. Once you've done all of this, you still have to convert resistance to temperature with tedious manual calculations. Super-Thermometers do all of this automatically.



## Specifications

	1575A			1590		
	Nominal Resistance	Accuracy (of indicated value)	Equivalent Temp. Value, at 0°C	Nominal Resistance	Accuracy (of indicated value)	Equivalent Temp. Value, at 0°C
Transfer accuracy (using external reference resistor)	0.25 Ω	40 ppm	0.01 °C	0.25 Ω	20 ppm	0.005 °C
	2.5 Ω	20 ppm	0.005 °C	2.5 Ω	5 ppm	0.00125 °C
	25 Ω	4 ppm	0.001 °C	25 Ω	1 ppm	0.00025 °C
	100 Ω	4 ppm	0.001 °C	100 Ω	1 ppm	0.00025 °C
	10 kΩ	10 ppm	0.00025 °C (thermistor at 25 °C)	10 kΩ	5 ppm	0.000125 °C (thermistor at 25 °C)
Absolute accuracy (using internal reference resistor)	0.25 Ω	100 ppm	0.025 °C	0.25 Ω	40 ppm	0.01 °C
	2.5 Ω	40 ppm	0.01 °C	2.5 Ω	20 ppm	0.005 °C
	25 Ω	8 ppm	0.002 °C	25 Ω	6 ppm	0.0015 °C
	100 Ω	8 ppm	0.002 °C	100 Ω	6 ppm	0.0015 °C
	10 kΩ	20 ppm	0.0005 °C (thermistor at 25 °C)	1 kΩ	10 ppm	0.00025 °C (thermistor at 25 °C)
Typical resolution	0.25 Ω	10 ppm	0.0025 °C	0.25 Ω	10 ppm	0.0025 °C
	2.5 Ω	5 ppm	0.00125 °C	2.5 Ω	2 ppm	0.0005 °C
	25 Ω	1 ppm	0.00025 °C	25 Ω	0.5 ppm	0.000125 °C
	100 Ω	1 ppm	0.00025 °C	100 Ω	0.5 ppm	0.000125 °C
	10 kΩ	3 ppm	0.000075 °C (thermistor at 25 °C)	10 kΩ	2 ppm	0.00005 °C (thermistor at 25 °C)
Resistance range	0 Ω to 500 kΩ					
Internal reference resistors	1 Ω, 10 Ω, 100 Ω, 10 kΩ					
Minimum measurement period	2 seconds					
Current source	0.001 mA to 15 mA, programmable					
Analog output	-5 to +5 V					
Display	Monochrome LCD with CCFT backlight			Color LCD with CCFT backlight		
Power	100 to 125/200 to 250 V ac (user switchable), 50/60 Hz, 1 A					
Calibration	Accredited NIST-Traceable resistance calibration provided					

## Specifications - Muxes

Channels	2575: 10 2590: 10 per unit, cascade up to 5 units for 50 channels
Connector	4-wire plug, floating guard
Terminals	Gold-plated Hart DWF Connectors
Relays	Low thermal EMF, hermetically sealed, magnetically shielded
Contact resistance	< 0.1 Ω
Isolation	1 x 10 <sup>12</sup> between relay legs
Channel selection	Manual or auto
Current capability	20 mA
Current levels	1575A: Current on active channel only 1590: Standby current 1 mA, 0.5 mA, or 10 µA on all channels
Power	Via connection to 1575A or 1590
Size	(HxWxD) 516 mm x 320 mm x 178 mm (20.3 in x 12.6 in x 7 in)

## Ordering Information

### Models

**1575A** Super-Thermometer

**2575** Multiplexer, 1575

**1590** Super-Thermometer II

**2590** Multiplexer, 1590

**742A-25** Standard DC Resistor,  
25 Ω

**742A-100** Standard DC Resistor,  
100 Ω



Fluke offers the widest range of standards-quality reference probes. A full range of PRTs, thermistors, and thermocouples fit a wide variety of requirements for accuracy, durability, and value.

Model	Range	Size	Basic Accuracy*
<b>PRTs</b>			
<b>Secondary Standards PRTs</b>			
5624	0 °C to 1000 °C	20 x 0.25 in	± 0.055 °C at 962 °C
5626	-200 °C to 661 °C	12 or 15 x 0.25 in	± 0.007 °C at 0 °C
2628	-200 °C to 661 °C	12 or 15 x 0.25 in	± 0.006 °C at 0 °C
<b>Secondary Reference PRTs</b>			
5612	-200 °C to 420 °C	9 x 0.187 in	± 0.018 °C at 0 °C
5613	-200 °C to 300 °C	6 x 0.187 in	± 0.018 °C at 0 °C
5614	-200 °C to 420 °C	12 x 0.25 in	± 0.018 °C at 0 °C
<b>Precision Industrial PRTs</b>			
5627-6	-200 °C to 300 °C	6 x 0.187 in	± 0.05 °C at 0 °C
5627-9	-200 °C to 420 °C	9 x 0.187 in	± 0.05 °C at 0 °C
5627-12	-200 °C to 420 °C	12 x 0.25"	± 0.05 °C at 0 °C
<b>Fast Response PRTs</b>			
5622-05	-200 °C to 350 °C	100 x 0.5 mm	± 0.04 °C at 0 °C
5622-10	-200 °C to 350 °C	100 x 1.0 mm	± 0.04 °C at 0 °C
5622-16	-200 °C to 350 °C	200 x 1.6 mm	± 0.04 °C at 0 °C
5622-32	-200 °C to 350 °C	200 x 3.2 mm	± 0.04 °C at 0 °C
<b>Small Diameter Industrial PRTs</b>			
5618A-6	-200 °C to 300 °C	6 x 0.125 in	± 0.05 °C
5618A-9	-200 °C to 500 °C	9 x 0.125 in	± 0.05 °C
5618A-12	-200 °C to 500 °C	12 x 0.125 in	± 0.05 °C
5623A	-200 °C to 156 °C	6 x 0.25 in	± 0.05 °C
<b>Thermistors</b>			
<b>Thermistor Standards</b>			
5640	0 °C to 60 °C	9 x 0.25 in	± 0.0015 °C
5641	0 °C to 60 °C	4.5 x 0.125 in	± 0.001 °C
5642	0 °C to 60 °C	9 x 0.125 in	± 0.001 °C
5643	0 °C to 100 °C	4.5 x 0.125 in	± 0.0025 °C
5644	0 °C to 100 °C	9 x 0.125 in	± 0.0025 °C
<b>Secondary Thermistor Probes</b>			
5665	0 °C to 100 °C	3 x 0.110 in	± 0.015 °C
5610	0 °C to 100 °C	6 or 9 x 0.125 in	± 0.015 °C
5611	0 °C to 100 °C	.110 or .070 in dia.	± 0.015 °C
5674	0 °C to 70 °C	9 x 0.188 in	± 0.07 °C
<b>Thermocouples</b>			
<b>Type S Thermocouple Standards</b>			
5650-20	0 °C to 1450 °C	20 x 0.25 in	± 0.7 °C at 1100 °C
5650-20C	0 °C to 1450 °C	20 x 0.25 in	± 0.7 °C at 1100 °C
5650-25	0 °C to 1450 °C	25 x 0.25 in	± 0.7 °C at 1100 °C
5650-25C	0 °C to 1450 °C	25 x 0.25 in	± 0.7 °C at 1100 °C

\*"Basic Accuracy" includes calibration uncertainty and short-term repeatability. It does not include long-term drift

# 5626 and 5828 Secondary Standard PRTs

riešenia na presné meranie

www.elseo.sk/Fluke-Calibration

**FLUKE**

**Thermometer  
Probes**

**Hart Scientific**

## High-temperature secondary standards



- Range to 661 °C
- Meets all ITS-90 requirements for resistance ratios
- RTPW drift < 20 mK after 500 hours at 661 °C

## Tech Tip

To maintain confidence in your reference probes, periodic checks of resistance in a triple point of water is highly recommended.

The 5626 and 5628 secondary standards fill the gap between affordable, but temperature-limited secondary PRTs and more expensive, highly accurate SPRTs. These probes are an excellent choice if you use block calibrators, furnaces, or temperature points above normal PRT temperatures (420 °C). The 5626 is nominally 100 Ω, and the 5628 is nominally 25.5 Ω. Both instruments have a temperature range of -200 °C to 661 °C. They make great working or check standards for calibration work up to the aluminum point.

Using a regular PRT at temperatures above 500 °C exposes the platinum to contamination. If the PRT is used as a reference or calibration standard, contamination is a major problem. SPRTs, which are more expensive and delicate, can handle the higher temperatures, but with greater risk to the instrument due to shock, contamination, or mishandling. The 5626 and 5628 are designed to reduce the contamination risk through the use of internal protection, while not impairing performance.

These PRTs are a great value. They come complete with an accredited calibration, with ITS-90 constants and a resistance-versus-temperature table.

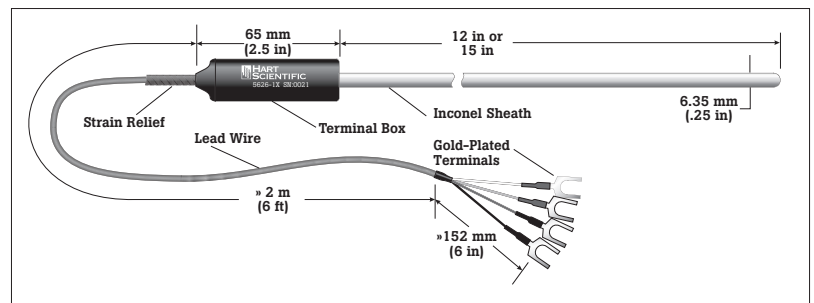

## Specifications

Temperature range	-200 °C to 661 °C
Handle temperature	0 °C to 80 °C
RT <sub>PW</sub>	5626: 100 Ω (± 1 Ω) 5628: 25.5 Ω (± 0.5 Ω)
W(Ga)	≥ 1.11807
Calibration uncertainty (k=2)	± 0.006 °C at -200 °C ± 0.004 °C at 0 °C ± 0.009 °C at 420 °C ± 0.014 °C at 661 °C
Stability	5626: ± 0.003 °C 5628: ± 0.002 °C
Long-term drift	5626: < 0.03 °C/500 hours at 661 °C 5628: < 0.02 °C/500 hours at 661 °C
Immersion	At least 5 in recommended
Sheath	Inconel™ 600
Lead wires	4-wire Super-Flex PVC, 22 AWG
Termination	Gold-plated spade lugs, or specify
Size	0.25 in diameter x 12 in or 15 in standard, custom lengths available
Calibration	Accredited NIST-traceable calibration with data included

## Ordering Information

### Models

**5626-12-X** High-temp PRT, 100 Ω, 12 in

**5626-15-X** High-temp PRT, 100 Ω, 15 in

**5628-12-X** High-temp PRT, 25.5 Ω, 12 in

**5628-15-X** High-temp PRT, 25.5 Ω, 15 in

X = termination. Specify "B" (bare wire), "D" (5-pin DIN for Tweener Thermometers), "G" (gold pins), "I" (INFO-CON for 1521 or 1522 Handheld Thermometers), "J" (banana plugs), "L" (mini spade lugs), "M" (mini banana plugs), or "S" (spade lugs).

### Options and Accessories

**2601** Spare Case, 12 in PRT

**2602** Spare Case, 15 in PRT

Case included with purchase of Model 5626 or 5628 PRT

Elsco Philips Service, Trenčín

Temperature Calibration 113

# 5612, 5613, 5614 Secondary Reference Temperature Standards

riešenia na presné meranie

www.elseo.sk/Fluke-Calibration

## Thermometer Probes

Durable, accurate sensors for use in the factory, field or lab



- Affordable wide-range accuracy
- Excellent stability
- Reference-grade platinum sensing element

## Tech Tip

When using a probe, care needs to be taken to make certain the handle temperature doesn't get too hot. Materials used in the construction of many handles do not withstand the same range that the sensor can.

These secondary temperature standards are durable but accurate sensors for use in the factory, field, or lab. These Platinum Resistance Thermometers (PRTs) are available up to 12 inches long, with an Inconel 600 sheath and a 1/4 inch outside diameter. They are designed to be used as transfer devices, from the highest laboratory standards to industrial or second-tier lab locations. They have short-term accuracy of  $\pm 0.02$  °C at 200 °C.

The element is constructed of reference-grade platinum wire (99.999 % pure), for excellent stability. The wire is wound in a coil and placed in a mandrel, where it's uniformly supported in a manner to virtually eliminate hysteresis. The electrical configuration is a four-wire current-potential hookup to eliminate effects of lead-wire resistance.

These Inconel-sheathed probes have a partially supported sensing element, making them more durable than SPRTs. The element is protected in an ultrahigh-purity ceramic case with a hermetic glass seal to improve output stability by locking out moisture and contaminants.

This probe comes calibrated in accordance with ITS-90, which makes it compatible with many Hart Scientific readout devices, including the 1529 Chub-E4, 1560 Black Stack, and 1502A Tweener. It bridges the gap between a 100  $\Omega$  industrial RTD and an SPRT. For those needing faster thermal response, or where diameter and immersion depth are problems, order the 6-inch 5613 or the 9-inch 5612. These probes are excellent reference probes for comparison calibrations in a Hart dry-well.

A printout of sensor resistance is provided in 1 °C increments for each probe. The 5614 and 5612 are calibrated from -196 °C to 420 °C. The 5613 is calibrated to 300 °C.

These instruments are inexpensive and have excellent durability. Each probe is individually calibrated and includes a report of calibration from the manufacturer. Contact your local representative for optional calibration in Hart's NVLAP accredited lab.

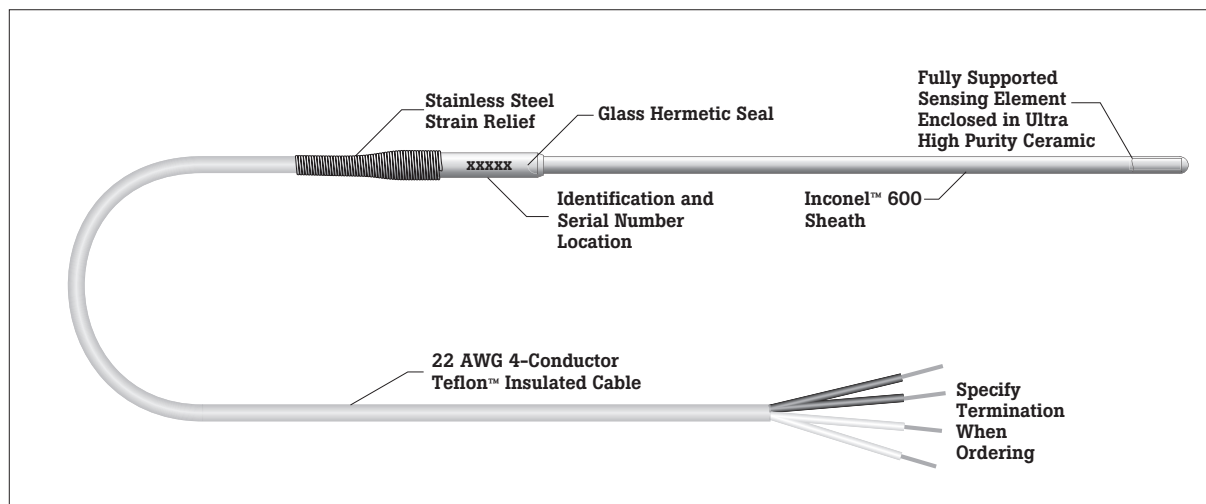

## Specifications

Resistance	Nominal 100 $\Omega$ ( $\pm 0.1 \Omega$ )
Temperature coefficient	0.003925 ohms/ohm/°C nominal
Temperature range	-200 °C to 420 °C (5613 to 300 °C; transition and cable temperature 150 °C maximum)
Transition temperature	5 °C to 200 °C
Drift rate	$\pm 0.01$ °C at 0 °C per year maximum, when used periodically to 400 °C
Sheath material	Inconel™ 600
Leads	Teflon™-insulated, silver-plated stranded copper, 22 AWG
Termination	Specify. See Ordering Information.
Hysteresis	< 0.01 °C at 0 °C using -196 °C and 420 °C as the end points
Immersion effects	Reading will not vary more than 0.005 °C when the probe immersion is varied between 4 inches and 10 inches in an ice bath (5614).
Calibration	Includes manufacturer's NIST-traceable calibration and table with R vs. T values in 1 °C increments from -183 °C to 500 °C. The 5614 and 5612 are calibrated to 420 °C and the 5613 to 300 °C. ITS-90 coefficients included. Optional accredited calibration available from Hart.
Probe accuracy (includes calibration uncertainty and short-term stability)	$\pm 0.018$ °C at -196 °C $\pm 0.018$ °C at 0 °C $\pm 0.019$ °C at 200 °C $\pm 0.023$ °C at 420 °C
Time constant	Nine seconds typical for 63.2 % response to step change in temperature in water flowing at 3 feet per second
Size	5612: 0.187 in diameter x 9 in 5613: 0.187 in diameter x 6 in 5614: 0.25 in diameter x 12 in

## Ordering Information

### Models

**5612-9-X** Secondary Standard  
PRT, 3/16 in x 9 in, -200 to  
420 °C

**5613-6-X** Secondary Standard  
PRT, 3/16 in x 6 in, -200 to  
300 °C

**5614-12-X** Secondary Standard  
PRT, 1/4 in x 12 in, -200 to  
420 °C

### Options and Accessories

#### 2601 Probe Carrying Case

X = termination. Specify "B" (bare wire), "D" (5-pin DIN for Tweener Thermometers), "G" (gold pins), "I" (INFO-CON for 1521 or 1522 Handheld Thermometers), "J" (banana plugs), "L" (mini spade lugs), "M" (mini banana plugs), or "S" (spade lugs).

# 5624 Platinum Resistance Thermometer to 1000 °C

riešenia na presné meranie

www.elseo.sk/Fluke-Calibration

## Thermometer Probes

### Precision PRT accuracy at thermocouple temperatures

- Temperature range of 0 °C to 1000 °C
- Accuracy (includes short-term stability and calibration uncertainty) of  $\pm 0.055$  °C to 962 °C
- Long-term drift of 0.01 °C at 0 °C after 100 hours at 1000 °C
- Designed by Hart's primary standards design team

### Tech Tip

A high temperature 5624 is the perfect companion reference probe for dry-wells above 600 °C or for furnaces below 1000 °C.

Until the introduction of the Model 5624, metrologists settled for expensive, high-temperature SPRTs or inaccurate thermocouples for high-temperature measurement. Ideal for use as a reference thermometer in high-temperature furnaces, the 5624 can reach a temperature of 1000 °C with long-term drift at 0 °C of 10 mK, and accuracy (including short-term stability and calibration uncertainty over the full range) of 55 mK.

Due to Hart Scientific's proprietary sensor design, this PRT has short-term stability of 5 mK, and an immersion requirement of less than 153 mm (6 inches) at 700 °C. The 5624 is assembled in an alumina sheath that is 508 mm (20 inches) long and 6.35 mm (0.25 inches) in diameter. Several termination configurations can be selected to match different thermometer read-outs. Each 5624 comes with a NIST-traceable, NVLAP-accredited fixed-point calibration from 0 °C to 962 °C. The 5624 also comes in a protective carrying case.

### Specifications

Range	0 °C to 1000 °C
Transition temperature	0 °C to 200 °C (handle and cable)
Calibration uncertainty	$\pm 0.05$ °C at 962 °C
Long-term drift ( $R_{tpw}$ )	< 0.01 °C at 0 °C/100 hours at 1000 °C < 0.06 °C at 0 °C/1000 hours at 1000 °C
Short-term stability	$\pm 0.005$ °C
Immersion	< 153 mm (6 in) at 700 °C
$R_{tpw}$	10 $\Omega$ ( $\pm 1$ $\Omega$ )
Hysteresis	< 0.005 °C from 0 °C to 1000 °C
Thermocycling	< 0.01 °C, 10 cycles from 0 °C to 1000 °C
Current	1 mA
Size	6.35 mm (0.25 in) O.D.
Length	508 mm (20 in)
Sheath material	Alumina
Lead wires	4-wire Teflon-insulated 24 AWG
Weight	1 kg (2 lb)
Calibration	Included 1913-6 fixed-point calibration

### Ordering Information

#### Models

**5624-20-X** Probe, 1000 °C, 10  $\Omega$  PRT, 6.35 mm (1/4 in) x 508 mm (20 in), (includes 2608 case and 1913-6 fixed-point calibration)

X = termination. Specify "B" (bare wire), "D" (5-pin DIN for 1502A), "G" (gold pins), "I" (infocon for 1521/1522), "J" (banana plugs), "L" (mini spade lugs), "M" (mini banana plugs, or "S" (spade lugs)

#### Options and Accessories

**2608** Case, SPRT, Plastic

# 5627 Precision Industrial PRTs

riešenia na presné meranie

www.elseo.sk/Fluke-Calibration

FLUKE®

Thermometer  
Probes

Hart Scientific

Durable PRTs with temperature range to 420 °C and accuracy to ± 0.05 °C



- Vibration and shock resistant
- 3/4-inch bend radius for increased durability
- NIST-traceable calibration included

The 5627 probes have a temperature range up to 420 °C and an accuracy as good as ± 0.05 °C. They come in three different lengths. (The six-inch model covers -200 °C to 300 °C.) Each instrument is shipped with its ITS-90 coefficients and a calibration table in 1 °C increments. One of the best features of this sensor is that it conforms to the standard 385 curve, letting you use your DIN/IEC RTD meters fully.

The 5627 is manufactured using a coil suspension element design for increased shock and vibration resistance. It has a mineral-insulated sheath with a minimum bend radius of 3/4-inch for flexibility and durability. (Bend, if any, should be specified at time of order.)

Six-inch 5627s are calibrated at -196 °C, -38 °C, 0 °C, 200 °C, and 300 °C. For 9-inch and 12-inch versions, an additional point is added at 420 °C.

Each probe is individually calibrated and includes a report of calibration from the manufacturer. Contact Hart for calibration in Hart's NVLAP-accredited lab. This probe is an excellent value. It has the price-to-accuracy and price-to-durability ratios you should demand in every PRT you buy.

## Specifications

Resistance	Nominal 100 Ω
Temperature coefficient	0.00385 Ω/Ω/°C nominal
Temperature range	-200 °C to 420 °C (5627-6 to 300 °C; transition and cable temperature: 0 °C to 150 °C)
Drift rate	± 0.13 °C at 0 °C after 1000 hours at 400 °C
Sheath material	316 Stainless Steel
Leads	Teflon™-insulated, nickel-plated stranded copper, 22 AWG
Termination	Specify. See Ordering Information.
Time constant	Four seconds maximum for 63.2 % response to step change in water moving at 3 fps
Bending radius	Sheath may be ordered with a bend on a minimum radius of 3/4 in except for 2 in area of sheath near tip. (Hart lab requires 20 cm [8 in] of unbent sheath to re-calibrate.)
Calibration	Includes manufacturer's NIST-traceable calibration and table with R vs. T values in 1 °C increments from -196 °C to 500 °C (to 300 °C for Model 5627-6). ITS-90 coefficients included. Optional accredited calibration available from Hart.
Immersion	At least 4 in recommended
Accuracy (includes calibration uncertainty and short-term stability)	± 0.050 °C at -196 °C ± 0.050 °C at 0 °C ± 0.051 °C at 200 °C ± 0.055 °C at 420 °C
Size	5627-12: 12 in L x 1/4 in diameter 5627-9: 9 in L x 3/16 in diameter 5627-6: 6 in L x 3/16 in diameter

## Ordering Information

### Models

**5627-6-X** Secondary PRT,  
6 in x 3/16 in, -200 °C to 300 °C

**5627-9-X** Secondary PRT,  
9 in x 3/16 in, -200 °C to 420 °C

**5627-12-X** Secondary PRT,  
12 in x 1/4 in, -200 °C to 420 °C

### Options and Accessories

**2601** Protective Case

X = termination. Specify "B" (bare wire), "D" (5-pin DIN for Tweener Thermometers), "G" (gold pins), "I" (INFO-CON for 1521 or 1522 Handheld Thermometers), "J" (banana plugs), "L" (mini spade lugs), "M" (mini banana plugs), or "S" (spade lugs).

# 5622 Fast Response PRTs

## Thermometer Probes

Designed for temperature measurements requiring fast response or short immersion over a wide range

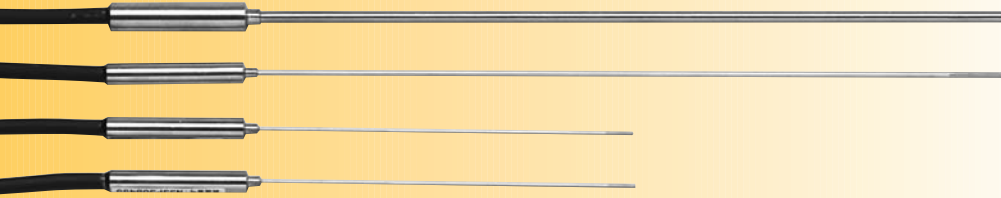

- Time constants as fast as 0.4 seconds
- Available as DIN/IEC Class A PRTs or with ITS-90 calibration
- Small probe diameters ranging from 0.5 mm to 3.2 mm

The 5622 Series PRTs are the perfect solution for special temperature measurement applications requiring fast response or short immersion over a wide temperature range.

The 5622 Series includes four models with stainless steel sheaths ranging from 0.5 to 3.2 mm (0.02 in to 0.125 in) in diameter. Because these high-quality wire-wound sensors come in small packages, heat transfer to the sensors occurs quickly. Time constants from 0 °C to 100 °C are as fast as 0.4 seconds.

Immersion requirements for these probes is also a plus, ranging from just 10 mm to 64 mm (0.4 in to 2.5 in), depending on the model. Getting into shallow or tight places is not a problem. And because these

probes can handle temperatures from –200 °C to 350 °C, they're more versatile than most thermistors.

5622 PRTs come with two calibration options. Uncalibrated, each of these probes conforms to DIN/IEC Class A requirements with accuracy of  $\pm 0.15$  °C at 0 °C and  $\pm 0.55$  °C at 200 °C and –200 °C. Alternatively, any 5622 PRT may be purchased with a 1922-4-N ITS-90 Comparison Calibration, which includes seven points from –197 °C to 300 °C. With calibration, short-term accuracies are achieved as good as  $\pm 0.04$  °C at 0 °C.

Readout options for the 5622 PRTs include Hart's 1521 and 1522 Handheld Thermometers, as well as the 1502A Tweener Thermometer. Each of these readouts will read your PRT as a standard DIN/IEC probe or as an individually calibrated PRT.

### Specifications

Temperature range	–200 °C to 350 °C
Nominal $R_{tpw}$	100 $\Omega$
Sensor	Four-wire "385" platinum
Calibrated probe accuracy (includes calibration uncertainty and short-term stability)	<b>5622-05 and 5622-10:</b> $\pm 0.04$ °C at –200 °C $\pm 0.04$ °C at 0 °C $\pm 0.09$ °C at 200 °C $\pm 0.09$ °C at 300 °C <b>5622-16 and 5622-32:</b> $\pm 0.04$ °C at –200 °C $\pm 0.04$ °C at 0 °C $\pm 0.045$ °C at 200 °C $\pm 0.055$ °C at 300 °C
Uncalibrated DIN/IEC conformity	DIN/IEC Class A; $\pm 0.15$ °C at 0 °C
Time constant (63.2 %) from 0 °C to 100 °C	5622-05: 0.4 seconds 5622-10: 1.5 seconds 5622-16: 3.0 seconds 5622-32: 10 seconds (90 %)
Immersion depth	5622-05: 10 mm (0.4 in) 5622-10: 20 mm (0.8 in) 5622-16: 32 mm (1.25 in) 5622-32: 64 mm (2.5 in)
Thermal EMF	20 mV at 350 °C
Sheath	316 SST 5622-05: 100 x 0.5 mm (4 in x 0.02 in) 5622-10: 100 x 1.0 mm (4 in x 0.04 in) 5622-16: 200 x 1.6 mm (8 in x 0.06 in) 5622-32: 200 x 3.2 mm (8 in x 0.13 in)
Cable	PVC, 4-wire cable, 2 meters long, 90 °C max temp
Calibration	All models conforms to DIN/IEC Class A; individual calibration optional

### Ordering Information

#### Models

**5622-05-X** Fast Response PRT, 0.5 mm (0.02 in)

**5622-10-X** Fast Response PRT, 1.0 mm (0.04 in)

**5622-16-X** Fast Response PRT, 1.6 mm (0.06 in)

**5622-32-X** Fast Response PRT, 3.2 mm (0.13 in)

All models come without calibration unless calibration purchased separately.

#### Options and Accessories

**1923-4-N** Calibration, PRT Comparison, –196 °C to 300 °C

**2601** Protective Case

X = termination. Specify "B" (bare wire), "D" (5-pin DIN for Tweener Thermometers), "G" (gold pins), "I" (INFO-CON for 1521 or 1522 Handheld Thermometers), "J" (banana plugs), "L" (mini spade lugs), "M" (mini banana plugs), or "S" (spade lugs).

Elseo Philips Service, Trenčín



# 5618A Small Diameter Industrial PRT

riešenia na presné meranie

www.elseo.sk/Fluke-Calibration

FLUKE®

Thermometer  
Probes

Hart Scientific

Secondary level performance with full ITS-90 calibration



- Small diameter sheath, 3.2 mm (0.125 in)
- Excellent stability
- Includes ITS-90 coefficients
- Calibrated from -200 °C to 500 °C

Featuring a 3.2 mm diameter (1/8-inch) sheath, these probes have reduced response time without compromising precision. This small diameter 5618A probe works well in many applications where immersion depth is limited. Each probe includes a full calibration report traceable to NIST and compliant to ANSI/NCSL

Z540. The report provides test data and the ITS-90 calibration coefficients that you can easily input into your Hart thermometer.

We recommend using the 5618A PRTs with the 1521, 1522, 1502A, 1529, or 1560 thermometer readouts.

## Specifications

Resistance	Nominal 100 $\Omega$ at 0 °C
Temperature coefficient	0.003923 $\Omega / \Omega / ^\circ\text{C}$ nominal
Temperature range	-200 °C to 500 °C, (-200 °C to 300 °C for 5618A-6-X)
Drift rate	$\pm 0.1$ °C when used periodically to 500 °C
Sheath material	316 SST
Leads	22 AWG Teflon, 6 ft
Termination	Specify
Hysteresis	Less than 0.01 °C at 0 °C when using -196 °C and 420 °C as the end points
Time constant	9 seconds max for 63.2 %
Thermal EMF	Less than 25 mV at 420 °C
Calibration	Includes manufacturer's NIST-Traceable (Z540) calibration w/ITS-90 coefficients, R vs. T values in 1 °C increments
Size	5618A-12: 12 in L x 1/8 in diameter 5618A-9: 9 in L x 1/8 in diameter 5618A-6: 6 in L x 1/8 in diameter
Probe accuracy (includes calibration uncertainty and short-term stability)	$\pm 0.05$ °C over entire range

## Ordering Information

### Models

**5618A-12X** 12-inch Small Diameter Probe

**5618A-9-X** 9-inch Small Diameter Probe

**5618A-6-X** 6-inch Small Diameter Probe

### Options and Accessories

**2601** Protective Case

X = termination. Specify "B" (bare wire), "D" (5-pin DIN for Tweener Thermometers), "G" (gold pins), "I" (INFO-CON for 1521 or 1522 Handheld Thermometers), "J" (banana plugs), "L" (mini spade lugs), "M" (mini banana plugs), or "S" (spade lugs).

# 5623A Precision RTD Freezer Probe

## Thermometer Probes

Fully immersible probe assembly to  $-200\text{ }^{\circ}\text{C}$



- NIST-traceable calibration and ITS-90 coefficients included
- Accuracy to  $\pm 0.05\text{ }^{\circ}\text{C}$  over the full range
- Can be immersed fully in fluids

The 5623A freezer probe is specially sealed from the sensing element to the end of the probe cable, preventing ingress of moisture when exposed to temperatures as low as  $-200\text{ }^{\circ}\text{C}$ . The entire assembly withstands temperatures over its full range ( $-200\text{ }^{\circ}\text{C}$  to  $156\text{ }^{\circ}\text{C}$ ), which is ideal for verification of freezers or autoclaves where a thermo-well isn't available. The 5623A assembly can be fully immersed in fluids when

the application may require use in a liquid bath. With accuracy (that includes calibration uncertainty and short term drift) of  $\pm 0.05\text{ }^{\circ}\text{C}$  over its full range, the 5623A is just right as a secondary standard for calibration of other process sensors.

We recommend using the 5623A with the 1521, 1522, 1502A, 1529, or 1560 thermometer readouts.

### Specifications

Resistance	Nominal 100 ( $\pm 0.1\ \Omega$ )
Temperature coefficient	0.003925 $\Omega/\Omega/^{\circ}\text{C}$ nominal
Temperature range	$-200\text{ }^{\circ}\text{C}$ to $156\text{ }^{\circ}\text{C}$
Transition temperature	$-200\text{ }^{\circ}\text{C}$ to $156\text{ }^{\circ}\text{C}$
Drift rate	$\pm 0.01\text{ }^{\circ}\text{C}$ per year when used periodically at max temperature
Sheath material	Inconel™ 600
Leads	Teflon™-insulated, silver-plated stranded copper, 22 AWG
Termination	Specify. See ordering information.
Calibration	Includes manufacturer's NIST-traceable calibration and table with R vs. T values in $1\text{ }^{\circ}\text{C}$ increments from $-200\text{ }^{\circ}\text{C}$ to $156\text{ }^{\circ}\text{C}$ . ITS-90 coefficients included. Optional accredited calibration available from Hart.
Probe accuracy (includes calibration uncertainty and short-term stability)	$\pm 0.05\text{ }^{\circ}\text{C}$ over the full range
Cable length	609.6 cm (20 ft)
Size	6.35 mm (0.25 in) dia. x 152 mm (6 in)

### Ordering Information

#### Models

**5623A-6-X** Freezer Probe, RTD  
1/4 in dia. x 6 in,  $-200$  to  $156\text{ }^{\circ}\text{C}$

X = termination. Specify "B" (bare wire), "D" (6-pin DIN for Tweener Thermometers), "G" (gold pins), "I" (INFO-CON for 1521 or 1522 Handheld Thermometers), "J" (banana plugs), "L" (spade lugs), "M" (mini banana plugs), or "S" (spade lugs).

#### Options and Accessories

2601 Probe Carrying Case

# 5640-5644 Thermistor Standards Probes

riešenia na presné meranie

www.elso.sk/Fluke-Calibration

**FLUKE**

**Thermometer Probes**

Hart Scientific

High accuracy probes with excellent stability



- Accuracy to  $\pm 0.001\text{ }^{\circ}\text{C}$
- Affordable system accuracy to  $\pm 0.004\text{ }^{\circ}\text{C}$  or better
- NIST-traceable calibration included from manufacturer; accredited Hart calibration optional

## Specifications

Model	Diameter x Length	Range	Drift $^{\circ}\text{C}/\text{Year}$	Accuracy (Mfr.)†		Nominal Wires	Resistance at 25 $^{\circ}\text{C}$
				0 to 60 $^{\circ}\text{C}$	60 to 100 $^{\circ}\text{C}$		
5640	6.35 x 229 mm (0.25 x 9 in)	0 $^{\circ}\text{C}$ to 60 $^{\circ}\text{C}$	$\pm 0.005\text{ }^{\circ}\text{C}$	$\pm 0.0015\text{ }^{\circ}\text{C}$	n/a	4	4 k $\Omega$
5641	3.18 x 114 mm (0.125 x 4.5 in)	0 $^{\circ}\text{C}$ to 60 $^{\circ}\text{C}$	$\pm 0.002\text{ }^{\circ}\text{C}$	$\pm 0.001\text{ }^{\circ}\text{C}$	n/a	4	5 k $\Omega$
5642	3.18 x 229 mm (0.125 x 9 in)	0 $^{\circ}\text{C}$ to 60 $^{\circ}\text{C}$	$\pm 0.002\text{ }^{\circ}\text{C}$	$\pm 0.001\text{ }^{\circ}\text{C}$	n/a	4	5 k $\Omega$
5643	3.18 x 114 mm (0.125 x 4.5 in)	0 $^{\circ}\text{C}$ to 100 $^{\circ}\text{C}$	$\pm 0.005\text{ }^{\circ}\text{C}$	$\pm 0.0015\text{ }^{\circ}\text{C}$	$\pm 0.0025\text{ }^{\circ}\text{C}$	4	10 k $\Omega$
5644	3.18 x 229 mm (0.125 x 9 in)	0 $^{\circ}\text{C}$ to 100 $^{\circ}\text{C}$	$\pm 0.005\text{ }^{\circ}\text{C}$	$\pm 0.0015\text{ }^{\circ}\text{C}$	$\pm 0.0025\text{ }^{\circ}\text{C}$	4	10 k $\Omega$

†Does not include long-term drift.

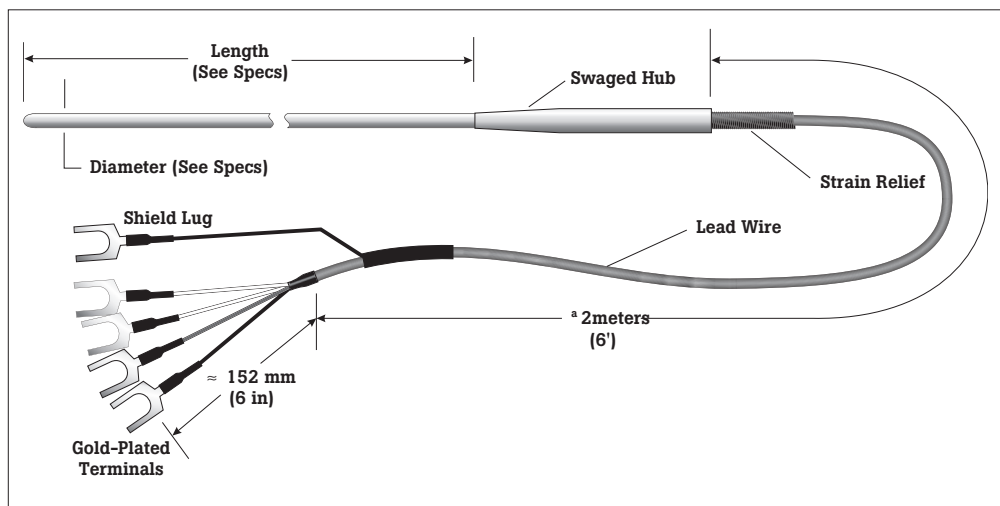

## Ordering Information

### Models

**5640-X** Standards Thermistor Probe

**5641-X** Standards Thermistor Probe

**5642-X** Standards Thermistor Probe

**5643-X** Standards Thermistor Probe

**5644-X** Standards Thermistor Probe

### Options and Accessories

**2601** Protective Case

X = termination. Specify "B" (bare wire), "D" (5-pin DIN for Tweener Thermometers), "G" (gold pins), "I" (INFO-CON for 1521 or 1522 Handheld Thermometers), "J" (banana plugs), "L" (mini spade lugs), "M" (mini banana plugs), or "S" (spade lugs).

Elsó Philips Service, Trenčín

Temperature Calibration 121

# 5610, 5611, 5665, 5674 Secondary Reference Thermistor Probes

prezentácia na presné meranie

www.elso.sk/Fluke-Calibration

## Thermometer Probes

Lab-grade thermistors probes for accurate work across a narrow temperature range

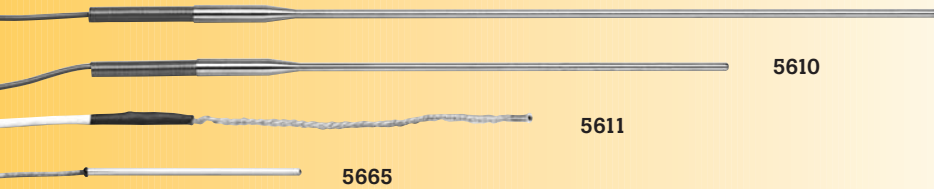

- Range 0 °C to 100 °C
- Short-term accuracy to  $\pm 0.015$  °C; one year drift  $< \pm 0.01$  °C
- Includes NIST-traceable calibration from manufacturer; accredited Hart calibration optional

### Specifications

	5610, 5611, 5665	5674
Resistance	Nominal 10,000 $\Omega$ at 25 °C	Nominal 10,000 $\Omega$ at 25 °C
Range	0 °C to 100 °C	0 °C to 70 °C
Calibration	R vs. T table with 0.1 °C increments, interpolation equation furnished	Optionally available from Hart
Calibration uncertainty	Table and equation are accurate to $\pm 0.01$ °C	
Drift	Better than $\pm 0.01$ °C per year	Better than $\pm 0.02$ °C per year
Repeatability	Better than $\pm 0.005$ °C	Better than $\pm 0.07$ °C
Size and construction	See drawings below	See drawings below
Termination	Specify when ordering	Specify when ordering

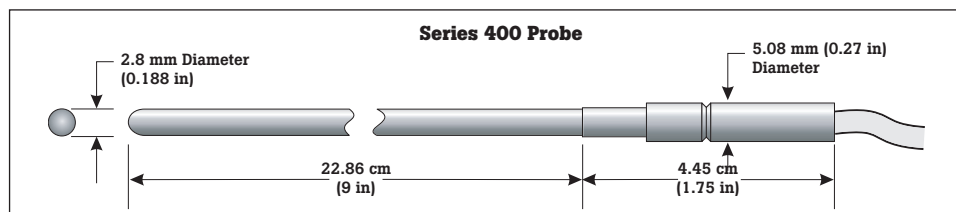
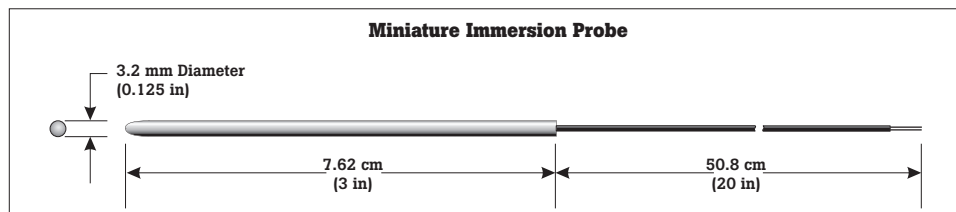
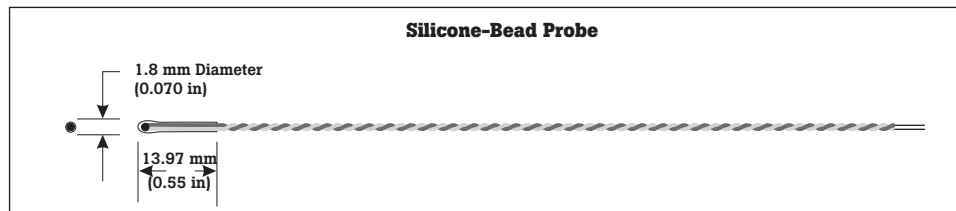
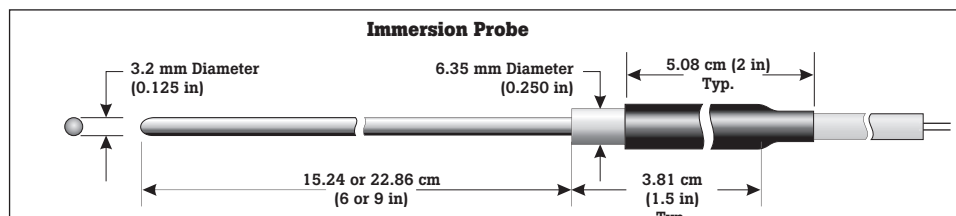

### Ordering Information

#### Models

- 5610-6-X 6 in Immersion Probe
- 5610-9-X 9 in Immersion Probe
- 5611-X Silicone-Bead Probe
- 5665-X Miniature Immersion Probe
- 5674-X Series 400 Thermistor

#### Options and Accessories

2601 Protective Case

X = termination. Specify "B" (bare wire), "D" (5-pin DIN for Tweener Thermometers), "G" (gold pins), "I" (INFO-CON for 1521 or 1522 Handheld Thermometers), "J" (banana plugs), "L" (mini spade lugs), "M" (mini banana plugs), or "S" (spade lugs).

# 5649 and 5650 Type R and S Thermocouple Standards

riešenia na presné meranie

www.elseo.sk/Fluke-Calibration

FLUKE®

Thermometer  
Probes

Hart Scientific

Eight models to fit any type R or S thermocouple application

5650

- Designed by Hart's primary standards design team
- Two sizes available, each with or without reference junction
- Calibration uncertainty of  $\pm 0.5\text{ }^{\circ}\text{C}$  to  $1100\text{ }^{\circ}\text{C}$ ,  $\pm 3\text{ }^{\circ}\text{C}$  to  $1450\text{ }^{\circ}\text{C}$

Made from the finest platinum and platinum-rhodium alloy, the Type R and Type S Thermocouples cover a temperature range of  $0\text{ }^{\circ}\text{C}$  to  $1450\text{ }^{\circ}\text{C}$  with uncertainties as good as  $\pm 0.15\text{ }^{\circ}\text{C}$  over most of that range. With four different models for each type, we have the thermocouple to fit your application. The measuring junction of both the 5649 and the 5650 is encased in a 6.35 millimeters (0.25-inch) alumina sheath that can be ordered in lengths of 50.8 or 63.5 centimeters (20 or 25 inches) to fit the specific requirements of your application. A reference, or "cold," junction may also be ordered. The reference junction uses a stainless steel sheath and is 21 centimeters long (8.25 inches) by 4.8 millimeters in diameter (0.188 inches). The thin diameter minimizes the immersion depth needed, but the extra length ensures you can get all the immersion

you like. Special tin-plated, solid-copper connecting wires with ultra-low EMF properties are used to help retain the integrity of your measurement junction where the probe attaches to your readout.

Each probe comes from a spool of wire that has been sample tested using fixed-point standards to ensure uncertainties less than  $0.5\text{ }^{\circ}\text{C}$  up to  $1100\text{ }^{\circ}\text{C}$ . From  $1100\text{ }^{\circ}\text{C}$  to  $1450\text{ }^{\circ}\text{C}$ , the uncertainty increases linearly to  $3.0\text{ }^{\circ}\text{C}$ . If you need greater accuracy, order an individual calibration with fixed-point standards to reduce uncertainties to  $\pm 0.15\text{ }^{\circ}\text{C}$  up to  $962\text{ }^{\circ}\text{C}$ ,  $\pm 0.25\text{ }^{\circ}\text{C}$  up to  $1100\text{ }^{\circ}\text{C}$ , and increasing linearly to  $\pm 2.0\text{ }^{\circ}\text{C}$  at  $1450\text{ }^{\circ}\text{C}$ .

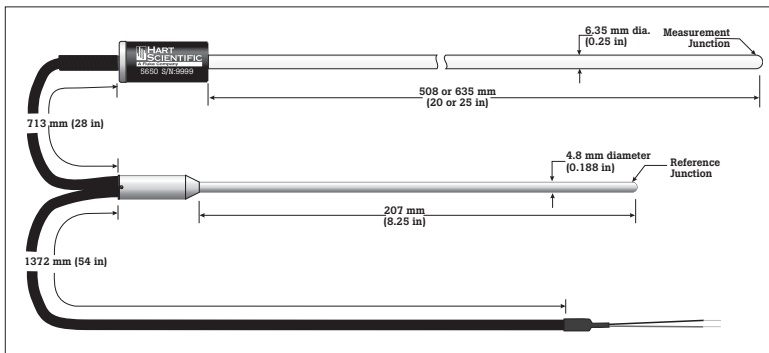

## Specifications

Range	$0\text{ }^{\circ}\text{C}$ to $1450\text{ }^{\circ}\text{C}$
Type	Platinum/10 % rhodium vs. platinum (type S) Platinum/13 % rhodium vs. platinum (type R)
Calibration	Wire spool sampling method by fixed point (optionally available by fixed point for individual thermocouples)
Calibration uncertainty	$\pm 0.5\text{ }^{\circ}\text{C}$ to $1100\text{ }^{\circ}\text{C}$ ; $\pm 3.0\text{ }^{\circ}\text{C}$ to $1450\text{ }^{\circ}\text{C}$
Hot junction sheath dimensions	6.35 mm (0.25 in) diameter; see Ordering Information for lengths
Reference junction sheath dimensions	4.8 in diameter x 210 mm length (0.188 x 8.25 in)
Long-term stability	$\pm 0.5\text{ }^{\circ}\text{C}$ to $1100\text{ }^{\circ}\text{C}$ ; $\pm 2.0\text{ }^{\circ}\text{C}$ to $1450\text{ }^{\circ}\text{C}$ (over 1 year depending on usage)
Short-term stabilities	$\pm 0.2\text{ }^{\circ}\text{C}$ to $1100\text{ }^{\circ}\text{C}$ ; $\pm 0.6\text{ }^{\circ}\text{C}$ to $1450\text{ }^{\circ}\text{C}$
Immersion	At least 6 in recommended
Copper/copper wires to readout	60 in L, tin-plated, Teflon-insulated, low EMF solid copper
Protective case	Model 2602 case included
Weight	1 kg (2 lb)

## Ordering Information

### Models

5649-20-X Type R TC, 20 x 1/4 in

5649-20CX Type R TC, 20 x 1/4 in with reference junction

5649-25-X Type R TC, 25 x 1/4 in

5649-25CX Type R TC, 25 x 1/4 in, with reference junction

5650-20-X Type S TC, 20 x 1/4 in

5650-20CX Type S TC, 20 x 1/4 in, with reference junction

5650-25-X Type S TC, 25 x 1/4 in

5650-25CX Type S TC, 25 x 1/4 in, with reference junction

X = termination. Specify "B" (bare wire), "W" (generic copper-to-copper TC connector), or "R" (standard Type R/S TC connector). Models with reference junctions should not specify "R" and models without reference junctions should not specify "W".

### Options and Accessories

1918-B Four-point calibration by fixed point (Sn, Zn, Al, Ag). Extrapolated to  $1450\text{ }^{\circ}\text{C}$ .

Note: Calibration uncertainty for individually calibrated 5649 and 5650 by fixed point is  $\pm 0.25\text{ }^{\circ}\text{C}$  below  $1100\text{ }^{\circ}\text{C}$  and  $\pm 2.0\text{ }^{\circ}\text{C}$  above  $1100\text{ }^{\circ}\text{C}$ . 2602 case included with new models.

2602 Spare Case

Elseo Philips Service, Trenčín

Temperature Calibration 123

## Baths

Temperature baths from Fluke are the most stable and uniform available, designed specifically for metrologists. A proprietary controlled developed with Hart Scientific technology provides unmatched stabilities (to  $\pm 0.0007\text{ }^{\circ}\text{C}$ ) and set-point resolution (to  $0.00003\text{ }^{\circ}\text{C}$ ). Multiple options for automation are available through RS-232 or IEEE-488 interfaces.

- Standard baths from  $-100\text{ }^{\circ}\text{C}$  to  $550\text{ }^{\circ}\text{C}$  have the best stabilities and uniformities available.
- Compact baths from  $-80\text{ }^{\circ}\text{C}$  to  $300\text{ }^{\circ}\text{C}$  feature small footprints, quick temperature changes, and super-quiet operation.
- Special-purpose baths for standard resistors, sea-water applications, viscosity testing, blackbody cones, and more – including custom baths – are available.



### Compact Series

Model	Range	Stability	Depth	Features
6330	$35\text{ }^{\circ}\text{C}$ to $300\text{ }^{\circ}\text{C}$	$\pm 0.005\text{ }^{\circ}\text{C}$ at $100\text{ }^{\circ}\text{C}$ $\pm 0.015\text{ }^{\circ}\text{C}$ at $300\text{ }^{\circ}\text{C}$	234 mm (9.25 in)	Small benchtop footprint. Optional cart includes storage space.
7320	$-20\text{ }^{\circ}\text{C}$ to $150\text{ }^{\circ}\text{C}$	$\pm 0.005\text{ }^{\circ}\text{C}$ at $-20\text{ }^{\circ}\text{C}$ $\pm 0.005\text{ }^{\circ}\text{C}$ at $25\text{ }^{\circ}\text{C}$	234 mm (9.25 in)	Small 2.4-gallon (9.2-liter) tank. Uniformity $\pm 0.005\text{ }^{\circ}\text{C}$ .
7340	$-40\text{ }^{\circ}\text{C}$ to $150\text{ }^{\circ}\text{C}$	$\pm 0.005\text{ }^{\circ}\text{C}$ at $-40\text{ }^{\circ}\text{C}$ $\pm 0.005\text{ }^{\circ}\text{C}$ at $25\text{ }^{\circ}\text{C}$	234 mm (9.25 in)	Low temperature calibrations. Metrology-level performance.
7380	$-80\text{ }^{\circ}\text{C}$ to $100\text{ }^{\circ}\text{C}$	$\pm 0.006\text{ }^{\circ}\text{C}$ at $-80\text{ }^{\circ}\text{C}$ $\pm 0.010\text{ }^{\circ}\text{C}$ at $0\text{ }^{\circ}\text{C}$	178 mm (7 in)	Achieves $-80\text{ }^{\circ}\text{C}$ in less than 130 minutes. Quiet operation.
7312	$-5\text{ }^{\circ}\text{C}$ to $110\text{ }^{\circ}\text{C}$	$\pm 0.001\text{ }^{\circ}\text{C}$ at $0\text{ }^{\circ}\text{C}$	496 mm (19.5 in)	Maintains two TPW cells. Compact, quiet.
6331	$40\text{ }^{\circ}\text{C}$ to $300\text{ }^{\circ}\text{C}$	$\pm 0.007\text{ }^{\circ}\text{C}$ at $100\text{ }^{\circ}\text{C}$ $\pm 0.015\text{ }^{\circ}\text{C}$ at $300\text{ }^{\circ}\text{C}$	457 mm (18 in)	18 in of depth with just 16 liters of fluid. RS-232 included.
7321	$-20\text{ }^{\circ}\text{C}$ to $150\text{ }^{\circ}\text{C}$	$\pm 0.005\text{ }^{\circ}\text{C}$ at $-20\text{ }^{\circ}\text{C}$ $\pm 0.005\text{ }^{\circ}\text{C}$ at $25\text{ }^{\circ}\text{C}$	457 mm (18 in)	Perfect for LIG thermometers with optional kit. Quiet operation.
7341	$-40\text{ }^{\circ}\text{C}$ to $150\text{ }^{\circ}\text{C}$	$\pm 0.005\text{ }^{\circ}\text{C}$ at $-40\text{ }^{\circ}\text{C}$ $\pm 0.005\text{ }^{\circ}\text{C}$ at $25\text{ }^{\circ}\text{C}$	457 mm (18 in)	Fast temperature changes. Access opening accommodates many thermometers.
7381	$-80\text{ }^{\circ}\text{C}$ to $110\text{ }^{\circ}\text{C}$	$\pm 0.006\text{ }^{\circ}\text{C}$ at $-80\text{ }^{\circ}\text{C}$ $\pm 0.005\text{ }^{\circ}\text{C}$ at $0\text{ }^{\circ}\text{C}$	457 mm (18 in)	Stability of $\pm 0.006\text{ }^{\circ}\text{C}$ or better over full range. Compatible with MET/TEMP II software.

### Standard Baths

Model	Range	Stability	Depth	Features
7060	$-60\text{ }^{\circ}\text{C}$ to $110\text{ }^{\circ}\text{C}$	$\pm 0.0025\text{ }^{\circ}\text{C}$ at $-60\text{ }^{\circ}\text{C}$ $\pm 0.0015\text{ }^{\circ}\text{C}$ at $25\text{ }^{\circ}\text{C}$	305 mm (12 in)	Reaches $-60\text{ }^{\circ}\text{C}$ with standard refrigeration.
7080	$-80\text{ }^{\circ}\text{C}$ to $110\text{ }^{\circ}\text{C}$	$\pm 0.0025\text{ }^{\circ}\text{C}$ at $-80\text{ }^{\circ}\text{C}$ $\pm 0.0015\text{ }^{\circ}\text{C}$ at $25\text{ }^{\circ}\text{C}$	305 mm (12 in)	Best combination of stability and ultra-low temperatures.
7100	$-100\text{ }^{\circ}\text{C}$ to $110\text{ }^{\circ}\text{C}$	$\pm 0.003\text{ }^{\circ}\text{C}$ at $-100\text{ }^{\circ}\text{C}$	337 mm (13.25 in)	No external cooling for $-100\text{ }^{\circ}\text{C}$ .
7008	$-5\text{ }^{\circ}\text{C}$ to $110\text{ }^{\circ}\text{C}$	$\pm 0.0007\text{ }^{\circ}\text{C}$ at $25\text{ }^{\circ}\text{C}$	331 mm (13 in)	Large tank for larger mass immersion. Maintains standard resistors.
7011	$-10\text{ }^{\circ}\text{C}$ to $110\text{ }^{\circ}\text{C}$	$\pm 0.0008\text{ }^{\circ}\text{C}$ at $0\text{ }^{\circ}\text{C}$ $\pm 0.0008\text{ }^{\circ}\text{C}$ at $25\text{ }^{\circ}\text{C}$	305 mm (12 in)	Self-contained refrigeration. Best-priced ultrastable, cooled bath.
7012	$-10\text{ }^{\circ}\text{C}$ to $110\text{ }^{\circ}\text{C}$	$\pm 0.0008\text{ }^{\circ}\text{C}$ at $0\text{ }^{\circ}\text{C}$ $\pm 0.0008\text{ }^{\circ}\text{C}$ at $25\text{ }^{\circ}\text{C}$	457 mm (18 in)	Maintains up to 4 TPW cells for weeks. Large access: 162 x 292 mm (6.3 in x 11.5 in).
7037	$-40\text{ }^{\circ}\text{C}$ to $110\text{ }^{\circ}\text{C}$	$\pm 0.002\text{ }^{\circ}\text{C}$ at $-40\text{ }^{\circ}\text{C}$ $\pm 0.0015\text{ }^{\circ}\text{C}$ at $25\text{ }^{\circ}\text{C}$	457 mm (18 in)	Lowest-temperature deep-well bath. Mercury cell maintenance bath.
7040	$-40\text{ }^{\circ}\text{C}$ to $110\text{ }^{\circ}\text{C}$	$\pm 0.002\text{ }^{\circ}\text{C}$ at $-40\text{ }^{\circ}\text{C}$ $\pm 0.0015\text{ }^{\circ}\text{C}$ at $25\text{ }^{\circ}\text{C}$	305 mm (12 in)	Self-contained single-stage refrigeration. Digital controller.
6020	$40\text{ }^{\circ}\text{C}$ to $300\text{ }^{\circ}\text{C}$	$\pm 0.001\text{ }^{\circ}\text{C}$ at $40\text{ }^{\circ}\text{C}$ $\pm 0.005\text{ }^{\circ}\text{C}$ at $300\text{ }^{\circ}\text{C}$	305 mm (12 in)	Broad range to $300\text{ }^{\circ}\text{C}$ . Optional RS-232 and IEEE-488 interface.
6022	$40\text{ }^{\circ}\text{C}$ to $300\text{ }^{\circ}\text{C}$	$\pm 0.001\text{ }^{\circ}\text{C}$ at $40\text{ }^{\circ}\text{C}$ $\pm 0.005\text{ }^{\circ}\text{C}$ at $300\text{ }^{\circ}\text{C}$	464 mm (18.25 in)	Deep tank for SPRT or LIG thermometers. Optional fluid level adapter.
6024	$40\text{ }^{\circ}\text{C}$ to $300\text{ }^{\circ}\text{C}$	$\pm 0.001\text{ }^{\circ}\text{C}$ at $40\text{ }^{\circ}\text{C}$ $\pm 0.005\text{ }^{\circ}\text{C}$ at $300\text{ }^{\circ}\text{C}$	337 mm (13.25 in)	Larger access opening and tank size for higher throughput.
6045	$40\text{ }^{\circ}\text{C}$ to $400\text{ }^{\circ}\text{C}$	$\pm 0.002\text{ }^{\circ}\text{C}$ at $100\text{ }^{\circ}\text{C}$ $\pm 0.004\text{ }^{\circ}\text{C}$ at $400\text{ }^{\circ}\text{C}$	305 mm (12 in)	Designed for use with oil or salt. High-resolution set-point to $0.00018\text{ }^{\circ}\text{C}$ .
6050H	$40\text{ }^{\circ}\text{C}$ to $550\text{ }^{\circ}\text{C}$	$\pm 0.002\text{ }^{\circ}\text{C}$ at $200\text{ }^{\circ}\text{C}$ $\pm 0.007\text{ }^{\circ}\text{C}$ at $500\text{ }^{\circ}\text{C}$	305 mm (12 in)	Better stability than sand baths. High temperatures, low gradients.

## Special Application

Model	Range	Stability	Depth	Features
6054	50 °C to 300 °C	± 0.003 °C at 100 °C ± 0.005 °C at 300 °C	610 mm (24 in)	Maintains constant fluid level.
6055	200 °C to 550 °C	± 0.003 °C at 200 °C ± 0.01 °C at 550 °C	432 mm (17 in)	Includes LIG sighting channel.
7007	-5 °C to 110 °C	± 0.001 °C at 0 °C ± 0.003 °C at 100 °C	610 mm (24 in)	Large, 7-inch-diameter working space.
7009	0 °C to 110 °C	± 0.0007 °C at 25 °C	331 mm (13 in)	Largest capacity with 4.8-cubic foot (167-liter) working area and 0.7 mK stability.
7015	0 °C to 110 °C	± 0.0007 °C at 25 °C	331 mm (13 in)	Ultrastable for maintaining resistors. Large access and workspace. Splash- and spill-resistant lid.
7108	20 °C to 30 °C	± 0.004 °C	203 mm (8 in)	Peltier cooling means no compressor and quieter performance. Maintains standard resistors.
7911A2	0 °C	± 0.002 °C	203 mm (8 in)	Easy and affordable zero-point source for calibrating temperature sensors

### Hart Scientific offers a wide variety of customized temperature baths including:

- oceanography baths with titanium tanks
- windowed baths for LIG and viscometry applications
- baths with built-in low-temperature blackbody cones  
baths with extended or shortened depths and widths
- much more

### Custom Baths

Bath fluids	Silicone oils, salt, and cold fluids in convenient, small quantities.
Bath accessories	Fluid level adapters, LIG magnifier, probe holding stands, brackets, and clamps.
Rosemount bath controllers	Model 7900 controller designed by Hart integrates the features of Hart's 2100 controller and can be used in place of the Rosemount 915 controller with Rosemount-designed baths.
Hart bath controllers	Model 2100 and 2200 controllers can be integrated with homemade baths or other heat sources to achieve performance levels approaching Hart baths.

Note: see page ??? for portable Micro-Baths.

### Custom solutions for your specific application

Hart's standard baths are well constructed and very stable, and they have software available for automated calibrations. However, if your needs aren't met by the standard sizes and temperature ranges, then Hart can build a reliable custom bath that meets your specific needs.

Hart engineers have built baths for a variety of applications, including oceanography, missile optics, infrared, down-hole tools and more. To discuss your custom application, contact your local Fluke representative. You may also contact Hart Scientific directly.

# 6330, 7320, 7340, and 7380 Compact Baths

riešenia na presné meranie

[www.elseo.sk/Fluke-Calibration](http://www.elseo.sk/Fluke-Calibration)

## Baths

Compact baths with the stability and uniformity required for precision thermometer testing



6330

- Stability and uniformity each better than  $\pm 0.008$  °C
- Metrology-level performance in lab-friendly sizes
- Convenient use on benchtops or on matching carts

## Tech Tip

Rate of baths' temperature change is highly influenced by liquid volume. Smaller volumes change temperatures faster, but larger volumes offer greater stability.

When you only need a circulator or utility bath to control a process within a few degrees or to maintain biological test samples, talk to a utility bath manufacturer. But when you're doing precision thermometer testing, and stability and uniformity are critical to the success of your work, talk to us.

Hart Scientific has been making the world's best-performing temperature baths for almost two decades. With our proven heating/cooling designs and hybrid analog-digital controller, Hart baths apply the most effective technologies that are commercially feasible. These four compact baths are no exception.

### Model 6330

This bath delivers all the high temperatures you need up to 300 °C (572 °F). With stability and uniformity at 300 °C better than  $\pm 0.015$  °C and  $\pm 0.020$  °C respectively, calibrations can easily be performed at this high temperature with total uncertainty better than  $\pm 0.05$  °C. At lower temperatures, stability and uniformity are even better.

The 6330 is only 12 inches wide and less than 19 inches tall, so it fits easily onto a benchtop without consuming precious space. An optional cart with casters and a storage area raises the 6330 to a convenient height when used on a floor and provides an extra cabinet for lab supplies. With built-in handles, it even lifts easily onto and off of its cart or benchtop. No matter where you want to use this bath – or even if you want to move it around – the 6330 gets there hassle-free.

### Models 7320 and 7340

Also featuring large work areas, our Model 7320 and 7340 baths address your needs for low temperature calibrations. The 7320 covers a range from  $-20$  °C to 150 °C and the 7340 reaches even colder temperatures to  $-40$  °C. Below 0 °C, these baths maintain an impressive stability of  $\pm 0.005$  °C with uniformities better than  $\pm 0.006$  °C. No utility bath performs as well as Hart's compact baths below 0 °C or at critical room and body temperatures – or even at important higher temperatures such as 100 °C and 122 °C.

### Model 7380

For ultracold temperatures, the 7380 reaches  $-80$  °C quickly and maintains a two-sigma stability of  $\pm 0.006$  °C when it gets there. The 7380 is a true metrology bath, not a chiller or circulator. With uniformity to  $\pm 0.008$  °C, comparison calibration of temperature devices can be performed with high precision.

Each bath includes an RS-232 serial interface and our Model 9930 Interface-*it* software for controlling your bath from a PC. With a Hart Scientific thermometer readout, such as a Black Stack, and our MET/TEMP II software, automated calibrations can run unattended.

Hart Scientific doesn't make chillers, circulators, or so-called utility baths, and utility bath manufacturers don't make metrology baths. Use the right tools for your work and reap the best possible results. Baths from Hart Scientific are the most stable and uniform of any you'll find. They'll give you results no other bath can.



## Specifications

	6330	7320	7340	7380
Range	35 °C to 300 °C	-20 °C to 150 °C	-40 °C to 150 °C	-80 °C to 100 °C
Stability	± 0.005 °C at 100 °C (oil 5012) ± 0.010 °C at 200 °C (oil 5017) ± 0.015 °C at 300 °C (oil 5017)	± 0.005 °C at -20 °C (ethanol) ± 0.005 °C at 25 °C (water) ± 0.007 °C at 150 °C (oil 5012)	± 0.005 °C at -40 °C (ethanol) ± 0.005 °C at 25 °C (water) ± 0.007 °C at 150 °C (oil 5012)	± 0.006 °C at -80 °C (ethanol) ± 0.010 °C at 0 °C (ethanol) ± 0.010 °C at 100 °C (oil 5012)
Uniformity	± 0.007 °C at 100 °C (oil 5012) ± 0.015 °C at 200 °C (oil 5017) ± 0.020 °C at 300 °C (oil 5017)	± 0.005 °C at -20 °C (ethanol) ± 0.005 °C at 25 °C (water) ± 0.010 °C at 150 °C (oil 5012)	± 0.006 °C at -40 °C (ethanol) ± 0.005 °C at 25 °C (water) ± 0.010 °C at 150 °C (oil 5012)	± 0.008 °C at -80 °C (ethanol) ± 0.012 °C at 0 °C (ethanol) ± 0.012 °C at 100 °C (oil 5012)
Heating time†	250 min, from 35 °C to 300 °C (oil 5017)	80 min, from 25 °C to 150 °C (oil 5012)	60 min, from 25 °C to 150 °C (oil 5012)	25 min, from 25 °C to 100 °C (oil 5010)
Cooling time	N/A	100 min, from 25 °C to -20 °C (oil 5012)	110 min, from 25 °C to -40 °C (ethanol)	130 min, from 25 °C to -80 °C (ethanol)
Stabilization time	15 to 20 minutes			
Temperature setting	Digital display with push-button data entry			
Set-point resolution	0.01 °; 0.00018 ° in high-resolution mode			0.01 °
Display resolution	0.01 °			
Digital setting accuracy	± 0.5 °C			
Digital setting repeatability	± 0.01 °C			
Access opening	94 x 172 mm (3.7 x 6.8 in)			86 x 114 mm (3.25 x 4.5 in)
Working area	81 x 133 mm (3.2 x 5.25 in)			86 x 114 mm (3 x 4 in)
Depth	234 mm (9.25 in)			178 mm (7 in)
Wetted parts	304 stainless steel			
Power	115 V ac (± 10 %), 50/60 Hz, 7 A or 230 V ac (± 10 %), 50/60 Hz, 3.5 A, specify	115 V ac (± 10 %), 60 Hz, 15 A or 230 V ac (± 10 %), 50 Hz, 8 A, specify, 1400 VA		115 V ac (± 10 %) 60 Hz, 16 A or 230 V ac (± 10 %), 50 Hz, 8 A, specify
Volume	9.2 liters (2.4 gallons)			4 liters (1 gallon)
Size (WxDxH)	305 x 546 x 470 mm (12 x 21.5 x 18.5 in) off cart; 305 x 546 x 819 mm (12 x 21.5 x 32.25 in) on cart	305 x 622 x 584 mm (12 x 24.5 x 23 in) off cart; 305 x 622 x 819 mm (12 x 24.5 x 32.25 in) on cart		305 x 610 x 762 mm (12 x 24 x 30 in)
Weight	19 kg (42 lb)	35.4 kg (78 lb)		52 kg (115 lb)
Automation package	Interface-it software and RS-232 included (IEEE-488 optional)			
Calibration	Baths are supplied with stability test data.			

†Rated at nominal 115 V (or optional 230 V)

### Ordering Information

#### Models

**6330** Compact Bath, 35 °C to 300 °C

**7320** Compact Bath, -20 °C to 150 °C

**7340** Compact Bath, -40 °C to 150 °C

**7380** Compact Bath, -80 °C to 100 °C

### Options and Accessories

**2020-6330** Spare Access Cover, SST, 6330

**2020-7320** Spare Access Cover, SST, 7320/7340

**2076-6330** Floor Cart, 6330 (13.5 in H)

**2076-7320** Floor Cart, 7320/7340 (9 in H)

**2020-7380** Spare Access Cover, SST, 7380

**2001-IEEE** IEEE-488 Interface

**2125-C** IEEE-488 Interface (RS-232 to IEEE-488 converter box)

# 6331, 7321, 7341, and 7381 Deep-Well Compact Baths

riešenia na presné meranie

[www.elseo.sk/Fluke-Calibration](http://www.elseo.sk/Fluke-Calibration)

## Baths

Ample immersion depth and great stability, in a high value compact bath



- 18 inches of depth with just 4.2 gallons of fluid
- Perfect for liquid-in-glass thermometer calibrations with optional LIG kit
- Fast, quiet, compact (yet deep), and economical

## Tech Tip

As a bath's fluid is heated, it expands – possibly overflowing its tank and making a mess of your lab. The unique fluid recovery feature of these baths averts this problem, taking the worry out of automated testing.

Need a bath with a lot of immersion depth, great stability, and a low price tag? How about one that minimizes fluid costs, changes temperatures quickly, and runs quietly?

The new deep-well compact bath series features four models covering temperatures from  $-80\text{ }^{\circ}\text{C}$  to  $300\text{ }^{\circ}\text{C}$ .

Each model includes an 18-inch (457 mm) deep tank to accommodate long-stem PRTs, SPRTs, and liquid-in-glass (LIG) thermometers. Access openings are 4.7 inches by 6.8 inches (120 by 172 mm) so you can calibrate many thermometers simultaneously. Yet only 4.2 gallons (15.9 liters) of fluid are needed to get all the benefits Deep-Well Compact Baths offer.

Outfitted with a best-in-class temperature controller, these baths deliver the performance you need for confidence in your calibrations. The Model 7381 ( $-80\text{ }^{\circ}\text{C}$  to  $110\text{ }^{\circ}\text{C}$ ) features both stability and uniformity better than  $\pm 0.007\text{ }^{\circ}\text{C}$  over its entire range. The Models 7341 and 7321 ( $-40\text{ }^{\circ}\text{C}$  to  $150\text{ }^{\circ}\text{C}$  and  $-20\text{ }^{\circ}\text{C}$  to  $150\text{ }^{\circ}\text{C}$ , respectively) are stable to  $\pm 0.005\text{ }^{\circ}\text{C}$  and uniform to  $\pm 0.007\text{ }^{\circ}\text{C}$  at temperatures below ambient. And the Model 6331 provides stability and uniformity from  $\pm 0.007\text{ }^{\circ}\text{C}$  to  $\pm 0.025\text{ }^{\circ}\text{C}$  over its range from  $40\text{ }^{\circ}\text{C}$  to  $300\text{ }^{\circ}\text{C}$ .

Be sure to understand the performance of the temperature calibration equipment you buy. Some manufacturers offer only limited (and often difficult to interpret) specifications. The table at right includes stability and uniformity values for the entire range of each bath – and tells you what fluid we used in the measurements. If that's still not enough, give us a call

and we'll be happy to explain anything – and share data with you.

The control system automatically adds refrigeration when you need to cool down quickly, and shuts down refrigeration when you need to heat up quickly. For maximum stability, refrigeration levels are automatically balanced to match the set-point temperature you're working at.

Connect any of these baths to a Hart thermometer readout and industry-leading MET/TEMP II temperature calibration software, and you'll be performing automated probe calibrations within minutes from switch-on.

Want to optimize your bath for calibrating liquid-in-glass thermometers? With the optional LIG Thermometer Calibration Kit, you get an easy-to-install fluid level adapter tube that raises the meniscus of the bath fluid to within about 0.5 inches of the top surface of the bath itself. The kit also includes a thermometer carousel that fits onto the top of the fluid level adapter tube and holds up to ten LIG thermometers in place. A magnifying scope (8X) is also available that mounts to the front of any Deep-Well Compact Bath so you can clearly see the liquid level of your thermometer against its temperature scale.

Like all of our baths, these units come with a report of test that includes one hour of stability data and a verification of set-point accuracy. A convenient overflow reservoir captures any excess fluid resulting from fluid expansion, allowing the trapped fluid to be reused following subsequent fluid contraction. A drain is also provided for easily emptying the bath's tank when needed.

## Specifications

	6331	7321	7341	7381
Range	40 °C to 300 °C	-20 °C to 150 °C	-40 °C to 150 °C	-80 °C to 110 °C
Stability	± 0.007 °C at 100 °C (oil 5012) ± 0.010 °C at 200 °C (oil 5017) ± 0.015 °C at 300 °C (oil 5017)	± 0.005 °C at -20 °C (ethanol) ± 0.005 °C at 25 °C (water) ± 0.007 °C at 150 °C (oil 5012)	± 0.005 °C at -40 °C (ethanol) ± 0.005 °C at 25 °C (water) ± 0.007 °C at 150 °C (oil 5012)	± 0.006 °C at -80 °C (ethanol) ± 0.005 °C at 0 °C (ethanol) ± 0.005 °C at 100 °C (oil 5012)
Uniformity	± 0.007 °C at 100 °C (oil 5012) ± 0.017 °C at 200 °C (oil 5017) ± 0.025 °C at 300 °C (oil 5017)	± 0.007 °C at -20 °C (ethanol) ± 0.007 °C at 25 °C (water) ± 0.010 °C at 150 °C (oil 5012)	± 0.007 °C at -40 °C (ethanol) ± 0.007 °C at 25 °C (water) ± 0.010 °C at 150 °C (oil 5012)	± 0.007 °C at -80 °C (ethanol) ± 0.007 °C at 0 °C (ethanol) ± 0.007 °C at 100 °C (oil 5012)
Heating time†	130 min, from 40 °C to 300 °C (oil 5017)	120 min, from 25 °C to 150 °C (oil 5012)	120 min, from 25 °C to 150 °C (oil 5012)	60 min, from 25 °C to 100 °C (oil 5012)
Cooling time†	14 hr, from 300 °C to 100 °C (oil 5017)	110 min, from 25 °C to -20 °C (ethanol)	120 min, from 25 °C to -40 °C (ethanol)	6 hr, from 25 °C to -80 °C (ethanol)
Stabilization time	15 to 20 minutes			
Temperature setting	Digital display with push-button data entry			
Set-point resolution	0.01 °; 0.00018 ° in high-resolution mode			
Display resolution	0.01 °			
Digital setting accuracy	± 1 °C			
Digital setting repeatability	± 0.01 °C			
Access opening	120 x 172 mm (4.7 x 6.8 in)			
Depth	457 mm (18 in) without Liquid-in-Glass Thermometer Cal Kit 482 mm (19 in) with Liquid-in-Glass Thermometer Cal Kit			
Wetted parts	304 stainless steel			
Power†	115 V ac (± 10 %), 50/60 Hz, 15 A or 230 V ac (± 10 %), 50/60 Hz, 8 A, specify	115 V ac (± 10 %), 60 Hz, 14 A or 230 V ac (± 10 %), 50 Hz, 7 A, specify	115 V ac (± 10 %), 60 Hz, 16 A or 230 V ac (± 10 %), 50 Hz, 8 A, specify	230 V ac (± 10 %), 50 or 60 Hz, specify, 10 A
Volume	15.9 liters (4.2 gallons)			
Size (WxDxH)	356 x 788 x 1067 mm (940 mm from floor to tank access opening) (14 x 31 x 42 in) (37 in from floor to tank access opening)			
Weight	33 kg (72 lb)	47 kg (103 lb)	48 kg (105 lb)	76 kg (167 lb)
Automation package	Interface-it software and RS-232 included (IEEE-488 optional)			
Calibration	Baths are supplied with stability test data			

†Rated at nominal 115 V (or optional 230 V).

## Ordering Information

## Models

6331 Deep Compact Bath,  
40 °C to 300 °C7321 Deep Compact Bath,  
-20 °C to 150 °C7341 Deep Compact Bath,  
-40 °C to 150 °C7381 Deep Compact Bath,  
-80 °C to 110 °COptions and  
Accessories2012-DCB Spare Access Cover,  
Plastic, 7321, 7341, 73812020-6331 Spare Access Cover,  
Stainless Steel, 63312019-DCB Liquid-in-Glass  
Thermometer Calibration Kit  
(includes both adapter tube and  
thermometer carousel)2069 8X Magnifier Scope,  
with mounts

2001-IEEE IEEE-488 Interface

# 7060, 7080, and 7100 Really Cold Baths

riešenia na presné meranie

www.elseo.sk/Fluke-Calibration

## Baths

Chill to  $-40$ ,  $-60$ , or  $-100$  °C without external coolants



- Self-contained refrigeration — no LN<sub>2</sub> or chiller required
- Temperatures as low as  $-100$  °C in real metrology baths
- Best stability and uniformity available at  $-60$  °C and below
- Large working areas for increased throughput

## Tech Tip

Condensed moisture can cause problems at temperatures below ambient. You can reduce moisture by:

- Using a cover over the access opening
- Supplying dry air to build a positive pressure in the bath
- Periodically boil off water or replace the fluid

The 7060, 7080 and 7100 baths are completely self-contained. They require no auxiliary cooling fluids or devices to achieve their set-point temperatures. Using Hart's unique "heat-port" design, stability at  $-100$  °C is  $\pm 0.003$  °C.

Automate each of these baths with an interface package and 9930 Interface-*it* software. Or use MET/TEMP II software to completely automate the entire calibration process.

## Specifications

	7060	7080	7100
Range	-60 °C to 110 °C	-80 °C to 110 °C	-100 °C to 110 °C
Stability	± 0.0025 °C at -60 °C (methanol) ± 0.002 °C at 0 °C (methanol) ± 0.0015 °C at 25 °C (water) ± 0.003 °C at 100 °C (oil 5012)	± 0.0025 °C at -80 °C (methanol) ± 0.0015 °C at 0 °C (methanol) ± 0.0015 °C at 25 °C (water) ± 0.003 °C at 100 °C (oil 5012)	± 0.003 °C at -100 °C (methanol)
Uniformity	± 0.005 °C at -60 °C (methanol) ± 0.005 °C at 0 °C (methanol) ± 0.003 °C at 25 °C (water) ± 0.005 °C at 100 °C (oil 5012)	± 0.007 °C at -80 °C (methanol) ± 0.005 °C at 0 °C (methanol) ± 0.003 °C at 25 °C (water) ± 0.005 °C at 100 °C (oil 5012)	± 0.005 °C at -100 °C (methanol)
Temperature setting	Digital display with push-button data entry		
Set-point resolution	0.01 °C; high-resolution mode, 0.00007 °C		
Display resolution	0.01 °C		
Digital setting accuracy	± 1 °C		
Digital setting repeatability	± 0.01 °C		
Heaters	500 and 1000 Watts		350 and 700 Watts
Access opening (call for custom sizes)	127 x 254 mm (5 x 10 in)		98 mm diameter (3.8 in)
Depth	305 mm (12 in)		406 mm (16 in)
Wetted parts	304 stainless steel		
Power	230 V ac (± 10 %), 50 or 60 Hz, 13 A, single phase, specify frequency		230 V ac (± 10 %), 50 or 60 Hz, 12 A, specify frequency
Volume	27 liters (7.2 gallons)		18 liters (4.8 gallons)
Weight	159 kg (350 lb)		182 kg (400 lb)
Size (HxWxD)	1168 x 775 x 483 mm (46 x 30.5 x 19 in)		1270 x 813 x 483 mm (50 x 32 x 19 in)
Automation package	Interface-It software and an RS-232 computer interface are available for setting the bath temperature via an external computer. For IEEE-488, add 2001-IEEE to the automation package.		
Calibration	Baths are supplied with stability test data		

### Ordering Information

#### Models

**7060** Standard Bath,  
-60 °C to 110 °C

**7080** Standard Bath,  
-80 °C to 110 °C

**7100** Standard Bath,  
-100 °C to 110 °C

#### Options and Accessories

**2001-7060** Automation Package  
for 7060

**2001-7080** Automation Package  
for 7080

**2001-7100** Automation Package  
for 7100

**2001-IEEE** Add for IEEE-488  
(requires Automation Package)

**2010** Access Cover, 5 in x 10 in,  
Lexan

**2007** Access Cover, 5 in x 10 in,  
Stainless Steel

**2011** Access Cover, 7.25 in x  
12.75 in, Lexan

**2009** Access Cover, 7.25 in x  
12.75 in, Stainless Steel

**2016-7060** Fluid Level Adapter,  
7060

**2016-7080** Fluid Level Adapter,  
7080

**2019-7100** Fluid Level Adapter,  
7100

**2069** 8X Magnifier Scope, with  
mounts

**2030** Fast Start Cooler

# 7008, 7011, 7012, 7037, 7040 Cold Baths

riešenia na presné meranie

[www.elseo.sk/Fluke-Calibration](http://www.elseo.sk/Fluke-Calibration)

## Baths

Wide selection, with the best digital temperature control available



7037

- Stability to  $\pm 0.0007$  °C
- Best digital temperature controller available
- “Super Tweak” function provides set-point resolution to  $0.00003$  °C
- Excellent for maintaining fixed-point cells

These six baths operate at temperatures as low as  $-40$  °C, and each one is built using CFC-free refrigerants. Hart’s proprietary controller design and unique tank construction produce bath stabilities to  $\pm 0.001$  °C or better. These baths are so stable and uniform that national labs use them for comparison calibrations and fixed-point cell maintenance.

Each bath (except the 7011) can be fully automated with a bath interface package and Hart’s MET/TEMP II automation software. Automation is done completely with computer-controlled solenoid valves for precision balancing of the heating and cooling system. MET/TEMP II performs all calibration tasks automatically, using your PC.

Hart cold baths do not require external coolants. Internal refrigeration systems are all that’s needed to reach each bath’s coldest temperature. Most cold baths may be ordered with an optional pumping lid for supplying external cooling requirements.

Each bath has unique characteristics that make it perfect for specific jobs. Some baths are excellent for SPRTs, some are great with thermistors, and some are perfect for maintaining triple point of water cells. A 7008IR bath can even be used to maintain the temperature of a blackbody cone.

Regardless of your application, Hart has a bath that gets the job done.

## Specifications

	7008	7040	7037	7012	7011
Range	-5 °C to 110 °C	-40 °C to 110 °C		-10 °C to 110 °C	
Stability	± 0.0007 °C at 25 °C (water) ± 0.001 °C at 25 °C (mineral oil)	± 0.002 °C at -40 °C (ethanol) ± 0.0015 °C at 25 °C (water) ± 0.003 °C at 100 °C (oil 5012)		± 0.0008 °C at 0 °C (ethanol) ± 0.0008 °C at 25 °C (water) ± 0.003 °C at 100 °C (oil 5012)	
Uniformity	± 0.003 °C at 25 °C (water) ± 0.004 °C at 25 °C (mineral oil)	± 0.004 °C at -40 °C (ethanol) ± 0.002 °C at 25 °C (water) ± 0.004 °C at 100 °C (oil 5012)		± 0.003 °C at 0 °C (ethanol) ± 0.002 °C at 25 °C (water) ± 0.004 °C at 100 °C (oil 5012)	
Temperature setting	Digital display with push-button data entry				
Set-point resolution	0.002 °C; high-resolution mode, 0.00003 °C	0.01 °C; high-resolution mode, 0.00007 °C		0.002 °C; high-resolution mode, 0.00003 °C	
Display resolution	0.01 °C				
Digital setting accuracy	± 1 °C				
Digital setting repeatability	± 0.01 °C			± 0.005 °C	
Heaters	500 and 1000 Watts				
Access opening (call for customs)	324 x 184 mm (12.75 x 7.25 in)	127 x 254 mm (5 x 10 in)	162 x 292 mm (6.38 x 11.5 in)	127 x 254 mm (5 in x 10 in)	
Depth	331 mm (13 in)	305 mm (12 in)	457 mm (18 in)	305 mm (12 in)	
Wetted parts	304 stainless steel				
Power	115 V ac (± 10 %), 60 Hz, 14 A or 230 V ac, 50 or 60 Hz, 8 A, specify	115 V ac (± 10 %), 60 Hz, 16 A or 230 V ac (± 10 %), 50 or 60 Hz, 9 A (specify voltage and frequency)		115 V ac (± 10 %), 60 Hz, 14 A or 230 VAC (±10 %), 50 Hz, 7 A, specify	
Volume	42 liters (11.2 gallons)	27 liters (7.2 gallons)	42 liters (11.2 gallons)	27 liters (7.2 gallons)	
Weight	61 kg (135 lb)	63.5 kg (140 lb)	68 kg (150 lb)	56.7 kg (125 lb)	
Size (HxWxD)	610 x 775 x 483 mm (24 x 30.5 x 19 in)	622 x 768 x 483 mm (24.5 x 30.25 x 19 in)	775 x 768 x 483 mm (30.5 x 30.25 x 19 in)	762 x 686 x 401 mm (30 x 27 x 15.8 in)	559 x 686 x 401 mm (22 x 27 x 15.8 in)
Automation package	Interface- <i>it</i> software and RS-232 computer interface are available for setting the bath temperature via an external computer. For IEEE-488, add the 2001-IEEE to the automation package. (Interfaces not available for Model 7011.)				
Calibration	Baths are supplied with stability test data				

### Ordering Information

#### Models

**7008** Standard Bath, -5 °C to 110 °C, High Capacity

**7011** Standard Bath, -10 °C to 110 °C

**7012** Standard Bath, -10 °C to 110 °C, deep

**7037** Standard Bath, -40 °C to 110 °C, deep

**7040** Standard Bath, -40 °C to 110 °C

#### Options and Accessories

**2001-IEEE** Add for IEEE-488 (requires Automation Package)

**2007** Access Cover, 5 in x 10 in, Stainless Steel (7011, 7037, 7040)

**2010** Access Cover, 5 in x 10 in, Lexan (7011, 7037, 7040)

**2011** Access Cover, 7.25 in x 12.75 in, Lexan (7008)

**2016-7008** Fluid Level Adapter, 7008

**2016-7011** Fluid Level Adapter, 7011

**2016-7012** Fluid Level Adapter, 7012

**2016-7037** Fluid Level Adapter, 7037

**2016-7040** Fluke Level Adapter, 7040

**2071** Bath Cart, 7011, 7012 (12.3 in H)

**2073** Bath Cart, 7008, 7037, 7040 (8.5 in H)

**2027-5901** TPW Holding Fixture (7012, 7037)

**2027-5903** Galium Cell Holding Fixture (7012)

**2069** 8X Magnifier Scope, with Mounts

**70081R** 7008, modified to accept an IR Cone

**2033** IR Cone (NIST design)

#### Software

**2001-7008** Automation Package for 7008

**2001-7012** Automation Package for 7012

**2001-7037** Automation Package for 7037

**2001-7040** Automation Package for 7040

**MET/TEMP II** Automation Software

# 6020, 6022, 6024 Hot Baths

riešenia na presné meranie

[www.elseo.sk/Fluke-Calibration](http://www.elseo.sk/Fluke-Calibration)

## Baths

**Stable, uniform heat sources for calibrations up to 300 °C**



6022

- Large-capacity tanks for higher productivity
- Calibrations up to 300 °C
- Built-in cooling coils for extended low range
- Stability to  $\pm 0.001$  °C

Comparison calibrations require a heat source that's stable and uniform. These oil baths are stable to  $\pm 0.001$  °C and do not require calibration blocks or use of special calibration techniques to achieve that stability. The specifications of all Hart baths are "true" specifications, representing the performance you can expect to achieve in your lab under your operating conditions.

Hart baths are built using a unique tank design that guarantees the best uniformity possible in a liquid bath. This, coupled with the industry's best-performing digital bath controller, achieves uncompromised performance and ease of use.

Not only does Hart's digital controller have features like its "Super-Tweak" high-resolution mode so you can dial in the exact temperatures you want, it also lets you completely automate the calibration process using your PC and Hart's 9938 MET/TEMP II software.



## Specifications

	6020	6022	6024
Range	20 °C to 300 °C†		
Stability	± 0.001 °C at 40 °C (water) ± 0.003 °C at 100 °C (oil 5012) ± 0.005 °C at 300 °C (oil 5017)		
Uniformity	± 0.002 °C at 40 °C (water) ± 0.004 °C at 100 °C (oil 5012) ± 0.012 °C at 300 °C (oil 5017)		
Temperature setting	Digital display with push-button data entry		
Set-point resolution	0.01 °C; high-resolution mode, 0.00018 °C		
Display temperature resolution	0.01 °C		
Digital setting accuracy	± 1 °C		
Digital setting repeatability	± 0.02 °C		
Heaters	350 and 1050 watts		
Access opening (call for custom openings)	127 mm x 254 mm (5 in x 10 in)		184 x 324 mm (7.25 in x 12.75 in)
Depth	12 in (305 mm)	464 mm (18.25 in)	337 mm (13.25 in)
Wetted parts	304 stainless steel		
Power	115 V ac (± 10 %), 50/60 Hz, 10 A or 230 V ac (± 10 %), 50/60 Hz, 5 A, specify		
Volume	27 liters (7.2 gallons)	42 liters (11.2 gallons)	
Weight	32 kg (70 lb)	36 kg (80 lb)	
Size (HxWxD)	648 x 406 x 508 mm (25.5 x 16 x 20 in)	813 x 406 x 508 mm (32 x 16 x 20 in)	699 x 483 x 584 mm (27.5 x 19 x 23 in)
Automation package	Interface- <i>it</i> software and RS-232 computer interface are available for setting bath temperature via remote computer. For IEEE-488, add the 2001-IEEE to the automation package.		
Calibration	Baths are supplied with stability test data		

†External cooling required for operation below 40 °C. Cooling coils are built into the bath walls. Tubing ports are accessible at the back of the bath for circulating chilled fluid or shop air to boost cooling.

### Ordering Information

#### Models

**6020** Standard Bath, 20 °C to 300 °C

**6022** Standard Bath, 20 °C to 300 °C, deep

**6024** Standard Bath, 20 °C to 300 °C, high capacity

#### Options and Accessories

**2001-IEEE** Add for IEEE-488 (requires Automation Package)

**2007** Access Cover, 5 in x 10 in, SST (6020, 6022)

**2009** Access Cover, 7.25 in x 12.75 in, SST (6024)

**2016-6020** Fluid Level Adapter, 6020

**2016-6022** Fluid Level Adapter, 6024

**2070** Bath Cart, 6020, 6022 (12.3 in H)

**2072** Bath Cart, 6024 (8.5 in H)

**2023** Fast-Start Heater, 16.5 in (6022)

**2024** Fast-Start Heater, 13.5 in (6020, 6024)

**2069** 8X Magnifier Scope, with Mounts

#### Software

**2001-6020** Automation Package for 6020

**2001-6022** Automation Package for 6022

**2001-6024** Automation Package for 6024

**MET/TEMP** Automation Software

# 6045, 6050H Really Hot Baths

riešenia na presné meranie

www.else.sk/Fluke-Calibration

## Baths

Designed for high-temperature calibration — up to 550 °C



6050H

- Eliminates messy sand baths
- Electronically adjustable temperature cutouts
- Stability of  $\pm 0.008$  °C at 550 °C

These models are designed for high-temperature work-up to 550 °C. Most labs use them as salt baths for calibration of thermocouples, RTDs, and SPRTs. These baths are stable to  $\pm 0.005$  °C at 300 °C.

Each bath has a drain, electronically adjustable temperature cutouts, optional floor carts, and optional automation software and interface packages. The 6050H comes with an insulated cover.

Complete automated calibration software packages are available that work with the bath interface option. The optional software is not just a data acquisition package; it actually controls the calibration, including bath temperatures.

Choose the model that most closely matches your needs. These baths are compatible with salt for higher temperatures and also with oils for lower temperatures.

Salt baths offer better performance and less mess than sand baths. SPRT comparison calibrations in a sand bath aren't reliable compared to salt bath comparisons. A complete selection of salts and fluids is available.

### 6045 Bath

This bath has a temperature range of 60 °C to 400 °C and is perfect for thermocouples and RTDs. It has a large well opening (5 by 10 inches) so you can calibrate a number of sensors at once. It's 12 inches deep and uses 27 liters of fluid.

The automation interface package gives you complete PC control of the bath, including pre-calibration setup. It's available with an RS-232 or IEEE-488 interface.

### 6050H Bath

If you need to reach the maximum temperature possible in a salt bath, the Hart 6050H goes to 550 °C and is 10 to 100 times more stable than alternative calibration devices.

It, too, is 12 inches deep and has a 5-by 10-inch well opening for easy access. Ports in the rear of the bath access cooling coils if you want to cool the bath rapidly with external fluids or air.

## Specifications

	6045	6050H
Range	60 °C to 400 °C	60 °C to 550 °C
Stability	± 0.002 °C at 100 °C (oil 5012) ± 0.005 °C at 300 °C (oil 5017) ± 0.004 °C at 400 °C (salt)	± 0.002 °C at 200 °C (salt) ± 0.004 °C at 300 °C (salt) ± 0.008 °C at 550 °C (salt)
Uniformity	± 0.004 °C at 300 °C (oil 5017) ± 0.007 °C at 400 °C (salt)	± 0.005 °C at 200 °C (salt) ± 0.020 °C at 550 °C (salt)
Temperature setting	Digital display with push-button data entry	
Set-point resolution	0.01 °C; high-resolution mode, 0.00018 °C	
Display temperature resolution	0.01 °C	
Digital setting accuracy	± 1 °C	
Digital setting repeatability	± 0.02 °C	
Heaters	350, 1000, and 1700 Watts	400, 1200, and 2000 Watts
Access opening	127 x 254 mm (5 in x 10 in)	
Depth	305 mm (12 in)	
Wetted parts	304 stainless steel	
Power	115 V ac (± 10 %), 18 A or 230 V ac (± 10 %), 9 A, specify, 50/60 Hz	230 V ac (± 10 %), 50/60 Hz, 10 A
Volume	27 liters (7.1 gallons), requires 112 lb of bath salt	
Weight	73 kg (160 lb)	82 kg (180 lb)
Size (HxWxD)	673 x 483 x 584 mm (26.5 x 19 x 23 in)	724 x 518 x 622 mm (28.5 x 20.4 x 24.5 in)
Automation package	Interface-it software and RS-232 computer interface are available for setting bath temperature via remote computer. For IEEE-488, add the 2001-IEEE to the automation package.	
Calibration	Baths are supplied with stability test data	

### Ordering Information

#### Models

**6045** Standard Bath,  
60 °C to 400 °C

**6050H** Standard Bath,  
60 °C to 550 °C

#### Options and Accessories

**2001-IEEE** Add for IEEE-488 (requires Automation Package)

**2072** Floor Cart with Casters

**2007** Access Cover, 5 in x 10 in, Stainless Steel (6045 only)

**2014** Spare Access Cover (for use with salt only, included with 6050H; optional for 6045)

**2196** Holding Fixture, 13 Probes, 5 in x 10 in

**5001** Bath Salt, 125 lb.

**2024** Fast Start Heater, 13.5 in (6045)

**2023** Fast Start Heater, 16.5 in (6050H)

**2016-6045** Fluid Level Adapter, 6045

**2016-6050H** Fluid Level Adapter, 6050H

**2069** 8X Magnifier Scope, with Mounts

#### Software

**2001-6045** Automation Package for 6045

**2001-6050** Automation Package for 6050H

# 7007, 6054, 6055 Deep-Well Baths

## Baths

**Extra-deep wells for thermometry work requiring extra tank depth and ultimate stability**



6055

- Constant liquid levels through concentric-tube design
- Special design for sighting LIG thermometers
- Depth up to 24 inches (61 cm)
- Optional interface packages control all settings

The 7007, 6054, and 6055 Deep-Well Baths have extra-deep wells for use with liquid-in-glass thermometers, SPRT calibrations, or other thermometry work requiring extra tank depth. Well depths vary from 17 to 24 inches to eliminate stem conduction effects in probes that require more than 12 inches of immersion. These baths are optimized for the visual calibration of liquid-in-glass thermometers. They were originally designed for a national standards lab.

The 7007 is designed for the temperature range of  $-5^{\circ}\text{C}$  to  $110^{\circ}\text{C}$ , has built-in refrigeration, and is 24 inches deep. The 6054 covers the temperature range of  $50^{\circ}\text{C}$  to  $300^{\circ}\text{C}$  and is also 24 inches deep. The 6055 is engineered for the temperature range of  $200^{\circ}\text{C}$  to  $550^{\circ}\text{C}$  with salt and is 17 inches deep.

The 6055 bath uses molten salts with a pumping system for maintaining the necessary consistent fluid level required for liquid-in-glass thermometer calibrations. A viewing channel is built into the top cover for a clear visual path to your glass thermometers.

The 6055 also has an optional thermometer carousel for holding several glass thermometers in the correct calibration position without exposing them to the hot

salts in the bath. The 2018 Carousel is completely constructed of stainless steel and has an elevated handle for rotating your thermometers to the viewing position.

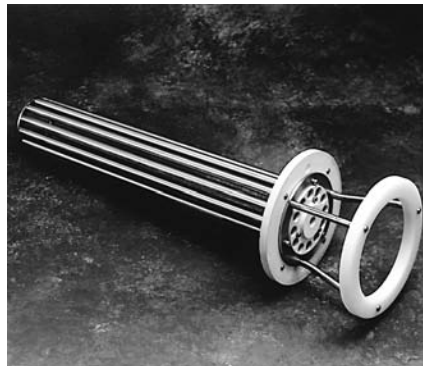

Model 2018 carousel for protecting your glass thermometers.

## Specifications

	7007	6054	6055
Range	-5 °C to 110 °C	50 °C to 300 °C	200 °C to 550 °C
Stability	± 0.001 °C at 0 °C (ethanol) ± 0.003 °C at 100 °C (oil 5012)	± 0.003 °C at 100 °C (oil 5012) ± 0.005 °C at 300 °C (oil 5017)	± 0.003 °C at 200 °C (salt) ± 0.01 °C at 550 °C (salt)
Uniformity	± 0.004 °C at 0 °C (ethanol) ± 0.007 °C at 100 °C (oil 5012)	± 0.007 °C at 100 °C (oil 5012)) ± 0.015 °C at 300 °C (oil 5017)	± 0.005 °C at 200 °C (salt) ± 0.010 °C at 550 °C (salt)
Temperature setting	Digital display with push-button data entry		
Set-point resolution	0.002 °C, high res. 0.00003 °C	0.01 °C, high res. 0.00018 °C	
Display temperature resolution	0.01 °C		
Digital setting accuracy	± 1 °C		
Digital setting repeatability	± 0.005 °C	± 0.01 °C	
Heaters	250 to 1000 W	250 to 1000 W	225 to 1800 W
Working area	178 mm diameter (7 in)	196 mm diameter (7.7 in)	107 mm diameter (4.2 in)
Depth	610 mm (24 in) deep, 7 in diameter, removable polycarbonate cover	610 mm deep (24 in), 7.7 in diameter, removable SST lid	432 mm deep (17 in), 4.2 in diameter, removable SST lid, special viewing channel for LIG sighting
Wetted parts	304 stainless steel		
Power	230 V ac (± 10 %), 50 or 60 Hz, 14 A (Specify frequency, contact Hart if CE mark required.)	230 V ac (± 10 %), 50/60 Hz, 10.7 A	230 V ac (± 10 %), 50/60 Hz, 7.8 A
Volume	42 liters (11.2 gallons)	50 liters (13.2 gallons)	19.8 liters (5.2 gallons), 95 lb. of bath salt
Size	18.5 in D x 30.5 in W x 47 in to working surface, 55 in to top of stir motor, 36 in to control panel	22.5 in D x 30 in W x 48 in to working surface, 56 in to top of stir motor box, 36 in to control panel	22.5 in D x 30.5 in W x 48 in to working surface, 60 in into top of stir motor box, 36 in to control panel
Distance from line of sight to top of fluid	9.5 mm (.375 in)	15.9 mm (.625 in)	
Automation package	Interface- <i>it</i> software and RS-232 computer interface are available for setting bath temperature via remote computer. For IEEE-488, add the 2001-IEEE to the automaton package.		
Calibration	Baths are supplied with stability test data		

### Ordering Information

#### Models

**7007** Refrigerated Deep-Well Bath

**6054** Mid-Range Deep-Well Bath

**6055** Hi-Temp Deep-Well Bath

#### Options and

#### Accessories

**2001-IEEE** Add for IEEE-488  
(requires Automation Package)

**2018** Carousel Holding Fixture  
for 6055

**2069** LIG Telescope with  
Mounting, 8X magnification

#### Software

**2001-7007** Automation Package  
for 7007

**2001-6054** Automation Package  
for 6054

**2001-6055** Automation Package  
for 6055

### Three size options for any quantity of resistors



7108

- Stability to  $\pm 0.0007$  °C
- Set-point resolution to 0.00003 °C
- Minimal long-term drift

No other baths limit long-term and short-term drift—as well as gradients—better than these baths. Hart's proprietary controller senses temperature changes as small as 0.00001 °C. Each bath can be delivered with any size resistor rack you want (a standard model is included with each bath), and the 7015 has several other special features that make your work easier.

#### 7015 Bath

The Model 7015 has a 95-liter tank and a temperature range of 0 °C to 110 °C. It is stable to  $\pm 0.0007$  °C. It has a one-piece stainless steel lid designed to drain spills and splashes back into the bath as you remove resistors. It has a large access opening to make handling large resistors, like the Thomas Design Standard resistors, easier. The tank has an electrically isolated resistor shelf.

#### 7009 Bath

This is a large bath with a tank 27½ inches long by 22 inches wide. It has a temperature range of 0 °C to 110 °C and a stability of  $\pm 0.0007$  °C. The 7009's tank can handle many resistors of any size.

#### 7108 Bath

The 7108 uses thermoelectric (Peltier) modules to provide heating and cooling over its range from 20 °C to 30 °C. Without a compressor, noise is dramatically reduced. Power requirements are also lower, so you save money running the bath and add less heat load to your lab.

With a 13.2-gallon (51-liter) tank, the 7108 holds a large number of resistors. A large 14 x 14 inch (356 x 356 mm) access opening allows you to move resistors in and out of the bath easily. A resistor rack that fits across the bottom of the tank comes with each unit. Made from hard-anodized perforated aluminum, this rack maintains the necessary electrical isolation between your resistors.

## Specifications

	7015	7009	7108
Range	0 °C to 110 °C	0 °C to 110 °C	20 °C to 30 °C
Stability at 25 °C	± 0.0007 °C (water) ± 0.001 °C (mineral oil 5011)		± 0.002 °C (water) ± 0.004 °C (mineral oil 5011)
Uniformity	± 0.003 °C at 25 °C (water) ± 0.005 °C at 25 °C (mineral oil 5011)		± 0.005 °C (water) ± 0.008 °C (mineral oil 5011)
Temperature setting	Digital display with push-button data entry		
Set-point resolution	0.002 °C; high-resolution mode, 0.00003 °C		
Display resolution	0.01 °C		
Digital setting accuracy	± 1 °C		± 0.5 °C
Digital setting repeatability	± 0.01 °C		
Heaters	500 and 1000 Watts		Peltier heating/cooling
Cooling capacity	100 to 200 Watts		100 W in ambient 23 °C
Access opening	699 x 279 mm (27.5 in x 11 in)	669 x 559 mm (27.5 in x 22 in)	356 x 356 mm (14 in x 14 in)
Bath chamber dimensions (unobstructed space)	27.5 in W x 11 in H x 13 in D (3933 cubic inches)	27.5 in W x 22 in H x 13 in D (7865 cubic inches)	355 x 203 x 355 mm (14 in W x 8 in H x 14 in D)
Depth	331 mm (13 in)		203 mm (8 in)
Wetted parts	304 stainless steel		Tank: 304 stainless steel Resistor rack: hard-anodized, perforated aluminum
Safety cutout	Factory-set high temperature		N/A
Power	115 V ac (± 10 %), 60 Hz, 15 A or 230 V ac, 50 or 60 Hz, 8 A, specify	230 V ac (± 10 %), 50 or 60 Hz, 12 A (specify frequency)	115 V ac (± 10 %), 50/60 Hz, 3 A or 230 V ac (± 10 %), 50/60 Hz, 1.6 A, specify
Volume	95 liters (25 gallons)	167 liters (44 gallons)	51 liters (13.2 gallons)
Weight	141 kg (310 lb)	150 kg (330 lb)	35 kg (75 lb)
Size (HxWxD)	1219 x 1118 x 559 mm (48 x 44 x 22 in)	1092 x 1130 x 864 mm (43 x 44.5 x 34 in)	489 x 413 x 559 mm (19.25 x 22 x 25 in)
Automation package	Interface- <i>it</i> software and RS-232 computer interface are available for setting the bath temperature via an external computer. (Both come standard with a 7108.) For IEEE-488, add the 2001-IEEE to the automation package.		
Calibration	Baths are supplied with stability test data		

## Ordering Information

### Models

**7015** Resistor Bath

**7009** Resistor Bath,  
High Capacity

**7108** Resistor Bath,  
Peltier-Cooled, includes RS-232

### Options and Accessories

**2001-IEEE** Add for IEEE-488  
(requires Automation Package)

**5011** Mineral Oil

### Software

**2001-7015** Automation Package  
for 7015

**2001-7009** Automation Package  
for 7009

# Bath Fluids

## Baths

Full line of bath fluids covering temperature ranges from  $-100\text{ }^{\circ}\text{C}$  to  $550\text{ }^{\circ}\text{C}$



Viscosity, volatility, and other properties that change with temperature affect the performance of fluids in controlled baths and circulators. Thorough testing has been conducted on each of the fluids we sell. Over the ranges recommended in the following table, each fluid remains at a low enough viscosity to be adequately pumped or stirred. Whether your application is industrial or critical lab calibration work, these fluids give you top performance and stability.

For temperature ranges too high for oils, we have a bath salt with a viscosity in the molten state similar to the viscosity of water. For your convenience, it is shipped in a granular form, making it easy to fill your bath.

Between  $180\text{ }^{\circ}\text{C}$  and  $550\text{ }^{\circ}\text{C}$ , this salt has the highest temperature stability and uniformity available in a bath fluid. It does not smoke like oils or give off dust like "sand" or fluidized alumina baths. Check with your bath manufacturer before using this salt to make sure your equipment is compatible. We offer three standard bath models and custom-designed units for use with this salt.

### Fluid specifications

It's important to understand a few specifications before selecting a bath fluid. For example, type 710 silicone oil has a freezing point of  $-22\text{ }^{\circ}\text{C}$ , but freezing point has nothing to do with the point at which the oil becomes so thick it cannot be properly stirred. Type 710 oil should really only be used down to about  $80\text{ }^{\circ}\text{C}$ . It's a

viscosity issue, not a freezing-point issue. Usable range is the question. Suitability for calibration work is the specification that counts.

The usable viscosity range is determined by your bath's stirring or pumping design. Hart baths can be operated using fluids with up to 50 centistokes viscosity, which gives you additional usable range in the lower temperature levels of the fluid.

Some baths advertised as calibration baths require fluids with 10 centistokes or less viscosity to operate properly. The usable ranges in our table on the previous page assume the use of a Hart bath.

In addition to range and viscosity issues, there are a number of other issues to consider when choosing a bath fluid. The other considerations are:

- Thermal characteristics
- Lifetime
- Change in characteristics due to temperature cycling
- Absorption of water from the air
- Vaporization-fumes and fume hood requirements
- Expansion due to heat
- Contamination-mixing oils or introducing contamination with unclean probes
- Conductivity properties
- Effects of using fluids outside of their range-fire, explosion, polymerization
- Effects of altitude on boiling point



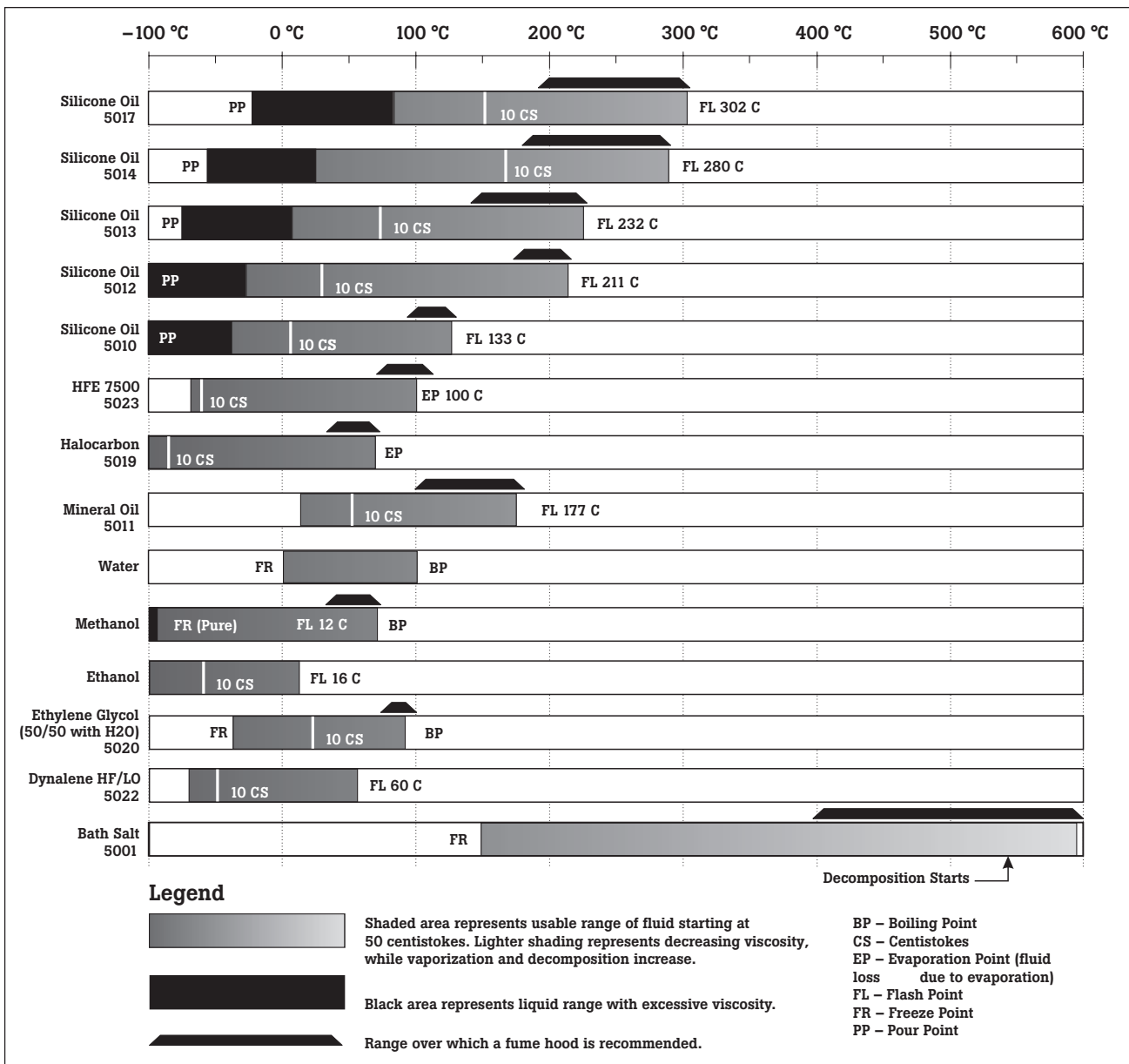

## Ordering Information

Model Number	Fluid	Usable Range <sup>[1]</sup>	Flash Point <sup>[2]</sup>
5019	Holocarbon 0.8 Cold Bath Fluid	-100 °C to 70 °C	N/A
5022	Dynalene HF/LO <sup>[3]</sup>	-65 °C to 58 °C	60 °C
5023	HFE Cold Bath Fluid	-75 °C to 100 °C	N/A
5020	Ethylene Glycol (Mix 1:1 with water)	-30 °C to 90 °C	N/A
5010	Silicone Oil Type 200.05	-40 °C to 130 °C	133 °C
5012	Silicone Oil Type 200.10	-30 °C to 209 °C	211 °C
5013	Silicone Oil Type 200.20	10 °C to 230 °C	232 °C
5014	Silicone Oil Type 200.50	30 °C to 278 °C	280 °C
5017	Silicone Oil Type 710	80 °C to 300 °C	302 °C
5011	Mineral Oil	10 °C to 175 °C	177 °C
5001	Bath Salt, 125 lb <sup>[4]</sup> (potassium nitrate 53 %, sodium nitrite 40 %, sodium nitrate 7 %)	180 °C to 550 °C	N/A

<sup>[1]</sup> Atmospheric pressure affects the usable ranges of some fluids. The temperatures quoted are at sea level.

<sup>[2]</sup> Flash point is the temperature at which a vapor (not the fluid) will ignite if exposed to an open flame. When the flame is removed, the vapor will stop burning. (Open cup method.)

<sup>[3]</sup> Electrical resistivity is greater than 20 MΩ-cm.

<sup>[4]</sup> 125 lb bath salt fills a 7.90-gallon tank.

MSDS available at [www.hartscientific.com](http://www.hartscientific.com)

# Bath Accessories

## Baths

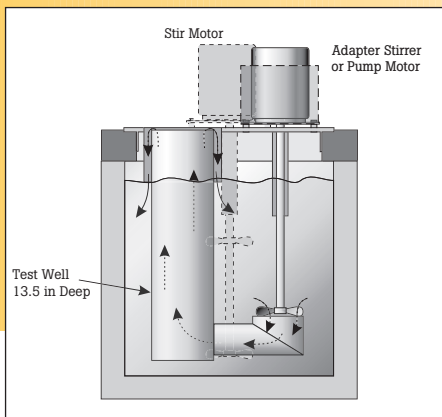
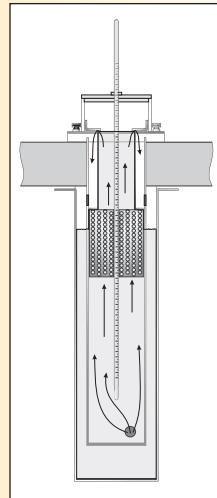
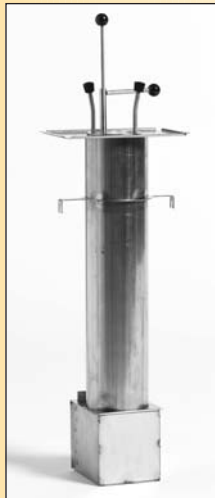
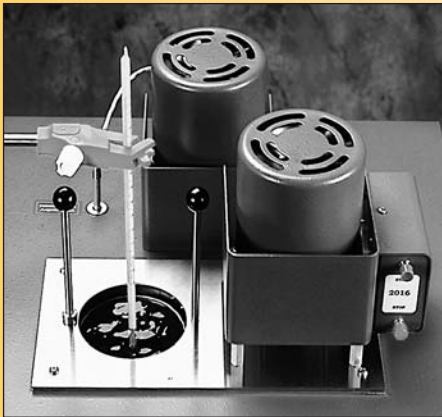

### 2016 Fluid Level Adapter

Add this accessory to your Hart bath for easy calibration of liquid-in-glass thermometers. This fluid level adapter fits in the access opening of your bath. It includes a pump and a cylindrical test well. Bath fluid is pumped up through the test well to a level just below the surface of the bath lid, giving you a clear sighting of the liquid column in your thermometer. The diameter of the test well is 3.5 inches. The adapter can be placed in your bath or easily removed with no complex installation assembly – simply plug it in.

### 2019 Fluid Level Adapter

The 2019 fluid level adapter slides directly into the test wells of the 7030, 7013, and 7100 calibration baths, for glass thermometer calibration applications.

The fluid level adapter creates a positive bath fluid surface. The bath fluid in the test well is pumped up to the surface of the bath and kept there. This puts the glass thermometer meniscus above the edge of the bath test well for clear viewing during calibration. The clear acrylic adapter cover protects the bath fluid from ambient temperature effects for better bath stability. The cover can be drilled for any size probe. The adapter is easily pulled from the bath test well to allow more room during calibration of other thermometers and sensors.

### 2069 Magnifying Scope

Using a magnifying scope when calibrating liquid-in-glass thermometers can lower your uncertainty by enlarging the thermometer's scale and providing improved viewing resolution. This inexpensive model mounts easily to the front of any Hart standard bath or deep-well compact bath and can be used in conjunction with a fluid level adapter for optimal viewing.

### Ordering Information

#### Models

2016-X Fluid Level Adapter

2017 LIG Thermometer Holder for 2016-X, holds 10 thermometers

2019-7030 Fluid Level Adapter, 7030

2019-7013 Fluid Level Adapter, 7013

2019-7100 Fluid Level Adapter, 7100

2069 8X Magnifier Scope, with Mounts

X = bath model number. Specify the bath model, its power requirements, and dimensions of its access opening.

### Micro-Baths

Model	Range	Accuracy	Description
6102 Micro-Bath	35 °C to 200 °C 95 °F to 392 °F	± 0.25 °C	World's smallest calibration bath. Stability to ± 0.02 °C. Stirred 2.5-inch-diameter tank.
7102 Micro-Bath	-5 °C to 125 °C 23 °F to 257 °F	± 0.25 °C	Portable bath to -5 °C. No refrigeration – solid-state cooling. Stability to ± 0.015 °C.
7103 Micro-Bath	-30 °C to 125 °C -22 °F to 257 °F	± 0.25 °C	Ultracold Micro-Bath reaches -30 °C. No refrigeration or external cooling needed. Stability to ± 0.03 °C.

### Handheld Dry-Wells

Model	Range	Accuracy	Description
9100S Handheld Dry-Well	35 °C to 375 °C 95 °F to 707 °F	± 0.25 °C at 100 °C ± 0.5 °C at 375 °C	World's smallest dry-well. Fixed block with 4-inch well depth. Four hole patterns available.
9102S Handheld Dry-Well	-10 °C to 122 °C 14 °F to 252 °F	± 0.5 °C	Handheld unit cools to -10 °C. Two 0.5-inch diameter, removable sleeves.

### Field Dry-Wells

Model	Range	Accuracy	Description
9009 Dual-Block Calibrator	-15 °C to 350 °C 5 °F to 662 °F	Cold block: ± 0.2 °C Hot block: ± 0.6 °C	Dual-block industrial dry-well. Each block has two wells with removable sleeves. Water- and air-tight enclosure.
9103 Field Dry-Well	-25 °C to 140 °C -13 °F to 284 °F	± 0.25 °C	Small, lightweight field calibrator reaches -25 °C. Stability to ± 0.02 °C. Calibrates up to six probes at once.
9140 Field Dry-Well	35 °C to 350 °C 95 °F to 662 °F	± 0.5 °C	Portable field calibrator. Choose from four multi-hole, removable inserts.
9141 Field Dry-Well	50 °C to 650 °C 122 °F to 1202 °F	± 0.5 °C to 400 °C ± 1 °C to 650 °C	High-temp field calibrator. Interface- <i>it</i> software and RS-232 included. Extremely small and fast for temperature range.

### Infrared Calibrators

Model	Range	Accuracy	Description
9132	50 °C to 500 °C 122 °F to 932 °F	± 0.5 °C at 100 °C ± 0.8 °C at 500 °C	Certifies most handheld pyrometers. Short heating and cooling times.
9133	-30 °C to 150 °C -22 °F to 302 °F	± 0.4 °C	Calibrates at cold temperatures. Gets to desired temperature quickly.



Fluke offers many practical solutions for calibrating all kinds of industrial temperature sensors. Proprietary Hart Scientific controllers provide the most stable and accurate temperatures available, over wide temperature ranges. Portable dry-wells, including the smallest handheld models available today, are designed to be carried to the test site. Lab, field, and handheld dry-wells cover temperatures from -45 °C to 1200 °C with world-class stability. Portable micro-baths can help you achieve the lowest uncertainties while calibrating even the most oddly shaped industrial thermometers. We also offer blackbody pyrometer calibrators, zero-point dry-wells, horizontal thermocouple furnaces, surface sensor calibrators, and much more.

### Laboratory Dry-Well

Model	Range	Accuracy	Description
9105 Low-Temp Dry-Well	-25 °C to 140 °C -13 °F to 284 °F	± 0.1 °C	Resolution: 0.01 °C, stability: ± 0.01 °C. Heats or cools in less than 15 minutes. Four fixed wells, 6 inches deep, plus one well with interchangeable inserts.
9107 -45 °C Dry-Well	-45 °C to 140 °C -49 °F to 284 °F	± 0.1 °C	Reaches -45 °C without aid from refrigeration, external cooling, or low ambient temperatures. Resolution: 0.01 °C, stability: ± 0.005 °C at 0 °C. Four fixed wells, 6 inches deep, plus one well with interchangeable inserts.
9122A High-Capacity Dry-Well	50 °C to 700 °C 122 °F to 1292 °F	± 0.1 °C at 100 °C ± 0.3 °C at 660 °C	Calibrates nine probes at once. Five fixed holes, four inserts, 150 mm (6 in) deep. Resolution: 0.01 °C, stability: ± 0.02 °C at 300 °C. Ramp and soak programming.
9127 High-Speed Dry-Well	35 °C to 600 °C 95 °F to 1112 °F	± 0.1 °C at 100 °C ± 0.5 °C at 600 °C	Heats to 100 °C in 6 min., 600 °C in 30 min. Choose from four removable, multi-hole inserts. Calibrates up to eight probes at once.
9101 Zero-Point Dry-Well	0 °C 32 °F	± 0.05 °C	Resolution: 0.01 °C, stability: ± 0.05 °C at 600 °C. Solid-state cooling. Replaces messy ice baths—easy to operate. Three wells, each 6 inches deep.
9011	Hot Block	50 °C to 67 °C 122 °F to 1238 °F	Combined ranges from -30 °C to 670 °C, 1 unit – 2 blocks Two independent temperature controllers (hot and cold side) Stability: ± 0.01 °C. Multi-hole inserts hold up to 8 probes at once
	Cold Block	-30 °C to 140 °C -22 °F to 284 °F ± 0.65 °C (Fixed wells)	

### Furnaces

Model	Range	Accuracy	Description
9150 Thermocouple Furnace	150 °C to 1200 °C 302 °F to 2192 °F	± 0.5 °C	Benchtop thermocouple furnace. Interchangeable insert sleeves. Fast heating and cooling.
9112A Calibration Furnace	300 °C to 1100 °C 572 °F to 2012 °F	± 0.1 °C	Standard block fits five probes. Accommodates long probes. Gradients less than ± 0.3 °C at 1000 °C

# 6102, 7102 and 7103 Micro-Baths

riešenia na presné meranie

www.elseo.sk/Fluke-Calibration

Industrial  
Temperature  
Calibrators

FLUKE®

Hart Scientific

## Portable and extremely stable



7103

- World's smallest portable calibration baths
- Calibrates sensors of any size or shape
- Stability to  $\pm 0.015\text{ }^{\circ}\text{C}$
- Ranges from  $-30\text{ }^{\circ}\text{C}$  to  $200\text{ }^{\circ}\text{C}$

## Tech Tip

The best way to take advantage of the superior uniformity characteristics of a fluid is to use a reference thermometer! Also, avoid using odd-shaped sensors in anything but a fluid.

Micro-Baths can be used anywhere for any type of sensor. The 6102 Micro-Bath weighs less than 10 pounds with the fluid. It's lighter and smaller than most dry-wells and has a spill-proof lid. Micro-Baths can even be transported with fluid in them.

Display accuracy is  $\pm 0.25\text{ }^{\circ}\text{C}$  for quick calibrations without a reference thermometer.

With a 1.9-inch diameter, 5.5-inch deep tank, a Micro-Bath can calibrate any type of sensor including short, square, or odd-shaped sensors. The problems of fit and immersion are virtually eliminated by using a fluid medium rather than a dry-block calibrator. Micro-Baths are perfect for liquid-in-glass and bimetal thermometers.

All Micro-Baths have RS-232 ports and come with Interface-*it* software. Also included are contacts to calibrate a thermal switch, eight set-point memory storage, ramp-rate adjust and over-temperature safety cutout.



A Micro-Bath's 1.9-inch diameter tank lets you calibrate almost any size of industrial sensor.

# 6102, 7102 and 7103 Micro-Baths

riešenia na presné meranie

www.elseo.sk/Fluke-Calibration

## Industrial Temperature Calibrators

### Specifications

	6102	7102	7103
Range	35 °C to 200 °C (95 °F to 392 °F)	-5 °C to 125 °C (23 °F to 257 °F)	-30 °C to 125 °C (-22 °F to 257 °F)
Accuracy	± 0.25 °C		
Stability	± 0.02 °C at 100 °C (oil 5013) ± 0.03 °C at 200 °C (oil 5013)	± 0.015 °C at -5 °C (oil 5010) ± 0.03 °C at 121 °C (oil 5010)	± 0.03 °C at -25 °C (oil 5010) ± 0.05 °C at 125 °C (oil 5010)
Uniformity	± 0.02 °C		
Resolution	0.01 °C/F		
Operating temperature	5 °C to 45 °C		
Heating time	25 °C to 200 °C: 40 minutes	25 °C to 100 °C: 30 minutes	25 °C to 100 °C: 35 minutes
Cooling time	200 °C to 100 °C: 35 minutes	25 °C to 0 °C: 30 minutes	25 °C to -20 °C: 45 minutes
Well size	64 mm diameter x 139 mm deep (2.5 in x 5.5 in) (access opening is 48 mm [1.9 in] in diameter)		
Size (WxHxD)	14 x 26 x 20 cm (5.5 x 10.38 x 8 in)	18 x 31 x 24 cm (7.2 x 12 x 9.5 in)	23 x 34 x 26 cm (9 x 13.2 x 10.5 in)
Weight	4.5 kg (10 lb) with fluid	6.8 kg (15 lb) with fluid	9.8 kg (22 lb) with fluid
Volume	0.75 L	0.75 L	1.0 L
Power	115 V ac (± 10 %), 2.3 A or 230 V ac (± 10 %), 1.1 A, switchable, 50/60 Hz, 270 W	115 V ac (± 10 %), 1.8 A or 230 V ac (± 10 %), 0.9 A, switchable, 50/60 Hz, 200 W	94 to 234 V ac (± 10 %), 50/60 Hz, 400 W
Computer interface	RS-232 included with free Interface-it software		
NIST-traceable calibration	Data at 50 °C, 100 °C, 150 °C, and 200 °C	Data at -5 °C, 25 °C, 55 °C, 90 °C, and 121 °C	Data at -25 °C, 0 °C, 25 °C, 50 °C, 75 °C, 100 °C, and 125 °C

### Ordering Information

#### Models

**7103-156** Micro-Bath, -30 °C to 125 °C (includes a transport seal lid and a 2085 test lid), (110 V)

**7103-256** Micro-Bath, -30 °C to 125 °C (includes a transport seal lid and a 2085 test lid), (220 V)

**7102-156** Micro-Bath, -5 °C to 125 °C (includes a transport seal lid and a 2082-P test lid), (110 V)

**7102-256** Micro-Bath, -5 °C to 125 °C (includes a transport seal lid and a 2082-P test lid), (220 V)

**6102-156** Micro-Bath, 35 °C to 200 °C (includes a transport seal lid and a 2082-M test lid) (110 V)

**6102-256** Micro-Bath, 35 °C to 200 °C (includes a transport seal lid and a 2082-M test lid) (220 V)

### Options and Accessories

**2082-P** Spare Test Lid, Plastic (7102)

**2082-M** Spare Test Lid, Metal (6102)

**2085** Spare Test Lid, Plastic (7103)

**2083** 3-inch Tank Expansion Adapter for 6102 and 7102 (affects stability, uniformity and range at extreme temperatures)

**5010-L** Silicone Oil, Type 200.05, 1 liter (usable range: -40 °C to 130 °C)

**5013-L** Silicone Oil, Type 200.20, 1 liter (usable range: 10 °C to 230 °C)

**3320** Spare Stir Bar, Micro-Bath

**9317** Carrying Case for 7103

**9310** Carrying Case for 6102

**9311** Carrying Case for 7102

# 9100S and 9102S Hand-held Dry-Well Calibrators

riešenia na presné meranie

www.elseo.sk/Fluke-Calibration

Industrial  
Temperature  
Calibrators

FLUKE®

Hart Scientific

World's smallest, lightest and most portable dry-wells



9100S



9102S

- Temperature ranges from  $-10\text{ }^{\circ}\text{C}$  to  $375\text{ }^{\circ}\text{C}$
- Stability during calibrations to  $\pm 0.05\text{ }^{\circ}\text{C}$
- Fast and easy calibrations of RTDs and thermocouples
- Includes RS-232 interface, Interface-it software

## Tech Tip

Typically a one-year calibration interval is recommended for a dry-well. However, the actual need may vary, depending on how an instrument is used and handled. Best advice: start with a six-month interval and then extend it as experience permits.

### 9100S Dry-Well

Despite its small size, (2 $\frac{1}{4}$  inches high and 5 inches wide) and light weight, the 9100S outperforms every dry-well in its class in the world. It is simple and convenient, too. It has a range to  $375\text{ }^{\circ}\text{C}$  ( $707\text{ }^{\circ}\text{F}$ ) and is perfect for checking RTDs, thermocouples, and small bimetal thermometers in the field.

Plus it in, switch it on, set the temperature with the front-panel buttons, and insert your probe into the properly sized well. Compare the reading of your device to the display temperature or to an external reference, and the difference is the error in your device. With a proprietary Hart Scientific temperature controller, the 9100S has a display resolution of 0.1 degrees. Display accuracy ranges from  $\pm 0.25\text{ }^{\circ}\text{C}$  to  $\pm 0.5\text{ }^{\circ}\text{C}$ , and stability ranges from  $\pm 0.07\text{ }^{\circ}\text{C}$  to  $\pm 0.3\text{ }^{\circ}\text{C}$ , depending on set-point temperatures.

### 9102S Dry-Well

For work in the temperature range of  $-10\text{ }^{\circ}\text{C}$  to  $122\text{ }^{\circ}\text{C}$ , the 9102S dry-well is another first in the industry, featuring display accuracy of  $\pm 0.25\text{ }^{\circ}\text{C}$ . This dry-well is only four inches high and six inches wide, achieves temperatures as low as  $-10\text{ }^{\circ}\text{C}$ , includes a NIST-traceable calibration, and is stable to  $\pm 0.05\text{ }^{\circ}\text{C}$ . The 9102S is excellent for dial gauges, digital thermometers, bulb switches, and other sensors that need calibration below ambient.



Handheld block calibrators have made industrial calibrations more portable.

The 9102S has two wells so you can use one for a reference thermometer to increase accuracy. Both wells are 12.7 millimeters (1/2 inch) in diameter, and each has inserts available for almost any sensor size. The 9102S also has a battery pack option that gives you approximately four hours of field use when ac power is unavailable.

# 9100S and 9102S Hand-held Dry-Well Calibrators

riešenia na presné meranie

www.elseo.sk/Fluke-Calibration

## Industrial Temperature Calibrators

### Specifications

	9100S	9102S
Range	35 °C to 375 °C (95 °F to 707 °F)	-10 °C to 122 °C (14 °F to 252 °F) at 23 °C ambient
Accuracy	± 0.25 °C at 50 °C; ± 0.25 °C at 100 °C; ± 0.5 °C at 375 °C	± 0.25 °C
Stability	± 0.07 °C at 50 °C; ± 0.1 °C at 100 °C; ± 0.3 °C at 375 °C	± 0.05 °C
Well-to-well uniformity	± 0.2 °C with sensors of similar size at equal depths within wells	
Heating times	ambient to 375 °C: 9.5 minutes	ambient to 100 °C: 10 minutes
Stabilization	5 minutes	7 minutes
Cooling times	375 °C to 100 °C: 14 minutes	ambient to 0 °C: 10 minutes
Well depth	102 mm (4 in); 1.6 mm (1/16 in) hole is 89 mm (3.5 in) deep	102 mm (4 in)
Removable inserts	N/A	Available in sizes from 1.6 mm (1/16 in) to 11.1 mm (7/16 in), [6.4 mm (1/4 in) and 4.8 mm (3/16 in) included]
Power	115 V ac (± 10 %), 1.5 A or 230 V ac (± 10 %), 0.8 A, specify, 50/60 Hz, 175 W	94 to 234 V ac (± 10 %), 50/60 Hz, 60 W; or 12 V dc
Size (HxWxD)	57 x 125 x 150 mm (2.25 x 4.9 x 5.9 in)	99 x 140 x 175 mm (3.9 x 5.5 x 6.9 in)
Weight	1 kg (2 lb 3 oz)	1.8 kg (4 lb)
Computer interface	RS-232 included with free Interface-it software	
NIST-traceable calibration	Data at 50 °C, 100 °C, 150 °C, 200 °C, 250 °C, 300 °C, and 375 °C	Data at -10 °C, 0 °C, 25 °C, 50 °C, 75 °C, 100 °C, and 122 °C

### 9102S Calibration Wells

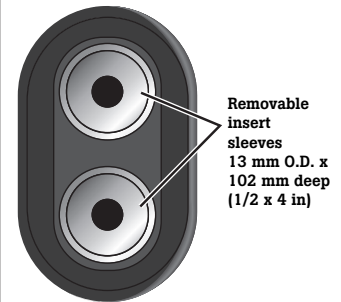

### 9100S Fixed-Block Options

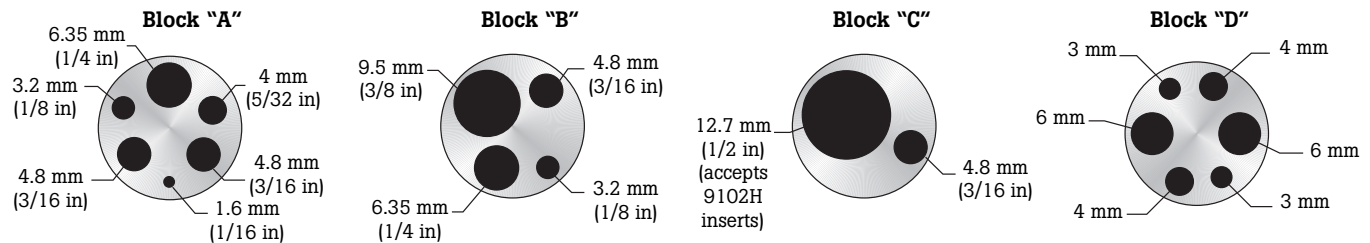

### Ordering Information

#### Models

- 9100S-A-156 Dry-Well, Block A<sup>1</sup>
- 9100S-A-256 Dry-Well, Block A<sup>2</sup>
- 9100S-B-156 Dry-Well, Block B<sup>1</sup>
- 9100S-B-256 Dry-Well, Block B<sup>2</sup>
- 9100S-C-156 Dry-Well, Block C<sup>1</sup>
- 9100S-C-256 Dry-Well, Block C<sup>2</sup>
- 9100S-D-156 Dry-Well, Block D<sup>1</sup>
- 9100S-D-256 Dry-Well, Block D<sup>2</sup>
- 9102S-156 Dry-Well, -10 to 122 (2 Wells)<sup>1</sup>
- 9102S-256 Dry-Well, -10 to 122 (2 Wells)<sup>2</sup>

### Options and Accessories

- 9300 Rugged Carrying Case, 9100S
- 9308 Hard Carrying Case, 9102
- 9320-156 Battery Pack, 9102S<sup>1</sup>
- 9320-256 Battery Pack, 9102S<sup>2</sup>
- 3102-1 Insert, AL 1/16 in (1.6 mm) (9102)
- 3102-2 Insert, AL 1/8 in (3.2 mm) (9102)
- 3102-3 Insert, AL 3/16 in (4.8 mm) (9102)
- 3102-4 Insert, AL 1/4 in (6.4 mm) (Standard, 9102)
- 3102-6 Insert, AL 3/8 in (9.5 mm) (Standard, 9102)

<sup>1</sup> 156 Blocks are 115 V 50/60 Hz  
<sup>2</sup> 256 Blocks are 220 V 50/60 Hz



# 9009 Industrial Dual-Block Calibrator

riešenia na presné meranie

www.else.sk/Fluke-Calibration

Industrial Temperature Calibrators

FLUKE®

Hart Scientific

Double your productivity or cut your calibration time in half



- Temperatures from  $-15\text{ °C}$  to  $350\text{ °C}$  in one unit
- Two wells in each block for simultaneous comparison calibrations
- Rugged, lightweight, water-resistant enclosure
- Controlled by precision Hart Scientific temperature controller

## Tech Tip

Drift of a thermometer probe, over time, can best be checked by confirming at least two temperatures – one for “zero” and one for “span.”



## 9009 Calibration Wells

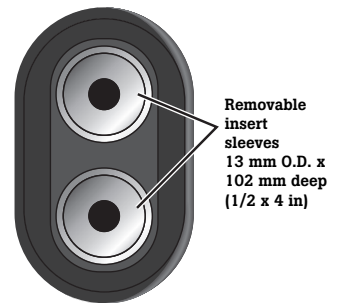

Hart's 9009 Industrial Dual-Block Calibrator lets you calibrate temperature probes from  $-15\text{ °C}$  to  $350\text{ °C}$ . Each temperature well is independently controlled, so while you're checking your transmitter sensor at one temperature, the other block can be heating or cooling to your next set-point.

Everything you need to calibrate thermometers is self-contained in a rugged, watertight case including four removable inserts, power cord, and removal tool. It's portable, covers a wide range, and – best of all – it's made by the world leader in temperature calibration.

## Specifications

	Hot Block	Cold Block
Range	$50\text{ °C}$ to $350\text{ °C}$ ( $122\text{ °F}$ to $662\text{ °F}$ )	$-15\text{ °C}$ to $110\text{ °C}$ ( $5\text{ °F}$ to $230\text{ °F}$ ) ( $-8\text{ °C}$ [ $18\text{ °F}$ ] with hot block at $350\text{ °C}$ [ $662\text{ °F}$ ])
Accuracy	$\pm 0.6\text{ °C}$	$\pm 0.2\text{ °C}$
Stability	$\pm 0.05\text{ °C}$	
Well-to-well uniformity	$\pm 0.1\text{ °C}$	
Display resolution	$0.1\text{ °}$	
Heating times	10 minutes from $25\text{ °C}$ to $350\text{ °C}$	15 minutes from $25\text{ °C}$ to $110\text{ °C}$
Cooling times	30 minutes from $350\text{ °C}$ to $100\text{ °C}$	16 minutes from $25\text{ °C}$ to $-15\text{ °C}$
Stabilization times	8 minutes	
Well depth	102 mm (4 in)	
Removable inserts	Two 6.4 mm (1/4 in) and two 4.8 mm (3/16 in) inserts included; see Ordering Information for other available inserts	
Computer interface	RS-232 included with free Interface-it software	
Power	115 V ac ( $\pm 10\%$ ), 3 A, or 230 V ac ( $\pm 10\%$ ), 2 A, specify, 50/60 Hz, 280 W	
Size (HxWxD)	178 x 267 x 248 mm (7 x 10.5 x 9.75 in)	
Weight	4.5 kg (10 lb)	
NIST-traceable calibration	Data at $50\text{ °C}$ , $100\text{ °C}$ , $150\text{ °C}$ , $200\text{ °C}$ , $250\text{ °C}$ , $300\text{ °C}$ , and $350\text{ °C}$	Data at $-8\text{ °C}$ , $0\text{ °C}$ , $25\text{ °C}$ , $50\text{ °C}$ , $75\text{ °C}$ , $100\text{ °C}$ , and $110\text{ °C}$

## Ordering Information

### Models

**9009-Y-156** Dry-Well, 110 V, Yellow Case

**9009-B-156** Dry-Well, 110 V, Black Case

**9009-Y-256** Dry-Well, 220 V, Yellow Case

**9009-B-256** Dry-Well, 220 V, Black Case

### Options and Accessories

**3102-1** Insert, AL 1.6 mm (1/16 in)

**3102-2** Insert, AL 3.2 mm (1/8 in)

**3102-3** Insert, AL 4.8 mm (3/16 in)

**3102-4** Insert, AL 6.4 mm (1/4 in)

**3102-6** Insert, AL 9.5 mm (3/8 in)

Else Philips Service, Trenčín

Temperature Calibration 151

# 9103, 9140, and 9141 Field Dry-Well

riešenia na presné meranie

www.elseo.sk/Fluke-Calibration

## Industrial Temperature Calibrators

### Great performance in portable instruments



9141

- Lightweight and portable
- Accuracy to  $\pm 0.25\text{ }^{\circ}\text{C}$
- RS-232 and Interface-*it* software included
- Easy to recalibrate and maintain

### Tech Tip

It is critical to have a well that fits your probe properly. Interchangeable inserts allow correct well size to be easily changed.

The 9103 covers below-ambient temperatures as low as  $-25\text{ }^{\circ}\text{C}$ . The 9140, weighing only six pounds, has a temperature range of  $35\text{ }^{\circ}\text{C}$  to  $350\text{ }^{\circ}\text{C}$  and reaches its maximum temperature in 12 minutes. The 9141 upright dry-well unit calibrates up to  $650\text{ }^{\circ}\text{C}$ , weighs only eight pounds and heats up to  $650\text{ }^{\circ}\text{C}$  in 12 minutes.

You can control all functions from the front panel or hook it up connect it to your PC with its built-in RS-232 port.

Each dry-well has four removable well inserts available, an optional carrying case, a NIST-traceable calibration, and the best price/performance in the industry.



Includes an RS-232 port and free Windows control software (Interface-*it*) to automate your dry-well.

### Interchangeable Insert Options

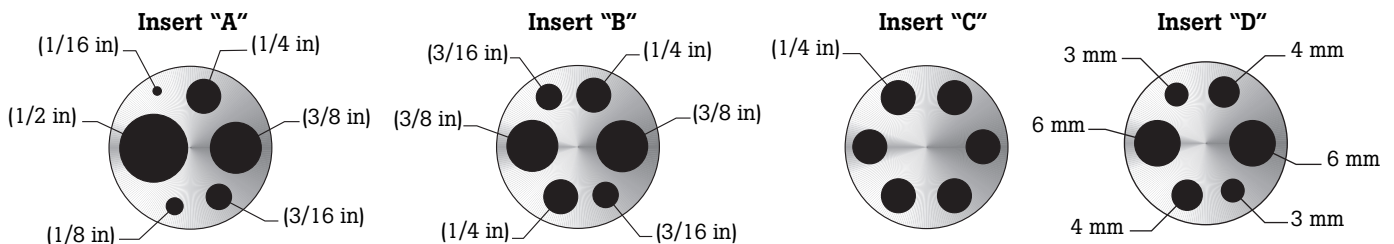

When ordering, replace the "X" with the appropriate insert letter. Order additional inserts as your applications require.

Elseo Philips Service, Trenčín

## Specifications

	9103	9140	9141
Range	-25 °C to 140 °C (-13 °F to 284 °F) at 23 °C ambient	35 °C to 350 °C (95 °F to 662 °F)	50 °C to 650 °C (122 °F to 1202 °F)
Accuracy	± 0.25 °C	± 0.5 °C (holes greater than 6.35 mm [1/4 in]: ± 1 °C)	± 0.5 °C to 400 °C; ± 1.0 °C to 650 °C (holes greater than 6.35 mm [1/4 in]: ± 2 °C)
Stability	± 0.02 °C at -25 °C, ± 0.04 °C at 140 °C	± 0.03 °C at 50 °C, ± 0.05 °C at 350 °C	± 0.05 °C at 100 °C, ± 0.12 °C at 500 °C, ± 0.12 °C at 650 °C
Well-to-well uniformity	± 0.1 °C between similarly sized wells	± 0.1 °C with similarly sized wells	± 0.1 °C below 400 °C, ± 0.5 °C above 400 °C with similarly sized wells
Heating times	18 minutes from ambient to 140 °C	12 minutes from ambient to 350 °C	12 minutes from ambient to 650 °C
Cooling times	20 minutes from ambient to -25 °C	15 minutes from 350 °C to 100 °C	25 minutes from 650 °C to 100 °C
Stabilization time	7 minutes		
Immersion depth	124 mm (4.875 in)		
Inserts	Insert A, B, C, or D included (specify when ordering)		
Outside insert dimensions	31.8 mm diameter x 124 mm length (1.25 in x 4.88 in)		28.5 mm diameter x 124 mm length (1.12 in x 4.88 in)
Computer interface	RS-232 included with free Interface-it software (Model 9930)		
Power	115 V ac (± 10 %), 1.3 A or 230 V ac (± 10 %), 0.7 A, switchable, 50/60 Hz, 150 W	115 V ac (± 10 %), 4.4 A or 230 V ac (± 10 %), 2.2 A, switchable, 50/60 Hz, 500 W	115 V ac (± 10 %), 8.8 A or 230 V ac (± 10 %), 4.4 A, switchable, 50/60 Hz, 1000 W
Size (WxHxD)	143 x 261 x 245 mm (5.63 x 10.25 x 9.63 in)	152 x 86 x 197 mm (6 x 3.375 x 7.75 in)	109 x 236 x 185 mm (4.3 x 9.3 x 7.3 in)
Weight	5.7 kg (12 lb)	2.7 kg (6 lb)	3.6 kg (8 lb)
NIST-traceable certificate	Data at -25 °C, 0 °C, 25 °C, 50 °C, 75 °C, 100 °C, and 140 °C	Data at 50 °C, 100 °C, 150 °C, 200 °C, 250 °C, 300 °C, and 350 °C	Data at 100 °C, 200 °C, 300 °C, 400 °C, 500 °C, and 600 °C



Calibrations using dry-wells can be improved by using an external reference such as the 1502A Tweener Thermometer.

## Ordering Information

### Models

**9103-X-156** Dry-Well, 110 V  
50/60 Hz (specify X, X = A, B, C,  
or D included insert), (110 V)

**9103-X-256** Dry-Well, 220 V  
50/60 Hz (specify X, X = A, B, C,  
or D included insert), (220 V)

**9140-X-156** Dry-Well, 110 V  
50/60 Hz (specify X, X = A, B, C,  
or D included insert), (110 V)

**9140-X-256** Dry-Well, 220 V  
50/60 Hz (specify X, X = A, B, C,  
or D included insert), (220 V)

**9141-X-156** Dry-Well, 110 V  
50/60 Hz, (specify X, X = A, B, C,  
or D included insert), (110 V)

**9141-X-256** Dry-Well, 220 V  
50/60 Hz, (specify X, X = A, B, C,  
or D included insert), (220 V)

### Options and Accessories

**3103-1** Insert, blank (9103)

**3103-2** Insert, A (9103)

**3103-3** Insert, B (9103)

**3103-4** Insert, C (9103)

**3103-6** Insert, D (9103)

**3140-1** Insert, blank (9140)

**3140-2** Insert, A (9140)

**3140-3** Insert, B (9140)

**3140-4** Insert, C (9140)

**3140-6** Insert, D (9140)

**3141-1** Insert, blank (9141)

**3141-2** Insert, A (9141)

**3141-3** Insert, B (9141)

**3141-4** Insert, C (9141)

**3141-6** Insert, D (9141)

**9316** Rugged Carrying Case  
(9103)

**9308** Rugged Carrying Case  
(9140)

**9309** Rugged Carrying Case  
(9141)

# 9105, 9107, 9122A, 9127 High-Accuracy Dry-Well

riešenia na presné meranie

www.else.sk/Fluke-Calibration

## Industrial Temperature Calibrators

The most stable and accurate dry-wells available



9127

- Largest-capacity temperature wells — room for many probes
- Model 9107 reaches lowest temperatures:  $-45\text{ °C}$  in  $23\text{ °C}$  ambient
- Model 9122A provides temperatures to  $700\text{ °C}$

### Tech Tip

As the need for calibration accuracy increases, depth of immersion becomes more important — the deeper the immersion, the more accurate the calibration.

These units are specifically built for the demanding requirements of temperature work in calibration labs. Each instrument has excellent stability, uniformity, and accuracy and features Hart's own proprietary controller for precision work; you can set the temperature with  $0.01\text{ °C}$  resolution.

All four dry-wells come with an RS-232 port and have an optional IEEE interface available. Each dry-well includes 9930 Interface-*it* software for controlling the unit with your PC. An optional software package, 9938 MET/TEMP II, totally automates the calibration process for RTDs, thermocouples, and thermistors.

If you don't want to use a PC with these dry-wells, program them through the front panel to automatically set and hold up to eight temperatures in the sequence and duration of your choice. Each unit also has a "switch test" protocol that locks in the triggering temperature for thermal switches. The dry-well's ramp rate can be set to a speed of your choosing.

Each dry-well is completely tested and calibrated before shipment, and includes a certificate of traceability. When accuracy and stability are important to your work, Hart is your best choice.

### 9105 Dry-Well

The 9105 Dry-Well has a temperature range of  $-25\text{ °C}$  to  $140\text{ °C}$  with a stability of  $\pm 0.01\text{ °C}$ . It has four outside wells of various sizes and a removable center well as shown in the illustration. Well-to-well uniformity in the drilled wells is  $\pm 0.05\text{ °C}$ . Used with a standards probe, the 9105 has the test well uniformity

and the stability to give you  $\pm 0.05\text{ °C}$  calibration accuracy. The high-precision, microprocessor-based controller has  $0.01$  degrees of resolution.

You recalibrate your 9105 through its front panel, which reduces the cost and problems of recertifying your instrument. It comes with a NIST-traceable calibration at no additional cost, making the 9105 dry-well an even better value.



Our 9304 carrying case fits the 9105, 9107 and 9127 Super Dry-Well models. (Use the 9324 to carry and protect a 9122A.)

### 9107 Ultracold Dry-Well

The 9107 Ultracold Dry-Well ranges to  $-45\text{ }^{\circ}\text{C}$  in a  $23\text{ }^{\circ}\text{C}$  ambient and still covers temperatures as high as  $140\text{ }^{\circ}\text{C}$ . The 9107 features five calibration wells, incredible accuracy, and stability better than  $\pm 0.005\text{ }^{\circ}\text{C}$  over most of its range. Like the 9105, this ultracold dry-well doesn't use a compressor and doesn't require external cooling. Peltier modules do all the work so you don't have to worry about external hookups or cold ambient temperatures.

### 9122A High Capacity Dry-Well

The 9122A High Capacity Dry-Well comes with nine test wells, a display calibrated to  $660\text{ }^{\circ}\text{C}$ , and an upper temperature limit of  $700\text{ }^{\circ}\text{C}$ . Test nine probes simultaneously or eight probes against a reference thermometer. Four of the nine wells accept removable inserts; the other five are drilled for  $6.35\text{ mm}$  ( $1/4\text{ in}$ ) probes. The center well on the 9122A is accurate to  $\pm 0.3\text{ }^{\circ}\text{C}$  and stable to  $\pm 0.05\text{ }^{\circ}\text{C}$  at  $660\text{ }^{\circ}\text{C}$ .

This unit also makes a perfect annealing furnace. Reference PRTs (and thermocouples) generally benefit from periodic annealing at high temperatures to remove sensor strain and oxidation build-up. With capacity for nine probes and temperatures to  $700\text{ }^{\circ}\text{C}$ , the 9122A offers a perfect solution.

### 9127 Dry-Well

The 9127 is an ideal solution for work between  $50\text{ }^{\circ}\text{C}$  and  $600\text{ }^{\circ}\text{C}$ . It has a "smart" controller that increases fan speed automatically for cooling the block and then reduces the fan speed at a specific set-point temperature for maximum stability during calibrations. It has an accuracy of  $\pm 0.15\text{ }^{\circ}\text{C}$  up to  $300\text{ }^{\circ}\text{C}$  and  $\pm 0.5\text{ }^{\circ}\text{C}$  to  $600\text{ }^{\circ}\text{C}$ . Resolution is  $0.01\text{ }^{\circ}\text{C}$  and stability is  $\pm 0.02\text{ }^{\circ}\text{C}$  at  $300\text{ }^{\circ}\text{C}$ . Inserts are available with multiple sensor holes for doing comparison calibrations. Uniformity between holes is  $\pm 0.05\text{ }^{\circ}\text{C}$ .

For fast cool-downs of a 9122A or 9127 dry-well, the optional 2032 Air Chiller connects directly to shop air to inject cool air into the well and reduce cooling times by more than 50 %.

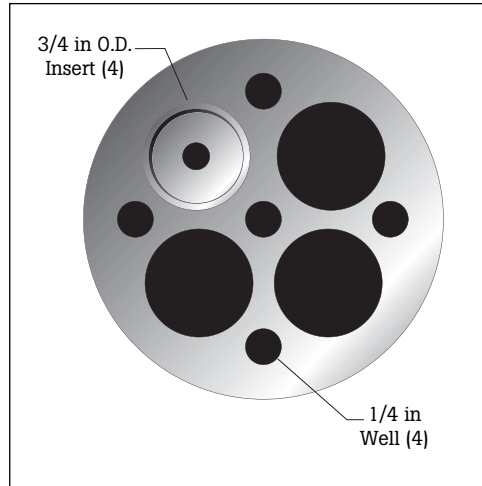

The 9122A has the most wells of any dry-well: nine total with four that accept interchangeable inserts.

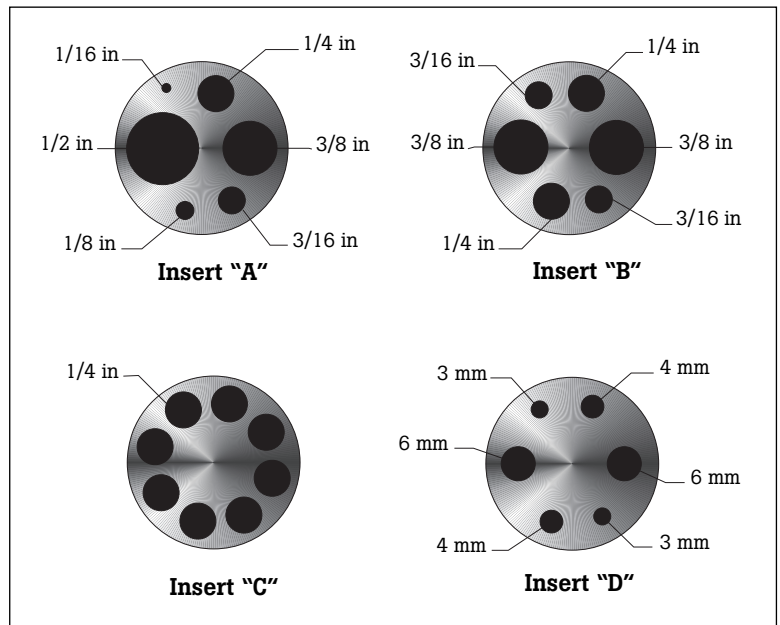

The 9127 block has one well that accepts interchangeable inserts.

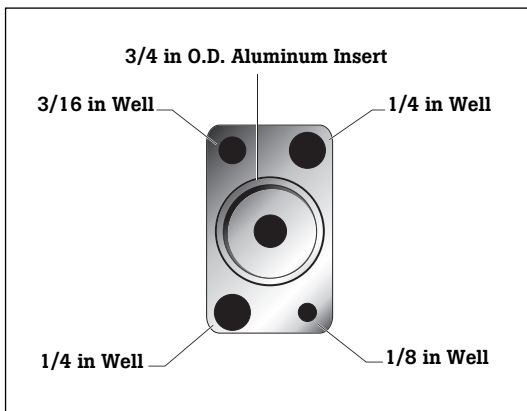

The 9105 and 9107 blocks have five calibration wells, one of which accepts interchangeable inserts.

# 9105, 9107, 9122A, 9127 High-Accuracy Dry-Well

riešenia na presné meranie

www.elseo.sk/Fluke-Calibration

## Industrial Temperature Calibrators

### Specifications

	9105	9107	9122A	9127
Range	-25 °C to 140 °C (-13 °F to 284 °F) at 23 °C ambient	-45 °C to 140 °C (-49 °F to 284 °F) at 23 °C ambient	50 °C to 700 °C† (122 °F to 1292 °F)	50 °C to 600 °C (122 °F to 1112 °F)
Accuracy	Center well: ± 0.1 °C	Center well: ± 0.1 °C	Center well: ± 0.1 °C at 100 °C ± 0.1 °C at 300 °C ± 0.3 °C at 660 °C	± 0.1 °C at 100 °C ± 0.15 °C at 300 °C ± 0.5 °C at 600 °C
Stability	± 0.01 °C	± 0.01 °C at -40 °C ± 0.005 °C at 0 °C ± 0.005 °C at 100 °C	± 0.01 °C at 100 °C ± 0.02 °C at 300 °C ± 0.05 °C at 660 °C	± 0.01 °C to 100 °C ± 0.02 °C to 300 °C ± 0.05 °C to 600 °C
Well-to-well uniformity	Drilled wells: ± 0.05 °C	Drilled wells: ± 0.05 °C	Drilled wells: ± 0.025 °C at 100 °C ± 0.1 °C at 300 °C ± 0.3 °C at 660 °C	± 0.05 °C
Well depth	6 in (152 mm)			
Computer interface	RS-232 Interface included with Model 9930 Interface-it control software, IEEE optional			
Heating time to max.	10 minutes	15 minutes	75 minutes	30 minutes
Cooling time	25 °C to -25 °C: 15 minutes	25 °C to -45 °C: 35 minutes	700 °C to 100 °C: 280 minutes	600 °C to 100 °C: 125 minutes
Test wells	5 wells: 2 at 6.35 mm (1/4 in), 1 at 4.8 mm (3/16 in), 1 at 3.2 mm (1/8 in), and 1 interchangeable (19.1 mm [3/4 in] O.D.)	5 wells: 2 at 6.35 mm (1/4 in), 1 at 4.8 mm (3/16 in), 1 at 3.2 mm (1/8 in), and 1 interchangeable (19.1 mm [3/4 in] O.D.)	9 wells: 4 interchangeable (19.1 mm [3/4 in] O.D.) and 5 at 6.35 mm (1/4 in)	1 interchangeable well accommodates multi-hole insert (38.1 mm [1.5 in] O.D.)
Resolution	0.01 °C or °F			
Display	LED, °C or °F, user-selectable			
Size (HxWxD)	343 x 198 x 302 mm (13.5 x 7.8 x 11.9 in)			
Weight	11.8 kg (26 lb)	10 kg (22 lb)	11.3 kg (25 lb)	11.3 kg (25 lb)
Power	115 V ac (± 10%), 3 A or 230 V ac (± 10 %), 1.6 A, specify, 50/60 Hz, 350 W	115 V ac (± 10 %), 4 A or 230 V ac (± 10 %), 3.15 A, specify, 50/60 Hz, 350 W	115 V ac (± 10 %), 8.8 A or 230 V ac (± 10 %), 4.4 A, specify, 50/60 Hz, 1000 W	115 V ac (± 10 %), 8.8 A or 230 V ac (± 10 %), 4.4 A, switchable, 50/60 Hz, 1000 W
NIST-traceable calibration	Data at -25 °C, 0 °C, 75 °C, and 140 °C	Data at -45 °C, 0 °C, 75 °C, and 140 °C	Data at 100 °C, 200 °C, 300 °C, 400 °C, 500 °C, and 660 °C	Data at 100 °C, 200 °C, 300 °C, 400 °C, 500 °C, and 600 °C

†Calibrated to 660 °C; reference thermometer recommended at higher temperatures.

### Ordering Information

#### Models

**9105** Low-Temp Dry-Well,  
includes 1/4 in insert

**9107** Ultra Low-Temp Dry-Well,  
includes 1/4 in insert

**9122A** High Capacity Dry-Well,  
includes 1/8 in, 3/16 in, 3/8 in,  
and 1/4 in inserts, and cleaning  
kit for wells and inserts

**9127-X** High Speed Dry-Well  
with removable multi-hole insert  
(specify X, X = A, B, C, or D  
included insert)

#### Options and

#### Accessories (9105, 9107)

**2125** IEEE-488 Option

**2169** 1.6 mm (1/16 in) Insert

**2170** 3.2 mm (1/8 in) Insert

**2171** 4 mm (5/32 in) Insert

**2172** 4.8 mm (3/16 in) Insert

**2173** 6.35 mm (1/4 in) Insert

**2174** 7.9 mm (5/16 in) Insert

**2175** 9.5 mm (3/8 in) Insert

**2176** 12.7 mm (1.2 in) Insert

**2177** 15.9 mm (5/8 in) Insert

**2181** 1 User-Specified Hole

**2182** 2 User-Specified Holes

**9304** Carrying Case

#### Options and Accessories (9122A)

**2125** IEEE-488 Option

**2152** Insert, Blank

**2154** 3.2 mm (1/8 in) Insert

**2155** 4 mm (5/32 in) Insert

**2156** 4.8 mm (3/16 in) Insert

**2157** 6.35 mm (1/4 in) Insert

**2158** 7.9 mm (5/16 in) Insert

**2159** 9.5 mm (3/8 in) Insert

**2160** 12.7 mm (1.2 in) Insert

**2161** 15.9 mm (5/8 in) Insert

**2162** 1 User-Specified Hole

**2163** 2 User-Specified Holes

**9324** Carrying Case, 9122A

**2032** Air Chiller, Dry-Well

**2037** Well and Insert Cleaning  
Kit

#### Options and Accessories (9127)

**2125** IEEE-488 Option

**3109-0** Insert, Blank

**3109-1** Insert A, holes at 1.6,  
3.2, 4.8, 6.35, 9.5, 12.7 mm  
(1/16, 1/8, 3/16, 1/4, 3/8, 1/2 in)

**3109-2** Insert B, two holes each  
at 4.8, 6.35, 9.5 mm (3/16, 1/4,  
3/8 in)

**3109-3** Insert C, eight holes each  
at 6.35 mm (1/4 in)

**3109-4** Insert D, two holes each  
at 3 mm, 4 mm, and 6 mm

**9304** Carrying Case

# 9101 Zero-Point Dry-Well

riešenia na presné meranie

www.else.sk/Fluke-Calibration

Industrial  
Temperature  
Calibrators

FLUKE®

Hart Scientific

Ice-point reference without the ice!



- Easy recalibration for long-term reliability
- Ready light frees user's time and attention
- Solid-state cooling technology

## Tech Tip

To achieve the best accuracy for tc calibration, a stable, accurate, ice-point reference is needed.

The 9101 Zero-Point Dry-Well has three test wells for inserting more than one probe at a time. All three wells are stable to  $\pm 0.005$  °C. One well accommodates changeable inserts for varying probe diameters.

The 9101 takes advantage of the latest solid-state cooling technology rather than relying on older, less reliable sealed-water-cell devices. This eliminates the possibility that the sealed-water cell will freeze and burst while transporting the unit to field locations. And the solid-state cooler is run by an adjustable electronic controller that can be recalibrated in your lab for convenient recertification. Simply place a certified standards thermometer in one of the wells and, if

needed, tweak the 9101 controller until the standards thermometer reaches equilibrium at 0 °C.

Since the unit is completely self-contained and doesn't require any user settings, you can run it on demand for instant access to an accurate, traceable zero point. Set it up with the reference junction of a thermocouple for high-accuracy thermocouple measurements.

Less costly than refrigerated baths, more accurate and less problematic than ice baths, and more durable and better looking than competitive units using sealed-water cells, the Hart Model 9101 Zero-Point Dry-Well is a great choice for any calibration lab.

## Specifications

Temperature range	0 °C (32 °F)
Stability	$\pm 0.005$ °C
Total instrument error	$\pm 0.02$ °C, typical; $\pm 0.05$ °C max. (18 to 25 °C ambient)
Stabilization time	Approx. 30 minutes (the ready lamp indicates stable control at 0 °C)
Temperature coefficient	$\pm 0.005$ °C/°C
Size (HxWxD)	311 x 216 x 146 mm (12.25 x 8.5 x 5.75 in)
Power	115 V ac ( $\pm 10$ %), 1 A or 230 V ac ( $\pm 10$ %), 0.5 A, specify, 50/60 Hz, 125 W
Well dimensions	2 wells 6.4 dia. x 152 mm D (0.25 in x 6 in), 1 well 7 dia. x 152 mm D (0.28 in x 6 in). Includes one set of telescoping inserts to provide various smaller diameters.
Weight	5.4 kg (12 lb)
NIST-traceable calibration	Data at 0 °C

## Ordering Information

### Models

**9101** Zero-Point Dry-Well (includes one set of telescoping inserts to provide various smaller diameters)

### Options and Accessories

**2130** Spare Well-Sizing Tube Set  
**9325** Rugged Carrying Case

# 9011 High-Accuracy Dual-Well Calibrator

riešenia na presné meranie

www.elseo.sk/Fluke-Calibration

## Industrial Temperature Calibrators

**Widest temperature range available in a single dry-well**



- Combined ranges for calibrating from  $-30\text{ }^{\circ}\text{C}$  to  $670\text{ }^{\circ}\text{C}$ ; one unit — two blocks
- Two independent temperature controllers (hot and cold side)
- Stability to  $\pm 0.02\text{ }^{\circ}\text{C}$
- Multi-hole wells calibrate up to eight probes simultaneously

The 9011 Dual-Well Calibrator allows temperature probes to be calibrated from  $-30\text{ }^{\circ}\text{C}$  to  $670\text{ }^{\circ}\text{C}$  in a single unit. It features two independently controlled temperature wells, which makes calibrating RTDs and thermocouples faster than ever. While readings are being taken at one temperature, the other well can be ramping up or down to the next point. Checking the zero and span points of temperature transmitters is a breeze. The cold block can even be used as a zero-point reference for a thermocouple making measurements in the hot block.

The 9011 is a high-accuracy unit that is capable of laboratory as well as field calibrations. Stabilities to  $\pm 0.02\text{ }^{\circ}\text{C}$  are possible, and display accuracy is better

than  $\pm 0.25\text{ }^{\circ}\text{C}$ . Using multi-hole interchangeable inserts, you can calibrate more probes at the same time. With a single RS-232 port for both wells, you can automate your calibration work and be even more efficient. Add on Hart's 9938 MET/TEMP II software and totally automate your calibrations of RTDs, thermocouples, and thermistors.

Every dry-well ships from the factory with a full NIST-traceable calibration report with test data for each well at each point. There's no extra charge for the report or the test readings from your unit. You also will receive your choice of multi-hole inserts. If you don't find one that suits your applications, Hart will provide a blank sleeve or have a custom one made.

### Specifications

	Hot Block	Cold Block
Range	$50\text{ }^{\circ}\text{C}$ to $670\text{ }^{\circ}\text{C}$ ( $122\text{ }^{\circ}\text{F}$ to $1238\text{ }^{\circ}\text{F}$ )	$-30\text{ }^{\circ}\text{C}$ to $140\text{ }^{\circ}\text{C}$ ( $-22\text{ }^{\circ}\text{F}$ to $284\text{ }^{\circ}\text{F}$ )
Accuracy	$\pm 0.2\text{ }^{\circ}\text{C}$ at $50\text{ }^{\circ}\text{C}$ $\pm 0.4\text{ }^{\circ}\text{C}$ at $400\text{ }^{\circ}\text{C}$ $\pm 0.65\text{ }^{\circ}\text{C}$ at $600\text{ }^{\circ}\text{C}$	$\pm 0.25\text{ }^{\circ}\text{C}$ (insert wells) $\pm 0.65\text{ }^{\circ}\text{C}$ (fixed wells)
Stability	$\pm 0.02\text{ }^{\circ}\text{C}$ at $100\text{ }^{\circ}\text{C}$ $\pm 0.06\text{ }^{\circ}\text{C}$ at $600\text{ }^{\circ}\text{C}$	$\pm 0.02\text{ }^{\circ}\text{C}$ at $-30\text{ }^{\circ}\text{C}$ $\pm 0.04\text{ }^{\circ}\text{C}$ at $140\text{ }^{\circ}\text{C}$
Uniformity	$\pm 0.2\text{ }^{\circ}\text{C}$ ( $\pm 0.05\text{ }^{\circ}\text{C}$ typical)	$\pm 0.05\text{ }^{\circ}\text{C}$ (insert wells) $\pm 0.25\text{ }^{\circ}\text{C}$ (fixed wells)
Well depth	152 mm (6 in)	124 mm (4.875 in)
Heating time to max.	30 minutes	15 minutes
Cooling times	120 minutes from $660\text{ }^{\circ}\text{C}$ to $100\text{ }^{\circ}\text{C}$	30 minutes from $140\text{ }^{\circ}\text{C}$ to $-30\text{ }^{\circ}\text{C}$
Well inserts	1 interchangeable well accommodates multi-hole insert	1 interchangeable well accommodates multi-hole insert, plus four outer wells, 1/4 in, 1/4 in, 3/16 in, and 1/8 in
Computer interface	RS-232 interface included with Model 9930 Interface-it control software	
Power	115 V ac ( $\pm 10\%$ ), 10 A or 230 V ac ( $\pm 10\%$ ), 5 A, switchable, 50/60 Hz, 1150 W	
Size (HxWxD)	292 x 394 x 267 mm (11.5 x 15.5 x 10.5 in)	
Weight	16.4 kg (36 lb)	
NIST-traceable certificate (8 points)	Data at $50\text{ }^{\circ}\text{C}$ , $100\text{ }^{\circ}\text{C}$ , $200\text{ }^{\circ}\text{C}$ , $300\text{ }^{\circ}\text{C}$ , $400\text{ }^{\circ}\text{C}$ , $500\text{ }^{\circ}\text{C}$ , $600\text{ }^{\circ}\text{C}$ , and $660\text{ }^{\circ}\text{C}$	Data at $-30\text{ }^{\circ}\text{C}$ , $0\text{ }^{\circ}\text{C}$ , $25\text{ }^{\circ}\text{C}$ , $50\text{ }^{\circ}\text{C}$ , $75\text{ }^{\circ}\text{C}$ , $100\text{ }^{\circ}\text{C}$ , $125\text{ }^{\circ}\text{C}$ , and $140\text{ }^{\circ}\text{C}$

Elseo Philips Service, Trenčín



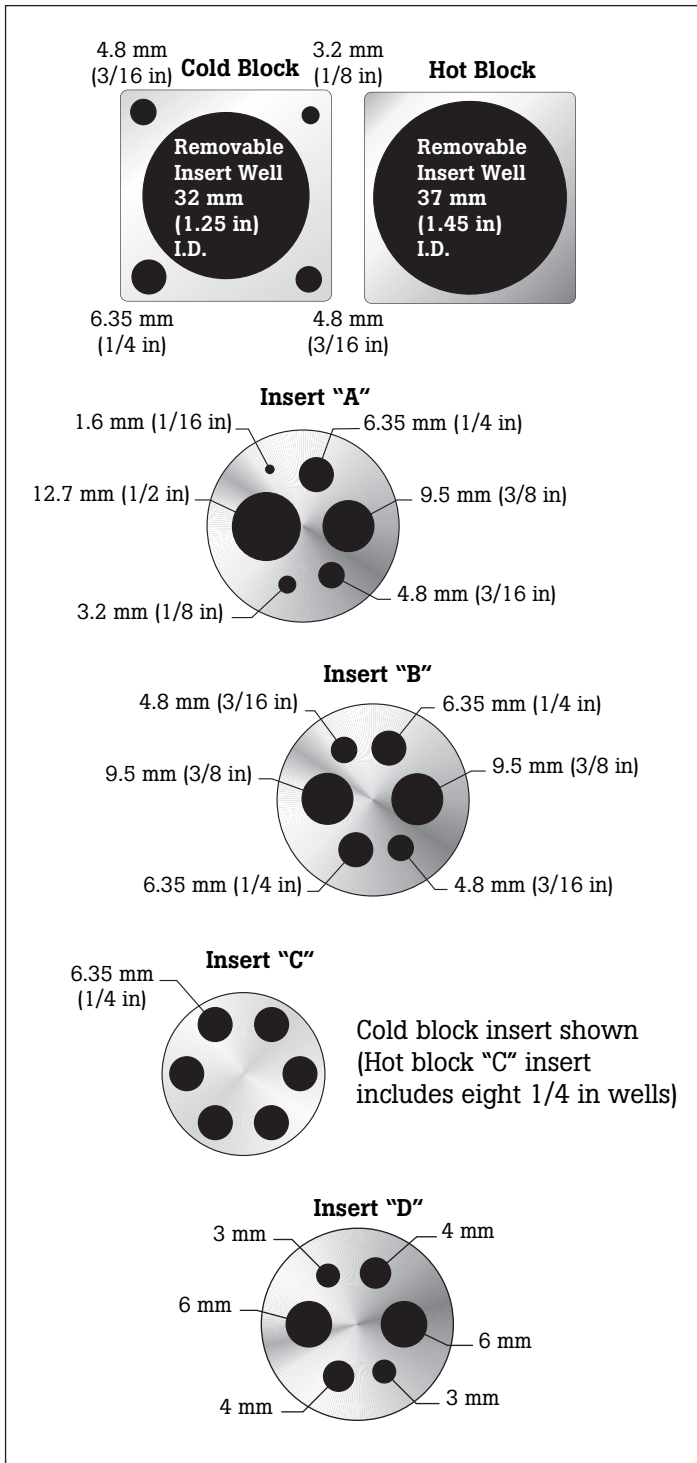

## Ordering Information

### Models

9011 High-Accuracy Dual-Well Calibrator

### Options and Accessories

3109-0 Insert, Blank (Hot Side)

3109-1 Insert A, Miscellaneous (Hot Side)

3109-2 Insert B, Comparison (Hot Side)

3109-3 Insert C, eight 1/4 in Wells (Hot Side)

3109-4 Insert D, Comparison - Metric (Hot Side)

3109-5 X Cell Adapter Sleeve (Hot Side)

3103-1 Insert, Blank (Cold Side)

3103-2 Insert A, Miscellaneous (Cold Side)

3103-3 Insert B, Comparison (Cold Side)

3103-4 Insert C, six 1/4 in Wells (Cold Side)

3103-5 X-Cell Adapter Sleeve (Cold Side)

3103-6 Insert D, Comparison - Metric (Cold Side)

2125-C IEEE-488 Option (Serial-to-IEEE-Converter Box)

9319 Large Instrument Case

# 9132 and 9133 Infrared Calibrators

riešenia na presné meranie

www.elseo.sk/Fluke-Calibration

## Industrial Temperature Calibrators

**Precision when you need it for infrared temperature calibration**



9132

- Easily certify IR pyrometers to 500 °C (932 °F)
- Large 57 mm (2.25 in) blackbody target
- RTD reference well for high precision
- Small, compact design

Hart's blackbody targets offer precision when you need it for infrared temperature calibration. Whether you're using in-line or handheld pyrometers, the 9132 Portable IR Calibrator can handle your workload to 500 °C. For calibrating IR guns at cold temperatures, the 9133 Portable IR Calibrator reaches -30 °C (22 °F) in normal ambient conditions.

Simply "point and shoot" to check your IR guns. For higher precision, a well is located directly behind the blackbody surface for contact calibration of the black-body using a calibrated PRT and readout. The 57 mm (2.25 in) target offers a large field of view area for optical variations in infrared thermometers. Emissivity of the target is 0.95 (± 0.02) and its temperature may be controlled in increments of 0.1 °C.

No other IR calibrators offer this performance in a compact package.



Large target for calibrating all IR thermometer types.



The 9133 includes a quick-attach fitting on the front bezel for dry air purging, which eliminates ice buildup on the target.

## Specifications

	9132	9133
Temperature range	50 °C to 500 °C (122 °F to 932 °F)	-30 °C to 150 °C at 23 °C ambient (-22 °F to 302 °F at 73 °F ambient)
Accuracy	± 0.5 °C at 100 °C (± 0.9 °F at 212 °F) ± 0.8 °C at 500 °C (± 1.4 °F at 932 °F)	± 0.4 °C (± 0.72 °F)
Stability	± 0.1 °C at 100 °C (± 0.18 °F at 212 °F) ± 0.3 °C at 500 °C (± 0.54 °F at 932 °F)	± 0.1 °C (± 0.18 °F)
Target size	57 mm (2.25 in)	
Target emissivity	0.95 (± 0.02 from 8 to 14 μm)	
Resolution	0.1 °	
Heating time	30 minutes (50 °C to 500 °C)	15 minutes (25 °C to 150 °C)
Cooling time	30 minutes (500 °C to 100 °C)	15 minutes (25 °C to -20 °C)
Computer interface	RS-232 included with 9930 Interface-it software	
Power	115 V ac (± 10 %), 3 A or 230 V ac (± 10 %), 1.5 A, switchable, 50/60 Hz, 340 W	115 V ac (± 10 %), 1.5 A, or 230 V ac (± 10 %), 1.0 A, switchable, 50/60 Hz, 200 W
Size (HxWxD)	102 x 152 x 178 mm (4 x 6 x 7 in)	152 x 286 x 267 mm (6 x 11.25 x 10.5 in)
Weight	1.8 kg (4 lb)	4.6 kg (10 lb)
NIST-traceable contact calibration	Data at 50 °C, 100 °C, 200 °C, 250 °C, 300 °C, 400 °C, and 500 °C	Data at -30 °C, 0 °C, 25 °C, 75 °C, 100 °C, 125 °C, and 150 °C

## Ordering Information

### Models

**9132-156** IR Calibrator, 110 V  
50/60 Hz IR, 50 to 500 °C

**9132-256** IR Calibrator, 220 V  
50/60 Hz IR, 50 to 500 °C

**9133-156** IR Calibrator, 110 V  
50/60 Hz IR, -30 to 150 °C

**9133-256** IR Calibrator, 220 V  
50/60 Hz IR, -30 to 150 °C

### Options and Accessories

**9308** Hard Carrying Case (9132)

**9302** Hard Carrying Case (9133)

# 9112A Thermocouple Calibration Furnace

riešenia na presné meranie

www.else.sk/Fluke-Calibration

Industrial  
Temperature  
Calibrators

FLUKE®

Hart Scientific

Unmatched stability and uniformity for thermocouple calibrations to 1100 °C



- Combined stability and uniformity better than  $\pm 0.4$  °C
- RS-232 serial interface standard
- High capacity for simultaneous comparison calibrations
- CE compliant
- Optional MET/TEMP II software automates the furnace and calibration processes

## Specifications

Range	300 °C to 1100 °C (572 °F to 2012 °F)
Stability	$\pm 0.05$ °C at 300 °C $\pm 0.1$ °C at 700 °C $\pm 0.1$ °C at 1100 °C
Uniformity	$\pm 0.1$ °C at 300 °C $\pm 0.2$ °C at 700 °C $\pm 0.3$ °C at 1100 °C
Heating rates	25 °C to 900 °C: 35 minutes, 900 °C to 1100 °C: 3 hours
Cooling rates	Nom. at 800 °C: $\geq 300$ °C/hour, Nom. at 600 °C: $\geq 180$ °C/hour
Stabilization time	Typically 2 hours midrange, slower at low-temperature end (4 hours), faster at high-temperature end
Interface	RS-232 included on all units
Outside dimensions	457 x 356 x 660 mm (18 x 14 x 26 in) (HxWxD)
Thermal block	406 mm (16 in) immersion; includes four wells at 6.35 mm (1/4 in) and one well at 7.11 mm (0.28 in)
Weight	33 kg (72.5 lb) with block
Power	230 V ac ( $\pm 10$ %), 50/60 Hz, 16 A, 3700 W
Calibration	NIST-traceable calibration at 420 °C

## Ordering Information

### Models

9112A-B Calibration Furnace  
(includes standard 16 in block)

# 9150 Thermocouple Furnace

riešenia na presné meranie

www.elseo.sk/Fluke-Calibration

## Industrial Temperature Calibrators

### Low cost thermocouple furnace



- Temperature range to 1200 °C
- Stability of  $\pm 0.5$  °C
- NIST-traceable calibration included
- RS-232 port standard

### Specifications

Temperature range	150 °C to 1200 °C (302 °F to 2192 °F)
Display resolution	0.1 ° to 999.9 ° 1 ° above 1000 °
Stability	$\pm 0.5$ °C
Display accuracy	$\pm 5$ °C
Well diameter	32 mm (1.25 in)
Well depth	140 mm (5.5 in); (101 mm [4 in] in removable insert plus 38 mm [1.5 in] in insulator)
Heating time	35 minutes to 1200 °C
Cooling time	140 minutes with block
Well-to-well uniformity	$\pm 0.5$ °C to $\pm 1.0$ °C (Insert "C" at 1200 °C)
Stabilization	20 minutes
Power	115 V ac ( $\pm 10$ %), 10.5 A or 230 V ac ( $\pm 10$ %), 5.2 A, switchable, 50/60 Hz, 1200 W
Size (HxWxD)	315 x 208 x 315 mm (12.4 x 8.2 x 12.4 in)
Weight	13 kg (28 lb)
NIST-traceable	Data at 150 °C, 300 °C, 450 °C, calibration 600 °C, 800 °C, 1000 °C, and 1200 °C

### 9150 Interchangeable Insert Options

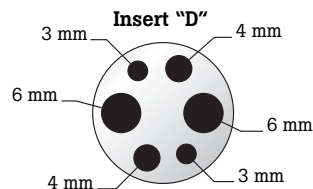
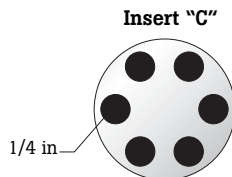
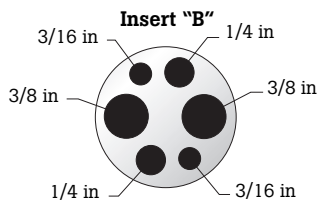
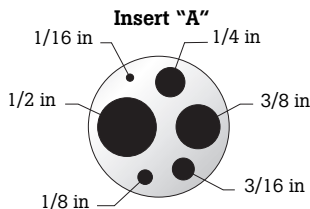

### Ordering Information

#### Models

9150-X Thermocouple Furnace  
(specify X, X = A, B, C, or D  
included insert)

#### Options and Accessories

3150-1 Custom Insert

3150-2 Insert A

3150-3 Insert B

3150-4 Insert C

3150-6 Insert D

9315 Rugged Carrying Case

# 5020A Thermo-Hygrometer

riešenia na presné meranie

www.else.sk/Fluke-Calibration

FLUKE®

## Temperature and Humidity

Comprehensive and precise environmental monitoring  
of temperature and humidity



- Best-in-the-world accuracy-temperature to  $\pm 0.125$  °C and RH to  $\pm 1.5$  %
- Large LCD for clear display of trend charts, statistics, real-time and historical data
- Two probe inputs for local and remote monitoring
- Two probe models available
- Interfaces with Fluke MET/CAL® Plus Calibration Management Software



### Tech Tip

For best measurements, locate the 5020A away from heat generating equipment.

The Fluke 5020A Thermo-Hygrometer is a dual-sensor, graphical data logger/analyzer offering precise real-time and historical display and analysis of temperature and humidity data. It is an ideal solution for environments where ambient temperature and humidity must be monitored and recorded, including calibration, research and medical testing laboratories, or pharmaceutical and food storage applications. The 5020A also replaces paper-based humidity chart recorders, eliminating the associated problems with paper, ink, records storage, and accuracy.

#### Dual inputs provide exceptional accuracy

The Fluke 5020A has two inputs with removable sensing probes. Each probe stores its own calibration constants, allowing probes to be used interchangeably between channels and between 5020A units while retaining full calibration integrity.

Two types of probes are available. The "S" model provides standard accuracies of  $\pm 0.25$  °C /  $\pm 2$  % RH, while the high accuracy "H" model provides accuracies of  $\pm 0.125$  °C /  $\pm 1.5$  % RH.

Both probes can be connected to extension cables and placed in remote locations up to 50 feet away from the 5020A mainframe. Alternatively, one probe can be mounted directly to the top of the 5020A.

#### MET/CAL® Plus Calibration Software interface

The Fluke 5020A, used with 5020A-LW3 software, provides an interface to Fluke's MET/CAL® Plus, the worldwide de facto standard in calibration software. This unique feature allows MET/CAL Plus (versions 7 or higher) to read temperature and humidity from the 5020A directly into a calibration record as you start to run a procedure. All the environmental information required for your calibration becomes a permanent part of the calibration record – without requiring you to enter the data manually or add it later when you create a report. And using the 5020A with MET/CAL Plus is easy, allowing you even greater automation and convenience.

#### Optional software retrieves, stores and analyzes data

5020A-LW3 software is a versatile application that retrieves data from the Fluke 5020A and stores it in a single database, to provide flexible, real-time and historical data management. You can view data in easily customized graphical and statistical formats for one or both sensors at user-defined time intervals. View real-time data as it streams into a chart format customized for your particular application.

# 5020A Thermo-Hygrometer

riešenia na presné meranie

www.elseo.sk/Fluke-Calibration

## Temperature and Humidity

### Specifications

Temperature range	0 °C to 50 °C
Temperature accuracy ("H" model)	16 °C to 24 °C: $\pm 0.125$ °C (calibrated) 0 °C to 16 °C, 24 °C to 50 °C: $\pm 0.5$ °C (uncalibrated typical)
Temperature accuracy ("S" model)	15 °C to 35 °C: $\pm 0.25$ °C (calibrated) 0 °C to 15 °C, 35 °C to 50 °C: $\pm 0.5$ °C (uncalibrated typical)
Delta temperature accuracy	$\pm 0.025$ °C for $\pm 1$ °C changes within 15 °C to 35 °C
Temperature display resolution	User selectable up to 0.001 °C (0.01 °C recorded)
RH range	0 % to 100 % RH
RH accuracy ("H" model)	20 % to 70 % RH: $\pm 1.5$ % RH (calibrated) 0 % to 20 % RH, 70 % to 100 % RH: $\pm 3$ % RH (uncalibrated, typical)
RH accuracy ("S" model)	20 % to 70 % RH: $\pm 2$ % RH (calibrated) 0 % to 20 % RH, 70 % to 100 % RH: $\pm 3$ % RH (uncalibrated, typical)
Delta humidity accuracy	$\pm 1.0$ % for $\pm 5$ % changes within 20 % to 70 % RH
RH display resolution	User selectable up to 0.01 % (0.1 % recorded)
Inputs	Two sensors, each measuring temperature and relative humidity; each is detachable, cable-extendable, and interchangeable, with self-contained calibration; each may be assigned a unique 16-character identification
Display	240 x 128 graphics monochrome LCD, displays temperature and humidity data graphically, numerically, and statistically; 16 pre-defined, user-changeable screen set-ups are included
Memory	400,000 typical individual time-stamped readings (excluding data card storage)
Alarms	Visual and audio alarms for temperature, temperature rate, RH, RH rate, and fault conditions
Communications	RS-232 and IR
Data card interface	Removable data card for transferring data to a computer; data can likewise be uploaded from a data card into the 5020A for graphical and statistical display
Mounting	The 5020A may be wall-mounted (hardware included) or set on a benchtop
Power	12 V dc from external 100-240 V ac power supply
Battery backup	Standard 9 V battery to allow continued measuring during power disruptions
Operating range	0 °C to 50 °C
Size (5020A)	125 mm H x 211 mm W x 51 mm D (4.9 in x 8.3 in x 2.0 in)
Size (probes)	79 mm H x 19 mm dia. (3.1 in H x 0.75 in)
Weight	0.7 kg (1.5 lb.)
Calibration	Certificate of NIST-traceable temperature and humidity calibration included; supplied data includes three each temperature and humidity points

### Environmental Conditions

Although the instrument has been designed for optimum durability and trouble-free operation, it must be handled with care. The instrument should not be operated in an excessively dusty, dirty, or wet environment. For full accuracy, operate the instrument within the calibrated temperature and relative humidity range of the sensors.

#### 5020A

Operating Temperature: 0 °C to 50 °C (32 °F to 122 °F)  
Relative Humidity: 0 % to 70 % RH

#### 5026A-H/S

Operating Temperature: 0 °C to 50 °C (32 °F to 122 °F)  
Relative Humidity: 0 % to 100 % RH

#### AC Adapter

Operating Temperature: 0 °C to 40 °C (32 °F to 104 °F)  
Relative Humidity: 5 % to 90 % non-condensing

#### General to all

Pressure: 75 kPa to 106 kPa  
Vibration should be minimized  
Altitude less than 2,000 meters  
Indoor use only

### Ordering information

#### Models

**5020A-S** Thermo-Hygrometer (includes standard-accuracy probe, wall mount bracket, and RS-232 cable)

**5020A-SKIT** Thermo-Hygrometer, Standard Accuracy spare probe kit (includes standard-accuracy 5020-S, probe, wall mount bracket, and RS-232 cable). Standard accuracy spare probe kit (5027A-S and 5020A-LW3 software, single-PC license)

**5020A-H** Thermo-Hygrometer, High Accuracy (includes high-accuracy probe, wall mount bracket, and RS-232 cable)

**5020A-HKIT** Thermo-Hygrometer, High Accuracy probe kit (includes high-accuracy probe, wall mount bracket, and RS-232 cable). High accuracy spare probe kit (5027A-H and 5020A-LW3 software, single-PC license)

#### Options and Accessories

**2626A-S** Spare Probe, Standard Accuracy

**2626A-H** Spare Probe, High Accuracy

**2627A-S** Spare Probe Kit, (includes standard-accuracy probe, probe case, wall mount bracket, and 7.6 m [25 ft] extension cable)

**5027A-S** Spare Probe Kit, (includes standard-accuracy probe, probe case, wall mount bracket, and 7.6 m [25 ft] extension cable)

**5027A-H** Spare Probe Kit, (includes high-accuracy probe, probe case, wall mount bracket, and 7.6 m [25 ft] extension cable)

**Y5028** Cable, 7.6 m (25 ft) extension cable

**Y5029** Cable, 15.2 m (50 ft) extension cable

**5032A-64MB** PC Card (PCMCIA), 64 MB

**5026A-CASE** Protective Case, Spare Probe

**5020A-CASE** Protective Case, 5020A-H (includes space for the 5020A, two probes, an extra PC Card, RS-232 cable, and power cord)

**5020A-PS** Spare Power Supply, 100-240 VAC to 12 V dc

**5020A-LW3** 5020A software, single-PC license

**5020A-LW3LIC** 5020A-LW3 license (for additional PCs)

# 5000A-RH/T Precision Data Logger

riešenia na presné meranie

www.elseo.sk/Fluke-Calibration

**FLUKE**®

## Temperature and Humidity

Now with an interface to Fluke MET/CAL® *Plus* Calibration Software for even more convenience in the cal lab



- MET/CAL® *Plus* Calibration Software interface
- Multi-station, multi-room capability
- Reliable, secure and accurate
- Powerful software interface



### Tech Tip

With a 10-year battery life, the 5000A-RH/T is a good choice for remote, long-term monitoring.

The 5000A-RH/T is a precision data logger that enables you to monitor ambient temperature and humidity in calibration environments. No charts, wires, connections or power cords are required. The 5000A-RH/T comes with Spectrum Software, a powerful Microsoft Windows® based program for configuring,

down-loading, displaying, analyzing and reporting your collected humidity and temperature data. An interface to MET/CAL *Plus* allows the software to read temperature directly into a calibration record as you start to run a procedure.

### Specifications

Relative Humidity (RH)	
Sensor type	Capacitive polymer-based monolithic integrated circuit
Precision	0.05 % RH
5-year accuracy	3 % RH
Hysteresis	0.8 % over full RH range
Measuring range	0 to 95 % RH
1-year accuracy	2 % RH over 10 to 90 %
Repeatability	0.5 % RH at 0 to 75 % RH
Temperature	
Sensor type	NTC thermistor
Measuring range	-40 °C to 70 °C
Precision	0.05 °C at 25 °C
1-year accuracy	0.015 °C at 25 °C; 0.25 °C over -20 °C to 70 °C
5-year accuracy	0.25 °C at 25 °C; 0.35 °C over -20 °C to 70 °C
Repeatability	0.01 °C
Hysteresis	0.01 °C
Memory	
Memory type	Non-volatile 32 K x 8 EEROM
Data sample capacity	21,500 12-bit samples
Memory modes	User-selectable: 1) Wrap when memory full, or 2) Stop when memory full
Memory protection	Data retention > 20 years backup without power
Sampling rates	User-selectable from once every 10 seconds to once every 24 hours
Recording span	Recording span depends on sample interval selected

### General Specifications

Size/Weight: 71 x 53 x 18 mm (2.8 x 2.1 x 0.7 in); 60 g (2.2 oz.)  
 Operating Range: -40 to 85 °C (-40 to 185 °F) and 0-100 % RH  
 Interfaces: RS-232 serial port; half-duplex; 19,600 baud  
 Mounting: Magnetic strips  
 PC Software: Designed for use with Spectrum Software and Fluke MET/CAL *Plus* Calibration Software.  
 Compatible with Windows 95, through XP  
 Clock: Accuracy: ± 1 min./month at 0 to 50 °C  
 Electromagnetic Interference: Meets FCC Part 15 for digital devices; meets CE requirements for radiated emissions, electrostatic discharge, and radiated susceptibility  
 Power Source: Internal lithium battery with life of 10 years at 1 min. sampling rate

### Calibration

NIST-traceable three point calibration on RH and one point temperature

### Ordering Information

#### Models

**5000A-RH/T** Precision Humidity and Temperature Data Logger, including Logger unit, RS-232 communication cable, Spectrum configuration and charting software

# 2620T/2635T Recording Thermometers

riešenia na presné meranie

www.elseo.sk/Fluke-Calibration

## Temperature and Humidity

Hydra Series II-based precision thermometer system for calibration applications



- Up to 0.09 ° accuracy (3 sigma)
- NIST traceable calibration covers the Hydra Series II and probe as a system
- Hydra Logger Software included

The Fluke 2635T and 2620T Recording Thermometers are precision multi-channel temperature recording and logging instruments that deliver up to 0.09 ° accuracy for temperature monitoring and calibration applications.

Based on the Fluke 20 channel Hydra Series II data loggers, these units are matched with a precision PRT probe on channel one and calibrated as a system for maximum accuracy and precision.

### Thermometer Accuracy Specifications

Temperature	Probe Uncertainty	2635T Uncertainty 90 day	2635T Uncertainty 1 year	2620T Uncertainty 90 day	2620T Uncertainty 1 year
-196 °C	± 0.003	± 0.05	± 0.10	± 0.13	± 0.14
0 °C	± 0.005	± 0.09	± 0.12	± 0.09	± 0.12
100 °C	± 0.005	± 0.10	± 0.13	± 0.12	± 0.15
200 °C	± 0.005	± 0.12	± 0.15	± 0.18	± 0.20
300 °C	± 0.006	± 0.14	± 0.17	± 0.22	± 0.24
400 °C	± 0.006	± 0.16	± 0.19	± 0.30	± 0.35

1 year, 18 ° to 28 ° ambient, slow measurement rate. IEC 751 Amendment 2 (ITS90); 2635A algorithms are based on ITS90; 2620A algorithms are based on IPTS68.

**Specification Note:** All specifications are based on 3 standard deviations from nominal value (3 Sigma). Actual measured point values are often ten times better than published specifications.

### Calibration

NIST-traceable system calibration from -50 °C to 150 °C

### Ordering Information

#### Models

**2620T** Recording Thermometer with Probe and Hydra Logger Software

**2635T** Recording Thermometer with Probe, Hydra Logger Software, and 256K PCMCIA memory card

**2600A-101** Extra PRT probe, 100 Ohm PT Probe with soft case only

#### Software

**2600A-904** Trend Link Software

Elseo Philips Service, Trenčín



# 5121 Benchtop Temperature/Humidity Generator

riešenia na presné meranie

www.elseo.sk/Fluke-Calibration

FLUKE®

Temperature and Humidity

Hart Scientific

Calibrate humidity probes, data loggers and chart recorders



- Full range accuracy  $\pm 0.5\%$  RH
- Large working volume for optimal throughput
- NIST-developed two-pressure principle
- RS-232 interface and ControLog automation software included

The 5121 is a self-contained generator that measures and controls humidity with high accuracy to  $\pm 0.5\%$  and a large working volume of 15 in x 15 in x 12 in (381 x 381 x 305 mm). Not only does it calibrate humidity probes but also entire chart recorders, data-loggers, and hygrometers (if the probe is not detachable, which is often the case).

5121 uses a "two-pressure" generation principle, which was originally developed by NIST and involves saturating a stream of air with water vapor at a known temperature and pressure. Relative humidity of the saturated air can be directly calculated through the following formula:

$$\%RH = \frac{f_s}{f_c} \cdot \frac{e_s}{e_c} \cdot \frac{P_c}{P_s} \cdot 100$$

To generate a known humidity, the 5121 controls the pressure ratio ( $P_c/P_s$ ), utilizing an enhancement factor ratio ( $f_s/f_c$ ) and the effective degree of saturation ( $e_s/e_c$ ). Humidity generated by this method is only dependant upon precision measurements of temperature and pressure, so the need to use an expensive chilled-mirror hygrometer as a reference is eliminated, reducing the cost of ownership. The 5121 generates RH with an accuracy of 0.5% over the range 0 °C to 70 °C and 10% RH to 98% RH. Chamber temperature accuracy is an amazing 0.06 °C. With this performance, you can calibrate ambient-measuring, temperature-probes.

To assist with your own calibration uncertainty analysis, be sure to visit the Hart website and download a copy of the 5121 series evaluation report that includes the detailed temperature and humidity uncertainty analysis.

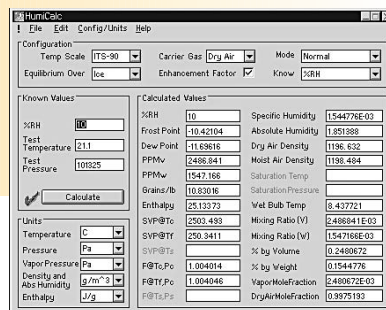

HumiCalc® software makes simple work of complex humidity conversions. A typical calculation requires only a temperature, a pressure, and one known humidity parameter. HumiCalc then computes all the final humidity values for you and can export them to a spreadsheet.

Operating the 5121 is so easy you'll be performing humidity calibrations minutes from switch-on. The generator is supplied as standard with all the equipment you'll need. Simply connect the generator to a clean, oil-free air supply, fill up the water reservoir, and plug it in; then place your chart recorders, data-loggers, or humidity sensors into the chamber, close the door, and program the desired temperature and humidity through the easy-to-use front panel display. You'll quickly be at set point and recording your calibration data! The front panel display provides loads of useful information, including chamber humidity and flow rates, as well as the saturation and chamber temperatures and pressures.

If you're looking for improved productivity in your humidity calibrations, try ControLog™ software, which allows you to program a series of humidity and temperature set-points, and automatically steps through the set-points to maintain stable calibration conditions for defined periods of time.

## Tech Tip

The 5121 Humidity Generator produces atmospheres of known humidities using the "two-pressure" principle developed and proven by NIST and used in most national standards laboratories. Details of this technology are outlined in a NIST paper entitled "Determining Uncertainties of Relative Humidity, Dew/Frost-Point Temperature, and Mixing Ratio in a Humidity Standard Generator."

[www.cstl.nist.gov/div836/836.05/papers/Huanghumidityunc.pdf](http://www.cstl.nist.gov/div836/836.05/papers/Huanghumidityunc.pdf)

# 5121 Benchtop Temperature/Humidity Generator

riešenia na presné meranie

www.elseo.sk/Fluke-Calibration

## Temperature and Humidity

### 5121 Specifications

Relative humidity range	10 % to 98 %
Relative humidity resolution	0.02 %
Relative humidity accuracy	± 0.5 %
Chamber temperature range	0 °C to 70 °C
Chamber temperature resolution	0.02 °
Chamber temperature uniformity	± 0.1 °C
Chamber temperature accuracy	± 0.06 °C
Gas flow rate range	5 to 20 slpm
Gas type	Air or Nitrogen
Heating/cooling rate	0.4 °C per minute
Interface	RS-232, Software ControLog™ and HumiCalc® included
Chamber dimensions	381 x 381 x 305 mm (15 in x 15 in x 12 in)
Power, chamber	100/120 V at 15 A, 50/60 Hz; 200/240 V at 8 A, 50/60 Hz
Power, compressor	100/120 V at 5 A, 50/60 Hz; 200/240 V at 2.5 A, 50/60 Hz
Air supply	Clean, oil-free, instrument air at 175 psiG and 20 slpm
Calibration	NIST-traceable temperature and humidity calibration with certificate and data
Warranty	Twelve months, parts-and-labor

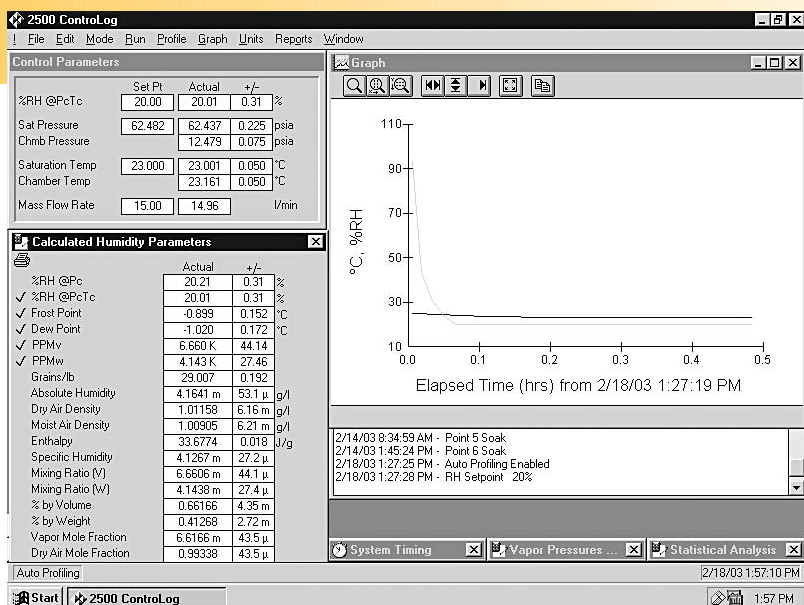

ControLog™ software can completely automate the operation of your 5121. Run a single set-point or quickly create a profile with a series of set-point/time values and let your 5121 run unattended. ControLog™ collects data and includes a report editor for semi-custom reports. It can operate your system in a variety of modes including %RH, Frost Point, Dew Point, PPMv and PPMw.

### Ordering Information

#### Models

5121 Humidity Generator,  
2500ST (LT)(TPA)

Elseo Philips Service, Trenčín

# Timer Counter Selection Guide

## Timer Counters



Fluke offers the broadest selection of counters in the industry. For traditional bench counter applications such as R&D, automated systems test, or calibration in the laboratory, Fluke can address your measurement needs with economical solutions and state-of-the-art performance. The PM 6690, PM 6681 and PM 6685 offer the ultimate in frequency counter performance at a price

for any budget. Combined with TimeView™ software, the PM 6681 becomes a modulation domain analyzer, to characterize frequency hopping/modulation or time jitter over time in amazing detail. The PM 6681R and PM 6685R are equipped with a Rubidium reference oscillator for on-site calibration of frequency, time interval or phase.

Functionality	PM6685	PM6681	PM6690
	Counter	Counter-Timer-Analyzer	
<b>General</b>			
Display and presentation modes	10 digit numerical read-out plus set-up information	10 digit numerical read-out plus set-up information	Graphical LCD gives multi-parameter numerical read-out, histogram, TrendPlot™
<b>Counter</b>			
Frequency range, primary channel(s)	LF to 300 MHz, A	LF to 300 MHz, A, B	LF to 300 MHz, A, B
Input C frequency range (optional)	1.3 GHz 3.0 GHz	1.3 GHz 2.7 GHz	3 GHz 8 GHz
Resolution (speed)	10 digits/second	11 digits/second	12 digits/second
Burst mode	carrier frequency and PRF of burst signals can be measured without external control signals		
Totalize modes	yes	yes	yes, with timestamp per sample
<b>Timer</b>			
Time interval on 2 channels		yes	yes
Resolution (single shot/averaged)	250 ps/100 ps	50 ps/1 ps	100 ps/12 digits/s measurement time
Pulse width	yes	yes	yes
Rise and fall time		yes	yes
Duty factor	yes	yes	yes
Phase		yes	yes
<b>Analyzer</b>			
Measurement speed, to internal memory	1600 meas./sec.	8 - 20 - 40 k meas./sec.	250 k meas./sec.
Memory capacity (readings)	2600	6100	750 000
Measurement speed, to bus	125 meas./sec.	250 meas./sec.	2000 meas./sec.
Modulation domain software	optional	included	optional
<b>Voltage</b>			
Automatic voltage meas.		Vmax or Vmin	Vmax, Vmin, Vpp
Analog bar graph level indicator	yes		
<b>Trigger</b>			
Level: <b>Auto Man GPIB USB</b>	A, M, G	A, M, G	A, M, G, U
Trigger level resolution		1.25 mV	2.5 mV
Input sensitivity, main input(s)	10 mV	20 mV	15 mV
<b>Features</b>			
Automatic limit testing			yes
Hold-off/digital filter	no	yes	yes
Low pass filter: analog/digital	yes/no	yes/no	yes/yes (progr.)
Statistics		yes	statistical analysis with numerical/histogram/TrendPlot display
Full math		yes	yes
Interface(s)	GPIB (optional)	GPIB (standard)	GPIB + USB standard
Size: 19", 2HE	1/2	3/4	1/2
Battery and dc-supply	optional		

# PM 6690/6681/6681R Timer/Counter/Analyzers

## Timer Counters

### Breakthrough timer/counter/analyzer performance



- 225 MHz or 300 MHz basic frequency range
- Options for 1.3 GHz, 2.7 GHz and 8.0 GHz ranges
- Down to 50 ps single shot measurement resolution
- 12 digit measurements within one second
- Ultra high accuracy with Rubidium time base option (PM 6681R)
- Up to 40,000 readings per second measuring speed
- TimeView™ Software provides complex time interval and modulation domain analysis



The PM 6690 offers an unmatched combination of performance and price that makes it today's undisputed value leader in counter timers. With 300 MHz basic frequency range extendable to 8.0 GHz (input C), an impressive array of measurement capabilities, and accuracy to  $2 \times 10^{-8}$ , the PM 6690 will be at home in the most demanding applications.

More than just counter/timers, the PM 6681 and PM 6681R set the standard for measurement and analysis of time intervals, frequency, phase and jitter.

Frequency range of the PM 6681 and PM 6681R is 300 MHz, extendable to 2.7 GHz (input C). Single shot time interval measurements can be achieved to 50 ps resolution and 11 digit measurements can be made within one second.

Measurement accuracy of  $2 \times 10^{-8}$  can be achieved with the PM 6681, or  $2 \times 10^{-10}$  with the Rubidium equipped PM 6681R.

Measurements can be made on burst or intermittent signals as well on continuous waves. With their revolutionary technology, measurement resolution, speed, and throughput, the PM 6681 and PM 6681R are comparable to the best time interval analyzers. Couple this with TimeView software and a PC and you have one of the most powerful tools available today for analyzing time interval or frequency distribution, jitter or modulation up to 2.7 GHz.

### Tech Tip

#### Jitter Measurements

Statistics provide an easy method of determining the short term timing instability (jitter) of pulse parameters. The jitter is usually specified with its rms value, which is equal to the standard deviation based on single measurements. The counter can then directly measure and display the rms jitter; otherwise, the standard deviation of mean values can be measured. The rms value is a good measure to quantify the jitter, but it gives no information about the distribution of the measurement values.

To improve a design, it might be necessary to analyze the distribution. Such measurements, as well as trend analysis, can be performed by means of the PM 6690 built in graphic capability.

## Measuring Functions

		PM 6690	PM 6681
<b>Frequency A, B, C</b>			
Range	Input A: Input B: Input C:	10 <sup>-3</sup> Hz to 300 MHz 10 <sup>-3</sup> Hz to 300 MHz 3 GHz or 8 GHz with option	10 <sup>-10</sup> Hz to 300 MHz 10 <sup>-10</sup> Hz to 100 MHz 1.3 GHz or 2.7 GHz with options
Resolution		12 digits/s using "multiple time-stamp averaging"	11 digits in 1 s measuring time
<b>Frequency Burst A, B, C</b>			
Frequency and PRF of burst signals can be measured without external control signal and with selectable start arming delay.			
Range	Input A: Input B: Input C:	10 <sup>-3</sup> Hz to 300 MHz 10 <sup>-3</sup> Hz to 300 MHz 3 GHz or 8 GHz with option	Up to 300 MHz Up to 100 MHz Up to 2.7 GHz with options
Start delay range		200 ns to 20 s, 100 ns resolution	200 ns to 1 s, 100 ns resolution
<b>Period A, B A</b>			
Range		3.3 ns to 10 <sup>3</sup> s, 330 ps to 10 ns via input C	3.3 ns to 10 <sup>10</sup> s
Resolution		100 ps (single) or 12 digits/s averaged	11 digits in 1s measuring time
<b>Ratio A/B, B/A, C/A, C/B A/B, C/B</b>			
Range		10 <sup>-9</sup> to 10 <sup>11</sup>	10 <sup>-9</sup> to 10 <sup>15</sup>
Frequency	Input A, B:	0.1 Hz to 300 MHz	10 <sup>-10</sup> Hz to 160 MHz
Range	Input C:	3 GHz or 8 GHz with option	1.3 GHz or 2.7 GHz with options
<b>Time Interval A to B A to B, B to A, A to A &amp; B to B A to B</b>			
Range		-10 <sup>6</sup> to + 10 <sup>6</sup> s	0 ns to 10 <sup>10</sup> s
Single shot resolution		100 ps	50 ps (1 ps average)
Frequency range		Up to 160 MHz	Up to 160 MHz
<b>Pulse Width A, B A</b>			
Range		1.6 ns to 10 <sup>6</sup> s	3 ns to 10 <sup>10</sup> s
Frequency range		Up to 300 MHz	Up to 160 MHz
<b>Rise and Fall Time A, B A</b>			
Range		700 ps to 10 <sup>6</sup> s	3 ns to 10 <sup>10</sup> s
Frequency range		Up to 160 MHz	Up to 160 MHz
Input amplitude			>250 mV <sub>pp</sub>
<b>Phase A Relative B, B Relative A A Relative B</b>			
Range		-180 ° to +360 °	-180 ° to +360 °
Resolution		0.001 °	0.01 °
Frequency range		Up to 160 MHz	0.03 Hz to 160 MHz
<b>Duty Factor A, B A</b>			
Range		0.000001 to 0.999999	10 <sup>-6</sup> to 1
Frequency range		0.1 Hz to 300 MHz	0.11 Hz to 160 MHz
<b>Totalize A, B Raw time stamp data with pulse counts on A or B, accessible through GPIB and USB</b>			
Range		100 ps resolution	0 to 10 <sup>17</sup> , 0 to 10 <sup>10</sup> in A-B modes
Frequency range		160 MHz	0 to 160 MHz
A Gated by B			Event counting on Input A during the presence of a pulse on Input B. Single or cumulative event counting during set measuring time.
A Start/Stop by B			Event counting on Input A between two consecutive pulses on Input B.
Manual A-B			Input A minus Input B event counting with manual start and stop.
Manual/Timed A-B			Input A minus Input B event counting with manual start. Stop after set measuring time. Time counted from first trigger event on A.
<b>AC/DC Voltage A, B A, B</b>			
Range		-50 V to +50 V, -5 V to +5 V	-50 V to +50 V, -5 V to +5 V
Frequency range		DC, 1 Hz to 300 MHz	DC, 1 Hz to 100 MHz
Mode		V <sub>max</sub> , V <sub>min</sub> , V <sub>pp</sub>	V <sub>max</sub> , V <sub>min</sub> , V <sub>pp</sub>
Resolution		2.5 mV	1.25 mV
Gated volt		True V <sub>peak</sub>	External masking of unwanted signal components such as overshoot.

# PM 6690/6681/6681R Timer/Counter/Analyzers

riešenia na presné meranie

www.elseo.sk/Fluke-Calibration

## Timer Counters

### Input and Output Specifications

	PM 6690	PM 6681
<b>Inputs A and B</b>		
Frequency range dc-coupled: ac-coupled:	DC to 300 MHz 10 Hz to 300 MHz	DC to 300 MHz 10 Hz to 300 MHz
Coupling	AC or DC	AC or DC
Impedance	1 M $\Omega$ //20 pF or 50 $\Omega$ (VSWR < 2:1) 1 M $\Omega$ //50 pF or 50 $\Omega$ (VSWR < 2:1) for rear panel inputs (optional)	1 M $\Omega$ //15 pF or 50 $\Omega$ (VSWR < 2:1) 1 M $\Omega$ //65 pF or 50 $\Omega$ with PM 9611/801 rear panel inputs
Trigger slope	Positive or negative	Positive or negative
Channel inputs	Separate A & B, common via A, common via B	Separate, common via A or swapped
Max. channel timing difference	500 ps	500 ps
Sensitivity	15 mV <sub>rms</sub> , < 200 MHz 25 mV <sub>rms</sub> , 200 to 300 MHz	20 mV <sub>rms</sub> , < 100 MHz 30 mV <sub>rms</sub> , 100 MHz to 200 MHz 40 mV <sub>rms</sub> , 200 MHz to 250 MHz 60 mV <sub>rms</sub> , > 250 MHz
Pulse width	1.6 ns	> 5 ns at 60 mV <sub>pp</sub> , > 3 ns at 90 mV <sub>pp</sub>
Attenuation	x1 or x10	x1 or x10
Hysteresis window (x1)	30 mV <sub>pp</sub>	20 mV <sub>pp</sub>
Variable hysteresis A (x1)		30 mV <sub>pp</sub> to 10 V <sub>pp</sub> up to 120 MHz
Dynamic range (x1)	30 mV <sub>pp</sub> to 10 V <sub>pp</sub> within $\pm 5$ V window	60 mV <sub>pp</sub> to 10 V <sub>pp</sub> (up to 100 MHz) within $\pm 5$ V window 75 mV <sub>pp</sub> to 10 V <sub>pp</sub> (100 to 200 MHz) within $\pm 5$ V window
Trigger level	Read-out on display	Read-out on display
Range		(x1): -5 V to +5 V; (x10): -50 V to +50 V
Resolution (x1)	2.5 mV	1.25 mV
Uncertainty (x1)	$\pm (10 \text{ mV} + 1 \% \text{ of trigger level})$	$\pm (4 \text{ mV} + 1 \% \text{ of trigger level})$
AUTO trigger level	Trigger level is automatically set to 50 % point of input signal (10 % and 90 % for Rise/Fall Time)	Trigger level is automatically set to 50 % point of input signal (10 % and 90 % for Rise/Fall Time, 75 % and 25 % for variable hysteresis A)
Frequency	> 1 Hz	> 1 Hz
<b>Auto Hysteresis</b>		
Time	Min Hysteresis Window (plus Hysteresis compensation)	
Frequency	67 % and 33 % of input signal, min Hysteresis window if Arming on A or B is used	
Auto frequency	> 1 Hz (20 Hz default setting)	
Low pass filter A	Nominal 100 kHz	100 kHz fixed. > 40 dB attenuation at 1 MHz.
Digital low pass filter	1 Hz to 5 MHz using trigger Hold-Off	1 Hz to 10 MHz using trigger Hold-Off
Trigger indicator	On Display	Tri-state LED-indicator
Max voltage without damage	1 M $\Omega$ : 350 V (DC + AC <sub>pk</sub> ) at DC to 440 Hz, falling to 12 V <sub>rms</sub> (x1) and 120 V <sub>rms</sub> (x10) at 1 MHz 50 $\Omega$ : 12 V <sub>rms</sub>	350 V (DC + AC <sub>pk</sub> ) at DC to 440 Hz, falling to 12 V <sub>rms</sub> (x1) and 120 V <sub>rms</sub> (x10) at 1 MHz 12 V <sub>rms</sub>

## Input C

	PM 6690/6xx	PM 6690/xxx	PM 6681/4xx	PM 6681/6xx
Frequency range	100 MHz to 3 GHz	200 MHz to 8 GHz	70 MHz to 1.3 GHz	100 MHz to 2.7 GHz
Pre-scale factor	16	256	512	32
<b>Operating Input Voltage</b>				
Range	100 to 300 MHz: 20 mV <sub>rms</sub> to 12 V <sub>rms</sub>	200 to 500 MHz: 20 mV <sub>rms</sub> to 7 V <sub>rms</sub>	70 to 900 MHz: 10 mV <sub>rms</sub> to 12 V <sub>rms</sub>	100 to 300 MHz: 20 mV <sub>rms</sub> to 12V <sub>rms</sub>
	0.3 to 2.5 GHz: 10 mV <sub>rms</sub> to 12 V <sub>rms</sub>	0.5 to 3.0 GHz: 10 mV <sub>rms</sub> to 7 V <sub>rms</sub>	0.9 to 1.1 GHz: 15 mV <sub>rms</sub> to 12 V <sub>rms</sub>	0.3 to 2.5 GHz: 10 mV <sub>rms</sub> to 12V <sub>rms</sub>
	2.5 to 2.7 GHz: 20 mV <sub>rms</sub> to 12 V <sub>rms</sub>	3.0 to 4.5 GHz: 20 mV <sub>rms</sub> to 7 V <sub>rms</sub>	1.1 to 1.3 GHz: 40 mV <sub>rms</sub> to 12 V <sub>rms</sub>	2.5 to 2.7 GHz: 20 mV <sub>rms</sub> to 12 V <sub>rms</sub>
	2.7 to 3.0 GHz: 40 mV <sub>rms</sub> to 12 V <sub>rms</sub>	4.5 to 6.0 GHz: 40 mV <sub>rms</sub> to 7 V <sub>rms</sub>		
		6.0 to 8.0 GHz: 80 mV <sub>rms</sub> to 7 V <sub>rms</sub>		
<b>Amplitude Modulation (Minimum signal must exceed minimum operating input voltage)</b>				
DC to 0.1 MHz	Up to 94 % depth	Up to 94 % depth	Up to 94 % depth	
0.1 to 6 MHz	Up to 85 % depth	Up to 85 % depth	Up to 85 % depth	
Impedance	50 Ω nominal, AC coupled, VSWR<2:1	50 Ω nominal, AC coupled, VSWR < 2.5:1	50 Ω nominal, AC coupled, VSWR <2:1	50 Ω nominal, AC coupled, VSWR < 2.5:1
Max voltage without damage	12 V <sub>rms</sub> pin diode protected	7 V <sub>rms</sub> , pin-diode protected	12 V <sub>rms</sub> , pin-diode protected	
Connector	Type N female	Type N female	BNC (female)	Type N female

## Rear Panel Inputs and Outputs

	PM 6690	PM 6681
Reference input	1, 5, or 10 MHz; 0.1 to 5 V <sub>rms</sub> sine signal	1, 2, 5, or 10 MHz; > 200 mV <sub>rms</sub> signal
Reference output	1x 10 MHz > 1 V <sub>rms</sub> sinewave into 50 Ω load	1x 10 MHz, > 0.5 V <sub>rms</sub> sinewave into 50 Ω load
PM 6681R		6x 10 MHz & 1x 5 MHz > 0.5 V <sub>rms</sub> sinewave into 50 Ω load
Arming input	Start Arming, Stop Arming, Start & Stop Arming	Most measuring functions can be performed via input E
Frequency range:	DC to 80 MHz	DC to 100 MHz
Slew rate:	> 2 V/μs	> 2 V/μs
Trigger level:	TTL level, 1.4 V nominal	TTL level, 1.4 V nominal
Trigger slope:	Positive or negative	Positive or negative
Gate output		Gate open/gate closed signal output
Trigger level outputs	(level indication on LCD)	Buffered outputs for channel A and B trigger levels
Probe compensation outputs		Outputs for channel A and B to adjust for best pulse response when using probes for counter input
Analog output		0 to 4.98 V proportional to 3 selected digits

## Auxiliary Functions

	PM 6690	PM 6681
<b>Trigger Hold-Off</b>		
Time delay range	20 ns to 2 s, 10 ns resolution	60 ns to 1.34 s, 10 ns resolution
Event delay range B		2 to 2 <sup>24</sup> -1, max. 100 MHz
<b>External Arming</b>		
Time delay range B, E	0 ns to 2 s, 10 ns resolution	200 ns to 1.6 s, 100 ns resolution
Event delay range B		2 to 2 <sup>24</sup> -1, max. 20 MHz
<b>Statistics</b>		
Functions	Maximum, Minimum, Mean, Δmax-min, Standard Deviation and Allan deviation	Maximum, Minimum, Mean and Standard Deviation
Sample size	2 to 2x10 <sup>9</sup> samples	1 to 2x10 <sup>9</sup> samples
Graphical display	Histogram and Trend Plot	
<b>Mathematics</b>		
Functions	(K*X+L)/M and (K/X+L)/M, where X is current reading and K, L and M are constants, set via keyboard or as frozen reference value (XO)	(K*X+L)/M and (K/X+L)/M, where X is current reading and K, L and M are constants, set via keyboard or as frozen reference value (XO) or as value from preceding measurement (Xn-1)

# PM 6690/6681/6681R Timer/Counter/Analyzers

riešenia na presné meranie

www.elseo.sk/Fluke-Calibration

## Timer Counters

### Other Functions

	PM 6690	PM 6681
Measuring time	20 ns to 1000 s for Period, Avg, Frequency and PRF 20 ns to 2 s for Frequency in Burst; Single Cycle for other functions.	Single cycle, 80, 160, 320, 640, 1280 ns and 20 $\mu$ s to 20 s (or to 400 s for some functions)
Display hold	Freezes measuring result, until a new measurement is initiated via Restart	Freezes measuring result, until a new measurement is initiated via Restart
Limit alarm	Indication on front panel and/or SRQ via GPIB	
Limit values:	Lower Limit (Limit 1), Upper Limit (Limit 2)	
Settings:	OFF Alarm if value is above limit 2 Alarm if value is below limit 1 Alarm if value is inside limits 1 and 2 Alarm if value is outside limits 1 and 2	
On alarm:	STOP or CONTINUE	
Alarm display:	Numerical and Graphical	
Instrument settings	20 instrument setups can be saved and recalled from internal non-volatile memory. 10 can be user protected.	20 instrument setups can be saved and recalled from internal non-volatile memory. 10 can be user protected.
Auxiliary menu		Gives access to additional functions
Display	320 x 97 Pixels Monochrome LCD with Backlight	10-digit LCD with high-luminance backlight. 2 additional digits accessible using mathematics.
GPIB interface	Included as standard	Included as standard
Programmable functions	All front panel accessible functions	All front panel accessible functions
Compatibility	IEEE 488.2-1987, SCPI 1991.0	IEEE 488.2-1987, SCPI 1991.0
Interface functions		SH1, AH1, T6, L4, SR1, RL1, DC1, DT1, E2
Modes	Native mode; Agilent 53131/2, 53181 emulation	
USB interface	Standard	
USB version	1.1 Full	
Protocol	USBTMC-USB488	
Time stamping	100 ps resolution	125 ns resolution
<b>Measurement Rate</b>		
Via GPIB	2000 readings/s, individually triggered	250 readings/s
To internal memory	Up to 50 k readings/s	8 k readings/s (50 ps resolution) 20 k readings/s (80 ns resolution)
Internal memory size	Up to 750 k readings	Up to 6100 readings
Data output	ASCII, IEEE double precision floating point	ASCII, IEEE double precision floating point
<b>Display Resolution</b>		
LSD displayed Unit value of the least significant digit displayed.	All calculated LSDs should be rounded to the nearest decade (e.g. 0.3 Hz is rounded to 0.1 Hz, 5 Hz is rounded to 10 Hz.) and cannot exceed the 14th digit.	All calculated LSDs should be rounded to the nearest decade (e.g. 0.3 Hz is rounded to 0.1 Hz, 5 Hz is rounded to 10 Hz.) and cannot exceed the 12th digit.
Frequency and period	(resolution/2 in s) x (Freq or Period)/measuring time	(50 ps x Frequency or Period)/measuring time
Time interval, RT, FT, PW	resolution/2 in s	50 ps $\sqrt{N}$
Duty factor	1 x 10 <sup>-6</sup>	1 x 10 <sup>-6</sup>
Phase	0.001 ° to 1 °	0.01 °
Ratio f1/f2	Prescaler Factor/(f2 x measuring time)	Prescaler Factor/(f2 x measuring time)
<b>General Specifications</b>		
Operating Temp.	0 °C to 50 °C	0 °C to 50 °C
Storage Temp.	-40 °C to 71 °C	-40 °C to 70 °C
Vibration	Random and sinusoidal per MIL-PRF-28800F, Class 3	3 G at 55 Hz per MIL-T-28800D
Shock	Half-sine 30 G per MIL-PRF-28800F; bench handling	Half-sine 40 G per MIL-T-28800D
Reliability	MTBF 30 000 h, calculated	MTBF 30 000 h (calculated)
Safety	EN 61010-1:2001, pollution degree 2, installation/overvoltage category II, measurement category I, CE CSA C22.2 No.61010-1-04	IEC 1010 Class 1, CSA 22.2 No.231, EN 61010-1, CE
EMC		EN 55011 ISM Group 1, Class B; EN 50082-2; FCC Part 15J Class A, CE
Power Requirements	90 to 265 VRMS, 45 to 440 Hz, < 40 W	90 to 265 VRms, 45 Hz to 440 Hz, 35 W, 100 W during warm-up (5 min.), 47 W during normal operation (PM 6681R)
Dimensions (W x H x D)		315 x 86 x 395 mm (12.4 x 3.4 x 15.6 in)
Weight	Net 4 kg (8.5 lb) Shipping 7 kg (15 lb)	Net 4 kg (8.5 lb), Shipping 7 kg (15 lb) (PM6681R) Net 4.8 kg (10.5 lb), Shipping 7.8 kg (16.8 lb)

Elseo Philips Service, Trenčín



## Time Base Options

Option model	PM66xx/-1-	PM66xx/-5-	PM66xx/-6-	PM66xxR/-7-
Retro-fittable option	non retrofit.	PM9691/011	PM9692/011	non retro-fit.
Time base type	Standard	OCXO	OCXO	Rubidium
<b>Uncertainty due to:</b>				
Calibration adjustment tolerance, at + 23 °C ± 3 °C	< 1x10 <sup>-6</sup>	< 2x10 <sup>-8</sup>	< 2x10 <sup>-9</sup>	< 5x10 <sup>-11</sup>
Aging				
per 24 hr.:	N/A	< 5x10 <sup>-10</sup>	< 1x10 <sup>-10</sup>	N/A
per month:	< 5x10 <sup>-7</sup>	< 1x10 <sup>-8</sup>	< 3x10 <sup>-9</sup>	< 5x10 <sup>-11</sup>
per year:	< 5x10 <sup>-6</sup>	< 7.5x10 <sup>-8</sup>	< 2x10 <sup>-8</sup>	< 2x10 <sup>-10</sup>
Temperature variation 0 °C to 50 °C, 20 °C to 26 °C (typical values):	< 1x10 <sup>-5</sup>	< 5x10 <sup>-9</sup>	< 2.5x10 <sup>-9</sup>	< 3x10 <sup>-10</sup>
Power voltage variation: ± 10 %	< 1x10 <sup>-8</sup>	< 5x10 <sup>-10</sup>	< 5x10 <sup>-10</sup>	< 1x10 <sup>-11</sup>
<b>Short term stability (Root Allan Variance)</b>				
τ = 1 s:		< 5x10 <sup>-12</sup>	< 5x10 <sup>-12</sup>	< 5x10 <sup>-11</sup>
τ = 10 s:	not specified	< 5x10 <sup>-12</sup>	< 5x10 <sup>-12</sup>	< 1.5x10 <sup>-11</sup>
τ = 100 s:		N/A	N/A	< 5x10 <sup>-12</sup>
<b>Power-on stability</b>				
Deviation versus final value after 24 hour on time	N/A	< 1x10 <sup>-8</sup>	< 5x10 <sup>-9</sup>	< 4x10 <sup>-10</sup>
after a warm-up time of:	30 min	10 min	10 min	10 min
<b>Total uncertainty, for operating temperature 0 °C to 50 °C, at 2σ (95 %) confidence interval:</b>				
1 year after calibration:	< 1.2x10 <sup>-5</sup>	< 1x10 <sup>-7</sup>	< 2.5x10 <sup>-8</sup>	< 4x10 <sup>-10</sup>
2 years after calibration:	< 1.5x10 <sup>-5</sup>	< 2x10 <sup>-7</sup>	< 5x10 <sup>-8</sup>	< 6x10 <sup>-10</sup>
<b>Typical total uncertainty, for operating temperature 20 °C to 26 °C, at 2σ (95 %) confidence interval</b>				
1 year after calibration:	< 7x10 <sup>-6</sup>	< 1x10 <sup>-7</sup>	< 2.5x10 <sup>-8</sup>	< 2.5x10 <sup>-10</sup>
2 years after calibration:	< 1.2x10 <sup>-5</sup>	< 2x10 <sup>-7</sup>	< 5x10 <sup>-8</sup>	< 5x10 <sup>-10</sup>

### Example Ordering Configuration:

To order the PM 6681 300 MHz, 50 ps version with the 2.7 GHz input C and standard Time Base, select the complete Model Number: PM 6681/616.

**Note:** When ordered together with the basic counter, options are factory installed. Options ordered separately can be customer retrofitted, except PM 9611/80 Real Panel Inputs.

### Specify an Input Frequency Pre-Scaler

/0\_ \_ Standard version, no additional input frequency pre-scaler  
 /4\_ \_ 1.3 GHz Input C (PM 9621)  
 /6\_ \_ 2.7 GHz Input C (PM 9624)  
 /x\_ \_ 8.0 GHz Input C (PM 96xx)

### Specify a TimeBase Option

/\_1\_ Standard Time base oscillator  
 /\_5\_ Very High Stability Oven Timebase (PM 9091)  
 /\_6\_ Ultra High Stability Oven Time Base (PM 9692)  
 /\_7\_ Rubidium Time base, Select model PM 6685R or PM 6681R

### Specify a Battery Unit and GPIB Interface Option

/\_3\_ Battery Unit (PM 9623) for PM 6685 only  
 /\_6\_ GPIB Interface (PM 9626/02) and TimeView™ Time and Frequency Analysis Software for PM6685 and PM6685R

### Ordering Information

#### Models

**PM 6690/\_ \_ 6** \* 300 MHz, 100 ps Timer/Counter including USB and GPIB-Interface and TimeView Time and Frequency Software

**PM 6681/\_ \_ 6** \* 300 MHz, 50 ps Timer/Counter including GPIB-Interface (PM 9626/00) and TimeView Time and Frequency Software plus External Reference Frequency Multiplier (1,5,10 MHz)

**PM 6681R/\_ 76** \* 300 MHz Rubidium Timer/Counter/Analyzer including GPIB-Interface (PM 9626/00) and TimeView Time and Frequency Software

\* Instrument optional configuration

#### Options and Accessories

**Y8021** Shielded IEEE-488 Cable, 1 m

**Y8022** Shielded IEEE-488 Cable, 2 m

**PM 9627** Carrying Case

**PM 9627H** Heavy Duty Aluminum Carrying Case

**PM 9611/801\*\*** Rear Panel Inputs

**PM 9621/001** 1.3 GHz Input C

**PM 9624/001** 2.7 GHz Input C

**PM 962x/001** 8.0 GHz Input C

**PM 9691/011** Very High Stability Oven Time Base

**PM 9692/011** Ultra High Stability Oven Time Base

**PM 9622/001** Rack-Mount Kit

**PM 9639/01\*\*\*** 2.3 GHz 500W probe set, 10:1 (BNC)

\*\*When ordered together with the basic counter, options are factory installed. Options ordered separately can be customer retrofitted, except PM 9611/80 Real Panel Inputs.

\*\*\*Each probe consists of:

- Probe cable assembly
- Probe body
- Retractable hook tip
- Ground lead and clip
- Insulator sleeve

# PM 6685/6685R Frequency Counters

riešenia na presné meranie

[www.elseo.sk/Fluke-Calibration](http://www.elseo.sk/Fluke-Calibration)

## Timer Counters

### Cal lab performance in the field

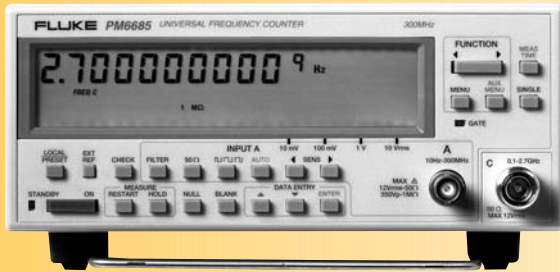

6685

- 300 MHz basic frequency range
- Options for 1.3 GHz and 2.7 GHz ranges
- Ultra high accuracy with Rubidium timebase option
- Measures to 10 digits within one second

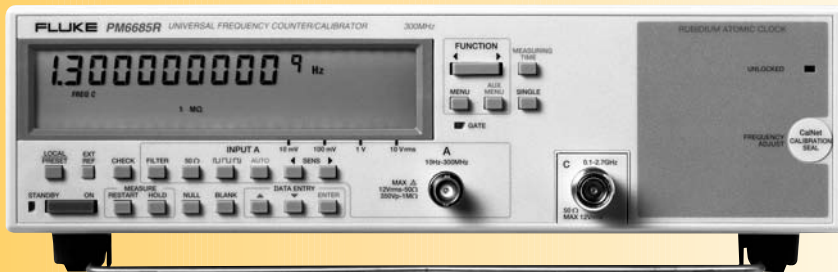

6685R



The PM 6685 frequency counter from Fluke brings cal lab accuracy to field measurements. With 10 digits per second, plus overflow (displays 11th and 12th digits), it delivers high-accuracy measurements instantly. The PM 6685 is easy to use, compact and – most important of all – it has today's smartest input triggering for frequency measurements. The battery option for the PM 6685 maintains oven stability for 20 hours, giving you instant oven performance even after long transportation.

## Measurement Functions

Frequency		A, C
Input A:	10 Hz to 300 MHz	
Input C:	(Optional Input Pre-Scaler) (PM 9621): 70 MHz to 1.3 GHz (PM 9624): 100 MHz to 3.0 GHz	
Resolution:	10 digits/s measurement time	
Burst Frequency		A
Frequency range:	100 Hz to 80 MHz	
PRF range:	up to 1 MHz	
Burst duration:	0.8 $\mu$ s to 50 ms, min. 3 periods of this signal	
Burst Frequency		C
Frequency range:	100 MHz to 3.0 GHz	
PRF range:	up to 1 MHz	
Burst duration:	0.5 $\mu$ s to 1.5 s, min. 196 cycles in burst	
Period		A
Range:	12 ns to 100 ms	
Resolution:	10 digits/s measurement time	
Ratio		A/E, C/A
Range:	$10^{-9}$ to $10^9$	
<b>Frequency Range:</b>		
Input A:	10 Hz to 300 MHz	
Input E:	10 Hz to 80 MHz	
Input C:	See input C frequency range	
Pulse Width		A
Range:	6 ns to 10ms	
Frequency range:	50 Hz to 60 MHz	
Voltage range:	100 mV <sub>pp</sub> to 70 V <sub>pp</sub>	
Duty Factor		A
Range:	0 to 1	
Frequency range:	50 Hz to 60 MHz	
Voltage range:	100 mV <sub>pp</sub> to 70 V <sub>pp</sub>	
Totalize		A (Event Counting on A with manual start and stop)
Range:	0 to $10^{14}$	
Frequency range:	0 to 100 MHz	

## Input and Output Specifications

Input A	
Frequency range:	10 Hz to 300 MHz
Coupling:	AC
Impedance:	1 M $\Omega$ //25 pF or 50 $\Omega$ , VSWR < 2:1
Sensitivity	
Sine wave:	10 mV <sub>rms</sub> , 10 Hz to 50 MHz 15 mV <sub>rms</sub> , 50 MHz to 100 MHz 20 mV <sub>rms</sub> , 100 MHz to 150 MHz 30 mV <sub>rms</sub> , 150 MHz to 200 MHz 50 mV <sub>rms</sub> , 200 MHz to 300 MHz
Pulse:	50 mV <sub>pp</sub> , 3 ns minimum pulse width
Dynamic range:	30 mV <sub>pp</sub> to 70 V <sub>pp</sub>
Manual Trigger	
Sensitivity range:	10 mV <sub>rms</sub> to 10 V <sub>rms</sub> , variable in 3 dB steps, indicated on bar graph
Trigger level:	Selectable for optimum triggering on waveforms with duty factors of < 0.25, 0.25 to 0.75 and > 0.75
Trigger slope:	Positive or negative
Auto trigger	Automatic setting of input signal conditioning circuits for optimum triggering on different amplitudes and waveforms
Frequency:	Minimum 50 Hz
Sensitivity range:	10 mV <sub>rms</sub> to 25V <sub>rms</sub>
Signal monitor	A bar graph displays actual input signal level in 3 dB steps, 10 mV <sub>rms</sub> to 10 V <sub>rms</sub>
Low pass filter	100 kHz nominal 3 dB point. Minimum 40 dB attenuation at 1 MHz.
Damage Level	
1 M $\Omega$ impedance:	350 V (DC + AC peak) at DC to 440 Hz, falling to 12 V rms at 1 MHz and above
50 $\Omega$ impedance:	12 V rms

## Auxiliary Functions

External arming/ External gate	External signal on input E can be used to inhibit start and/or stop triggering. Stop arming is not applicable to Pulse Width and Duty Factor measuring modes.
Start arming delay	OFF or 200 ns to 5 s in 100 ns steps
Nulling/frequency offset	Nulling enables measurements to be displayed relative to a previously measured value or to any value entered via front panel keys

## Input C

	(PM 9621)	(PM 9624)
Frequency range:	70 MHz to 1.3 GHz	100 MHz to 3.0 GHz
Pre-scaler factor:	512	64
Sensitivity:	10 mV <sub>rms</sub> to 12 V <sub>rms</sub> , 70 to 900 MHz 40 mV <sub>rms</sub> to 12 V <sub>rms</sub> , 1100 to 1300 MHz 10 mV <sub>rms</sub> to 12 V <sub>rms</sub> , 0.3 to 2.5 GHz	15 mV <sub>rms</sub> to 12 V <sub>rms</sub> , 900 to 1100 MHz 20 mV <sub>rms</sub> to 12 V <sub>rms</sub> , 100 to 300 MHz 20 mV <sub>rms</sub> to 12 V <sub>rms</sub> , 2.5 to 2.7 GHz 100 mV <sub>rms</sub> to 12 V <sub>rms</sub> , 2.7 to 3.0 GHz
Amplitude modulation:	DC to 0.1 MHz: Up to 94 % depth 0.1 to 6 MHz: Up to 85 % depth (Minimum signal must exceed Input Sensitivity)	DC to 0.1 MHz: Up to 94 % depth 0.1 to 6 MHz: Up to 85 % depth (Minimum signal must exceed Input Sensitivity)
Impedance:	50 $\Omega$ nominal, ac coupled, VSWR < 2:1	50 $\Omega$ nominal, ac coupled, VSWR < 2.5:1
Damage level:	12 V <sub>rms</sub> , pin diode protected	12 V <sub>rms</sub> , pin diode protected
Connector:	BNC	Type N Female

# PM 6685/6685R Frequency Counters

riešenia na presné meranie

www.elseo.sk/Fluke-Calibration

## Timer Counters

### External Reference

<b>Input D</b>	<b>The use of external reference is indicated on the front panel display</b>
Input frequency:	10 MHz standard
Voltage range:	200 mV <sub>rms</sub> to 10 V <sub>rms</sub>
Impedance:	Approximately 1 kΩ, ac coupled
<b>Input E</b>	<b>Used in ratio A/E and external arming / gating modes</b>
Frequency range:	DC to 80 MHz
Pulse width:	6 ns minimum
Slew rate:	2 V/μs minimum
Trigger level:	TTL level, 1.4 V nominal
Trigger slope:	Positive or negative
Impedance:	Approximately 2 kΩ, dc coupled
Damage level:	± 25 V peak
<b>Reference Output G</b>	
Frequency:	10 MHz, sine wave
Output:	> 1.0 V <sub>rms</sub> into 50 Ω load, ac coupled

### Options

Battery unit PM 9623	The PM 9623 is a rechargeable battery unit for mounting inside the counter.
Battery type	Sealed lead-acid cells
Battery capacity at 25 °C Standby mode: Operating mode:	Typically 20 hours with Oven Time Base Typically 3 hours without options, 2.5 hours with Oven Time Base, and 2 hours with Oven Time Base and Input C
Recharge time	Typically 8 hours in standby mode
Battery protection:	Overcharge and deep discharge protection
External dc:	12 V to 24 V via socket on rear panel (16 V to 24 V to charge internal battery)
Line failure protection:	Counter automatically switches to internal battery or external DC when the line voltage falls below 90 Vac
Temperature Operating: Storage:	0 °C to +40 °C -40 °C to +50 °C
Weight	1.5 kg (3.3 lb)
GPIB PM 9626/03	Includes analog output function
Programmable functions	All front panel and AUX MENU functions
Compatibility	IEEE 488.2-1987, SCPI 1991.0
Interface functions	SH1, AH1, T6, L4, SR1, RL1, DC1, DT1, E2
Maximum measurement Rate to internal memory	200 to 1600 readings/s, depending on measurement function and internal data format
Internal memory size	764 to 2600 readings, depending on measurement function and internal data format
Maximum bus transfer Rate from internal memory	150 to 1000 readings/s, depending on internal data format and output data format
Data output format	ASCII, IEEE double precision floating point
Time out	Off or 100 ms to 25.5 s in 100 ms steps
Analog output (included with GPIB option)	0 to 4.98 V in 20 mV steps, derived from three consecutive digits selected from the measurement result
Output impedance	200 Ω

### Other Functions

Measuring time	Single Cycle, 100 ns to 15 s in 1-2-5 steps
Local/preset	Go to local function in remote mode, or preset counter to default setting in local mode
Restart	Starts a new measurement
Display hold	Freezes measuring result
Check	Applies 10 MHz to the measuring logic
Display	LCD with high-luminance backlight
Number of digits	10 digits plus exponent
Blanking	Least significant digits can be blanked
Bar graph	Displays input signal level or sensitivity setting in 3 dB steps from 10 mV <sub>rms</sub> to 10 V <sub>rms</sub>
Auxiliary menu	The following functions are available from the AUX MENU and via the GPIB interface
Save/recall	20 complete instrument settings 10 settings can be user protected
GPIB address	Read and temporarily change via front panel keys. (Set new address on rear panel switch.)
Burst frequency	Set input A and C synchronization delay time
PRF	Set input A and C synchronization delay time
Trigger slope	Positive or negative slope
Arming start	Positive or negative slope, set start arming delay time
Arming stop	Positive or negative slope
Null	Read and change stored offset frequency
Display overflow	Display of the 11th and 12th digits
Test	Select selftest
Program version	Display instrument and GPIB program versions
Time out	OFF or 100 ms to 25.5 s in 100 ms steps
Analog output	(Included with GPIB option only) 0 to 4.98 V in 20 mV steps, derived from three consecutive digits selected from the measurement result
Display backlight	On/off
Power requirements AC: DC:	90 to 265 V <sub>rms</sub> , 45 to 440 Hz, Max 30 W (PM 9623 Option) Internal Battery or external 12 to 24 Vdc, max 2 A
Safety	According to CE-regulation 73/23 EN61010-1 CAT II, Pollution Degree 2
EMC	According to CE regulation 89/336: Emission according to EN 50081-1, EN 55011 Immunity according to EN 50082-1, inclusive IEC 801-2, -3, -4
Mechanical data Size: Weight:	210 mm W x 86 mm H x 395 mm D (8.25 in W x 3.4 in H x 15.6 in D) 3.2 kg (7 lb)

## Time Base Options

Option model	PM66xx/-1-	PM66xx/-5-	PM66xx/-6-	PM66xxR/-7-
Retro-fittable option	non retrofit.	PM9691/011	PM9692/011	non retro-fit.
Time base type	Standard	OCXO	OCXO	Rubidium
<b>Uncertainty due to:</b>				
Calibration adjustment tolerance, at + 23 °C ± 3 °C	< 1x10 <sup>-6</sup>	< 2x10 <sup>-8</sup>	< 2x10 <sup>-9</sup>	< 5x10 <sup>-11</sup>
Aging				
per 24 hr.:	N/A	< 5x10 <sup>-10</sup>	< 1x10 <sup>-10</sup>	N/A
per month:	< 5x10 <sup>-7</sup>	< 1x10 <sup>-8</sup>	< 3x10 <sup>-9</sup>	< 5x10 <sup>-11</sup>
per year:	< 5x10 <sup>-6</sup>	< 7.5x10 <sup>-8</sup>	< 2x10 <sup>-8</sup>	< 2x10 <sup>-10</sup>
Temperature variation 0 °C to 50 °C, 20 °C to 26 °C (typical values):	< 1x10 <sup>-5</sup>	< 5x10 <sup>-9</sup>	< 2.5x10 <sup>-9</sup>	< 3x10 <sup>-10</sup>
Power voltage variation: ± 10 %	< 1x10 <sup>-8</sup>	< 5x10 <sup>-10</sup>	< 5x10 <sup>-10</sup>	< 1x10 <sup>-11</sup>
<b>Short term stability (Root Allan Variance)</b>				
τ = 1 s:		< 5x10 <sup>-12</sup>	< 5x10 <sup>-12</sup>	< 5x10 <sup>-11</sup>
τ = 10 s:	not specified	< 5x10 <sup>-12</sup>	< 5x10 <sup>-12</sup>	< 1.5x10 <sup>-11</sup>
τ = 100 s:		N/A	N/A	< 5x10 <sup>-12</sup>
<b>Power-on stability</b>				
Deviation versus final value after 24 hour on time	N/A	< 1x10 <sup>-8</sup>	< 5x10 <sup>-9</sup>	< 4x10 <sup>-10</sup>
after a warm-up time of:	30 min	10 min	10 min	10 min
<b>Total uncertainty, for operating temperature 0 °C to 50 °C, at 2σ (95 %) confidence interval:</b>				
1 year after calibration:	< 1.2x10 <sup>-5</sup>	< 1x10 <sup>-7</sup>	< 2.5x10 <sup>-8</sup>	< 4x10 <sup>-10</sup>
2 years after calibration:	< 1.5x10 <sup>-5</sup>	< 2x10 <sup>-7</sup>	< 5x10 <sup>-8</sup>	< 6x10 <sup>-10</sup>
<b>Typical total uncertainty, for operating temperature 20 °C to 26 °C, at 2σ (95 %) confidence interval</b>				
1 year after calibration:	< 7x10 <sup>-6</sup>	< 1x10 <sup>-7</sup>	< 2.5x10 <sup>-8</sup>	< 2.5x10 <sup>-10</sup>
2 years after calibration:	< 1.2x10 <sup>-5</sup>	< 2x10 <sup>-7</sup>	< 5x10 <sup>-8</sup>	< 5x10 <sup>-10</sup>

### Example Ordering Configuration:

To order the PM 6685 300 MHz, with the 2.7 GHz input C and standard Time Base, select the complete Model Number: PM 6685/616.

**Note:** When ordered together with the basic counter, options are factory installed. Options ordered separately can be customer retrofitted, except PM 9611/80 Real Panel Inputs.

### Specify an Input Frequency Pre-Scaler

/0\_ \_ Standard version, no additional input frequency pre-scaler  
 /4\_ \_ 1.3 GHz Input C (PM 9621)  
 /6\_ \_ 2.7 GHz Input C (PM 9624)

### Specify a TimeBase Option

/\_1\_ Standard Time base oscillator  
 /\_5\_ Very High Stability Oven Timebase (PM 9091)  
 /\_6\_ Ultra High Stability Oven Time Base (PM 9692)  
 /\_7\_ Rubidium Time base, Select model PM 6685R or PM 6681R

### Specify a Battery Unit and GPIB Interface Option

/\_1\_ Standard version  
 /\_3\_ Battery Unit (PM 9623) for PM 6685 only  
 /\_6\_ GPIB Interface (PM 9626/02) and TimeView™ Time and Frequency Analysis Software for PM 6685 and PM 6685R

## Ordering Information

### Models

**PM 6685/\_ \_ 1\*** 300 MHz Universal Frequency Counter  
**PM 6685R/\_71\*** 300 MHz Rubidium Frequency Counter/Calibrator

\* Instrument optional configuration

### Options and Accessories

These accessories are compatible with model: PM 6685 Universal Frequency Counter

### Options and Accessories

**Y8021** Shielded IEEE-488 Cable, 1 m

**Y8022** Shielded IEEE-488 Cable, 2 m

**PM 9627** Carrying Case

**PM 9627H** Heavy Duty Aluminum Carrying Case

**PM 9611/801\*\*** Rear Panel Inputs

**PM 9621/001** 1.3 GHz Input C

**PM 9624/001** 3.0 GHz Input C

**PM 9691/011** Very High Stability Oven Time Base

**PM 9692/011** Ultra High Stability Oven Time Base

**PM 9622/001** Rack-Mount Kit

**PM 9639/01\*\*\*** 2.3 GHz 500W probe set, 10:1 (BNC)

\*\*\*When ordered together with the basic counter, options are factory installed. Options ordered separately can be customer retrofitted, except PM 9611/801 Real Panel Inputs.

\*\*\*Each probe consists of:

- Probe cable assembly
- Probe body
- Retractable hook tip
- Ground lead and clip
- Insulator sleeve

# 908/909 Frequency References

riešenia na presné meranie

www.else.sk/Fluke-Calibration

## Frequency Standards

**Stable frequency references for test systems and calibration labs**



- Accurate reference “Atomic clock” in automated test systems
- Affordable and very cost effective
- Designed for easy portability with optional carrying case
- No need for battery backup during transportation
- Fast warm-ups

The 908 and 909 are ideal for use in calibration laboratories where there is a specific need to calibrate a wide range of instruments, such as frequency counters and synthesizers. Unlike off-air frequency receivers, the 908 and 909 have very high short term stability that enables much faster frequency calibration. If frequency standards are located in several departments, spread over a number of buildings, you will discover the portable 909 Rubidium standard offers a more cost-effective solution than a central reference with a costly distribution system.

### Frequency Stability

Stability	908 (Oven)	909 (Rubidium)
Aging per month	$3 \times 10^{-9}$	$5 \times 10^{-11}$
Aging per year (per 10 years)	$< 2 \times 10^{-8}$ (1 year)	$1 \times 10^{-9}$ (10 years)
Temperature: (20 °C to 26 °C)	$< 4 \times 10^{-10}$ typical	$2 \times 10^{-11}$ typical
(0 °C to +50 °C)	$2.5 \times 10^{-9}$	$3 \times 10^{-10}$
Short term (root Allan variance)	$5 \times 10^{-12} t = 10 \text{ s}$	$1 \times 10^{-11} t = 10 \text{ s}$
	$5 \times 10^{-12} t = 1 \text{ s}$	$3 \times 10^{-11} t = 1 \text{ s}$
Warm-up (at +25 °C)	10 min. to $5 \times 10^{-9}$	5.4 min to lock 11 min to $4 \times 10^{-10}$

#### Reference outputs

Base model: 5 x 10 MHz, 1 x 5 MHz:  
sine  $> 0.6 \text{ V rms}$  in 50  $\Omega$   
With option 70: 10 x 10 MHz, 1 x 5 MHz:  
sine  $> 0.6 \text{ Vrms}$  in 50  $\Omega$

#### Environment

Temperature: 0 °C to +50 °C (operating);  
-40 °C to +70 °C (storage)  
Safety: Compliant to EN 61010-1, Cat II,  
pollution degree 2  
EMI: Compliant to EN 55011 ISM group,  
class B, EN 50082-2

#### Power consumption

(90 to 264 V, 47 to 63 Hz)  
908:  $< 20 \text{ W}$  at warm up,  $< 7 \text{ W}$   
continuous operation  
909:  $< 70 \text{ W}$  at warm up,  $< 30 \text{ W}$   
continuous operation

#### Dimensions and weight

Size: 315 mm W x 86 mm H x 395 mm D  
(12.6 in W x 3.4 in H x 15.8 in D)  
Weight: 4.8 kg (net), 7.8 kg (shipping)

### Ordering Information

#### Models

908 OCXO Frequency Reference

909 Rubidium Frequency Reference

#### Options and Accessories

908-50, 909-50 Rack Mount Kit

908-60, 909-60 Carrying Case

908-70, 909-70 Additional 5 x 10 MHz outputs

# 910/910R GPS Controlled Frequency Standards

riešenia na presné meranie

www.elseo.sk/Fluke-Calibration

FLUKE®

Frequency Standards

The first truly traceable, ultra stable GPS-disciplined frequency references



- The world's first truly traceable frequency reference
- Cesium-controlled frequency via GPS satellites
- Accurate frequency and time references anywhere in the world
- Frequency comparator and secondary standard united in one unit

The 910 and 910R GPS-controlled frequency standards deliver a precision frequency and time reference which, with its many connectivity options, can be installed, monitored and managed from virtually any location. Both models receive their long-term frequency stability from the built-in cesium standards in the GPS-satellite array, yet can also provide a very high short-term stability from the built-in oven controlled crystal oscillator (OCXO) or rubidium standard (Rb).

Both the 910 and 910R are fully traceable and extremely accurate frequency standards and are ideally suited for use as frequency standards in many applications, including telecommunications, calibration and automatic test systems.

## Unique traceability feature means no more re-calibrations

Off-air frequency standards have existed for several years. But until now, they all have had the same internal architecture (Figure 1). The unit is, in effect, a "black box," with an antenna input and a frequency output.

The local oscillator's control process (disciplining) is hidden from the user. Typically, users have used another frequency reference (for example, a rubidium standard), a timer/counter and a PC for logging the deviation between the "black box" and the frequency reference.

The concept of traceability requires an unbroken chain of comparisons to international standards, on a continuing basis, where all comparisons produce documented results with stated uncertainty.

Now, for the first time, a documenting frequency comparator and a very stable secondary standard are united within the same instrument together with the GPS receiver.

The received GPS signal is measured continuously against the local oscillator. Phase and frequency deviation is stored internally and can at any time be transferred to any PC directly from the 910/910R or, via the optional Ethernet interface, from or to almost anywhere. Then by using the GPSView™ software supplied with every model, a printout of the traceability record can be obtained. The unbroken calibration history chain – day by day – is maintained in the non-volatile memory for several years, with the current 24-hour mean offset being displayed continuously on the front panel's LCD display.

Such unique traceability to primary standards means that the 910 and 910R never need to be away for re-calibration. Thanks to this design, the very high stability built-in rubidium or OCXO oscillator is continuously calibrated to the primary frequency standards in the US Naval Observatory and ultimately to UTC, in whatever operating mode, disciplined or manual hold-over.

## Two high-stability models to meet your application, and fit your budget

Fluke offers two standard models in its controlled frequency standards range; the very-high stability 910R with its built-in rubidium atomic clock as the local oscillator, and the affordable 910 with its high stability local oven controlled crystal oscillator.

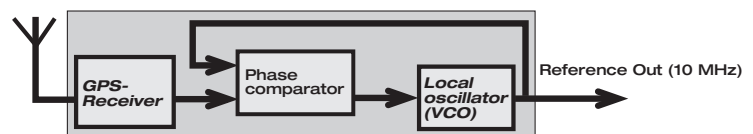
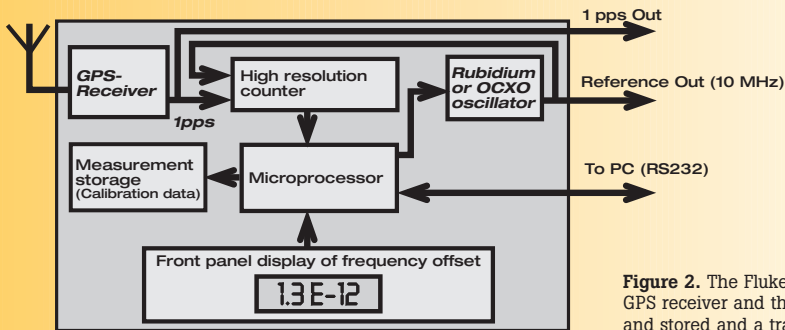

Figure 1. A typical "black box GPS receiver" (antenna in – reference out). Internal oscillator offset and adjustments are invisible to the user.



**Figure 2.** The Fluke 910 and 910R have built-in comparison between the GPS receiver and the internal oscillator. The frequency offset is displayed and stored and a traceability record can be produced at any time.

### Up to 13 outputs, maximizing cost efficiency

Both models come with one 5 MHz and five 10 MHz sinewave outputs as standard. A 1 pulse-per-second output is also included.

If your application requires more outputs – for example, if several other instruments need to be supplied from the same frequency standard – option 70 allows you to mount five more 10 MHz outputs. Alternatively, option 72 allows you to expand your instrument to give five extra 2.048 MHz outputs, which is particularly useful in many telecoms applications. Option 73 provides five extra 13 MHz outputs, the standard frequency for GSM base station master clocks. Another variant on output configuration is offered through option 71, which gives the instrument an additional four sine wave outputs of 10 MHz, 5 MHz, 1 MHz and 0.1 Hz, plus a 0.1 MHz square wave output.

And finally, option 75 allows you to define your own pulse frequency output.

### Central or remote monitoring, management and data collection, using the 910/910R Ethernet-port

The 910 and 910R can both be fitted with an optional Ethernet communication interface (Option 76) which enables on-line access. Using the GPSView™ software supplied, it is possible to monitor both instrument and GPS status, or even collect calibration data, via the internet or any Local Area Network.

With Ethernet interface connectivity, distances to which data can be transmitted become unlimited, unlike that of any standard GPIB or RS232 interface, thereby allowing the 910/910R to be monitored from practically anywhere.

This means that the metrologist or lab technician no longer requires a ‘floating’ laptop PC to directly perform instrument management tasks, as this can now be achieved from any desktop PC, from any location inside or outside the calibration laboratory. It also allows data from multiple instruments to be simultaneously viewed in real time.

### Liberate your GPS controlled frequency standard with the FL-15 GPS Antenna Fiber Link

Until now, the location of every off-air frequency standard has been governed by the location of its antenna and the limiting length and thickness of the coaxial cable between the antenna and the instrument.

Frequently, this has meant that the instrument has been inconveniently positioned within the lab, or even outside the controlled environment of the calibration laboratory.

The FL-15 GPS fiber link eliminates this problem and allows the user to position the instrument practically anywhere. The low loss (0.4 dB/km) lightweight fiber optic link means that the distance between antenna and instrument can be as much as 10 km. What’s more, the highly flexible, lightweight fiber optic cable has a very small cable diameter and can fit into virtually any cable pipeline.

Consisting of a fiber optic link for the GPS signal, and transmitter and receiver modules, the FL-15 package also provide the 910 and 910R immunity to electrical interference, such as lightning strikes and EMP interference as well as electrical isolation between antenna and receiver module.

### Two high-stability operating modes to suit your application

Most users prefer automatic adjustment (known as disciplining) of their frequency standard, to fully eliminate long-term frequency changes (aging). This disciplined mode is also the default mode in the 910 and 910R. As long as there is a valid satellite signal, the internal local oscillator is monitored and adjusted and the mean 24-hour frequency offset is always virtually zero. However, in this mode, the inherent short-to-medium term stability of all local oscillators, except rubidium, is compromised. This is true for all GPS frequency references. The received GPS signal has relatively large short-term frequency variations, due to variations in atmospheric conditions. This means that when using the received GPS signal for disciplining, the stability is reduced a little for averaging times of 100 s to 1000 s.

In this mode, the frequency deviation between the internal timebase oscillator and the received GPS-signal is used to continuously adjust the oscillator (disciplining). The resulting frequency offset and adjustment data is stored in non-volatile memory every 24h, to enable printout of the traceability record. The actual frequency offset (24h mean value) is calculated and displayed on the front panel.

Some applications demand superior short-medium term stability, especially for jitter and wander measurements in digital telecommunication networks.





Figure 3. GPSView can print a calibration protocol at any time.

The unique manual hold-over mode makes it possible to switch over temporarily from disciplined to hold-over mode during the actual measurement, thereby achieving a superior frequency accuracy at the start of the measurement and a superior stability through the measurement.

Here, the internal oscillator is not adjusted. This mode is normally automatically entered when there is no usable received GPS-signal. This mode can also be selected manually by activating the Manual Hold-Over Key. If Manual hold-over is set together with a valid received GPS signal, the actual frequency offset is calculated, displayed and stored in non-volatile memory every 24 hours.

## Specifications

### 910R (GPS-Rb) Frequency stability – locked to GPS

Frequency offset (24h mean):  
 $< 1 \times 10^{-12}$ \*

**Short term (Allan dev.):**  
 $< 1 \times 10^{-12}$  ( $\tau = 1000$  s)  
 $< 3 \times 10^{-12}$  ( $\tau = 100$  s)  
 $< 1 \times 10^{-11}$  ( $\tau = 10$  s)  
 $< 3 \times 10^{-11}$  ( $\tau = 1$  s)

Warm up (+25 °C): 20 mins to lock  
 \*At temperature 23 °C  $\pm$  3 °C

### Frequency stability – Hold-Over

Aging/24h:  $< 2 \times 10^{-12}$  (typical)  
 Aging/month:  $< 5 \times 10^{-11}$   
 Temp. (0 °C to +50 °C):  $< 3 \times 10^{-10}$   
 Temp. (23 °C  $\pm$  3 °C):  $< 2 \times 10^{-11}$  (typical)

**Short term (Allan dev.):**  
 $< 3 \times 10^{-12}$  ( $\tau = 100$  s)  
 $< 1 \times 10^{-11}$  ( $\tau = 10$  s)  
 $< 3 \times 10^{-11}$  ( $\tau = 1$  s)  
 Warm up (+25 °C): 10 minutes to  
 $4 \times 10^{-10}$

### Phase noise

Offset	Phase noise
1 Hz	-80 dBc/Hz (typ.)
10 Hz	-90 dBc/Hz (typ.)
100 Hz	-130 dBc/Hz (typ.)
1 kHz	-140 dBc/Hz (typ.)
10 kHz	-140 dBc/Hz (typ.)
100 kHz	-145 dBc/Hz (typ.)

### 910 (GPS-OCXO) Frequency stability – locked to GPS

Frequency offset (24h mean):  
 $< 2 \times 10^{-12}$ \*

**Short term (Allan dev.):**  
 $< 5 \times 10^{-11}$  ( $\tau = 1000$  s)  
 $< 3 \times 10^{-11}$  ( $\tau = 100$  s)  
 $< 5 \times 10^{-12}$  ( $\tau = 10$  s)  
 $< 5 \times 10^{-12}$  ( $\tau = 1$  s)  
 Warm up (+25 °C): 20 mins to lock  
 \*At temperature 23 °C  $\pm$  3 °C

### Frequency stability – Hold-Over

Aging/24h:  $< 3 \times 10^{-10}$   
 Aging/month:  $< 3 \times 10^{-9}$   
 Temp. (0 °C to +50 °C):  $< 2.5 \times 10^{-9}$   
 Temp. (23 °C  $\pm$  3 °C):  $< 4 \times 10^{-10}$  (typical)

For the ultra-stable rubidium oscillator in the 910R, there is no measurable difference between the stability in disciplined and hold-over mode, for averaging times up to 1000s.

### Designed for portability too

When using manual hold-over mode, the 910 or 910R act as a stand-alone OCXO or rubidium frequency standard. This means that one typical drawback of a GPS receiver, lack of portability, is eliminated. A typical GPS receiver needs hours to lock after a change of location, whereas the 910 and 910R are up and running after just ten minutes.

### GPSView™ Software

GPSView is a Windows program that communicates with the GPS-controlled frequency standard. Its main purpose is to provide a traceable calibration document based on the 24 hour frequency offset values, internally stored in the non-volatile memory of model 910/910R (Figure 3).

It is only necessary to download data to a PC to the 910/910R once every second year to obtain an unbroken traceability chain since first use. For performance analysis over a shorter period and for short-term phase variation, data can be obtained over the latest forty-day period.

From GPSView, the user can control the operating mode (Disciplined or Hold-Over), and lock the front panel to prevent unintended change via the Manual Hold-Over Key. The user can also set the optional pulse output frequency and duty cycle.

### Short term (Allan dev.):

$< 5 \times 10^{-12}$	( $\tau = 1000$ s)
$< 5 \times 10^{-12}$	( $\tau = 10$ s)
$< 5 \times 10^{-12}$	( $\tau = 1$ s)

Warm up (+25 °C): 10 minutes to  
 $5 \times 10^{-9}$

### Phase noise

Offset	Phase noise
1 Hz	-100 dBc/Hz (typ.)
10 Hz	-120 dBc/Hz (typ.)
100 Hz	-130 dBc/Hz (typ.)
1 kHz	-135 dBc/Hz (typ.)
10 kHz	-135 dBc/Hz (typ.)
100 kHz	-135 dBc/Hz (typ.)

## Common

### Reference outputs (BNC)

10 MHz: Sine wave, 0.6 V rms into 50  $\Omega$   
 5 MHz: Sine wave, 0.6 V rms into 50  $\Omega$   
 1 pps: TTL-levels; low  $< 0.4$  V, high  $> 2$  V into 50  $\Omega$  load  
 Pulse output (opt. 75): TTL-levels; low  $< 0.4$  V, high  $> 2$  V into 50  $\Omega$  load

### 10 MHz and 5 MHz outputs

Frequency Stability: See frequency stability specs for 910 and 910R

# 910/910R GPS Controlled Frequency Standards

riešenia na presné meranie

www.elseo.sk/Fluke-Calibration

## Frequency Standards

### 1-pps output (locked to GPS)

Duty cycle: Approx. 20 %  
Jitter: < 60 ns rms relative to UTC or GPS (position hold, SA on)

### 5 additional 10 MHz outputs (option 70)

See specification for 10 MHz above

### Multiple reference outputs (option 71)

Sine wave outputs: 10, 5, 1 and 0.1 MHz > 1 V<sub>rms</sub> into 50 Ω  
Pulse output: 0.1 MHz; > 3 V<sub>p-p</sub> into 50 Ω; 0 V ≤ L<sub>0</sub> < 0.8 V, 3 V < H<sub>1</sub> ≤ 5 V

### 5 additional 2.048 MHz outputs (option 72)

Frequency: 2.048 MHz square wave  
Output level: -1.2 V to +1.2 V ± 10 % into 75 Ω (G.703:10)  
Jitter: < 0.01 UI

### 5 additional 13 MHz outputs (option 73)

Output signal: TTL (symmetrical)  
Typical levels into 50 Ω:  
High voltage: 2.35 V  
Low voltage: 0 V  
Jitter: < 0.01 UI  
Long term stability: Same as main reference

### Pulse output (option 75)

The frequency and duty cycle are set via the included PC-program  
Selectable frequency:  $\frac{1}{N \cdot 10^{-7}}$  Hz; N is an integer  
Factory default setting: 1 Hz  
Jitter: < 500 ps rms  
Freq. Stability: See frequency stability specs for 910 and 910R

### Ethernet interface (option 76)

#### Communication Port:

Connector: RJ45  
Protocol: 10Base-T  
Buffer RAM: 1 kbit

#### Configuration Port:

Connector: Dsub9, RS-232

### Internal data storage

24h-freq. Offset: 2 years data, Non-volatile memory  
Adjustment data: 2 years data, Non-volatile memory  
Phase data (TIE): 40 days data, Volatile memory

### LED indicators

Locked to GPS, Alarm, Manual Hold-over

### Display indicators

#### 7-segment area:

24h mean freq. Offset (if valid data exist)  
Time of day (if GPS gives valid time)  
"910" or "910R" (if GPS contact not sufficient)  
Alarm text (plus Alarm LED)  
REMOTE segment: Local Lock-out (from PC):  
Analog bar graph: Satellite signal strength

### GPS-receiver

Antenna connector: Type N  
Channels: 8, parallel tracking  
Carrier, code: L1, C/A

### Antenna (option 01)

Type: active L1  
Operating temp.: -40 °C to +70 °C  
Height: 81 mm (3.2") (excluding connector)  
Weight: 230 g (8 oz.)  
Gain: > 30 dB  
Connector: TNC

### Antenna cable (option 02/20, option 02/50)

Type: RG213  
Length: 20 m (02/20), 50 m (02/50)  
Connectors: N-type and TNC (male)  
Cable delay: 101 ns (02/20), 251 ns (02/50)

#### Attenuation:

Approx. 8 dB at 1.6 GHz (02/20)  
Approx. 20 dB at 1.6 GHz (02/50)

### FL-15 (GPS antenna fiber link)

Bandwidth: < 950 MHz to > 1750 MHz  
Gain Flatness: ± 1 dB

#### Dynamic Range:

Input third order intercept: > + 10 dB  
Input P1 dB: > 0 dBm

### PC-connection

Interface: RS-232, DTE

### Environmental

Temperature: 0 °C to +50 °C (operating); -40 °C to +70 °C (storage)  
Safety: Compliant to CE: EN 61010-1 + A1 (1992) + A2 (1995)  
EMI: Compliant to CE: EN 61326-1 (1997)

#### Power consumption

Line voltage: 100 to 240 V (± 10 %)  
Line frequency: 47 to 63 Hz  
Power 910R: < 75 W at warm-up < 35 W continuous operation  
Power 910: < 25 W at warm-up < 12 W continuous operation

### Dimensions and weight

WxHxD: 315 x 86 x 395 mm  
12.4 x 3.4 x 15.6 in

#### Weight:

910R: 4.4 kg (net), 7.4 kg (shipping)  
9.7 lb (net), 16.3 lb (shipping)  
910: 3.9 kg (net), 6.9 kg (shipping)  
8.6 lb (net), 15.2 lb (shipping)

## Ordering Information

### Models

**910** GPS-Controlled OCXO Frequency Standard 5 x 10 MHz and 1 x 5 MHz outputs

**910R** GPS-Controlled Rubidium Frequency Standard 5 x 10 MHz and 1 x 5 MHz outputs

**910X-70** 5 additional 10 MHz outputs

**910X-71** Multiple reference outputs – 0.1 MHz, 1 MHz, 5 MHz and 10 MHz sinewave outputs, plus a 0.1 MHz squarewave output

**910X-72** 5 additional 2.048 MHz outputs

**910X-73** 5 additional 13 MHz outputs

**910X-75** 1 additional pulse output 0.5 Hz to 5 MHz

**910X-76** Ethernet interface

### Included accessories

Operators manual, Calibration certificate, GPSView Software

### Options and Accessories

**910X-50** Rack Mount Kit

**910X-60** Carrying Case

**910X-01** GPS Antenna

**910X-01/50** GPS Antenna Mounting Kit

**910X-02/20** Antenna Cable, 20 m

**910X-02/50** Antenna Cable, 50 m

**910X-FL-15** GPS Antenna Fiber Link

### The complete solution for automating calibration processes plus managing and reporting measurement assets



- Integrated solution, with asset management and automated calibration
- Large library of calibration procedures
- True client-server architecture allows multiple workstations with one database as a repository for all results data
- Handles complex calibration procedures, yet is easy to use
- Supports international languages
- Highly customizable

### Tech Tip

Fluke sponsors a MET/SUPPORT web community. To join, go to [support.fluke.com](http://support.fluke.com), select your language and MET/SUPPORT, then click "Register." Follow the directions on the screen.

The MET/CAL Plus 7.1 suite of applications automates the operation and management of your calibration facilities, providing you with all the tools you need to:

- Perform automated calibrations – including computer-aided, closed-case, and closed-loop calibrations – on all kinds of test and measurement tools and equipment, together with signal generators, function generators, and RF and microwave instruments.
- Create, edit, test, and document calibration procedures with sample procedures to get you started, and hundreds more available from Fluke and third-party providers.
- Configure and report a wider range of measurement uncertainty parameters and include verification data to provide an audit trail and support further analysis.
- Track asset information including calibration and maintenance history and status, traceability, users, customers, and location and have the option to access this information over the Internet.
- Analyze and report asset information; produce printed certificates and reports.
- Make data available to other corporate systems.
- Import asset and calibration data into MET/CAL Plus.
- Meet the requirements of quality standards like ISO 9000, ANSI Z540, ISO/IEC 17025, NRC 10 CFR, and others.

Whether you have a single, standalone computer or a network of many workstations throughout your organization, MET/CAL Plus 7.1 offers a powerful calibration solution.

### MET/CAL® – industry-leading software for automated calibration

MET/CAL reflects more than 50 person-years experience in automated calibration software development. More calibration facilities have automated with MET/CAL than all other products combined. MET/CAL Plus is the most complete software solution available to calibration professionals, so it's no surprise that it has become the *de facto* standard in calibration software worldwide.

MET/CAL is a powerful, flexible full-featured automated calibration environment for PCs running the Microsoft Windows® operating system. It generates and writes test results to the SQL database managed by MET/TRACK® and enables you to:

- Create and edit calibration procedures using a wide range of standards.
- Run those procedures.
- Collect test data during the calibration process.
- Generate calibration reports and certificates.
- Make data available to other software applications such as Microsoft Word and Excel.

With MET/CAL, it is easy to perform calibrations faster and with more repeatable results, and to collect and report a wealth of information about:

- Test data
- Measurement uncertainty
- Adequacy of standards
- Traceability
- Procedures used
- And more

MET/CAL Plus 7.1 also includes new support for guardbanding that gives metrologists the option to tailor the algorithm to automatically tighten the pass limits associated with a UUT's calibration specifications. The primary purpose of guardbanding is to account for the uncertainty of the measuring equipment in the calibration process and thereby to avoid accepting units that are close to their specification limits but may in fact be out of tolerance. Guardbanding is particularly important when the test accuracy ratio (TAR) is low because, in that case, the uncertainty contributed by the inherent accuracy of the reference instrument is relatively large, which creates a greater risk of accepting an out of tolerance UUT.

The heart of MET/CAL Plus is MET/BASE, which features a powerful, industry standard SQL database server – SQL Anywhere™ from Sybase – for secure, dependable storage of calibration and asset data. This robust database management application protects your mission critical data from loss and corruption. And it's compatible with the Microsoft Open Database Connectivity (ODBC) standard so you can access your calibration data from any ODBC-compatible application (such as Microsoft Excel or Word) for further processing and analysis. The package also includes several preformatted reports in Crystal Reports Professional to add even more power and flexibility to report information.

### Automated calibration that supports the way your lab operates

MET/CAL is structured around the flow of instruments through the calibration process and addresses a wide range of test and measurement instrument calibration needs, from the simple to the complex. It is based on the traditional calibration model as its framework – comparing an instrument to a standard of known uncertainty. MET/CAL features a familiar Windows-based interface that makes it easy for users to learn and use, reducing your training and support costs, while making your operators more productive.

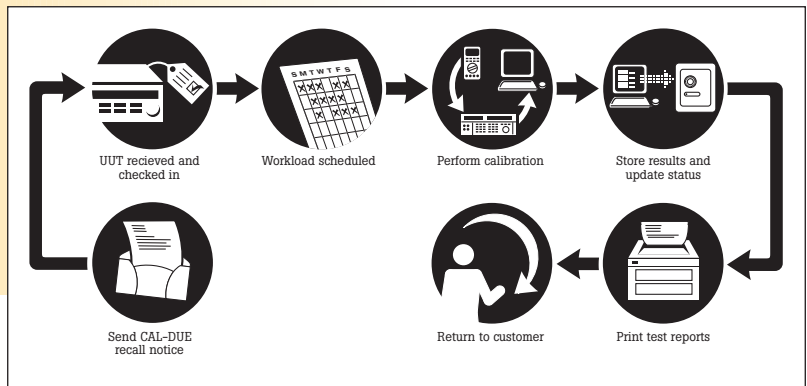

### Step 1. Generating recall reports.

Periodically, your lab needs to recall instruments that are due for calibration. MET/TRACK generates recall reports that you can send to your customers and to the user's e-mail address and location. These recall reports may also include details of the last calibration performed in your lab.

Calibration Due By Loc. By Status Through 30 Nov 2004						
Addrs sorted Desc for calibration for next 30 days.						
Asset Number	Mfg	Model	Description	Dept	User Name	Techn. Next Cal Due
<b>Location Analysis</b>						
* 1473	Analog Devices	LT1220D	LT1220	100-0	Parik, D	25-Sep-04
* 1289	Bent	52	Wrenchmen	100-0	Cirrusco, P	21-Jan-04
* 1388	S&C	MV120	Calibrator	100-0	Agilent, M	1-Sep-04
* 742-1	Fluke	742A1	Standard Resistor	100-0	Agilent, M	20-Sep-03
* 1227	Fluke	27	Multimeter	100-0	Agilent, M	15-Sep-04
* 1221	Heathkit	2221A	Generator	100-0	Parik, D	20-Sep-04
* 1483	Heathkit	2487A	Multimeter	100-0	Parik, D	7-Aug-04
* 1440	Heathkit	3502A	Probe High Frequency	100-0	Agilent, M	8-Aug-04
* 1125	Heathkit	3502B	Generator	100-0	Cirrusco, P	29-Jul-04
* 1281	Heathkit	178A	Multimeter	100-0	Parik, D	16-Nov-04
* 1281	Heathkit	2201	Multimeter	100-0	Agilent, M	16-Sep-04
* 1181	Stamco	22181	Thickness Gauge	100-0	Agilent, M	26-Sep-04
* 1064	Talmecia	712A	Oscilloscope	100-0	Cirrusco, P	29-Aug-04
* 1140	Talmecia	718A	Oscilloscope	100-0	Parik, D	9-Nov-04
* 1052	Talmecia	7A22	Amplifier	100-0	Cirrusco, P	21-Sep-03
* 1221	Talmecia	7A28	Amplifier	100-0	Agilent, M	18-Nov-04
* 1055	Talmecia	7850	Timebase	100-0	Cirrusco, P	13-Nov-04
* 1050	Talmecia	7853A	Timebase	100-0	Agilent, M	11-Jan-04



**Step 2. Adding new items.**

As instruments come into the lab for calibration they are added to the database. The technician simply enters basic asset information in an electronic form, selecting from drop-down validation menus to assure consistent and accurate entry. For brand new assets, fields are provided to capture the model, serial number, description, location, and calibration history summary. Many other fields are also available and can be switched on as needed. For returning instruments, simply enter the asset number and check them in. If needed, you can add your own fields to track special information about your assets. You can customize the validation rules to match your company's terminology. Information can also be imported automatically with validation.

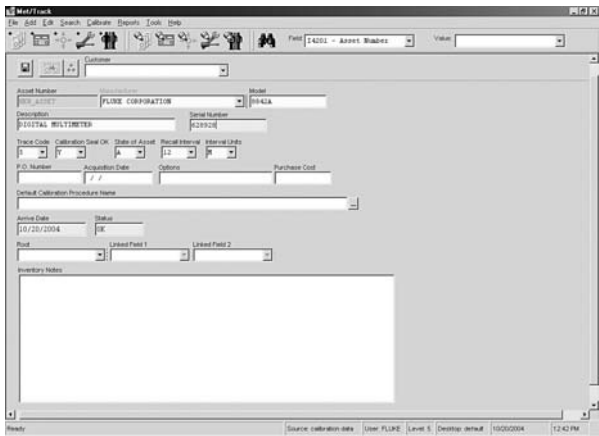

**Step 3. Performing automated calibration**

Automated calibration with MET/CAL is fast, repeatable, and powerful. At first glance, most people see it as a way to perform calibrations faster, and MET/CAL can certainly deliver dramatically improved productivity. However, consistency is another significant benefit. With self-documented procedures, you can ensure that all operators complete all tests and collect appropriate test data the same way every time the procedure is performed. Plain language operator prompts and graphics guide technicians through even the most complex calibrations. MET/CAL also enables you to illustrate operator messages, connection diagrams, and adjustment points within your procedures, using commonly used .jpg, .gif, and .bmp graphics formats to make the procedures easier to follow.



MET/CAL captures complete calibration results, including traceability data and environmental conditions. Technicians can keep track of results in a pop-up screen, with color coding to indicate passed tests, marginal results, or failures. When calibration is finished, MET/CAL saves the information to the database, so that you can review it on screen or print it. Complete results records help you identify out-of-tolerance conditions and satisfy the records requirements of ISO 9000. The combination of these automated easy-to-use features in MET/CAL helps to make operators more productive and reduces your time and cost per calibration.



**Step 4. Storing results and update status.**

MET/CAL now stores all parameters for every test performed in unformatted "raw readings" to ease report creation and to support further analysis. Because each test is fully documented for every procedure that is run and traceability information for each standard is stored in the database, you have complete documentation of calibration status, history, adequacy, and traceability for all the test and measurement instruments you manage.



**Step 5. Printing test reports.**

MET/CAL Plus includes a range of reports that can be previewed on screen, then printed. At the end of each calibration event, the technician can choose to print calibration test results or a Certificate of Calibration. All are prepared with Crystal Reports Professional, so they can be modified to meet your needs or used as a basis for creating your own custom reports.

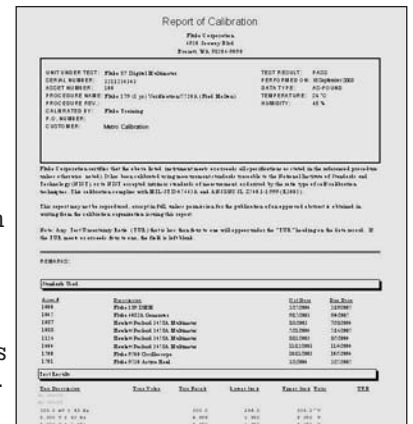

### Choose from thousands of calibration procedures or write your own

MET/CAL comes with a range of sample procedures that can be used as-is or can be modified to meet your needs. These procedures are also valuable as examples to guide you through creating your own. You can also receive additional warranted procedures by subscribing to the MET/CAL Gold support plan. You can view the current list of available procedures by visiting the MET/CAL Plus page on Fluke's web site <http://www.fluke.com>.

### Write your own procedures

You can write procedures using the MET/CAL colored text Editor, which uses a special calibration procedure language. Procedures for simple devices like DMM's, gauges, and mechanical tools use a very simple language syntax. Learning to write simple DMM and oscilloscope procedures can be expedited by using our AutoPro utility program. It generates procedures by using the device's specifications. Fluke offers specialized training for writing more complex procedures.

**Choose standards.** Creating completely new procedures is easy with a little practice. MET/CAL's powerful procedure language uses a calibration-oriented building block approach. Function Select Codes represent various standards and functions used during a test. MET/CAL's procedure language FSC's support more than 100 standards and calibrators. For instruments not directly supported, the Run-Time module in MET/CAL can send IEEE commands to implement an automated procedure.

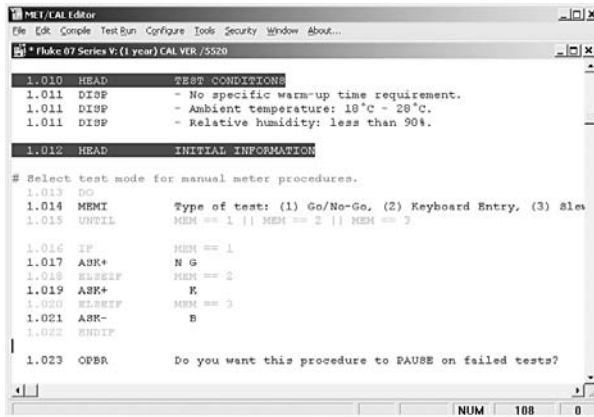

```
1.010 HEAD TEST CONDITIONS
1.011 DISP - No specific warm-up time requirement.
1.011 DISP - Ambient temperature: 18°C - 28°C.
1.011 DISP - Relative humidity: less than 90%.

1.012 HEAD INITIAL INFORMATION

# Select test mode for manual meter procedures.
1.013 DO
1.014 MEMI Type of test: (1) Go/No-Go, (2) Keyboard Entry, (3) Sla
1.015 UNTIL MEM == 1 || MEM == 2 || MEM == 3

1.016 IF MEM == 1
1.017 ASK+ N G
1.018 ELSEIF MEM == 2
1.019 ASK+ K
1.020 ELSEIF MEM == 3
1.021 ASK+ B
1.022 ENDF

1.023 OPBR Do you want this procedure to PAUSE on failed tests?
```

**Write procedure.** Procedures can be as simple or as powerful as you need them to be. To create a procedure, simply combine FSCs and test parameters. Each available FSC is completely described in on-line help files. MET/CAL includes a library of commonly used connection messages which will be displayed to the operator during the calibration to guide him through instrument setups. If test setups are more complex, then you can add graphic files to be displayed at the appropriate time to the operator.

**Evaluate measurement uncertainty.** MET/CAL Plus enables you to establish minimum test uncertainty ratios (TURs) to assure that tests performed by the calibrator are sufficiently accurate for the instrument being calibrated. Flagging TURs helps demonstrate the adequacy of standards according to ISO 9001, 4.11.2a.

**Test run.** You can execute procedures directly from within the procedure editor in test-run mode to make short work of tracking down errors. MET/CAL even keeps track of test uncertainty ratios, instrument specifications and capabilities, and traceability information to make sure procedures meet your quality standards for adequacy and validity. And to help you organize your procedures, MET/CAL supports multiple directories, so that you can arrange procedures in logical groups, such as by instrument type, or by released and unreleased procedures.

**Release procedure.** Once you're satisfied with the procedure, release it to production where your technicians can replicate all tests consistently on your workload.

### MET/TRACK® — a dedicated system for T&M property management

MET/TRACK is a powerful database management system for test and measurement that provides back-end asset management for MET/CAL Plus. Because it was created specifically to manage equipment in the calibration environment, MET/TRACK gives you flexibility, power, and security not available in generic database applications. It enables you to track the information you need to maintain quality calibrations. And it supports the traceability and record-keeping requirements of modern quality and accreditation standards, including ISO/IEC 17025, ISO 9000, QS 9000, EN 45000, ANSI Z540, and MIL STD 45662A, without having to write your own programs, set up your own databases, or test and document the system.

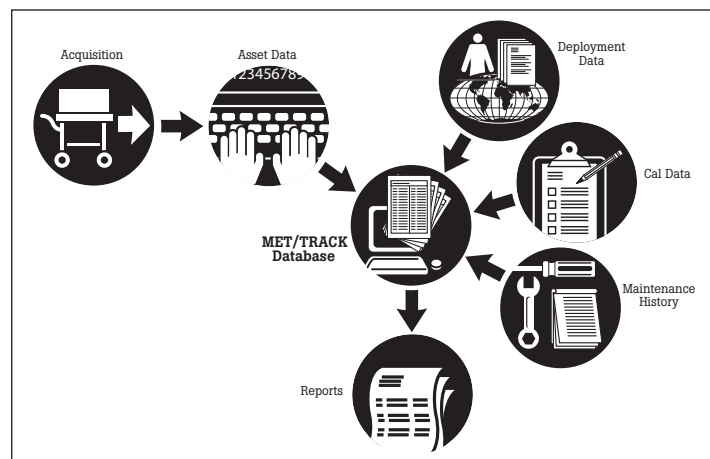

Multiple tables that cover all aspects of your test and measurement tool inventory are linked by an asset number, which you can format to fit your company's requirements.

MET/TRACK, like MET/CAL, works the way your calibration lab works. It manages and stores data the way that works best for you so that you can easily access it to track calibration/maintenance schedules and for audits and reporting.



**Asset data.**

Basic asset information is required for each instrument that is to be calibrated by MET/CAL. All calibration records as well as maintenance and location records are stored in MET/TRACK using a specific asset number which is established when the initial asset information is added to the database.



**Deployment data.**

By keeping track of who has possession of each metrology asset, MET/TRACK enables you to contact that person or department to schedule periodic calibration and maintenance. In addition to simple location information, MET/TRACK allows you to store complete customer information for every asset in the system.



**Comprehensive calibration data.**

Summary calibration event histories as well as complete calibration test results are stored in MET/TRACK automatically for every MET/CAL calibration event. For assets calibrated manually or on different systems, both summary and detailed test results can be manually added to MET/TRACK, giving you one place for all your metrology asset tracking needs.

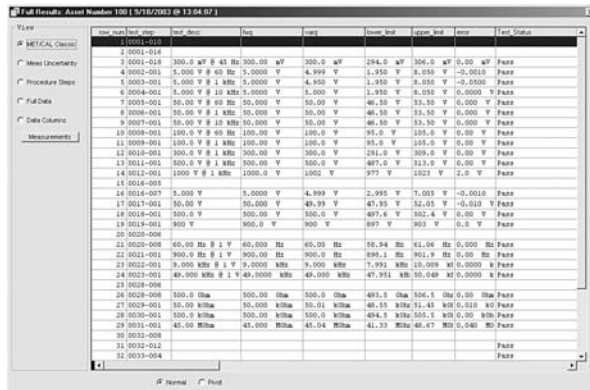

**Repair tracking and preventative maintenance.**

As each repair or preventative maintenance activity is completed, details of that event, including labor and parts costs, can be entered. You can also schedule periodic maintenance events. In addition, maintenance histories are included to give you a complete cost of ownership for all tracked assets.

**Reporting**

MET/TRACK generates reports to meet a wide range of requirements. MET/TRACK includes the Quick Report Builder, which enables you to create ad hoc reports quickly on the fly to meet your most immediate needs for information.

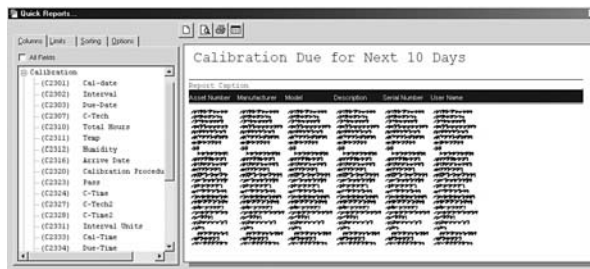

MET/CAL Plus also offers a variety of standard reports prepared with Crystal Reports™ Professional, which is included in the package. These report formats cover a wide range of information to help you meet a variety of documentation requirements, including those for ISO 9000 and similar quality standards. They report on forward and reverse traceability, allowing you to easily document traceability from any asset to the equipment calibrated. And MET/CAL Plus offers enhanced measurement uncertainty reporting to provide increased compliance with the requirements of ISO/IEC 17025. In addition to standard reports, such as equipment location and items due for calibration, Crystal Reports makes it easy to create custom reports, lists, and labels using data from your existing databases. Its graphical user interface makes it easy to build reports, and its powerful query tools quickly draw values from a variety of data tables, allowing you to easily manipulate the data to:

- Calculate and compare data values.
- Calculate subtotals and grand totals of field values.
- Calculate group averages, count the records in a group and test for minimum and maximum values.
- Test for specific values.
- Present data only if certain conditions are met.
- Evaluate logical relationships between values.
- Convert data from one type to another.
- Merge text, graphics and data. Crystal Reports doesn't modify the calibration data in your database, so you can manipulate the selected data as much as you want to produce the reports you need while preserving the integrity of your database.

### Data integrity and security you can count on

**Data validation.** Your MET/TRACK system is only as good as the data it contains. To ensure that the information is entered correctly every time, MET/TRACK includes two types of data validation. Use Required Validation where the entry must be in a validation list for the technician to enter it. Or use non-required Choice List Validation where, if the entry is on the validation list, the text box will fill in automatically as you type. This ensures correct and efficient data entry and makes it easier to search for information. For example, an oscilloscope could be described as a scope, an oscope, or a DSO, which would make it difficult to retrieve information consistently. The data validation feature in MET/TRACK assures that you identify an instrument – or manufacturer or department name or other term – by the same name every time.

To make data entry even faster and more accurate, you can link key fields on MET/TRACK forms so that selecting one item causes other fields on the form to be completed automatically. For example, entering "34401A" could be set up to make "DMM" appear in the description field and "Agilent" appear in the manufacturer field.

**User permissions.** Five levels of security, from "read only" to "system manager," ensure that only authorized users gain access to inventory data, so your data remains secure. Because the security is managed by the

server, all users – even those accessing data from other applications – must be authorized. In addition to the "Group" security level, permissions can be granted or prevented for specific features for each individual user.

### Customize MET/TRACK to meet your requirements

Rather than forcing you to work with a rigid set of fields and formats, MET/TRACK allows you to manage your equipment the way that works best for you. New desktop customization features enable you to personalize the way data appears on the screen. And you can create multiple desktops to display the same information in different formats for multiple users and multiple workstations. You can edit field names to match your organization's terminology. Suppress or enable fields to include only the information that matters to you. And control the type and format of information entered into key fields. Virtually any kind of measurement asset in your organization – electrical, mechanical or dimensional – can be managed with MET/TRACK, even if it doesn't require calibration. And, whether the calibration interval is measured in days, weeks, months, even use cycles, you can count on MET/TRACK to keep you up to date.

### Build your own tables

In addition to a broad set of calibration, maintenance, and location records, MET/TRACK offers additional features so that you can store more custom information about your calibration assets.

**Merge tables.** Merge tables allow you to expand on the data held by particular fields in MET/TRACK tables. For example, it may be necessary to know more about the manufacturer of an instrument. The normal manufacturer field can hold values like Fluke, Agilent or Tek, but if you need to hold specific contact information about these manufacturers, a "Merge Table" can provide the storage space you need. You only need to enter the data once, and the Merge Table will be linked to specific values of manufacturer, no matter how many times that value occurs in the table.

**User auxiliary tables.** If you need more than the standard data fields provided and the field expansion capability of Merge Tables to hold your required data, you can create your own tables within the MET/TRACK database and link the records to any asset.

### 5500/CAL – Compact, portable automation for on-site applications

For those who use Fluke oscilloscope and multiproduct calibrators, 5500/CAL provides nearly all the automated calibration and test and measurement asset management capabilities of MET/CAL, in a lower cost, portable version. It features RS-232 (serial) control, eliminating the need for IEEE-488 interfaces or PC cards. And it's designed to work with Fluke's rugged, portable 5500A, 5520A, 5800A, and 5820A calibrators via their unique pass-through serial port. 5500/CAL also supports the Hewlett-Packard 34401A, Keithley 2000 digital multimeters, and any instrument that has a serial interface supported by MET/CAL.



Serial control makes 5500/CAL ideal for use with laptop computers, providing all the power and versatility of a PC, with the portability you need for onsite work. You're never restricted to just a small set of simple procedures that do little more than store front panel settings.

### The flexibility to fit your needs — from single workstations to company-wide networks

MET/CAL *Plus* 7.1 is designed for a wide range of automation needs. Its modular architecture means you can buy precisely the capability you need, and add to or expand it as your requirements change. Its client/server architecture and industry standard SQL database ensure scalability.

You can set your system up on a single personal computer, or take advantage of its client/server design to operate multiple MET/CAL, 5500/CAL, and MET/TRACK workstations over your network. The key to MET/CAL *Plus* versatility is its flexible configuration. You can mix and match the capabilities you need.

- **MET/BASE-7** is the "engine" of your system, whether you're using MET/CAL, 5500/CAL, or MET/TRACK. It includes Crystal Reports Professional. Generally you need only one MET/BASE package per installation. All of the basic MET/CAL *Plus* 7.1 programs are included in the MET/BASE package. Applying the appropriate license unlocks the associated programs so you can use them.
- **MET/CAL-L** provides a single, concurrent license for all MET/CAL *Plus* 7.1 automation and MET/TRACK asset management applications. A concurrent license is one where the software is installed on many machines, but is licensed to run only on a specific number of those machines at any given time. Start with one or more licenses, depending on the number of workstations you require, and add workstations as your needs change. MET/CAL *Plus* 7.1 can be used in combination with any and all of the other MET/CAL *Plus* applications. For example, additional data entry stations can be added to an existing MET/CAL installation by purchasing MET/TRACK licenses.
- **5500/CAL-L** provides a single concurrent license for its automation and MET/TRACK asset management functions. Its automation capabilities are similar to those of MET/CAL, but are designed around RS-232 (serial) instrument control. It supports: Agilent 33250A, Fluke 2620T, Fluke 2635T, Fluke 45, Fluke 525A, Fluke 5500A, Fluke 5500ACOIL, Fluke 5520A, Fluke 5725A, Fluke 5800A, Fluke 5820A, HP 33120A, HP 3325B, HP 34401A, HP 34420A, Keithley 2000, Marconi 2024, Wavetek 395, Agilent E4418B, Agilent E4419B, Fluke 700 Series Pressure Modules, Fluke 525A Series Pressure Modules. Like MET/CAL, you can start with one or more licenses, depending on the number of workstations you require, and add workstations as your needs change.
- **MET/TRACK-L** provides you with a concurrent license for the test and measurement asset management capabilities of MET/CAL *Plus*. Choose it when your application calls only for asset management.
- **The Metrology Xplorer™** option allows you to access information in your MET/CAL *Plus* database, through a Web browser, from any workstation connected to your network. It consists of Metrology Xplorer™ from Fluke software partner On-Time Support, Inc. ([www.ontimesupport.com](http://www.ontimesupport.com)), and is designed to allow authorized users to perform queries to view asset information with the same customized layout that is established for your MET/TRACK screens. You can also generate reports quickly using data stored in your MET/CAL *Plus* system for display and printing on your remote web browser. It's ideal for sites where the corporate intranet is used to access and distribute information. Metrology Xplorer can also be used to access MET/CAL *Plus* calibration and asset information and reports over the Internet. Stringent user security keeps your vital information safe from unauthorized eyes.
- **BC Magic Basic** Barcode Magician Basic® software enables you to make real-time changes to your MET/CAL *Plus* database automatically for both small and large quantities of instruments. This ensures that even inexperienced users can make changes quickly and consistently. Developed by Fluke software partner On Time Support, Inc., Barcode Magician software enables you to automate repetitive database entry tasks, using a simple barcode tool or keyboard. Its simple, easy-to-use interface allows calibration technicians and instrument custodians to update a MET/CAL *Plus* database quickly and efficiently, while at the same time drastically reducing data entry errors and substantially increasing productivity.
- **BC Magic Plus** Barcode Magician *Plus*® software provides all the capabilities of Barcode Magician Basic, with additional features like added pre-defined functions and a new batch calibration feature.
- **Change/Log** On Time Support has created Change/Log to keep track of changes to MET/TRACK tables. Inventory, Calibration, Location, Maintenance, Customer and Standards tables are all monitored and all record changes are recorded, including the state of the record before the change was made, who performed the change, and what the record was changed to. This add-on product is ideal for those industries that must maintain strict control of all data.
- **MET/CAL Email** E-Mail Notification from On Time Support allows you to schedule the delivery of e-mail from the MET/TRACK application. Messages may include cal due notifications. Messages are sent automatically on a schedule you determine using a simple web-based interface.
- **5000A-RH/T** Precision Humidity and Temperature Data Logger allows MET/CAL to read temperature and humidity directly into a calibration record as you start to run a procedure. This environmental information becomes a permanent part of the calibration record without requiring you to enter the data manually. The 5000A-RH/T is manufactured by Fluke partner Veriteq Instruments Inc.

## Software

- **5020A** 2-Channel Digital Temperature and Humidity Recorder automatically logs temperature and humidity values for MET/CAL procedures. Requires LogWare III and can be used in place of the Veriteq 5000A-RH/T.

### How to upgrade from previous versions of MET/CAL

- **From version 7.** If you are already using MET/CAL Plus 7 then you can upgrade to version 7.1 by purchasing a MET/BASE upgrade. No license upgrades are required.
- **From version 5 or 6.** To upgrade to MET/CAL Plus 7.1 from version 5 or 6, simply acquire an upgrade to the MET/BASE package, and then acquire the license upgrades you need. You will be asked to provide the serial number for your existing software licenses.
- **From pre-version 5.** MET/CAL Plus customers using versions prior to 5.0 will need to acquire a new, complete MET/CAL Plus 7.1 product, including a new MET/BASE and appropriate new MET/CAL, 5500/CAL or MET/TRACK licenses.

For more information, see Ordering Information. MET/SUPPORT Gold members receive a free upgrade to MET/CAL Plus 7.1.

### The support you need, when you need it

When you register your new copy of the MET/BASE portion of MET/CAL Plus, you are enrolled automatically in the MET/SUPPORT Silver program for 60 days of free support via telephone, fax, and e-mail – to help get you up and running quickly and easily. But the support doesn't stop there. Enroll in the annual MET/SUPPORT Gold program and receive additional premium support and services to help keep you as productive as possible. In addition to priority support by telephone, fax or e-mail, you will get free access to Fluke's library of Warranted Procedures, software updates and upgrades, discounts on training courses, and more. Even if you use only a few of the Gold services, you can easily recover more than the cost of your membership fee.

Fluke's commitment to support provides additional benefits as well, including invitations to user group meetings and conferences, and a newsletter. You will become part of a worldwide community of software users who have already discovered why MET/CAL is the *de facto* standard.

### Recommended hardware

Processor: Intel Pentium  
Memory: 256 MB  
Client and standalone operating system: Microsoft Windows NT Workstation 4.0, Windows 2000, Windows XP  
Server Operating System: Microsoft Windows NT Server 4.0, Windows 2000, Windows XP  
Hard Disk : 5 GB available  
Supported Network Protocols: NetBIOS, IPX, TCP/IP  
Backup Device: Strongly Recommended  
Monitor: 800 X 600 dpi resolution minimum  
Two GPIB interface cards

### Ordering Information

#### Models

**MET/BASE-7** Calibration Software Database System. One or more MET/CAL, 5500/CAL and/or MET/TRACK 7 license disks required for use.

**MET/CAL-L** License disk for MET/CAL. Includes capabilities of 5500/CAL and MET/TRACK. MET/BASE 7 or earlier version required.

**5500/CAL-L** License disk for 5500/CAL. Includes capabilities of MET/TRACK 7. MET/BASE 7 or earlier version required.

**MET/TRACK-L** License disk for MET/TRACK metrology property management software. MET/BASE 7 or earlier version required.

**MET/BASE-7U** MET/BASE Upgrade. Upgrades MET/BASE from version 5.0 or later to current version. Upgrade licenses are also required for systems running MET/BASE older than version 7.0.

**MET/CAL-LU** License disk upgrade. MET/BASE 7 and serial number for prior version (5 or newer) of MET/CAL required.

**5500/CAL-LU** License disk upgrade. MET/BASE 7 and serial number for prior version (5 or newer) of 5500/CAL required.

**MET/TRACK-LU** License disk upgrade. MET/BASE 7 and serial number for prior version (5 or newer) of MET/TRACK required.

**Metrology XPlorer** Web-based data viewer for MET/CAL and MET/TRACK, with Reports

**BC Magic Basic** Barcode Magician Basic automated data entry  
**BC Magic Plus** Barcode Magician Plus enhanced version

**Change/Log** Records changes made to the MET/TRACK Database

**MET/CAL EMAIL** Automated E-Mail generation

**5000A-RH/T** Humidity/Temp Logger w/CBL, Software and Cal Cert

**5020A-S** (Requires 5020A-LW3) Thermo-Hygrometer, Dewk, standard

**5020A-H** (Requires 5020A-LW3) Thermo-Hygrometer, Dewk, high

**5020A-LW3** LogWare III Software

**MET/CAL-CBT7** Same

**Scheduled Training** Scheduled courses available

**MET/SUPPORT GOLD** Priority support agreement for one workstation. For additional workstations contact sales rep.

## Included with Hart baths and dry-wells

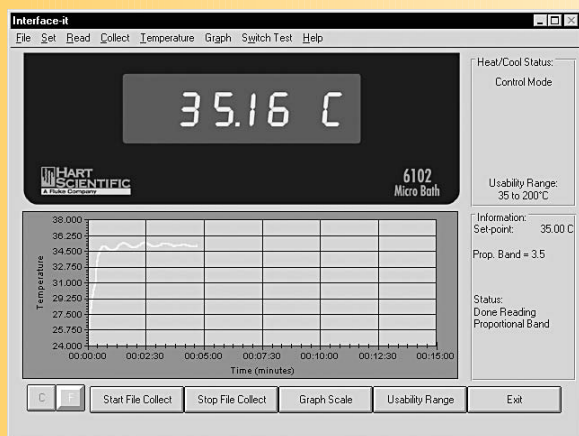

- Free with nearly every Hart heat source
- Provides PC access to Hart controller functions
- Graphically displays heat source temperatures

The 9930 Interface-it software package is included with every Hart dry-well and bath that has an RS-232 interface. The 9930 lets you use your own PC to control the function of that Hart bath or dry-well. You can view the temperature, program the ramp and soak routine, change the set point, see the power usage, or check the proportional band setting. The 9930 software also has basic data collection features.

### Ordering Information

#### Model

9930 Interface-it Software

### Easy-to-use temperature calibration automation software

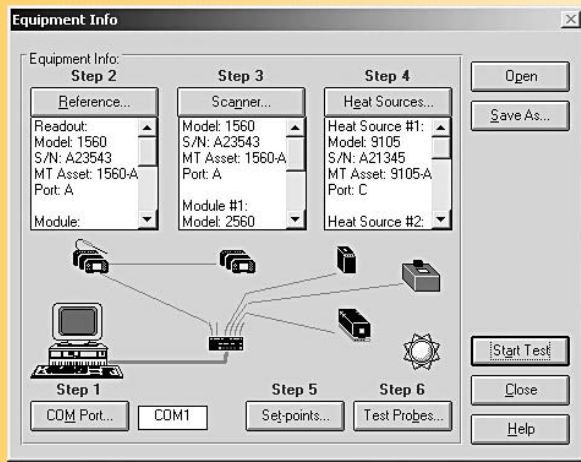

- Fully automated calibration of RTDs, TCs, thermistors, and many heat sources
- Calibrates up to 100 sensors at up to 40 points
- Performs coefficient calculations and generates tables and reports
- Includes optional integration with the Fluke MET/TRACK® database software



You may be familiar with the Hart Scientific automation software duo Calibrate-it and Generate-it. Now both come in a single package, called MET/TEMP II. This software package interfaces with the Fluke MET/TRACK® software – the industry standard for asset management.

With MET/TEMP II software, you simply place your test sensors in a heat source, connect them to a read-out, and enter your setup data into your PC. Sometime later, hit your print button, take the reports out of your printer, sign them, and ship the sensors back to your customer. It's fast and it's easy.

This software package tests thermocouples (all types), RTDs, SPRTs, thermistors, and even liquid-in-glass thermometers (LIGs). Virtually any sensor with a resistance or voltage output can be tested, up to 100 sensors at a time. They don't even have to be the same type. You can select as few as 1 or as many as 40 temperatures at which to test your sensors. You don't need to worry about special software drivers for each different piece of equipment. Just plug and play.

#### Use MET/TEMP II with these instruments:

##### Thermometer Readouts

1590 Super-Thermometer II  
(2590 Mighty-Mux II optional)  
1575A Super-Thermometer  
(2575 Mighty-Mux optional)  
1560 *Black Stack* (with any combination of modules)  
1529 Chub-E4  
1502, 1504 Tweener Thermometers  
1521, 1522 Handheld Thermometers  
Fluke Hydra series data loggers

#### Heat Sources

All Hart baths with RS-232  
All Hart dry-blocks with RS-232, including 9112 & 9114 furnaces  
Fluke dry-block models 514, 515, 517, 518  
Any other heat source (temperatures must be set manually)

MET/TEMP II also works with the Fluke Hydra Series II data loggers. You can even calibrate heat sources such as Hart dry-wells and Micro-Baths with this software.

MET/TEMP II also lets you perform semi-automated fixed-point calibrations. The software allows you to program soak times in the cell before taking readings. You may even mix fixed points with comparison points in the same calibration. Fixed-point information is included on the new report layout.

If you use the 1560 *Black Stack*, you can simultaneously calibrate up to 64 RTDs, 64 thermistors, 96 thermocouples, or any combination.

MET/TEMP II allows you to track the serial numbers, model numbers, calibration dates, and recall dates of all test equipment and sensors under test. Optionally, this data may be synchronized with information in your MET/TRACK database. MET/TEMP II also stores customer names and addresses for printing on reports.

With MET/TEMP II, you make your own choices regarding precision and throughput. When setting up tests, you specify the required stability level at each set-point to ensure that readings are taken only under the conditions you require. You'll get the exact level of precision you want based on the equipment you have and the calibration time you set.

MET/TEMP II interfaces with MET/TRACK® software to record calibration and maintenance history, traceability information, and even the location of your thermometers and heat sources. Use it with MET/TRACK and watch your productivity take a big step up.

Calibration reports are created automatically from your setup data and test results. Each report conforms completely to the requirements of ANSI/NCSL Z540-1. It's fast, it's accurate, and it's complete.

MET/TEMP II runs on Windows 9x/ME/2000/NT/XP and includes a context-sensitive online help system. Just click the help button (or press F1) from any screen and you'll get the information you need.

The MET/TEMP II Coefficients and Tables application contains utilities for data analysis. It calculates ITS-90 coefficients and residuals for each sensor tested. Tables can be generated with temperature-versus-resistance, temperature-versus-ratio, or temperature-versus-EMF data. Each report can be generated in °C, °F, or K and in selectable increments from 0.01 to 100.

For PRTs, MET/TEMP II calculates coefficients for ITS-90, IPTS-68, Callendar-Van Dusen, and polynomial functions. For thermistors, it calculates coefficients for polynomial functions, including Steinhart-Hart. Thermocouple coefficients can be calculated for types B, E, J, K, N, R, S, T, and AuPt. This software even allows you to verify that the appropriate temperatures are used to calculate coefficients.

Need subranges in ITS-90? No problem. Want to print tables for any temperature range and in any incremental amounts? No problem. Need to generate formatted reports that conform to ANSI/NCSL Z540-1? No problem.

Data can also be exported to spreadsheets or other statistical analysis software as comma-delimited or tab-delimited text. MET/TEMP II does all of that and more, but best of all it does it automatically.

## Ordering Information

### Models

**9938** MET/TEMP II Software  
(package includes CD-ROM,  
RS-232 multiplexer box, adapter,  
and PC cable)

**LIC-9938** MET/TRACK License

### Calculates and generates data using manually entered data

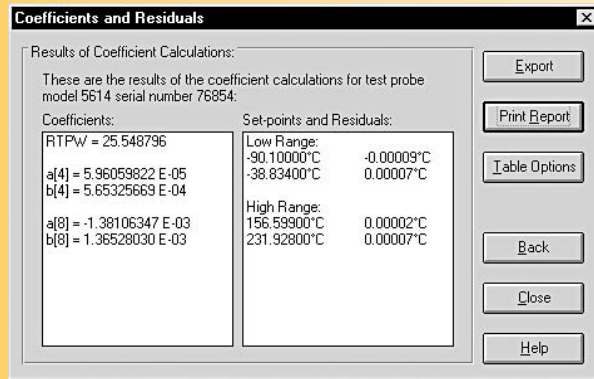

- Calculates coefficients for RTDs, thermistors, and thermocouples
- Generates three types of temperature tables
- Easy-to-use, time-saving interface
- Outputs to ASCII text file or printed report

The 9933 TableWare software package does everything that the MET/TEMP II Coefficients and Tables Application does except automatically collect data. TableWare is a calculate-and-generate data software package that uses manually entered data, saving you time and money on your calculations.

TableWare calculates coefficients for RTDs, thermistors, and thermocouples. It uses ITS-90, IPTS-68, Callendar-Van Dusen, and polynomial equations. TableWare also generates temperature-versus-resistance, temperature-versus-ratio, and temperature-versus-EMF tables. And it includes functions for importing and exporting data for use with other data analysis programs.

Simply enter or import the raw resistance or voltage data from your calibrations. TableWare generates coefficients, calculates residual values, and generates useful tables. TableWare works the way you do.

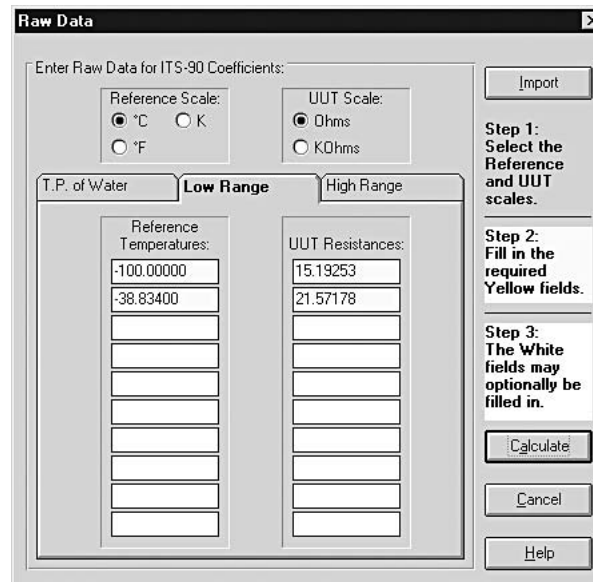

Input screen

**Ordering Information**  
Models  
9933 TableWare Software

## Turns any Hart thermometer readout into a real-time data logger

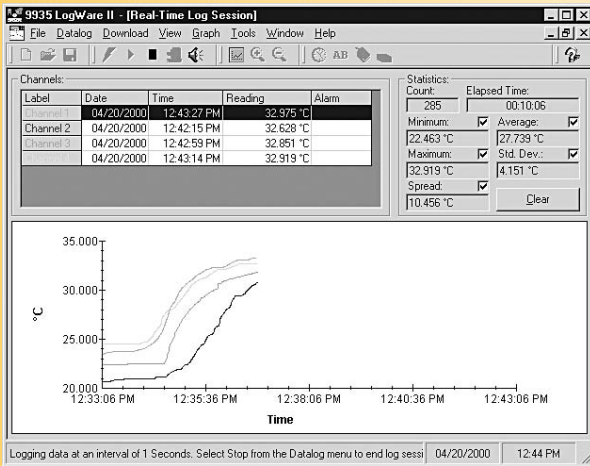

- Calculates statistics and displays customized graphs
- User-selectable alarms, delayed start times, and sample intervals
- Two versions for single-channel or multi-channel thermometer readouts

LogWare was designed specifically for temperature data acquisition. Use 9934 LogWare with a single-channel thermometer readout or 9935 LogWare II with one of Hart's multi-channel readouts.

LogWare lets you acquire data to your PC graphically and store it to a text file. It also performs statistical functions automatically on each data set. Set high and low alarm conditions, program a delayed start time, store a data log for a fixed number of readings or length of time, program the acquisition interval from 1 second to 24 hours, and let the software record the data you need the way you need it.

During a log session you can view the data in a time/temperature trend graph while the data points are stored to a file on your PC. Output the graph to your printer, view the test points from a spreadsheet, or review the pertinent log statistics once your log is completed. With LogWare II you can collect and view data from up to 96 probes.

With Hart's 1522 and 1529 thermometer readouts, there's even more you can do. Both readouts store thousands of data points in multiple log sessions. LogWare lets you download your data into individual log sessions and view each one separately. Store readings from your freezers, ovens, chambers, and anywhere else you need to record temperature, bring it back to your PC (through a standard serial cable or infrared dongle), and LogWare will separate each log session into individual data sets. You don't have to load the text file into your spreadsheet and try to figure out which data points went with which log session. LogWare does all that for you.

LogWare also gives you the ability to make configuration changes to your thermometer readout. Program your probe coefficients, write calibration data to your meter, set password-protected parameters, and access other tools specific to your thermometer readout all from your PC.

### Ordering Information

#### Models

**9934-S** LogWare, Single Channel, Single User

**9934-M** LogWare, Single Channel, Multi User

**9935-S** LogWare II, Multi Channel, Single User

**9935-M** LogWare II, Multi Channel, Multi User

### Professional training pays off in productivity



- A full spectrum of useful classes, regularly scheduled at convenient locations
- Classes taught by highly-trained professionals
- Comprehensive lectures combined with hands-on experience
- On-site training available
- Self-paced training available

Fluke offers many ways to learn, including instructor led courses, web-based courses, and self-study tools. Detailed schedules are available on the web at [calibration.fluke.com](http://calibration.fluke.com).

#### Fluke instructor-led classroom courses (N. America\*):

- **Principles of Metrology.** This five-day workshop covers electrical/electronic measurements and calibration. Participants will become more productive in calibrating test instrumentation.
- **Cal Lab Management I.** This five-day course covers the requirements for establishing and operating a calibration lab. It also provides the tools you need to organize, develop and arrange a cal lab.
- **Cal Lab Management II.** This advanced five-day course covers fiscal management, management techniques, international standards, and more.
- **MET/CAL® Database and Reports.** This five-day in-depth course uses hands-on sessions to teach a systematic approach to data collection and to consistently and completely manage your metrology assets.
- **MET/CAL Procedure Writing.** In this five-day workshop, you will learn to use MET/CAL software effectively in your automated calibration application.
- **Advanced MET/CAL Procedure Writing I.** The five-day class is for experienced MET/CAL users who want to improve their skills in developing procedures.

- **Advanced MET/CAL Procedure Writing II.** This five-day workshop for experienced MET/CAL users focuses on oscilloscope calibration procedures.

#### ■ Product specific training.

- **On-Site Training** is available for most of the above classes.

\*Similar instructor led courses are held in Europe and Asia. Visit the Training pages of [calibration.fluke.com](http://calibration.fluke.com) for details.

#### Instructor-led web-based courses (N. America):

- **MET/CAL Database Web-Based Training.** This live four-hour web workshop is intended for new or upgrading MET/CAL users. Attendees become familiar with the latest MET/CAL *Plus* features and capabilities.
- **MET/CAL® 7 Procedure Development Web-Based Training.** Learn to create procedures with the latest version of MET/CAL – without leaving your office. This workshop is presented as a five part, ten-hour course with each two-hour session scheduled on consecutive days.

#### Self-paced web courses:

Easy-to-access menu driven curriculum lets you complete the course in one sitting or over time.

- **Introduction to Measurement and Calibration**
- **Precision Electrical Measurement**
- **Measurement Uncertainty**
- **AC/DC Metrology**
- **Metrology for Technicians**
- **5520A Getting Started**



**Self-paced training tools:**

- **MET/CAL-CBT7 Computer Based Training.** This CD contains two complete, interactive training courses that teach you how to operate MET/CAL Plus Version 7 and how to create MET/CAL reports.
- **Calibration: Philosophy in Practice,** textbook

**Hart Scientific metrology, calibration and product training**

Hart offers three seminars in temperature calibration: Industrial Temperature Calibration, Temperature Metrology, and Realizing and Approximating ITS-90. Each of these is a 2½-day course taught at Hart by leading metrologists. Courses include instruction in theory, as well as demonstrations, question/answer sessions, and some hands-on work.

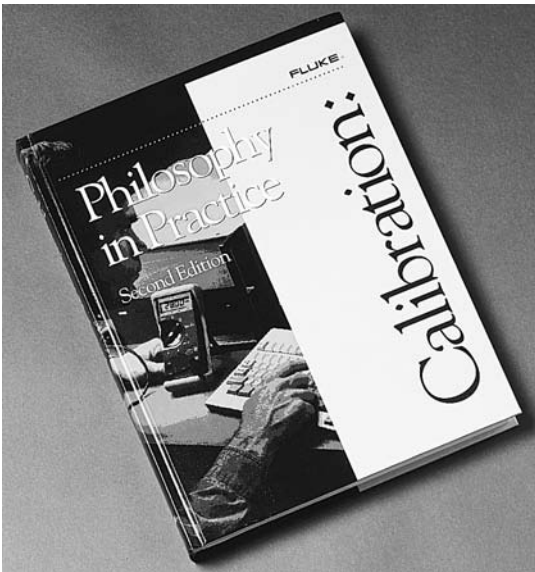
**Calibration: Philosophy in Practice, Second Edition**

- The only comprehensive text book on dc/lf metrology
- Hardbound, with more than 400 pages
- An easy-to-use resource for the new technician or the seasoned metrologist
- Includes coverage on the effects of ISO 9000 and other quality standards

**Fluke wrote the book on calibration**

The second edition of *Calibration: Philosophy in Practice* is a complete and thorough update of the only comprehensive textbook on dc/low frequency metrology.

This revised volume covers real-world concepts and applications, with clear descriptions of all concepts plus generous use of photos and diagrams to help illustrate subjects. Subjects include elements of metrology primary and secondary standards calibrators and calibration statistics and specifications laboratory management practical considerations like parasitic, guarding and grounding plus a full index and comprehensive glossary.

*Calibration: Philosophy and Practice* is both an excellent training guide for new technicians, as well as a reference tool for the working technician, engineer or metrologist.

**Ordering Information****Fluke Training**

**TRC 1000** Principles of Metrology

**TRC 1005** Cal Lab Management I

**TRC 1015** Cal Lab Management II

**TRC 1007** MET/CAL® Database and Reports

**TRC 1006** MET/CAL® Procedure Writing

**TRC 1016** Advanced MET/CAL® Procedure Writing I

**TRC 1017** Advanced MET/CAL® Procedure Writing II

**TRC 7000** Product Specific Training

**TWB1021** MET/CAL® Database Web-Based Training

**TWB 1031** MET/CAL® 7 Procedure Development Web-Based Training

**TRC 4001** Introduction to Measurement and Calibration

**TRC 4002** Precision Electrical Measurement

**TRC 4003** Measurement Uncertainty

**TRC 4004** AC/DC Metrology

**TRC 4010** Metrology for Technicians

**TRC 4020** 5520A Getting Started

**MET/CAL-CBT7** Fluke Metrology Software Computer Based Training

**CAL-BOOK** *Calibration: Philosophy in Practice, Second Edition*

### Enhance the value of your Fluke hardware and software



- Calibration and repair service plans
- Official Fluke replacement components
- Product enhancement and upgrade programs
- Software services

Fluke offers a variety of services to enhance the value of your investment in calibration hardware and software. All services are not available in all areas; contact your local Fluke representative for more information about specific services available in your area, or visit the Service pages on [www.fluke.com](http://www.fluke.com).

#### Calibration and repair services

At Fluke's modern service and calibration facilities around the world, factory trained technicians can evaluate, repair and calibrate test equipment from most major manufacturers. Accredited calibration laboratories in the United States, Canada, Netherlands, Germany, France, United Kingdom, are approved by and traceable to the National Standards Institutes of their respective countries. A variety of accredited calibration and repair services are available.

#### Extended warranty services

The Fluke Extended Warranty Plan provides ultimate equipment protection at an economical price. Comprehensive agreements provide routine calibration at regular intervals or repair service as needed. You can combine these options for full service coverage.

#### Official Fluke replacement components

Fluke makes it convenient to service your own instrumentation by offering replacement parts that meet our rigorous quality standards. All components are the latest design and meet your instrument's exact specification. Fast response delivery from us is guaranteed.

#### Product enhancement and upgrade programs

Fluke offers a variety of enhancement and upgrade programs to add even more functionality to your Fluke calibration equipment. Enhancements for Fluke Multi-Product Calibrators include the addition of oscilloscope calibration capabilities to 600 MHz (5500A and 5520A) or 1.1 GHz (5520A). The 5700A/EP is an upgrade option that extends both the performance and service life of a 5700A Multifunction Calibrator, including a 40 % improvement in uncertainty specifications.

#### Software services

**MS-PSWD.** If you forget or lose your MET/CAL *Plus* system administrator's password, this service will recover it for you. Our trained technicians will use specially developed tools to reconstruct the password.

**MS-DBFIX.** If a user's database becomes corrupted, our technical support personnel can repair the damage in most cases, returning the original data to you ready to use.

**MS-ONSITE.** This system integration and training option provides the services of a qualified onsite systems specialist to set up and initiate the MET/CAL *Plus* calibration system as well as provide training in your calibration lab. You'll be assured of a smooth integration of data and MET/CAL processes.

**MS-MIGRATE.** Fluke can help you move your legacy data into a new MET/CAL *Plus* database. Just ship your data to Fluke and our MET/SUPPORT technicians will do the rest, returning a populated MET/CAL *Plus* file to you.

### Temperature calibration from accredited labs in the United States and United Kingdom



- Calibrations from approximately -200 °C to 1000 °C
- NVLAP (US) and UKAS (UK) accredited
- All calibrations include comprehensive reports

Hart's NVLAP accredited Metrology Laboratory (lab code 200348) in American Fork, Utah provides temperature calibrations from approximately -200 °C to 1000 °C using fixed-point and comparison methods. Hart's accredited uncertainties are among the lowest commercially available anywhere in the world. The prices are very competitive and turn-around times are excellent. You'll receive reports that are comprehensive and include as-found and as-left data as well as pass/fail criteria (where applicable) and a concise statement of the method used. Calibrations performed at Hart are traceable to NIST and meet the new ISO 17025 requirements.

For fixed-point calibrations, the service technicians use Hart fixed-point cells and apparatus, Hart SPRTs as check standards, and conventional dc bridges with dc standard resistors. Fixed-point calibration procedures are based on CCT procedures, so you can be confident that the technique is current, correct, and thorough.

For comparison calibrations, Hart uses Hart baths, Hart SPRTs, and Hart readouts. Several different techniques are used to minimize uncertainties, while maximizing efficiency to keep the costs as low as possible without compromising quality. All Hart-manufactured instruments (except SPRTs and some thermocouples, which come uncalibrated) are certified before they are shipped to you.

### European Lab

In 2003, after extensive planning and a significant capital investment, Hart Scientific opened a primary temperature calibration laboratory in Europe. This new lab in Norwich, England, provides services to meet the precision temperature calibration needs of customers in Europe, the Middle East, and Africa. The UK lab uses the same Hart fixed point cells, furnaces, baths, and thermometers used in the American Fork, Utah lab. And the lab is staffed by recognized metrology experts. The UK lab is UKAS accredited, with similar uncertainties to that of Hart's American Fork, Utah lab.

**Silver support to get you up and running; Gold support to maximize your investment**



- 60 days free Priority Silver MET/SUPPORT<sup>SM</sup> with product registration
- Annual Gold MET/SUPPORT provides additional premium support and benefits\*

Fluke is committed to helping you get the most from your investment in MET/CAL<sup>®</sup> Plus Calibration Software. Now we're offering two ways to get the support you need, when you need it most. The complimentary Silver program is designed to help you get up and running quickly with MET/CAL Plus. The Gold program has been designed to provide premier support services that help you maximize your software investment over time.

When you register your copy of the MET/BASE portion of MET/CAL Plus, you automatically become enrolled in the MET/SUPPORT Silver program for 60 days of priority MET/SUPPORT. Your primary benefit will be priority access to technical product support by telephone, fax, and email.

MET/SUPPORT Gold is an annual membership program offering additional premium support and services to help you stay as productive as possible. Use only a few of the Gold services and you can easily recover more than the cost of your membership fee:

\* Not all services are equally available outside of North America and Western Europe. See your local Fluke representative for more information.

- Priority Access to our MET/SUPPORT technicians via a special Gold hotline
- Free software updates
- Free software upgrades
- 20 % discount on calibration software training
- Free access to MET/CAL and Portocal Procedures Libraries
- Substantial discounts on custom-developed calibration procedures
- Free password recovery
- Free database repair
- Free license disk replacement, your insurance policy against accidental loss or destruction of the disk.

### Ordering Information

#### MET/SUPPORT GOLD

MET/SUPPORT Gold Product Support Program. Single Workstation. One-Year Membership.

#### MET/SUPPORT GLDNW

MET/SUPPORT Gold product Support Program. Up to 4 Workstations. One-Year Membership.

#### MET/SUPPORT GLD5 through MET/SUPPORT GLD15

MET/SUPPORT Gold Product Support Program. Support for 5-15 Workstations. One-Year Membership.

Support is available for larger systems; contact your local Fluke representative. Elseo Philips Service, Trenčín

## Data Acquisition

Fluke gives you a broad choice in how you collect and transfer data for manufacturing test, process monitoring and laboratory test systems. You can choose a stationary or portable system. Transfer data to internal memory, to a removable memory card, or directly to your PC. Choose a

standalone or distributed networked units. And you can expand your system from 20 to 2000+ channels, depending on the series. Regardless of which you choose, you'll always get the accuracy, reliability, speed, and ease of use you've come to expect from Fluke.



	Hydra 2620A/ 2625A	Hydra 2635A	NetDAQ 2640A	NetDAQ 2645A	2680A-DIO	2680A-PAI	2680A-FAI
<b>Measurement</b>							
Thermocouples	9 types	9 types	9 types	9 types		11 types	11 types
RTDs	100 Pt 385	100 Pt 385	100 Pt 385	100 Pt		100 Pt	100 Pt
Resistance	To 10 MΩ	To 10 MΩ	To 3 MΩ	To 3 MΩ		To 3 MΩ	To 3 MΩ
DC voltage ranges	100 mV-150 V 300 V <sup>[1]</sup>	90 mV-150V 300 V <sup>[1]</sup>	90 mV-150/ 300 V <sup>[1]</sup>	90 mV-50 V		90 mV-150 V/ 300 V <sup>[1]</sup>	90 mV-50 V
Max dc resolution	1 μV	1 μV	1 μV	10 μV		1 μV	10 μV
AC voltage ranges	300 mV-150 V/ 300 V <sup>[1]</sup>	300 mV-150 V/ 300 V <sup>[1]</sup>	300 mV-150 V/ 300 V <sup>[1]</sup>	300 mV-30 V		300 mV-150 V/ 300 V <sup>[1]</sup>	300 mV-30 V
DC current <sup>[2]</sup>	4-20 mA	4-20 mA	4-20 mA	4-20 mA		4-20 mA	4-20 mA
Status (contacts)	Yes	Yes	Yes	Yes		Yes	Yes
Frequency	To 1 MHz	To 1 MHz	To 1 MHz	To 1 MHz		To 1 MHz	To 1 MHz
Event totalize	Yes	Yes	Yes	Yes	Yes	Yes	Yes
<b>Outputs</b>							
Status or alarms (# of chs)	12	12	8	8	20 DIO/8 Relay		
<b>Features</b>							
Analog input channels (max)	21	21	400	400		120 per chassis 2000 per system	120 per chassis 2000 per system
Basic accuracy (V dc)	0.01 %	0.01 %	0.01 %	0.02 %		0.01 %	0.02 %
Speed (ch/sec)	4/17	4/17	6/40/100	45/200/1000		6/40/100	45/200/1000
Instrument setup and operation	Front panel or computer	Front panel or computer	Computer	Computer	Computer <sup>[3]</sup>	Computer <sup>[3]</sup>	Computer <sup>[3]</sup>
RS-232C-IEEE-488/ Ethernet	Std/Opt/NA	Std/Opt/NA	NA/NA/Std	NA/NA/Std	Ethernet <sup>[6]</sup> 10/100 baseT	Ethernet <sup>[3]</sup> 10/100 baseT	Ethernet <sup>[3]</sup> 10/100 baseT
12 Vdc operation	9-16 V dc	9-16 V dc	9-16 V dc	9-16 V dc	9-45 V dc	9-45 V dc	9-45 V dc
Data storage	Host/MF	Host/PC card/MF	Via host	Via host	Via host <sup>[3]</sup>	Via host <sup>[3]</sup>	Via host <sup>[3]</sup>
Battery back-up	Program, clock, data	Program, clock, data	Program, clock	Program, clock	Via main frame	Via main frame	Via main frame
Software included	Yes	Yes	Yes	Yes	Yes	Yes	Yes

<sup>[1]</sup> 300 V from front panel and channels 1 and 11.

<sup>[2]</sup> With 2620A-101, 10 Ω shunt set (12 each).

<sup>[3]</sup> Via 2680A/2686A chassis.

### Standalone or networked precision multi-channel DAQ



- 120-channel capacity chassis, 2,000+ channels in a system
- Universal analog input channels
- Measures: RTD, frequency, dc, ac, resistance, thermistor and thermocouple
- Digital input/output and alarm contact outputs
- Ethernet TCP/IP protocols provide a network interface to 10/100 BaseT
- Powerful reporting, HMI development software and OPC server software available

The Fluke 2680 Series delivers the precision necessary for meticulous lab work along with the rugged flexibility to meet the ever-changing needs of industrial applications. Run one standalone data logging system with 20 to 120 universal channels or connect several networked data acquisition systems to serve 2,000+ channels on your LAN.

Two basic chassis models are available. The 2680A Data Acquisition System is a front-end style chassis for multi-channel applications requiring reliable Ethernet communications. The Fluke 2686A Data Logging System writes data to a memory card, making it ideal for remote locations and mobile or non-computer assisted data logging applications.

Both chassis models feature six slots. Five slots are available for any combination of 20-channel analog input modules. The sixth slot is reserved for a digital I/O relay module to add control capabilities to your system, or for an additional input module.

#### Choose the modules you need for your application

The 2680A-FAI Fast Analog Input module provides chassis throughput rates of more than 3,000 channels-per-second. Specially manufactured field effect transistors (FETs) allow up to  $\pm 50$  V input, well above the 15 V industry norm, and channel-to-channel isolation to give you more confidence in the integrity of your measurements.

The Fluke 2680A-PAI Precision Analog Input 20-channel high precision, high isolation module offers 300 V of isolation on two channels and 150 V on 18 channels, as well as 18-bit resolution and excellent thermocouple accuracy, all in a scalable system.

Both the 2680A-FAI and the 2680-PAI modules support a wide range of inputs including dc volts, ac volts, RTD, Ohms, thermocouple, thermistor, dc current, ac current, and frequency. Other sensors and transducers, such as load cells, pressure sensors, and displacement sensors can be easily incorporated into your measurement system.

For data acquisition systems that also require control functionality, the Fluke 2680A-DIO digital I/O and relay output module provides 20 digital I/O and eight hard-contact 1 Amp form-C relays. This equips each chassis to respond to a wide range of alarm or control situations. The 2680A-DIO also includes an up/down counter with preset start count capability, so you don't need to begin all counts at zero.

#### Fluke DAQ software streamlines setup and performance

The Fluke 2680A Series systems come with our powerful, easy-to-use Fluke DAQ configuration software. Fluke DAQ enables you to quickly configure your 2680 Series unit; set up data files; collect and chart data; and manage PC card files. Fluke DAQ also enables you to integrate Fluke NetDAQ® 2640A and 2645A units seamlessly into a 2680 Series system.

### Tech Tip

Thermocouple measurement accuracy is the hallmark of data acquisition equipment manufactured by Fluke. Use less costly thermocouple elements and get the best accuracy your thermocouples can offer.

### Optional software extends system capabilities

Optional 2680A-DEVSW Indusoft Web Studio is an object-oriented development program that enables programmers and non-programmers to develop modern HMI's which open graphical windows to your application. 2680A-OPC server software provides a common communication link to any software package that supports OPC, allowing you to create custom applications with popular industrial software packages. The Fluke 2680A-DLL library provides the full DLL toolbox for application software developers who need to write original programs for the 2680 Series, using Visual C++, and other languages. LabView drivers are available from [www.fluke.com](http://www.fluke.com).



## Measurement accuracy

### Model 2680A-PAI

Thermocouples [2]		Accuracy [1], 3σ, ± °C				
		18 to 28 °C			-10 to 60 °C	
		90 Day		1 Year		
Type	Temp (°C)	Slow	Slow	Fast	Slow	Fast
J	-100 °C to 80 °C	0.45	0.5	0.8	0.6	0.8
	80 °C to 230 °C	0.35	0.5	0.7	0.6	0.8
	230 °C to 760 °C	0.4	0.5	0.7	0.8	0.9
K	-100 °C to -25 °C	0.55	0.6	0.9	0.7	1.0
	-25 °C to 120 °C	0.4	0.5	0.8	0.6	0.9
	120 °C to 800 °C	0.5	0.65	0.9	1.0	1.2
	800 °C to 1372 °C	0.7	1.0	1.3	1.6	1.9
N	-100 °C to -25 °C	0.65	0.75	1.2	0.8	1.3
	-25 °C to 120 °C	0.55	0.6	1.0	0.7	1.1
	120 °C to 1000 °C	0.45	0.6	0.9	1.0	1.2
	1000 °C to 1300 °C	0.55	0.75	1.0	1.2	1.5
E	-100 °C to -25 °C	0.45	0.5	0.8	0.6	0.8
	-25 °C to 20 °C	0.35	0.4	0.6	0.5	0.7
	20 °C to 600 °C	0.3	0.4	0.6	0.5	0.8
	600 °C to 1000 °C	0.4	0.5	0.7	0.9	1.0
T	-100 °C to 0 °C	0.6	0.65	1.0	0.7	1.1
	0 °C to 150 °C	0.4	0.5	0.8	0.6	0.9
	150 °C to 400 °C	0.3	0.4	0.6	0.6	0.8
R	250 °C to 600 °C	0.9	1.0	2.1	1.2	2.2
	600 °C to 1500 °C	0.8	0.9	1.8	1.3	2.0
	1500 °C to 1767 °C	0.85	0.85	1.9	1.7	2.5
S	250 °C to 1000 °C	0.95	1.1	2.3	1.3	2.4
	1000 °C to 1400 °C	0.8	1.0	1.9	1.4	2.3
	1400 °C to 1767 °C	1.0	1.3	2.2	1.8	2.8
B	600 °C to 900 °C	1.2	1.4	3.1	1.5	3.2
	900 °C to 1200 °C	0.9	1.0	2.2	1.2	2.4
	1200 °C to 1820 °C	0.75	1.0	1.9	1.3	2.2
C	0 °C to 150 °C	0.8	0.9	1.6	1.0	1.7
	150 °C to 650 °C	0.65	0.75	1.4	1.0	1.5
	650 °C to 1000 °C	0.65	0.85	1.4	1.2	1.8
	1000 °C to 1800 °C	1.0	1.3	2.1	2.1	2.8
	1800 °C to 2316 °C	1.6	2.1	3.2	3.4	4.6
L	-100 °C to 100 °C	0.9	1.0	2.0	1.3	2.0
	100 °C to 800 °C	0.5	0.9	1.4	1.2	1.7
	800 °C to 900 °C	0.5	0.7	1.1	1.3	1.5
U	-100 °C to 0 °C	1.5	1.5	2.6	1.6	3.0
	0 °C to 600 °C	0.6	0.8	1.6	1.1	1.9

### Model 2680A-FAI

Thermocouples [2]		Accuracy [1], 3σ, ± °C				
		18 to 28 °C			-10 to 60 °C	
		90 Day		1 Year		
Type	Temp (°C)	Slow	Slow	Fast	Slow	Fast
J	-100 °C to 80 °C	0.8	0.9	1.6	0.9	1.7
	80 °C to 230 °C	0.7	0.8	1.4	0.9	1.5
	230 °C to 760 °C	0.7	0.8	1.3	1.0	1.5
K	-100 °C to -25 °C	1.0	1.1	2.0	1.2	2.1
	-25 °C to 120 °C	0.8	0.9	1.7	1.0	1.8
	120 °C to 1000 °C	0.9	1.1	1.8	1.5	2.2
	1000 °C to 1372 °C	1.2	1.5	2.3	2.0	2.9
N	-100 °C to -25 °C	1.4	1.5	2.8	1.5	2.9
	-25 °C to 120 °C	1.1	1.3	2.3	1.3	2.4
	120 °C to 1000 °C	1.0	1.1	2.0	1.2	2.1
	1000 °C to 1300 °C	1.0	1.2	1.9	1.6	2.4
E	-100 °C to -25 °C	0.8	0.9	1.5	1.0	1.6
	-25 °C to 20 °C	0.7	0.7	1.2	0.8	1.3
	20 °C to 600 °C	0.6	0.7	1.1	0.8	1.2
	600 °C to 1000 °C	0.6	0.8	1.2	1.1	1.5
T	-100 °C to 0 °C	1.1	1.2	2.2	1.3	2.3
	0 °C to 150 °C	0.9	1.0	1.7	1.0	1.8
	150 °C to 400 °C	0.7	0.8	1.4	0.8	1.5
R	250 °C to 600 °C	2.4	2.7	5.6	2.8	5.7
	600 °C to 1500 °C	2.0	2.3	4.6	2.4	4.8
	1500 °C to 1767 °C	2.0	2.3	4.5	2.8	5.1
S	250 °C to 1000 °C	2.6	2.8	5.9	2.9	6.0
	1000 °C to 1400 °C	2.0	2.3	4.6	2.6	5.0
	1400 °C to 1767 °C	2.3	2.7	5.3	3.3	5.9
B	600 °C to 1200 °C	3.6	3.9	8.5	4.0	8.6
	1200 °C to 1550 °C	2.1	2.4	5.0	2.6	5.2
	1550 °C to 1820 °C	2.0	2.3	4.7	2.7	5.0
C	0 °C to 150 °C	1.9	2.0	4.0	2.1	4.2
	150 °C to 650 °C	1.6	1.7	3.5	1.8	3.6
	650 °C to 1000 °C	1.4	1.7	3.2	2.0	3.5
	1000 °C to 1800 °C	2.0	2.5	4.5	3.2	5.3
	1800 °C to 2316 °C	3.1	3.8	6.8	5.1	8.1
L	-100 °C to 100 °C	1.2	1.3	2.9	1.6	3.1
	100 °C to 800 °C	0.9	1.0	2.1	1.2	2.3
	800 °C to 900 °C	0.7	0.8	1.3	1.0	1.5
U	-100 °C to 0 °C	2.0	2.1	4.3	2.2	4.6
	0 °C to 600 °C	1.3	1.4	2.5	1.6	2.6

**Note:** The terms "slow" and "fast" in these tables refer to the minimum and maximum measurement speed (Rdgs/s) as listed in the specifications for a specific model.

[1] Total instrument accuracy for the indicated time period and ambient temperature range. Includes A/D errors, linearization conformity, initial calibration error, isothermality errors, reference junction conformity and power line voltage effects within the range from 100 V ac to 264 V ac.

[2] Resolution is 0.02 °C or 0.04 °F over the useful range of base metal thermocouples (J, K, T, E, N, L, U) and 0.1 °C or 0.2 °F resolution for types R, S, B, and C with slow scan.

### Model 2680A-PAI

DC Voltage		Accuracy <sup>[1]</sup> , 3σ, ± (% input + V) 18 to 28 °C		
Range	Resolution	90 Day	1 Year	
	Slow	Slow	Slow	Fast
90 mV	.3 μV	0.01 % + 7 μV	0.013 % + 8 μV	0.013 % + 18 μV
300 mV	1 μV	0.01 % + 15 μV	0.013 % + 17 μV	0.013 % + 35 μV
3 V	10 μV	0.01 % + .1 mV	0.013 % + .15 mV	0.013 % + .2 mV
30 V	100 μV	0.01 % + 1.5 mV	0.013 % + 1.7 mV	0.026 % + 3.5 mV
150/300 V	1 mV	0.01 % + 15 mV	0.013 % + 17 mV	0.052 % + 35 mV
Resistance		Accuracy <sup>[1],[3]</sup> (4-wire), 3σ, ± (% input + Ω)		
300 Ω	1 mΩ	0.015 % + 20 mΩ	0.02 % + 30 mΩ	0.02 % + 120 mΩ
3 k Ω	10 mΩ	0.02 % + .3 Ω	0.02 % + .5 Ω	0.02 % + .12 Ω
30 k Ω	100 mΩ	0.03 % + 3 Ω	0.03 % + 5 Ω	0.04 % + 15 Ω
300 kΩ	1 Ω	0.1 % + 40 Ω	0.1 % + 60 Ω	0.2 % + 150 Ω
3 MΩ	10 Ω	0.25 % + 800 Ω	0.25 % + 1 kΩ	0.5 % + 1.5 kΩ

### Model 2680A-FAI

DC Voltage		Accuracy <sup>[1]</sup> , 3σ, ± (% input + V) 18 to 28 °C		
Range	Resolution	90 Day	1 Year	
	Slow	Slow	Slow	Fast
90 mV	3 μV	0.01 % + 20 μV	0.013 % + 23 μV	0.013 % + 50 μV
300 mV	10 μV	0.01 % + 40 μV	0.013 % + 49 μV	0.013 % + 93 μV
3 V	100 μV	0.01 % + .3 mV	0.013 % + .38 mV	0.013 % + .64 mV
30 V	1 mV	0.01 % + 4 mV	0.013 % + 4.9 mV	0.026 % + 9.5 mV
150/300 V	10 mV	0.01 % + 30 mV	0.013 % + 40 mV	0.052 % + 64 mV
Resistance		Accuracy <sup>[1],[4]</sup> (4-wire), 3σ, ± (% input + Ω)		
300 Ω	10 mΩ	0.02 % + 60 mΩ	0.02 % + .1 Ω	.02 % + .2 Ω
3 kΩ	100 mΩ	0.02 % + 6Ω	0.02 % + 1 Ω	.02 % + 3 Ω
30 kΩ	1 Ω	0.02 % + 6Ω	0.02 % + 10 Ω	.02 % + 300 Ω
300 kΩ	10 Ω	0.5 % + 80Ω	0.5 % + 150 Ω	1.0 % + 3 kΩ
3 MΩ	100 Ω	1.3 % + 1 kΩ	1.3 % + 2 kΩ	2.0 % + 200 kΩ

### Model 2680A-PAI

AC Voltage				
Range	Resolution	Frequency	Accuracy <sup>[1],[2]</sup> , 3σ, (% input + counts)	
	Slow		Slow	Fast
300 mV	1 μV	20 Hz to 50 Hz 50 Hz to 20 kHz 20 kHz to 50 kHz 50 kHz to 100 kHz	3.0 % + 25 0.4 % + 25 2.0 % + 30 5.0 % + 50	6.0 % + 50 1.0 % + 50 3.0 % + 50 5.0 % + 100
3 V	100 μV	Same frequencies, similar accuracies as above		
30 V	1 mV	Same frequencies, similar accuracies as above		
150/300 V	10 mV	Same frequencies, similar accuracies as above		
RTD (Pt 100)		Accuracy <sup>[1],[5]</sup> , 3σ, ± °C (4-wire)		
Temperature °C	Resolution °C	90 Day, 18 to 28 °C	1 Year, 18 to 28 °C	
	Slow	Slow	Slow	
-200 °C	0.003	0.06	0.09	
0 °C	0.003	0.09	0.13	
100 °C	0.003	0.10	0.16	
300 °C	0.003	0.14	0.21	
600 °C	0.003	0.19	0.30	
Thermistor <sup>[7]</sup> 2 k to 100 kΩ				
-40 °C to 150 °C	0.003	0.3	0.4	
Frequency Measurement Accuracy <sup>[1]</sup> , -20 to 60 °C				
Range	Resolution		Accuracy, 3σ, ± (% input + Hz)	
	Slow	Fast	Slow	Fast
15 Hz to 900 Hz	0.01 Hz	0.1 Hz	0.05 % + 0.02 Hz	0.05 % + 0.2 Hz
900 Hz to 9 kHz	0.1 Hz	1 Hz	0.05 % + 0.1 Hz	0.05 % + 1 Hz
9 kHz to 90 kHz	1 Hz	10 Hz	0.05 % + 1 Hz	0.05 % + 10 Hz
90 kHz to 900 kHz	10 Hz	100 Hz	0.05 % + 10 Hz	0.05 % + 100 Hz
1 MHz	100 Hz	1 kHz	0.05 % + 100 Hz	0.05 % + 1 kHz
Frequency Measurement Sensitivity (sine wave)				
Frequency	Minimum Signal		Maximum Signal	
15 Hz to 200 Hz	100 mV rms		150/300 V rms	
200 Hz to 70 kHz	100 mV rms		30 V rms	
70 kHz to 100 kHz	100 mV rms		20 V rms	
100 kHz to 200 kHz	150 mV rms		10 V rms	
200 kHz to 300 kHz	150 mV rms		7 V rms	
300 kHz to 1 MHz	linearly increasing from 150 mV rms at 300 kHz to 2 V rms at 1 MHz		linearly decreasing from 7 V rms at 300 kHz to 2 V rms at 1 MHz	

### Model 2680A-FAI

AC Voltage				
Range	Resolution	Frequency	Accuracy <sup>[1],[2]</sup> , 3σ, (% input + counts)	
	Slow		Slow	Fast
300 mV	10 μV	20 Hz to 50 Hz 50 Hz to 20 kHz 20 kHz to 50 kHz 50 kHz to 100 kHz	3.0 % + 25 0.4 % + 25 2.0 % + 30 5.0 % + 50	6.0 % + 50 1.0 % + 50 3.0 % + 50 5.0 % + 100
3 V	100 μV	Same frequencies, similar accuracies as above		
30 V	1 mV	Same frequencies, similar accuracies as above		
RTD (Pt 100)		Accuracy <sup>[1],[5]</sup> , 3σ, ± °C (4-wire)		
Temperature °C	Resolution °C	90 Day, 18 to 28 °C	1 Year, 18 to 28 °C	
	Slow	Slow	Slow	
-200 °C	0.03	0.16	0.25	
0 °C	0.03	0.20	0.31	
100 °C	0.03	0.23	0.34	
300 °C	0.03	0.30	0.41	
600 °C	0.03	0.53	0.63	
Thermistor <sup>[7]</sup> 10 k to 100 kΩ				
-40 °C to 150 °C	0.03	0.4	0.5	
Frequency Measurement Accuracy <sup>[1]</sup> , -20 to 60 °C				
Range	Resolution		Accuracy, 3σ, ± (% input + Hz)	
	Slow	Fast	Slow	Fast
15 Hz to 900 Hz	0.01 Hz	0.1 Hz	0.05 % + 0.02 Hz	0.05 % + 0.2 Hz
900 Hz to 9 kHz	0.1 Hz	1 Hz	0.05 % + 0.1 Hz	0.05 % + 1 Hz
9 kHz to 90 kHz	1 Hz	10 Hz	0.05 % + 1 Hz	0.05 % + 10 Hz
90 kHz to 900 kHz	10 Hz	100 Hz	0.05 % + 10 Hz	0.05 % + 100 Hz
1 MHz	100 Hz	1 kHz	0.05 % + 100 Hz	0.05 % + 1 kHz
Frequency Measurement Sensitivity (sine wave)				
Frequency	Minimum Signal		Maximum Signal	
15 Hz to 200 Hz	100 mV rms		30 V rms	
200 Hz to 70 kHz	100 mV rms		30 V rms	
70 kHz to 100 kHz	100 mV rms		20 V rms	
100 kHz to 200 kHz	150 mV rms		10 V rms	
200 kHz to 300 kHz	150 mV rms		7 V rms	
300 kHz to 1 MHz	linearly increasing from 150 mV rms at 300 kHz to 2 V rms at 1 MHz		linearly decreasing from 7 V rms at 300 kHz to 2 V rms at 1 MHz	

<sup>[1]</sup> Total instrument accuracy for the indicated time period and ambient temperature range. Includes A/D errors, linearization conformity, initial calibration error, isothermality errors, reference junction conformity and power line voltage effects within the range from 100 V AC to 264 V AC.  
<sup>[2]</sup> Sine wave inputs >2000 counts (slow), >200 counts (fast). Accuracies for crest factor 2.0.  
<sup>[3]</sup> For two-wire measurements add 5 Ω to basic accuracy (does not include lead-wire resistances).

<sup>[4]</sup> For two-wire measurements add 700-1000 Ω to basic accuracy (does not include lead-wire resistances). Ohms varies due to the resistance of the solid state switches.  
<sup>[5]</sup> DIN/IEC 751 only, assumes no lead-wire resistance errors.  
<sup>[6]</sup> Accuracy for both slow and fast scan speeds.  
<sup>[7]</sup> Using Stein hart - Hart thermistor polynomial: T = A+B (lnR) + C (lnR)<sup>3</sup>  
 T = temp in °K; A, B and C = fitting constants; R = resistance of thermistor in Ω.  
 Elseo Philips Service, Trenčín



### 2680A (Chassis)

- 20 to 120 channels
- Universal inputs
- 10 BaseT / 100 BaseT operation

### 2686A (Chassis)

Same as 2680A, plus:

- PC ATA flash memory card to 2 GB
- Stand-alone operation or networked

## 2680A Series

### Analog Channel capacity (2680A or 2686A)

20 to 120 channels per chassis (6 analog input modules of 20 channels each)

One master alarm (open collector) per chassis

Communications: 10BaseT/100BaseT, TCP/IP via RJ45 connector, Cat 5

### Math functions

In addition to its analog and digital input channels, each chassis supports 60 computed channels. Calculations include: time and rate, addition, subtraction, multiplication, division, log, natural log, exponent, square root, absolute value, integer function and average.

### Measurement speed (2680A-PAI)

Slow: 6 readings/second nominal

Medium: 41 (50 Hz), 48 (60 Hz)

readings/second nominal

Fast: 143 readings/second nominal

(5 readings/second for V ac

nominal, 140 readings/second on

300 Ω range, 37 readings/second

on 3 MΩ range)

### Measurement speed (2680A-FAI)

Slow: 45 (50 Hz), 54 (60 Hz)

readings/second nominal

Medium: 200 readings/second

nominal

Fast: 667 readings/second nominal

(5 readings/second for V ac

nominal, 370 readings/second on

300 Ω range, 44 readings/second

on 3 MΩ range)

### Analog to digital converter

2680A-PAI: 18 bit, multi-slope type

2680A-FAI: 16 bit, multi-slope type

### Common mode rejection

2680A-PAI:

AC:  $\geq 120$  dB (50/60 Hz,  $\pm 0.1$  %

max 1 kΩ source imbalance)

DC:  $\geq 120$  dB

2680A-FAI:

AC:  $\geq 100$  dB (50/60 Hz,  $\pm 0.1$  %

max 1 kΩ source imbalance)

DC:  $\geq 100$  dB

### Normal mode rejection

50 dB @ 50/60 Hz,  $\pm 0.1$  %

### Common mode voltage maximum

2680A-PAI: 300 V dc or V ac rms

(channels 1,11); 150 V dc or

V ac rms (all other channels)

2680A-FAI: 50 V dc or 30 V ac rms

(all channels)

## 2680A-DIO

### Totalizing input

Pre-settable starting count

up/down counter: DC coupled,

non-isolated, max +30 V, min -4 V

Max count: 4,294,967,295

Minimum signal: 2 V peak

Threshold: 1.4 V

Rate: 0-5 kHz (debounce off)

Hysteresis: 500 mV

Input debouncing: None or 1.66 ms

### Digital inputs/outputs: 20

Threshold: 1.4 V

Hysteresis: 500 mV

Maximum input: +30 V,

min -4 V; non-isolated

**Logical "zero" output:**

0.8 V max |out = -1.0 mA

(1 LSTTL load equivalent)

1.8 V max |out = -20 mA

3.25 V max |out = -50 mA

**Logical "one" output:**

Output voltage depends on

external load

3.8 V min |out = 0.05 mA

(1 LSTTL load equivalent)

### Relays

Quantity: 8

Type: Form C; DPST

Current: 1 amp, non-inductive

Operation time: 75 ms

### Alarm associations

Each Digital I/O may be randomly assigned as a digital input, status output, or alarm output (associated with any input channel or channels)

### Trigger input

Minimum pulse: 5 μs

Minimum latency: 100 ms

Input "High": 2.0 V min, 7.0 V max

Input "Low": -0.6 V min, 0.8 V max

non-isolated, contact closure and

TTL compatible

### Clock

Accurate to within 1 minute/month

for 0 °C to 50 °C range

## General Specifications

### Power

100 to 240 V ac, 50 or 60 Hz

100 VA max, or 9 to 45 V dc

(50 W dc) (if both sources are

applied simultaneously, the greater

of ac or dc is used.), at 120 V ac the

equivalent dc voltage ~14.5 V

### Temperature, humidity (non-condensing)

Operating: -20 °C to 28 °C,  $\leq 90$  %

RH; 28 °C to 40 °C,  $\leq 75$  % RH;

40 °C to 60 °C,  $\leq 50$  % RH

Storage: -40 °C to 70 °C, 5 % to

95 % RH

### Altitude

Operating: 2000 m

Storage: 12,200 m

### Standards

**All inputs: IEC Overvoltage rating**

**Category II**

**Product conforms to the following**

**safety and emission standards:**

EN50082-2

EN55022-1

EN55011 class A

EN61000-4-2,3,4,6,8

EN61326

EN61010-1, CAT II

CSA C22.2 No. 1010.1

### Operating temperature

-20 °C to 60 °C (-4 °F to +140 °F)

### Storage temperature

-40 °C to 70 °C (-40 °F to +158 °F)

### Dimensions/Weight

Size: 473 mm H x 423 mm W x  
237 mm D (18.6 in H x 17 in W x  
9.3 in D)

Weight (2680A/2686A chassis only):

8.47 kg (18.86 lbs)

2680A-FAI: 0.79 kg (1.74 lbs)

2680A-PAI: 1.21 kg (2.66 lbs)

2680A-DIO: 0.80 kg (1.75 lbs)

### Interfaces

Ethernet: Conforms to IEEE 802.3

Ethernet standard,

compatible with 100BaseT and  
10BaseT standards, uses TCP/IP  
protocol

RS-232C: For calibration only

### Calibration

None required/or possible on  
2680A/2686A and 2680A-DIO

2680A-FAI/PAI: Statement of  
calibration practices non-serialized,  
no data. Other calibrations are  
available, contact your local  
representative.

### 2686A memory card storage capacity

2686A - Active channels and memory card capacity (scans)						
Memory Card/ Active Channels	20 ch	40 ch	60 ch	80 ch	100 ch	120 ch
16 MB	100,548	66,765	50,074	40,059	33,382	28,613
128 MB	800,000	528,000	400,000	320,000	264,000	224,000
256 MB	1.6 M	1.056 M	800,000	640,000	528,000	448,000
512 MB	3.2 M	2.112 M	1.6 M	1.28 M	1.056 M	896,000
1 GB	6.2 M	4.224 M	3.2 M	2.56 M	2.112 M	1.792 M

Estimating space: 80 bytes / scan + 4 bytes / channel scanned (allow 4.5 % overhead for card formatting)

### Ordering Information

#### Model

**2680A** Data Acquisition System  
Chassis, 6 slots

**2686A** Data Logging System  
Chassis with ATA Flash memory

**2680A-FAI** Fast Analog Input  
Module

**2680A-PAI** Precision Analog  
Input Module

**2680A-DIO** Digital I/O and Relay  
Module

#### Options and Accessories

**2680A-180** Universal Input  
Module, extra connector

**2680A-102** 2680A-DIO Connec-  
tor Module, extra connector

**2620A-101** Current Shunts 10  $\Omega$ ,  
0.1 %, set of 12 ea. 100 mA max.

**2686A-800** 16 MB ATA Flash  
memory card for 2686A

**2686A-801** 128 MB ATA Flash  
memory card for 2686A

**2686A-802** 256 MB ATA Flash  
memory card for 2686A

**2686A-805** 512 MB ATA Flash  
memory card for 2686A

**2686A-810** 1 GB ATA Flash  
memory card for 2686A

**Y2680** Rack mount kit for 2680  
Series

#### Software\*

**2680A-APSW** Fluke DAQ Config-  
uration software for 2680 Series

**2680A-DEVSU** Indusoft Web  
Studio, Development software  
for Fluke DAQ

**2680A-DLL** DLL Library for  
2680 Series

**2680A-OPC** OPC software for  
2680 Series

**2680A-904** Trend Link for Fluke  
includes 2680A-OPC (NetDAQ,  
2680 Series)

\*Requires Windows 98 or above

# Hydra Series Portable Data Acquisition

riešenia na presné meranie

www.elseo.sk/Fluke-Calibration

**FLUKE**®

## Data Acquisition

Portable, flexible solutions for stand-alone or PC-based data acquisition



### Tech Tip

Universal input signal conditioning provides flexibility and saves money over dedicated input systems. Removable input connectors aid test setup and tear down.

- 20 universal input channels
- Convenient flexibility
- Quick setups with menu-driven software
- Fail-safe memory features
- Application software
- Measures: RTD, frequency, dc, ac, resistance, thermocouple

The Hydra Series is available in three models to fit many application requirements. The 2620A Hydra Data Acquisition Unit is a compact front end for use with your PC. The portable 2625A Hydra Data Logger features non-volatile memory that stores more than 42,000 readings, for stand-alone applications. And the 2635A Hydra Data Bucket™ with its removable memory

card for data and set-up storage, is the most versatile model – ideal for remote monitoring applications. All models are easy to set up and reconfigure from the front panel. Additionally, all units have universal signal conditioning. The RS-232C interface enables control from a host computer. An optional GPIB/IEEE-488 interface is available for the 2620A only.

### 2635A memory card

Type: SRAM type only; PCMCIA compliant

Capacity: The chart below shows memory card storage capacity in scans for one data file. One scan comprises date and time, readings from all defined analog input channels, the status of the four alarm outputs, eight digital I/O and the totalizer count.

### Number of scans per card

Memory card size	Channels in scan		
	4	10	20
256 kb	8900	4800	2710
512 kb	18250	9840	5560
1 Mb	36860	19860	11210
2 Mb	74110	39910	22550
4 Mb	149039	80251	45359

### 2625A data memory

- Stores 2,047 scans
- Stored with each scan: time stamp, all defined analog input channels, the status of four alarm outputs and eight digital I/O, and the totalizer count
- Memory life: 5 years minimum; at 25 °C

Temp. (°C)	RTD (Pt 100)		Accuracy <sup>1,3</sup> ± °C (4-Wire)	
	Resolution		Slow	Fast
	Slow	Fast		
-200 °C	0.02	0.1	0.05	0.47
0 °C	0.02	0.1	0.09	0.55
100 °C	0.02	0.1	0.10	0.58
300 °C	0.02	0.1	0.14	0.65
600 °C	0.02	0.1	0.20	0.76

Range	Frequency		Accuracy (Slow/Fast) ± (% + Hz)
	Resolution		
	Slow	Fast	
15 to 900 Hz	0.01 Hz	0.1 Hz	0.05 + 0.2 Hz
9 kHz	0.1 Hz	1.0 Hz	0.05 + 1 Hz
90 kHz	1 Hz	10 Hz	0.05 + 10 Hz
900 kHz	10 Hz	100 Hz	0.05 + 100 Hz
1 MHz	100 Hz	1 kHz	0.05 + 1 kHz

Sensitivity	
Frequency	Level
15 Hz to 100 kHz	100 mV rms sine wave
100 kHz to 300 kHz	150 mV rms sine wave
300 kHz to 1 MHz	2 V rms sine wave
Above 1 MHz	not specified

**Note:** The terms "slow" and "fast" in these tables refer to the minimum and maximum measurement speed (Rdgs/s) as listed in the specifications for a specific model.

### Measurement accuracy

DC Voltage			Accuracy <sup>[1]</sup> , 3σ, ± (% + V)			
Range	Resolution		Slow		Fast	
	Slow	Fast	90 days	1 year	1 year	
90 mV*	1 μV	10 μV	.019 % + 6 μV	.024 % + 6 μV	.044 % + 20 μV	
300 mV	10 μV	100 μV	.018 % + 20 μV	.023 % + 20 μV	.040 % + 0.2 mV	
3 V	100 μV	1 mV	.019 % + 0.2 mV	.024 % + 0.2 mV	.041 % + 2 mV	
30 V	1 mV	10 mV	.019 % + 2 mV	.024 % + 2 mV	.041 % + 20 mV	
300/150 V	10 mV	100 mV	.019 % + 20 mV	.024 % + 20 mV	.041 % + 0.2V	
Resistance			Accuracy (4-wire) <sup>[1],[3]</sup> ± (% + Ω)			
300 Ω	10 mΩ	100 mΩ	0.013 % + 20 mΩ	0.014 % + 20 mΩ	0.014 % + 200 mΩ	
3 kΩ	100 mΩ	1 Ω	0.015 % + 0.2 Ω	0.016 % + 0.2 Ω	0.016 % + 2 Ω	
30 kΩ	1 Ω	10 Ω	0.013 % + 2 Ω	0.014 % + 2 Ω	0.014 % + 20 Ω	
300 kΩ	10 Ω	100 Ω	0.020 % + 20 Ω	0.021 % + 20 Ω	0.021 % + 0.2 kΩ	
3 MΩ	100 Ω	1 kΩ	0.059 % + 0.2 kΩ	0.063 % + 0.2 kΩ	0.063 % + 2 kΩ	
10 MΩ	1 kΩ	10 kΩ	0.168 % + 2 kΩ	0.169 % + 2 kΩ	0.709 % + 20 kΩ	
AC Voltage (True-rms, ac-coupled)		Frequency	Accuracy <sup>[1],[2]</sup> ± (% + counts)			
300 mV 3 V 30 V 300/150 V	10 μV 100 μV 1 mV 10 mV 100 mV	100 μV 1 mV 10 mV 100 mV	20 Hz to 50 Hz	1.43 % + 15	1.43 % + 4	
			50 Hz to 150 Hz	0.3 % + 15	0.3 % + 4	
			150 Hz to 10 kHz	0.16 % + 15	0.16 % + 4	
			10 kHz to 20 kHz	0.37 % + 15	0.37 % + 4	
			20 kHz to 50 kHz	1.9 % + 20	1.9 % + 4	
			50 kHz to 100 kHz	5.0 % + 50	5.0 % + 10	
Thermocouples <sup>[5]</sup>		Accuracy <sup>[1],[4]</sup> , 3σ, (± °C)				
2635A ITS90		18 to 28 °C			0 to 60 °C	
Type	Temp. (°C)	90 days slow	1 year slow	1 year fast	1 year slow	1 year fast
J	-100 °C to -30 °C	0.42	0.43	0.91	0.55	1.08
	-30 °C to 150 °C	0.37	0.39	0.80	0.57	1.02
	150 °C to 760 °C	0.44	0.48	0.94	0.88	1.38
K	-100 °C to -25 °C	0.52	0.53	1.13	0.65	1.31
	-25 °C to 120 °C	0.43	0.44	0.93	0.62	1.16
	120 °C to 1000 °C	0.61	0.68	1.38	1.28	2.03
	1000 °C to 1372 °C	0.89	0.98	1.87	1.85	2.79
N	-100 °C to -25 °C	0.62	0.63	1.44	0.75	1.61
	-25 °C to 120 °C	0.53	0.55	1.22	0.67	1.39
	120 °C to 410 °C	0.47	0.49	1.08	0.69	1.28
	410 °C to 1300 °C	0.70	0.78	1.52	1.45	2.23
E	-100 °C to -25 °C	0.44	0.46	0.91	0.57	1.09
	-25 °C to 350 °C	0.38	0.39	0.77	0.61	0.98
	350 °C to 650 °C	0.39	0.43	0.82	0.80	1.23
	650 °C to 1000 °C	0.50	0.56	1.05	1.11	1.63
T	-150 °C to 0 °C	0.68	0.69	1.50	0.82	1.71
	0 °C to 120 °C	0.45	0.46	0.95	0.59	1.13
	120 °C to 400 °C	0.36	0.39	0.78	0.61	1.02
R	250 °C to 400 °C	0.83	0.85	2.47	1.02	2.66
	400 °C to 1000 °C	0.79	0.81	2.30	1.15	2.53
	1000 °C to 1767 °C	0.96	1.05	2.59	1.85	3.42
S	250 °C to 1000 °C	0.88	0.89	2.60	1.26	2.80
	1000 °C to 1400 °C	0.83	0.89	2.34	1.47	2.94
	1400 °C to 1767 °C	1.07	1.17	2.96	2.03	3.84
B	600 °C to 1200 °C	1.11	1.12	3.53	1.27	3.69
	1200 °C to 1550 °C	0.74	0.77	2.25	1.18	2.57
	1550 °C to 1820 °C	0.82	0.89	2.35	1.43	2.90
C	0 °C to 150 °C	0.72	0.73	1.90	0.86	2.08
	150 °C to 650 °C	0.62	0.64	1.62	0.99	1.94
	650 °C to 1000 °C	0.70	0.76	1.81	1.29	2.38
	1000 °C to 1800 °C	1.12	1.25	2.86	2.38	4.04
	1800 °C to 2316 °C	1.86	2.08	4.61	4.06	6.66

\*2635A only

**Note:** The terms "slow" and "fast" in these tables refer to the minimum and maximum measurement speed (Rdgs/s) as listed in the specifications for a specific model.

<sup>[1]</sup> Total instrument accuracy for 1 year following calibration (unless otherwise stated). Ambient operating temperature 18 to 28 °C (unless otherwise stated). Includes A/D errors, linearization conformity, initial

calibration error, isothermality errors, and reference junction conformity. (Sensor inaccuracies not included.) Relative humidity up to 90 % non-condensing (except up to 70 % for the 300 kΩ, 3 MΩ, and 10 MΩ ranges).

<sup>[2]</sup> Sine wave inputs > 2000 counts (slow), > 200 counts (fast). Accuracies for crest factor ≤ 2.0.

<sup>[3]</sup> DIN/IEC 751 only, 4-wire configurations.

<sup>[4]</sup> Resolution is 0.1 °C or 0.1 °F over the useful range of base metal thermocouples (J, K, T, E, N) and 0.2 ° resolution for types R, S, B, and C, with slow scan. Fast scan resolution = 1 °C or F.

<sup>[5]</sup> Open thermocouple detection is performed on each thermocouple channel unless defeated by computer command. IPTS 68 specifications are published in the user manual.

### Channel capacity

Analog inputs: 21  
Digital I/O and alarm outputs: 12 total  
Totalizer: 1

### Front panel input

DC V, AC V, (300 V maximum) resistance, frequency. Use any of the Fluke TL Series of test leads. (One set of TL70 test leads included with Hydra)

### Common mode rejection

AC: ≥ 120 dB (50/60 Hz, ± 0.1 % max 1 kΩ source imbalance)  
DC: ≥ 120 dB

### Normal mode rejection

53 dB (60 Hz, ± 0.1 %)  
47 dB (50 Hz, ± 0.1 %)

### Scan speed

Slow: 4 readings/second nominal  
Fast: 18 readings/second nominal (1.5 readings/second for AC V and Ω inputs nominal)

### Analog to digital converter

Dual Slope type, linear to 17 bits

### Totalizing inputs

DC coupled, non-isolated, max +30 V, min -4 V  
Max count: 65,535  
Minimum signal: 2 V peak  
Threshold: 1.4 V  
Rate: 0-5 kHz (debounce off)  
Hysteresis: 500 mV  
Input debouncing: None or 1.66 ms

### Digital inputs

Threshold: 1.4 V  
Hysteresis: 500 mV  
Maximum input: +30 V, min -4 V; non-isolated

### Digital/Alarm outputs

The open collector output lines are non-isolated, TTL compatible with the following logic levels:

#### Logical "zero" output:

0.8 V max | out = -1.0 mA (1 LSTTL load equivalent)  
1.8 V max, | out = -20 mA  
3.25 V max, | out = -50 mA

**Logical "one" output:**

Output voltage depends on external load  
3.8 V min, | out = 0.05 mA  
(1 LSTTL load equivalent)

**Trigger input**

Minimum pulse: 5 µs  
Maximum latency: 100 ms  
Repeatability: 1 ms  
Input "High": 2.0 V min, 7.0 V max  
Input "Low": -0.6 V min, 0.8 V max  
Non-isolated, contact closure and TTL compatible

**Clock**

Accurate to within 1 minute/month for 0 °C to 50 °C range

**Power**

90 to 264 V ac, 50 or 60 Hz (< 10 W), or 9 to 16 V dc (< 4 W)  
(If both sources are applied simultaneously, the greater of ac or dc is used.) At 120 V ac the equivalent dc voltage ~ 14.5 V.

**Temperature, humidity (non-condensing)**

Operating: 0 °C to 28 °C, ≤ 90 % RH; 28 °C to 40 °C, ≤ 75 % RH; 40 °C to 60 °C, ≤ 50 % RH  
Storage: -40 °C to 75 °C, 5 % to 95 % RH

**Altitude**

Operating: 2000 m  
Storage: 12000 m

**Voltage ratings**

300 V dc or V ac rms (channels 0,1,11); 150 V dc or V ac rms (all other inputs) IEC Overvoltage Category II

**Common mode voltage**

300 V dc or ac rms maximum from any analog input (channel) to earth provided that channel to channel maximum voltage ratings are observed

**Alarms associations**

Configured from	Alarm outputs				Digital I/O							
	0	1	2	3	0	1	2	3	4	5	6	7
Front panel	ch0	ch1	ch2	ch3	digital inputs				ch4	ch5	ch6	ch7
	(Fixed)								ch8	ch9	ch10	ch11
									ch12	ch13	ch14	ch15
									ch16/20	ch17	ch18	ch19
Computer	ch0	ch1	ch2	ch3	Each Digital I/O may be randomly assigned as a digital input, status output, or alarm output (associated with any input channel or channels), except ch 0-3							

**Standards**

IEC 1010, ANSI/ISA-S82.01-1994, CSA-C22.2 No. 1010.1-92, and EN61010-1:1993. Complies with EN 50081-1, EN 50082-1, Vfg. 243/1991 and FCC-15B at the Class B level, when shielded cables are used.

**Dimension/Weight**

Size: 9.3 cm H x 21.6 cm W x 31.2 cm D  
(3.6 in H x 8.5 in W x 14.4 in D)  
Weight: 3.0 kg

**Memory life**

10 years minimum for real time clock, setup configuration and measurement data (from date of manufacture)

**Interfaces****RS-232**

Connector: Nine pin male (DB-9P)  
Signals: TX, RX, DTR, GND, CTS,\* DSR,\* RTS\*

Modem control: Full duplex  
Baud rate: 300, 600, 1200, 2400, 4800, 9600, 19.2 k\*, 38.4 k\*  
Data format: 8 data bits, no parity, one stop bit; or 7 data bits, one parity bit, one stop bit  
Parity: Odd, even, none  
Echo: On/Off  
Flow control: XON/XOFF, CTS\*

\*2635A only

**IEEE-488 (Optional, 2620A only)**

Disables RS-232 interface while in use.

**Calibration**

Calibration is performed closed-case via software, eliminating troublesome mechanical adjustments. This improves operational reliability by avoiding the drift caused by vibration, temperature, and humidity on conventional calibration controls.

**Calibration provided**

Statement of calibration practices non-serialized, no data. Other calibrations are available, contact your local representative.

**Ordering Information****Models\***

- 2620A** Hydra Data Acquisition Unit
- 2620A/05** Hydra data Acquisition Unit with IEEE-488 interface
- 2625A** Hydra Data Logger
- 2635A** Hydra Data Bucket (256KB memory card)
- 2635A 1MB** Hydra Data Bucket (1MB memory card)
- 2635A 2MB** Hydra Data Bucket (2MB memory card)
- 2635A 4MB** Hydra Data Bucket (4MB memory card)
- 2620T** Recording Thermometer with probe and software
- 2635T** Recording Thermometer with probe, software and 256 KB PC memory card

\*All mainframes include 2635A-901 software and RS43 cable.

**Options and Accessories**

- 26XXA-600** Portable Battery Pack
- RS43** RS-232C DB9 to DB9 for PC to unit, 6 ft
- Y8021** Shielded IEEE-488 Cable, 1 m (3.28 ft)
- Y8022** Shielded IEEE-488 Cable, 2 m (6.56 ft)
- 2620A-101** Current Shunts 10 Ω, 0.1 %, set of 12 ea. 100 mA max.
- 2620A-100** Extra I/O Connector Set: includes Universal Input Module, Digital I/O and Alarm Output Connectors
- 2620A-05K** IEEE-488 Interface Kit (2620A only)
- 263XA-804** 256 KB Memory Card
- 263XA-805** 1 MB Memory Card
- 263XA-806** 2 MB Memory Card
- 263XA-807** 4 MB Memory Card
- 2600A-101** Extra PRT Probe, 100 PT, Probe with soft case only
- M00-200-634** Rack Mount Kit

**Software\***

- 2600A-904** Trend Link for Fluke
- 2635A-901** Hydra Logger for Windows
- 2635A-902** Hydra Logger for Windows with Trending

\*Requires Windows 98 or above.

### Networked data acquisition



### Tech Tip

Grouping is a technique that allows multiple NetDAQ units to synchronize and collect data into one continuous data file.

- Universal inputs: any channel may be configured in any combination of dc V, ac V, dc I, ac I, thermocouple, RTD, resistance and frequency inputs
- Delivers versatile solutions for distributed data acquisition
- Real-time, networked results
- 20 channels up to 400 channels/systems
- Measurement: RTD, frequency, dc, ac, resistance, thermocouple

NetDAQ networked data acquisition units are a powerful combination of hardware and software seamlessly integrated to deliver data directly over an existing network. This family of Fluke systems, combined with Trend Link software, enables multiple users to view only the information they need in real time, from anywhere on the system. View current, temperature, voltage, and more criteria on the same screen at the same time. NetDAQ can also monitor several units simultaneously – making it perfect for applications such as equipment monitoring, product testing, and process validation. NetDAQ replaces aging chart recorders and adds future expandability to your precision measurement system.

Combine from one to 20 NetDAQ units into an integrated NetDAQ system of up to 400 channels. Use an existing network or simply connect the system directly

to your PC. Two models offer a choice of scan speeds (up to 1000 readings/second), and accuracy (up to 0.01 %) to meet the needs of your specific operation.

#### NetDAQ 2640A

High accuracy and resolution provide calibration level performance with the 2640A. It measures up to 300 V with 0.01 % dc voltage accuracy and 18-bit resolution, scanning 6 to 143 readings per second.

#### NetDAQ 2645A

NetDAQ delivers higher speed data acquisition, making it perfectly suited for applications that require more dynamic signal capture. The 2645A directly measures 20 inputs of up to 50 V at 1000 readings/sec with 0.02 % Volts dc accuracy and 16-bit resolution.

## Measurement accuracy

### Model 2640A

Thermocouples <sup>[5],[6]</sup>		Accuracy <sup>[1],[4]</sup> , 3 $\sigma$ , $\pm$ °C				
		18 to 28 °C			-10 to 60 °C	
		90 Day	1 Year		1 Year	
Type	Temp (°C)	Slow	Slow	Fast	Slow	Fast
J	-100 °C to 80 °C	0.45	0.5	0.8	0.6	0.8
	80 °C to 230 °C	0.35	0.5	0.7	0.6	0.8
	230 °C to 760 °C	0.4	0.5	0.7	0.8	0.9
K	-100 °C to -25 °C	0.55	0.6	0.9	0.7	1.0
	-25 °C to 120 °C	0.4	0.5	0.8	0.6	0.9
	120 °C to 800 °C	0.5	0.65	0.9	1.0	1.2
	800 °C to 1372 °C	0.7	1.0	1.3	1.6	1.9
N	-100 °C to -25 °C	0.65	0.75	1.2	0.8	1.3
	-25 °C to 120 °C	0.55	0.6	1.0	0.7	1.1
	120 °C to 1000 °C	0.45	0.6	0.9	1.0	1.2
	1000 °C to 1300 °C	0.55	0.75	1.0	1.2	1.5
E	-100 °C to -25 °C	0.45	0.5	0.8	0.6	0.8
	-25 °C to 20 °C	0.35	0.4	0.6	0.5	0.7
	20 °C to 600 °C	0.3	0.4	0.6	0.5	0.8
	600 °C to 1000 °C	0.4	0.5	0.7	0.9	1.0
T	-100 °C to 0 °C	0.6	0.65	1.0	0.7	1.1
	0 °C to 150 °C	0.4	0.5	0.8	0.6	0.9
	150 °C to 400 °C	0.3	0.4	0.6	0.6	0.8
R	250 °C to 600 °C	0.9	1.0	2.1	1.2	2.2
	600 °C to 1500 °C	0.8	0.9	1.8	1.3	2.0
	1500 °C to 1767 °C	0.85	0.85	1.9	1.7	2.5
S	250 °C to 1000 °C	0.95	1.1	2.3	1.3	2.4
	1000 °C to 1400 °C	0.8	1.0	1.9	1.4	2.3
	1400 °C to 1767 °C	1.0	1.3	2.2	1.8	2.8
B	600 °C to 900 °C	1.2	1.4	3.1	1.5	3.2
	900 °C to 1200 °C	0.9	1.0	2.2	1.2	2.4
	1200 °C to 1820 °C	0.75	1.0	1.9	1.3	2.2
C	0 °C to 150 °C	0.8	0.9	1.6	1.0	1.7
	150 °C to 650 °C	0.65	0.75	1.4	1.0	1.5
	650 °C to 1000 °C	0.65	0.85	1.4	1.2	1.8
	1000 °C to 1800 °C	1.0	1.3	2.1	2.1	2.8
	1800 °C to 2316 °C	1.6	2.1	3.2	3.4	4.6

### Model 2645A

Thermocouples <sup>[5],[6]</sup>		Accuracy <sup>[1],[4]</sup> , 3 $\sigma$ , $\pm$ °C				
		18 to 28 °C			-10 to 60 °C	
		90 Day	1 Year		1 Year	
Type	Temp (°C)	Slow	Slow	Fast	Slow	Fast
J	-100 °C to 80 °C	0.8	0.9	1.6	0.9	1.7
	80 °C to 230 °C	0.7	0.8	1.4	0.9	1.5
	230 °C to 760 °C	0.7	0.8	1.3	1.0	1.5
K	-100 °C to -25 °C	1.0	1.1	2.0	1.2	2.1
	-25 °C to 120 °C	0.8	0.9	1.7	1.0	1.8
	120 °C to 1000 °C	0.9	1.1	1.8	1.5	2.2
	1000 °C to 1372 °C	1.2	1.5	2.3	2.0	2.9
N	-100 °C to -25 °C	1.4	1.5	2.8	1.5	2.9
	-25 °C to 120 °C	1.1	1.3	2.3	1.3	2.4
	120 °C to 1000 °C	1.0	1.1	2.0	1.2	2.1
	1000 °C to 1300 °C	1.0	1.2	1.9	1.6	2.4
E	-100 °C to -25 °C	0.8	0.9	1.5	1.0	1.6
	-25 °C to 20 °C	0.7	0.7	1.2	0.8	1.3
	20 °C to 600 °C	0.6	0.7	1.1	0.8	1.2
	600 °C to 1000 °C	0.6	0.8	1.2	1.1	1.5
T	-100 °C to 0 °C	1.1	1.2	2.2	1.3	2.3
	0 °C to 150 °C	0.9	1.0	1.7	1.0	1.8
	150 °C to 400 °C	0.7	0.8	1.4	0.8	1.5
R	250 °C to 600 °C	2.4	2.7	5.6	2.8	5.7
	600 °C to 1500 °C	2.0	2.3	4.6	2.4	4.8
	1500 °C to 1767 °C	2.0	2.3	4.5	2.8	5.1
S	250 °C to 1000 °C	2.6	2.8	5.9	2.9	6.0
	1000 °C to 1400 °C	2.0	2.3	4.6	2.6	5.0
	1400 °C to 1767 °C	2.3	2.7	5.3	3.3	5.9
B	600 °C to 1200 °C	3.6	3.9	8.5	4.0	8.6
	1200 °C to 1550 °C	2.1	2.4	5.0	2.6	5.2
	1550 °C to 1820 °C	2.0	2.3	4.7	2.7	5.0
C	0 °C to 150 °C	1.9	2.0	4.0	2.1	4.2
	150 °C to 650 °C	1.6	1.7	3.5	1.8	3.6
	650 °C to 1000 °C	1.4	1.7	3.2	2.0	3.5
	1000 °C to 1800 °C	2.0	2.5	4.5	3.2	5.3
	1800 °C to 2316 °C	3.1	3.8	6.8	5.1	8.1

### Model 2640A

DC Voltage		Accuracy <sup>[1]</sup> , 3 $\sigma$ , $\pm$ (% input + V) 18 to 28 °C			
Range	Resolution	90 Day	1 Year		
		Slow	Slow	Fast	
90 mV	.3 $\mu$ V	0.01 % + 7 $\mu$ V	0.013 % + 8 $\mu$ V		0.013 % + 18 $\mu$ V
300 mV	1 $\mu$ V	0.01 % + 15 $\mu$ V	0.013 % + 17 $\mu$ V		0.013 % + 35 $\mu$ V
3 V	10 $\mu$ V	0.01 % + .1 mV	0.013 % + .15 mV		0.013 % + .2 mV
30 V	100 $\mu$ V	0.01 % + 1.5 mV	0.013 % + 1.7 mV		0.026 % + 3.5 mV
150/300 V	1 mV	0.01 % + 15 mV	0.013 % + 17 mV		0.052%+35 mV
Resistance		Accuracy <sup>[1],[2]</sup> (4-wire), 3 $\sigma$ , $\pm$ (% input + $\Omega$ )			
300 $\Omega$	1 m $\Omega$	0.015 % + 20 m $\Omega$	0.02 % + 30 m $\Omega$		0.02 % + 120 m $\Omega$
3 k $\Omega$	10 m $\Omega$	0.02 % + .3 $\Omega$	0.02 % + .5 $\Omega$		0.02 % + 1.2 $\Omega$
30 k $\Omega$	100 m $\Omega$	0.03 % + 3 $\Omega$	0.03 % + 5 $\Omega$		0.04 % + 15 $\Omega$
300 k $\Omega$	1 $\Omega$	0.1 % + 40 $\Omega$	0.1 % + 60 $\Omega$		0.2 % + 150 $\Omega$
3 M $\Omega$	10 $\Omega$	0.25 % + 800 $\Omega$	0.25 % + 1 k $\Omega$		0.5 % + 1.5 k $\Omega$

**Note:** The terms "slow" and "fast" in these tables refer to scanning rates.

<sup>[1]</sup> Total instrument accuracy for the indicated time period and ambient temperature range. Includes A/D errors, linearization conformity, initial calibration error, isothermality errors, reference junction conformity and power line voltage effects within the range from 107 V ac to 264 V ac.

<sup>[2]</sup> For two-wire measurements add 5  $\Omega$  to basic accuracy (does not include lead-wire resistances).

<sup>[3]</sup> For two-wire measurements add 700-1000  $\Omega$  to basic accuracy (does not include lead-wire resistances). Ohms varies due to the resistance of the solid state switches.

### Model 2645A

DC Voltage		Accuracy <sup>[1]</sup> , 3 $\sigma$ , $\pm$ (% input + V) 18 to 28 °C			
Range	Resolution	90 Day	1 Year		
		Slow	Slow	Fast	
90 mV	3 $\mu$ V	0.01 % + 20 $\mu$ V	0.013 % + 23 $\mu$ V		0.013 % + 50 $\mu$ V
300 mV	10 $\mu$ V	0.01 % + 40 $\mu$ V	0.013 % + 49 $\mu$ V		0.013 % + 93 $\mu$ V
3 V	100 $\mu$ V	0.01 % + .3 mV	0.013 % + .38 mV		0.013 % + .64 mV
30 V	1 mV	0.01 % + 4 mV	0.013 % + 4.9 mV		0.026 % + 9.5 mV
150/300 V	10 mV	0.01 % + 30 mV	0.013 % + 40 mV		0.052 % + 64 mV
Resistance		Accuracy <sup>[1],[3]</sup> (4-wire), 3 $\sigma$ , $\pm$ (% input + $\Omega$ )			
300 $\Omega$	10 m $\Omega$	0.02 % + 60 m $\Omega$	0.02 % + .1 $\Omega$		.02 % + .2 $\Omega$
3 k $\Omega$	100 m $\Omega$	0.02 % + 6 $\Omega$	0.02 % + 1 $\Omega$		.02 % + 3 $\Omega$
30 k $\Omega$	1 $\Omega$	0.02 % + 6 $\Omega$	0.02 % + 10 $\Omega$		.02 % + 300 $\Omega$
300 k $\Omega$	10 $\Omega$	0.5 % + 80 $\Omega$	0.5 % + 150 $\Omega$		1.0 % + 3 k $\Omega$
3 M $\Omega$	100 $\Omega$	1.3 % + 1 k $\Omega$	1.3 % + 2 k $\Omega$		2.0 % + 200 k $\Omega$

<sup>[4]</sup> Resolution is 0.02 °C or 0.04 °F over the useful range of base metal thermocouples (J, K, T, E, N) and 0.1 °C or 0.2 °F resolution for types R, S, B, and C with slow scan.

<sup>[5]</sup> Open thermocouple detection is performed on each thermocouple channel unless defeated by computer command.

<sup>[6]</sup> When NetDAQ is mounted on its side, using the Y2642 adapter or other means, thermocouples at the ends of the input connector module may have an additional  $\pm$  0.25 °C error.

### Model 2640A

AC Voltage				
Range	Resolution	Frequency	Accuracy <sup>[1],[2]</sup> , 3σ, (% input + counts)	
			Slow	Fast
300 mV	1 μV	20 Hz to 50 Hz	3.0 % + 25	6.0 % + 50
		50 Hz to 20 kHz	0.4 % + 25	1.0 % + 50
		20 kHz to 50 kHz	2.0 % + 30	3.0 % + 50
		50 kHz to 100 kHz	5.0 % + 50	5.0 % + 100
3 V	100 μV	Same frequencies, similar accuracies as above		
30 V	1 mV	Same frequencies, similar accuracies as above		
150/300 V	10 mV	Same frequencies, similar accuracies as above		
RTD (Pt 100)		Accuracy <sup>[1],[3]</sup> , 3σ, ± °C (4-wire)		
Temperature °C	Resolution °C	90 Day, 18 to 28 °C	1 Year, 18 to 28 °C	
			Slow	Slow
-200 °C	0.003	0.06	0.09	
0 °C	0.003	0.09	0.13	
100 °C	0.003	0.10	0.16	
300 °C	0.003	0.14	0.21	
600 °C	0.003	0.19	0.30	
Frequency Measurement Accuracy <sup>[1]</sup> , -20 to 60 °C				
Range	Resolution		Accuracy, 3σ, ± (% input + Hz)	
	Slow	Fast	Slow	Fast
15 Hz to 900 Hz	0.01 Hz	0.1 Hz	0.05 % + 0.02 Hz	0.05 % + 0.2 Hz
900 Hz to 9 kHz	0.1 Hz	1 Hz	0.05 % + 0.1 Hz	0.05 % + 1 Hz
9 kHz to 90 kHz	1 Hz	10 Hz	0.05 % + 1 Hz	0.05 % + 10 Hz
90 kHz to 900 kHz	10 Hz	100 Hz	0.05 % + 10 Hz	0.05 % + 100 Hz
1 MHz	100 Hz	1 kHz	0.05 % + 100 Hz	0.05 % + 1 kHz
Frequency Measurement Sensitivity (sine wave)				
Frequency	Minimum Signal		Maximum Signal	
15 Hz to 200 Hz	100 mV rms		150/300 V rms	
200 Hz to 70 kHz	100 mV rms		30 V rms	
70 kHz to 100 kHz	100 mV rms		20 V rms	
100 kHz to 200 kHz	150 mV rms		10 V rms	
200 kHz to 300 kHz	150 mV rms		7 V rms	
300 kHz to 1 MHz	linearly increasing from 150 mV rms at 300 kHz to 2 V rms at 1 MHz		linearly decreasing from 7 V rms at 300 kHz to 2 V rms at 1 MHz	

**Note:** The terms "slow" and "fast" in these tables refer to scanning rates.

<sup>[1]</sup> Total instrument accuracy for the indicated time period and ambient temperature range. Includes A/D errors, linearization conformity, initial calibration error, isothermality errors, reference junction conformity and power line voltage effects within the range from 107 V ac to 264 V ac.

### Channel capacity

Analog inputs: 20  
 Computed channels: 10  
 Digital I/O and alarm outputs: 8 total  
 Totalizer: 1

### Math functions

In addition to its 20 analog input channels, each NetDAQ unit supports 10 computed channels. Calculations include: addition, subtraction, multiplication, division, log, natural log, exponent, square root, absolute value, integer function, average and M x + b.

### Measurement speed (2640A)

Slow: 6 readings/second nominal

Medium: 41 (50 Hz), 48 (60 Hz) readings/second nominal  
 Fast: 143 readings/second nominal (5 readings/second for V ac nominal, 140 readings/second on 300 Ω range, 37 readings/second on 3 MΩ range)

### Measurement speed (2645A)

Slow: 45 (50 Hz), 54 (60 Hz) readings/second nominal  
 Medium: 200 readings/second nominal  
 Fast: 1000 readings/second nominal (5 readings/second for V ac nominal, 370 readings/second on 300 Ω range, 44 readings/second on 3 MΩ range)

### Analog to digital converter

2640A: Multi-slope type, linear to 18 bits  
 2645A: Multi-slope type, linear to 16 bits

### Common mode rejection

**2640A:**  
 AC: ≥ 120 dB (50/60 Hz, ± 0.1 % max 1 kΩ source imbalance)  
 DC: ≥ 120 dB  
**2645A:**  
 AC: ≥ 100 dB (50/60 Hz, ± 0.1 % max 1 kΩ source imbalance)  
 DC: ≥ 100 dB

### Normal mode rejection

50 dB @ 50/60 Hz, ± 0.1 %

### Model 2645A

AC Voltage				
Range	Resolution	Frequency	Accuracy <sup>[1],[2]</sup> , 3σ, (% input + counts)	
			Slow	Fast
300 mV	10 μV	20 Hz to 50 Hz	3.0 % + 25	6.0 % + 50
		50 Hz to 20 kHz	0.4 % + 25	1.0 % + 50
		20 kHz to 50 kHz	2.0 % + 30	3.0 % + 50
		50 kHz to 100 kHz	5.0 % + 50	5.0 % + 100
3 V	100 μV	Same frequencies, similar accuracies as above		
30 V	1 mV	Same frequencies, similar accuracies as above		
RTD (Pt 100)		Accuracy <sup>[1],[3]</sup> , 3σ, ± °C (4-wire)		
Temperature °C	Resolution °C	90 Day, 18 to 28 °C	1 Year, 18 to 28 °C	
			Slow	Slow
-200 °C	0.03	0.16	0.25	
0 °C	0.03	0.20	0.31	
100 °C	0.03	0.23	0.34	
300 °C	0.03	0.30	0.41	
600 °C	0.03	0.53	0.63	
Frequency Measurement Accuracy <sup>[1]</sup> , -20 to 60 °C				
Range	Resolution		Accuracy, 3σ, ± (% input + Hz)	
	Slow	Fast	Slow	Fast
15 Hz to 900 Hz	0.01 Hz	0.1 Hz	0.05 % + 0.02 Hz	0.05 % + 0.2 Hz
900 Hz to 9 kHz	0.1 Hz	1 Hz	0.05 % + 0.1 Hz	0.05 % + 1 Hz
9 kHz to 90 kHz	1 Hz	10 Hz	0.05 % + 1 Hz	0.05 % + 10 Hz
90 kHz to 900 kHz	10 Hz	100 Hz	0.05 % + 10 Hz	0.05 % + 100 Hz
1 MHz	100 Hz	1 kHz	0.05 % + 100 Hz	0.05 % + 1 kHz
Frequency Measurement Sensitivity (sine wave)				
Frequency	Minimum Signal		Maximum Signal	
15 Hz to 200 Hz	100 mV rms		30 V rms	
200 Hz to 70 kHz	100 mV rms		30 V rms	
70 kHz to 100 kHz	100 mV rms		20 V rms	
100 kHz to 200 kHz	150 mV rms		10 V rms	
200 kHz to 300 kHz	150 mV rms		7 V rms	
300 kHz to 1 MHz	linearly increasing from 150 mV rms at 300 kHz to 2 V rms at 1 MHz		linearly decreasing from 7 V rms at 300 kHz to 2 V rms at 1 MHz	

<sup>[2]</sup> Sine wave inputs > 2000 counts (slow), > 200 counts (fast). Accuracies for crest factor ≤ 2.0.

<sup>[3]</sup> DIN/IEC 751 only, assumes no lead-wire resistance errors.



### Common mode voltage maximum

2640A: 300 V dc or V ac rms (channels 1,11); 150 V dc or V ac rms (all other channels)  
2645A: 50 V dc or 30 V ac rms (all channels)

### Totalizing inputs

DC coupled, non-isolated, max +30 V, min -4 V  
Max count: 4,294,967,295  
Minimum signal: 2 V peak  
Threshold: 1.4 V  
Rate: 0 to 5 kHz (debounce off)  
Hysteresis: 500 mV  
Input debouncing: None or 1.66 ms

### Digital inputs

Threshold: 1.4 V  
Hysteresis: 500 mV  
Maximum input: +30 V, min -4 V; non-isolated

### Digital/master alarm outputs

The open collector output lines are non-isolated, TTL compatible with the following logic levels:

#### Logical "zero" output:

0.8 V max |out = -1.0 mA  
(1 LSTTL load equivalent)  
1.8 V max |out = -20 mA  
3.25 V max |out = -50 mA

#### Logical "one" output:

Output voltage depends on external load  
3.8 V min |out = 0.05 mA  
(1 LSTTL load equivalent)

### Alarm associations

Each Digital I/O may be randomly assigned as a digital input, status output, or alarm output (associated with any input channel or channels)

### Trigger input

Minimum pulse: 5 µs  
Minimum latency: 2 ms  
Repeatability: 1 ms  
Input "High": 2.0 V min, 7.0 V max  
Input "Low": -0.6 V min, 0.8 V max  
non-isolated, contact closure and TTL compatible

### Clock

Accurate to within 1 minute/month for 0 °C to 50 °C range

### Power

107 to 264 V ac, 50 or 60 Hz (< 15 W), or 9 to 16 V dc (< 6 W) (if both sources are applied simultaneously, the greater of ac or dc is used.), at 120 V ac the equivalent dc voltage ~14.5 V

### Temperature, humidity (non-condensing)

Operating: -20 °C to 28 °C, ≤ 90 % RH; 28 °C to 40 °C, ≤ 75 % RH; 40 °C to 60 °C, ≤ 50 % RH  
Storage: -40 °C to 70 °C, 5 % to 95 % RH

### Altitude

Operating: 2000 m  
Storage: 12,200 m

### Electromagnetic interference (EMI)

FCC-15B Class B Equipment, Vfg. 243, European Norms EN50081-1 and EN50082-1, CE. When shielded cables are used.

### Safety

Complies with applicable sections of the IEC 1010-1, ANSI/ISA-S82.01-1994, CSA-C22.2, No. 1010.1-92. Overvoltage Category II

### Weight

3.7 kg (8.16 lbs)

### Size

9.3 cm H x 21.6 cm W x 36.2 cm D (3.66 in H x 8.5 in W x 14.25 in D)

### Battery life

10 years minimum for real time clock (from date of manufacture)

### Interfaces

Ethernet: Conforms to IEEE 802.3 Ethernet standard, compatible with 10Base2 and 10BaseT standards, uses TCP/IP protocol  
RS-232C: For calibration only. The optional NetDAQ Service Manual provides step-by-step calibration instructions.

### Data buffer memory

- Stored with each scan: time stamp, all defined analog input channels, the status of the eight digital I/O, and the totalizer count.
- The number of stored scans varies with the number of channels configured. The following table shows the scan size and time it takes to fill the data buffer memory.

### Calibration

Statement of calibration practices non-serialized, no data. Other calibrations are available, contact your local representative.

## Ordering Information

### Models

**2640A** NetDAQ® Data Acquisition Unit

#### Included with Instrument:

Universal Input Module, 4 m Ethernet Cable, and power cable

**2645A** NetDAQ Data Acquisition Unit

#### Included with Instrument:

Universal Input Module, 4 m Ethernet Cable, and power cable

### Options and Accessories

**Y2643** 4m Ethernet Cable Kit

**2620A-100** Extra I/O Connector Set: includes Universal Input Module, Digital I/O and Alarm Output Connectors

**2620A-101** Current Shunts 10 Ω, 0.1 %, set of 12 ea. 100 mA max.

**942615** NetDAQ Service Manual

**Y2641** 19-inch Rackmount kit, single/dual

#### Software\*

**2640A-911** NetDAQ Logger for Windows

**2640A-912** NetDAQ Logger w/ Trending

**264XA-903** Developer's Toolbox (16 bit)

**2600A-904** Trend Link for Fluke (Hydra, NetDAQ)

**2680A-904** TrendLink for Fluke includes 2680A-OPC (NetDAQ, 2680 Series)

\*Requires Windows 98 or above.

Elseo Philips Service, Trenčín

Number of channels configured	Number of scans stored	Time to fill the 2640A's buffer (100 rps)	Time to fill the 2645A's buffer (1,000 rps)
1	6,400	48 sec (118 rps)	14 sec (427 rps)
2	5,688	77 sec (131 rps)	17 sec (628 rps)
5	4,266	133 sec (142 rps)	23 sec (886 rps)
10	3,011	183 sec (145 rps)	29 sec (1019 rps)
20	1,896	227 sec (147 rps)	33 sec (1102 rps)

### Gain advanced trending capabilities



- Easily view, analyze, and compare real-time or historical data
- Quickly find specific data
- Manage data file size
- Cut and paste data into spreadsheet and word processing programs

### Tech Tip

Variable scaling, graph positioning and time-axis control are important features to look for in a trending program.

Trend Link for Fluke software, available for Hydra, NetDAQ and 2680 Series, enables you to easily access, view, analyze, and compare tremendous amounts of real-time or historical data from any Fluke data acquisition product, making paper chart recorders obsolete. Trend Link makes it easy to:

- Review real-time data in the context of historical data for performance or batch comparisons
- Automatically view statistics on any channel and compare multiple channels from different time periods
- Zoom in on a particular time span for closer analysis
- View multiple windows – each featuring different process parameters – in real time
- Calculate basic statistics such as mean and standard deviation for any trend
- Create X-bar R charts and X-Y scatter diagrams for statistical analysis
- Import data directly into spreadsheet programs from trend plots
- Attach text notes to any point on a trace that become a part of a permanent record

### Quickly find specific data

With Trend Link, you can quickly scroll through volumes of historical and real-time data looking for key events or changes in the process. The dead-banding feature lets you limit recording to only those readings outside of the range of your normal process limits, saving you valuable disk space. Trend Link time stamps data with millisecond resolution so you can find just the data you're looking for. Then you can compare multiple traces on the same screen or zoom in on a particular point in time.

### Manage your data

The File Rollover feature lets you manage data file size, which is a big advantage for long duration data collection. You can create new data files when the file reaches a certain size, at a specific time interval, or at a specified hour each day.

### Document your results

Cut and paste the data and trend plots you generate with Trend Link software into spreadsheet and word processing programs to generate presentation-quality reports. Or print plots directly for hard copy documentation.

### OPC enabled

Model 2680A-904 is OPC (OLE for process control) enabled allowing communication and trending of any instrument on the system with OPC server software.

### Ordering Information

#### Models

**2600A-904** Trend Link for Fluke (Hydra, NetDAQ)

**2680A-904** Trend Link for Fluke, includes 2680A-OPC (2680 Series, NetDAQ)

# 1362S VXIbus Precision DMM

riešenia na presné meranie

www.elseo.sk/Fluke-Calibration

**FLUKE**®

VXI Products

Plug&play drivers combine full performance with easy installation



- 4½ to 6½ digit resolution
- DC voltage, ac voltage and resistance functions
- Current and ratio options
- 1,000 readings per second
- Up to 1000 V rms input

## Tech Tip

The 1362S is the only C-size VXI DMM that can measure current directly.

The 1362S provides the full performance envelope of rack and stack system DMMs in a message-based, single-width, C-size card DMM conforming to VXI specification revision 1.4.

The 1362S provides dc V, ac V, and ohms with resolutions between 4.5 and 6.5 digits and read rates up to 1,000 per second.

## Specifications

	1362S
<b>DC Voltage</b>	
Ranges	100 mV to 300 V in decades
Resolution	10 nV, 6.5 digits
Accuracy	90 days, 23 ° ± 5 °C, ± (ppm R + ppm FS). FS = 2 x range
100 mV range	30 + 6
1 V Range	20 + 3
10 V Range:	20 + 2
100 V ranges:	30 + 3
Read rate	5/s at 6.5 digits, 1000/s at 4.5 digits
Input impedance	10 GΩ (0.1 V to 10 V ranges) 10 MΩ (100 V and 300 V ranges)
CMRR (1 kΩ unbalance)	> 146 dB at dc > 80 dB + NMRR at 1 to 60 Hz
NMRR	Filter out > 54 dB at 50/60 Hz + 0.1 % filter in add 20 dB to above
<b>True RMS AC Voltage</b>	
Ranges	100 mV to 1000 V in decades
Resolution	1 μV, 5.5 digits
Accuracy	90 days, 23 ° ± 5 °C, Signal > 1 % FS, ± ( % R + % FS); FS = 2 x range
10 to 40 Hz range	0.4 + 0.1
40 Hz to 20 kHz range	0.035 + 0.01
20 to 50 kHz range	0.1 + 0.02
50 to 100 kHz range	0.16 + 0.03
Hf accuracy (1 V and 10 V ranges, typical)	
100 to 300 kHz	± 1 % R + 0.1 % FS
300 kHz to 1 MHz	± 2 % R + 1 % 2 FS
Read rate	12 readings/sec max
Input impedance	1 MΩ/100 pF
CMRR (1 kΩ unbalance)	> 80 dB at dc to 60 Hz
Crest factor	5:1 at full range

# 1362S VXIbus Precision DMM

riešenia na presné meranie

www.else.sk/Fluke-Calibration

VXI Products

1362S	
<b>Resistance</b>	
Ranges	100 Ω to 10 MΩ in decades
Resolution	10 μΩ, 6.5 digits
Accuracy	90 days, 23 ° ± 5 °C, ± (ppm R + ppm FS); FS = 2 x range
100 Ω range	35 + 6
1 kΩ and 10 kΩ range	30 + 3
100 kΩ range	40 + 3
1 MΩ range	80 + 3
10 MΩ range	200 + 4
Read rate	As dc V function
Protection all ranges	250 V rms
Max lead resistance	100 Ω in any or all leads
Open circuit voltage	10 V
<b>DC current</b>	
Protection all ranges	250 V rms
Max lead resistance	100 Ω in any or all leads
Open circuit voltage	10 V
Range	1000 mA
Resolution	1 μA, 6.5 digits
Accuracy	90 days, 23 ° ± 5 °C, ± (ppm R + ppm FS); FS = 2 X range: 200 +10
Read rate	As dc V function
<b>AC current</b>	
Ranges	1000 mA
Resolution	1 nA, 5.5 digits
Accuracy	90 days, 23 °C ± 5 °C, ± (% R + % FS):
10 to 40 Hz	0.4 + 0.1
40 Hz to 3 kHz	0.08 + 0.03
Read rate	As ac V function
<b>General</b>	
Triggering	Selectable front-panel or VXI backplane triggers, including measurement complete. Conforms to VXI synchronous and asynchronous protocol.
Remote programming	IEEE-488.2 and SCPI
Operating temp	0 °C to +50 °C
Dimensions	Single-slot, C-size HxWxD: 234 x 340 x 30 mm (9.2 x 13.4 x 1.2 in)
Weight	1.6 kg (3.5 lb)
Power	1.5 A (5 V), 0.5 A (± 12 V) approx

## Ordering Information Models

**1362S** VXIbus Precision Digital Multimeter and VXI *Plug&play* driver

## Options and Accessories

**1362S-30** DCI and ACI current converter. Current to 2 A.

**1362S-40** Comprehensive ratio (includes a 1506 input lead kit)

**1505** Single input lead

**1506** Ratio input lead

Else Philips Service, Trenčín

# Signal Sources Selection Guide

## Signal Sources

Fluke offers a range of function, pulse/function and universal waveform generators that are designed to meet your requirements and stay within your

budget. Whether you require a simple LF function generator, or a powerful multi-channel arb, we have a product designed with you in mind.



Model	Function Generators			Universal Waveform Generators		
	80	81	271	281	282	284
Output channels	1	1	1	1	2	4
Maximum amplitude (into 50 Ω)	16 Vpp	16 Vpp	10 Vpp	10 Vpp	10 Vpp	10 Vpp
<b>Standard Waveforms</b>						
Sine maximum frequency	50 MHz	50 MHz	10 MHz	16 MHz	16 MHz	16 MHz
Square maximum frequency	50 MHz	50 MHz	10 MHz	16 MHz	16 MHz	16 MHz
Pulse maximum frequency	N/A	50 MHz	10 MHz	10 MHz	10 MHz	10 MHz
Pulses	No	Single	Multi-level	Pulse Train	Pulse Train	Pulse Train
Noise Generator	No	No	Random	No	No	No
Frequency Accuracy			10 ppm	10 ppm	10 ppm	10 ppm
<b>Arbitrary Waveforms</b>						
Maximum Sampling Frequency			27.48 MS/s	40 MS/s	40 MS/s	40 MS/s
Waveform length (points)			1024	4 - 65536	4 - 65536	4 - 65536
Waveform memory			5 x 1 K blocks	64 k blocks	64 K	64 K
Vertical resolution			10 bits	12 bits	12 bits	12 bits
Waveform sequencing (max. # of segments)				16	16	16
Looping			No	Yes	Yes	Yes
<b>Operating Modes</b>						
Triggered	Yes	Yes	Yes	Yes	Yes	Yes
Gated	Yes	Yes	Yes	Yes	Yes	Yes
Burst	Yes	Yes	Yes	Yes	Yes	Yes
Frequency sweep	Yes	No	Yes	Yes	Yes	Yes
Selectable output filter				10 MHz Elliptical, 10 MHz Bessel, none	10 MHz Elliptical, 10 MHz Bessel, none	10 MHz Elliptical, 10 MHz Bessel, none
Modulation source				External dc-100 kHz	External dc-100 kHz	External dc-100 kHz
Modulation	AM, FM	AM, PWM	AM, FSK, Tone	AM, Tone	AM, Tone, DTMF	AM, Tone, DTMF
Signal summing	No	No	No	No	No	No
VCO/VCA input	Yes	Yes	No	Yes	Yes	Yes
Phase lock to external analog signal	Yes	Yes	No	No	No	No
Multi-unit phase lock	Yes	Yes	Yes	Yes	Yes	Yes
<b>General</b>						
GPIB interface	Yes	Yes	Yes	Yes	Yes	Yes
RS-232 interface (conventional mode)	No	No	Yes	Yes	Yes	Yes
USB	No	No	No	No	No	No
Ethernet	No	No	No	No	No	No
Waveform software			Waveform Mgr. Plus Optional	Waveform Mgr. Plus	Waveform Mgr. Plus	Waveform Mgr. Plus
Recommended replacement for obsolete models	HP 8116A	HP 8116A	Wavetek 29A	Wavetek 39A	Wavetek/Fluke 195	Wavetek/Fluke 195/001

Model	Arbitrary Waveform Generators				
	291	292	294	396	397
Output channels	1	2	4	1	2
Maximum amplitude (into 50 Ω)	10 Vpp	10 Vpp	10 Vpp	10 Vpp	10 Vpp
<b>Standard Waveforms</b>					
Sine maximum frequency	40 MHz	40 MHz	40 MHz	50 MHz	50 MHz
Square maximum frequency	50 MHz	50 MHz	50 MHz	50 MHz	50 MHz
Pulse maximum frequency	10 MHz	10 MHz	10 MHz	10 MHz	10 MHz
Pulses	Pulse Train	Pulse Train	Pulse Train	No	No
Noise generator	No	No	No	Yes	Yes
Frequency accuracy	10 ppm	10 ppm	10 ppm	1 ppm	1 ppm
<b>Arbitrary Waveforms</b>					
Maximum sampling frequency	80 MS/s	80 MS/s	80 MS/s	125 MS/s	125 MS/s
Waveform length (points)	262144	262144	262144	16 to 4 M	16 to 4 M
Waveform memory	256 K blocks removable FLASH card	256 K blocks removable FLASH card	256 K blocks removable FLASH card	1 MByte memory	4 MByte memory
Vertical resolution	12 bit	12 bit	12 bit	14 bits	14 bits
Waveform sequencing (max. # of segments)	1024	1024	1024	4096	4096
Looping	Yes	Yes	Yes	Yes	Yes
<b>Operating Modes</b>					
Triggered	Yes	Yes	Yes	Yes	Yes
Gated	Yes	Yes	Yes	Yes	Yes
Burst	Yes	Yes	Yes	Yes	Yes
Frequency sweep	Yes	Yes	Yes	Yes	Yes
Selectable output filter	40 MHz Elliptic, 20 MHz Bessel, none	40 MHz Elliptic, 20 MHz Bessel, none	40 MHz Elliptic, 20 MHz Bessel, none	50 MHz, 25 MHz, both or none	50 MHz, 25 MHz, both or none
Modulation source	External dc-100 kHz	External dc-100 kHz	External dc-100 kHz	Internal dc-200 kHz	Internal dc-200 kHz
Modulation	AM, SCM, Tone	AM, SCM, Tone	AM, SCM, Tone	AM, FM, FSK, Ramped FSK	AM, FM, FSK, Ramped FSK
Signal summing	Yes	Yes	Yes	No	No
VCO/VCA input	Yes	Yes	Yes	No	No
Phase lock to external analog signal	Yes	Yes	Yes	Yes	Yes
Multi-unit phase lock	Yes	Yes	Yes	Yes	Yes
<b>General</b>					
GPIB interface	Yes	Yes	Yes	Yes	Yes
RS-232 interface (conventional mode)	Yes	Yes	Yes	Yes	Yes
USB	Yes	Yes	Yes	Yes	Yes
Ethernet	No	No	No	No	Yes
Waveform software	Waveform Mgr. Plus	Waveform Mgr. Plus	Waveform Mgr. Plus	ArbExplorer software	ArbExplorer software
Recommended replacement for obsolete models				Wavetek 395	

# 80/81 Function Pulse Generators

## Function Generators

### 50 MHz function/pulse generators

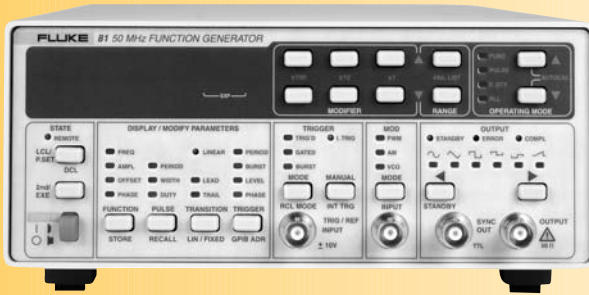

81 Function Generator



80 Function Generator

- Powerful performance
- Trigger, gate, and burst modes
- AM, FM, VCO, and phaselock/offset control modes
- Automated calibration
- Ideal replacement for HP 8116A (emulation mode model 81 only)

### Tech Tip

Model 81 employs a built-in counter/timer circuit. It is utilized when the instrument is placed in PLL operating mode for automatically detecting the external reference frequency. It can measure external frequencies from 10 Hz to over 60 MHz and external periods from .1 s to 16 ns. Frequency and period readings are given with fixed resolution of four digits. Decimal point and exponent are displayed automatically.

Ideal for both benchtop and ATE applications, the 80/81 family of 50 MHz waveform generators provides an unmatched combination of powerful operating features and great value.

The model 80 combines a function generator, linear and logarithmic sweep generator, and phase lock generator capabilities with dc output.

The model 81 provides a function generator, pulse generator with leading and trailing edge timing control and a phase lock generator.

### Standard Waveforms

Standard waveforms	Sine, triangle, square, positive and negative pulses (Model 81 only) and dc (Model 80 only)
--------------------	---

### Frequency

Range	10 mHz to 50 MHz
Resolution	4 digits
Accuracy (continuous mode)	10 mHz to 999.9 mHz: $\pm 3\%$ 1 Hz to 50 MHz: $\pm 0.1\%$ Jitter: $\leq 0.1\% \pm 50$ ps

### Sync Output

Level (into 50 $\Omega$ )	0 to 1 V
Rise/fall time	< 3 ns

### Waveform Quality

Sine wave	
Harmonic Distortion (Sine)	100 mHz to 1 MHz: < 1 % THD 1 MHz to 5 MHz: Max harmonic < -40 dB 5 MHz to 50 MHz: Max harmonic < -21 dB
Flatness	10 mHz to 999.9 kHz: $\pm 1$ % 1 MHz to 9.999 MHz: $\pm 2$ % 10 MHz to 50 MHz: -15 %
Triangle, Ramp	
Linearity	$\leq 5$ MHz (10 % to 90 % of Amplitude): > 99 %
Square wave	
Rise/fall time	(10 % to 90 % of Amplitude): < 6 ns
Aberrations	< 5 %

### Main Output

Modes	Normal (on) or disabled (off)
Impedance	50 $\Omega \pm 1$ %
Output protection	Protected against continuous short to chassis ground
Output level	20.0 mV to 32.0 $V_{p-p}$ into open circuit, 10.0 mV to 16.0 $V_{p-p}$ into 50 $\Omega$
Resolution	3 digits
Accuracy	$\pm 4$ % of reading

### DC Offset

DC offset	Offset and amplitude are independently adjustable within two windows: -800 mV to +800 mV -8 V to +8 V
Range	$\pm 800$ mV Window: $\pm 795$ mV $\pm 8$ V Window: $\pm 7.95$ V
Resolution	3 digits
Accuracy (at 1 kHz)	$\pm 800$ mV Window: $\pm (1$ % of setting + 1 % of amplitude + 0.2 mV) $\pm 8$ V Window: $\pm (1$ % of setting + 1 % of amplitude + 2 mV)

### Modulation

AM and SCM	External 0 to 10 V produces 0 to 200 % Range: 0 to 200 %, reduced to 70 % at 1 MHz Bandwidth: dc to 1 MHz
VCO	Range: 4.7 V change produces approx 1000:1 frequency change Bandwidth: dc to 50 kHz
FM (Model 80 only)	Range: 0 to 0.5 V change produces 1 % deviation Bandwidth: dc to 50 kHz



**Pulse and Ramp (Model 81 Only)**

Pulse modes	Symmetrical pulse, positive pulse, negative pulse, and the complement to all pulse waveforms
Pulse period	Range: 20 ns to 99.99 s Resolution: 4 digits Accuracy and Jitter: As for frequency
Pulse width	Range: 10 ns to 999 ms Setting Accuracy: 10 ns to 99.9 ns: $\pm (5\% + 2\text{ ns})$ 100 ns to 999 ms: $3\% \pm (4\% + 2\text{ ns})$ Resolution: 3 digits Duty Cycle Range: 1 % to 80 %. Up to 99 % using the complement mode PWM Range: 0 to 5 V $\pm 20\%$ produces > 10 % pulse width change from pulse width setting PWM Bandwidth: dc to 70 kHz Ramp Modes: Positive or negative going ramp
Ramp period	Range: 7 $\mu\text{s}$ to 99.99 s Resolution: 4 digits
Ramp width	Range: 5 $\mu\text{s}$ to 999 ms Setting Accuracy (5 $\mu\text{s}$ to 999 ms): 3 % Resolution: 3 digits Duty Cycle Range: 1 % to 80 %
Transition times	Range: 8 ns to 99.9 ms in six overlapping ranges. Leading and trailing edges are independently programmable. Max Ratio between Ranges: 100 to 1 Accuracy: 8 ns to 99 ns: $\pm (5\% + 2\text{ ns})$ 100 ns to 99.9 ms: $\pm (4\% + 2\text{ ns})$

**Operating Modes**

Operating modes	Continuous, triggered, phaselock, start phase, and sweep (Model 80 only)
-----------------	--

**Sweep Operation (80 Only)**

Modes	Sweep may be continuous or triggered by any trigger mode
Sweep spacing	Linear and logarithmic
Sweep directions	Up, down, up-down, and down-up
Sweep range	Log: 10 decades max Linear: 3 decades max
Sweep rate	Log: 10 ms to 999 s per decade Linear: 10 ms to 999 s
Sweep Out	0 to 5 V ramp proportional to frequency at rear panel BNC Marker Output: Output signals when marker frequency is reached

### Triggered Operation

Modes	Single shot, gated, and burst
Sources	Manual (front panel key), internal trigger rate generator, and external signal input
Triggered	For each trigger, one output cycle is generated
Gated	Continuous waveform cycles are generated for the duration of the active portion of the trigger signal. Last cycle is always completed
Burst	Preset number of waveform cycles are generated by a trigger: 1 to 4,000
Manual trigger	Key provides trigger signal
Internal trigger rate generator	1 mHz to 50 kHz
External input	Via Trig Input BNC Impedance: 10 k $\Omega$ $\pm$ 5 % Sensitivity: 500 mVp-p Max Input Voltage: $\pm$ 20 V Min Pulse Width: 20 ns Max Frequency: 50 MHz Slope: Positive or negative going leading edges Trigger Level: Variable -10 V to +10 V
Start phase of triggered waveform	To 500 kHz: Adjustable from -90 ° to +90 °. From 500.1 kHz to 50 MHz: Adjustable range proportionally reduced as frequency increases Accuracy (to 500 kHz): $\pm$ 3 °

### Phaselock Operation

Phaselock operation	Output waveform locks to frequency and phase of external signal. Phase may be offset.
Impedance	10 k $\Omega$ $\pm$ 5 %
Min pulse width	10 ns
Locking range	10 Hz to 60 MHz
Phase offset (10 Hz to 19.99 MHz)	Continuously adjustable from -180 ° to +180 °
Resolution	1 °
Accuracy (10 Hz to 100 kHz)	3 ° + 3 % of reading

### General

Remote Operation: GPIB interface is standard on Models 80 and 81. HP8116A emulation mode (Model 81 only)

### Environment

Operating Temperature: 0 °C to 50 °C, ambient  
For Specified Accuracy: Within  $\pm$  5 °C and 24 hours of last internal calibration  
Storage Temperature: -40 °C to +70 °C  
Humidity: 80 % R.H.  
Power: 115/230 V ac, optional 100 V, 50 or 60 Hz, 60 W max  
Stored Set-ups: Complete sets of front-panel set-ups stored: 30

### Dimensions

8.9 cm (3.5 in) high x 21.1 cm (8.3 in) wide x 39.1 cm (15.4 in) deep

### Rack mount dimensions

Single: 8.9 cm (3.5 in) H x 48.3 cm (19 in) W  
Dual: 13.3 cm (5.25 in) H x 48.3 cm (19 in) W

### Weight

6 kg (12 lb)

### Ordering Information

#### Models

**Model 80** 50 MHz Function Generator

**Model 81** 50 MHz Function/Pulse Generator

# 271 DDS Function Generator with ARB

riešenia na presné meranie

www.else.sk/Fluke-Calibration

FLUKE®

## Function Generators

### High performance function generator



- High stability 10 MHz DDS function generator
- Arbitrary capability with storage for five user defined waveforms
- Multiple standard and complex waveforms recalled from internal memory
- Extensive modulation capabilities include sweep, AM, Gating, Trigger/Burst, FSK and Hop
- GPIB and RS-232 interfaces

### Tech Tip

Direct digital synthesis (DDS) is a technique for generating waveforms digitally using a phase accumulator, a look-up table and a digital-to-analog-converter (DAC). The accuracy and stability of the resulting waveforms is related to that of the crystal master clock. The DDS generator offers not only exceptional accuracy and stability but also high spectral purity, low phase noise and excellent frequency agility.

The 271 is a high performance function generator using Direct Digital Synthesis techniques. A wide variety of standard waveforms are provided and an arbitrary waveform capability allows it to be used to generate non-standard and user-defined waveforms. Extensive modulation capabilities make this a highly versatile signal source.

### Waveforms

Standard waveforms are sine, square, positive pulse, negative pulse, triangle, ramp up, ramp down. Additionally arbitrary waveforms, multi-level squarewaves, waveform hopping and pseudo-random noise can be generated.

### Waveforms

Frequency	
All waveforms are available up to 10 MHz. However, the purity of triangle, ramp, and multi-level square wave waveforms is not specified above the frequencies indicated in the following section.	
Range	0.1 mHz to 10 MHz
Resolution	7 digits or 0.1 mHz
Accuracy	Typically $< \pm 10$ ppm for 1 year, 18 °C to 28 °C
Tempco.	Typically $< 1$ ppm/°C outside 18 °C to 28 °C
Sinewave	
Distortion	$< -60$ dBc to 20 kHz, $< -50$ dBc to 300 kHz, $< -35$ dBc to 10 MHz
Spurii	Non -harmonically related spurii typically $< -60$ dBc to 10 MHz
Squarewave	
Rise and fall times	$< 22$ ns
Triangle	
Linearity error	$< 0.5$ % to 30 kHz
Positive and Negative Ramp	
Linearity error	$< 0.5$ % to 30 kHz
Positive and Negative Pulse	
Rise and fall times	$< 22$ ns
Multi-Level Squarewave	
Up to 16 steps available per cycle, each step selectable for amplitude (10 bit resolution) and duration (1 to 1024 samples). Above 27 kHz a 36 ns edge uncertainty is introduced.	
Rise and fall times	$< 22$ ns
Arbitrary (and complex)	
A number of "complex" waveforms are pre-programmed in ROM . A further five, user defined, waveforms may be loaded via the digital interfaces and stored in non-volatile RAM. Frequency range: All waveform points can be continuously output up to 27 kHz, beyond which they are sampled.	
No. of samples	1024 10 bit samples
Noise	Wideband noise with variable amplitude and offset.
Symmetry	
Range	Sine – 1 % to 99 % at all frequencies; Other waveforms – 1 % to 99 % to 30 kHz, 20 % to 80 % to 10 MHz
Resolution	0.1 %

### Main Output

Output impedance	50 $\Omega$ or 600 $\Omega$ switchable
Amplitude	5 mV to 20 V pk-pk open circuit (2.5 mV to 10 V into 50 $\Omega$ /600 $\Omega$ ). Output can be specified as V-H: 2 (open circuit value) or V (Voltage into the characteristic impedance) in pk-pk, RMS or dBm. Note that in positive or negative pulse modes the amplitude range is 2.5 mV to 10 V pk-pk O/C.
Accuracy	Typically $\pm 3$ % $\pm 1$ mV at 1 kHz into 50 $\Omega$ /600 $\Omega$
Flatness	$\pm 0.2$ dB to 500 kHz; $\pm 1$ dB to 10 MHz
Pulse aberrations	$< 5$ % + 2 mV
DC offset	$\pm 10$ V from 50 $\Omega$ /600 $\Omega$ offset plus signal peak limited to $\pm 10$ V from 50 $\Omega$ /600 $\Omega$
Resolution	3 digits or 1 mV for both amplitude and offset

### Modulation

Amplitude Modulation	
Carrier frequency	0.1 mHz to 10 MHz
Carrier waveforms	All
Depth	0 to 100 %, resolution 1 %
Internal source	1 kHz fixed sinewave or 0.005 Hz to 50 kHz square wave
External	See "VCA In" section
Frequency Shift Keying (FSK)	
Phase coherent switching between two frequencies at a rate defined by the switching signal source	
Carrier frequency	0.1 mHz to 10 MHz
Carrier waveforms	All
Switch repetition rate	dc to 50 kHz internal, dc to 1 MHz external
Switching signal source	Internal from keyboard or trigger generator. External from EXT TRIG input or remote interface.

## Operating Modes

Trigger/burst	
Phase coherent signal keying – each positive edge of the trigger signal will produce one burst of the carrier, starting and stopping at the phase angle specified by the start/stop phase setting	
Carrier frequency	0.1 MHz to 10 MHz
Carrier waveforms	All
Number of cycles	1 to 1023 (resolution 1 cycle) or 0.5 to 511.5 (resolution 1/2 cycle)
Trigger rep. rate	dc to 50 kHz internal, dc to 1 MHz external
Source	Internal from keyboard or trigger generator. External from EXT TRIG input or remote interface
Gated	
Non phase-coherent signal keying – output is On while Gate signal is high and Off while low.	
Carrier frequency	From 0.1 MHz to 10 MHz
Carrier waveforms	All
Trigger rep. rate	dc to 50 kHz internal dc to 1 MHz external
Gate source	Internal from keyboard or trigger generator. External from EXT TRIG input or remote interface
Sweep	
Carrier waveforms	All
Sweep mode	Linear or logarithmic, single or continuous
Sweep width	0.1 MHz to 10 MHz. Phase continuous. Independent setting of the start and stop frequency.
Sweep time	10 ms to 999 s (3 digit resolution)
Markers	Two markers variable during sweep. Available at the TRIG/SWEEP OUT socket
Sweep trigger source	The sweep may be free run or triggered from: keyboard, EXT TRIG input, remote interface
Hop	
Up to 16 different "hop" waveforms can be defined in terms of function, frequency, amplitude, offset and duration. Duration setable per step 1 ms to 60 s.	
Start/Stop Phase	
Carrier frequency:	0.1 MHz to at least 1 MHz
Carrier waveforms	All
Range	-360 to +360 degrees
Resolution	1 degree
Accuracy	Typically 1 degree to 30 kHz
Trigger Generator	
Internal source 0.005 Hz to 50 kHz squarewave adjustable in 20 us steps. 3 digit resolution. Available for external use from TRIG/SWEEP OUT socket.	

## Auxiliary Outputs

Aux Out	
CMOS/TTL levels with symmetry and frequency of main output and phase of start-stop phase setting	
Trig/Sweep Out	
Multi-function output depending upon mode. Except in sweep mode, the output is that of the trigger generator at CMOS/TTL levels from 1 k $\Omega$ . In Sweep mode the output is a 3-level waveform, changing from high (+4 V) to low (0 V) at the start of sweep, with narrow 1 V pulses at each marker point.	

## Inputs

Ext Trig	
Frequency range	DC to 1 MHz
Signal range	TTL (1.5 V) threshold; maximum input $\pm$ 10 V
Min. pulse width	50 ns
VCA In	
Frequency range	DC - 100 kHz
Signal range	2.5 V for 100 % level change at maximum output
Input impedance	Typically 6 k $\Omega$

### Phase Locking

Clock in/out	TTL/CMOS threshold levels; output impedance typically 50 $\Omega$ as an output
Sync out	TTL/CMOS logic levels from typically 50 $\Omega$ . The signals from these sockets are used to phase lock two or more generators.

### Interfaces

RS-232	Variable Baud rate, 9600 Baud maximum. 9-pin D-connector.
IEEE-488	Conforming with IEEE488.1 and IEEE488.2

### General

Display	20 character x 4 row alphanumeric LCD
Data entry	Keyboard selection of mode, waveform etc.; value entry direct by numeric keys or by rotary control.
Stored settings	Up to 9 complete instrument set-ups may be stored and recalled from battery-backed memory.
Size	3U (130 mm) height; half-rack (212 mm) width, 330 mm long
Weight	4.1 kg (9 lb)
Power	100 V ac, 110 to 120 V ac or 220 to 240 V ac $\pm$ 10 %, 50/60 Hz ac by internal adjustment; 30 VA max.
Operating range	+5 °C to 40 °C, 20 to 80 % RH
Storage range	-20 °C to +60 °C
Options	IEEE-488 interface; 19-in rack mounting kit

### Ordering Information

#### Models

271 10 MHz DDS Function Generator with Serial Cable

#### Options and Accessories

Y2801 271 Rackmount Kit

# 281/282/284 Waveform Generators

riešenia na presné meranie

www.else.sk/Fluke-Calibration

Universal  
Waveform  
Generators

FLUKE®

A selection of universal waveform generators offering superior performance and excellent value



284 Waveform Generator



281 Waveform Generator

- Choice of 1, 2 and 4 independent or linked channels
- 40 MS/s max. sampling speed
- 16 MHz function generator
- 10 MHz pulse generator
- Pulse train pattern generator
- Arbitrary waveforms of up to 65 k points
- Powerful modulation capabilities
- Built-in trigger generators
- Waveform Manager Plus for Windows® software
- Multiple standard waveforms recalled from internal memory
- RS-232 and GPIB interfaces

## Tech Tip

A true arbitrary generator provides a fully variable clock frequency to read data out of the waveform memory. This variable-clock type of arbitrary generator can faithfully reproduce the stored waveform at any repetition rate within the limits of its maximum and minimum clock frequencies. The waveform can potentially have any length up to the maximum of the storage memory.

These universal waveform generators combine many generators in one instrument. Their extensive signal simulation capabilities include arbitrary waveforms, function generator, pulse/pulse train generator, sweep generator, trigger generator, tone generator, noise generator, and amplitude modulation source.

The 280 use Direct Digital Synthesis techniques as well as variable clock sampling technology to provide a fully featured programmable function and arbitrary waveform capability. The 281, 282 and 284 are 40 MS/s arbitrary waveform generators with one, two, and four channels, respectively.

Waveform Manager Plus Software provides all the features needed for creation, manipulation and management of arbitrary waveforms within a single Windows-based program.

### Waveforms

Standard Waveforms: sine, square, triangle, dc, positive ramp, negative ramp, sine(x)/x, pulse, pulse train, cosine, haversine and havercosine.

Specifications apply at 18-28 °C after 30 minutes warm-up, at maximum output into 50 Ω

### Arbitrary Waveforms

Waveforms	Maximum waveform size is 65,536 points; minimum waveform size is 4 points. Up to 100 user defined waveforms may be stored in the 256 K point nonvolatile RAM. Waveforms can be defined by front panel editing controls or by downloading of waveform data via RS-232 or GPIB.
Waveform memory	64 k points per channel
Vertical resolution	12 bits
Sample clock	100 mHz to 40 MHz
Resolution	4 digits
Accuracy	± 1 digit of setting
Sequencing	Up to 16 waveforms may be linked. Each waveform can have a loop count of up to 32,768. A sequence of waveforms can be looped up to 1,048,575 times or run continuously.
Output filter	Selectable between 16 MHz Elliptic, 10 MHz Elliptic, 10 MHz Bessel or none

# 281/282/284 Waveform Generators

riešenia na presné meranie

www.elseo.sk/Fluke-Calibration

## Universal Waveform Generators

### Standard Waveforms

All Waveforms	
Accuracy	10 ppm for 1 year
Temp. stability	Typically < 1 ppm/°C.
Output level	2.5 mV to 10 Vpp into 50 Ω
Sine, Cosine, Haversine, Haver cosine	
Range	0.1 mHz to 16 MHz
Resolution	0.1 mHz or 7 digits
Harmonic distortion	< 0.1 % THD to 100 kHz; < -65 dBc to 20 kHz, < -50 dBc to 300 kHz, < -35 dBc to 10 MHz < -30 dBc to 16 MHz
Nonharmonic spuri	< -65 dBc to 1 MHz, < -65 dBc + 6 dB/octave 1 MHz to 16 MHz
Square	
Range	1 mHz to 16 MHz
Resolution	1 mHz (4 digits)
Accuracy	± 1 digit of setting
Rise/fall times	< 25 ns
Pulse and Pulse Train	
Rise/fall times	< 25 ns
Period range	100 ns to 100 s
Period resolution	4 digit
Accuracy	± 1 digit of setting
Delay range	-99.99 s to + 99.99 s
Delay resolution	0.002 % of period or 25 ns, whichever is greater
Width range	25 ns to 99.99 s
Width resolution	0.002 % of period or 25 ns, whichever is greater
Triangle	
Range	0.1 mHz to 100 kHz
Resolution	0.1 mHz or 7 digits
Linearity error	< 0.1 % to 30 kHz
Ramps and Sin(x)/x	
Range	0.1 mHz to 100 kHz
Resolution	0.1 mHz (7 digits)
Linearity error	0.1 % to 30 kHz

**Note:** The pulse width and absolute value of the delay may not exceed the pulse period at any time. Pulse trains of up to 10 pulses may be specified, each pulse having independently defined width, delay and level. The baseline voltage is separately defined and the sequence repetition rate is set by the pulse train period.

### Operating Modes

Continuous	
Waveform runs continuously	
Triggered Burst	
Each active edge of the trigger signal will produce one burst of the waveform	
Carrier waveforms	All standard and arbitrary
Max. Carrier Frequency	40 Msamples/s for ARB and Sequence. 1 MHz or the maximum for the selected waveform.
Number of cycles	1 to 1,048,575
Trigger repetition	0.005 Hz to 100 kHz internal dc to 1 MHz external
Trigger signal source	Internal from keyboard, previous channel, next channel or trigger generator. External from TRIG IN or remote interface.
Trigger start/stop phase	± 360 ° settable with 0.1 ° resolution, subject to waveform frequency and type
Gated	
Waveform will run while the Gate signal is true and stop while false	
Carrier waveforms	All standard and arbitrary
Max. carrier frequency	40 Msamples/s for ARB and Sequence. 1 MHz or the maximum for the selected waveform.
Number of cycles	1 to 1,048,575
Trigger repetition	0.005 Hz to 100 kHz internal dc to 1 MHz external
Gate signal source	Internal from keyboard, previous channel, next channel or trigger generator. External from TRIG IN or remote interface.
Gate start/stop phase	± 360 ° settable with 0.1 ° resolution, subject to waveform frequency and type

Elsco Philips Service, Trenčín



## Operating Modes continued

Sweep	
Frequency sweep capability is provided for both standard and arbitrary waveforms. Arbitrary waveforms are expanded or condensed to exactly 4096 points and DDS techniques are used to perform the sweep.	
Carrier waveforms	All standard and arbitrary except pulse, pulse train and sequence
Sweep mode	Linear or logarithmic, triggered or continuous
Sweep direction	Up, down, up/down or down/up
Sweep range	From 1 mHz to 16 MHz in one range. Phase continuous. Independent setting of the start and stop frequency.
Sweep time	30 ms to 999 s
Marker	Variable during sweep
Sweep trigger source	The sweep may be free run or triggered from the following sources: Manually from keyboard. Externally from TRIG IN input or remote interface.
Sweep hold	Sweep can be held and restarted by the HOLD key
Multi channel sweep	Any number of channels may be swept simultaneously but the sweep parameters will be the same for all channels. Amplitude, Offset and Waveform can be set independently for each channel.
Tone Switching	
Capability provided for both standard and arbitrary waveforms. Arbitrary waveforms are expanded or condensed to exactly 4096 points and DDS techniques are used to allow instantaneous frequency switching.	
Carrier waveforms	All except pulse, pulse train and sequence
Frequency list	Up to 16 frequencies from 1 mHz to 10 MHz
Trigger repetition rate	0.005 Hz to 100 kHz internal. DC to 1 MHz external. Usable repetition rate and waveform frequency depend on the tone switching mode.
Source	Internal from keyboard, previous channel, next channel or trigger generator. External from TRIG IN or remote interface.
Tone switching modes	
Gated	The tone is output while the trigger signal is true and stopped, at the end of the current waveform cycle, while the trigger signal is false. The next tone is output when the trigger signal is true again.
Triggered	The tone is output when the trigger signal goes true and the next tone is output, at the end of the current waveform cycle, when the trigger signal goes true again.
FSK	The tone is output when the trigger signal goes true and the next tone is output, immediately, when the trigger signal goes true again. Using 2 channels with their outputs summed together it is possible to generate DTMF test signals.
Trigger Generator	
Internal source 0.005 Hz to 100 kHz square wave adjustable in 10 us steps. 3-digit resolution. Available for external use from any SYNCOUT socket.	

## Outputs

Main Output — One for each channel	
Output impedance	50 Ω
Amplitude	5 mV to 20 Vpp open circuit (2.5 mV to 10 Vpp into 50 Ω). Amplitude can be specified open circuit (hi Z) or into an assumed load of 50 Ω or 600 Ω Vpkpk, Vrms or dBm.
Amplitude accuracy	2 % ± 1 mV at 1 kHz into 50 Ω
Amplitude flatness	± 0.2 dB to 200 kHz; ± 1 dB to 10 MHz; ± 2.5 dB to 16 MHz
DC offset range	± 10 V from 50 Ω. Offset plus signal peak limited to ± 10 V
DC offset accuracy	Typically 3 % ± 10 mV, unattenuated
Resolution	3 digits or 1 mV for both amplitude and dc offset
Sync Out — One for each channel	
Multifunction output user definable or automatically selected to be any of the following:	
Waveform sync (all waveforms)	A square wave with 50 % duty cycle at the main waveform frequency, or a pulse coincident with the first few points of an arbitrary waveform.
Position markers	Any point(s) on the waveform may have associated marker bit(s) set high or low
Burst done	Produces a pulse coincident with the last cycle of a burst.
Sequence sync	Produces a pulse coincident with the end of a waveform sequence.
Trigger	Selects the current trigger signal. Useful for synchronizing burst or gated signals.
Sweep sync	Outputs a pulse at the start of sweep to synchronize an oscilloscope or recorder.
Phase lock out	Used to phase lock two generators. Produces a positive edge at the 0 ° phase point.
Output signal level	TTL/CMOS logic levels from typically 50 Ω.
Cursor/marker out	Adjustable output pulse for use as a marker in sweep mode or as a cursor in arbitrary waveform editing mode. Can be used to modulate the Z axis of an oscilloscope or be displayed on a second 'scope channel. Output Signal Level: Adjustable from nominally 2 V to 14 V, normal or inverted; adjustable width as a cursor.
Output impedance	600 Ω typical

### Inputs

Trig In	
Frequency range	DC to 1 MHz
Signal range	Threshold nominally TTL level; maximum input $\pm 10$ V
Min. pulse width	50 ns, for Trigger/Gate; 50 $\mu$ s for Sweep mode
Polarity	Selectable as high/rising edge or low/falling edge
Input impedance	10 k $\Omega$
Modulation In	
Frequency range	DC to 100 kHz
VCA signal range	Approximately 1 V pkpk for 100 % level change at maximum output
SCM signal range	Approximately $\pm 1$ V pk for maximum output
Input impedance	Typically 1 k $\Omega$
Sum In	
Frequency range	DC to 8 MHz
Signal range	Approximately 2 V pk-pk input for 20 V pk-pk output
Input impedance	Typically 1 k $\Omega$
Hold	
Holds an arbitrary waveform at its current position. A TTL low level or switch closure causes the waveform to stop at the current position and wait until a TTL high level or switch opening which allows the waveform to continue. The front panel MAN HOLD key or remote command may also be used to control the Hold function. While held the front panel MAN TRIG key or remote command may be used to return the waveform to the start. The Hold input may be enabled independently for each channel.	
Input impedance	10 k $\Omega$
Ref Clock In/Out	
Set to input	Input for an external 10 MHz reference clock. TTL/CMOS threshold level.
Set to output	Buffered version of the internal 10 MHz clock. Output levels nominally 1 V and 4 V from 50 $\Omega$
Set to phase lock	Used together with SYNC OUT on a master and TRIG IN on a slave to synchronise (phase lock) two separate generators.

### Inter-Channel Operation

Inter-Channel Modulation	
The waveform from any channel may be used to Amplitude Modulate (AM) or Suppressed Carrier Modulate (SCM) the next channel. Alternatively any number of channels may be Modulated (AM or SCM) with the signal at the MODULATION input socket.	
Carrier frequency	Entire range for selected waveform
Carrier waveforms	All standard and arbitrary waveforms
Modulation types: AM	Double sideband with carrier. SCM: Double sideband suppressed carrier
Modulation source	Internal from the previous channel. External from Modulation input socket. The external modulation signal may be applied to any number of channels simultaneously.
Frequency range	DC to $> 100$ kHz
Internal AM depth	0 % to 105 %.
Internal AM resolution	1 %
Carrier suppression (SCM)	$> 40$ dB
External modulation signal range	VCA: Approximately 1 V pk-pk for 100 % level change at maximum output
SCM	Approximately $\pm 1$ V pk for max. output
Inter-Channel Analogue Summing	
Waveform Summing sums the waveform from any channel into the next channel. Alternatively any number of channels may be summed with the signal at the SUM input socket.	
Carrier frequency	Entire range for selected waveform
Carrier waveforms	All standard and arbitrary waveforms
Sum source	Internal from the previous channel. External from SUM IN socket.
Frequency range	DC to $> 8$ MHz
Ext. signal range	Approx. 5 V pk-pk input for 20 V pk-pk output
Inter-Channel Phase Locking	
Two or more channels may be phase locked together. Each locked channel may be assigned a phase angle relative to the other locked channels. Arbitrary waveforms and waveform sequences may be phase locked but certain constraints apply to waveform lengths and clock frequency ratios. With one channel assigned as the Master and other channels as Slaves a frequency change on the master will be repeated on each slave thus allowing multiphase waveforms at the same frequency to be easily generated. DDS waveforms are those with 7 digits of frequency setting resolution, while Non-DDS waveforms have 4 digits.	
Phase resolution Non-DDS waveforms	DDS waveforms: 0.1 degree or 360 degrees/number of points whichever is the greater
Phase error	$< \pm 10$ ns all waveforms
The signals from the REF IN/OUT socket and the SYNC OUT socket can be used to phase lock two instruments where more than 4 channels are required.	

**Inter-Channel Operation** continued**Inter-Channel Triggering**

Any channel can be triggered by the previous or next channel. The previous/next connections can be used to 'daisy chain' a trigger signal from a 'start' channel, through a number of channels in the 'chain' to an 'end' channel. Each channel receives the trigger out signal from the previous (or next) channel, and drives its selected trigger out to the next (or previous) channel. The 'end' channel trigger out can be set up to drive the 'start' channel, closing the loop. In this way, complex and versatile interchannel trigger schemes may be set up. Each channel can have its trigger out and its output waveform set up independently. Trigger out may be selected from Waveform End, Position Markers, Sequence Sync or Burst Done. Using the scheme above it is possible to create a sequence of up to 64 waveform segments, each channel producing up to 16 segments and all channels being summed to produce the complete waveform at the output of channel 4.

**Interfaces**

RS-232	Variable Baud rate, 9600 Baud maximum
IEEE-488	Conforms with IEEE488.1 and IEEE488.2
Software included	Windows™-based software for waveform creation, editing and management is supplied.
Instrument drivers	LabView and LabWindows CVI drivers are either supplied with the instrument or are available via your local Fluke office

**General Specifications**

Display	20 character x 4 row alphanumeric LCD
Data entry	Keyboard selection of mode, waveform etc.; value entry direct by numeric keys or by rotary control
Stored settings	Up to 9 complete instrument setups may be stored and recalled from battery-backed memory. Up to 100 arbitrary waveforms can also be stored independent of the instrument settings.
Size	130 mm (3 U) height; 335 mm long; width 350 mm (282/284), 212 mm (281)
Weight	7.2 kg. (16 lb) (282/284); 4.1 kg (9 lb) (281)
Power	230 V, 115 V or 100 V nominal 50/60 Hz, adjustable internally; operating range $\pm 14\%$ of nominal; 100 VA max. for 4 channels, 75 VA max. for 2 channel, 40 VA max. for 1 channel. Installation Category II.
Operating range	+5 °C to 40 °C, 20-80 % RH
Storage range	-20 °C to + 60 °C
Environmental	Indoor use at altitudes to 2000 m, Pollution Degree 2
Options	19-in rack mounting kit
Safety	Complies with EN61010-1
EMC	Complies with EN61326

**Ordering Information****Models**

**281** 1 Channel 40 MS/s Arbitrary Waveform Generator and Waveform Manager Plus Software

**282** 2 Channel, 40 MS/s Arbitrary Waveform Generator and Waveform Manager Plus Software

**284** 4 Channel, 40 MS/s Arbitrary Waveform Generator and Waveform Manager Plus Software

**Options and Accessories**

**Y2801** (was 39A-001) 281 and 291 Rackmount Kit

**Y2824** (was 195/002) 282, 284, 292 and 294 Rackmount Kit  
Calibration Results (required)

# 291/292/294 Waveform Generators

riešenia na presné meranie

www.elseo.sk/Fluke-Calibration

## Universal Waveform Generators

1, 2, or 4 Channel 80 MS/s waveform generator



294 Waveform Generator



291 Waveform Generator

- 80 MS/s 12-bit arbitrary waveform capability
- 256 K point waveform memory
- 40 MHz function generator capabilities using DDS (50 MHz for square waves)
- 10 ns pulse pattern generator
- Waveform sequencing with up to 1024 segments
- Unlimited waveform storage using CF memory cards
- Waveform Manager Plus for Windows software
- USB interface in addition to RS-232 and GPIB

### Tech Tip

#### Linked-sequence operation

Up to 1024 arbitrary waveforms may be linked in a sequence. Each waveform can have a loop count of up to 32,768 and the whole sequence can be run continuously or repeated more than a million times. For multi-channel models, waveforms on different channels can be "daisy chained" and looped. By summing the channel outputs, up to 64 segments can be used to create highly complex waveforms.

These universal waveform generators combine many generators in one instrument. Their extensive signal simulation capabilities include arbitrary waveforms, function generator, pulse/pulse train generator, sweep generator, trigger generator, tone generator, noise generator and amplitude modulation source.

The 290 series uses Direct Digital Synthesis techniques as well as variable clock sampling technology to provide a fully featured programmable function and arbitrary waveform capability.

The 291, 292 and 294 are 80 MS/s arbitrary waveform generators designed to handle real world requirements by test experts. These models can easily simulate complex signals while being easy to use, compact and affordable. On multi-channel units each channel can be operated fully independently, or multiple channels can be linked using simple or complex relationships.

Waveform Manager Plus software provides all the features needed for creation, manipulation and management of arbitrary waveforms within a single Windows based programs.

**N.B.** Two- and four-channel 80 MS/s models will be introduced in 2005.

### Arbitrary Waveform

Waveforms	The maximum arbitrary waveform size is 262,144 points. Up to 500 user-defined waveforms may be stored on the removable memory card. Arbitrary waveforms can be defined by front panel editing controls, by downloading of waveform data via RS-232,USB or GPIB, or by writing directly to the removable memory card using the USB card reader/writer connected to a PC.
Waveform memory	256 K points. Minimum waveform size is 8 points.
Vertical resolution	12 bits
Sample clock range	100 mHz to 80 MHz
Resolution	4 digits
Accuracy	± 1 digit of setting
Output filter	Selectable between 40 MHz Elliptic, 20 MHz Bessel or none
Sequence	Up to 1024 waveforms may be linked. Each waveform can have a loop count of up to 32,768. A sequence of waveforms can be looped up to 1,048,575 times or run continuously.
Noise function	Digital noise generated by a 35-bit linear feedback register clocked at 100 MHz. User's external filter defines bandwidth and response.

## Standard Waveforms

Waveforms	Sine, square, triangle, DC, positive ramp, negative ramp, sin(x)/x, pulse, pulse train, cosine, haversine and havercosine
<b>Sine, Cosine, Haversine, Havercosine</b>	
Range	0.1 mHz to 40 MHz
Resolution	0.1 mHz or 10 digits
Accuracy	Better than 10 ppm for 1 year
Temperature stability	Typically < 1 ppm/°C
Output level	5 mV to 20 V p-p from 50 Ω
Harmonic distortion	< 0.15 % THD to 100 kHz; < -60 dBc to 20 kHz, < -50 dBc to 1 MHz, < -40 dBc to 10 MHz, < -30 dBc to 40 MHz
Non-harmonic spuri	< -60 dBc to 1 MHz, < -60 dBc + 6 dB/octave 1 MHz to 40 MHz
<b>Square</b>	
Range	1 mHz to 50 MHz
Resolution	1 mHz (4 digits)
Accuracy	± 1 digit of setting
Output level	5 mV to 20 V p-p from 50 Ω
Rise and fall times	< 8 ns
<b>Triangle</b>	
Range	0.1 mHz to 500 kHz
Resolution	0.1 mHz or 10 digits
Accuracy	Better than 10 ppm for 1 year
Output level	5 mV to 20 V p-p from 50 Ω, linearity error: < 0.1 % to 30 kHz
<b>Ramps and Sin(x)/x</b>	
Range	0.1 mHz to 500 kHz
Resolution	0.1 mHz or 10 digits
Accuracy	Better than 10 ppm for 1 year
Output level	5 mV to 20 V p-p from 50 Ω
Linearity error	< 0.1 % to 30 kHz
<b>Pulse and Pulse Train</b>	
Output level	5 mV to 20 V p-p from 50 Ω
Rise and fall times	< 8 ns
Period	Range: 40 ns to 100 s; Resolution: 4-digits; Accuracy: ± 1 digit of setting
Delay	Range: -99.9 s to + 99.99 s; Resolution: 0.001 % of period or 10 ns
Width	Range: 10 ns to 99.99 s; Resolution: 0.001 % of period or 10 ns

Trains of up to 10 pulses may be specified, each having independently defined width, delay and level. The baseline voltage is separately defined and the sequence repetition rate is set by the pulse train period.

## Operating Modes

<b>Continuous</b>	
Waveform runs continuously	
<b>Triggered Burst</b>	
Each active edge of the trigger signal will produce one burst of the waveform	
Carrier waveforms	All standard and arbitrary
Max. carrier frequency	The smaller of 2.5 MHz or the maximum for the selected waveform. 100 Msamples/s for ARB or Sequence.
Number of Cycles	1 to 1048575
Trigger rep. rate	0.005 Hz to 100 kHz internal, dc to 1 MHz external
Trigger source	Internal from keyboard or trigger generator. External from TRIG IN or remote interface.
Start/stop phase	± 360 ° settable with 0.1 ° resolution, subject to waveform frequency and type
<b>Gated</b>	
Waveform will run while the Gate signal is true and stop while false	
Carrier waveforms	All standard and arbitrary
Max. carrier frequency	The smaller of 2.5 MHz or the maximum for the selected waveform. 80 Msamples/s for ARB or Sequence.
Trigger rate	0.005 Hz to 100 kHz internal, dc to 1 MHz external
Gate signal source	Internal from keyboard or trigger generator. External from TRIG IN or remote interface.
Start/stop phase	± 360 ° settable with 0.1 ° resolution, subject to waveform frequency and type
<b>Sweep</b>	
Capability provided for both standard and arbitrary waveforms. Arbitrary waveforms are expanded or condensed to exactly 4096 points and DDS techniques are used to perform the sweep.	
Carrier waveforms	All standard and arbitrary except pulse, pulse train and sequence. Sweep mode: Linear or logarithmic, continuous or triggered.
Sweep direction	Up, down, up/down or down/up

### Operating Modes continued

Sweep range	1 mHz to 40 MHz in one range. Phase continuous. Independent setting of start/stop frequency.
Sweep time	1 ms to 999 s (3 digit resolution)
Marker	Variable during sweep.
Sweep trig. source	The sweep may be free run or triggered from the following sources: Manually from keyboard. Externally from TRIG IN input or remote interface.
Sweep hold	Sweep can be held and restarted by HOLD key
<b>Tone Switching</b>	
Capability provided for both standard and arbitrary waveforms. Arbitrary waveforms are expanded or condensed to exactly 4096 points and DDS techniques used to allow instantaneous frequency switching.	
Carrier waveforms	All waveforms bar pulse, pulse train, sequence
Frequency list	Up to 16 frequencies from 1 mHz to 40 MHz
Trigger rep. rate	0.005 Hz to 100 kHz internal, dc to 1 MHz external. Usable repetition rate and waveform frequency depend on the tone switching mode.
Source	Internal from keyboard or trigger generator. External from TRIG IN or remote interface.
<b>Tone switching modes</b>	
Gated	The tone is output while the trigger signal is true and stopped, at the end of the current waveform cycle, while the trigger signal is false. The next tone is output when the trigger signal is true again.
Triggered	The tone is output when the trigger signal goes true and the next tone is output, at the end of the current waveform cycle, when the trigger signal goes true again.
FSK	The tone is output when the trigger signal goes true and the next tone is output, immediately, when the trigger signal goes true again.
<b>External Amplitude Modulation</b>	
Carrier frequency	Entire range for selected waveform
Carrier waveforms	All standard and arbitrary waveforms
Modulation source	Modulation socket
Frequency range	DC to 500 kHz
Signal range	Approx. 1 V pk-pk for 100 % level change at maximum output
<b>External Signal Summing</b>	
Carrier frequency	Entire range for selected waveform
Carrier waveforms	All standard and arbitrary waveforms
Sum source	Sum socket
Frequency range	DC to 16 MHz
Signal range	Approximately 2 Vpk-pk input for 20 Vpk-pk output.
<b>Trigger Generator</b>	
Internal source 0.005 Hz to 100 kHz squarewave adjustable in 10 us steps. 3 digit resolution. Available for external use from the SYNC OUT socket.	

### Outputs

<b>Main Outputs — One for each channel</b>	
Output impedance	50 Ω
Amplitude	5 mV to 20 V pk-pk open circuit (2.5 mV to 10 V pk-pk into 50 Ω. Amplitude can be specified open circuit (Hi Z) or into an assumed load of 50 Ω or 60 Ω, in Vpk-pk, Vrms or dBm.
Ampl. accuracy	Better than 2 % ± 1 mV at 1 kHz into 50 Ω
Ampl. flatness	± 0.2 dB to 1 MHz; ± 0.4 dB to 40 MHz
DC offset range	± 10 V. DC offset plus signal peak limited to ± 10 V from 50 Ω
Offset accuracy	Typically within ± 3 % ± 10 mV, unattenuated
Resolution	3 digits or 1 mV for both Amplitude and DC Offset
<b>Sync Out — One for each channel</b>	
Multifunction output user definable or automatically selected to be any of the following:	
Waveform sync (All waveforms)	A square wave with 50 % duty cycle at the main waveform frequency, or a pulse coincident with the first few points of an arbitrary waveform.
Position markers (Arbitrary only)	Any point(s) on the waveform may have associated marker bit(s) set high or low
Burst done	Produces a pulse coincident with the last cycle of a burst
Sequence sync	Produces a pulse coincident with the end of a waveform sequence
Trigger	Selects the current trigger signal. Useful for synchronising burst or gated signals.
Sweep sync	Outputs a pulse at the start of sweep to synchronise an oscilloscope or recorder. Can additionally output a sweep marker.
Phase lock out	Used to phase lock two generators. Produces a positive edge at the 0° phase point.
Output signal level	Logic level of < 0.8 V to > 3 V for all outputs except Sweep Sync. Sweep Sync is a 3-level waveform.

## Inputs

Trig In	
Frequency range	DC to 1 MHz
Signal range	Threshold nominally TTL level; max. input $\pm 10$ V
Min. pulse width	50 ns for Trigger and Gate modes; 50 $\mu$ s for Sweep mode
Input impedance	10 k $\Omega$
Modulation In	
Frequency range	DC to 500 kHz
Signal range	VCA: Approximately 1 Vpk-pk for 100 % level change at maximum output SCM: Approximately $\pm 1$ Vpk for maximum output
Input impedance	Typically 1 k $\Omega$
Sum In	
Frequency range	DC to 30 MHz (291) DC to 16 MHz (292/294)
Signal range	Approximately 2 Vpk-pk input for 20 Vpk-pk output
Input impedance	Typically 1 k $\Omega$
Hold	Holds an arbitrary waveform at its current position. A TTL low level or switch closure causes the waveform to stop at the current position and wait until a TTL high level or switch opening which allows the waveform to continue. The front panel MAN/HOLD key or remote command may also be used to control the Hold function.
Input impedance	10 k $\Omega$
Ref Clock In/Out	
Set to input	Input for an external 10 MHz reference clock. TTL/CMOS threshold level.
Set to output	Buffered version of the internal 10 MHz clock. Output levels nominally 1 V and 4 V from 50 $\Omega$ .
Set to phase lock	Used together with SYNC OUT on a master and the TRIG IN on a slave to synchronize (phase lock) two generators
ARB Clock In	
Frequency range	DC to 50 MHz
Max. input voltage	+5 V, -1 V

## Inter-Channel Operation

Inter-Channel Modulation	
The waveform from any channel may be used to Amplitude Modulate (AM) or Suppressed Carrier Modulate (SCM) the next channel. Alternatively any number of channels may be Modulated (AM or SCM) with the signal at the MODULATION input socket.	
Carrier frequency	Entire range for selected waveform
Carrier waveforms	All standard and arbitrary waveforms
Modulation types	AM: Double sideband with carrier. SCM: Double sideband suppressed carrier
Modulation source	Internal from the previous channel. External from Modulation input socket. The external modulation signal may be applied to any number of channels simultaneously.
Frequency range	DC to > 100 kHz
Internal AM depth	0 % to 105 %
Internal AM resolution	1 %
Carrier Suppression (SCM)	> 40 dB
External modulation signal range	VCA: Approximately 1 V pk-pk for 100 % level change at maximum output SCM: Approximately $\pm 1$ Vpk for max. output
Inter-Channel Analogue Summing	
Waveform Summing sums the waveform from any channel into the next channel. Alternatively any number of channels may be summed with the signal at the SUM input socket.	
Carrier frequency	Entire range for selected waveform
Carrier waveforms	All standard and arbitrary waveforms
Sum source	Internal from the previous channel. External from SUM IN socket.
Frequency range	DC to > 16 MHz
Ext. signal range	Approx. 5 Vpk-pk input for 20 Vpk-pk output

### Inter-Channel Operation continued

#### Inter-Channel Phase Locking

Two or more channels may be phase locked together. Each locked channel may be assigned a phase angle relative to the other locked channels. Arbitrary waveforms and waveform sequences may be phase locked but certain constraints apply to waveform lengths and clock frequency ratios. With one channel assigned as the Master and other channels as Slaves a frequency change on the master will be repeated on each slave thus allowing multiphase waveforms at the same frequency to be easily generated. DDS waveforms are those with 7 digits of frequency setting resolution, while Non-DDS waveforms have 4 digits.

Phase resolution	DDS waveforms: 0.1 degree
Non-DDS waveforms	0.1 degree or 360 degrees/number of points whichever is the greater
Phase error	< ± 10 ns all waveforms.

#### Inter-Channel Triggering

Any channel can be triggered by the previous or next channel. The previous/next connections can be used to 'daisy chain' a trigger signal from a 'start' channel, through a number of channels in the 'chain' to an 'end' channel. Each channel receives the trigger out signal from the previous (or next) channel, and drives its selected trigger out to the next (or previous) channel. The 'end' channel trigger out can be set up to drive the 'start' channel, closing the loop. In this way, complex and versatile interchannel trigger schemes may be set up. Each channel can have its trigger out and its output waveform set up independently. Trigger out may be selected from Waveform End, Position Markers, Sequence Sync or Burst Done. Using the scheme above it is possible to create a sequence of up to 64 waveform segments, each channel producing up to 16 segments and all channels being summed to produce the complete waveform at the output of channel 4. The signals from the REF IN/OUT socket and the SYNC OUT socket can be used to phase lock two instruments where more than 4 channels are required.

### Interfaces

RS-232	Variable Baud rate, 9600 Baud maximum
IEEE488	Conforms with IEEE488.1 and IEEE488.2
USB	Conforms with USB 1.1

### General Specifications

Display	20 character x 4 row alphanumeric LCD
Data entry	Keyboard selection of mode, waveform etc.; value entry by numeric keys or by rotary control.
Memory card	Removable memory card conforming to the Compact Flash memory card standard. Sizes from 32 MB to 1 GB can be used.
Stored settings	Up to 500 complete instrument set-ups may be stored and recalled from the memory card. Up to 500 arbitrary waveforms can also be stored independent of the instrument settings.
Size	130 mm (3U) high; 335 mm long; 350 mm wide (292/294), 212 mm wide (291)
Weight	292/294: 7.2 kg (16 lb); 291: 4.1 kg (9 lb)
Power	110 to 120 V or 100 V nominal 50/60/400 Hz; 220 to 240 V nominal, 50/60 Hz. Voltage adjustable internally; operating range ± 10 % of nominal; 60 VA max. Installation Category II.
<b>Compliance</b>	
Operating range	+5 °C to 40 °C, 20 to 80 % RH
Storage range	-20 °C to +60 °C
Environmental	Indoor use at altitudes to 200 m, Pollution Degree 2
Safety	Complies with EN61010-1
EMC	Complies with EN61326
Instrument drivers	Labview and LabWindows CVI drivers are either supplied with the instrument or are available via your local Fluke Office
Supplied Items	IEC Mains Lead. Printed manual (partly multi-language), multi-language manual on CD, Waveform Manager Plus software, compact Flash memory card, compact Flash card reader/writer (USB connection to PC)
Options	19 inch rack mounting kit

### Ordering Information

#### Models

**291** 1 Channel 80 MS/s Arbitrary Waveform Generator and Waveform Manager Plus Software. Compact Flash Memory Card & USB Card Reader/Writer.

**292** 2 Channel, 80 MS/s Arbitrary Waveform Generator and Waveform Manager Plus Software. Compact Flash Memory Card & USB Card Reader/Writer.

**294** 4 Channel, 80 MS/s Arbitrary Waveform Generator and Waveform Manager Plus Software. Compact Flash Memory Card & USB Card Reader/Writer.

#### Options and Accessories

**Y2801** (was 39A-001) 281 and 291 Rackmount Kit

**Y2824** (was 195/002) 282, 284, 292 and 294 Rackmount Kit



# 396/397 Universal Waveform Generators

riešenia na presné meranie

www.elseo.sk/Fluke-Calibration

Universal  
Waveform  
Generators

FLUKE®

125 MS/s high performance universal waveform generators

Tech Tip



397 Waveform Generator

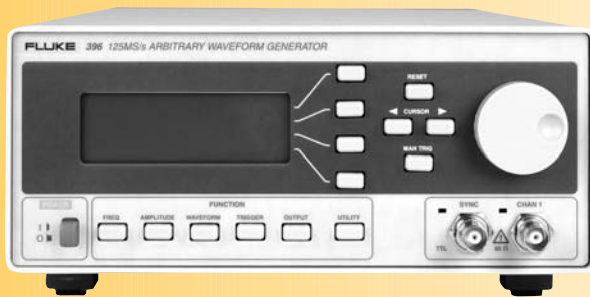

396 Waveform Generator

- Unprecedented combination of universal generator and synthesizer
- Versatile performance
- High resolution and wide frequency range
- Extremely good performance-to-price ratio

## Waveform resolution

The 14-bit resolution provides 16,384 output levels. This means that even audio waveforms can be generated with excellent fidelity. It also allows video – and other complex waveforms – to be generated, with small details superimposed on large signals, in order to test the response of receiving systems.

The single-channel 396 and dual-channel 397 systems break new ground in universal waveform generator design. With their unprecedented combination of universal generator and synthesizer, versatility, high resolution and wide frequency range, and extremely good performance-to-price ratio, the 396 and 397 offer a range of benefits that will facilitate work in many fields.

The 14-bit resolution provides 16,384 output levels. This means that the 396 and 397 even generate audio waveforms with excellent fidelity. The 14-bit resolution also allows video – and other complex waveforms – to be generated with small details superimposed on large signals, so you can test the response of receiving systems.

The 125 MS/s sample rate allows the vertical accuracy to be converted into excellent performance at high frequencies. This opens up many applications in communication, video and television, telecommunication, radar, and ultrasonics.

Features include 11 basic waveforms with adjustable parameters: sine, triangle, square, pulse, ramp, sinc, Gaussian, exponential up, exponential down, noise, as well as dc. All are accessible from the front panel

The 396 and 397 also offer 1 Meg Word memory for arbitrary waveforms. Given the 14-bit resolution and its ability to operate the instrument with two different clock frequencies, the 396 and 397 offer enormous power. In addition, their memory can be divided into as many as 4,096 segments, which can be looped and linked in many different ways. Using 1 Meg Word at 25 MS/s to generate a video signal, for example, the duration is 0.04 s, 25 Hz, even without any looping of repetitive elements.

### Abbreviated Specifications

	396	397
<b>Waveforms</b>		
Waveforms	Standard waveforms: sine, square, triangle, ramp, sinc, pulse, noise, Gaussian as well as dc	
<b>Sine</b>		
Range	0.1 mHz to 50 MHz	
Resolution	7 digits or 0.1 mHz	
Accuracy	< 1 ppm for 1 year	
Temp. coefficient	< 1 ppm/°C	
Harmonic distortion and non related spurious below 10 MHz	< 0.1 % THD to 100 kHz (2000 waveform points) < -55 dBc to 1 MHz < -40 dBc to 5 MHz < -35 dBc to 10 MHz < -22 dBc to 50 MHz	
<b>Square</b>		
Range	0.1 mHz to 50 MHz	
Resolution	0.1 mHz or 7 digits	
Rise and fall times	< 10 ns	
<b>Triangle</b>		
Range	0.1 mHz to 12.5 MHz	
Resolution	0.1 mHz or 7 digits	
Accuracy	1 ppm for 1 year	
Linearity error	< 0.1 % to 100 kHz	
<b>Pulse</b>		
Range	0.1 mHz to 12.5 MHz	
Delay	0 % to 99.9 % of period	
Rise and fall times	0 % to 99.9 % of period	
High time	0 % to 99.9 % of period	
Resolution	0.1 %	
<b>Arbitrary Waveforms</b>		
Stored waveforms	Up to 4096	Up to 4096 each channel
Waveform length	16 to 4 M points	
Vertical resolution	14 bits	
Sample clock range	100 mHz to 125 MHz	
Waveform sequencing	Up to 4096 segments may be linked. Minimum segment duration 1 $\mu$ s. Segments can be looped up to 1,000,000 times	
<b>Amplitude</b>		
Output impedance	50 $\Omega$	
Amplitude	Range: 10 mVpp to 10 Vpp (20 mVpp to 20 Vpp into open circuit)	
Accuracy	< 1 % $\pm$ 25 mV between 1 V to 10 Vpp into 50 $\Omega$	
Flatness	$\pm$ 5 % to 10 MHz; $\pm$ 20 % to 50 MHz	
DC offset	$\pm$ 4.5 V into 50 $\Omega$ . DC offset plus signal peak limited to $\pm$ 10 V. DC offset attenuated with amplitude range	
<b>Output Filters</b>		
Filter type	50 MHz Elliptic and 2 MHz Elliptical	
<b>Modulation Modes</b>		
Triggered burst	Each active edge of the trigger signal will produce one burst of the carrier waveform, waveforms starts from point n and completes at point n-1	
Gated	The selected waveform is output continuously at the programmed frequency while the selected gate signal is true	
Waveforms	All standard and arbitrary	
Carrier frequency	125 Msample/s for ARB and Sequence. 2.5 MHz or the maximum of selected waveform	
No. of cycles	1 to 1,000,000	
Trigger source	Manual trigger key, adjacent channel or internal trigger generator or external trigger input or remote trigger command	
Trigger rate	Internal trigger generator: 0.1 Hz to 2 MHz; External signal: dc to 2 MHz	
Start/stop phase	$\pm$ 360 $^\circ$ , settable to 0.1 $^\circ$ subject to waveform frequency and type	
Frequency sweep	Manual, continuous, triggered; linear or logarithmic sweep; up or down. Variable sweep marker.	
Sweep range	1 mHz to 125 MHz	
Sweep time	1 ms to 999 s	
Sweep trigger source	External trigger input or remote trigger command	
Tone switching	FSK tone switching for all waveforms	
External AM	Via rear panel BNC input, dc-500 kHz for all standard and arbitrary waveforms	

## Outputs and Inputs

	396	397
Main outputs	Single channel	Two channel
Sync outputs	Front panel BNC connector generates sync pulse synchronous with output waveform. In FM and sweep modes this output is synchronous with sample clock frequencies.	
Ext. trigger in	DC to 2 MHz. Threshold nominally TTL level; maximum input 5 V. Selectable as positive rising edge or negative falling edge. Minimum pulse width 20 ns for trigger and gated modes	
AM input	0 V to +5 V (5 V <sub>pp</sub> ) produce 100 % modulation	
Ref clock in	Input for an external 10 MHz reference clock. Threshold nominally TTL level.	
SCLK output, SCLK input and DSUB connector	Connect instruments to achieve synchronization. DSUB 9- pin connector and cable supplied.	

## Inter-Channel Operations

	396	397
Inter-channel modulation	The waveform from any channel may be used to amplitude modulate (AM) the adjacent instrument/channel. Alternatively, any number of channels may be modulated (AM) with the signal at the modulation input socket.	
Carrier frequency	Entire range for selected waveform	
Carrier waveforms	All standard and arbitrary waveforms	
Modulation freq.	DC to 500 kHz	
Modulation depth	0 % to 100 %	
Inter-channel synchronization	Both channels are tightly synchronized in phase and waveform start. Channel 2 has sample clock divider for arbitrary and sequenced waveforms.	
Phase resolution	1 sample clock period of channel 2	
Skew error	± 2 ns	
Inter-instrument synchronization	Two or more instrument may be slaved to one master instrument. Each Slave can have a unique phase angle relative to the Master.	
Phase error	4 points	
Skew error	± 15 ns, typically with 1 meter coax cables	
Inter-channel/instrument triggering	Any channel/instrument can be triggered by the previous or next channel instrument	

## General Specifications

	396	397
<b>Software</b>		
Waveform Software	ArbExplorer Software for Windows is supplied with each instrument. This provides full waveform creation, editing and management including an equation editor, clipboard import/export and freehand drawing.	
<b>Interfaces</b>		
Interface types	GPIB and RS-232	GPIB, USB and Ethernet
Remote control	Full remote control facilities are available through the interfaces	
RS-232	Variable Baud rate, 115 k Baud. 9-pin D-connector	
GPIB	Conforms with IEEE-488.1 and IEEE-48.2	
Ethernet	Twisted pair 10/100Base-T, auto negotiation	
USB	Type A receptacle, version 2.0	
Display	20 character x 4 row alphanumeric LCD	3.5 in color LCD reflective, 320 x 240 pixels, back-lit
Size	88 x 415 x 212 mm (H x D x W)	
Weight	6 kg (13 lb)	
Power	85 V to 265 V, 48 - 63 Hz, 60W	
Operating temperature range	0 °C to 50 °C	
Operating humidity (non condensing)	11 °C to 30 °C 85 % RH; 31 °C to 40 °C 75 % RH; 41 °C to 50 °C 45 % RH	
Storage range	-20 °C to + 60 °C	
Environmental	Indoor use at altitudes to 2,000 m, Pollution degree 2	
Safety	Complies with EN61010-1	
EMC	Complies with EN61326, CE marked	

## Ordering Information

### Models

**396** 1 Channel 125 MS/s Arbitrary Waveform Generator & ArbExplorer Software, includes instrument synchronization cable

**397** 2 Channel, 125 MS/s Arbitrary Waveform Generator & ArbExplorer Software, includes instrument synchronization cable

### Options and Accessories

**Y396** 396 Rackmount Kit

**Y397** 397 Rackmount Kit  
Calibration Results (required)

# Handheld Industrial Test Tools

## Innovative tools for faster, safer and easier measurements

For over 50 years, Fluke Corporation has been dedicated to the design and manufacture of innovative test and measurement instruments. Each year, Fluke engineers and product developers interview thousands of customers to discover how engineers and technicians design, install and troubleshoot electrical and electronic systems. This input has helped make Fluke instruments more versatile, safer and easier to use.

More information about Fluke's industrial handheld test tools is available on the Fluke web site, [www.fluke.com](http://www.fluke.com), and from your local Fluke distributor.

## Industrial/electronic service, installation, and maintenance

Today, electronics are being integrated into an increasing number of electrical and electro-mechanical systems. Fluke Corporation's comprehensive line of digital multimeters, electrical power controls and accessories plus the integrated ScopeMeter® handheld test tools are being used by a growing number of service technicians, plant engineers and installation and maintenance technicians. These tools provide them the ability to troubleshoot these complex new systems and detect problems.



The new Fluke 87V has improved measurement functions, trouble-shooting features, resolution and accuracy to solve more problems on motor drives, in plant automation, power distribution and electro-mechanical equipment.

## Electrical

Electricians, HVAC/R technicians, plant engineers and power quality consultants involved in the maintenance, service and design of every type of residential, industrial, plant and commercial building, use Fluke professional test tools. Fluke products such as power harmonics meters, electrical testers, digital multimeters (DMMs), clamp meters, ScopeMeter® test tools, current clamps, digital thermometers and DMM accessories that are designed for day-to-day field troubleshooting and maintenance of electrical systems, electrical power systems, HVAC/R systems, and associated equipment. Fluke products help electrical technicians analyze, troubleshoot and repair these systems for optimum performance. In addition, many Fluke tools offer computer connectivity and documentation software to help report and analyze data results.

## Process tools

Fluke is the world leader in test tools for field calibration and maintenance of control instrumentation in process industries – chemicals, petroleum, pulp/paper, food/beverage manufacture and waste/water management. The complete Fluke line, from simple loop calibrators to sophisticated documenting process calibrators, addresses temperature, pressure, current, voltage resistance and frequency. Instrumentation management software from Fluke, and from major process instrument vendors, helps users meet increasing demands for rigorous maintenance documentation.

## Power quality

Fluke Power Quality provides portable and installed power quality instruments for both in-depth analysis and fast troubleshooting. Handheld troubleshooting tools include single phase and three phase power meters, power quality analyzers, and power recorders. Analysis instruments like Power Recorder, Multipoint and Insite may be configured for specific, critical applications.

Pictured at right: Fluke 430 Series Three-Phase Power Quality Analyzers help users pinpoint power quality problems faster, safer and in greater detail. These complete three-phase troubleshooting tools measure virtually every power system parameter: voltage, current, frequency, power, power consumption (energy), unbalance and flicker, harmonics and inter-harmonics.



## Temperature

Fluke knows temperature, with more than two decades of thermometry experience. Products include the latest in non-contact IR temperature test tools, digital thermometers, probes, accessories, and expertise for a complete range of applications.

Pictured at right: Reach for a rugged Fluke 60 series IR thermometer for jobs requiring temperature measurement in hard-to-reach, hot, rotating, or dangerous situations.



## Thermography

Fluke offers an affordable, easy-to-use, portable thermal imager that includes software for image storage, analysis, and reporting plus a 2 day training class. The camera and software uniquely support predictive maintenance routing, making inspections as easy as aim, focus and shoot.

Pictured at right: The Fluke Ti30 best meets the needs of infrared predictive maintenance from trouble shooting to inspection routing – at an affordable price.



Elseo Philips Service, Vlnšičin

# Handheld Industrial Test Tools

riešenia na presné meranie

www.elseo.sk/Fluke-Calibration

FLUKE®

## Clamp Meter Selection Table

	321	322	333	334	335	336	337
<b>Choose the model that fits your work.</b> Match the features and functions listed below to the Fluke Clamp Meter that is best suited for the job.	AC Amps Ohms AC Volts Auto-off Hold Compact	AC Amps Ohms AC Volts Auto-off Hold Compact <b>DC Volts</b>	AC Amps Ohms AC Volts Auto-off Hold <b>Full Size</b> DC Volts	AC Amps Ohms AC Volts Auto-off Hold Full Size DC Volts <b>In-rush</b> <b>Backlight</b>	AC Amps Ohms AC Volts Auto-off Hold Full Size DC Volts In-rush Backlight <b>True-rms</b>	AC Amps Ohms AC Volts Auto-off Hold Full Size DC Volts In-rush Backlight True-rms <b>DC Amps</b>	AC Amps Ohms AC Volts Auto-off Hold Full Size DC Volts In-rush Backlight True-rms DC Amps <b>Frequency</b> <b>Large Jaw</b> <b>MIN/MAX</b>
Measure ac current	400.0 A	40.00 A 400.0 A	400.0 A	600.0 A	600.0 A	600.0 A	999.9 A
Measure ac voltage	400.0 V 600 V	400.0 V 600 V	600.0 V	600.0 V	600.0 V	600.0 V	600.0 V
Measure continuity	≤ 30 Ω	≤ 30 Ω	≤ 30 Ω	≤ 30 Ω	≤ 30 Ω	≤ 30 Ω	≤ 30 Ω
Measure dc voltage		400.0 V 600 V	600.0 V	600.0 V	600.0 V	600.0 V	600.0 V
Higher resolution for loads below 40 amperes		0 - 40.00 A 40.0 - 400.0 A					
Measure resistance	400.0 Ω	400.0 Ω	600.0 Ω	6000 Ω	6000 Ω	6000 Ω	6000 Ω
Measure in-rush				100 mS	100 mS	100 mS	100 mS
Work in poorly lit areas				Backlight	Backlight	Backlight	Backlight
Measure non-linear loads					True-rms	True-rms	True-rms
Measure dc current						600.0 A	999.9A
Variable speed drives and stand-by power							400.0 Hz
Maximum wire diameter	25.4 mm (1 in)	25.4 mm (1 in)	30.5 mm (1.2 in)	30.5 mm (1.2 in)	30.5 mm (1.2 in)	43.2 mm (1.7 in)	43.2 mm (1.7 in)

## ScopeMeter Selection Table

	ScopeMeter 190C Series		ScopeMeter 190B Series			Industrial ScopeMeter
	Fluke 199C	Fluke 196C	Fluke 199B	Fluke 196B	Fluke 192B	Fluke 123
Bandwidth	200 MHz	100 MHz	200 MHz	100 MHz	60 MHz	20 MHz
Maximum real time sample rate	2.5 GS/s	1 GS/s	2.5 GS/s	1 GS/s	500 MS/s	25 MS/s
Display	Color		Monochrome			
Maximum record length in Scope mode	1200 points per input		1200 points per input			512 min/max points per input
Capture last 100 screens	Automatic with Replay capability					-
Dual input TrendPlot	Yes, with Cursors and Zoom					Yes
True-rms multimeter	5000 counts, Volts, Amps, Ohms, Continuity, Diode, Temp					
Safety certified (EN61010-1)	1000 V Cat II/ 600 V CAT III (instrument and accessories)					600 V CAT III

## Process Calibrator Selection Table

Calibrator Type	DPC			MPC	Pressure			Temperature					Loop					Thermometers									
	744	743B	741B	725	718	717	724	714	712	789	787	715	707	705	68	66	63	65	61	54	53	52	51				
V dc	MS	MS	MS	MS			MS	MS		M	M	MS	M	M													
V ac true-rms	M	M	M							M	M																
Ohms	MS	MS	MS	MS			MS		MS	M	M																
mA dc	MS	MS	MS	MS	M	M	M			MS	MS	MS	MS	MS													
24V Loop Supply	●	●	●	●	●	●	●			●		●	●	●													
mA ac										M	M																
Temperature, RTDs	MS	MS	MS	MS			MS		MS						M	M		M	M								
Temperature, TCs	MS	MS	MS	MS			MS	MS												M	M	M	M				
Temperature, Infrared															M	M	M										
Pressure	1	1	1	1	2	2																					
Frequency	MS	MS	MS	MS						M	M																
Built-in hand pump					●																						
As found/As left Results	●	●	●																								
Log data; upload to PC	●	●													●	●				●	●						
HART Communication	●																										
Min/Max	●	●	●		●	●				●	●				●	●		●									
Hold					●	●				●	●				●	●	●	●	●	●	●	●	●	●			
Distance to spot ratio															50	30	12	8	8								
Max voltage	300	300	300	30	30	30	30	30	30	1000	1000	30	30	30			30	30	30	30							
IEC 61010 Category	Cat II	Cat II	Cat II							Cat III	Cat III																

M = Measure S = Source and / or simulate MPC = Multifunction Process Calibrator  
1 = With Fluke 700 Pressure Modules 2 = With internal sensor, 30 or 100PSI, or with Fluke 700 Pressure Modules

## Thermometers

# Handheld Industrial Test Tools

## Digital Multimeter Selection Table

Models	HVAC and electrical tester 16	Compact design 112	True-rms and built-in thermometer 179	Water and chemical resistant 27	Industrial trouble-shooting 87V	Automotive trouble-shooting 88V	Highest accuracy w/ data logging 189	4-20 mA loop diagnostics 789
<b>Basic Features</b>								
True-rms readings		AC	AC		AC		AC+DC	AC
Basic dc accuracy	0.9 %	0.07 %	0.9 %	0.1 %	0.05 %	0.1 %	0.025 %	0.1 %
Wide bandwidth				30 kHz	20 kHz		100 kHz	
Auto/manual ranging	●	●	●	●	●	●	●	●
Digits	3-1/2	3-1/2	3-1/2	3-1/2	4-1/2	4-1/2	4-1/2	3-1/2
Counts	4000	6000	6000	3200	20000	20000	5000	4000
Motor drive measurement					●			
<b>Measurements</b>								
Voltage ac/dc	600 V	600 V	1000 V	1000 V	1000 V	1000 V	1000 V	1000 V
Current ac/dc	200 μA	10 A	10 A	10 A	10 A	10 A	10 A	10 A
Resistance	40 MΩ	40 MΩ	50 MΩ	32 MΩ	50 MΩ	50 MΩ	500 MΩ	40 MΩ
Frequency		50 kHz	100 kHz		200 kHz	200 kHz	1 MHz	200 kHz
Capacitance	10,000 μF	10,000 μF	10,000 μF		9,999 μF	10,000 μF	50,000 μF	
Temperature	+400 °C		+400 °C		+1090 °C	+1090 °C	+1350 °C	
dB	60 dB						60 dB	
Conductance	50 nS			32 nS	50 nS		50 nS	
Duty cycle/pulse width					●		●	●
Continuity with beeper	●	●	●	●	●	●	●	●
Diode test	●	●	●	●	●	●	●	●
<b>Display</b>								
Dual display							●	
Analog bargraph		●	●	●	●	●	●	●
Backlight		●	●		●	●	●	●
<b>Diagnostics and Data</b>								
Min/Max recording		●	●	●	●	●	●	●
Min/Max recording/with time stamp	●						●	●
Fast Min/Max					250 μs	250 μs	250 μs	
Display Hold/Auto (Touch) Hold		●	●	●	●	●	●	
Relative reference			●	●	●	●	●	●
RS-232 interface							●	●
Data logging							●	with PC
Logged readings							995	
<b>Other Features</b>								
Automatic selection, V-Check	●							
Real time clock							●	
Overmolded case, integrated holster			●				●	●
Removable holster	●	●			●	●		
Closed case calibration		●	●		●	●	●	●
Battery door		●	●	●	●	●	●	●
Completely sealed/watertight				●				
Automatic power off	●	●	●		●	●	●	
Low battery indication	●	●	●	●	●	●	●	●
Operating temperature range	-10 °C, +50 °C	-10 °C, +50 °C	-10 °C, +50 °C	-40 °C, +55 °C	-20 °C, +55 °C	-20 °C, +55 °C	-20 °C, +55 °C	-20 °C, +55 °C
4-20 mA								●
24 V loop supply								●
RPM						●		
<b>Warranty and electrical safety</b>								
Limited lifetime warranty			●	●	●	●	●	
Warranty (years)	2	3						3
Input alert					●	●	●	
Dangerous voltage indication		●	●	●	●	●	●	
CAT III measurements	600 V	600 V	1000 V	1000 V	1000 V	1000 V	1000 V	1000 V
CAT IV measurements			600 V		600 V	600 V	600 V	600 V

More comprehensive information is available in the DMM section of [www.fluke.com](http://www.fluke.com)

## Network SuperVIsion Solutions™ provide greater insight, control, and return on IT investments

Fluke Networks provides innovative solutions for the testing, monitoring and analysis of enterprise and telecommunications networks and the installation and certification of the fiber and copper foundation of those networks. Its comprehensive line of Network SuperVIsion Solutions provide network installers, owners, and maintainers with superior vision, combining speed, accuracy and ease of use to optimize network performance. Headquartered in Everett, Washington, Fluke Networks has over 500 employees worldwide and distributes its products in more than 50 countries.



### Fluke Networks SuperVIsion Solutions include hardware, software and systems for:

- Network analysis. Software and hardware solutions to give you complete visibility into your entire Enterprise network.
- Copper test. Complete solutions for the installation, testing, documentation and certification of copper premises cabling.
- Handheld network testers. Choose from the most powerful line of handheld network problem-solving testers ever designed.
- Telecom/DSL/outside plant. Flexible, turn-key solutions, tools, systems and services to help you maintain and manage your outside plant network.
- Application performance management. Solutions to isolate and troubleshoot application response time performance problems.
- Fiber test. Complete solutions for the installation, testing, documentation and certification of fiber premises cabling.
- Wireless network analysis. Long-term security solutions for deploying, testing and maintaining your wireless network segment
- WAN analysis. Solutions to test throughput and monitor utilization and errors on critical Wide Area links.
- Residential network test. Powerful verification and certification tools for the installation of voice, data and video.

Fluke Networks also provides superior support programs that include unlimited 24-hour-per-day technical assistance; training courses, technology seminars and materials; and calibration and repair services. Detailed information about Fluke Networks is available at [www.flukenetworks.com](http://www.flukenetworks.com), or from your local Fluke Networks representative or distributor.

## Better products. More choices. One company.

Fluke Biomedical is the world leader in the development, manufacture, distribution, and service of biomedical test instrumentation and software.

Fluke Biomedical was created by the integration of the premier biomedical companies, Bio-Tek Instruments and DNI Nevada, with the Fluke Corporation. With over 30 years experience serving biomedical test customers and Fluke's 55 years defining electronic test products, Fluke Biomedical is positioned to bring innovation and value to the health care support organizations. Clinical and Biomedical Engineers around the world utilize Fluke Biomedical test equipment and software. Fluke Biomedical customers and equipment can be found within hospitals, third party maintenance organizations, the military, and in all facets of medical product manufacturing.

Today, biomedical personnel must meet increasing regulatory pressures, higher quality standards, and rapid technological growth, while performing their work faster and more efficiently than ever. Fluke Biomedical stands behind you, ready to provide a whole range of hardware tools to meet today's challenges.



### Innovative design from customer feedback

Fluke Biomedical strives to be the market leader through ongoing improvement of current offerings and creative solutions to customer needs. Multi-functional project teams have a remarkable in-house knowledge base; including expertise in mechanics, electronics, software, systems, engineering, service, and manufacturing technology. Today's new product innovations are the result of Fluke Biomedical marketing, sales, and research and development staff listening to the needs of their customers.

### Fluke Biomedical product families

- Automated electrical safety and performance analyzers
- Defibrillator/pacer performance analyzers
- Electrical safety analyzers
- Electrosurgery performance analyzers
- External pacemaker analyzers
- Incubator performance analyzers
- IV pump performance analyzers
- Medical Scopometers
- Non-invasive blood pressure simulators
- Patient simulators
- Pressure meter performance analyzer
- SpO2 simulators
- Thermo-hygrometer
- Ultrasound wattmeter
- Ventilator/gas-flow analyzer and test lungs

FLUKE®

Biomedical

### Demanding customer satisfaction

The Fluke Biomedical service department is involved early in the life cycle of all new projects to ensure that products are serviceable from release to maturity. Technical assistance is provided through the Technical Assistance Call (TAC) Center to answer customer product questions.

### Quality assurance maintains high standards utilizing ISO 9001

Fluke Biomedical shows its ongoing commitment to quality through the continuous improvement process required by their internationally recognized ISO 9001 Quality System registration. This program guarantees independent audits of all aspects of Fluke Biomedical products and services.

Product compliance to U.S. and international requirements is necessary from the design stage to final test. Products are directly or indirectly measurement traceable to the U.S. National Institute of Standards and Technology (NIST) and registered with the U.S. Food and Drug Administration (FDA) when appropriate. Product designs are type tested per UL, CSA or ETL and bear the CE mark where appropriate.

Detailed information about Fluke Biomedical products and services, as well as contact information, is available at [www.flukebiomedical.com](http://www.flukebiomedical.com). You can also request a printed catalog on the web or by calling 800-648-7952 (toll free in the US) or 775-883-3400.



## Worldwide leader in infrared temperature measurement

Raytek's mission is to be the leading supplier of infrared, noncontact, industrial temperature measurement instruments in the world.

Founded in 1963, Raytek designs, manufactures, markets and services a complete line of infrared, noncontact temperature measurement instruments for industrial, process control and maintenance applications. Raytek strives to develop instruments that improve the productivity, reliability, and efficiency of customers' processes and maintenance activities and, ultimately, the quality of their products and services.

With worldwide headquarters in Santa Cruz, California, USA, European Headquarters in Berlin, Germany, and South American Headquarters in Sorocaba, Brazil, Raytek has also established strategic business units in Japan, China, and France, as well as distributors in over 60 countries around the world.



## Automation and portable products solutions for a broad range of applications

Raytek Corporation provides innovative automation solutions in applications requiring fixed-mount thermometers including:

- cement and lime production
- glass processing
- gypsum wallboard drying
- induction heating
- metal processing
- plastic processing
- OEM (dryers, ovens, furnaces)

Raytek also provides portable products solutions featuring handheld infrared thermometers for applications including:

- automotive
- food service
- HVAC/R and industrial
- plant/facilities maintenance
- home safety and energy audits, "Do-It-Yourself" applications, and hobbies

**Raytek®**  
A Fluke Company

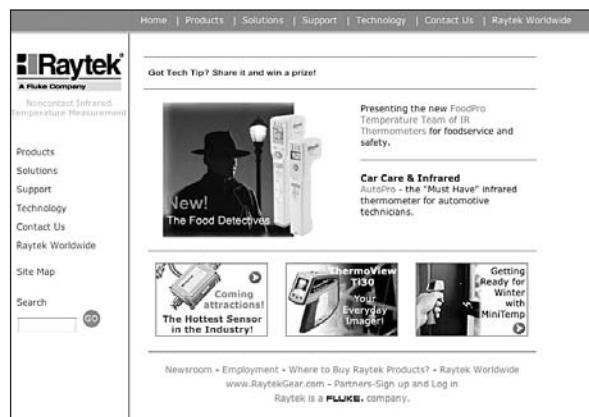

Detailed information about Raytek products is available on the web at [www.raytek.com](http://www.raytek.com), or from your local Raytek distributor.

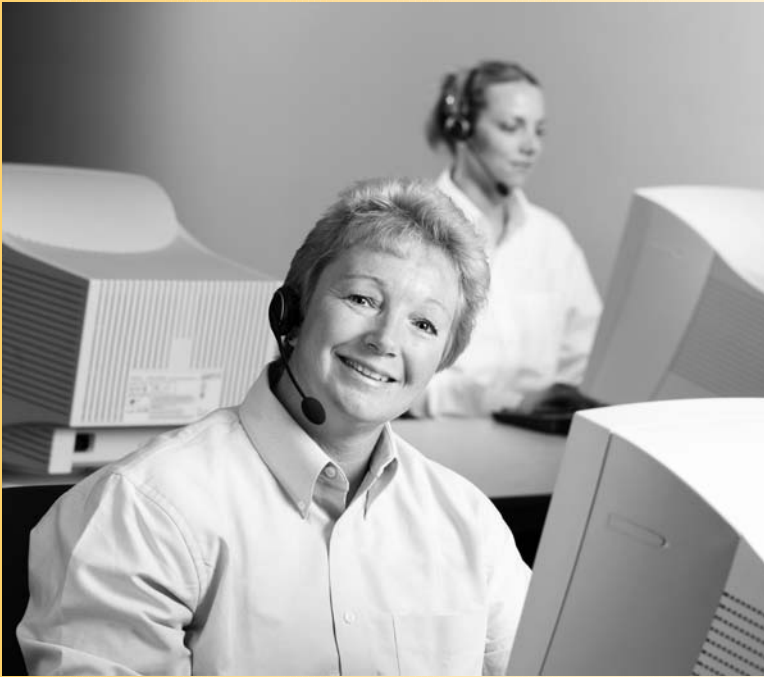

## Ordering Fluke products

Fluke representatives and authorized distributors are located worldwide to provide you with immediate sales assistance, on your local level. For the most up-to-date sales contact information, visit us on the web at [www.fluke.com](http://www.fluke.com) or [www.hartscientific.com](http://www.hartscientific.com). Your local representative or distributor will be happy to discuss your specific application and provide details about delivery and terms in your local area.

## Product changes

Although product information and illustrations in this catalog were current at the time it was approved for printing, Fluke Corporation, in a continuing effort to offer excellent products at a fair value, reserves the right to change specifications, designs, and models without notice.

## Product manuals

Comprehensive sets of Fluke manuals, operator's guides, and selected service manuals are available for download from the Fluke web site. This ready reference source is offered as a free service by Fluke for the convenience of our customers.

## Calibration documentation

Every instrument manufactured by Fluke has been calibrated in accordance with applicable Fluke calibration procedures during the manufacturing process. Instruments manufactured under contract for Fluke are produced by manufacturers selected and managed subject to the Fluke quality management system. These procedures are ISO-9001 controlled and are designed to assure that the instrument will meet its published specifications.

Fluke Corporation further certifies that the measurement standards and instruments used during the calibration of products it manufactures are traceable to the national calibration standards in the country of manufacture.

The following calibration documentation is available:

**Statement of Calibration Practices:** This document is shipped automatically and free of charge with all mainframe instruments manufactured by Fluke. This document states that the instruments were calibrated with standards traceable to national standards in the country of origin.

**Statement of Quality Assurance Practices:** This document is shipped automatically and free of charge with all mainframe instruments manufactured for Fluke. This document states that the manufacturer of the instrument was selected and managed under the Fluke quality management system which is certified to meet ISO-9001.

**Certificate of Calibration:** This document establishes evidence of traceability to national calibration standards in the country of manufacture; for example, the National Institute of Standards and Technology (NIST) in the US. A Certificate of Calibration, a label indicating date of calibration, a tamper resistant seal and as an option, a printout of outgoing readings are provided.

A Report of Calibration, including outgoing readings, a label indicating date of calibration, and a tamper resistant seal are provided free of charge with the purchase of model numbers 5700A, 5720A, 5725A, 5790A, 5500A, 792A, 742A-XX, 732B with 000 or 100 option, and the FLUKE-7XX, 9100, 9500, 8508, 6100 and 7000 series products and modules.

## Power cords

Fluke instruments are fitted with one of the power cord and plug options shown below and are wired for the voltage indicated. The power cord supplied with your instrument is the one commonly used in the country where the instrument will be shipped.

If you require a power cord and plug other than the one listed below for the country where the instrument will be delivered, specify that power cord and plug when you order.

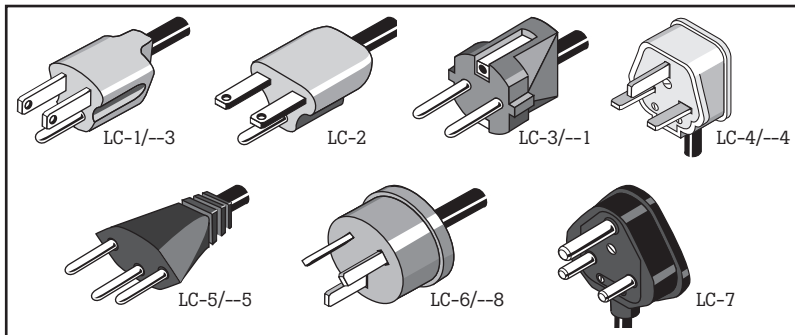

		Fluke	Product Category 1*	Product Category 2**
North America	120 V/15 A	Option LC-1	/-3	Specify country of destination on order
North America	240 V/15 A	Option LC-2		
Universal Euro	220 V/16 A	Option LC-3	/-1	
United Kingdom	220 V/13 A	Option LC-4	/-4	
Switzerland	220 V/10 A	Option LC-5	/-5	
Australia	240 V/10 A	Option LC-6	/-8	
South Africa	240 V/5 A	Option LC-7	Ask for LC 7	

\*Final digit in model number format PM-- for Category 1 Product including Multimeters and Recorders.

\*\*Category 2 products including signal sources, pulse generators, pattern generators and counters.

## Support for discontinued products

The Fluke Corporation recognizes the importance of continued support services for discontinued products. Providing support services is an important element to ensure that Fluke products meet customers' expectations during the active life of the product.

Our policy is to provide support services for a specified minimum period of time after a product has been discontinued from production. Support periods for most Fluke products are classified into one of three groups.

Contact any Fluke Service Center or your Fluke Sales Representative for the support period applicable to specific model numbers. These support services are the same as during the active life of the product. During this support period, Fluke will retain sufficient technical expertise and resources to ensure availability of replacement parts, exchange, and calibration/repair services. This support is available both on a one-time or per-incident basis, as well as under a service agreement program.

Extended support can be provided as long as demand and availability of parts allow us to deliver effective service and customer value. Extended support is subject to availability of replacement parts at a reasonable cost. Trained and/or qualified personnel to perform the service, and equipment to repair and/or calibrate the specific model involved.

Most maintenance services for extended support are performed under time and material provisions. Repair turnaround times are typically longer than normal due to longer procurement and delivery times of replacement parts. Repair costs are typically higher than normal, due to lower volumes, higher parts costs, or special re-training or skills requirements. Service may only be available at selected service centers with specialized equipment or trained personnel.

Group	Description	Period
I	Most handheld service tools and higher cost accessories	4 years
II	General purpose instruments	5 years
III	Lower cost accessories. The support period is the standard warranty period	1 year
IV	Selected handheld service tools. This support period covers defects in material and workmanship for the life of the product to the original purchaser only. See individual product warranty for conditions	Lifetime Limited

**1**

<b>1362S</b> VXIbus Precision Digital Multimeter .....	217-218
<b>1502</b> Tweener PRT Thermometer .....	101-102
<b>1504</b> Tweener PRT Thermometer .....	101-102
<b>1521</b> Thermometer, Handheld .....	99-100
<b>1522</b> Thermometer, Handheld .....	99-100
<b>1529</b> Chub-E4 Thermometer .....	103-104
<b>1529-R</b> Chub-E4 Thermometer .....	103-104
<b>1529-T</b> Chub-E4 Thermometer .....	103-104
<b>1560</b> Thermometer Base Unit .....	105-108
<b>1575A</b> Super-Thermometer .....	109-111
<b>1590</b> Super-Thermometer II .....	109-111

**2**

<b>2016</b> Fluid Level Adapter .....	144
<b>2017</b> LIG Thermometer Holder .....	144
<b>2019</b> Fluid Level Adapter .....	144
<b>2560</b> SPRT Module, for 1560 .....	105, 108
<b>2561</b> High-Temp PRT Module, for 1560 .....	106, 108
<b>2562</b> PRT Scanner Module, for 1560 .....	106, 108
<b>2563</b> Standards Thermistor, for 1560 .....	106, 108
<b>2564</b> Thermistor Scanner, for 1560 .....	106, 108
<b>2565</b> Precision Thermocouple Module, for 1560 .....	106, 108
<b>2566</b> Thermocouple Scanner Module, for 1560 .....	106, 108
<b>2567</b> SPRT Module, for 1560 .....	107, 108
<b>2568</b> PRT Scanner Module, for 1560 .....	107, 108
<b>2575</b> Multiplexer, 1575 .....	110-111
<b>2590</b> Multiplexer, 1590 .....	110-111
<b>2600A-904</b> Trend Link Software .....	215-216
<b>2620A</b> Hydra Data Acquisition Unit .....	209-211
<b>2620T</b> Recording Thermometer .....	166, 211
<b>2625A</b> Hydra Data Logger .....	209-211
<b>2635A</b> Hydra Data Bucket .....	209-211
<b>2635T</b> Recording Thermometer .....	166, 211
<b>2640A</b> NetDAQ Data Acquisition Unit .....	212-215
<b>2640A-911</b> NetDAQ Logger for Windows .....	212-215
<b>2640A-912</b> NetDAQ Logger w/Trending .....	212-215
<b>2645A</b> NetDAQ Data Acquisition Unit .....	212-215
<b>264XA-903</b> Developer's Toolbox (16 bit) .....	212-215
<b>2680A</b> Data Acquisition System Chassis .....	204-208
<b>2680A-904</b> Trend Link for Fluke (2680 Series, NetDAQ) .....	208, 215, 216
<b>2680A-DIO</b> Digital I/O and Relay Module .....	204-208
<b>2680A-FAI</b> Analog Input Module .....	204-208
<b>2680A-PAI</b> Analog Input Module .....	204-208
<b>2686A</b> Data Logging System Chassis .....	204-208

<b>271</b> 10 MHz DDS Function Generator .....	225-228
<b>281</b> 1 Channel 40 MS/x Arbitrary Waveform Generator .....	229-233
<b>282</b> 2 Channel, 40 MS/s Arbitrary Waveform Generator .....	229-233
<b>284</b> 4 Channel, 40 MS/s Arbitrary Waveform Generator .....	229-233
<b>291</b> 1 Channel, 100 MS/s Arbitrary Waveform Generator .....	234-238
<b>292</b> 2 Channel, 100 MS/s Arbitrary Waveform Generator .....	234-238
<b>294</b> 4 Channel, 100 MS/s Arbitrary Waveform Generator .....	234-238

**3**

<b>3560</b> Communications Module, for 1560 .....	108
<b>396</b> 1 Channel 125 MS/s Arbitrary Waveform Generator .....	239-241
<b>397</b> 2 Channel, 125 MS/s Arbitrary Waveform Generator .....	239-241

**5**

<b>5000A-RH/T</b> Humidity and Temperature Data Logger .....	165, 191
<b>5001</b> Bath Salt .....	143
<b>5010</b> Silicone Oil Type 200.05 .....	143
<b>5011</b> Mineral Oil .....	143
<b>5012</b> Silicone Oil Type 200.10 .....	143
<b>5013</b> Silicone Oil Type 200.20 .....	143
<b>5014</b> Silicone Oil Type 200.50 .....	143
<b>5017</b> Silicone Oil Type 710 .....	143
<b>5019</b> Halocarbon 0.8 Cold Bath .....	143
<b>5020</b> Ethylene Glycol .....	143
<b>5020A-H</b> Thermo-Hygrometer, High Accuracy .....	163-164, 192
<b>5020A-HKIT</b> Thermo-Hygrometer, High Accuracy Kit .....	163-164
<b>5020A-LW3</b> LogWare III Software .....	163-164
<b>5020A-S</b> Thermo-Hygrometer, Standard Accuracy .....	163-164, 192
<b>5020A-SKIT</b> Thermo-Hygrometer, Standard Accuracy Kit .....	163-164
<b>5022</b> Dynalene HF/LO .....	143
<b>5023</b> HFE Cold Bath .....	143
<b>5023</b> HFE Cold Bath Fluid .....	143
<b>5100B</b> Calibrator Emulation .....	29
<b>5121</b> Humidity Generator .....	167-168
<b>5200A</b> Calibrator Emulation .....	29, 31
<b>525A Series</b> Pressure Modules .....	36-39
<b>525A</b> Temperature/Pressure Calibrator .....	36-39

<b>525A-GPIB</b> Temperature/Pressure Calibrator.....	36-39
<b>5500/CAL</b> Automated Calibration Software.....	185-192
<b>5500A</b> Multi-Product Calibrator.....	13-20
<b>5500A-SC300</b> Oscilloscope Option.....	13, 20, 49-52
<b>5500A-SC600</b> Oscilloscope Option.....	13, 20, 49-52
<b>5520A</b> High Performance Multi-Product Calibrator.....	13-20
<b>5520A-PQ</b> Power Quality Option.....	62-65
<b>5520A-SC1100</b> Oscilloscope Option.....	13, 20, 49-52
<b>5610</b> Immersion Probe.....	122
<b>5611</b> Silicone-Bead Probe.....	122
<b>5612</b> Secondary Standard PRT.....	114-115
<b>5613</b> Secondary Standard PRT.....	114-115
<b>5614</b> Secondary Standard PRT.....	114-115
<b>5618</b> Small Diameter PRT.....	119
<b>5622</b> Fast Response PRT.....	118
<b>5623</b> Freezer Probe, RTD.....	120
<b>5624</b> Secondary Standard PRT.....	116
<b>5626</b> High-Temp PRT.....	113
<b>5627</b> Secondary PRT.....	117
<b>5628</b> High-Temp PRT.....	113
<b>5629</b> Gold-Platinum Thermocouple.....	84
<b>5640</b> Standards Thermistor Probe.....	121
<b>5641</b> Standards Thermistor Probe.....	121
<b>5642</b> Standards Thermistor Probe.....	121
<b>5643</b> Standards Thermistor Probe.....	121
<b>5644</b> Standards Thermistor Probe.....	121
<b>5649</b> Type R TC.....	123
<b>5650</b> Type S TC.....	123
<b>5665</b> Miniature Immersion Probe.....	122
<b>5674</b> Series 400 Thermistor.....	122
<b>5680-S</b> 25 $\Omega$ Working Standard Metal-Sheath SPRT.....	82
<b>5681-S</b> SPRT 25.5 $\Omega$ , 661 $^{\circ}\text{C}$ .....	80-81
<b>5682-S</b> 100 $\Omega$ Working Standard Metal-Sheath SPRT.....	82
<b>5683-S</b> SPRT 25.5 $\Omega$ , 480 $^{\circ}\text{C}$ .....	80-81
<b>5684-S</b> SPRT 0.25 $\Omega$ , 1070 $^{\circ}\text{C}$ .....	80-81
<b>5685-S</b> SPRT 2.5 $\Omega$ , 1070 $^{\circ}\text{C}$ .....	80-81
<b>5686-B</b> Glass Capsule SPRT.....	83
<b>5695-B</b> Glass Capsule SPRT.....	83
<b>5698-25</b> 25 $\Omega$ Working Standard SPRT.....	80-81
<b>5699-S</b> Extended Range Metal-Sheath SPRT.....	82
<b>5700A</b> Multifunction Calibrator.....	28-30
<b>5700A/EP</b> UG Upgrade.....	31
<b>5720A</b> Multifunction Calibrator.....	28-30
<b>5725A</b> Amplifier.....	20, 28, 29, 30
<b>5790A</b> AC Measurement Standard.....	66-68
<b>57LFC</b> ATE System Source.....	32-35
<b>5820A</b> Oscilloscope Calibrator.....	46-48
<b>5900</b> Mercury Cell, Stainless Steel.....	87-89
<b>5901</b> TPW Cell.....	85
<b>5901B</b> Mini Quartz TPW Cell.....	93
<b>5903</b> Gallium Cell, Pyrex Glass.....	87-89
<b>5904</b> Indium Cell, Quartz Glass.....	87-89
<b>5905</b> Ten Cell, Quartz Glass.....	87-89
<b>5906</b> Zinc Cell, Quartz Glass.....	87-89
<b>5907</b> Aluminum Cell, Quartz Glass.....	87-89
<b>5908</b> Silver Cell, Quartz Glass.....	87-89
<b>5909</b> Copper Cell, Quartz Glass.....	87-89
<b>5914A</b> Mini Quartz Indium Cell.....	93
<b>5915A</b> Mini Quartz Tin Cell.....	93
<b>5916A</b> Mini Quartz Zinc Cell.....	93
<b>5917A</b> Mini Quartz Aluminum Cell.....	93
<b>5918A</b> Mini Quartz Silver Cell.....	93
<b>5919A</b> Mini Quartz Copper Cell.....	93
<b>5924</b> Indium Cell, Open Quartz.....	87-89
<b>5925</b> Tin Cell, Open Quartz.....	87-89
<b>5926</b> Zinc Cell, Open Quartz.....	87-89
<b>5927A-L</b> Aluminum Cell, Open Quartz.....	87-89
<b>5927A-S</b> Aluminum Cell, Open Quartz.....	87-89
<b>5928</b> Silver Cell, Open Quartz.....	87-89
<b>5929</b> Copper Cell, Open Quartz.....	87-89
<b>5931</b> X Cell, Triple Point of Water.....	96
<b>5933</b> X Cell, Gallium.....	96
<b>5934</b> X Cell, Indium.....	96
<b>5943</b> Gallium Cell, Stainless Steel.....	87-89
<b>5944</b> Mini Metal Cased Indium Cell.....	93
<b>5945</b> Mini Metal Cased Tin Cell.....	93
<b>5946</b> Mini Metal Cased Zinc Cell.....	93
<b>6</b>	
<b>6020</b> Standard Bath.....	134-135
<b>6022</b> Standard Bath.....	134-135
<b>6024</b> Standard Bath.....	134-135
<b>6045</b> Standard Bath.....	136-137
<b>6050H</b> Standard Bath.....	136-137
<b>6054</b> Mid-Range Deep-Well Bath.....	138-139
<b>6055</b> Hi-Temp Deep-Well Bath.....	138-139
<b>6100A</b> Electrical Power Standard.....	56-61
<b>6102</b> Micro-Bath.....	147-148
<b>6120</b> 2-Phase Power Standard.....	61
<b>6130</b> 3-Phase Power Standard.....	61
<b>6140</b> 4-Phase Power Standard.....	61
<b>6330</b> Compact Bath.....	126-127
<b>6331</b> Deep Compact Bath.....	128-129

## 7

<b>700 Series</b> Pressure Modules.....	36-39
<b>7000</b> DC Voltage Reference Module.....	72-73
<b>7000S</b> 10 V External Input Module.....	72-73
<b>7001</b> DC Voltage Reference.....	72-73
<b>7004N</b> 4-Reference Nanoscan Voltage Reference System.....	72-73
<b>7004T</b> 4-Reference 'Transfer' Volt Maintenance System.....	72-73
<b>7007</b> Refrigerated Deep-Well Bath.....	138-139
<b>7008</b> Standard Bath.....	132-133
<b>7009</b> Resistor Bath, High Capacity.....	140-141
<b>7010N</b> 10-Reference Nanoscan Voltage Maintenance System.....	72-73
<b>7010T</b> 10-Reference 'Transfer' Volt Maintenance System.....	72-73
<b>7011</b> Standard Bath.....	132-133
<b>7012</b> Standard Bath.....	132-133
<b>7015</b> Resistor Bath.....	140-141
<b>7037</b> Standard Bath.....	132-133
<b>7040</b> Standard Bath.....	132-133
<b>7060</b> Standard Bath.....	130-131
<b>7080</b> Standard Bath.....	130-131
<b>7100</b> Standard Bath.....	130-131
<b>7102</b> Micro Bath.....	147-148
<b>7103</b> Micro Bath.....	147-148
<b>7108</b> Resistor Bath, Peltier-Cooled.....	140-141
<b>7196</b> LN <sub>2</sub> Comparison Calibrator.....	97
<b>720A</b> Kelvin-Varley Voltage Divider.....	76
<b>7312</b> TPW Maintenance Bath.....	86
<b>7320</b> Compact Bath.....	120-127
<b>7321</b> Deep Compact Bath.....	128-129
<b>732B</b> DC Standard.....	70-71
<b>7340</b> Compact Bath.....	126-127
<b>7341</b> Deep Compact Bath.....	128-129
<b>734A</b> DC Reference Standard.....	70-71
<b>7380</b> Compact Bath.....	126-127
<b>7381</b> Deep Compact Bath.....	128-129
<b>742A</b> Series Resistance Standards.....	74
<b>752A</b> Reference Divider.....	75
<b>792A</b> AC/DC Transfer Standard.....	77-78

## 8

<b>80</b> 50 MHz Function Generator.....	221-224
<b>81</b> 50 MHz Function/Pulse Generator.....	221-224
<b>8508A</b> Reference Multimeter.....	4-10
<b>8508A/01</b> Reference Multimeter.....	4-10

## 9

<b>9009</b> Dual-Block Dry-Well.....	151
<b>9011</b> High-Accuracy Dual-Well Calibrator.....	158-159
<b>908</b> OCXO Frequency Reference.....	180
<b>909</b> Rubidium Frequency Reference.....	180
<b>910</b> GPS-Controlled OCXO Frequency Standard..	181-184
<b>9100</b> Calibration Workstation.....	21-27
<b>9100</b> Oscilloscope Calibration Option.....	53-54
<b>9100S</b> Dry-Well.....	149-150
<b>9101</b> Zero-Point Dry-Well.....	157
<b>9102S</b> Dry-Well.....	149-150
<b>9103</b> Dry-Well.....	152-153
<b>9105</b> Low-Temp Dry-Well.....	154-156
<b>9107</b> Ultra Low-Temp Dry-Well.....	154-156
<b>910R</b> GPS-Controlled Rubidium Frequency Standard.....	181-184
<b>910X-71</b> Multiple Reference Outputs.....	184
<b>910X-72</b> 5 Additional 2.048 MHz Outputs.....	184
<b>910X-73</b> 5 Additional 13 MHz Outputs.....	184
<b>910X-75</b> 1 Additional Pulse Output 0.5 Hz to 5 MHz.....	184
<b>910X-76</b> Ethernet Interface.....	184
<b>9112-B</b> Calibration Furnace.....	161
<b>9114</b> Metrology Furnace.....	90-91
<b>9115</b> Sodium Heat Pipe Furnace.....	90-91
<b>9116</b> Three-Zone Freeze-Point Furnace.....	90-91
<b>9117</b> Annealing Furnace.....	92
<b>9122A</b> High Capacity Dry-Well.....	154-156
<b>9127-X</b> High Speed Dry-Well.....	154-156
<b>9132</b> IR Calibrator.....	160
<b>9133</b> IR Calibrator.....	160
<b>9140</b> Dry-Well.....	152-153
<b>9141</b> Dry-Well.....	152-153
<b>9150</b> Thermocouple Furnace.....	162
<b>9210</b> Mini TPW Maintenance Apparatus.....	94-95
<b>9230</b> Gallium Cell Maintenance System.....	94-95
<b>9260</b> Mini Fixed Point Furnace.....	94-95
<b>9500B/1100</b> Oscilloscope Calibrator Workstation...	41-45
<b>9500B/3200</b> Oscilloscope Calibrator Workstation.....	41-45
<b>9500B/600</b> Oscilloscope Calibrator Workstation...	41-45
<b>9930</b> Interface- <i>it</i> Software.....	193
<b>9933</b> TableWare Software.....	196
<b>9934</b> LogWare Software.....	197
<b>9934-M</b> LogWare Software.....	197
<b>9934-S</b> LogWare II Software.....	197
<b>9935-M</b> LogWare II Software.....	197
<b>9938</b> MET/TEMP II Software.....	194-195

<b>A</b>		<b>H</b>	
A40 Current Shunts .....	66, 69	Handheld Industrial Test Tools .....	242-244
A40A Current Shunts .....	66, 69	Hydra Series Portable Data Acquisition .....	209-211
Artifact Calibration .....	29, 70		
<b>B</b>		<b>I</b>	
Bath Accessories .....	144	Industrial Calibrators Selection Guide .....	145-146
Bath Fluids .....	142-143		
Bath Selection Guide .....	124-125	<b>M</b>	
BC MAGIC BASIC Software .....	191	MET/CAL <i>Plus</i> Automated Calibration	
BC MAGIC <i>PLUS</i> Software .....	191	Management Software .....	13, 41, 42, 163, 185-192
Black Stack Thermometer .....	105-108	MET/CAL-CBT7 Fluke Metrology	
		Software Computer-Based Training .....	198-199
<b>C</b>		MET/SUPPORT GOLD Product Support Program .....	42, 202
CALBOOK Calibration:		MET/TRACK Asset Management Software .....	188-192
Philosophy in Practice, Second Edition .....	199	METROLOGY XPLOERER Software .....	191
Calibration and Repair Services .....	200-201	MS-DBFIX .....	200
Calibration Documentation .....	248	MS-MIGRATE .....	200
Calibration Training Selection Guide .....	12	MS-ONSITE .....	200
Calibration Selection Guide .....	11-12	MS-PSW .....	200
CHANGE/LOG Software .....	191	<b>N</b>	
Chub-E4 Thermometer .....	103-104	NetDAQ Networked Data Acquisition System .....	212-215
Clamp Meter Selection Guide .....	243	Network SuperVision Solutions .....	245
Custom Baths .....	125		
<b>D</b>		<b>O</b>	
Data Acquisition Selection Guide .....	203	Oscilloscope Calibrator Selection Guide .....	40
Digital Multimeter Selection Guide .....	244		
Discontinued Products, support for .....	249	<b>P</b>	
<b>E</b>		PM 6681 Timer/Counter .....	170-175
E-MAIL NOTIFY Software .....	191	PM 6681R Rubidium Timer/Counter/Analyzer .....	170-175
		PM 6685 Universal Frequency Counter .....	176-179
<b>F</b>		PM 6685R Rubidium	
Fluke Networks .....	245	Frequency Counter/Calibrator .....	176-179
Fluke Biomedical .....	246	PM 6690 Timer/Counter .....	170-175
		Power Calibration Selection Guide .....	55
<b>G</b>		Power Cords .....	249
GPSView Software .....	183	Primary Temperature Standards Selection Guide .....	79
		Process Calibrator Selection Table .....	243
		<b>R</b>	
		Raytek Corporation, a Fluke Company .....	247

**S**

ScopeMeter Selection Table .....	243
Signal Sources Selection Guide .....	219
Standards Selection Guide .....	12
Super Thermometers .....	109-111

**T**

Thermography .....	242
Thermometer Probe Selection Guide .....	112
Thermometer Readout Selection Guide .....	98
Ti30 Thermal Imager .....	242
Timer Counter Selection Guide .....	169
TRC 1000 Principles of Metrology .....	198-199
TRC 1005 Cal Lab Management I .....	198-199
TRC 1006 MET/CAL Procedure Writing .....	198-199
TRC 1007 MET/CAL Database and Reports .....	198-199
TRC 1015 Cal Lab Management II .....	198-199
TRC 1016 Advanced MET/CAL Procedure Writing I .....	198-199
TRC 1017 Advanced MET/CAL Procedure Writing II .....	198-199
TRC 4001 Introduction to Measurement and Calibration .....	198-199
TRC 4002 Precision Electrical Measurement .....	198-199
TRC4003 Measurement Uncertainty .....	198-199
TRC 4004 AC/DC Metrology .....	198-199
TRC 7000 Product Specific Training .....	198-199
TWB 1021 MET/CAL Database Web-Based Training .....	198-199
TWB 1031 MET/CAL 7 Procedure Development Web-Based Training .....	198-199
Tweener Thermometer .....	101-102

**W**

Working with Fluke .....	248-249
--------------------------	---------





riešenia na presné meranie™

Elso Philips Service; tel: +421 32 6582410  
email: [else@else.sk](mailto:else@else.sk); web: [www.else.sk](http://www.else.sk)

**Fluke.** *Keeping your world  
up and running.*

**Fluke Corporation**

PO Box 9090, Everett, WA USA 98206

Fluke Europe B.V.

PO Box 1186, 5602 BD

Eindhoven, The Netherlands

For more information call:

In the U.S.A. (800) 443-5853 or

Fax (425) 446-5116

In Europe/M-East/Africa (31 40) 2 675 200

or Fax (31 40) 2 675 222

In Canada (800) 36-FLUKE or

Fax (905) 890-6866

From other countries +1 (425) 446-5500 or

Fax +1 (425) 446-5116

Web access: <http://www.fluke.com>

©2004 Fluke Corporation. All rights reserved.

Elso Philips Service changes without notice.

Printed in U.S.A. 12/2004 2162262 C-US-N Rev A