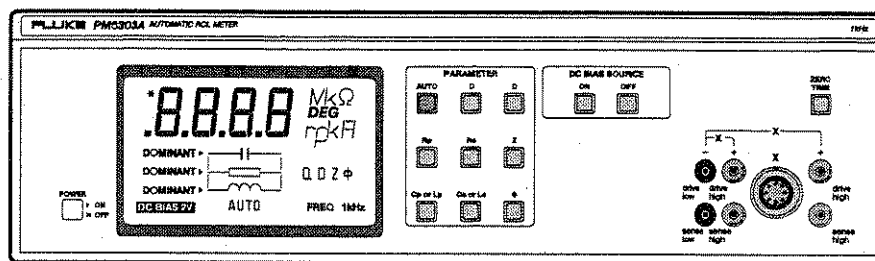


# Automatic RCL Meter

PM6303A

Users Manual

951111



**FLUKE**®

**Please note**

In correspondence concerning this instrument, please quote the type number and serial number as given on the type plate.

**Bitte beachten**

Bei Schriftwechsel über dieses Gerät wird gebeten, die Typennummer und die Gerätenummer anzugeben. Diese befinden sich auf dem Typenschild an der Rückseite des Gerätes.

**Noter s.v.p.**

Dans votre correspondance et dans vos réclamations se rapportant à cet appareil, veuillez toujours indiquer le numéro de type et le numéro de série qui sont marqués sur la plaquette de caractéristiques.

**Important**

As the instrument is an electrical apparatus, it may be operated only by trained personnel. Maintenance and repairs may also be carried out only by qualified personnel.

**Wichtig**

Da das Gerät ein elektrisches Betriebsmittel ist, darf die Bedienung nur durch eingewiesenes Personal erfolgen. Wartung und Reparatur dürfen nur von geschultem, fach- und sachkundigem Personal durchgeführt werden.

**Important**

Comme l'instrument est un équipement électrique, le service doit être assuré par du personnel qualifié. De même, l'entretien et les réparations sont à confier aux personnes suffisamment qualifiées.

The wordmark Philips and the Philips shieldemblem  
are used under licence from Philips Export B.V.

© 1995, 1996 Fluke Corporation.

All rights reserved.

Data subject to change without notice

Printed in Germany

**FLUKE**®



## CONTENTS

|   |      |
|---|------|
| Operating manual  | (GB) |
| Gebrauchsanleitung  | (D)  |
| Mode d'emploi   | (F)  |
| Instrucciones de preparación y de seguridad                 | (E)  |
| Istruzioni per la messa in funzione e norme di sicurezza    | (I)  |
| Instructies met betrekking tot de installatie en veiligheid | (NL) |
| Inledande anvisningar och säkerhetsanvisningar              | (S)  |
| Figures   |      |
| Service Centers   |      |



# USERS MANUAL



**CONTENTS**

|   | Page  |
|---|---|
| <b>SHIPMENT NOTE AND INITIAL INSPECTION</b> |   |
| <b>1</b>                                    | <b>INSTALLATION AND SAFETY INSTRUCTIONS</b> 1 - 1     |
| 1.1   | SAFETY INSTRUCTIONS 1 - 1                             |
|   | 1.1.1 Maintenance and Repair 1 - 1                    |
|   | 1.1.2 Grounding (Earthing) 1 - 2                      |
|   | 1.1.3 Connections 1 - 2                               |
|   | 1.1.4 Line Voltage Setting and Fuses 1 - 3            |
| 1.2   | OPERATING POSITION OF THE INSTRUMENT 1 - 4            |
| 1.3   | RADIO INTERFERENCE SUPPRESSION 1 - 4                  |
| <b>2</b>                                    | <b>MAIN FEATURES</b> 2 - 1                            |
| <b>3</b>                                    | <b>OPERATING INSTRUCTIONS</b> 3 - 1                   |
| 3.1   | GENERAL INFORMATION 3 - 1                             |
| 3.2   | TURNING THE INSTRUMENT ON 3 - 1                       |
| 3.3   | SELF-TEST ROUTINE 3 - 1                               |
| 3.4   | BRIEF CHECKING PROCEDURE 3 - 2                        |
|   | 3.4.1 General 3 - 2                                   |
|   | 3.4.2 Functional Test 3 - 3                           |
| 3.5   | OPERATION AND APPLICATION 3 - 5                       |
|   | 3.5.1 Control Elements, Display and Connections 3 - 5 |
|   | 3.5.2 Measurement Setup and Accessories 3 - 8         |
|   | 3.5.3 Automatic Zero Trim 3 - 13                      |
|   | 3.5.4 Component Measurement 3 - 15                    |
| 3.5.  | Out-of-Range and Error Messages 3 - 17                |
|   | 3.5.6 Component Measurement at Range Limits 3 - 18    |
| 3.6   | MEASUREMENT PRINCIPLE 3 - 21                          |
| 3.7   | SELF DIAGNOSTICS 3 - 27                               |

|          |  |              |
|----------|--|--------------|
| <b>4</b> | <b>CHARACTERISTICS</b>   | <b>4 - 1</b> |
| 4.1      | SAFETY AND EMC REQUIREMENTS  | 4 - 1        |
| 4.2      | PERFORMANCE SPECIFICATIONS   | 4 - 2        |
| 4.3      | POWER SUPPLY   | 4 - 6        |
| 4.4      | ENVIRONMENTAL CONDITIONS   | 4 - 6        |
| 4.5      | SAFETY & QUALITY DATA; CABINET   | 4 - 8        |
| 4.6      | ACCESSORIES  | 4 - 9        |
| <b>5</b> | <b>PERFORMANCE TEST</b>  | <b>5 - 1</b> |
| 5.1      | INTRODUCTION   | 5 - 1        |
| 5.2      | RECOMMENDED TEST EQUIPMENT   | 5 - 1        |
| 5.3      | SELF-TEST ROUTINE, ERROR MESSAGES  | 5 - 2        |
| 5.4      | PERFORMANCE VERIFICATION   | 5 - 2        |
| 5.4.1    | Measurement Voltage  | 5 - 2        |
| 5.4.2    | Measurement Frequency  | 5 - 3        |
| 5.4.3    | Open-Circuit Trimming  | 5 - 3        |
| 5.4.4    | Short-Circuit Trimming   | 5 - 4        |
| 5.4.5    | Resistor Measurement   | 5 - 4        |
| 5.4.6    | Capacitance/Inductance Measurement   | 5 - 5        |
| <b>6</b> | <b>LIMITED WARRANTY &amp; LIMITATION OF LIABILITY,<br/>DECLARATION OF CONFORMITY</b> | <b>6 - 1</b> |

**INSTALLATION AND SAFETY INSTRUCTIONS IN  
FOREIGN LANGUAGES**

**FIGURES**

- Fig. 1 Front view
- Fig. 2 Rear view
- Fig. 3 PM 9540/TWE, SMD Tweezers
- Fig. 4 PM 9540/BAN, 4-wire test cable with banana plugs
- Fig. 5 PM 9541A, 4-wire test cable
- Fig. 6 Single and double test posts
- Fig. 7 PM 9542SMD, SMD Adapter
- Fig. 8 PM 9542A, RCL Adapter

**SERVICE CENTERS**

0  
1  
2  
3  
4  
5  
6  
7  
8  
9  
A  
B  
C  
D  
E  
F  
G  
H  
I  
J  
K  
L  
M  
N  
O  
P  
Q  
R  
S  
T  
U  
V  
W  
X  
Y  
Z



## SHIPMENT NOTE

The following parts should be included in the shipment:

- 1 Fluke PM6303A Automatic RCL Meter 1 kHz
- 1 Users Manual
- 1 Power Cable
- 2 Fuses
- 2 Single Test Posts

## INITIAL INSPECTION

Check that the shipment is complete and note whether any damage has occurred during transport. If the contents are incomplete or there is damage, file a claim with the carrier immediately, and notify the Fluke Sales or Service organization to facilitate the repair or replacement of the instrument. The addresses are listed in the back of the manual.

The performance of this instrument can be tested by using the Performance Test in Chapter 5 of this manual.



Chapter **1**

**INSTALLATION AND SAFETY INSTRUCTIONS**



# 1 INSTALLATION AND SAFETY INSTRUCTIONS

## 1.1 SAFETY INSTRUCTIONS

Upon delivery from the factory the instrument complies with the required safety regulations (see Chapter 4). To maintain this condition and to ensure safe operation, the instructions below must be followed carefully.

### 1.1.1 Maintenance and Repair

#### **Failure and excessive stress:**

If the instrument is suspected of being unsafe, remove it from operation immediately and secure it against any unintended operation. The instrument is considered to be unsafe when any of the following conditions exist:

- It shows physical damage.
- It does not function anymore.
- It is stressed beyond the tolerable limits (e.g., during storage and transportation).

#### **Disassembling the Instrument:**

#### **WARNING**

**Calibration, maintenance, and repair of the instrument must be performed only by trained personnel who are aware of the hazards involved. To avoid electric shock, do not remove the cover unless you are qualified to do so.**

**Before removing the cover, disconnect the instrument from all power sources. The capacitors in the instrument may remain charged for several seconds after all power has been disconnected.**

### 1.1.2 Grounding (Earthing)

Before any other connection is made the instrument must be connected to a protective earth conductor via the three-wire power cable.

The power plug shall be inserted only into a grounded outlet.

Do not defeat the protective action by using an extension cord without a grounded conductor.

Do not connect a protective ground conductor into the measurement contacts on the front panel, the four contacts of the connector to which the circuit ground is applied, or the external contact of the connector plug.

#### WARNING

**Any interruption of the protective ground conductor inside or outside the instrument or disconnection of the protective ground terminal, is likely to make the instrument dangerous. Intentional interruption is prohibited.**

### 1.1.3 Connections

The circuit ground potential is applied to four of the eight contacts of the front panel connector and is connected to the instrument case via parallel-connected capacitors and a resistor. The external contact of the connector is connected to the instrument case. This avoids ac ground loops while providing good RF grounding.

If the circuit ground potential in a measurement setup is different from the protective ground potential, make sure that the four contacts of the front panel connector are not live.

#### 1.1.4 Line Voltage Setting and Fuses

Before plugging in the line cable, make sure that the instrument is set to the correct line voltage.

#### WARNING

**To avoid injury or death, changing fuses and modifying line cables to local power must be done by qualified service personnel who are aware of the hazards involved.**

On delivery from the factory, the instrument is set to one of the following line voltages:

| Type    | Code No.       | Line Voltage | Delivered Power Cable |
|---------|----------------|--------------|-----------------------|
| PM6303A | 9452 063 03101 | 220 V        | Universal Europe      |
| PM6303A | 9452 063 03103 | 120 V        | North America         |
| PM6303A | 9452 063 03104 | 240 V        | England (U.K.)        |
| PM6303A | 9452 063 03105 | 220 V        | Switzerland           |
| PM6303A | 9452 063 03108 | 240 V        | Australia             |

The line voltage setting and the corresponding fuse specification are indicated on the rear panel.

Make sure that replacement fuses are of the type and current rating specified. The use of repaired fuses and/or the short-circuiting of fuse holders are prohibited. Do not defeat this important safety feature.

The instrument can be set to the following line voltages: 100 V, 120 V, 220 V and 240 V ac. These nominal voltages can be selected by means of the voltage selector, located on the rear panel, next to the line voltage connector. The fuse is located in a holder at the same place. For line voltage selection or replacement of the fuse, remove the line cable and pry open the compartment with a small screwdriver (see illustration).





# Chapter **2**

## **MAIN FEATURES**



## 2 MAIN FEATURES

The **PM6303A Automatic RCL Meter** is used for precise measurements of resistance, capacitance and inductance. The instrument provides auto-function and auto-ranging facility. It allows fast and high precision measurements of passive components over a wide range.

The component to be measured is connected to the instrument via front panel test posts, the PM 9541A four-wire test cable, or the PM 9542A four-terminal test adapter. The Adapter PM 9542SMD or the PM 9540/TWE SMD Tweezers for surface-mounted components are also available.

The measurement result, the numerical value, dimension, and the equivalent circuit symbol, is immediately displayed on the large four-digit liquid-crystal display (LCD), which is updated at a rate of two measurements per second.

A microprocessor controls the measurement process, computes the measurement value, and transfers the result to the display.

In the AUTO mode the dominant parameter, either R, C, or L of the component under test is automatically selected for display.

For example, for an inductance with a quality factor Q between 1 and 500, the instrument indicates the measurement value of the series inductance and as equivalent circuit symbol, the series connection of a resistance and an inductance.

In addition to the AUTO mode, eight component parameters can be selected manually by pressing pushbuttons:

- Quality factor Q
- Dissipation factor D
- Parallel resistance R<sub>p</sub>
- Series resistance R<sub>s</sub>
- Impedance Z
- Parallel capacitance C<sub>p</sub> or parallel inductance L<sub>p</sub>
- Series capacitance C<sub>s</sub> or series inductance L<sub>s</sub>
- Phase angle  $\Phi$

An internal DC BIAS voltage can be added to the measurement voltage for electrolytic capacitors.

The PM6303A RCL Meter is especially suited for use in laboratories, for quality control, in service workshops, and for educational purposes.

PM6303A RCL METER

Chapter **3**

**OPERATING INSTRUCTIONS**



### 3 OPERATING INSTRUCTIONS

#### 3.1 GENERAL INFORMATION

This section outlines the procedure and precautions necessary for operation. It identifies and briefly describes the functions of the front and rear panel controls and the display, and explains the practical aspects of operation.

#### 3.2 TURNING THE INSTRUMENT ON

##### WARNING

**Before turning the instrument on, ensure that it has been installed in accordance with the instructions in Chapter 1.**

After the instrument has been connected to the line voltage in accordance with Section 1.1.4, it can be turned on by setting the **POWER** switch on the front panel to **ON**.

The specifications given in chapter 4 are valid when the instrument is installed in accordance with the instructions in chapter 1 and a warm-up period of 5 minutes.

After turning the power off, wait at least 5 seconds before turning it on again. This allows all power to completely discharge and the instrument to reset.

#### 3.3 SELF-TEST ROUTINE

After power on, the instrument performs a self-test of the PROM, processor RAM, and external RAM. After this the software version is indicated in the upper line of the display for approximately 1 second. All segments of the display field are shown for approximately 2 seconds, and the instrument automatically recalls its instrument state before power off.

A possible fault is indicated as follows:

e.g. **Err2**

The digits mean:

- 1 Program memory checksum
- 2 RAM processor
- 3 External RAM defective
- 4 Backup memory

For detailed information see Section 3.5.5.

### 3.4 BRIEF CHECKING PROCEDURE

#### 3.4.1 General

This procedure checks the instrument functions with a minimum of steps. It is assumed that the operator doing the test is familiar with the instrument and its characteristics. If this test is started within a short period after power on, test steps may be out of specification due to insufficient warm-up time.

#### WARNING

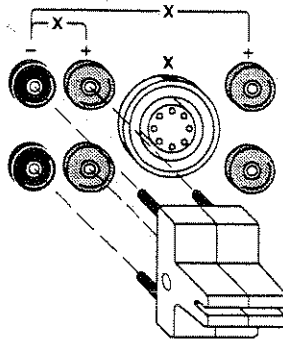
**Before turning the instrument on, ensure that it has been installed in accordance with the instruction in Chapter 1.**



### 3.4.2 Functional Test

Immediately after power on a self-test routine is performed. Then the instrument automatically recalls measurement settings prior to the last power off (see Section 3.3).

Insert the test posts supplied into the connector on the front panel (Logos face to face).



Press the green **AUTO** key.



The display shows:

AUTO

Press the **ZERO TRIM** key.



The display shows  
for approximately 3 seconds:

**BUSY**

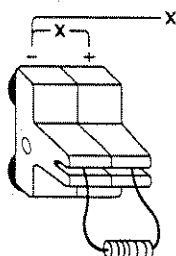
If the ZERO TRIM operation  
is unsuccessful, the display shows:  
Refer to Section 3.5.3.

**FAIL**

If the ZERO TRIM operation  
is successful, the display shows:

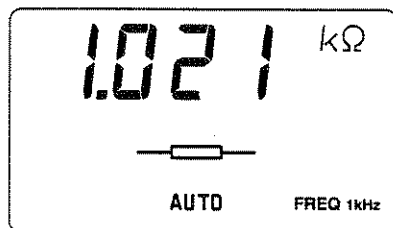
**PASS**

Insert a known component into  
the test posts, e.g., a 1 k $\Omega$  resistor.



The display shows:

When the display is correct  
the functional test is finished.



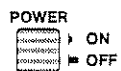
## 3.5 OPERATION AND APPLICATION

### 3.5.1 Control Elements, Display and Connections

#### 3.5.1.1 Front Panel

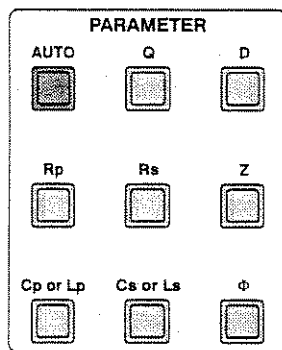
##### Keyboard

| Description | Function |
|-------------|----------|
|-------------|----------|



Power switch

Keypad used to select required measurement:



**AUTO** Automatic measurement mode:  
the dominant parameter is  
automatically displayed.

**Q** Quality factor ( $\tan \phi$ ;  $Q = 1/D$ ).

**D** Dissipation factor ( $\tan \delta$ ;  $D = 1/Q$ ).

**Rp** Parallel resistance

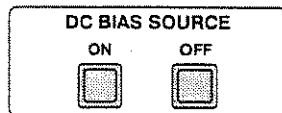
**Rs** Series resistance

**Z** Impedance (image impedance)

**Cp or Lp** Parallel capacitance/inductance

**Cs or Ls** Series capacitance/inductance

**Φ** Phase angle



Key used to switch the internal 2 V dc bias on or off (to measure electrolytic capacitors).



Key used for automatic trimming of

- Open-circuit impedance ( $>100 \text{ k}\Omega$ )
- Short-circuit impedance ( $<10 \Omega$ )

Description

Function

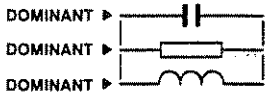
Display Section



Maximum of four digits for the measurement value. The asterisk indicates that the component is outside the 0.25 % accuracy range of the instrument.

MkΩ  
DEG  
n p k F

Display of measuring unit:  
M Ω kΩ Ω For resistances  
DEG (degree) For phase angle  
n F p F μ F m F For capacitances  
μ H m H H kH For inductances



Equivalent circuit symbols with marker for dominant component.

Q D Z φ

Display of selected parameter  
Q : Quality factor  
D : Dissipation factor  
Z : Impedance  
φ : Phase angle

DC BIAS 2V

Indication that internal bias voltage is turned on.

AUTO

Automatic measurement of dominant parameter.

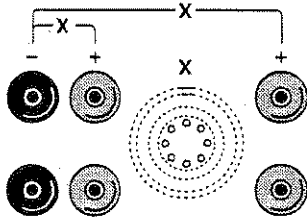
FREQ 1kHz

Measurement frequency 1 kHz (fixed).

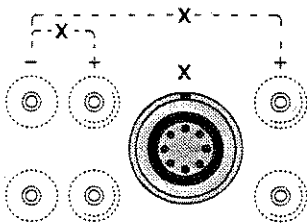
PM6303A

| Description | Function |
|-------------|----------|
|-------------|----------|

**Connections**

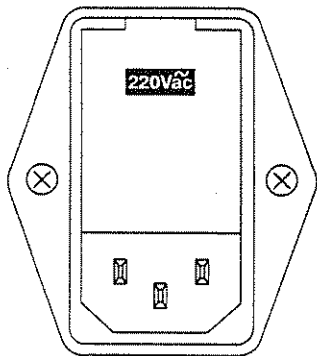


- Connectors for
- Test posts for four-wire measurement.
  - PM 9542SMD, SMD ADAPTER



- Connector for
- PM 9541A 4-wire Kelvin Clip Test Cable
  - PM 9542A RCL Adapter
  - PM 9540/TWE, SMD TWEEZERS
  - PM 9540/BAN, 4-WIRE TEST CABLE with banana plugs

**3.5.1.2 Rear Panel**



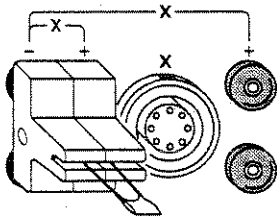
Input power module with fuse and voltage selector.  
 ~ ac (alternating current).  
 For details, see Section 1.1.4:  
 Line Voltage Setting and Fuses.

### 3.5.2 Measurement Setup and Accessories

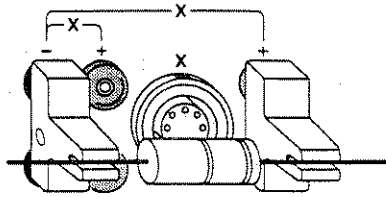
For best accuracy, you should perform ZERO TRIM (see Section 3.5.3) when you change the measurement setup.

#### Test posts

Most common components can be measured with the supplied test posts plugged into the front panel connectors.



Radial-Lead Component

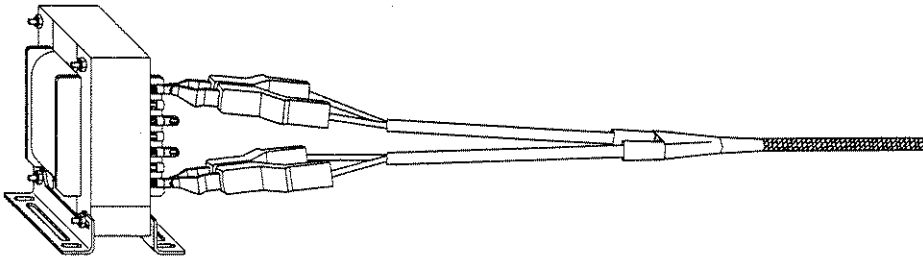


Axial-Lead Component

#### PM 9541A Test Cable with Kelvin Clips

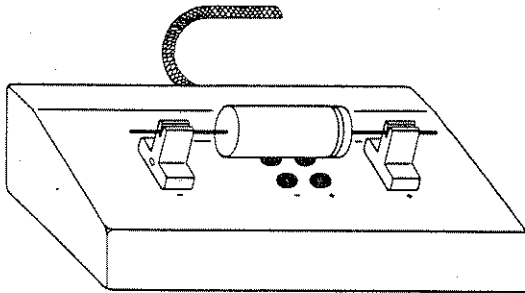
Use the test cable to measure in-circuit components or components of large size.

The test cable is connected to the instrument via the round plug (red markings face to face). The plug locks automatically. To unlock the plug, pull on the ridged part.



### PM 9542A RCL Adapter

The RCL adapter allows you to make component measurements away from the front panel of the instrument. The RCL adapter can also handle larger components than the front panel connector can.



The RCL adapter is connected to the instrument via the round plug on the front panel (red markings face to face).

The supplied single test posts and the double test post can also be directly inserted into the front panel connector of the instrument.

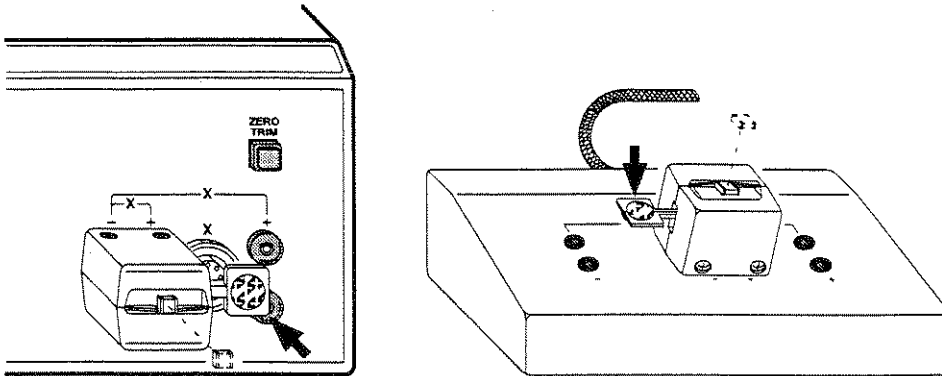
**Note:** For accurate measurements you should insert only the test posts, cable, or adapter that you need for the actual measurement.

### PM 9542SMD, SMD Adapter

The SMD adapter can be used to measure SMD components with a length of 2 to 10 mm, depth >1 mm, height >0.5 mm, or a diameter >1 mm.

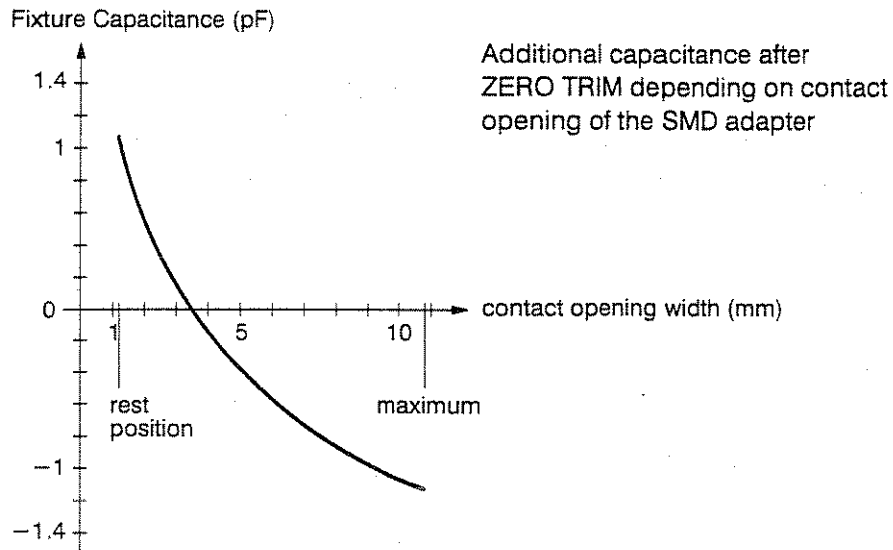
For easy and quick insertion and removal of components, insert the SMD adapter into the PM 9542A RCL Adapter.

You can also insert the SMD adapter directly into the front panel connector of the instrument. To ease insertion of components, set the instrument in a sloping position (handle folded down)



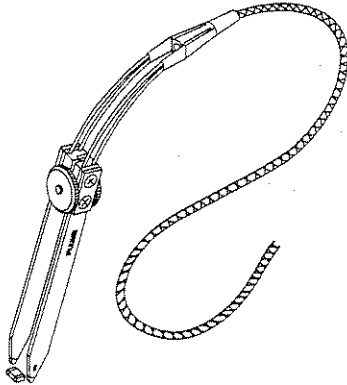
When you use the SMD adapter to measure very small capacitances especially below 100 pF, you must take into account the alteration of the stray fixture capacitances, depending on the separation of the contacts.





### PM 9540/TWE SMD Tweezers

Use the SMD Tweezers to measure single SMD components or in-circuit SMD components.



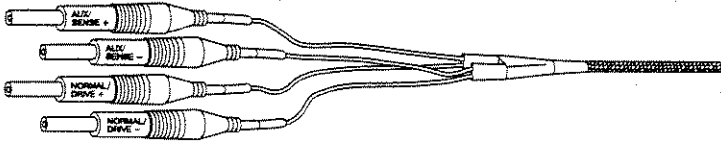
The SMD Tweezers are connected to the instrument via the round plug on the front panel (red marking face to face).

For open-circuit trimming when you are measuring small capacitances, set the opening of the tweezers to the size of the component.

The two-wire measuring technique and the pressure applied by the tips of the tweezers can cause a measuring error in addition to the basic error of the RCL Meter, due to the additional serial resistance (typical  $0.02 \Omega$ ). The presence of dirt or contaminants on the tips of the tweezers can also affect measurements. The tips may be periodically cleaned with alcohol and a non-abrasive cloth.

### PM 9540/BAN Test Cable with Banana Plugs

Use the test cable if you need banana plugs for your own special applications.

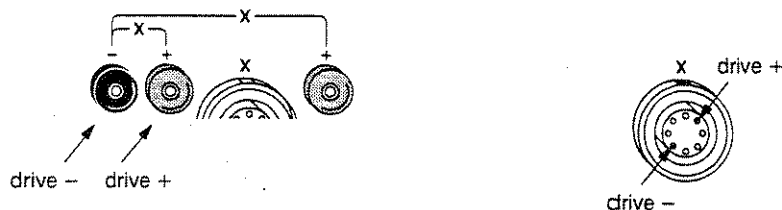


The test cable is connected to the instrument via the round plug on the front panel (red marking face to face).

When you perform ZERO TRIM short-circuit DRIVE+ with SENSE+ and DRIVE- with SENSE- for the open-circuit trimming. Short-circuit all four plugs for the short-circuit trimming.

### Two-Wire Measurements

You can measure components with normal test leads in two-wire mode by using the upper two connectors. To reduce stray capacitances and interferences, use short leads. These connections are also available on the eight-pole round connector.



The technical specifications given in chapter 4 are valid for four-wire measurements, which are particularly important for low resistance components and large capacitances.

#### 3.5.3 Automatic Zero Trim

When pressing the **ZERO TRIM** key for approximately 2 seconds the instrument performs an impedance measurement of the measurement setup and stores the value determined. The display shows **PR55**. For all further measurements this value will be taken into consideration. **To ensure best measuring accuracy you should perform ZERO TRIM when you change the measurement setup.**

If you press the **ZERO TRIM** key with a component connected with an impedance of  $<10 \Omega$  or  $>100 \text{ k}\Omega$ , the value of the component will be taken into consideration. At open or short-circuited contacts of the measurement setup the instrument now indicates a negative resistance value, for instance, or an inductance in case of a connected capacitance (or a capacitor in case of a an inductance.) Please perform ZERO TRIM once again without any component connected in order to obtain correct values.

The TRIM data are stored in a memory and will persist even if the instrument is switched off.

### Short-Circuit Trimming

For measuring low impedances, below  $100\ \Omega$  in particular, please short-circuit the contacts of the measurement setup and press the **ZERO TRIM** key for approximately 2 seconds. The display shows **bU5Y**. The instrument now performs a measurement and stores the value determined, which is the short circuit impedance. The display shows **PR55**. For all further measurements this value is taken into consideration, including the line and contact impedances.

If during short circuit trimming the measured impedance is  $>10\ \Omega$ , **FRIL** will be displayed.

### Open-Circuit Trimming

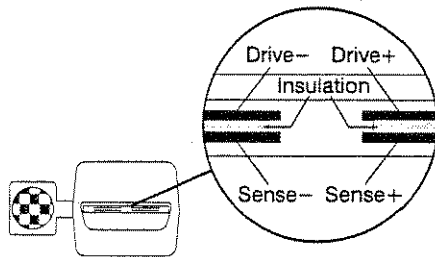
When you measure low capacitances the open-circuit impedance of the measurement setup may affect the result. Remove any connected component and press the **ZERO TRIM** key for approximately 2 seconds. The display shows **bU5Y**. The instrument again performs a measurement considering the value determined, which is the open-circuit impedance, for all following measurements. The display shows **PR55**.

If the impedance measured during open-circuit trimming is  $<100\ \text{k}\Omega$ , the display shows **FRIL**.

For the **ZERO TRIM** the contacts **DRIVE+** and **SENSE+** as well as **DRIVE-** and **SENSE-** should be connected. As far as the adapters available from Fluke are concerned, this is normally ensured automatically, except for the PM 9540/BAN cable and for the PM 9542SMD SMD Adapter.

If you use the PM 9540/BAN cable in your own special application short-circuit **DRIVE+** with **SENSE+** and **DRIVE-** with **SENSE-** for the open-circuit trimming. Short-circuit all four plugs for the short-circuit trimming.

As far as the SMD Adapter is concerned the contacts are insulated from each other. The contacts are only closed when a component is inserted.

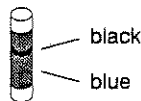


Contacts of the PM 9542SMD, SMD Adapter

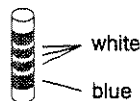
To perform ZERO TRIM at an open adapter with the DRIVE/SENSE contacts connected, the SMD Adapter is equipped with SMD components with an impedance of  $Z \rightarrow \infty$ . Please use this component for open-circuit trimming. For short-circuit trimming you can use one of the attached components with an impedance of  $Z \rightarrow 0 \Omega$ . These components have a real resistance of typical 4 m $\Omega$ . You should take into account this value if you measure low impedances.

If you need spare sets you can order them via your Service Organization with the following number: 5322 310 32275.

$Z \rightarrow 0 \Omega$



$Z \rightarrow \infty$



### 3.5.4 Component Measurement

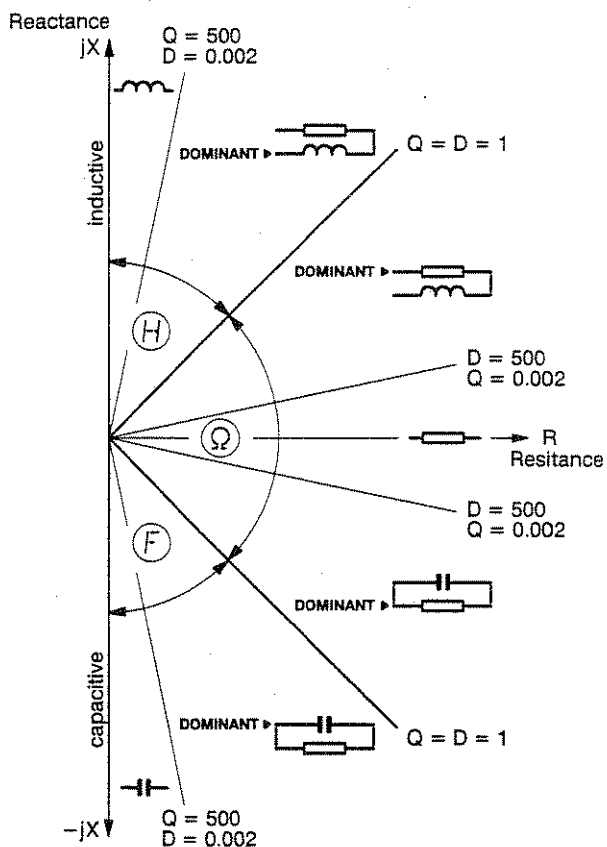
Choose a convenient measurement setup (see Section 3.5.2) and, if necessary, press the **ZERO TRIM** key. Insert the component.

**CAUTION:** To avoid damage of the instrument discharge capacitors with high residual charge (>5 V) before connecting them to the instrument.

After power on, the instrument automatically recalls measurement settings prior to the last power off. The measurement frequency is 1 kHz fixed.

In most cases you will be interested in the dominant parameter of the component under test. This is automatically detected and displayed in AUTO mode. Press the green **AUTO** key. The display shows AUTO, the value of the dominant parameter and the appropriate equivalent circuit symbol.

The decision criterion for defining the dominant parameter is  $Q = D = 1$  (see Section 3.6). Values  $Q$  and  $D$  are related to the internal measurement frequency 1 kHz.



AUTO Mode Decision Diagram

If you want to display any other parameter, press the appropriate key:

|                 |  |
|-----------------|--|
| <b>Q</b>        | Quality factor ( $\tan \phi$ ; $Q = 1/D$ )       |
| <b>D</b>        | Dissipation factor ( $\tan \delta$ ; $D = 1/Q$ ) |
| <b>Rp</b>       | Parallel resistance                              |
| <b>Rs</b>       | Series resistance                                |
| <b>Z</b>        | Impedance (image resistance)                     |
| <b>Cp or Lp</b> | Parallel capacitance/inductance                  |
| <b>Cs or Ls</b> | Series capacitance/inductance                    |
| $\Phi$          | Phase angle                                      |

Electrolytic capacitors should be measured with the internal bias voltage on. Press the **DC BIAS ON** key; the display shows **DC BIAS 2V**.

### 3.5.5 Out-of-Range and Error Messages

The center segments of the digits flash when the following limits are exceeded:

- Resistances > 200 M $\Omega$
- Capacitances > 100 mF
- Inductances > 20 kH
- Quality/dissipation factor > 500

The segments also flash when **DC BIAS** is switched on during measurement of resistors or inductors, indicating that direct current is being sourced to the component.

The asterisk in front of the digits indicates that the measured component is outside the 0.25 % accuracy range of the instrument.

During operation the instrument checks the trim data, the measurement range setting, the counter, and the communication to the storage register. Errors are indicated as follows:

|             |                                    |
|-------------|------------------------------------|
| <b>Err3</b> | External RAM defective             |
| <b>Err5</b> | Trim data error                    |
| <b>Err6</b> | Error of measurement range setting |
| <b>Err7</b> | Counter overflow                   |
| <b>Err8</b> | Error of reference measurement     |

1, 2, and 4 are error messages that occur during power-on; see Section 3.3.

### 3.5.6 Component Measurement at Range Limits

As described in previous chapters, in AUTO mode the instrument determines and displays the dominant parameter of the component under test. The measurement frequency determines whether the reactance or the resistance is dominant. PM6303A measures at 1 kHz. You must take this into account when you measure low-resistance capacitors and inductors or high value resistors. For example, a 10 M $\Omega$  resistor may appear to be more capacitive than resistive to the instrument because the shunt capacitance across the resistor is dominant.

#### Lossy inductors:

When you measure small lossy inductances, the series loss resistance is often identified as the dominant parameter and is displayed, because at 1 kHz, the series reactance is very low. Therefore, for Ls or Lp display, press **Cs** or **Ls** or the **Cp** or **Lp** key.

#### Lossy capacitors with high capacitance, e.g. electrolytic capacitors:

Because the reactance of large capacitors is very low, the series resistance may be dominant, resulting in  $Q < 1$  and display of the parallel resistance Rp. Therefore, for capacitance display, press **Cp** or **Lp** or the **Cs** or **Ls** key.

#### High-resistance resistors:

When you measure resistors in the higher M $\Omega$  range, the parasitic parallel capacitance may be displayed as the dominant parameter. Press **Rp** or **Rs** to display the resistance value.

#### Large inductance paralalled by a parasitic capacitance:

The resonant frequency of the component may be below the measurement frequency of 1 kHz. At 1 kHz the component represents a capacitance, and the display shows a parallel capacitance as the dominant parameter.



### Large inductors in the kHz range:

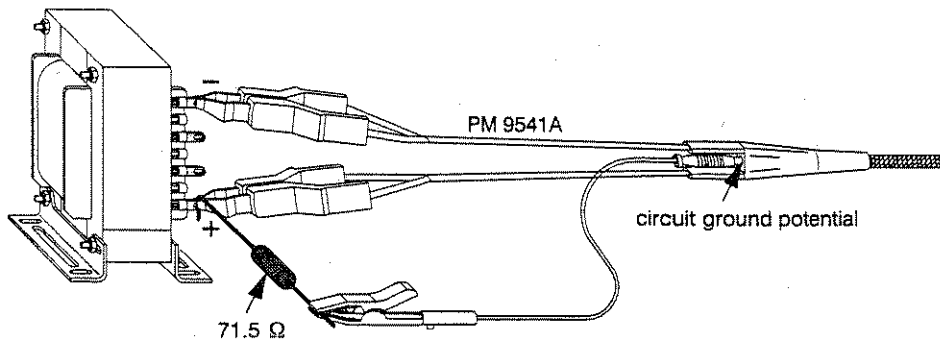
The measurement result may be influenced by relatively small parallel capacitances. Be sure to use the **ZERO TRIM** function to remove stray capacitance effects from the fixture.

### Inductors with ferromagnetic cores:

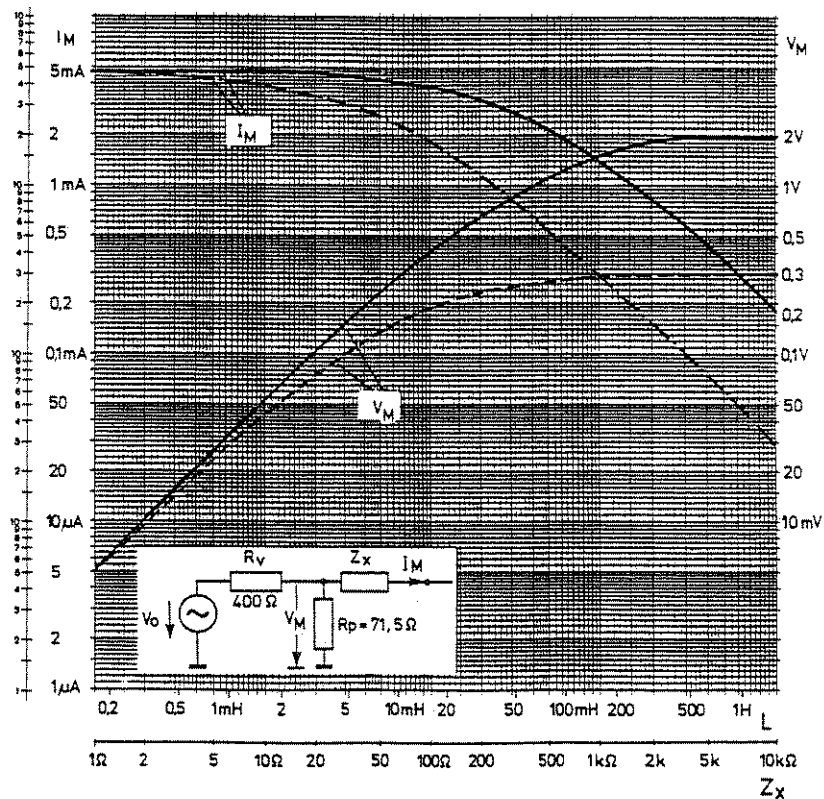
When you measure inductors with ferrite cores the inductance decreases with increasing voltage and current amplitudes due to saturation effects. Smaller test signals may be required.

In the PM6303A, the open-circuit voltage is 2 Vrms with 400  $\Omega$  internal resistance. The impedance of the component determines the amplitudes. For lower amplitudes, an additional resistor  $\geq 71.5 \Omega$  may be connected between measurement output and circuit ground potential. For this the PM 9541A 4-Wire Kelvin Clip Test Cable is best suited.

Adding this resistor lowers the drive level through the voltage divider relationship as shown in the following illustrations.



For a parallel resistor of 71.5 Ω the following diagram shows the measurement voltage and current as a function of the test component impedance. The error limit in the inductance range shown increases to a maximum of 0.5 % with this load resistor.



Ignoring the impedance of the component under test you can calculate  $R_p$  for different drive levels  $V_M$ :

$$V_M = \frac{R_p}{R_p + 400 \Omega} \times V_o \quad V_o = 2 \text{ V}$$

### 3.6 MEASUREMENT PRINCIPLE

The component measurement is based on the current and voltage technique. The component voltage and the component current are measured and converted into binary values. The CPU calculates the electrical parameters of the component from these values. Depending on the parameters that were selected on the front panel, either the dominant parameter is automatically displayed (in **AUTO** mode resistance, capacitance, or inductance) or the selected parameter is displayed.

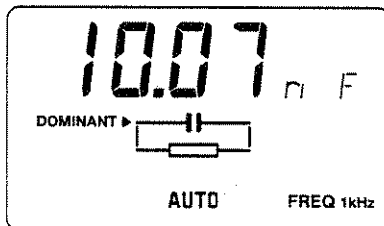
Each measurement cycle lasts approximately 0.5 seconds and consists of five single measurements, the results of which are stored and arithmetically evaluated. Finally the result is transferred to the display. The five single measurements are as follows:

#### 1. Reference measurement

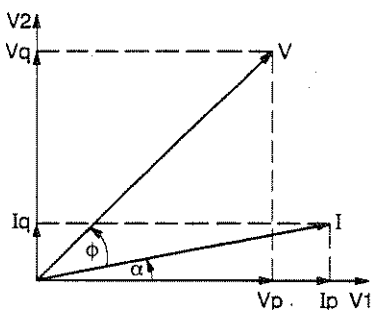
At the beginning of each measurement cycle, a reference measurement is performed. The measured value serves as reference for the subsequent four measurements.

2. Voltage measurement:  $0^\circ$
3. Voltage measurement:  $90^\circ$
4. Current measurement:  $0^\circ$
5. Current measurement:  $90^\circ$

At the end of the single measurements, the five measured values are stored. Using the measurement values, the microprocessor calculates the equivalent series resistance  $R_s$ , the equivalent series reactance  $X_s$ , and the quality factor  $Q = X_s/R_s$  of the component. In **AUTO** mode, the microprocessor determines the dominant parameter,  $R_s$ ,  $R_p$ ,  $C_p$ , or  $L_s$ , calculates its value, and displays it together with the equivalent circuit symbol. If one of the other parameters is manually selected, this parameter is calculated and displayed. After that the next measurement cycle starts with the next five single measurements.



The following phase diagrams and formulas show the mathematic basics for internal calculation of the component value.



V: voltage  
 I: current  
 V1, V2: 0°-voltage, 90°-voltage

The phase angle between I and V is  $\phi$ .  
 The phase angle between I and V1 is  $\alpha$ .

In the diagram the phase relation between I and V happens to be a lossy inductance.

In each measurement cycle, the following components are determined:

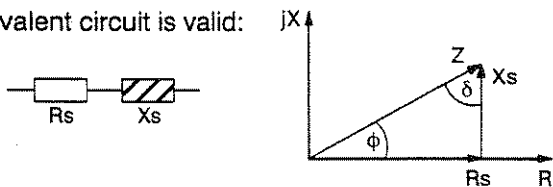
$V_p, V_q, I_p, I_q$ .

The series resistance and reactance are calculated from these components.

$$R_s = \frac{V_p I_p + V_q I_q}{I_p^2 + I_q^2} \quad (1)$$

$$X_s = \frac{V_q I_p - V_p I_q}{I_p^2 + I_q^2} \quad (2)$$

The following equivalent circuit is valid:



Quality factor:  $Q = \tan\phi = 1/D = \frac{|X_s|}{R_s} \quad (3)$

Dissipation factor:  $D = \tan\delta = 1/Q = \frac{|R_s|}{X_s} \quad (4)$

The magnitude of Q and the sign of  $X_s$  determine which parameter of the component is dominant.

- $X_s$  positive = inductive
- $X_s$  negative = capacitive

The formulas for the various parameters are as follows:

$$Q = \frac{|X_s|}{R_s} \quad \text{see equation (3)}$$

$$Z = \sqrt{R_s^2 + X_s^2}$$

$$D = \frac{1}{Q}$$

$$C_p = \frac{1}{\omega(1 + 1/Q^2)|X_s|} \quad \text{if } X_s < 0$$

$$R_p = (1 + Q^2) \times R_s$$

$$L_p = \frac{(1 + 1/Q^2)|X_s|}{\omega} \quad \text{if } X_s > 0$$

$R_s$  see equation (1)

$$C_s = \frac{1}{\omega|X_s|} \quad \text{if } X_s < 0$$

$$L_s = \frac{|X_s|}{\omega} \quad \text{if } X_s > 0$$

$$\text{Impedance } Z = R + jX$$

$$\text{Admittance } Y = 1/Z$$

#### Example:

By using the five measurements, the instrument has calculated  $R_s$  and  $X_s$  in accordance with formulas 1 and 2, for example,

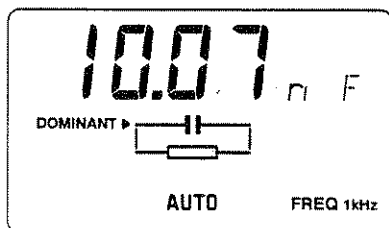
$$R_s = 3.037 \text{ k}\Omega$$

$$X_s = -15.197 \text{ k}\Omega$$

From this the instrument calculated:

$$Q = \frac{|X_s|}{R_s} = 5.004$$

The instrument displays the corresponding equivalent circuit symbol with the dominant parameter, according to the criteria of the Auto Mode Decision Diagram on page 3 - 16; in this case, as  $X_s$  is negative and  $1 < Q < 500$ :



The calculation of the dominant parameter  $C_p$  was done according to the following formula:

$$C_p = \frac{1}{\omega(1 + 1/Q^2)|X_s|}$$

$$C_p = \frac{1}{2\pi \times 1 \text{ kHz} (1 + 1/5.004^2) \times 15.197 \text{ k}\Omega} = 10.068 \text{ nF}$$

The maximum display is four digits  $\pm 1$  digit tolerance.

Calculation of the other selectable parameters are performed as follows:

$$D = \frac{1}{Q} = \frac{1}{5.004} = 0.199$$

$$R_p = (1 + Q^2) \times R_s = (1 + 5.004^2) \times 3.037 \text{ k}\Omega = 79.08 \text{ k}\Omega$$

$$R_s = 3.037 \text{ k}\Omega \text{ (calculated by the instrument according to formula 1)}$$

$$Z = \sqrt{R_s^2 + X_s^2} = \sqrt{(3.037 \text{ k}\Omega)^2 + (15.197 \text{ k}\Omega)^2} = 15.497 \text{ k}\Omega$$

$$C_s = \frac{1}{\omega|X_s|} = \frac{1}{2\pi \times 1 \text{ kHz} \times 15.197 \text{ k}\Omega} = 10.472 \text{ nF}$$

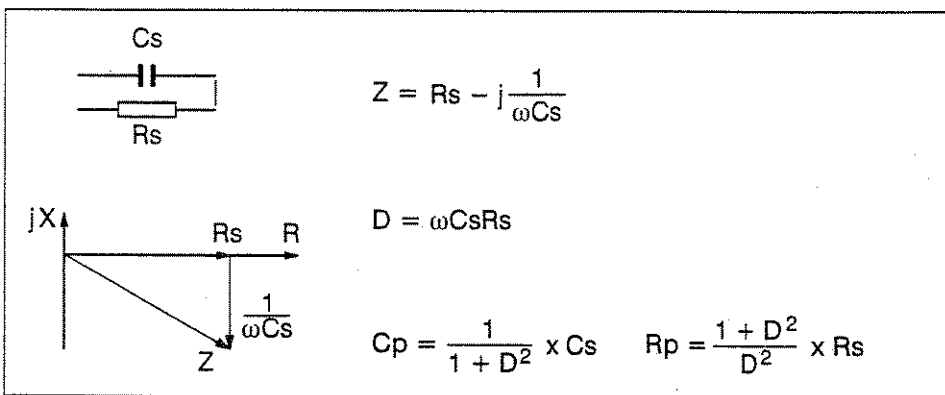
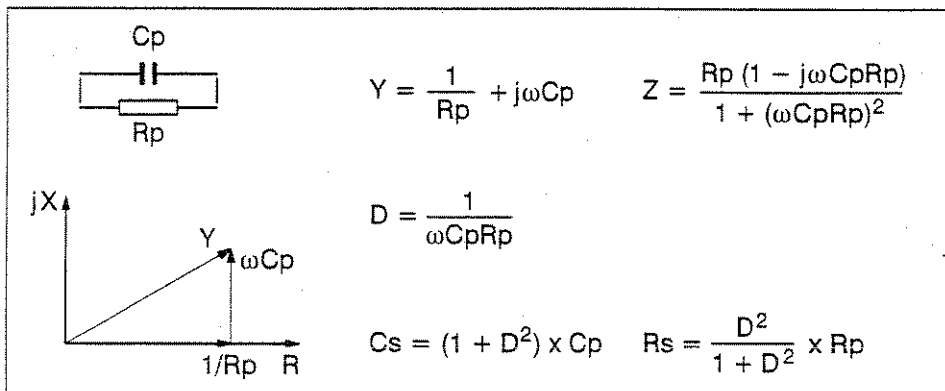
$\Phi$ : The instrument calculates

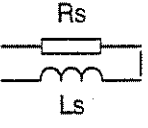
$$\tan \Phi = \frac{|X_s|}{R_s} = \frac{15.197 \text{ k}\Omega}{3.037 \text{ k}\Omega} = 5.004$$

and gets  $\Phi$  from an internal tangent table similar to a calculator

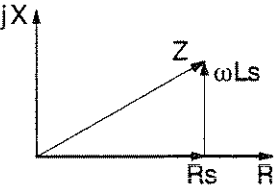
$$\Phi = -78.7 \text{ DEG}$$

If you are interested in mathematics, the following two pages show the phasor diagrams and formulas for the various components as an appendix.



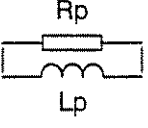


$Z = R_s + j\omega L_s$

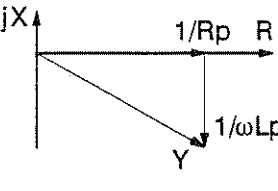


$D = \frac{R_s}{\omega L_s}$

$L_p = (1 + D^2) \times L_s$        $R_p = \frac{1 + D^2}{D^2} \times R_s$



$Y = \frac{1}{R_p} - j\frac{1}{\omega L_p}$        $Z = \frac{R_p (1 + jR_p/\omega L_p)}{1 + (R_p/\omega L_p)^2}$



$D = \frac{\omega L_p}{R_p}$

$L_s = \frac{1}{1 + D^2} \times L_p$        $R_s = \frac{D^2}{1 + D^2} \times R_p$



### 3.7 SELF DIAGNOSTICS

The test program contains the following six subprograms:

- Pro 1* Display test
- Pro 2* Keyboard test
- Pro 3* Storage register test
- Pro 4* Test of the single measurement steps
- Pro 5* Test of a measurement cycle
- Pro 6* Test of measurement range settings

Tests 4, 5, and 6 serve as an aid to the Service Technician for trouble shooting. In-circuit measurements with an open instrument are necessary; therefore, those tests are described in the Service Manual.

Press the **AUTO** key, while turning the instrument on. After the power-on routine the letters **TEST** appear in the display, then the menu of subprograms Pro 1 to 6 appears. Press any key briefly to select and carry out the test required. Press a key again for about 1 second to return to the subprogram menu. To leave the test program, turn the instrument off.

#### Program 1: Display Test

The display test checks the liquid crystal display and the respective decoders/drivers. When the text *Pro 1* appears in the subprogram menu, press a key. All segments of the display are switched on one after the other. You can stop and release the test with any key. The instrument then waits with the total display lit up until you press any key to return to the submenu or until you leave the test program.

### Program 2: Keyboard Test

This test checks the function of each key as well as those of the keyboard encoder.

Press any key when the text **Prø?** appears in the submenu; the display shows **b[od**. If you briefly press any key in random, the current number of this key appears in the display alone with a control number, e.g., **2-3** when key **Q** is pressed. This control number is generated by the keyboard encoder and can be changed to 0, 1, 2, or 3 by pressing this key again. The keys are numbered row by row from left to right. For example, the **ZERO TRIM** key has the number 6; and the **Z** key has number 9. To return to the subprogram menu, press any key for one second.

### Program 3: Memory Register Test

This test checks the memory for the storage of instrument settings and trim data (**ZERO TRIM**). The contents of this memory are not written over or deleted during the test and can be used as usual when the test has been completed.

The test runs automatically. The display shows **rEE** and then shows **PA55** at the end of the test. If the test finds an error, the display shows **E r r**. Press any key to return to the subprogram menu.

To leave the test program, turn the instrument off.



Chapter **4**

**CHARACTERISTICS**



## 4 CHARACTERISTICS, SPECIFICATIONS

### 4.1 SAFETY AND EMC REQUIREMENTS

The PM6303A Automatic RCL Meter DC – 1 MHz is

**in accordance with EN 61010-1,**

**respectively IEC 1010-1 (safety requirements),**

an instrument for measurement and test including accessories

- intended for professional, industrial process, and educational use.
- Overvoltage Category II, Pollution Degree 1.
- a Class I equipment.

**in accordance with EN 55011,**

**respectively CISPR 11 (radio interference suppression),**

an ISM equipment (industrial, scientific, and medical RF-equipment)

- of Group I,  
which intentionally generates and/or uses conductively coupled radio frequency energy which is necessary for the internal functioning of the equipment itself.
- of Class B,  
suitable for use in domestic establishments and in establishments directly connected to a low voltage power supply network which supplies buildings used for domestic purposes.

**in accordance with EN 50082-1 (radio frequency immunity)**

an instrument for use in all locations which

- are characterized by being supplied directly at low voltage from the public mains.
- are considered to be residential, commercial or light-industrial, both indoor and outdoor.

### 4.2 PERFORMANCE SPECIFICATIONS

Properties expressed in numerical values with stated tolerance are guaranteed by the manufacturer. Specified non-tolerance numerical values indicate those that could be nominally expected from the mean of a range of identical instruments. This specification is valid after the instrument has warmed up for 5 minutes. For reference conditions, see Sections 4.3 and 4.4.

|                                       |  |  |
|---------------------------------------|--|--|
| <b>PARAMETERS</b>                     | <b>AUTO</b>  | For AUTO the dominant  |
| 9 pushbuttons for the parameters      | Q Quality factor<br>D Dissipation factor<br>Rp<br>Rs<br>Z<br>Cp or Lp<br>Cs or Ls<br>Φ Phase angle | parameter R, C, or L is automatically determined.  |
| <b>DC BIAS SOURCE</b>                 | 2 V<br>ON and OFF  | Internal bias voltage for galvanic non-conducting components, e.g., electrolytic capacitors. |
| <b>Meas. voltage (rms)</b>            | 2 V ±0.2 V   | Voltage source with 2 V open-circuit voltage and 400 Ω internal resistance.                  |
| <b>Max. measurement current (rms)</b> | 5 mA ±0.5 mA   |  |
| <b>Meas. frequency</b>                | 1 kHz ±0.025 %   | Fixed  |
| <b>Meas. update rate</b>              | 2 measurements per second.   |  |

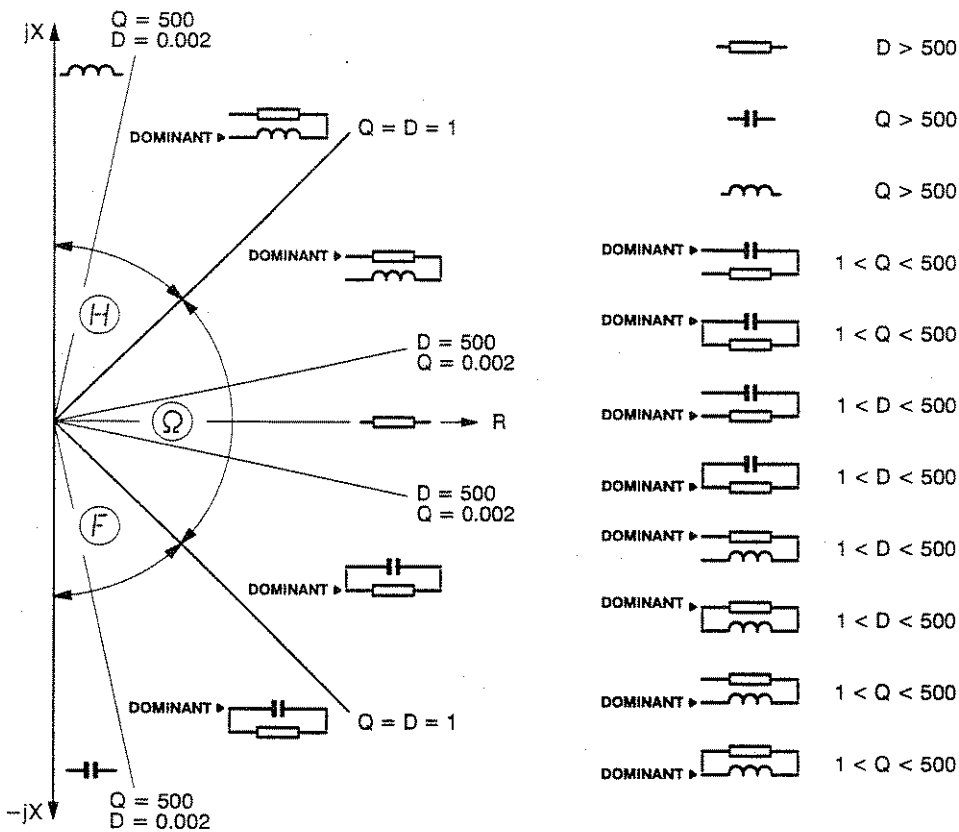


**Display** LCD: liquid-crystal backlit display

**Measurement value** Maximum 4 digits

**Units**  $\Omega$ , k $\Omega$ , M $\Omega$ ,  
pF, nF,  $\mu$ F, mF  
 $\mu$ H, mH, H, kH  
DEG

11 equivalent circuit symbols.



Equivalent circuit symbol and dominant parameter in the sectors of the phasor plane (AUTO mode).

|                           |                                  |        |  |
|---------------------------|----------------------------------|--------|--|
| <b>Measurement ranges</b> | 0.000 $\Omega$ to 200 M $\Omega$ | R, Z   | } Overrange indicated<br>by flashing of the<br>center segments<br>of the four digits |
|                           | 0.0 pF to 100 mF                 | C      |  |
|                           | 0.0 $\mu$ H to 32 kH             | L      |  |
|                           | 0.002 to 500                     | Q, D   |  |
|                           | -90.0 to +90.0 DEG               | $\Phi$ |  |

- ZERO TRIM key**
- For open adapter compensation of the open-circuit impedance if this is  $> 100 \text{ k}\Omega$ .
  - For short-circuit adapter compensation of short-circuit impedance if this is  $< 10 \Omega$ .

**Component connection**

4-wire connection by Kelvin clips via:

- Test posts, inserted into the front panel banana sockets.
- PM 9541A, 4-WIRE TEST CABLE
- PM 9542A, RCL ADAPTER
- PM 9542SMD, SMD ADAPTER

PM 9540/BAN, 4-WIRE TEST CABLE with banana plugs.

2-wire connection by PM 9540/TWE, SMD TWEEZERS.

**Front panel connector**

Six 2 mm connector  
8-pole round connector

Max. ext. DC voltage  $\pm 5 \text{ V}$  Between each connector.

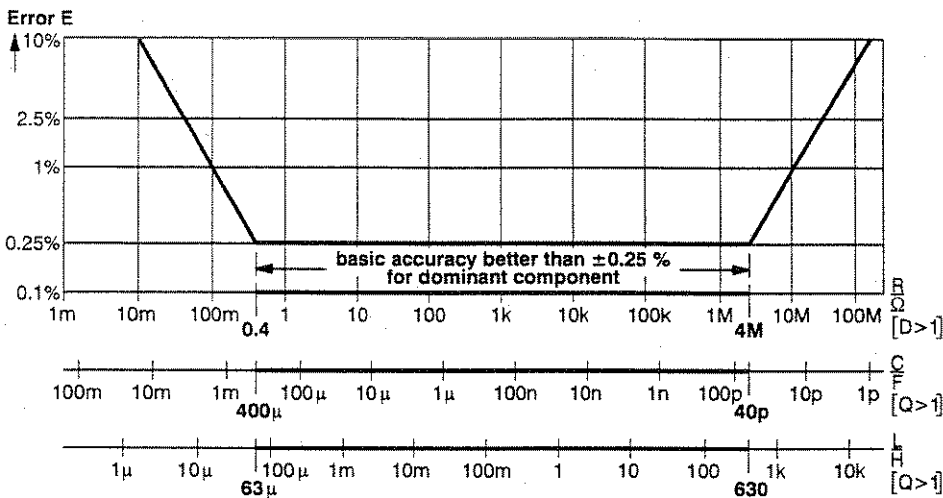


**Meas. accuracy** Data are valid for 4-wire component connection and after ZERO TRIM as described.

|                          |                          |                                 |            |
|--------------------------|--------------------------|---------------------------------|------------|
| Limit for basic accuracy | $\pm 0.25\% \pm 1$ digit | R: 0.4 $\Omega$ to 4 M $\Omega$ | D $\geq 1$ |
| for dominant R, C, L,    |                          | C: 40 pF to 400 $\mu$ F         | Q $\geq 1$ |
| and for Z.               |                          | L: 63 $\mu$ H to 630 H          | Q $\geq 1$ |
|                          |                          | Z: 0.4 $\Omega$ to 4 M $\Omega$ |            |

The asterisk \* on display lights if component exceeds measurement range for basic accuracy. For example, a 10 pF capacitor can be measured with < 1.5 % accuracy.

Accuracy limits for error E  $\pm 1$  digit  
domin. R, C, L and for Z  
in total meas. range



|                        |                     |                    |
|------------------------|---------------------|--------------------|
| Accuracy limits        | E x Q $\pm 1$ digit | For R, Q $\geq 1$  |
| for secondary R, C, L, | E x D $\pm 1$ digit | For C and L, D > 1 |
| and for Z              | E $\pm 1$ digit     | For Z              |

Accuracy limits  
For Q  $\geq 1$  E x (1 + Q)  $\pm 1$  digit  
D > 1 E x (1 + D)  $\pm 1$  digit  
 $\Phi$  1.2 x E  $\pm 1$  digit

E = Error

See figure above.

### 4.3 POWER SUPPLY

#### AC power

- Nominal voltage rms 100 V, 120 V, 220 V, or 240 V  
selectable at power input connector.
- Reference voltage 220 V  $\pm$  2 %
- Operating limits nominal voltage  $\pm$  10 %
- Nominal frequency range 50 Hz to 100 Hz  
– Operating limit 47.5 to 105 Hz
- Power consumption 16 VA
- Power cable versions Alternatively supplied for
  - Universal Europe
  - North America
  - England (U.K.)
  - Switzerland
  - Australia

### 4.4 ENVIRONMENTAL CONDITIONS

#### Ambient temperature:

- Reference value +23 °C  $\pm$  1 K
- Nominal working range + 0 °C to +50 °C
- Storage and transport range -40 °C to +70 °C

#### Relative humidity:

- Reference range 45 % to 75 %
- Nominal working range 20 % to 80 %
- Limit range of use 10 % to 90 %
- Range for storage and transport 0 % to 90 %

## Air pressure

- Reference value 1013 hPa
- Nominal working range 800 to 1060 hPa

## Air speed

- Reference range 0 to 0.2 m/s
- Nominal working range 0 to 0.5 m/s

## Heat radiation

Direct sunlight radiation not allowed.

## Vibration

- Limits for storage and transport Max. amplitude 0.35 mm, max. acceleration 5 g (10 to 150 Hz)

## Functional shock

MIL-T-28800D

- Acceleration 20 g

## Operating position

Normally upright on feet or with tilt bale extended

## Warm-up time

5 minutes

**4.5 SAFETY & QUALITY DATA; CABINET**

|                    |  |
|--------------------|--|
| Safety             | According to EEC regulation 73/23,<br>HD 401 S1,<br>IEC 348 Ed. 2, CSA 22.2 no. 231.   |
| Protection type    | IP 20 (IEC 529)  |
| Protection class   | Class I, protective conductor (IEC 348).   |
| EMC                | According to EEC regulation 89/336.<br>Emission according to EN 55 011,<br>Group 1, Class B,<br>respectively CISPR 11.<br>Immunity according to EN 50 082-1,<br>inclusive IEC 801-2, -3, -4. |
| Call rate          | < 0.05 units per year  |
| MTBF (calculated)  | 35,000 hours   |
| Cabinet dimensions | <ul style="list-style-type: none"><li>▪ Width 315 mm (12.4")</li><li>▪ Height 105 mm (4.13")</li><li>▪ Depth 405 mm (15.9")</li><li>▪ Weight 3.8 kg (8.4 lb)</li></ul>                       |

**4.6 ACCESSORIES**

**STANDARD ACCESSORIES**

- Power cable
- Fuses
- Test post red 5322 264 30351
- Test post black 5322 264 30352
- Users Manual 4822 872 10158

**OPTIONAL ACCESSORIES**

- PM 9540/BAN, 4-WIRE TEST CABLE with banana plugs
- PM 9540/TWE, SMD TWEEZERS
- PM 9541A, 4-WIRE TEST CABLE
- PM 9542A, RCL ADAPTER with 2 single test posts and 1 double test post
- PM 9542SMD, SMD ADAPTER
- PM 9563, RACK MOUNT KIT (3E high)
- PM 9564, RACK MOUNT KIT (2E high)
- Service Manual 4822 872 15161
- Test Set 5322 310 10634



Chapter **5**

**PERFORMANCE TEST**





## 5 PERFORMANCE TEST

### 5.1 INTRODUCTION

This chapter describes the performance test for the key parameters of the PM6303A RCL Meter using the instrument specifications in Chapter 4 as the performance standard.

These performance tests may be used as an acceptance test upon receipt of the instrument, as an indication that repair and/or adjustment is required, or as a performance verification after repair or adjustment of the instrument.

The PM6303A must be warmed up with all covers in place for at least 5 minutes before starting the tests. The reference conditions, described in Sections 4.3 and 4.4, must be met.

### 5.2 RECOMMENDED TEST EQUIPMENT

AC rms Voltmeter      FLUKE 8920A  
 DC Voltmeter          Philips PM 2535  
 Counter                 PHILIPS PM 6665

For the voltmeter and counter, no critical specification is required.

2 Single Test Posts      PM6303A standard accessory

Test Set of precision metal film resistors and capacitor, code no. 5322 264 30353.

| Quantity | Component Value          | Max. Tolerance for Test         |
|----------|--------------------------|---------------------------------|
| 1        | R 1 $\Omega$ (see label) | $\pm 0.05$ % (of labeled value) |
| 1        | R 34.8 $\Omega$          | $\pm 0.05$ %                    |
| 1        | R 3.48 k $\Omega$        | $\pm 0.05$ %                    |
| 1        | R 34.8 k $\Omega$        | $\pm 0.05$ %                    |
| 1        | R 348 k $\Omega$         | $\pm 0.05$ %                    |
| 1        | R 3 M $\Omega$           | $\pm 0.05$ %                    |
| 1        | R 100 M $\Omega$         | $\pm 1$ %                       |
| 1        | C 10 nF (see label)      | $\pm 0.05$ % (of labeled value) |

If you use your own test components, the values of which are exactly known, the test result must be calculated accordingly (instrument tolerance is  $\pm 0.25$  %, or  $\pm 5$  % for 100 M $\Omega$ , each  $\pm 1$  digit).





**Test result:** 1.8 to 2.2 V rms

- Connect the DC voltmeter to pin 8 and pin 1.
- Set PM6303A to DC BIAS ON.

**Test result:** 1.8 to 2.2 V dc

#### 5.4.2 Measurement Frequency

**Test equipment:** Counter

- Press the **DC BIAS OFF** key.
- Set counter to 1 s gate time.
- Connect counter with tips between pin 8 and 1 of the round connector.

**Test result:** 999.75 to 1000.25 Hz

#### 5.4.3 Open-Circuit Trimming

- Insert the two single test posts into the **two left** positions (logos face to face).
- Press the **Cp** or **Lp** key.
- Press the **ZERO TRIM** key.

**Test result:**

The display shows **BUSY PASS** and finally **0.0 pF**

- Press the **Rp** key.

**Test result:**

The display shows overrange **— — — — (flashing)**

#### 5.4.4 Short-Circuit Trimming

- Short circuit the test posts by a clean wire, with a minimum diameter of 1 mm.
- Press the **Rs** key.
- Press the **ZERO TRIM** key.

#### Test result:

The display shows **BUSY** **PASS** and finally **0.000  $\Omega$**

#### 5.4.5 Resistor Measurement

- Set the PM6303A to AUTO.

For test 1, the 1  $\Omega$  resistor must completely be inserted into the test posts.

The **test result** is calculated in accordance with the instrument tolerance ( $\pm 0.25\%$  or  $\pm 5\%$  for 100 M $\Omega$ ) and the resolution of the display,  $\pm 1$  **digit** in general.

| Test | Component Value          | Instrument Accuracy | Test Result                                |
|------|--------------------------|---------------------|--|
| 1    | R 1 $\Omega$ (see label) | $\pm 0.25\%$        | Value on label<br>$\pm 0.25\% \pm 1$ digit |
| 2    | R 34.8 $\Omega$          | $\pm 0.25\%$        | 34.70 to 34.90 $\Omega$                    |
| 3    | R 3.48 k $\Omega$        | $\pm 0.25\%$        | 3.470 to 3.490 k $\Omega$                  |
| 4    | R 34.8 k $\Omega$        | $\pm 0.25\%$        | 34.70 to 34.90 k $\Omega$                  |
| 5    | R 348 k $\Omega$         | $\pm 0.25\%$        | 347.0 to 349.0 k $\Omega$                  |
| 6    | R 3 M $\Omega$           | $\pm 0.25\%$        | 2.992 to 3.009 M $\Omega$                  |
| 7    | R 100 M $\Omega$         | $\pm 5\%$           | 94.9 to 105.1 M $\Omega$                   |

#### 5.4.6 Capacitance/Inductance Measurement

After the measurement accuracy is checked by precision resistors, it is necessary to test the capacitance/inductance measurement function by only one capacitor measurement or by one dissipation factor measurement with one of the resistors:

| Test | Component Value                 | Instrument Accuracy | Test Result   |
|------|---------------------------------|---------------------|---|
| 8    | 10 nF; exact value<br>see label | $\pm 0.25\%$        | Value on label<br>$\pm 0.25\% \pm 1$ digit  |
| or   |                                 |                     |   |
| 9    | 3.48 k $\Omega$                 | not applicable      | -----<br>flashing display<br>indicates overrange,<br>i.e., dissipation factor<br>>500 |

If you cannot meet the test result for test 8 it might be that the test capacitor has drifted from its labeled original value. Please check whether the capacitor should be measured again.

The measurement uncertainty must be  $< 0.02\%$ .

You can also order a new capacitor; code number 5322 126 13738.

The original measurement date is indicated on the bag for the capacitor.

The capacitance drift is specified to  $< 0.2\%$  in 3 years.

According to our experience the drift is much lower:  $< 0.04\%$  in 3 years.

There are no capacitors with lower drift at the low price of this capacitor on the market.

If you have access to a low-drift standard capacitor in your calibration laboratory or elsewhere, please make use of.



Chapter **6**

**LIMITED WARRANTY & LIMITATION OF LIABILITY**

**DECLARATION OF CONFORMITY**





## 6 LIMITED WARRANTY & LIMITATION OF LIABILITY

Each Fluke product is warranted to be free from defects in material and workmanship under normal use and service. The warranty period is one year and begins on the date of shipment. Parts, product repairs and services are warranted for 90 days. This warranty extends only to the original buyer or end-user customer of a Fluke authorized reseller, and does not apply to fuses, disposable batteries or to any product which, in Fluke's opinion, has been misused, altered, neglected or damaged by accident or abnormal conditions of operation or handling. Fluke warrants that software will operate substantially in accordance with its functional specifications for 90 days and that it has been properly recorded on non-defective media. Fluke does not warrant that software will be error free or operate without interruption.

Fluke authorized resellers shall extend this warranty on new and unused products to end-user customers only but have no authority to extend a greater or different warranty on behalf of Fluke. Warranty support is available if product is purchased through a Fluke authorized sales outlet or Buyer has paid the applicable international price. Fluke reserves the right to invoice Buyer for importation costs of repair/replacement parts when product purchased in one country is submitted for repair in another country.

Fluke's warranty obligation is limited, at Fluke's opinion, to refund of the purchase price, free of charge repair, or replacement of a defective product which is returned to an Fluke authorized service center within the warranty period.

To obtain warranty service, contact your nearest Fluke authorized service center or send the product, with a description of the difficulty, postage and insurance prepaid (FOB Destination), to the nearest Fluke authorized service center. Fluke assumes no risk for damage in transit. Following warranty repair, the product will be returned to Buyer, transportation prepaid (FOB Destination). If Fluke determines that the failure was caused by misuse, alteration, accident or abnormal condition of operation or handling, Fluke will provide an estimate of repair costs and obtain authorization before commencing the work. Following repair, the product will be returned to the Buyer transportation prepaid and the Buyer will be billed for the repair and return transportation charges (FOB Shipping Point).

GB

THIS WARRANTY IS BUYER'S SOLE AND EXCLUSIVE REMEDY AND IS IN LIEU OF ALL OTHER WARRANTIES, EXPRESS OR IMPLIED, INCLUDING BUT NOT LIMITED TO ANY IMPLIED WARRANTY OF MERCHANTABILITY OR FITNESS FOR A PARTICULAR PURPOSE. FLUKE SHALL NOT BE LIABLE FOR ANY SPECIAL, INDIRECT, INCIDENTAL OR CONSEQUENTIAL DAMAGES OR LOSSES, INCLUDING LOSS OF DATA, WHETHER ARISING FROM BREACH OF WARRANTY OR BASED ON CONTRACT, TORT, RELIANCE OR ANY OTHER THEORY.

Since some countries or states do not allow limitation of the term of an implied warranty, or exclusion or limitation of incidental or consequential damages, the limitations and exclusions of this warranty may not apply to every buyer. If any provision of this Warranty is held invalid or unenforceable by a court of competent jurisdiction, such holding will not affect the validity or enforceability of any other provision.

product32994rjm

Fluke Corporation  
P.O. Box 9090  
Everett, WA  
98206-9090  
USA

Fluke Industrial B.V.  
P.O. Box 680  
7600 AR  
Almelo  
The Netherlands



**FLUKE.**

**DECLARATION OF CONFORMITY**

for

**FLUKE**  
**Automatic RCL Meter**  
**PM 6303A**

**Manufacturer**

Fluke Deutschland GmbH  
Meiendorfer Str. 205  
D-22145 Hamburg  
Germany

**Statement of Conformity**

Based on test results using appropriate standards, the product is in conformity with  
Electromagnetic Compatibility Directive 89/336/EEC  
Low Voltage Directive 73/23/EEC

**Sample tests**

Standards used:

EN 55011 (1992)

Radio Frequency Product-Family Emission Standard

EN 50082-1 (1992)

Electromagnetic Compatibility; Generic Immunity Standard:  
IEC 801-2 (1984), IEC 801-3 (1984), IEC 801-4 (1988)

HD 401 S1 (1988)

Safety Requirements for Electronic Measuring Apparatus:  
IEC 348 (1978)

The tests have been performed in a typical configuration.

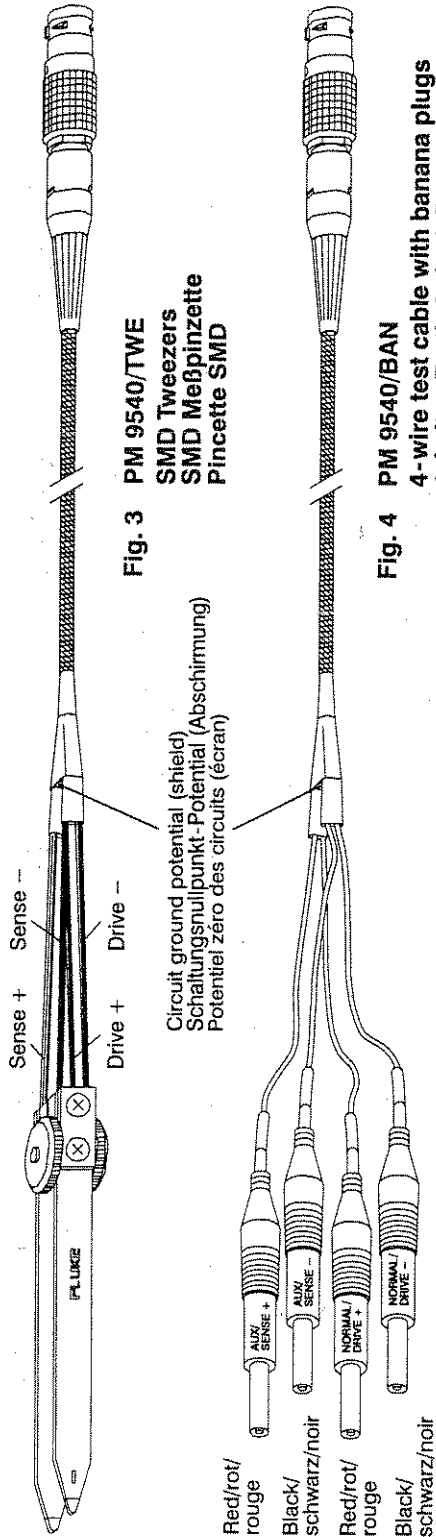
This Conformity is indicated by the symbol **CE**, i.e. "Conformité européenne".



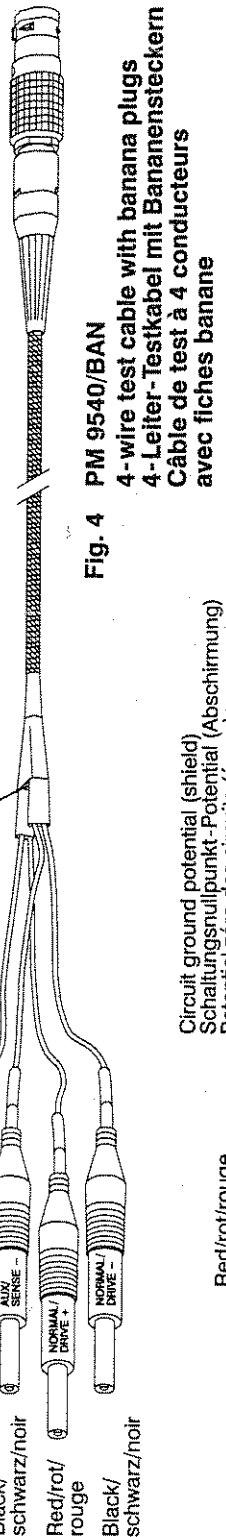
**FIGURES**

**SERVICE CENTRES**

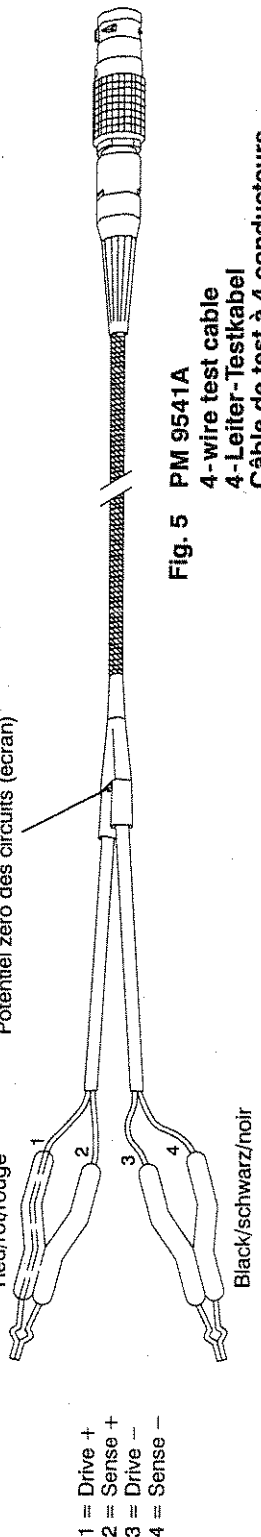




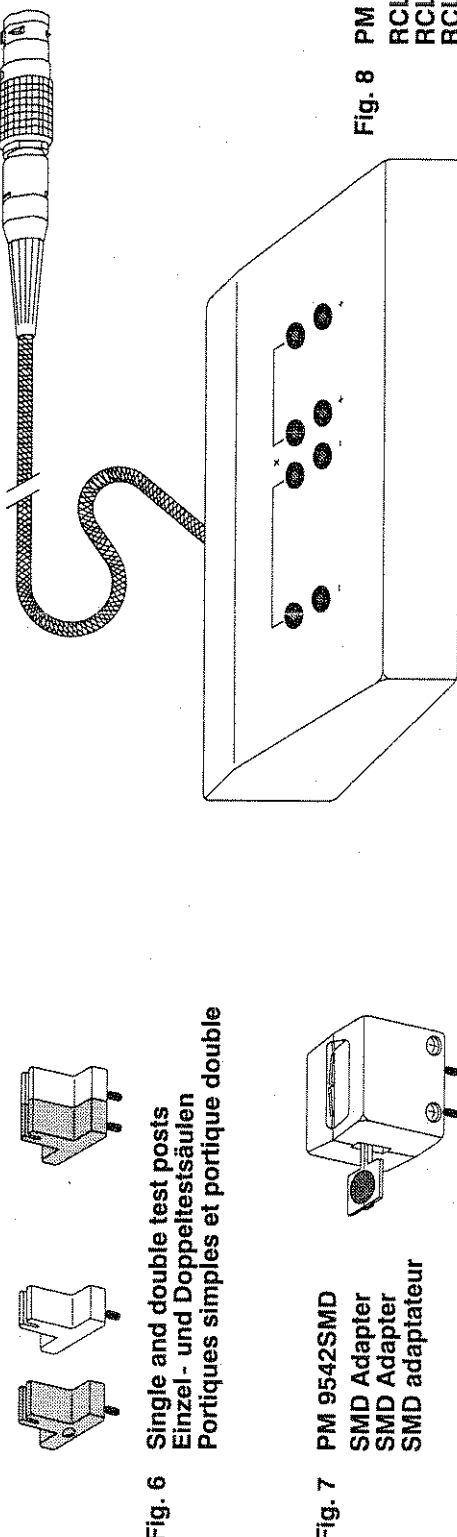
**Fig. 3 PM 9540/TWE**  
**SMD Tweezers**  
**SMD Meßpinzette**  
**Pincette SMD**



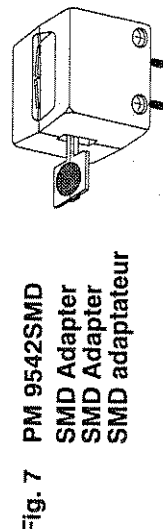
**Fig. 4 PM 9540/BAN**  
**4-wire test cable with banana plugs**  
**4-Leiter-Testkabel mit Bananensteckern**  
**Câble de test à 4 conducteurs avec fiches banane**



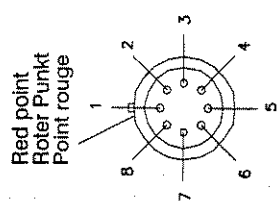
**Fig. 5 PM 9541A**  
**4-wire test cable**  
**4-Leiter-Testkabel**  
**Câble de test à 4 conducteurs**



**Fig. 6 Single and double test posts**  
**Einzel- und Doppeltestsäulen**  
**Portiques simples et portique double**



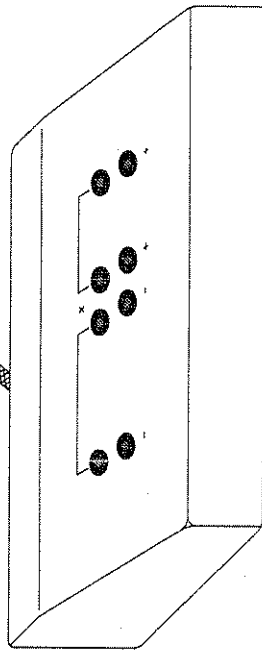
**Fig. 7 PM 9542SMD**  
**SMD Adapter**  
**SMD Adapter**  
**SMD adaptateur**



**View into the plug**  
**Blick in den Stecker**  
**Vue avant du prise**

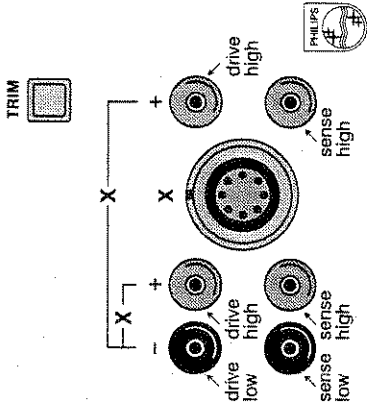
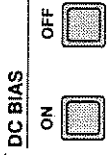
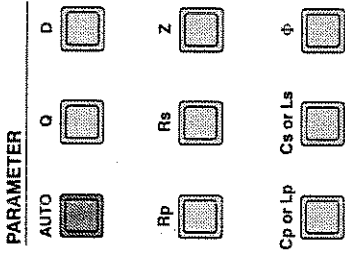
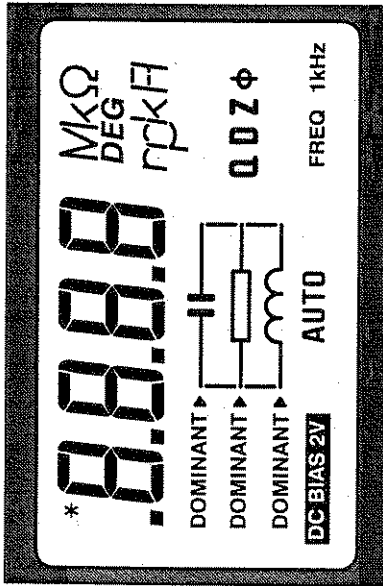
- Pin 1 = Shield of sense - / circuit ground
- Pin 2 = Sense -
- Pin 3 = Shield of drive -
- Pin 4 = Drive -
- Pin 5 = Shield of Sense +
- Pin 6 = Sense +
- Pin 7 = Shield of Drive +
- Pin 8 = Drive +

**Fig. 8 PM 9542A**  
**RCL Adapter**  
**RCL Adapter**  
**RCL adaptateur**



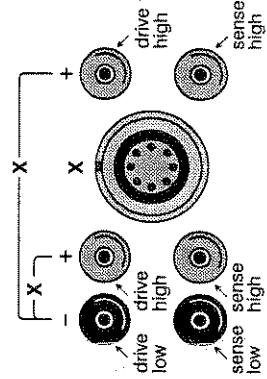
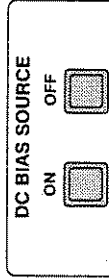
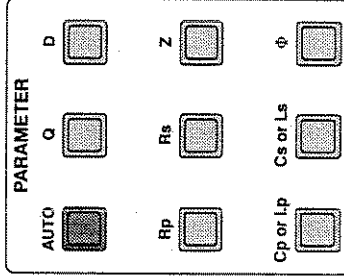
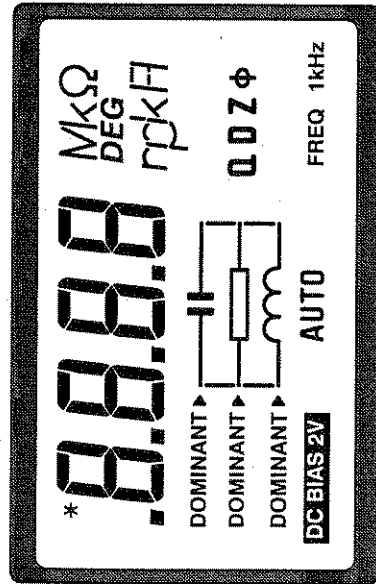






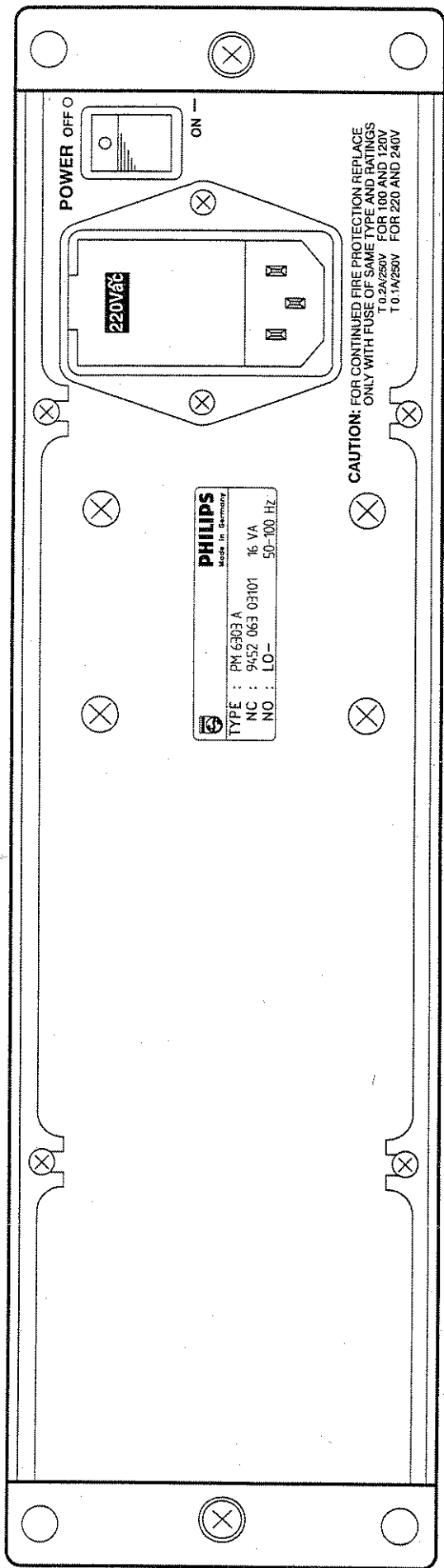
until serial number LO 646 605

Fig. 1  
Front view  
Frontansicht  
Face avant



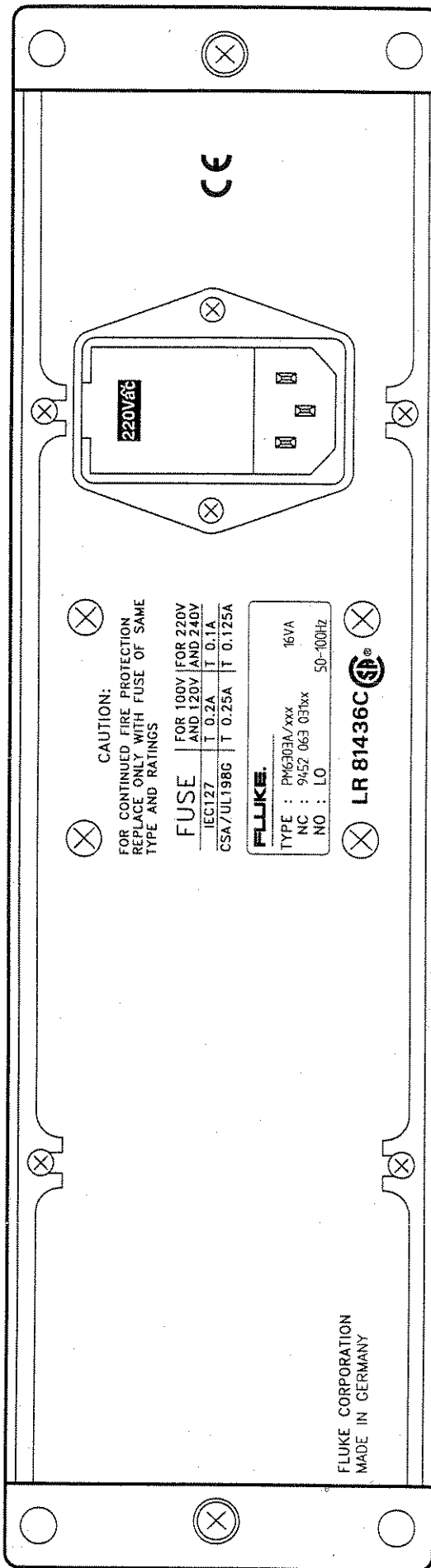
onwards serial number LO 646 606





until serial number LO 646 605

Fig. 2  
 Rear view  
 Rückansicht  
 Face arrière



onwards serial number LO 646 606



## SERVICE CENTERS

### Argentina

Viditec S.A.  
Lacarra 234  
Buenos Aires CP 1407  
Phone: +54-1-636-1200  
Fax: +54-1-636-2185

### Australia

Philips Scientific & Industrial,  
Pty., Ltd.  
34 Waterloo Road  
North Ryde, N.S.W. 2113  
Phone: +61-2-888-8222  
Fax: +61-2-888-0440

### Austria

Fluke Vertriebsges GmbH  
Südbrandstraße 7  
P.O. Box 10  
A 1232 Wien  
Phone: +43-1-61410-30  
Fax: +43-1-61410-10

### Bahrain

Mohammed Fakhroo & Bros.  
P.O. Box 439 Bahrain  
Phone: +973-253529  
Fax: +973-275996

### Belgium

N.V. Fluke Belgium S.A.  
Sales & Service Department  
Langeveldpark - Unit 5 & 7  
P. Basteleusstraat 2 - 4 - 6  
1600 St. Pieters-Leeuw  
Phone: +32-2-331-2777  
[Ext 218]  
Fax: +32-2-331-1489

### Bolivia

Coasin Bolivia S.R.L.  
Casilla 7295  
Calle Ayacucho No. 208  
Edificio Flores, 5to. Piso  
La Paz  
Phone: +591-2-317531  
Fax: +591-2-317545

### Brazil

Sistest  
Av. Ataulfo De Paiva  
135 S/ 1117 - Leblon  
22.449-900 - Rio De Janeiro  
Phone: +55-21-259-5755  
Fax: +55-21-259-5743

### Brazil

Sigtron Instrumentos E. Servicos  
Ltda  
Rua Alvaro Rodrigues  
269 - Brooklin  
Sao Paulo  
Phone: +55-11-240-7359  
Fax: +55-11-533-3749

### Brazil

Philips Medical Syst., Ltda.  
Av. Interlagos North  
3493 - Campo Grande  
04661-200 Sao Paulo S.P.  
Phone: +55-11-523-4811  
Fax: +55-11-524-4873 (ID2148)

### Bulgaria

Ac Sophico  
Customer Support Services  
P.O. Box 42  
1309 Sofia  
Phone: +359-2-292-1815  
Fax: +359-2-292-1915

### Canada

Fluke Electr. Canada, Inc.  
400 Britannia Road East, Unit #1  
Mississauga, Ontario  
L4Z 1X9  
Phone: +1-905-890-7600  
Fax: +1-905-890-6866

### Chile

Intronica  
Instrumentacion Electronica  
S.A.C.I  
Guardia Vieja 181 Of. 503  
Casilla 16500  
Santiago 9  
Phone: +56-2-232-3888  
Fax: 56-2-231-6700

### China

Fluke Int'l Corporation  
Room 2111 Scite Tower  
Jianguomenwai Dajie  
Beijing 100004, Prc  
Phone: +86-10-512-3436  
Fax: +86-10-512-3437

### China

China Academy Of Science  
Guangzhou Institute Of  
Ele. Researc  
100 Xian Lie Road Central  
Guangzhou  
Phone: +86-20-776-9464  
Fax: +86-20-776-9464

### Colombia

Sistemas E Instrumentacion, Ltda.  
Calle 83, No. 37-07 Barrio Patria  
Ap. Aereo 29583 Bogota  
Phone: +57-1-635-7266  
Fax: +57-1-623-3334

### Costa Rica

Electronic Engineering, S.A.  
Carretera De Circunvalacion  
Sabanilla Av. Novena  
P.O. Box 4300-1000  
San Jose  
Phone: +506-\*253-3759  
Fax: +506-\*225-1286

### Countries not listed

For Eastern Europe And Middle  
East  
Export Sales  
Science Park Eindhoven 5110  
5692 EC Son  
The Netherlands  
Phone: +31-402-678 265  
Fax: +31-402-678 260

### Croatia

Kaitim - Zagreb  
Fluke Sales & Service  
Draga 8  
41425 Sveta Jana  
Phone: +385-41-837115  
Fax: +385-41-837237

### Cyprus

D. Ouzounian, M. Soultanian & Co.  
P.O. Box 1775  
Nicosia  
Phone: +357-2-442220  
Fax: +357-2-459885

### Czech Republic

Eiso  
NA. Berance 2  
16000 Prague 6  
Phone: +42-2-316-4810  
Fax: +42-2-364-986

## SERVICE CENTERS

### Czech Republic

Eiso  
Branch Office  
Opátova 17a  
63700 Brno  
Phone: +42-5-41220263  
Fax: +42-5-524742

### Denmark

Fluke Danmark A/S  
Ejby Industrivej 40  
DK 2600 Glostrup  
Phone: +45-43-44-1900  
Fax: +45-43-43-9192

### Ecuador

Proteco Coasin Cia., Ltda.  
Av. 12 de Octubre 2449 y  
Orellana  
P.O. Box 17-03-228-A  
Quito  
Phone: +593-2-230283  
Fax: +593-2-561980

### Egypt

EEMCO  
Nasr City  
19 Shararah Bldgs.  
Hassan Mamoun Street  
Cairo  
Phone: +20-2-2718873  
Fax: +20-2-2718873

### Finland

Fluke Finland Oy  
Sinikalliontie 5  
P.L. 151  
SF 02631 Espoo  
Phone: +358-0-61525-620  
Fax: +358-0-61525-630

### France

Fluke France S.A.  
37, rue Voltaire  
B.P. 112  
93700 Drancy  
Phone: +33-1-4896-6310  
Fax: +33-1-4896-6330

### Germany

Fluke Deutschland GmbH  
Oskar Messter Straße 18  
85737 Ismaning  
München  
Phone: +49-89-99611-260  
Fax: +49-89-99611-270

### Germany

Fluke Deutschland GmbH  
Meiendorfer Straße 205  
22145 Hamburg  
Phone: +49-40-67 960 434  
Fax: +49-40-67 960 421

### Greece

George D. Zis & SIA O.E.  
Fluke Sales & Service  
Zacharitsa 27  
117 41 Athens  
Phone: +30-1-922 1581  
Fax: +30-1-924 9087

### Hong Kong

Schmidt & Co., Ltd.  
1st Floor  
323 Jaffe Road  
Wanchai  
Phone: +852-2223-5623  
Fax: +852-2834-1848

### Hungary

Mia-Mmsz Kft.  
Etele Ut. 59 - 61  
P.O. Box 58  
H 1502 Budapest  
Phone: +361-203-4319  
Fax: +361-203-4328

### Hungary

MTA-MMSZ Kft.  
Etele Ut. 59 - 61  
P.O. Box 58  
H 1502 Budapest  
Phone: +361-203-4298  
Fax: +361-203-4353

### Iceland

Taeknivai Hf  
P.O. Box 8294  
Skeifunni 17  
128 Reykjavik  
Phone: +354-550-4000  
Fax: +354-550-4001

### India

Hinditron Services Pvt., Ltd.  
204-206 Hemkunt Tower  
98 Nehru Place  
New Delhi 110 019  
Phone: +91-11-641-3675  
Fax: +91-11-642-9118

### India

Hinditron Services Pvt., Ltd.  
Castle House, 5th Floor  
5/1 A, Hungerford Street  
Calcutta 700 017  
Phone: +91-33-247-9094  
Fax: +91-33-247-6844

### India

Hinditron Services Pvt., Ltd.  
Emerald House, 5th Floor  
114 Sarojini Devi Road  
Secunderabad 500 003  
Phone: +91-40-844033  
Fax: +91-40-847585

### India

Hinditron Services Pvt., Ltd.  
1st Floor  
Hinditron House, 23-B  
Mahal Industrial Estate  
Mahakali Caves Road,  
Andheri East  
Mumbai 400 093  
Phone: +91-22-836-4560  
Fax: +91-22-836-4682

### India

Hinditron Services Pvt., Inc.  
33/44A 8th Main Road  
Raj Mahal Vilas Extension  
Bangalore 560 080  
Phone: +91-80-334-8266  
Fax: +91-80-334-5022

### Indonesia

P.T. Daeng Brothers  
Philips House  
J/n H.R. Rasuna Said Kav. 3-4  
Jakarta 12950  
Phone: +62-21-520-1122  
Fax: +62-21-520-5189

### Israel

R.D.T Equipment & Systems  
(1993) Ltd.  
P.O. Box 58072  
Tel Aviv 61580  
Phone: +972-3-645-0745  
Fax: +972-3-647-8908

### Italy

Fluke Italia S.R.L.  
Viale Delle Industrie, 11  
20090 Vimodrone (MI)  
Phone: +39-2-268-434-203  
Fax: +39-2-250-1645

## SERVICE CENTERS

### Japan

Fluke Corporation Japan  
Sumitomo Higashi Shinbashi  
Bldg.  
1-1-11 Hamamatsucho  
Minato-ku, Tokyo 105  
Phone: +81-3-3434-0181  
Fax: +81-3-3434-0170

### Jordan

Jordan Medical Supplies and  
Services  
P.O. Box 140415  
Amman 11814  
Phone: +962-6-699353  
Fax: +962-6-663556

### Korea

Fluke Korea Co., Ltd.  
5th Floor, Juan Bldg  
646-14, Yuksam-Dong  
Kangnam-Ku  
Seoul 135-080  
Phone: +82-2-539-6311  
Fax: +82-2-539-6311

### Kuwait

Yusuf A. Alghanim & Sons  
W.L.L.  
P.O. Box 223 Safat  
Alghanim Industries  
Airport Road Shuwaikh  
13003 Kuwait  
Phone: +965-4842988  
Fax: +965-4847244

### Lebanon

DC Electronics S.A.R.L.  
Autostrada Dora  
Hayek Building  
P.O. Box 90  
1388 Beirut  
Phone: +961-1-884271  
Fax: +961-1-898842

### Macedonia

Tehnokom  
Koco Racin 42  
91000 Skopje  
Phone: +389-91-236817  
Fax: +389-91-236851

### Malaysia

Cnn Sdn. Bhd.  
17D, 2nd Floor  
Lebuhraya Batu Lancang  
Taman Seri Damai  
11600 Jelutong Penang  
Phone: +60-4-657-9584  
Fax: +60-4-657-0835

### Malta

Cam Services Ltd.  
Cam Centre  
Triq 1 - Industrija  
Qormi QRM 09  
Phone: +356-484640  
Fax: +356-447174

### Mexico

Metrologia Y Calibraciones Ind.,  
S.A. De C.V.  
Industrial S.A. De C.V.  
Calle Diagonal No. 27 - 4 Piso  
Colonia Del Valle  
Mexico 03100 D.F.  
Phone: +52-5-682-8040  
Fax: +52-5-687-8695

### Netherlands

Fluke Nederland B.V.  
Customer Support Services  
Science Park Eindhoven 5108  
5692 EC Son  
Phone: +31-402-678 310  
Fax: +31-402-678 321

### New Zealand

Philips Scientific & Industrial,  
Pty., Ltd.  
Private Bag 41904  
St. Lukes, 2 Wagener Place  
Mt. Albert  
Auckland 3  
Phone: +64-9-849-4160  
Fax: +64-9-849-7814

### Norway

Fluke Norge A/S  
Customer Support Services  
P.O. Box 6054  
Etterstad  
N 0601 Oslo  
Phone: +47-22-65-3400  
Fax: +47-22-65-3407

### Pakistan

Philips Electrical Industries Of  
Pakistan Ltd.  
Islamic Chamber of Commerce  
St-2/A, Block 9  
KDA Scheme 5, Clifton  
Karachi 75600  
Phone: +92-21-587-4641  
Fax: +92-21-577-0348

### Peru

Importaciones &  
Representaciones  
Jr. Pumacahua 955  
Lima 11  
Phone: +51-14-235099  
Fax: +51-14-310707

### Philippines

Spark Electronics Corporation  
P.O. Box 610, Greenhills  
Metro Manila 1502  
Phone: +63-2-700621  
Fax: +63-2-721-0491

### Poland

Electronic Instrument Service  
(E.I.S.)  
UL. Malechowska 6  
60 188 Poznan  
Phone: +48-61-681998  
Fax: +48-61-682256

### Portugal

ARESAGANTE  
Representacoes Estudos e  
Servicos, Lda.  
Rua Oliveira Gaio, 333 F/C, Esq.  
4465 S.Mamede Infesta  
Phone: +351-2-906.00.22  
Fax: +351-2-901.68.72

### Qatar

Darwish Trading Co.  
P.O. Box 92  
Doha  
Phone: +974-422781  
Fax: +974-417599

### Rep. of Belarus

Component & Systems Ltd.  
7, Melnikaite Str.  
220004 Minsk  
Phone: +375-172-292103  
Fax: +375-172-292110

### Romania

RONEXPRIM S.R.L.  
Str. Transilvaniei Nr. 24  
70778 Bucharest - I  
Phone: +40-1-6143597  
Fax: +40-1-6594468

### Russia

Swemel Innovation Enterprise  
15, 4-Th Likhachevskiy Lane  
125438 Moscow  
Phone: +7-095-154-5181  
Fax: +7-095-154-0201

## SERVICE CENTERS

### Russia C.I.S.

Infomedia  
Petrovsko Razumovsky  
Proezd. 29  
103287 Moscow  
Phone: +7-095-2123833  
Fax: +7-095-2123838

### Saudi Arabia

A. Rajab & Silsilah Co.  
Sales & Service Department  
P.O. Box 203  
21411 Jeddah  
Phone: +966-2-6610006  
Fax: +966-2-6610558

### Singapore

Fluke Singapore Pte., Ltd.  
#27-03 PSA Building  
460 Alexandra Road  
Singapore 119963  
Phone: +65\*-276-5161  
Fax: +65\*-276-5929

### Slovak Republic

Eiso  
Stef nikova 20  
911 01 Trenčín  
Phone: +42-8313-1410  
Fax: +42-8313-1592

### Slovenia

Micom Electronics d.o.o.  
Resljeva 34  
61000 Ljubljana  
Phone: +386-61-317830  
Fax: +386-61-320670

### Slovenia

Elacss d.o.o.  
Medvedova 28  
61000 Ljubljana  
Phone: +385-61-317178  
Fax: +385-61-301595

### South Africa

Spescom Measuregraph Pty., Ltd.  
SPESCOM Park  
Cm. Alexandra Rd. & Second St.  
Halfway House  
Midrand 1685  
Phone: +27-11-315-0757  
Fax: +27-11-805-1192

### Spain

Fluke Ibérica S.L.  
Centro Empresarial Euronova  
C/Ronda De Poniente, 8  
28760 - Tres Cantos  
Madrid  
Phone: +34-1-804-2301  
Fax: +34-1-804-2496

### Sultanate Of Oman

Mustafa & Jawad Science &  
Industry Co. LLC.  
P.O. Box 1918  
112 Ruwi - Muscat  
Phone: +968-602009  
Fax: +968-607066

### Sweden

Fluke Sverige AB  
P.O. Box 61  
S 164 94 Kista  
Phone: +46-8-751-0235  
Fax: +46-8-751-0480

### Switzerland

Fluke Switzerland A.G.  
Rütistrasse 28  
CH 8952 Schlieren  
Phone: +41-1-730-3310  
Fax: +41-1-730-3720

### Taiwan, R.O.C.

Schmidt Scientific Taiwan, Ltd.  
6f, No. 109, Tung Hsing St.  
Taipei  
Phone: +886-2-767-8890  
Fax: +886-2-767-8820

### Thailand

Measuretronix Ltd.  
2102/31 Ramkamhang Road  
Bangkok 10240  
Phone: +66-2-375-2733  
Fax: +66-2-374-9965

### Turkey

Pestas Prof. Elektr. Sistemler  
Tic. ve San. A.S.  
Meydan Sokak  
Meydan Apt. No. 6/23  
Akatlar 80630  
Istanbul  
Phone: +90-212-2827839  
Fax: +90-212-283-0987

### U.A.E.

Hans Al-Afaq Ltd.  
P.O. Box 8141  
Dubai  
Phone: +971-4-283623  
Fax: +971-4-281285

### U.S.A.

Fluke Corporation  
Service Center - Palatine  
1150 W. Euclid Avenue  
Palatine, IL 60067  
Phone: +1-847-705-0500  
Fax: +1-847-705-9989

### U.S.A.

Fluke Corporation  
Service Center - Paramus  
West 75 Century Road  
Paramus, NJ 07652-0930

### U.S.A.

Fluke Corporation  
Service Center - Everett  
P.O. Box 9090  
Everett, WA 98206-9090  
Phone: +1-206-356-5531  
Fax: +1 206 356 6390

### U.S.A.

Fluke Calibration Center  
C/o Flw Service Corporation  
3505 Cadillac Ave., Bldg E.  
Costa Mesa, Ca 92626  
Phone: +1-714-863-9031  
Fax: +1-714-751-0213

### U.S.A.

Fluke Corporation  
Service Center  
42711 Lawrence Place  
Fremont, CA 94538  
Phone: +1-510-651-5112  
Fax: +1-510-651-4962

### U.S.A.

Fluke Corporation  
Service Center - Dallas  
2104 Hutton Drive  
Suite 112  
Carrollton, TX 75006  
Phone: +1-214-406-1000  
Fax: +1-214-247-5642



## SERVICE CENTERS

### **United Kingdom**

Fluke United Kingdom Ltd.  
Colonial Way  
Watford  
Hertfordshire WD2 4TT  
Phone: +44-1923-240511  
Fax: +44-1923-212157

### **Uruguay**

Coasin Instrumentos S.A.  
Acevedo Diaz 1161  
11200 Montevideo  
Montevideo  
Phone: +598-2-492-436  
Fax: +598-2-492-199

### **Venezuela**

Coasin C.A.  
Calle 9 Con Calle 4  
Edif Edinurbi Piso - 3  
La Urbina  
Caracas 1070-A  
Phone: +58-2-242-7466  
Fax: +58-2-241-1939

### **Vietnam**

Schmidt-Vietnam Co., Ltd.  
8/f. Schmidt Tower  
Hanoi International Technology  
Ctr  
Km8, Highway 32, Cau Giay  
Tu Liem, Hanoi  
Phone: +84-4-8346-186  
Fax: +84-4-8346-188

### **All other countries**

Fluke Corporation  
P.O. Box 9090  
Mail Stop 268C  
Everett, WA 98206-9090  
USA

1 2 3 4 5 6 7 8 9 10 11 12 13 14 15 16 17 18 19 20 21 22 23 24 25 26 27 28 29 30 31 32 33 34 35 36 37 38 39 40 41 42 43 44 45 46 47 48 49 50 51 52 53 54 55 56 57 58 59 60 61 62 63 64 65 66 67 68 69 70 71 72 73 74 75 76 77 78 79 80 81 82 83 84 85 86 87 88 89 90 91 92 93 94 95 96 97 98 99 100