

## Errata

**Title & Document Type:** 8502A Transmission / Reflection Test Set Operating and Service Manual

**Manual Part Number:** 08502-90001

**Revision Date:** August 1977

### About this Manual

We've added this manual to the Agilent website in an effort to help you support your product. This manual provides the best information we could find. It may be incomplete or contain dated information, and the scan quality may not be ideal. If we find a better copy in the future, we will add it to the Agilent website.

### HP References in this Manual

This manual may contain references to HP or Hewlett-Packard. Please note that Hewlett-Packard's former test and measurement, life sciences, and chemical analysis businesses are now part of Agilent Technologies. The HP XXXX referred to in this document is now the Agilent XXXX. For example, model number HP8648A is now model number Agilent 8648A. We have made no changes to this manual copy.

### Support for Your Product

Agilent no longer sells or supports this product. You will find any other available product information on the Agilent Test & Measurement website:

[www.agilent.com](http://www.agilent.com)

Search for the model number of this product, and the resulting product page will guide you to any available information. Our service centers may be able to perform calibration if no repair parts are needed, but no other support from Agilent is available.

OPERATING AND SERVICE MANUAL

**8502A**  
**TRANSMISSION/  
REFLECTION  
TEST SET**  
**500 kHz — 1.3 GHz**



HEWLETT  PACKARD

## **SAFETY**

*This instrument has been designed and tested according to International Safety Requirements. To ensure safe operation and to keep the instrument safe, the information, cautions, and warnings in this manual must be heeded. Refer to Section I for general safety considerations applicable to this instrument.*

## **CERTIFICATION**

*Hewlett-Packard Company certifies that this instrument met its published specifications at the time of shipment from the factory. Hewlett-Packard Company further certifies that its calibration measurements are traceable to the United States National Bureau of Standards, to the extent allowed by the Bureau's calibration facility, and to the calibration facilities of other International Standards Organization members.*

## **WARRANTY AND ASSISTANCE**

*This Hewlett-Packard product is warranted against defects in materials and workmanship for a period of one year from the date of shipment. Hewlett-Packard will, at its option, repair or replace products which prove to be defective during the warranty period provided they are returned to Hewlett-Packard, and provided the proper preventive maintenance procedures as listed in this manual are followed. Repairs necessitated by misuse of the product are not covered by this warranty. **NO OTHER WARRANTIES ARE EXPRESSED OR IMPLIED, INCLUDING BUT NOT LIMITED TO THE IMPLIED WARRANTIES OF MERCHANTABILITY AND FITNESS FOR A PARTICULAR PURPOSE. HEWLETT-PACKARD IS NOT LIABLE FOR CONSEQUENTIAL DAMAGES.***

*Service contracts or customer assistance agreements are available for Hewlett-Packard products that require maintenance and repair on-site.*

*For any assistance, contact your nearest Hewlett-Packard Sales and Service Office. Addresses are provided at the back of this manual.*

HEWLETT  PACKARD

OPERATING AND SERVICE MANUAL

**8502A**  
**TRANSMISSION/REFLECTION**  
**TEST SET**

**500 kHz — 1.3 GHz**

**SERIAL NUMBERS**

This manual applies directly to HP Model 8502A with serial prefix numbers 1603A and 1616A.

For additional information about serial numbers, see INSTRUMENTS COVERED BY MANUAL in Paragraph 7.

Copyright © HEWLETT-PACKARD COMPANY 1976  
1400 FOUNTAIN GROVE PARKWAY, SANTA ROSA, CALIFORNIA, U.S.A.

MANUAL PART NO. 08502-90001  
Microfiche Part No. 08502-90002

Printed: AUGUST 1977

**CONTENTS**

| Paragraph                        | Page | Paragraph                                | Page |
|----------------------------------|------|--|------|
| 1. GENERAL INFORMATION           | 1    | 35. PERFORMANCE TESTS                    | 11   |
| 2. Introduction                  | 1    | 36. Introduction                         | 11   |
| 5. Description                   | 1    | 39. Equipment Required                   | 11   |
| 7. Instruments Covered by Manual | 1    | 41. Test Record                          | 11   |
| 9. Input Level Caution           | 1    | 43. Directivity Test                     | 11   |
| 10. Specifications               | 1    | 44. Transmission Frequency Response Test | 11   |
| 12. Equipment Available          | 1    | 45. Reflection Frequency Response Test   | 16   |
| 14. Recommended Test Equipment   | 1    | 46. TEST Port Open/Short Ratio Test      | 21   |
| 16. INSTALLATION                 | 3    | 47. TEST Port Return Loss Test           | 28   |
| 17. Initial Inspection           | 3    | 48. Port Return Loss Tests               | 29   |
| 19. Preparation for Use          | 3    | 49. ADJUSTMENTS                          | 37   |
| 20. Mating Connectors            | 3    | 51. REPLACEABLE PARTS                    | 37   |
| 22. Operating Environment        | 5    | 53. Ordering Instructions                | 37   |
| 24. Storage and Shipment         | 5    | 55. SERVICE                              | 42   |
| 25. Environment                  | 5    | 56. Module Exchange Program              | 42   |
| 27. Packaging for Shipment       | 5    | 59. Case Disassembly                     | 42   |
| 30. OPERATION                    | 5    | 62. Principles of Operation              | 42   |
| 31. Panel Features               | 5    | 67. Troubleshooting                      | 43   |
| 33. Incoming Inspection          | 5    |  |      |

**ILLUSTRATIONS**

| Figure   | Page | Figure  | Page |
|--|------|---|------|
| 1. Model 8502A Transmission/Reflection Test Set                    | 0    | 17. INCIDENT Port Return Loss (1000 to 1300 MHz)                            | 32   |
| 2. Serial Number Plate   | 1    | 18. INCIDENT Port Return Loss (100 to 1000 MHz)                             | 33   |
| 3. HP Model 11851A Cable Accessory Set                             | 3    | 19. INCIDENT Port Return Loss (2 to 100 MHz)                                | 34   |
| 4. 8502A Front and Rear Panel Controls, Connectors and Case Bottom | 6    | 20. INCIDENT Port Return Loss (0.5 to 2 MHz)                                | 34   |
| 5. Incoming Inspection Test  | 8    | 21. Major Assemblies and Parts Locations                                    | 39   |
| 6. Transmission Frequency Response Test Setup                      | 12   | 22. Type N Connector Assembly (08502-60001), Exploded View                  | 40   |
| 7. Transmission Frequency Response Magnitude                       | 14   | 23. 8502A Attaching Hardware  | 40   |
| 8. Transmission Frequency Response Phase                           | 15   | 24. Model 8502A Case Disassembly  | 42   |
| 9. Reflection Frequency Response Test Setup                        | 16   | 25. Model 8502A Simplified Block Diagram                                    | 43   |
| 10. Reflection Frequency Response Magnitude                        | 19   | 26. Model 8502A Transmission/Reflection Test Set Troubleshooting Procedure  | 44   |
| 11. Reflection Frequency Response Phase                            | 20   | 27. Model 8502A Transmission/Reflection Test Set Equivalent Circuit         | 47   |
| 12. TEST Port Open/Short Ratio Test                                | 21   | 28. Model 8502A Transmission/Reflection Test Set Major Assemblies Locations | 47   |
| 13. TEST Port Open/Short Ratio Magnitude >2 MHz                    | 24   |   |      |
| 14. Slope Peak-To-Peak Measurement                                 | 24   |   |      |
| 15. TEST Port Open/Short Ratio Phase >2 MHz                        | 26   |   |      |
| 16. INCIDENT, REFLECTED, and RF INPUT Port Return Loss Test Setups | 30   |   |      |

**TABLES**

| Table                                       | Page | Table  | Page |
|---|------|--|------|
| 1. Model 8502A Specifications               | 2    | 5. Loss of Typical Coaxial Cable Used for 6-Ft. "Test" Cable | 25   |
| 2. Model 8502A Supplemental Characteristics | 2    | 6. Model 8502A Performance Test Record                       | 36   |
| 3. Recommended Test Equipment               | 4    | 7. 8502A Replaceable Parts                                   | 38   |
| 4. Connectors that Mate with 8502A Ports    | 5    |  |      |

Model 8502A

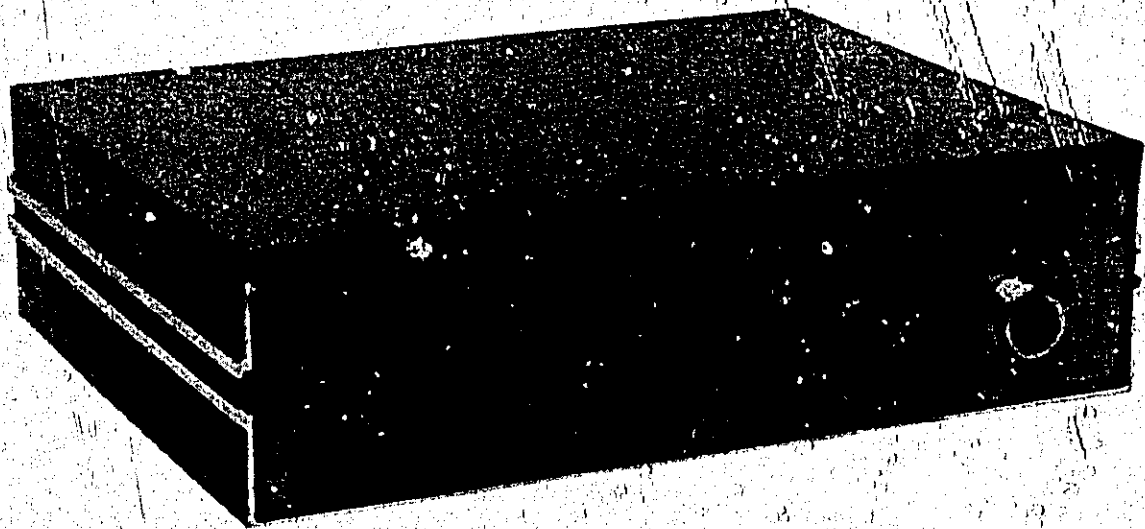

MODEL 8502A

*Figure 1. Model 8502A Transmission/Reflection Test Set*

## 1. GENERAL INFORMATION

### 2. Introduction

3. This Operating and Service manual applies to the Hewlett-Packard Model 8502A Transmission/Reflection Test Set (Figure 1). It contains information necessary to operate, test, and service the HP Model 8502A.

4. On the title page of this manual, below the manual part number, is a "Microfiche" part number. This number may be used to order a 4- x 6-inch microfilm transparency of this manual.

### 5. Description

6. The Hewlett-Packard Model 8502A Transmission/Reflection Test Set provides all of the RF hardware necessary to make simultaneous transmission and reflection measurements between 500 KHz and 1300 MHz. The test set consists of an RF power splitter to develop a reference or incident signal, a directional bridge to develop a reflected signal, and an attenuator to control the signal incident on the device under test.

### 7. Instruments Covered by Manual

8. Attached to the instrument is a serial number plate (Figure 2). The serial number is in two parts. The first four digits and the letter are the serial number prefix; the last five digits are the suffix. The prefix is the same for all identical instruments; it changes only when a change is made to the instrument. The suffix, however, is assigned sequentially and is different for each instrument. The contents of this manual apply to instruments with the serial number prefix(es) listed under SERIAL NUMBERS on the title page. If your instrument does not have a serial number prefix that is listed on the title page, refer to the manual changes supplement, or contact your nearest HP office for change information.

### 9. Input Level Caution

**CAUTION**

Do not apply signals greater than listed below or damage to the test set circuits

may result. TEST port limits are +26 dBm and 30 Vdc. RF INPUT port limits are +30 dBm (1.0 watt) and 7.0 Vdc. BIAS INPUT port limits are 500 mA and 30 Vdc.

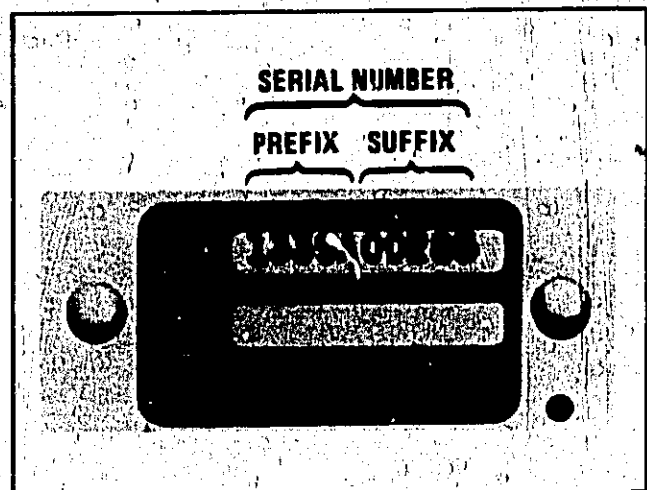

Figure 2. Serial Number Plate

## 10. Specifications

11. Instrument specifications are listed in Table 1. These specifications are the performance standards or limits against which the instrument may be tested. Table 2 lists supplemental characteristics. These are not specifications but are typical characteristics included as additional information for the user.

## 12. Equipment Available

13. Hewlett-Packard Cable Accessory Set 11851A, shown in Figure 3, contains four double-shielded and phase-matched cables for high accuracy measurements with the HP Model 8505A Network Analyzer and other instruments.

## 14. Recommended Test Equipment

15. Equipment required for performance testing and troubleshooting of the Hewlett-Packard Model 8502A Transmission/Reflection Test Set is listed in Table 3. Other equipment may be substituted if it meets or exceeds the critical specifications listed in the table.

Table 1. Model 8502A Specifications

| SPECIFICATIONS<br>8502A TRANSMISSION/REFLECTION TEST SET  |   |
|---|---|
| <b>Frequency Range:</b> 500 kHz to 1.3 GHz  | <b>Phase:</b> $\leq \pm 6^\circ$ from 2 to 1000 MHz                             |
| <b>Impedance:</b> 50 ohms   | <b>Magnitude:</b> $\leq \pm 0.9$ dB from 1000 to 1300 MHz                       |
| <b>Directivity:</b> $\geq 40$ dB  | <b>Phase:</b> $\leq \pm 7.5^\circ$ from 1000 to 1300 MHz                        |
| <b>Frequency Response:</b>  | <b>Magnitude:</b> $\leq \pm 1.25$ dB from 0.5 to 2 MHz                          |
| <b>Transmission:</b>  | <b>Phase:</b> $\leq \pm 10^\circ$ from 0.5 to 2 MHz                             |
| <b>Magnitude:</b> $\leq \pm 0.8$ dB   | <b>Incident Port Return Loss*:</b>  |
| <b>** Phase:</b> $\leq \pm 8^\circ$   | $\geq 25$ dB ( $\leq 1.12$ SWR) from 2 to 1000 MHz                              |
| <b>Reflection:</b>  | $\geq 23$ dB ( $\leq 1.15$ SWR) from 0.5 to 1300 MHz                            |
| <b>Magnitude:</b> $\leq \pm 1.5$ dB from 0.5 to 1300 MHz  | <b>Reflection Port Return Loss*:</b>  |
| <b>Phase:</b> $\leq \pm 15^\circ$ from 0.5 to 1300 MHz  | $\geq 25$ dB ( $\leq 1.12$ SWR) from 2 to 1000 MHz                              |
| <b>** Phase:</b> $\leq \pm 10^\circ$ from 2 to 1300 MHz   | $\geq 23$ dB ( $\leq 1.15$ SWR) from 0.5 to 1300 MHz                            |
| <b>Port Match:</b>  | <b>RF Input Port Return Loss*:</b>  |
| <b>Test Port Return Loss*:</b>  | $\geq 23$ dB ( $\leq 1.15$ SWR)   |
| $\geq 26$ dB ( $\leq 1.11$ SWR) from 2 to 1300 MHz  | <b>Maximum Operating Level:</b> $\leq +20$ dBm                                  |
| $\geq 20$ dB ( $\leq 1.22$ SWR) from 0.5 to 2 MHz   | <b>TEST port:</b> +26 dBm 30 Vdc Max  |
| <b>Test Port Open/Short Ratio:</b>  | <b>RF INPUT port:</b> +30 dBm (1W) 7 Vdc Max                                    |
| <b>Magnitude:</b> $\leq \pm 0.75$ dB from 2 to 1000 MHz   | <b>Bias:</b> 30 Vdc 500 mA Max  |
|   | <b>Damage Level:</b> $> 1$ watt (+30 dBm) CW                                    |
|   | <b>Dimensions:</b> 101 mm wide, 61.5mm high, 204mm deep (7-1/2" x 2-7/16" x 8") |
|   | <b>Weight:</b>  |
|   | <b>Net:</b> 1.7 kg (3-3/4 lb.)  |
|   | <b>Shipping:</b> 3.1 kg (7 lb.)   |
| *Other ports terminated in 50 ohms $\pm 10\%$ tolerance.      ** $\pm$ degrees, specified as deviation from linear phase. |   |

Table 2. Model 8502A Supplemental Characteristics

|  |  |
|--|--|
| <b>Test Port Return Loss:</b> Typically 30 dB from 2 to 1300 MHz | <b>RF Attenuator Range:</b> 0 to 70 dB in 10-dB steps  |
| <b>Insertion Loss with Attenuator Set to Zero:</b>               | <b>DC Bias Input Range:</b> $\pm 30$ Vdc, $\pm 200$ mA; some degradation in RF specifications from 500 kHz to 100 MHz. 500 mA maximum. |
| <b>Input to Test Port:</b> 13 dB                                 | <b>RF Connectors:</b> 50 ohm Type N Female   |
| <b>Input to Incident Port:</b> 19 dB                             | <b>DC Bias Input Connector:</b> Type BNC Female  |
| <b>Input to Reflection Port with Short on Test Port:</b> 19 dB   |  |



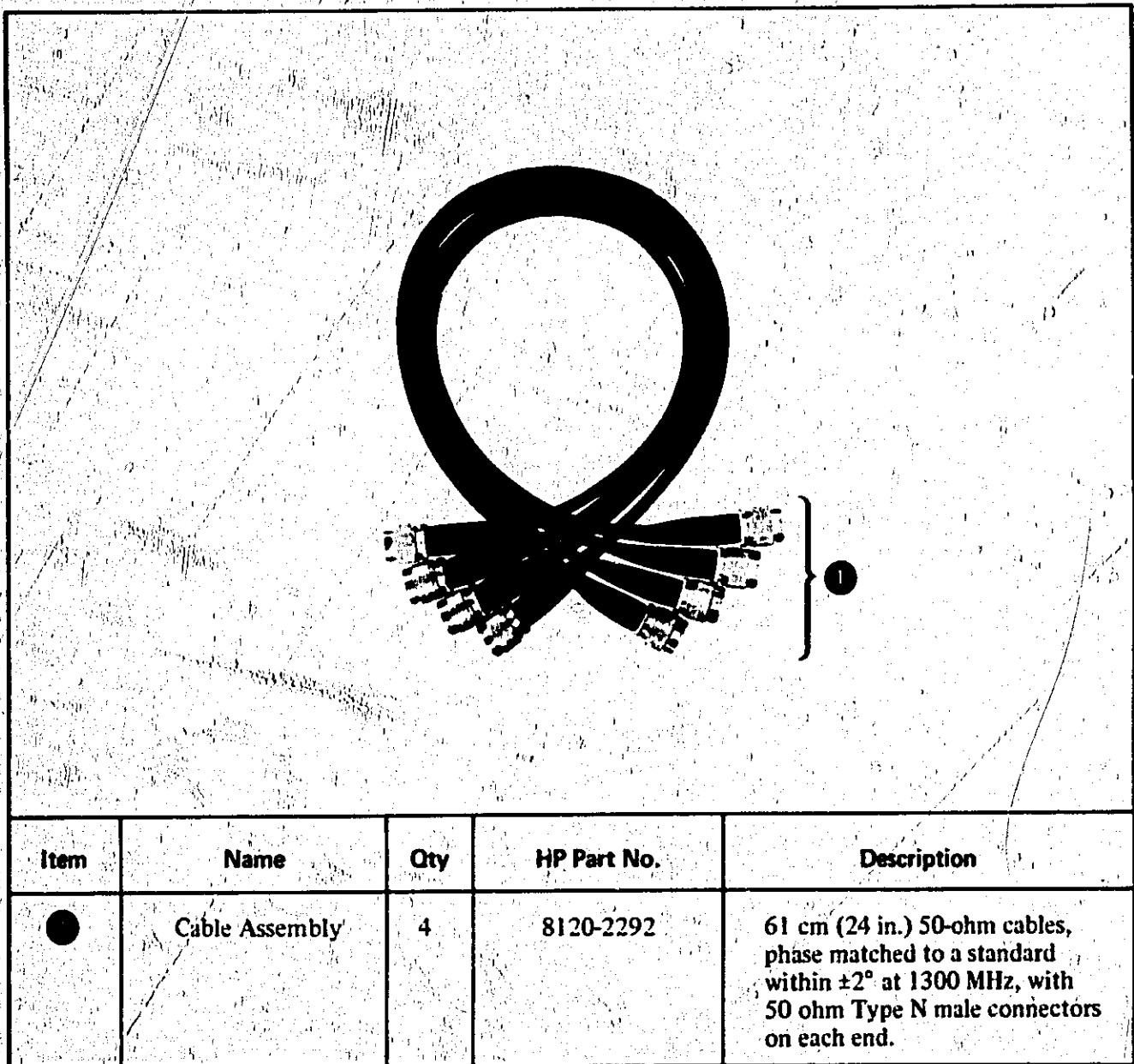

Figure 3. HP Model 11851A Cable Accessory Set

**16. INSTALLATION**

**17. Initial Inspection**

18. Inspect the shipping container for damage. If the shipping container or cushioning material is damaged, it should be kept until the contents of the shipment have been checked for completeness and the instrument has been checked mechanically and electrically. Procedures for checking electrical performance are given in Paragraph 35. If the contents of the shipment are incomplete or if the equipment is mechanically damaged, or does not pass the electrical performance test, notify the nearest Hewlett-Packard office. If, in

addition, the shipping container is damaged or the cushioning material shows signs of stress, notify the carrier as well as the Hewlett-Packard office. Keep the shipping materials for the carrier's inspection. At Hewlett-Packard's option, the HP office may arrange for repair or replacement without waiting for claim settlement.

**19. Preparation for Use**

**20. Mating Connectors**

21. The connectors that mate with the HP Model 8502A ports are shown in Table 4. This table identifies each connector and gives the HP Part Number and part numbers of alternative sources.

Table 3. Recommended Test Equipment

| Instrument                        | Critical Specifications  | Recommended Model         | Use*   |
|-----------------------------------|--|---------------------------|--------|
| Network Analyzer                  | Frequency Range: 0.5 – 1300 MHz  | HP 8505A                  | P, T   |
| Dual Directional Coupler          | Frequency Range: 100 – 1300 MHz<br>Directivity: $\geq 36$ dB, 0.1 – 1 GHz<br>$\geq 32$ dB, 1.0 – 1.3 GHz                                       | HP 778D, Opt. 012         | P      |
| Directional Bridge <sup>1</sup>   | Frequency Range: 0.5 – 100 MHz<br>Directivity: $\geq 40$ dB, 1 – 100 MHz<br>$\geq 30$ dB, .5 – 1 MHz   | HP 8721A                  | P      |
| 3-Way Power Splitter              | Tracking between any two ports:<br>$\leq 0.1$ dB Magnitude<br>$\leq 1.5^\circ$ Phase<br>$\geq 32$ dB Output Source Match                       | HP 11850A                 | P      |
| Termination (4 required)          | Impedance: 50 $\Omega$ with Type N male connector  | HP 909A, Opt. 012         | P      |
| Termination <sup>2</sup>          | Impedance: 50 $\Omega$ with Type N male<br>SWR: $\leq 1.005$   | HP 909A, Opt. 012 and H69 | P<br>P |
| Short                             | Type N female Connector  | HP 11511A                 | P      |
| Short                             | Type N male Connector  | HP 11512A                 | P, T   |
| Adapter (2 required)              | Type BNC male to N male  | HP 1250-1473              | P      |
| Adapter                           | Type N female to SMA female  | Cablewave Systems No. 721 | T      |
| Adapter <sup>4</sup> (2 required) | Type N female to SMA male  | Cablewave Systems No. 718 | T      |
| Cable                             | 6 ft. 50 $\Omega$ coaxial cable, Type R6-214, with Type N male connectors on both ends   | HP 11500A                 | P      |
| Cable (2 required)                | 6 ft. 50 $\Omega$ coaxial cable, Type RG-214, with Type N male connector on one end and Type N female connector on the other end               | HP 11501A                 | P      |
| Cable Set <sup>3</sup>            | 24 in. 50 $\Omega$ coaxial cable phase matched matched to a standard within $\pm 2^\circ$ at 1300 MHz with Type N male connectors on both ends | HP 11851A                 | P      |

\*P = Performance; T = Troubleshooting

<sup>1</sup>This part is included in HP 11652A Transmission/Reflection Kit.

<sup>2</sup>These parts are included in HP 85032A 50 $\Omega$  Type N Calibration Kit.

<sup>3</sup>These parts are included in HP 11851A RF Cable Kit.

<sup>4</sup>Part of HP11854A 50 $\Omega$  BNC Accessory Kit

Table 4. Connectors that Mate with 8502A Ports

| Connector | Industry Identification | HP Part Number | Alternate Sources and Part Numbers                        |
|-----------|-------------------------|----------------|---|
| J1        | Type N male, UG-216/U   | 1250-0882      | Bendix, No. 30481-2<br>Specialty Connectors, No. 25P117-2 |
| J2 Bias   | Type BNC male, UG-88/U  | 1250-0256      | Amphenol, No. 31-202-1021                                 |

**22. Operating Environment**

23. The operating environment should be within the following limits:

- a. Temperature: 0° C (+32° F) to 55° C (+131° F)
- b. Humidity: <95% relative
- c. Altitude (Barometric): <15,000 feet (4,600 meters)

**24. Storage and Shipment****25. Environment**

26. The Model 8502A should be stored in a clean, dry environment. The following environmental limitations apply to both storage and shipment:

- a. Temperature: -40° C (-40° F) to +75° C (+167° F)
- b. Humidity: <95% relative
- c. Altitude (Barometric): <50,000 feet (15,300 meters)

**27. Packaging for Shipment**

**28. Original Type Packaging.** Containers and materials identical with those used in factory packing are available through Hewlett-Packard offices. If the instrument is being returned to Hewlett-Packard for servicing, attach a tag indicating the type of service required, return address, model number and full serial number. Also, mark the container FRAGILE to assure careful handling. In any correspondence, refer to the instrument by the model number and full serial number.

**29. Other Packaging.** The following general instructions should be used for re-packaging with commercially available materials.

a. Wrap the instrument in heavy paper or plastic. If shipping to Hewlett-Packard office or service center, attach a tag indicating the type of service required, return address, model number, and full serial number.

b. Use a strong shipping container. A double-wall carton made of 350-pound test material is adequate.

c. Use enough shock-absorbing material (3 to 4-inch layer) around all sides of the instrument to provide firm cushion and prevent movement inside the container. Protect the front of the instrument with cardboard.

d. Seal the shipping container securely.

e. Mark shipping container FRAGILE to assure handling.

f. In any correspondence, refer to instrument by model number and full serial number.

**30. OPERATION****31. Panel Features**

32. Front and rear panel controls and connectors are illustrated and functionally described in Figure 4.

**33. Incoming Inspection**

34. The test given in Figure 5 is primarily designed to meet the needs of incoming inspection. The test will prove that the HP Model 8502A Transmission/Reflection Test Set is functioning correctly, and tests that the most critical specification, directivity, is within the specification. If a test for each detailed specification is required, then go to the performance test section beginning with Paragraph 35 and run each test.

### FRONT PANEL FEATURES

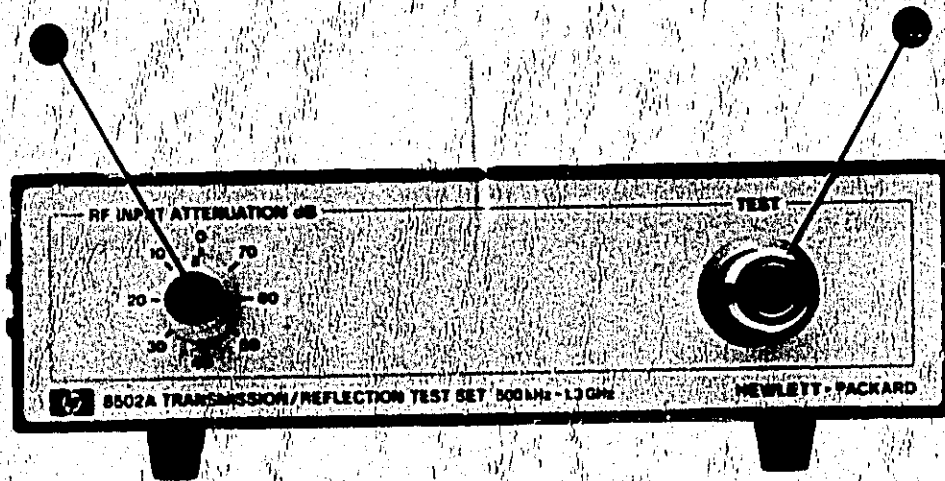

### REAR PANEL FEATURES

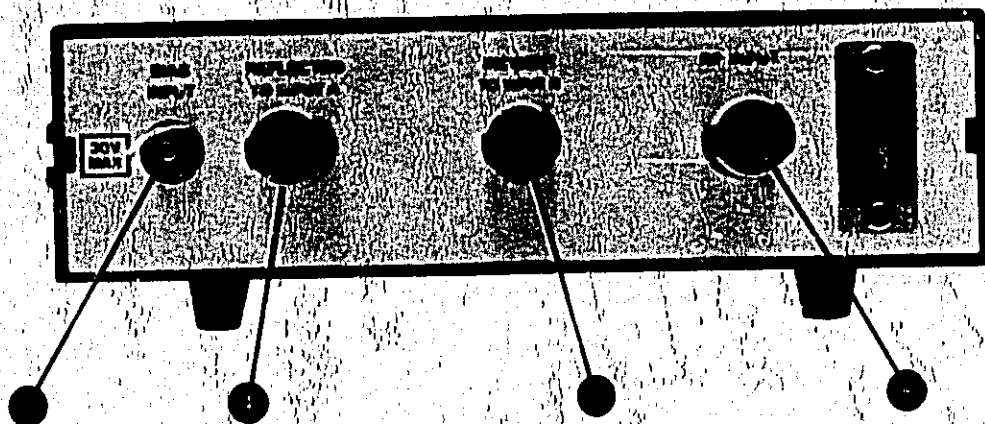
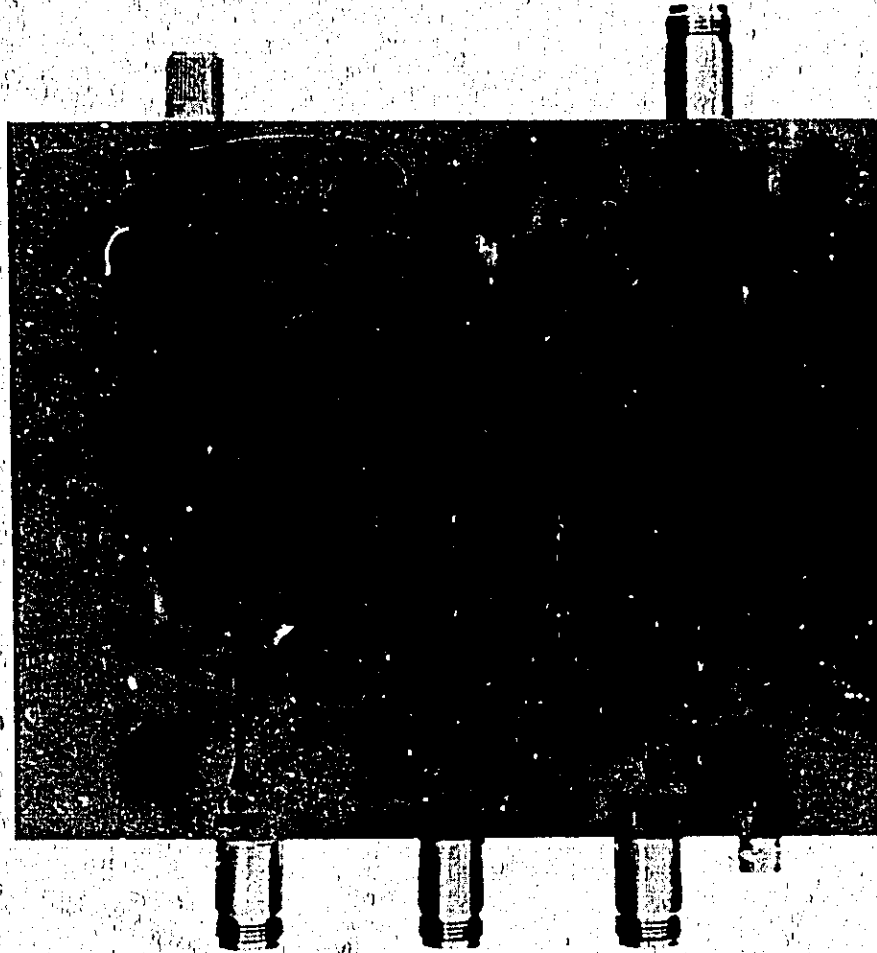

Figure 4. 8502A Front and Rear Panel Controls, Connectors and Case Bottom (1 of 2)

## CASE BOTTOM



- **RF INPUT ATTENUATION dB knob.** Selects attenuation in test signal path.
- **TEST connector J1.** Provides mainline output signal to unit under test. Reflected signals from unit under test are also routed back through TEST port.
- **BIAS INPUT connector J2.** Provides means to bias center conductor of TEST port when bias required by unit under test.

- **REFLECTED TO INPUT A connector J3.** Output signal from this port is proportional to the signal reflected back into the TEST port by the device under test.
- **INCIDENT TO INPUT R connector J4.** Output signal from this port is incident with main line signal and provides reference signal for ratio measurements.
- **RF INPUT connector J5.** Signal source connected to this port.

Figure 4. 8502A Front and Rear Panel Controls, Connectors and Case Bottom (2 of 2)

**INCOMING INSPECTION TEST**

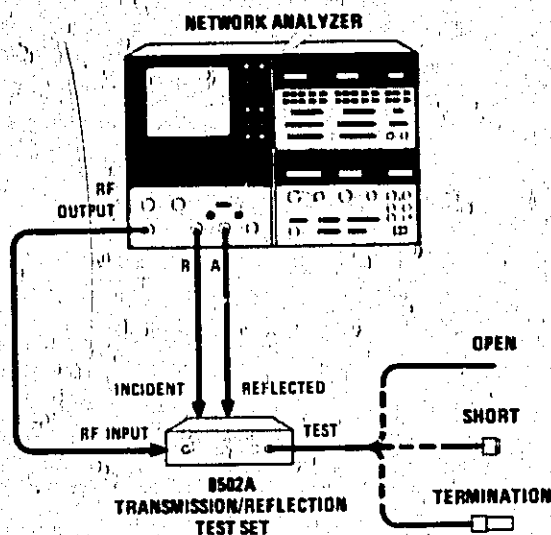

**EQUIPMENT:**

- Network Analyzer ..... HP 8505A
- Type N Male Short ..... HP 11512A
- 50Ω Type N Male Termination with <math><1.005\text{ SWR}^\*</math> ..... HP 909A  
Option 012 and H69

\*Part of IIP 85032A 50Ω Type N Calibration Kit.

**PROCEDURE:**

- a. Set 8505A controls as follows:

**A1 Source/Converter:**

- OUTPUT LEVEL dBm ..... -10
- OUTPUT LEVEL Vernier ..... 0
- INPUT LEVEL MAX ..... -10

**A2 Frequency Control:**

- RANGE MHz ..... LIN .5 - 1300
- MODE ..... LIN FULL
- WIDTH ..... START/STOP 1
- SCAN TIME SEC ..... 1 - .1
- TRIGGER ..... AUTO
- MARKER Switch ..... 1
- MARKER Vernier ..... Mid-range
- FREQUENCY MHz START ..... 0
- FREQUENCY MHz STOP ..... 1300

Figure 5. Incoming Inspection Test (1 of 3)

## INCOMING INSPECTION TEST

## PROCEDURE (Cont'd):

## A3 Signal Processor:

## Channel 1:

INPUT..... A/R  
 MODE..... MAC  
 SCALE/DIV..... 20 dB

## Channel 2:

MODE..... OFF

## Electrical Length:

MODE..... OFF

- b. Set 8502A RF INPUT ATTENUATION control to 0 dB.
- c. Connect equipment as shown in test setup with TEST port open.
- d. On 8505A CRT display, depress REF LINE POSN pushbutton. Adjust CH 1 control until trace is positioned to center of screen. Press REF LINE POSN pushbutton again to return system to normal operation.
- e. Place 8505A Frequency Control MARKER 1, on center graticule.
- f. To calibrate the system for directivity measurements, attach short directly to 8502A TEST port. On 8505A Signal Processor Channel 1 press DISPLAY MKR then ZRO pushbuttons to place marker on reference line and to zero digital readout.

## NOTE

The termination must be properly seated in the connector with the tightening nut correctly aligned. If the termination is not properly seated, low directivity will be measured, and the measurement will not be repeatable.

- g. To measure the directivity of the 8502A, remove the short and replace it with a  $50\Omega$  termination HP 909A, Option 012 and H69. The SWR of the termination must be  $\leq 1.005$  ( $\geq 52$  dB Return Loss).
  - (1) Move 8505A Frequency Control MARKER 1 control to worst-case directivity as indicated on CRT (the point closest to calibration line as shown in the waveform).
  - (2) Read worst-case directivity from 8505A Signal Processor Channel 1 digital display. The indication should be  $\geq 40$  dB below the 0 dB reference level ( $-40$  dB or below).

Figure 5. Incoming Inspection (2 of 3)

### INCOMING INSPECTION TEST

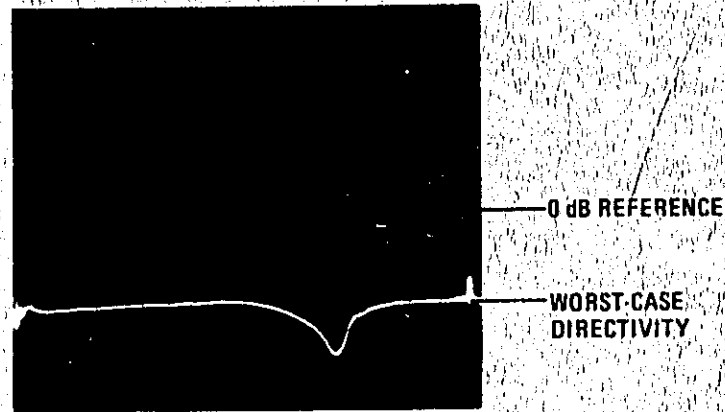

### NOTE

If the worst-case directivity appears to be less than 40 dB, then remove the termination. Observe the 8505A digital marker readings with the TEST port open, then shorted. The average value between the digital marker readings (open and shorted) is the true reference at that frequency. Replace the termination. The directivity is the difference between the true reference and the digital reading taken with the termination.

Figure 5. Incoming Inspection Test (3 of 3)



# PERFORMANCE CHECK

**35. PERFORMANCE TESTS****36. Introduction**

37. The procedures in this section test the electrical performance of the instrument using the specifications of Table 1 as the performance standards. All tests can be performed without access to the interior of the instrument. A simpler incoming inspection test is included in Paragraph 33.

38. The performance test procedures should be performed in the sequence given. If a function fails to operate, go to Paragraph 71, Troubleshooting to find which major assembly or cable has failed.

**39. Equipment Required**

40. Equipment required for the performance tests is listed in the Recommended Test Equipment in Table 3. Any equipment that satisfies the critical specifications given in the table may be substituted for the recommended model.

**41. Test Record**

42. Results of the performance tests may be tabulated on the Test Record at the end of the procedures (Table 6). The Test Record lists all of the tested specifications and their acceptable limits. Test results recorded at incoming inspection can be used for comparison in troubleshooting and after repairs.

**PERFORMANCE TESTS****NOTE**

Allow one hour warm-up time on 8505A Network Analyzer before making the Performance Tests.

**43. DIRECTIVITY TEST****SPECIFICATION:**

Directivity:  $\geq 40$  dB

**DESCRIPTION:**

Directivity is tested using the internal coupler to measure the reflection coefficient of a standard termination. The termination return loss is much greater than the directivity, therefore the resultant measurement is the approximate coupler directivity.

The Directivity Test has been used for the Incoming Inspection Test. The test setup, equipment and procedures needed to test the directivity specifications are found in Figure 5, Incoming Inspection Test.

**44. TRANSMISSION FREQUENCY RESPONSE TEST****SPECIFICATION:**

Transmission Frequency Response:  $\leq \pm 0.8$  dB Mag  
 $\leq \pm 8^\circ$  Phase ( $\pm$  degrees tested as deviation from linear phase)

**PERFORMANCE TESTS**

**44. TRANSMISSION FREQUENCY RESPONSE TEST (Cont'd)**

**DESCRIPTION:**

The frequency response of the 8505A Network Analyzer System is first recorded with a grease pencil on the CRT display. The 8502A is connected and the transmission frequency response is superimposed over the reference grease pencil trace. The difference in the two traces is the transmission frequency response of the 8502A.

**CONFIGURATION A**

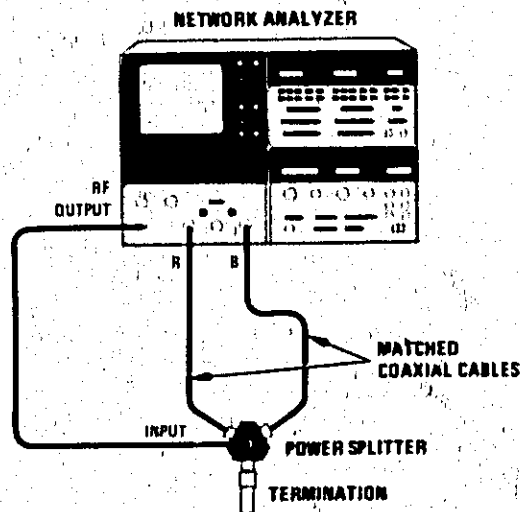

**CONFIGURATION B**

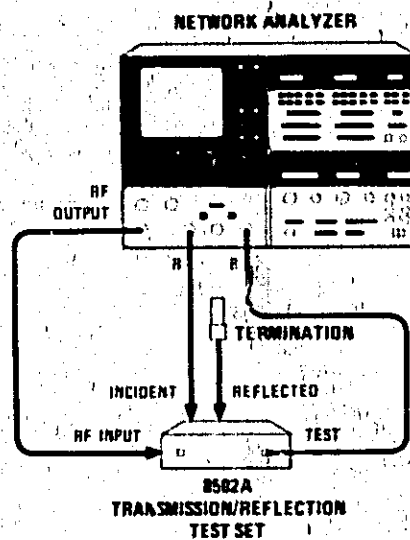

*Figure 6. Transmission Frequency Response Test Setup*

**PERFORMANCE TESTS**

**44. TRANSMISSION FREQUENCY RESPONSE TEST (Cont'd)**

**EQUIPMENT:**

|  |                    |
|--|--------------------|
| Network Analyzer.....                      | HP 8505A           |
| 3-Way Power Splitter.....                  | HP 11850A          |
| 50Ω Type N Male Termination.....           | HP 909A Option 012 |
| Matched Type N Male Coaxial Cable Kit..... | HP 11851A          |

**PROCEDURE:**

a. Set 8505A controls as follows:

**A1 Source/Converter:**

|                           |     |
|---------------------------|-----|
| OUTPUT LEVEL dBm.....     | -10 |
| OUTPUT LEVEL Vernier..... | 0   |
| INPUT LEVEL MAX.....      | -10 |

**A2 Frequency Control:**

|                            |              |
|----------------------------|--------------|
| RANGE MHz.....             | 5 - 1300     |
| MODE.....                  | LIN FULL     |
| WIDTH.....                 | START/STOP 1 |
| SCAN TIME SEC.....         | 1 - .1       |
| TRIGGER.....               | AUTO         |
| MARKERS Switch.....        | 1            |
| MARKER Vernier.....        | Mid-range    |
| FREQUENCY MHz START.....   | 0            |
| FREQUENCY MHz STOP.....    | 1300         |
| SCAN TIME SEC Vernier..... | Mid Position |

**A3 Signal Processor:**

**Channel 1:**

|                |      |
|----------------|------|
| INPUT.....     | B/R  |
| MODE.....      | MAG  |
| SCALE/DIV..... | 2 dB |

**Channel 2:**

|                |        |
|----------------|--------|
| INPUT.....     | B/R    |
| MODE.....      | PHASE  |
| SCALE/DIV..... | 90 DEG |

**Electrical Length:**

|            |     |
|------------|-----|
| INPUT..... | B   |
| MODE.....  | X10 |

**Display Section:**

|                   |        |
|-------------------|--------|
| BW.....           | 10 kHz |
| Video Filter..... | OFF    |

b. Connect equipment as shown in Figure 6, Configuration A.

## PERFORMANCE TESTS

## 44. TRANSMISSION FREQUENCY RESPONSE TEST (Cont'd)

- c. On 8505A CRT display, depress REF LINE POSN pushbutton. Adjust CH 1 and CH 2 controls until traces are positioned to center of screen. Press REF LINE POSN pushbutton again to return system to normal operation.
- d. On 8505A Signal Processor turn Channel 2 MODE switch to OFF.
- e. To determine the magnitude frequency response of the Network Analyzer, place 8505A Frequency Control MARKER 1 on center graticule:
- (1) On the 8505A Signal Processor Channel 1 press DISPLAY MKR and ZRO pushbuttons to place marker on reference line and to zero digital readout.
  - (2) Grease pencil the trace on the CRT.
- f. To measure the transmission magnitude frequency response of the 8502A connect equipment as shown in Figure 6, Configuration B.
- (1) Set 8502A RF INPUT ATTENUATION control to zero dB.
  - (2) On 8505A Signal Processor Channel 1 press REF OFFSET pushbuttons to center the display around the grease pencil magnitude trace.
  - (3) Measure the maximum difference between the grease pencil trace and the display trace (Figure 7). This measured value should be  $\leq 0.8$  dB.
- g. To determine the phase frequency response of the Network Analyzer connect equipment as shown in Figure 6, Configuration A:
- (1) Remove CRT grease pencil traces from previous test.
  - (2) Turn 8505A Signal Processor Channel 1 MODE switch to OFF and Channel 2 MODE switch to PHASE.

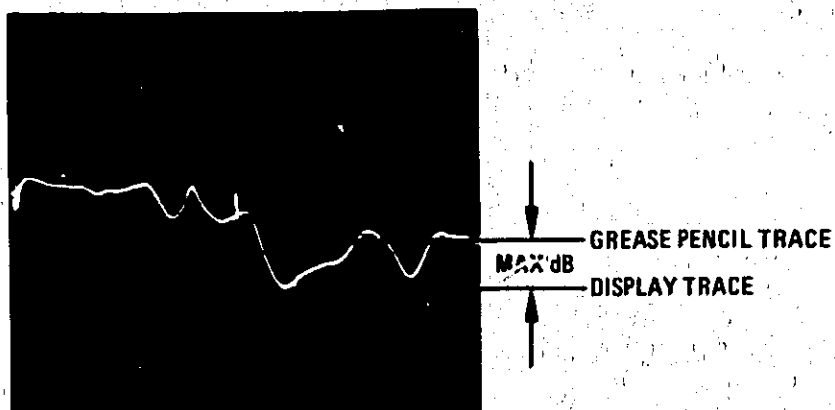

Figure 7. Transmission Frequency Response Magnitude

## PERFORMANCE TESTS

### 44. TRANSMISSION FREQUENCY RESPONSE TEST (Cont'd)

- (3) On the 8505A Signal Processor Electrical Length, press the LENGTH pushbuttons and adjust VERNIER B control to display a horizontal trace on the CRT.
  - (4) Set 8505A Signal Processor Channel 2 SCALE/DIV switch to 2 DEG.
  - (5) On the 8505A Signal Processor Channel 2 press DISPLAY MKR and ZRO pushbuttons to place marker on reference line and to zero digital readout.
  - (6) Grease pencil the trace on the CRT.
- h. To measure the transmission phase frequency response of the 8502A connect equipment as shown in Figure 6, Configuration B:
- (1) Set 8505A Signal Processor Channel 2 SCALE/DIV switch to 90 DEG.
  - (2) On 8505A Signal Processor Electrical Length, press the LENGTH pushbuttons and adjust VERNIER B control to display a horizontal trace on the CRT.
  - (3) Set 8505A Signal Processor Channel 2 SCALE/DIV switch to 2 DEG and repeat step h (2).
  - (4) On 8505A Signal Processor Channel 2 press MKR and ZRO pushbuttons.
  - (5) On 8505A Signal Processor Channel 2 press the REF OFFSET pushbuttons to center the display around the grease pencil phase trace.
  - (6) Measure the maximum difference between the grease pencil trace and the display trace (Figure 8). This measured value should be  $< 8^\circ$ .

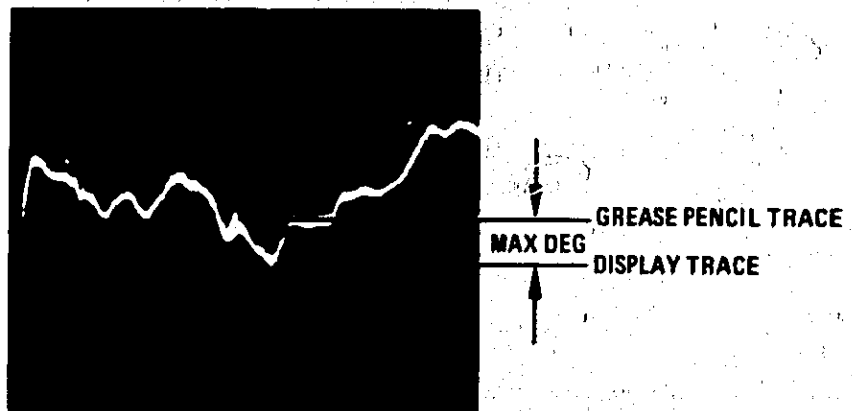

Figure 8. Transmission Frequency Response Phase

**PERFORMANCE TESTS**

**45. REFLECTION FREQUENCY RESPONSE TEST**

**SPECIFICATION:**

- $\leq \pm 1.5$  dB Mag from 0.5 to 1300 MHz
- $\leq \pm 15^\circ$  Phase from 0.5 to 1300 MHz
- $\leq \pm 10^\circ$  Phase from 2 to 1300 MHz

**DESCRIPTION:**

The reflection frequency response of the 8505A Network Analyzer system is first recorded with a grease pencil on the CRT display. The 8502A is connected and the reflection frequency response is superimposed over the reference grease pencil trace. The difference in the two traces is the reflection frequency response of the 8502A.

**CONFIGURATION A**

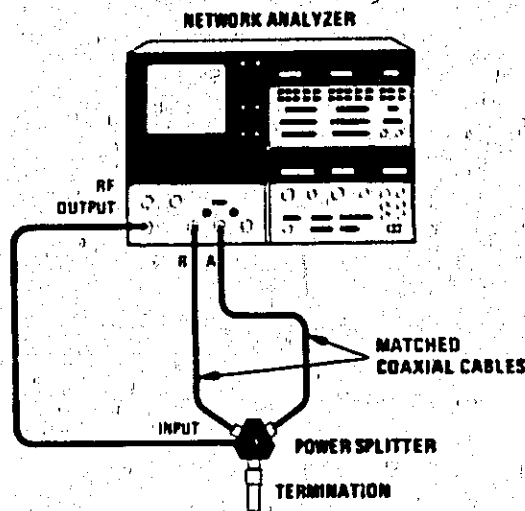

*Figure 9. Reflection Frequency Response Test Setup (1 of 2)*

PERFORMANCE TESTS

45. REFLECTION FREQUENCY RESPONSE TEST (Cont'd)

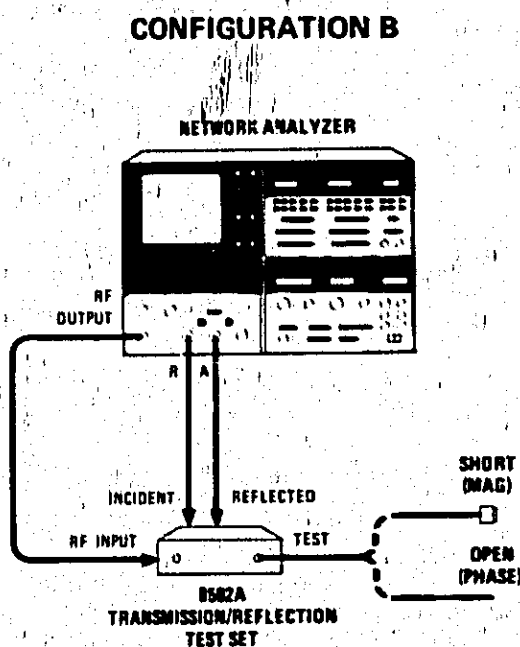

Figure 9. Reflection Frequency Response Test Setup (2 of 2)

**EQUIPMENT:**

|   |                    |
|---|--------------------|
| Network Analyzer .....                      | HP 8505A           |
| 3-Way Power Splitter .....                  | HP 11850A          |
| 50Ω Type N Male Termination .....           | HP 909A Option 012 |
| Matched Type N Male Coaxial Cable Kit ..... | HP 11851A          |
| Type N Male Short .....                     | HP 11512A          |

**PROCEDURE:**

- a. Set 8505A controls as follows:

**A1 Source/Converter:**

|                            |     |
|----------------------------|-----|
| OUTPUT LEVEL dBm .....     | -10 |
| OUTPUT LEVEL Vernier ..... | .0  |
| INPUT LEVEL MAX .....      | -10 |



PERFORMANCE TESTS

45. REFLECTION FREQUENCY RESPONSE TEST (Cont'd)

A2 Frequency Control:

RANGE MHz ..... 5 - 1300  
 MODE ..... LIN FULL  
 WIDTH ..... START/STOP 1  
 SCAN TIME SEC ..... .1 - .01  
 TRIGGER ..... AUTO  
 MARKERS Switch ..... 1  
 MARKER Vernier ..... Mid-range  
 FREQUENCY MHz START ..... 0  
 FREQUENCY MHz STOP ..... 1300

A3 Signal Processor:

Channel 1:

INPUT ..... A/R  
 MODE ..... MAG  
 SCALE/DIV ..... .5 dB

Channel 2:

INPUT ..... A/R  
 MODE ..... PHASE  
 SCALE/DIV ..... 90 DEG

Electrical Length:

INPUT ..... A  
 MODE ..... XI

- b. Connect equipment as shown in Figure 9, Configuration A.
- c. On 8505A CRT display, depress REF LINE POSN pushbutton. Adjust CH 1 and CH 2 controls until traces are positioned to center of screen. Press REF LINE POSN pushbutton again to return system to normal operation.
- d. On 8505A Signal Processor turn Channel 2 MODE switch to OFF.
- e. To determine the magnitude frequency response of the Network Analyzer move 8505A Frequency Control MARKER 1 to center graticule:
  - (1) On the 8505A Signal Processor Channel 1 press DISPLAY MKR and ZRO pushbuttons to place marker on reference line and to zero digital readout.
  - (2) Grease pencil the trace on the CRT.
- f. To measure the reflection magnitude frequency response of the 8502A connect equipment as shown in Figure 9, Configuration B with TEST port shorted.
  - (1) Set 8502A RF INPUT ATTENUATION control to 0 dB.
  - (2) On 8505A Signal Processor Channel 1 press REF OFFSET pushbuttons to center the display around the grease pencil magnitude trace.

## PERFORMANCE TESTS

## 45. REFLECTION FREQUENCY RESPONSE TEST (Cont'd)

- (3) Measure the maximum difference between the grease pencil trace and the display trace (Figure 10). This measured value should be  $\leq 1.5$  dB for the entire 0.5 to 1300 MHz frequency range.

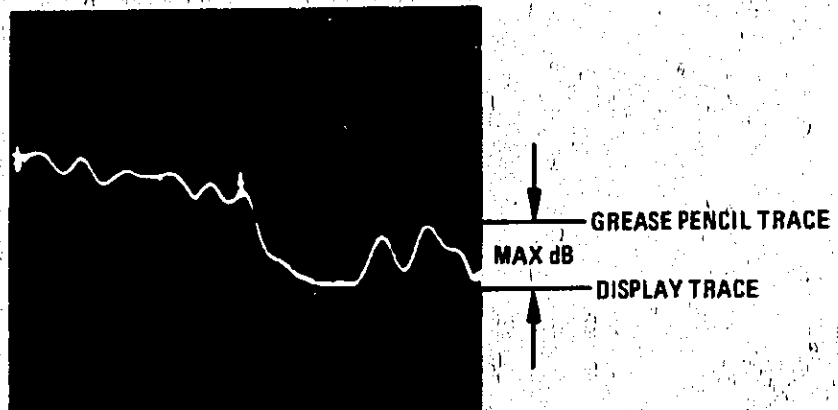

Figure 10. Reflection Frequency Response Magnitude

- g. To determine the phase frequency response of the Network Analyzer for the full 0.5 to 1300 MHz frequency range connect equipment as shown in Figure 9, Configuration A:
- (1) Remove CRT grease pencil trace from previous test.
  - (2) Turn 8505A Signal Processor Channel 1 MODE switch to OFF and Channel 2 MODE switch to PHASE.
  - (3) On the 8505A Signal Processor Electrical Length, press the LENGTH pushbuttons and adjust VERNIER A control to display a horizontal trace on the CRT.
  - (4) Set 8505A Signal Processor Channel 2 SCALE/DIV switch to 5 DEG and repeat step g (3).
  - (5) On the 8505A Signal Processor Channel 2 press DISPLAY MKR and ZRO pushbuttons to place marker on reference line and to zero digital readout.
  - (6) Grease pencil the trace on the CRT.
- h. To measure the reflection phase frequency response of the 8502A connect equipment as shown in Figure 9, Configuration B with TEST port open.
- (1) Set 8505A Signal Processor Channel 2 SCALE/DIV switch to 90 DEG.
  - (2) On 8505A Signal Processor ELECTRICAL LENGTH press the LENGTH pushbuttons and adjust VERNIER A control to display a horizontal trace on the CRT.
  - (3) Set 8505A Signal Processor Channel 2 SCALE/DIV switch to 5 DEG and repeat step h (2).
  - (4) On 8505A Signal Processor Channel 2 press MKR and ZRO pushbuttons.

## PERFORMANCE TESTS

**45. REFLECTION FREQUENCY RESPONSE TEST (Cont'd)**

- (5) On 8505A Signal Processor Channel 2 press the REF OFFSET pushbuttons to center the display around the grease pencil phase trace.
- (6) Measure the maximum difference between the grease pencil trace and the display trace (Figure 11). This measured value should be  $<15^\circ$  for the entire 0.5 to 1300 MHz frequency range.

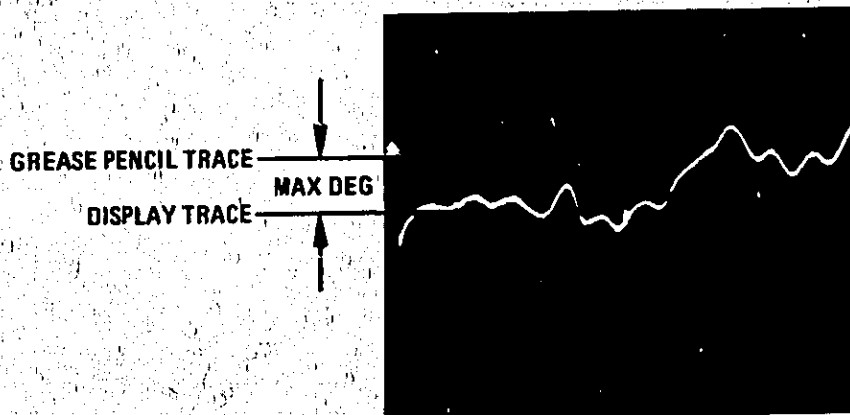

*Figure 11. Reflection Frequency Response Phase*

- i. To determine the phase frequency response of the Network Analyzer for the 2 to 1300 MHz frequency range, connect equipment as shown in Figure 9, Configuration A:
  - (1) Remove CRT grease pencil trace from previous test.
  - (2) On 8505A Frequency Control set MODE switch to LIN EXPAND.
  - (3) Set 8505A Frequency Control FREQUENCY MHz START control to 2 and FREQUENCY MHz STOP control to 1300.
  - (4) Set 8505A Signal Processor Channel 2 SCALE/DIV switch to 90 DEG.
  - (5) Repeat steps g (3) through g (6).
- j. To measure the reflection phase frequency response of the 8502A connect equipment as shown in Figure 9, Configuration B with TEST port open.
  - (1) Repeat steps h (1) through h (5).
  - (2) Measure the maximum difference between the grease pencil trace and the display trace (Figure 11). This measured value should be  $<10^\circ$  for the 2 to 1300 MHz frequency range.
  - (3) Remove grease pencil trace from CRT.

## PERFORMANCE TESTS

## 46. TEST PORT OPEN/SHORT RATIO TEST

## SPECIFICATION:

## Test Port Open/Short Ratio:

$\leq \pm 0.9$  dB Mag and  $\leq \pm 7.5^\circ$  Phase from 1000 to 1300 MHz

$\leq \pm 0.75$  dB Mag and  $\leq \pm 6^\circ$  Phase from 2 to 1000 MHz

$\leq \pm 1.25$  dB Mag and  $\leq \pm 10^\circ$  Phase from 0.5 to 2 MHz

## DESCRIPTION:

Magnitude open/short ratio and Phase open/short ratio for frequencies above 2 MHz are measured using the reflections generated by a short through a 6-ft. coaxial cable which is connected to the 8502A TEST port. Peak-to-peak readings are taken from the CRT trace to determine the actual open/short ratio while the effect of the return loss of the cable used is accounted for. To compensate for the added line length on the 8502A TEST port, a 12-ft. coaxial cable is connected from the 8502A INCIDENT port to the 8505A R Channel. For frequencies below 2 MHz, the TEST port is directly shorted, then opened, and this ratio is read directly from the CRT trace.

**CONFIGURATION A**  
(Frequency Range: 2 – 1300 MHz)

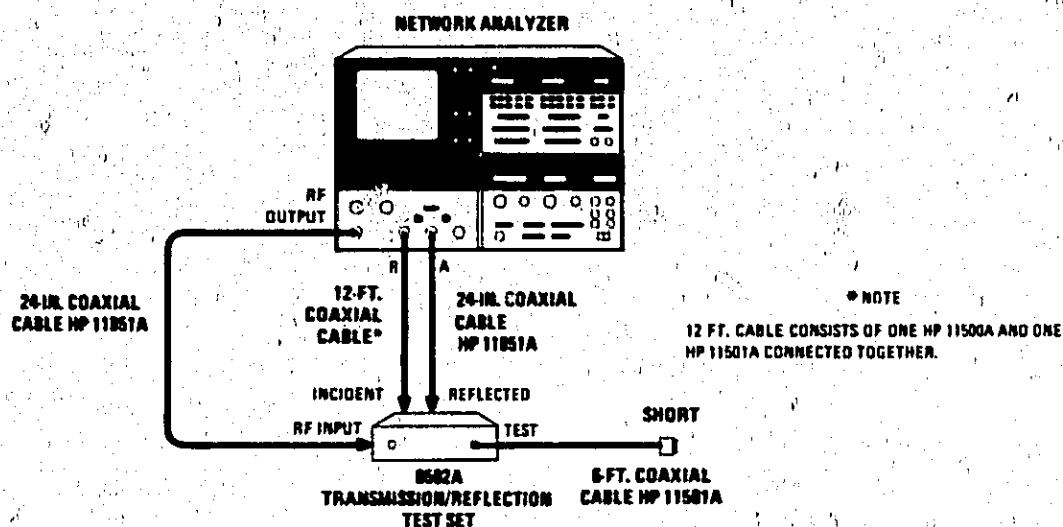

Figure 12. TEST Port Open/Short Ratio Test (1 of 2)

PERFORMANCE TESTS

46. TEST PORT OPEN/SHORT RATIO TEST (Cont'd)

CONFIGURATION B  
(Frequency Range: 0.5 – 2 MHz)

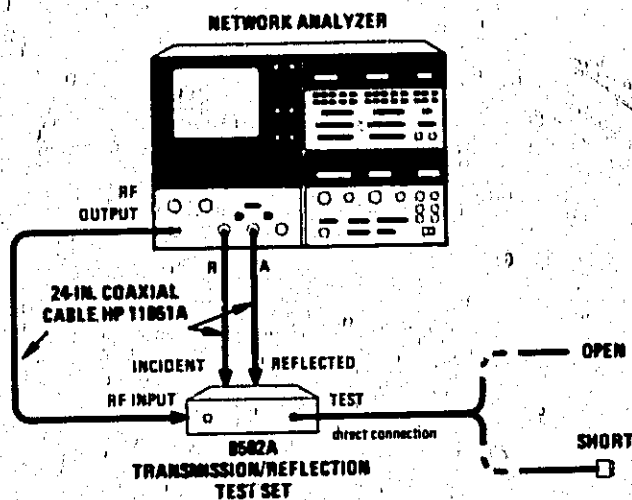

Figure 12. TEST Port Open/Short Ratio Test (2 of 2)

EQUIPMENT:

|  |           |
|--|-----------|
| Network Analyzer.....  | HP 8505A  |
| Type N Male Short.....   | HP 11512A |
| 6-Ft. Coaxial Cable, Type RG-214, with Type N Male Connector on One End and Type N Female Connector on the Other end (2 required)..... | HP 11501A |
| 6-Ft. Coaxial Cable, Type RG-214, with Type N Male Connectors on Each End.....   | HP 11500A |
| 24-In. 50Ω Matched Coaxial Cable with Type N Male Connectors on Each End (3 required).....   | HP 11851A |

PROCEDURE:

a. Set 8505A controls as follows:

AI Source/Converter:

|                           |     |
|---------------------------|-----|
| OUTPUT LEVEL dBm.....     | -10 |
| OUTPUT LEVEL Vernier..... | 0   |
| INPUT LEVEL MAX.....      | -10 |

PERFORMANCE TESTS

46. TEST PORT OPEN/SHORT RATIO TEST (Cont'd)

A2 Frequency Control:

RANGE MHz ..... 5 - 1300 MHz  
 MODE ..... LIN EXPAND  
 WIDTH ..... START/STOP 1  
 SCAN TIME SEC ..... 1 - .1  
 TRIGGER ..... AUTO  
 FREQUENCY MHz START ..... 1000  
 FREQUENCY MHz STOP ..... 1300  
 MARKER Vernier ..... Clockwise

A3 Signal Processor:

Channel 1:  
 INPUT ..... A/R  
 MODE ..... MAG  
 SCALE/DIV ..... .5 dB

Channel 2:  
 INPUT ..... A/R  
 MODE ..... PHASE  
 SCALE/DIV ..... 5 DEG

Electrical Length:

INPUT ..... A  
 MODE ..... X10

- b. Set 8502A RF INPUT ATTENUATION control to 20 dB.
  - c. Connect equipment as shown in Figure 12, Configuration A.
  - d. On 8505A CRT display, depress REF LINE POSN pushbutton. Adjust CH 1 and CH 2 controls until traces are positioned to center of screen. Press REF LINE POSN pushbutton again to return system to normal operation.
  - e. On 8505A Signal Processor turn Channel 2 MODE switch to OFF.
  - f. To measure the TEST port open/short magnitude ratio between 1000 and 1300 MHz move 8505A Frequency Control MARKER 1 to center graticule.
- (1) On the 8505A Signal Processor Channel 1 press DISPLAY MKR and ZRO pushbuttons to place marker on reference line and to zero digital readout.

PERFORMANCE TESTS

46. TEST PORT OPEN/SHORT RATIO TEST (Cont'd)

- (2) Measure the maximum peak-to-peak variation on the display (Figure 13) and record the results:

Magnitude: 1000 to 1300 MHz = \_\_\_\_\_ dB

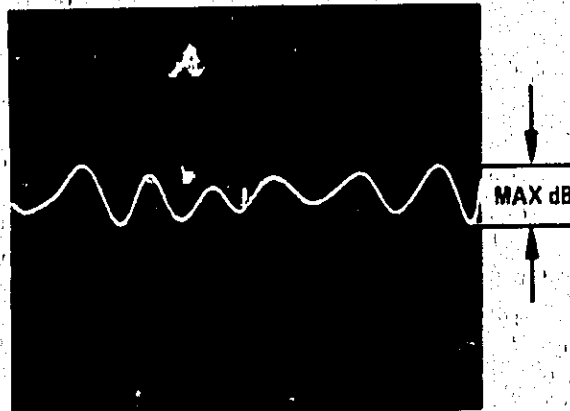

Figure 13. TEST Port Open/Short Ratio Magnitude > 2 MHz

NOTE

If a peak-to-peak measurement is made in an area where there is some slope, a corrected reading can be obtained by connecting two adjacent upper peaks with a dotted line. Extend a vertical line up from the lower peak until it intersects the dotted line. This constructed vertical line is the averaged or corrected peak-to-peak measurement to be used (Figure 14). Avoid making peak-to-peak measurements at extreme slope changes.

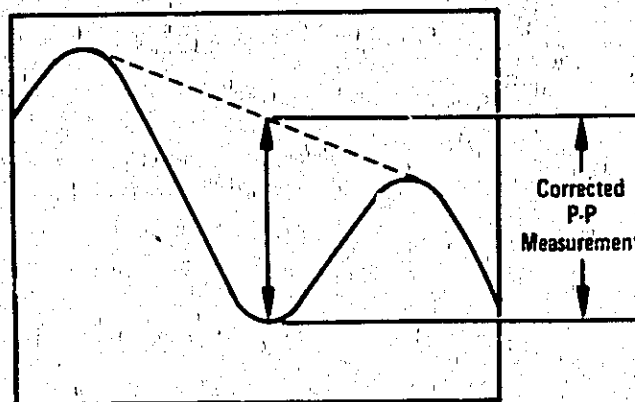

Figure 14. Slope Peak-To-Peak Measurement

## PERFORMANCE TESTS

## 46. TEST PORT OPEN/SHORT RATIO TEST (Cont'd)

- g. Calculate the actual maximum open/short magnitude ratio for the 1000 to 1300 MHz frequency range by dividing the measured value (recorded previously) by the reflection coefficient of the test cable used (Table 5, Column 1000 MHz), or:

$$\frac{\text{MEASURED VALUE dB}}{\text{REFLECTION COEFFICIENT OF TEST CABLE}} = \text{ACTUAL OPEN/SHORT RATIO MAGNITUDE}$$

The actual open/short ratio magnitude for 1000 to 1300 MHz should be  $\leq 1.8$  dB ( $\leq \pm 0.9$  dB).

Table 5. Loss of Typical Coaxial Cable Used for 6-Ft. "Test" Cable

| Cable Type | 600 MHz                           | 1000 MHz                          |
|------------|-----------------------------------|-----------------------------------|
|            | $\rho$ for 12-Ft.<br>(out & back) | $\rho$ for 12 Ft.<br>(out & back) |
| RG-214/u   | 0.91                              | 0.88                              |
| RG-58/u    | 0.91                              | 0.88                              |
| RF-218/u   | 0.96                              | 0.95                              |

- h. To measure the TEST port open/short phase ratio between 1000 and 1300 MHz:
- (1) Set 8505A Signal Processor Channel 1 MODE switch to OFF and Channel 2 MODE switch to PHASE.
  - (2) On 8505A Signal Processor Channel 2, press DISPLAY MKR and ZRO pushbuttons to place marker on reference line and to zero digital readout.
  - (3) On 8505A Signal Processor ELECTRICAL LENGTH, press the LENGTH pushbuttons and adjust VERNIER A control to display a horizontal trace on the CRT. If necessary you can change 8505A Signal Processor Channel 2 SCALE/DIV switch to a lower sensitivity to position trace to a horizontal position, then return it to PHASE 5 DEG setting before going on with test.
  - (4) On 8505A Signal Processor Channel 2, press REF OFFSET pushbuttons to move trace to a readable position on the CRT.



## PERFORMANCE TESTS

## 46. TEST PORT OPEN/SHORT RATIO TEST (Cont'd)

- (5) Measure the maximum peak-to-peak variation on the display (Figure 15) and record the results (See Figure 14):

PHASE: 1000 to 1300 MHz = \_\_\_\_\_ DEG

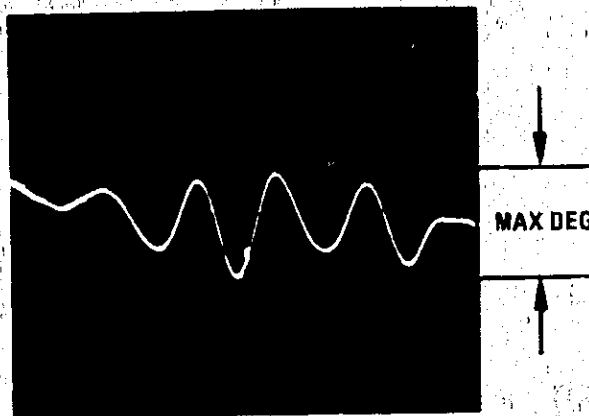

Figure 15. TEST Port Open/Short Ratio Phase > 2 MHz

- i. Calculate the actual maximum open/short ratio phase for the 1000 to 1300 MHz frequency range by dividing the measured value (recorded above) by the reflection coefficient of the test cable used (Table 5, Column 1000 MHz), or:

$$\frac{\text{MEASURED VALUE DEG}}{\text{REFLECTION COEFFICIENT OF TEST CABLE}} = \text{ACTUAL OPEN/SHORT RATIO PHASE}$$

The actual open/short ratio phase for 1000 to 1300 MHz should be  $\leq 15^\circ$  ( $\leq 7.5^\circ$ ).

- j. To measure the TEST port open/short magnitude ratio between 2 and 1000 MHz:

- (1) Set 8505A Frequency Control FREQUENCY MHz START control to 2 and FREQUENCY MHz STOP control to 1000.
- (2) Set 8505A Signal Processor Channel 2 MODE switch to OFF and Channel 1 MODE switch to MAG.
- (3) Repeat step f except that the measured value for the frequency range 2 to 1000 MHz = \_\_\_\_\_ dB.
- (4) To calculate the actual open/short magnitude for the 2 to 1000 MHz frequency range, repeat step g except use the 600 MHz column in Table 5 to find the reflection coefficient of the test cable used. The actual open/short ratio magnitude for 2 to 1000 MHz should be  $\leq 1.5$  dB ( $\leq \pm 0.75$  dB).

## PERFORMANCE TESTS

---

### 46. TEST PORT OPEN/SHORT RATIO (Cont'd)

- k. To measure the TEST port open/short ratio phase between 2 and 1000 MHz:
- (1) Repeat step h except that the measured value for the frequency range 2 to 1000 MHz = \_\_\_\_\_ dB.
  - (2) To calculate the actual open/short ratio phase for 2 to 1000 MHz frequency range, repeat step i except use the 600 MHz column in Table 5 to find the reflection coefficient of the test cable used. The actual open/short ratio phase for 2 to 1000 MHz should be  $\leq 12^\circ$  ( $\leq \pm 6^\circ$ ).
- l. To measure magnitude and phase open/short ratios below 2 MHz connect equipment as shown in Figure 12, Configuration B with TEST port open.
- (1) Set 8505A Frequency Control RANGE MHz switch to .5 - 13.
  - (2) Set 8505A Frequency Control FREQUENCY MHz START control to 00.50 and FREQUENCY MHz STOP control to 02.00.
  - (3) Set 8505A Signal Processor Channel 2 MODE switch to PHASE.
  - (4) On 8505A CRT display, depress REF LINE POSN pushbutton. Adjust CH 1 and CH 2 controls until traces are positioned to center of screen. Press REF LINE POSN pushbutton again to return system to normal operation.
  - (5) On 8505A Signal Processor Channel 1 and Channel 2 press MKR then ZRO pushbuttons to bring trace to on-screen position.
  - (6) On 8505A Frequency Control set Frequency Counter MHz MARKER 1 to beginning of sweep on CRT.
  - (7) On 8505A Signal Processor Channel 1 and Channel 2 press MKR then ZRO pushbuttons to place marker on reference line and to zero digital readout.
  - (8) Set 8505A Signal Processor Channel 2 MODE switch to OFF.
- m. To measure the TEST port open/short ratio magnitude between 0.5 and 2 MHz:
- (1) Attach short directly to TEST port.
  - (2) 8505A Signal Processor Channel 1 MKR digital display should indicate  $\leq 2.50$  dB ( $\leq \pm 1.25$  dB).
- n. To measure the TEST port open/short ratio phase between 0.5 and 2 MHz:
- (1) Remove the short from the 8502A TEST port.
  - (2) Set 8505A Signal Processor Channel 1 MODE switch to OFF and Channel 2 MODE switch to PHASE.

**PERFORMANCE TESTS**

---

**46. TEST PORT OPEN/SHORT RATIO TEST (Cont'd)**

- (3) On 8505A Signal Processor Electrical Length, press the LENGTH pushbuttons and adjust VERNIER A control to display a horizontal trace on the CRT. If necessary, change 8505A Signal Processor Channel 2 SCALE/DIV switch to a lower sensitivity to position trace to a horizontal position, then return it to PHASE 5 DEG setting before going on with test.
- (4) On 8505A Signal Processor Channel 2 press MKR then ZRO then DISPLAY REF pushbuttons.
- (5) On 8505A Signal Processor Channel 2 press REF OFFSET pushbuttons to indicate +180 DEG on digital display.
- (6) On 8505A Signal Processor Channel 2 press DISPLAY MKR pushbutton.
- (7) Attach short directly to 8502A TEST port.
- (8) Digital display should indicate  $<20^\circ$  ( $< \pm 10^\circ$ ).

---

**47. TEST PORT RETURN LOSS TEST****SPECIFICATION:**

TEST port return loss:  $>26$  dB from 2 to 1300 MHz  
 $>20$  dB from 0.5 to 2 MHz

**DESCRIPTION:**

Perform the Directivity (Incoming Inspection Test, Figure 5) and the Open/Short Ratio (Paragraph 46) Tests. These two tests confirm that the TEST port Return Loss of the 8502A is within specification. If a more direct and accurate test is required for the TEST port Return Loss specification, refer to the 8507A Accuracy Enhancement Program (AIM) procedure for the method of making an error-corrected return loss measurement. An 8542B Automatic Network Analyzer may also be used to make this measurement between 100 and 1300 MHz.

---

**PERFORMANCE TESTS**

---

**48. PORT RETURN LOSS TESTS****SPECIFICATIONS:**

**INCIDENT Port Return Loss:**

- 23 dB from 1000 – 1300 MHz
- 25 dB from 100 – 1000 MHz
- 25 dB from 2 – 100 MHz
- 23 dB from 0.5 – 2 MHz

**REFLECTED Port Return Loss:**

- 23 dB from 1000 – 1300 MHz
- 25 dB from 100 – 1000 MHz
- 25 dB from 2 – 100 MHz
- 23 dB from 0.5 – 2 MHz

**RF INPUT Port Return Loss:**

- 23 dB from 100 – 1300 MHz
- 23 dB from 0.5 – 100 MHz

**DESCRIPTION:**

The system is calibrated by shorting or opening the main line TEST port of the Directional Coupler to establish a 0 dB reference line on the CRT display. The INCIDENT, REFLECTED or RF INPUT port of the 8502A is then connected in place of the short to the Dual Directional Coupler or Directional Bridge with all other ports terminated in 50 ohms. The Return Loss is measured directly with the 8505A MARKER digital display and the CRT trace. When using this method to measure Return Loss, ambiguity due to "imperfect" directivity of the directional device is introduced. The ambiguity of the measurement may be as great as  $\pm 2$  dB. If a more direct and accurate test is required to the port Return Loss specifications, refer to the 8507A Accuracy Enhancement Program (AIM) procedure for the method of making an error-corrected Return Loss measurement.

PERFORMANCE TESTS

48. PORT RETURN LOSS TESTS (Cont'd)

**CONFIGURATION A**  
(Frequency Range: 100 – 1300 MHz)

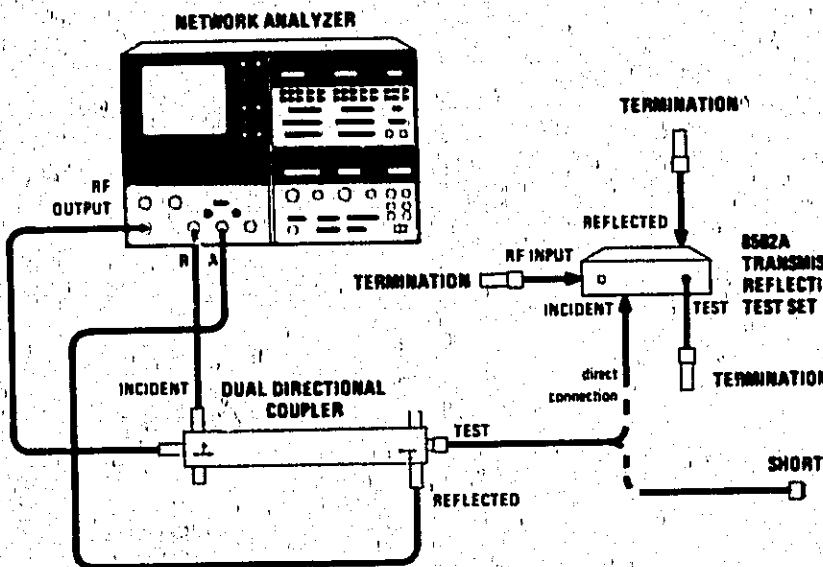

NOTE:

THE TEST SETUP SHOWN IS FOR INCIDENT PORT RETURN LOSS MEASUREMENTS. FOR REFLECTED OR RF INPUT PORT MEASUREMENTS THE SETUPS (CONFIGURATIONS A AND B) ARE IDENTICAL EXCEPT THAT THE PORT TO BE MEASURED IS DIRECTLY CONNECTED TO THE DUAL DIRECTIONAL COUPLER (CONFIGURATION A) OR THE DIRECTIONAL BRIDGE (CONFIGURATION B) WITH ALL OTHER PORTS TERMINATED IN 50 OHMS.

**CONFIGURATION B**  
(Frequency Range: 0.5 – 100 MHz)

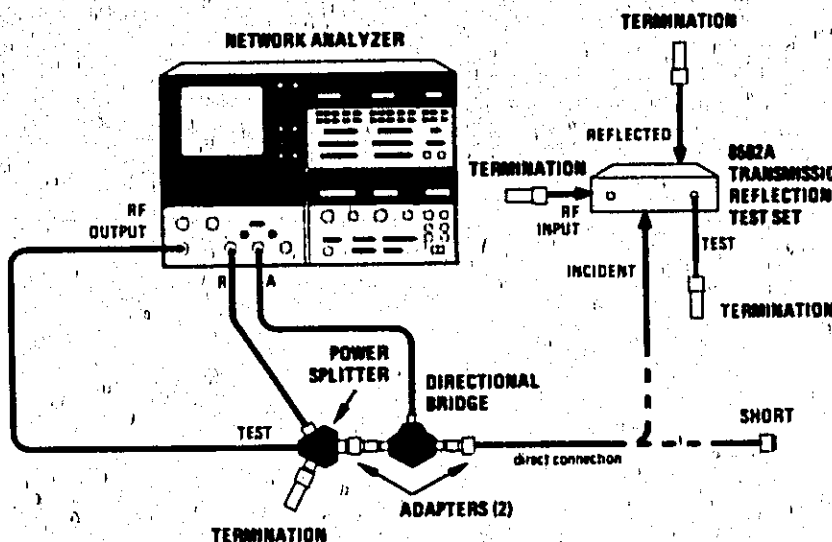

Figure 16. INCIDENT, REFLECTED, and RF INPUT Port Return Loss Test Setups

**PERFORMANCE TESTS**

**48. PORT RETURN LOSS TESTS (Cont'd)**

**EQUIPMENT:**

|   |                    |
|---|--------------------|
| Network Analyzer.....                             | HP 8505A           |
| Dual Directional Coupler.....                     | HP 778D            |
| Directional Bridge*.....                          | HP 8721A           |
| 3-Way Power Splitter.....                         | HP 11850A          |
| Type N Female Short.....                          | HP 11511A          |
| 50Ω Type N Male Termination (4 required).....     | HP 909A Option 012 |
| Type N Male to BNC Male Adapter (2 required)..... | HP 1250-1473*      |

\*Part of HP 11652A Transmission/Reflection Kit.  
 \*\*Part of HP 11854A 50Ω BNC Accessory Kit.

**PROCEDURE:**

a. Set 8505A controls as follows:

**A1 Source/Converter**

|                           |     |
|---------------------------|-----|
| OUTPUT LEVEL dBm.....     | -10 |
| OUTPUT LEVEL Vernier..... | 0   |
| INPUT LEVEL MAX.....      | -10 |

**A2 Frequency Control**

|                          |                  |
|--------------------------|------------------|
| RANGE MHz.....           | 0.5 - 1300 MHz   |
| MODE.....                | LIN EXPAND       |
| WIDTH.....               | START/STOP 1     |
| SCAN TIME SEC.....       | .1 - .01         |
| VERNIER.....             | Counterclockwise |
| TRIGGER.....             | AUTO             |
| MARKERS Switch.....      | 1                |
| FREQUENCY MHz START..... | 100              |
| FREQUENCY MHz STOP.....  | 1300             |
| MARKER 1.....            | 1000             |

**A3 Signal Processor:**

**Channel 1:**

|                |       |
|----------------|-------|
| INPUT.....     | A/R   |
| MODE.....      | MAG   |
| SCALE/DIV..... | 20 dB |

**Channel 2:**

|           |     |
|-----------|-----|
| MODE..... | OFF |
|-----------|-----|

**Electrical Length:**

|           |     |
|-----------|-----|
| MODE..... | OFF |
|-----------|-----|

b. Set 8502A RF INPUT ATTENUATION control to 20 dB.

c. For INCIDENT port return loss measurements connect equipment as shown in Figure 16, Configuration A with no connection to mainline TEST port of Directional Coupler.

**PERFORMANCE TESTS**

**48. PORT RETURN LOSS TESTS (Cont'd)**

- d. On 8505A display, depress REF LINE POSN pushbutton. Adjust CH 1 control until trace is positioned to center of screen. Press REF LINE POSN pushbutton again to return system to normal operation.
- e. Set 8505A Frequency Control MARKERS switch to 2.
- f. Place 8505A Frequency Control MARKER 2 on center graticule.
- g. To calibrate the system for Return Loss measurement, attach short directly to Dual Directional Coupler mainline TEST port. On 8505A Signal Processor Channel 1, press DISPLAY MKR then ZRO pushbuttons to place MARKER 2 on reference line and to zero digital readout.
- h. To measure the INCIDENT port return loss for the frequency range 1000 to 1300 MHz:
  - (1) Remove short and connect Dual Directional Coupler directly to 8502A INCIDENT port with RF INPUT, REFLECTED, and TEST ports terminated.
  - (2) Move 8505A Frequency Control MARKER 2 control to worst-case, Return Loss between 1000 and 1300 MHz as indicated on CRT. (This is the point closest to calibration line right of 1000 MHz MARKER 1 as shown in Figure 17.)

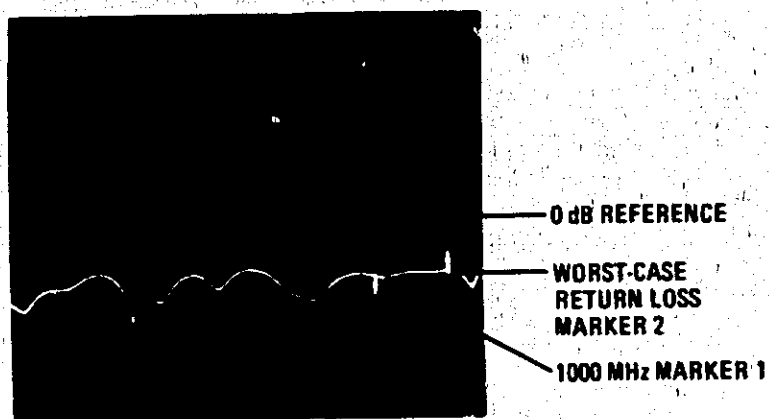

*Figure 17. INCIDENT Port Return Loss (1000 to 1300 MHz)*

- (3) Read worst-case Return Loss from 8505A Signal Processor Channel 1 digital display. The indication should be  $>23$  dB below the zero dB reference level for the frequency range 1000 to 1300 MHz.
- i. To measure the INCIDENT port Return Loss for the frequency range 100 to 1000 MHz:
  - (1) Move 8505A Frequency Control MARKER 2 control to worst-case Return Loss between 100 and 1000 MHz as indicated on CRT. (The point closest to calibration line to left of 1000 MHz MARKER as shown in Figure 18.)

## PERFORMANCE TESTS

## 48. PORT RETURN LOSS TESTS (Cont'd)

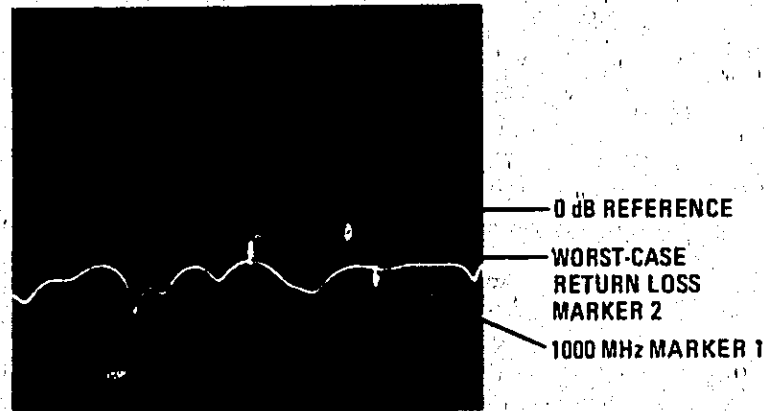

Figure 18. INCIDENT Port Return Loss (100 to 1000 MHz)

- (2) Read worst-case Return Loss from 8505A Signal Processor Channel 1 digital display. The indications should be  $\geq 25$  dB below the zero dB reference level for the frequency range 100 to 1000 MHz.
- j. To determine the INCIDENT port Return Loss for the frequency range 2 to 1000 MHz connect equipment as shown in Figure 16, Configuration B with LOAD port on Directional Bridge shorted. Set 8505A Frequency Control RANGE MHz switch to .5 - 130. Adjust FREQUENCY MHz START control to 002.0 and FREQUENCY MHz STOP control to 100.0.
  - k. To calibrate the system for Return Loss measurements:
    - (1) On 8505A CRT display, push REF LINE POSN pushbutton and adjust CH1 control until trace is positioned to center of screen. Press REF LINE POSN pushbutton again to return system to normal operation.
    - (2) Set 8505A Frequency Control MARKERS switch to 1 and adjust MARKER 1 control to center graticule.
    - (3) On 8505A Signal Processor Channel 1 press DISPLAY MKR and ZRO pushbuttons to place MARKER 1 on reference line and to zero digital readout.
  - l. To measure the INCIDENT port Return Loss for 2 to 100 MHz:
    - (1) Connect 8502A INCIDENT port directly to Directional Bridge LOAD Port with TEST, RF INPUT, and REFLECTED ports terminated.
    - (2) Move 8505A Frequency Control MARKER 1 control to worst-case Return Loss between 2 and 100 MHz as indicated on CRT. (This is the point closest to calibration line as shown in Figure 19.)



PERFORMANCE TESTS

48. PORT RETURN LOSS TESTS (Cont'd)

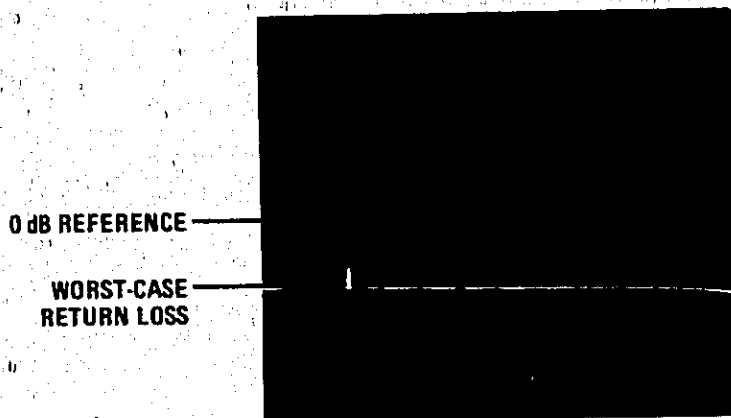

Figure 19. INCIDENT Port Return Loss (2 to 100 MHz)

(3) Read worst-case Return Loss from 8505A Signal Processor Channel 1 digital display. The indications should be  $\geq 25$  dB below the zero dB reference level for the frequency range 2 – 100 MHz.

m. To determine INCIDENT port Return Loss for the frequency range 0.5 to 2 MHz:

- (1) Set 8505A Frequency Control RANGE MHz switch to .5 to 13. Adjust FREQUENCY START control to 00.50 and FREQUENCY STOP control to 02.00.
- (2) Repeat steps k through l except that the indication should be  $\geq 23$  dB below the zero dB reference level for the frequency range .5 to 2 MHz (Figure 20).

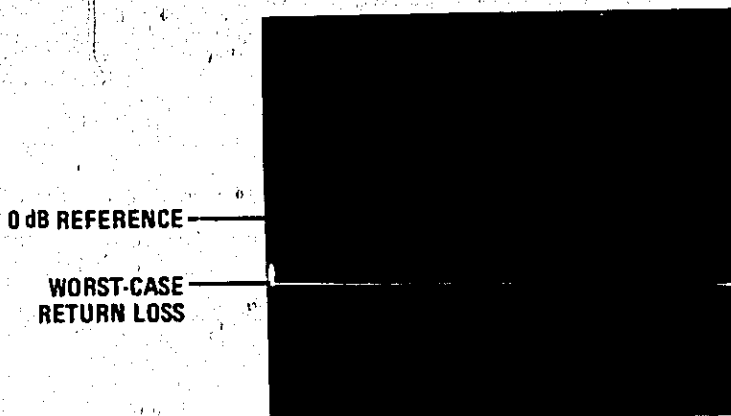

Figure 20. INCIDENT Port Return Loss (0.5 to 2 MHz)

---

**PERFORMANCE TESTS**

---

**48. PORT RETURN LOSS TESTS (Cont'd)**

- n. For REFLECTED port Return Loss measurements repeat steps a — m, except directly connect the REFLECTED port to the Dual Directional Coupler (Figure 16, Configuration A) or the Directional Bridge (Figure 16, Configuration B) with RF INPUT, INCIDENT, and TEST ports terminated in 50 ohms. The worst-case Return Loss measurements should be:
- > 23 dB from 1000 — 1300 MHz
  - > 25 dB from 100 — 1000 MHz
  - > 25 dB from 2 — 100 MHz
  - > 23 dB from 0.5 — 2 MHz
- o. For RF INPUT port Return Loss measurements repeat steps a — m, except directly connect the RF INPUT port to the Dual Directional Coupler (Figure 16, Configuration A) or the Directional Bridge (Figure 16, Configuration B) with REFLECTED, INCIDENT, and TEST ports terminated in 50 ohms. The worst-case Return Loss measurements should be:
- > 23 from 100 — 1300 MHz
  - > 23 from 0.5 — 100 MHz

Table 6. Model 8502A Performance Test Record

| Hewlett-Packard Model 8502A<br>Transmission/Reflection Test Set |  | Test Performed By: _____   |  |   |
|---|--|--|--|---|
| Serial Number: _____  |  | Date: _____  |  |   |
| Para. No.   | Description  | Lower Limit  | Measured Value   | Upper Limit                                     |
| 43.   | <b>DIRECTIVITY TEST</b>  | 40 dB  | _____  |   |
| 44.   | <b>TRANSMISSION FREQUENCY RESPONSE TEST</b><br>f.(3) MAG:<br>h.(6) PHASE:  |  | _____<br>_____   | 0.8 dB<br>8°                                    |
| 45.   | <b>REFLECTION FREQUENCY RESPONSE TEST</b><br>f.(3) MAG: 0.5 - 1300 MHz<br>h.(6) PHASE: 0.5 - 1300 MHz<br>j.(2) PHASE: 2 - 1300 MHz   |  | _____<br>_____<br>_____  | 1.5 dB<br>15°<br>10°                            |
| 46.   | <b>TEST PORT OPEN/SHORT RATIO TEST</b><br>g. MAG: 1000 - 1300 MHz<br>i. PHASE: 1000 - 1300 MHz<br>j.(4) MAG: 2 - 1000 MHz<br>k.(2) PHASE: 2 - 1000 MHz<br>m.(2) MAG: 0.5 - 2 MHz<br>n.(8) PHASE: 0.5 - 2 MHz   |  | _____<br>_____<br>_____<br>_____<br>_____<br>_____   | 1.8 dB<br>15°<br>1.5 dB<br>12°<br>2.5 dB<br>20° |
| 47.   | <b>TEST PORT RETURN LOSS TEST</b><br>2 - 1300 MHz<br>0.5 - 2 MHz   | 26 dB<br>20 dB   | _____<br>_____   |   |
| 48.   | <b>PORT RETURN LOSS TESTS</b><br><br>Incident Port<br>h.(3) 1000 - 1300 MHz<br>i.(2) 100 - 1000 MHz<br>l.(3) 2 - 100 MHz<br>m.(2) 0.5 - 2 MHz<br><br>Reflected Port<br>h.(3) 1000 - 1300 MHz<br>i.(2) 100 - 1000 MHz<br>l.(3) 2 - 100 MHz<br>m.(2) 0.5 - 2 MHz<br><br>RF Input Port<br>h.(3), i.(2) 100 - 1300 MHz<br>l.(3), m.(2) 0.5 - 100 MHz | 23 dB<br>25 dB<br>25 dB<br>23 dB<br><br>23 dB<br>25 dB<br>25 dB<br>23 dB<br><br>23 dB<br>23 dB | _____<br>_____<br>_____<br>_____<br><br>_____<br>_____<br>_____<br>_____<br><br>_____<br>_____ |   |

# PARTS LIST

#### 49. ADJUSTMENTS

50. No adjustments are necessary for the HP Model 8502A Transmission/Reflection Test Set.

#### 51. REPLACEABLE PARTS

52. Replaceable parts are listed in Table 7 and identified in Figure 21. Parts of Type N Connector Assembly (J3, J4, and J5) are shown in Figure 22. 8502A attaching hardware (screws, washers, etc.) is listed and identified in Figure 23.

#### 53. Ordering Instructions

54. To order a part listed in Table 7 or Figure 23, quote the Hewlett-Packard part number, indicate quantity desired, and address the order to the nearest Hewlett-Packard office. Do not try to replace any parts not listed.

#### CAUTION

The 50-ohm Bridge/Power Splitter Assembly A1 and the Input Step Attenuator Assembly A2 are not field repairable and each must be replaced as an assembly.

Model 8502A

Table 7. 8502A Replaceable Parts

| Reference Designation | HP Part Number | Qty | Description   |
|-----------------------|----------------|-----|---|
| A1                    | 5086-7228      | 1   | 50 Ohm Bridge/Power Splitter                          |
| A2                    | 08558-60003    | 1   | 0 - 70 dB Input Step Attenuator                       |
|                       | 08495-60004    |     | Restored 08558-60003, Requires Exchange               |
| J2                    | 1250-0083      | 1   | Connector: RF BNC                                     |
| J3, J4, J5            | 08502-60001    | 3   | Connector: Assembly, Type N Female<br>(See Figure 22) |
| MP1                   | 0370-2874      | 1   | Knob  |
| MP2-MP5               | 08411-4003     | 4   | Foot  |
| MP6                   | 08502-00002    | 1   | Panel: Front  |
| MP7                   | 08502-00003    | 1   | Deck: Main  |
| MP8                   | 08502-00004    | 1   | Panel: Rear Sub                                       |
| MP9                   | 08502-00005    | 1   | Panel: Rear   |
| MP10                  | 08502-20001    | 1   | Case: Bottom Cover                                    |
| MP11                  | 08502-20002    | 1   | Case: Top Cover                                       |
| MP12, MP13            | 08502-20007    | 2   | Trim: Cabinet (Zipper Lock)                           |
| MP14                  | 08503-20008    | 1   | Washer: Dress   |
| MP15-MP18             | 08502-20010    | 4   | Spring Clip   |
| W1                    | 08502-20005    | 1   | Cable: RF Reflected                                   |
| W2                    | 08502-20004    | 1   | Cable: RF Incident                                    |
| W3                    | 08502-20003    | 1   | Cable: RF Input                                       |
| W4                    | 08502-20011    | 1   | Cable: RF Attenuator                                  |
| W5                    | 08502-20006    | 1   | Cable: RF Attenuator/Bridge                           |

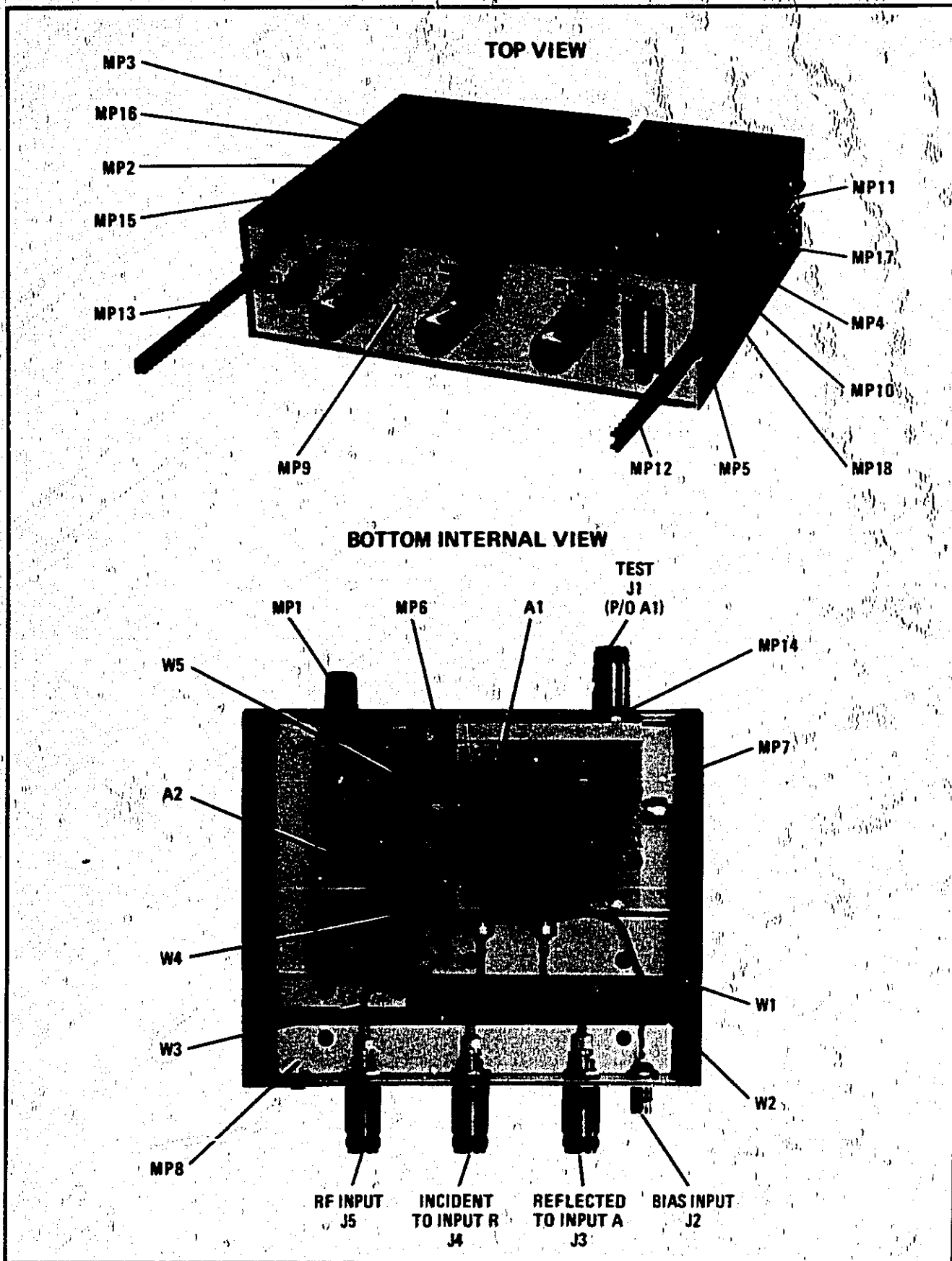
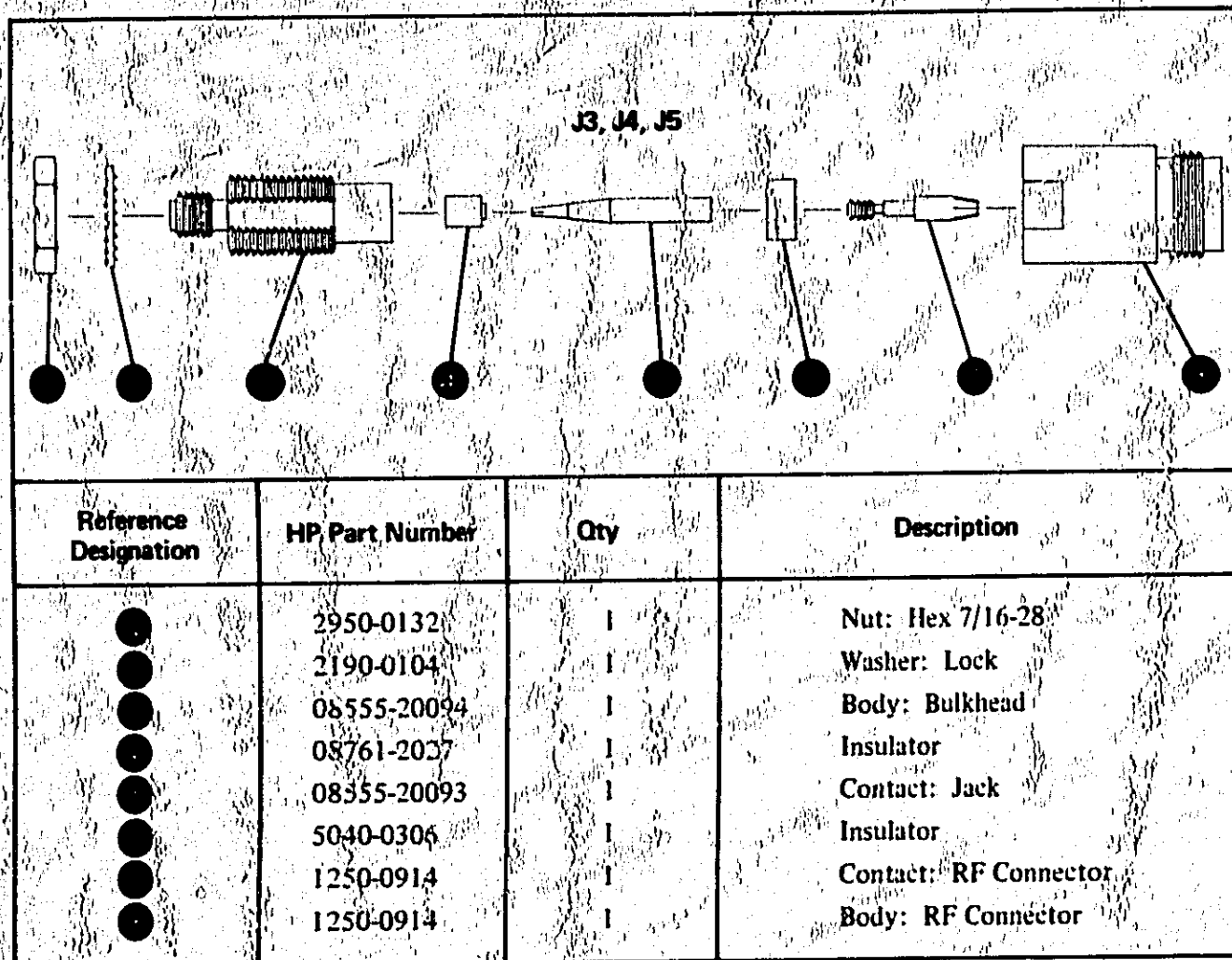

Figure 21. Major Assemblies and Parts Locations

Model 8502A



| Reference Designation | HP Part Number | Qty | Description           |
|-----------------------|----------------|-----|-----------------------|
| ●                     | 2950-0132      | 1   | Nut: Hex 7/16-28      |
| ●                     | 2190-0104      | 1   | Washer: Lock          |
| ●                     | 08555-20094    | 1   | Body: Bulkhead        |
| ●                     | 08761-2037     | 1   | Insulator             |
| ●                     | 08555-20093    | 1   | Contact: Jack         |
| ●                     | 5040-0306      | 1   | Insulator             |
| ●                     | 1250-0914      | 1   | Contact: RF Connector |
| ●                     | 1250-0914      | 1   | Body: RF Connector    |

Figure 22. Type N Connector Assembly (08502-60001), Exploded View

| Reference Designation | HP Part Number | Qty | Description          |
|-----------------------|----------------|-----|----------------------|
| ●                     | 3030-0221      | 4   | No. 4 Allen Screw    |
| ●                     | 2360-0331      | 4   | No. 6 Screw          |
| ●                     | 2190-0815      | 4   | No. 6 Flat Washer    |
| ●                     | 2950-0001      | 1   | Nut                  |
| ●                     | 2190-0016      | 1   | Internal Lock Washer |
| ●                     | 2190-0104      | 3   | Internal Lock Washer |
| ●                     | 2950-0132      | 3   | Nut                  |
| ●                     | 2200-0103      | 6   | No. 4 Posi-Screw     |
| ●                     | 3050-0105      | 8   | No. 4 Flat Washer    |
| ●                     | 2200-0105      | 2   | No. 4 Posi-Screw     |

Figure 23. 8502A Attaching Hardware (1 of 2)



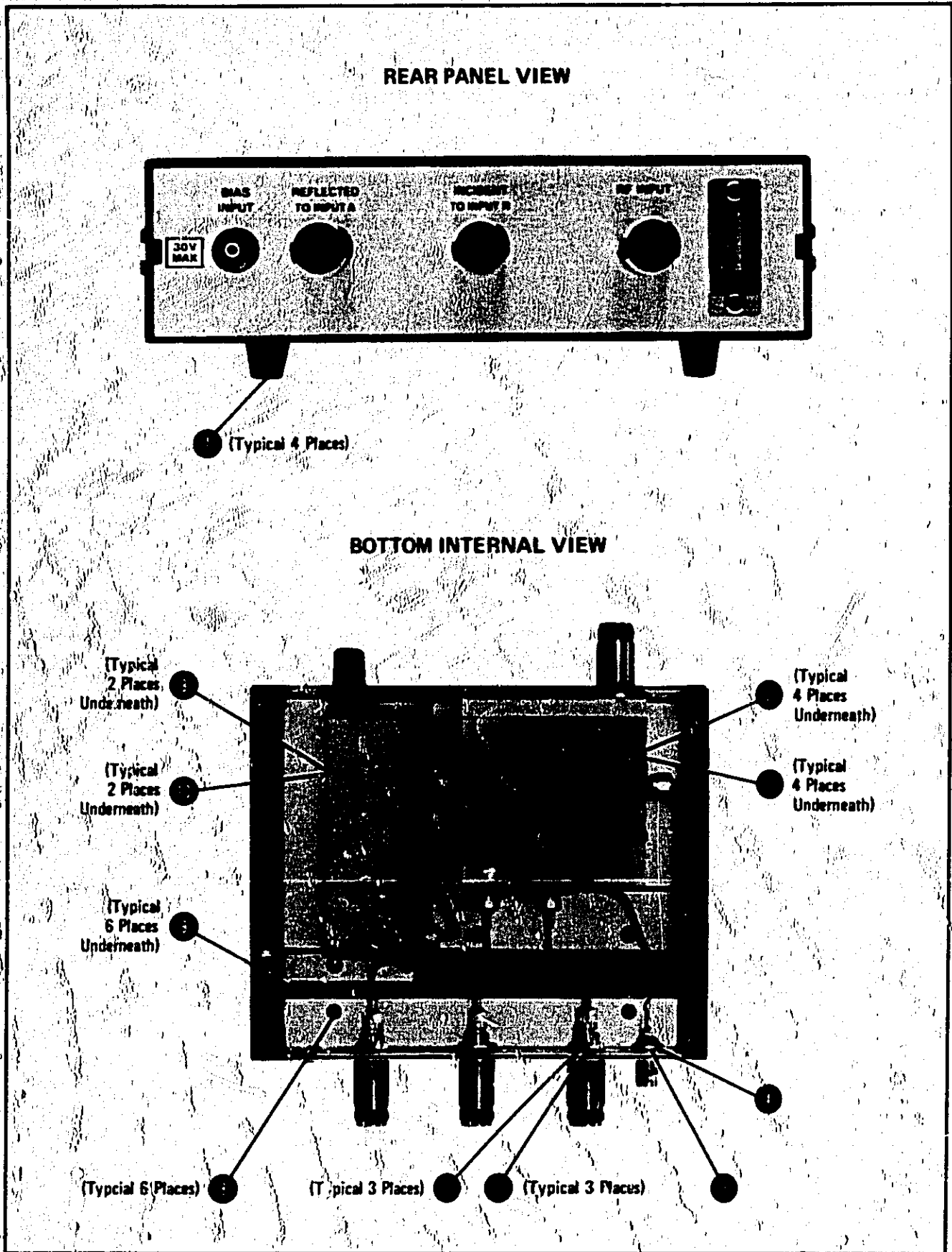

Figure 23. 8502A Attaching Hardware (2 of 2)

# **SERVICE INFORMATION**

## Model 8502A

### 55. SERVICE

#### 56. Module Exchange Program

57. Factory repaired exchange modules are available for modules that are not field-repairable. In addition, repaired exchange modules are available for major sub-assemblies as an alternate method of repair. The factory repaired modules are available at a considerable savings in cost, over the cost of a new model.

58. Those exchange modules should be ordered from the nearest Hewlett-Packard Sales/Service office using the part numbers in Table 7, Replaceable Parts.

#### 59. Case Disassembly

60. Place the HP Model 8502A top side down on a flat surface. Squeeze top and bottom of case together by applying pressure at end being opened. Using a small screw driver, push each "zipper" lock toward the rear panel (Figure 24) until you are able to grasp it firmly with your thumb and index finger. Pull the "zippers" from the 8502A case, then lift the case bottom from the instrument.

61. To reassemble the HP Model 8502A, replace the case bottom and squeeze top and bottom of case, together at end being "zipped." Slide the "zippers" into their slots from the rear panel toward the front panel.

#### 62. Step Attenuator and Directional Bridge Removal Procedure

63. Disassemble case as described in Paragraph 59 and proceed as follows:

- a. Remove attenuator knob using a .050 allen wrench.
- b. Remove RF connector body (outer shell) and dress washer from TEST port using a special 9/16 open-end wrench (HP Part Number 8710-0877).
- c. Remove four pozi-drive screws from Main Deck (MP7).
- d. Remove cables W1, W2, and W3 from Directional Bridge A1. (See Figure 21.) Use 5/16 open-end wrench to loosen cable connectors.

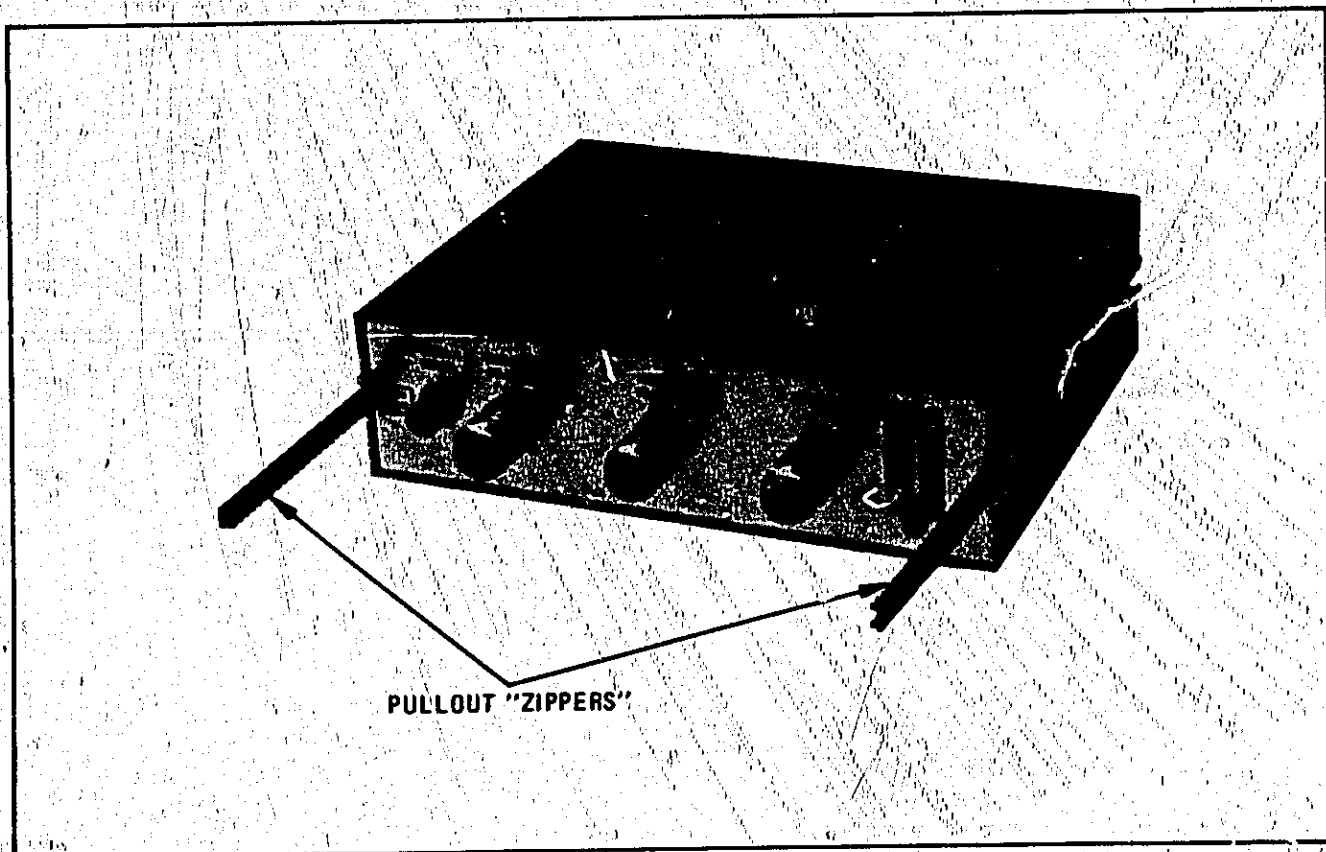

Figure 24. Model 8502A Case Disassembly

- e. Carefully slide Main Deck assembly out far enough to clear the three RF cables and turn it over.
- f. Remove four pozi-drive screws from Directional Bridge A1 and two pozi-drive screws from Step Attenuator A2.
- g. Carefully remove Main Deck with Front Panel attached and set it aside.
- h. Remove cables W4 and W5 from Directional Bridge A1 and Step Attenuator A2. (See Figure 21.)
- i. If replacing Directional Bridge A1, unsolder bias input lead at terminal on A1.

#### 64. Step Attenuator and Directional Bridge Installation Procedure

65. This procedure assumes that the 8502A has been disassembled as described in Paragraph 63. To reassemble 8502A, proceed as follows:

- a. Connect cable W4 (longest of the two U-shaped cables) to connector farthest from control shaft on Step Attenuator A2. Do not tighten connection.
- b. Connect cable W5 to connector closest to control shaft on Step Attenuator A2. Do not tighten connection.
- c. Connect cables W4 and W5 to Directional Bridge A1 with control shaft of Step Attenuator and TEST port (J1) of Directional Bridge facing the same direction. Tighten the four connectors on W4 and W5 with fingers only.
- d. Position Main Deck over top of A1/A2 assemblies and align Step Attenuator mounting holes on Main Deck. Fasten Step Attenuator using two 4-40 screws (HP Part Number 2200-0105) and two flat washers (HP Part Number 3050-0105). Make certain that bias input lead is not pinched between Step Attenuator and Main Deck.
- e. Install dress washer and RF connector body (outer shell) on TEST port and tighten with special 9/16 open-end wrench.
- f. Loosely fasten Directional Bridge to Main Deck using four 6-32 screws (HP Part Number

2360-0331) and four flat washers (HP Part Number 2190-0815).

- g. With thumb on end of TEST port and fingers at rear edge of Main Deck, apply a squeezing force to make certain that Front Panel is held tightly against Main Deck. Tighten Directional Bridge mounting screws while still squeezing.
- h. Turn Main Deck assembly over and carefully slide it into the 8502A top case (upside down on flat surface).
- i. Connect cables W1, W2, and W3 to Directional Bridge A1. (See Figure 21).
- j. Carefully tighten all RF connectors on A1 and A2 assemblies using a 9/16 open-end wrench.

#### CAUTION

Avoid damaging connectors. Tighten connector nuts until snug; do NOT overtighten.

- k. Fasten Main Deck to 8502A case using four 4-40 screws (HP Part Number 2200-0103) and four flat washers (HP Part Number 3050-0105). Make certain that bias input lead is not pinched between Main Deck and case.

- l. Solder bias input lead to terminal on Directional Bridge (feed-through capacitor) if not already connected.

- m. Install knob on front-panel RF INPUT ATTENUATION dB control. If position of control is unknown, tighten one set screw in knob and rotate control to fully clockwise position. Loosen set screw and set knob pointer to 0. Tighten both set screws in knob.

- n. To reassemble 8502A case, refer to Paragraph 61.

69. The reflected signal from the unit under test is transmitted back through the 8502A TEST port and is coupled by an internal directional bridge to the REFLECTION port of the 8502A. This reflected current contains information such as source match, return loss, etc., of the unit under test.

70. A DC BIAS INPUT port can provide bias to the unit under test when bias is needed by coupling a DC signal to the center conductor of the TEST port.

#### 71. Troubleshooting

72. A troubleshooting flow diagram (Figure 26) provides a step-by-step procedure to isolate the cause of a malfunction and identify the defective assembly or component. An equivalent circuit diagram (Figure 27) and major assemblies locator

(Figure 28), aid in troubleshooting to the component level.

73. After the defective component or assembly has been repaired or replaced, perform the incoming inspection test in Paragraph 33 (Figure 5) to confirm that the Model 8502A is again functioning properly.

74. Test equipment and accessories required to troubleshoot and maintain the Model 8502A are listed in Table 3. If the equipment listed is not available, equipment that meets the minimum specifications shown may be substituted.

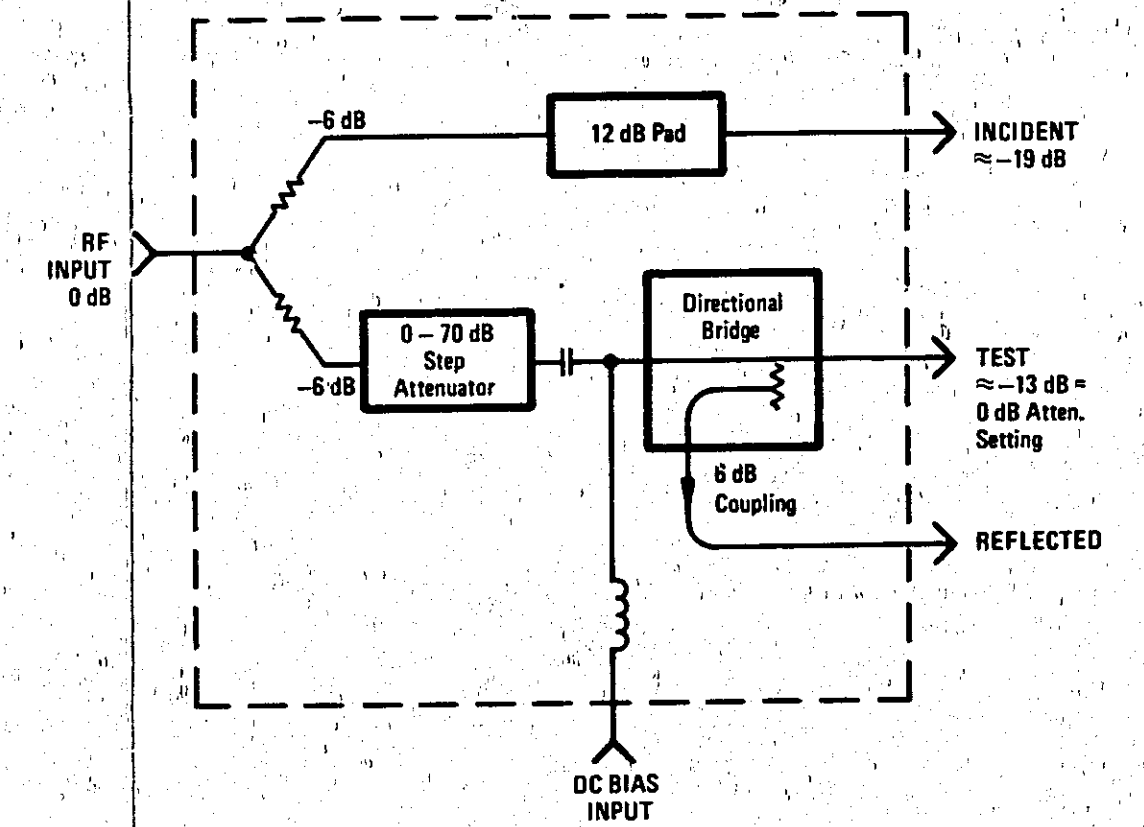

Figure 25. Model 8502A Simplified Block Diagram

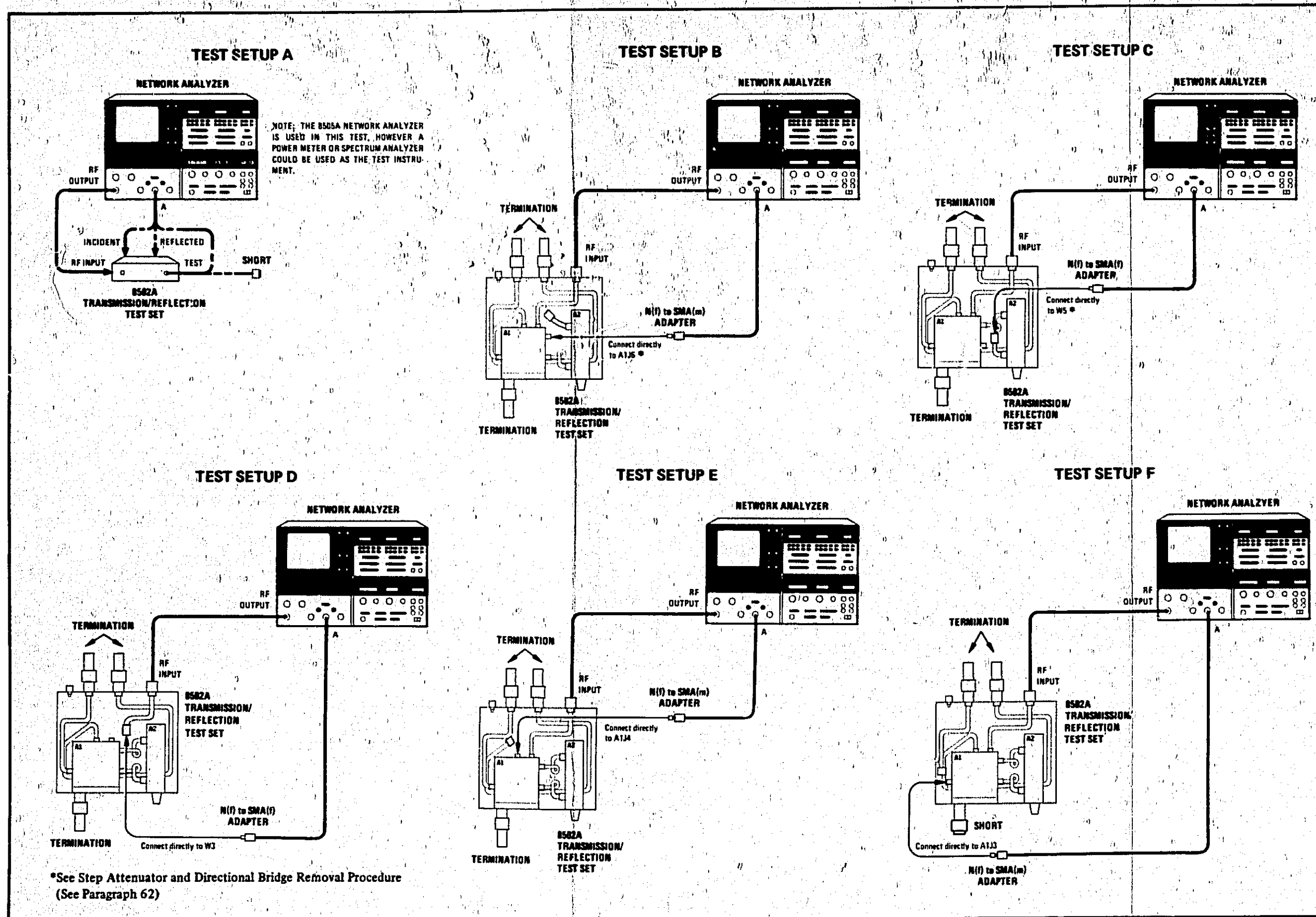

Figure 26. 8502A Transmission/Reflection Test Set Troubleshooting Procedure (1 of 2)

◀ SIMPLIFIED BLOCK DIAGRAM

**EQUIPMENT:**

Network Analyzer ..... HP 8505A  
 Type N Female to SMA Male Adapter ..... Cablewave Systems No. 718  
 Type N Female to SMA Female Adapter ..... Cablewave Systems No. 721  
 Type N Male Short ..... HP 11512A  
 50Ω Type N Male Termination (3 required) ..... HP 909A, Option 012

**INITIAL SETUP**

**NOTE:** Unless otherwise specified, terminate all unused ports on the 8502A.

Connect equipment as in Test Setup A. Connect 8502A TEST port to 8505A port A.

**SOURCE/CONVERTER:**

OUTPUT LEVEL dBm ..... 0  
 OUTPUT LEVEL VERNIER ..... Adjust for -10 dBm at RF port  
 INPUT LEVEL MAX. .... -10'

**FREQUENCY CONTROL:**

RANGE MHz ..... 0.5 - 1300  
 MODE ..... LIN FULL  
 WIDTH ..... START STOP 1  
 SCAN TIME SEC ..... 0.1 - 01  
 VERNIER ..... COUNTERCLOCKWISE  
 TRIGGER ..... AUTO  
 MARKERS SWITCH ..... 1

**SIGNAL PROCESSOR:**

CHANNEL 1 INPUT ..... A  
 CHANNEL 1 MODE ..... MAG  
 CHANNEL 1 SCALE/DIV ..... MAG 5 dB  
 CHANNEL 2 MODE ..... OFF  
 ELECTRICAL INPUT MODE ..... OFF

Set 8502A RF INPUT ATTENUATION dB control to 0.  
 Set reference line on 8505A to center graticule.  
 Clear 8505A Reference Offset.

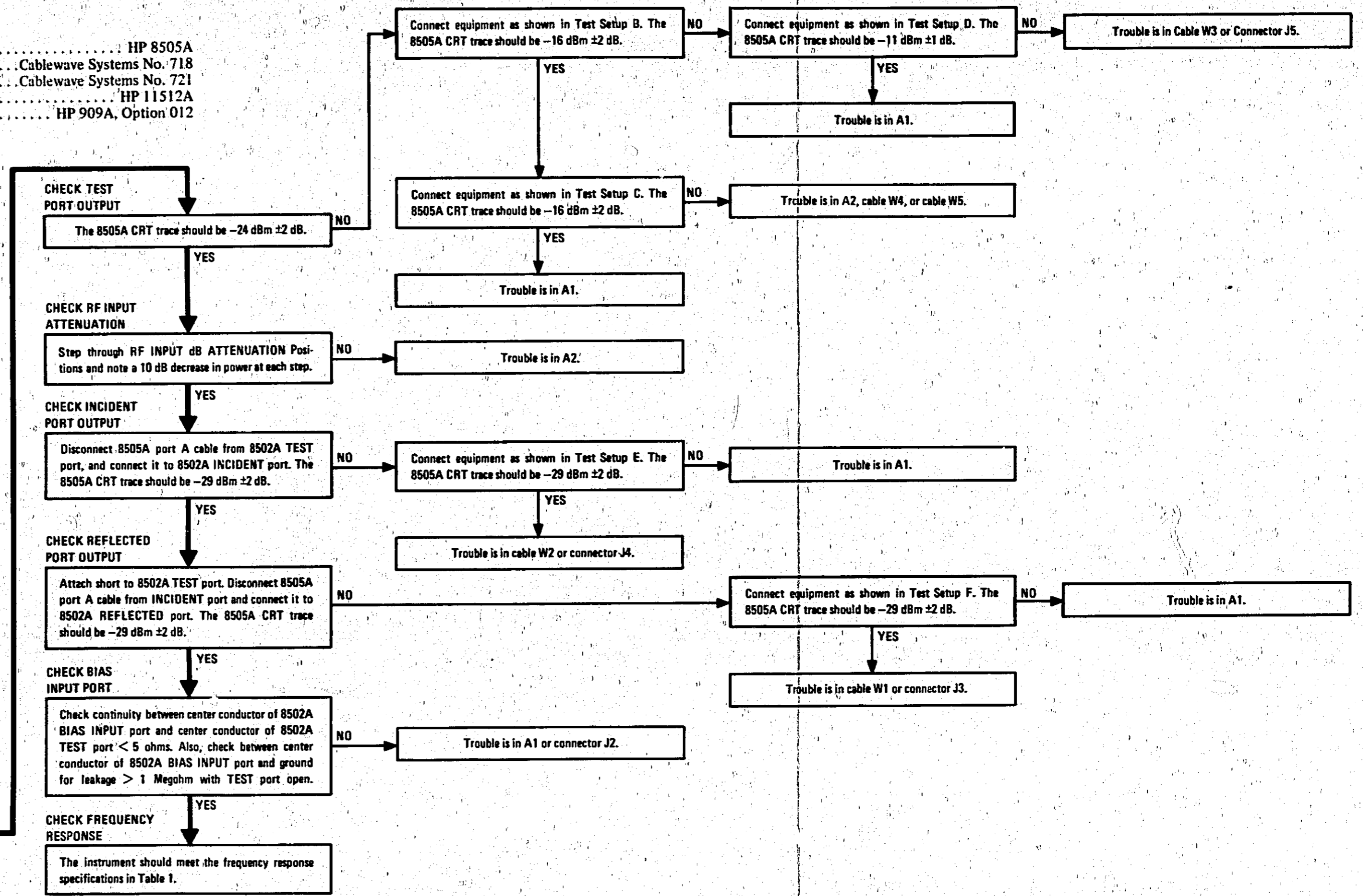

Figure 26. Model 8502A Transmission/Reflection Test Set Troubleshooting Procedure (2 of 2)

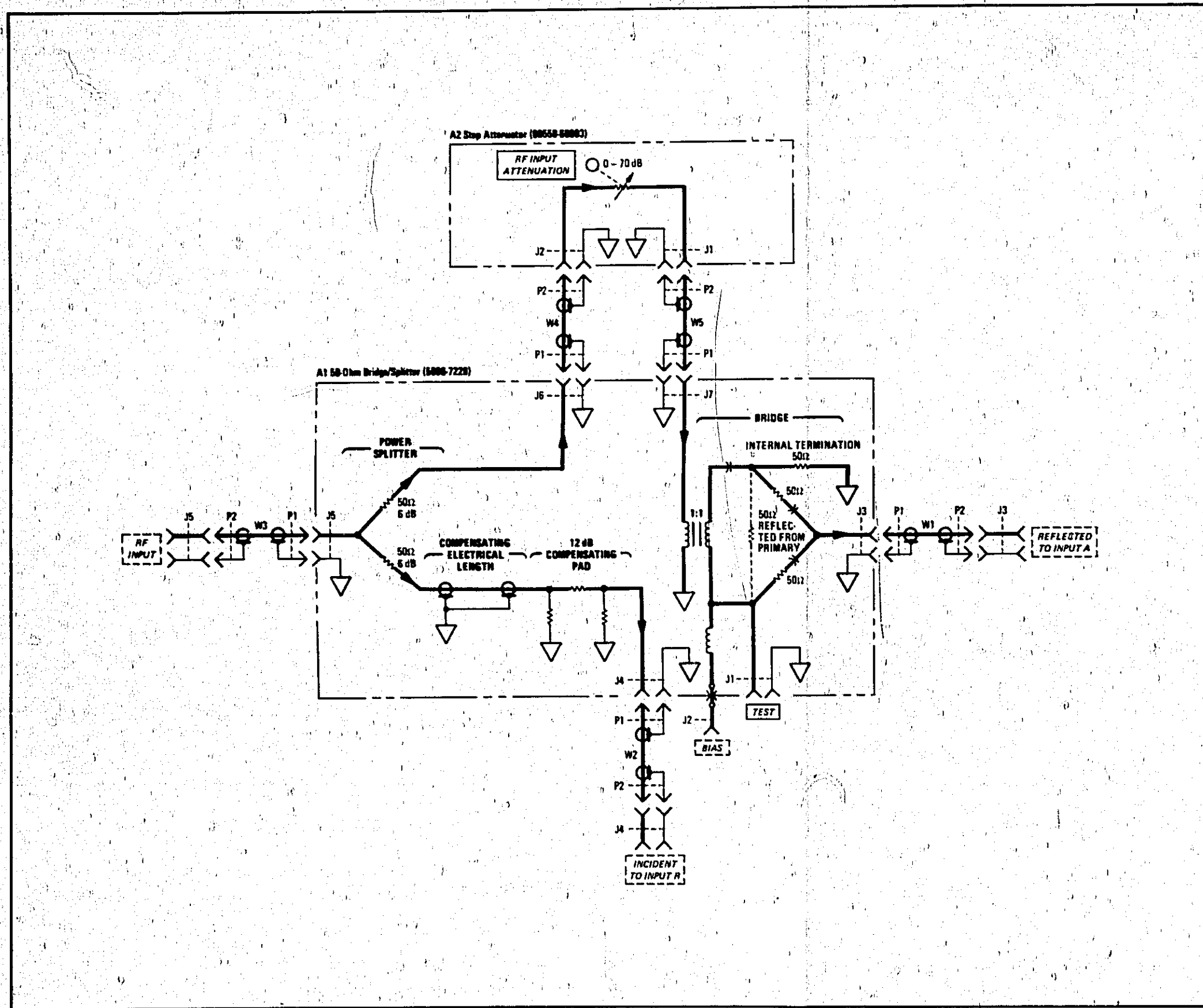

Figure 27. Model 8502A Transmission/Reflection Test Set Equivalent Circuit

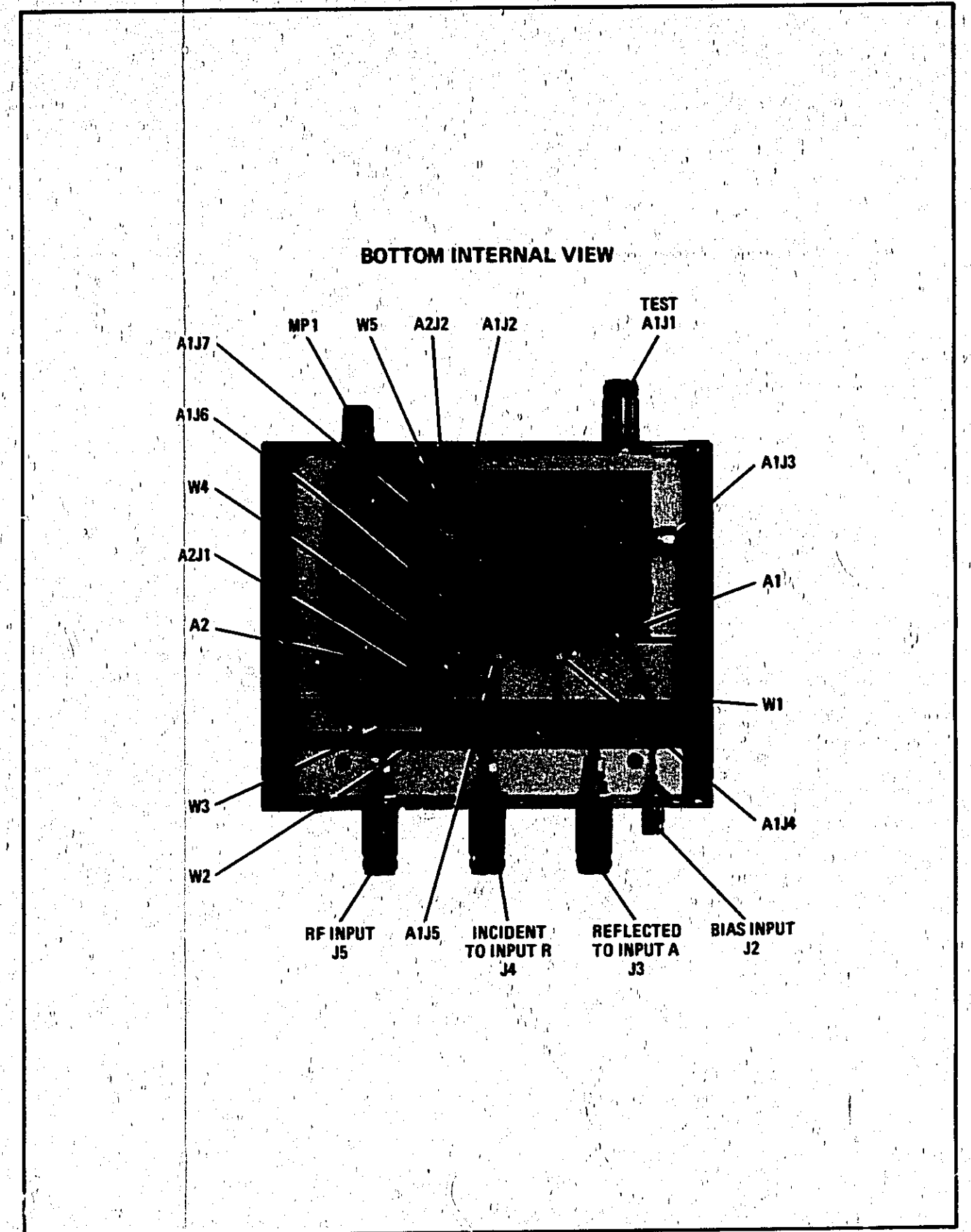

Figure 28. Model 8502A Transmission/Reflection Test Set Major Assemblies Locations

# MANUAL CHANGES



# MANUAL CHANGES

## MANUAL IDENTIFICATION

Model Number: 8502A

Date Printed: October 1979

Part Number: 08502-90001

This supplement contains important information for correcting manual errors and for adapting the manual to instruments containing improvements made after the printing of the manual.

To use this supplement, make all ERRATA corrections and all appropriate serial number related changes indicated in the tables below.

| SERIAL PREFIX OR NUMBER | MAKE MANUAL CHANGES |
|-------------------------|---------------------|
| 2025A and 2028A         | 1                   |
| 2420A                   | 1,2                 |
|                         |                     |
|                         |                     |
|                         |                     |
|                         |                     |
|                         |                     |
|                         |                     |
|                         |                     |

| SERIAL PREFIX OR NUMBER | MAKE MANUAL CHANGES |
|-------------------------|---------------------|
|                         |                     |
|                         |                     |
|                         |                     |
|                         |                     |
|                         |                     |
|                         |                     |
|                         |                     |
|                         |                     |
|                         |                     |

► NEW ITEM

### NOTE

Manual change supplements are revised as often as necessary to keep manuals as current and accurate as possible. Hewlett-Packard recommends that you periodically request the latest edition of this supplement. Free copies are available from all HP offices. When requesting copies, quote the manual identification information from your supplement, or the model number and print date from the title page of the manual.

Printed in U.S.A.

28 MAY 1986

6 pages



**HEWLETT  
PACKARD**

**ERRATA**▶ **Page 1, Paragraph 11:**

Change this paragraph to read: Hewlett-Packard Cable Accessory Set 11851A, shown in Figure 3, contains four cables. Three of these are phase matched to a standard, and are available individually. These cables help provide accurate measurements when using the HP 8505A Network Analyzer and other instruments.

▶ **Page 2, Table 1:**

Under Port Match: Change "Test Port Return Loss\*:" to "Test Port Equivalent Source Match (Ratio Mode)\*:".

▶ **Page 3, Figure 3:**

Replace Figure 3 with the HP 11851A Cable Accessory Set figure supplied in this Change Sheet.

▶ **Page 28. PERFORMANCE TESTS:**

Change test heading 47 to read: TEST PORT EQUIVALENT SOURCE MATCH (RATIO MODE).

Change the second sentence in the Description of Performance Test 47 to read as follows: "These two tests confirm that the Test Port Equivalent Source Match (Ratio Mode) of the 8502A is within specification."

▶ **Page 38, Table 7:**

Change A2 (first listing) to HP Part Number 5086-7363. CD9.

Change A2 (second listing) description to: "Restored 5086-7363. Requires Exchange"

▶ **Change MP8 to HP Part Number 08502-00017, Qty. 1, Panel: Rear Sub.**

Note: When ordering a replacement for the obsolete rear sub panel having HP Part Number 08502-00004, order the Rear Panel Replacement Kit having HP Part Number 08502-60004. This kit consists of the newer MP8 and MP9, required when replacing the obsolete MP8 or MP9.

▶ **Change MP9 to HP Part Number 08502-00016, Qty. 1, Panel: Rear.**

Note: When ordering a replacement for the obsolete rear panel having HP Part Number 08502-00005, order the Rear Panel Replacement Kit having HP Part Number 08502-60004. This kit consists of the newer MP8 and MP9, required when replacing the obsolete MP8 or MP9.

**CHANGE 1**▶ **Page 38, Table 7:**

Change MP6 to 08502-00013. CD4.

Change MP7 to 08502-00012. CD3.

**CHANGE 2**▶ **Page 38, Table 7:**

Add C2, having HP Part Number 0160-4833. CD5. CAPACITOR-FXD .022UF  $\pm 10\%$  100VDC CER.

Add F1, having HP Part Number 2110-0424. CD9. FUSE .75A 125V NTD .25X.27.

Add R1, having HP Part Number 0757-0394. CD0. RESISTOR 51.1 1% .125W F TC= $0 \pm 100$ .

Add R2, having HP Part Number 0698-8827. CD4. RESISTOR 1M 1% .125W F TC= $0 \pm 100$ .

Change MP7 to HP Part Number 08502-00018. CD9.

Change MP8 to HP Part Number 08502-00017. CD8.

Change MP9 to HP Part Number 08502-00016. CD7.

Add MP19, having HP Part Number 1400-0110. CD4. FUSEHOLDER-BIPIN SKT 5A 125V.

Add MP20, having HP Part Number 1400-0111. CD5. FUSEHOLDER NUT FOR USE WITH HP P/N 1400-0110.

Add MP21, having HP Part Number 1400-0112. CD6. FUSEHOLDER CAP FOR USE WITH HP P/N 1400-0110.

▶ **Page 47/48, Figure 27:**

Replace Figure 27 with the Model 8502A Transmission/Reflection Test Set Equivalent Circuit diagram supplied in this change sheet.

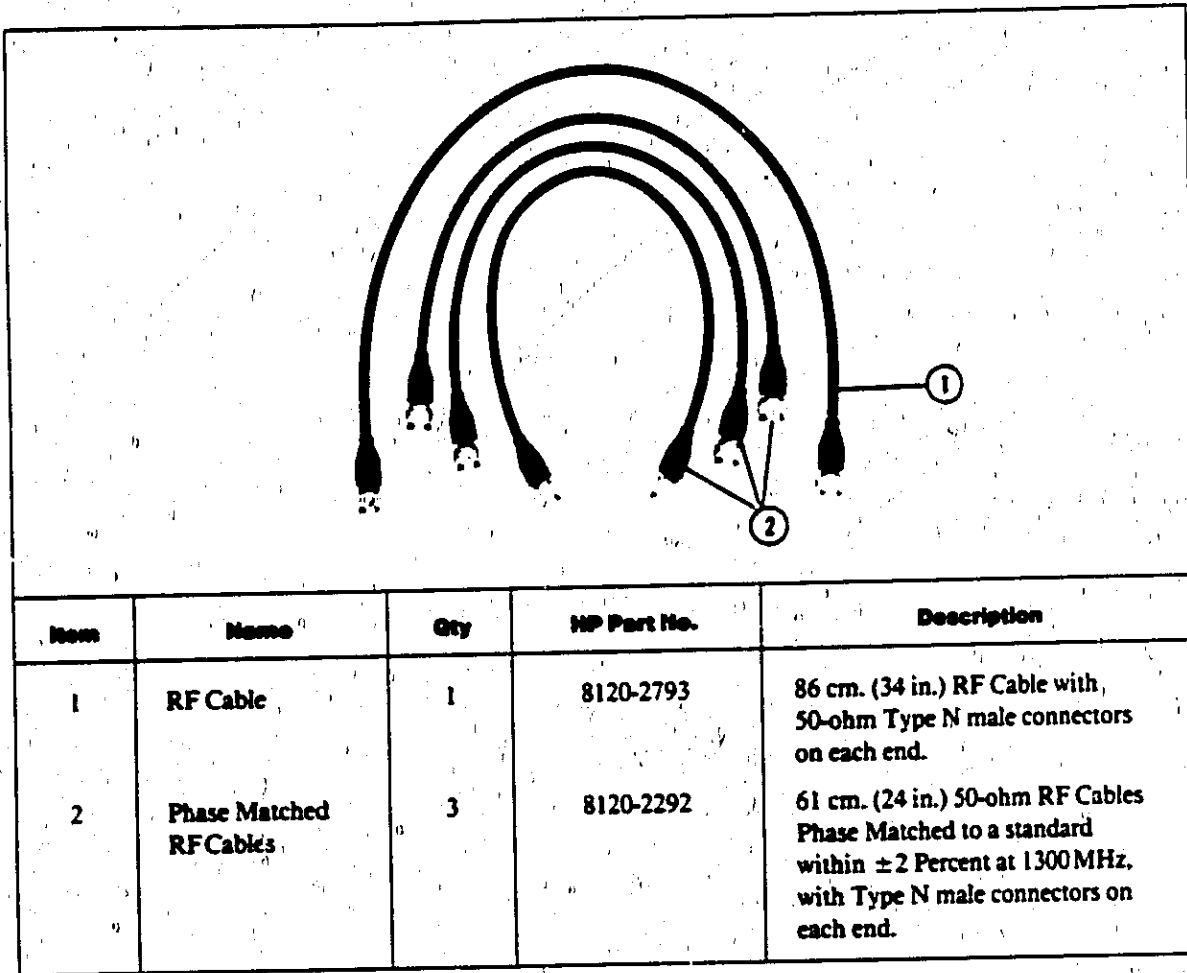

Figure 3. HP 11851A Cable Accessory Set (ERRATA)

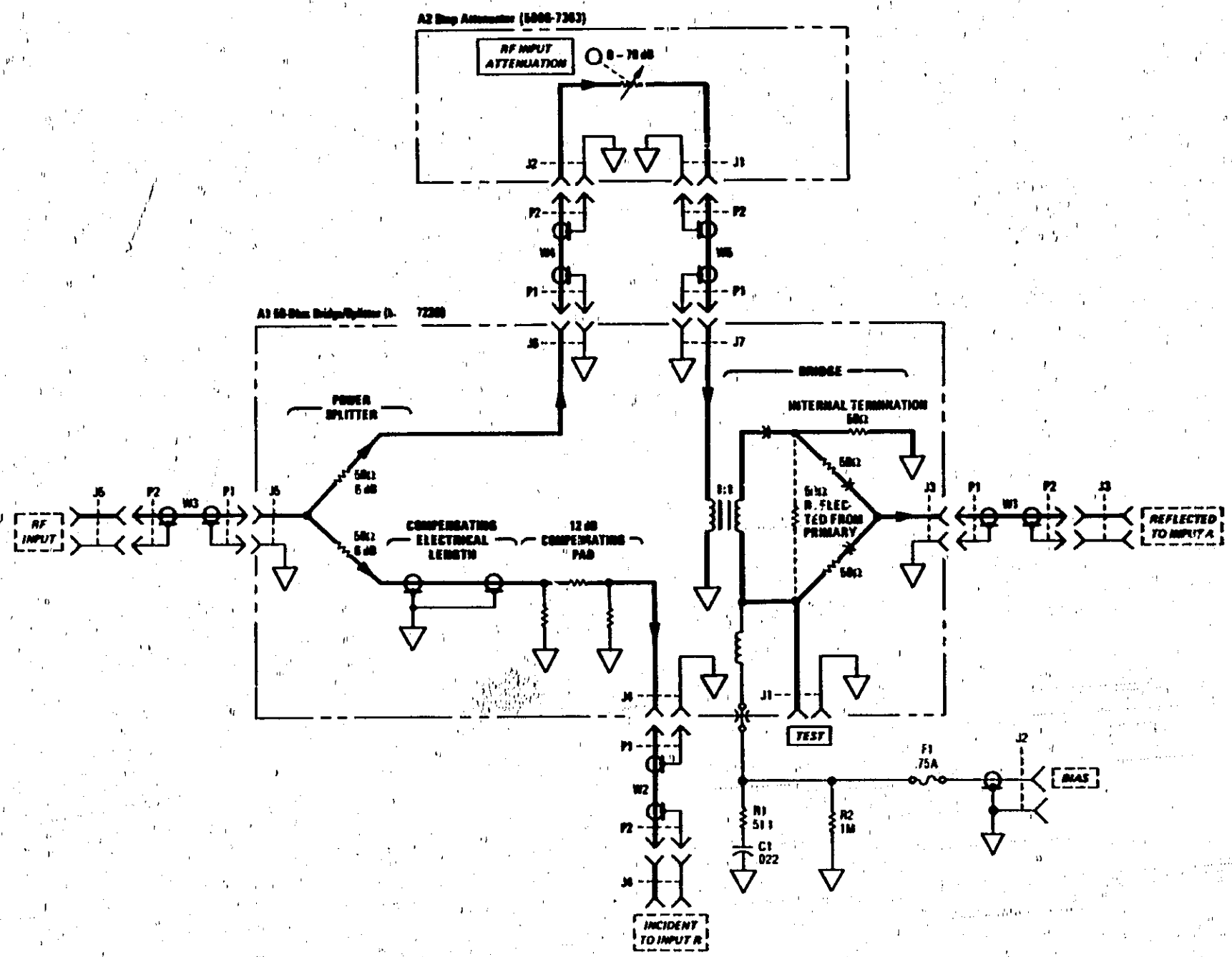

Figure 27. Model 8502A Transmission/Reflection Test Set Equivalent Circuit (CHANGE 4)