

## Errata

**Title & Document Type:** Applications and Operations of the  
8970A Noise Figure Meter (PN8970A-1)

**Manual Part Number:** 08970-99000

**Revision Date:** November 1, 1981

---

### HP References in this Manual

This manual may contain references to HP or Hewlett-Packard. Please note that Hewlett-Packard's former test and measurement, semiconductor products and chemical analysis businesses are now part of Agilent Technologies. We have made no changes to this manual copy. The HP XXXX referred to in this document is now the Agilent XXXX. For example, model number HP8648A is now model number Agilent 8648A.

### About this Manual

We've added this manual to the Agilent website in an effort to help you support your product. This manual provides the best information we could find. It may be incomplete or contain dated information, and the scan quality may not be ideal. If we find a better copy in the future, we will add it to the Agilent website.

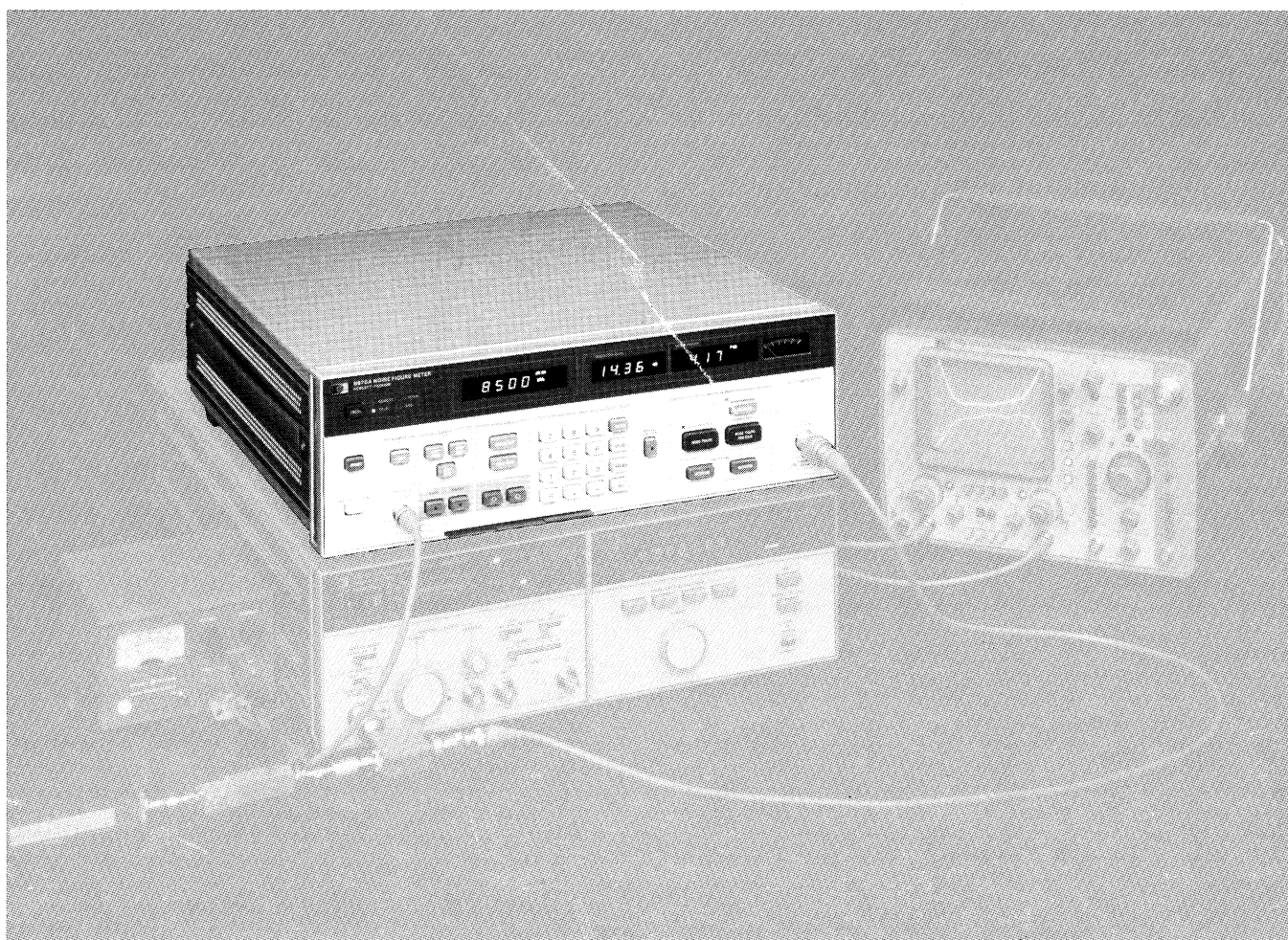
### Support for Your Product

Agilent no longer sells or supports this product. You will find any other available product information on the Agilent Test & Measurement website:

[www.tm.agilent.com](http://www.tm.agilent.com)

Search for the model number of this product, and the resulting product page will guide you to any available information. Our service centers may be able to perform calibration if no repair parts are needed, but no other support from Agilent is available.

# Applications and Operation of the 8970A Noise Figure Meter



Product Note 8970A-1

# CONTENTS

<b>CHAPTER I</b>	
Introduction .....	1
How the 8970A Measures Noise .....	1
Key Features of the 8970A and 346B .....	1
What This Document Is .....	1
Where to Get Additional Information .....	1
<b>CHAPTER II</b>	
Measurement Examples .....	3
Getting Started .....	3
Front Panel .....	3
Power Up and Preset .....	4
FNR Entry .....	4
Amplifier Measurement (Swept RF) .....	5
RF Calibration .....	5
Smoothing .....	5
Corrected Noise Figure and Gain	
Measurement .....	6
Uncorrected Noise Figure Measurement .....	6
Oscilloscope Display .....	6
Display of Effective Input Noise	
Temperature, $T_e$ .....	8
$T_c$ Correction .....	8
Microwave Amplifier Measurement (Swept LO) .....	9
8970A LO Control .....	9
Microwave Calibration (Swept LO) .....	10
Corrected Noise Figure and Gain	
Measurement (Swept LO) .....	10
X-Y Recorder Display .....	11
Microwave Amplifier Measurement (Swept IF) .....	11
Single Sideband Measurement .....	11
Calibration and Measurement .....	12
Single Sideband Measurement (Swept LO)	
(1.1 SP) .....	12
Real Time Adjustment .....	13
Amplifier Mode and Sideband Summary .....	13
Mixer Measurements .....	14
Mixer Measurement (Swept LO) .....	14
Calibration and Measurement .....	15
Automatic 3 dB Adjustment .....	15
Mixer and Receiver Measurement (Swept IF) .....	16
Calibration and Measurement .....	16
Mode and Sideband Selection Chart .....	16
<b>CHAPTER III</b>	
Additional Topics .....	19
Selecting a Local Oscillator .....	19
Transistor Measurements .....	19
Waveguide Measurements .....	20
Amplifier Measurements from 1.5 to 2.0 GHz .....	20
Measurement Error Considerations .....	21
Method Comparison .....	21
<b>CHAPTER IV</b>	
Theory of Operation .....	23
Input Section .....	23
First Converter .....	23
Second Converter .....	23
300 MHz IF Section .....	23
20 MHz IF Section .....	23
Noise Power Detector .....	24
Controller .....	24
<b>CHAPTER V</b>	
Front Panel and Special Function Summary .....	27
Front Panel Operation .....	27
Entry Protocol .....	27
ENR Entry Key .....	27
Sweep Frequency Keys .....	27
Fixed Frequency Keys .....	27
Measurement Keys .....	28
Storage Location Keys .....	28
Special Functions .....	29
Initialize Special Functions (0 SP) .....	29
Measurement Modes (1.N SP) .....	29
Sideband Selection (2.N SP) .....	31
IF and LO Frequency Entry (3.N SP) .....	32
Automatic Control of an External LO	
(4.N and 40.N to 42.4 SP) .....	32
Addresses (40.N SP) .....	34
External LO Programs and Auxiliary	
Commands (41.N and 42.N SP) .....	34
Changing LO Output Power .....	34
Output Selection (43.N SP) .....	34
Noise Source Data (5.N SP) .....	35
$T_{COLD}$ (6.N SP) .....	36
Temperature Units (11.N SP) .....	36
Power Density Measurement (9.N SP) .....	36
Displaying 8970A Measurements .....	36
Oscilloscope (7.N SP) .....	36
X-Y Recorder (20 to 23 SP) .....	36
Strip Chart Recorder (24 SP) .....	37
Display Limits (8.N SP) .....	37
Display Units (10.N SP) .....	37
Resolution of Displayed Data	
(12.N SP) .....	37
Smoothing (13.2 SP) .....	38
Manual (Hot/Cold) Measurements	
(14.N and 15.N SP) .....	38
Trigger Control (30.N SP) .....	39
Calibrations .....	39
Frequency Calibration (31.N SP) .....	39
Input Gain Calibration (32.N SP) .....	39
IF Attenuator Calibration (33 SP) .....	40
Loss Compensation (34.N SP) .....	40
Sequence Control (35.N SP) .....	40
Special Function Catalog (50.N SP) .....	41
Special Function LED .....	41
Error Codes and Recovery from Errors .....	41

# ILLUSTRATIONS

Figures	Page	Figures	Page
I-1. Available Noise Power .....	1	II-13c. Mode 1.3 Single Sideband (With Filter) .....	13
II-1. Front Panel (Foldout) .....	2	II-14. Mixer Measurement Setup .....	14
II-2. 8970A Self-Measurement .....	4	II-15. Typical Display of Mixer Measurement .....	15
II-3. 346B Calibration Report and Label .....	4	II-16. Mode and Sideband Selection Chart .....	17
II-4. RF Measurement Setup .....	5	III-1. Typical 2 to 12 GHz Transistor Measurement Setup .....	19
II-5. Oscilloscope Test Pattern .....	7	III-2. Measuring Noise Figure of Waveguide Preamps .....	20
II-6. Typical Oscilloscope Display for 136 MHz Amplifier .....	8	III-3a. 1.5 to 2.0 GHz Swept IF Measurement .....	20
II-7. Effect of Changing $T_c$ .....	8	III-3b. 1.5 to 2.0 GHz Swept LO Measurement .....	20
II-8. Errors Introduced by Assuming $T_c = 290K$ .....	9	IV-1. 8970A Block Diagram .....	25
II-9. Swept LO Amplifier Measurement Setup .....	9	V-1. 8970A Measurement Modes — Signal Descriptions .....	30
II-10. Typical Display of Microwave Amplifier Measurement .....	10	V-2. Noise Unit Comparison .....	37
II-11a. Effect of Low IF .....	11	V-3. Loss Compensation Setup .....	40
II-11b. Effect of High IF .....	11	A. Pullout Cards (Pullout Card I Foldout) .....	45
II-12. Swept IF Amplifier Measurement Setup .....	12		
II-13a. Mode 1.2 Double Sideband (Not Allowed) .....	12		
II-13b. Mode 1.2 Single Sideband (With Filter) .....	12		

# TABLES

Tables	Page	Tables	Page
II-1. Amplifier Mode and Sideband Summary .....	13	V-2. Frequency Display for Measurement Modes .....	31
III-1. Example of Measurement Uncertainties .....	21	V-3. ASCII to Decimal Conversion Table .....	33
III-2. 8970A Compared to Other Noise Figure Measurement Methods .....	22	V-4. LO Program Summary .....	34
V-1. 8970A Settings Saved During STORE and RECALL .....	29	V-5. Special Functions that Light Special Function LED .....	41

# APPENDICES

A. Suggested Equipment for 10 MHz to 18 GHz Measurements (SMA/APC-3.5) .....	43
B. X-Y Recorder Graph .....	44

## Introduction

The 8970A Noise Figure Meter is a very sensitive, tunable, automatic receiver. Its capability is greatly enhanced by a microprocessor used for many control, timing, and calculation purposes. With an appropriate solid state noise source, such as the 346B Noise Source, it automatically measures the noise figure of the device under test (DUT) inserted between the output of the noise source and the input of the 8970A. The 8970A may be tuned to any frequency between 10 and 1500 MHz and digitally swept over all or part of this range. To measure DUT's with output frequencies greater than 1500 MHz, an external mixer and local oscillator (LO) are required to down convert the frequency into the 10 to 1500 MHz range. The 8970A can also automatically remove the noise contribution of the second stage (the measurement system) from the measurement. It can measure and display both gain and noise figure of the DUT.

Noise properties of the DUT may be displayed as noise figure (dB or ratio), effective input noise temperature (kelvins, K), or Y factor (dB or ratio). Gain is displayed in dB. A table of excess noise ratio (ENR) vs frequency data for the noise source being used may be entered from the front panel for as many as 27 frequencies. The table is automatically used by the 8970A to correct for variations of ENR with frequency. When the 8970A is turned off, the ENR vs frequency data (the ENR table) remains because it is stored in non-volatile memory. Swept measurement of noise figure and gain vs frequency may be displayed on an oscilloscope or plotted on an X-Y analog or strip chart recorder using X and Y axis outputs on the rear panel. The Z axis output from the 8970A blanks the retrace of the oscilloscope or lifts the pen of the recorder.

Most functions may be remotely programmed via the Hewlett-Packard Interface Bus (HP-IB).

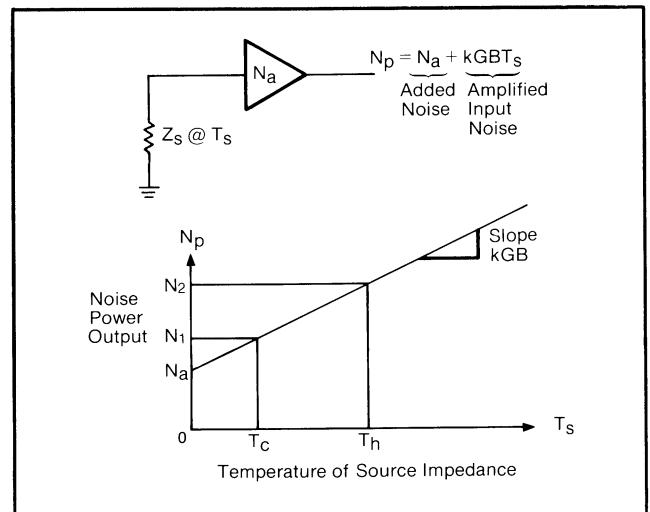
### How the 8970A Measures Noise

The 8970A determines the noise added by a device under test (DUT) to that noise already present at the DUT input. Consider the representation of noise power at the output of the DUT vs the temperature of the source impedance at the DUT input.

$$N_p = N_a + kGBT_s$$

**Figure I-1** is a graph of this equation. In the equation,  $N_a$  is the noise added by the DUT,  $k$  is Boltzmann's constant,  $G$  is the gain of the DUT,  $B$  is the measurement bandwidth, and  $T_s$  is the temperature in kelvins of the source termination.

The 8970A drives a solid state noise source on and off to generate two temperature points ( $T_c$  and  $T_h$ ) on the straight line  $kBG$ , and measures the two power outputs of the DUT ( $N_1$  and  $N_2$ ) for these two temperatures. Extrapolating the straight line to the  $T_s = 0$  point gives  $N_a$ , the noise added by the DUT. This noise added is transformed to a figure of merit for the DUT, such as noise figure,  $F$ , in dB, or effective input noise temperature,  $T_e$ , in kelvins. Using self-calibration, the 8970A also measures its own noise figure and sets a gain reference. It can then correct for the noise figure of the measurement system and calculate and display the noise figure and gain of the DUT alone.



**Figure I-1.** Available Noise Power

## Key Features of the 8970A and 346B

### Accuracy Features - 8970A

1. Complete table entry of noise source ENR vs frequency (interpolated as necessary).
2. Compensation for  $T_c$  not equal to 290K.
3. High display resolution (0.01 dB).
4. Variable smoothing to reduce display jitter.
5. Correction for measurement system (second stage) noise contribution, in real time.

### Accuracy Features - 346B

1. ENR calibration at 20 frequencies, ( $\pm 0.1$  to  $0.2$  dB RSS uncertainty at each frequency).
2. Low reflection coefficient ( $SWR \leq 1.15$  to 5 GHz and 1.25 to 18 GHz).
3. Adapters not needed for many noise source applications (346B available in 4 connector types).
4. Broad band (10 MHz to 18 GHz) allows one noise source for both RF and microwave frequency applications.

## Convenience and Flexibility Features — 8970A

1. Tunable from 10 to 1500 MHz without the need of an external local oscillator or mixer.
2. Additional external gain is not required because of high sensitivity.
3. Measures the gain of the DUT.
4. Controls an external local oscillator over HP-IB for microwave measurements.
5. Simple and accurate swept measurements.
6. Digital storage for refreshed output to ordinary oscilloscopes.
7. Error correction is done in real time.
8. Choice of output units: F dB, F,  $T_e$ , Y dB, Y.
9. HP-IB is standard.

## What This Document Is

This product note is an introductory manual for the 8970A, focusing on applications. It serves as 1) a summary of 8970A features and operation for those desiring more information than the data sheet, 2) a step-by-step guide to several measurement examples, and 3) a general reference document for use with the 8970A. It covers a middle ground between the Technical Data Sheet and the comprehensive Operating and Service Manual.

The chapters of this publication 1) introduce the front panel and basic functions, 2) show how to make some typical


measurements, 3) discuss some additional application topics, 4) discuss briefly the theory of operation of the 8970A, and 5) explain in more detail most of the special and basic functions of the 8970A to broaden understanding.

In this note, the terms “RF” and “microwave” are used with specific meanings. “RF” refers to measurements made at frequencies up to 1500 MHz. “Microwave” refers to measurements above 1500 MHz to 18 GHz, where an external mixer and LO are always required.

## Where to Get Additional Information

For basic noise and noise figure measurement topics beyond those specifically required to use the 8970A, see Application Note 57-1, “Fundamentals of RF and Microwave Noise Figure Measurements”. This note is expected in early 1983. AN57-1 is a tutorial on noise and noise figure, and is recommended as both an introduction to noise figure as well as a concise review for those familiar with the subject. A helpful part of AN 57-1 is a more detailed explanation of the straight line noise power relationship shown in Figure I-1. This concept can be used to summarize graphically almost every aspect of noise figure measurement and terminology.

For complete reference material on the 8970A as well as introductory information on control of the 8970A using a programmable external controller, see the 8970A Operating and Service Manual.

*Figure II-1. Front Panel* 

# 8970A Noise Figure Meter

**LOCAL** returns control to front panel from external controller.

Used to enter ENR vs frequency data for noise source.

Initializes front panel set-up and most keyed-in parameters to default values.

Drives solid state noise sources OFF and ON with 28.0 volt bias.

Pullout cards prompt many measurement set-ups and convenience features through SPECIAL FUNCTIONS. Pullout cards remain accessible when rack mounted.

Convenient frequency buttons allow selecting a fixed measurement frequency, incrementing to a special frequency of interest, or making repetitive sweeps across a band.

Displays gain of unit under test.

Selectable output units in terms of measured noise figure, Y factor, or effective input noise temperature.

Measures and stores the measurement system noise characteristic at each frequency for correction of later measurements.

Simultaneously displays noise figure and gain of the unit under test with the measurement system noise contribution automatically removed.

Tunable input frequency over the 10 to 1500 MHz range by operating the frequency keys.

Set start, stop, and step size frequencies for repeated or single sweeps.

Up to 9 front panel measurement configurations may be STORED for later RECALL in arbitrary sequence.

Measures and displays overall noise figure, including second stage contribution.

Smoothing INCREASES or DECREASES the number of measurements averaged to achieve optimum speed of response and steady display.

## Rear Panel Features

Gain trace brightness adjustment.

Analog output for flicker-free scope display of stored data that is updated as new measurements are made.

28V noise source drive (in parallel with front panel).

20 MHz IF output.

HP-IB connector for operation in systems.



HP-IB; Not just IEEE-488, but the hardware, documentation, and support that delivers the shortest path to a measurement system.

## Measurement Examples

This chapter introduces the front panel and shows how to get started on the 8970A. Several specific measurement examples are introduced step-by-step, including:

- 1 An RF amplifier measurement
- 2 A swept LO microwave amplifier measurement
- 3 A swept IF microwave amplifier measurement (single sideband)
- 4 A swept LO mixer measurement
- 5 A swept IF receiver measurement

These examples include detailed information on how to use many of the features of the 8970A such as:

- 1 ENR table entry
- 2 Calibration for corrected measurement
- 3  $T_e$  correction
- 4 Oscilloscope output
- 5 Smoothing
- 6  $T_e$  (effective input noise temperature) display
- 7 Single sideband measurement
- 8 Real time adjustment
- 9 Mode and sideband selection

The measurement examples discussed in this chapter use an equipment set that is detailed in Appendix A. In addition, two amplifiers are used as DUTs. The first is a narrow-band RF amplifier with a nominal center frequency of 136 MHz, a gain of approximately 25 dB, and a minimum noise figure of approximately 0.5 db. The second is a microwave amplifier with a 50 to 4500 MHz bandwidth, a gain of approximately 10 dB, and a noise figure of approximately 7 dB. A 4.4 GHz low pass filter is also needed for Swept IF Microwave Amplifier Measurement later in this chapter.

### NOTE:

1. The DUTS measured in the following examples may be easily exchanged for others with different noise figures, gains, and frequency ranges by merely substituting different numbers in the examples given.

2. Since one or more features are discussed in each of the examples, it would help to read through all of the examples to gain an understanding of each feature discussed.

It will be helpful to make frequent reference to the three pullout cards in a slot at the bottom of the 8970A front panel as special functions, measurement setups, and error codes are mentioned, to strengthen understanding. Useful





foldout pages, *Figure II-1* in this chapter and *Figure A* inside the back cover, show the front panel pullout cards, respectively.

## Getting Started Front Panel

There are three digital displays on the front panel of the 8970A (see *Figure II-1*). The displays, moving from left to right, are primarily used for frequency, insertion gain and noise figure, but are sometimes used to display other data.

The keys on the front panel are in several groups. Starting on the left, LOCAL is used to return control to the 8970A front panel from an external controller when HP-IB is used. PRESET enters default values and initializes certain special functions, and LINE is the on-off switch. The ENR key is used to enter the ENR vs frequency table of the noise source into the 8970A. Below it is the 28 volt pulsed output to drive the noise source.

Next is a group of keys to control the sweep function. START FREQ, STOP FREQ, and STEP SIZE set the start frequency, stop frequency, and step size increments of the desired sweep. Pressing any one of these keys displays its current value. If one of these keys is followed by number keys, then by ENTER, this will enter a new frequency in MHz. The two keys at the bottom, AUTO and SINGLE, when pressed, initiate a repetitive or single sweep, respectively.

The next group of keys is for controlling a single fixed frequency. Pressing FREQUENCY, followed by numerical digit keys, then ENTER, sets the fixed measurement frequency of the 8970A. FREQUENCY may also be used as a convenient "clear entry" key for mistakes made during entry of other parameters. Pressing FREQ INCR, number keys, and ENTER displays and allows entry of the frequency increment used by the  and  keys to incrementally tune the 8970A. Pressing  or  once moves the measurement frequency up or down by the amount of the increment. Holding either key down causes repeated frequency increments to occur.

The next group of keys is for data entry. The right column in this group consists of the ENTER, STORE, RECALL, and SEQ keys. ENTER executes entry of data. STORE and RECALL are used to store and recall the front panel and internal instrument states of the 8970A in any of 10 internal storage locations. SEQ allows sequencing among as many as 9 of the stored states. The SPECIAL FUNCTION (SP) key extends the capability of the 8970A



beyond front panel functions. Pressing a number key sequence, followed by SP, makes available about 150 extra functions that include various measurement, data display, and data entry modes.

The last group of keys is for measurement. Pressing CALIBRATE measures and stores the measurement system noise figure and sets a power reference. These allow gain measurement and second stage correction when NOISE FIGURE AND GAIN is pressed. NOISE FIGURE is pressed when second stage correction is not desired. NOISE FIGURE or NOISE FIGURE AND GAIN may also be used as "clear entry" keys. INCREASE and DECREASE, the smoothing keys, make it possible to reduce display jitter. These keys increase or decrease the number of measurements averaged before displaying a measurement result.

More information on all of these functions is contained in Chapter V of this note. In addition, the three 8970A pullout cards summarize user special functions. HP-IB information, error codes, and measurement setups.

### Powering and TDRS

Turn on the noise figure meter. All LED indicators should light up for a few seconds as the 8970A performs power-up checks. Press

PRESET

Within a few seconds the left display should read 30 MHz, the default measurement frequency. The small LED next to UNCORRECTED above the NOISE FIGURE button should be lit, showing that the indicated noise figure is uncorrected for second stage noise. The right display (noise figure) will show two dashes, indicating noise figure greater than 32 dB, until the noise source is connected. Connect a BNC cable from the 28V NOISE SOURCE DRIVE OUTPUT on the 8970A to the 346B Noise Source (28V dc) input. Then connect the 346B output to the RF INPUT on the 8970A (*Figure II-2* shows the connections). An adapter will be needed on the 8970A input unless the

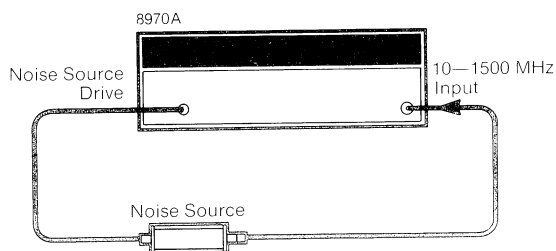


Figure II-2. 8970 Self-Measurement

346B is an Option 001 (Type N male) output connector. When connection is made, the 8970A's own noise figure at 30 MHz will be displayed, about 5 dB.

### Calibration

The 8970A stores the excess noise ratio (ENR) calibration table data for the 346B Noise Source in non-volatile memory. A linearly interpolated value is automatically used at each measurement frequency whether measuring uncorrected noise figure or corrected noise figure and gain. With every 346B a calibration report is supplied containing the ENR values at 20 frequency points. These points are also plotted on a chart on the 346B body. The report and chart label are shown in *Figure II-3*.

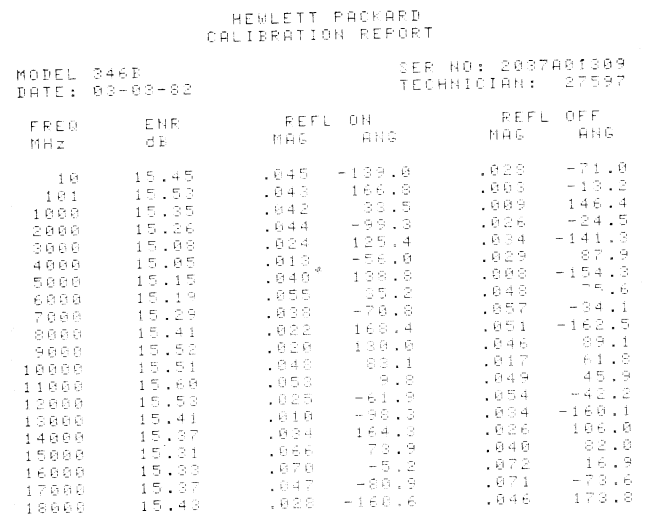


Figure II-3. 346B Calibration Report and Label

To enter the calibration table into the 8970A, press

ENR

(The 346B need not be connected.) The 8970A displays the first calibration table frequency (10 MHz initialized at the factory) in the left display and the ENR value (15.20 initialized at the factory) at that frequency in the middle display. The MHz units LED will be flashing in the left display, indicating a new frequency entry is possible. Key in the proper number or leave the current value. Press

ENTER

This will enter the digits in the left display into the 8970A memory and will cause the dB unit indicator to flash in the

middle display, indicating ENR entry is possible. To enter the noise source ENR value for 10 MHz, key in the appropriate ENR value (from the 346B calibration report) or leave the current value. Press

**(ENTER)**

The frequency of 100 MHz with a flashing MHz annunciator will appear in the left display. Repeat the previous steps until the complete 346B table is entered. The table must be entered in increasing frequency order. The 8970A recognizes the end of the table by a frequency inserted in decreasing order. The ENR for any additional frequencies will be ignored. The 8970A will use the ENR value for the last frequency in increasing order for all additional frequencies. For example, in *Figure II-3*, if 2000 MHz were erroneously entered as 200 MHz, an ENR of 15.35 dB would be used for all frequencies above 1000 MHz. After entering the last table frequency, enter zero or any frequency smaller than the previous one.

If a mistake is made before ENTER is pressed, press

**(NOISE FIGURE)**

to recover. Simply reenter the digits. If ENTER has been pressed, complete the table because it is easiest to return again for corrections. To return, press

**(ENR)**

Then press

**(ENTER)**

repeatedly until the error is in the display with the flashing unit indicator. Key in the correct value and press

**(ENTER)**

The rest of the table will not be affected. If more than one error was made after ENTER was pressed, proceed through the table as shown above to make all corrections.

To exit the table entry mode press

**(FREQUENCY)**

## Amplifier Measurement (Swept RF)

The following steps characterize the noise figure and gain of the 136 MHz low noise amplifier mentioned at the beginning of this chapter.

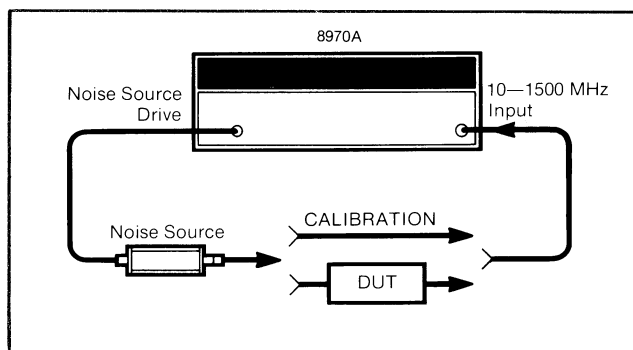
Press

**(PRESET)**

to put the 8970A in a known state. This places the 8970A in the RF mode (mode 1.0).

## RF Calibration

Calibration is necessary to correct for the noise contribution of the measurement system (the 8970A). This calibration automatically measures the system noise figure, with no DUT in place, at three 8970A input attenuator settings. Three attenuator settings are used because the 8970A does not yet know what the gain of the DUT will be and must prepare for a range of gain values. Connect the 346B output directly to the 8970A input (CALIBRATION line in *Figure II-4*). For best accuracy during a swept measurement, the



*Figure II-4. RF Measurement Setup*

desired start, stop, and step frequencies should be selected before calibration. For this amplifier, suitable frequencies are:

start: 110 MHz,  
stop: 160 MHz, and  
step size: 2 MHz.

Enter these frequencies by pressing

START FREQ	1	1	0	ENTER
STOP FREQ	1	6	0	ENTER
STEP SIZE	2	ENTER		

Any values between 10 and 1500 MHz may be used, as long as the number of steps does not exceed 81 (The 110 to 160 MHz sweep in 2 MHz steps uses 26). Press

**(CALIBRATE)**

The 8970A proceeds through the frequency range three times, measuring its own noise characteristics. When the small LED near the CALIBRATE key goes out, calibration is complete. It takes less than 30 seconds for the 26 steps when smoothing is at a minimum.

## Smoothing

The 8970A has smoothing to reduce the jitter of the readout of both gain and noise figure. This jitter is a natural

result of all noise measurements. Increased smoothing provides smoother oscilloscope traces at the sacrifice of measurement speed. Smoothing is set with a smoothing factor,  $n$ , which is the number of measurements averaged for each frequency point displayed. Chapter V, Smoothing, has further information. With minimum smoothing (a smoothing factor of 1) 3 to 5 measurement points per second are displayed during a sweep. With maximum smoothing (a smoothing factor of 512) the time between displayed data points during a sweep increases to approximately 1 minute. For most measurements, a smoothing factor between 2 and 8 is satisfactory. To increase the smoothing press



and the smoothing factor is displayed in the left window while the key is held down. Each time INCREASE is pressed, the smoothing factor is doubled until 512 is reached. To decrease smoothing, press



and the factor decreases in the same way. The smoothing factor may also be entered by pressing

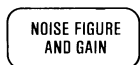


then the desired smoothing factor digits and then



## Corrected Noise Figure and Gain Measurement

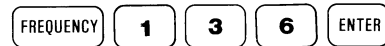
To measure noise figure that is corrected for second stage (measurement system) effects and to measure gain, press



With calibration completed and no DUT inserted, both gain and noise figure should be near zero dB, showing that the 8970A is indeed removing the noise from the measurement system. Since the input is noise, there will be some variation above and below zero. (If an error message, E20, appears in the right display when corrected measurement is attempted, it means that calibration is not valid or has not been done. Perhaps the frequencies have been changed. Error messages are described further in Pullout Card 2, or Chapter V, or the Operating and Service Manual).

To make a corrected measurement of the RF amplifier, connect its output to the 8970A input. Connect the 346B Noise Source 28V dc input to the 28V noise source drive output and the 346B output to the input of the amplifier, the device under test (DUT), as shown in *Figure II-4*. Apply proper dc power to the amplifier (in this case 12V). Select the frequency of interest, usually the amplifier center fre-

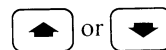
quency, by pressing



The corrected noise figure in dB is displayed in the right window. Gain is displayed in the center window. To find the frequency where noise figure is minimum, select a frequency increment such as 2 MHz by pressing



Pressing FREQ INCR provides only a momentary display of the increment value. To obtain continuous display, hold FREQ INCR down. Move the frequency of the 8970A above or below 136 MHz to find the minimum noise figure by pressing

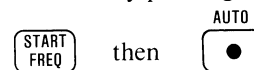


Note the minimum noise figure for later comparison with uncorrected noise figure.

For repeated automatic sweeps press



Note that the sweep starts at the current measurement frequency, and sweeps toward the stop frequency. A full sweep is started by pressing



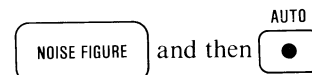
For a single full sweep, press



To stop the sweep, press whichever sweep key is lit a second time. These keys toggle the sweep on and off.

## Uncorrected Noise Figure Measurement

To make an uncorrected measurement, press



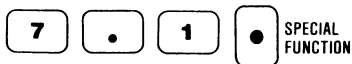
Compare the minimum noise figure obtained from the corrected measurement with that from the uncorrected measurement. The difference is due to the second stage correction in the previous measurement.

## Oscilloscope Display

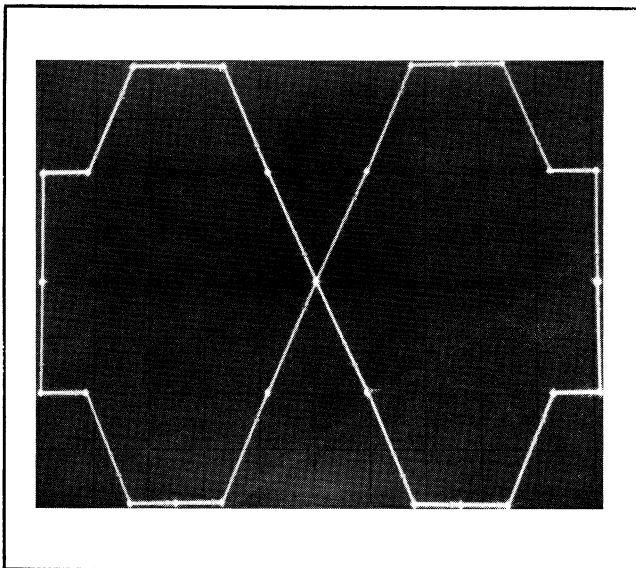
Swept measurements are more easily observed when displayed on an oscilloscope. The 8970A provides accurate display of noise figure and gain on any ordinary oscilloscope with A vs B (or X vs Y) capability. Suitable oscilloscopes are the HP 1740 or 1742. A storage oscilloscope such

as the HP 1741 may also be used. To adjust the oscilloscope, connect the 8970A rear panel X, Y, and Z outputs to the oscilloscope A, B, and Z (or X, Y, and Z) inputs, and place the oscilloscope in the A vs B (or X vs Y) mode. The 8970A X output increases linearly as the frequency increases during the sweep. The Y output is proportional to the measured noise figure and gain values (when measuring corrected noise figure and gain), and proportional to the noise figure alone (when measuring uncorrected noise figure). The Z output is used to blank the oscilloscope on retrace and to make the gain trace dimmer. Set the oscilloscope input coupling to dc for both horizontal and vertical deflection.

Make the 8970A send a test pattern to the oscilloscope by pressing



Adjust the oscilloscope position and then the gain controls to make the test pattern fill the graticule, touching the outer lines on all four sides (see *Figure II-5*). There should be a crossing at the center of the screen. The oscilloscope is now scaled to the 8970A, and the limits on noise figure and gain may now be set from the front panel of the 8970A for any measurement without adjusting the oscilloscope. It may be necessary to readjust the oscilloscope occasionally because its amplifiers may drift.



*Figure II-5. Oscilloscope Test Pattern*

Return the oscilloscope to the normal display of noise figure and gain by pressing

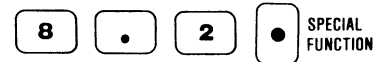


(The . and 0 may always be omitted.)

Assume the RF amplifier measured has a noise figure range of 0.5 to 4 dB and a gain range of 0 to 25 dB over the 110 to 160 MHz frequency range. Display the noise figure lower limit for the oscilloscope in the left window of the 8970A by pressing



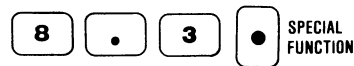
The default value is 0.00 dB, which is suitable for the 0.5 to 4 dB noise figure range of this amplifier. To display the upper limit for the noise figure oscilloscope display, press



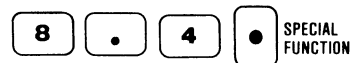
The default value is 8.00 dB. For this amplifier, change the upper limit to 4 dB (0.5 dB per division, 8 divisions high) by pressing



Similarly display the lower and upper limits on the oscilloscope for gain by pressing

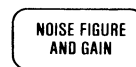


and then

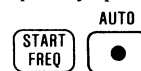


respectively. The default values of 0.00 dB and 40.00 dB (5 dB per division) are satisfactory values for the 0 to 25 dB range of the RF amplifier, and need not be changed unless more gain resolution is desired.

To display the corrected swept measurement on the oscilloscope, press



Then for a repeated swept measurement starting at the start frequency, press

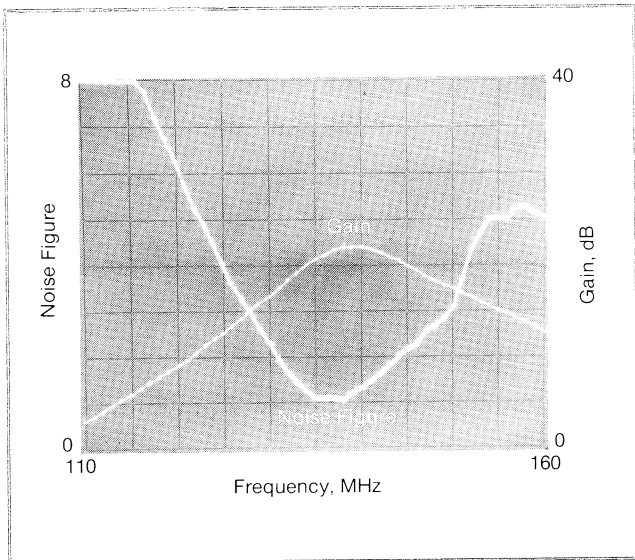


The oscilloscope display data are digitally stored and are refreshed at a rate between 250 and 3000 Hz for a flicker-free display. The display is updated during the sweep at each measurement point. To stop the sweep, press



again. A typical oscilloscope display for the 136 MHz amplifier is shown in *Figure II-6*.

If necessary, adjust the gain trace to be fainter than the noise figure trace using the screwdriver adjustment marked



**Figure II-6.** Typical Oscilloscope Display for 136 MHz Amplifier

GAIN TRACE on the 8970A rear panel. A combination of the screwdriver adjustment and oscilloscope intensity adjustment will likely provide the most pleasing display.

Store the 8970A settings, including the oscilloscope limits, in storage location 1 by pressing

STORE 1

These settings will be used later.

### Display of Effective Input Noise Temperature, $T_e$

Some users prefer the display of noise performance in units other than noise figure in dB. To obtain effective input noise temperature in kelvins, K, press

1 0 . 4 SPECIAL FUNCTION

The maximum possible effective input noise temperature display is 9999K (equivalent to a noise figure of 15.5 dB). For other units consult Pullout Card 1.

The X, Y and Z rear panel analog outputs correspond to any new units chosen using 10.N. Therefore upper and lower noise figure limits, 8.1 and 8.2 SP, usually require adjustment for the range of the new units. For example, when 10.4 SP is selected using the oscilloscope limits set previously (0 to 4 dB), the limits become 0 to 4K. For the 136 MHz amplifier, a maximum  $T_e$  value of 200K is suitable (25K per division on the graticule). Therefore, press

8 . 2 SPECIAL FUNCTION 2 0 0 ENTER

Start a sweep by pressing

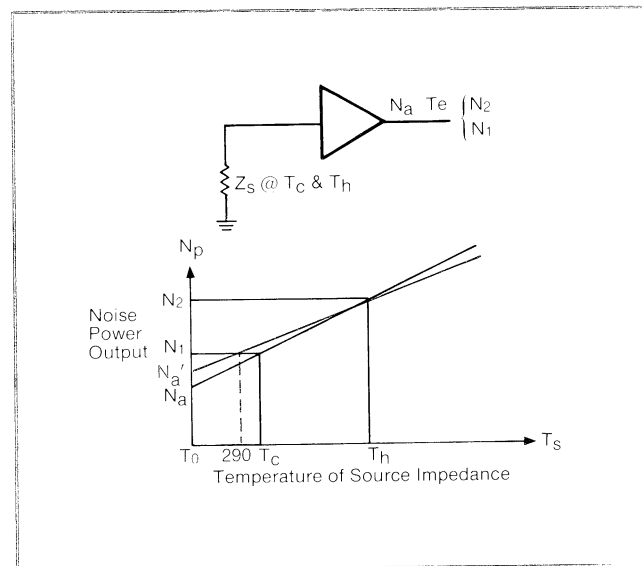
AUTO or SINGLE

To return the display to F in dB and to recall the previous oscilloscope limits, press

RECALL 1

### $T_c$ Correction

Before the 8970A, noise figure meters assumed that  $T_c$  was 290K because of the difficulty in making exact calculations for other values. From **Figure II-7** this assumption can be seen to introduce error. The measurements  $N_2$  and  $N_1$  are noise power measurements made by all noise figure meters at  $T_c$  (input noise temperature with the noise source biased off) and  $T_h$  (input noise temperature with the noise source biased on). If  $T_c$  is assumed to be 290K and is in fact different, the noise added by the amplifier,  $N_a$ , will be calculated as  $N_a'$  in **Figure II-7** when in fact it is  $N_a$ . This will lead to an incorrect calculation for noise figure, F, or effective input noise temperature,  $T_e$ .



**Figure II-7.** Effect of Changing  $T_c$

The amount of error introduced is illustrated in **Figure II-8**, a plot of error vs noise figure for selected values of actual  $T_c$ . If  $T_c$  is higher than 290K, as it usually is, the measured noise figure will be too high.

The 8970A does not assume  $T_c$  is 290K. To illustrate this, select the  $T_e$  display by pressing

1 0 . 4 SPECIAL FUNCTION

Note the effective input noise temperature,  $T_e$ , of the ampli

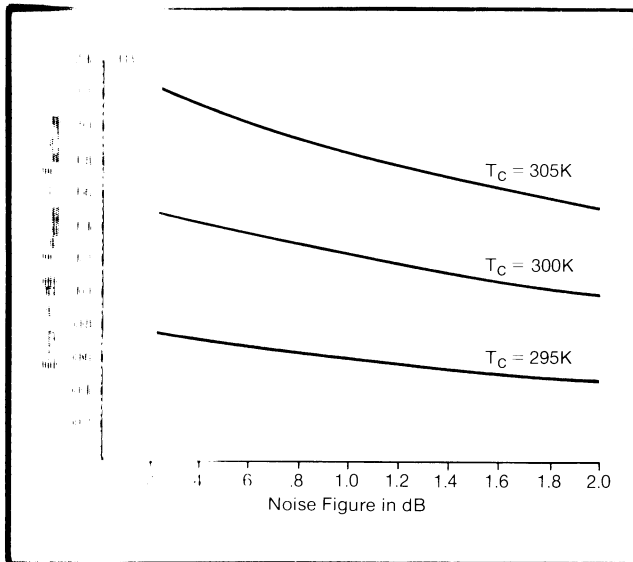


Figure II-8. Errors Introduced by Assuming  $T_c = 290K$  (Actual  $T_c$  Shown)

Set at its minimum value by adjusting the 8970A frequency. Display the assumed ambient,  $T_c$ , by pressing

{ 6 } ( ● ) SPECIAL FUNCTION

This shows 296.5K, the default value. Change  $T_c$  to 290K by pressing

{ 2 } { 9 } { 0 } ENTER

and note the change in  $T_c$ . This change is nearly 7K (the noise figure change is nearly 0.1 dB), which is significant for an amplifier with a  $T_c$  near 35K (a noise figure near 0.5 dB).

Restore the default value of  $T_c$  to 296.5K and the noise units to F in dB by pressing

{ RECAL } { 1 }

which recalls all of the temperature, frequency, display unit, and oscilloscope settings previously made when measuring corrected noise figure and gain.

## Microwave Amplifier Measurement (Swept LO)

Microwave amplifier measurements are nearly as simple as RF measurement, with the addition of a local oscillator and mixer. The following example uses the 8672A Synthesized Signal Generator as a local oscillator and the Hewlett-Packard HMXR-5001 mixer to down convert to the frequency range of the 8970A. The system is used to measure the 50 to 4500 MHz amplifier over a 3.7 to 4.2 GHz frequency range. The noise figure for the amplifier typically varies from 6 to 10 dB and the gain from 5 to 15 dB over this reduced frequency band.

## 8970A LO Control

The 8970A can control the 8672A over HP-IB without the need for an external controller. To set the 8970A up to measure the microwave amplifier using the swept external LO and a fixed IF, make the connections shown in **Figure II-9** (the CALIBRATION line). Connect the HP-IB cable between the rear panel connectors on each instrument. Turn on both instruments. Press

PRESET

to return the 8970A to a known state. Select mode 1.1 (variable frequency external LO, fixed IF) by pressing

{ 1 } { . } { 1 } ( ● ) SPECIAL FUNCTION

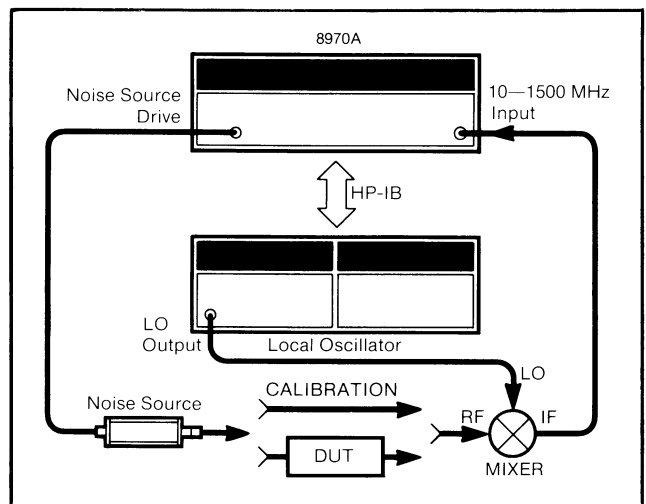


Figure II-9. Swept LO Amplifier Measurement Setup

Error message E42 (no external LO) may occur. However, the cause will soon be removed, so ignore it. E42 is discussed later in this example. Select an appropriate IF, such as 40 MHz. Display the current IF and change it to 40 MHz from the 30 MHz default value by pressing

{ 3 } ( ● ) SPECIAL FUNCTION { 4 } { 0 } ENTER

Instruct the 8970A to output the preprogrammed level and frequency commands for the 8672A over HP-IB by pressing

{ 4 } { 1 } { . } { 2 } ( ● ) SPECIAL FUNCTION

Turn on the 8970A controller function by pressing

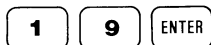
{ 4 } { . } { 1 } ( ● ) SPECIAL FUNCTION

This will light the 8970A TALK annunciator. Note that after making mode selection (1.1 SP), the above steps may be performed in any order.

The 8672A REMOTE annunciator should now be lit. If it is not, the 8970A may be using an incorrect address for the 8672A. Display the assumed external LO address by pressing

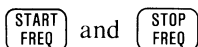


The address may be changed to match the actual 8672A address (factory set to 19). To set the address to 19 (after first entering 40.1 SP) press



If the address of the 8672A is not 19 and is not known, the 8672A cover may be removed and the switch settings checked as explained in the 8672A Operating and Service Manual. However, it may take less time to try addresses 0 through 30 until the correct one is found.

To assure that the 8970A is talking to the 8672A, press the 8970A



keys. This should change the 8672A frequency to match the 8970A start and stop frequencies.

If E42 ever appears in the right display of the 8970A, this error message indicates that no external LO is connected (see Pullout Card 2). The problem is most likely one of the following:

1. the HP-IB cable is either not attached or is not making proper contact,
2. the external LO (in this case an 8672A) is not turned on, or
3. the 8970A has the wrong address for the external LO.

### Microwave Calibration (Swept LO)

Calibration of the microwave measurement system is similar to RF calibration. If not done already, attach the mixer LO port to the 8672A, connect the 346B Noise Source output to the mixer RF input, and connect the mixer IF output to the 8970A input (see **Figure II-9**, the CALIBRATION line). Set start, stop and step size frequencies for the amplifier to be tested. For the example microwave amplifier, appropriate figures are

start: 3700 MHz,  
stop: 4200 MHz, and  
step size: 20 MHz.

Press

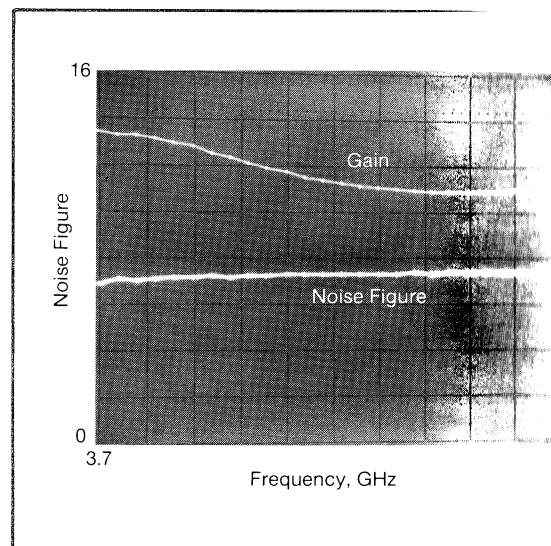


The calibration cycle again sweeps three times. In the first sweep, noise figures of about 10 dB are measured. Values near 6 dB are exceptional, and values near 3 dB indicate that the added parts (mixer, LO, adapters, cables) may be introducing too much noise.

When calibration is complete (CALIBRATION line off), the measurement system is calibrated at the input. The second stage includes the mixer, the cables, adapters, and the 8970A.

### Corrected Noise Figure and Gain Measurement (Swept LO)

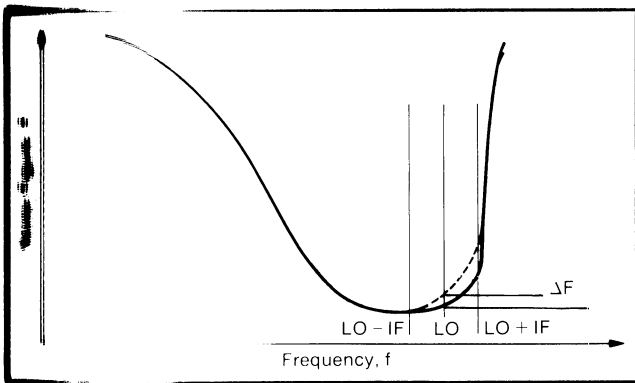
A measurement corrected for the second stage calibration may now be made. It is good practice to measure gain and noise figure of the direct connection. A gain and noise figure of  $0 \text{ dB} \pm 0.3 \text{ dB}$  are not unusual when measuring with a smoothing factor of one. Insert the DUT into the system as shown in **Figure II-9**. Results may be displayed on the oscilloscope using the steps as those described in the RF amplifier measurement under Oscilloscope Display. A typical oscilloscope display of noise figure and gain is shown in **Figure II-10**.



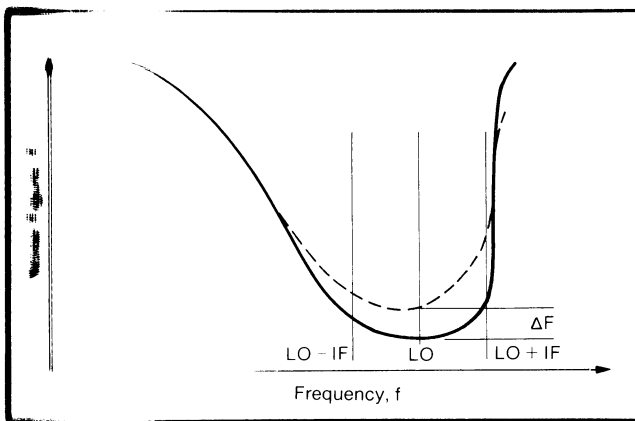
**Figure II-10.** Typical Display of Microwave Amplifier Measurement

The measurement just made is a double sideband measurement. The result is essentially an average of two measurements 80 MHz apart (each in a 4 MHz band, 40 MHz above the LO frequency, the other 40 MHz below). Low IF was chosen so the two measurement bands would close together and minimize the effect of averaging. This effect is important if the gain or noise figure varies rapidly with frequency (such as a very narrow band amplifier) or with sharp corners at the band edges, or one with

distortions in the pass band). See **Figure II-11** for the effect of a low IF vs a high IF when measuring an amplifier in double sideband mode.



**Figure II-11a.** Effect of Low IF



**Figure II-11b.** Effect of High IF

There is usually no need to “correct” for double sideband when the above measurement is made. The total measurement bandwidth is the same during both calibration and measurement, so the gain and noise figure are displayed correctly. There is no need for a 3 dB or other adjustment. Problems only occur when the noise figure and/or gain vary greatly from one sideband to the other.

There is more discussion on single vs double sideband measurement in this chapter (the next example and at the end of the chapter) and in Chapter V, Sideband Selection.

### X-Y Recorder Display

In addition to the digitally stored oscilloscope output, the 8970A can provide analog outputs for an X-Y recorder such as the HP 7015B and 7045B X-Y Recorders. It saves time to first obtain the desired display on an oscilloscope, although not strictly necessary, before making a hard copy on the X-Y recorder.

To make a plot, first set the desired display limits for noise figure and gain using 8.N SP (see Pullout Card 1). If

an oscilloscope was used to set the limits, the same limits are probably appropriate. Appendix B is a graph paper sheet ruled for oscilloscopes with 8 vertical and 10 horizontal divisions, and may be copied for X-Y recorder use.

Match the X-Y recorder limits to the 8970A by first pressing



for lower left (zero volts). Connect the X, Y, and Z rear panel outputs on the 8970A to the X, Y, and pen lift inputs on the X-Y recorder and turn it on. Adjust the X and Y zero set on the X-Y recorder.

For upper right press



and set the X and Y vernier controls for the upper right corner. The X and Y output voltages range from 0 to 6 volts, so the X and Y recorder amplifiers (voltage ranges) may need to be adjusted to accommodate the 6 volt value. Check the lower left again to account for any interaction of the limit setting. The X-Y recorder is now scaled to limits previously set by the 8.N SP entries.

Noise figure and gain must be plotted separately. Use a single sweep if only a single trace is desired. To plot noise figure, press



for a single sweep. For a gain plot, press



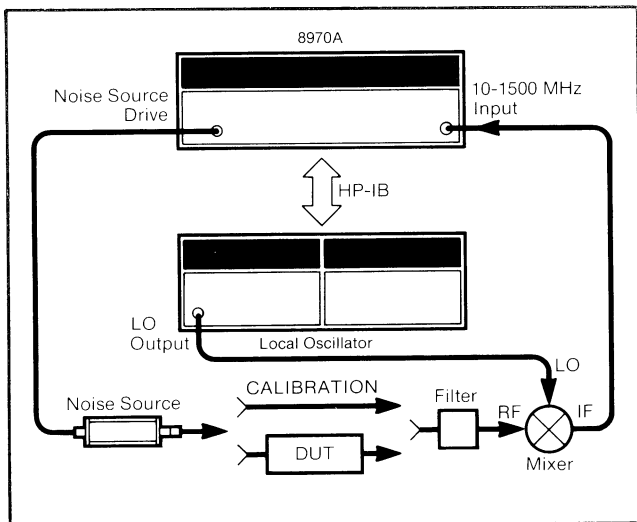
## Microwave Amplifier Measurement (Swept IF)

With the 8970A it is not always necessary to have a swept LO to make swept measurements. The LO can be fixed and the 8970A input frequency can sweep, giving a swept measurement. Thus the LO may be a klystron or cavity-tuned oscillator. The following example is based on the same equipment used previously, but requires the addition of a 4.4 GHz low pass filter such as the HP 11689A (see **Figure II-12**).

### Single Sideband Measurement

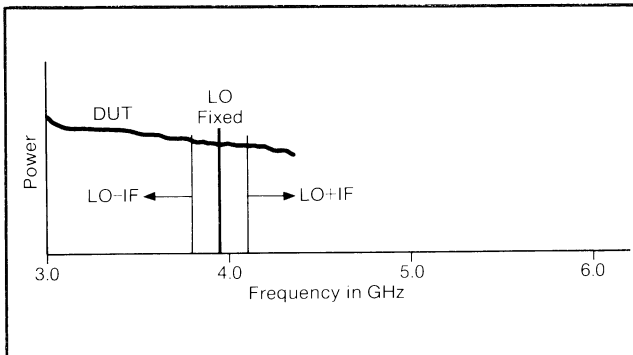
A microwave amplifier measurement with swept IF, mode 1.2 (1.2 SP), always requires a single sideband measurement. External filtering is needed to eliminate the noise power in the unwanted sideband. If double sideband measurement is attempted in mode 1.2, the error message E34 (Double sideband not allowed in mode 1.2) is displayed.



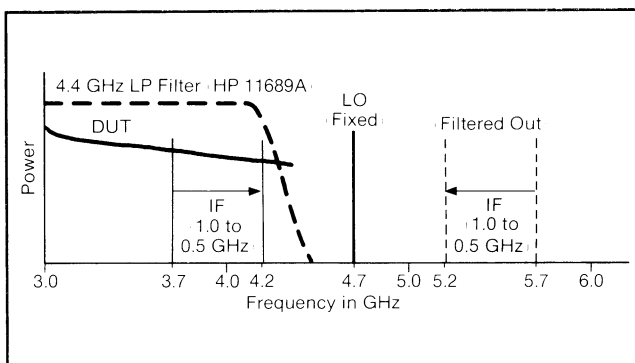


**Figure II-12.** Swept IF Amplifier Measurement

The reason for this may be seen in **Figure II-13a**, depicting power output vs. frequency for the microwave amplifier to be measured over a 3.7 to 4.2 GHz range. With the LO fixed at 3.95 GHz, for example, a double sideband measurement (the default) would make no sense. This is because the average frequency of the two microwave frequency sidebands ( $LO \pm IF$ ) is always the same, regardless of the IF value. The output obtained is not useful.



**Figure II-13a.** Mode 1.2 Double Sideband Measurement (not allowed)



**Figure II-13b.** Mode 1.2 Single Sideband Measurement (with filter)

**Figure II-13b** depicts the frequencies involved in a single sideband measurement of the microwave amplifier over a 3.7 to 4.2 GHz range. To make this measurement, first press

PRESET

to return the 8970A to a known state. Set the start, stop, and step size frequencies to 3700, 4200, and 20 MHz respectively. Select the mode for fixed LO, swept IF (mode 1.2), by pressing

1 . 2  SPECIAL FUNCTION

The indicated error message, E34, is corrected by selecting the correct (lower) sideband. Press

2 . 1  SPECIAL FUNCTION

The indicated error message, E33 (IF will be out of range), is corrected by the following step. Set the LO to 4.7 GHz and tell the 8970 this LO frequency by pressing

3 . 1  SPECIAL FUNCTION  
4 7 0 0 ENTER

If the 8970 is enabled as a controller as in the previous section, and the LO is one that can respond over HP-IB (like an 8672A), this automatically sets the LO to 4.7 GHz.

## Calibration and Measurement

Before calibrating, the 4.4 GHz low pass filter must be inserted as part of the measurement system as shown in **Figure II-12**. Press

CALIBRATE

The 8970A will sweep its tunable input frequency (the IF) from 1000 to 500 MHz three times, but will display the microwave measurement frequency sweeping from 3.7 to 4.2 GHz.

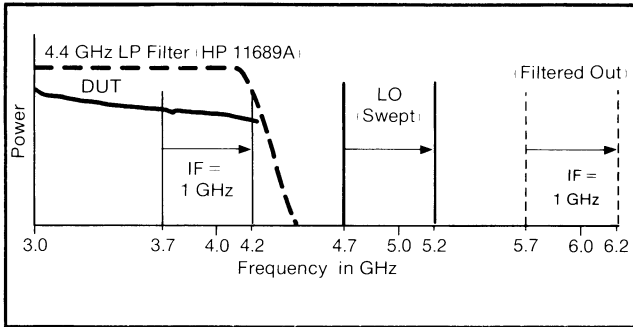
During measurement with the DUT inserted, it is important that the filter be on the mixer input rather than the 346B output. Otherwise some added noise from the DUT will likely be in the unwanted sideband and create a measurement error. The filter must be in place for both calibration and measurement. It will filter out the upper sideband (5.7 to 5.2 GHz). For the measurement, press

NOISE FIGURE AND GAIN and  AUTO

## Single Sideband Measurement (Swept LO) (1.1 SP)

This same single sideband measurement result may be obtained in mode 1.1 (1.1 SP) as shown in **Figure II-13c**, using a fixed IF frequency and the same physical setup. The

start, stop and step frequencies are still 3700, 4200, and 20 MHz. The lower sideband (2.1 SP) is still the correct one. A fixed IF of 1000 MHz may be used (3 SP 1000 ENTER), giving an LO sweep from 4.7 to 5.2 GHz as shown below



**Figure II-13c. Mode 1.1 Single Sideband Measurement (with filter)**

When making this measurement in mode 1.1, the IF must always be greater than one-half the measurement frequency sweep range to assure filtering of the unwanted sideband. How much greater depends on the filter cut-off frequency. For this example the IF is set to 1000 MHz. With a 4.4 GHz low-pass filter, a 1000 MHz IF assures that the upper sideband sweep (from 5.7 to 6.2 GHz) will always lie in the reject band of the filter.

The results from this measurement in mode 1.1 (1.1 SP) should agree with those obtained using mode 1.2 (1.2 SP).

## Real Time Adjustment

The 8970A can easily be used to make real-time adjustments to the DUT by displaying swept measurements at a few frequencies on the oscilloscope. To do this, reduce the number of steps in the frequency range to about 5 by increasing the step size. Since the 8970A makes approximately 5 readings per second, the effect of any DUT adjustment is updated approximately once each second, allowing easy observation while adjusting. It is often helpful to choose the step size to place measurement points on or near particular frequencies of interest. As an example of simulating device adjustment, decrease the power supply voltage to the DUT and note the result on the oscilloscope display. (Be careful not to increase the power supply voltage enough to burn out the amplifier). After initial DUT adjustment is made, decreasing the step size will increase resolution for any final adjustment or observation.

## Amplifier Mode and Sideband Summary

**Table II-1** is a summary of the advantages and limitations of each of the mode/sideband selections for amplifier measurements above 1500 MHz.

In summary, the mode 1.1 double sideband measurement is broadband, is simpler, and requires less equipment. It may, however, introduce averaging errors and cannot cover

**Table II-1. Amplifier Mode and Sideband Summary**

Mode	Sideband	Advantages	Limitations
1.1 (Variable LO, fixed IF)	Double Sideband (DSB)	Covers broadest frequency range (2—18 GHz with 8672A). Needs no filter. Can use a mixer with narrow IF range.	Errors at band edges of narrow-band amplifiers. Errors possible due to ripple in passband. Cannot cover 1500 to 2000 MHz with most sweeping LOs.
	Single Sideband (SSB)	Overcomes 1.1 DSB limitations. Sweep widths possible up to 3000 MHz. Covers 1500 to 2000 MHz.	Sweep widths cannot exceed 3000 MHz. Requires filter Usually higher second stage NF than DSB (due to higher IF and 3 dB more NF in Mixer). Requires mixer with broad IF range.
1.2 (Fixed LO, variable IF)	Single Sideband (SSB)	Overcomes 1.1 DSB limitations. Covers 1500 to 2000 MHz. Does not require swept or HP-IB LO.	Sweep widths cannot exceed 1500 kHz. Requires filter. Usually higher second stage NF than DSB (due to higher IF and 3 dB more NF in mixer). Requires mixer with broad IF range.

1500 to 2000 MHz with most sweeping LOs. Single sideband measurement, in either mode 1.1 or 1.2, overcomes the above limitations. Mode 1.1 single sideband has a wider possible sweep range (3000 MHz) than mode 1.2 (1500 MHz), but mode 1.2 does not require a swept or HP-IB LO.

## Mixer Measurements

Mixer noise figure measurements usually raise the question as to whether the measurement is single sideband or double sideband. Mixers ordinarily convert input power from two different frequency bands to the IF. The two input frequency bands are  $f_{LO} + f_{IF}$  (called the upper sideband or USB) and  $f_{LO} - f_{IF}$  (called the lower sideband or LSB). In most applications, however, useful input signal enters the mixer in only one of these bands, the desired sideband. Unless the mixer is specially designed or unless special filters are included ahead of the mixer, noise enters in the undesired sideband, gets converted to the IF, and obscures useful signals that enter in the desired sideband. If the measurement system includes the input noise in the undesired sideband, the measurement is said to be double sideband (DSB). If it rejects input noise from the undesired sideband, the measurement is said to be single sideband (SSB). The results are usually different; it is important to qualify whether the mixer or converter measurement is SSB or DSB.

When a mixer is added ahead of the 8970A, the 8970A measures the actual situation. If the external mixer is arranged to reject one sideband, the 8970A gives the SSB result. If both sidebands are converted by the external mixer, the 8970A gives the DSB result. Confusion and arguments arise when a DSB result is to be used for predicting performance in a SSB system or in a system where signal arrives in only one sideband. The next three paragraphs will discuss various aspects of this situation.

When measuring the noise figure and gain vs frequency of a microwave amplifier, it normally makes no difference whether the measurement system is DSB or SSB if the DUT noise figure and gain are flat with frequency. The results should be the same. However, because the DSB measurement is an average of performance in the USB and LSB, the DSB result could have some errors because of fine-grain variations with frequency.

When making a DSB measurement on a mixer, receiver, or other frequency converting device, the 8970A indicated gain will be about 3 dB too large. If the 8970A indicates the gain is -6 dB (6 dB loss), the actual gain is -9 dB (9 dB loss). The 8970A overstates the gain by 3 dB because the bandwidth changed between calibration (when the 8970A measured the noise from the source over a single 4 MHz band centered at the IF) and DUT measurement (when the noise

coming into the 8970A was from two 4 MHz bands, one for each sideband). This correction of 3 dB is proper when the gain (conversion loss) in each sideband is the same.

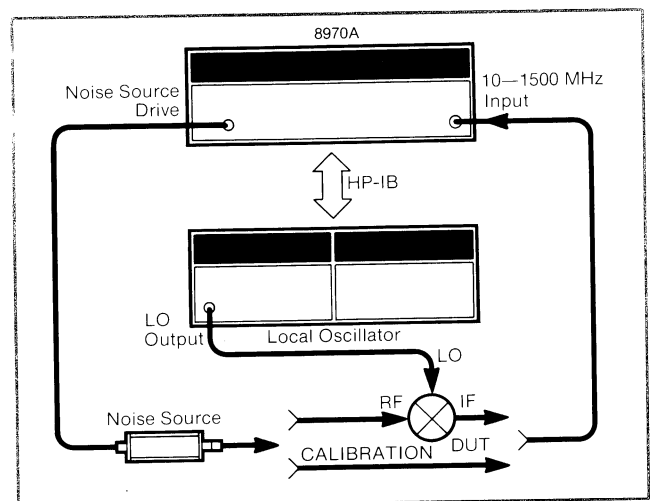
If the DSB noise figure measurement data is to be used to predict performance in a SSB system or a system with signal in only one sideband, the indicated noise figure on the 8970A should be increased by 3 dB. Some 8970A special functions can automatically apply the 3 dB corrections to noise figure and gain. This will be covered below under Automatic 3 dB Adjustment.

For further discussion of sideband noise figure and gain adjustments see Chapter V under Sideband Selection.

Mixer measurements may be made with a variable LO and fixed IF in mode 1.3 (1.3 SP) or with a fixed LO and variable IF in mode 1.4 (1.4 SP). Note that any mixer measurement includes the effect of the LO, so a noisy LO may result in a larger measured mixer noise figure.

## Mixer Measurement (Swept LO)

This example will measure the mixer used previously, the HMXR-5001, from 2 to 12 GHz. It usually has a conversion loss for this frequency interval of 6 to 10 dB and a single sideband noise figure of about the same value. Use the measurement setup for mode 1.3 shown in **Figure II-14**.



**Figure II-14.** Mixer Measurement Setup

To make the measurement, first, return the 8970A to a known state by pressing

**PRESET**

Select mode 1.3, (swept external LO, fixed IF, conversion in the DUT) by pressing

**1** **.** **3** **SPECIAL FUNCTION**

Set the start, stop and step size frequencies to 2000, 12000 and 500 MHz respectively. Set an appropriate IF such as 20 MHz by pressing

**3** **SPECIAL FUNCTION** **2** **0** **ENTER**

**NOTE**

An IF of 30 MHz is suitable for most mixer measurements. However, in some cases high LO noise or sharp variations in noise figure or conversion loss in a 2 times IF frequency interval may affect the measurement. If either of these problems are suspected, vary the IF until the measurement is "well behaved". Generally, a lower IF will increase the measurement resolution for a varying noise figure, and a higher IF will reduce the effect of LO noise. The IF used must, of course, be within the IF output range of the mixer under test.

**Calibration and Measurement**

For calibration, connect the 346B directly to the 8970A input. Press

**CALIBRATE**

The 8970A will calibrate at 20 MHz on each of the three RF attenuator settings. The displays of corrected noise figure and gain may not show 0 dB (plus jitter) after calibration with no DUT inserted. This is because the 8970A is now using the microwave frequency ENR, while the 8970A input is tuned to the IF (expecting a mixer as the DUT).

Connect the appropriate ports on the mixer to the external LO, noise source, and 8970A input. Insure that the 8970A is the controller by pressing

**4** **.** **1** **SPECIAL FUNCTION**

Also insure that the 8970A is properly set to program the LO. For an 8672 press

**4** **1** **.** **2** **SPECIAL FUNCTION**

On the oscilloscope, the gain limits must be changed, using 8.N SP, to accept a negative reading, since the mixer has loss. To set the limits for zero to 8 dB of conversion loss (-8 to zero dB of gain), press

**8** **.** **3** **SPECIAL FUNCTION** **-** **8** **ENTER**

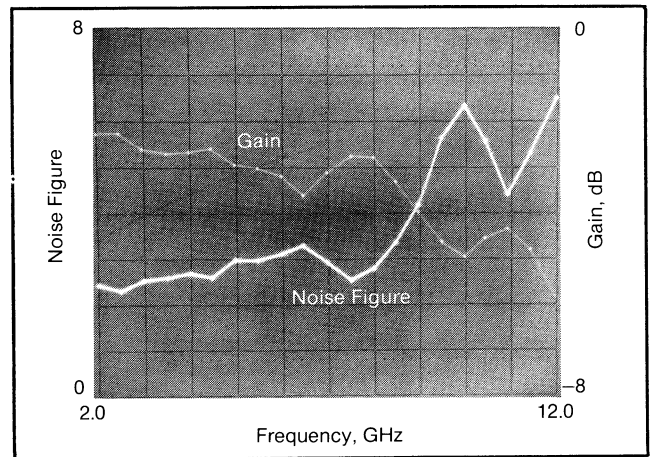
**8** **.** **4** **SPECIAL FUNCTION** **0** **ENTER**

After calibration, a fixed or swept measurement may be made. This will be a double sideband measurement and (the

PRESET default condition was double sideband). For a repeated sweep, press

**AUTO**

A typical oscilloscope display is shown in **Figure II-15**. The 8970A and oscilloscope show double sideband noise figure and an overstated value for insertion gain (corresponding to a doubled measurement bandwidth). To obtain actual insertion gain (assuming equal gain at each sideband frequency) subtract 3 dB from the displayed value (e.g. if -6 dB is displayed, the proper value is -9 dB). Similarly, to obtain single sideband noise figure from the double sideband displayed value add 3 dB.



**Figure II-15. Typical Display of Mixer Measurement**

**Automatic 3 dB Adjustment**

The loss compensation special function (34.N SP) may be used to make the correction of double sideband data to estimate single sideband results by entering a fictitious negative input loss at 290K. This will subtract 3 dB from the displayed gain and add 3 dB to the displayed noise figure. Steps are as follows

Enable the loss compensation function by pressing

**3** **4** **.** **1** **SPECIAL FUNCTION**

The adjustment (loss) in dB (-3 dB) is entered by pressing

**3** **4** **.** **2** **SPECIAL FUNCTION** **-** **3** **ENTER**

The temperature of the fictitious loss (290K) is set by pressing

**3** **4** **.** **3** **SPECIAL FUNCTION**

**2** **9** **0** **ENTER**

This adjusts both noise figure and gain. Note that using this correction lights the annunciator in the SPECIAL FUNCTION key. This warns the operator that the measurement is being made in a way not obvious from the front panel: The measurement is being corrected for an extra loss to form the displayed result.

A fixed or swept measurement may be made as in previous examples. Turn off loss compensation by pressing



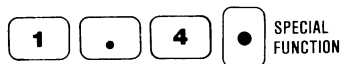
## Mixer and Receiver Measurement (Swept IF)

Both double and single sideband measurements may be made in mode 1.4, unlike mode 1.2. This example will use the HP HMXR-5001 mixer and will include the 8672A as the LO. It will make a simulated receiver measurement which will include the 8672A as part of the DUT. The measurement will be double sideband at 4 GHz and will sweep the 8970A IF from 10 to 1000 MHz. This measurement may be useful to choose the optimum IF for a mixer or receiver or to measure how mixer or receiver noise figure and gain vary with IF.

To return the 8970A to a known state, press



Select the variable IF, fixed LO mode (mode 1.4) by pressing

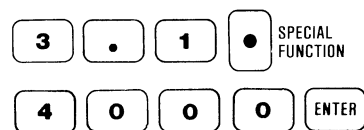


Note that the left display (frequency) is shown at the IF (30 MHz default), rather than the LO frequency.

PRESET, pressed above, has reset the sideband selection to double sideband (2.0 SP). The default start and step size frequencies of 10 and 20 MHz are satisfactory for this measurement. The stop frequency should be set to 1000 MHz (the maximum IF of the HMXR-5001) by pressing



Tell the 8970A the frequency of the LO by pressing



and set the LO to 4 GHz. (The previous special function entry will automatically set the 8672A to 4 GHz if the 8970A is in controller mode (4.1 SP), the proper external LO program is selected (41.2 SP), the 8970A has the correct

8672A address, and an HP-IB cable is properly connected between the rear panels).

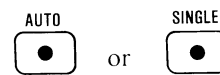
## Calibration and Measurement

To calibrate, connect the 346B directly to the 8970A and press



The 8970A sweeps from 10 to 1000 MHz on the three RF input attenuator settings. The CALIBRATE annunciator goes out when 8970A calibration is complete.

To make the measurement on the simulated receiver, connect the 346B to the input of the receiver (the mixer RF port). The receiver is the mixer/8672A combination, with the 8672A output connected to the mixer LO port. Connect the receiver output (the mixer IF port) to the 8970A. To observe a sweep, press



This measurement is double sideband if the receiver is double sideband and should be adjusted as described in the previous example (swept LO mixer measurement) if single sideband data are desired.

## Mode and Sideband Selection Chart

The previous examples and Pullout Card 3 illustrate mode and sideband selection. For a more complete treatment of the selection process, see *Figure II-16*.

The mode and sideband selection decision depends on answers to several questions including the following:

1. Does the DUT have frequency conversion?
2. What is the DUT frequency and bandwidth?
3. Can the LO frequency range (extended if necessary by using the 8970A maximum frequency of 1500 MHz) cover the DUT frequency range?
4. Is the DUT a transistor?
5. Is the LO HP-IB compatible with the 8970A?
6. Does the DUT have noise figure and gain variations in a 2 times IF range that would not be properly resolved by double sideband measurement (such as at sharp band edges)?
7. Is a single sideband or double sideband measurement desired?
8. Are filters needed and are the proper ones available if a single sideband measurement is made?

Consider a 3.7 to 4.2 GHz swept amplifier measurement (a previous example). It may be made in three ways: Mode 1.1 double sideband, mode 1.1 single sideband (if the LO is HP-IB compatible with the 8970A), and mode 1.2 single sideband. Chapter V, under Automatic Control of an



External Local Oscillator, comments on HP-1B compatibility. If a fixed LO is used, only mode 1.2 single sideband may be used for swept measurements.

As another example, to measure a standard (i.e. not image rejection) 2 to 18 GHz mixer over the full range, only

a mode 1.3 double sideband measurement is possible. From this measurement, single sideband performance may be inferred as discussed previously, using loss compensation. (However, the 8970A can measure nearly 3 GHz segments of the mixer range using mode 1.3 in single sideband if a suitable filter is available).

## Additional Topics

This chapter gives brief comments on several topics that are often of special concern. The topics are listed in the table of contents.

### Selecting a Local Oscillator

Several questions should be considered in choosing an LO for use with the 8970A:

1. Is the frequency range suitable to measure the DUT?
2. Is swept LO (8970A control) or fixed LO (8970A swept IF) measurement desired?
3. Is the broad band noise floor of the LO low enough for mixer measurements? (About  $-130$  dBm/Hz at  $\pm 30$  MHz from the carrier is usually sufficient. For amplifier measurements, if calibration can be performed, the LO noise is usually low enough).
4. Is the power output sufficient to drive the mixer? (7 to 10 dBm is usually adequate).
5. Is the frequency accuracy sufficient for the measurement application?
6. Is HP-IB available and necessary for control by either the 8970A or an external controller?

For measurements using the HP 8970A to control the LO, the HP 8672A Option 008 is a good solution. The 8350A Sweep Oscillator with a 2 to 20 GHz 83590A or the 8350A with the 2 to 18.6 GHz 86290B plug-in and 11869A adapter are lower cost alternatives, if lower frequency accuracy is acceptable. For narrow band measurements using a fixed LO and varying the 8970A input frequency (IF), the 2.3 to 6.5 GHz 8683A Option 001 and 5.4 to 12.5 GHz 8684A Option 001 are good choices if  $\pm 1$  percent frequency accuracy is sufficient. The 8350A, 8683A and 8684A (as fixed LOs) may be complemented by a counter if high frequency accuracy is desired.

Other LOs may be used, but should usually be tried to make sure their noise is low enough. LO noise can cause a

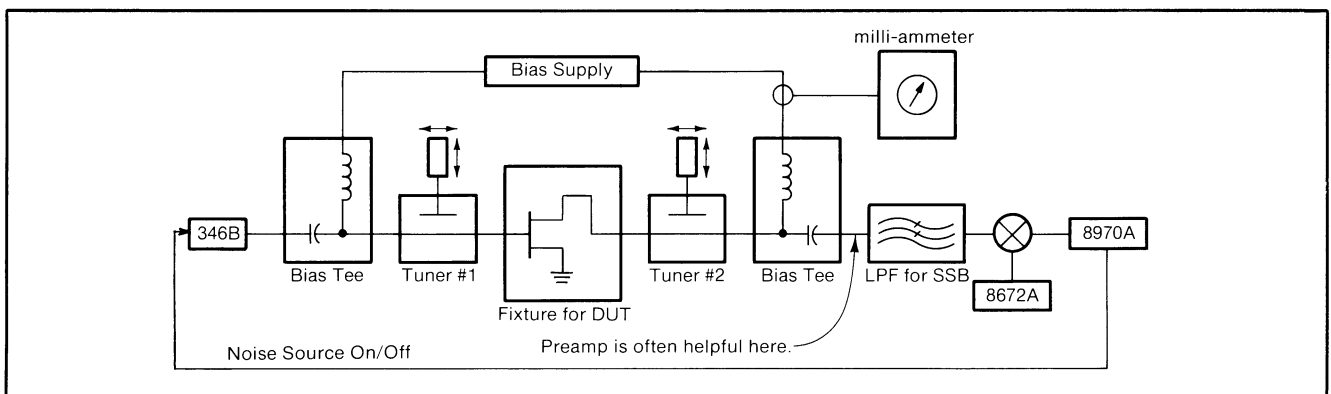
sharp increase in noise figure for the mixer/LO combination and noise calibration of the system might not be possible. A broad band, high gain amplifier at the LO output usually generates unacceptable noise. This is almost always the case when a heterodyne-type sweep oscillator or signal generator is used.

### Transistor Measurements

Transistor noise figure and available gain depend on source impedance. The insertion gain measured by the 8970A depends on both source and load impedances. **Figure III-1** shows a typical setup to measure noise figure and available gain. Available gain is approximated by the insertion gain measured by the 8970A.

One possible outline used to measure a transistor at a single frequency point is as follows:

1. Select mode 1.1 or 1.2 and single sideband measurement. (Single sideband measurement is required because of the variations in tuner impedance with frequency).
2. Decrease ENR by the "backed out" input tuner loss plus the input bias tee loss. (These losses are the negatives of the available gain (dB) for each device).
3. Calibrate with tuners backed out and a through connection in place of the transistor.
4. Insert the transistor, tune tuner #2 for maximum gain and tuner #1 for minimum noise figure (assuming minimum noise figure is desired).
5. Repeat step 4 above until no further reduction in noise figure is possible.
6. Correct for added tuner loss using loss compensation. Enter the added loss before the DUT using 34.2 SP, added loss after the DUT using 34.4 SP, and the ambient temperature of both losses using 34.3 SP. Enable loss compensation, 34.1 SP.
7. Read the noise figure and gain.

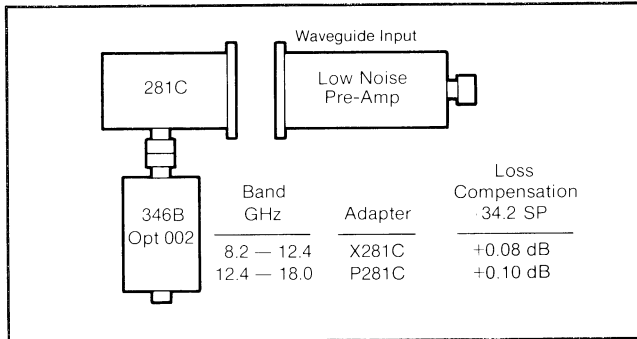


**Figure III-1.** Typical Transistor Measurement Setup



## Waveguide Measurements

Noise figure measurements of amplifiers and receivers with a waveguide input are accommodated by using waveguide-to-coax adapters. HP X281C (for WR90) and P281C (for WR62) low SWR, low loss adapters are recommended if applicable. **Figure III-2** includes the frequency ranges and correction factors. HP 281A adapters for the S, G, J, and H bands may be used if the insertion loss is measured and compensated for.

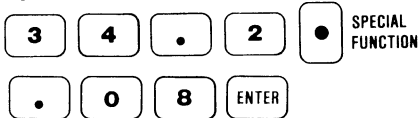


**Figure III-2.** Measuring Noise Figure of Waveguide Preamps

The measurement steps to measure an amplifier with waveguide input, using an adapter, are as follows:

1. Load the actual 346B ENR table in the 8970A.
2. Connect the 346B to the measurement system and calibrate.
3. Enter the loss of the adapter using 34.2 SP.
4. Enter the ambient temperature of the adapter using 34.3 SP.
5. Compensate for the adapter loss by using 34.1 SP. (Note that the annunciator in the SPECIAL FUNCTION key comes on).
6. Insert the adapter and DUT.
7. Measure the DUT (compensated for the adapter loss).
8. Read the noise figure and gain.

For a measurement at 12 GHz, for example, the loss compensation of 0.08 dB would be entered by pressing

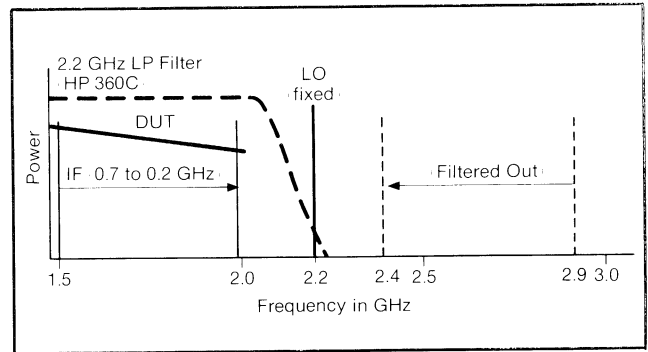


Further information on loss compensation is contained in Chapter V, under Loss Compensation (34.N SP).

## Amplifier Measurements From 1.5 to 2.0 GHz

**Method 1.** Measurements between 1.5 and 2 GHz using an LO with 2 GHz minimum frequency may be made much like the swept IF microwave amplifier measurement example in Chapter II. Pullout Card 3, mode 1.2, shows

the filter and Appendix A includes the extra equipment necessary. The microwave amplifier discussed previously may be used as an example, since its frequency range is 50 to 4500 MHz. **Figure III-3a** shows the signals.



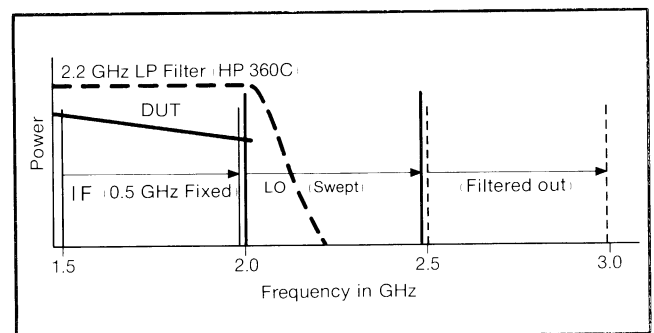
**Figure III-3a.** 1.5 to 2.0 GHz Swept LO Measurement

Proceed as follows:

1. PRESET to get a known state.
2. Select mode 1.2. Ignore the E34 (Double sideband not allowed) in the 8970A display.
3. Select lower sideband (2.1 SP). Ignore the E33 (IF will be out of range) in the 8970A display.
4. Enter LO frequency (3.1 SP), (such as 2200 MHz).
5. Enter start, stop, and step size frequencies (such as 1500, 2000, 10).
6. Make the connections shown on Pullout Card 3 for calibration (with filter).
7. Calibrate.
8. Insert the DUT between the 346B and filter as shown on Pullout Card 3.
9. Make the measurement.

The LO will remain fixed at 2200 MHz. The 8970A will sweep its frequency to get the 1500 to 2000 MHz sweep (sweeping its input frequency from 700 down to 200 MHz).

**Method 2.** As with the Swept LO single sideband amplifier measurement in Chapter II, this measurement may also be made in mode 1.1 (1.1 SP), with a swept LO and the same filter. **Figure III-3b** shows the frequency relationships, using an IF of 500 MHz and a swept LO going from 2000 to 2500 MHz.



**Figure III-3b.** 1.5 to 2.0 GHz Swept LO Measurement

## Measurement Error Considerations

The measurement of noise figure includes the following errors:

1. Second stage errors.
2.  $T_c$  errors ( $T_c$  not equal to 290K).
3. Adapter loss.
4. ENR variation with frequency.
5. ENR uncertainty at noise source calibration points.
6. Mismatch uncertainty.
7. Instrumentation uncertainty.

The 8970A has second stage correction and allows entry of  $T_c$  for use in measurement. Loss compensation gives simple correction for adapter loss. The 8970A interpolates between the 20 calibration points of the 346B to reduce the effect of ENR variations with frequency. Therefore, errors 1, 2, 3, and 4 can be eliminated except for the uncertainties involved in the corrections. The remaining three errors can only be minimized through good instrument design and good measurement practice. The root-sum-of-the-squares ENR uncertainty is typically  $\pm 0.1$  dB at the noise source calibration frequencies. Mismatch uncertainty is usually the greatest single source of error. It is a function of the DUT parameters (noise figure and SWR). It is also a function of the noise source output SWR for the noise source on as well as off. Common values of mismatch uncertainty range from  $\pm 0.1$  to  $\pm 0.4$  dB, with 0.15 dB being average. The 8970A instrumentation uncertainty for noise figure measurement is  $\pm 0.1$  dB.

In *Table III-1* are uncertainty values for two typical measurements, one measuring an RF amplifier, and one measuring an X band microwave amplifier. Total uncertainty is calculated using the root-sum-of-the-squares (RSS) method.

The (RSS) method is a realistic method of combining uncertainties that is gaining in popularity. The RSS uncer-

tainty is based on the fact that most of the errors in power measurements, although systematic and not random, are independent of each other. Since they are independent, they are random with respect to each other and combine like random variables. The RSS method of combining random variables is justified by statistical considerations that are beyond the scope of this note. The calculation is made by squaring the individual uncertainties, summing them, and then taking the square root. The total RSS uncertainty is usually less than half the total worst-case uncertainty.

*Table III-1. Example of Measurement Uncertainties*

	RF		Micro-wave	
Second stage correction uncertainty		0.01 dB		0.10 dB
Second stage noise figure	6 dB		10 dB	
$T_c$ correction uncertainty		0.01		0.01
ENR uncertainty		0.10		0.15
Mismatch uncertainty		0.15		0.15
Source SWR	<1.10		<1.13	
DUT SWR	<1.4 0		<1.5	
Instrumentation uncertainty		0.10		0.10
Total uncertainty (Root-sum-of-the-squares)		0.21 dB		0.25 dB

## Method Comparison

Noise figure measurements may be made with instruments other than a noise figure meter. *Table III-2* (next page) compares three methods of noise figure measurement: the 8970A, the power meter, and the spectrum analyzer. For accuracy, sensitivity, and convenience, the 8970A is the best choice. It is a product optimized for noise figure measurements. An external controller is not necessary.

*Table III-2. 8970A Compared to Other Noise Figure Measurement Methods*

	<b>8970A</b>	<b>Power Meter</b>	<b>Spectrum Analyzer</b>
<b>Measurement Accuracy Limitations</b>	Very good accuracy, usually limited by: <ul style="list-style-type: none"> <li>• ENR accuracy</li> <li>• Mismatch uncertainty</li> </ul>	Very good accuracy, usually limited by: <ul style="list-style-type: none"> <li>• ENR accuracy</li> <li>• Mismatch uncertainty</li> </ul>	Poor accuracy limited by: <ul style="list-style-type: none"> <li>• Instrumentation uncertainty</li> <li>• ENR uncertainty</li> <li>• Mismatch uncertainty</li> </ul>
<b>Estimated System Accuracy in X-Band</b>	±0.25 dB RSS	±0.25 dB RSS	±1.1 dB RSS
<b>Method of Operation</b>	Stand-alone or HP-IB	Manual or HP-IB	HP-IB only
<b>Sensitivity in 4MHz B.W.</b>	Very good >-100 dBm, doesn't need pre-amp	Fair >-50 dBm, needs pre-amp	Fair >-65 dBm, needs pre-amp
<b>Speed</b>	Good ≈0.2 to 0.3 sec/meas.	Fair ≈2 sec/meas.	Fair ≈5 sec/meas. (depends on averaging)
<b>Convenience</b>	Excellent Automatically makes all the conversions and corrections.	Good if HP-IB Needs additional components such as controller filter, pre-amp, and step attenuator	Good Needs additional components such as controller, and pre-amp
<b>General Comments</b>	Product optimized to noise figure measurements.	Special application of a general purpose product. Requires an ext. controller.	Special application of a general purpose products. Requires an ext. controller.

## Theory of Operation

The 8970 Noise Figure Meter is a microprocessor-controlled, triple conversion, tunable receiver. It turns the noise source on and off, measures noise power in a 4 MHz bandwidth tunable from 10 to 1500 MHz, and makes the calculations necessary to obtain noise figure and gain. The following discussion explains the block diagram in *Figure IV-1*.

### Input Section

A low pass filter at the input of the 8970A helps reject frequencies greater than 1550 MHz. It also filters any 2050 MHz signal (such as from an external LO) that would interfere with the signal at the first IF. The remainder of the input section consists of a switchable 20 dB broadband preamplifier, three switchable 10 dB attenuators, and a power detector. These are used to set the signal power incident on the following First Converter. RF power is detected and converted to a dc voltage by the input power detector circuit. This voltage is used by the Controller to set the overall gain of the input assembly through the switch control lines. The net gain of the Input Section ranges from -30 dB to +20 dB in 10 dB steps. The broadband RF power output (10 to 1500 MHz) to the First Converter is kept as high as possible but less than -20 dBm with the noise source on.

### First Converter

The First Converter up converts the 10 to 1500 MHz input noise power to a fixed 2050 MHz intermediate frequency (IF). The first LO is a YIG oscillator covering the range of 2060 to 3550 MHz. The 1550 MHz low-pass filter before the mixer rejects the image response (4110 to 5600 MHz), allowing only the desired sideband to pass. The 2050 MHz first IF output signal passes through a 5000 MHz low pass filter (to reduce harmonic mixing products) and an isolator to the Second Converter.

### Second Converter

The 2050 MHz IF signal enters the Second Converter through a band pass filter consisting of three circular slugs-tuned cavity resonators. The cavities provide high Q for good selectivity at 2050 MHz. A 1750 MHz LO converts the 2050 MHz IF to 300 MHz. The 300 MHz second IF signal is coupled through a low pass matching filter to the 300 MHz IF Section.

### 300 MHz IF Section

The 300 MHz IF Section amplifies, filters, and down converts the 300 MHz IF, mixing with a 280 MHz LO to get the 20 MHz third IF. Input signals are first amplified by a

300 MHz IF amplifier with a gain of about 20 dB. The signal then passes through a 300 MHz bandpass filter which filters out the first LO feed-through and selects the proper sideband for down conversion to 20 MHz. The filtered output then enters the third converter where it is mixed with the 280 MHz LO signal from a crystal oscillator. The 20 MHz output is passed to the 20 MHz IF Section. The signal gain through the 300 MHz IF Section is approximately 10 dB.

### 20 MHz IF Section

The 20 MHz IF Section is a series of filters, amplifiers, and attenuators which determine the bandwidth and adjust the power level of the 20 MHz (center frequency) noise signal sent to the Noise Power Detector. The nominal bandwidth of the complete 20 MHz IF Section is 4 MHz. The gain of this section is set by the Controller in 5 dB steps from +40 dB to +75 dB by means of control lines to three attenuators (5, 10 and 20 dB). An extra detector circuit is included in this IF section to detect first LO feed-through during a frequency calibration operation, when the LO is tuned near 2050 MHz.

The first elements in the 20 MHz IF Section are two 20 MHz bandpass filters on either side of a 22 dB amplifier. These two filters plus a third filter in the noise power detector combine to form an 8-pole bandpass filter with a nominal 4 MHz 3 dB bandwidth. These filters also reject the first LO feed-through.

For frequency calibration, the Controller tunes the first LO to 2050 MHz. This feedthrough is at the first IF frequency and is not filtered out by any of the IF sections. The Controller adjusts the first LO frequency to obtain maximum signal from the frequency calibration detector during the calibration routine. This insures that the first LO feed-through (converted to 300 MHz, then 20 MHz) is at the center of the 20 MHz IF passband at the end of the routine. This is equivalent to tuning the instrument to zero frequency to set the frequency reference. The frequency calibration detector is isolated from the 20 MHz IF circuit by a buffer amplifier. A filter (100 kHz) provides a narrow bandwidth to set the frequency reference within  $\pm 100$  kHz. The Controller performs this frequency calibration automatically at defined intervals unless overridden by a special function.

The remainder of the 20 MHz IF Section consists of the 20, 10, and 5 dB attenuators, each preceded and followed by an amplifier. These amplifiers provide gain and have the input and output impedances required by the attenuators. The output of the last amplifier is passed to the noise power detector.

## Noise Power Detector

The Noise Power Detector includes the third 20 MHz band pass filter, the detector itself, and auxiliary outputs for IF and detector voltages. The detected dc voltages are passed to an analog-to-digital converter so the microprocessor in the Controller can process the data for display.

## Controller

The Controller provides the timing, calculation, and control for the instrument. It provides timing for the noise source

drive, controls the YIG local oscillator driver, and controls switches for the RF and IF gain/attenuation as needed. The Controller accesses the memory, both ROM (26k bytes) and RAM (4k bytes) and processes the digitized noise power detector output for display. The Controller is also the interface for the oscilloscope digital storage and X-Y recorder analog outputs, the front panel display, the keyboard, and the Hewlett-Packard Interface Bus (HP-IB). HP-IB allows control by the 8970A of an external LO as well as control of the 8970A by an external controller.

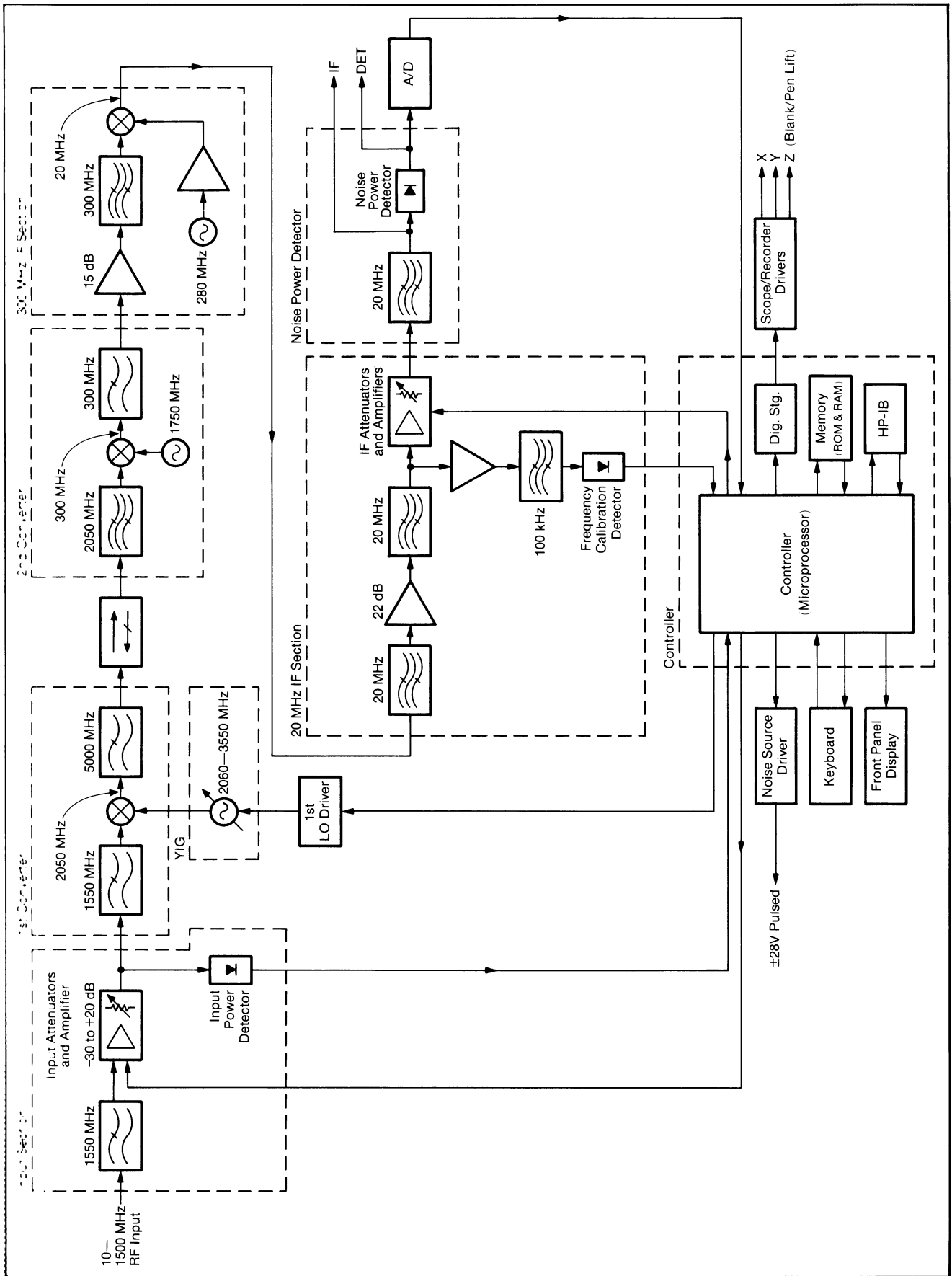


Figure IV-1. 8970A Block Diagram

## Front Panel and Special Function Summary

The purpose of this chapter is to provide a summary of front panel function and special function operation to supplement the material provided in Chapter II. More detailed information is available in the 8970A Operating and Service Manual.

### Front Panel Operation Entry Protocol

The entry protocol for front panel functions is generally in the following order:

1. A prefix (such as FREQUENCY),
2. One or more digits of data, which may or may not include a decimal or minus sign, and
3. the ENTER key, which is the only suffix key.

There are some exceptions which will be noted as they are encountered. See *Figure II-1* in Chapter II for a reproduction of the front panel.

LOCAL returns the 8970A to local front panel control from HP-IB control unless Local Lockout has previously been sent over HP-IB. LOCAL turns the REMOTE annunciator off but leaves the TALK or LISTEN lights on if they were on before. Otherwise, the state of the 8970A remains unchanged.

PRESET places the 8970A in a known standard state. It sets all standard functions to their default values except the ENR table, the HP-IB addresses, and the external LO commands. It resets nearly all special functions to their default values. It does not, however, erase the data stored by pressing CALIBRATE nor the front panel settings stored using the STORE key (see Pullout Card 1 for details).

### ENR Entry Key

ENR is used to enter the the table of ENR vs frequency for the noise source, using the left and center display windows. The ENR table is factory set to 15.2 dB at each frequency. The list of frequencies initially stored in the table corresponds to those for which the 346B Noise Source is calibrated. Pressing the appropriate digit keys followed by ENTER changes the table entry for which the annunciator is flashing (MHz or dB). Pressing ENTER with no preceding digits leaves that table value unchanged. Twenty-seven frequency/ENR pairs are allowed. Frequencies must be in ascending order because the 8970A considers a decreasing

frequency value as the end of the table. The SNR part of the Special Functions section in this chapter has further information.

### Sweep Frequency Keys

These keys set and select the start, stop, and step size frequencies for calibration and swept measurements, and execute either automatically repeated or single sweeps. The START FREQ or STOP FREQ keys, when pressed, display the start or stop frequency of the sweep in the left window. They also tune to the start or stop frequency, measuring continuously at that selected frequency. The start or stop frequency may be changed by first pressing either key as a prefix, then entering the digits, and pressing ENTER. If the stop frequency is less than the start frequency, the measurement frequency will sweep downward. Pressing either button will stop the sweep. All frequency entries are accepted only in MHz; decimal fractions are rounded to the nearest MHz.


STEP SIZE, when pressed, displays and enables changing of the step size used during sweep. It displays the step size only as long as the key is held down.




The AUTO key, when pressed, starts a sweep at the current frequency, continuing the sweep until terminated. The AUTO key is a toggle key; it will stop the sweep when pressed a second time. Most other front panel keys also stop the sweep. Exceptions are LOCAL, DECREASE, INCREASE, SP, NOISE FIGURE, and NOISE FIGURE AND GAIN. To start a sweep at the start frequency, press START FREQ before pressing AUTO.

SINGLE operates like AUTO, except that it initiates a single sweep beginning at the start frequency and stopping at the stop frequency.

### Fixed Frequency Keys

These keys control the fixed frequency operation. Pressing FREQUENCY displays the current measurement frequency. It is also a prefix key allowing a new fixed frequency to be entered by pressing number digits, then ENTER. This key may also act as a "clear entry" key when an error is made during entry of some other parameter. If no other prefix key has been pressed, any digits entered followed by ENTER will be interpreted as if the FREQUENCY key were always the prefix.

FREQ INCR, when pressed, displays the frequency increment in the left display only as long as the key is held down. The frequency increment is used by the  and

 keys to increment and decrement the frequency setting. If either  or  is pressed rapidly in succession, the frequency display will update everytime the key is pressed, but the measurement display may be delayed (— — — — in the display), especially if SMOOTHING is being used. If either key is held down, after a short pause the steps will come in succession, with one reading being made at each step. Decrementing is slower than incrementing because hysteresis is removed from the YIG oscillator magnet in the 8970A at each step for decreasing frequency. This is not necessary for increasing frequency.

## Measurement Keys

**CALIBRATE**, when pressed, measures the measurement system noise figure and sets a reference for gain measurement to be used in second stage correction. The noise figure and gain reference data are stored in volatile memory and remain there until the machine is turned off or calibrated again. Calibration is performed by first connecting the noise source to the input of the measurement system and pressing **CALIBRATE**. Calibration is usually done in a swept manner; that is, from the start frequency to the stop frequency in the step size set from the front panel. (In mode 1.3, however, the input frequency to the measurement system does not change; there is only one calibration frequency.) The maximum number of calibration frequencies is 81.

Calibration is normally performed at the three most sensitive input RF attenuator settings; three sweeps are required to calibrate. When calibrated, the 8970A automatically interpolates between calibrated points when swept or fixed frequency measurements are made at other frequencies. Thus the calibration need not be done at every measurement frequency in the range. The 8970A will not extrapolate the calibration points, however, so corrected measurements cannot be made outside the start-to-stop frequency range of calibration. Smoothing may be used during calibration to reduce the effects of jitter in the stored second stage calibration values and therefore can improve accuracy. When calibration is finished, the small LED near the **CALIBRATE** key goes out and the 8970A returns to the measurement it was making when the **CALIBRATE** key was pressed. **CALIBRATE** is a toggle key, and calibration may be aborted by pressing the key a second time. While **CALIBRATE** is being performed, most front panel keys are disabled. **PRESET** also aborts calibration.

### NOTE

*If E27 is displayed following calibration, it means that an overflow occurred at one or more calibration frequencies. This does not mean the calibration is invalid. Continue with the measurement. At any measurement frequency where*

*corrected values are displayed, the calibration is valid. If E22 occurs, change to a different set of attenuator settings using 32.N SP.*

**NOISE FIGURE** causes the 8970A to measure noise figure without second stage correction. However, the 8970A still corrects for ENR vs frequency variations and uses the current value for  $T_c$  (either the default value of 296.5K or an entered value) rather than 290K. The noise figure measured is the combined noise figure of the DUT and the measurement system, including cables, connectors, adapters, etc. **NOISE FIGURE** is also a "clear entry" key for functions such as ENR table entry and 8.N SP without returning to frequency display. Measurement is continuous, and noise figure units are in dB, although other units are available using 10.N SP.

**NOISE FIGURE AND GAIN**, when pressed, measures noise figure and gain and corrects for the second stage noise figure. Gain units are always in dB. Calibration must be done before **NOISE FIGURE AND GAIN** is pressed or an error will appear in the display (E20 to E25). See Pullout Card 2 for more information on error codes.

Smoothing is varied by using the **DECREASE** and **INCREASE** keys, which vary the amount of digital averaging or smoothing to reduce random jitter in the display. This jitter is necessarily a part of noise measurement. The numbers that are sent to the gain and noise figure displays are each averaged before display. For fixed frequency measurement, exponential averaging is used as follows

$$\text{New Display} = \frac{\text{New measurement}}{n} - \frac{\text{Previous display} \times (n-1)}{n}$$

where  $n$  is the smoothing factor. When smoothing is being used at a fixed frequency, the settling time may be reduced for large measurement value changes (such as when disconnecting one DUT and connecting another) by pressing **NOISE FIGURE** (or any other key). A swept frequency measurement takes an arithmetic average of  $n$  readings and displays that average.

The allowed values of  $n$  can range from 1 to 512 in steps that are multiples of two. The default value is 1. **INCREASE** doubles  $n$  each time the key is pressed. **DECREASE** halves  $n$  each time the key is pressed. The current smoothing factor is displayed momentarily each time **INCREASE** or **DECREASE** is pressed. Holding either key down keeps the smoothing factor in the display. Arithmetic smoothing may be chosen for fixed frequency measurements by using 13.1 SP.

## Storage Location Keys






**STORE** and **RECALL** are used to store and recall up to ten front panel settings and instrument states, including



special functions and some other data. The smoothing factor is not stored. To use storage location 3, for example, the operations are STORE 3 and RECALL 3. All stored settings are kept in non-volatile memory and remain stored even when the 8970A is turned off.

For a list of the settings and instrument states stored, see **Table V-1**. Important settings or states *not* stored are AUTO and SINGLE sweep, the measurement keys (NOISE FIGURE and GAIN and NOISE FIGURE), and the smoothing factor. The sweep stops if any front panel key is pressed except the smoothing keys. The measurement keys and smoothing factor and all other settings not saved remain at the state they were in before RECALL was pressed. Note that the only external LO commands saved are the auxiliary commands. (For more details, see Automatic Control of an External LO in this chapter.)

**Table V-1.** 8970A Settings Saved during STORE and RECALL

FRONT PANEL	
	Start Frequency
	Stop Frequency
	Step Size
	Frequency
	Frequency Increment
SPECIAL FUNCTIONS	
1.N SP	Measurement Mode Selection
2.N SP	Sideband Frequency Offset
3.N SP	Enter LO and IF Frequencies
5.N SP	ENR and $T_{hot}$ Settings (except 5.2 and 5.5)
6.0 SP	$T_{cold}$ Setting
8.N SP	Enter Oscilloscope Units
9.N SP	Power Measurements
10.N SP	Noise Figure Display Units
14.N SP	Manual Measurement Functions
42.0 SP	External LO Auxiliary Commands

SEQ, each time it is pressed, steps the 8970A through the settings saved using STORE. The stepping order is entered using 35.2 SP. The sequence may have nine steps, any combination of storage locations 1 through 9. The default is 1 through 9 in order. Any zeros are skipped, so storage location 0 may not be part of a sequence. When all 9 locations have been used (or skipped in the case of zero), pressing SEQ begins the sequence again starting at location 1. Each time SEQ is pressed the current storage location number is displayed momentarily. 35.N SP discusses sequencing further.

## Special Functions

While simple front panel control of the 8970A satisfies many noise figure measurement needs, some applications need more measurement capability. For this purpose about 150 special functions are easily selected using a numerical code and the special function key. The numerical code usually takes the form NN.N followed by the SPECIAL FUNCTION (SP) key. Each N may be any digit, 0 through 9, and leading zeros and trailing decimal points and zeros may be omitted. There are three function types:

1. Execute or Select functions act immediately. (For example, 1.2 SP selects mode 1.2).
2. Display and Enter functions display numerical variables which may be changed by keying digits followed by ENTER. (For example, 3 SP 40 ENTER sets the IF to 40 MHz).
3. Display functions which simply display but neither execute nor allow entry. (For example, 5.2 SP displays the current ENR in dB).

For a brief listing of the user-oriented special functions, see Card 1 of the 8970A pullout cards. The cards are also reproduced inside the back cover of this note. The following brief descriptions of the special functions are divided into categories. For further detail on these special functions and information on Special Functions 60 through 90, refer to the Operating and Service Manual.

### Initialize Special Functions (0 SP)

0 (zero) SP clears most special functions (to states shown in bold green on Pullout Card 1), but does not affect any data stored in the 8970A (green default values are not entered).

### Measurement Modes (1.N SP)

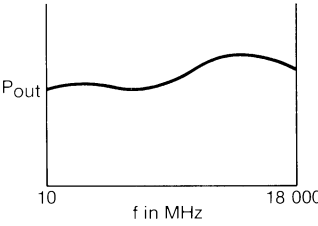
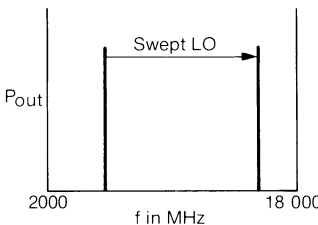
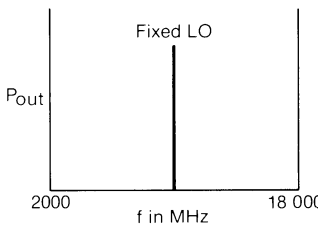
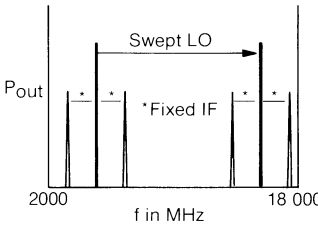
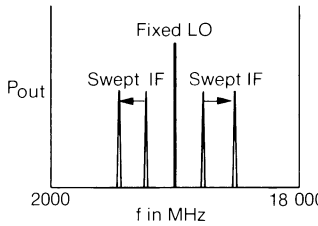
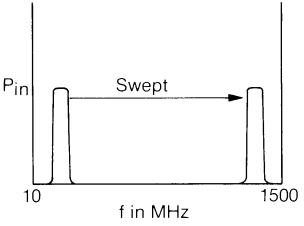
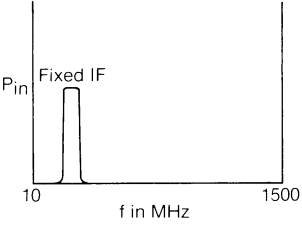
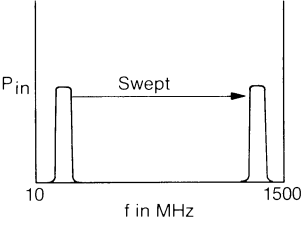
There are five measurement modes available using the 8970A. The setups are illustrated on Pullout Card 3 inside the back cover. These may be grouped in three groups. The first group is a single mode, mode 1.0 (1.0 SP). This is the 8970A stand-alone mode with no external mixer or LO, for frequencies in the range of 10 to 1500 MHz. The second group consists of mode 1.1 (1.1 SP) and mode 1.3 (1.3 SP). Both of these modes use down conversion into the range of the 8970A. Both have a variable frequency external LO and a fixed IF. Mode 1.1 measures a DUT with no frequency conversion (an example is an amplifier or transistor) while mode 1.3 measures a DUT with frequency conversion (such as a mixer or receiver). The third group, mode 1.2 (1.2 SP) and mode 1.4 (1.4 SP) uses a fixed frequency external LO and a variable IF. Mode 1.2 is for measurements with frequency conversion in the system but not in the DUT, and mode 1.4 is for measurements with frequency conversion in the DUT. Mode 1.2 must be a single sideband

measurement; either 2.1 SP or 2.2 SP must be selected and external filtering of the undesired sideband provided. Unless 2.1 or 2.2 SP is selected, the display will show error message E34 (Double sideband not allowed). An example of swept IF microwave amplifier measurement is in chapter II.

Pullout Card 3 illustrates the measurement and calibration connections for the five modes. Pullout Card 3 also lists the minimum requirements for modes 1.1 and 1.3 when the 8970A is acting as controller over HP-IB.

**Figure V-1** may be helpful in understanding what happens to the signals in each of the modes. Each column shows one of the 3 groups of modes, and each row shows the signals at a point in the measurement system. The LO is assumed to be an 8672A. The signal points are

- the output of a 346B Noise Source,
- the output of an 8672A LO,
- the frequencies existing at the mixer, and
- the 8970A input.

Mode \ Signal	1.0 RF	1.1 & 1.3 Swept LO Fixed IF	1.2 & 1.4 Fixed LO Swept IF
a. 346B Noise Source	Same		Same
b. 8672A Local Oscillator	Not applicable		
c. Mixer	Not applicable		
d. 8970A Input			

**Figure V-1.** 8970A Measurement Modes Signal Descriptions

In *Figure V-1a*, the noise source output is the same for all modes, varying in its power level (ENR) from 10 to 18000 MHz.

In *Figure V-1b*, there is no LO for mode 1.0. However, for modes 1.1 and 1.3, the LO may be swept over any interval within the 2 to 18 GHz range of the 8672A. For modes 1.2 and 1.4 the LO frequency is fixed at some point in the 8672A range.

*Figure V-1c*, the mixer, does not apply to mode 1.0. However, for modes 1.1 and 1.3, there are two sidebands each separated from the LO by the fixed IF. Sweeping the LO sweeps both the upper and lower sidebands (along with the LO) in the same direction within the 2 to 18 GHz range. The arrow indicates increasing LO frequency. The situation is different for modes 1.2 and 1.4. Here the LO is fixed while the sidebands sweep away from the LO in opposite directions. The arrows indicate increasing the 8970A input frequency.

*Figure V-1d* shows the position and movement of the 4 MHz bandwidth of the 8970A. In mode 1.0 a swept measurement sweeps the 4 MHz bandwidth over frequencies within the 10 to 1500 MHz input range. For modes 1.1 and 1.3, the IF is fixed while the LO may be swept. In modes 1.2 and 1.4, as in mode 1.0, the 4 MHz bandwidth may be swept within the 10 to 1500 MHz range. In modes 1.1, 1.3, and 1.4, because of the frequency conversion, either the upper, lower or both sidebands will be accepted by the 8970A unless filtered or rejected. For mode 1.2, however, a double side band sweeping measurement would be meaningless, so only single sideband measurement is allowed. The double sideband measurement is meaningless because the measurement frequency, being the average frequency, is the LO frequency; it does not change when the IF changes.

*Table V-2* indicates the frequency that will be displayed in the left window of the 8970A depending upon the sideband chosen (2.N SP). Please note that 1.2 and mode 1.4 are different. Mode 1.2 displays the microwave measurement frequency, and mode 1.4 displays the IF.

## Sideband Selection (2.N SP)

Double sideband vs single sideband measurement becomes a consideration in modes 1.1, 1.3 and 1.4. Mode 1.2 must be single sideband. The purpose of 8970A Sideband Selection (2.N SP) is to allow the 8970A to properly control (offset) the local oscillator frequency and to tune its own frequency properly. That is all 2.N SP accomplishes — it does not change the algorithms applied for calculating noise figure or correcting for second stage contribution. Any filtering necessary to reject an unwanted sideband must be accomplished outside the 8970A.

**Table V-2. Frequency Display for Measurement Modes**

Measurement Mode					
Selected Sideband	1.0	1.1	1.2	1.3	1.4
Double Sideband	$f_{\text{measured}}$	$f_{\text{LO}}$	not allowed	$f_{\text{LO}}$	IF
Lower Single Sideband (2.1SP)	$f_{\text{measured}}$	$f_{\text{LO}} - \text{IF}$	$f_{\text{LO}} - \text{IF}$	$f_{\text{LO}} - \text{IF}$	IF
Upper Single Sideband (2.2SP)	$f_{\text{measured}}$	$f_{\text{LO}} + \text{IF}$	$f_{\text{LO}} + \text{IF}$	$f_{\text{LO}} + \text{IF}$	IF

In mode 1.0, there is no need to be concerned about 2.N SP because the 8970A is designed to have only one response — a 4 MHz band about the frequency shown in the left display.

2.0 SP selects double sideband measurement. The measured result is a sort of average of the noise figure at two frequencies, the LO plus and minus the IF. For 2.1 SP the 8970A offsets the measurement frequency below the LO by the amount of the IF, and uses the noise source ENR value at the measurement frequency. For 2.2 SP the 8970A offsets the measurement frequency above the LO by the amount of the IF, and uses the noise source ENR values stored in memory at the measurement frequency.

Two concerns arise when making a double sideband measurement that has frequency conversion in the DUT: the gain will be overstated and the noise figure may be in error unless special steps are taken. A double sideband noise figure measurement result is not the proper one to make whenever the final application of the device allows

1. desired signals in only one sideband and
2. input noise in both sidebands.

Since input noise is processed from both sidebands, but signals from only one, the device is processing twice as much input noise as it has to. Its ability to process low-level signals is reduced. The noise figure defined by the IEEE is higher than the measured value because of the spurious response to input noise in the unused sideband. This situation often occurs with mixers and receivers that do not have some way of rejecting noise in the undesired sideband. Note that this penalty for a spurious response was not a part of the straight line discussion of devices in Chapter 1.

In the case of **gain**, the 8970A solves the following equation, by calculating the denominator during calibration and the numerator during measurement.

$$G'_{\text{dut}} = \frac{k B_m G_s G_{\text{dut}}}{k B_c G_s}$$

In this equation  $G'_{\text{dut}}$  is the displayed gain of the DUT.  $G_{\text{dut}}$  is the actual DUT gain.  $G_s$  is the measurement system gain,  $k$  is Boltzmann's constant,  $B_m$  is the effective measurement bandwidth, and  $B_c$  is the effective calibration bandwidth.

If the 8970A makes a double sideband measurement, but only calibrates in a single sideband (calibration in modes 1.3 and 1.4 is single sideband), the  $B_m$  equals  $2B_c$ , and the displayed gain is overstated by 3 dB (assuming the DUT gain is the same in each sideband). Filtering the unwanted sideband gives the correct gain. The correct gain is approximated by subtracting 3 dB from the double sideband measurement result.

In the case of **noise figure**, a similar situation holds true. The 8970A actually measures  $T_e$ , the effective input noise temperature, and always calculates the displayed noise figure from the equation

$$F' = (1 + T_e/290)$$

But the IEEE defines noise figure as

$$F = \frac{k \Sigma(BG)}{k B_s G_s} (1 + T_e/290)$$

The summation of  $BG$  in the numerator refers to the bandwidth and gain for each accepted sideband or response of the DUT, but the  $B_s$  and  $G_s$  in the denominator refer only to the bandwidth and gain for the sidebands that will have legitimate signal.  $B_s$  is the bandwidth in the sideband in which the desired (measured) signal appears.  $G_s$  is the gain for the desired (measured) signal, and  $T_e$  is the effective input noise temperature.

Assume that the gain of the DUT and the measurement bandwidth are the same at both sidebands. In systems with signals in both sidebands,  $B_s G_s$  and  $\Sigma(BG)$  are equal; both the numerator and denominator cover both sidebands.  $F' = F$  and the 8970A displays the proper noise figure,  $1 + T_e/290$ .

If the DUT passes both sidebands but signal occurs in only one,  $B_s G_s$  is half  $\Sigma(BG)$ . The 8970A displays  $F'$  above, but the proper answer is approximately  $2(1 + T_e/290)$  or 3 dB higher. The 8970A has no way of knowing

that in the final system signal will occur in only one sideband or that half of the DUT response is spurious and not intended. Filtering must be used to reject the unwanted sideband and give the right answer.

If the DUT passes only one sideband, then the numerator and denominator include only one response and the 8970A gives the correct answer.

Any band-limiting filters inserted in the measurement system should be just before the mixer (whether or not the mixer is the DUT), to filter out any noise which may fall in the undesired sideband.

## IF and LO Frequency Entry (3.N SP)

3.0 SP displays and allows entry of the fixed IF for modes 1.1 and 1.3. It is ignored when the 8970A is operated in modes 1.0, 1.2, and 1.4.

3.1 SP displays and allows entry of the fixed LO frequency for use in modes 1.2 and 1.4 and is ignored when using modes 1.0, 1.1, and 1.3.

## Automatic Control of an External LO (4.N and 40.N to 43.N SP)

The 8970A will control the 8672A Synthesized Signal Generator and 8350A Sweep Oscillator, as well as some other LOs that can be controlled over HP-IB. The LO must be able to accept frequency commands of the form ppnnnnnss, where pp is a two character prefix (such as FR or CW), nnnnn is the frequency in MHz (to 60000 MHz), and ss is a two character suffix (such as MZ). The 8970A can also send up to 10 other auxiliary command characters that can perform tasks like setting LO output level and turning off modulation. Both of these functions are discussed later in this section under External LO Programs.

There are two families of special function associated with control of an external local oscillator. The first is 4.N SP and the second is 40.0 to 42.4 SP. 4.0 SP selects the normal talker-listener condition. 4.1 SP selects the controller function that enables the 8970A to control frequency and level of an external local oscillator. 40.N, 41.N, and 42.N SP are used with 4.1 SP to set the messages needed by each kind of LO.

4.2 SP selects the talk-only function, which causes the 8970A to continuously output data to a listen-only logging device, such as an HP-IB printer. The 4.0 and 4.2 SP functions use 43.N SP to select the output data format. None of the 4.N functions is available over HP-IB. Both 4.1 and 4.2 SP light the TALK light. Only one of these functions (4.1 or 4.2 SP) may be used at a time.

Table V-3. ASCII to Decimal Conversion Table

ASCII	Binary	Octal	Decimal	Hexa-decimal
NUL	00 000 000	000	0	00
SOH	00 000 001	001	1	01
STX	00 000 010	002	2	02
ETX	00 000 011	003	3	03
EOT	00 000 100	004	4	04
ENQ	00 000 101	005	5	05
ACK	00 000 110	006	6	06
BEL	00 000 111	007	7	07
BS	00 001 000	010	8	08
HT	00 001 001	011	9	09
LF	00 001 010	012	10	0A
VT	00 001 011	013	11	0B
FF	00 001 100	014	12	0C
CR	00 001 101	015	13	0D
SO	00 001 110	016	14	0E
SI	00 001 111	017	15	0F
DLE	00 010 000	020	16	10
DC1	00 010 001	021	17	11
DC2	00 010 010	022	18	12
DC3	00 010 011	023	19	13
DC4	00 010 100	024	20	14
NAK	00 010 101	025	21	15
SYN	00 010 110	026	22	16
ETB	00 010 111	027	23	17
CAN	00 011 000	030	24	18
EM	00 011 001	031	25	19
SUB	00 011 010	032	26	1A
ESC	00 011 011	033	27	1B
FS	00 011 100	034	28	1C
GS	00 011 101	035	29	1D
RS	00 011 110	036	30	1E
US	00 011 111	037	31	1F
SP	00 100 000	040	32	20
!	00 100 001	041	33	21
"	00 100 010	042	34	22
#	00 100 011	043	35	23
\$	00 100 100	044	36	24
%	00 100 101	045	37	25
&	00 100 110	046	38	26
'	00 100 111	047	39	27
(	00 101 000	050	40	28
)	00 101 001	051	41	29
*	00 101 010	052	42	2A
+	00 101 011	053	43	2B
,	00 101 100	054	44	2C
-	00 101 101	055	45	2D
.	00 101 110	056	46	2E
/	00 101 111	057	47	2F
0	00 110 000	060	48	30
1	00 110 001	061	49	31
2	00 110 010	062	50	32
3	00 110 011	063	51	33
4	00 110 100	064	52	34
5	00 110 101	065	53	35
6	00 110 110	066	54	36
7	00 110 111	067	55	37
8	00 111 000	070	56	38
9	00 111 001	071	57	39
:	00 111 010	072	58	3A
;	00 111 011	073	59	3B
<	00 111 100	074	60	3C
=	00 111 101	075	61	3D
>	00 111 110	076	62	3E
?	00 111 111	077	63	3F

ASCII	Binary	Octal	Decimal	Hexa-decimal
@	01 000 000	100	64	40
A	01 000 001	101	65	41
B	01 000 010	102	66	42
C	01 000 011	103	67	43
D	01 000 100	104	68	44
E	01 000 101	105	69	45
F	01 000 110	106	70	46
G	01 000 111	107	71	47
H	01 001 000	110	72	48
I	01 001 001	111	73	49
J	01 001 010	112	74	4A
K	01 001 011	113	75	4B
L	01 001 100	114	76	4C
M	01 001 101	115	77	4D
N	01 001 110	116	78	4E
O	01 001 111	117	79	4F
P	01 010 000	120	80	50
Q	01 010 001	121	81	51
R	01 010 010	122	82	52
S	01 010 011	123	83	53
T	01 010 100	124	84	54
U	01 010 101	125	85	55
V	01 010 110	126	86	56
W	01 010 111	127	87	57
X	01 011 000	130	88	58
Y	01 011 001	131	89	59
Z	01 011 010	132	90	5A
[	01 011 011	133	91	5B
\	01 011 100	134	92	5C
]	01 011 101	135	93	5D
^	01 011 110	136	94	5E
_	01 011 111	137	95	5F
`	01 100 000	140	96	60
a	01 100 001	141	97	61
b	01 100 010	142	98	62
c	01 100 011	143	99	63
d	01 100 100	144	100	64
e	01 100 101	145	101	65
f	01 100 110	146	102	66
g	01 100 111	147	103	67
h	01 101 000	150	104	68
i	01 101 001	151	105	69
j	01 101 010	152	106	6A
k	01 101 011	153	107	6B
l	01 101 100	154	108	6C
m	01 101 101	155	109	6D
n	01 101 110	156	110	6E
o	01 101 111	157	111	6F
p	01 110 000	160	112	70
q	01 110 001	161	113	71
r	01 110 010	162	114	72
s	01 110 011	163	115	73
t	01 110 100	164	116	74
u	01 110 101	165	117	75
v	01 110 110	166	118	76
w	01 110 111	167	119	77
x	01 111 000	170	120	78
y	01 111 001	171	121	79
z	01 111 010	172	122	7A
{	01 111 011	173	123	7B
:	01 111 100	174	124	7C
}	01 111 101	175	125	7D
~	01 111 110	176	126	7E
DEL	01 111 111	177	127	7F

Note that an external controller cannot be used when the 8970A acts as a controller. The 8970A will neither pass nor accept control over HP-IB.

**Addresses (40.N SP).** 40.0 displays and allows entry of the HP-IB address of the 8970A in decimal form. The address initially set at the factory is 8. This can only be changed from the front panel; it cannot be set over HP-IB. 40.1 displays and allows entry of the HP-IB address of the external LO to be controlled. The address set initially at the factory is 19. This function is available over HP-IB. Neither 40.0 nor 40.1 SP is affected by PRESET, 0 SP, or LINE.

**External LO programs (41.N and 42.SP).** 41.0 SP selects a predefined program for the 8350A Sweep Oscillator. This program may be changed using 42.N SP. 41.2 selects the predefined program for the 8672A, and this program may also be changed using 42.N SP. 42.0 SP displays and allows entry of ten auxiliary characters to be sent to the external LO. These are decimal representations of ASCII characters, and are sent each time a new frequency is sent. They are primarily useful for controlling the output level and removing any modulation of the external LO. Entry is performed as in ENR entry: any number may be changed by pressing digits followed by ENTER. If no change is desired, simply press ENTER to display the next number. *Table V-3* is a decimal/ASCII conversion table. *Table V-4* summarizes the program data.

There are no preprogrammed auxiliary commands for the 8350A because the 8350A main frame misinterprets output level commands when using some of the 8620 plug-ins accommodated by the 8350A. The appropriate decimal representations of ASCII characters must be entered by the user depending on his 8350A configuration. When the correct program is entered it is stored in non-volatile memory. The 8672A auxiliary commands are defined in *Table V-4*.

If a program other than 41 or 41.2 SP is desired, select one of these two programs (for a known starting point). Then alter it as desired. All program elements (42 through 42.4 SP) will be retained. This new program will not be lost by power-off, 0 SP, or PRESET but will be reset to the default any time 41 or 41.2 SP is keyed. The auxiliary commands alone (42 SP) may be saved in a storage location (by STORE) available through RECALL. Then they will not be affected by 41 or 41.2 SP.

#### NOTE

*The new 2 to 26 GHz 8673A Synthesized Signal Generator was anticipated for the 8970A, and a suitable program may be selected using 41.3 SP. For more information consult the 8673A Operating and Service Manual. The 8671A Microwave Frequency Synthesizer will accept the 8672A program contained in 41.2 SP.*

42.1 SP displays and allows entry of the two prefix and two suffix characters used to send frequencies to the external LO. (See *Table V-4*). Five frequency digits are sent after the first two characters each time frequency is changed. The frequency digits are always in MHz. For example, for the 8350A the decimal representations of CW and MZ are sent as the prefix and suffix. These are 67, 87, 77, and 90. For the 8672A, codes 0 and 255 are not sent to the LO. 0 is ignored. 255 tells the 8970 to "send leading zeros". Leading zeros are not normally sent to the LO, but are required by the 8672A.

42.2 SP displays and allows entry of the required settling time of the external LO in milliseconds. This is the time the 8970A will wait after changing the external LO frequency before starting a measurement. When sweeping with AUTO the 8970A waits 2 times the settling time for sweep retrace from the sweep stop frequency to the start frequency.

42.3 SP and 42.4 SP display and allow entry of the minimum and maximum allowed frequencies of the external LO during controller operation (4.1 SP). An error message (E32) is displayed if entry of an LO frequency is outside this range and the 8970A is in controller mode.

**Changing LO Output Power.** To change the output power of the 8672A to +10 dBm from the preprogrammed value of +7 dBm, for example, first press 41.2 SP, then 42.0 SP and ENTER ENTER ENTER 51 ENTER. This changes the preprogrammed decimal value of the fourth character from 54 to 51, which sets the 8672A output level vernier to 0 dB. *Table V-4* has the program detail and the 8672A Operating and Service Manual has the overall command structure. A simple way to remember how to set a desired output level for the 8672A is to subtract the desired output in dBm from 61 and enter that decimal number to set the output level vernier. In this example,  $61 - 10 = 51$ , the number used. This calculation works (the 8970A sends the proper message to the 8672A) for power levels from 0 dBm to +13 dBm. However, the 8672A may not provide the higher power levels; the 8672A maximum output power level is specified at 3 dBm (8 dBm with Option 008). Typical 8672A's give several dB above the specified value.

**Output Selection (43.N SP).** 43.0 and 43.1 SP select the output format when the 8970A is asked for data. These keys are also used with 4.2 SP (the talk-only function). Using 4.2 SP, a listen-only printer will give one output line for every 8970A measurement. However, the 8970A cannot output data in talk-only mode and act as controller at the same time. 43.0 SP sends only the data in the right window, the noise data. Typically this is noise figure or an alternate noise unit such as  $T_e$  in kelvins (See 10.N SP). However, other data may be displayed and sent. 43.1 SP sends the data

Table V-4. LO Program Summary

Contents		8350 (41.0 SP)			8672A (41.2 SP) (Output 7 dBm)*			
		Description	ASCII Code	Decimal	Description	ASCII Code	Decimal	
42.0SP	Auxiliary Commands (10 Characters)	No program		0	Set output level range att. to 0 dB	K	75	
				0		0	48	
				0		Set output level vernier to -3 dB*	L	76
				0			6	54
				0		Set AM modulation to off	M	77
				0		Set FM modulation to off	N	78
				0			7	55
				0		Set alternate level control to internal, 10 dBm range**	0	79
0	3	51						
42.1SP	Prefix (2 Characters)	CW frequency	C W	67	Most significant digit is 10 GHz Send leading zeroes (used by 8672A only)	P	80	
				87			255	
	5 digits of frequency data in MHz are sent between prefix and suffix.***							
	Suffix (2 Characters)	Megahertz	M Z	77 90	Execute frequency Dummy variable	Z 0	90 48	
42.2SP		Wait time	Entry		Wait time	Entry		
			60 (ms)			20 (ms)		
42.3SP	Min. frequency		2000 (MHz)			2000 (MHz)		
42.4SP	Max. frequency		18000 (MHz)			18000 (MHz)		
<p>* To obtain other levels between zero and about +10 dBm, set output level vernier entry (54 for +7 dBm) to 61 minus the desired level. For example, +10 dBm is 60 - 10 = 51.</p> <p>** For the +10 dBm ALC range, the output level range must set to zero dBm.</p> <p>*** Auxiliary commands are actually sent <i>after</i> suffix characters. (Cannot use PRESET as auxiliary command for 8350A).</p>								

displayed in all three windows in order from left to right. Typically this is frequency, gain, and noise figure data, but may be other data. The 8970A will send whatever is displayed.

To make a measurement using the 8970A as a controller, the following minimum conditions must be met:

1. an HP-IB cable must be connected between the 8970A and the external LO,
2. the external LO control must be selected (4.1 SP),
3. the external LO address must be correct (40.1 SP), and
4. an external LO program must be selected (41.0 or 41.2 SP or a specially constructed program).

The three special functions chosen may be entered in any order, and once entered they are not altered using PRESET, 0 SP, or turning off the 8970A (LINE). The commands stored using 42.N SP are also stored in non-volatile memory and all of these remain until changed.

### Noise Source Data (5.N SP)

These special functions select and display ENR and  $T_h$  values etc. used by the 8970A and are companions to the front panel ENR button. 5.0 SP is the default function and uses the ENR calibration table entered using the front panel ENR button. Pressing the ENR key also selects the use of the ENR table in the measurement. Only dB values for ENR may be stored in the table.

5.1 SP selects the use of a single value or “spot” ENR value. Entry of a single value is performed by 5.3 or 5.4 SP (soon to be discussed). Spot value entry is convenient if a different noise source is being used for comparison purposes at a single frequency. 5.2 SP displays the ENR value being used by the 8970A at the current measurement frequency (interpolated, if necessary). 5.3 SP displays and allows entry of a single (spot) ENR value in dB and also executes the 5.1 SP (spot ENR) function. 5.4 SP displays and allows entry of a single value (spot)  $T_h$  in temperature units specified by 11.N SP (soon to be discussed). This also puts the 8970A into 5.1 SP. 5.5 SP displays and allows entry of the serial number or other identifier of the noise source (up to 5 digits) for which calibration data was entered.

### **$T_{COLD}$ (6.0 SP)**

6.0 SP displays and allows entry of  $T_{COLD}$  ( $T_C$ ) in units soon to be discussed in 11.N SP. One number is used for all frequencies. PRESET sets  $T_C$  to 296.5 K or 74° F. The active (current)  $T_C$  value is stored whenever STORE is used.

### **Temperature Units (11.N SP)**

These units are used for 5.4, 6.0, and 34.3 SP. They are not suffixes, but once selected remain in force unless changed, or unless PRESET or 0 SP is pressed. These units are not stored in STORE/RECALL registers. 11.0 SP selects kelvins, K, for  $T_h$  and  $T_C$  entries. This is the PRESET and 0 SP state. 11.1 SP selects Celsius, and 11.2 SP selects Fahrenheit. To enter a value of 80 degrees Fahrenheit, for example, the following keystrokes would be used: 11.2 SP 6 SP 80 ENTER. The formulas are

$$K = C + 273.15$$

$$F = (9/5) C + 32$$

### **Power Density Measurement (9.N SP)**

These special functions measure noise power density in dB relative to -174 dBm/Hz with the noise source on or off, either approximate or calibrated. -174 dBm is the thermal noise available from a resistor at 290K in a 1 Hz bandwidth. 9.1 SP measures noise power at the input of the 8970A with the noise source off. This measurement corrects for a typical value for the 8970A effective noise temperature and gain so that calibration is not necessary. 9.2 SP measures noise power as in mode 9.1 but the noise source is biased on. 9.3 SP measures noise power at the 8970A with the noise source off, but requires calibration to be done first (using CALIBRATE in the usual way). This measurement corrects for the measured value of the effective input noise temperature of the 8970A. 9.4 SP measures noise power as in 9.3 SP except the noise source bias is turned on. These measurements may be used to make absolute power density measurements or simply to make sure that a measurement

system is operating as expected through cables, adapters, connectors, etc. To return to normal measurement from any of the power measurement special functions, press NOISE FIGURE, NOISE FIGURE AND GAIN, or 10.N SP.

### **Displaying 8970A Measurements**

The following special functions relate to oscilloscope and recorder presentation, and to noise figure units, resolution, and smoothing. One set of functions, 7.N and 20 to 24 SP, select among various display modes using the analog output jacks on the 8970A rear panel labeled SCOPE/RECORDER. Only one these special functions may be used at a time. For oscilloscope and recorder modes, whatever is displayed in the right window is displayed or plotted. This includes, for example, power measurement (9.N SP). Noise figure is plotted in the units selected by 10.N SP and gain is plotted in dB.

**Oscilloscope (7.N SP).** The rear panel Y-axis output is time-shared on an alternate sweep basis for the noise and gain measured by the 8970A. The rear panel X axis output is proportional to frequency sweep from the start frequency to the stop frequency. The rear panel Z axis output is a blanking signal for the oscilloscope retrace. The noise, gain, and frequency signals are converted from digitally stored data to analog voltages varying from 0 to 6 volts. The oscilloscope display is refreshed at a rate greater than 250 Hz. 7 SP selects the noise figure and gain display (the right and center windows). If only noise is being measured, only noise is displayed in whatever units are in effect from 10.N SP. The gain trace is less intense than the noise figure trace, and its intensity can be adjusted by the GAIN TRACE adjustment on the 8970A rear panel. 7 SP is the PRESET and 0 SP state.

7.1 SP selects a test pattern used for adjustment of the oscilloscope position and gain controls. Once adjusted to completely fill the graticule, all adjustment of upper and lower display limits is done from the front panel of the 8970A using 8.N SP. Since the oscilloscope may drift, display the pattern and readjust the oscilloscope occasionally. 7.2 SP selects the “noise figure only” display. Noise figure alone is displayed on the oscilloscope even if noise figure and gain are both being measured. 7.3 SP selects the “gain only” oscilloscope display. If gain is not being measured, a horizontal line appears at the bottom of the screen.

**X-Y Recorder (20 to 23 SP).** The following special functions adjust an X-Y analog recorder to the 8970A and display the measurement output. The rear panel Y axis output is used for both noise figure and gain, the rear panel X axis output is proportional to frequency from the start frequency to the stop frequency, and the rear panel Z axis output is a pen-lift signal. 20 SP puts out 0 volts on both



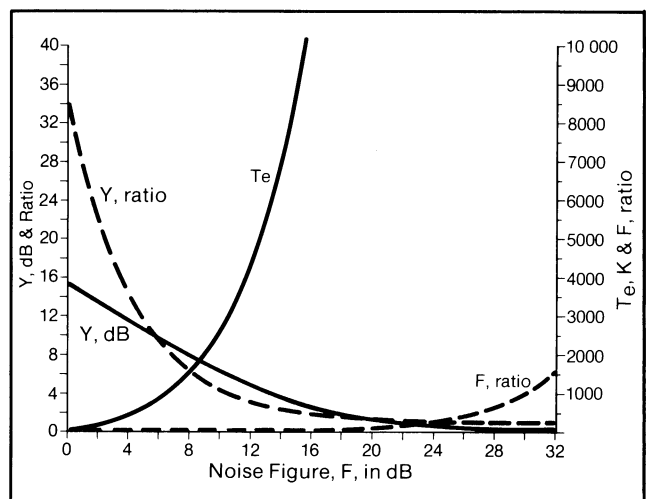
axes with the pen up. This sends the X-Y recorder to lower left so the zero (or position) controls may be adjusted. 21 SP puts out +6 volts on both axes with the pen lifted. This sends the recorder to upper right and allows the gain controls to be adjusted. 22 SP selects the “noise figure only” mode. When AUTO or SINGLE is pressed, noise is plotted. Whatever signal is in the right window is plotted vs frequency on the X-Y recorder. 23 SP selects the “gain only” mode with gain in dB. If gain is not being measured, a horizontal line is drawn at the bottom of the page. In both of the above plotting modes, a backward sweep is not allowed. For an example using the X-Y recorder, see Chapter II under Swept LO Microwave Amplifier Measurement.

**Strip-Chart Recorder (24 SP).** This mode is useful to plot noise figure or gain versus time. This output may also be used, for example, to drive a large meter for precise tuning of amplifiers or to plot noise figure versus bias current. 24 SP selects the recorder mode. The rear panel X axis terminal puts out a voltage proportional to the noise figure display. The rear panel Y axis terminal puts out a voltage proportional to gain in dB, and the rear panel Z axis terminal puts out a pen lift/blanking voltage, +6 volts, during retrace. 20 and 21 SP may still be used to set the recorder position and gain (vernier) controls.

**Display Limits (8.N SP).** The following special functions apply to both the oscilloscope and recorder modes of display. Once the oscilloscope or recorder is adjusted to the 8970A, the following special functions display and allow entry of the lower and upper measurement result limits sent to the external display devices as analog voltages 0 and 6V respectively. 8.1 SP displays and allows entry of the lower limit for noise figure, and 8.2 SP displays and allows entry of the upper limit for noise figure. The unit type (F, Y, etc.) for these two special functions is entered using 10.N SP (soon to be discussed). If a new unit type is entered, the number for the scale limit stays the same. For example, the default value for 8.2 SP is 8. If the display units are changed to effective input noise temperature,  $T_e$  in kelvins, the upper limit is now 8 kelvins. 8.3 SP displays and allows entry of the lower limit for gain in dB. 8.4 SP displays and allows entry of the upper limit for gain in dB. The default values are 0 and 8 for noise figure and 0 and 40 for gain, respectively. Whatever values being used are also stored in non-volatile memory and are not affected by 0 SP. PRESET sets them to the default values. The values are stored whenever the STORE key is used.

**Display Units (10.N SP).** Special functions of the form 10.N SP select the way noise performance is displayed in the right window and light the appropriate annunciator. 10 SP selects noise figure displayed in dB. The maximum value is 32 dB. Higher measurements cause the right window to

show two dashes. Increased smoothing may make a stable display possible, since the two dashes are displayed only if the smoothed value is greater than 32 dB. 10 SP is selected with PRESET and 0 SP. 10.1 SP selects noise figure displayed as a ratio (sometimes called noise factor) to a maximum of 9999. 10.2 SP selects Y-factor to be displayed in dB. 10.3 SP selects Y-factor to be displayed as a ratio. The Y-factor value is always uncorrected. It is a ratio of the two noise powers with the noise source on and off, and second stage correction has no meaning. 10.4 SP selects  $T_e$  to be displayed in kelvins. The maximum value is 9999 kelvins, corresponding to a noise figure of 15.5 dB. **Figure V-2** illustrates the relationship of several alternate units to noise figure in dB: Y-factor as a ratio and in dB, effective input noise temperature  $T_e$ , and noise figure as a ratio. This particular graph assumes that  $T_c$  is 290K and the ENR is 15.2 dB.



**Figure V-2.** Noise Unit Comparison

**Resolution of Displayed Data (12.N SP).** These special functions allow a reduction in resolution in both the noise figure and gain display windows. This may be useful in a production test application where less resolution may allow easier adjustment, measurement, or data recording by production personnel. 12.0 SP selects the maximum resolution for both noise figure and gain displays. 12.1 SP selects less resolution for the noise figure display. The resolution of F in dB becomes 0.1 dB instead of 0.01 dB. The maximum resolution of F as a ratio becomes 0.01 instead of 0.001. The resolution of Y in dB becomes 0.1 instead of 0.01 dB. The maximum resolution of Y as a ratio becomes 0.01 instead of 0.001. The maximum resolution of  $T_e$  becomes 1 kelvin instead of 0.1 kelvin. 12.2 SP selects less resolution for the gain display; the maximum resolution for gain becomes 0.1 dB instead of 0.01 dB.

**NOTE**

*The resolution of data sent over HP-IB by the 8970A is always one digit more than the display.*

## Smoothing (13.2 SP)

The DECREASE and INCREASE keys on the front panel decrease and increase smoothing or averaging. An example in Chapter II under Swept LO Microwave Amplifier Measurement used and discussed smoothing. The 4 MHz bandwidth of the 8970A and the measurement timing were chosen to allow approximately 0.1 dB peak-to-peak of jitter in the measurement and display of low noise figures with no additional smoothing. For some measurements a more stable display is required. This is obtained by increasing the smoothing or averaging factor until a stable display results. Smoothing may be used in both calibration and measurement and may be changed during the sweep while measurements are in progress. However, once selected for CALIBRATE, the smoothing factor cannot be changed until calibration is complete. 13 SP selects exponential smoothing for fixed frequencies. Arithmetic smoothing (numerical averaging), is always used during sweep and calibration. This is also the PRESET and 0 SP mode.

During exponential smoothing at a fixed frequency, the display is updated approximately 5 times per second for all smoothing factors. 13.1 SP selects arithmetic smoothing when the frequency is fixed. Arithmetic smoothing makes the number of measurements indicated by the smoothing factor and averages them before the result is displayed. Therefore, the display is updated each time  $n$  measurements are made, where  $n$  is the smoothing factor. With a smoothing factor of 1, from 3 to 5 measurement updates are made each second. At the other extreme for a numerical average, with  $n = 512$ , the measurement update interval is typically 50 seconds to 1 minute. 13.2 SP displays and allows entry of the smoothing factor. The value entered, if not a power of 2, is changed to the next lower power of 2 and displayed upon entry. PRESET sets  $n$  to 1 and 0 SP has no effect.

## Manual (Hot/Cold) Measurements (14.N and 15.N SP)

The primary use of these special functions is for making measurements with a hot/cold noise source. Hot/cold measurements are more difficult and slower than those using a 346B Noise Source with the 8970A. Under certain conditions, however, this method is more accurate. The following paragraphs outline some cautions to observe and a step by step procedure for making the measurement. Several steps are required for measurement at each frequency point.

The measurement is similar to that made using a 346B, except that a hot source and a cold source must be physically connected for each noise power reading. The difficulty in working with liquid nitrogen (for the cold source) and in correcting for temperature gradients, condensation, etc. can introduce error unless the measurement is very carefully performed. The 346B may be used as a proxy for the hot/cold source in the following example and is automati-

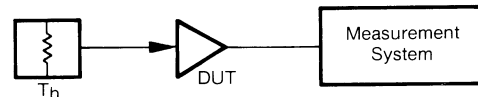
cally turned on or off by the appropriate one of the 14.N functions. 14.2 and 14.4 SP, for example, turn on the bias to the 346B to provide  $T_h$ .

Four important facts should be noted when making manual (hot/cold) measurements.

1. A stable reading must be stored in the 8970A memory before any change is made to the physical connections. A reading is stored by executing the NEXT special function in the sequence before changing connections.
2. The DUT must first be connected to the measurement system and then the RF input attenuators set by the 8970A. The attenuators must then be held fixed for the entire manual measurement by pressing 62 SP.
3. The IF attenuators must be allowed to autorange between calibration and measurement by using 70 SP.
4. The IF attenuators must be held fixed for both calibration readings (noise source on and off) and also for both measurement readings (noise source on and off) using 72 SP.

The steps of a typical measurement are as follows.

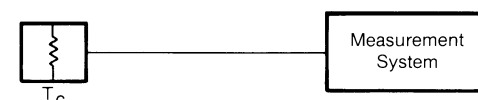
1. Press PRESET to return the 8970A to a known state.
2. Find and hold RF attenuators.
  - a. Enter mode, sideband, frequency, LO frequency,  $T_h$ ,  $T_c$ , etc. for the measurement to be made.
  - b. Connect the hot source,  $T_h$ , to the DUT input and the DUT output to the measurement system.



- c. Press 14.2 SP to obtain noise power with source at  $T_h$ .
  - d. Press 62 SP to hold RF attenuators for the entire measurement.
3. Calibrate
  - a. Remove the DUT and connect the hot source,  $T_h$ , to the measurement system.



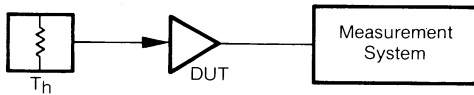
- b. Press 14.4 SP to calibrate with noise source at  $T_h$ .
  - c. Press 72 SP to hold the IF attenuators.
  - d. Press 14.3 SP to store the  $T_h$  calibration and to select the  $T_c$  calibration.
  - e. Connect  $T_c$  to the measurement system.



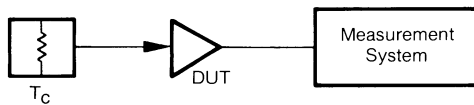
- f. Press 14.2 SP to store the  $T_c$  calibration reading and to select  $T_h$  measurement.

#### 4. Measure

- a. Connect  $T_h$  to the DUT and the DUT to the measurement system.



- b. Press 70 SP to allow the IF attenuators to autorange.
- c. Press 72 SP to hold the IF attenuators fixed at the new value.
- d. Press 14.1 SP to store  $T_h$  measurement and select  $T_c$  measurement.
- e. Disconnect  $T_h$  from the DUT and connect  $T_c$  to the DUT.



#### 5. Calculate and display.

- a. Press 15.1 SP to calculate and display the DUT noise figure (unless already in 15.1 SP from a previous DUT). This turns on the annunciator in the SPECIAL FUNCTION key. The measurement continues to be made for the last 14.N special function pressed before pressing 15.1 SP (in this case 14.1 SP). This last measurement is used to make the calculations which update the display.
  - b. Press 10.N SP (if desired) to change display units.
6. Measure another DUT or another frequency?
- a. If another DUT, press 14.2 SP and repeat steps in 4 and 5 above. The calibration data remain stored, so calibration need not be repeated.
  - b. If another frequency, begin the procedure again by pressing PRESET.
  - c. If neither, pressing 15 SP and NOISE FIGURE will return to normal display. 15 SP followed by NOISE FIGURE AND GAIN OR BY 10.N SP will also return to normal display. So does 0 SP and PRESET.

Note that in all 14.N states, the number displayed is proportional to the power in milliwatts at the detector. Note also that 10.N SP, NOISE FIGURE, NOISE FIGURE AND GAIN may be used to control the display during the 15.1 SP operation.

### Trigger Control (30.N SP)

These special functions are used to select

1. Free run trigger for continuous readings (30 SP),
2. Hold trigger to hold the last reading (30.1 SP), and
3. Execute trigger to make one measurement (30.2 SP).

30 SP selects the free run trigger. This is the PRESET and 0 SP state. 30.1 SP selects the hold trigger state; the last

reading made is held in the display. This causes measurements to cease. The held data may be read over HP-IB as many times as desired. 30.2 SP executes a trigger. This causes the 8970A to make one measurement, output the data to the front panel and scope/recorder outputs, and make it available for HP-IB. If a smoothing factor has been selected, the 8970A will make the number of measurements determined by the smoothing factor before the smoothed measurement is displayed. After a triggered measurement is completed, the 8970A returns to free run trigger (30 SP) or hold trigger (30.1 SP), whichever it was in before 30.2 SP was executed.

### Calibrations

In addition to the calibration for second stage correction made by pressing the CALIBRATE key on the front panel, there are three additional types of calibration performed by the 8970A. These are

1. Frequency calibration to set the 8970A frequency reference.
2. Input gain calibration to select the input attenuator and gain ranges (3 of them) used during CALIBRATE.
3. IF attenuator calibration to measure and correct for changes in the IF attenuators with time or temperature.

**Frequency calibration (31.N SP).** This is used to tune the first LO (a YIG oscillator) for correct display of measurement frequency. In Chapter IV, in the 20 MHz IF section, the frequency calibration detector is explained. Frequency calibration is always performed when the following keys are pressed: PRESET, CALIBRATE, 31.2 SP, and LINE (at turn-on). During frequency calibration the right window shows four dashes. 31.0 SP selects the automatic frequency calibration mode. In addition to the times mentioned above, frequency calibration is performed automatically 15 minutes after turn on, 30 minutes later, 1 hour later, and every 2 hours thereafter. This is the PRESET and 0 SP state. 31.1 SP disables the automatic frequency calibration mode. Frequency calibration is still performed when the keys mentioned earlier are pressed, but there is no routine automatic calibration. 31.1 SP may be used when it is inconvenient for a frequency calibration to be performed during an automatic measurement or data-logging operation. 31.2 SP executes a frequency calibration immediately, returning to 31 SP or 31.1 SP, whichever was the previous state.

**Input gain calibration (32.N SP).** This function allows the choice of input gain and attenuation settings used for the three runs made when CALIBRATE is pressed. Settings other than the default values are used primarily when calibrating to measure with high external gain preceding the 8970A. 32.0 SP selects input gains for calibration of +20, +10, and 0 dB. These are the maximum gain settings and are

the PRESET and 0 SP states. 32.1 SP selects input gains for calibration of +10, 0, and -10 dB. 32.2 SP selects input gains of 0, -10, and -20 dB. 32.3 SP selects input gains of -10, -20, and -30 dB. If E22 is displayed during measurement, a different choice of settings is necessary.

**IF attenuator calibration (33 SP).** This function measures the IF attenuators and stores the actual values to compensate for any difference from nominal values during measurement. This is required approximately every six months or if the ambient temperature changes more than approximately 10 degrees C from the last calibration temperature. With the noise source drive output connected to the noise source 28V dc input and the noise source output connected to the 8970A input, calibrate the IF attenuators by pressing 33 SP. This calibration is stored in non-volatile memory when power is removed. It is not cleared by PRESET or 0 SP. If the error code E26 is observed in the right window, an IF attenuator calibration is required.

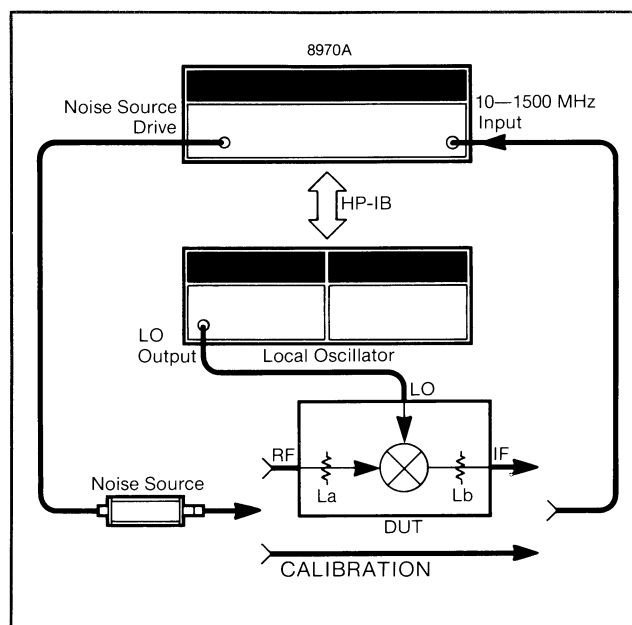
### Loss Compensation (34.N SP)

Loss compensation allows the 8970A to automatically correct for loss at the input and output of the DUT, taking into account the temperature of the two losses. This is important in several cases such as for:

1. Amplifiers with waveguide input, where a waveguide-to-coax adapter is needed.
2. Transistors, where input and output tuners are required.
3. Non-50Ω converters (such as TV tuners and amplifiers) where matching pads or transformers are required.
4. Compensation for fixed attenuators used to improve SWR.
5. Double sideband measurement modification to obtain approximate single sideband results.

Loss compensation may be done manually by correcting the noise source ENR table for the input loss (entering it into the 8970A) and by making the output loss part of the second stage. However, loss compensation on the 8970A can automatically make the adjustments.

These special functions allow the selection of input and output loss compensation, the entry of the input or output loss, and the temperature of the loss (of both losses if both are used). Loss compensation is implemented according to **Figure V-3**, and the measurement should be arranged to correspond with this figure. 34 SP turns loss compensation off. This is the PRESET and 0 SP mode. 34.1 SP turns loss compensation on. The 8970A will correct for input loss before the DUT, output loss after the DUT, or both. When 34.1 SP is selected it is necessary to have entered the loss(es) using 34.2 and 34.4 SP and the temperature of the loss(es) in 34.3. 34.2 SP displays and allows entry of the amount of loss between the noise source and the DUT. The units are in dB.



**Figure V-3.** Loss Compensation Setup ( $L_a$  and  $L_b$  are input and output losses, respectively)

PRESET clears this to 0 dB, but 0 SP has no effect. 34.3 SP displays and allows entry of the temperature of the loss(es). The units are those in force entered by 11.N SP. PRESET clears this to 0K, but 0 SP has no effect. 34.4 SP displays and allows entry of the loss between the DUT and the second stage (the connection point for calibration). Units are in dB. PRESET clears this to 0 dB but 0 SP has no effect.

For estimating the loss of mixers measured in double sideband mode, entering -3 dB of output loss compensation at 0K will give an approximation of the desired gain reading without affecting the noise figure. Entering -3 dB at 290K for the input loss will give correct gain and an approximation of the single sideband noise figure of the DUT. An example is discussed in Chapter II under Swept LO Mixer Measurement.

### Sequence Control (35.N SP)

The front panel SEQ key steps through stored front panel settings in a preselected sequence, one step each time the SEQ key is pressed. The following special functions allow the order of the sequence steps to be entered and automatic sequencing to be chosen. 35.0 SP selects the manual sequence mode. The 8970A will step through the defined sequence one step at a time each time SEQ is pressed. This is the PRESET and 0 SP state. 35.1 SP selects automatic sequencing, toggled on or off by the SEQ key. The 8970A will then automatically step through the complete sequence of front panel settings one after the other. 35.2 SP displays and allows entry of the desired sequence. There are 9 STORE/

RECALL storage locations through which the 8970A front panel and instrument states may be sequenced. The number of the storage location to be recalled at each step of the sequence is displayed in turn in the left window. If a change is desired, enter the new storage location number and press ENTER. If no change, press ENTER to step to the next location in the sequence. After all 9 storage locations have been displayed, the 8970A returns to normal measurement. Any zeros within the sequence are ignored and skipped. 35.3 SP clears the sequence to all zeros. PRESET sets the sequence to 1, 2, 3, . . . , 8, 9.

### Special Function Catalog (50.N SP)

The special function catalog displays 6 lines of status information on specific special functions. It allows the user to quickly determine the current state of many of the special functions (see Pullout Card 2). 50 SP sequences through all 6 catalog lines, and 50.1 to 50.6 SP display the specified catalog line.

50.1 SP, for example, displays the N = 1 line. Under the left display window are reference characters, N, 1, 2, 3, and 4. These characters refer to the digit positions in the display. Pullout Card 2 illustrates the following example. Assume that pressing 50.1 SP produced the display 1 4 2 1 0. The first digit is the line number of the catalog (the 1 in 50.1), and the remaining four digits are the special function code suffixes (the digit to the right of the decimal in the special function code). The numbers indicate that in line 1 of the catalog the following special functions are currently active as shown:

Special Function					
Catalog (50.1SP)	1	4	2	1	0
Active Special					
Functions	(line 1)	1.4	2.2	4.1	5.0

The other lines of the table may be interpreted as shown on Pullout Card 2.

### Special Function LED

**Table V-5** is a list of special functions that light the special function LED. The special function LED is generally lit when special functions that will affect the displayed data are different from their PRESET or 0 SP states and when this is not immediately obvious from other front panel annunciators. For example, it is obvious from the front panel when the 8970A is not in mode 1.0 (1.0 SP): the EXT MIX annunciator is lit in the frequency window. Therefore, the special function LED is not lit. As another example,

however, there is no direct way of knowing the 8970A is not in double sideband without going to the special function catalog. Therefore the LED is lit when either lower sideband (2.1 SP) or upper sideband (2.2 SP) frequency offsets have been activated.

**Table V-5. Special Functions that Light Special Function LED**

2.1 Lower Single Sideband
2.2 Upper Single Sideband
5.1 Use Spot ENR
15.1 Display Manual Measurement Result
32.1 Calibration with Input Gain at 10, 0, -10 dB
32.2 Calibration with Input Gain at 0, -10 dB, -20 dB
32.3 Calibration with Input Gain at -10, -20 dB, -30 dB
34.1 Loss Compensation On
35.1 Automatic Sequence On and Running

This LED is also lit for certain Service Special Functions. (See the 8970A Operating and Service Manual.)

## Error Codes and Recovery From Errors

The 8970A generates error messages to indicate operating problems, incorrect keyboard entries, or service related problems. An error message is cleared when the error condition is removed. Error messages are displayed in the right window of the front panel, with an "E" followed by two digits. The error code groups are as follows. E10 to E49 are operating and entry errors. Operating errors can usually be cleared using front panel keys, changing the equipment set-up, or correcting an HP-IB code. Entry errors require that a new keyboard entry or function selection be made. E50 to E80 are service errors which provide additional service information. These are discussed in the 8970A Operating and Service Manual. For the two special displays (dashes) and the list of error codes see Pullout Card 2 inside the back cover.

### NOTE

*If E27 is displayed following calibration, it means that an overflow occurred at one or more calibration frequencies. This does not mean the calibration is invalid. Continue with the measurement. At any measurement frequency where corrected values are displayed, the calibration is valid.*

# APPENDIX A

## Suggested Equipment for 10 MHz—18 GHz Measurement System for Measuring Devices with SMA or APC-3.5 Connectors

### Instruments

Noise Figure Meter .....	(1)	HP 8970A
Noise Source .....	(1)	HP 346B
Synthesized Signal Generator .....	(1)	HP 8672A
Mixer .....	(1)	HP HMXR-5001
3 dB Attenuator (used at mixer input to reduce mismatch uncertainty) ....	(1)	HP 8493B Opt. 003

### Cables and Adapters

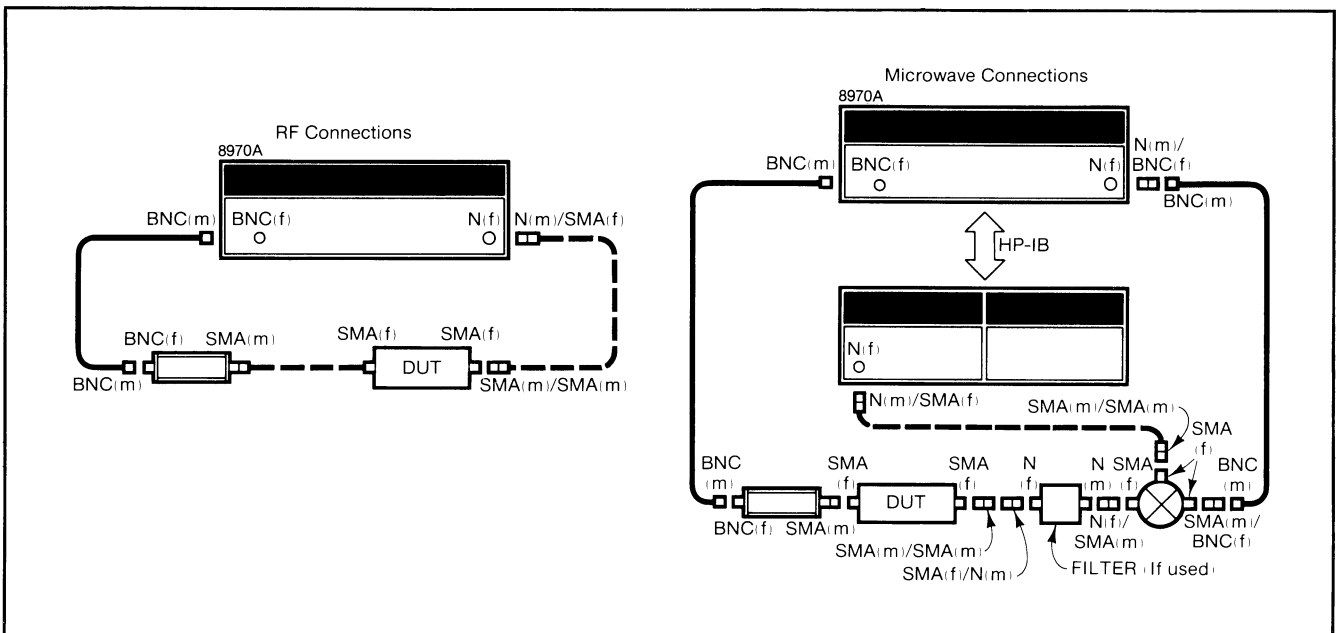
HP-IB Cable (shielded) .....	(1)	HP 10833A
Coaxial Cable (with BNC Connectors, 48 in. long for Oscilloscope and Noise Source Drive) .....	(4)	HP 11170C
Coaxial Cable (with BNC Connectors, 37 in. long — Triple Shielded for IF) .....	(1)	HP 11652-60004

### Adapters

	SMA	APC-3.5
N(m) to BNC(f) Adapter .....	(1) HP 1250-0780	—
SMA(f) to SMA(f) Adapter .....	(2) HP 1250-1158	HP 1250-1749
SMA(m) to SMA(m) Adapter .....	(2) HP 1250-1159	HP 1250-1748
SMA(m) to BNC(f) Adapter .....	(2) HP 1250-1200	—
SMA(f) to N(m) Adapter .....	(1) HP 1250-1250	HP 1250-1744

### For Covering 1.5 to 2.0 GHz

Low pass filter .....	(1)	HP 360C	—
SMA(f) to N(m) Adapter .....	(1)	HP 1250-1250	HP 1250-1744
SMA(m) to N(f) Adapter .....	(1)	Sealectro, #50-674-670180	HP 1250-1750



Suggested Equipment for 10 MHz to 18 GHz Measurements (SMA/APC 3.5)

**MEASUREMENT MODES**

There are 3 groups of Measurement Modes:

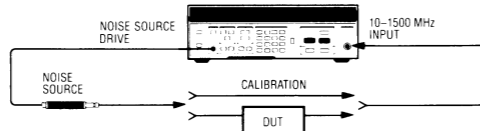
- I. Mode 1.0 is used from 10 to 1500 MHz, no Ext LO or frequency conversion.
- II. Modes 1.1 and 1.3 are used with a variable-frequency Ext LO and a fixed IF.
- III. Modes 1.2 and 1.4 are used with a fixed-frequency Ext LO and a variable IF.

The external equipment is similar for Modes 1.1 and 1.2 or 1.3 and 1.4 (see figures below).

**MINIMUM REQUIREMENTS for Modes 1.1 and 1.3 when the HP 8970A is the controller:**

- a. HP-IB cable connected between 8970A and the Ext LO.
- b. Ext LO control selected (4.1 SP).
- c. Ext LO address correct (40.1 SP).
- d. An Ext LO program selected (For example, 41.0 or 41.2 SP).

**CALIBRATION AND MEASUREMENT SETUP (MODE 1.0)**

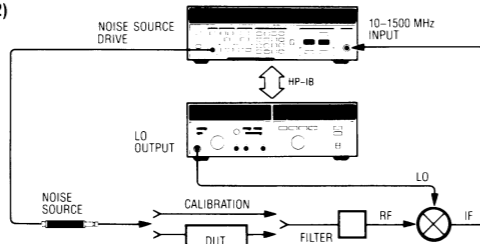


**MODE 1.0 (1.0 SP)**

10-1500 MHz measurement, no Ext LO or frequency conversion.

- a. Press 1.0 SP.
- b. Set frequency parameters.
- c. Calibrate as shown.
- d. Insert device under test (DUT) and measure.

**CALIBRATION AND MEASUREMENT SETUP (MODE 1.1 AND 1.2)**



**MODE 1.1 (1.1 SP)**

Variable-frequency Ext LO, frequency conversion in measurement system but not in DUT.

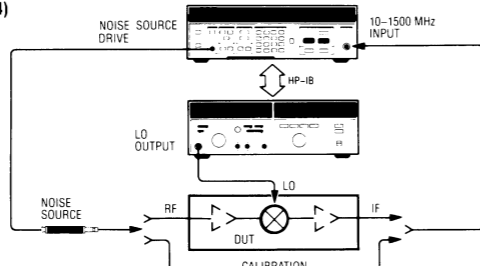
- a. Verify minimum requirements (see above).
- b. Press 1.1 SP.
- c. Set frequency parameters (including fixed IF, 3.0 SP).
- d. Calibrate as shown.
- e. Insert DUT and measure.

**MODE 1.2 (1.2 SP)**

Fixed-frequency Ext LO, single sideband, frequency conversion in measurement system but not in DUT.

- a. Select single sideband offset (2.1 or 2.2 SP).
- b. Press 1.2 SP (left display shows E33 until step c. is performed).
- c. Set frequency parameters (including fixed LO Frequency, 3.1 SP).
- d. Calibrate as shown (external filtering is required).
- e. Insert DUT and measure.

**CALIBRATION AND MEASUREMENT SETUP (MODE 1.3 AND 1.4)**



**MODE 1.3 (1.3 SP)**

Variable-frequency Ext LO, frequency conversion in DUT (for testing mixer or receiver).

- a. Verify minimum requirements (see above).
- b. Press 1.3 SP.
- c. Set frequency parameters (including fixed IF, 3.0 SP).
- d. Calibrate as shown.
- e. Insert DUT and measure.

**MODE 1.4 (1.4 SP)**

Fixed-frequency Ext LO, variable IF, frequency conversion in DUT (for testing mixer or receiver).

- a. Set frequency parameters (including fixed LO Frequency, 3.1 SP).
- b. Press 1.4 SP.
- c. Calibrate as shown.
- d. Insert DUT and measure.
- e. Left display shows IF frequency.

**SPECIAL DISPLAYS**

- Measurement overflow or Noise Figure reading greater than 32 dB. See Table 1, code 99 below.
- -- -- -- -- Display ready. The reserved number 90000 E + 06 is sent over HP-IB when the instrument receives a read command while this display is present in the Trigger Hold mode. (90000 E + 06 is also sent when a display is blank.)

**HP-IB**

HP-IB OUTPUT COMMANDS  
 HP-IB: <command> <data> <data> ... NN CR LF  
 HP-IB: <command> <data> <data> ... NN, + DDDDD E = NN, - DDDDD E = NN CR LF

Errors  
 Error Code: 1  
 Reserved Number: + 90000 E + 06 CR LF  
 Used for the "---" special display and for a blank display.

**HP-IB STATUS WORD**

Bit	7	6	5	4	3	2	1
Condition	1	0	0	0	0	0	0
	HP-IB Error	HP-IB Busy	0 (always)	0 (always)	HP-IB Code Error	Cal Complete	Data Ready

**SPECIAL FUNCTION CATALOG**

Special Functions are listed in the Special Function Catalog. 50.0 SP sequences thru all 6 catalog entries and displays the specified catalog line. For example:

[ 5 ] [ 0 ] [ 0 ] [ 0 ] [ 0 ] [ 0 ] Displays the N = 1 line.

The first digit is the catalog line number. Each of the other digits is the suffix of a special function. The suffixes are shown in the table below.

SP Code suffixes					
This display indicates the following special functions: 1.4, 2.2, 4.1, 5.0					
Digit positions					
SP code prefixes N = 1					
LINE NO.	1	2	3	4	5
1	1.0	1.1	1.2	1.3	1.4
2	1.0	1.1	1.2	1.3	1.4
3	NA	NA	NA	NA	NA
4	NA	NA	NA	NA	NA
5	NA	NA	NA	NA	NA
6	NA	NA	NA	NA	NA

- 1 = 0.4, 2 = 1.0, 3 = 1.1, 4 = 1.2, 5 = 1.3, 6 = 9.2 SP; 7 = 9.3 SP; 8 = 9.4 SP.
- \*\* Indicates a special function output.
- 0 = 3.0, 1 = 3.1, 2 = 3.2, 3 = 3.3, 4 = 23.0 SP; 5 = 23.0 SP; 6 = 24.0 SP.
- † Indicates a special function program.
- 0 = 41.0, 1 = 41.1, 2 = 41.2 SP (8672A); 9 = Custom Ext LO Program.

**ERROR CODES**

- Hardware Error**  
 (Press 99.0 SP to clear error signal. See Manual if same error repeats.)
- E10 A Device Error
  - E11 A Device Error
  - E12 Input Error
  - E13 IF attenuator not calibrated
  - E14 Cannot select proper IF or RF attenuators.
  - E18 Frequency calibration failed.
  - E80 Continuous memory failure.

- Not Properly Calibrated for Corrected Measurement**  
 (Repeat calibration.)
- E20 Not calibrated for the current LO frequency (measurement modes 1.1 and 1.3).
  - E21 Current LO frequency out of calibrated range.
  - E22 Current LO frequency not calibrated.
  - E23 Not calibrated for the current measurement mode (measurement modes 1.1 and 1.3).
  - E24 Not calibrated for the current IF (measurement modes 1.1 and 1.3).
  - E25 Not calibrated for the current LO frequency (measurement mode 1.2).
  - E26 IF attenuators not calibrated (perform Special Function 33).
  - E27 Overflow while calibrating.

- Invalid Frequency Error**  
 (Change frequency and repeat and repeat measurement.)
- E30 Start frequency is greater than stop frequency or the lower limit is greater than the upper limit (Special Function 8).
  - E31 Number of cal. points exceeds 81.
  - E32 LO frequency will be out of range.
  - E33 IF will be out of range.
  - E34 DSB not allowed in meas. mode 1.2.

- Entry Error**  
 (Check and reenter.)
- E35 Entered characters out of range
  - E36 Undefined parameter function
  - E37 Parameter not allowed
  - E40 Undefined command
  - E41 Invalid HP-IB characters.
  - E42 No external LO is connected when in controller mode (4.1 SP).
  - E43 Commands received while in Talk Only mode (4.2 SP).

- Service Error**  
 (Do not affect data or status byte.)
- E50-79 Service error factors (see Manual).
  - E80 Continuous memory failure (see Hardware Error).
  - E99 (HP-IB only) This error is sent on the HP-IB when the "---" display is shown.

**PRESET AND SPECIAL FUNCTION**

- PRESET** This key initiates a frequency calibration, initializes selected Special Functions and enters the default data values indicated in green. (To initialize Special Functions only, use 0.0 SP.) PRESET also sets the following parameters:
- START FREQ = 10 MHz
  - STOP FREQ = 1500 MHz
  - STEP SIZE = 20 MHz
  - FREQUENCY = 30 MHz
  - FREQ INCR = 20 MHz
  - SWEEP = OFF
  - CALIBRATION = OFF
  - MEAS. = NOISE FIGURE
  - SMOOTHING = 1

- SPECIAL FUNCTION** This key completes a Special Function (SP) entry and activates the selected Special Function. Special Functions perform one or more of the following tasks:
- a. Execute or Select Commands
    - [ 1 ] [ . ] [ 2 ] [ . ] Selects Measurement Mode 1.2
  - b. Display and Enter Data
    - [ 3 ] [ . ] [ 1 ] [ . ] Displays current Ext LO Frequency
    - [ 3 ] [ 0 ] [ 0 ] [ 0 ] [ ENTER ] Enters new Ext LO Frequency of 3000 MHz
  - c. Display Information
    - [ 5 ] [ . ] [ 2 ] [ . ] Displays current ENR in dB

- |  |  |
|--|--|
| <p><b>INITIALIZE SPECIAL FUNCTIONS</b></p> <ul style="list-style-type: none"> <li>0.0 (CS) Initialize selected Special Functions to settings in green. However, the default data values are not entered. The existing values are not changed.</li> </ul> <p><b>MEASUREMENT MODE SELECTION</b></p> <ul style="list-style-type: none"> <li>1.0 (E0) Mode 1.0: 10 to 1500 MHz, No Ext LO</li> <li>1.1 (E1) Mode 1.1: Variable-freq. Ext LO, Fixed IF</li> <li>1.2 (E2) Mode 1.2: Fixed-freq. Ext LO, Variable IF (Single Sideband)</li> <li>1.3 (E3) Mode 1.3: Variable-freq. Ext LO, Fixed IF (Mixer in DUT)</li> <li>1.4 (E4) Mode 1.4: Fixed-freq. Ext LO, Variable IF (Mixer in DUT)</li> </ul> <p><b>SIDEBAND FREQUENCY OFFSET</b></p> <ul style="list-style-type: none"> <li>2.0 (B0) Double Sideband-No Offset</li> <li>2.1 (B1) LSB (F<sub>SIGNAL</sub> &lt; F<sub>LO</sub>)</li> <li>2.2 (B2) USB (F<sub>SIGNAL</sub> &gt; F<sub>LO</sub>)</li> </ul> <p><b>ENTER IF AND LO FREQUENCIES</b></p> <ul style="list-style-type: none"> <li>3.0 (IF) IF: Modes 1.1 and 1.3 (30 MHz)</li> <li>3.1 (LF) LO: Modes 1.2 and 1.4 (10000 MHz)</li> </ul> <p><b>CONTROL FUNCTION SELECTION</b></p> <ul style="list-style-type: none"> <li>4.0 Normal Talker and Listener</li> <li>4.1 Enable Ext LO Control</li> <li>4.2 Talk Only</li> </ul> <p><b>ENR AND T<sub>HOT</sub> SETTINGS</b><br/>             (See Manual for ENR Table Entry)</p> <ul style="list-style-type: none"> <li>5.0 (S0) Use ENR Table</li> <li>5.1 (S1) Use Spot ENR</li> <li>5.2 (SE) Display Current ENR in dB</li> <li>5.3 (NE) Enter and Use Spot ENR (15.2 dB)</li> <li>5.4 (TH) Enter and Use Spot T<sub>HOT</sub> (9893K)</li> <li>5.5 (SN) Enter Noise Source Identifier</li> </ul> <p><b>T<sub>COOLD</sub> SETTING</b></p> <ul style="list-style-type: none"> <li>6.0 (TC) Enter T<sub>COOLD</sub> (296.5K)</li> </ul> <p><b>OUTPUT TO OSCILLOSCOPE</b></p> <ul style="list-style-type: none"> <li>7.0 (A0) Noise Figure and Gain</li> <li>7.1 (A1) Test Pattern</li> <li>7.2 (A2) Noise Figure Only</li> <li>7.3 (A3) Gain Only</li> </ul> <p><b>ENTER OSCILLOSCOPE LIMITS</b></p> <ul style="list-style-type: none"> <li>8.1 (NL) Noise Figure Lower Limit (0)</li> <li>8.2 (NU) Noise Figure Upper Limit (0)</li> <li>8.3 (GL) Gain Lower Limit (0)</li> <li>8.4 (GU) Gain Upper Limit (40)</li> </ul> <p><b>POWER MEASUREMENTS (dB Rel. to kT<sub>0</sub>)</b></p> <ul style="list-style-type: none"> <li>9.1 (N5) SOURCE Off-Uncal</li> <li>9.2 (N6) SOURCE On-Uncal</li> <li>9.3 (N7) SOURCE Off-Cal</li> <li>9.4 (N8) SOURCE On-Cal</li> </ul> <p><b>NOISE FIGURE DISPLAY UNITS</b></p> <ul style="list-style-type: none"> <li>10.0 (N0) F dB</li> <li>10.1 (N1) F</li> <li>10.2 (N2) Y dB</li> <li>10.3 (N3) Y</li> <li>10.4 (N4) Te K</li> </ul> <p><b>SELECT NOISE SOURCE TEMP. UNITS FOR DATA INPUT</b><br/>             (Applies to 5.4, 6.0, and 34.3 SP)</p> <ul style="list-style-type: none"> <li>11.0 (D0) K</li> <li>11.1 (D1) °C</li> <li>11.2 (D2) °F</li> </ul> <p><b>DISPLAY RESOLUTION</b></p> <ul style="list-style-type: none"> <li>12.0 (X0) Maximum Resolution</li> <li>12.1 (X1) Less Res. on Noise Figure</li> <li>12.2 (X2) Less Res. on Gain</li> </ul> | <p><b>SMOOTHING (AVERAGING)</b></p> <ul style="list-style-type: none"> <li>13.0 (V0) Exponential Smoothing</li> <li>13.1 (V1) Arithmetic Smoothing</li> <li>13.2 (AF) Smoothing Factor (1)</li> </ul> <p><b>MANUAL MEASUREMENT FUNCTIONS</b></p> <ul style="list-style-type: none"> <li>14.1 (MC) Cold Meas.-SOURCE Off</li> <li>14.2 (MH) Hot Meas.-SOURCE On</li> <li>14.3 (CC) Cold Calibration-SOURCE Off</li> <li>14.4 (CH) Hot Calibration-SOURCE On</li> <li>15.0 (P0) Normal Display Mode</li> <li>15.1 (P1) Display Manual Meas. Results</li> </ul> <p><b>RECORDER FUNCTIONS</b></p> <ul style="list-style-type: none"> <li>20.0 (LL) Go to Lower Left</li> <li>21.0 (UR) Go to Upper Right</li> <li>22.0 (A4) Plot Noise Figure</li> <li>23.0 (A5) Plot Gain</li> <li>24.0 (A6) Strip Chart Mode (X = Noise Figure; Y = Gain)</li> </ul> <p><b>TRIGGER SELECTION</b></p> <ul style="list-style-type: none"> <li>30.0 (T0) Free Run</li> <li>30.1 (T1) Hold</li> <li>30.2 (T2) Execute</li> </ul> <p><b>FREQUENCY CALIBRATION</b></p> <ul style="list-style-type: none"> <li>31.0 (Y0) Automatic</li> <li>31.1 (Y1) Disable Frequency Cal</li> <li>31.2 (Y2) Perform One Frequency Cal</li> </ul> <p><b>INPUT GAIN CALIBRATION</b></p> <ul style="list-style-type: none"> <li>32.0 (C0) 20, 10, and 0 dB</li> <li>32.1 (C1) 10, 0, and -10 dB</li> <li>32.2 (C2) 0, -10, and -20 dB</li> <li>32.3 (C3) -10, -20, and -30 dB</li> </ul> <p><b>IF ATTENUATOR CALIBRATION</b></p> <ul style="list-style-type: none"> <li>33.0 (IC) Use Mode 1.0 calibration setup (See Card 3) and press 33.0 SP.</li> </ul> <p><b>LOSS COMPENSATION</b></p> <ul style="list-style-type: none"> <li>34.0 (L0) Off</li> <li>34.1 (L1) On</li> <li>34.2 (LA) Enter dB Loss before DUT (0 dB)</li> <li>34.3 (LT) Enter Temperature of Losses (0K)</li> <li>34.4 (LB) Enter dB Loss after DUT (0 dB)</li> </ul> <p><b>SEQUENCE FUNCTIONS</b></p> <ul style="list-style-type: none"> <li>35.0 (QM) Manual</li> <li>35.1 (CA) Automatic</li> <li>35.2 (QS) Set (1-9)</li> <li>35.3 (QC) Clear</li> </ul> <p><b>HP-IB ADDRESSES</b></p> <ul style="list-style-type: none"> <li>40.0 Display and Enter 8970A Address</li> <li>40.1 (EA) Display and Enter Ext LO Address</li> </ul> <p><b>EXTERNAL LO PROGRAMS</b></p> <ul style="list-style-type: none"> <li>41.0 (J0) HP 8350A Sweep Oscillator</li> <li>41.2 (J2) HP 8672A Syn. Sig. Generator</li> </ul> <p><b>EXTERNAL LO COMMANDS</b></p> <ul style="list-style-type: none"> <li>42.0 (AC) Auxiliary Commands</li> <li>42.1 (PS) CW Prefix and Suffix</li> <li>42.2 (TM) Settling Time in ms</li> <li>42.3 (N7) Min Frequency in MHz</li> <li>42.4 (MX) Max Frequency in MHz</li> </ul> <p><b>HP-IB DATA OUTPUT SELECTION</b></p> <ul style="list-style-type: none"> <li>43.0 (H0) NOISE FIGURE Only</li> <li>43.1 (H1) Frequency (Left Display), INSERTION GAIN, NOISE FIGURE</li> </ul> <p><b>SERVICE REQUEST</b><br/>             (See Status Byte, Card 2)</p> <ul style="list-style-type: none"> <li>44.0 (Q0) Disable SRQ capability</li> <li>44.1 (Q1) Enable Data Ready</li> <li>44.2 (Q2) Enable Cal Complete</li> <li>44.3 (Q3) Enable HP-IB Code Error</li> <li>44.6 (Q6) Enable Instrument Error</li> </ul> <p><b>SPECIAL FUNCTION CATALOG</b></p> <ul style="list-style-type: none"> <li>50.N Refer to Card 2</li> </ul> <p>For Special Functions 60 thru 99 refer to the Manual.</p> |
|--|--|

Figure A. Pullout Cards