

## Errata

**Document Title:** Recent Advances in Pulsed RF and  
Microwave Frequency Measurements (AN 173)

**Part Number:** 5952-7334

**Revision Date:** October 1974

---

### HP References in this Application Note

This application note may contain references to HP or Hewlett-Packard. Please note that Hewlett-Packard's former test and measurement, semiconductor products and chemical analysis businesses are now part of Agilent Technologies. We have made no changes to this application note copy. The HP XXXX referred to in this document is now the Agilent XXXX. For example, model number HP8648A is now model number Agilent 8648A.

### About this Application Note

We've added this application note to the Agilent website in an effort to help you support your product. This manual provides the best information we could find. It may be incomplete or contain dated information, and the scan quality may not be ideal. If we find a better copy in the future, we will add it to the Agilent website.

### Support for Your Product

Agilent no longer sells or supports this product. You will find any other available product information on the Agilent website:

[www.agilent.com](http://www.agilent.com)

Search for the model number of this product, and the resulting product page will guide you to any available information. Our service centers may be able to perform calibration if no repair parts are needed, but no other support from Agilent is available.

# APPLICATION NOTE 173

Recent Advances in Pulsed RF and Microwave Frequency Measurements



## TABLE OF CONTENTS

|      |  |     |
|------|--|-----|
| I.   | EVOLUTION OF PULSED MICROWAVE FREQUENCY MEASUREMENTS .....               | 1-1 |
| II.  | GENERAL PULSED RF MEASUREMENT CONSIDERATIONS .....                       | 2-1 |
|      | Traditional and Reciprocal Counters .....                                | 2-1 |
|      | The Importance of Synchronization .....                                  | 2-1 |
|      | Pulsed RF Generation and Considerations .....                            | 2-1 |
|      | General Considerations .....   | 2-3 |
| III. | HIGH RESOLUTION PULSED RF MEASUREMENTS TO 500 MHz .                      | 3-1 |
|      | Automatic Pulsed RF Measurements .....                                   | 3-1 |
|      | Advantages of Controlled Gating .....                                    | 3-1 |
|      | External Gating .....  | 3-1 |
|      | Increased Resolution with Frequency Averaging .....                      | 3-3 |
|      | Increased Accuracy with Frequency Averaging .....                        | 3-4 |
|      | Taking a Measurement .....   | 3-5 |
|      | Determining Calibration Factor .....                                     | 3-5 |
| IV.  | HIGH RESOLUTION PULSED RF MEASUREMENTS TO 4 GHz ....                     | 4-1 |
|      | Operation of the 5354A Automatic Frequency Converter .....               | 4-1 |
|      | Operating Modes .....  | 4-2 |
|      | Automatic Pulsed RF Measurement Mode .....                               | 4-3 |
|      | Manual Band Selection .....  | 4-4 |
|      | External Gating for Increasing Resolution and Accuracy .....             | 4-4 |
|      | Example of FVIDEO .....  | 4-5 |
|      | Example Using the 5354A Automatic Frequency Counter .....                | 4-6 |
|      | Determining the Calibration Factor .....                                 | 4-7 |
|      | Notes on Pulsed RF Measurement .....                                     | 4-7 |
| V.   | PULSED MEASUREMENT TO 18 GHz WITH 5245 SERIES PLUG-INS .....             | 5-1 |
|      | Heterodyne Converters for CW Measurements to 18 GHz .....                | 5-1 |
|      | Pulsed Microwave Measurements to 18 GHz with Heterodyne Converters ..... | 5-1 |
|      | Measurements to 18 GHz with 5257A Transfer Oscillator .....              | 5-4 |
| VI.  | EXTERNAL GATE SYNCHRONIZATION .....                                      | 6-1 |
|      | Generating the External Gate .....                                       | 6-1 |
|      | Deriving the Sync Pulse From the Pulse Envelope .....                    | 6-1 |
|      | Deriving the Sync Pulse From the Video Signal .....                      | 6-1 |

## I. EVOLUTION OF PULSED MICROWAVE FREQUENCY MEASUREMENTS

Many present day ground based and airborne RF systems depend on a pulsed RF mode of operation. These include radar, navigation systems, identification systems and altimeters to name a few. During the course of routine maintenance and check out of such systems as well as during initial development, it is necessary to make accurate measurements on pulsed frequencies which may range from 100 MHz or so up thru the high GHz range.

In the past, pulsed RF frequencies were measured by use of a cavity wavemeter together with a detector and a display. The operator would tune a calibrated cavity until a "notch" appeared on an oscilloscope display of the detected pulse, then he would read the frequency from the scale on the wavemeter. Accuracy was in the order of 0.1%.

With the advent of the electronic counter, a transfer oscillator was developed to measure pulsed RF. This technique is still in use today. The operator in this case tunes a CW oscillator (termed local oscillator or LO) until one of its harmonics matches the pulsed RF frequency as shown by a "zero beat" detected on headphones, an oscilloscope, a meter or other indicator. The operator then measures the LO frequency with a counter and multiplies by the appropriate harmonic number to determine the unknown RF frequency. While giving better resolution than a wavemeter this method is limited in accuracy to 20 kHz or so and depends on operator skill since errors result from the difficulty of manual tuning. Tuning becomes more difficult and resolution decreases for narrow pulses, low repetition rates and at high microwave frequencies. Automatic transfer oscillators (HP 5340A and similar counters) and phase locked manual transfer oscillators (HP 5257A) introduce no tuning error but are limited in operations to CW signals only.

Many of the measurements discussed in this applications note are made possible due to the advent of a new high performance electronic counter, the 5345A. The unique features of this instrument which allow new measurements to be made are:

1. Reciprocal Operation with a 500 MHz clock to give high resolution in very short measurement times. Resolution is independent of input frequency and depends only on gate time.
2. A new family of EECL sub-nanosecond logic which allows the counter to have extremely narrow gate times that can be positioned as desired *within* an RF or microwave pulse.
3. A unique method of "frequency averaging" which uses a statistically jittered 500 MHz clock to insure a true average under all conditions.

For frequencies above 500 MHz the counter uses a wideband automatic heterodyne converter, the 5354A, to translate signals down into the frequency range of the mainframe.

Now, for the first time, high resolution measurements can be made directly on (or within) a microwave pulse rather than on an unlocked, lower frequency, local oscillator.

## II. GENERAL PULSED RF MEASUREMENT CONSIDERATIONS TRADITIONAL AND RECIPROCAL COUNTERS

Pulsed RF is much more difficult to measure than CW. Any electronic counter measures continuous wave (CW) frequency by either counting the number of input cycles occurring in some known time (conventional counter) or by measuring the time required for one cycle (period) to occur then displaying the reciprocal which is frequency (reciprocal counter). Conventional CW frequency measurements are an average taken over some period of time. This represents no particular problems for CW measurements since the cycles occur continuously and due to the nature of the generating device each one is nearly identical to the previous one.

### THE IMPORTANCE OF SYNCHRONIZATION

Pulsed RF on the other hand is not as easily characterized for several reasons. First, since the signal exists only part of the time, the counter must be capable of synchronization so the measurement will be taken only when the signal is present. Second, it is difficult to turn a signal source on and off and at the same time have each cycle be identical to every other cycle. In short the cycles at the beginning and ending of an RF pulse may not be the same as the ones in the middle. Also, the frequency may shift continuously throughout the duration of the RF pulse. Third, the frequency may change from pulse to pulse. In any case, the counter will define frequency in terms of the average number of cycles which occurred during its measurement interval so the answer will vary depending on the length of the measurement and where within the RF pulse the measurement is made.

### PULSED RF GENERATION AND CONSIDERATIONS

Pulsed RF is generated in several ways:

1. The RF oscillator is turned on and off by synchronizing pulses. Magnetrons, airborne ATC transponders and similar devices are turned on and off by turning their DC supply voltage ON and OFF. These devices are prone to transients on the leading and trailing edge of the RF pulse and may change frequency during the pulse due to the nature of the generator. A simple definition of frequency is not possible in a case like this because it may be continually changing. In some radar systems the frequency is intentionally changed (FM'ed) during the pulse. In either case, a frequency profile of the pulse, ie, a display of frequency versus time may be desirable.
2. The RF oscillator runs continuously and drives a pulse modulator. The modulator essentially switches a CW output off and on to generate pulsed RF. The CW generator can be crystal controlled or phase locked to a frequency standard in order to achieve the desired degree of stability.

At microwave frequencies this switching operation is frequently done with a PIN modulator consisting of a  $50\Omega$  transmission line with PIN diodes arranged along the line. When the diodes are turned on (forward biased) they absorb and dissipate the power in the line while still maintaining a 50 ohm line impedance. The level of forward bias voltage determines the degree of power absorption; therefore, this type of modulator can be used for AM modulation or when driven hard can produce pulsed RF signals (full off or full on). When a PIN line is used as a pulse modulator the frequency at the center of the pulse may be as stable as the CW signal; however, it can and usually will have transients associated with the beginning and ending of the pulse due to feed thru of the PIN modulator drive signal. This may feed thru as a single "spike" or may show up as "ringing". Ringing appears as a damped sine wave oscillator at the leading or trailing edge of the pulse. Application Note 922, **Application of PIN DIODES** and AN 929, **Fast Switching PIN DIODES** have more details on PIN lines.

- Used in the voltage controlled attenuator mode, a double balanced mixer can be used to generate RF pulses and gives the advantage of less perturbations in the leading and trailing portions of the pulse. Noise on the modulating signal should be kept to a minimum as it can amplitude modulate the RF pulse. Also the two input signals plus other modulation products may be present at low levels on the output.

For typical operational instructions and considerations refer to the HP 10514A Double Balanced Mixer Data Sheet.

Any of the above mentioned modulation methods generate some spurious signals which make it difficult to get a simple definition of frequency within the burst and may cause false operations of a measuring system particularly when in the automatic band selection mode of operation. FIG. II-1 shows how the down converted (VIDEO) signal looks when spurious signals are present.

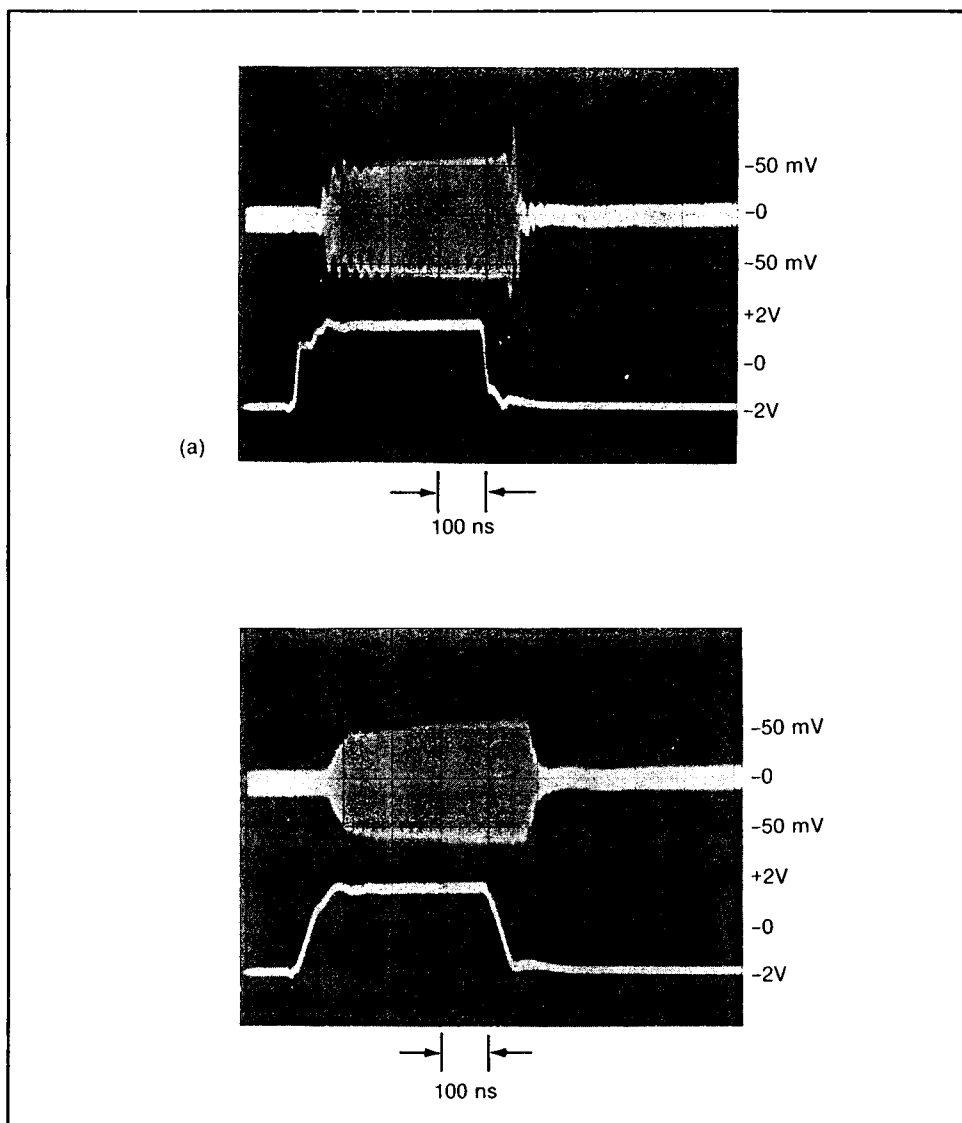

**FIGURE II-1** Down converted (VIDEO) signal and drive pulse to PIN modulator showing transients introduced by a fast rise drive pulse (a). RF input to 5354A 3.56 GHz at -5dBm peak.

## GENERAL CONSIDERATIONS

Many present day CW and pulse modulated signal generators generate the signal at a low level then use a power amplifier to get a more useable level at the output terminal. The block diagram FIG II-2 shows a typical generating configuration and points out some of the areas that may create measurement problems.

Several points are worth remembering as they can affect measurements made on the generator.

1. If the oscillator (A) signal is not clean all its noise and spurious components will appear amplified at the generator output terminal.
2. The continuously variable level control (B) drops the output level of the signal from the oscillator (A) but does **not** reduce any of the noise introduced by the power amplifier, metering or modulating circuits. Consequently, OUTPUT signal to noise ratio **degrades** when this control is used to reduce output level. In some generators the oscillator (A) is actually driven harder when the output step attenuator is in the MAX output position so that the signal purity may be worse at maximum output than for any other attenuator step.
3. The output attenuator (F) reduces all internally generated signals and noise if connected just ahead of the OUTPUT terminal. For best signal to noise ratio keep the variable control (B) set as high as possible and reduce signal level with OUTPUT ATTEN (F).

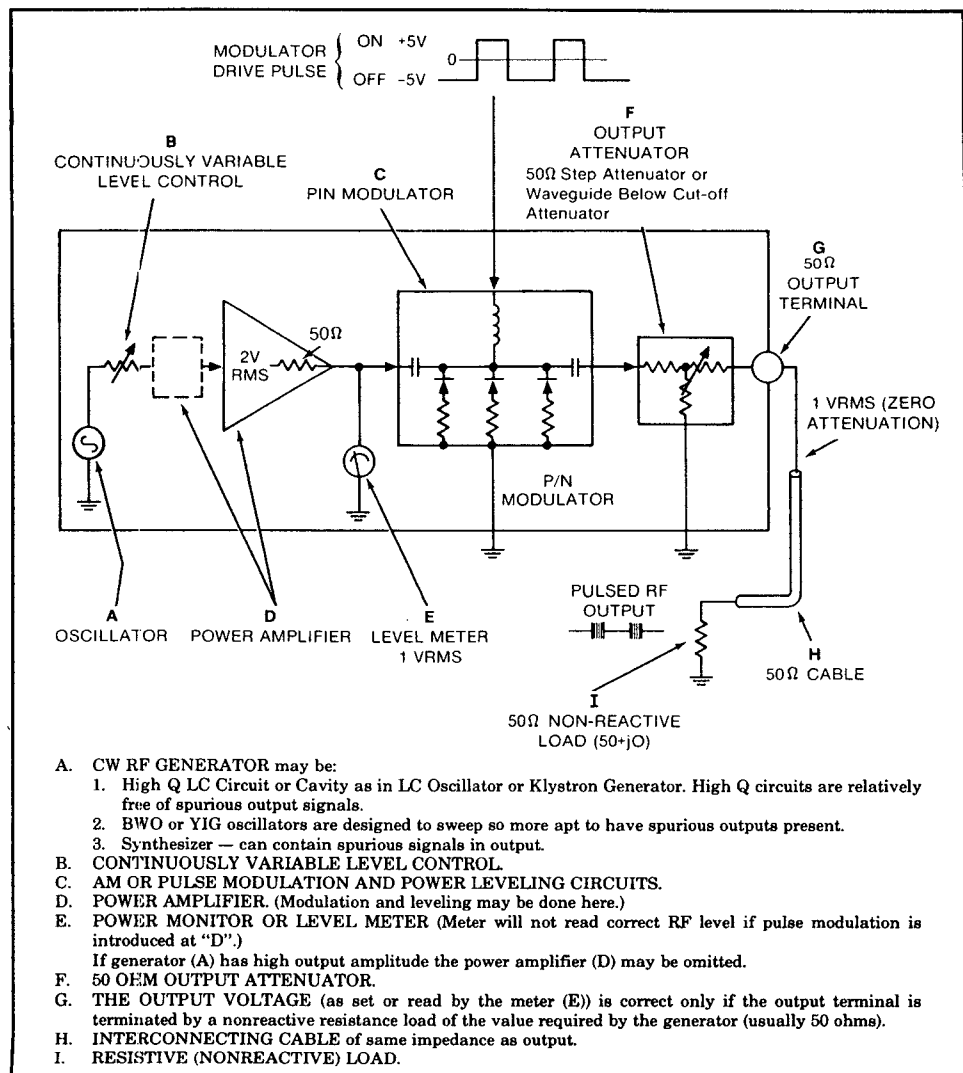

FIGURE II-2 Typical microwave signal generator block diagram.

4. The output voltage or power level, as indicated by the meter, is correct **only** if the generator is terminated with its specified resistance load. The voltage is also the same at the end of an interconnecting cable except for some cable loss (usually small for 2 to 3 foot cables used in measuring set ups but not necessarily small for cable runs of 100 feet or more). Generator impedance is 50 ohms for most general purpose generators; however it may be 75 ohms, 93 ohms or 125 ohms on some communications and TV test equipment. Correct termination requires not only the correct load resistance but also interconnection with cables designed for that particular impedance.

For most generators, the open circuit terminal voltage will be twice that indicated by the meter since the internal generator impedance for a matched system is the same as the required external load. Also, a short circuit which reduces the terminal voltage to zero does **not** necessarily change the meter reading due to internal isolation.

One other important consideration when driving high resistance (1 megohm input) instruments is the use of 50 $\Omega$  feed thru loads. A 50 $\Omega$  resistor provides a correct resistive termination when paralleling the 1 megohm resistor in the instrument, however, a shunt capacitance of only 30 pf looks like 20 ohms reactive at 300 MHz and less at higher frequencies. This of course provides a very poor termination for a 50  $\Omega$  line even if the resistive component is correct. The only correct termination for a 50 ohm line is a load of 50 $\Omega$  + j0 which means that the load has no reactive component.

5. The 50 $\Omega$  position on the 5345A and B inputs is important when working with high frequencies as it provides a correct termination for a 50 $\Omega$  line.

Care must be taken to insure proper terminations at high frequencies, specially where standing waves may be present, since at 500 MHz a quarter wave transmission line is only 10 inches long for an air line and even shorter for co-ax cable. The same care and matching considerations practiced at microwave frequencies should be observed if accurate, repeatable measurements are to be assured.



### III. HIGH RESOLUTION PULSED RF MEASUREMENTS TO 500 MHz

#### AUTOMATIC PULSED RF MEASUREMENTS

The HP 5345A Electronic Counter offers a solution to the problem of automatically measuring pulsed RF frequencies. This counter has triggered gating circuitry so a measurement does not begin until the first cycle of the input pulsed RF signal occurs; consequently, pulsed RF measurements to 500 MHz as well as CW measurements can be made without use of auxiliary equipment. The only special requirement is that the front panel GATE TIME selector, 0.1 $\mu$  sec to 1000 sec, must be set to less than the width of the RF burst. If the GATE TIME is slightly too long or if the counter should arm itself near the end of the pulse the LED test (same as for reset) will appear on the display. The "MIN" setting gives a measurement time of approximately one cycle of the RF signal or 50 nsec whichever is longer, beginning with the first cycle of the input pulsed RF signal of sufficient amplitude to trigger the counter.

Adequate measurement resolution is a problem in practical pulsed RF measurements because many systems operate with pulse widths of less than 5  $\mu$ sec, in fact many systems use pulse widths under 1  $\mu$ sec. The 5345A reciprocal counter is ideally suited for short pulse measurements for several reasons: First, it always measures one or more periods of the input signal then calculates and displays frequency. This technique gives the highest possible resolution for a given input frequency. Second, resolution is independent of the frequency being measured, since the  $\pm 1$  count error is associated with the 500 MHz (2 nsec) clock rather than with the input signal as is the case for a conventional counter. Third, the 5345A can accept an external arm or external gate signal to avoid inaccuracies caused by transients associated with many pulsed RF signals.

#### ADVANTAGES OF CONTROLLED GATING

A pulsed RF signal may have undesirable frequency transients at the beginning and end which are not representative of the frequency present during the body of pulse. Inclusion of these transients can lead to errors in measuring a pulsed frequency. These errors become even more significant when narrow RF pulses are being measured since the time during which transients are present becomes a greater percent of the pulse width. Such transients can be ignored by providing an EXT ARM or EXT GATE signal to the counter. EXT ARM mode can be used to start a measurement at some designated time following the beginning of a pulse burst. The 5345A counter will "ARM" in less than 1  $\mu$ sec after receipt of a 0 to -1 Volt arming pulse.

NOTE: SAMPLE RATE must be in HOLD when using EXT ARM or the counter will receive an extra ARM pulse each time SAMPLE RATE "runs down".

Even greater advantages are provided by the external gating and frequency averaging capabilities unique to the 5345A.

#### EXTERNAL GATING

EXT GATE is the most useful function for pulsed RF measurements. This mode of operation allows the user to not only control the starting time of the measurement but also to select the exact length of the measurement. It allows the operator to choose any arbitrary gate time greater than 20 nsec and to position the measurement as desired within the RF burst to avoid transients associated with the beginning and ending of the RF pulse. This is done by supplying a -1 Volt EXT GATE pulse of desired duration to the GATE CONTROL INPUT connector on the rear panel of the 5345A counter. The counter will be armed in less than 20 nsec after the EXT GATE signal is applied. One EXT GATE pulse (-1 V to 0 V transition) is needed to ARM the counter and subsequent pulses operate the gate.

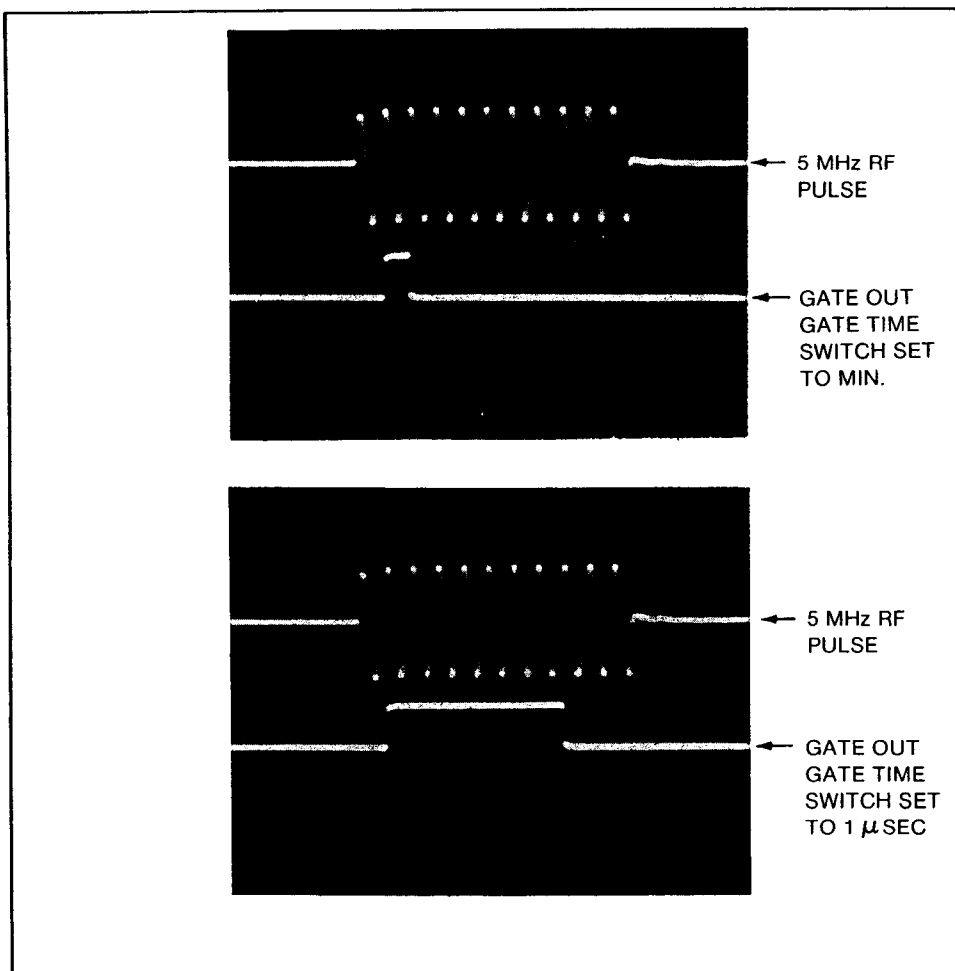

**FIGURE III-1** Pulsed RF measurement on a system when counter clock, RF frequency and EXT GATE are all synchronized. Generated with 10514A.

Use of an EXT GATE of appropriate width also allows the measurement to be made over a greater portion of the pulse than is possible with the front panel GATE TIME control which is adjustable only in decade steps from  $0.1 \mu\text{sec}$  to 1000 sec. A gate nearly as long as the RF pulse is desirable since it will give the greatest measurement resolution. Resolution below 500 MHz is 3 digits for a  $1 \mu\text{sec}$  gate for a single pulse measurement, 4 digits for a  $10 \mu\text{sec}$  gate and so on for the CHANNEL A input.

A further advantage is that the 5345A can measure the frequency profile of a frequency agile pulse by using a short EXT GATE which can be "scanned" through a wide RF pulse to measure the frequency distribution at different points within the pulse. Scanning can be done manually using the delay control of a pulse generator or electrically using a timing generator.

In applications such as frequency profile measurements an EXT GATE as narrow as 20 nsec may be used. For such narrow gates frequency averaging is usually necessary to achieve the desired resolution.

The external gate width is easily determined by switching the counter panel controls to TIME INT A to B & CHECK. The counter display will be the EXT GATE width with correctly positioned decimal point and units.

### INCREASED RESOLUTION WITH FREQUENCY AVERAGING

The 5345A Counter has frequency averaging capability to provide even greater frequency resolution on repetitive pulsed RF signals.

Averaging improves the worst case rms resolution over that of a single pulse measurement by  $\sqrt{N}$  where  $N$  equals the number of samples averaged. The actual display on the counter will increase in direct proportion to  $N$  even though the rms resolution increases by  $\sqrt{N}$ . For example, a measurement consisting of 100 samples will increase the display two digits. The least significant digit may be unstable and can be removed with the DISPLAY POSITION control if desired.

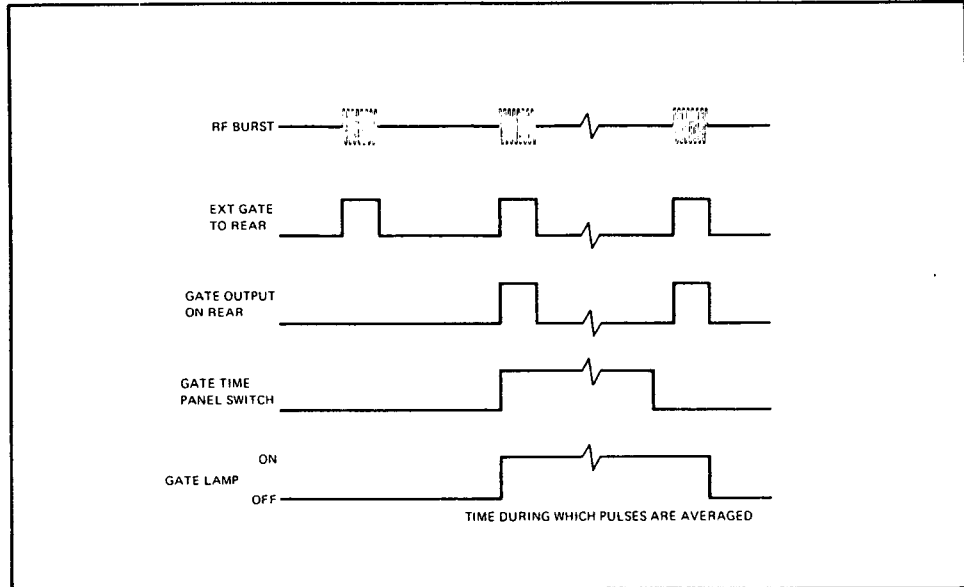

FIGURE III-2 For frequency averaging use EXT GATE on rear.

If it is difficult to determine the rms value of the extra digit, increasing the GATE TIME one more step should insure that the digit is stable 95% ( $3\sigma$ ) of the time.

The following example shows some important factors in an actual measurement. The original resolution will be determined by the single shot gate width and is  $2 \times 10^{-9}$ /sec of gate time, i.e.,  $1 \mu\text{sec} = 3$  digits,  $10 \mu\text{sec} = 4$  digits, . . . ,  $1 \text{sec} = 9$  digits.

In this example

|  |  |
|--|--|
| EXT GATE width   | = $1 \mu\text{sec}$ (giving 3 digits)  |
| EXT GATE repetition rate                                     | = 200 Hz   |
| GATE TIME setting  | = $100 \mu\text{sec}$  |
| Number of samples averaged                                   | = $\frac{100 \mu\text{sec}}{1 \mu\text{sec}} = 100$                              |
| Increase in display  | = 100  |
| RMS worst case increase in resolution over single shot case. | = $\sqrt{100} = 10$  |
| Measurement Time   | = $\frac{100 \mu\text{sec}}{1 \mu\text{sec}} / 200 \text{ Hz} = 0.5 \text{ sec}$ |

True averaging is achieved **only** when the input pulse repetition rate is not coherent with the counter clock. The 5345A has a unique circuit that adds white noise to the clock frequency whenever an EXT GATE is used and the TIME BASE switch on the front is out of "MIN". This white noise breaks up any coherence between the pulsed RF repetition rate and the clock frequency of the counter so the operator need not be concerned with the repetition rate of his input signal as he had to with the earlier counters that did averaging.

This circuit is disabled when making "one shot" measurements as clock noise would reduce accuracy in this case.

When frequency averaging, one EXT GATE pulse is necessary to arm the counter, subsequent pulses are averaged.

$$\begin{aligned} \text{Number of bursts averaged} &= \frac{\text{GATE TIME set on front panel}}{\text{*EXT GATE width supplied to rear}} \\ \text{Measurement Time} &= \frac{\text{bursts averaged}}{\text{**repetition rate}} = \text{seconds} \end{aligned}$$

### INCREASED ACCURACY WITH FREQUENCY AVERAGING

While displaying a relatively large amount of very usable resolution, the absolute accuracy of frequency average measurements will be less than the displayed resolution (will read slightly low) due to known circuit delays within the counter. The gate time error is a fixed time error of a few pico seconds; therefore, the frequency error will become more pronounced as the EXT GATE signal becomes narrower. For any given EXT GATE width a good portion of this error can be calibrated out of the measurement when maximum accuracy is required.

When averaging 100 measurements for an improvement of X10 in stable resolution the gate error is usually insignificant.

When taking more samples for greater resolution, greater absolute accuracy can also be obtained by using a calibration factor for the particular EXT GATE width being used. The calibration factor may be determined by counting a stable high frequency signal applied to CHAN A using the FREQ A mode and the **same** external gating pattern as used for the signal of interest. Average as many readings as necessary to get the resolution desired. When using the 10 MHz STANDARD available on the rear panel of the 5345A the counter may display 9.99xx MHz instead of the expected 10.0000 MHz. The calibration factor, cf, for this external gate width will be

$$Cf = \frac{\text{known frequency}}{\text{displayed frequency}} = \frac{10.000 \text{ MHz}}{9.99xx \text{ MHz}} = 1.00xx$$

The unknown pulse carrier = displayed pulse carrier x Cf.

If the 10 MHz STANDARD output of the counter is used to determine the calibration factor, the absolute accuracy of a FREQUENCY AVERAGED pulse measurement can be improved by a factor of at least 20 over the single shot case (where accuracy is essentially the same as the resolution).

NOTE: When using the 5354A Automatic Frequency Converter the correction factor applies only to the signal being counted by the mainframe, F VIDEO. The L O portion of the counters display (1.0 GHz, 1.5 GHz, etc.) contains no error.

The calibration factor also varies somewhat as a function of frequency. A further improvement can be made, almost to the displayed resolution, by using a CW calibration frequency close to the video frequency the mainframe is counting, i.e., counter displays 362.7 MHz, choose 350 MHz. The value of the chosen stable high frequency signal can be found easily by applying it to CHAN A, and measuring FREQ A with internal gating, thus determining the "known frequency". Switching to EXT GATE will determine "displayed frequency" so the correction factor, cf, is determined as before.

\*Set counter to TIME INT. A to B and CHECK to verify EXT GATE width.

\*\*Set counter to INT GATE, FREQ A, apply EXT GATE signal to channel A and measure the sampling repetition rate.

### EXAMPLE

Video signal applied to mainframe = 345.678910 MHz  
 External gate pulse width = 1  $\mu$ sec (or 500 clock pulses)  
 Single shot video resolution = 345 MHz  
 Single shot accuracy =  $\frac{\pm 1 \text{ clock pulse}}{500 \text{ clock pulses}} = 0.2\%$

### TAKING A MEASUREMENT

RMS resolution when averaging  $= \sqrt{N}$ , so for a visibly stable extra digit take 1000 samples.

Measurement with 1000 samples  $F_{\text{VIDEO}} = 345.5$  Measurement is within  $\pm 1$  count of actual value.

Measurement with 100,000 samples  $F_{\text{VIDEO}} = 345.57$  Resolution is stable but actual value is low.

### DETERMINING CALIBRATION FACTOR

$Cf^1$  . . . determined by using the 10 MHz out of the counter.

NOTE: At least 10 periods of the calibrating signal should fall within the external gate being used. In this case the period of 10 MHz = 100 nsec so 10 periods will be present in 1  $\mu$ sec.

$$Cf^1 = \frac{\text{CW value (INT GATE)}}{\text{pulsed value (EXT GATE)}} = \frac{10.0000}{9.9973} = 1.000270$$

$$\begin{aligned} \text{corrected video} &= F_{\text{VIDEO}} \times Cf^1 = 345.57 \times 1.000270 \\ &= 345.66 \text{ MHz} \end{aligned}$$

Therefore, in this example we have an accuracy improvement factor over the single shot case of

$$\frac{0.2\%}{\frac{1}{34566} \times 100\%} = \frac{0.2}{0.00289} = 69$$

As mentioned before, calibrating with the 10 MHz STD OUT signal, as above, will give an expected accuracy improvement factor of at least X20 over the single shot accuracy.

$Cf^2$  . . . determined by using a stable video source close in frequency to the measured  $F_{\text{VIDEO}}$ . In this case 350 MHz was chosen and  $10^6$  samples were taken.

$$Cf^2 = \frac{\text{CW value}}{\text{pulsed value}} = \frac{350.0000}{349.896} = 1.000297$$

$$\begin{aligned} \text{Actual video} &= F_{\text{VIDEO}} \times Cf^1 = 345.57 \times 1.000297 \\ &= 345.67 \text{ MHz} \end{aligned}$$

In this case both the resolution and accuracy have been improved by a factor of X100 over the single shot case.

Cf<sup>3</sup> . . . determined by using a video signal the same as the video in the microwave pulse. In this case a synthesizer was used and 10<sup>6</sup> samples were averaged.

$$Cf^3 = \frac{\text{CW value}}{\text{pulsed value}} = \frac{345.678910}{345.567} = 1.000297$$

Here again we have an improvement factor of X100 for both resolution and accuracy.

When frequency averaging, higher resolution comes at the expense of increased measurement time. Theoretically, resolution could be as great as desired by merely choosing a large "N". In actual practice however, if a measurement takes too long (seconds or minutes) other factors such as signal source drift, trigger level changes, etc., adversely affecting the expected results so for very long measurement times improvement may not be as great as expected.

## IV. HIGH RESOLUTION PULSED RF MEASUREMENTS TO 4 GHz

### OPERATION OF THE 5354A AUTOMATIC FREQUENCY CONVERTER

Most pulsed RF measurements are on signals above 1 GHz so the balance of this section will deal with the 5345A and 5354A Automatic Frequency Converter plug-in which extends automatic pulsed RF measurement capability as well as CW measurements to 4 GHz. The 5354A is an automatic heterodyne converter which down converts RF signals as high as 4 GHz to the 500 MHz range of the 5345A mainframe. This unit is designed to function equally well on pulsed RF or CW signals. Figure IV-1 details heterodyne converter operation.

A heterodyne converter operates in much the same manner as the front end of a superheterodyne radio receiver to translate an unknown high frequency signal,

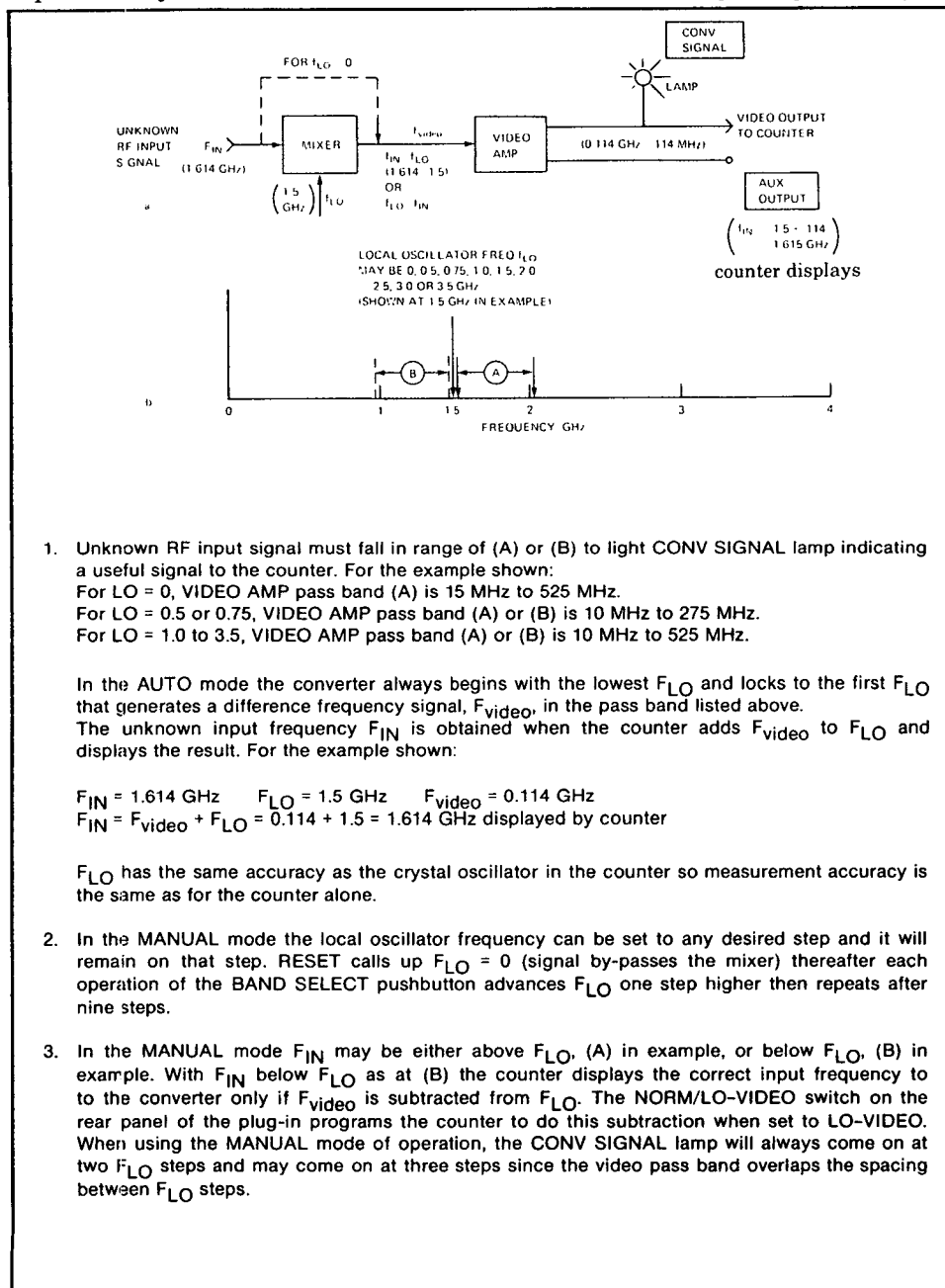

FIGURE IV-1. Heterodyne Converter Operation.

$F_{IN}$ , to a lower frequency,  $F_{VIDEO}$ , within the range of the counter. This is done by mixing  $F_{IN}$  with a precisely known local oscillator frequency,  $F_{LO}$ , derived from the counter's time base. The resulting difference-frequency signal,  $F_{VIDEO}$ , is counted by the electronic counter. Then, if the known  $F_{LO}$  is lower in frequency than the unknown (which can be ensured by always tuning or stepping the converter local oscillator from the low end of its range upward), the counted frequency,  $F_{VIDEO}$  is added to the known  $F_{LO}$  to determine the unknown frequency  $F_{IN}$ . (If  $F_{LO}$  is higher than  $F_{IN}$  the counter reading is subtracted from  $F_{LO}$  to determine the unknown frequency.) A switch on the rear panel of the 5354A allows the counter to perform this addition (NORM) or subtraction (LO-VIDEO) automatically.

In the AUTO mode, the 5354A always acquires a signal with  $F_{LO}$  below  $F_{INPUT}$  so it is important to set the NORM/LO-VIDEO rear switch set to NORM for a proper counter display.

The difference frequency,  $F_{VIDEO}$ , is also present at the 50Ω AUX OUT connector on the rear of the plug-in and may be viewed on a high frequency oscilloscope or used for triggering purposes.

### Operating Modes

- AUTOMATIC:** Measures lowest frequency signal of sufficient amplitude to trigger counter. (approximately -15 dBm).
- MANUAL:** Measures signal within selected band. Signals below 500 MHz feed through directly to counter mainframe so a 500 MHz high pass filter might be desirable in the input line from a microwave source if there is a possibility of low frequency spurious signals interfering with the measurement.

For either mode of operation the CONV SIGNAL lamp indicates a usable signal is applied to the INPUT connector and that the 5354A has selected the appropriate LO frequency.

### CAUTION

When using any high frequency converter, sampler, or other similar device, connect the cable first to the signal generator or other source (so the source load resistor can drain off any dc or static charge) then connect it to the converter. Since all high frequency input circuits are physically small to prevent resonant frequencies within their operating range they do not have a large thermal capacity and are more easily damaged by voltage spikes than are the inputs of low frequency devices.

The nomograph below relates volts, watts and dB for a 50 ohm system and also indicates specified operating ranges for 5354A heterodyne converters.

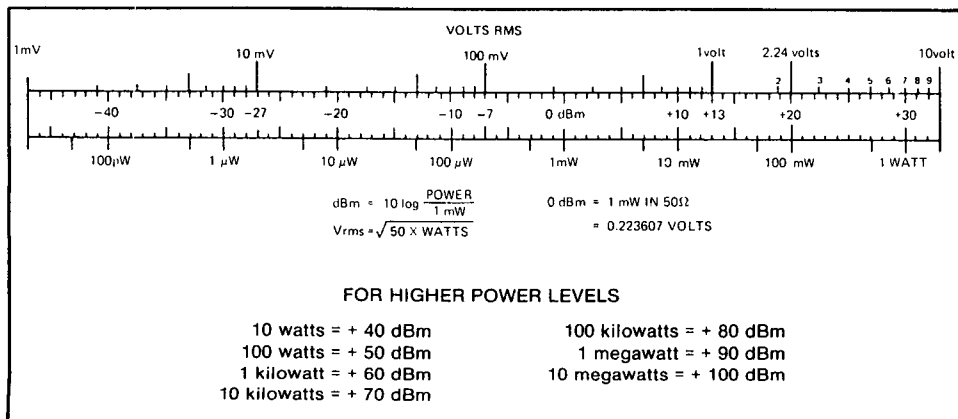

FIGURE IV-2 Nomograph relating dBm, watts and volts for a 50 ohm system.



## AUTOMATIC PULSED RF MEASUREMENT MODE

The 5354A converter is as easily set up for automatic measurement of pulsed RF signals as it is for CW. Operation is the same except the CONT WAVE/PULSED RF switch is switched to the PULSED RF position. This slows the search operation to allow acquisition of bursts with repetition rates as low as 40 Hz for pulses as narrow as 250 nsec. The GATE TIME switch on the counter must be set to a time shorter than the pulse width of the RF burst for a valid measurement. When it is set to MIN, measurements can be made on widths as narrow as 50 nsec. Since a long GATE TIME increases the resolution of the measurement the longest available gate time that is less than the pulse width is usually used.

When automatic RF measurements are being made with the 5354A, spurious signals such as pulse modulator drive feed through on the input signal must not exceed the minimum input required by the plug-in at any frequency below the unknown input frequency to be measured. If a lower frequency spurious signal should exceed this minimum, the 5354A will measure the first such signal above 15 MHz that meets this minimum amplitude requirement rather than the desired signal.

This happens in the AUTO mode of operation because the 5354A always resets to zero then searches toward the high end of its range whenever the CONV SIGNAL light goes out due to:

1. Loss of input signal (or amplitude below approx -11 dBm at the 500 mHz or -16 dBm at 4 GHz end of range at 25°C ambient).
2. Signal sweeps above the band range.
3. Signal sweeps below the band range.

When the CONV SIGNAL light goes out the 5354A first resets to the lowest band (LO=0) then steps upward in frequency stopping at the *first* signal of sufficient amplitude and width. The plug-in operates in the same manner when measuring an RF signal scanning upward in frequency. The LO does not merely step to the next higher LO frequency when the input signal reaches the upper edge of the selected band. Instead, the 5354A resets to zero then scans up to the appropriate LO frequency for the higher input frequency.

Strong spurious signals can be identified by switching the converter to the MAN PULSED RF mode. RESET the 5354A then manually step through the nine LO bands to see if the CONV SIGNAL light comes on in any band below the desired one.

An input signal toward the low end of the sensitivity specification (-10 dBm) helps to reduce the undesirable effect of spurious signals by dropping them below the sensitivity threshold of the plug-in.

NOTE: Many signal generators have the variable level control in a stage before the output amplifier. This control will reduce the amplitude of the output without reducing the amplitude of residual noise and spurious signals. If this is the case, keep the variable level control toward maximum to give best signal to noise ratio. Use the internal step attenuator if it is between the amplifier and output terminal or use an external attenuator to reduce signal level as necessary to drop undesirable signal components below the counter sensitivity threshold. See FIG II-2 for more detail.

HP 11697A, B, C or 8430 series band pass filters can be used at the input to attenuate spurious signals.

## MANUAL BAND SELECTION

The 5354A front panel also has a MANUAL switch position together with BAND SELECT and RESET pushbuttons. MANUAL operating is exactly the same as AUTO except the operator programs the local oscillator frequency,  $F_{LO}$ , by depressing the BAND SELECT button. This mode is used when the approximate input frequency is known and operator wishes to begin making measurements in the shortest possible time after application of an input signal. Since auto-ranging has been eliminated, the counter is now ready to begin taking a reading in about 20 nsec. after the signal appears. Also, when autoranging is not required, pulse measurements can be made on signals with pulse widths down to less than 50 nsec. When manually range changing, the RESET pushbutton resets the 5354A to the "O" or direct through position (no  $F_{LO}$ ) for the range of 15 MHz to 525 MHz. Each push of the BAND SELECT pushbutton steps the local oscillator frequency one step higher in the range 0 (zero is reset state), 0.5, 0.75, 1.0, 1.5, 2.0, 2.5, 3.0 and 3.5 GHz.

NOTE: In MANUAL it is sometimes helpful to be able to verify the operating  $F_{LO}$  of the plug-in. This can be easily done at any time by switching the mainframe to CHECK. The counter will then display  $F_{LO} + 100$  MHz. (For option 011, the NORM/LO-VIDEO switch on rear of plug-in must be in NORM or the display will be  $F_{LO}-100$  MHz.)

Each of these LO frequencies has the same accuracy as the crystal oscillator in the counter so the 5354A introduces no additional error in the measurement.

In the manual mode of operation, the unknown input may either be below or above the local oscillator frequency. The NORM position of the NORM/LO-VIDEO switch on the rear panel is used when the unknown frequency is above the LO and instructs the counter to add the video difference frequency measured by the counter to the local oscillator frequency,  $F_{LO}$ , and display the correct answer. The LO-VIDEO position of the switch instructs the counter to subtract the video difference frequency from the LO frequency and is used when the unknown input frequency is lower than the LO frequency. When operating near the low edge of a band it is often desirable to use the next higher  $F_{LO}$  frequency and LO-VIDEO mode.

For example, with a 100 ns gate:

$$F_{IN} = 1.020 \text{ GHz} \quad F_{LO} = 1.0 \text{ GHz} \quad F_{VIDEO} = F_{IN} - F_{LO} = 20 \text{ MHz (period} = 50 \text{ ns)}$$

In this case only 2 periods of  $F_{VIDEO}$  would be measured by the counter.

Suppose instead

$$F_{LO} = 1.5 \text{ GHz were used.} \quad F_{VIDEO} = F_{LO} - F_{IN} = 480 \text{ MHz (period} \approx 2 \text{ ns)}$$

In this case approximately 50 periods of  $F_{VIDEO}$  are measured, so trigger error is reduced by 25 to 1.

## EXTERNAL GATING FOR INCREASING RESOLUTION AND ACCURACY

External Gating when using the 5354A Automatic Frequency Converter is accomplished in the same manner as when using the mainframe alone (see Section III). The position of the EXT GATE SIGNAL within a microwave pulse can be observed by applying both the 5354A AUX OUT and 5345A GATE OUT signals to a dual trace high frequency oscilloscope.\*

Frequency averaging on a pulsed microwave signal is accomplished exactly the same as for a pulsed RF signal (see Section III) except it is performed only on the video signal fed to the 5345A from the 5354A plug-in.

\*On single shot measurements or when averaging a few bursts, the EXT GATE INPUT signal (negative) gives a better oscilloscope display than the GATE OUT signal as it appears on every burst. The GATE OUT signal is present only on the bursts measured by the counter.

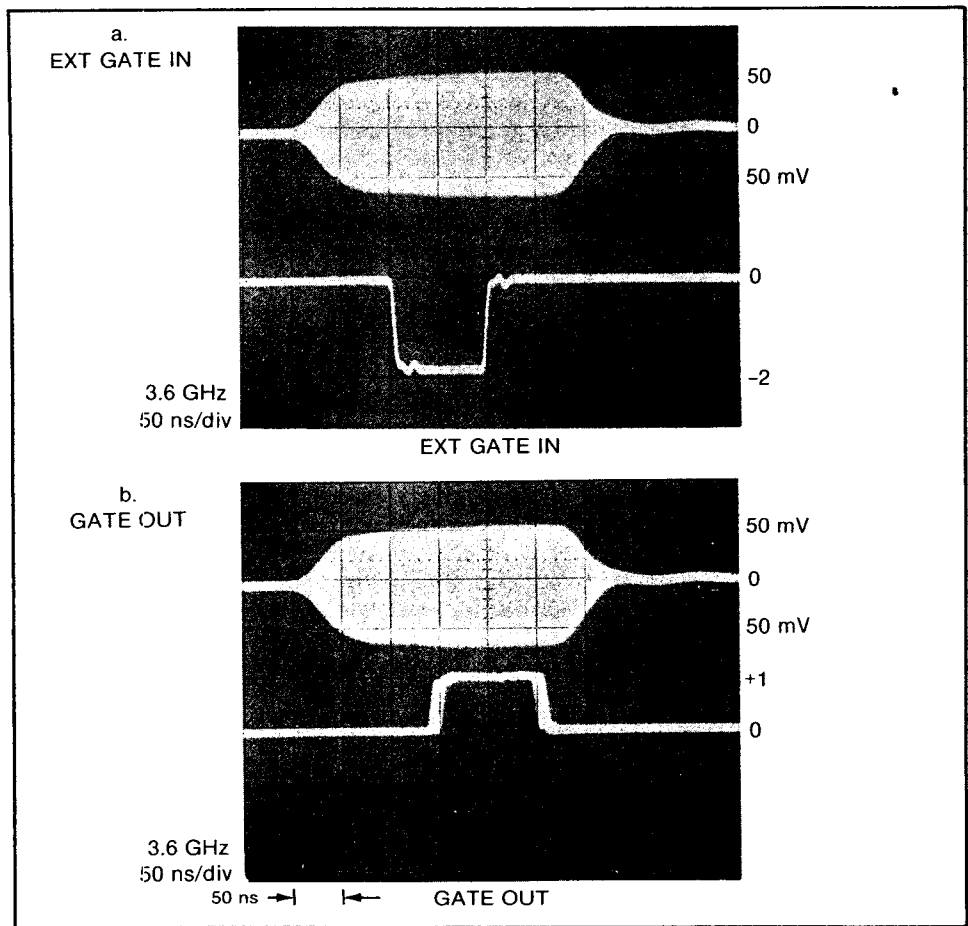

**FIGURE IV-3** Frequency averaging with 5354A. AUX OUT (VIDEO) = 50 mv/division. Pulsed RF input is 3.6 GHz at -10 dBm 300 ns wide. EXT GATE -2V 100 ns wide. GATE OUT is +1 volt.

The video signal is the result of mixing the incoming microwave signal with a harmonic of the counters stable time base,  $F_{LO}$ . The mainframe counts  $F_{VIDEO}$ , adds the proper harmonic frequency and displays the result.

**EXAMPLE OF  $F_{VIDEO}$**

|  | <b>Case 1</b> | <b>Case 2</b> |
|--|---------------|---------------|
| Unknown Microwave Frequency .....                                | 2.8034 GHz    | 1.0304 GHz    |
| Local Oscillator Frequency, $F_{LO}$ .....                       | 2.5 GHz       | 1.0 GHz       |
| Difference Frequency, $F_{VIDEO}$ ,<br>Counted by Mainframe..... | 303 MHz       | 30.4 MHz      |
| Counter Gate Time.....   | 1 $\mu$ sec   | 1 $\mu$ sec   |
| Resultant Display on Counter .....                               | 2.803 GHz     | 1.0304 GHz    |

The resolution of  $2 \times 10^9$ /sec of gate time applies only to  $F_{VIDEO}$ , i.e., 1  $\mu$ sec of gate time = 3 digits of  $F_{VIDEO}$ . Averaging, resolution and accuracy as discussed in Section III apply only to  $F_{VIDEO}$ . The information from the mixing  $F_{LO}$  can be thought of as an extra one or two digits.

Resolution on the video portion of the microwave signal can be increased through FREQUENCY AVERAGING in the same manner as for other RF signals. The discussion on increased resolution in Section III-4 applies directly to microwave signals.

The absolute accuracy of a pulsed microwave carrier frequency measurement can be calculated in a manner similar to that described in Section III-5. Improved

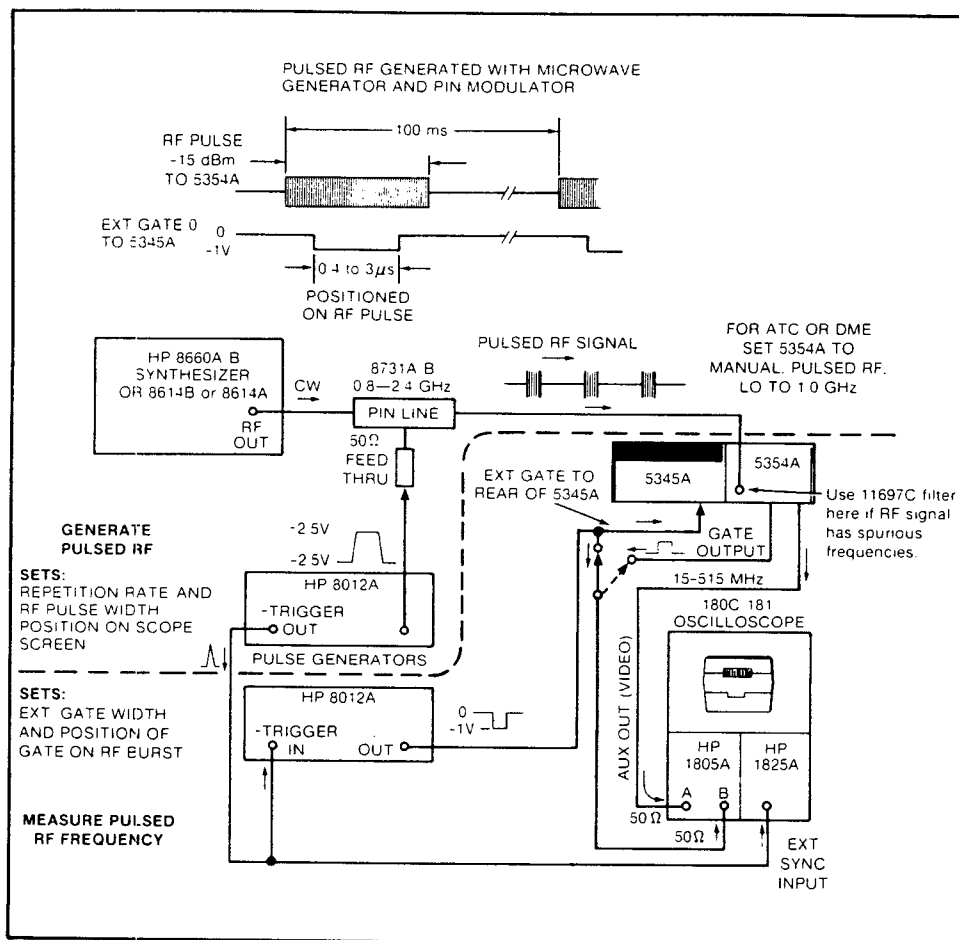

FIGURE IV-4 Frequency averaging of pulsed RF signal using EXT GATE for increased resolution and accuracy.

accuracy when averaging can be achieved by determining a calibrated factor for the EXT. GATE width as described before. The calibration factor is applied to the video portion of the measurement only. The corrected  $F_{VIDEO}$  is then added to the harmonic frequency,  $F_{LO}$ , for the final answer.

#### EXAMPLE USING THE 5354A AUTOMATIC FREQUENCY COUNTER

|                                       |   |
|---------------------------------------|---|
| Actual Microwave Pulse Carrier .....  | 2.845678910 GHz   |
| Local Oscillator Freq, $F_{LO}$ ..... | 2.5 GHz   |
| Video Applied to mainframe .....      | 345.678910 MHz  |
| EXT. GATE pulse width .....           | 1 $\mu$ sec   |
| Single Shot Video Resolution .....    | 345 MHz   |
| Single Shot Video Accuracy .....      | $\frac{\pm 1}{500} = 0.2\%$   |
| Single Shot Video Error .....         | 345 x 0.2% = $\pm 0.69$ MHz   |
| Single Shot Microwave Error .....     | 2.845 $\pm$ .00069 GHz which<br>will appear as 2.845<br>$\pm$ count |
| Single Shot Microwave Accuracy .....  | $\frac{\pm 1}{2845} = 0.035\%$                                      |

## DETERMINING THE CALIBRATION FACTOR

The calibration factor is determined and applied to FVIDEO as described in Section III-5. Cf<sup>1</sup> in this example is determined by using the 10 MHz STD OUT of the 5345A Mainframe. Calibration factors for the EXT GATE pulse width determined at other video frequencies may be used in a similar manner.

$$Cf^1 = \frac{\text{CW VALUE (INT. GATE)}}{\text{PULSED VALUE (EXT. GATE)}} = \frac{10.000}{9.9973} = 1.000270$$

$$F_{\text{VIDEO}} = \text{measured video} = 345.57 \text{ MHz (1x10}^5 \text{ samples)}$$

$$\text{corrected video} = F_{\text{VIDEO}} \times Cf^1 = 345.66 \text{ MHz}$$

$$\text{corrected microwave} = 2.84566 \text{ GHz}$$

$$\text{microwave error} = \frac{\pm 1}{284567} = 0.00035\%$$

Therefore in this example we have an improvement factor over the single shot case of nearly x100.

### Notes on Pulsed RF Measurement

GATE TIME (internal or EXT GATE) must be less than the RF pulse width when measuring pulsed RF signals. An EXT GATE is necessary to do frequency averaging on pulsed RF signals.

| Mode   |           | Acquisition Time | Minimum        |                 | Notes  |
|--------|-----------|------------------|----------------|-----------------|--|
|        |           |                  | Pulse Width    | Repetition Rate |  |
| Auto   | Cont Wave | <160 μsec        | does not apply |                 | a. CHECK reads LO frequency +100 MHz only if CONV. SIGNAL light is on.<br>b. In normal operation video signal from rear BNC is chopped by channel scan signal (period of approx. 160 μsec) as soon as CONV. SIGNAL light goes off.<br>c. Spurious signals. See note on page 4-3.                 |
| Auto   | Pulsed RF | 1 sec            | 250 ns         | 40 Hz           | a. Same as above except pulsed waveform has period of approx. 1 sec when scanning bands when CONV. SIGNAL light goes off.  |
| Manual | Cont Wave | <1 μsec          | does not apply |                 | a. AUX OUTPUT video signal always present if appropriate signal connected to INPUT and BAND SELECT is on correct band. Operator selects LO frequency band manually.<br>b. AUX OUTPUT level gets lower as signal decreases. Counter "locks out" and goes to ARM when CONV. SIGNAL light goes out. |
| Manual | Pulsed RF | <20 nsec         | 50 ns          | no minimum      | a. Same as above except counter lockout circuit is disabled so measurements can be made down to noise level of 5354A.<br>b. Gives added 10 dB or so sensitivity on both CW and pulsed RF.<br>c. May count noise with no RF input signal.   |

FIGURE IV-5. 5345A Operation.

When changing from CW to PULSED RF the band scanning rate is lowered so the 5354A will lock to pulse repetition rates as low as 40 Hz. Time constants on the lock detectors are increased so the unit will lock on low duty cycle pulses.

Filter and level detector circuits require a certain minimum RF INPUT signal level before they will operate. Switching to PULSED RF "arms" these circuits, improving input sensitivity by 10 dB or more and increasing FM tolerance beyond the specifications even for CW signals.

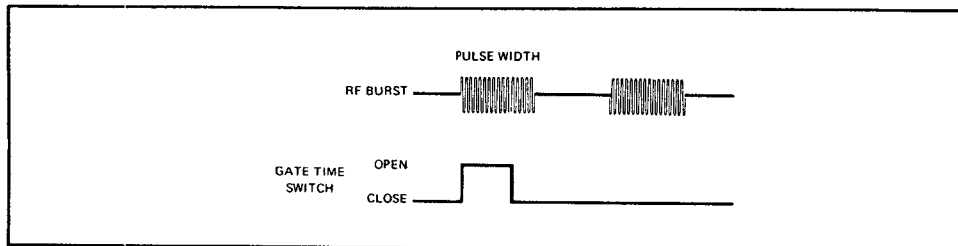

**FIGURE IV-6** For INT ARM, GATE TIME must be less than pulse width.

## V. PULSED MEASUREMENT TO 18GHz WITH 5245 SERIES PLUG-INS

### HETERODYNE CONVERTERS FOR CW MEASUREMENTS TO 18 GHz

Although the 5255A and 5256A Frequency Converter plug-ins were originally designed for counters in the 5245 series, they work even better in the 5345A Counter with the 10590A Plug-In Adapter since their measurement speed and resolution are improved. Operating procedures using the PLUG-IN mode of the 5345A are the same as with counters in the 5245 series, so operating procedures in the plug-in manuals apply without change for CW measurements. Resolution in a given measurement time is greater than it was with the 5245L since 5345A resolves 9 digits per second of GATE TIME.

When using the manual heterodyne plug-ins start tuning at the low end of the converter dial, stop and peak the tuning at the first LO frequency where the LEVEL METER goes to the GREEN part of the scale. Then add the counter reading (FVIDEO) to the LO frequency on the plug-in dial. Decimal point location and measurement units on the counter display may not be the same as for the LO dial so care must be exercised to add the two readings correctly. The 5354A performs this step automatically.

### PULSED MICROWAVE MEASUREMENTS TO 18 GHz WITH HETERODYNE CONVERTERS

Although the 5245 series converters were designed for CW operation the modified H12-5255A and HO3-5256A versions can be used to make pulsed RF measurements in the 3 to 18 GHz range on pulses down to several hundred nsec in width. Electrical modifications detailed below are the same for either plug-in unit.

1. On control circuit assembly A9 the collector of transistor A9Q8 is disconnected from the circuit board. This change disables the low signal lockout circuit which would otherwise reset the counter to zero whenever the signal level meter fell below the GREEN section of the scale.
2. On the 200 MHz video amplifier assembly A7A1, capacitors C2 and C3, 6800 pf, are replaced with 100 pf, HP Part No. 0150-0073.

Remove the 4 screws that secure the front panel to the side plates. Remove the 2 bolts and nuts holding the bottom plate to the rear plastic moulding (one on each side of the rear connector). Slide the front panel and tuner assembly forward for access to the cover on video amplifier assembly A7.

This change decreases the amplitude of transients coupled to the video amplifier at the beginning and ending of the RF burst to permit measurement of pulses less than 2  $\mu$ sec wide. Low frequency video cut off is raised from 1 MHz to about 25 MHz so sensitivity will be lower than for a standard unit at low difference (video) frequencies.

In all other respects these plug-ins are electrically identical to standard units.

The following procedure is used when making a pulsed RF measurement with one of these modified plug-in units.

1. Connect a 182C/1805A/1825A or 1710A Oscilloscope to the AUX OUT of the converter to serve as a tuning indicator.

This is necessary since the SIGNAL LEVEL meter on the converter no longer functions. Its operation is based on average power input so it will not read on low duty cycle pulses.

If desired, a microwave CW signal generator with a calibrated attenuator can be connected to the plug-in input to get a calibration of RF input level vs AUX OUT peak to peak volts displayed on the oscilloscope. When tuning the converter, tune for a peak indication on the oscilloscope.

Typical peak to peak AUX OUT levels for a 5255A with a 3.45 GHz input and FLO dial peaked at 3.4 GHz are shown:

| CW or Peak pulsed<br>RF LEVEL | 3.45 GHz<br>50 MHz VIDEO<br>Peak to peak<br>AUX OUTPUT TO SCOPE |
|-------------------------------|---|
| 0dBm                          | 150 mV p-p into 50Ω   |
| -5                            | 150   |
| -10                           | 150   |
| -11                           | 150—5255A video amplifier limits with CW input                  |
| -15                           | 110   |
| -16                           | 90—5255A LEVEL METER at RED-GREEN<br>transition with CW input   |
| -20                           | 60  |
| -25                           | 30  |
| -30                           | 20  |

The AUX OUTPUT frequency can go as high as 230 MHz, however a 100 MHz Oscilloscope (182C/1805A/1825A or a 1710A) can be used by tuning to the LO frequency above the unknown RF INPUT if necessary so that the difference frequency is kept below 100 MHz. (subtract counter reading from LO to get INPUT frequency). Alternately, a real time oscilloscope of 200 MHz or greater bandwidth and 10 millivolt sensitivity could be used.

- RF input level is more critical when measuring pulsed RF than when measuring CW signals. A high amplitude RF pulsed signal gives a better signal to noise ratio at the video output of the plug-in but it also introduces a bigger step at the beginning and end of the pulse as shown in FIG V-1. This can degrade measurement accuracy. Pulse modulators can also introduce spurious frequencies at the beginning and end of pulses and this also causes measurement problems even when signal levels are set correctly.

For these reasons pulsed RF measurements are best made using an EXT GATE input to the rear of the 5345A counter since the measurement can be positioned within the RF burst to avoid obvious abnormalities. See Section II for a general discussion of pulsed RF measurements. An EXT GATE is of course mandatory when frequency averaging is used to improve resolution.

When measuring radar and other high power pulsed RF systems a high pass filter or bandpass (HP 8430 series) filter may be necessary at the RF input to the 5255A/5256A to prevent pulse modulator feedthru from saturating the video amplifier of the plug-in.

In any pulsed RF work the oscilloscope display is invaluable in setting up the measurement as it will show many of the problems that lead to incorrect results. In general best results can be obtained by keeping the input level low and monitoring the down converted video signal with an oscilloscope.



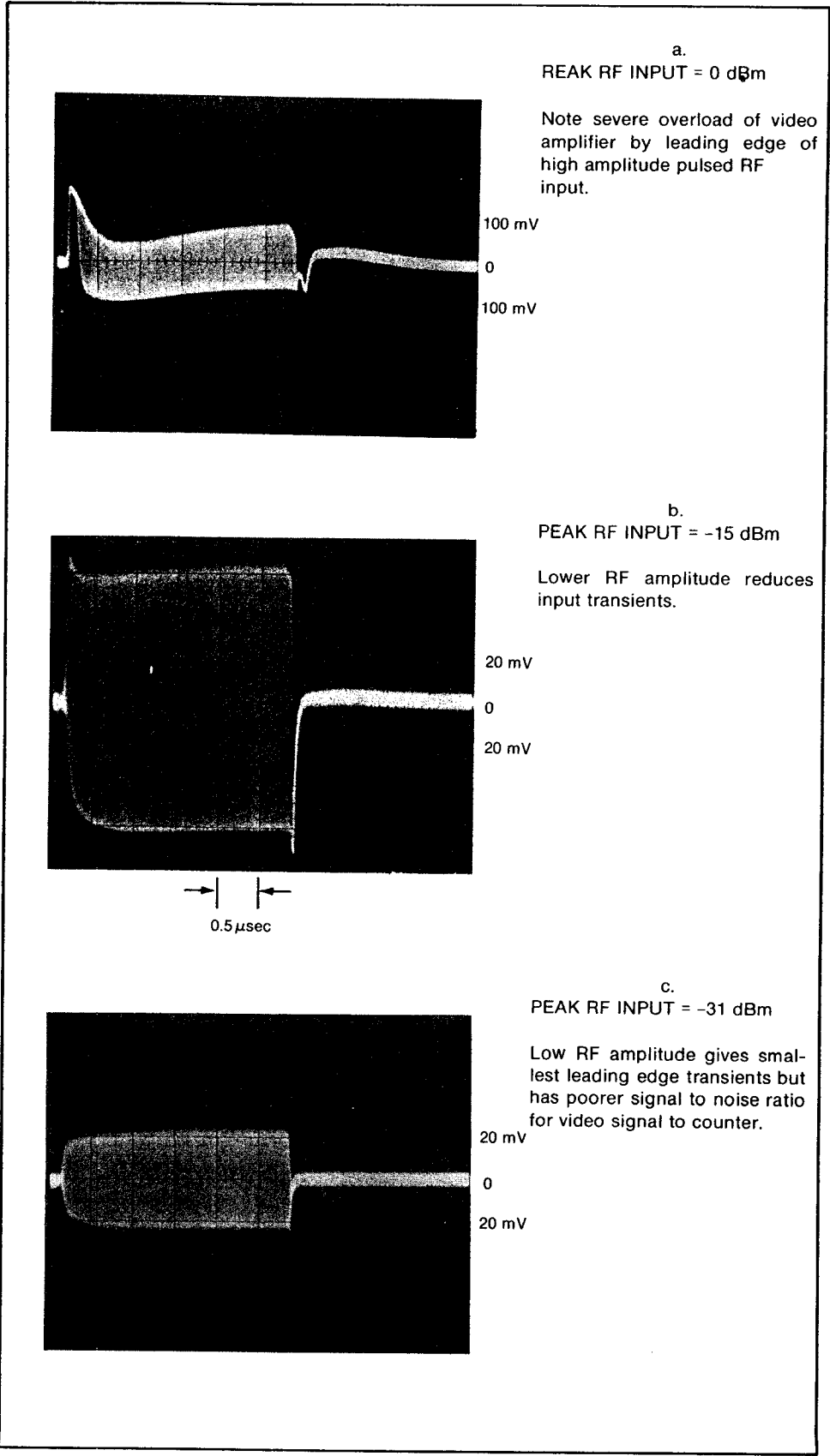

**FIGURE V-1** AUX OUT (VIDEO) from the H12-5255A displayed on a 100 MHz oscilloscope with sweep of .5 μsec/division. Signal input of 3.46 GHz.

3. On particularly noisy or distorted pulses, improvement can sometimes be obtained by counting the AUX OUT of the plug-in with the FREQ A mode of the counter rather than by reading the internally connected F VIDEO with the PLUG-IN mode.

Assuming the manual heterodyne converter has been properly tuned, additional control over the video signal can now be obtained by connecting a  $50\Omega$  attenuator (HP 355C, 0 to 12 db) between the plug-in AUX OUT and the mainframe FREQ A input. Also, the SLOPE and LEVEL controls on the CHANNEL A input will be effective in selecting an optimum trigger point.

Greater sensitivity can be achieved with this technique also, since F VIDEO is now being counted with the 10 mv input of the mainframe.

4. The 5254A/B/C Frequency Converter with 10590A Adapter can be used for the range between 500 MHz and 3 GHz. Modifications are not necessary as these plug-ins do not have the low signal level lock-out feature of the high frequency units. Operation and precautions are the same as discussed previously for the 5255A and 5256A. For most applications in this range the 5354A Automatic Frequency Converter is recommended particularly for pulsed RF work because its wider frequency range and superior high frequency performance will give better response on narrow pulses.

#### MEASUREMENTS TO 18 GHz WITH 5257A TRANSFER OSCILLATOR

The 5257A Transfer Oscillator/10590A Plug-in Adapter measures CW, AM, FM and pulsed RF signals better in the 5345A than in the 5245 series counters for which it was originally designed. Operation is identical including calculating the harmonic number and setting the harmonic number "N" switches. The 5345A displays the signal input frequency directly complete with decimal point and measurement units when the proper harmonic number "N" has been selected with the thumbwheel switches.

NOTE: Do *not* use an EXT GATE with the 5257A Transfer Oscillator. It is not necessary since the counter always measures the CW oscillator in the plug-in. Therefore the INT ARM mode and a gate of desired length gives best resolution and accuracy.

Advantages of the transfer oscillator plug-in are:

1. The 5345A plus one plug-in gives continuous coverage to 18 GHz.
2. All types of RF signals such as CW, FM, AM and pulsed signals can be measured.
3. FM deviation, pulse width, pulse repetition rate and other measurements can also be made if an oscilloscope is used to monitor the PULSED RF OUT of the plug-in.

The disadvantages are:

1. Greater measurement time is required for a given resolution compared to direct or heterodyne measurements.
2. Greater operator skill necessary for proper operation than with heterodyne converters.
3. When measuring pulsed RF, operation becomes more difficult at low repetition rate signals and for pulse widths  $<1 \mu s$ .

The 5257A Operating and Service Manual, Application Note No. 141 **AM, FM Measurements with the Transfer Oscillator**, the **HP Journal** Volume 19, No. 6 February 1968 and the 5257A Transfer Oscillator Training Manual give complete information on the use of this plug-in.

## VI. EXTERNAL GATE SYNCHRONIZATION

### GENERATING THE EXTERNAL GATE

Frequency averaging may be used only on repetitive pulses and requires an EXT GATE which can be generated by an HP 8007A, HP 8012A or a similar pulse generator triggered by a sync pulse coincident with the RF burst. Controls on the pulse generator set EXT GATE width with the pulse width control and the location within the RF burst with the delay control. (The 1821A Time Base and Delay Generator in a 180 series oscilloscope can be used to generate gates of 1  $\mu$ sec and longer.) The EXT GATE is activated by applying a neg. one volt signal to the 5345A rear panel 50 $\Omega$  GATE CONTROL INPUT. The width of the EXT GATE signal can be accurately measured by simply switching the 5345A front panel control to TIME INT A to B and to CHECK.

### DERIVING THE SYNC PULSE FROM THE PULSE ENVELOPE

A sync pulse, when available from the modulating source, can be used to trigger the EXT GATE generator as described above. However, if a sync pulse is not available, it can be generated by demodulating and amplifying the input microwave pulse. A power splitter at the input can be used to drive a demodulator/amplifier as well as the plug-in input. An important advantage of this method of generating a trigger is that if the RF pulse has jitter, the sync pulse will follow the jitter on a pulse by pulse basis. The disadvantage is the demodulator and amplifier introduce some delay, perhaps up to a microsecond or two primarily due to the detector rise time, so the EXT GATE cannot be scanned through the entire microwave pulse.

When measuring a transmitter (RADAR, ATC, DME, etc) an attenuator, rather than an amplifier is required to reduce the RF signal to a level that can be safely measured by the plug-in. See Nomograph on Figure IV-2 for power levels. A power splitter is used to drive the detector at a peak level of 100 milli-watt or higher to generate a trigger pulse. Additional attenuation (HP 8491A/B or HP 354A) in the other output is used to bring the peak level to about -5 dBm for the plug-in.

### DERIVING THE SYNC PULSE FROM THE VIDEO SIGNAL

Another way to generate an external gate synchronous with an RF pulse is shown in Fig. VI-1. The AUX OUT (VIDEO) signal from the rear of the 5354A Frequency Converter (or the front of the 5255A/5256A) can be amplified and connected to the EXT INPUT of the 8007A/B Pulse Generator operating in the GATE mode. The first half cycle of the VIDEO signal ( $\pm$  slope depending on 8007A/B input control settings) triggers the pulse generator to generate one EXT GATE drive pulse for each RF burst. The PULSE DELAY control of the pulse generator controls the position of the EXT GATE on the RF burst (minimum delay is approx 100 ns) and the PULSE WIDTH control sets the EXT GATE width. The circuit, as shown, is limited to maximum video frequencies of about 100 MHz due to trigger input limitations of the 8007B Pulse Generator, however, the technique can be applied over the full 500 MHz video bandwidth if a suitable pulse generator, oscilloscope sweep delay or fabricated circuit is used.

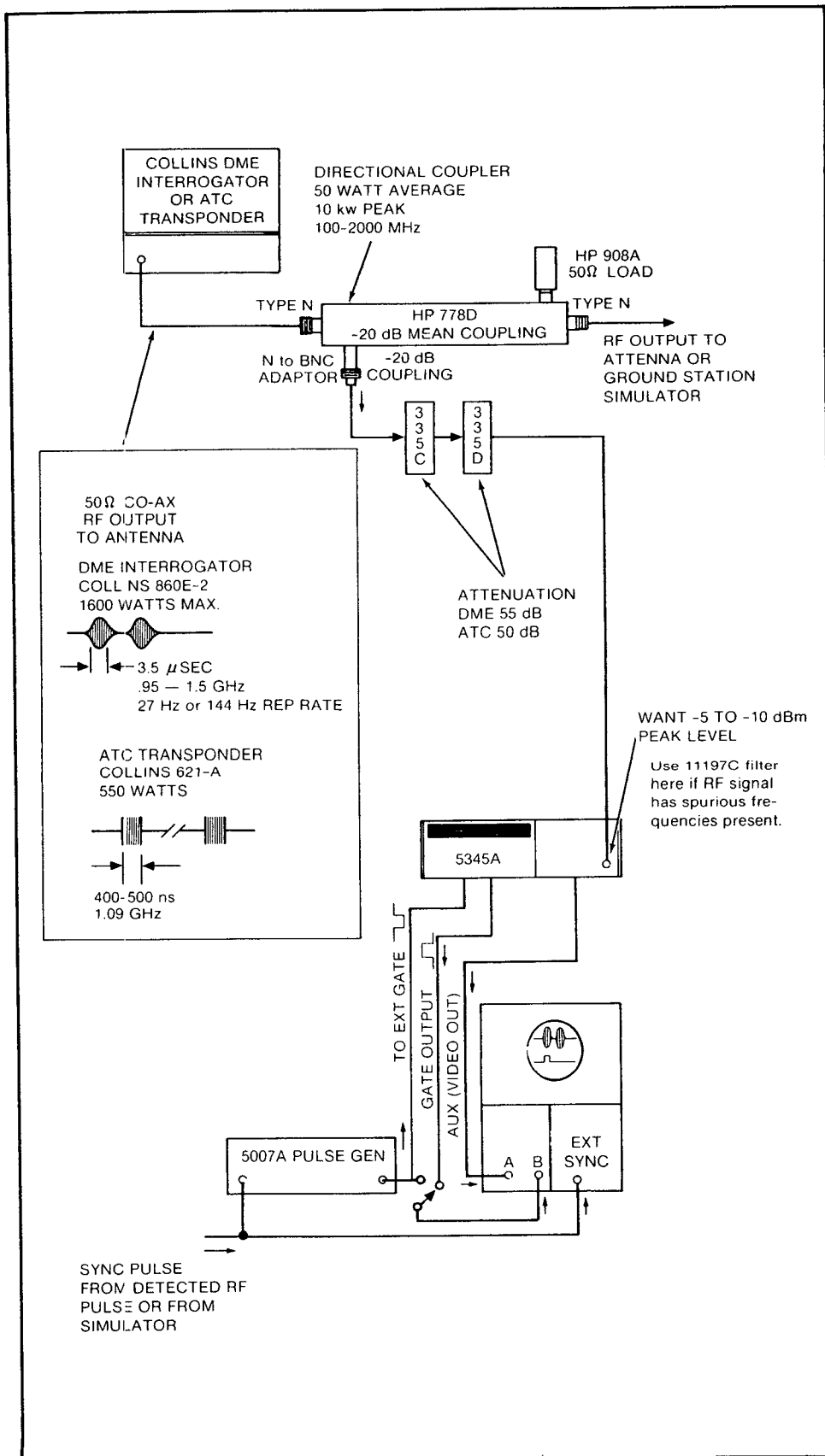

FIGURE VI-1 Measuring frequency of Airborne Transponder.

