

HP Archive

This vintage Hewlett Packard document was preserved
and distributed by

[www. hparchive.com](http://www.hparchive.com)

Please visit us on the web !

On-line curator: Glenn Robb

1968 INSTRUMENTATION·ELECTRONIC·ANALYTICAL·MEDICAL

HEWLETT  PACKARD

About this reference book . . .

Your copy of this catalog is presented with the compliments of Hewlett-Packard, to simplify and aid in your selection of quality instrumentation for almost every measuring task—and to provide helpful information about applications and measuring techniques. We hope you will find it easy to use, and we welcome your suggestions for making future editions more useful.

To locate an instrument or system . . . select one of four product sections shown at right . . . use thumbcut to open catalog to that section's TABLE OF CONTENTS page . . . and locate page number for item of interest. Should the item not be listed in that TABLE, refer to FUNCTIONAL INDEX at rear of catalog.

To locate an instrument or system by its model number . . . refer to MODEL NUMBER INDEX at rear of catalog.

To determine the sales and service office serving your area . . . see page 1.

To receive information about new products introduced during 1968 . . . you are invited to place your name on the circulation list for any of our three technical periodicals described on page 16. In addition to receiving timely applications and measuring technique information, you will automatically receive catalog updating digests as they are published.

**FOR COMPLETE
APPLICATION & SALES
INFORMATION
CALL**

Holly Cole
your

NEELY
FIELD ENGINEER

**HEWLETT PACKARD
NEELY**

Sales Division

3939 LANKERSHIM BLVD.
NORTH HOLLYWOOD, CALIF.
877-1282

About Hewlett-Packard

Analytical Instrumentation

Medical Instrumentation

Recorders, Data Acquisition Systems, Computers & Peripherals

Electronic Instrumentation and Components

Indexes

ELECTRONICS SHOP
RM. 64 CHURCH

Carbon-Hydrogen-Nitrogen
 Analyzers
 Gas Chromatographs,
 High Efficiency
 Gas Chromatographs,
 Laboratory

Gas Chromatographs,
 Preparative
 Gas Chromatographs,
 Research
 Osmometers, Membrane

Osmometers, Vapor Pressure
 Spectrometers, Microwave
 Thermometers, Quartz
 Viscometers, Automatic

Cardiac Output Computer
 Catheterization Laboratory
 Equipment
 Coagulation Analyzers
 Diagnostic Sounders,
 Ultrasonic
 ECG Amplifiers,
 Multi-Channel

Electrocardiographs
 Electromyographs
 Heart Sound Amplifiers
 Magnetic Tape Recorders
 Oscillographic Recorders
 Patient Monitoring
 Systems, Intensive Care

Patient Monitoring
 Systems, Operating Room
 Physiological Signal
 Conditioners
 Thermal Dilution System
 Transducers
 Vectorcardiograph Systems

Computers, Digital
 Data Acquisition
 Systems, Digital
 Magnetic Tape Recorders,
 Instrumentation
 Magnetic Tape Units,
 Digital

Optical Mark Readers
 Oscillographic Recorders,
 Fluid Process
 Oscillographic Recorders,
 Optical

Oscillographic Recorders,
 Thermal
 Printers/Recorders, Digital
 Strip Chart Recorders
 X-Y Recorders

Amplifiers
 Attenuators
 Communications/Telephone
 Test Equipment
 Distortion & Wave Analyzers
 Electronic Counters
 Frequency Synthesizers
 Generators: Function, Noise,
 Pulse, Signal, Sweep

Impedance Instruments
 Leak & Friction Detectors
 Loudness Analyzer
 Microwave Instrumentation
 Mixers & Modulators
 Network Analyzers
 Noise Figure Meters
 Nuclear Instrumentation
 Oscillators

Oscilloscopes
 Power Meters
 Power Supplies, DC
 Solid State Components
 Spectrum Analyzers
 Standards, Frequency & Time
 Voltage/Current/Resistance
 Instruments

Alphabetical by functional characteristic or name of instrument or system
 Numerical by model number of instrument or system

Rear of
 Catalog

ABOUT HEWLETT-PACKARD**ORDERING INFORMATION****GENERAL INFORMATION**

Hewlett-Packard products are manufactured in factories located throughout the free world. The Hewlett-Packard field sales office, representative, or distributor in your area is equipped to handle all your needs for information on any HP product, and for parts or service on HP products you are already using. A worldwide listing of field offices, representatives and distributors follows this page.

Order by model number

When you order, please specify the catalog model number and name of instrument desired. For example, "Model 180A Oscilloscope." To prevent misunderstanding, include significant specifications. Whenever you want special options or features such as special color, non-standard power line voltage, etc., include specific instructions.

Many Hewlett-Packard instruments are supplied in cabinets along with easily attached hardware for direct mounting in 19" equipment racks. Other HP instruments are available in cabinets for bench use or with 19" panels (for example, "180AR")

for rack mounting. Catalog listings indicate the availability of cabinet or rack mounting arrangements. Please be sure your order indicates which you desire.

Price and delivery information

The illustrations and product information herein were current at the time this catalog was approved for printing. However, in order to continue to offer the finest instrumentation available, Hewlett-Packard Company reserves the right to change specifications, designs, models or prices without notice and without liability for such changes. Prices listed are F.O.B. USA factory or warehouse. Consult your nearest field sales office to confirm prices and to obtain current delivery information.

Local technical assistance

Technical assistance in selecting equipment and preparing orders is available, without charge, from field engineers at sales offices in the USA and in principle areas throughout the world.

FOR CUSTOMERS IN THE USA**Where to send your order**

Your order should be made out to the Hewlett-Packard Company and sent to the HP field office nearest you. Each field office has special communication channels to the Hewlett-Packard factories to assure prompt and efficient handling of your order.

Shipping methods

Shipments to destinations in the USA are made directly from local factories or warehouses. Unless specifically requested otherwise, express or truck transportation is used, whichever is less expensive and most serviceable to you. Small items are sent parcel post. If rapid delivery is needed we will gladly ship by the more expensive methods of air freight, air express, or air parcel post when specified on your order. In many parts of the USA a consolidated air freight service provides the speed of air transport at surface rates. Ask your field engineer for details.

Terms

Terms in the USA are 30 days net. Unless credit has already been established, shipments will be made C.O.D., or on receipt of cash in advance.

Quotations

Upon request, quotations including destination prices, will be furnished to you by your local Hewlett-Packard sales office.

FOR CUSTOMERS OUTSIDE THE USA**Where to send your order**

In many countries, your order can be placed directly on your local Hewlett-Packard distributor or representative. If there is none, as yet, in your area, your order should be placed directly on the office indicated on the map for your region.

Shipping methods

Shipments to customers outside the USA or Western Europe are made from the appropriate Hewlett-Packard facility by either surface or air, as requested. Sea shipments usually require commercial export packaging at a nominal extra charge.

Terms

Terms for orders from countries outside the United States of America which are placed on the Hewlett-Packard Company, Hewlett-Packard S.A., or Hewlett-Packard Inter-Americas, are irrevocable letter of credit or cash in advance, unless other terms have been arranged previously. Terms for orders placed on authorized Hewlett-Packard distributors are mutually determined between the customer and the distributor.

Quotations and pro forma invoices

FAS, CIF, C&F; etc. quotations or pro forma invoices, as well as exportation and importation assistance, are available on request from local authorized Hewlett-Packard sales office or representative.



About Hewlett-Packard

Sales and Service Offices 2-8

- Africa, Asia, Australia, 6
- Central and South America, 8
- Europe, 4
- United States of America and Canada, 2

Services 11-22

Manufacturing Operations 9-10

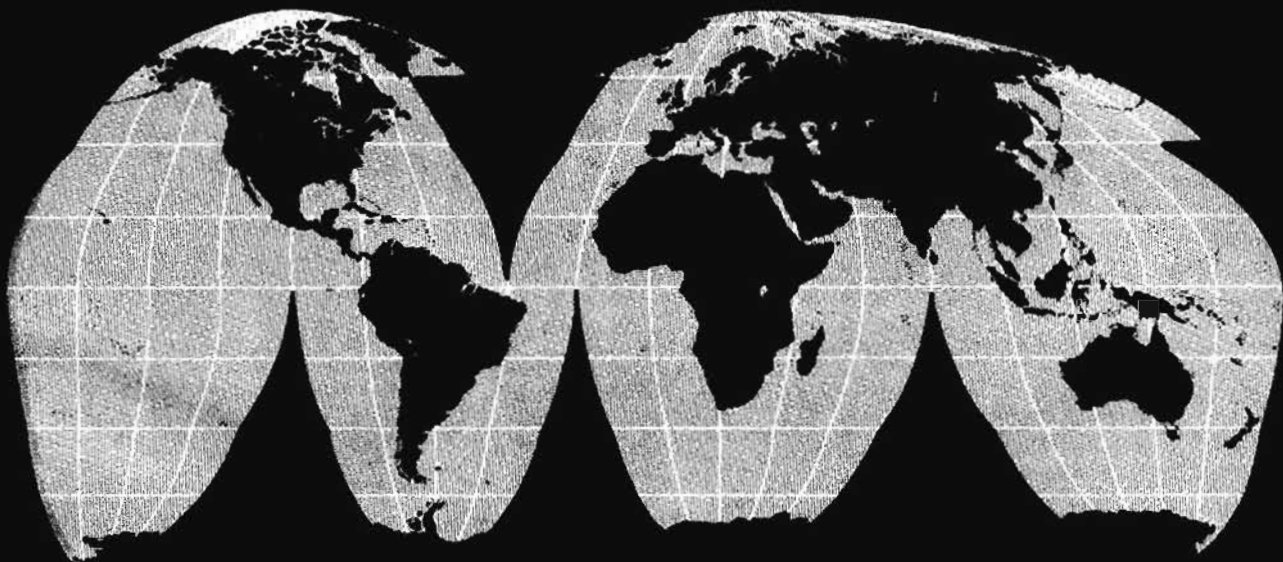

SALES & SERVICE OFFICES



UNITED STATES AND CANADA

- Electronic Instrumentation
- Analytical Instrumentation
- Medical Instrumentation

ALABAMA

1 P.O. Box 4207
2003 Byrd Spring Road S.W.
Huntsville 35802
Tel: (205) 881-4591
TWX: 810-726-2204

ARIZONA

2 3009 North Scottsdale Road
Scottsdale 85251
Tel: (602) 945-7601
TWX: 910-950-1282

3 5737 East Broadway
Tucson 85715
Tel: (602) 298-2313
TWX: 910-952-1162

CALIFORNIA

4 3939 Lankershim Boulevard
North Hollywood 91604
Tel: (213) 877-1282
TWX: 910-499-2170

5 1101 Embarcadero Road
Palo Alto 94303
Tel: (415) 327-6500
TWX: 910-373-1280

6 2591 Carlsbad Avenue
Sacramento 95821
Tel: (916) 482-1463
TWX: 910-367-2092

7 1055 Shafter Street
San Diego 92106
Tel: (714) 223-8103
TWX: 910-335-2000

COLORADO

8 7965 East Prentice
Englewood 80110
Tel: (303) 771-3455
TWX: 910-935-0705

CONNECTICUT

9 508 Tolland Street
East Hartford 06108
Tel: (203) 289-9394
TWX: 710-425-3416

10 111 East Avenue
Norwalk 06851
Tel: (203) 853-1251
TWX: 710-468-3750

DELAWARE

11 3941 Kennett Pike
Wilmington 19807
Tel: (302) 855-6161
TWX: 510-666-2214

FLORIDA

12 P.O. Box 545
Suite 106
9999 N.E. 2nd Avenue
Miami Shores 33153
Tel: (305) 758-3626
TWX: 810-848-7262

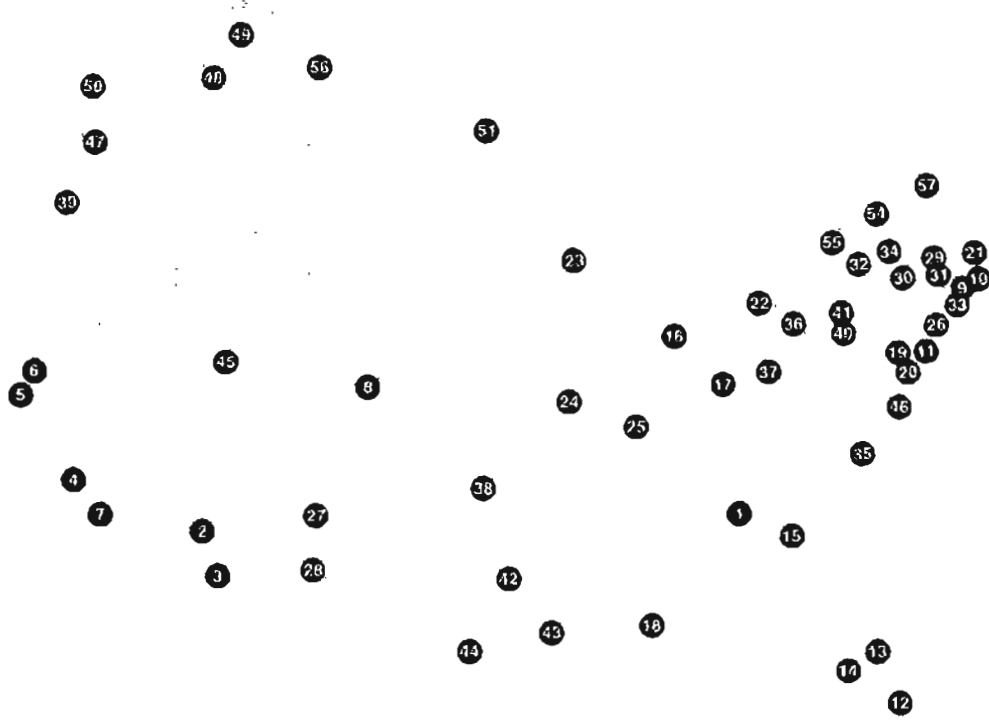

13 P.O. Box 20007
Herndon Station 32814
621 Commonwealth Avenue
Orlando
Tel: (305) 841-3970
TWX: 810-850-0113

14 P.O. Box 8128
Madelra Beach 33708
410 150th Avenue
St. Petersburg
Tel: (813) 391-0211
TWX: 810-863-0366

GEORGIA

15 P.O. Box 28234
2340 Interstate Parkway
Atlanta 30328
Tel: (404) 436-6181
TWX: 810-766-4890

ILLINOIS

16 5500 Howard Street
Skokie 60076
Tel: (312) 677-0400
TWX: 910-223-3813

INDIANA

17 4002 Meadows Drive
Indianapolis 46205
Tel: (317) 546-4891
TWX: 810-341-3263

LOUISIANA

18 P.O. Box 858
1942 Williams Boulevard
Kenner 70062
Tel: (504) 721-8201
TWX: 810-955-5524

MARYLAND

19 6707 Whitestone Road
Baltimore 21207
Tel: (301) 944-5400
TWX: 710-862-0850

20 P.O. Box 727
Twinbrook Station 20851
12303 Twinbrook Parkway
Rockville
Tel: (301) 427-7560
TWX: 710-828-9684

MASSACHUSETTS

21 32 Hartwell Road
Lexington 02173
Tel: (617) 861-8960
TWX: 710-332-0382

MICHIGAN

22 24315 Northwestern Highway
Southfield 48075
Tel: (313) 353-9100
TWX: 810-232-1532

MINNESOTA

23 2459 University Avenue
St. Paul 55114
Tel: (612) 645-9461
TWX: 910-563-3734

MISSOURI

24 9208 Wyoming Place
Kansas City 64114
Tel: (816) 333-2445
TWX: 910-771-2087

25 2812 South Brantwood Blvd.
St. Louis 63144
Tel: (314) 644-0220
TWX: 910-760-1670

NEW JERSEY

26 W. 120 Century Road
Paramus 07652
Tel: (201) 265-5000
TWX: 710-991-9707

NEW MEXICO

27 P.O. Box 8366
Station C
6501 Lomas Boulevard N.E.
Albuquerque 87108
Tel: (505) 255-5586
TWX: 910-989-1665

28 156 Wyatt Drive
Las Cruces 88001
Tel: (505) 526-2485
TWX: 910-983-0550

NEW YORK

29 1702 Central Avenue
Albany 12205
Tel: (518) 869-8462
TWX: 710-441-8270

30 1219 Campville Road
Endicott 13764
Tel: (607) 754-0050
TWX: 510-252-0890

31 82 Washington Street
Poughkeepsie 12601
Tel: (914) 454-7330
TWX: 510-248-0012

32 39 Saginaw Drive
Rochester 14623
Tel: (716) 473-9500
TWX: 510-253-5981

33 1025 Northern Boulevard
Roslyn, Long Island 11576
Tel: (516) 869-8400
TWX: 510-223-0811

34 5858 East Molloy Road
Syracuse 13211
Tel: (315) 454-2486
TWX: 710-541-0482

NORTH CAROLINA

35 P.O. Box 5188
1923 North Main Street
High Point 27262
Tel: (919) 882-6873
TWX: 510-926-1516

OHIO

36 5579 Pearl Road
Cleveland 44129
Tel: (216) 884-9209
TWX: 810-421-8500

37 3460 South Dixie Drive
Dayton 45439
Tel: (513) 298-0351
TWX: 810-459-1925

OKLAHOMA

38 2919 United Founders Boulevard
Oklahoma City 73112
Tel: (405) 848-2801
TWX: 910-830-6862

OREGON

39 Westhills Mall, Suite 158
4475 S.W. Scholls Ferry Road
Portland 97225
Tel: (503) 292-9171
TWX: 910-464-6103

PENNSYLVANIA

40 2500 Moss Side Boulevard
Monroeville 15146
Tel: (412) 271-0724
TWX: 710-797-3650

41 144 Elizabeth Street
West Conshohocken 19428
Tel: (215) 248-1600, 828-6200
TWX: 510-680-8715

TEXAS

42 P.O. Box 7166
3605 Inwood Road
Dallas 75209
Tel: (214) 357-1881
TWX: 910-861-4081

43 P.O. Box 22813
4242 Richmond Avenue
Houston 77027
Tel: (713) 667-2407
TWX: 910-881-2545

44 GOVERNMENT CONTRACT OFFICE
225 Billy Mitchell Road
San Antonio 78226
Tel: (512) 434-4171
TWX: 910-871-1170

UTAH

45 2890 South Main Street
Salt Lake City 84115
Tel: (801) 486-8166
TWX: 910-925-5681

VIRGINIA

46 P.O. Box 6514
2111 Spencer Road
Richmond 23230
Tel: (703) 282-5451
TWX: 710-956-0157

WASHINGTON

47 433-108th N.E.
Bellevue 98004
Tel: (206) 454-3971
TWX: 910-443-2303

FOR U.S. AREAS NOT LISTED:

Contact the regional office nearest you:
Atlanta, Georgia . . . North Hollywood, California . . . Paramus, New Jersey . . . Skokie, Illinois. Their complete addresses are listed above.

CANADA**ALBERTA**

48 X-Ray Radium Ltd.
239-10th Avenue, S.E.
Calgary
Tel: (403) 266-2718
Cable: X-RAD Calgary

Hewlett-Packard (Canada) Ltd.
10010-105th Street
Edmonton
Tel: (403) 424-0718
TWX: 610-831-2431

49 X-Ray and Radium Ltd.
11011-107th Avenue
Edmonton
Tel: (403) 422-8615
Cable: X-RAD Edmonton

BRITISH COLUMBIA

50 Hewlett-Packard (Canada) Ltd.
304-1037 West Broadway
Vancouver 9
Tel: (604) 731-5301
TWX: 610-922-5059

X-Ray and Radium Ltd.
2283 West Broadway
Vancouver
Tel: (604) 731-1543
Cable: X-RAD Vancouver

MANITOBA

51 X-Ray and Radium Ltd.
58 Westbrook Street
Winnipeg 2
Tel: (204) 942-8211
Cable: X-RAD Winnipeg

NEW BRUNSWICK

52 X-Ray and Radium Ltd.
177 Prince William Street
Saint John
Tel: (506) 693-2057
Cable: X-RAD Saint John

NOVA SCOTIA

53 Hewlett-Packard (Canada) Ltd.
7001 Mumford Road
Suite 355
Halifax
Tel: (902) 455-0511
TWX: 610-271-4482

X-Ray and Radium Ltd.
6100 Young Street
Halifax
Tel: (902) 455-4291
Cable: X-RAD Halifax

ONTARIO

54 Hewlett-Packard (Canada) Ltd.
880 Lady Ellen Place
Ottawa 3
Tel: (613) 722-4223
TWX: 610-562-1952

55 Hewlett-Packard (Canada) Ltd.
1415 Lawrence Avenue West
Toronto
Tel: (416) 249-9196
TWX: 610-492-2382

X-Ray and Radium Ltd.
1400 Don Mills Road
Don Mills
Tel: (416) 447-5171
Cable: X-RAD Toronto

SASKATCHEWAN

56 X-Ray and Radium Ltd.
88-24th Street, East
Saskatoon
Tel: (306) 242-0529
Cable: X-RAD Saskatoon

QUEBEC

57 Hewlett-Packard (Canada) Ltd.
275 Hymus Boulevard
Pointe Claire
Tel: (514) 697-4232
TWX: 610-422-3022
Telex: 01-20607

X-Ray and Radium Ltd.
2800 Bates Road
Montreal
Tel: (514) 739-2408
Cable: X-RAD Montreal

FOR CANADIAN AREAS NOT LISTED:

Contact Hewlett-Packard (Canada) Ltd. in
Pointe Claire, at the complete address
listed above.

SALES & SERVICE OFFICES



EUROPE

- Electronic Instrumentation
- Analytical Instrumentation
- Medical Instrumentation

AUSTRIA

- 1** Unlabor GmbH
Wissenschaftliche Instrumente
Rummelhardtgasse 6/3
P.O. Box 33
Vienna IX/71
Tel: 426 181
Cable: LABORINSTRUMENT Vienna

BELGIUM

- 2** Hewlett-Packard Benelux S.A.
348 Boulevard du Souverain
Brussels 16
Tel: 72 22 40
Cable: PALOBEN Brussels
Telex: 23 494

DENMARK

- 3** Hewlett-Packard A/S
Langebjerg 6
2850 Naerum
Tel: 01 80 40 40
Cable: HEWPACK AS
Telex: 66 40

FINLAND

- 4** Hewlett-Packard Oy
Gydenintie 3
Helsinki 20
Tel: 67 35 38
Telex: 12-1563

FRANCE

- 5** Hewlett-Packard France
150 Boulevard Masséna
75 Paris 13e
Tel: 707 97 19
Cable: HEWPACK Paris
Telex: 25048
- 6** Hewlett-Packard France
2, rue Tâte d'Or
69 Lyon 6e
Tel: 52 35 66
Telex: 31617

GERMANY

- 7** Hewlett-Packard Vertriebs-GmbH
Lützenburger Strasse 30
1 Berlin W.30
Tel: 24 86 36
- 8** Hewlett-Packard Vertriebs-GmbH
Herrenberger Strasse 110
703 Böblingen, Württemberg
Tel: 07031-6971
Cable: HEPAG Böblingen
Telex: 72 65 739
- 9** Hewlett-Packard Vertriebs-GmbH
Achenbachstrasse 15
4 Düsseldorf 1
Tel: 68 52 58/59
Telex: 85 86 533
- 10** Hewlett-Packard Vertriebs-GmbH
Kurfürstenstrasse 95
6 Frankfurt 50
Tel: 52 00 36
Cable: HEWPACKSA Frankfurt
Telex: 41 32 49
- 11** Hewlett-Packard Vertriebs-GmbH
Beim Strohhause 26
2 Hamburg 1
Tel: 24 05 51/52
Cable: HEWPACKSA Hamburg
Telex: 21 53 32

- 12** Hewlett-Packard Vertriebs-GmbH
Reginfriedstrasse 13
8 Munich 9
Tel: 69 51 21/22
Cable: HEWPACKSA Munich
Telex: 52 49 85

GREECE

- 13** Kostas Karayannis
18, Ermou Street
Athens 126
Tel: 230 301
Cable: RAKAR Athens
- "Inteco" Technical Agencies
Skoufa 15
Athens 136
Tel: 631 072
- Etanem Co.
Amerikis Street 12
Athens 134
Tel: 626 972
Cable: ETANEM Athens

ICELAND

- 14** Elding Trading Company Inc.
Hafnarhvoll-Tryggvagötu
Reykjavik
Tel: 1 58 20
Cable: ELDING Reykjavik

IRELAND

- 15** Smith & Sheppard (1940) Ltd.
124 St. Stephen's Green
Dublin
Tel: 5 25 00
Cable: SURGICAL Dublin
- 16** Hewlett-Packard Ltd.
224 Bath Road
Slough, Bucks, England
Tel: Slough 28406-9, 29468-9
Cable: HEWPIE Slough
Telex: 84413

ITALY

- 17** Hewlett-Packard Italiana S.p.A.
Viale Lunigiana 46
20125 Milan
Tel: 69 15 84
Cable: HEWPACKIT Milan
Telex: 32046
- 18** Hewlett-Packard Italiana S.p.A.
Palazzo Italia
Piazza Marconi 25
00144 Rome-Eur
Tel: 591 25 44
Cable: HEWPACKIT Rome

NETHERLANDS

- 19** Hewlett-Packard Benelux N.V.
De Boelelaan 1043
Amsterdam, Z.2
Tel: 42 77 77
Cable: PALOBEN Amsterdam
Telex: 13 216

NORWAY

- 20** Hewlett-Packard Norge A/S
Nesvelen 13
Haslum
Tel: 53 83 60
Cable: HEWPACK Oslo
Telex: 6621

PORTUGAL

- 21** Telectra
Rua Rodrigo da Fonseca 103
P.O. Box 2531
Lisbon 1
Tel: 68 60 72
Cable: TELECTRA Lisbon
Telex: 1598

- Munditer
Intercambio Mundial de
Comercio S.a.r.l.
Avenida Antonio Augusto de
Aguilar 138
Lisbon
Tel: 73 21 31
Cable: INTERCAMBIO Lisbon

SPAIN

- 22** Atajo Ingenieros
Enrique Larreta 12
Madrid, 16
Tel: 235 43 44
Cable: TELEATAJO Madrid
Telex: 2 72 49
- 23** Atajo Ingenieros
Urgei, 259
Barcelona, 11
Tel: 230 69 88

SWEDEN

- 24** HP Instrument AB
Svetsarvägen 7
Fack
Solna
Tel: (08) 98 12 50
Cable: MEASUREMENTS Stockholm
Telex: 10 721
- 25** HP Instrument AB
Hagakersgatan 7
Mölnådal
Tel: 031 27 68 00

SWITZERLAND

- 26** HEWPAK AG
Zürcherstrasse 20
8952 Schlieren Zurich
Tel: (051) 98 15 21
Cable: HEWPACKAG Zurich
Telex: 53933
- 27** HEWPAK A.G.
54 Route des Acacias
1211 Geneva 24
Tel: 43 79 29
Telex: 2 24 86

TURKEY

- 28** Telekom Engineering Bureau
P.O. Box 376 Galata
Istanbul
Tel: 49 40 40
Cable: TELEIMATION Istanbul
- Dr. Faruk Komili
Vali Konagi Caddesi No. 35
Harbiye, Istanbul
Tel: 48 18 07
Cable: PIKTRON Istanbul

UNITED KINGDOM

- 29** Hewlett-Packard Ltd.
224 Bath Road
Slough, Bucks
Tel: Slough 28406-9, 29486-9
Cable: HEWPIE Slough
Telex: 84413

YUGOSLAVIA

- 30** Belram S.A.
83 Avenue des Mimosas
Brussels 15, Belgium
Tel: 34 33 32
Cable: BELRAMEL Brussels
Telex: 21790

FOR AREAS NOT LISTED, CONTACT:

Hewlett-Packard S.A.
54 Route des Acacias
1211 Geneva, Switzerland
Tel: (022) 42 81 50
Telex: 2.24.86
Cable: HEWPACKSA Geneva

11

4

20

24

25

16

3

15

7

11

19

9

28

10

2

5

8

12

1

6

26

27

17

30

22

23

18

20

13

SALES & SERVICE OFFICES

AFRICA, ASIA,
AUSTRALIA

- ⊗ Electronic Instrumentation
- ⊖ Analytical Instrumentation
- ⊕ Medical Instrumentation

AUSTRALIA

- ⊗ 1 Hewlett-Packard Australia Pty. Ltd.
22-26 Weir Street
Glen Iris 3148
Victoria
Tel: 20 1371 (4 lines)
Cable: HEWPARD Melbourne
- ⊗ 2 Hewlett-Packard Australia Pty. Ltd.
61 Alexander Street
Crows Nest 2065
New South Wales
Tel: 43.7865
Cable: HEWPARD Sydney
- ⊗ 3 Hewlett-Packard Australia Pty. Ltd.
97 Churchill Road
Prospect 5082
South Australia
Tel: 65.2366
Cable: HEWPACK Adelaide

CEYLON

- ⊗ 4 United Electricals Ltd.
P.O. Box 681
Yahala Building
Staples Street
Colombo 2
Tel: 5496
Cable: HOTPOINT Colombo

ETHIOPIA

- ⊗ 5 African Salespower & Agency
Private Ltd., Co.
P.O. Box 718
58/59 Cunningham Street
Addis Ababa
Tel: 12285
Cable: ASACO Addisababa

HONG KONG

- ⊗ 6 Schmidt & Co. (Hong Kong) Ltd.
P.O. Box 297
1511, Prince's Building
15th Floor
10, Chater Road
Hong Kong
Tel: 240168, 232735
Cable: SCHMIDTCO Hong Kong

INDIA

- ⊗ 7 The Scientific Instrument Co., Ltd.
6, Tej Bahadur Sapru Road
Allahabad 1
Tel: 2451
Cable: SICO Allahabad
- ⊗ 8 The Scientific Instrument Co., Ltd.
240, Dr. Dadabhai Naoroji Road
Bombay 1
Tel: 26-2642
Cable: SICO Bombay
- ⊖ Pioneer Equipment Co., Pvt. Ltd.
Seksaria Chambers
139, Nagindas Master Road
P.O. Box 1909
Fort, Bombay 1
Tel: 25-1882
Cable: PIOMETAL Bombay
- ⊗ 9 The Scientific Instrument Co., Ltd.
11, Esplanade East
Calcutta 1
Tel: 23-4129
Cable: SICO Calcutta
- ⊖ Pioneer Equipment Co., Pvt. Ltd.
3, Esplanade East
Calcutta 1

- ⊗ 10 The Scientific Instrument Co., Ltd.
30, Mount Road
Madras 2
Tel: 86339
Cable: SICO Madras

⊖ Pioneer Equipment Co., Pvt. Ltd.
22, Royapettah High Road
First Floor, North Wing
Madras 14

- ⊗ 11 The Scientific Instrument Co., Ltd.
B-7, Ajmeri Gate Extn.
New Delhi 1
Tel: 27-1053
Cable: SICO New Delhi

⊖ Pioneer Equipment Co., Pvt. Ltd.
36-B, Nizamuddin West
New Delhi 13

IRAN

- ⊗ 12 Telecom, Ltd.
P.O. Box 1812
240 Kh. Saba Shomali
Teheran
Tel: 48111, 43850
Cable: BASCOM Teheran

ISRAEL

- ⊗ 13 Electronics & Engineering
Division of Motorola Israel Ltd.
16, Kremenski Street
Tel-Aviv
Tel: 35021 (four lines)
Cable: BASTEL Tel-Aviv

JAPAN

- ⊗ 14 Yokogawa-Hewlett-Packard Ltd.
Nisei Ibaragi Bldg.
2-2-8, Kasuga
Ibaragi-shi
Osaka
Tel: 0726-23-1641
- ⊗ 15 Yokogawa-Hewlett-Packard Ltd.
Ito Building
No. 59, Kotori-cho
Nakamura-ku, Nagoya City
Tel: 551-0215
- ⊗ 16 Yokogawa-Hewlett-Packard Ltd.
Ohashi Building
No. 59, 1-chome, Yoyogi
Shibuya-ku, Tokyo
Tel: 370-2281
Telex: YHPMARKET TOK 23-724
- ⊖ The Nissho Company Ltd.
Nissho Building
10, Nihonbashi-Edobashi, 1-chome
Chuo-ku, Tokyo
Tel: 273-5111
Cable: NISSHOCONY Tokyo
- ⊕ Heiwa Bussan Co., Ltd.
18, 2-chome, Marunouchi
Chiyoda-ku, Tokyo
Tel: 211-8456
Cable: KISHMAKER Tokyo

KENYA

- ⊗ 17 R. J. Tilbury Ltd.
P.O. Box 2754
Suite 517-518
Hotel Ambassadeur
Nairobi
Tel: 25670, 26803, 68206. 58196
Cable: ARJAYTEE Nairobi
- ⊕ International Aeradio (E.A.) Ltd.
P.O. Box 19012, Nairobi Airport
Nairobi
Tel: 82222
Cable: INTAERIO Nairobi

KOREA

- ⊗ 18 American Trading Co., Korea, Ltd.
Seoul P.O. Box 1103
112-35 Sokong-Dong
Jung-ku, Seoul
Tel: 3,7049, 3,7613
Cable: AMTRACO Seoul
- ⊕ Asia Science & Company
International P.O. Box 1250
Choong-ku, Seoul
Tel: 28-1431
Cable: ASIASCIENT Seoul

LEBANON

- ⊗ 19 Constantin E. Macridis
Clémenceau Street
Clémenceau Center
Beirut
Tel: 220846
Cable: ELECTRONUCLEAR Beirut
- ⊕ F. Makhlof & Co.
144, Damascus Avenue
P.O. Box 983
Beirut
Tel: 22.62.21, 24.26.62
Cable: MAKHLOUFCO Beirut

19
13

5

34

17

32

36

29

27

28

KENYA

- ⊗ 17 R. J. Tilbury Ltd.
P.O. Box 2754
Suite 517-518
Hotel Ambassadeur
Nairobi
Tel: 25670, 26803, 68206. 58196
Cable: ARJAYTEE Nairobi
- ⊕ International Aeradio (E.A.) Ltd.
P.O. Box 19012, Nairobi Airport
Nairobi
Tel: 82222
Cable: INTAERIO Nairobi

KOREA

- ⊗ 18 American Trading Co., Korea, Ltd.
Seoul P.O. Box 1103
112-35 Sokong-Dong
Jung-ku, Seoul
Tel: 3,7049, 3,7613
Cable: AMTRACO Seoul
- ⊕ Asia Science & Company
International P.O. Box 1250
Choong-ku, Seoul
Tel: 28-1431
Cable: ASIASCIENT Seoul

LEBANON

- ⊗ 19 Constantin E. Macridis
Clémenceau Street
Clémenceau Center
Beirut
Tel: 220846
Cable: ELECTRONUCLEAR Beirut
- ⊕ F. Makhlof & Co.
144, Damascus Avenue
P.O. Box 983
Beirut
Tel: 22.62.21, 24.26.62
Cable: MAKHLOUFCO Beirut

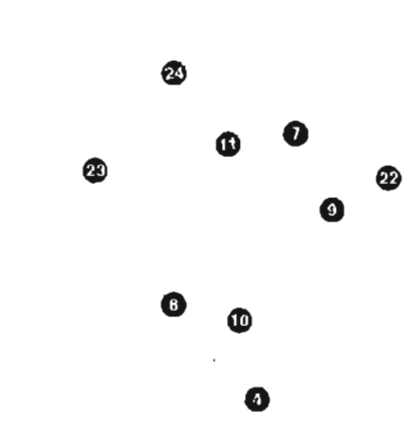

MALAYSIA

☎ 20 Mecomb Malaysia Ltd.
2 Lorong 13-6A
Section 13
Petaling Jaya, Selangor
Cable: MECOMB Kuala Lumpur

NEW ZEALAND

☎ 21 Hewlett-Packard (N.Z.) Ltd.
32-34 Kent Terrace
P.O. Box 9443
Wellington, N.Z.
Tel: 56-409
Cable: HEWPACK Wellington

☎ Dental & Medical Supply Co., Ltd.
P.O. Box 1994
128 Wakefield Street
Wellington, C. 1
Tel: 70-789
Cable: DENTAL Wellington

PAKISTAN (EAST)

☎ 22 Mushko & Company, Ltd.
31, Jinnah Avenue
Dacca
Tel: 80058
Cable: NEWDEAL Dacca

☎ Dodhys Agencies
9-H, Motijheel
Dacca 2
Cable: DODHYS Dacca

PAKISTAN (WEST)

☎ 23 Mushko & Company, Ltd.
Oosman Chambers
Victoria Road
Karachi 3
Tel: 51027, 52927
Cable: COOPERATOR Karachi

☎ 24 Dodhys Agencies
2, McLeod Road
Lahore 6
Tel: 66180
Cable: DODHYS Lahore

PHILIPPINES

☎ 25 International Industrial Investment
P.O. Box 2511
Plaza de Binondo
No. 417 J. Luna Street
Manila
Tel: 4-26-06, 4-81-52
Cable: THREE-I Manila

SINGAPORE

☎ 26 Mechanical & Combustion
Engineering Company Ltd.
9, Jalan Kilang
Singapore 3
Tel: 642361-3
Cable: MECOMB Singapore

SOUTH AFRICA

☎ 27 F. H. Flanter & Co. (Pty.), Ltd.
Hill House
43 Somerset Road
Cape Town
Tel: 2-9711
Cable: AUTOPHONE Cape Town
Telex: 7038CT

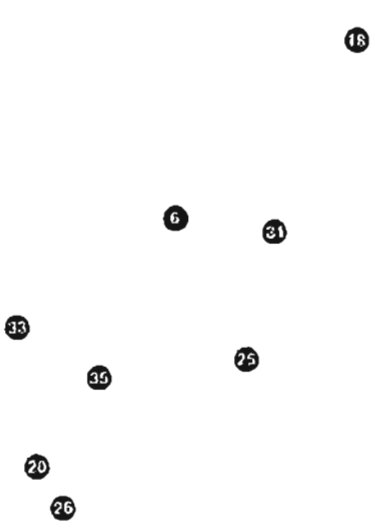

☎ Nucleonic Engineering (Pty.) Ltd.
P.O. Box 3841
510 Libertas, Hertzog Boulevard
Foreshore, Cape Town
Tel: 37769
Cable: NUCLEAR Cape Town

☎ 28 Nucleonic Engineering (Pty.) Ltd.
P.O. Box 2143
82, Syfret House
36, Gardiner Street
Durban, Natal
Tel: 20272

☎ 29 Nucleonic Engineering (Pty.) Ltd.
P.O. Box 1257, Braamfontein
Total Centre, 9th Floor
Corner Jorissen and Bertha Streets
Johannesburg
Tel: 724-9341/2/3
Cable: NUCLEAR Johannesburg

☎ F. H. Flanter & Co. (Pty.), Ltd.
607, Pharmacy House
80 Jorissen Street
Braamfontein, Johannesburg
Tel: 724-4172
Telex: 0028 JHB



SYRIA

☎ 30 Sawah & Co.
Placa Azme
B.P. 2308
Damascus
Tel: 16367, 19697, 14268
Cable: SAWAH Damascus

TAIWAN

☎ 31 Hwa Sheng Electronic Co., Ltd.
P.O. Box 1558
21 Nanking West Road
Taipei
Tel: 46078, 45935, 48661
Cable: VICTRONIX Taipei

TANZANIA

☎ 32 International Aeradio (E.A.), Ltd.
P.O. Box 861
Dar-Es-Salaam

THAILAND

☎ 33 The International Engineering
Co., Ltd.
P.O. Box 39
614 Sukhumvit Road
Bangkok
Tel: 910722 (7 lines)
Cable: GYSOM Bangkok

☎ Chalermmas
39 Prapithuck Road
Bangkok
Tel: 27508
Cable: CHALERMMA Bangkok

UGANDA

☎ 34 International Aeradio (E. A.), Ltd.
P.O. Box 2577
Kampala
Cable: INTAERIO Kampala

VIETNAM

☎ 35 Landis Brothers & Company, Inc.
P.O. Box: H-3
218, Hien-Vuong
Saigon
Tel: 20,805
Cable: LANBROCOMP Saigon

ZAMBIA

☎ 36 R. J. Tilbury (Zambia) Ltd.
P.O. Box 2792
Lusaka
Zambia, Central Africa

FOR AREAS NOT LISTED, CONTACT:

Hewlett-Packard Export Marketing
1501 Page Mill Road
Palo Alto, California 94304
Tel: (415) 326-7000
TWX: 910-373-1267
Telex: 034-8461
Cable: HEWPACK Palo Alto

SALES & SERVICE OFFICES



CENTRAL AND SOUTH AMERICA

- Electronic Instrumentation
- Analytical Instrumentation
- Medical Instrumentation

ARGENTINA

1 Hewlett-Packard Argentina S.A.C.e.I.
Lavalle 1171 - 3°
Buenos Aires

Lutz, Ferrando y Cia. S. A.
Florida 240 (R.5)
Buenos Aires
Tel: 46-7241, 46-1635
Cable: OPTICA Buenos Aires

BRAZIL

2 Hewlett-Packard Do Brasil
I.e.C. Ltda.
Rua Cel. Oscar Porto, 691
São Paulo - 8, SP
Tel: 71-1503
Cable: HEWPAK Sao Paulo

3 Hewlett-Packard Do Brasil
I.e.C. Ltda.
Avenida Franklin Roosevelt 84-
grupo 203
Rio de Janeiro, ZC-39, GB
Tel: 32-9733
Cable: HEWPAK Rio de Janeiro

CHILE

4 Hector Calcagni P.
Casilla 13942
Estado 215 - Oficina 1016
Santiago
Tel: 31-890, 490-505

General Machinery Co., Ltda.
Paraguay 486
Casilla 13910
Santiago
Tel: 31-123, 31-124
Cable: GEMCO Santiago

COLOMBIA

5 Instrumentacion
Henrik A. Langebaek & Cia. Ltda.
Carrera 7 # 48-59
Apartado Aéreo 6287
Bogotá, 1. D.E.
Tel: 45-78-06, 45-55-46
Cable: AARIS Bogota

General Electric de Colombia, S.A.
Apartado Aereo 6799 y 3644
Kilometro 7 Carretera a Bosa
Bogotá
Tel: 38 2040
Cable: GELCOLSA Bogotá

COSTA RICA

6 Lic. Alfredo Gallegos Gurdán
Apartado 3243
San José
Tel: 21-86-13
Cable: GALGUR San José

ECUADOR

7 Laboratorios de Radio-Ingeniería
Calle Guayaquil 1246
Post Office Box 3199
Quito
Tel: 12496
Cable: HORVATH Quito

J. A. Vizcaino V. & Cia.
García Moreno No. 1224
Casilla 2925
Quito
Tel: 213697, 217034
Cable: VIZCAINO Quito

EL SALVADOR

8 Electrónica
Apartado Postal 1589
27 Avenida Norte 1133
San Salvador
Tel: 25 74 50
Cable: ELECTRONICA San Salvador

GUATEMALA

9 Olander Associates Latin America
Apartado 1226
7a. Calle, 0-22, Zona 1
Guatemala City
Tel: 22812
Cable: OLALA Guatemala City

HONDURAS

10 Roberto L. Rodríguez
Apartado Postal No. 4
Tegucigalpa, D.C.
Tel: 2-2871
Cable: RODRIGUEZ Tegucigalpa

MEXICO

11 Hewlett-Packard Mexicana, S.A.
de C.V.
Apartado Postal 12-832
Eugenia 408, Dept. 1
Mexico 12, D.F.
Tel: 43-03-79, 36-08-78

12 Equipo para Hospitales, S.A.
Tonahú 161
Mexico 7, D.F.
Tel: 25-87-36, 14-82-71

NICARAGUA

13 Roberto Terán G.
Apartado Postal 689
Edificio Terán
Managua
Tel: 3451, 3452
Cable: ROTERAN Managua

PANAMA

14 Electronica Balboa, S.A.
P.O. Box 4929
Ave. Manuel Espinosa No. 13-50
Bldg. Alina
Panama City
Tel: 30833
Cable: ELECTRON Panama City

PERU

15 Fernando Ezeta B.
Avenida Petit Thouars 4719
Miraflores
Casilla 3061
Lima
Tel: 50346
Cable: FEPERU Lima

H. W. Kessel S.A.
Apartado 552
Av. Corpac 212 San Isidro
Lima
Tel: 23900
Cable: KESSEL Lima

PUERTO RICO

16 San Juan Electronics, Inc.
P.O. Box 5167
Ponce de Leon 154
Pda. 3-Pta. de Tierra
San Juan, P.R. 00906
Tel: (174) 725-3342
Cable: SATRONICS San Juan

URUGUAY

17 Pablo Ferrando S.A.
Comercial e Industrial
Avenida Italia 2877
Casilla de Correo 370
Montevideo
Tel: 40-3102
Cable: RADIUM Montevideo

VENEZUELA

18 Hewlett-Packard De Venezuela C.A.
Edificio Arisón-Of. 4
Ayda, Francisco de Miranda
Chacaito
Caracas
Tel: 71-88-05
Cable: HEWPAK Caracas
Mailing Address: Apartado del
Este 10934 Caracas

FOR AREAS NOT LISTED, CONTACT:

Hewlett-Packard Inter-Americas
1501 Page Mill Road
Palo Alto, California 94304
Tel: (415) 326-7000
TWX: 910-373-1267
Telex: 034-8461
Cable: HEWPAK Palo Alto

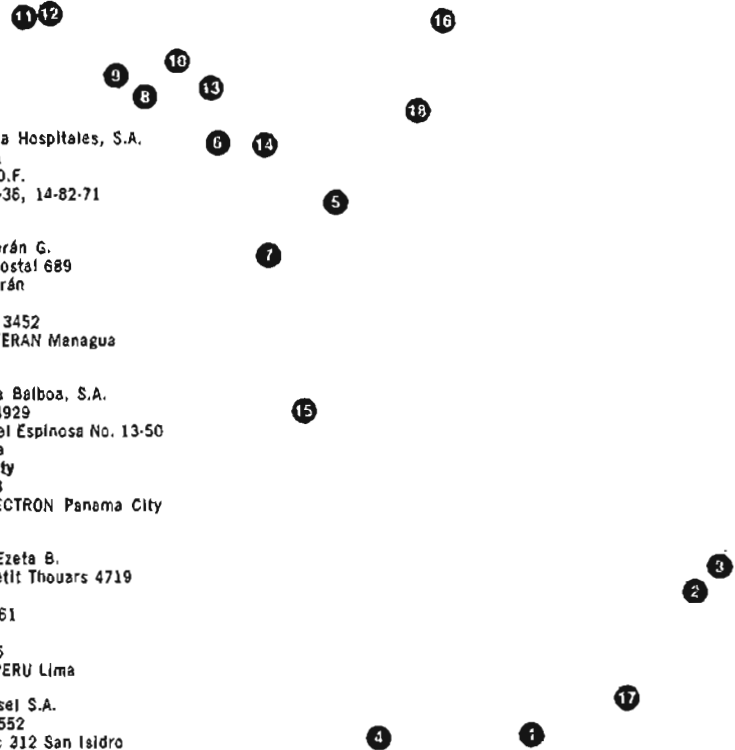

MANUFACTURING OPERATIONS



ABOUT HEWLETT-PACKARD

"I often say that when you can measure what you are speaking about, and express it in numbers, you know something about it; but when you cannot measure it, when you cannot express it in numbers, your knowledge is of a meager and unsatisfactory kind . . ."

Lord Kelvin (1824-1907)

Instruments for measurement are Hewlett-Packard's business. Electronic, analytical, and medical instrumentation products in the HP family now number more than 1500.

Since its founding in Palo Alto, California, in 1939, Hewlett-Packard has grown from a two-man operation into a world-wide organization of more than 12,000 people, with annual sales volume exceeding \$200,000,000.

The company and its affiliates now have more than a dozen manufacturing plants, including two in Western Europe and one in Japan. Sales and service offices are located in nearly every major city in the free world.

The original Hewlett-Packard products were electronic measuring instruments. With growth, the company's product family has expanded, and now it includes instruments for analytical, biomedical, nuclear, and scientific measurement and analysis. Hewlett-Packard increasingly is applying high-speed data handling and electronic computational techniques to instrument applications, developing computers for this purpose and the instruments that work with them.

The key to prospective involvement by Hewlett-Packard in any field of interest is *contribution*. Its philosophy of diversification and expansion is founded upon the concept of building on present strength.

At Corporate headquarters, in Palo Alto, California, are located the executive and administrative offices, and Hewlett-Packard Laboratories, the advanced research and development arm of the corporation.

Hewlett-Packard manufacturing operations

Hewlett-Packard is organized into the product-centered divisions and affiliates listed below to assure concentrated effort in developing true state-of-the-art measuring tools, and to provide the specialized manufacturing experience and know-how that results in instrument quality and reliability.

Avondale Division

Avondale, Pennsylvania — Analytical instrumentation, gas chromatographs, CHN analyzers, osmometers, viscometers.

Colorado Springs Division

Colorado Springs, Colorado — Oscilloscopes (dc through X-band, including storage), time domain reflectometers, pulse generators, TV waveform oscilloscopes.

Delcon Division

Mountain View, California — Ultrasonic translator detectors for telephone and industrial applications, buried cable fault locators, open fault locators.

Frequency and Time Division

Palo Alto, California — Electronic counters, quartz and atomic frequency standards, frequency synthesizers, digital printers, nuclear instrumentation, rf mixers.

Beverly, Massachusetts — Cesium beam tubes, hydrogen maser frequency standards.



Hewlett-Packard corporate headquarters, Palo Alto, California

Harrison Division

Berkeley Heights, New Jersey — Regulated dc power supplies and related equipment, precision TV picture monitors.

Hewlett-Packard G.m.b.H

Böblingen, West Germany — Audio analysis equipment and pulsers for world-wide distribution; also some of Hewlett-Packard's most widely used instruments for the European Common Market.

Hewlett-Packard Ltd.

South Queensferry, Scotland — Communications test equipment for world-wide distribution, noise generators and related equipment; also Hewlett-Packard's more popular instruments for the British, EFTA, and Commonwealth markets.

HP Associates

Palo Alto, California — Solid-state devices including hot-carrier, step-recovery and PIN diodes; microwave switches, mixers, and detectors; optoelectronic detectors and sources, photoconductors, photochoppers.

Loveland Division

Loveland, Colorado — Analog, digital, and differential voltmeters; oscillators and signal generators, sweep generators, function generators; ammeters, ohmmeters, working standards for voltage and resistance, distortion analyzers, wave analyzers, amplifiers, comparators, communications test equipment.

Microwave Division

Palo Alto, California — Microwave instruments, sweep and signal generators, signal sources, power meters, spectrum analyzers for microwave and high frequencies, network

analyzers, waveguide and coaxial measurement devices, microwave spectrometers.

Mountain View Division

Mountain View, California — Digital magnetic tape recorders, analog instrumentation tape recorders and accessories.

Palo Alto Division

Palo Alto, California — Computers, data acquisition instruments and systems, digital voltmeters, data amplifiers, signal-conditioning equipment, quartz thermometers.

Rockaway Division

Rockaway, New Jersey — Impedance and Q meters, inductance standards, high-frequency signal sources and signal generators, air navigation test sets.

Sanborn Division

Waltham, Massachusetts — Medical and biophysical instrumentation, oscillographs, transducers, signal-conditioning equipment, instrumentation amplifiers.

Yokogawa-Hewlett-Packard Ltd. (a joint venture)

Tokyo, Japan — Impedance measuring instruments, oscillators, power supplies, telephone speech scrambling equipment, for world-wide distribution; also more popular Hewlett-Packard instruments for the Japanese market.

Applications assistance

Hewlett-Packard provides complete applications assistance and after-sale back-up through more than 170 sales and service offices situated around the world. Contact the office nearest you next time you have a measurement need.



Hewlett-Packard has fifteen product-centered manufacturing operations.

TOTAL SERVICE--PROVIDED WITH EVERY HEWLETT-PACKARD INSTRUMENT



SERVICES

For nearly three decades, users of measuring instrumentation have found that they can rely on the integrity of Hewlett-Packard. This customer confidence has built Hewlett-Packard into one of the world's foremost manufacturers of electronic and scientific measuring instruments.

Companies making sophisticated measuring instruments have a special responsibility to their customers because of the highly critical ways in which instruments of this kind are often used. Whether the use is found in the maintenance of international communications, in the control laboratory of a petroleum refinery, or in a hospital operating room, it is essential that the equipment's performance meet its advertised specifications.

In recognition of this responsibility, Hewlett-Packard firmly adheres to the philosophy that its obligation to you as a customer does not end when your new instrument is delivered. In purchasing an HP measuring instrument, you are purchasing a way to do a job. You have the right to expect that your instrument will continue to do this job today, tomorrow, next week, and for a reasonable number of months and years in the future.

Hewlett-Packard implements this philosophy in two ways: (1) by initially making sure that it designs and builds for HP customers the finest, most reliable instruments possible, and (2) by backing up those instruments with a customer service program which can respond with speed and completeness to HP customers' needs.

This customer service program is one of the most important facets of Hewlett-Packard's worldwide operations. Directly involved in it at present are some 700 people located throughout the company.

... HP's customer service begins during the instrument design phase. Service engineers in each manufacturing division work closely with design and manufacturing engineers to assure that every instrument is as easily serviceable as possible.

... More than 100 HP field sales offices located in North America and abroad provide rapid and convenient service for Hewlett-Packard instruments. You need not correspond with a factory several thousand miles away for repair service, replacement parts, and technical assistance.

Backing up these local offices are regional repair centers and major service centers with extensive replacement parts inventories and facilities for major overhauls and large calibration and repair operations. Serving HP's customers are four repair centers and one service center in the U. S. and one service center in Europe.

Listed below are the elements of Hewlett-Packard's customer service program. The following pages briefly describe some of the benefits available to you as an HP customer under each of these headings:

- THE HEWLETT-PACKARD WARRANTY
- PRE-SALE PRODUCT INFORMATION
- TECHNICAL PUBLICATIONS
- TECHNICAL TRAINING PROGRAMS
- REPLACEMENT PARTS
- REPAIR SERVICE
- CUSTOMER SERVICE AGREEMENTS
- RECALIBRATION AND STANDARDS CALIBRATION

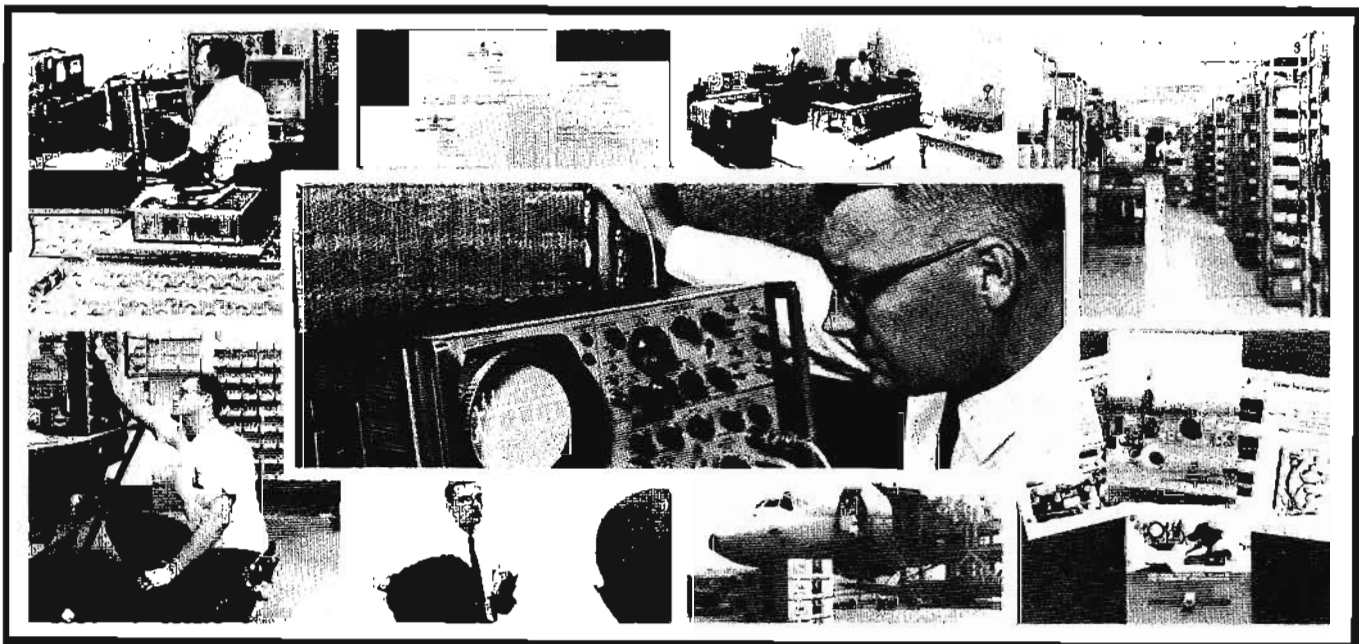

Hewlett-Packard gears its entire operation to one goal—the satisfied customer.

SERVICES

THE HEWLETT-PACKARD WARRANTY

When you buy a Hewlett-Packard instrument, you can count on receiving an instrument built with quality materials and workmanship. You can be sure that this instrument will perform as reliably and consistently as possible for a sophisticated piece of equipment.

The Hewlett-Packard warranty is an expression of confidence in the ability of HP instruments to measure up to this standard of performance.

The following warranty is the heart of an important and enduring Hewlett-Packard aim—to satisfy you initially and to keep you satisfied. It guarantees you an instrument which will perform the way you expect it to perform. It is backed by nearly 30 years of experience in the manufacture of precision measuring instruments:

Certification

Hewlett-Packard certifies that this instrument was thoroughly tested and inspected and found to meet its published specifications when it was shipped from the factory. Hewlett-Packard further certifies that its calibration measurements are traceable to the U.S. National Bureau of Standards to the extent allowed by the Bureau's calibration facility.

Warranty and Assistance

All Hewlett-Packard products are warranted against defects in materials and workmanship. This warranty applies for one year from the date of delivery, or, in the case of certain major components listed in the operating manual, for the specified period. We will repair or replace products which prove to be defective during the warranty period. No other warranty is expressed or implied. We are not liable for consequential damages.



Ease of service is an important consideration during the various instrument design stages.

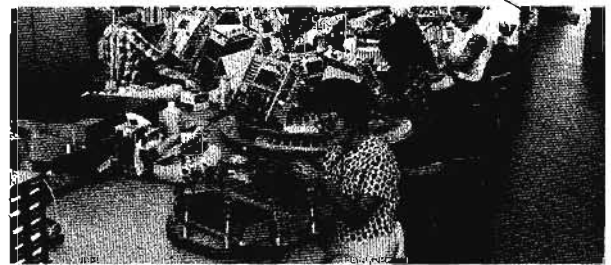

Production lines are designed to provide optimum worker accuracy and efficiency.



Every instrument manufactured is subjected to a thorough mechanical test.



A complete electrical test is also made to ensure that each instrument meets its published specifications.



Modern packing procedures minimize damage in transit.

PRE-SALE PRODUCT INFORMATION



SERVICES

To help you as a prospective buyer of measuring instrumentation make the best possible purchasing decision, Hewlett-Packard devotes a considerable amount of attention to making available accurate and complete product information.

Technical Data Sheets

When you need information about a specific Hewlett-Packard instrument or system, HP's technical data sheets are a convenient and informative source of detailed data and specifications. These data sheets are well-written and amply illustrated with photographs, diagrams, and charts.

A Highly Qualified Field Sales Force

Hewlett-Packard is proud of the members of its sales organization located throughout the world. These men are carefully selected and well trained in the capabilities of HP products and the needs of instrumentation users. You can rely on your local HP field instrumentation specialist for sound technical information and for accurate, concise answers to your questions.

Staff Engineers

When you need technical assistance in a hurry, the quickest, most efficient source of information is your field sales office staff engineer. He's as near as your telephone — always available and ready to answer your call.

As the in-office counterpart of your HP field specialist, the HP staff engineer works together with him in providing you with the finest possible technical assistance. If you need applications information or technical data on HP products, be sure to give your local staff engineer a call.

Demonstration Instruments

To make it possible for you to get a close look at the capabilities of Hewlett-Packard instruments, HP demonstration vans travel around the U. S. and other parts of the world making frequent demonstration stops. These vans offer you a chance to see and evaluate HP instruments in working displays.

Special Instrument Modifications

With Hewlett-Packard's broad product base, standard instruments may often be modified to meet a wide variety of special applications. HP's divisionalization of product groups permits flexibility in manufacturing methods, and provides almost unlimited potential for special modifications. If you have a unique application and cannot find a standard instrument to do the job, check with your local HP field specialist. He is always ready to help you solve your measurement problems.

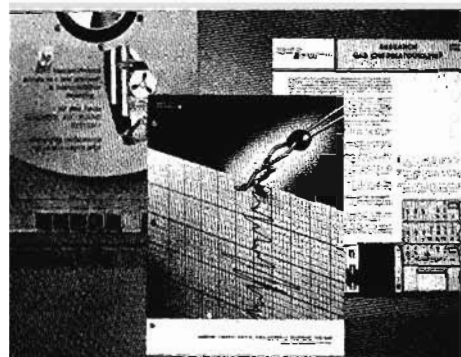



Sophisticated measuring instruments are very often rather intricate pieces of hardware. To take full advantage of the capabilities of these instruments, users generally have to familiarize themselves with a considerable amount of highly technical information. The primary source of this information for a particular instrument is the written material supplied by the manufacturer of that instrument.

Recognizing this responsibility, Hewlett-Packard devotes unusual attention to developing and distributing to its customers the most informative, readable, and generally useful written material of any manufacturer of measuring instrumentation.

Operating and Service Manuals

The most important publication of all to a customer is the Operating and Service Manual for his instrument.

Hewlett-Packard's Operating and Service Manuals are outstanding technical publications—logically organized, well written, containing ample photographs, diagrams, and illustrations, and compatible with several publications standards. Included in each manual are sections covering the theory of operation, operating instructions, maintenance and calibration information, and a table of replacement parts.

A manual is supplied with each new instrument. As a further service, extra manuals for all current Hewlett-Packard instruments, as well as for many older instruments, are also available at reasonable cost.

Service Notes

This series of technical publications is intended primarily as a vehicle for disseminating repair and maintenance information on Hewlett-Packard instruments. Acting as a convenient means of updating customers' Operating and Service Manuals, Service Notes cover such topics as new or special calibration techniques, instrument modifications, and special repair procedures—all written in a detailed manner. Ask your local field specialist for a copy of the Service Note Index so you can order those Service Notes of interest to you.

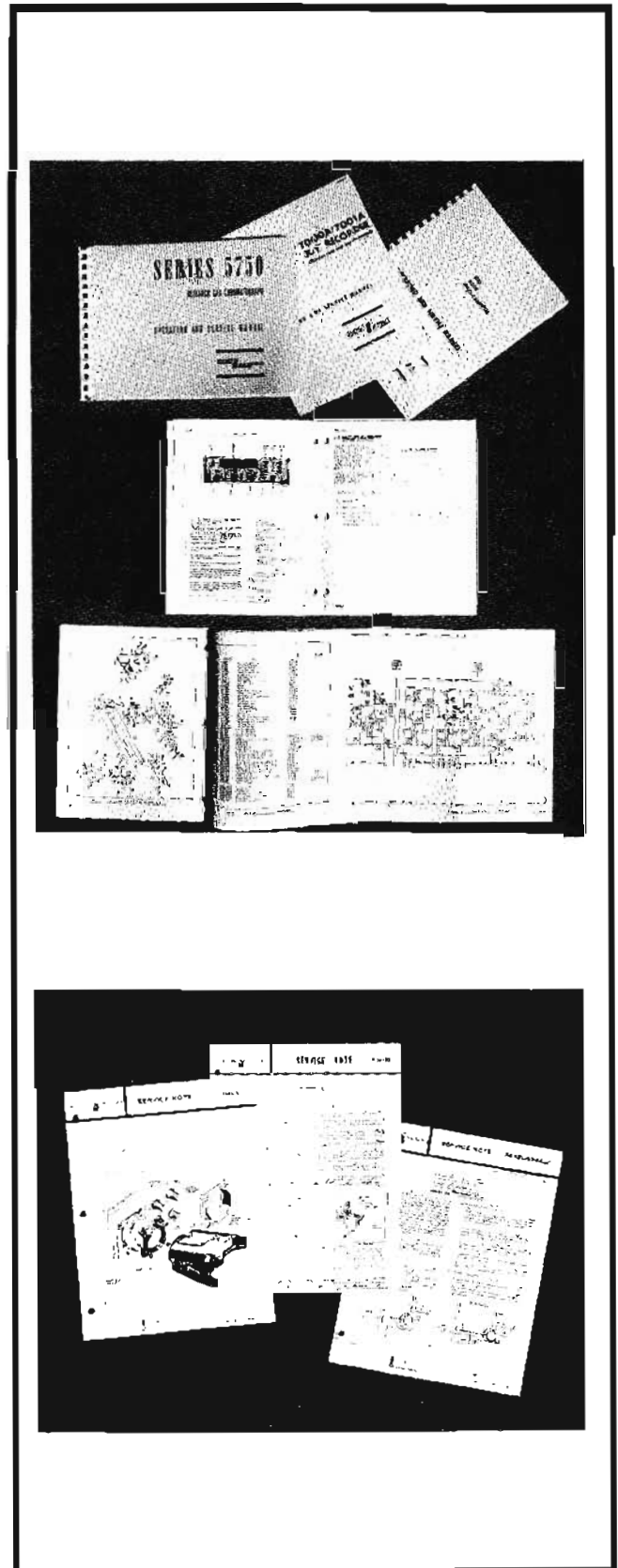

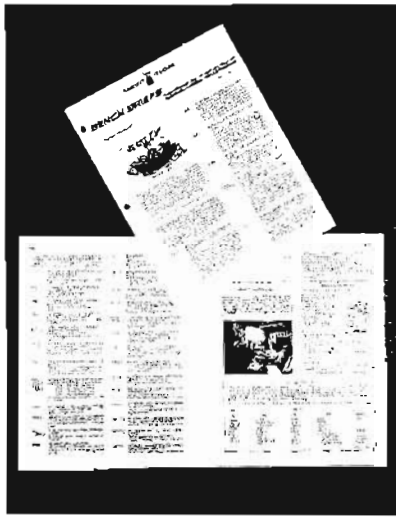

Bench Briefs

This newsletter briefly describes new Service Notes and other service publications as they become available. Servicing tips and suggestions which may be helpful to you are also included. Your local Hewlett-Packard field sales office will be happy to place your name on the regular Bench Briefs mailing list.

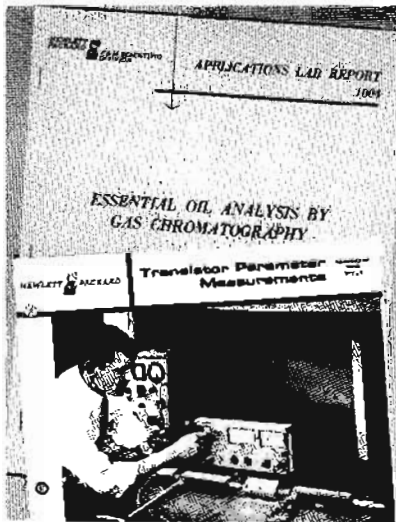

Application Publications

Hewlett-Packard application publications generally deal with individual measurement problems and offer suggestions and guidelines for developing analytical systems to meet these problems. Hewlett-Packard's two main application publications are Application Notes, primarily directed at the electronic discipline, and Applications Lab Report, intended mainly for chemical instrumentation users.

Because of their specialized nature, Hewlett-Packard's application publications are distributed by individual request. Your local field sales office will be glad to provide a list of application publications available.

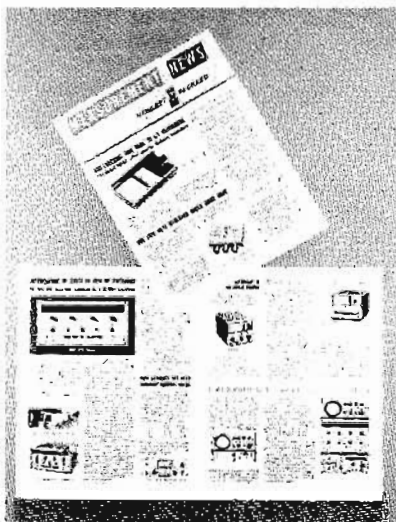

Measurement News

Announcements of new electronic instruments and articles of local interest are brought to you by your local field office in this bi-monthly publication. Also included are descriptions of new application publications as they become available. Ask your HP field sales office to place you on the regular mailing list.

SERVICES

**TECHNICAL PERIODICALS
FROM HEWLETT-PACKARD**

The Hewlett-Packard Journal

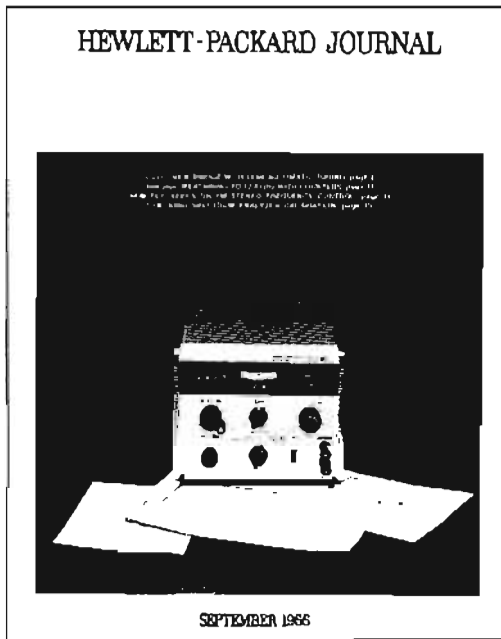

The Hewlett-Packard Journal is recognized as one of the most widely read engineering magazines in the electronics field. A monthly publication, the *Journal* contains authoritative articles by HP electronics engineers and scientists on the subjects of new instrumentation, measuring techniques, and related topics.

To be added to the circulation records, contact any HP field office or write: Editor, *Hewlett-Packard Journal*, 1501 Page Mill Road, Palo Alto, California, 94304.

Facts and Methods for Scientific Research



Facts and Methods for Scientific Research—published bi-monthly by the HP Chemical Applications Laboratory—is devoted to reporting the results of applications work and new technological developments in the field of chemical instrumentation.

To receive future issues of *Facts and Methods*, send your name and address to any HP field sales office or 1501 Page Mill Rd., Palo Alto, California 94304.

Measuring for Medicine and the Life Sciences



Measuring for Medicine and the Life Sciences, a quarterly publication from Hewlett-Packard's Sanborn Division, demonstrates by reports of actual applications how Sanborn and other HP instrumentation helps medicine and the life sciences obtain information on living processes—accurately, rapidly, and in the most meaningful form.

If you are interested in receiving *Measuring for Medicine*, contact your HP field sales office or 1501 Page Mill Rd., Palo Alto, California 94304.

TECHNICAL TRAINING PROGRAMS



SERVICES

To help assure that Hewlett-Packard customers are satisfied customers, HP makes available an extensive schedule of training courses, or training "seminars", that are designed to help users of measuring instruments maximize the efficiency of their equipment.

Seminar Content

The seminars available to you from HP can be classified in two types. The first has to do with *using* equipment effectively. Subject matter generally includes the theory and application of a particular measuring technique, and the approach that HP has followed in developing an instrument to make use of this technique. This type of training session is called an "Applications Seminar".

The second type of seminar has to do with ways and means of *maintaining* equipment—in terms of both repair and calibration. This program is intended primarily for service technicians, and is called a "Service Seminar". By taking advantage of it, you can have factory trained technicians in your own facility.

Training Locations

Both of these seminars are available to you in two locations—at HP field sales offices and at HP manufacturing

plants. Seminars conducted in field sales offices generally cover a given product area, such as oscilloscopes, nuclear instruments, gas chromatographs, etc., and last for 1-3 days.

Seminars conducted at manufacturing plants offer broader and deeper product coverage and generally last for one or two weeks. Portions of this training are tailored to individual needs where possible. Practical user experience in operation, repair, and calibration is emphasized.

Seminar Arrangements

All sessions are conducted by technically competent instructors who are experienced in instructional techniques.

Your local HP field sales office will be glad to provide you with the schedule of seminars coming up in future months. In the case of field seminars (both applications and service), scheduling depends largely on the preferences expressed by customers. So if you would like to see a particular seminar offered in your area, be sure to mention it to your local field sales office.

Of course, there is no charge for any Hewlett-Packard training seminar. Your only cost is for your own transportation, lodging, and meals. If you wish, HP will be happy to help you arrange for lodging.

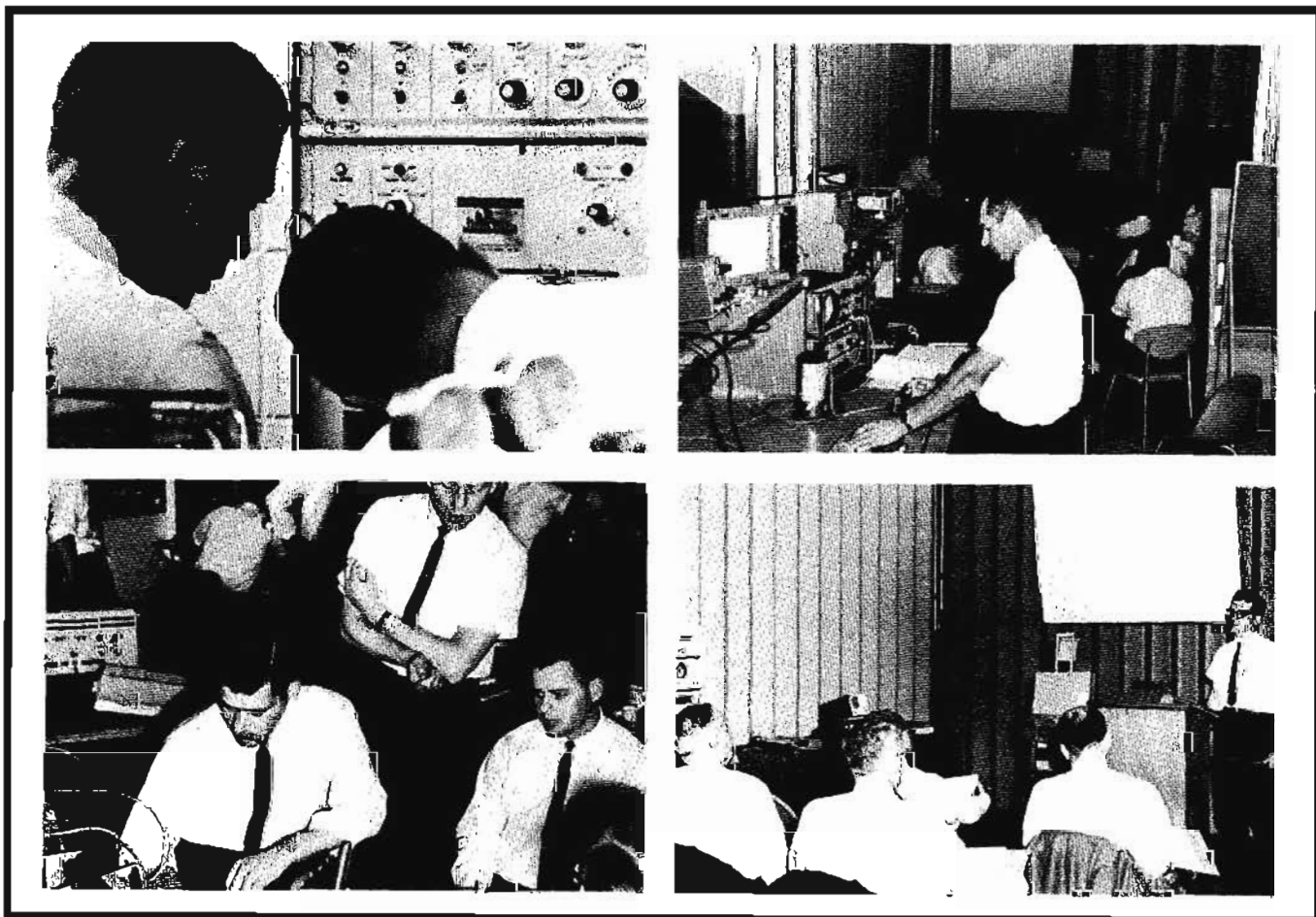



Inventories

Prompt instrument maintenance, done either in your facility or by Hewlett-Packard, depends on the immediate availability of replacement parts. For this reason, HP maintains extensive parts inventories at its field sales offices in many locations. These field sales offices are backed up by service centers, which maintain full factory level inventories, including many parts for older HP instruments.

Parts Identification

As mentioned earlier, every HP instrument manual has a "Table of Replacement Parts" to make it easy for you to identify parts you wish to replace.

If you need further help in identifying replacement parts, be sure to call your Hewlett-Packard field sales office. Each office maintains extensive technical files to help identify parts rapidly and further support is given each office by the service centers which have complete microfiles including many of the older products. This capability provides complete information in a matter of seconds.

Delivery Time

When it comes to replacement parts, customers have a right to expect product quality and fair value from their supplier. From Hewlett-Packard, this is exactly what they receive. Customers also have a right to expect fast delivery. With its extensive distribution of field sales offices and convenient local inventories, HP is uniquely qualified to provide fast delivery.

Normally, a replacement part order received by a USA field sales office will be filled and shipped the same day. Even if the office does not have the part in stock, this speed is not lost thanks to a computerized dataphone communications system linking each field office and service center.

In the USA if a field sales office receives an order for a part which it cannot supply, the order will be instantly relayed to a service center via the dataphone link. The order is then filled and shipped directly to the customer by the service center.

Hewlett-Packard can in this way offer unusual speed in the delivery of replacement parts.

AT LEAST 90% OF THE ORDERS FOR REPLACEMENT PARTS RECEIVED BY AN HP FIELD SALES OFFICE WILL BE SHIPPED THE SAME DAY — EITHER FROM THE SALES OFFICE ITSELF OR FROM A SERVICE CENTER.

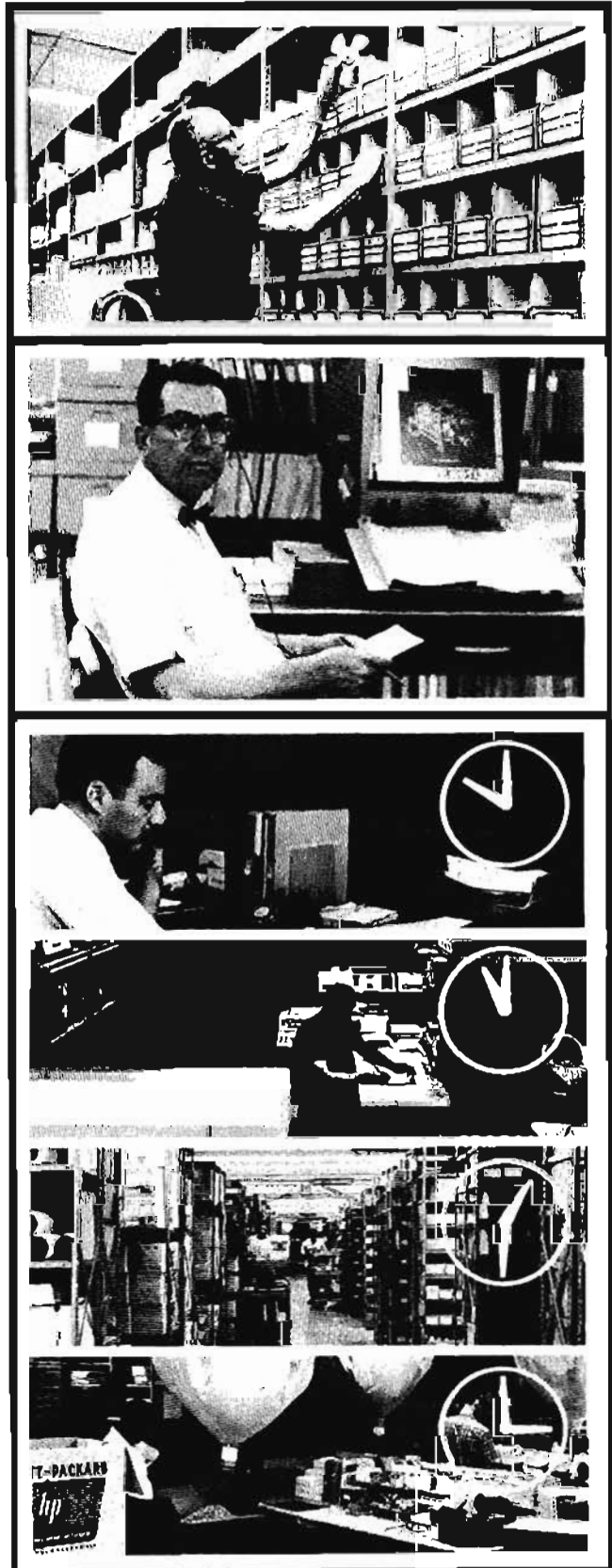

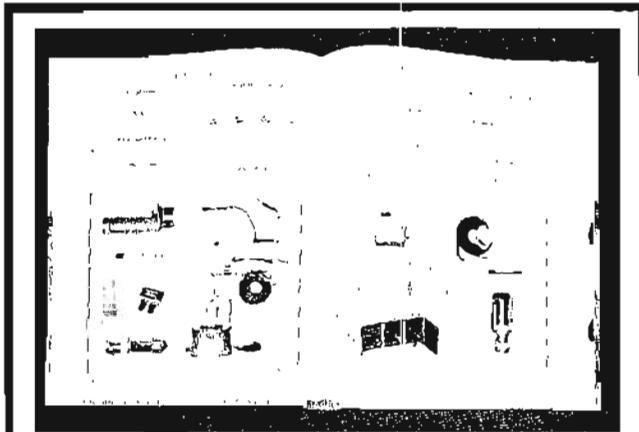

A wide variety of instrument accessories are always available for Hewlett-Packard Products.



Shown here is the modification kit for the internal light source of the model 196A oscilloscope camera.



These items make up a spare parts kit for the model 417A VHF detector.

Other Supplies

In addition to the usual replacement parts, *Accessories and Operating Supplies* are also in stock ready for immediate delivery.

Modification Kits may also be ordered from your nearby field sales office. Two publications from HP Customer Service, "Service Notes" and "Bench Briefs" (referred to earlier under TECHNICAL PUBLICATIONS), keep you abreast of modifications which are available.

Several types of *Spare Parts Kits* are available to sustain continuous operation from your HP instruments when they are being used in an isolated area, or where loss of the instrument's use would be extremely critical. "Running Spares" and "Isolated Service Kits" offer varying degrees of completeness, and you can choose the kit that most nearly satisfies your requirements.

Ordering Procedure

When ordering a replacement part or supply item, please specify: (1) the HP stock number for the part, and (2) its complete name as indicated in the "Table of Replacement Parts" in your Operating and Service Manual. Since the characteristics of a given component may have been altered in subsequent production changes, you should be sure to take this information from the Operating and Service Manual you originally received with the instrument.

As indicated above, your local field sales office can also provide help in parts identification. If you do place an order for a part without a stock number, please include the instrument model number, its serial number, a complete description of the part, its function, and its location within the instrument.

SERVICES**REPAIR SERVICE**

Hewlett-Packard is always prepared to back its products with the best possible repair service at a fair price.

To this end, most HP field sales offices throughout the world have repair and maintenance groups. These offices are backed by regional repair centers and service centers which have complete maintenance facilities, sophisticated test equipment, factory trained specialists, and a full line of replacement parts. You are thus able to deal with one local HP sales office for all your instrumentation needs.

Service is always provided at a price which reflects a fair value for the work actually done and is consistent with what

customers reasonably expect to pay for the benefits received. In addition to needed repairs, HP performs calibration, preventive maintenance, and both mechanical and electrical inspection to ensure satisfactory operation and a prolonged life for your HP instruments.

HP also offers extensive overhaul services for older instruments. These models can often be rebuilt to meet the specifications of the current production models. If a model is no longer manufactured, an overhaul will restore the instrument to its original usefulness.

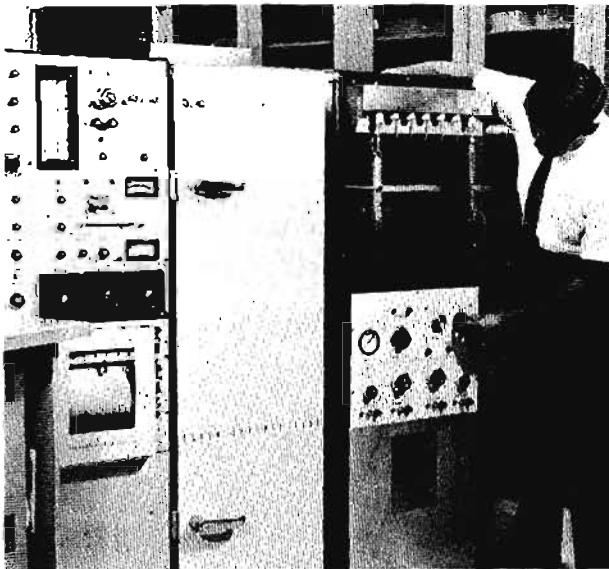
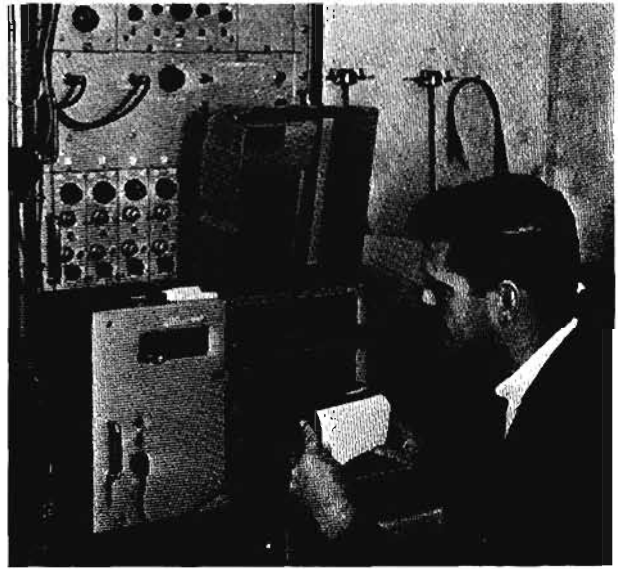
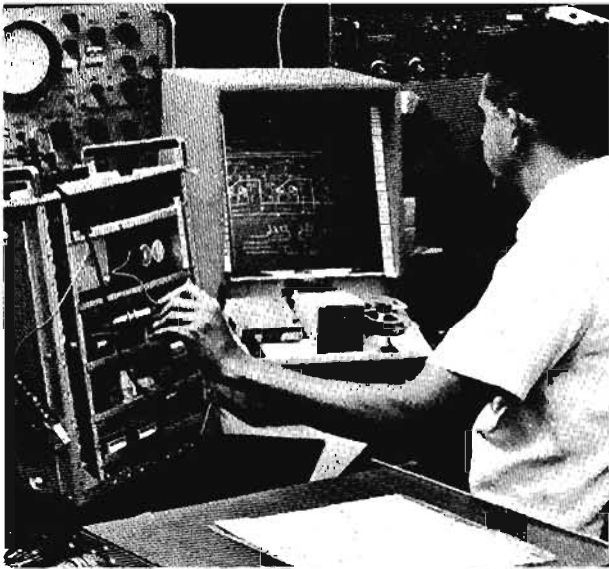

CUSTOMER SERVICE AGREEMENTS



SERVICES

Many Hewlett-Packard customers have found that an HP Customer Service Agreement is the best way to optimize their instrumentation maintenance expenditures. Each agreement is shaped to best meet each individual customer's needs and at the same time, save him money.

HP Service Agreements offer a well-tested service program that can reduce your costs by ensuring reliable operation, minimum downtime, and maximum useful life for your instruments. For a fixed annual cost, you can let HP assume all or part of your maintenance responsibilities.

Some of the services you may choose to include in your agreement are: 1) regularly scheduled and documented calibration and preventive maintenance; 2) a fixed number of emergency repair service calls; 3) an unlimited number of emergency repair service calls; 4) the replacement of any worn or defective parts; 5) service to be performed at your location or at HP facilities; 6) pick-up and delivery of your

instruments; 7) the use of the HP standards lab for your special requirements. This list by no means defines all of the service options you may choose under an HP Service Agreement to best meet your maintenance needs.

An additional benefit under all HP instrument Customer Service Agreements is that all new HP instrumentation you purchase during the course of the Agreement may be included under the Agreement at no additional charge.

Hewlett-Packard's Customer Service Agreement program is based on years of detailed maintenance information on each HP instrument. By taking advantage of this information you can improve the usefulness and efficiency of each of your instruments, and do it at a fair price. You may find, as many other satisfied customers have, that a Hewlett-Packard Customer Service Agreement is the best answer to your maintenance needs.

Contact your local HP field office for more information.

Maximum equipment use

Minimized downtime

Trained repair specialists

Known annual cost

New instruments added free

On-site service

Defective parts replaced free

Standards lab calibration

SERVICES



RECALIBRATION AND STANDARDS CALIBRATION

To insure that an electronic instrument continues to perform reliably, its operation should be routinely verified from time to time. Each Hewlett-Packard operating and Service Manual provides the information you need to recalibrate instruments in your own facility. If you prefer, the local HP sales office will be happy to arrange your recalibration for you.

In addition to this normal recalibration service, Hewlett-Packard also offers a standards calibration service for a wide variety of components, instruments and systems.

A standards calibration generally consists of obtaining the necessary corrections to be applied so that an instrument can be used with improved accuracy. In other cases, the standards calibration report is evidence of compliance with requirements for traceability to the National Bureau of Standards, important in government contracts.

The calibration report issued on every calibration gives the measurement conditions, a brief description of the technique used, the measurement uncertainty, the statement of traceability, and the actual test data, expressed in the most useful form. HP's standards capabilities cover almost all of the usual electronic quantities, at frequencies from dc to 40 GHz. An instrument of any manufacture can be calibrated, provided only that it is in good condition and shows the requisite stability.

Most customer standards calibrations are done by the Measurement Standards Laboratory at HP's headquarters in Palo Alto, California. As a further service, however, many of the HP field sales offices have been equipped with standards calibration capabilities for selected types of measurements.

Contact your local Hewlett-Packard field sales office for more information on the recalibration and standards calibration services available to you from HP.

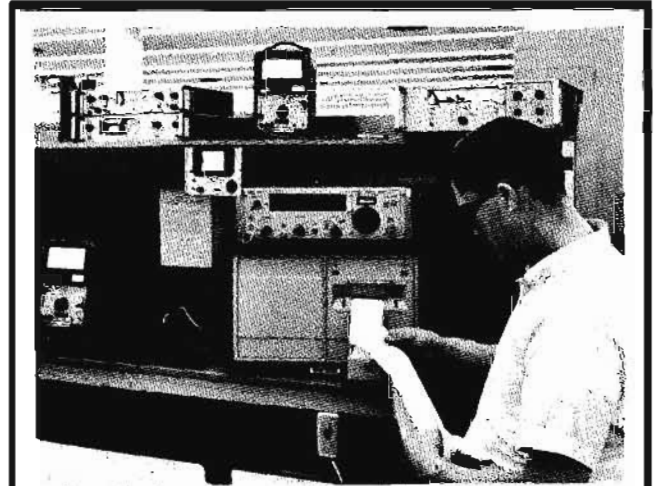

Recalibrations are performed by factory trained technicians at local field service facilities



HP's flying clocks are used by major world time keeping centers to calibrate their time standards.



The DC Room in HP's Palo Alto Standards Laboratory has temperature controlled within $\pm 0.03^{\circ}\text{C}$.

Analytical Instrumentation

Analytical Instrumentation	24-52
Accessories	50
Introduction	24
Gas Chromatographs	26-38
Automatic Prep	35
High Efficiency	31
Laboratory	33
Manual Prep	37
Molecular Weight Determination	43-49
Auto-Viscometer	48
Membrane Osmometer	46
Quartz Thermometer	43
Vapor Pressure Osmometer	44
Specialized Analyzers	39-42
CHN Analyzer	41
Microwave Spectrometer	39
<i>See also:</i>	
Leak and Friction Detectors	626
Nuclear Instrumentation	610
Temperature-Physical Measurements	623

Complete Indexes 633-649



Long recognized as the foremost supplier of electronic measuring instruments for the engineer, Hewlett-Packard has more recently become an important source of analytical instrumentation for the chemist. Included in this growing line of HP instruments is: a full choice of gas chromatographs both analytical and preparative; instruments for the determination of molecular weight; a special analyzer for CHN determinations; and a microwave spectrometer.

Gas chromatographs

Although only 15 years old, gas chromatography has taken over from classical and other instrumental methods the bulk of analytical work performed in chemical laboratories around the world. There is an excellent reason for the revolutionary effect of the gas chromatograph on analytical chemistry: no other method gets more accurate results, at greater speed, and for less cost.

The Analytical Instruments Division was a pioneer in the development of gas chromatography. Currently, it offers as complete a line of analytical and preparative gas chromatographs as any manufacturer anywhere in the world. Its standard catalog includes more than 50 models.

Analytical gc: There are basically three types of analytical gas chromatographs currently being manufactured: a "research" instrument that incorporates all the state-of-the-art advances that are needed to reach the highest possible level

of performance in a great variety of analyses; a "laboratory" instrument which can be ordered with only the basic equipment that is required to perform satisfactorily a particular set of routine analyses; and a "high-efficiency" instrument whose primary advantage is a large oven that accommodates U-tube glass columns for the analysis of sensitive materials.

Hewlett-Packard manufactures all three types. The choice should be based along functional lines as outlined in Figure 1.

Besides the choice of instruments, the key to a good separation by gas chromatography lies in the selection of a proper column. This is a rather involved procedure since there are literally hundreds of available column materials. Much of the needed information from which to make a correct choice is contained in Columns and Accessories Catalog No. 3.

Preparative gc: A natural outgrowth of analytical gc, the preparative gas chromatograph is used not to analyze, but to isolate and collect quantities of pure chemicals. For many types of samples, preparative gas chromatography is the fastest and most economical way to collect pure fractions. Its application is growing rapidly, especially as the result of technological improvements such as the recently introduced 2½ and 4 inch OD columns. The latter are capable of collecting in a few hours as much pure chemical as can be collected in several days by classical methods such as distillation.

Most manufacturers classify preparative gas chromatographs by capacity, with general agreement that there are two classes: those that accommodate small-capacity columns up to ¾ inch OD, and those that have the high-capacity 2½ and 4 inch columns. This classification scheme does not apply to Hewlett-Packard preparative gas chromatographs however because they all accommodate, with equal ease, both the low-capacity and the high-capacity columns.

Molecular weight instruments

The special skills of the polymer chemist are needed in practically every scientific field today, whether food technology, biomedical science, petroleum chemistry, etc. Hewlett-Packard serves the polymer chemist with a line of instruments that helps him make fast and accurate molecular weight determinations of all sizes of molecules. In this area of analysis, there are several different types of HP instruments, each intended for a particular kind of molecular weight determination: number-average, weight-average, and viscosity-average.

A polymer solution invariably consists of a number of different molecules that encompass a variety of chain lengths and weights. It is often useful to the polymer chemist to make all three kinds of molecular weight determinations because each gives him a better idea of the actual molecular weight of the sample and also tells

Fig. 1—Gas Chromatographs

Type	Description	Detectors	Model No.	Price
Research gc	Highest quality; performance equal to the strictest research requirements; simultaneous installation of any three detectors and simultaneous operation of any two with dual column compensation; fully versatile and automated. With model 5756B, three detectors can be operated simultaneously.	Dual flame (df)	5751B	\$3700
		Dual thermal conductivity (dtc)	5752B	3400
		Electron capture(ec)	5753B	3600
		Df and dtc	5754B	4800
		Df and ec	5755B	4600
		Df, dtc and ec	5756B	5600
Laboratory gc	Low cost dual-column instrument with modular design that permits easy addition of functional accessories.	Dual thermal conductivity	700-00	\$1100
		Dual flame	700-1099F	1700
		Electron capture	700-3099F	1850
		Micro cross section	700-4099F	1650
High-efficiency gc	Dual U-tube glass columns, high-efficiency gc system, multiple detector options . . . for the analysis of hard-to-chromatograph materials.	Df	402	\$3700
		Df and ec (tritium)	402 + opt. 02	4295
		Df and ec (Ni ⁶³)	402 + opt. 03	4600
Preparative gc	True prep-scale instruments accommodate various sizes of prep columns between ¾ and 4" OD, with built-in analytical capability.	Automatic	775	\$9500 (including recorder)
		Manual	776	4500

him something of the distribution of the type of molecules in his sample. In the example of Figure 2, it's easy to see that the number-average determination represents the most probable molecular weight of the sample. Although less representative of the actual molecular weight, the weight-average and viscosity-average determinations give the polymer chemist useful information about the breadth of the distribution curve and, in combination with the number-average determination, a basis for predicting the physical properties of the polymer solution.

At one time or another, the polymer chemist needs the kind of information that each of these HP instruments is capable of producing for him. He may even want to make molecular weight measurements according to the classical cryoscopic or ebulliometric methods. If so, Hewlett-Packard can simplify his job again, this time with the quartz thermometer, an instrument that directly measures and digitally displays temperature or temperature difference to a resolution of 0.0001°.

Once again, the choice between the various types of Hewlett-Packard instruments should be based on functional considerations, as outlined in Figure 3.

Microwave spectrometer

The HP Series 8400B Microwave Spectrometer provides a means of measuring the total amount of information available from gas-phase microwave spectroscopy absorption lines. These measurements are: frequency, intensity, and line-width.

Research scientists use this measurement to provide information in such areas as molecule identification, molecular con-

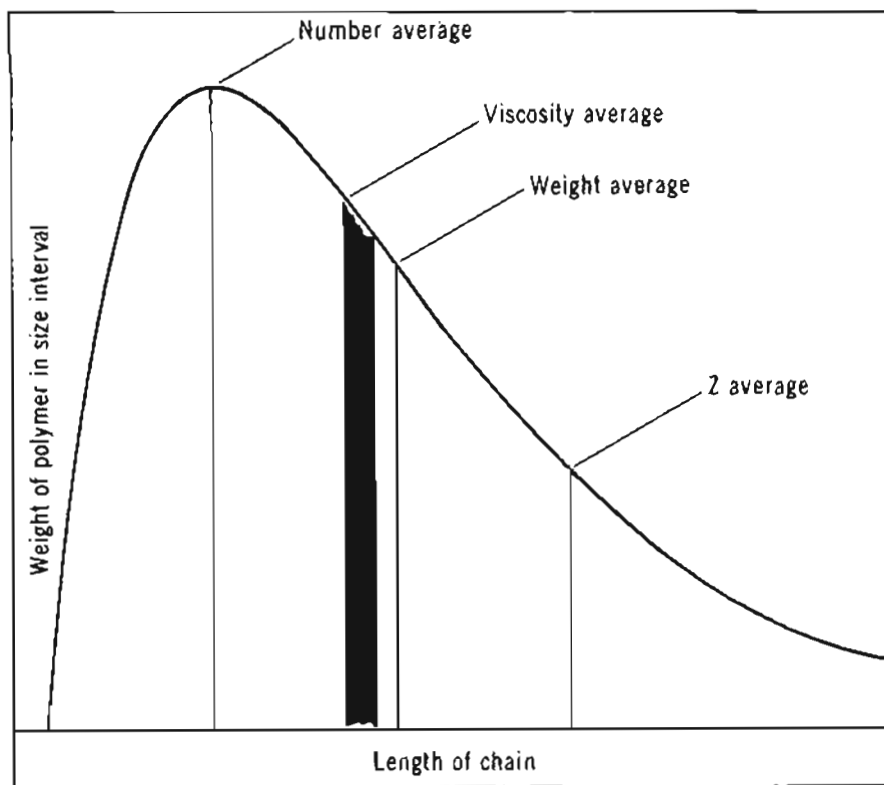

Figure 2. Typical molecular weight distribution.

centration, bond - distance, bond - angle, molecular vibrational levels, barriers to internal rotation, equilibrium constants, molecular collision rates, and reaction kinetics.

CHN analyzer

The Model 185 Carbon Hydrogen Nitrogen Analyzer performs a complete elemental analysis of organic materials simultaneously and automatically in less than 10 minutes. In the few years since its introduction, it has already gained con-

siderable acceptance among microchemists. The reason is its ability to perform, even under difficult circumstances, elemental analyses whose accuracy is well within the accepted allowable error of $\pm 0.3\%$, at a speed advantage of 4 to 8 times over classical methods.

In addition to being faster than the classical methods, the Model 185 also requires a much smaller laboratory investment because it enables a technician with only a minimum of microanalytical training and experience to obtain reliable re-

Fig. 3—Molecular weight instruments

Type	Description	Temperature	Model no.	Price
Vapor pressure osmometer	For number-average molecular weight determinations between 100 and 25,000; consecutive readings every 2 to 3 minutes; aqueous or nonaqueous operation.	25° to 130°C (must specify)	302	\$2600 (plus probe and thermostat)
Membrane osmometer	For number-average molecular weight determinations between 10,000 and 1,000,000; automatic readings in 3 to 10 minutes; for aqueous or nonaqueous operation.	Ambient to 65°C Ambient to 130°C 5° to 65°C	501 502 503	\$4375 \$125 \$700
Auto-viscometer (5901B) Printer-programmer	For viscosity-average molecular weight determinations to precision of 0.005%; completely automated. Provides automatic sequential and/or repetitive measurements on each channel with tape printout.	Ambient to 150°C	5901B (inc. 4 detectors) 5903A	\$2650 3600
Quartz thermometer	Measures temperature or temperature difference directly and displays digital readout in °C or °F to a resolution as high as 0.0001°; calibration accuracy is within +0.02°C absolute.	-80° to +250°C	2801A (inc. 2 sensors)	\$3250

sults under normal laboratory conditions.

Accessories

Often the effectiveness and utility of HP analytical instruments can be significantly extended through the use of an accessory that has been specially engineered for that purpose. The most important ones, which are described at the end of the Analytical Instrumentation section of this catalog, include strip chart recorders designed especially for use with gas chromatographs; a series of sample introduction and collection devices, again for gc; and some temperature measurement and control accessories for HP osmometers. Complete information on these and many other useful accessories is given in the Columns and Accessories Catalog, available on request.

Hewlett-Packard services

The analytical instrumentation described in this section is backed by the quarter-century-old Hewlett-Packard tra-

dition that "service starts before the sale and extends through the life of the instrument."

In implementing this policy, Hewlett-Packard offers a complete instrument service to the analytical chemist.

Technical Assistance: Technically trained Analytical Instrumentation sales representatives in all major cities of the U.S., Canada, and Europe will be glad to assist you in the selection, application, and use of Hewlett-Packard instruments.

Instrument service: Qualified and experienced service personnel, located in Hewlett-Packard sales offices and service centers, are on call to perform routine instrument maintenance or emergency repair in your laboratory.

Training courses: Training courses in the application of the techniques of gas chromatography to biochemical and industrial analysis are held regularly at various Hewlett-Packard sales offices, as are courses on preparative chromatography. Field workshops are also spon-

sored periodically by the Analytical Instruments Division in cooperation with local institutions.

Applications research: Investigators at the Chemical Applications Laboratory in Avondale are constantly developing new techniques and improving existing methods. The result of their applications work is made available through papers presented at technical meetings, in scientific journals, and by comprehensive articles in Hewlett-Packard publications. Their services are also available for information about the application of gas chromatography to specific analytical problems.

Technical publications: Hewlett-Packard maintains constant communication with its analytical instrumentation customers about the use, maintenance, and general upkeep of their instruments. This is accomplished through a variety of technical publications such as the Chemical Applications Laboratory's "Facts & Methods," a bimonthly publication that contains comprehensive papers and technical articles on chemical instrumentation.

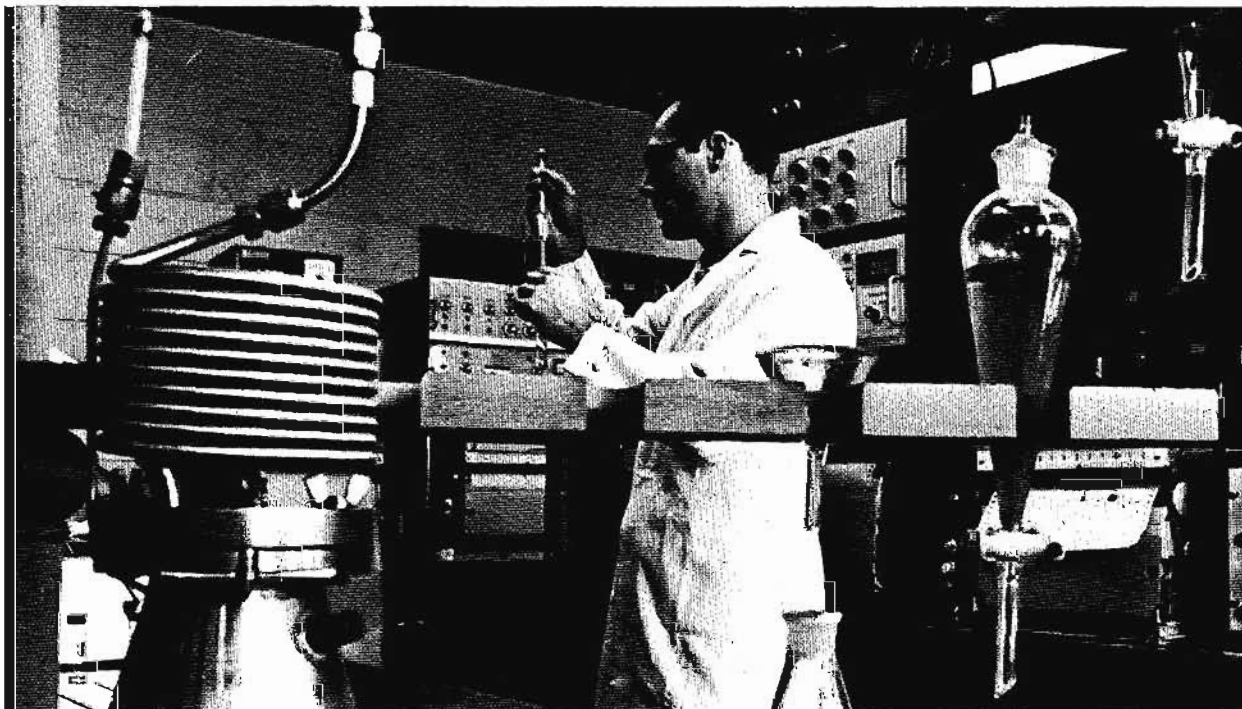

RESEARCH GC

Automated, multiple-detector for top performance
5750 Series



GAS CHROMATOGRAPHY

Series 5750 Gas Chromatographs are automated yet fully versatile instruments whose performance is equal to the strictest research requirements. They are a 'top-of-the-line' instrument incorporating improvements that are available in no other gas chromatograph. Behind these improvements stand some quiet but important advances in the state-of-the-art that have made gas chromatography an even more useful tool than it was just a few years ago when the 5750's predecessor was introduced. Parallel advances in design make the 5750 still the most useful gas chromatograph around. Some of the most useful of the new design features of the Series 5750 GC are discussed below.

Three detector positions

The Series 5750 permits the simultaneous installation and operation of three detectors, from a choice of five interchangeable types: flame ionization, thermal conductivity, electron capture (H^3), electron capture (Ni^{63}) and micro cross-section.

Each of these detectors has been significantly redesigned to increase its performance to the highest level possible on the basis of current technology.

High-linearity dual flame detector

Tenfold better than the best previously reported, the 5750's new dual flame ionization detector is linear up to 2 ml of propane with a peak width at base of 7 seconds, peak current of 2×10^{-6} amp, equivalent to 3.7×10^{-4} grams C/sec.

Performance of the new detector was carefully evaluated on a 4-foot column with constant 30 ml/min carrier gas flow. Injections of propane gas in sample sizes from 10 to 2000 microliters were made with a calibrated syringe capable of $\pm 1\%$ accuracy. Results indicate a deviation in detector response of less than $\pm 10\%$ from theoretical at 2000 microliters, and much better at the smaller sample sizes.

The improvement in linearity is accompanied by a 30% increase in sensitivity with no increase in noise level and by a much greater tolerance to variations in gas flow. End result is that the 5750 flame detector permits the determination of trace components at much lower concentration levels . . . and better qualitative and quantitative reproducibility with large sample sizes.

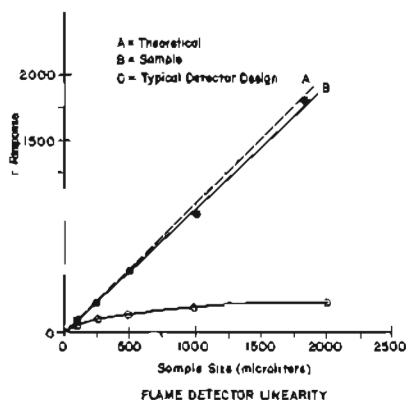

5750

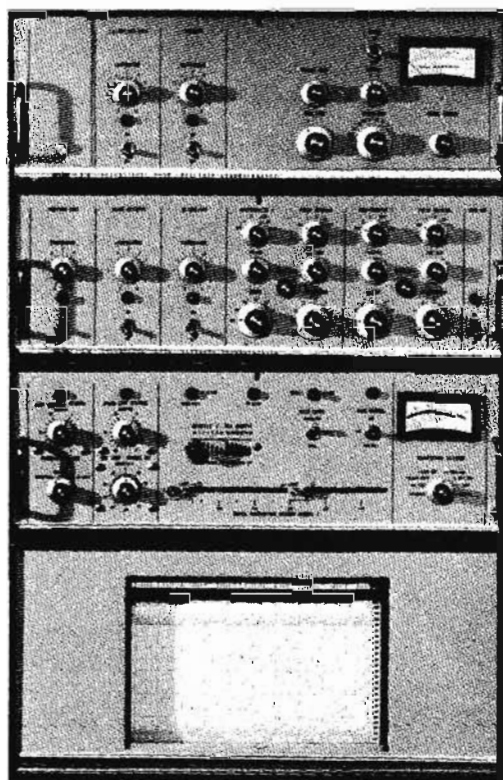

RESEARCH GC *continued***Automated, multiple-detector for top performance
Series 5750****High-stability dual thermal conductivity detector**

Improved baseline stability characterizes the dual thermal conductivity detector. Routine checkout procedures require that baseline drift be within $\pm 4\%$ per hour with the detector block at 350°C, a filament current of 150 ma, a helium flow of 30-60 ml/min, and a well conditioned column in an ambient temperature oven.

There are four distinct reasons for the improvement in performance. The new cell geometry (1) isolates the cell from external temperature changes through a well-insulated and controlled buffer zone, (2) optimizes the length of transfer lines between column and detector, (3) eliminates thermal gradients within the cell through four symmetrically distributed heaters and (4) insures a high degree of flow insensitivity and systematic sweep-out of the cell even at low flows.

High and low-temperature electron capture detectors

The 5750 offers a choice of two electron capture detectors: the standard tritium cell, with a sensitivity of 1×10^{-12} grams of Lindane, for operation up to 220°C and a new nickel cell for temperatures up to 355°C. Both feature the variable pulsed voltage design for optimum sensitivity and linearity of response. The new Ni⁶³ cell is especially useful for the analysis of high-boiling components. Since it can be operated at higher temperatures, deposition of column substrate and high-boilers in the cell is substantially reduced.

The new cell has a useful life expectancy better than twice that of tritium cells (up to 5 years under moderate operating conditions) and a sensitivity of 2×10^{-12} gram of Lindane. Its thermal stability, built-in-over-heat protection and efficient shielding eliminate all possibility of health hazard from radioactivity.

Versatile detector controls

Now available with either a single-channel or dual-channel electrometer — both with dual input capability for each channel — the 5750 offers the analyst a choice of three compact detector controls, one of which is suited exactly to his need and budget:

(1) *Single-channel electrometer* accommodates any one of the ionization detectors. Because it has dual-input capability, it operates the dual flame ionization detector either as a differential input (dual column compensation) or as a single input (single column operation). In either case, the electrometer provides a single output to the recorder.

(2) *Dual-channel electrometer* is also compatible with any of the ionization detectors. Since *each* channel has dual-input capability, this electrometer can be used for simultaneous operation of two detectors while permitting dual column compensation... as well as for independent operation of the two sides of the dual flame detector.

(3) *Thermal conductivity detector bridge* is designed specifically for use with the improved 5750 thermal conductivity detector. Noise has been reduced and integration capability has been improved.

State-of-the-art oven and flow systems

This section of the 5750 has been completely redesigned in the light of recent state-of-the-art advances and a better understanding of its importance to the precision of gas chromatography.

OVEN — The 5750 oven possesses an excellent combination of fast response and temperature uniformity. In the matter of response, it heats from 50°C to 400°C in ten minutes, cools from 400°C to 50°C in 8 minutes. Concerning temperature uniformity during isothermal operation, the gradient of the air around the columns does not exceed $\pm 0.5\%$ at any temperature up to 400°C; in programmed operation, it does not exceed $\pm 1.0\%$. If column packing temperature is measured rather than the air surrounding the column, the gradient is considerably less (about $\pm 0.25\%$ isothermally).

INJECTION PORT — Entirely new in design, the 5750's injection port permits true on-column injection, eliminates dead volume,

minimizes thermal gradients, allows minimum sample backflash, and provides for the use of inserts.

FLOW CONTROLLER — A newly designed flow controller maintains flow rates with a precision about five to ten times better than that obtainable with presently available commercial flow controllers.

Automated operation

The Series 5750 oven temperature control system is designed to give the analyst complete versatility of operation, from manual isothermal to fully automatic programmed runs.

When in automatic operation, the 5750 will re-establish all oven parameters without manual resetting of any kind. The entire cycle is automatic, from temperature programming, through variable time delays, to automatic cooling and re-equilibration at the starting temperature, provided the initial temperature is sufficiently above ambient.

Specifications, Series 5750B**Detectors****Flame ionization**

Dual detector unit.

Isolated jet, operating potential 350 vdc.

Extended linear operating range of over 10^4 with hydrocarbon sample.

Sensitivity: 40 millicoulombs/gram of carbon with hydrocarbon sample and oxygen as combustion gas.

Operating temp.: ambient to 500°C.

Voltage-stabilized power regulator.

Flame igniter standard.

Thermal conductivity

Dual detector unit.

Operating temp.: ambient to 450°C.

Carrier gas: helium, 5-200 ml/minute.

High-sensitivity, spiral flow-thru tungsten-rhenium filament.

Noise: $\pm 1/4\%$ at 150 ma, detector 350°C, isothermal oven, helium carrier gas.

Drift: $\pm 4\%$ per hour at 150 ma, detector 350°C, isothermal oven, helium carrier gas.

Power-proportioning temp. controller.

Relatively insensitive to flow changes.

"Detector protector": carrier gas pressure reduction automatically cuts off filament current.

Electron capture*

Pulsed voltage: 5, 15, 50 and 150 microsecond intervals.

Electron source:

(1) 200 millicuries tritium.

operating temp.: ambient to 220°C $\pm 5^\circ$.

(2) 2 millicuries Ni⁶³

operating temp.: ambient to 355°C $\pm 5^\circ$.

Integral overheat protection.

Carrier gas: argon-methane or helium with purge.

Purge gas: argon-methane.

Voltage-stabilized power regulator.

Parallel plate configuration.

Micro cross-section*

Electron source: 200 millicuries tritium.

Operating temp.: ambient to 220°C $\pm 5^\circ$.

Integral overheat protection.

Carrier gas: argon-methane or helium with purge.

Purge gas: none required.

Voltage-stabilized power regulator.

Parallel plate configuration.

Injection port

Dual unit.

Flash vaporizer.

Operating temp.: to 500°C.

On-column injection.

Accepts replaceable inserts and special sampling devices.

Splitter system (optional)

Voltage-stabilized power regulator.

*AEC license required; Hewlett-Packard Sales Offices supply necessary license application information.

Oven.

Temperature range: ambient to 500°C with detectors and injection port at 100°C. 80°C is minimum oven temperature possible with detectors and injection port at 275°C to 300°C.

Isothermal gradients: $\pm 0.5\%$ max. (measured in air).

Programmed gradients: $\pm 1.0\%$ at 10°C per minute to 400°C (measured in air).

Max. heating rate: 50° to 400°C in 10 minutes with 120 Vac across the heaters and without columns.

Cooling rate: 400°C to 50°C in 8 minutes without columns.

Linear programmer: 10 rates from 1° to 60°C/minute.

Simultaneous installation of up to 3 detectors.

Capacity: up to 150 feet of 1/4 inch OD column and proportional lengths of 1/16", 1/8" and 1/2" OD columns.

Power-proportioning temperature controller.

Automated programming cycle including cooling.

Installable accessories: injection splitter, effluent splitter, heated collection vent, gas sampling valve, backflush valve.

Columns

Packed: glass (limited to 2-10' columns or 1-20' column); metal. Analytical or preparative.

Outside diameter: 1/16, 1/8, 1/4 and 1/2 inch.

Lengths up to 150 feet, 1/4" inch OD column on average 9-inch diameter coil.

Temperature control

Separate controls for all heated components.

Readout on indicating pyrometer with eight-position selector switch.

Direct setting in degrees of column oven temperature.

Gas flow system

Dual-column design with dual injection and exit ports and five flow paths:

(1) dual compensating columns

(2) two columns in series

(3) two columns in parallel

(4) single analytical column

(5) single preparative column

Gas supply: fittings and plumbing for four gases:

(1) Carrier Gas

1/8-inch entrance fitting

drying tube

two 3-inch matched rotameters with calibration curve for flow-range 0-200 ml/min @ 30 psig helium

two differential flow controllers with needle valve adjustment

(2) Hydrogen Gas (flame ionization models only)

1/8-inch entrance fitting

adjustable-matched restrictors (flow rates up to 125 ml/min)

two optional 3-inch rotameters

needle valve shut-off control

(3) Air (flame ionization models only)

1/8-inch entrance fitting

adjustable-matched restrictors (flow rates up to 500 ml/min)

two optional 3-inch rotameters

(4) Auxiliary Gas

1/8-inch entrance fitting

needle valve for adjustment and shut-off

T. C. bridge

Continuous current adjustment and readout (0-300 ma).

Coarse and fine zero controls.

Attenuator for bridge output (12 positions to 1024).

Output polarity switch.

Separate output for electronic integrator.

Line-operated power supply.

Electrometer

Single and dual-channel models.

Input (each channel): dual flame ionization, single flame ionization, electron capture or micro cross-section detectors.

Sensitivity: 1.0×10^{-12} A full scale output on a 1 mv. recorder at range 1, attenuation 1.

Dynamic range: 100,000 to 1 on all range resistors.

Total linear range of 4.0×10^{-11} to 10^{-6} A.

Noise: 2.0×10^{-11} A peak to peak (cables disconnected at the electrometer).

Coarse and fine zero controls, with background suppression of 1.0×10^{-10} A on all ranges.

Separate input and output attenuation controls.

Line-operated power supply.

Output impedance: to recorder ≤ 1.28 k Ω ; to integrator = 11.5 k Ω .

Electrical

Supply requirements: 105-125 V, 60 Hz, single phase (50 Hz optional); 19 A max. at 115 V for normal operation.

Circuit breaker on both sides of main power line.

All key circuits fused.

Ground through power cable.

Physical dimensions

Oven module: W 23", D 20 3/4", H 18"

Control module: W 21", D 19", H min, 15" w/o recorder, 25" with moseley. max. 40 1/2".

Oven compartment: 12" x 12" x 6".

How to order

Ordering No.	Description Complete Instruments	Price
5751B	Dual flame detector instrument with single-channel electrometer.	\$3700
5752B	Dual thermal conductivity detector instrument with bridge.	3400
5753B	Electron capture detector instrument with single-channel electrometer.	3600
5754B	Dual flame and dual thermal conductivity detector instrument* with single-channel electrometer and bridge.	4800
5755B	Dual flame and electron capture (tritium) detector instrument* with dual-channel electrometer.	4600
5756B	Dual flame, dual thermal conductivity and electron capture (tritium) detector instrument* with dual-channel electrometer and bridge.	5600
H10-7127A	Moseley single pen; strip chart recorder; right hand zero; 10" chart; 1 mV input module (filtered) with detector selection switch; gray panels.	1100
H10-7128A	Moseley two pen; strip chart recorder; right hand zero; 10" chart; 1 mV input module (filtered) for each channel with detector selection switches; gray panels.	1650
Options (factory-installed)		
01	Second electrometer channel for Models 5751B, 5754B (allows alternate or simultaneous* operation of two ionization detector systems, or independent operation of both sides of the dual flame detector).	500
02	Dual thermal conductivity detector and bridge installed on Model 5753B*.	1000
03	Electron capture detector (tritium) and single-channel electrometer installed on Model 5752B*.	1300
04	Same as Option 03* except that detector contains a high-temperature Ni ⁶³ foil.	1600
05	Micro cross-section detector installed on Models 5751B and 5754B; instrument capable of alternate operation of either ionization detector.	475

RESEARCH GC *continued***Automated, multiple-detector for top performance Series 5750**

06	Micro cross-section detector, single-channel electrometer installed on Model 5752B*.	\$1225
07	To substitute Ni ⁶³ electron capture detector in Model 5753B, 5755B or 5756B.	275
08	Inlet splitter (installed).	125
10	Heated collection vent*** (installed).	100
11	Dual rotameters for air and hydrogen flows (installed).	300
12	Gas sampling valve without shut-off valve (installed).	225
13	Gas sampling valve with shut-off valves (installed).	275
15	Effluent splitter (2, 3 way)	175
21	230 V, 50 Hz operation	82

Modules (customer-installed)

5760B	Dual channel electrometer, consists of two dual-input single-output electrometer channels which permit dual column compensation on either channel while leaving the other channel free for operation of a second ionization detector.	1300
5761A	Single channel electrometer, with dual-input single-output for use whenever an additional electrometer channel is required. To be used only with 5750A Series Electrometers.	800
5761B	Single channel electrometer, with dual-input single-output for use whenever an additional electrometer channel is required. To be used with 5750B Series Instruments or 5750A Series Instruments where 5750B Series Electrometer has been previously supplied.	500
5762A	Detector, pulser and necessary hardware for adding tritium electron capture detection to Models 5751A or 5754A. (Allows alternate operation** of either ionization detector.) To be used only with 5750A Series electrometers.	695
5762B	Detector, pulser and necessary hardware for adding tritium electron capture detection to Models 5751B or 5754B. (Allows alternate operation** of either ionization detector.) To be used only with 5750B Series Electrometers.	695
5763A	Detector, pulser and necessary hardware for adding Ni ⁶³ foil electron capture detection to Models 5751A or 5754A. (Allows alternate operation** of either ionization detector.) To be used only with 5750A Series Electrometers.	1000

5763B	Detector, pulser and necessary hardware for adding Ni ⁶³ foil electron capture detection to Models 5751B or 5754B. (Allows alternate operation** of either ionization detector.) To be used only with 5750B Series Electrometers.	\$1000
5764A	Detector, bridge, power supply, and necessary hardware for adding dual thermal conductivity detection to Models 5751*, 5753*, or 5755*. For use with 5750A or 5750B Series Instruments. (Specify basic instrument type.)	1100
5765B	Detector, single channel electrometer, pulser and necessary hardware for adding electron capture (tritium foil) detection to Model 5752A* or Model 5752B*.	1395
5766B	Detector, single channel electrometer, pulser and necessary hardware for adding electron capture (Ni ⁶³ foil) detection to Model 5752A* or Model 5752B*.	1700

5767A	Detector, and necessary hardware for adding micro cross-section detection to Models 5751A and 5754A or 5751B and 5754B. (Allows alternate operation** of either ionization detector.)	575
5768B	Detector, single channel electrometer, and necessary hardware for adding micro cross-section detection to Model 5752A* or 5752B*.	1325
5769B	Detector, single channel electrometer, and necessary hardware for adding dual flame detection to Model 5752A or 5752B. (Allows alternate or simultaneous* operation of both detectors.)	1400
5770A	Detector, and necessary hardware for adding dual flame detection to Model 5753A. (Allows alternate** operation of either detector.)	490
5770B	Detector, and necessary hardware for adding dual flame detection to Model 5753B. (Allows alternate** operation of either detector.) For use with 5750B Series Electrometers.	550

Accessories (customer-installed)

19031A	Heated collection vent***	100
19032A	Dual-rotameter kit for air and hydrogen flows	300
19034A	Effluent splitter	175
19035A	Inlet splitter	125
19047A	Gas sampling valve without shut-off valves	225
19048A	Gas sampling valve with shut-off valves	275

*Capable of simultaneous operation of two detectors when equipped with 2 single-pen or one dual-pen recorder and splitters.

**Capable of simultaneous operation of two detectors when equipped with additional electrometer and recorder channels and effluent splitter.

***Requires effluent splitter.

HIGH EFFICIENCY GC

Multi-detector, dual U columns, all-glass system
Series 402



GAS CHROMATOGRAPHY

Designed specifically for the analysis of thermally sensitive, polar and other hard-to-chromatograph materials, Series 402 High-Efficiency Gas Chromatographs incorporate a number of unique instrument characteristics that minimize or eliminate the decomposition or absorption of unstable materials.

Straight-through on-column injection

The 402's unique injection port is characterized by a straight-through design which has substantial advantages over the more common T-design:

a—*it accomplishes true on-column injection* since the syringe discharges the sample at least one inch into the column, rather than in a separate chamber, thus essentially eliminating sample contact with metal in the hot injection zone;

b—*a stream of high-velocity carrier gas sweeps the entire injection area* including the inside surface of the septum, thus preventing sample holdup or condensation on the septum;

c—*it eliminates the dead volume and sample backflash* that are characteristic of T-type designs, thus producing an ideal "plug" injection.

Multiple-detector, dual-column system

Series 402 GC's are dual-column instruments with multiple detector capability. Each of its two-columns can be equipped with an effluent splitter, thus giving the analyst a choice of functions that includes:

- a—single-column operation
- b—concurrent runs on two different columns
- c—dual-column baseline compensation
- d—simultaneous operation of two detectors
- e—simultaneous analytical/preparative runs for the collection of individual separated components.

No dead spaces

Dead space (i.e. stagnant carrier gas) has been virtually eliminated throughout the 402's GC system especially in the four critical areas:

- a—*injection port . . . carrier gas sweeps the whole area;*
- b—*where column joins injection port . . . on-column injection eliminates this dead space;*
- c—*where column joins detector . . . the 402's primary detectors attach directly to the column end, eliminating this dead space;*
- d—*detectors . . . all 402 detectors are based on flow-through design and are devoid of dead space.*

All-glass system

The 402 is designed so that the sample "sees" virtually nothing but glass, from injection directly on glass, through a glass column and a glass and Teflon effluent splitter, to the detector; or into a Teflon collection system that attaches directly to either of the instrument's auxiliary detector positions.

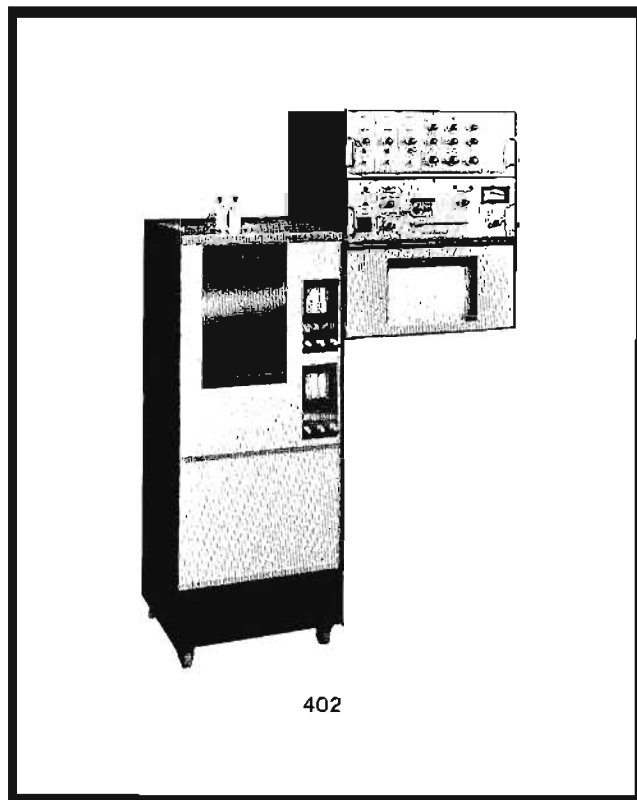

High-turbulence U-tube oven

Two 3000 RPM centrifugal blowers at opposite ends of the oven create a high-turbulence environment for two 6-foot U-tube columns. Twin heaters are mounted in the blower stream to eliminate thermal lag and create uniform temperatures in the immediate column environment (gradient less than 2°C top to bottom).

Performance

Even with the most sensitive materials—pesticides, steroids, vitamins, organo metallics, polyfunctional industrial organic chemicals—the 402 produces a chromatogram that bears all the marks of a high-efficiency instrument:

peak symmetry so fine that there is no trace of tailing even at picogram levels of detection;

column efficiency so high (often exceeding 700 theoretical plates per foot) that even the most difficult separations are completed on as little as 12 feet of column;

elimination of component loss so complete that steroids give accurate quantitative response, even at the nanogram level;

sensitivity so high that picogram quantities of many materials are detected without even extending the detector;

dual column operation so versatile that it permits baseline compensation, or concurrent analytical runs on two different columns, or with special modification, simultaneous operation of up to four detectors, or combined analytical/preparative runs.

Specifications

Gas flow system

Facilities for handling four gases:

- (1) Carrier gas: dual differential flow controllers and needle valves; dual matched 3-inch rotameters sized for helium flow range of 0-250 cc/min at 40 psig; drying tube.
- (2) Hydrogen: dual needle valves; dual matched 3-inch rotameters sized for flow range of 0-100 cc/min.
- (3) Air: dual needle valves; dual matched 3-inch rotameters sized for flow range of 0-700 cc/min.
- (4) Purge: needle valve, drying tube.

Column system

Dual on-column injection with removable flash heaters. Dual columns, each 4 or 6-feet, glass U-shaped with 3 mm ID and 6 mm OD (longer glass columns of paper clip configuration and metal columns may also be used).

Oven: stainless steel shell with double insulation 1½" thick; two low-mass heaters each 800 watts; two blowers; thermal fuse.

Effluent splitter (optional): annular split design; made of glass with Teflon* insert for min. sample contact with metal; infinitely variable split ratio of approx. 1:1 to 20:1.

Detectors

Dual flame ionization (standard): low-mass design; minimum sample contact with metal.

Twin flame: for independent operation of both sides of the dual flame detector.

Electron capture: choice of tritium cell for operation up to 220°C and nickel cell for temperatures up to 355°C; tritium cell has 200 millicuries source and nickel cell, 2 millicuries; pulsed voltage type with variable pulse interval of 5, 15, 50 and 150 microseconds; built-in overheat protection; tritium cell of Teflon* and stainless steel; nickel cell made of ceramic and stainless steel; venting required; requires specific AEC license.

Micro cross-section: 200 millicuries tritium source; dc voltage type; no purge gas required; built-in overheat protection; made of Teflon* and stainless steel; no venting required below 150°C; requires specific AEC license.

Electrometers

Sensitivity: 4.0 x 10⁻¹³ A full scale on 1 mV recorder.

Linear dynamic range: 4 x 10⁻¹⁴ to 1 x 10⁻⁶ A.

Background suppression: 10⁻⁵ A, supplied by battery.

Input attenuation: 4 powers of 10.

Output attenuation: 8 multiples of 2.

Output for potentiometric recorders: 0-1 mV.

Temperature controls

Oven: power-proportioning controller and linear programmer with 12 rates from 0.5 to 30°C/min.; max. temp. of 400°C; max. temperature gradient of 2°C; max. heating time from ambient to 400°C is 40 min.; cooling from 400°C to 50°C in 15 min.; program delay timer variable 0-20 min.

Injection port: voltage-stabilized power regulator; max. temp. of 450°C.

Flame detector: voltage-stabilized power regulator; max. temp. of 425°C.

Auxiliary detector: voltage-stabilized power regulator; max. temp. of 225°C, or 360°C.

Readout: indicating pyrometer and five-position selector switch.

Physical

Size: oven module: 48" high, 18" wide, 19" deep; control cabinet: 33" high, 21" wide, 22" deep.

Weight: oven module: 180 pounds; control cabinet with recorder: 215 pounds.

Electrical

Power requirements: 105-125 V, 50 or 60 Hz (specify on order), 20 A.

Fuses: main power has circuit breakers on both sides of line; key circuits are fused.

* DuPont's registered trademark for fluorocarbon resin

How to order

Ordering No.	Description	Price
Complete instruments		
402	Basic dual flame ionization detector instrument with single-channel electrometer*, 115 V, 50 or 60 Hz (specify)	\$3700.00
H10-7127A	HP single pen; strip chart; right hand zero; 10" chart; 1 mV input module (filtered) with detector selection switch; gray panels; 60 Hz operation	1100.00
H10-7128A	HP two pen; strip chart; right hand zero; 10" chart; 1 mV input module (filtered) for each channel with detector selection switches; gray panels; 60 Hz operation	1650.00
Options		
01	Adds second electrometer channel (for alternate or simultaneous** operation of two ionization detector systems, or for independent operation* of both sides of a dual flame detector)	750.00
02	Adds detector and all necessary hardware for electron capture (tritium foil) detection***	595.00
03	Same as Option 02 except that detector contains a high-temperature Ni ⁶³ foil	900.00
04	Two-way effluent splitter	95.00
21	230 V, 50 Hz operation	82.00
Additional items (customer-installed)		
5801A	Single-channel electrometer with dual-input single-output (for use whenever an additional electrometer channel is required)	800.00
5802A	Detector and all necessary hardware for adding tritium electron capture detection	695.00
5803A	Same as Model No. 5802A except that detector contains Ni ⁶³ foil	1000.00
5804A	Detector and all necessary hardware for adding micro cross-section detection	575.00
5805A	"U" column oven with dual flame detector for use with Series 810 Gas Chromatograph	2100.00
5806A	Ni ⁶³ Detector and necessary hardware to replace tritium Detector	800.00
Accessories		
19050A	Two-way effluent splitter	95.00
19055A	Total collection system	120.00

* Independent operation of both sides of the dual flame detector (twin flame) can be obtained through use of a second electrometer channel (Option 01) and a dual-channel recorder.

** Requires two single-channel or one dual-channel recorder.

*** For simultaneous operation, an effluent splitter, second electrometer channel and second recording channel are required.

LAB GAS CHROMATOGRAPH

Low-cost modular dual-column GC
Series 700



GAS CHROMATOGRAPHY

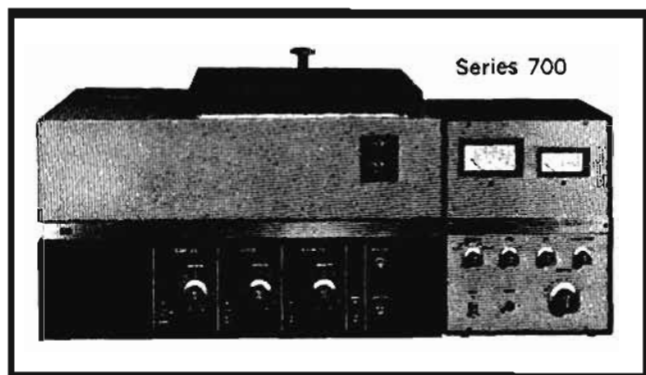

The basic Series 700 unit is an isothermal gas chromatograph with a flexible two-column design that permits single column, series or parallel two-column operation as well as dual column compensation. The 700 is also capable of manual temperature programming and high-temperature operation, with independent control of injection port, detector, and oven to 400°C. Injection can be either directly onto the column or into a flash vaporizer. All Series 700 oven modules are equipped with a voltage-stabilized power regulator. An adapter plate and switch permit bypassing the standard power regulator and allows the plug-in use of either a Model 220 Temperature Controller or a Model 240 Temperature Programmer for oven control. Except for Model 700-00, all Series 700 instruments are equipped with flow controllers.

Interchangeable detectors

Regardless of which detector is initially ordered with the instrument, the analyst has the option of replacing it with any one of the four detector attachments that are presently available: dual thermal conductivity, dual flame, electron capture and micro cross-section. All are completely interchangeable one with the other.

Each detector attachment for Series 700 instruments is packaged as a kit with all the necessary hardware for installation. The same basic instrument is used for all detectors, thus affording the analyst a multi-detector instrument at low cost.

Modular accessories

Power-proportioning oven controller: an adapter plate and switch permit bypassing the standard power regulator and allows the plug-in use of either a Model 220 temperature controller or a Model 240 temperature programmer for oven temperature control. The Model 220 controller is a solid state device that modulates power input to the oven heating element in proportion to the actual need for heat.

Temperature programmer: the Model 240 Linear Programmer provides precise programming of Series 700 oven heating rates. It also incorporates a power-proportioning controller described above. The programmer provides 12 discrete heating rates from 0.5 to 30°C/min.

Power supply for TC detectors: a HP power supply was specifically designed for thermal conductivity circuits and packaged to fit the Control Module of the Series 700. It can be set for 15 volts to supply type W filaments or for 30 volts to supply type WX filaments.

It converts 105-125 V ac (50 or 60 Hz) to a regulated dc output through full-wave solid-state circuitry that incorporates regulation and filtering for stability. It has 300 mA capacity.

Flow measurement: an optional dual rotameter, installed on the Oven Module, continuously and accurately indicates the gas flow rate through both columns.

Flow controllers: factory installed on all but Model 700-00. These controllers include one or two diaphragm-actuated control valves installed in the Oven Module to keep the flow of carrier gas constant regardless of changes in column temperature or viscosity. It replaces the standard needle valve flow control of Series 700 instruments.

Series 700 specifications

Gas flow system

Dual column design with dual injection and exit ports and five flow paths:

- (1) dual compensating columns
- (2) two columns in series
- (3) two columns in parallel
- (4) single analytical column
- (5) single preparative column

Gas supply requirements: regulated 0-100 psi.

Gas supply connections:

- (1) for thermal conductivity models:
one 1/4" connection for carrier gas with flow controllers for each column except on Model 700-00
- (2) for flame ionization models:
one 1/4" connection for carrier gas with flow controllers for each column
one 1/8" connection for hydrogen, split through matched snubbers; needle valves for each flow
one 1/8" connection for combustion air split through matched snubbers
- (3) for electron capture and micro cross-section models:
one 1/4" connection for carrier and purge gas with needle valve (flow controller optional)

Columns

Standard column sizes: any OD from 1/8 to 1/2 inch. Large oven holds up to 150 feet of 1/4-in. OD column. Accepts packed metal, glass or preparative columns.

Detectors

Four Interchangeable detectors:

- (1) Thermal conductivity:
dual detector
four-wire hot filament type, 300 mA range
W or WX filament standard
- (2) Flame ionization:
dual detector
low-mass design on cast aluminum base
manual flame igniter

LAB GAS CHROMATOGRAPH *continued***Low-cost modular dual-column GC
Series 700**

- (3) Electron capture (tritium or N¹⁵)
pulsed voltage type with variable interval of 5, 10,
50 and 150 microseconds
200 millicuries tritium or 2 millicuries of N¹⁵ source
with integral overheat protection
no venting required below 150°C
specific AEC license required
- (4) Micro cross-section:
DC voltage type
200 millicuries tritium source with integral overheat
protection
no venting required below 150°C
specific AEC license required

T. C. bridge

Continuous current adjustment and readout
Coarse and fine zero adjustment
Attenuator (12 positions to 1024)
Output polarity switch

Power requirements:

for W filaments—15 V dc, 300 mA
for WX filaments—30 V dc, 300 mA

Electrometer

Input: HP dual flame ionization, electron capture or micro
cross-section detectors.

Sensitivity: 1×10^{-11} A full scale.

Linearity: $\pm 1.5\%$ full scale over entire range.

Time constant: less than 1 second at full sensitivity.

Noise: less than 10^{-13} A.

Drift: less than 1% full scale per hour.
Live zero and background suppression.

Power requirements: self-powered from integral 135 V bat-
tery supply; no ac.

Temperature control

Separate controls for detector, oven and injection port

Detector: voltage-stabilized variable power regulator, (pow-
er-proportioning controller standard with WX filament
t.c. detector).

range: ambient to 400°C.

heater rating: 170 W.

fuse: 1 A.

Oven: voltage-stabilized variable power regulator (power-
proportioning controller and linear programmer optional).
range: ambient to 400°C.

heating rate: 15 min. ambient to 400°C.

cooling rate: 10 min. 400°C to ambient.

heater rating: 1050 W (1200 W with 220 or 240).

fuse: 15 A, plus temperature limit fuse.

Injection port: variable power transformer.

range: ambient to 400°C.

heater rating: 85 W.

fuse: 1 A.

Temperature readout: indicating pyrometer and five position
selector switch.

Physical

Oven module: 25" wide, 16½" high, 20½" deep; 76 lbs net.

Bridge module: 10" wide, 13½" high, 10½" deep; 12 lbs net.

Electrometer module: 10" wide, 13½" high, 10½" deep;
18 lbs net.

Electrical

Oven module: 110-125 V ac, 50-60 Hz, 20 A.

Bridge module: (as noted).

Electrometer module: self-powered.

Fuses: main power has circuit breaker; all key circuits sep-
arately fused.

How to order**Complete instruments**

700-00	Dual thermal conductivity detector (TC) instrument.	\$1,100.00
700-0019F	Dual TC instrument with power supply and dual flow controllers.	1,450.00
700-0119F	Dual TC instrument with power supply, dual flow controllers and proportioning oven temperature controller.	1,850.00
700-2419F	Dual TC instrument, with WX filaments, power supply, dual flow controllers and proportioning detector temperature controller.	1,700.00
700-021	Dual TC instrument with power supply, dual flow controllers and linear programmer	2,100.00
700-231	Dual TC instrument with WX filaments, power supply, dual flow controllers, proportioning detector temperature controller and linear programmer	2,350.00
700-1099F	Dual flame ionization detector (FI) instrument with dual flow controllers.	1,700.00
700-1199F	Dual FI instrument with dual flow controllers and proportioning oven temperature controller.	2,100.00
700-12	Dual FI instrument with dual flow controllers and linear programmer.	2,350.00
700-3099F	Electron capture detector (EC) instrument with dual flow controllers. Option 04 for N ¹⁵ Electron Capture Detector, add \$275.	\$1,850.00
700-3199F	EC instrument with dual flow controllers and proportioning oven temperature controller. Option 04 for N ¹⁵ Electron Capture Detector, add \$275.	2,250.00
700-4099F	Micro cross-section detector (MCS) instrument with dual flow controllers.	1,650.00
700-4199F	MCS instrument with dual flow controller and proportioning oven temperature controller.	2,050.00
700-42	MCS instrument with dual flow controllers and linear temperature programmer.	2,300.00

Attachments

700-A-091	Dual TC detector with W filaments, bridge, 15-30 volt power supply, detector oven and installation hardware.	545.00
700-A-291	Dual TC detector with WX filaments, bridge, 15-30 volt power supply, detector oven and proportioning temperature controller and installation hardware.	795.00
700-A-1*	Dual FI detector and hardware.	450.00
700-A-3*	EC detector, pulser, temperature limit controller and installation hardware. Option 04 for N ¹⁵ Electron Capture Detector, add \$275.	695.00
700-A-4*	mcs detector, temperature controller and installation hardware.	575.00
700-A-99E	Electrometer.	350.00

*If attachment is for use with Model 700 that is not equipped with electrometer, Part No. 700-A-99E must be ordered also.

AUTOMATIC PREP GC

High-capacity with versatile automation
Model 775



PREPARATIVE GAS CHROMATOGRAPH

An all-purpose preparative gas chromatograph, the Model 775 accommodates with equal ease, both the "long-narrow" columns of $\frac{3}{8}$, $\frac{1}{2}$ or $\frac{3}{4}$ inch OD and the new "short-wide" columns of $2\frac{1}{2}$ and 4 inches OD. Because of this unique capability, it is equally capable of making high-capacity, high-resolution and trace component separations.

High-capacity

When you want to collect very large volumes of a major component, the Model 775 does the job with either $2\frac{1}{2}$ or 4-inch OD columns. Sample injections as large as 125 ml are made repeatedly and as much as a liter of the desired pure component may be collected in a single day. For example, the Model 775 automatically made injections of about 65 ml each of a turpentine sample every half-hour for 30 hours, until 3480 ml of the two major components (α and β -pinene) were collected, each at a purity of better than 98%.

High-resolution

When you want to collect only a small quantity of a hard-

to-separate component, equip your Model 775 with long-narrow columns (as much as 400 feet of $\frac{3}{8}$ or shorter lengths of $\frac{1}{2}$ or $\frac{3}{4}$ -inch OD column, depending on the desired degree of resolution.) In another example, the Model 775 separated a 2.0 ml sample of premium gasoline on 32 feet of $\frac{3}{4}$ -inch column; approximately 50 milligrams of one component was collected with a purity of 97.9%, for subsequent identification by infrared spectrometry.

Trace components

When you want to collect a trace component from a mixture, a great deal of time can be saved by using short-wide columns and a large sample size. With this technique, the trace component can be collected in an adequate quantity after only a single run. As a final illustration, a 10 ml injection of proprietary plasticizer compound was made on 40 inches of 4-in. OD-column and the impurities were separated out and collected apart from the main component.

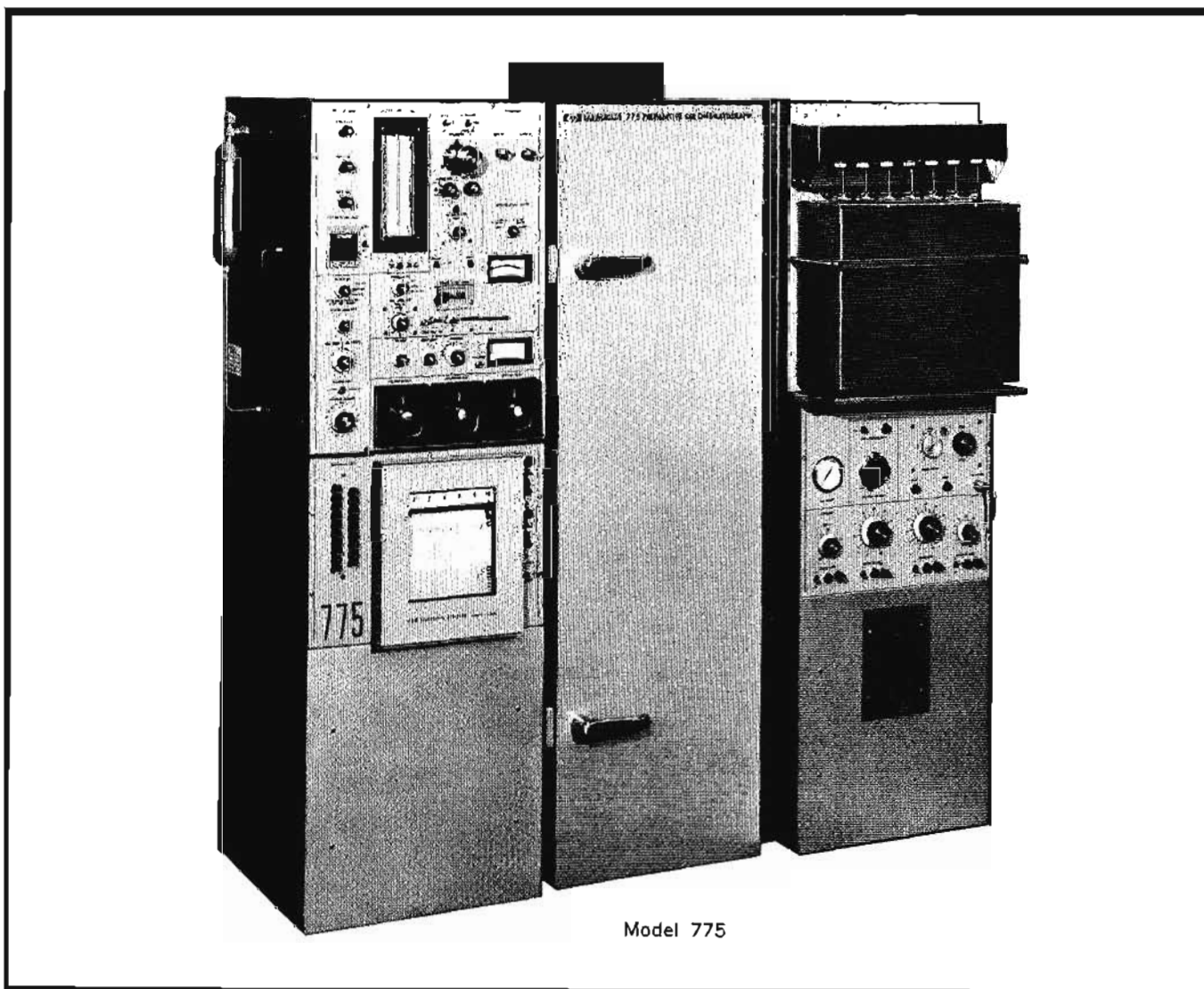

Model 775

AUTOMATIC PREP GC *continued***High-capacity with versatile automation
Model 775****Flame ionization detector**

Available as an optional factory-installed second detector (the thermal conductivity detector is always standard) or as a separate kit for installation by the customer on an existing 775, the flame ionization detector is of a unique design that employs separate jets for the effluent and hydrogen flows, thus eliminating any possibility of accidental back-up of hydrogen into the oven. An effluent splitter is provided to control flow to the detector.

Whether ordered as an option or a kit, the flame detector includes a control panel with line-operated electrometer, remote igniter, rotameters and needle valves for hydrogen and air flow control and an effluent splitter.

Refrigeration unit and cooling bath

Easily interchangeable with the standard cooling bath, this optional unit comprises a compressor and special bath equipped with cooling coils. The special bath has the same internal and external dimensions as the standard bath with which it is completely interchangeable in size and capacity.

It is capable of maintaining bath temperatures anywhere between ambient and -15°C through an integral temperature controller.

It permits completely unattended operation of the instrument even when collecting components that condense only at temperatures substantially lower than ambient, by eliminating the need for replenishing ice in the cooling bath.

Specifications, Model 775**Injection system**

Sample reservoir: pressurized; can be filled, emptied and flushed without removing from instrument; 300 ml capacity standard, optional 1000 and 2250 ml available.

Prep injection: three types provided.

1. Septum-port for manual syringe.
2. Auto-injector for automatic injection adjustable $\frac{1}{4}$ to 12 ml.
3. Timed system for automatic injection adjustable 0 to 125 ml.

Analytical injection: separate septum port for syringe.

Vaporizer: 250 watt heaters in heat sink supply 664 calories per 1°C temperature drop.

Cycle controller: counts and controls number of automatic injections.

Column system

Oven: 12 in. wide by $6\frac{1}{2}$ in. deep by 53 in. high; accommodates up to 400 feet of $\frac{3}{8}$ -in. OD column, or up to 80 inches of 4-in. OD; also accepts proportionate length of $\frac{1}{4}$, $\frac{3}{4}$ and $2\frac{1}{2}$ -in. OD column.

Thermal conductivity detector: (standard) four-filament type with high-capacity design (no splitting required); integral power supply and bridge controls.

Flame ionization detector (optional): designed with isolated hydrogen supply; line-operated electrometer, remote igniter, integral power supply and prep effluent splitter.

Flow controls: separate rotameters and differential flow controllers for control of carrier gas to preparative and analytical columns; rotameters and needle valves for air and hydrogen flows (flame detector only); gauge continuously indicates prep column head pressure.

Temperature controls: separate controllers for each of following:

1. Injection port: variable, ambient to 350°C .
2. Detector oven: variable, ambient to 350°C .
3. Manifold: variable, ambient to 350°C .
4. Buffer zone: variable, ambient to 350°C .
5. Column oven: isothermal or programmed from ambient to 325°C ; 10 programming rates form 0.25 to 10°C min.; adjustable 0-60 min. timers for pre-, post-injection and upper limit delays; variable high-temperature safety cut-off automatic cooling.

Temperature readout: pyrometer with five-position switch.

Collection system

Component selector: automatically selects for collection up to six components in a sample containing up to 17 components.

Manifold: seven positions; heated up to the trap, to prevent condensation; check valves prevent diffusion; plugs provide access for cleanout.

Bath: accommodates up to seven 50 ml traps; adjustable and removable; optional refrigeration unit and bath for cooling down to -15°C .

Traps: seven 50 ml glass spiral traps standard; optional 50 ml glass thermal gradient, 10 ml and 2 ml glass traps and 1 liter stainless steel traps also available.

Recorder: Integral Honeywell ElectroniK 18 strip chart recorder equipped with front-set collection switch.

Physical: 5 ft. high by 4 ft. 9 in. wide by 19 in. deep; 665 pounds net, 879 pounds shipping.

Electrical: 208-220 V, 60 Hz (50 Hz optional), 20 amps; three main circuit breakers and individual circuit fuses.

How to order

Ordering No.	General Description Complete instrument	Price
Model 775	Automatic Preparative GC with thermal conductivity detector, one 300 ml sample reservoir, seven 50 ml glass spiral traps, 48" of $\frac{1}{4}$ " OD stainless steel column, 80" of $\frac{3}{4}$ " OD stainless steel column and ElectroniK 18 recorder.	\$9,500.00

Accessories

Columns and Packings:	Complete choice (write for Columns & Accessories catalog).	
Sample Reservoirs:	1000 ml; stainless steel (part No. 4-5512-2).	\$ 135.00
	2250 ml; stainless steel (part No. 4-5512-1).	200.00
Collection Traps:	50 ml; glass, thermal gradient (part No. 2-3832, w/o adaptor).	44.00
	spiral; glass (part No. 2-4619, w/o adaptor).	42.00
	1000 ml; stainless steel (part No. 1-5918, with adaptor).	210.00

Option

Opt. 04	Flame ionization detector completely installed with electrometer, effluent splitter, and H_2 and air flow controls.	\$1,700.00
Opt. 05	Refrigeration unit and cooling bath for automatic operation down to -15°C .	800.00

MANUAL PREP GC

Economical high-capacity, manual operation
Model 776



PREPARATIVE GAS CHROMATOGRAPH

The Model 776 Preparative Gas Chromatograph offers an economical alternative to the Model 775, with the same true prep-scale capacity but without the automatic features. It accepts any prep column between $\frac{3}{8}$ and 4" OD, handles up to 125 ml/injection, with a demonstrated collection efficiency of 90-98% at purity levels approaching 100%. The 776 also has an integral analytical gc capability.

Semi-automatic sampling system

Preparative injections can be made through a pair of valves that apply carrier gas pressure to the sampling reservoir and thus inject the sample. These semi-automatic injections are visually monitored from the calibrated sampling reservoir. A manual syringe may also be used directly in the preparative injection port. A separate septum-type injection port, located adjacent to the preparative injection port, accommodates the 776's analytical gc system.

Unique flame detector

The flame detector of the Model 776 is unique in that the hydrogen-air supply is fed to the flame, independently of column flow conditions, thus allowing better control of flame size and avoiding inadvertent back-flow of hydrogen into the oven. For normal operation with 4" columns, approximately 0.1% of the column effluent is diverted to the flame detector.

This flow is measured by a manometer and controlled by a variable splitter.

All effluent from the analytical column feeds into the flame detector.

Unlimited oven capacity

The basic 776 oven is designed for isothermal operation but it can also be manually programmed. Its two-element, two-blower heating system yields a maximum temperature of 300°C. A solid-state controller is used along with an upper limit cut-off to control oven temperature.

Design of the 776 permits the use of multiple "Add-On" Oven Modules that are identical in capacity and operating characteristics to the basic oven, thus giving the 776 a virtually unlimited column capacity.

Versatile collection system

A high-efficiency collection manifold has five positions each of which is equipped with a 50 ml glass spiral trap, a vent tube that protrudes above the manifold, and a gravity-seal plug. To switch collection from one trap to another is simply a matter of transferring the plug from one trap outlet to another.

The supporting tray for the traps and cooling bath is vertically adjustable for convenience.

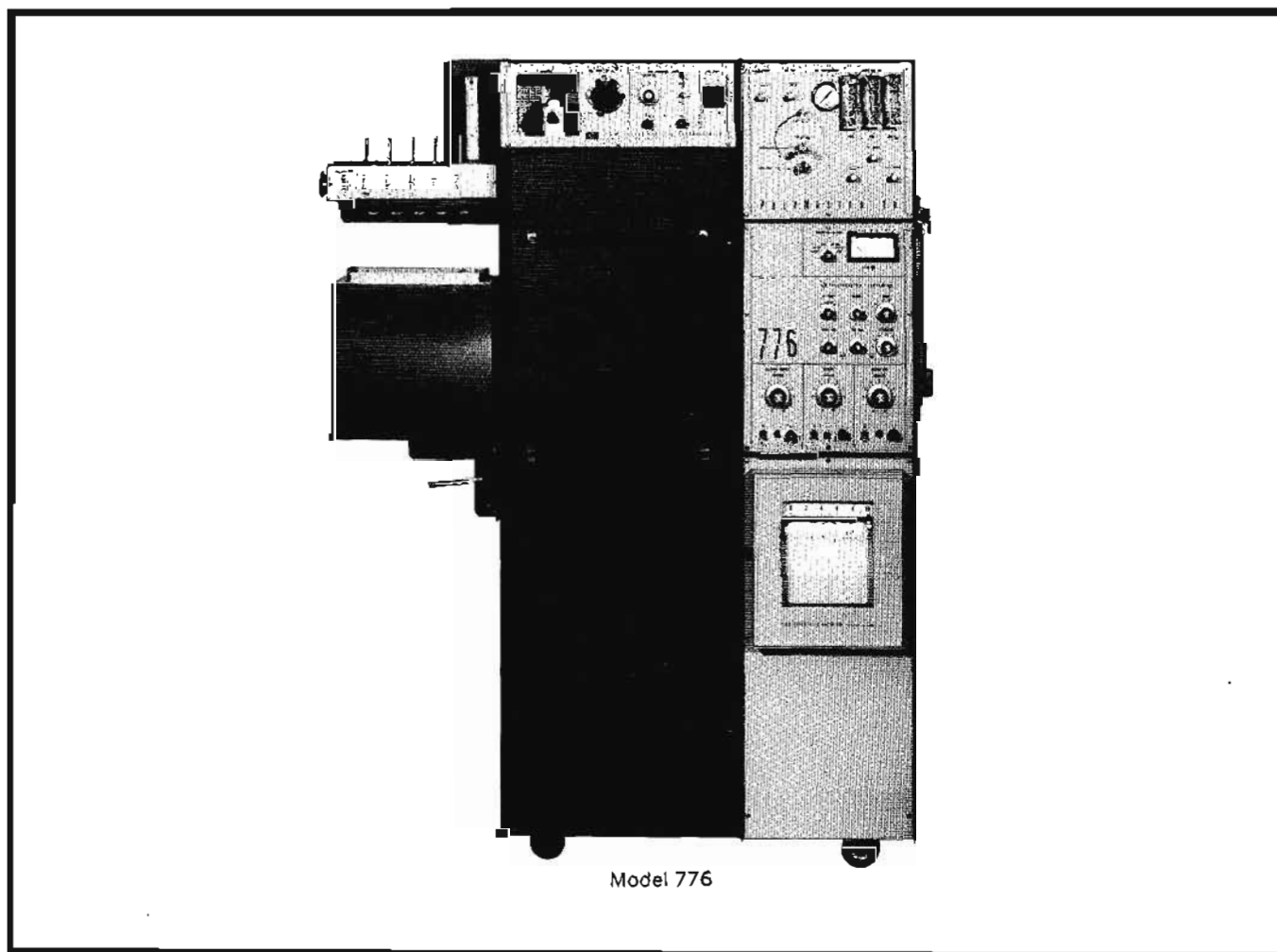

Model 776

MANUAL PREP GC *continued*

Economical high capacity manual operation
Model 776

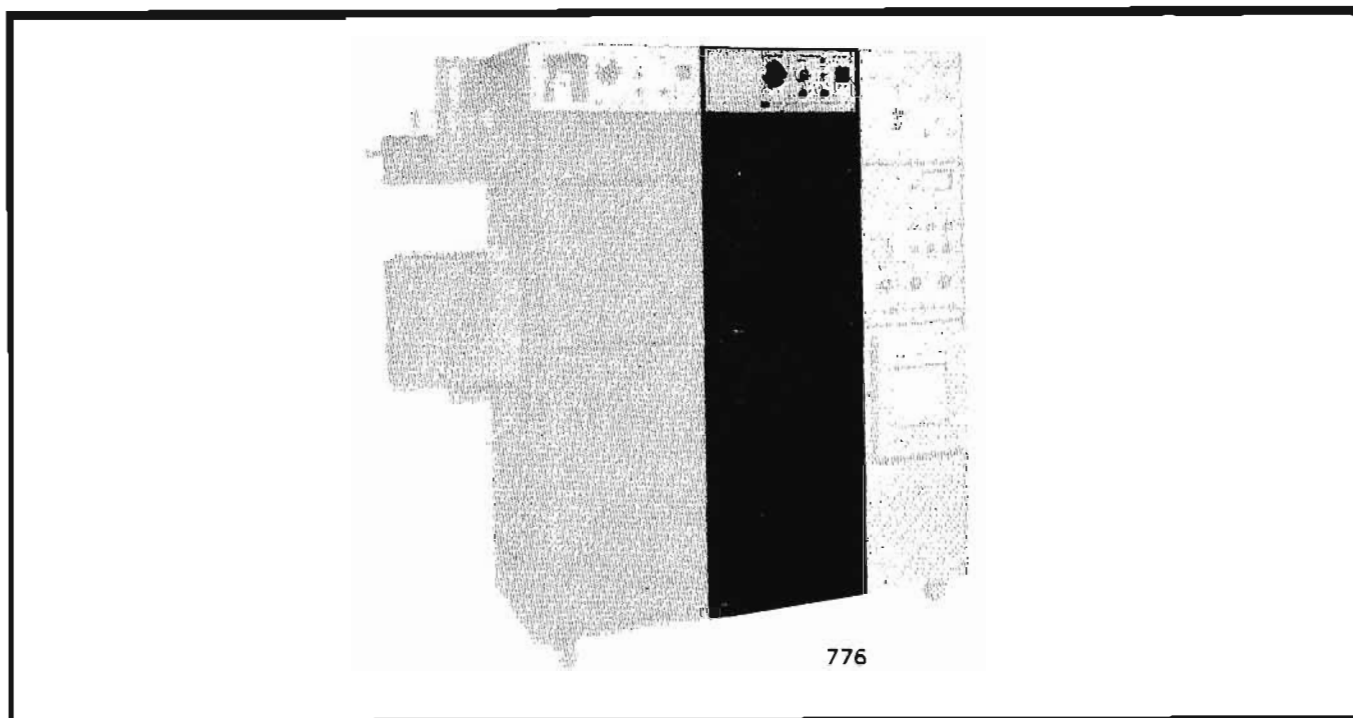
**Model 776 Specifications****Columns**

Preparative: accepts up to 80 inches of 4" OD; proportionate lengths of 1/2", 3/8", 3/4" and 2 1/2" OD.

Analytical: 1/4" OD.

Detector

Unique flame ionization detector design avoids back flow of flame gas, permits nitrogen as carrier gas.
Integral electrometer.

Temperature control

Controllers: independent indication and control of injection port and manifold to 350°C, and column oven to 300°C.

Safety limit controller: hi-limit oven temperature cut-off prevents accidental overheating of columns; interlock prevents operation of column oven heater without fan.

Sample Injection

Semi-automatic: gas-operated injector for 1.00 to 125 ml injections.

Manual: septum type.

Vaporizer: high-capacity heat sink supplies 664 calories per °C temperature drop for sample vaporization.

Sample reservoir: 75 ml pressurized reservoir.

Sample collection

Traps: five 50 ml glass traps and cooling bath; manually selected bypass.

Recorder

Optional strip chart recorder.

Flow measurement

Rotameter: for continuous indication of carrier gas flows; needle valves for control.

Manometer: for measurement of detector gas flows.

Physical

63" high, 48" wide, 23" deep; 425 lbs (shipping). Casters and leveling pads.

Electrical

115-125 V, 60 Hz, 20 A.

Three circuit breakers.

Ordering No.**How to order****General Description****Price****Complete Instrument**

Model 776	Manual Preparative GC with Flame Ionization Detector, including 75 ml sample reservoir, five 50 ml glass spiral traps and cooling bath, 80" of 3/4" OD stainless steel prep column, and 48" of 1/4" OD stainless steel analytical column.	\$4500.00
-----------	---	-----------

Options

01	230 V, 50 Hz operation	82.00
02	Honeywell ElectroniK 18 recorder with 6" chart.	\$ 850.00
03	Temperature programmer accessory and necessary hardware.	\$1000.00
04	Add-on Oven (part number 5810A) identical in capacity and function to basic oven (15A; 115 V).	\$1200.00

Columns, Packings, Traps

Columns and Packings	Complete choice (write for Columns & Accessories Catalog).
----------------------	--

Collection Traps	50 ml; glass, thermal gradient (part no. 2-3832, w/o adaptor).	\$ 44.00
	Spiral; glass (part no. 2-4619, w/o adaptor).	\$ 42.00
	1000 ml; stainless steel (part no. 1-5918, with adaptor).	\$ 214.00

MICROWAVE SPECTROMETER

Molecular Structure, Quality, Collision Rates
Model 8400B



SPECIALIZED ANALYZERS

Four basic microwave spectrometers are available covering the waveguide frequency bands between 8 and 40 GHz. The basic spectrometer consists of 1) a signal calibrator for molecular density and relaxation measurements, 2) phase-locked microwave source, capable of being swept over any part or all of the frequency band, 3) six-foot Stark cell, 4) modulation and detection system, 5) direct frequency readout and marking system, 6) power leveling instrumentation, and 7) analog display instruments (meter, recorder, and oscilloscope). All necessary couplers and attenuators are included. The entire system is completely assembled in consoles. The price includes on-site installation, instruction of operating personnel, and a full one-year warranty on overall spectrometer performance.

Frequency conversion kits are available to convert any of the four 8400B Microwave Spectrometers to other waveguide bands. The frequency conversion kit includes the signal

calibrator, RF unit, leveling-loop instruments, and necessary waveguide, couplers, isolators, low-pass filters, and detectors.

For those who already have their own microwave spectrometers, sub-assemblies such as phase-locked sources, modulation and detection systems, and Stark cells are available separately.

A technical publication, "Molecules and Microwaves," is available upon request. Published periodically, "Molecules and Microwaves" presents results of selected experiments from the Microwave Spectroscopy Applications Laboratory at Hewlett-Packard. Excerpts from the first two issues appear on these pages.

For more information on specifications, applications, price and delivery, contact your local Hewlett-Packard Field Office or the Microwave Division, 1501 Page Mill Road, Palo Alto, California 94304.

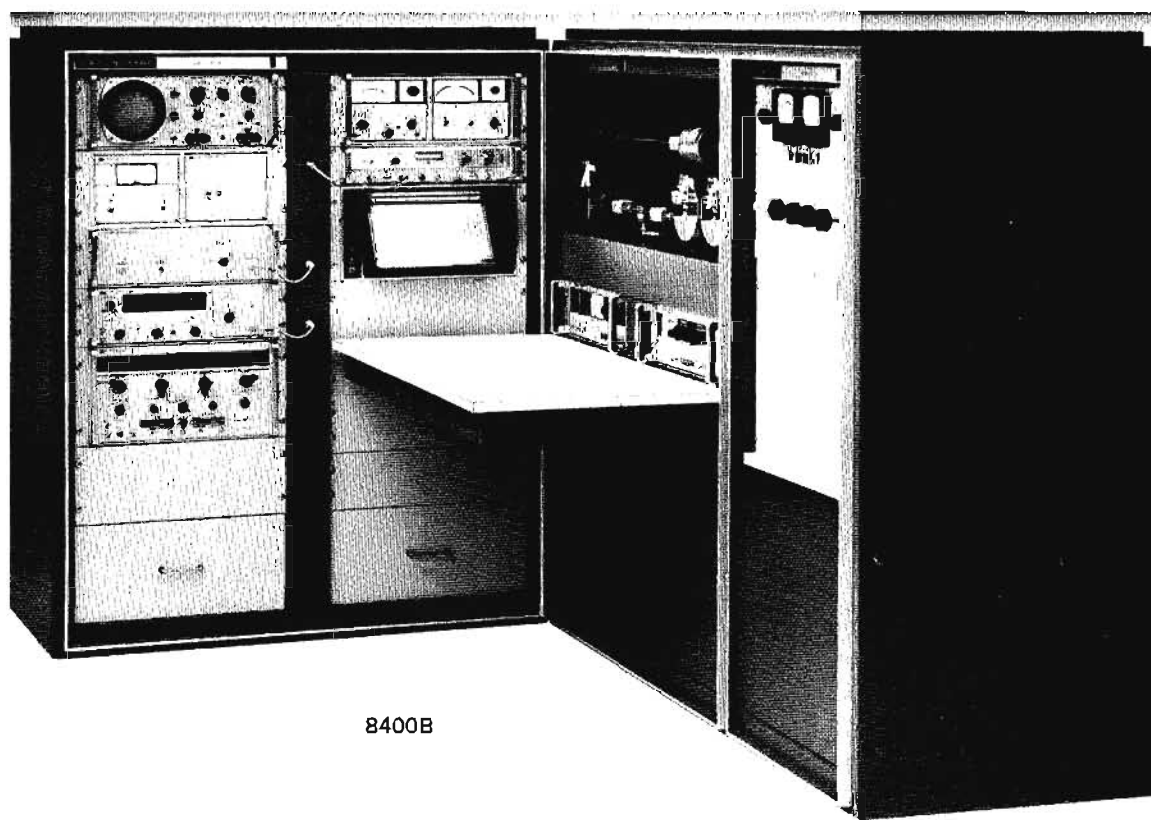

8400B

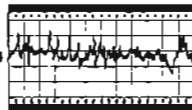

MOLECULES and MICROWAVES

MICROWAVE SPECTRUM OF $\text{CH}_3\text{-C}_6\text{H}_4\text{-Cl}$

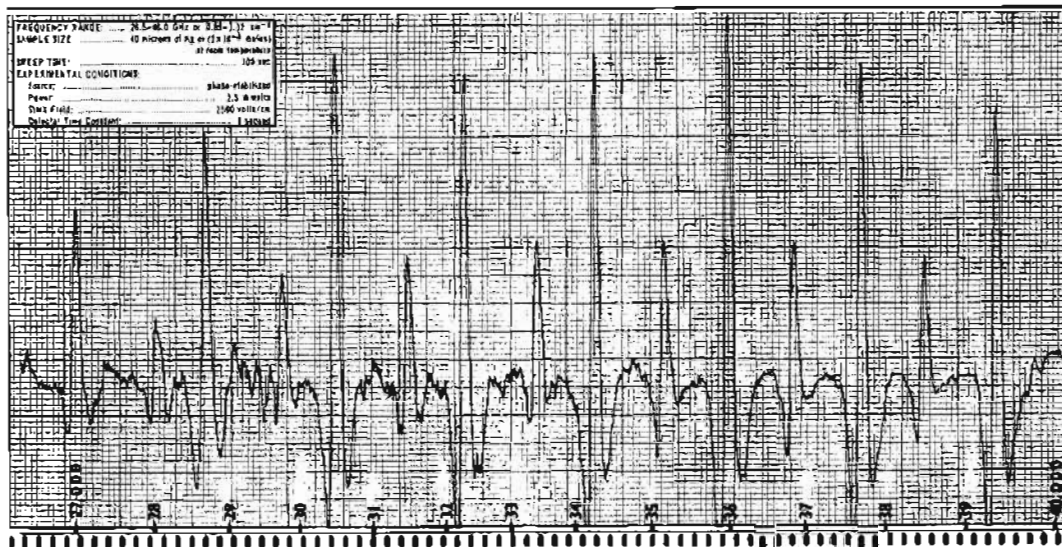

Both the chlorine-35 and chlorine-37 species of para-Chlorotoluene are near-symmetric tops. This is concluded from an examination of the rotational microwave absorption spectrum, which shows two sets of equally spaced absorption peaks. The stronger and weaker peak belong respectively to the chlorine-35 and chlorine-37 isotopic species of p-Chlorotoluene.

ISOTOPE EFFECT IN MICROWAVE SPECTROSCOPY

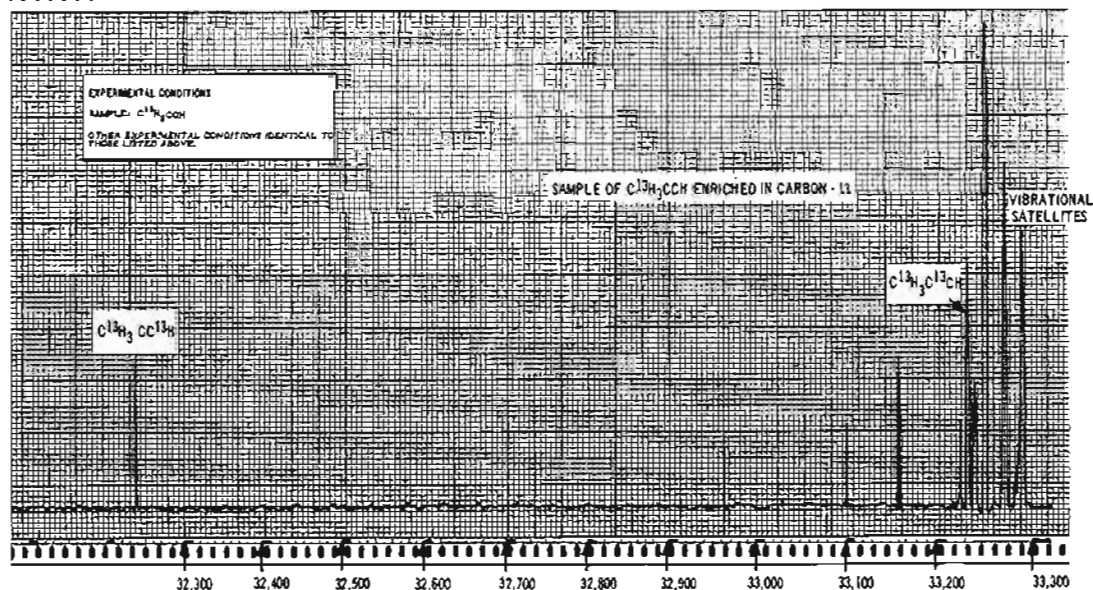

The $J=1-2$ rotational transition for various carbon 13 species of methyl acetylene. Vibration satellites of the $J=1-2$ transition of $\text{C}^{13}\text{H}_3\text{CCH}$ are also observed. The spectral region covered is part of the R-band (26.5-40.0 GHz) of the microwave region. Experimental conditions are shown on the charts. The absorption amplitudes on the above charts are related roughly logarithmically. The traces were recorded with the HP R8400B Stark-modulated microwave spectrometer.

CHN ANALYZER

Simultaneous microdetermination of C, H and N

Model 185



SPECIALIZED ANALYZERS

The classical Pregl and Dumas methods for the microdetermination of carbon, hydrogen and nitrogen are slow, tedious and expensive. With the Model 185 Carbon Hydrogen Nitrogen Analyzer, the microchemist now has at his disposal an equally accurate and reliable alternate method that is 4 to 8 times faster — the complete 185 analysis takes less than 10 minutes.

In addition to being faster than the conventional methods, the 185 also requires a much smaller laboratory investment because it enables a technician with only a minimum of microanalytical training and experience to obtain reliable results under normal laboratory conditions.

Complete CHN analysis in 10 minutes

A second-generation performance-proved instrument for the simultaneous microdetermination of carbon, hydrogen, and nitrogen in organic materials, the Model 185 performs a complete elemental analysis in 10 minutes. There are five separate reasons for the Model 185's exceptional speed advantage over the 45 to 80 minutes generally required by the combined Pregl-Dumas procedures:

- (1) *only one sample* is required rather than two for Pregl-Dumas;
- (2) *only one weighing* is needed, rather than the multiple "weigh-in, weigh-out" procedures of the classical methods;
- (3) *analysis computation is greatly simplified*, normally requiring only a measurement of peak height on the recorder chart. The reason is that the standard Model 185 is equipped with a ratio recording system that links the sample balance and the recorder. The result is that samples of the same composition give the same peak height regardless of differences in sample weight. Sample weight need not be recorded therefore, and the computation is reduced to a simple multiplication;
- (4) *analysis can be continuous* because one sample can be weighed while the combustion products of the previous sample are being chromatographed; and
- (5) *the extensive automation* of the Model 185 greatly simplifies all other aspects of the microanalysis.

Micro laboratory environment not required

Microanalysis with a Model 185 requires a single weighing of a small (less than 1 mg) sample directly into a light aluminum boat on a low-capacity, environment-insensitive microbalance under normal laboratory conditions. Since absorption tubes are neither required nor used, the special laboratory environment that is necessary for the conventional microanalytical weighing is not needed.

The 185 offers still another economy in the micro lab: minimal operator training. To train a technician who is generally familiar with conventional microanalytical laboratory routine takes only a short time. Because the 185 method is much more simple than the conventional procedure and particularly because it eliminates the weighing of heavy absorption tubes on a high-capacity microbalance, a technician with only limited microanalytical experience can be trained to obtain reliable results in a minimum of time.

Instrument design features

The Model 185 CHN Analyzer incorporates a number of important design features that are unique among instruments for elemental analysis, the result of Hewlett-Packard's experience in the field which surpasses that of any other manufacturer.

Two-stage furnace for optimum oxidation and reduction: the Model 185 uses a two-stage furnace for sample combustion:

- (1) an oxidation furnace, automatically controlled at any temperature between 750 and 1050°C as selected by the analyst for the best oxidation conditions for the sample at hand;
- (2) a reduction furnace, automatically held at 400 to 600°C to provide complete reduction of all nitrogen oxides and access oxygen, thus ensuring nitrogen determinations that are reliable within the allowable error of $\pm 0.3\%$.

Automatically timed combustion cycle: the peak height response obtained during the chromatography of the oxidation products is dependent upon the time the sample is confined in the combustion

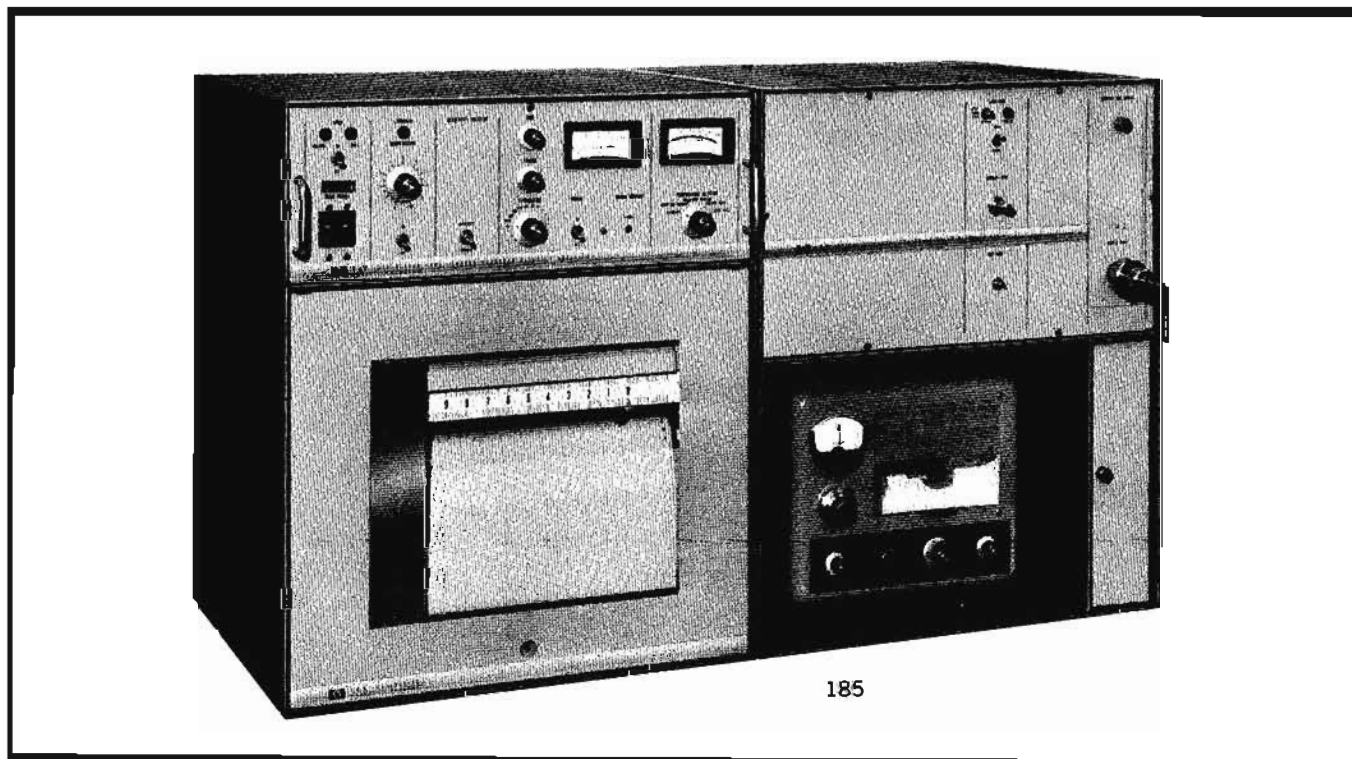

CHN ANALYZER *continued***Simultaneous microdetermination of C, H and N
Model 185**

chamber. In the 185, the combustion period is automatically and precisely controlled to eliminate analytical error from this source. A flow diversion switch and timer are used for this purpose. In the "Timed" position, carrier gas flows through the furnace until a "Start" button is pushed. When timer is started, carrier gas bypasses the furnace for a precisely timed 20 or 30 second period, at end of which it is automatically re-directed through the furnace, sweeping combustion products into the gas chromatograph.

In the "Manual" position, carrier gas bypasses the furnace. Pilot lights indicate whether carrier gas flow is in "bypass" or "through furnace" (as shown in diagram).

Two-zone oven for consistent GC analysis: the 185's column oven consists of an outer shell and an inner column oven, each equipped with separate and independent temperature control. The outer shell maintains an ambient temperature near that of the oven and keeps column temperature stable. Peak height thus responds to sample composition only and the baseline is stable.

Single-column single-detector GC system: improved column technology led to the single-column, single-detector design of the 185. All three combustion products — CO₂, H₂O, N₂ — are separated in a single pass resulting in a three-peak chromatogram, one peak for each of the combustion products.

Automatic sensitivity selector: an automatic sensitivity selector keeps all three peaks on scale for all types of samples, and allows direct peak height readout of the analytical trace. This feature releases the operator from having to manually attenuate the CO₂ peak on each analytical run, thus providing unattended operation from sample injection to completion of run.

Specifications

Analysis time: 10 minutes total.

Accuracy: comparable to Pregl and Dumas methods. Based on test analyses with NBS standards; the same limitations that apply to the classical method also apply to the 185, especially with regard to samples that are difficult to combust.

Sample range: any solid or liquid material that burns completely at 1050°C or less, including those that contain O, S, P, Cl, Br, I, F, As, Sb, and Sn.

Furnace: two-stage type with oxidation furnace and reduction furnace, each independently temperature-controlled.

Oven: two-zone type with inner oven and outer shell, each independently temperature-controlled.

Temperature control:

1. Oxidation furnace: variable voltage transformer, adjustable to 1050°C.
2. Reduction furnace: variable voltage transformer, adjustable 400 to 600°C.
3. Oven: thermostat controller, adjustable ambient to 150°C.
4. Shell: thermostat controller, adjustable ambient to 150°C.

Temperature readout: pyrometer graduated 0-1200°C and five-position selector switch for readout of 4 positions noted above plus ambient.

Detector: four-filament thermal conductivity type equipped with current adjustment, bridge balance and output attenuation controls.

Carrier gas: automatically timed bypass control; shutoff control; pressure regulator.

Balance: Cahn Ratio Electrobalance.

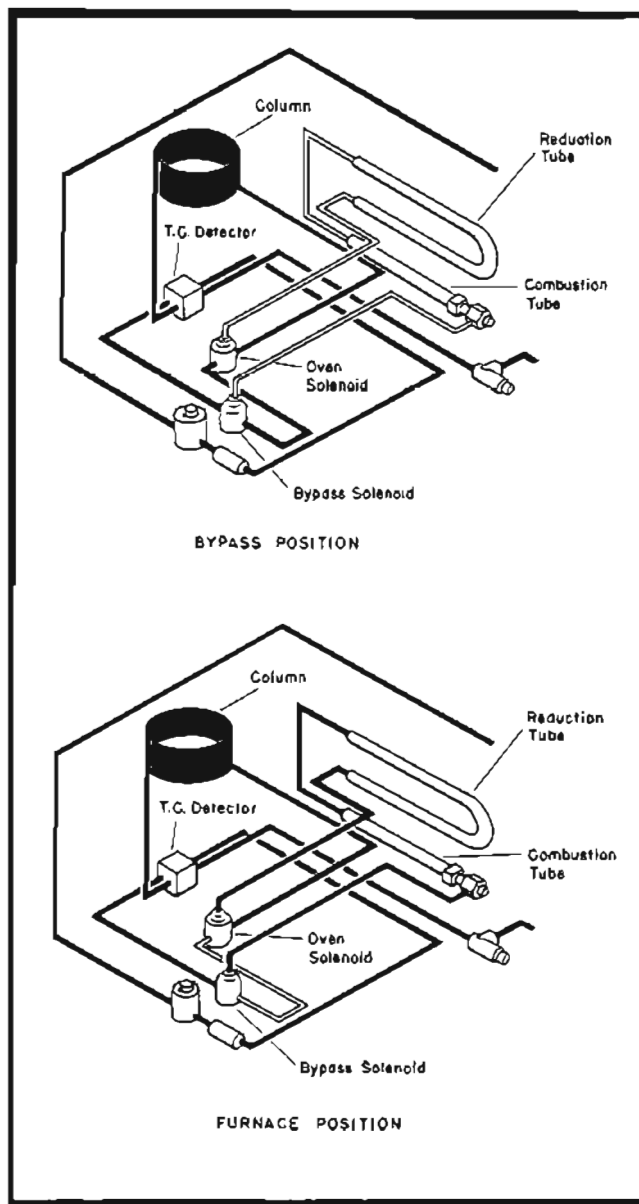

Recorder: Honeywell ElectroniK 16 equipped for operation with automatic sensitivity selector and Ratio Electrobalance.

Weight: 316 lbs overall.

How to order

Ordering No.	Description	Price
185	Model 185 with Honeywell ElectroniK 16 Strip Chart Recorder and Cahn Ratio Electrobalance	\$6000.00
19046A	Gas Purifier	\$ 275.00
(Regulator Kit)	Carrier Gas cylinder regulator kit (two-stage pressure regulator, 6 feet of 1/4 in. O.D. copper tubing with appropriate fittings). Specify carrier gas supplier or CGA No. of cylinder outlet	\$ 50.00

QUARTZ THERMOMETER

Precise temperature measurements for chemistry
Model 2801A



MOLECULAR WEIGHT DETERMINATION

The Hewlett-Packard Quartz Thermometer, whose detailed description appears on page 623, is a compact, self-contained temperature measuring system that provides a precise digital indication of temperature to a resolution of one-tenth millidegree. It is equipped with two sensing probes, and can indicate the absolute temperature of either probe or the temperature difference between them. Operation is simply a matter of placing the probe in the measurand, selecting the resolution required (by pushbutton) and reading the temperature.

The Quartz Thermometer also provides outputs for directly recording measurements on a printer, or the data may be transferred through a coupler and recorded on punched tape, punched cards or magnetic tape for subsequent entry into a computer. The Quartz Thermometer output may also be converted to analog form to obtain high-resolution strip-chart recording (as high as $.001^{\circ}\text{C}$ full scale on a 10-inch chart width.)

These and other features render the Quartz Thermometer an invaluable means of measuring temperature in a wide variety of scientific applications, and in particular the field of chemical analysis. Some examples of the use of the Quartz Thermometer in this area are:

Calorimetry: measuring heat capacity and heats of solutions, reaction, combustion and titration.

Cryoscopy: determining solvent purity, from observation of freezing point depression of solutions

Ebulliometry: determining solute molecular weight by measuring the boiling point elevation of solutions

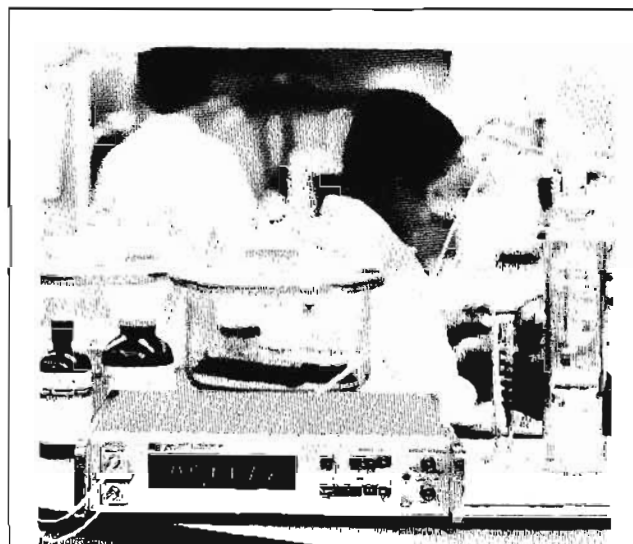

2801A Quartz Thermometer being used with a differential ebulliometer to measure boiling point elevation of a solution, from which the solute molecular weight is derived.

Differential Thermal Analysis: qualitative characterization and quantitative identification of materials, by measuring temperature difference between sample and inert reference

The use of the Quartz Thermometer in calorimetry is described thoroughly in notes available to you from Hewlett-Packard; write for your copy of Application Note 78-3. Cryoscopy and ebulliometry are covered in Application Note 78-2.

The Quartz Thermometer may also be used to establish absolute temperature, temperature stability and temperature gradients in liquid baths, and as a laboratory transfer standard for calibrating thermocouples, resistance thermometers, mercury thermometers, thermistors and temperature controllers.

Since the Quartz Thermometer offers an accurate, reliable, yet very easy to use method of making precise temperature measurements, the application potential of this instrument is virtually unlimited. Industrial applications of the Quartz Thermometer include the determination of hydraulic turbine efficiency, by measuring the increase in temperature of the working fluid resulting from friction and turbulence. The hydro-thermal method is easier to use than hydro-mechanical methods, particularly since it does not involve interrupting operation of the turbine.

The Quartz Thermometer may also be used to measure temperature at remote, widely separated points. This is possible because it operates by converting temperature changes into proportional changes in frequency of a radio-frequency oscillation. Temperature signals can be transmitted considerable distances over conventional coaxial cables, without accuracy problems from cable resistance or noise pick-up. Probes may be located up to 500 feet from the instrument, or to 4500 feet using small booster amplifiers in series with the signal cable. A specially-rugged probe (Model HP-2833A) is available for measuring temperature in deep wells and in the ocean.

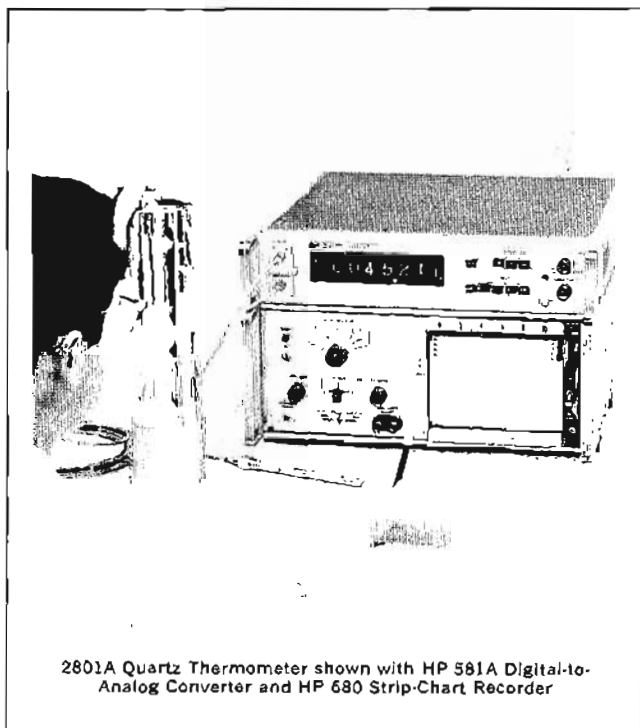

2801A Quartz Thermometer shown with HP 581A Digital-to-Analog Converter and HP 680 Strip-Chart Recorder

MOLECULAR WEIGHT DETERMINATION



VAPOR PRESSURE OSMOMETER

Fast number-average molecular weights

Model 302

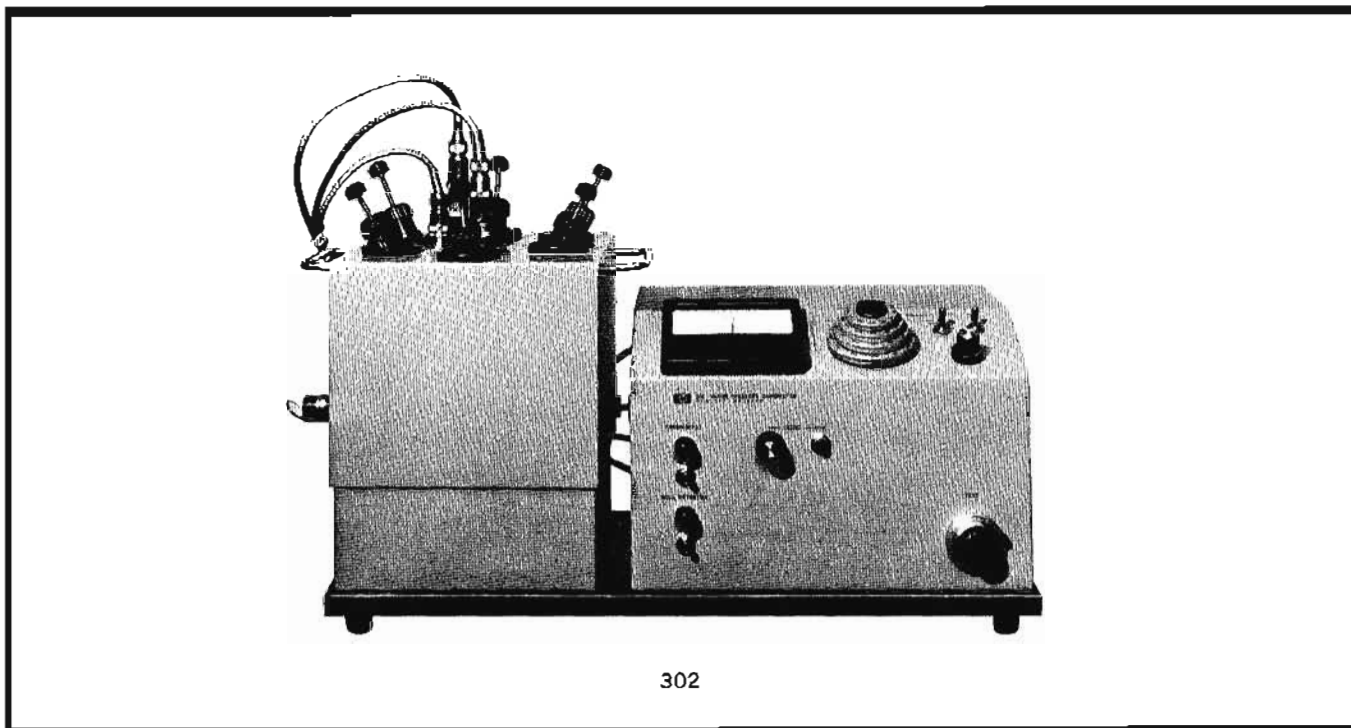

302

The Model 302 Vapor Pressure Osmometer measures the osmotic concentration of a solution, operating on the principle of vapor pressure lowering. From this data, number-average molecular weights of solute species in solution are determined precisely.

The Model 302 VPO is designed for molecular weight materials in the range of 100 to 25,000 and are effective for both natural and synthetic polymer measurements. It can be operated at 25°, 37°, 50°, 65°, 100°, or 130°C and can operate successfully with sample sizes as small as 10 microliters. It is capable of measuring temperature differential between sample and solvent drops to better than 0.0001°C.

Principles of operation

In the VPO, two bead thermistors are suspended in a precisely thermostated chamber saturated with solvent vapor. The beads, which undergo a large change in resistance (ΔR) for a relatively small change in temperature, form two legs of a Wheatstone bridge.

When a drop of solvent is placed on the reference thermistor and a drop of solution placed on the measuring thermistor, solvent condenses on the solution drop because of the lower vapor pressure of the solution. This condensation warms the measuring thermistor, producing a difference in temperature and, as a result, a relatively large bridge imbalance ΔR (approximately 400 ohms per mole for benzene).

Since ΔR is a relative quantity dependent on both the solvent and the probe, the VPO must be calibrated with a known molecular weight solute for each solvent and probe used. Its value is determined at several concentrations and plotted. The curve is then extrapolated to infinite dilution to determine the molar constant (K). Once established, this constant does not vary for the particular probe and solvent used and only a

single calibration is needed. The molecular weight of the unknown is then calculated as follows:

$$MW = \frac{K}{\left(\frac{\Delta R}{c}\right) C \rightarrow 0}$$

where c = grams/liter

Rapid measurement

The VPO's syringe method of introducing sample drops into chamber permits readings on a series of samples at 2 to 3 minute intervals. A single reading may be taken in 2 minutes for most organic solvent-solute systems, in 4 to 5 minutes with aqueous solutions. Usually, some 60 to 80 measurements can be made each 8-hour day.

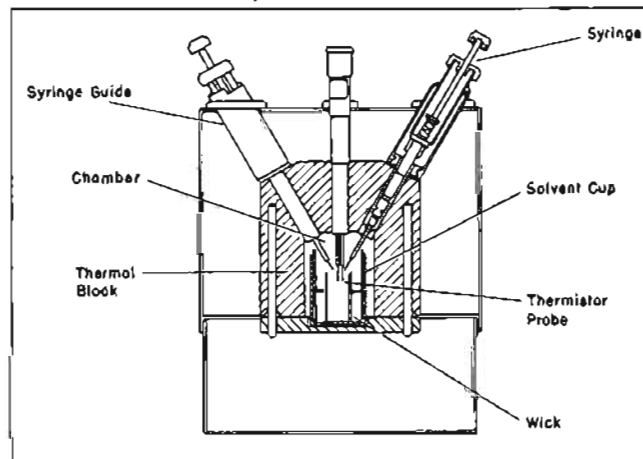

Dependable results

The VPO is capable of operating on an around-the-clock basis, providing 1% accuracy for low molecular weight compounds and useful data for molecular weights to 25,000. Reproducibility is better than 1% except at very low readings. The following table gives accuracy of the instrument for representative determinations:

Sample Type	Formula MW	VPO MW	Error
Benzene calibrated with benzil			
1. Anthracene	178.2	177.0	-0.7%
2. Sucrose Octoacetate	678.6	675.0	-0.5%
Water calibrated with dextrose			
1. dl-alanine	89.1	89.7	+0.7%
2. Raffinose	594.5	586.0	-1.3%

Precision

The VPO's bridge circuitry measures 1.00 ohm to the nearest 0.01 ohm (1% precision).

For a typical organic solvent at 37°C operating temperature, the Vapor Pressure Osmometer will show a bridge imbalance of 400 ohms per mole of solute. Thus a 0.01 molar solution will give an imbalance of 4.0 ohms (neglecting concentration effects) which can be read to 1% precision. A molecular weight polymer of 20,000, assuming a 2% weight concentration solubility, would give a ΔR of 0.40 ohm which can be read to ± 0.01 ohm, a precision of 2½%.

For aqueous solutions, sensitivity is lower due to the high heat of vaporization. ΔR for water is about 55 ohms per mole. A 3% weight concentration would give 1% precision for molecular weights up to 700 and 4.3% precision up to 3500.

The final accuracy of a measurement is dependent on several factors unrelated to instrument precision, such as the extrapolation, interactions, purity, and concentration effects.

Temperature range

Unlike the cryoscopic and ebulliometric methods, VPO determinations are made without changing the physical state of the solution. Model 302 may be ordered with thermostat and thermistor probe set for any of the following temperatures: 25°, 37°, 50°, 65°, 100° or 130°C. Intermediate temperatures available on request. Chamber temperature control to within $\pm 0.001^\circ\text{C}$, is provided.

Choice of solvents

Model 302 instruments are successfully used with many different solvents, a few of which are benzene, cyclohexane, carbon tetrachloride, tetrahydrofuran, ethyl acetate, acetone, pentane, toluene, ethanol, dimethylformamide, methanol, methyl ethyl ketone, isopropanol, solvent blends, and water.

Convenience

The Vapor Pressure Osmometer requires only 10½" x 23" of bench-top space and weighs only 46 pounds. The unique syringe sample introduction system, simple bridge controls, and durable design allow the instrument to be operated routinely. The electronic section consists of three plug-in sub-chassis for ease of servicing.

Typical applications

Osmotic Coefficients	Polyolefins
Proteins	Polyamides
Sugars	Cellulosics
Lipids	Elastomers
Chemical Monomers	Petrochemicals
Hydrocarbons	Silicones
Prepolymers	Waxes

How to order

Ordering No.	Description	Price
302	VAPOR PRESSURE OSMOMETER, 115 V, 50-60 Hz	\$2,600.00

NOTE: Specify one or more options from Group I.

GROUP I

Non-Aqueous Probe and Thermostat

Option 12: 25°C operation	add \$290.00
Option 13: 37°C operation	add 290.00
Option 14: 50°C operation	add 290.00
Option 15: 65°C operation	add 290.00
Option 16: 100°C operation	add 340.00
Option 17: 130°C operation	add 340.00

Aqueous Probe and Thermostat

Option 18: 25°C operation	add 290.00
Option 19: 37°C operation	add 290.00
Option 20: 50°C operation	add 290.00
Option 21: 65°C operation	add 290.00

GROUP II

Additional Options

Option 01: 230 V, 50-60 Hz operation	add \$ 40.00
Option 02: Self-draining solvent cup	add 66.00
Option 03: High range decade	add 110.00
Option 22: Inert gas inlet	add 53.00

MOLECULAR WEIGHT DETERMINATION



MEMBRANE OSMOMETER

Automated determination of \bar{M}_n
Series 500

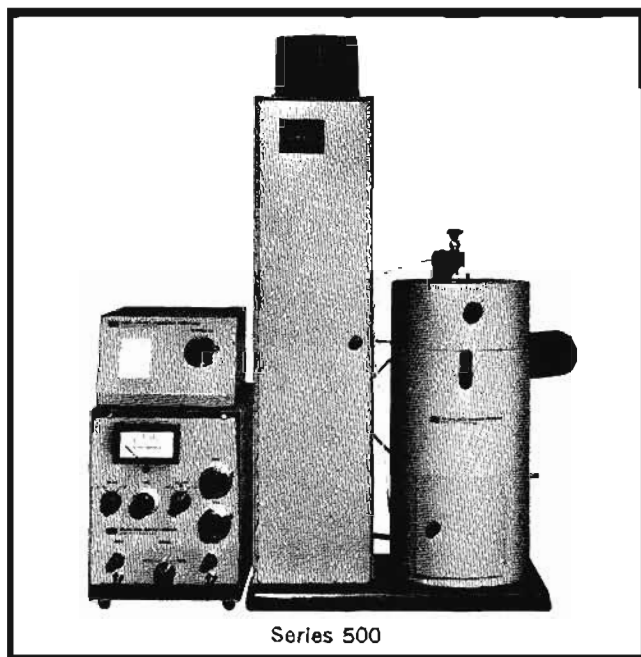

Series 500

Series 500 Membrane Osmometers are automated instruments for the precise and speedy determination of the number-average molecular weight of natural and synthetic polymers in the range 10,000 to 1,000,000. They operate with aqueous as well as organic solvents, at temperatures between 5°C and 130°C. The 500 measures osmotic pressure with a repeat accuracy of ± 0.02 cm of solvent in a range of 20.00 . . . on samples as small as 1 ml.

Based on the dynamic method of measuring osmotic pressure, the 500 reaches equilibrium when no more than 10^{-6} liter of solvent has moved into the membrane.

Individual readings are frequently completed within 10 minutes after the sample has been introduced . . . and a full concentration series, within an hour.

Sample introduction and flushing are speeded by a valved siphon system. A single membrane is used, thus there are no membrane matching problems. Dynamic osmometry eliminates dilution of the solution and the consequent need for washing out the solvent reservoir after each determination.

Once the sample has been introduced into the 500, the rest is fully automatic. Its sensitive optical-servo system automatically adjusts the height of the solvent reservoir until equilibrium is reached . . . reading out the osmotic pressure directly on the digital counter or on a recorder chart.

How it operates

Sample solution is introduced above and pure solvent below the membrane of the 500. Since the membrane is semi-permeable (solvent molecules may pass but not sample molecules), solvent tends to pass through it in proportion to the force of the osmotic pressure of the solution. But the 500 is a dynamic osmometer which detects and opposes this force through an optical servo-mechanism that reduces the hydrostatic head on the solvent side of the membrane until it exactly equals the osmotic pressure of the solution *and thus prevents solvent flow*. The system is so sensitive and fast that less than 10^{-6} liter of solvent flows into the membrane before equilibrium is established.

Here's how the servo system works. The solvent reservoir is mounted on a motor-driven screw elevator and connected to the solvent side of the membrane through a capillary in which there is a small air bubble. A light source is focused on the bubble and refracted to a companion photocell. Any flow of solvent through the capillary tends to move the air bubble and this motion is immediately detected by a change of light intensity on the photocell. The amplified output of the photocell activates a servo motor which drives the screw elevator and adjusts the height of the solvent reservoir to return the bubble to its previous position. As a result, the hydrostatic head of the solvent is exactly opposed to the osmotic pressure of the solution.

At all times during the process, the hydrostatic head on the solvent side of the membrane is indicated on the 500's digital counter. At equilibrium, which is frequently reached within 10 minutes, the counter reading is equivalent to the osmotic pressure of the solution.

Advantages of the 500

The Series 500 Membrane Osmometer is literally the fastest way to determine number-average molecular weight \bar{M}_n . An individual determination is frequently completed within 10 minutes after the sample has been introduced; some samples take as little as three minutes while even the most difficult seldom require as much as an hour. As a result, a full concentration series for determinations is frequently completed within an hour . . . as compared to several hours for other instrumental techniques, and several days for manual static osmometry.

The 500 derives still another speed advantage from its dynamic osmometry principle. There is no net flow of solvent across the membrane and therefore no dilution of the sample. This speeds calculations as well as instrument prep time.

The 500 is capable of precise number-average molecular weight determinations between 10,000 and 1,000,000. Commercially available membranes even permit operation below 10,000 in many cases. The instrument is also capable of osmotic and oncotic pressure measurements up to 20 cm of hydrostatic head pressure . . . of measuring activity coefficients and interactions . . . and of testing membranes.

Because its sample chamber volume is less than 0.4 ml, the 500 can make useful measurements with as little as 0.5 ml of sample. Standard procedure, for best accuracy, calls for 1 ml of sample including two rinses. For greatest convenience, when sample solution is plentiful, a 5 ml sample is used.

The 500 continuously displays osmotic pressure on an integral 4-digit counter with a readability of 0.01 cm of solvent head. The instrument also incorporates a recorder output with range and zero adjustments.

Applications

The most frequent application of Series 500 Membrane Osmometers is to determine the number-average molecular weight \bar{M}_n of soluble macro molecules. There are two good reasons for this:

1. \bar{M}_n is the most useful of the molecular weight calculations because it lies near the peak of the molecular weight distribution curve; \bar{M}_n therefore represents the most probable molecular weight of the polymer. Furthermore, the breadth of the distribution curve can be approximated from the relationship of

$\frac{\bar{M}_n}{\bar{M}_w}$ and this relationship is useful in predicting the physical

properties of the polymer.

2. The Series 500 measures \bar{M}_n faster and more easily than any other method. Procedures are quite simple: three or four very dilute concentrations of the polymer solution are prepared and their osmotic pressure (π) is measured in the 500... automatically. Reduced osmotic pressure (π/C) is calculated and plotted against concentration (C). Finally, the value of π/C at zero concentration is extrapolated from the plot and the final calculation is made:

$$\bar{M}_n = \frac{RT}{(\pi/C)_{C \rightarrow 0}}$$

Molecular conformation studies

Measurement of osmotic pressure can also yield useful information about polymer-solvent interactions and, through this, insight into molecular conformation and chain configuration.

Here's how. Polymer-solvent interactions result in non-zero slopes when reduced osmotic pressure (π/C) is plotted against concentration (C). Measurement of the slope gives a quantitative measure of the energy of interaction, usually expressed as the second virial coefficient as follows:

$$\frac{\pi}{C} = RT \left[\frac{1}{\bar{M}_n} + A_2 C \right]$$

where A_2 = second virial coefficient

R = gas constant

T = absolute temperature

The second virial coefficient itself measures deviations from ideal solution behavior. It can be approximately related to the excluded volume (μ) of the polymer molecule as follows:

$$A_2 = \frac{N\mu}{2M^2}$$

where N = Avogadro's number

M = molecular weight

Specifications

Sample volume: 0.5 ml min.; 1.0 ml standard.

Sample concentration:

Molecular weight	Minimum conc.		Maximum conc.	
	g/l	moles/l	g/l	moles/l
10,000	0.05	5×10^{-6}	5	5×10^{-4}
100,000	0.5	5×10^{-6}	50	5×10^{-4}
1,000,000	5.0	5×10^{-6}	50	5×10^{-4}

Sample transport: siphon type, with control valve.

Membrane: 2 cm² active area; 42 mm diameter for aqueous, 47 mm for non-aqueous.

Materials in contact with sample-solvent: stainless steel, Teflon and Pyrex.

Solvent type: aqueous or non-aqueous, as specified.

Temperature range: Model 501, 25° to 65°C; Model 502, 25° to 130°C; Model 503, 5° to 65°C (includes thermoelectric cooler).

Temperature control: standard, thermostat pre-set for control at fixed temperature (5°, 25°, 37°, 50°, 65°, 100°, 110°, 130°C, as specified).

Optional—variable temperature controller for operation at any temperature within overall range of instrument.

Safety cut-off: separate thermostat cuts off power to heater in case of excessive heat.

Observation systems: telescope for viewing sample stack; port for viewing capillary.

Elevator

Servo system: optical servo system automatically adjusts elevator to balance hydrostatic head of solvent against osmotic pressure of solution.

Hydrostatic head readout: type, four-digit counter; range, 20 cm nominal; readability, 0.01 cm; repeatability, ± 0.02 cm.

Electronics

Servo controls: selector switches and milliammeter.

Recorder output: 10 mV standard; 1 mV optional. Range and zero controls standard (max. sensitivity gives full-scale response for 1 cm of hydrostatic head).

Power consumption: 115 V, 50 or 60 Hz, 60 watts.

Recorder: (optional), full transistorized, 10-inch pen travel, 1/2-second pen speed, 0.2% accuracy, 0.1% linearity; 4-speed chart drive (1/2, 3, 6 and 12 in./hr.).

Dimensions

Elevator and sample chamber: 34 1/2" high (87.5 cm), 21 1/2" wide (54.6 cm), 14 1/2" deep (36.8 cm); 76 lbs net (34.5 kg).

Electronics module: 11 3/4" high (29.8 cm), 9" wide (22.9 cm), 21" deep (53.2 cm); 35 lbs net (15.9 kg) for 115 V operation, 43 lbs (19.6 kg) for 230 V operation.

Thermoelectric cooler: (Model 503 only), 14 1/2" high (36.8 cm), 8 1/8" wide (20.6 cm), 5 1/4" deep (13.3 cm).

Ordering

How to order

No.	Description	Price
501	Standard membrane osmometer, 10 mV recorder output; 115 V, 60 Hz	\$4375.00
502	High temperature membrane osmometer, 10 mV recorder output; 115 V, 60 Hz	5125.00
503	Low temperature membrane osmometer, 10 mV recorder output; 115 V, 60 Hz	5700.00

Options (factory-installed)

01	For aqueous operation	n/c
02	Non-aqueous operation	n/c
03	For operation at 25°C	100.00
04	For operation at 37°C	100.00
05	For operation at 50°C	100.00
06	For operation at 65°C	100.00
07	Thermostat for operation at 100°C (Model 502 only)	100.00
08	Thermostat for operation at 110°C (Model 502 only)	100.00
09	Thermostat for operation at 130°C (Model 502 only)	100.00
10	Variable Temperature Controller	375.00
11	1 mV recorder output	n/c
12	Thermostat for operation at 5°C (Model 503 only)	100.00
20	50 Hz operation (115 V)	n/c
21	50 Hz operation (230 V)	75.00

Recorder

H02-7127A	Moseley strip chart recorder with 17504-80060 plug-in 10 mV input module, 10-inch calibrated chart, 0.2% accuracy, four-speed chart travel; 115 V, 50 or 60 Hz	1050.00
-----------	--	---------

MOLECULAR WEIGHT DETERMINATION



AUTO-VISCOMETER

Automatic programming, recording of efflux time
Models 5901B and 5903A

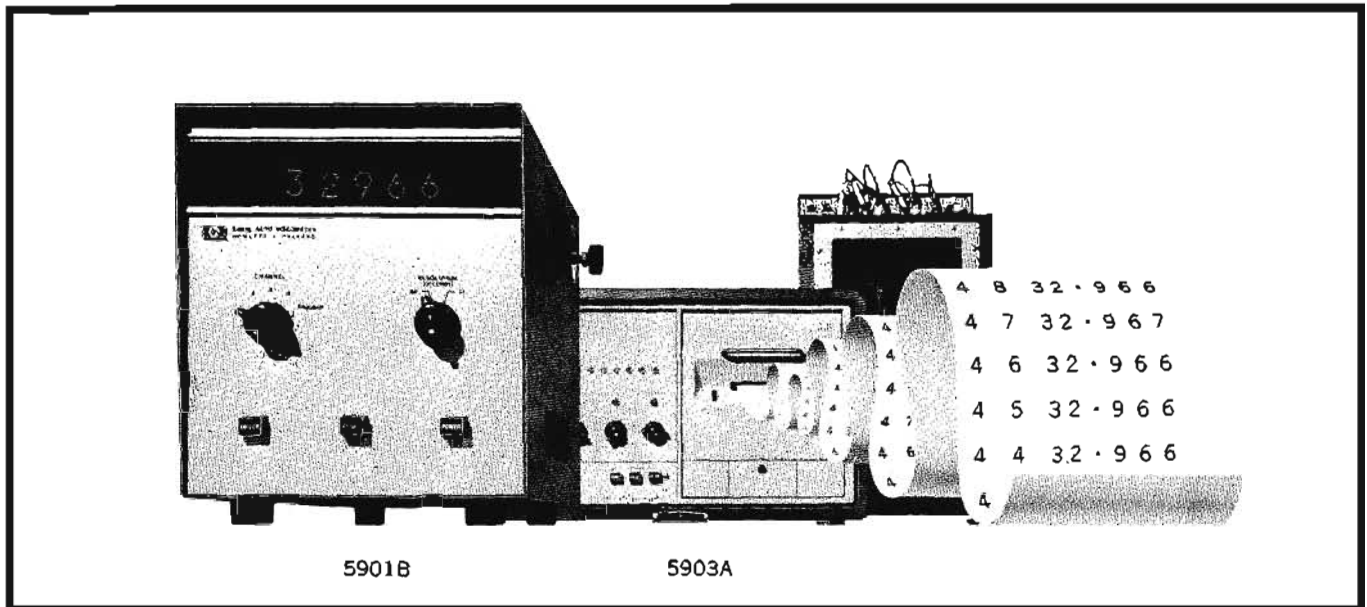

Highest accuracy in determining efflux times yields highest accuracy in final calculations—whether for intrinsic viscosity, kinematic viscosity, or for molecular weight.

The instruments described here—in combination—provide extremely high accuracy and reliability in measuring efflux times. Using the Auto-Viscometer and the Programmer you can expect:

- 20 times better accuracy than stopwatch techniques.
- Unlimited and automatic repeat measurements on any viscometer.
- Automatic sequences for all four viscometers in the system with up to 10 repeat measurements per viscometer.
- A permanent record of all efflux times measured.

Improves precision of efflux time measurement to 0.005%

Although the more obvious advantage of the HP Auto-Viscometer system is the efficiency that it lends to viscosity measurements by eliminating tedious and time-consuming routine, its more important contribution in the scientific sense is the improvement in precision that results from its use.

Manual methods of viscometry, even in the hands of the most skilled and careful investigator, are limited to a precision of about 0.1% with relatively long efflux times, and considerably worse with short efflux times. The HP Auto-Viscometer system is capable of a routine improvement to 0.01%, and up to 0.005% when optimum care is exercised.

In the test reported below, two operators using stopwatches (one with substantial experience, the other relatively inexperienced in manual viscometry) were compared against the 5901B. Unfiltered toluene was timed in Ub-

belohde suspended-level viscometers of two sizes. The Auto-Viscometer improved the precision of the results by a factor of at least 20 times.

Sample (toluene)	Standard deviation* (rel. %)		
	Manual method		Auto-Viscometer (5901B and 5910A)
	Operator A	Operator B	
Viscometer #1 (efflux = 38 sec)	0.53%	0.61%	0.007%
Viscometer #2 (efflux = 178 sec)	0.13%	0.14%	0.007%

* Based on 12 or more replicates.

5901B Auto-Viscometer

Heart of the whole viscometer system is the improved version of the Auto-Viscometer, which employs a new external pumping system and a new internal pressure regulating system. This allows the use of inert gas (in place of air) as the pressure pumping medium. Inert gas is sometimes preferable to avoid oxidation of sensitive sample liquids. Four detector sets come with the unit. Each set consists of an upper and lower photocell detector for detecting meniscus movement. These detectors will fit most glass capillary viscometers. Reverse flow viscometers can be used with the 5901B by ordering the special photocell detectors available as accessory 18545A—Option 02.

Automatic infusing and timing eliminates error between operators due to differences in techniques and human fatigue. The bright neon-Nixie® display provides a digital readout that can be held for observation until released by the operator. A switch, selecting one of four sets of detectors, allows continuous operation. While one viscometer is running, another can be pre-warmed and others cleaned and loaded.

The Auto-Viscometer measures efflux time in glass capillary viscometers with a transistorized electronic counter using a quartz crystal oscillator as a time base reference. This approach not only makes viscosity measurements more efficient, but produces results at least 10 times more accurate than stopwatch techniques. The electronic counter measures efflux time automatically through use of photocell detectors mounted at upper and lower reference points on the glass viscometer.* Positioning screws are provided for spacing adjustments between upper and lower reference points. Each detector consists of a self-contained, miniature light source and photocell in a compact submersible unit. "On and Off" triggering of the time interval counter occurs when the meniscus of the solution drops past the detectors; the time is read on the Nixie® display. This reading remains until intentionally erased by the operator. After the operator records the efflux time, he can either repeat the run or switch to another channel for a new measurement.

5903A Programmer

The repetition of efflux time measurements yields data of high confidence, and final viscometry calculations will have utmost precision. A combination programmer and printer, the 5903A virtually eliminates the tedium of constant monitoring and recording of data, while giving you the capability for unlimited measurements. It attaches to the Auto-Viscometer to automatically program efflux time measurements. The Programmer can control a sequential run from channel to channel (one through four on the Auto-Viscometer) and will repeat the program for as long as the operator wishes. Up to 10 repeat measurements per channel can be made, with 40-second intervals between measurements. Alternately, an unlimited number of repeat measurements can be done on individual viscometers. This automatic printout of efflux times gives you a permanent record of measurements, and is a time-saver. Each reading, moreover, is coded with viscometer number and run number. The printer is identical to HP 562A, described on page 115 in this catalog.

With the timer option, you can have an automatic system for timed interval measurements for reaction kinetic studies where a change of viscosity occurs.

The timer will set the programmer to make measurements from 5 to 100 minutes apart. Timer settings are in 5-minute increments.

Specifications, 5901B Auto-Viscometer

Range and resolution: up to 1000 seconds ± 0.01 second; up to 100 seconds ± 0.001 second.

* Glass Viscometers: Hewlett-Packard does not sell glassware but recommends the standard Ubbelohde-Dilution (suspended level) and the Ubbelohde Semi-Micro Viscometers described in ASTM D445 and DIP 71, appendices C and M. These types are convenient to use, however, virtually any U-tube viscometer may be used, including Sil, Ostwald, Cannon-Fenske.

Readout: Neon Nixie® 5-Digit Register with decimal point indicated.

Accuracy: at least ± 1 second. Based on reproducibility of typical measurements of efflux time up to 300 seconds using Model 5910A Bath.

Operating temperature: 5°C to 135°C.

Glassware*: detectors will accommodate viscometers with 6.5 to 10 mm diameter at point of detection.

Response time: 10 microseconds.

Minimum meniscus speed: 1 inch per minute.

Power requirements: 115/230 V $\pm 10\%$, 50 or 60 Hz, 60 watts.

Dimensions: 10" high, 8½" wide, 13" deep.

Weight: net 17 lbs; shipping 22 lbs.

5903A Programmer

Printer: see specifications on HP 562A on page 115.

Programmer: sequence and repeat selectors for four viscometer channels.

Power requirements: 115/230 V $\pm 10\%$; 50 or 60 Hz; 130 watts.

Dimensions: 12½" high, 20¾" wide, 18½" deep.

Weight: 35 lbs.

Ordering No.	How to order	
	Description	Price
5901B	Auto-Viscometer, complete with pump and 4 sets of detectors	\$2650.00
5903A	Programmer, with printer	\$3600.00
	Option 01: timer for measurement intervals of 5 to 100 minutes, add	\$225.00

Accessories

18545A Opt. 01	Spare Photocell Detector for Auto-Viscometer	230.00
18545A Opt. 02	Detector with 15" leads and replaceable light source for reverse flow Viscometer	230.00

* Glassware not supplied with instrument.

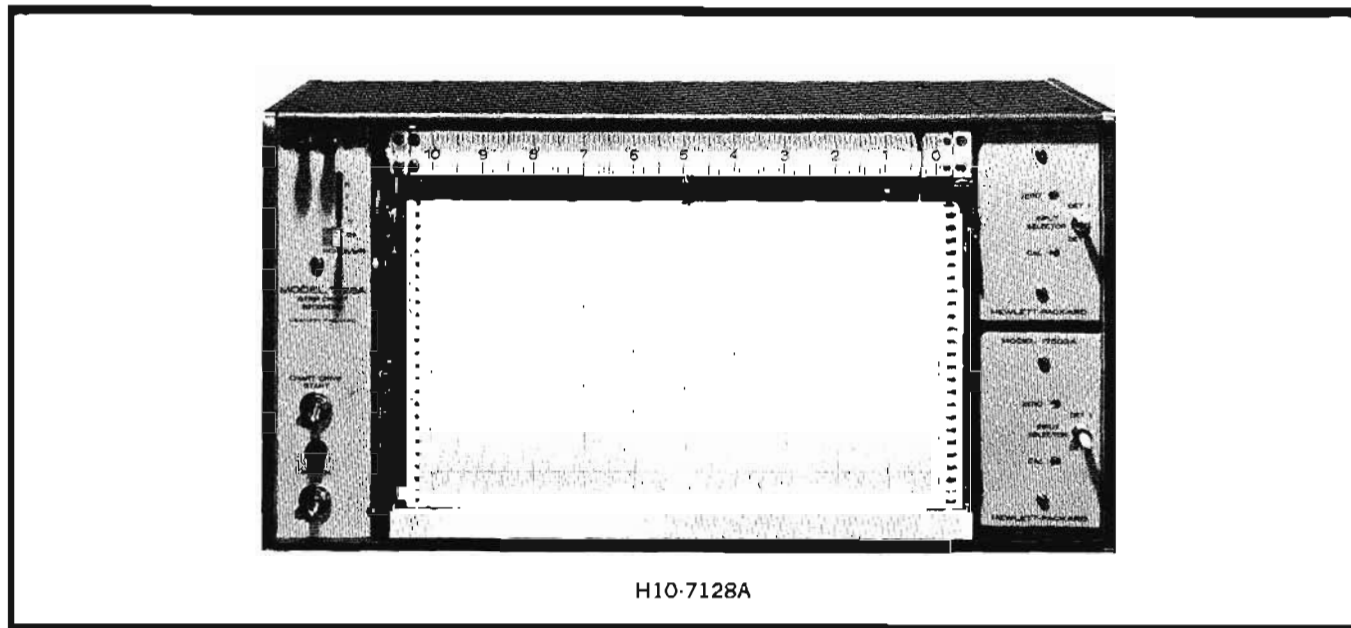
GC STRIP CHART RECORDER
 For top performance in gas chromatographs
 Models H10-7127A, H10-7128A

H10-7128A

Compact solid-state instruments with a 10-inch calibrated chart and one or two pens, these strip chart recorders are specifically designed for use with gas chromatographs. To insure accurate recording of the chromatogram, they incorporate plug-in input modules whose low-pass filter rejects power line frequencies and the differential noise that is commonly associated with gc detector output.

The Model H10-7127A has one and the H10-7128A has two servo-actuated pens and input modules. All input modules are equipped with a detector selector switch that allows the operator to choose either of two gc detector signals for recording. Both models have a 1 mV full-scale span for each pen; input can be floated up to 500 V above ground with high common mode rejection; zero can be positioned over full span or suppressed up to 100% of full scale.

Standard features:

- One or two servo pens
- Detector selector for each pen
- One-half second full-scale pen speed
- Four chart speeds
- Three-position chart table

Optional features:

- Disc integrator
- 50 Hz operation
- Fully adjustable limit switches
- Event markers

Specifications

Sensitivity: 1 mV full scale.

Response time: 0.5 second max. full scale (0.6 sec. max. 50 Hz).

Accuracy: $\pm 0.2\%$ of full scale.

Linearity: terminal based: 0.1% of full scale.

Dead band: 0.1% of full scale.

Pen: capillary type.

Zero: right side.

Chart: 10-inch calibrated width, 120 feet long.

Chart speeds: $\frac{1}{4}$, $\frac{1}{2}$, 1 and 2 inches per minute.

Interference rejection: 120 dB dc common mode; 100 dB line frequency common mode.

Source impedance: up to 5 k Ω without effect on performance.

Radio frequency interference: meets MIL-I-6181D.

Power: 115 or 230 V $\pm 10\%$, 60 Hz, 42 va for Model H10-7127A, 65 va for Model H10-7128A.

Dimensions: 16 $\frac{3}{4}$ in. long, 8-11/16 in. high, 7 $\frac{1}{4}$ in. deep.

Weight: Model H10-7127A, 25 lbs net; 32 lbs shipping.
Model H10-7128A, 30 lbs net, 38 lbs shipping.

Accessories supplied: 4 red and 4 blue ink cartridges, balancing pot lubricant and cleaner, ink system cleaner, extra pen for each channel, rear input mating connector, pen cleaning wire, one roll of paper, power cord, instruction manual.

Prices: (basic frame plus input module for each channel).
Single channel, Model H10-7127A \$1100
Dual channel, Model H10-7128A 1650

Options

- | | |
|--|-----------|
| 01 High-low limit switches on one channel | add \$ 50 |
| 03 50 Hz operation at 115 or 230 volts | n/c |
| 04 Event marker, left-mounted | add 35 |
| *06 Two event markers, left and right | add 70 |
| 07 Disc integrator (installed on channel 2 of Model H10-7128A; not available with option 06) | add 585 |
| 11 Carrying handle | add 25 |
| 12 Mounted in cabinet compatible with HP gas chromatographs** | add 100 |

* Cannot be installed when instrument is equipped with Option 07.

** No charge when ordered with Series 402 or 5750 Instruments.

ACCESSORIES

Extend usefulness, versatility of GC's

Models SI-4, 80, GV-10/11, 60, 50B, 19035A, 19034A,



**ANALYTICAL
INSTRUMENTATION**

SI-4 Solid Sample Injector

The Solid Sample Injector is ideally suited for introducing exact weights of solid or viscous materials into a gas chromatograph and is adaptable to most makes of chromatographs. It employs a glass melting point capillary to hold and inject sample. Stainless steel, 1 lb SI-4, Solid Sample Injector basic price: \$150.

80 Pyrolyzer

The Pyrolyzer extends the scope of GC by decomposing nonvolatile samples semiautomatically and is useful in analyzing large polyfunctional molecules. Suitable for direct connection to HP instruments, these pyrolyzers can be adapted to most other GC makes. 115/220 V, 60 Hz (50 Hz, optional), 16 lbs. 80 Pyrolyzer basic price, including adapters: \$350.

Gas Sampling Valves

Hewlett-Packard Gas Sampling Valves provide a convenient means of introducing gaseous samples into a gas chromatograph. They are designed as 2-way valves which allow a continuous sample gas stream whether the valve is in the bypass or inject position.

Models GV-10 and GV-11 are the same in every feature except that GV-11 has shutoff valves on the sample inlet and exit ports. Both types are provided with the standard 0.5 cc sample loop. Accessory sample loops are also available from 0.5 to 25 cc; price \$15.

Description		Cat. No.	Price
Model GV-10	for Series 500	19036A	\$225
	for Series 700	19037A	
	for Series 720	19038A	
	for Series 810	19039A	
	for Series 5750	19047A	
Model GV-11	for Series 500	19040A	\$275
	for Series 700	19041A	
	for Series 720	19042A	
	for Series 810	19043A	
	for Series 5750	19048A	

60 Backflush Valve

The Backflush Valve reverses direction of carrier gas through the column with the twist of a knob. This rapidly clears the column of unwanted components in an analysis; e.g., natural gas analysis, where only low-boilers are of importance. The valve has an integral heater and a replaceable teflon rotor with compression adjustment for leakfree operation up to 225°C and 50 psig. For proper operation the heater requires an auxiliary controller. For prices and ordering information, see table.

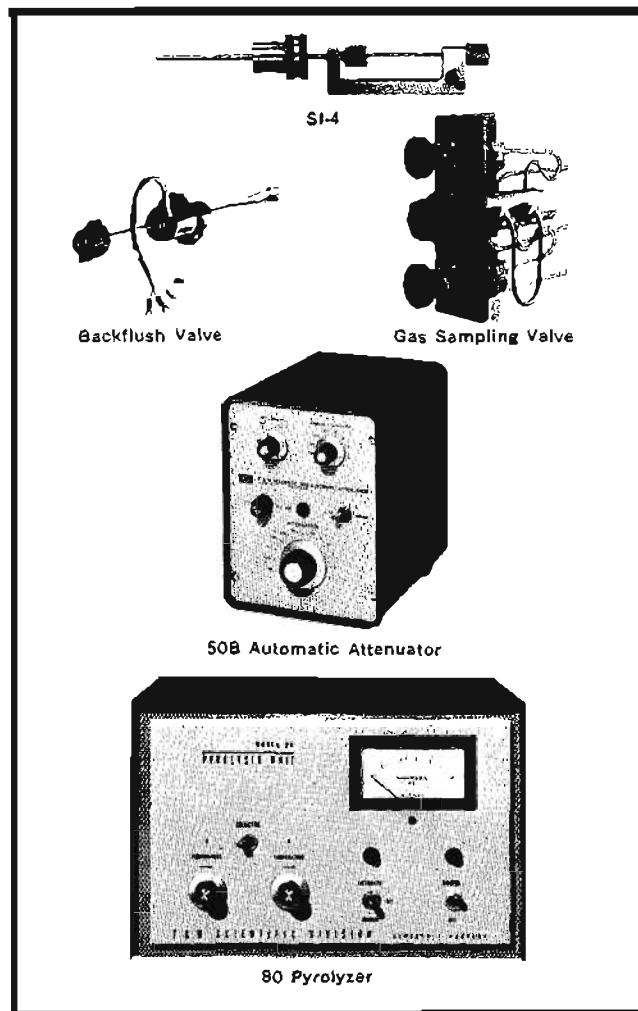

For Instrument models	Description	Part No.	Price
Series 700	Backflush valve, with temp controller and pyrometer readout	60C	\$465
Series 810	Backflush valve only	60D	\$225
Series 5750	Backflush valve only	19030A	\$350
Series 810 or Series 5750	Temp controller with pyrometer readout	19045A	\$225

ACCESSORIES *continued***Extend usefulness, versatility of GC's**

Models SI-4, 80, GV-10/11, 60, 508, 19035A, 19034A

19035A Sample Injection Splitter

Specially designed for use with small-diameter, lowflow GC columns the Sample Injection Splitter (not shown) attaches directly to the injection port and provides a variable split ratio to give proper volume of sample injection on these columns. Includes integral heater to keep the system at injection port temperatures. Careful splitter design minimizes the ghosting, nonlinear, and fractionation difficulties often encountered in splitter systems. (For use with Series 5750 Gas Chromatographs only.) 19035A Sample Injection Splitter price: \$125.

19034A Effluent Splitter

Effluent splitters are for simultaneous operation of two or three detector systems in gas chromatography. They also can be used to divert portions of effluent in a flame or electron capture GC system (which are destructive to samples) to an analytical collection system. For use with Series 810 and 5750 Gas Chromatographs, the 19034A Effluent Splitter converts to either three-way splits (for the Series 5750) or two-way splits (for both series). It comes complete with a set of interchangeable splitters for fixed ratios in all combinations possible with 1:5:10 splits (e.g., 1:5:5, 1:10:5, 1:1:1). All mounting hardware is included for connection to 1/4" outlets. Price: \$175.

19055A Total Collection System

For trapping components of a mixture as they elute from an analytical instrument, the total collection system (not shown) traps both carrier gas and component as desired. The system consists of a 300 ml glass flask, a manifold needle valve and a soap-film flowmeter. Useful for small-scale collections needed in further analytical work. Requires adapters for specific instruments. 19055A Total Collection System, basic price without adapters: \$120.

19046A Gas Purifier

The Gas Purifier (not shown) will clean up a GC carrier gas source of contaminants which would degrade analytical results, principally unwanted oxygen, carbon dioxide, or low hydrocarbons. It is specifically recommended for use with the Models 180 and 185 C-H-N Analyzers where these impurities would critically reduce accuracy of microanalysis. The purifier consists of a molecular sieve dryer tube which removes CO₂ and water; a heated tube which removes hydrocarbons and CO by precombustion, and oxygen by forming CuO as the gas passes over reduced Cu. 19046A Gas Purifier, basic price: \$275.

Thermistor Probes

Thermistor probes for the 302 Vapor Pressure Osmometer are all interchangeable and easily installed. They sense the temperature differential between solvent and solute drops within 0.001°C. Two types are available: one for aqueous operation, one for nonaqueous operation. See table for prices and ordering number.

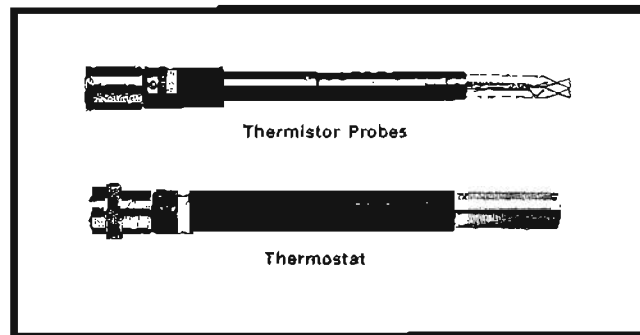

Solvent type	Operating temperature	For use with Model No. 301A and 302	Ordering No.	Price
Nonaqueous	25°C	X	18501A	\$190
	37°C	X	18502A	\$190
	50°C	X	18503A	\$190
	65°C	X	18504A	\$190
	100°C	X	18509A	\$240
	130°C	X	18510A	\$240
Aqueous	25°C	X	18505A	\$190
	37°C	X	18506A	\$190
	50°C	X	18507A	\$190
	65°C	X	18508A	\$190

X = available.

Thermostats

Interchangeable with both Model 302 Vapor Pressure Osmometers and Series 500 Membrane Osmometers. These thermostats maintain specified temperature within 0.001°C. Basic price: \$100. See table for ordering number.

Temperature control point	For use with Model No.			Ordering No.	Price
	Vapor Pressure Osm. 301A and 302	Membrane Osm. 501 502 503			
5°C			X	18543A	\$100
25°C	X	X	X	18511A	\$100
37°C	X	X	X	18512A	\$100
60°C	X	X	X	18513A	\$100
65°C	X	X	X	18514A	\$100
100°C	X		X	18515A	\$100
110°C	X		X	18517A	\$100
130°C	X		X	18516A	\$100

X = available.

18526A Variable Temperature Controller

A single device (not shown) which allows the operator a continuous control of temperatures within the range of his particular Series 500 Membrane Osmometer. It is necessary to specify serial and model number of your Membrane Osmometer to insure receipt of proper installation kit for the Variable Temperature Controller. 18526A (18562A for 50 Hz operation) Variable Temperature Controller, basic price: \$375.

Further information on chemical instrumentation accessories is available in a 56-page Columns and Accessories for Analytical Instrumentation Catalog No. 3. For your copy, contact your nearest Hewlett-Packard sales office.

Medical Instrumentation

Cardiac Instrumentation	60-65
Electrocardiographs	
Heart Sound Amplifier	
Vectorcardiographs	
Diagnostic Instrumentation	55-59
Coagualgraph	
Diagnostic Sounder	
Electromyograph	
Patient Monitoring — Intensive Care	66-75
Central Station Display	
DC Defibrillator	
ICU Systems	
Monitor Scopes	
Transducers	
Patient Monitoring — Operating Room ..	76-79
Research	80-88
Cardiac Computer	
Magnetic Tape Recorders	
Oscillographic Recorders	
Signal Conditioners	
Technical Information	54

Complete Indexes	633-649
-------------------------------	----------------



Instruments and Systems for Measuring, Monitoring and Recording Physiological Data: The following pages summarize the main features of the majority of Hewlett-Packard instruments for clinical medicine, clinical laboratory, patient monitoring, resuscitation, multi-channel diagnosis and multi-channel research. Additionally, references will be made in the following text to various Hewlett-Packard test instruments which are applicable to the medical instrumentation listed.

Total system concept

In order to best meet the needs of a customer in the bio-medical field, Hewlett-Packard strives to provide, wherever possible, a *total* recording system rather than isolated instrument components so that our medical customer can be assured of obtaining the desired results in the most appropriate form.

A complete data acquisition system consists of a signal pick-up, signal conditioner, readout device, and as required a data storage unit.

The pick-up consists of electrodes for sensing bioelectric phenomena and transducers for converting the physical phenomena into an electrical signal. The signal conditioner simply amplifies the signal from the pick-up so that there is sufficient drive for readout devices, or the signal conditioner may modify the pick-up signal in order to convert the data into a more useful form for readout. The readout device presents the data in a form convenient for monitoring and/or study. The storage device preserves the data for readout at a later time.

The readouts can be in the form of an oscillograph, XY recorder, visual display, alarm, and/or typewriter output.

Oscillographs are available in four basic types: heated-stylus, fluid-process, optical photographic, and optical ultraviolet.

The visual displays consist of various size single and multi-channel oscilloscopes, large scale meters and numerical readouts.

Alarms are both audible and visual type.

Storage devices consist of punched tape, punched card, digital magnetic tape and analog magnetic tape systems.

The wide choice of Hewlett-Packard instrument components in the categories listed above, distinctly equips Hewlett-

Packard to provide *total* data acquisition systems.

Clinical medicine

Hewlett-Packard provides an extensive group of instruments designed primarily for clinical applications. These include the 1500A Electrocardiograph (portable use) and the 1511A (a mobile unit). The 1506A Heart Sound Amplifier may be associated with the ECG, to record heart sounds through the electrocardiograph. For vector presentation, the HP 1520A provides a degree of flexibility never before available. The 1501A Coagulation Analyzer is another outstanding instrument, designed for determination of clotting time, lysis time, and estimation of fibrinogen concentration. The 7214A Diagnostic Sounder provides the clinic with facilities for internal body measurements, whether for finding the brain mid-line, observing heart valve motion, or locating the presence and position of foreign material within the body. The 1510A Electromyograph is another versatile clinical instrument, giving a wide range of facilities and superior ease of operation in a single unit package.

Patient monitoring

Patient monitoring has been shown to be of great value in the intensive care unit, recovery room, and operating room. Intensive care of patients can be aided and indeed enhanced through the use of electronic instruments which continuously observe various physiological factors such as ECG, blood pressure, temperature and respiration. The physiological data is appropriately displayed on readout devices for convenient and effortless monitoring by the medical staff. High and low limits can be set so the nursing staff can be particularly alerted when an abnormal situation occurs which may indicate patient distress.

Hewlett-Packard Company has developed a special series of electronic instruments for the particular function of patient monitoring. The 780 Series of monitoring units offer many possibilities of system variations to satisfy the particular requirements of monitoring in different areas.

780 units are small, compact, self-contained instruments which are used in various combinations at the patient's bedside. Signals from the 780 units are available for use at a central station where a

number of patients may be conveniently monitored.

In some areas such as the operating room where patient monitoring is combined with the data acquisition for research, HP multi-channel systems are used with either the "350" or "760" Series of signal conditioners.

Resuscitation

An isolated pacemaker and synchronized DC defibrillator is available for cardiac resuscitation in all areas of the hospital.

Multi-channel diagnostic systems

Multi-channel systems are used routinely in cardiac catheterization laboratories to record pertinent data such as cardiac blood pressures, indicator dilution characteristics and the electrocardiogram. In the heart station, multi-channel electrocardiograms may be recorded in addition to heart sounds, ballistocardiograms, as well as various pulses. In the pulmonary function laboratory, the recording of respiratory airflows, volumes and pressures are essential in analyzing respiratory diseases.

Multi-channel research systems

In order to provide a researcher with a system designed to suit his particular needs and to assure the greatest flexibility, Hewlett-Packard has a special products group which on special order provides custom-designed systems utilizing standard instrument components. The focal point of a large research system is a signal distribution panel which affords maximum flexibility in distributing signals from the various signal conditioners to the several readout devices and storage unit. Using an analog magnetic data recording unit, signals may be played back to the various readout devices with ease and if desired these playback signals may be further modified by signal conditioners in order to extract additional information from the raw data.

Test equipment

Throughout the Hewlett-Packard catalog will be found a wide choice of electronic test equipment ideally suited for trouble shooting, alignment and performance checkout of medical data acquisition systems.

COAGULATION ANALYSIS

Clotting, lysis, fibrinogen concentration
Model 1501A



DIAGNOSTIC

Uses:

- Determination of clotting time
- Determination of lysis time
- Estimation of fibrinogen concentration
- For a wide spectrum of coagulation tests

Features:

- Complete and point detector and reaction monitor
- Permanent graphic records (coagulograms)
- Handles whole blood, recalcified whole blood, native plasma, recalcified plasma, fibrinogen solutions, and other liquids which coagulate or congeal
- Uses conventional reagents and test methods
- Three independent channels, each with three recorder speeds for different reaction times
- Precise temperature control of reactants
- Means of detection and recording does not affect the reaction
- Accepts small sample volumes

Description

The 1501A Coagulation Analyzer is a new Hewlett-Packard system for measuring and graphically recording the entire dynamic process of fibrin formation and lysis, as an instrument to be used for a wide spectrum of coagulation studies. The 1501A coagulograms allow the user to precisely designate points on a curve with respect to time and amplitude, instead of depending on error-prone visual observations, to provide more accurate and repeatable quantitative determinations.

Versatility is the outstanding feature of the 1501A. The instrument observes and records the entire dynamic process of fibrin formation and lysis. Its three channels are independent, to allow any combination of different or identical tests to be run at the same time. Each strip chart recorder has three individually selected chart speeds, to allow slow or fast reactions to be observed with equal ease. It can deal with plasma or whole blood with equal facility.

Operation is based on the optical density principle, where the 1501A measures and records the amount of light transmitted through a sample. As coagulation proceeds, the formation of fibrin reduces the amount of light reaching a photocell, causing a proportional indication on the recording.

Construction is designed for simplest operation, in a compact tabletop unit. The instrument contains six cuvet stations in a temperature controlled aluminum block, three single-channel strip chart recorders, and the associated measuring and control circuits. Three of the cuvet stations use vertical cuvettes, for fast reactions; three use horizontal cuvettes for tests having a longer clotting time, for tests utilizing whole blood, or when lysis is involved.

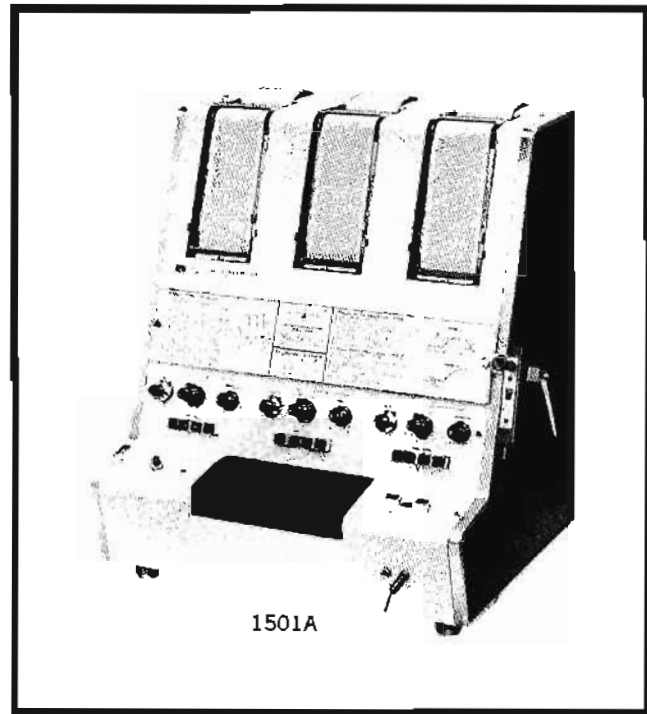

Specifications

Chart speed: individually selectable each channel; 5 mm/2 s (fast); 5 mm/1 min (medium); 5 mm/10 min (slow).

Sample size: 0.1 ml min for whole blood clotting; for tests requiring plasma, sample size is compatible with existing procedures.

Repeatability: repeat readings on same sample will fall within $\pm 3\%$ for time, and $\pm 5\%$ for amplitude.

Accuracy: chart speeds (time) are accurate within $\pm 2\%$; estimates of fibrinogen concentration under recommended conditions are accurate to $\pm 15\%$ when compared to gravimetric fibrinogen determinations.

Calibration: with calibrating cuvettes; standard sensitivity is obtained when deflection from baseline in mm is same as printed number on calibrating cuvette; cuvette temp: $37.2 \pm 0.2^\circ\text{C}$, adjust $34^\circ - 42^\circ$.

Warmup time: 20 min approx.

Power: 115/230 V $\pm 10\%$, 50/60 Hz, 120 W max.

Dimensions: 17 $\frac{1}{2}$ " high, 16 $\frac{3}{4}$ " wide, 13 $\frac{1}{4}$ " deep (445 x 426 x 337 mm).

Weight: 49 lbs (22.2 kg).

Price: 1501A Coagulation Analyzer, including all accessories, 115/230 V, 60 Hz, \$3900.

Option 08: same except 50 Hz operation, add \$25.

DIAGNOSTIC



ULTRASONIC DIAGNOSIS

Easily-obtained data on internal body structures
Model 7214A

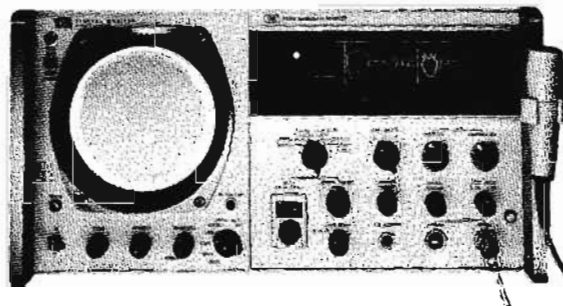
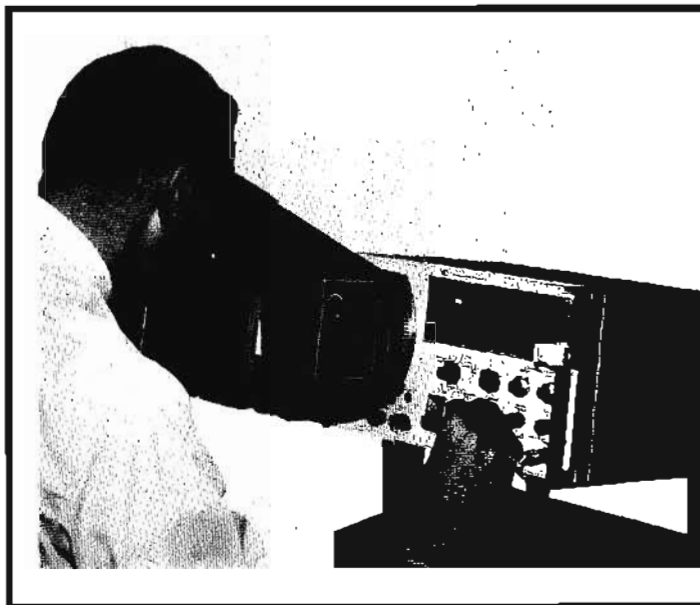

7214A

The Model 7214A Diagnostic Sounder — with associated transducers is a new, easily-operated ultrasonic diagnostic system with versatile usefulness in both clinical and research applications. Used alone or in conjunction with other diagnostic methods, the 7214A permits rapid, safe and accurate determinations in areas such as:

Sono-Encephalography (SEC) In neurology — for determining brain mid-line displacement caused by space-occupying lesions; measuring ventricular structures; detecting certain hematomas and tumors.^{1,2}

Echo-Cardiography In cardiology — for observing the motions of the mitral valve and heart walls, in the diagnosis of mitral stenosis and pericardial effusion.^{3,4}

Fetalometry in obstetrics and gynecology — for measuring the biparietal diameter of a fetal head as an aid to determining fetal weight and growth pattern.⁵

Ocular pathology In ophthalmology — for measuring eye length, cornea and lens thickness; studying myopia, growth, circulation, detached retinas, glaucoma and similar conditions; and for locating foreign particles in the eye.⁶

Renal studies in internal medicine — for estimating the amount of urine in the bladder by measuring the A-P diameter of the bladder; determining insertion depth of biopsy needle; and locating renal stones during surgery.⁷

Principle of operation—the 7214A uses the difference in ultrasonic reflective properties between a tissue interface or internal structure and those of surrounding tissue of a different density or elasticity. The system generates a series of very short ultrasonic pulses (in the 1 MHz to 10 MHz frequency range) which are transmitted into the body by a transducer in firm contact with the surface of the body, and through a coupling medium such as an ultra-sound transmission gel. When the pulses encounter a tissue interface or internal structure whose density or elasticity is different from the surrounding tissue, an echo pulse is reflected to the transducer and displayed on the monitor. With the screen calibrated in centimeters, the depth of the pulse-reflecting tissue interface or structure can be read directly. Data is obtained quickly and easily, without danger or discomfort to the patient.

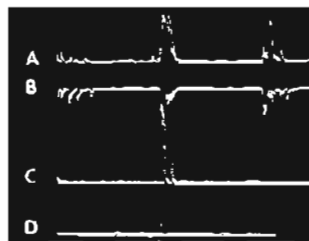

A-Scan mode showing brain mid-line examination of normal patient. (A) Right to left examination using normal vertical deflection. (B) Left to right examination using inverted vertical deflection. (C) Through transmission, notice through distance corresponds to distance of mid-line echo. (D) Marker trace set to indicate mid-line echo.

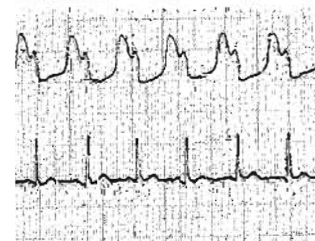

T-M mode showing a recording of the motion of the mitral valve (top), taken simultaneously with an ECG (bottom). Upstroke of the curve represents movement towards the chest wall. Downstroke represents movement away from chest wall.

Separate operating modes are provided for (1) *measuring fixed distances* between interfaces ("A-Scan") and (2) *locating and visualizing physiologic structures in motion* ("T-M" or "Time-Motion"). An example of each measurement is shown in the study of the mid-line structure of the brain (A-Scan) and in the motion of the mitral valve (T-M) in the photographs above.

Features and advantages — to provide optimum performance of the system and greatest measurement accuracy, four different transducers are available: 1 MHz, 2.5 MHz, 5 MHz and 10 MHz. The 2.5 and 5 MHz types are recommended for most applications; 1 and 10 MHz types are designed for better penetration and more resolution respectively. Connecting the transducers to the front panel jack automatically selects corresponding operating frequency and lights an indicator identifying the frequency.

Bright, clear, parallax-free traces in a large 10 cm x 10 cm display area are achieved by a special internal graticule, which also facilitates high-quality photographs made with the new HP 197A Scope Camera. Depth measurements accurate to within one mm are made possible by a calibrated marker trace used with a front panel numerical readout. If the user wishes

to compare two moving interfaces or structures simultaneously, an optional variable-persistence scope permits retention of one signal on the scope face for up to one hour. Other features which simplify the operation of the 7214A Diagnostic Sounder include calibrated gain controls for quickly resetting instrument to previously-determined values; beam-finder pushbutton which brings trace on the screen regardless of intensity or position control settings; and an audible tone signal whose pitch varies according to echo amplitude in A-Scan mode, and echo motion from the start of the gate in T-M mode, to help prevent loss of signal.

For scope trace photography, the new HP 197A Scope Camera produces high-quality prints of excellent resolution and contrast, quickly and easily. Built-in ultraviolet light illuminates the internal graticule. Standard Polaroid® camera back is interchangeable with 4" x 5" Graflex® back.

For permanent records of T-M measurements, a signal for strip chart recording is available at a front panel jack, this permits simultaneous recordings with electrocardiograms and/or phonocardiograms.

Reference bibliography — ultrasonic diagnostic applications

1. Grossman, Charles C.: *The Use of Diagnostic Ultrasound in Brain Disorders*, C. C. Thomas, Publisher, Springfield, Ill., 1966.
2. McKinney, W. M.; Thurstone, F. L.; Avant, W. S. Jr.; and Wallace, W. K.: "The Significance of Intracranial Echo Pulsations", *Diagnostic Ultrasound**, pp. 114-116, Plenum Press, New York, 1966.
3. Edler, Inge: "Mitral Valve Function Studies by the Echo Method", *Ibid.*, pp. 198-228.
4. Joyner, C. R. Jr.: "Experience with Ultrasound in the Study of Heart Disease and the Production of Intracardiac Sound", *Ibid.*, pp. 237-248.
5. Thompson, H. E.: "Studies of Fetal Growth by Ultrasound", *Ibid.*, pp. 416-426.
6. Sokollu, A.: "The Use of Diagnostic Ultrasound in Eye Research", *Ibid.*, pp. 46-58.
7. Holmes, J. H.: "Ultrasonic Studies of the Bladder and Kidney", *Ibid.*, pp. 465-480.

Specifications, 7214A Diagnostic Sounder

Operating modes: A-Scan or T-M study; in A-Scan the vertical deflection is either normal or inverted for range info.

Test frequencies: 1, 2.5, 5 or 10 MHz, selected by connecting desired transducer.

Display: cathode ray tube with an internal graticule calibrated in centimeters.

Depth range: 0.5 to 50 cm of tissue.

Depth resolution: 1 mm or less at 10 MHz.

Marker: range marker on alternate trace, for accurate measurement of distance from start of transmitted pulse.

Trace height: max. 2 or 5 cm, selectable by operator.

Vertical sweep: variable speed, for T-M mode.

Gate: permits selection of any echo or group of echos.

Audio output: tone frequency depends on amplitude of echo appearing in gate during A-Scan, and on motion of echo from start of gate in T-M.

Pulse rep. rate: approx. 500 Hz.

Avg. power from acoustic element: less than 2 mW.

Time varying gain: approx. 80 dB of time varying gain provided by calibrated front panel controls to compensate for attenuation due to tissue absorption and scattering.

Input connections: two, on front panel, for transducer: normal for pulse echo operation, or through transmission mode used for calibration purposes.

Output connection: T-M recorder output signal jack on front panel; capable of supplying a minimum ± 1 volt open circuit.

Circuitry: all silicon solid-state, except for CRT and its power supply.

Size: 9" high, 16 $\frac{3}{4}$ " wide, 18 $\frac{3}{4}$ " deep (229 x 426 x 476 mm).

Weight: net 50 lbs (22,7 kg); shipping 60 lbs (27,2 kg).

Power: 115/230 V, 50-60 Hz, 285 W.

Prices: HP 7214A (less 21000 series transducers), \$3900.

Option 01: variable persistence scope instead of short persistence, add \$900.

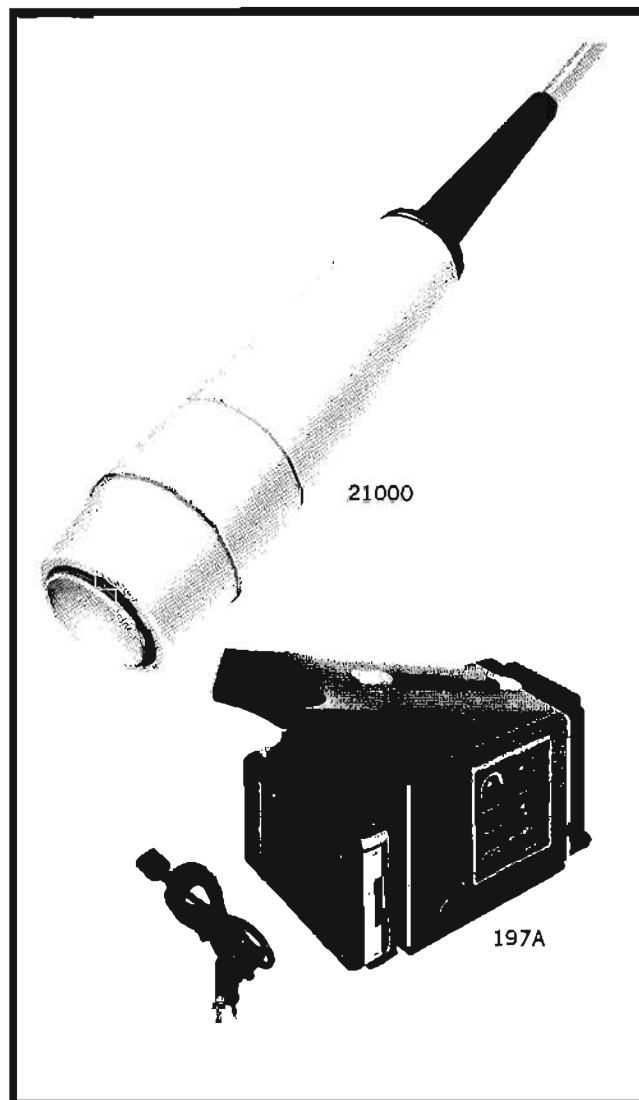

*Contains the Proceedings of the First International Conference of the Society for Diagnostic Ultrasound, University of Pittsburgh, May 1965.

DIAGNOSTIC

ELECTROMYOGRAPH

Multiple functions in a unit instrument
Model 1510A

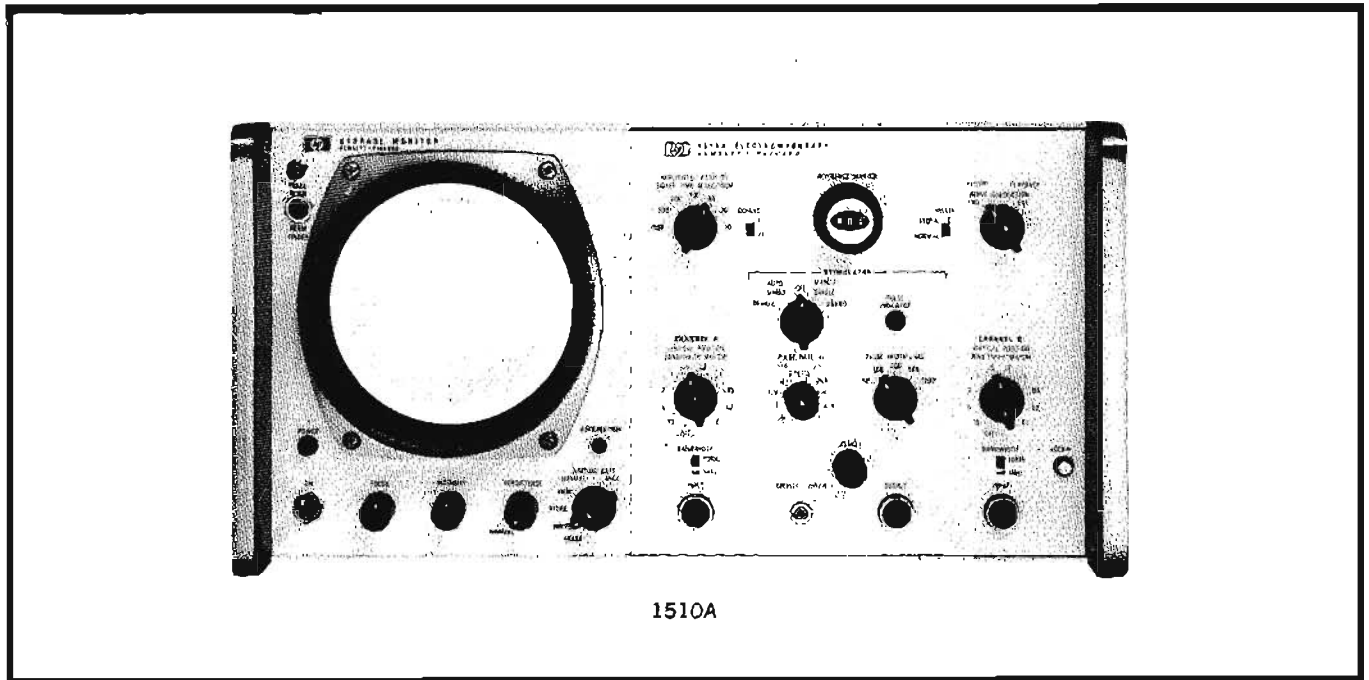

Model 1510A Electromyograph is a dual-channel instrument which features readout on a variable persistence storage scope as well as audible indication on a built-in loudspeaker, with stimulator and amplifier circuits designed primarily for studies of nerve and muscle abnormalities, and for monitoring the process of regeneration. These features make the instrument suited for diagnosis, research, teaching, and the evaluation of therapy.

The variable persistence storage scope allows easier viewing of complex patterns, and allows the operator to study or photograph a single trace up to an hour after it is made, as well as simplifying nerve conduction velocity measurement at low stimulus repetition rates.

In the EMG mode of operation, the sweep is free-running, to view the patient's muscle voltages without external stimulus. Alternatively, in the nerve conduction mode of operation, the stimulator delivers a pulse to the patient, and simultaneously triggers the sweep, for observation of the muscle voltages which result. A special step-sweep is provided as a standard feature. In the EMG mode, this stepping will expand the patient's self-excited muscle action potentials over four successive vertically spaced segments on the scope tube face, corresponding to a single, 16-inch display. In the nerve conduction mode, four successive stimuli and the resulting muscle action potentials are shown on four successive sweeps.

Electrodes are supplied with the 1510A for both stimulator and signal-pickup functions. The stimulator electrode is a plastic case with a built-in level control (0-350 V) designed to be held by hand at the point of stimulus. Pickup electrodes include one set of three surface electrodes and one coaxial needle electrode.

Variable bandwidth is provided for a response band up to

10 kHz, used to observe high frequency fibrillation potentials, or up to 1 kHz, to reject high-frequency noise components. Other amplifier features include high common mode rejection, low noise, isolated input, and a high input impedance. Amplifiers follow modern design by use of solid-state circuits for reliability, on printed-circuit plug-in cards for simplified maintenance, with fixed calibration for easier operation.

Simplified measurement of nerve conduction velocity is provided by a reference marker and by double stimulation pulses. The reference marker is a reference spike which may be moved across the scope tube face by a panel control having a counting dial, to give a direct numeric reading in percent of total sweep time, which can be easily converted into milliseconds. The double pulse stimulator feature can be used as desired, for rapid, easy measurement of H-reflex response, or of the refractory period.

High quality photographs may be made by use of the Hewlett-Packard Model 197A Scope Camera, with added flexibility and range of applications being provided by the variable persistence scope feature of the 1510A. The camera mounts directly on the bezel of the oscilloscope and may be swung away from its mounting when not in use. An ultraviolet light in the camera illuminates the internal graticule of the scope.

HP peripheral equipment which may be coordinated with the 1510A includes such instruments as (1) 3900 Series of Magnetic Data Recorders for information storage and playback, (2) 4500 Series Optical Recorders for permanent records, (3) HP Counters, such as HP 5223C or HP 5233C, for measuring conduction time and for measuring total muscle activity.

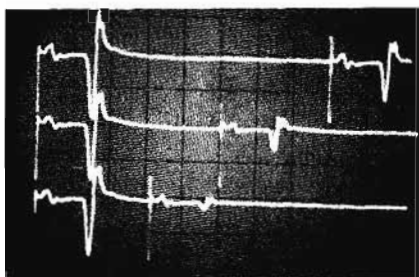

H-reflex response recovery using double pulse mode. Stimulation at start of sweep and at marker. Sensitivity 2 mV/cm. Sweeptime 20 ms/cm.

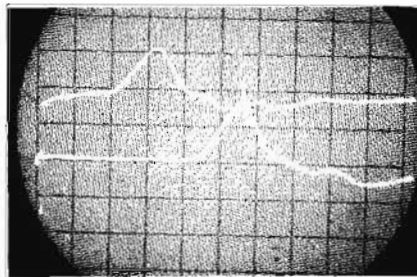

Conduction velocity determination. Ulnar nerve stimulated at the elbow and at the wrist. Response in abductor digiti quinti. Sensitivity 5 mV/cm. Sweeptime 2 ms/cm.

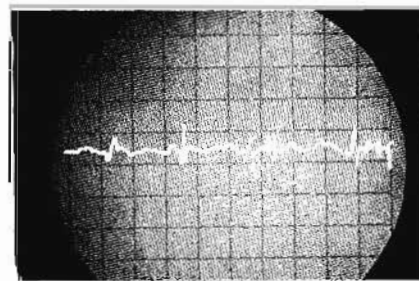

Fibrillation potentials. Sensitivity 100 μ V/cm. Sweeptime 10 ms/cm.

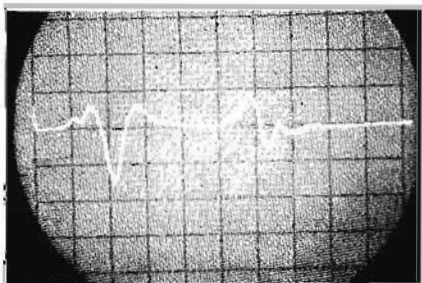

M and H-response tibial nerve stimulated at popliteal fossa; response monitored at gastrocnemius. Sensitivity 1 mV/cm. Sweeptime 5 ms/cm.

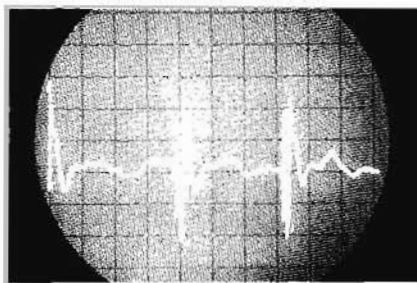

Complex, or polyphasic, potentials. Sensitivity 100 μ V/cm. Sweeptime 10 ms/cm.

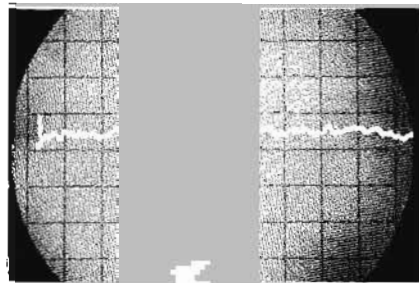

Normal motor unit action potential. Sensitivity 100 μ V/cm. Sweeptime 10 ms/cm.

Specifications

1510A Display

Visual and aural: variable persistence 5" scope, for persistence times 0.2 — 60 s, with storage times (at reduced intensity) up to one hour. Built-in loudspeaker and amplifier.

1510A Time Base

Sweep speeds: 1 to 100 ms/cm, in steps 1, 2, 5, 10, 20, 50, 100 ms/cm, plus 5X magnifier.

Triggering: free-running in EMG mode; triggered by stimulator in nerve conduction mode; triggered by ± 1 V pulse in external mode.

Marker: time interval marker for nerve conduction velocity measurements, absolute accuracy $\pm 2\%$.

1510A Signal Amplifier and Electrodes

Input: dual-channel, guarded, differential, impedance above 50 M Ω .

Sensitivity: 10 μ V/cm max; gain markings on panel accurate $\pm 5\%$.

Noise: 2 μ v rms, bandwidth to 10 kHz.

Frequency response: 10 Hz, to switch-selected 1 kHz or 10 kHz.

Common mode rejection: 100 dB at 60 Hz with 100 k Ω source impedance, unbalance 2 k Ω in guard lead.

Chopper frequency: 160 kHz.

Electrodes: one coaxial needle, set of three surface electrodes.

1510A Stimulator

Four modes: single auto; single manual; double auto; double manual.

Auto mode repetition rates: 0.5 pulses/s to 50 pulses/s.

Manual mode: trigger by panel pushbutton or external switch closure.

Double pulse: first stimulator pulse triggers the sweep; reference marker triggers the second pulse.

Selected pulse width: 50 μ s to 1 ms $\pm 5\%$.

Pulse amplitude: zero to 350 V.

Output: isolated from ground.

1510A Physical Characteristics

Size: 8-23/32" high, 19" wide, 18 $\frac{3}{8}$ " deep (221 x 483 x 467 mm).

Weight: net 50 lbs (22,7 kg), shipping 70 lbs (27,2 kg).

Power: 115/230 V, 50 - 60 Hz, 90 W.

Price: HP 1510A Electromyograph, 115/230 V, 50 - 60 Hz, with variable persistence scope, \$3750.

Option 01: short persistence scope instead of variable persistence, less rear input, output connections, deduct \$900.

Option accessory prices

HP 197A Scope Camera, \$540.

197A Opt 01, less ultraviolet illuminator, deduct \$50.

197A Opt 02, with f/1.4 lens instead of f/1.9, add \$270.

197A Opt 03, Graflox back in place of Polaroid back, no extra charge.

197A Opt 05, shutter/sweep sync cable, add \$15.

197A Opt 12, 230 V operation, no extra charge.

119A Testmobile, 38" high, 19 $\frac{1}{4}$ " wide, 23 $\frac{1}{2}$ " front-to-back (965 x 489 x 597 mm); net weight 42 lbs (19,1 kg), shipping weight 45 lbs (20,5 kg); assembly hardware and mounting hardware provided: \$110.

10480A Storage Cabinet for Testmobile, 11 $\frac{1}{2}$ " high, 18 $\frac{1}{4}$ " wide, 15" deep (292 x 464 x 371 mm); net weight 19 $\frac{1}{2}$ lbs (8,9 kg), shipping weight 22 $\frac{1}{2}$ lbs (10,0 kg): \$110.

14045A Miniplug-to-Miniplug Cable, to interconnect 1510A and tape recorder, recording or playback, consult HP field sales office.

14046A Miniplug-to-BNC Cable, for use with auxiliary devices, consult HP field sales office.

14047A Foot Switch for remote control of 1510A Stimulator, or remote erase: \$20.

651-1021-1 Redux Creme, 4 oz bottle: \$1.10.



ELECTROCARDIOGRAPHS

2 Speeds, 4 Sensitivities, Definitive Traces

1500A, 1511A Electrocardiographs

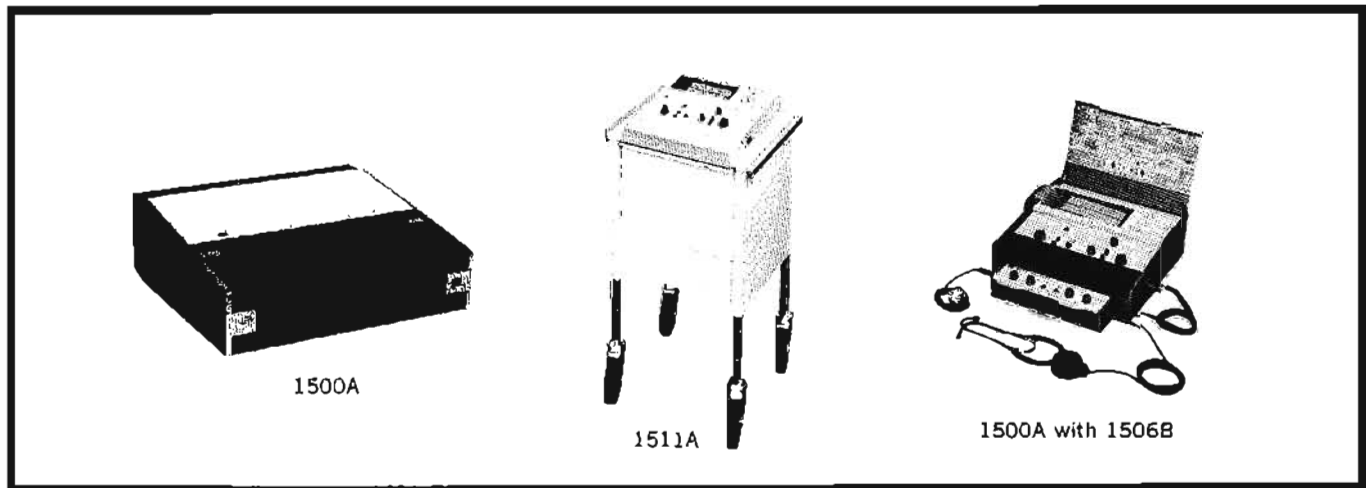

The 1500A and 1511A Electrocardiographs are modern instruments designed for the latest requirements in ECG monitoring and recording, both portable (1500A) and mobile (1511A, in mobile cart). Added patient protection is provided by a special input circuit, isolated from ground, which not only affords complete patient protection without a fuse, but which also reduces leakage current to less than 4 microamperes under the worst possible conditions. During defibrillation the ECG may remain connected to the patient without damage or danger, to allow recording of the ECG waveform immediately following the defibrillation pulse. Low writing hysteresis allows the display of even the smallest notches of the ECG waveforms. All solid-state circuitry makes for long-term stability and fast (less than 10-second) warmup.

Specifications

Sensitivity: (ac) $\frac{1}{4}$, $\frac{1}{2}$, 1, or 2 cm/mV, switch selected. When used as a 1-channel recorder, dc sensitivities are 25, 50, 100 or 200 mV/cm, switch selected. Nominal output: 1 V/cm stylus deflection.

Chart, chart speeds: heat-sensitive, inkless Permapaper,[®] 50 mm wide, 1 mm vertical and horizontal grid, every fifth line accentuated; $6\frac{1}{2}$ " chart visible at all times, 150-ft. roll. Chart speeds 25 and 50 mm/s, switch selected.

Low frequency response: 3 dB down at 0.05 Hz.

High frequency response: two switch-selected ranges: Low, down less than 3 dB at 45 Hz; High, down less than 3 dB at 100 Hz.

Major controls: Off-On-Run, Power On Light, Polarity Test pushbutton, Regulated Stylus Heat (screwdriver control), Stylus Position, Lead Marker, 1-mV Stand. signal, 9-pos. Lead Selector switch with stylus-stabilizing Instomatic action and paper stop between settings (Std. 1, 2, 3, AVR, AVL, AVF, V, CF).

Size and weight: 1500A, 1100A: $5\frac{1}{4}$ " high, $13\frac{3}{4}$ " wide, $13\frac{3}{4}$ " front to back (133 x 350 x 350 mm). With all accessories, 22 lbs (10 kg).

Power: 115 V, 60 Hz, 60 W.

Prices: 1500A Electrocardiograph, in carrying case with protective cover and standard accessories, \$850.

1511A Mobile Electrocardiograph, in mobile cart, with standard accessories, \$975. Following options for both models, except as indicated.

Option 01: 3-wire power cord, no extra charge.

Option 02: fine-line stylus, no extra charge.

Option 05: Model 1500A only, remote run and marker facilities for use with 780-13A at intensive care central station, with standard and additional ECG accessories, add \$50.

Option 08: 50 Hz operation, no extra charge (with option 08 you must also select option 09, 10, 11, 12, or 13).

Option 09: 115/230 V operation, add \$25.

Option 10: 100 V operation, add \$25.

Option 11: 127 V operation, add \$25.

Option 12: 150 V operation, add \$25.

Option 13: 200 V operation, add \$25.

For recording phonocardiograms (heart sound tracings) of diagnostic quality, the Model 1506B Heart Sound Amplifier is especially designed for use with the 1500A/1511A. High resolution tracings of 50-2000 Hz heart sounds may be obtained which reveal the shape, duration and location of the sounds and murmurs, to aid in augmenting auscultation made difficult by the presence of complex arrhythmias or marked tachycardias.

For transmission of ECGs by telephone equipment, the 1500A/1511A is completely compatible without modification with Dataphone Transmitters 603A and 603D, and Receiver 603B. A single connecting cable (see Accessories, facing page) between ECG and Dataphone permits transmission of ECG to any diagnostic facility equipped with Dataphone Receiver.

For scope display of ECG waveform, particularly in ICU areas, the 1500A/1511A is compatible with 780-3 and 780-6 oscilloscopes. For remote, automatic ECG recording at an ICU Central Station, the 1500A Option 05 may be used with the 780-13A Remote Switching Unit.

For amplification/recording of other ac and dc signals, the 1500A/1511A accepts ac signals from 0.05 to 100 Hz, with a max. sensitivity of 1 cm stylus deflection/0.25 mV signal; with dc signals up to 100 Hz, max. sensitivity is 1 cm stylus deflection/25 mV input signal. (For more data, consult Hewlett-Packard field office.)

ECG ACCESSORIES

For Models 1500A, 1511A, 500, 500A

Cables and adapters

14000B Exercise Cable, 5-wire, with electrodes	\$21.50
14008A Adapter, 5-pin to 6-pin (for 373 Transducer)	7.50
8120-1010 Patient 3' Extension Cable	10.50
8120-1066 Standard ECG Patient Cable	14.50
14034A Output Cable from ECG to 780-3 or 780-6A	15.00
460-218A Output Cable from ECG to Bell Telephone, 603A, 603D Dataphone Transmitter	27.00
460-218B Input Cable, from Bell Telephone 603B Dataphone Receiver to ECG	27.00

Electrodes, Redux Creme, Redux Paste, straps

500-602 Standard Limb Electrode	\$ 2.00
572-1717 Limb Electrode, with binding post	3.00
572-1714 Chest Electrode, 3 cm, with handle	3.50
300-800-C1 Infant Chest/Limb Electrode	2.00
233-25 Handle for chest electrode	1.40
9301-0122 Welsh Electrode, 15 mm vacuum cup (infant)	4.50
9301-0119 Welsh Electrode, 30 mm vacuum cup	4.50
651-1021-1 Redux Creme, 4 oz squeeze bottle	1.10*
651-1022 Redux Creme, 37 oz bottle	6.50*
651-1008-1 Redux Paste, 5 oz tube	.85*
572-1760 Redux Paste, 1 pt jar	2.60*
651-1 Esophageal Electrode	26.50
14030A Limb Electrode Strap, 15"	.45
14030B Electrode Strap and button assembly, 30"	.75
14030C Electrode Strap and button assembly, 60"	1.40

Master two-step exercise assembly

651-32, for standard master test, step 9" high, 9" deep, 17½" wide (23 x 23 x 44 cm), folds for storage	\$61.00
---	---------

Mobile cart

1512A Mobile Cart, rolls easily to examining table or bedside, storage space provided.	\$175.00
--	----------

ECG mounting cards, folders, envelopes

All mounting cards, folders 8½" x 11", 12 leads, unless noted.

9320-1120 Mounting Card, pregummed for mounting	per C \$10.00*
9320-1121 Mounting Card, slide in to mount	per C 9.50*
1320-1117 Mounting Card, 5" x 8", slide in to mount	per C 9.05*
9320-1118 Mounting Card, slide in to mount	per C 9.50*
9320-1126 Mounting Folder, slide in to mount	per C 10.00*
9320-1124 Mounting Folder, mount with paste or tape	per C 6.25*
9320-1119 Mounting Folder, 15 leads, slide in to mount	per C 10.00*
8750-0024 Small Record Inserter, 1" x 6⅞"	.75
1530-0914 Large Record Inserter, 2⅛" x 10⅞"	1.00
P102 Record Envelope, manila	per C 3.25*
572-780 Record Envelope, transparent, 2¾" x 8½"	per C 10.00*

Protective covers

4040-0099 Weather Cover	\$ 5.50
4040-0098 Dust Cover	1.50

Permapaper® recording paper

651-40-1 One-Channel, 50-mm, 50-div, 150' long	per roll \$ 3.50*
--	-------------------

Styli (writing arms)

412-5 Standard Writing Arm	\$ 7.15
412-7 Fine Line Writing Arm	7.15

Pulse wave transducer

373 Pulse Wave Transducer, requires 14008A adapter above.	\$71.00
---	---------

* Quantity discounts apply. Consult HP Sales Office.

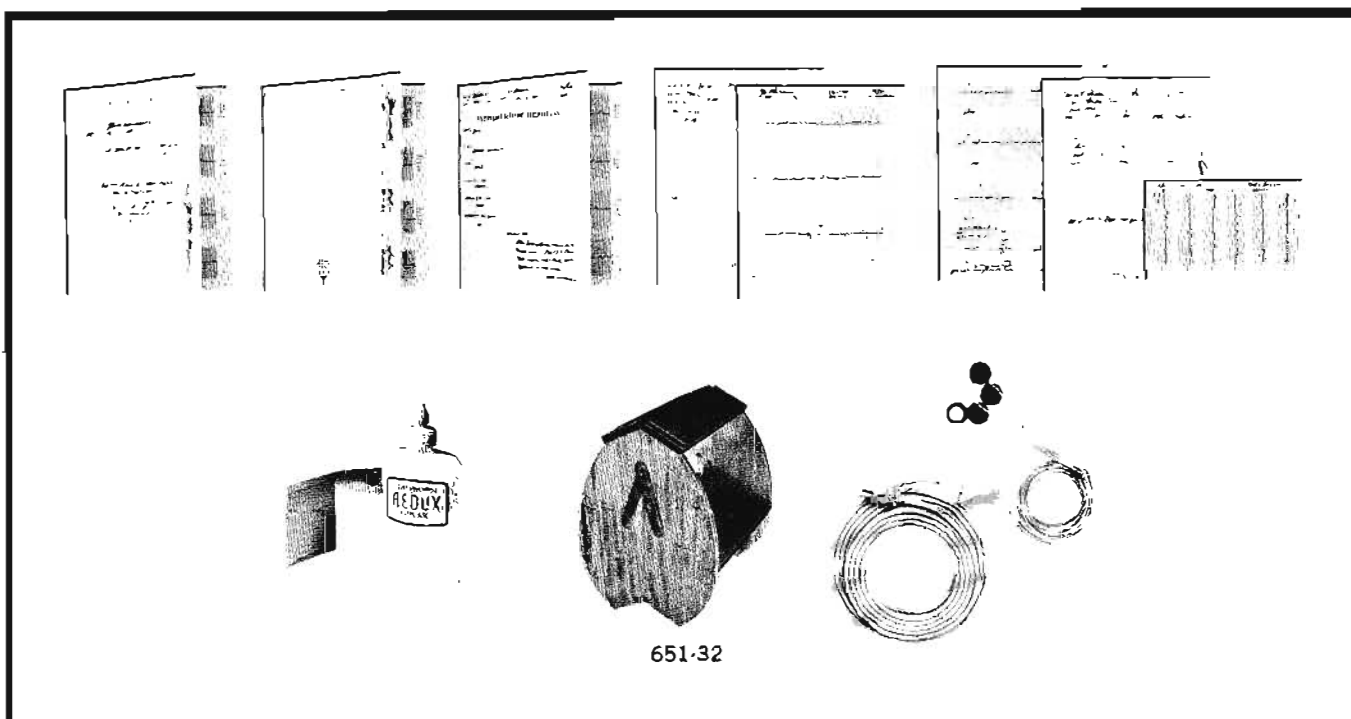

651-32



HEART SOUND AMPLIFIER

Diagnostic heart sounds with ECG recorder
Model 1506B

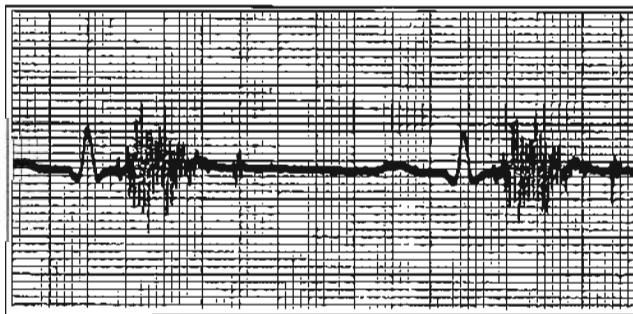
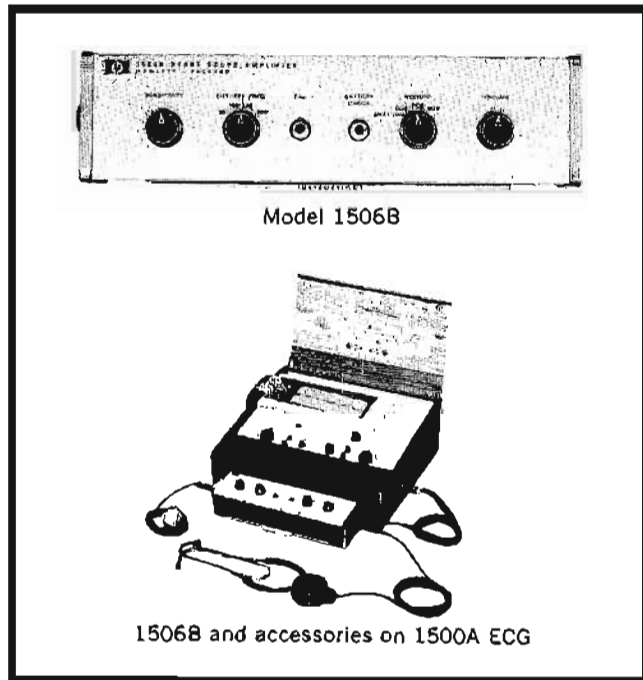

PCG mixed with ECG to establish timing of first sound

Description

The 1506B Heart Sound Amplifier permits heart sound recordings of diagnostic quality to be made by Model 1500A, 1511A, or 500A Electrocardiographs, or other ECG's having a 50 mm/second chart speed and adequate frequency response. Such recordings can provide valuable information on the location, intensity and duration of sounds and murmurs, and the 1506B can also serve as an electronic stethoscope for listening at normal or amplified levels. Three recording modes are available: ECG only, PCG (phonocardiogram) only, and Lead II ECG superimposed on PCG, for timing. Used with a Model 1500A, 1511A, or 500A, the system covers a heart sound frequency range from 50 to 2000 Hz (cps) with recording resolution of 0.01 second. The 1506B operating principle involves electronic detection of the heart sound waveform envelope, with sampling at an 85 Hz rate, with the resultant signal fed to the input of the cardiograph for graphic recording.

The 1506B is a compact, lightweight unit with all solid-state circuitry, self-powered by long-life internal batteries (6 mos. with an average use of 2 hrs./day). It clips easily and securely

to the front of a 1500A, 1511A, or 500A Electrocardiograph. Controls are provided for recording mode (ECG, PCG, ECG-PCG Mix); cut-off freq. (50, 100, 250, 500 cps); sensitivity; audiophone volume; battery check; and calibration.

Specifications

Input impedance: approximately 5 megohms.

Microphone: an input jack is provided for use with crystal or other high impedance microphones.

Calibration: with the microphone disconnected and the Cal. button pushed, an 85 Hz signal (± 6 cycles) of approximately 4.5 millivolts peak is applied to the input stage. Cal. signal should be used only with the Cut-off Freq. switch on the 50 Hz filter position.

Sensitivity (at 1000 Hz): not more than 10 μ V rms input is required to produce 1 mV peak-to-peak signal going to the cardiograph input with Cut-off Freq. switch at 500 Hz, Sensitivity control at maximum and Record switch on PCG or Mix. The sensitivity of the unit at 1000 Hz in the other filter position is as follows:

Filter Switch	Input Signal to Produce 1 mV Peak-to-Peak
50 Hz	+40 dB = 3 dB*
100 Hz	+28 dB = 3 dB*
250 Hz	+12 dB = 3dB*

* (Referred to 18 μ V rms input to amp.).

Frequency response: the high frequency cut-off is fixed for all filter positions down 3 dB at 2000 c/s with a slope of approximately 12 dB/octave. The low frequency cut-off is down 3 dB at 50, 100, 250, or 500 Hz depending on the position of the Cut-off Freq. switch. The filters roll off at 24 dB/octave. The response in the pass band is flat within ± 3 dB.

Envelope detection and modulation: both the positive and negative envelopes are detected and stored in capacitors with an approximate discharge time constant of 14 milliseconds. The envelopes are chopped at an 85 Hz rate (± 6 Hertz) and summed together. The 50 Hz position of the Cut-off Freq. switch is the only position that by-passes the modulator.

Output: a maximum undistorted signal of 6 mV peak-to-peak is applied to the input of the cardiograph with the Record switch in PCG and the Cut-off Freq. switch in any position except 50 c/s. In the 50 c/s position the maximum undistorted signal is 4 mV peak-to-peak. The output impedance is approximately 27 k.

Size: 2 $\frac{1}{4}$ " high, 10 $\frac{3}{8}$ " wide, 2-13/16" deep (58 x 270 x 72 mm).

Weight: 1 $\frac{3}{4}$ lbs (0,79 kg).

Power: 13.5 V at 2 mA, supplied by two 6.75 V internal batteries in series. (Easily checked by recording output voltage pulse on ECG, using battery check pushbutton.)

Prices: Model 1506B with Contact Microphone (14011A), Audiophone (62-1500-C9), and Output Cable to 1500A, 1511A, or 500A (14017B), \$450. Option 01, for use with Model 100 Viso ECG (14021A Output Cable to 100 Viso, 5-pin to 6-pin adapter to connect 100 Viso patient cable to 1506A), no extra charge; Option 02, for mounting on 1500A combined with 1512A Cart, see local HP Sales Office.

ECG DATA ACQUISITION

Multi-channel ECG amplifier

Model 1508A, 1509A



CARDIAC INSTRUMENTATION

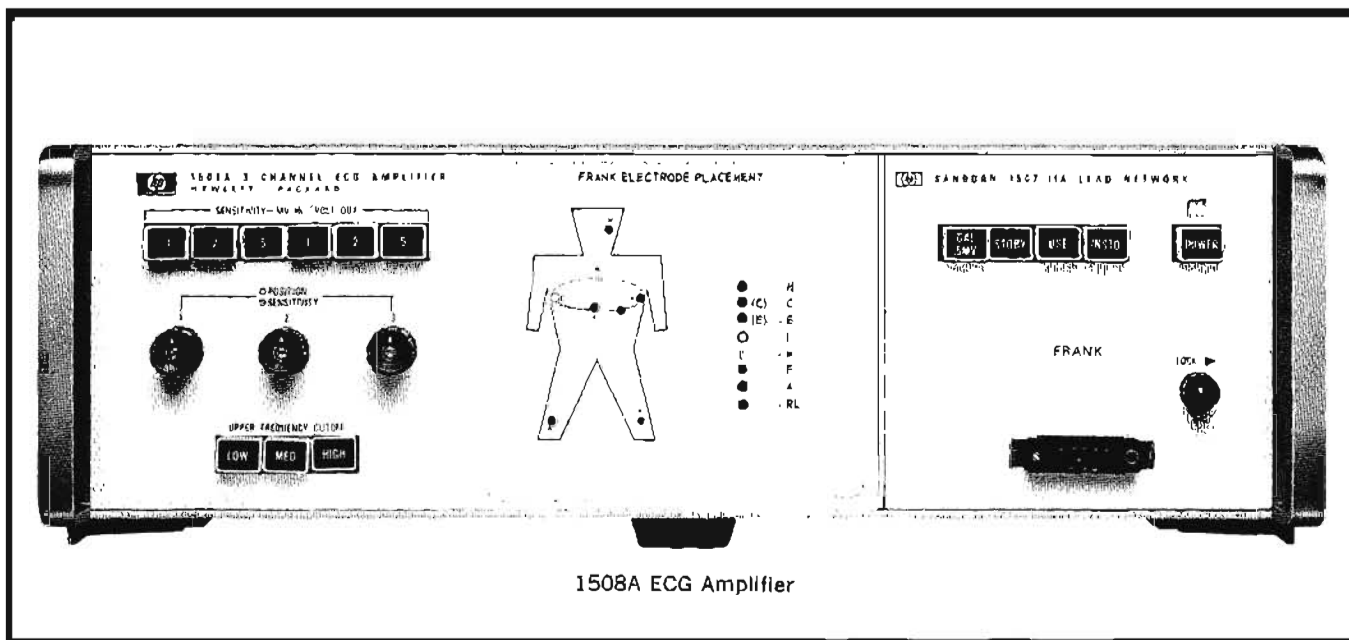

1508A ECG Amplifier

Models 1508A, 1509A

ECG Amplifiers 1508A (three-channel) and 1509A (six-channel) are multi-channel instruments for system use, which provide simultaneous ECG voltages for a strip chart recorder, for ECG computer analysis, for storage on magnetic tape, or for presentation on a monitoring oscilloscope. The instrument is especially valuable as part of a multi-channel ECG screening program, or used in a large hospital ECG installation. The 1508A unit accepts one of four plug-in lead networks. The Frank lead network, with an eight-wire patient cable is standard. Options include the Cube/Tetrahedron network plug-in with nine-wire patient cable, the Axial lead network plug-in with ten-wire patient cable, and the ECG/VCG lead network plug-in with fifteen-wire patient cable. The ECG/VCG plug-in is the most versatile since it offers lead selection in four groups of three leads each (1, 2, 3; aVR, aVL, aVF; V1, V2, V3; V4, V5, V6), plus the three orthogonal components V_x , V_y , V_z of the Frank vector lead system, allowing comparison of the two systems. The 1509A provides ECG/VCG facilities without plug-ins, to provide lead selection in two groups of six leads each (1, 2, 3, aVr, aVL, aVF; V1, V2, V3, V4, V5, V6), plus a third group which shows the three orthogonal components of the Frank system (other vector lead systems by option).

Six fixed sensitivities (0.1 to 5 mv input per volt output) may be selected by panel pushbutton. High impedance buffer amplifiers are present in each lead to permit the use of electrode cream and to preserve summing accuracy in lead resistive networks. A right-leg drive circuit minimizes power line interference and affords increased patient protection.

Specifications

Sensitivity: 0.1, 0.2, 0.5, 1, 2, 5 mV input/volt output.

Buffer amplifiers: one per lead (except right leg), having input impedance at least 50 M Ω shunted by 2000 pF.

Common mode rejection: above 500:1 at line frequency.

Contact potential tolerance: up to ± 300 mV.

Output: single-ended to ground, ± 3 volts across 800 ohms minimum, voltage swing limited to approx ± 3.5 volts.

Bandwidth: low frequency effective time constant greater than 3.5 seconds for first 200 milliseconds of a changing voltage. High frequency limit of 1000 Hz (HIGH), 200 Hz (MEDIUM), or 50 Hz (LOW).

Positioning: to ± 3 volts, separately for each channel.

Noise: Below 10 μ V p-p referred to input, with 50 k Ω source impedance and maximum bandwidth.

Calibration: 0.5 mV $\pm 2\%$ for the internal amplifiers; 2.0 V $\pm 1\%$ for calibrating external equipment.

General

Power: 115 or 230 V $\pm 10\%$, 50-60 Hz, 30 W.

Dimensions: 5 $\frac{1}{4}$ " high, 16 $\frac{3}{4}$ " wide, 18 $\frac{3}{8}$ " deep (133 x 425 x 467 mm).

Weight: approx 20 lbs (9 kg).

Price: Model 1508A, 3-channel, with Frank network plug-in and 8-wire cable, \$1350.

1508A Option 01, with Frank plug-in replaced by Cube/Tetrahedron, using 9-wire cable, add \$60.

1508A Option 03 with Frank plug-in replaced by Axial, using 10-wire cable, add \$35.

1508A Option 04, with Frank plug-in replaced by ECG/VCG, using 15-wire cable, add \$150.

Model 1509A, consult your nearest Hewlett-Packard office.



VECTOR SYSTEM

Extended capabilities in vectorcardiography
Model 1520A

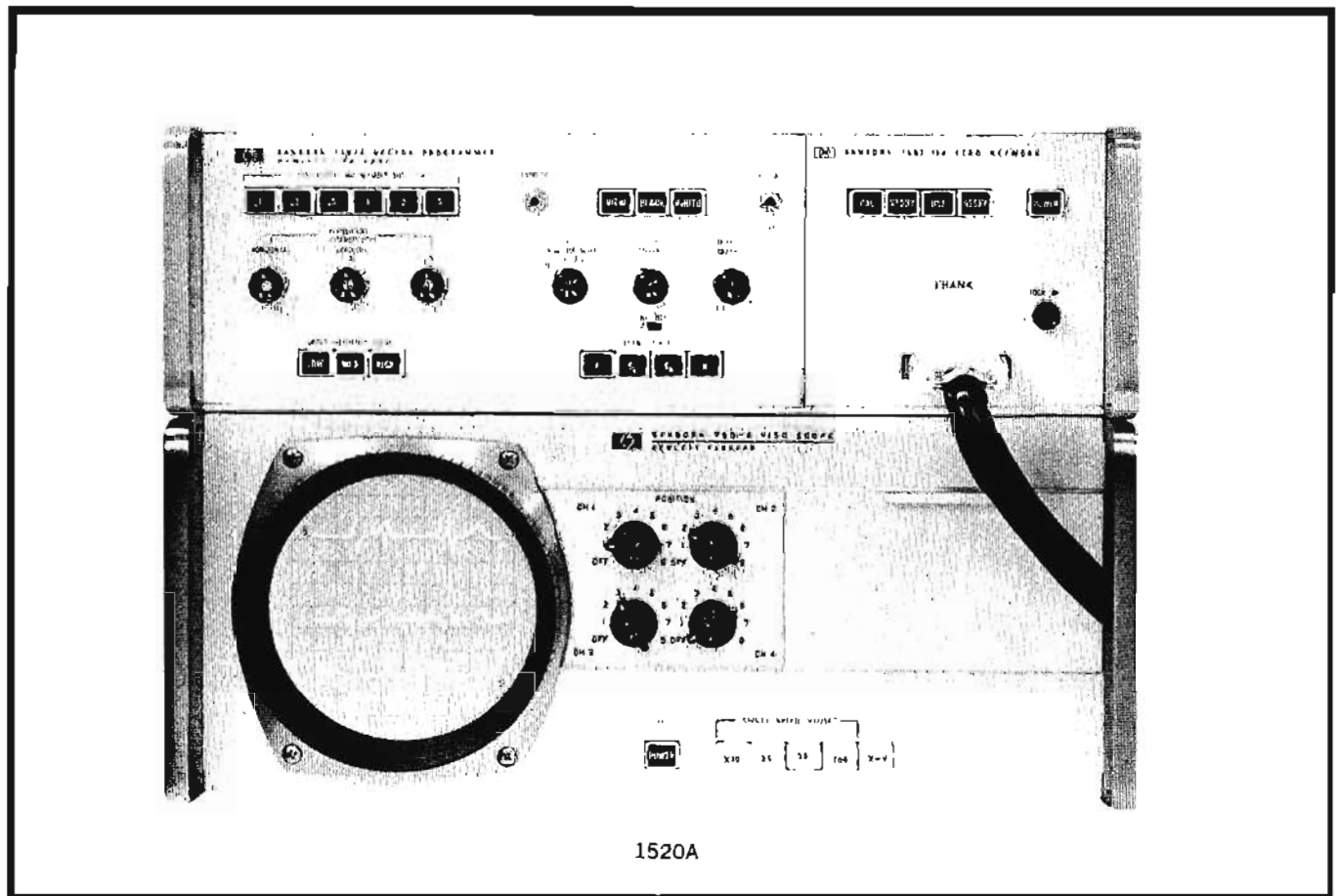

Compact, versatile, easy-to-use — the Hewlett-Packard 1520A Vector System is designed for both clinical and research vectorcardiography. The system consists of the Model 1507A Vector Programmer and the Model 780-6A Viso-Scope with the Model C04-197A Hewlett-Packard Scope Camera optionally available.

The Vector Programmer provides pushbutton selection of vector loops in the frontal, sagittal, or horizontal planes. Teardrop-shaped dashes are provided in loop display, if desired, to indicate direction of rotation and time in 1, 2.5 or 5 msec intervals. The programmer includes 3 ECG Amplifiers which make possible 3-channel sweep display and recording of the orthogonal components V_x , V_y , V_z , in addition to vector loops. The display unit section of the programmer provides controls which permit great versatility in the presentation of vector information. For example, the 1507A System can be programmed to present a single VCG loop automatically at the push of a button. Additionally, P, QRS, or T segments may be selected and enlarged for loop or sweep display. These and other features pictured and described on the next page make it possible to obtain records of excellent photographic quality easily.

The programmer accepts the user's choice of either the Frank (Standard) or Cube/Tetrahedron (Opt. 01) or McFee Axial (Opt. 02) networks. This plug-in flexibility allows

for system compatibility with other present, as well as future vector lead systems. High impedance electrode amplifiers are included for each lead to permit the use of electrode creme and preserve summing accuracy in lead resistive networks. A right leg circuit reduces power line interference and affords patient protection. Appropriate patient cables with coded, fluid column electrodes are provided with the selected lead network plug-in.

The 780-6A Viso-Scope is equipped with an electronic switch for simultaneous display of the orthogonal components V_x , V_y , V_z . The scope provides pushbutton selection of the following sweep speeds: 25, 50, 100, 250, 500 and 1000 mm/sec or loop display. The higher sweep speeds enable accurate QRS duration determinations with time resolution to 1 msec/mm. In the sweep display mode, time information is readily obtained throughout the entire cardiac cycle.

The small size and modular configuration of the system permits mounting on a 780-10 Cart for moving to the patient's bedside or other areas of the hospital.

For photographing scope traces, the new Hewlett-Packard 197A Scope Camera is available as an optional accessory. The entire camera can be swung away from its mounting when not in use to expose scope face.

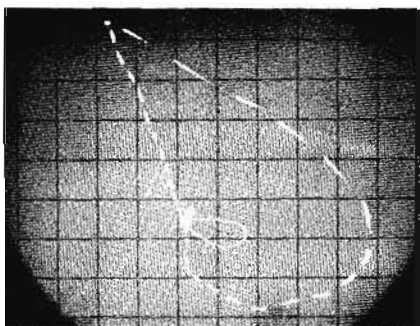

Horizontal plane vector loop with illuminated graticule. The HP Scope Camera attaches to the bezel of the scope. The operator programs the desired vector loop and simply opens the camera shutter to automatically obtain a picture of one complete loop.

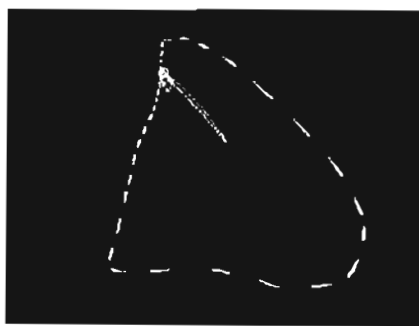

Frontal plane. Consecutive viewing of frontal, horizontal, and sagittal planes is easily accomplished by pushbutton selection. P and T loops are clearly recorded; beam velocity modulation prevents fill-in of "e" point.

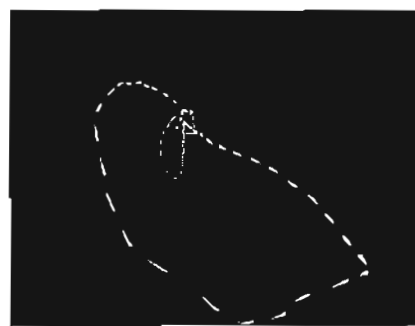

Sagittal left plane. Teardrop shaped dashes may be applied to the loop to give information on direction of loop travel and timing. The heavier end of the dash points to the direction of loop travel.

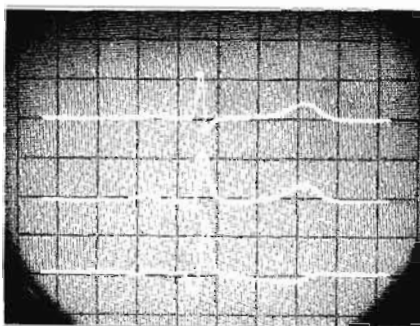

Three separate ECG amplifiers allow simultaneous presentation and recording of the orthogonal V_x , V_y , and V_z voltages versus time, thus permitting detailed comparison and analysis of these leads.



"P-loop" sagittal left plane. Sections of the VCG loop, such as the P-wave loop, can be selected for display and can be enlarged while the remainder of the loop is simultaneously "blanked out". Sensitivity: 0.05 mV/cm.

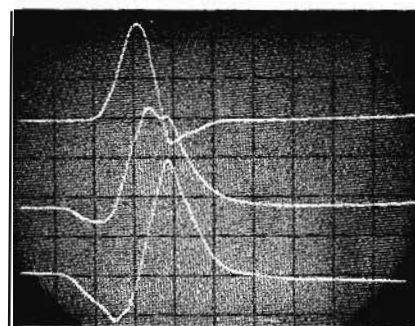

V_x , V_y , V_z components of the QRS wave are sweep synchronized. Precise timing of QRS complexes or other segments of the cardiac cycle can be achieved using increased sweep speeds of 250, 500 and 100 mm/s.

Specifications

1507A Vector programmer (amplification)

Sensitivity: sensitivities of 0.1, 0.2, 0.5, 1, 2 and 5 mV in per volt out, $\pm 2\%$, for 3 channels of ECG amplification.

Electrode amplifiers: buffer amplifier for all electrode leads (except right leg) presents an input impedance > 50 megohms to electrodes and an output impedance of approx. 50 ohms to vector lead network.

Common-mode rejection: $> 500:1$ at line frequency. Special right leg amplifier is incorporated to reduce the amount of common-mode signal on the patient.

Outputs: single-ended to ground, ± 3 volts across 800 ohms minimum.

Bandwidth: LOW, MEDIUM, and HIGH selections are provided with approximate 3 dB points of 50, 200 and 1000 Hz respectively. The low frequency time constant is controlled by a single RC circuit with a cutoff point > 2.2 s. Through an RC pre-emphasis network an effective time constant > 3.5 seconds is presented to the first 200 ms of a changing voltage.

Positioning: individual position control to ± 3 volts is provided for each of the three ECG amplifiers.

Noise: noise is less than 10 μ V pp referred to the input with 50 K ohm source impedance and 1000 Hz bandwidth.

Calibration: 0.5 mV $\pm 2\%$ dc pulse calibrated reference for the three ECG amplifiers; 2.0 V $\pm 1\%$ dc signal for calibrating the oscilloscope and other associated equipment.

1507A Vector programmer (display)

Direction and timing: teardrop-shaped dashes are provided at 1, 2.5 and 5 ms ($\pm 3\%$) intervals.

Logic circuitry: functions on heart rates from less than 20 BPM to over 300 BPM.

780-6A Viso-scope (Option 01)

Sensitivity: loop display: 2 cm deflection per 1 volt in. Sweep display: 1 cm deflection per 1 volt in.

Sweep range: 25, 50, 100 mm/s with an X10 switch to provide sweeps of 250, 500, and 1000 mm/second.

X-Y operation: loops selectable with front panel pushbutton. Internal graticule: 10 cm x 10 cm, marked in cm squares with 2 mm subdivisions on major axes.

Physical characteristics of 1520A system (1507A and 780-6A combined):

Color: blue cabinets with white enamel front panels.

Weight: net 50 lbs (22.5 kg); shipping 70 lbs (31.5 kg).

Dimensions: 12 $\frac{3}{8}$ " high, 16 $\frac{3}{4}$ " wide, 18 $\frac{3}{8}$ " deep (320 x 425 x 467 mm).

Power: 115 or 230 V $\pm 10\%$, 50 or 60 Hz, approx. 125 W.

Prices

Model 1520A Vector system: including 1507A Programmer with Frank lead network plug-in and patient cable, 780-6A Viso-scope with Option 01 Electronic Switch, and joining bracket installed between 1507A (above) and 780-6A (below), \$2535. Option 01, Cube/Tetrahedron plug-in and cable replaces Frank Plug-in, add \$60. Option 03, McFee/Axial plug-in and cable replaces Frank Plug-in, add \$35. Option 04, ECG/VCG plug-in and cable replaces Frank Plug-in, add \$150.

Model 197A Opt 05: Hewlett-Packard Scope Camera (same as HP 197A but with shutter synchronization cable which connects between scope and camera and automatically activates display circuitry when camera shutter is opened), \$535.

PATIENT MONITORING— INTENSIVE CARE



ICU SYSTEMS CAPABILITIES

Planning, installation, service
Series 780 modules



The cardiovascular intensive care unit at Christian Holmes Hospital, Cincinnati, Ohio, makes extensive use of Hewlett-Packard monitoring, warning, and display instruments. At the bedside (left), the nurse may adjust the 780-7A Patient Monitor to observe ECG, pulse, or heart rate, with the 7802A DC Defibrillator ready for use if needed. At the central station (right), the nurse can select and display ECG waveforms on the 780-6A Monitoring Oscilloscope, and monitor patient variables on the 5601A Numerical Readout, with the 780-11 Patient Selector ready at all times to give visual and audible alarm of patient distress.

The coronary intensive care unit at the Washoe Medical Center, Reno, Nevada, provides multi-bed facilities for patient monitoring. A 780B Viso Monitor at each bedside furnishes multi-variable observation of the patient's condition, plus cardiac distress warning, automatic or manual pacing, and ECG recording at pre-set intervals on the integral ECG recorder.

The intensive care patient monitoring systems shown above represent but two of an almost unlimited number of systems which can be created using the 21 instruments described on the following pages, to provide the measurement, display, alarm and recording functions desired. All units in this 780 Series are electrically and physically compatible with each other. Since each provides one or more specific monitoring functions, the desired system can be easily and economically achieved by selecting only the specific modules needed. Advantages of such a "modular system" include a cost which reflects only those monitoring capabilities needed, without the penalty of obsolescence or inflexibility when the system is changed or enlarged at a future time; complete freedom to change or enlarge the system to monitor more patients, more parameters, or a different combination of parameters at each bed, as needs and budget change; and ease of combining modular 780 units at the bedside and central station, because of standardized packaging in Hewlett-Packard "half-module" and "full module" cases.

In design and performance, 780 instruments reflect thorough attention to reliability, patient safety and comfort, high readability and accuracy of data displayed, and ease of operation by hospital personnel. These characteristics are the result of features such as all solid-state circuits and operation of key components well below rated values; constant current output of pacemaker, for example, isolated from ground and power lines, and patient leads protected for use with defibrillators; lightweight patient cables and transducers for greatest patient comfort consistent with reliable operation; easy-to-read visual indicators such as rectangular, horizontal meters with large numerals, and illuminated plaques of contrasting colors to distinguish various monitored conditions; adjustable alarm delays permitting the medical staff to select

the delay interval which will prevent transients or other events of no clinical significance from triggering an alarm.

Three important advantages to the hospital, in addition to those just described relating to the 780 "modular" concept and the extremely wide choice of instruments, can help insure that the *right* patient monitoring system is installed in both existing and newly-constructed ICU's, and that the system will provide *continuing* clinical value. The first is thorough, expert system planning skills offered by Hewlett-Packard Company through field sales offices world-wide. Medical electronics instrumentation engineers familiar with the needs, objectives and budgets of hospitals like yours will discuss both your present and anticipated needs with you and recommend the system which most economically and flexibly meets those needs. Comprehensive, written proposals with itemized costs are always supplied prior to contract agreement. The second benefit is the availability of system installation services and responsibility for performance, from the HP sales office in your locality. Close coordination with architects, hospital staff, and local building regulations characterize this optional HP service. Finally, local HP field office men will train your staff in operating and maintenance procedures, and stand ready to provide instrument service, supplies or service agreements to insure continued, reliable operation of your monitoring system.

Monitoring instruments in this section of the catalog are described in this sequence: bedside measurement/display instruments; dc defibrillators and internal/external pacemaker; central station instruments for display, alarm and recording; and related products such as transducers, electrodes, cables, mobile carts, wall mounts, etc. They are also indexed by name, function and model number elsewhere in this catalog.

ICU SYSTEMS CAPABILITIES

Bedside scope, heart rate/ECG, temp./resp. monitor
Models 780-3, 780-7 and 7A, 780-8



PATIENT MONITORING— INTENSIVE CARE

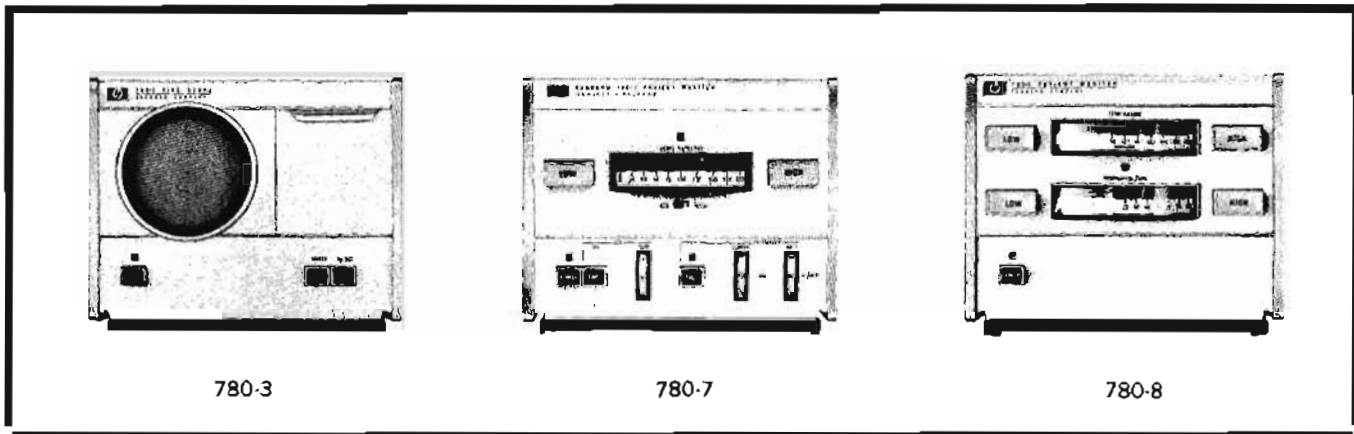

780-3 Viso-Scope

Model 780-3 Viso-Scope is a general-purpose, 3"-screen oscilloscope with slow sweep speeds and simplified controls suitable for physiologic waveform display — at the bedside, central station or elsewhere. Waveform appears as a bright, long-persistence amber trace. With proper interconnection to the ECG monitor, sweep synchronization can provide R wave superposition at the beginning of each trace sweep on the scope. This simplifies the set-up procedure for synchronized defibrillation, by causing the ECG waveform and superimposed discharge marker pulse to appear at the same position on the screen in each cardiac cycle. Sweep synchronization can also be useful for ECG waveform monitoring. Sweep speeds (25 and 50 mm/sec) and power are push-button controls; intensity, focus, vertical position and sensitivity are screwdriver adjustments behind hinged panel. Size: 6½" high, 7¼" wide, 11" deep (165 x 197 x 279 mm) (std. Hewlett-Packard "half-module"). Weight: 10 lbs (4,5 kg). Power: 115/230 V, 50-60 Hz, 30 watts. Price: 780-3, \$495. Option 03, 2' power cord in place of 12' cord, no extra chg. Option 04, with hardware for stacking 780 half-module above, no extra chg.

780-7 Patient Monitor

Model 780-7 Patient Monitor for ECG, Pulse, Heart Rate and Pacing (Model 780-7A without Pacing) has an ECG amplifier for waveform display or recording on other units; 0-300 bpm heart rate meter with adjustable high and low threshold limits, indicator which flashes with each beat, and high and low visual alarms which light if limits are exceeded; simultaneous pulse signal (from plethysmograph or 780-9) can be used in place of ECG for determining heart rate or for pulse waveform display on associated scope.

Internal/external pacemaker provides pulses adjustable from 5 to 15 mA for internal stimulus, 50 to 150 mA for external stimulus, at rates from 50 to 150 pulses/min. Pacemaker output is isolated from ground, case and power line for safety, and is protected permitting pacemaker to remain connected if defibrillator is used. Controlled current reduces the effect of changes in patient impedance which could change the pacing amplitude; pulse duration is also fixed, for uniform cardiac stimulation. Separate, non-interchangeable

cables for internal and external pacing, with associated pacing mode selection switch, prevent incorrect connection and operation. Pace indicator on front panel lights when pacing circuit is operating. Pacemaker also delivers a blanking pulse to ECG amplifier to identify instant of pacing and allow uninterrupted ECG display or recording.

Front panel controls: power, 1 mV calibration, heart rate alarm/reset, ECG sensitivity, pacing, pace current, pace rate. Rear connectors: ECG cable, int. and ext. pacing, ac power, remote, defibrillator, pulse input, scope output and sync. output. Size: 780 half-module (same as 780-3). Weight: 10 lbs (4,5 kg). Power: 115/230 V, 50-60 Hz. Price: 780-7 with 12' power cord, ECG and pacing cables, Redux Creme, \$820; 780-7A (omits pacemaker) \$695. Option 03 (both models), 2' power cord, no extra charge. Option 04 (both models), with hardware for stacking 780 half-module above, no extra charge. Option 05 (both models) with audible alarm, can not be used with Option 04, add \$100. (See related transducers, cables, and accessories.)

780-8 Patient Monitor

Model 780-8 Patient Monitor for Temperature and Respiration Rate displays patient's temperature from 96° to 106°F (30° to 41° C on optional version) on 3½" panel meter; each detected breath by a panel lamp flash; and respiration rate from 0 to 80 breaths/min. on another 3½" meter. Adjustable high and low limits selectable on each meter; alarm delays adjustable up to 10 sec.; indicators illuminate if any limit setting is exceeded. Temperature, respiration rate and alarm signals available at rear connector for remote monitoring (see Model 5601A Numerical Readout, under HP ICU transducers). Temperature may be measured by Yellow Springs Series 400 rectal, esophageal or skin thermistor probe, respiration by 780-14 Respiration Transducer. Size: 780 half-module (same as 780-3).

Weight: 8 lbs (3,6 kg). Power: 115/230 V, 50-60 Hz.

Price: 780-8 with 12' power cord, temp. meter calibrated in °F, \$675. Following Options available at no extra charge: Option 01, temp. meter in C; Option 03, with 2' power cord; Option 04, with hardware for stacking 780 half-module above.

PATIENT MONITORING— INTENSIVE CARE



VISO-MONITOR

Recorder; pacemaker; endless-loop tape recorder
Models 780B, 780-5A

780B Viso-Monitor

Model 780B Viso-Monitor is a comprehensive bedside system for monitoring heart rate and peripheral pressure pulse, with visual alarms of distress conditions and signal outputs for central station display/recording; ECG recording either automatically at preset intervals, or at will; and internal or external pacemaker stimulus current delivered automatically after a selectable asystole interval, or at will.

Heart rate is displayed by a panel meter with high and low limit indicators set at desired thresholds. If either limit is exceeded beyond a preset delay period, an alarm plaque lights and the ECG recorder (if set for automatic operation) begins recording. Loss of peripheral pulse signal, or arrest, also starts recorder. For 10-sec. sampling traces periodically, the recorder can be set to run automatically at 15, 30 or 60 minute intervals; it may also be manually turned on for 10-sec. or continuous recording whenever needed. In the ECG chart margin, a marker stylus records peripheral pulse signal; this stylus also distinguishes regular interval recording by a straight line, distress recording by an oscillating line.

Internal/external pacemaker provides pulses adjustable from 5 to 15 mA for internal stimulus, 50 to 150 mA for external stimulus, at rates from 50 to 150 pulses/min. In automatic mode, pacing begins after an asystole interval selectable from 1.5 to 11 sec. Pacemaker output is isolated from ground, case and power line for safety, and is protected permitting pacemaker to remain connected if defibrillator is used. Controlled current reduces the effect of changes in patient impedance which could change the pacing amplitude; pulse duration is also fixed, for uniform cardiac stimulation. Separate, non-interchangeable cables for internal and external pacing, with associated mode selection switch, prevent incorrect connection and operation. Pace indicator on front panel lights when pacing circuit is operating. As a check on pacing effectiveness, ECG may be recorded during pacing; pace appears as a negative spike.

Front panel indicators: heart rate meter (0-300 bpm); QRS, flashes white on each QRS complex; tachycardia, amber plaque lights; bradycardia, amber plaque lights; no pulse, red plaque lights after 5-sec. loss of signal; arrest, red plaque lights after 1.5 to 11 sec. absence of ECG signal; pacing, white plaque lights when pacemaker is operating; green plaque remains lighted unless ac power is lost; in-operate, red plaque lights if electrodes become loose or detached, excessive 60 cycle interference exists, paper is depleted, or stylus is off scale.

Front panel controls: recorder (sample, auto., run, stop, stylus heat, 1 mV cal., sensitivity, position); Viso-Monitor functions (reset, standby, monitor, off); high and low heart rate limits; pacing (current, rate; on, off, auto.); arrest delay; QRS threshold.

Output for remote display/alarm/recording: output jacks permit connection to hospital call system, monitor scope, 780-800B Remote Monitor for visual display and audible alarm, or other central station arrangements. Size: 12 $\frac{3}{4}$ " high, 16 $\frac{3}{4}$ " deep (323 x 425 x 450 mm). Weight: 46 lbs (209 kg). Power: 115 V, 60 Hz. Prices: HP 780B

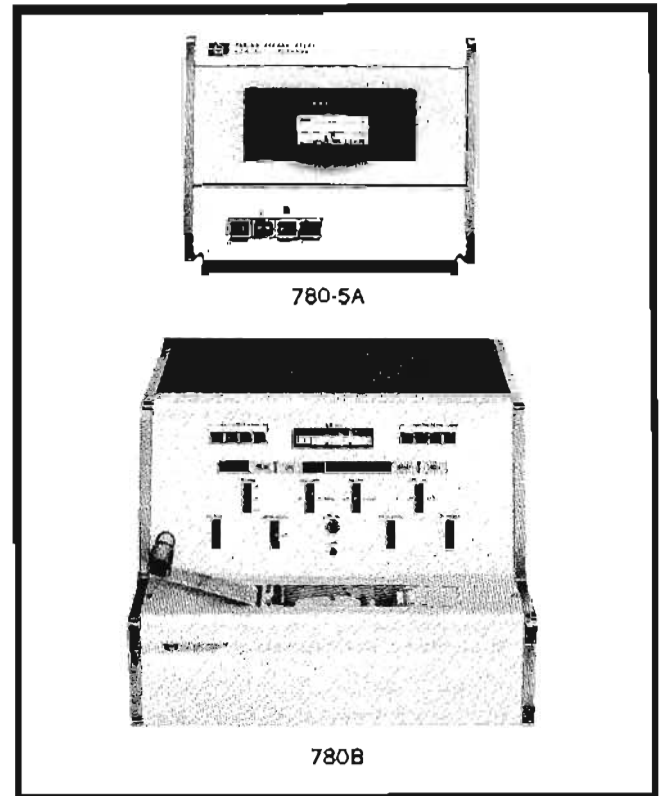

Viso-Monitor with cables, Permapaper®, Redux: \$2275. Option 01, 115/230 V, 60 Hz, add \$25. 780 BX, 115/230 V 50 Hz, \$2300. Option 04 (both models), with combining hardware for two 780 half-modules, no extra charge.

780-5A Signal Delay

Model 780-5A Signal Delay allows a readout recording of the patient's ECG immediately preceding as well as following any arrhythmia or cardiac distress episode that triggers an alarm in an associated ECG monitor. Used with the 780B Viso-Monitor, the 780-5A continuously records the patient's ECG (plus a second signal on the optional second channel), adding new information and erasing the oldest according to the length of the tape loop (40-s capacity standard). Should an alarm condition occur, the unit functions in one of two pushbutton preselected modes: in the "delay" mode, the 780-5A plays back the preceding 40 seconds of stored data from the tape loop, plus 10 additional seconds which followed the start of the alarm condition; in the "automatic stop" mode, the 780-5A records for 10 seconds after the alarm, then stops to store this data. Alternative procedures are possible in which the patient may bypass the unit, or in which the tape recorded signal is produced without being erased.

Size: standard 780 half-module (same as 780-3). **Weight:** 10 lbs (4.5 kg). **Price:** 780-5A with 40-s cartridge, for one input signal, \$700. Option 01, for two input signals, \$825.

PATIENT MONITORING

Pressure, temperature, ECG/EEG; pacemaker
Models 780-9, 780-18, 780-19, 7804A



PATIENT MONITORING— INTENSIVE CARE

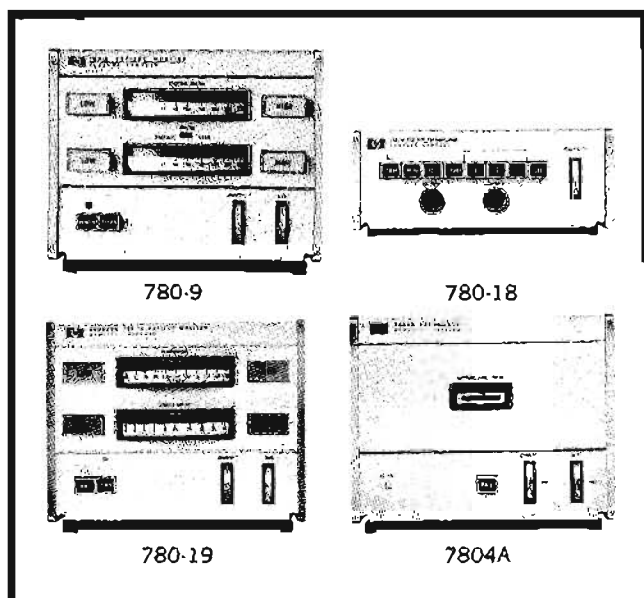

780-9 Patient Monitor

Model 780-9 Patient Monitor displays systolic and diastolic (or mean) blood pressures on separate $3\frac{1}{2}$ " panel meters calibrated 0-300 mm Hg, gives visual warning by illuminated plaque if high or low preset limits of either pressure are exceeded, and supplies signals and alarms at rear connector for remote monitoring. Upper and lower limits independently adjustable; alarm delays internally adjustable from 1 to 10 seconds. Signal input to this Monitor is obtained from HP 267AC or 1280A Physiological Pressure Transducers. For remote monitoring/alarm functions, the following signals are available at connectors on the rear of the 780-9: systolic pressure with high and low alarms; diastolic pressure with high and low alarms (diastolic pressure channel can be switched to read mean pressure with a switch on the front panel); arterial pressure waveform (may be used as input to 780-7, -7A to derive heart rate). Size: 780 half-module (see 780-5 opposite). Weight: 8 lbs (3,6 kg). Power: 115/230 V, 50-60 Hz. Prices: HP 780-9, \$875. Option 03, with 2' power cord instead of std. 12' cord, no extra charge. Option 04, with combining hardware for mounting another 780 half-module above, no extra charge.

780-18 ECG-EEG Preamplifier

Model 780-18 ECG-EEG Preamplifier is a small, lightweight modular 780 instrument designed to be used with the 780-3 oscilloscope, to answer the requirements for an easily-operated basic monitoring system in the intensive care area. The simplicity and economy of the two units make possible a practical, portable monitor that can be quickly set-up at the patient's bedside in either private or ward rooms. The system may also be used in emergency situations during application of pacing stimulus by a 780-series pacemaker, or counter-shock from a 7802B defibrillator: defibrillation and pace-making pulses will not affect the ECG monitor. Operating convenience is afforded by front-panel pushbutton selection

of ECG or EEG input; front panel connectors for patient cables; and controls for power, reset, EEG, Standby, ECG leads 1, 2 and 3, calibration and sensitivity. Size: 3 " high, $7\frac{3}{4}$ " wide, 11" deep (76.2 x 197 x 279 mm). Weight: 15 lbs (6,8 kg). Power: 115/230 V, 50-60 Hz. Prices: 780-18, \$300. Option 03, 2' power cord, no extra charge. Option 04, with combining hardware for mounting another 780 half-module above, no extra charge.

Model 780-19 Patient Monitor displays temperature and venous pressure on separate $3\frac{1}{2}$ " panel meters calibrated 96°F to 106°F (30°C to 41°C optional) and 0 to 30 mm Hg, respectively; gives visual warning by illuminated plaque if high or low preset limits of either phenomena are exceeded; and supplies temperature and pressure output signals at rear for remote monitoring, alarm or recording. Useful in both medical and surgical intensive care patient monitoring, the 780-19 allows continuous observation of the patient with abnormally high or low body temperature, and through monitoring central venous pressure, can aid in the management of heart failure from primary and secondary causes, hemorrhage with circulatory collapse, and in judging blood volume replenishment in shock therapy. Temperature may be measured by Yellow Springs Series 400 rectal, esophageal or skin thermistor probe (see HP ICU transducers); blood pressure by 268A transducer using catheter. Output connections at rear for remote monitoring of temperature, pressure waveform, mean pressure, high and low alarms. Size, weight and power: same as 780-9. Prices: Sanborn 780-19, \$875. Following options, no extra charge: Option 01, meter with 30°C to 41°C . Option 03, 2' power cord instead of std. 12' cord, no extra charge. Option 04, with combining hardware for mounting another half-module above, no extra charge.

7804A Pacemaker

Model 780-4 Pacemaker provides electrical stimulus internally or externally to cardiac patients with atrio-ventricular dissociation, ventricular slowing resulting in reduced cardiac output, or cardiac arrest. The instrument features greater isolation from ground, on both internal and external outputs; a rechargeable battery which will maintain pacing effectiveness for more than one month between recharges on internal current setting, and a special pace indicator which denotes each properly delivered pace pulse, and ignores any which are less than that set on the front panel control. The battery insures continuous pacing, even with failure of the ac power line; the increased isolation assures that no more than eight microamperes of current flow (in the worst possible case of improper grounding with a 120 V, 60 Hz system), and the pace indicator informs the doctor of a pacing indication only when the current pulse matches that shown on the panel. The simplified panel uses only pacing current and pacing rate operating adjustments. Size: standard 780 half-module (same as 780-9). Weight: 5 lbs (2,3 kg). Power 115/230 volts, 50 to 60 Hz. Price: 7804A, \$525. Option 01, less battery. AC line operation only, \$450. Option 03, 2' power cord, no extra charge. Option 04, with combining hardware for mounting another 700 half-module above, no extra charge.

PATIENT MONITORING— INTENSIVE CARE



DC DEFIBRILLATOR

Internal or external application
Model 7802B

7802B Defibrillator

Model 7802B Defibrillator is a dc, capacitor-discharge countershock device for termination of ventricular fibrillation—and, with optional Synchronizer circuit, for conversion of arrhythmias such as atrial fibrillation. Electrical discharge, in accordance with accepted practice, is a five msec. pulse, with an energy level of 0 to 400 watt-seconds selected by the operator. It is applied to the patient's chest wall in external defibrillation, and to the exposed heart in internal defibrillation. Significant features of this compact, all-solid-state instrument include: availability as a *dc Defibrillator only* (7802B); as a *Defibrillator-Synchronizer* (7802B Option 01) which permits controlled placement of the countershock within the cardiac cycle and avoidance of the vulnerable T-wave period; as a *Defibrillator with ECG circuitry* (7802B Option 2), protected against the high potentials of the countershock pulse and with automatic baseline stabilization, for monitoring the patient's ECG waveform on an associated scope or recording it on an electrocardiograph; as a *complete synchronized defibrillation system with ECG monitoring capabilities* (7802B Options 01 & 02) using an associated scope and/or ECG recorder.

For reducing hazard to both patient and operator, the 7802B features completely floating output. For an even greater emphasis on safety, the defibrillator can be discharged only once for each charge, thus eliminating the hazard of any residual charge on the storage capacitor appearing across the electrodes. An internal load resistor permits discharging the defibrillator without shorting the electrodes.

Operating principles: an adjustable dc voltage is supplied to a capacitor which is discharged when the operator depresses a pushbutton on the handle of one of the patient electrodes. The switch actuates a relay which disconnects the capacitor from its charging circuit and connects it to the electrodes. Correct pulse shape during its passage through the patient's body is maintained by the Defibrillator's circuitry. Placement of the pulse at the desired point in the cardiac cycle is accomplished by the Synchronizer circuit in conjunction with an ECG R-wave signal supplied by the ECG circuit (Option 02) or by a 780B, 780-7, 780-7A or 780-18. Synchronizer controls allow the operator to preset the instant of energy discharge to any desired point in the ECG cycle, up to one second after the R-wave. The marker pulse of the Synchronizer also appears on the associated monitoring scope or electrocardiograph chart, enabling the defibrillator operator to see exactly where the defibrillator output will occur in the ECG cycle. Visual assurance of Synchronizer operation and sufficient ECG signal input for proper timing is supplied by an "operative" light which flashes in response to each R wave. The ECG circuitry (Option 02) supplies amplified ECG signals for monitoring and/or recording.

Rapid, straightforward operation of the Defibrillator in intensive care areas and emergency rooms is aided by the single, compact physical package of the entire defibrillator system; the clearly-marked energy-level control and asso-

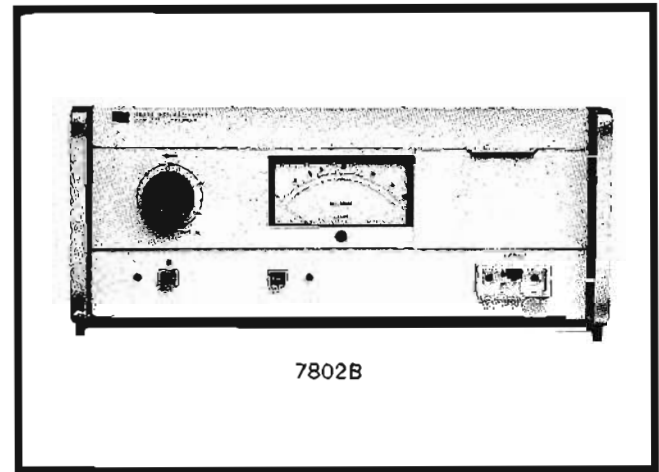

ciated large-scale meter; countershock discharge switch on the electrode handle, where it is under the control of the system operator only, at all times; and the positive nature of operating controls and indicators for placing the countershock at precisely the desired point in the ECG cycle. If a continuously operative (unsynchronized) mode is desired, this can be accomplished by closing the hinged door on the front of the 7802B. The Defibrillator (alone or with Synchronizer and ECG optional plug-ins), together with an associated 780-3 or 780-6A monitoring scope, 1500A/1511A ECG, 7804A Pacemaker, and all necessary cables, electrodes, drugs and other items used in cardiac resuscitation can be ready for immediate use when mounted in the 780-1 Mobile Cart. The instrument may also be used with other 780-series modules as part of a bedside system. Internal or external defibrillation electrode cable plugs into a front panel receptacle; connections for ECG input, monitoring and synchronization output signals, and ac input power, are located on the rear panel.

Size: Hewlett-Packard full module, 7" high, 16" wide, 16" front to back (178 x 406 x 406 mm).

Weight: net 70 lbs (31.5 kg). Shipping 82 lbs (37 kg).

Power: 115 V, 15 amp surge during charge (0.3 amp to hold full charge), 50 to 60 Hz.

Prices:

- Model 7702B, with external electrodes, \$1125.
- Option 01, with synchronizer plug-in, add \$150.
- Option 02, with ECG amplifier plug-in, add \$200.
- Option 03, less external electrodes, deduct \$175.
- Option 04, combining hardware for mounting two 780 half modules on 7802B, no extra charge.
- Option 05, internal electrodes, add \$175.
- Option 06, anterior-posterior electrodes, add \$175.
- Option 07, pediatric electrodes, add \$175.
- Option 08, 115/230 V operation, add \$25.

CENTRAL STATION DISPLAY

Alarm and signal switching units

Models 780-11, 780-12, 780-13A



PATIENT MONITORING—
INTENSIVE CARE

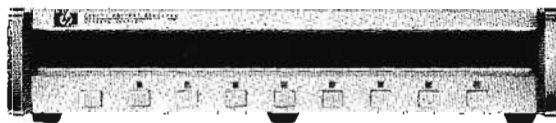

780-11



780-12

780-11 Patient Selector

Model 780-11 Patient Selector combines visual and audible patient distress alarms with patient signal switching to associated display or recording instruments. Used at the central station, the 780-11 is connected to patient signal cables from the monitors at up to eight beds, and has output connections to whatever display/recording instruments are used at the central station. Prominent red numerals 1 through 8 on the front panel are illuminated at a low intensity to show that monitoring equipment is "on" and functioning at up to eight beds; if a monitored condition *exceeds* the upper or lower limits preset by the physician at the bedside, a chime alarm in the 780-11 sounds at five-second intervals and the numeral for the patient in distress flashes at full brightness at one-second intervals.

Display switching to associated instruments such as a 780-6A Viso-Scope, 5601A Numerical Display, 1500A Opt 05 ECG or multi-channel strip chart recorder is initiated by the central station attendant by depressing the pushbutton on the 780-11 below the appropriate patient numeral, which transfers any two of the monitored signals to the display or recording device. A white indicator light above the pushbutton lights to show that this monitoring function is occurring. Compact modular cabinet has tilt stand to provide best viewing angle; a 780-11 may be stacked with a 780-6A Monitor Scope, or several 780-11's stacked together to accommodate more than eight patients (also see 780-13A below for expanded and/or automatic readout capabilities).

Size: 3 $\frac{7}{8}$ " high, 16 $\frac{3}{4}$ " wide, 13 $\frac{1}{4}$ " deep (98 x 425 x 343 mm).

Weight: 13 lbs (5,9 kg).

Power: 115/230 V, switch selected, 50-60 Hz, 30 watts.

Price: Model 780-11, \$700; Option 01, display insert for beds 9-16, no extra charge.

780-13A Remote/Auxiliary Signal Switch

Model 780-13A Remote/Auxiliary Signal Switch (not illustrated) expands the capabilities of a 780-11 to more signals per patient and an automatic mode of signal transfer to associated display/recording instruments. The unit, which is mounted inside the junction box at the central station, offers the following choice of operating modes: (1) trans-

fer of up to 12 signals per patient to associated display/recording instruments at the central station, by depressing pushbutton on 780-11 corresponding to desired patient (780-13A, Option 02); (2) automatically detect an alarm condition at any one of eight beds, turn on a 1500A Opt 05 ECG and record for a period (internally adjustable) from 5 to 25 seconds, activate the ECG's marker stylus to produce a coded patient identification, and turn off the ECG at the end of the recording cycle and reset the circuits (780-13A, Option 01); or (3) automatically transfer, on alarm, up to 12 monitored signals for that patient to the readout devices in use at the central station (780-13A, Options 01 and 02). This automatic response to alarm conditions described in (2) and (3) above occurs after the central station attendant depresses the "AUTO" pushbutton on the 780-11. A valuable additional operating feature is also present in either of these modes: if a *second* patient alarm occurs while the display/recording instruments are operating in response to a prior alarm, the second alarm will be sensed and stored until the first 5-25 second period ends, whereupon immediate signal transfer will be made to the second alarm condition.

Price: 780-13A Remote/Auxiliary Signal Switch, \$225; Option 01, automatic switching circuit plug-in, add \$350; Option 02, relay assembly (order up to 8 relays), includes 3' cable, add \$50.

780-12 Patient Alarm Display

Model 780-12 Patient Alarm Display is a large wall-mounted unit for alerting personnel in the central station area to patient distress conditions. Alarms sensed by bedside monitors, for any of four conditions at up to eight beds, actuate a repeating chime in the 780-12 and illuminate a patient-identifying numeral for the alarm condition. Condition names (such as temp., heart rate, resp. rate, blood pressure) and patient numerals are in red, 1 $\frac{1}{2}$ " high, easily readable from a distance. Unit mounts on swivel bracket for best viewing angle.

Size: 9 $\frac{3}{8}$ " high, 23 $\frac{1}{2}$ " wide, 5 $\frac{1}{8}$ " deep (238 x 597 x 130 mm).

Weight: 12 lbs (5,4 kg).

Power: 115/230 V, 50-60 Hz, 50 watts.

Price: HP 780-12 with mtg. hardware, \$1000; Option 01, display insert for beds 9-16, no extra charge.

PATIENT MONITORING— INTENSIVE CARE



MONITOR SCOPE

Central station display & alarm units

Models 769A, 768S, 780-21, 780-800B

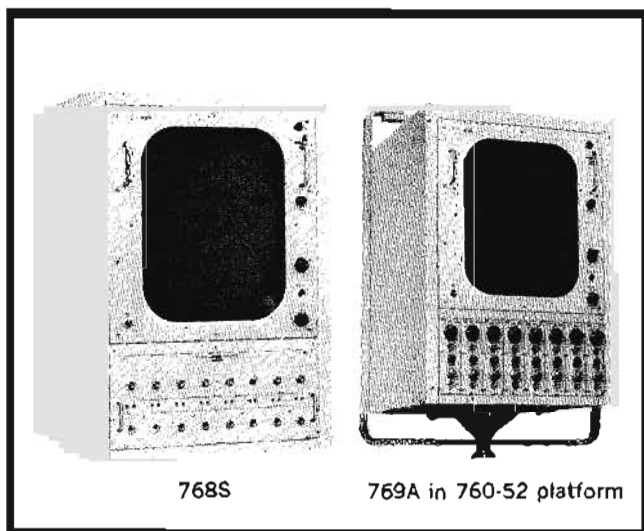

768S

769A in 760-52 platform

Models 769A and 768S Monitor Scopes

Models 769A and 768S Monitor Scopes are 17"-screen oscilloscopes capable of displaying up to eight waveforms simultaneously, for accurate interpretation from a distance in the ICU central station, OR, catheterization laboratory or similar location. They are designed to be used with HP signal conditioners, patient monitors, oscillographic and magnetic tape recording systems, and obtain their inputs from the signal conditioners in these systems. Gating amplifiers (individual channel plug-ins in the 769A, 8-channel unit in the 768S) are located below the CRT and function as an electronic switch. Controls permit positioning any waveform anywhere on the screen. Input sensitivity is 5 in/V (769A) and 2 in/V (768S). Scope front panel is pivoted within cabinet to permit tilting forward up to 20°; grid overlay facilitates amplitude measurements. Polaroid filter minimizes interference from room lights.

Specifications of 769A include automatic sweep periods of 3, 6, 12 sec manual, 3, 6, 12, 30 sec; sweep linearity better than 3%; freq. resp. dc to 3 dB down at 1 kHz; input balanced or single-ended, impedance 400 k Ω ; common mode rejection 40 dB min., max. voltage ± 15 V. Size: 28" high, 19" wide, 21" deep (711 x 483 x 533 mm). Weight: 115 lbs (52 kg), with 8 gating amplifiers. Power: 115 V, 50-60 Hz, 275 watts. Option 09, 230 V. Price: 769A System, or 769AR rack mount model, with cabinet, without gating amplifiers, \$1550. System requires one 779-100 Gating Amplifier per channel, maximum 8 channels. Option 09, 230 V, no extra charge. Option 11, white front panel, add \$50. 779-100 Gating Amplifier, \$150. Option 11, white front panel, add \$25. 768S System, or 768SR rack mount, with cabinet and 8-channel gating amplifier, \$2175. Option 09, 230 V, no extra charge. Option 11, white front panel, add \$50.

Model 780-21 Remote Alarm Indicator

Model 780-21 Remote Alarm Indicator is a simple, compact and economical unit consisting of a red light and repeating tone, to alert personnel in corridors, doctor's or

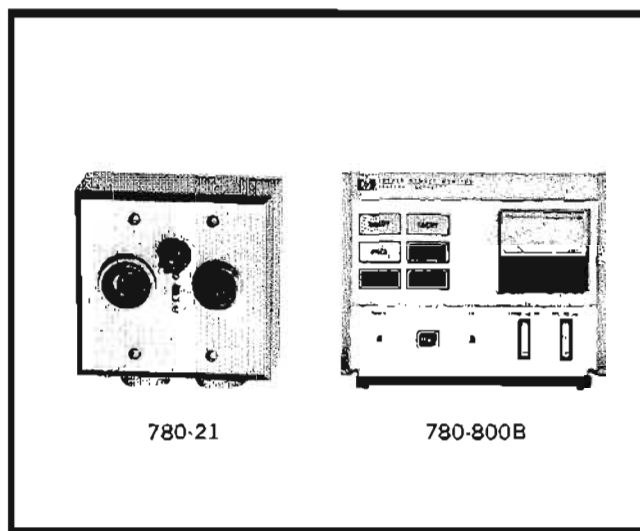

780-21

780-800B

nurse's lounge, etc. of distress conditions. Each 780-21 can alert the staff to the occurrence of up to four alarm conditions at each of eight beds. It includes a call relay which may be used to turn on a call bell or indicator at an alternate location.

Compatible with bedside 780-7/7A, -8, -9, -19, 780B units, central station 780-11, -12. Connection can be with conduit, surface raceway or exposed cabling. Size: two-gang aluminum NEMA box, 5" high, 5" wide, 3" deep (127 x 127 x 76 mm). Weight: 5 lbs (2,25 kg). Power: 115/230 V, 50-60 Hz. Price: Sanborn 780-21, \$125.

Model 780-800B Remote Monitor

Model 780-800B Remote Monitor is the companion unit to the 780B Viso-Monitor, duplicating all visual displays of the Viso-Monitor and also providing audible signals for each QRS complex (beep) and any of the four distress conditions (steady tone). Individual volume controls permit adjustment of each sound. A control button at the remote unit may be used to reset the audible distress alarm. If the distress situation has passed, the audible alarm will not recur. The visual alarms remain lighted until reset on the main unit at the patient's bedside. Remote Monitor also has output jack for oscilloscope monitoring.

Indicators on the Remote Monitor include: Heart Rate meter (0-300 bpm), Tachycardia (amber), Bradycardia (amber), No Pulse (red), Arrest (red), QRS Complex (white, flashing), Pacing (white), Inoperate (red), and Power (white).

Size: std. HP half-module 7 $\frac{7}{8}$ " wide, 6 $\frac{1}{2}$ " high, 11" deep (197 x 165 x 279 mm); easily stacked or combined side-by-side with other 780 units. Weight: 8 lbs (3,6 kg). Power: from 780B. Price: Model 780-800B with 50' cable, \$325. Option 01, less cable (when conduit cabling used), deduct \$30. Option 04, with hardware for mounting another 780 half-module above, no extra charge.

For Numerical Readout and Graphic Recording Facilities at the central station, refer to Model 5601A and Model 1500A Electrocardiograph.

VISO - SCOPE

Simple, accurate physiological monitoring
Model 780-6A



PATIENT MONITORING - INTENSIVE CARE

Patient signals can be accurately observed on the Model 780-6A general purpose 5-inch oscilloscope. ECG, pressure, pulse and other patient signals can be observed as sharply defined displays, due to the slow sweep speeds and long-persistence scope image. With the optional electronic switch, four patient signals can be monitored simultaneously. The electronic switch accepts eight rear panel inputs, any four of which may be selected for viewing on the oscilloscope screen. The modular design of the Model 780-6A allows it to be used with other 780-series modules either at the nurses station or at the patients bedside, or it may be easily converted for rack mounting in compatible recording systems.

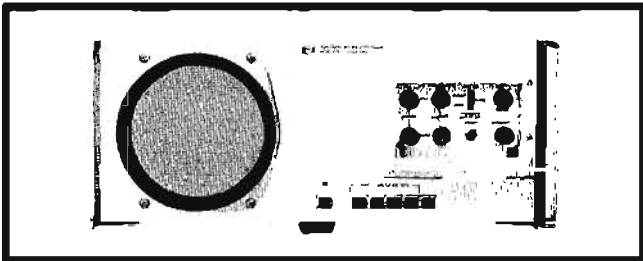

Specifications

Time base

Range: 25, 50, 100 mm/s and X10 multiplier (X.1 multiplier available on special order); accuracy $\pm 5\%$.

Triggering: free run, normal, or triggered.

Free run: circuit free runs independently of trigger circuit.

Normal: circuit free runs, can be reset any time after 5 cm of sweep by applying ext trigger of 5 V or greater (jack on rear panel); input RC, 100K ohms shunted by 40 pF; max input 15 V.

Triggered: initiated by ext trigger signal, or front panel pushbutton; sweep can be reset in same manner as Normal.

Vertical amplifier

Bandwidth: dc to 200 kHz. (Option 01, see below.)

Deflection factor (sensitivity): variable from 100 mV/cm to 1 V/cm.

Balanced input: connections for +, -, and ground provided.

Common-mode rejection: greater than 40 dB for common-mode signals of less than ± 3 volts at 1 kHz.

Input RC: 1 megohm shunted by approximately 200 pF from each side of balanced input to ground. Maximum input ± 10 V.

Connectors:

Y vertical input: 3-conductor phone jack on rear panel.

Y vertical output: 3-conductor phone jack on rear panel in parallel with Y vertical input.

Option 01 (four-channel electronic switch):

Chopping rate: 40 kHz (10 kHz per channel when all four channels are turned on).

Connectors: Amp Series M 14-pin connector on rear panel;

2-conductor phone jacks in parallel with inputs 1 through 4 on rear panel.

Each channel:

Bandwidth: 1 kHz.

Deflection factor (sensitivity): set simultaneously for all channels with one control; variable from about 200 mV/cm to about 2 V/cm.

Input RC: single-ended, 20K ohms shunted by 80 pF.

Controls: position control, and 9-position switch allowing each channel to be connected to any one of eight rear panel inputs or Off.

Horizontal amplifier

Bandwidth: dc to 70 kHz.

Deflection factor (sensitivity): 0.5 V/cm, variable $\pm 25\%$.

Balanced input: connections for +, -, and ground provided.

Common-mode rejection: greater than 40 dB for common-mode signals of less than ± 3 volts at 1 kHz.

Input RC: 1 megohm shunted by approximately 160 pF from each side of balanced input to ground.

Connector: 3-conductor phone jack on rear panel.

X-Y operation: selectable with front panel pushbutton.

General

Cathode ray tube: mono-accelerator, 2500-volt accelerating potential; supplied with P7 long persistence phosphor and amber filter; etched safety glass faceplate reduces glare.

Graticule: 10 x 10 cm parallax-free internal graticule marked in cm squares; major horizontal and vertical axes have 2 mm subdivisions.

Intensity modulation: +5 V pulse will blank trace of normal intensity; z-axis input, dc coupled; input is to 2-conductor phone jack on rear panel; input impedance, 25K ohms; maximum z-axis input, 10 V.

Location of controls:

Front panel: power, sweep speed, X-Y and multiplier.

Behind door: focus, intensity, X and Y sensitivity and position, sweep mode, and manual trigger.

Dimensions: 16 $\frac{3}{4}$ " wide, 7 $\frac{1}{2}$ " high, 18 $\frac{3}{8}$ " deep overall (426 x 191 x 466 mm); hardware furnished for quick conversion to 7" x 19" (178 x 483 mm) rack mount.

Color: blue cabinet with white enamel front panel standard; gray panel available, see options.

Weight: net 27 lbs (12.2 kg); shipping 33 lbs (14.9 kg).

Power: 115 or 230 volts $\pm 10\%$, 50 to 1000 Hz, approx. 95 W; Aux. power output (5 amp max.) is provided for connecting other equipment.

Price: HP Model 780-6A, \$700.

Options: (specify by option number)

01: 4-channel electronic switch for vertical amplifier, add \$175.

04: combining hardware for mounting two half-modules on top of a Model 780-6A, no additional charge.

05: gray front panel instead of standard white, add \$25.

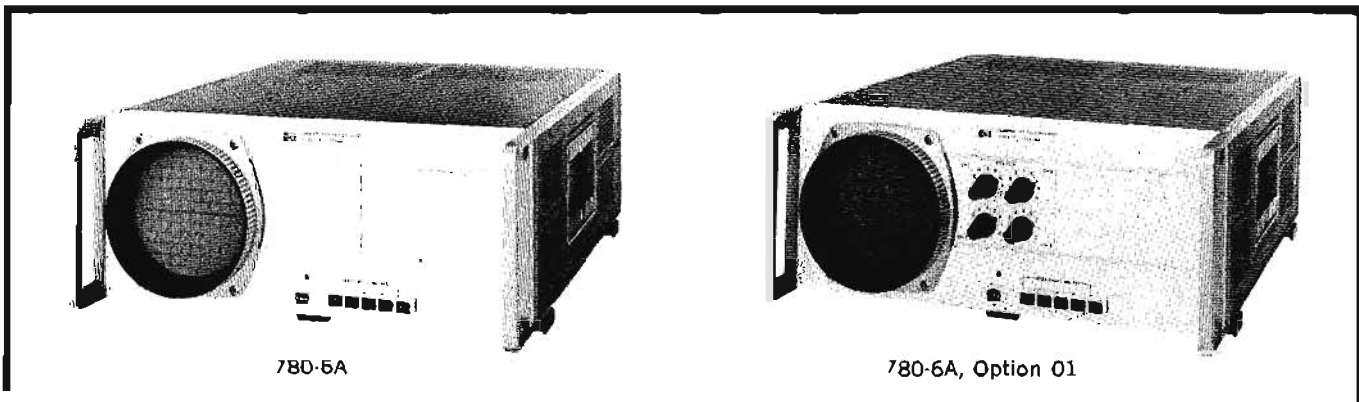

PATIENT MONITORING— INTENSIVE CARE



MONITOR SCOPES

General purpose physiological monitoring
Models H40-120B, H41-120B, H45-120B

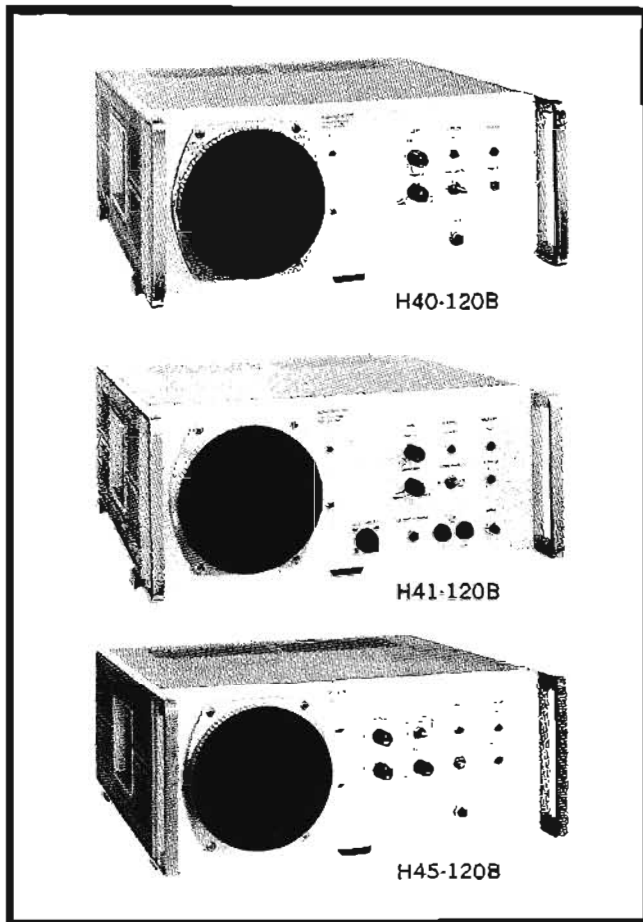

The Hewlett-Packard Monitor Scopes are special purpose, two sweep-speed, long persistence oscilloscopes specially suited for all types of physiological monitoring. Individual ECG, pressure, pulse, and other patient signals can be observed as a sharply defined display, due to the slow sweep speeds and clear, long-persistence scope image.

These economically priced oscilloscopes are designed for ease of operation, even by non-technical personnel. Standard ECG sweep speeds are selected by a toggle switch on the front panel. All operating controls are simplified as well as being kept to a logical minimum.

The Model H40-120B is the basic unit designed to operate with the Sanborn 780 Monitoring Systems. The H41-120B is similar to the H40; in addition to operation with the Patient Monitoring System, a vertical channel preamplifier may be switched in for direct monitoring of patient signals. The H45-120B also was designed for the Patient Monitoring System, however, it is also capable of displaying two signals at once for side by side comparisons. Either one or both channels can be selected by a front panel switch.

Specifications, H40-120B

Vertical amplifier:

Bandwidth: dc to 50 kHz.

Deflection factor (sensitivity): variable from 100 mV/cm to 1 V/cm.

Input: single ended on rear panel.

Input RC: 1 megohm shunted by approximately 150 pF.

Input connector: two-conductor phone jacks (2) in parallel on rear panel.

Time base:

Range: 25 and 50 mm/s.

Triggering: sweep circuit free runs or may be triggered externally with 5-volt signal; triggering selected by switch on rear panel; external trigger input phone jack on rear panel.

General:

Cathode ray tube: mono-accelerator, 2500-volt accelerating potential, supplied with P7 long-persistence phosphor, and amber filter.

Graticule: 10 cm by 10 cm parallax-free internal graticule marked in cm squares; major horizontal and vertical axis have 2mm subdivisions.

Dimensions: 16 $\frac{3}{4}$ " wide, 7 $\frac{1}{2}$ " high, and 18 $\frac{3}{4}$ " deep overall (426 x 191 x 466 mm).

Color: blue cabinet with white enamel front panel standard; gray panel available on special order.

Weight: net, 26 lbs (11.7 kg); shipping, 32 lbs (14.4 kg).

Power: 115 or 240 V \pm 10%, 50 to 1000 Hz, approximately 95 W.

Price: HP Model H40-120B, \$525.

Accessories available:

Rack mount kit (order HP Part number 5060-0433), \$10.

Handle kit, contains two handles and mounting hardware for installation on instrument side castings (order HP part number K04-120B), \$10. Testmobile, designed so that instrument height above floor may be varied from 5 to 6 feet (approximately); instrument may be tilted to any position (order HP Model K41-1118A), \$135.

Options: (specify by option number)

04: Combining hardware for mounting two half modules on top of the instrument, no additional charge.

20: Tone generator; provides a 150 msec burst of approximately 700 Hz tone, triggered by the R wave; front panel controls for volume and R wave trigger sensitivity, add \$65.

21: Rear panel signal outputs; two phone jack connectors on rear panel provide approximate 0.5 V/cm and 1 mV/cm analog outputs, add \$50.

Specifications, H41-120B

Same as Model H40-120B except:

Vertical amplifier

Bandwidth: 0.15 Hz to 1 kHz (time constant 0.5 s).

Deflection factor (sensitivity): variable from 500 μ V/cm to 5 mV/cm.

Balanced input: connections for +, -, and ground are provided.

Common mode rejection: greater than 60 dB for common mode signals of less than \pm 1 volt.

Input RC: 1 megohm shunted by approximately 150 pF from each side of balanced input to ground.

Input connector: amphenol 5-pin jack on front panel.

Calibrator: 1 mV signal initiated by front panel pushbutton.

Patient protection: 5 mA front panel fuse.

Price: HP Model H41-120B, \$625.

Specifications, H45-120B

Same as Model H40-120B except:

Vertical amplifiers: (Channels A and B)

Bandwidth: dc to 1 kHz.

Deflection factor (sensitivity): variable from 200 mV/cm to 2 V/cm.

Input RC: 20 k ohms shunted by approximately 80 pF.

Input connectors: two-conductor phone jacks, A and B inputs on rear panel. Either or both channels selected by front panel switch.

Price: HP Model H45-120B, \$675.

PATIENT MONITORING

Transducers, electrodes, cables, carts, brackets
267, 780, 37P, 48 and 651 Series



PATIENT MONITORING— INTENSIVE CARE

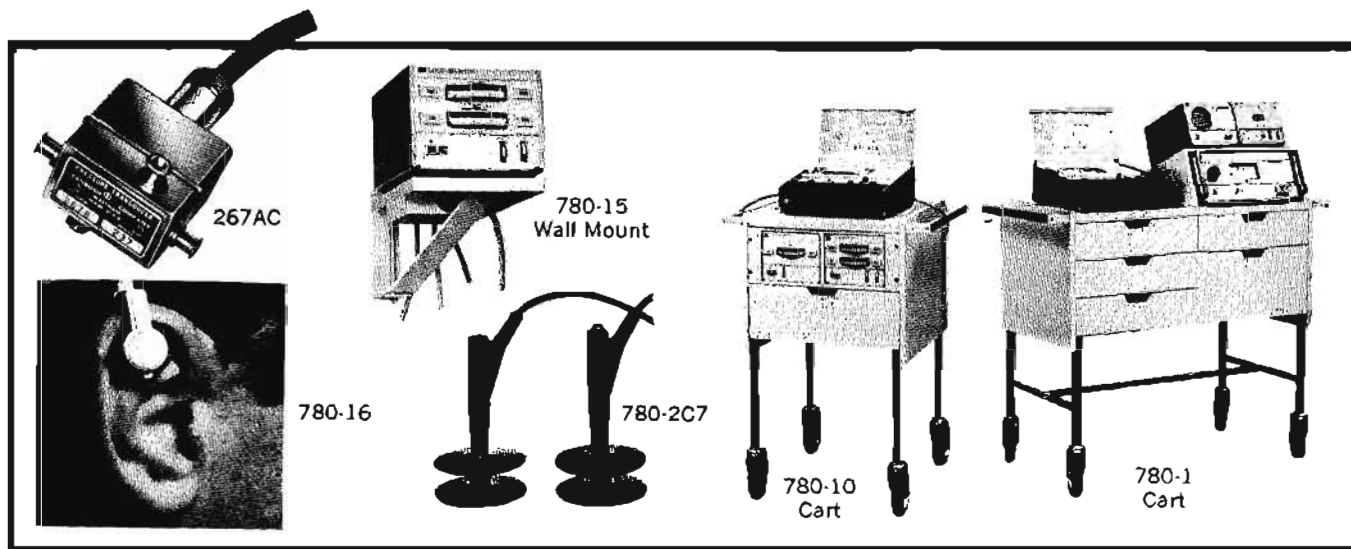

Transducers and electrodes

267AC	Fluid pressure, -100 to +400 mm Hg. Luer taper-twist connectors, 8' cable, Monel construction. Use with 780-9	\$225
268A	Same, except -40 to +40 mm Hg.	\$225
780-14	Respiration rate, detects chest expansions/contractions as small as 0.021". Use with 780-8, 760-2200 resp. rate preamp	\$100
9301 Series	Thermistor temperature probe. Use with 780-8 and 780-19	
9301-0133	Internal esophageal-rectal	\$ 15
9301-0132	Rectal, infant	27
9301-0134	Tubular	23
9301-0162	Surface (air)	30
9301-0135	Tubular	30
9301-0136	Surface (banjo-type)	29
9301-0137	Surface	23
780-16	Earpiece photo-plethysmograph. Detects blood pressure pulsations. Use with 780-7, -7A, 780B.	\$100
780-2C7	Defibrillating electrodes, external. Paddle-type; pushbutton switch on handle. Use with 7802B.	\$175
780-2C8	Defibrillating electrodes, internal. Use with 7802B.	\$175
780-2C17	Defibrillating electrodes, infant, internal. Use with 7802B.	\$175
14013A	Defibrillating, Anterior-Posterior electrodes, external. Use with 7802B.	\$175
1280A	Fluid pressure transducer. Use with HP carrier preamplifier and 780-9 patient monitor.	\$295

Cables

780-1200-C8	Pacing, internal. Use with 780B, 780-4, 780-7.	\$ 11
780-1200-C9	Pacing, external. Use with 780B, 780-4, 780-7.	\$ 11
780-1200-C10	ECG with fluid-column electrodes. 8' long. Use with 780B, 780-7/7A, ECGs.	\$ 13

Wall Mount Bracket

780-15	Rugged, easily-mounted unit holds up to two 780 half-modules. Swivel bracket facilitates cable connections, best viewing angle. Wall-mounting frees area around bedside, protects monitors from possible damage. With all mounting hardware.	\$ 35
--------	--	-------

Mobile Instrument Carts

780-1	Useful as emergency resuscitation cart for quickly getting all instruments, drugs and sup-	
-------	--	--

plies to the patient, or as a bedside cart for a monitoring system. Sloping compartment at right holds 7802B Defibrillator or 780-6A, two half-modules or one full-module on top left. Four drawers and storage compartments hold all cables, electrodes, drugs, etc. Handles at both ends; 6" ball-bearing wheels, conductive tires; four electrical outlets at rear, 15' three-wire power cord. Size: 42" high, 43 1/2" wide, 20 3/8" deep (1067 x 1105 x 524 mm). Weight 138 lbs. (62 kg). Price \$345. Following options at no extra charge: Option 04: combining hardware for mtg. two half-mods. on sloping section. Option 05: combining hardware for mtg. full mod. on sloping section or left top. Option 07: combining hardware for mtg. 1500A on left top. Option 08: combining hardware for mounting 780-6A scope on sloping section, add \$25.

780-10	Same features as 780-1 cart, in smaller size—37 1/2" high, 26 3/8" wide, 20 3/8" deep (953 x 670 x 524 mm). Wide flexibility in mounting half- or full 780 modules. Weight 81 lbs. (36 kg). Prices: 780-10 with one drawer, \$195; 780-10A, no drawer, \$165; 780-10B, two drawers, \$245. Fol. options supply combining/mtg. hardware for modules: Option 03: (except 780-10B) two half-modules in space below top, add \$42. Option 04: two half-modules on top of cart, no charge. Option 05: 780B or 7802B on top of cart, no charge. Option 06: (except 780-10B) full-module in space below top, add \$30. Option 07: 1500A ECG on top of cart, add \$4.	
--------	---	--

Magnetic Tape Cartridges, endless-loop, for 780-5

9162-0037	40-sec. capacity	\$ 13.50
1490-0798	15-minute capacity	\$ 9.50

Permapaper® Recording Chart Paper

651-190	40 div., 35 mm wide, for 780B	\$ 2.75
651-40	For 1500A ECG	\$ 3.50

Electrical Fittings and Supplies for 780 Systems: a wide choice of junction boxes, terminal boxes, interconnection yokes, cables in std. and special lengths with specific terminations required, and mounting hardware for 780-series patient monitoring systems. Consult your local Hewlett-Packard field sales office for details.

PATIENT MONITORING— OPERATING ROOM



OPERATING ROOM SYSTEMS

Systems engineering approach
Recording and display instruments

A wide choice of OR patient monitoring systems is available from Hewlett-Packard, primarily because no two hospitals have exactly the same patient phenomena to monitor, identical physical locations and system operating conditions, or the same budgetary considerations. Provision is made for incorporating instrumentation advances into existing systems, thus avoiding system obsolescence.

The two installations shown below on this and the facing page are but two of many complete monitoring systems designed, built and installed by Hewlett-Packard during the last 20 years. Each system incorporates the most appropriate signal acquisition, signal conditioning, visual display and recording elements for the type of surgery and medical staff who use the system—with the functional elements drawn from the individual instruments shown between the installation photos and from others described in the Research Instruments section of this catalog.

Functional elements available for OR monitoring systems from Hewlett-Packard include: *transducers* for translating the patient's physiological variables into representative electrical signals; *signal conditioners* for amplifying, refining or selecting certain portions of these signals; *visual display devices* for

continuous monitoring of patient signals during the operation, and possible subsequent study or teaching of operative events through the medium of magnetic tape playback; *graphic recording instruments* for obtaining data in permanent chart form, either during surgery or later by data playback; and *magnetic tape instrumentation* for acquiring all data, preserving its original electrical form, and reproducing it at its original rate or at a faster or slower rate as the investigator desires. (Patient data on magnetic tape also facilitates its analysis by computer at any later date).

Examples of the specific Hewlett-Packard medical electronics products in each of these categories can give the hospital a measure of choices available in system capabilities. Medical transducers include types for the detection/measurement of heart sounds; peripheral pressure pulse; respiration rate; fluid and membrane pressures; gas pressures; myographic forces; internal and external temperatures; linear displacement and velocity; pO_2 of blood and other fluids. *Signal conditioners* provide maximum flexibility of control and fidelity of amplification, in plug-in interchangeable units specifically designed for pressure transducer outputs; heart sounds; ECG, EEG potentials; heart and respiration rate transducers; pH electrodes;

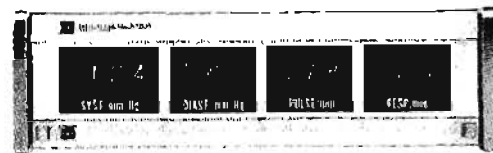
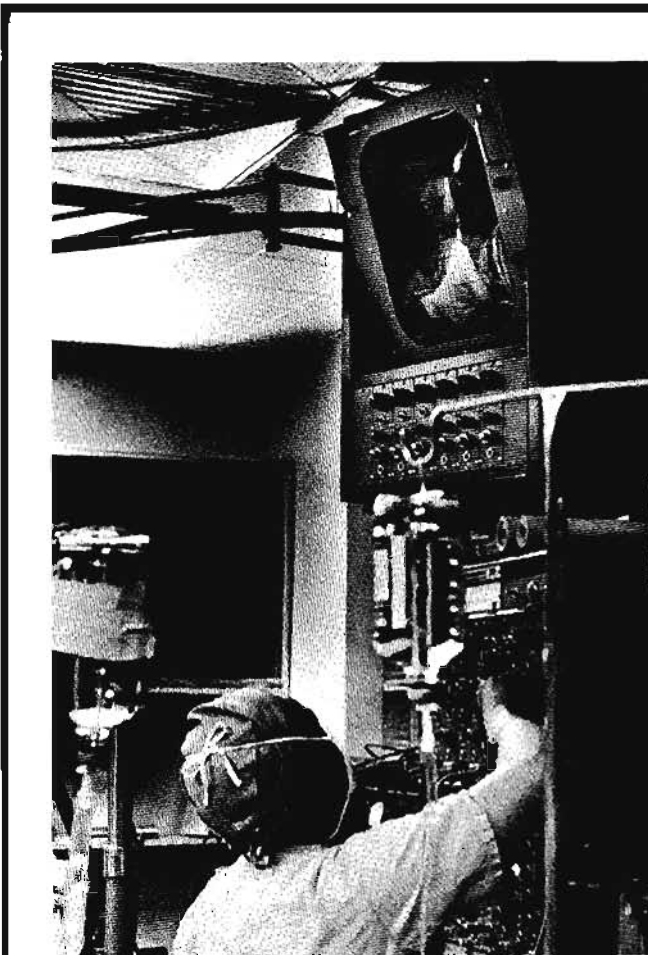

5601A

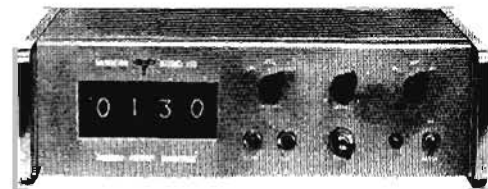

130

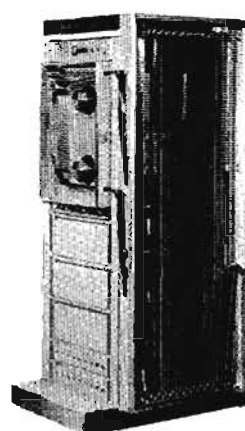

3900B

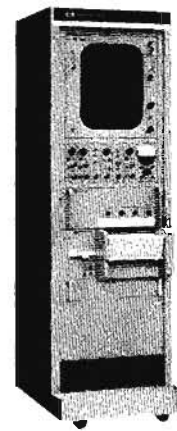

7734A

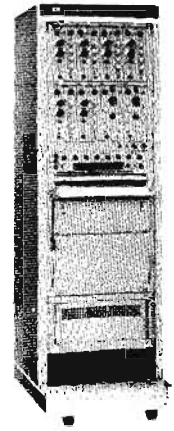

7718A

thermistor temperature probe and other low-level outputs. Two different series of these signal conditioners are offered, with eight models in one series and 12 in the second. Typically they are located above the recorder in an oscillograph, as shown below, but they can be positioned anywhere in the system and used as unit amplifiers as well. *Visual display* instruments include single- and multi-channel oscilloscopes, image-retaining scopes, a four-channel numerical display for slowly-changing events (shown below), and large-scale panel meters. Oscillographs for *graphic chart recordings* are represented by the thermal-, fluid-, and optical-writing systems shown below. Heated-stylus and fluid types for dc to 150 Hz (heat) or 160 Hz (fluid) are available in a variety of models, designed to meet the widest possible range of operating conditions and requirements. Optical systems include dc to 500 Hz photographic recorders with rapid developer units, and dc to 5 kHz ultra-violet recorders in 1- to 24-channel capacities.

For data storage and playback in a variety of modes, HP magnetic tape recording/reproducing systems allow the user to equip his system with precisely the number of direct or FM channels he needs from one to 14, a voice channel

for spoken commentary, and valuable options such as an endless-loop device for repetitive playback, remote control unit, system packaging in portable cases for greater mobility, etc. Conformance of system specifications to established IRIG standards also means that tapes may be used by other hospitals and research centers equipped with IRIG standard systems. Other functional elements of an OR monitoring system, which Hewlett-Packard has experience in providing, include inter-communication systems for OR staff, system operator and observers; dye curve integrator for cardiac output determination; vector-cardiograph display/photography units.

In planning a modest or comprehensive OR monitoring system, for either general or specialized surgical procedures, Hewlett-Packard uses a true systems-engineering approach: compatibility of performance and readout of each unit in relation to all other units is given major attention, as well as realistic recognition of actual operating conditions, degree of operator skill required, servicing and maintenance without disruption of the entire system, and positive safety for patient and medical staff alike. For a detailed system proposal with cost estimate, call your Hewlett-Packard field sales office to discuss your requirements.

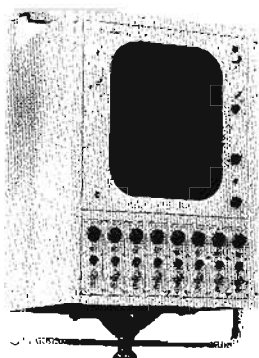

769 with 760-52 ceiling mount

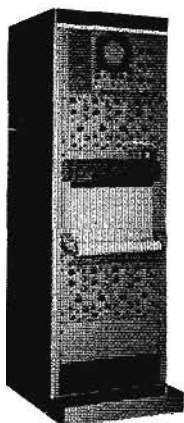

7719A

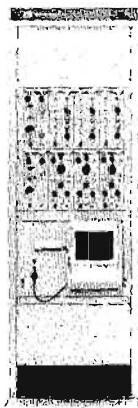

4568B

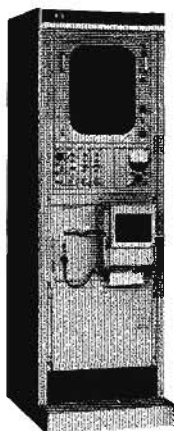

4561B

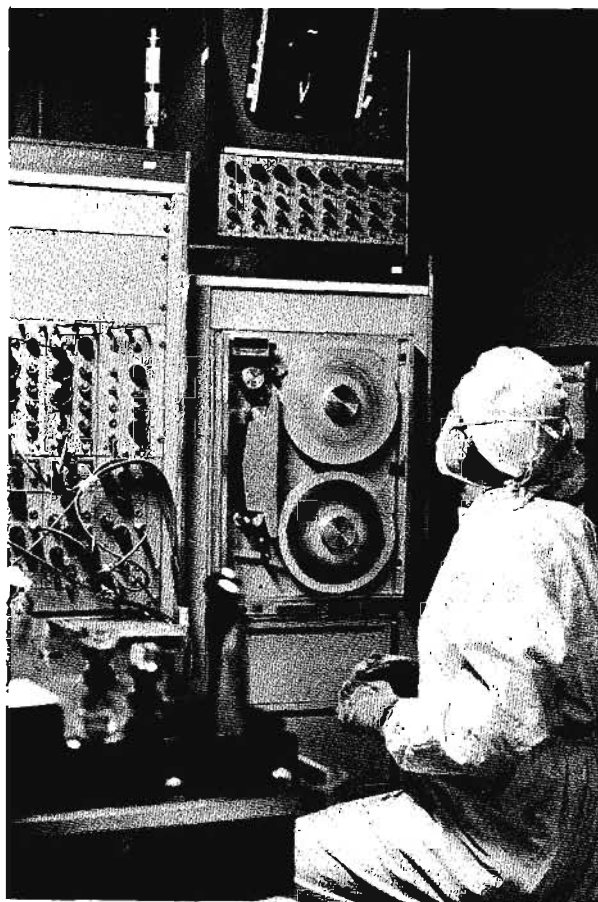

PATIENT MONITORING— OPERATING ROOM



MEDICAL TRANSDUCERS

Reliable, accurate, easy-to-use

Models 267, 270, APT, FTA, 1280, 760-53, 350-1700-C10

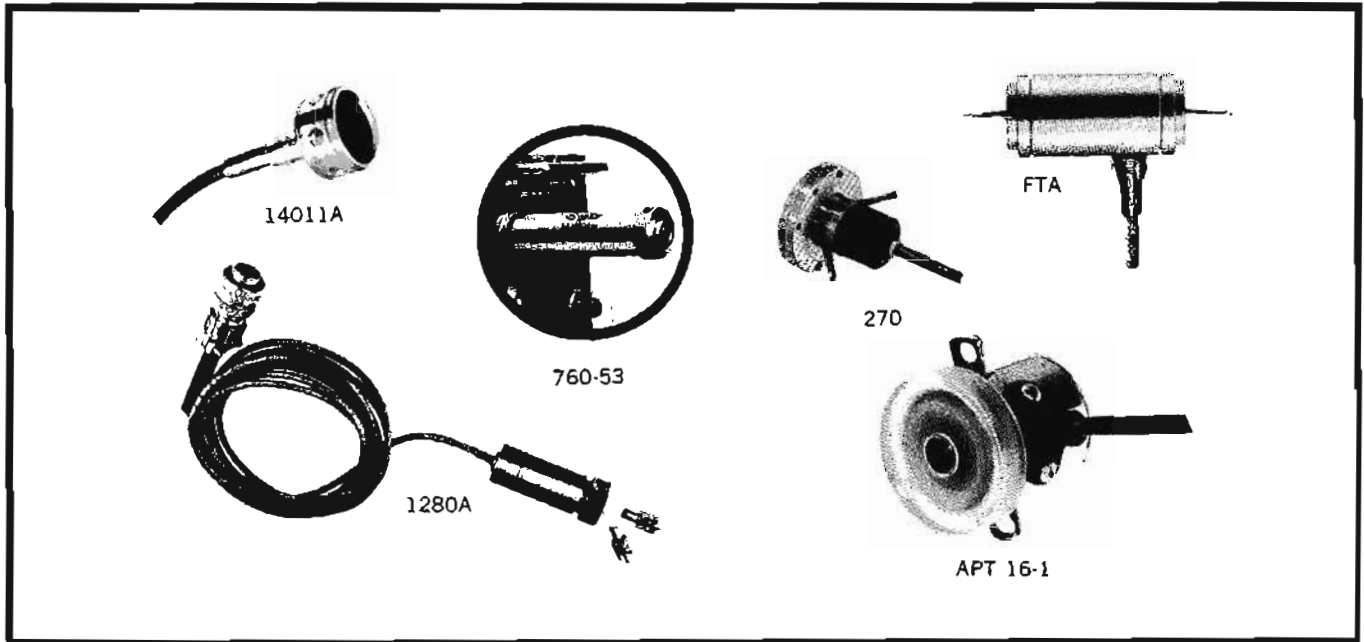

267AC, 267BC, 268A, 268B Pressure Transducers

Compact, sensitive pressure transducers measure gas or fluid pressures, especially for blood pressure, GI and esophageal studies. Models 267BC, 268B measure differentially

	Models: 267AC, 267BC	Models: 268A, 268B
Working range	-100 to +400 mm Hg	-40 to +40 mm Hg
Sensitivity*	1 cm/1 mm Hg	1 cm/0.1 mm Hg
Volume displacement	0.04 mm ³ /100 mm Hg	0.4 mm ³ /100 mm Hg
Frequency response	The response of a transducer system depends on the diameter and length of needle and/or catheter, the connecting hardware, the internal volume, volume displacement, and the pressure medium.	
Maximum Pressure	750 mm Hg	300 mm Hg
Internal volume	0.2cc.	0.2cc.
Hysteresis and non-linearity	All models, single-ended mode, = 1% max. B models, differential mode, = 1.5% max.	
Operating temperature	Not over 120 degrees F°.	
Electrical connections	Eight-foot cable to mate with HP Carrier Pre-amplifier, Extension cables available.	
Differential performance	Equal static pressure applied to both inputs of 267BC, 268B (in differential measurement) will produce an output representing less than 0.5% of the applied pressure. (267AC, 268A are for single-ended measurements only).	
Recording system carrier Pre-amplifier	350-3000C, 760-3000; *Special plug-in harmonic filter furnished without cost.	
Dimensions and connections	Monel body: 1-9/16" wide, 1/4" high, 1" deep (40 x 38 x 25 mm). Female Luer locks extend 1/4" (10 mm) from four sides of body. Cable coupling extends 1-1/8" (27 mm) beyond body.	
Weight	Transducer net 9 oz (0, 1 kg), unit net 15.5 oz (0,4 kg), shipping 1 lb (0,4 kg)	
Price	267AC, \$225; 267BC, \$250; 268A, \$225; 268B, \$250.	

*Sensitivity given on most sensitive position of HP Carrier Pre-amplifier.

in relation to atmospheric or any other reference pressures, have sensitivities in each two chambers maintained within 0.5%. Each pressure chamber has an inlet and outlet for bubble-flushing. All pressure-exposed parts are of corrosion-resistant Monel. All units have standard Luer taper twist-lock connectors. Both single-ended and differential models are available in two sensitivities: 1cm/1mmHg and 1cm/0.1mmHg. Electrical connection to Carrier Pre-amplifier is by 8-foot cable (supplied). (Optional extension cable lengths are available; consult a Hewlett-Packard sales office for further details.)

14011A Contact Crystal Microphone

Reproduces all heart sounds from low pitch rumbles to high-pitch murmurs at frequencies up to 1,000 Hz. Used with Model 350-1700C Heart Sound Pre-amplifier. Shipping weight: 2 lbs. Price: \$56.

APT16-1 Applanation Pressure Transducer

The APT16-1 transducer measures internal fluid pressure through contact with the surface of a flexible membrane. The transducer has a cylindrical guard ring which extends down over a spring-restrained plunger rod, which comprise the probe end. The face of the ring and plunger are in the same plane. In use, the ring and plunger flatten the skin or membrane surface; then internal pressure through the membrane displaces the plunger relative to the plane of the guard ring.

This transducer is compatible with appropriate Sanborn pre-amplifiers in Hewlett-Packard direct-writing, photographic recording, meter and scope readout systems.

The sensitivity (1 div/2 mm Hg) permits clear traces on an HP ECG Recorder. It can also be used with Low-Level or DC Preamplifiers in recording systems. The APT16-1 is a "dc in-dc out" unit which requires a 6-volt power supply. Model APT16-1 is also designed to measure pulse waves.

APT 16-1	
Pressure range	0-180mmHg
Sensitivity	1.5 mV dc /mmHg with 6 V dc excitation.
Natural frequency in air	300 Hz
Compliance	1.1 micron /mmHg
Recommended Excitation	6 V dc @ 20 mA
Dimensions diameter length	1.06" (26, 9) .96 (24,4)
Weight	8 oz. (0,6 kg)
Price	\$220
T41-18 power supply,	\$80.

It has a 25.4 mm diameter guard ring and 6.4 mm diameter plunger and can be easily strapped to the body. The Model T41-18 is a 6-volt battery power supply with appropriate connectors.

1280 Series

The 1280 Series transducers are designed for measurement of fluid pressures. They feature a transparent dome and small volume displacement. They are sensitive, compact units suited for measurement of blood pressure, esophageal, and gastro-intestinal phenomena. Single-ended with male Linden pressure connectors.

Specifications

Linear range: —100 to 400 mm Hg.
Overload: —100 to 750 mm Hg (max.).
Sensitivity: 4mV/Vx/100 mm Hg (1 cm/mm Hg on most sensitive position of standard HP Carrier Preamplifier Recording System channel).
Sensor: bridge-type, not compatible with 150-3000, 350-3000 preamplifiers.
Input impedance: 130 ohms.
Output impedance: 100 + j50.
Excitation: 5 vac (max.), 2.4 kHz.
Linearity: 0.5%.
Temperature range: +40° to +130°F.
Natural frequency: greater than 2 kHz in air.
Volume (Internal): 0.28 cc (dome only).

Volume displacement: .04 mm³/100 m Hg.

Weight: net 29 oz (0,4 kg); shipping 1.1 lbs (0,5 kg).

Dimensions: 4.35" long (110 mm), 1.19" (30.2 mm) dia.

Price: on request.

Linearsyn, 7DCDT, and LVsyn Transducers

Linearsyn and 7DCDT differential transformer transducers are used for the measurement of the displacement of muscle, limb, blood vessel, chest wall and other physiological motions. LVsyn models are designed to measure the velocity of these motions.

Calibrated Temperature Bridge

The Calibrated Temperature Bridge, Model 760-53 is an adaptor for use with any Carrier Preamplifier and a variety of interchangeable thermistor probes for accurate recording or monitoring of physiologic temperatures.

Weight: net 3 oz (0,03 kg); shipping 1 lb (0,4 kg).

Price: \$99.

FTA Transducers

The FTA series of myographic force transducers is designed primarily for the measurement of isometric muscle contraction. They are also useful for measuring such characteristics as weight, surface tension, and buoyant force. Shipping weight 1³/₄ lbs (700 gms). Price, with 8-ft cable and connector, \$200.

Differential gas pressure transducers

Model 270 Differential Gas Pressure Transducer is designed for high-sensitivity measurement of low gas pressures, such as used in pulmonary studies, either single-ended or differentially. The transducer features excellent linearity, low thermal drift, and the ability to measure positive or negative pressures with equal facility, and can be used to replace the standard 14-inch water manometer.

Full scale: —400 to +400 mm H₂O.

Sensitivity: 8 mV/V; with HP signal conditioner, gives full-scale for 2.5 mm H₂O.

Linearity: error less than 1% of full scale.

Internal volume: 4 cc.

Connections: electrical, through 8' cable; to pressure, by 1/8" ID rubber tubing.

Operating temperature: 0° to 50°C; less than 1% change in sensitivity over this range, with less than 0.04 mm H₂O per F degree zero deviation.

Shipping weight: 1 lb (0,4 kg.)

Price: \$295.



SIGNAL CONDITIONERS

Versatility in physiological recording
Series 350 and 760

Two separate series of HP Physiological Signal Conditioners—Series 350 and Series 760 Preamplifiers—are used in the Hewlett-Packard Recording and Monitoring Systems described on the following pages. The 350's are the most versatile and highly developed of Hewlett-Packard interchangeable, plug-in physiological preamplifiers. There are 12 different types available for monitoring and/or recording more than a score of physiological phenomena. The 350 types may also be used as unit amplifiers, independent of the recording system, to drive panel meters, scopes, numerical displays, etc. The 760 types are also interchangeable plug-in units. They are available in fewer models but have the advantage of smaller size, all solid state circuits and, in most cases, lower cost. Whether a system accepts 350 or 760 Preamps the specific preamplifiers selected will depend on the phenomena to be measured as well as on the type of transducer or other measuring equipment used. (The Applications Table suggests suitable signal conditioners for different physiologic variables, the exact selection again depending on the transducer or other measuring equipment used.) Plug-in 350 Preamplifiers weigh approximately 5 pounds (2.3 kg) each and are 10½ inches high by 4-3/16 inches wide by 19 inches deep (including an individual 350-500B Power Supply connected at the rear (267 x 106 x 173 mm). Transistorized 760 Preamplifiers weigh approximately two pounds (.9 kg) each and measure 7 inches high by 2 inches wide (178 x 51 mm).

The **350-1000B DC Preamplifier** with wide bandwidth is suitable for recording output of numerous indicating devices and transducers. It may also be used for recording analog data from tape recorders. \$325

The **350-1100CM Carrier Preamplifier** is used for registration of physiological pressures, with any of numerous strain

gage, variable reluctance and differential transformer pickups; and for temperature measurements with Model 760-53 Calibrated Temperature Bridge. Other phenomena, such as force, stress, displacement, velocity, flow, vibration and acceleration may be measured with the 350-1100CM and appropriate transducers, such as Model 1280A (pressure). The Model 350-1100CM has a harmonic filter installed for use with Models 267 and 268 Transducers. \$485.

The **Model 350-1300C DC Preamplifier** is a moderate gain, three-stage dc amplifier, featuring two gain stages and a cathode follower output. It may be used for recording the output of such laboratory instruments as gas analyzers, densitometers, cardiometers, and magnetic tape recorders. It may also be used for recording dc signals directly from certain transducers. \$250

The **350-1500A Low Level Preamplifier** offers 8 interchangeable plug-in front-ends, making the preamplifier a practical choice for flexibility in low level measurement and recording. Plug-in front-ends include Model 350-2B a general purpose dc amplifier with zero suppression, Model 350-3A EEG-ECG Plug-in, Model 350-4A Strain Gage Plug-in for operation of strain gage bridges in the 100-1000 ohm impedance range, Model 350-12 Galvanic Skin Resistance Plug-in, and Model 350-15 Thermal Dilution Plug-in. Price 350-1500A, \$325; 350-2B, \$190; 350-3A, \$225; 350-4A, \$130; 350-12, \$265; 350-15, \$265.

The **Model 350-1700C Heart Sound Preamplifier** is designed to be used with the HP Poly Beam Recorders (or other optical recorders having 500 Hz galvanometers) for electrical auscultation and the registration of diagnostic phonocardiograms. Additionally this preamplifier may be used externally with a 350-500B Power Supply and a 450 style portable case as an Amplifying Stethoscope. \$275

Physiologic variable	Applicable Preamplifiers	
	Model 350-	Model 760-
Apex cardiogram	3200A or 2700C	
Ballistocardiogram	1500A w/350-2; 3200A or 2700C	1600A
Compliance (lung)	5000B	
Dye curve	1000B; 1300C; 2700C or 3200A	1300
ECG (adult, child, large and small animal)	3200A or 2700C	1600A
Electromyograms	3200A or 2700C	1600A or 2700A
Electroretinogram	2700C	2700A
Fetal ECG	2700C or 1500A w/350-3A	2700A
Flow, air	1100CM or 3000C	3000
Flow, blood	1000B; 1300C; 3200A or 2700C	1300
Galvanic skin resistance (GSR)	1500A w/350-12	760-1500 w/350-12
Gas analysis (carbon monox., carbon diox., nitrogen)	1000B; 1300C; 2700C or 3200A	1300
Heart Rate	3400A	3A
Heart sound	1700C	
Heart sound timing	3200A or 2700C	

Physiologic variable	Applicable preamplifiers	
	Model 350-	Model 760-
pCO ₂	3600A+adapter	
pH	3600A	
Pneumogram	3200A or 2700C	
pO ₂	3600A+adapter	
Plethysmogram, limb-digit	1100CM; 3200A or 2700C	3000 or 1600A
Plethysmogram, body	1100B or 3000B	3000
Pressure (direct)—arterial, esophageal, GI, spinal, venous	1100CM or 3000C	3000
Pulse wave	3200A or 2700C	
Resistance, total pulmonary	5000B	
Respiration rate		2200
Scalar VCG	one to three 2700C's	
Temperature	1100CM; 3000C or 1500A w/350-2B	3000
Thermal-dilution	1500A w/350-15	
Vectorcardiogram	(2) 2700C	
Volume, respiratory	3700A	

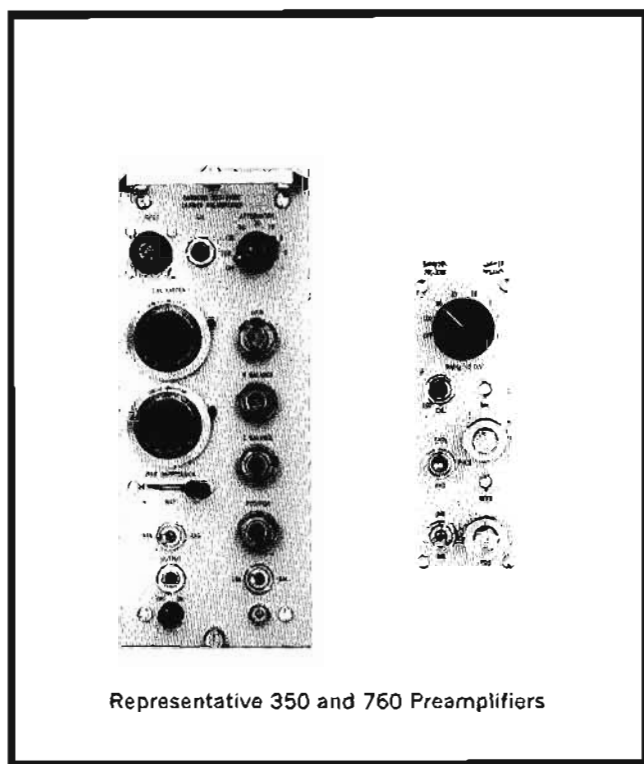

Representative 350 and 760 Preamplifiers

The **350-2700C High Gain Preamplifier** is useful for single channel EEG work such as monitoring anesthesia level or for fetal ECG's, for small muscle myography, and for nerve potential and muscle tissue measurements, as well as pulse wave measurements with Model 374 Adapter. In addition, it provides lead selection for routine ECG's. A dc input jack permits recording the same functions as the 350-1300C and the dc section of the 350-3200A. It is also useful for vectorcardiography.

The **350-3000C Medical Carrier** is designed for use with Physiological Pressure Transducers (Models 267 and 268 Series) for the determination of pressure with respect to atmospheric pressure or the difference between two applied pressures, and the Model 270, a high sensitivity differential pressure gas transducer). The 350-3000C is also useable with the 760-53 Calibrated Temperature Bridge and with HP Force Transducers; (not for use with 1280A). \$325

The **350-3200A ECG/General Preamplifier** provides accurate, diagnostic ECG's. Up to four 350-3200A's may be used in multi-channel systems equipped with ECG input facilities. The dc section of the preamplifier is suitable for recording the output of indicating devices used in gas analysis and dye dilution studies. The ac section will accept the output of the 108 Pneumograph Attachment, certain Ballistocardiographs, and transducer outputs such as 374 Pulse Wave Adapter with pp signals from 5 to 200 mV full scale.

The **350-3400A Cardio-Tach Preamplifier** may be used for measuring either average heart rate or the time interval between consecutive R-waves. Readout of average rate may be made on a recorder, or the 760-20 Monitor Meter. Readout of the time interval output—a ramp voltage function in which maximum amplitude is proportional to the time between the two previous R-waves—may be on a recorder or oscilloscope. \$550

The **350-3600A pH Preamplifier** may be used in multi-channel systems to provide precise, intermittent graphic measurement of pH or $p\text{CO}_2$ changes in samples of blood or other biological solutions. When packaged in a portable 450 case it serves as an independent meter for the measurement of pH or $p\text{CO}_2$ in whole blood and for general pH measurements in the 3 to 11 pH range. May also be used for $p\text{O}_2$ measurements with 461-212 or 461-215 Adapter. \$650

The **350-3700A Integrating Preamplifier** is designed to integrate or summate the output of 350 Preamplifiers or certain transducers. In the integration mode, the preamplifier performs as a low pass RC filter with a time constant as high as 2000 seconds, followed by a high gain chopper amplifier. As an area summator, the areas under the positive input signals are added. When the output is connected to a recorder, the results indicate precisely the rate and amount of activity that occur over a given period of time. Typical applications are found in electromyography and pulmonary function studies. \$450

The **350-5000B Respiratory Preamplifier**—used in conjunction with other 350 style preamplifiers—performs the integration of flow resulting in an electrical signal equivalent to the volume change of the lungs. Electrical signals related to flow of air into and out of the lungs, the volume change of the lungs, and the total pressure across the lungs are presented on an oscilloscope in loop form. \$550

The **760-1300 DC Coupler** performs the same functions as the 350-1300C. \$135

The **760-1500 Low Level Preamplifier** is a chopper type dc preamp for monitoring low level signals, such as those derived from thermocouples, photocells, oxygen electrodes, oximeters, thermistors, strain gage bridges and dye dilution equipment. In some applications, an input coupler may be required. Available also is the 350-12 Galvanic Skin Resistance Plug-in. \$300

The **760-1600A ECG Preamplifier** permits monitoring ECG bipolar leads (Leads 1, 2, 3). It may be used with 760-3A Cardiotach to monitor heart rate. \$225

The **760-2200 Respiration Rate Preamplifier** is designed to produce a dc voltage at the output directly proportional to average respiration rate. The input signal comes from a respiration transducer, or the output of a 350 or 760 Carrier Amplifier which derives its signal from a pneumotach screen and pressure transducer. \$400

The **Model 760-2700A EEG Preamplifier** is similar in function and purpose to the 350-2700C High Gain Preamplifier. \$200

The **Model 760-3000 Carrier Preamplifier** corresponds in function and purpose to the 350-3000C Medical Carrier; can use 1280A Pressure Transducer. \$225

The **Model 760-3100 Pressure Processor** is designed for monitoring systolic, diastolic, and mean arterial blood pressures. It is used in conjunction with the 760-3000 Carrier which obtains its input from blood pressure via a Pressure Transducer or strain gage type pressure transducer. \$500

The **760-3A Cardio-tach** produces a dc voltage at the output directly proportional to average heart rate. The heart rate may be obtained from any one of 3 different signal sources: 1) R-wave in the ECG waveform (760-1600A); 2) arterial pressure pulse (760-3000), ear plethysmograph (780-16). \$325

RESEARCH



OSCILLOGRAPH RECORDING

Instantaneous, permanent, rectilinear
7700 Series

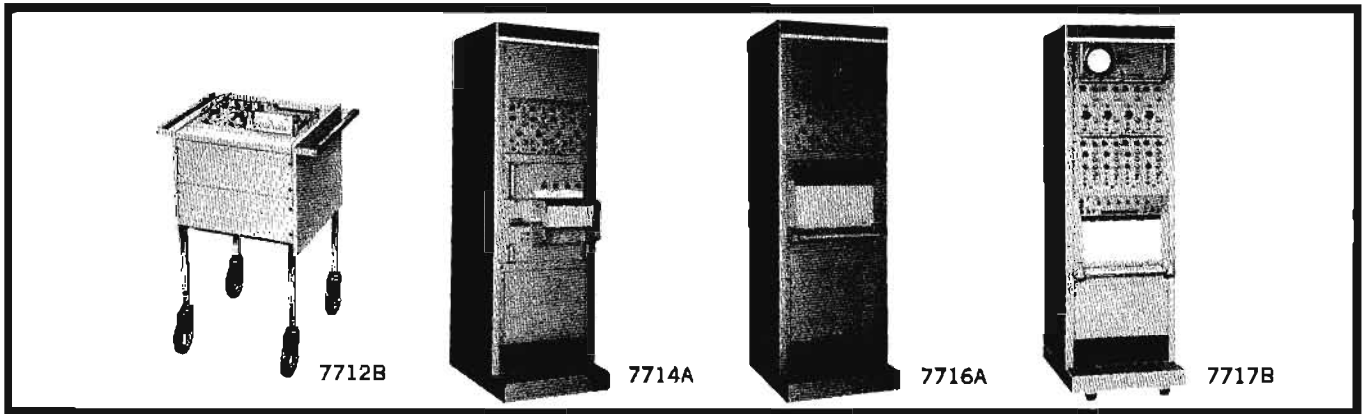

7712B Two channel recording system

The 7712B two channel thermal recording system features mobile cart mounting, for wheeling the system to the point of measurement. This facilitates clinical and research applications of the system, with any two of the "350" series of plug-in preamplifiers. Pushbuttons select 2.5, 5, 25 and 50 mm/s speeds on Options 10, 11. Recording channels are 50-mm wide, with a recorded frequency response from dc to 125 Hz unless limited by the preamplifier. Chart speeds 1, 5, 20, 100 mm/s.

Power requirements: 115 V, 60 Hz, 200 W.

Overall size: 14" high, 19" wide, 17 $\frac{1}{4}$ " deep (356 x 483 x 438 mm).

Weight: net 130 lbs (58,5 kg); shipping 172 lbs (77,2 kg).

Price: HP Model 7712B, \$1970. Opt. 01, less cart, deduct \$195. Opt. 02, portable case, deduct \$40. Opt. 08, 115/230 V 50 Hz, add \$50. Opt. 10, 2.5, 5, 25, 50 mm/s speeds, 60 Hz, no extra charge. Opt. 11, 2.5, 5, 25, 50 mm/s speeds, 50 Hz, (requires Opt. 08), no extra charge.

7714A Four channel recording system

The 7714A four channel thermal recording system for use with any four "350" series plug-in preamplifiers is complete in its fully enclosed upright cabinet. The system features a horizontal chart table, for easier notation on the recording. The four recording channels, each 50-mm wide, provide a recording response from dc to 125 Hz unless limited by the preamplifier. Mechanically selected chart drive speeds are 0.25, 0.5, 1, 2.5, 5, 10, 25, 50, and 100 mm/s.

Power requirements: 115 V, 60 Hz, 350 watts.

Overall size: 72 $\frac{1}{8}$ " high, 22-1/16" wide, 30" deep (1832 x 560 x 762 mm).

Weight: net 473 lbs (214 kg); shipping 569 lbs (256 kg).
Price: HP Model 7714A, \$3970.

Option 01: less cabinet; requires adequate cooling; deduct \$275. Option 06: ECG input facility; for cabinet use only; add \$200. Option 08: 50 Hz operation; add \$50. Option 09: adds 230 volt transformer 66A-10; specify in cabinet or loose; add \$100. Option 12: less one channel; deduct \$200. Option 13: add slides for 780-6A Scope; add \$25. Option 14: with 8-channel signal cable for 780-6A Option 01; add \$50. Option 15, extra marker, add \$70.

7716A Six channel recording system

The 7716A six channel thermal recording system is de-

signed to operate with any six of the "350" series of plug-in preamplifiers as a single cabinet-mounted system. The system features a flush-front recording drive, to allow observation of the recording as it is being made. The six recording channels, each 50-mm wide, record from dc to 125 Hz unless limited by the preamplifier. Electrically selected speeds by pushbutton are 0.25, 0.5, 1, 2.5, 5, 10, 25, 50, and 100 mm/sec.

Power requirements: 115 V, 60 Hz, 900 watts.

Overall size: 72 $\frac{1}{8}$ " high, 22-1/16" wide, 30" deep (1832 x 560 x 762 mm).

Weight: net 574 lbs (259 kg); shipping 670 lbs (302 kg).

Price: HP Model 7716A, \$5325.

Option 01: less cabinet; requires adequate cooling; deduct \$375. Option 02: for portable cases; price, add \$58. Option 06: ECG input facility; add \$200. Option 08: 50 Hz operation; add \$50. Option 09: adds 230 volt transformer 66A-10; specify in cabinet or loose; add \$100. Option 11: adds mm/min. speeds; recorder 356-100DW; add \$250. Option 12: less one channel deduct \$200. Option 15, extra marker, add \$70.

7717B Six Channel Recording System

The 7717B six channel thermal recording system features a visual display facility for single or multi-channel display, as a unified system complete in one upright cabinet. The system operates with any six of the "350" series of plug-in preamplifiers. Each recording channel is 50-mm wide, and provides a response from dc to 125 Hz unless limited by the preamplifier. Electrically selected speeds by pushbutton are 0.25, 0.5, 1, 2.5, 5, 10, 25, 50, and 100 mm/sec.

Power requirements: 115 V, 60 Hz, 970 watts.

Overall size: 72 $\frac{1}{8}$ " high, 22-1/16" wide, 30" deep (1832 x 560 x 762 mm).

Weight: net 590 lbs (266 kg); shipping 686 lbs (309 kg).

Price: HP Model 7717B, \$6400.

Option 06: ECG input facility; add \$200. Option 08, 50 Hz, add \$50. Option 09: add 230 volt transformer 66A-10; specify in cabinet or loose; add \$100. Option 11: add mm/min speeds; recorder 356-100DW; add \$250. Option 12: less one channel; deduct \$200. Option 15, extra marker, add \$70.

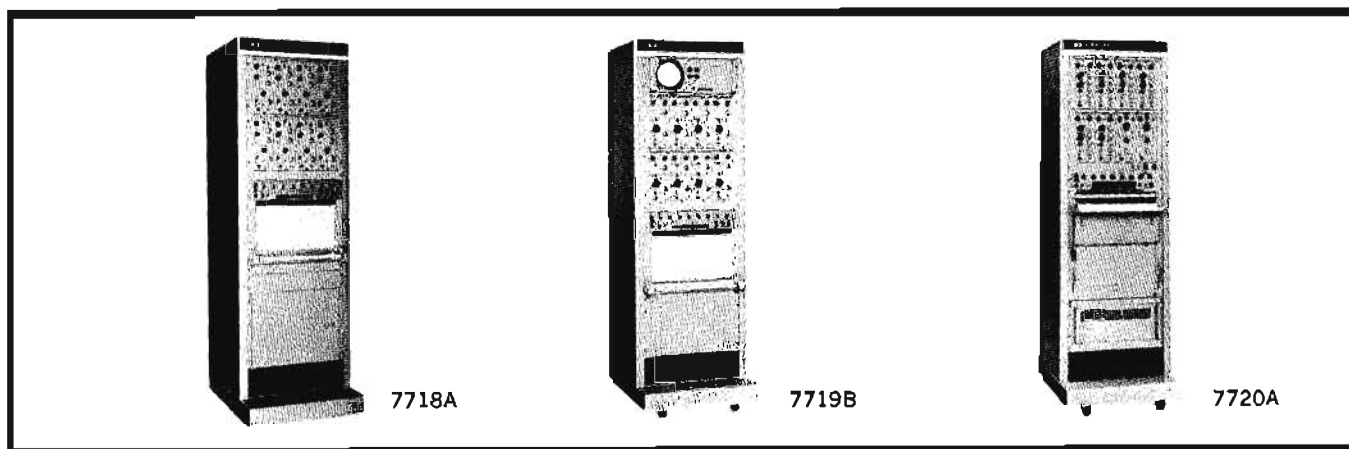

7718A Eight channel recording system

The 7718A eight channel thermal recording system provides the advantages of eight recording channels on one chart, with a wide response from dc to 150 Hz unless limited by the preamplifiers. This provides a maximum of recording facilities, which adds flexibility to both clinical and research applications, and furnishes a maximum amount of recorded data for any one observation. The eight recording channels are each 40 mm wide, divided into 50 divisions. The system operates with any eight of the "350" series of plug-in preamplifiers. Electrically selected speeds by pushbutton are 0.25, 0.5, 1, 2.5, 5, 10, 25, 50, and 100 mm/sec.

Power requirements: 115 V, 60 Hz, 950 watts.

Overall size: 72 $\frac{1}{8}$ " high, 22-1/16" wide, 30" deep (1832 x 560 x 762 mm).

Weight: net 532 lbs (240 kg); shipping 628 lbs (283 kg).

Price: HP Model 7718A, \$6350.

Option 01: less cabinet; requires adequate cooling; deduct \$375. Option 02: in portable cases; no extra charge. Option 06: ECG input facility; add \$200. Option 08: 50 Hz operation; add \$50. Option 09: adds 230 volt transformer 66A-10; specify in cabinet or loose; add \$100. Option 11: add mm/min speeds; recorder 358-100D; add \$250. Option 12: less one channel deduct \$200. Option 15: extra marker, add \$70.

7719B Eight Channel Recording System

The 7719B eight channel thermal recording system features a visual display facility as a standard part of the completed system. This facility is designed around a cathode ray oscilloscope, and may be used for the display of vectorcardiographic loops, or for showing other physiological phenomena such as ECG, EEG, pulse waves, etc. The entire system is complete in one upright cabinet, and includes provisions for inserting any selection of eight "350" series plug-in preamplifiers. Each of the eight recording channels is 40 mm wide, divided into 50 divisions, with a recorded frequency response from dc to 150 Hz unless limited by the preampli-

fier. Electrically selected speeds by pushbutton are 0.25, 0.5, 1, 2.5, 5, 10, 25, 50, and 100 mm/sec.

Power requirements: 115 V, 60 Hz, 950 watts.

Overall size: 72 $\frac{1}{8}$ " high, 22-1/16" wide, 30" deep (1832 x 560 x 762 mm).

Weight: net 532 lbs (240 kg); shipping 628 lbs (283 kg).

Price: HP Model 7719B, \$7325.

Option 06: add ECG input facility; add \$200. Option 08: 50 Hz operation; add \$50. Option 09: adds 230 volt transformer 66A-10; specify in cabinet or loose; add \$100. Option 11: add mm/min speeds; recorder 358-100D; add \$250. Option 12: less one channel deduct \$250. Option 15: extra marker, add \$70.

7720A Eight channel recording system

The 7720A eight channel thermal recording system operates with any eight "350" preamplifiers. The system features a horizontal chart table, for easier notation on the recording. Multi-channel recording furnishes a maximum amount of information on the chart for clinical or research measurements. Recording channels are 40 mm wide, 50 divisions, with a recorded response from dc to 125 Hz, unless limited by the preamplifier. Mechanically selected chart speeds are 0.25, 0.5, 1, 2.5, 5, 10, 25, 50, and 100 mm/sec.

Power requirements: 115 V, 60 Hz, 950 watts.

Overall size: 72 $\frac{1}{8}$ " high, 22-1/16" wide, 30" deep (1832 x 560 x 762 mm).

Weight: net 532 lbs (240 kg); shipping 628 lbs (283 kg).

Price: HP Model 7720A, \$6650.

Also available: 7721A, six channel; price \$5620. 7722B, eight channel, with visual display; price \$7725. 7723B, six channels, with visual display; price \$6695.

Option 06: ECG input facility; add \$200. Option 08: 50 Hz operation; add \$50. Option 09: add 230 volt transformer 66A-10; specify in cabinet or loose; add \$100. Option 12: less one channel; deduct \$200. Option 15: extra marker, add \$70.

OSCILLOGRAPHIC RECORDING *continued*

Versatile, reliable, wide range
7700, 7800, 4500 Series

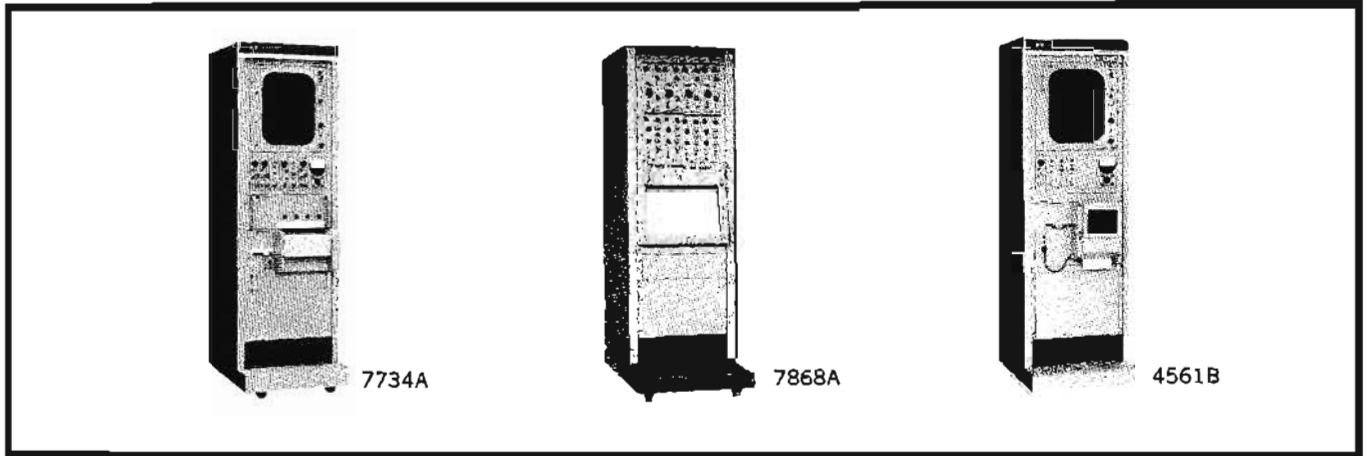
**7734A Monitor Recording System**

The 7734A system features a complete, multi-channel 13½" x 10" (viewing area) oscilloscope for data presentation, with a four-channel data recorder having a dc to 125 Hz response (unless limited by Preamplifier). Oscilloscope sweep speeds are 3, 6, and 12 mm/second, automatic or manual, plus 30 mm/second manual, on a long persistence screen. The thermal recorder makes an instantaneous record on four 50-mm channels at a mechanically-selected speed of 0.25, 0.5, 1, 2.5, 5, 10, 20, 50, or 100 mm/second chart speed. The system uses any six 760-series preamplifiers; the output from four appears on the oscilloscope and recorder, leaving two channels for other display or for mounting other plug-in units.

Power requirements: 115 V 60 Hz, 600 W.

Overall size: 72-½" high, 22-1/16" wide, 30" deep (1841 x 560 x 762 mm).

Weight: net 408 lbs (184 kg), shipping 504 lbs (225 kg).

Price: HP 7734A, \$4980. Option 08, 50 Hz operation, add \$50.

Option 09, 230 V operation, add \$100. Option 15, extra marker, add \$70.

4561B Monitor Recording System

The 4561B system features a wide-range, four-channel optical recorder (Rapid Developer optional), plus a multichannel large-screen monitoring oscilloscope. The recorder, with its eight manually-selected chart speeds (2.5 to 200 mm/second; 5-100 mm/second with Rapid Developer) use either 6" wide, 200' long bromide recording paper, or (with Rapid Developer) a 6 cm wide, 175' long roll. Paper is darkroom-loaded, exposed in the recorder under normal room illumination, then developed in the darkroom or by Rapid Developer 563. Beams may be superimposed, or separated into their individual portions of the chart. Amplitude and timing lines are recorded at the same time as the data, with the timing lines being controlled by an independent synchronous motor. Recorded frequency response extends from dc to 500 Hz (other ranges available) unless limited by the Preamplifier. The monitoring oscilloscope is the same as used in the 7734A, and provides the same features. The system uses any six 760-series Preamplifiers; the output from four appears on the oscilloscope and recorder, leaving two channels for other display or for mounting other plug-in units.

Power requirements: 115 V 60 Hz, 650 W.

Overall size: 72-½" high, 22-1/16" wide, 30" deep. (1841 x 560 x 762 mm).

Weight: net 408 lbs (184 kg), shipping 533 lbs (240 kg).

Price: HP Model 4561B, \$4765. Option 08, 50 Hz operation, no extra charge. Option 09, 230 V operation, add \$100.

7868A Fluid-Process Recording System

The 7868A fluid-process recording system features an advanced chart feed and pressure-modulated recording fluid supply, which permits recording on either Z-fold packs, or on rolls of recording chart paper. The low-pressure recording fluid supply is pressure modulated to match the recording pen velocity, for a closely regulated flow of recording fluid. This provides a constant width line at all recording velocities, and prevents leakage as the pen passes over the fold of Z-fold chart paper. The sturdy, geometrically accurate linkage system provides true rectilinear recording over a long service life. The change from Z-pack to rolls may be easily completed in a matter of moments.

Any combination of eight "350" series plug-in preamplifiers may be used as signal conditioners, for a wide range of physiologic or other variables. Fourteen chart speeds from 0.025 to 200 mm/second provide wide flexibility, to match the waveforms of the data being recorded. All parts of the recorder, including the new, straight-line modular design chart speed reduction mechanism, are accessible for easy maintenance. Chart rolls and Z-fold packs are numbered for easy reference to recorded data. The recording fluid cartridge supplies over 1,000 miles of recorded line, and may be replaced without shutting down the system; a warning light indicates when replacement is necessary.

Power requirements: 115 V 60 Hz, 350 W (less Preamplifiers).

Overall size: 72-1/8" high, 27-7/8" wide, 35-3/4" deep (1852 x 606 x 906 mm).

Weight: 550 lbs (249 kg), in cabinet, with representative group of "350" Preamplifiers.

Prices: 7868A system, without Preamplifiers, \$10350. Option 01, less cabinet, deduct \$425. Option 02, portable cabinet, no extra charge. Option 08, 50 Hz operation, add \$50. Option 09, 230 V operation, add \$100.

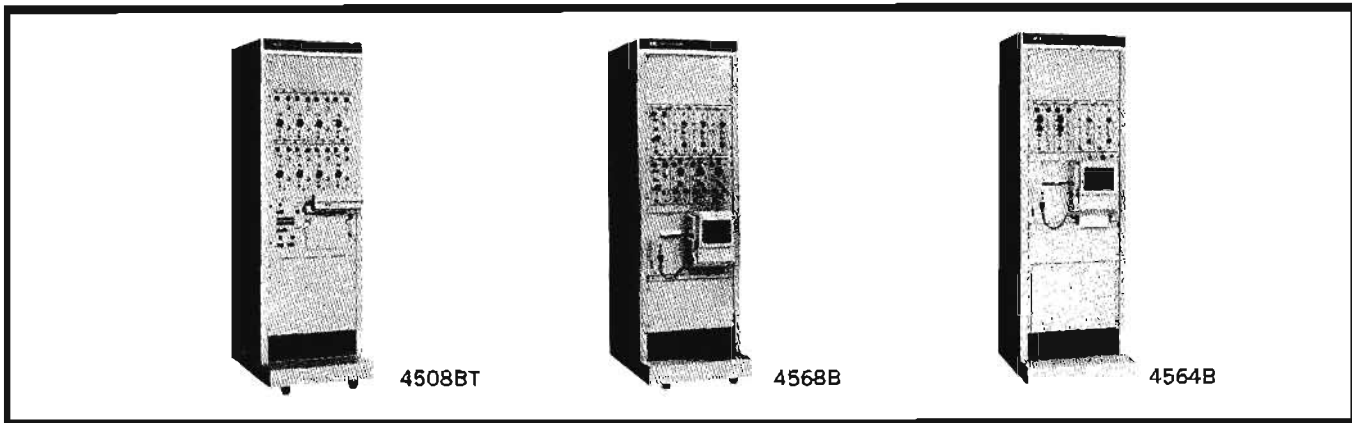

4564B Photographic Recording System

The 4564B Photographic Recording System features the same optical recorder as is used in the 4561B system, but utilizes the more versatile series of 350 plug-in preamplifiers. These preamplifiers permit recording an extensive range of physiologic phenomena, at a frequency range from dc to 500 Hz, or as limited by the preamplifier (to 1 kHz with 350-1700C). Rapid Developer 563 (optional) provides the advantages of wide-range optical recording without the delay of darkroom processing before the final recording may be used.

Power requirements: 115 V 60 Hz, 700 watts (approx.).
Overall size: 72½" high, 22-1/16" wide, 30" deep (1841 x 560 x 762 mm).

Weight: net 458 lbs (206 kg); shipping 554 lbs (252 kg).
Price: HP Model 4564B, \$3455.

Options

- | | |
|---|-----------------|
| 06 ECG input facility; add | \$200 |
| 08 50 Hz operation | no extra charge |
| 09 Adds 230 volt transformer 66A-10; specify in cabinet or loose; add | \$100 |
| 13 Add slides for 780-6A scope; add | \$ 25 |
| 14 With 8-channel signal cable for 780-6 Option 01; add | \$ 50 |

4568B Photographic recording system

The 4568B photographic recording system features the same optical photographic recorder as used in the 4561B and 4564B systems, operating with any eight of the "350" series of plug-in preamplifiers, to provide eight separate or overlapping channels of wide-range data recording. Use of all eight channels provides a thorough presentation of physiologic events and their waveforms, as they may occur in clinical investigation of a patient, or in research-oriented experimentation on a subject. The wide frequency range of the recording, which extends from dc to 500 Hz unless limited by the preamplifier (to 1 kHz with 350-1700C) permits extensive small-animal investigation, as well as routine recording of such high frequency variables as heart sounds and electromyographic potentials. Other ranges available on order.

Power requirements: 115 V, 60 Hz, 1000 watts (approx.).
Overall size: 72½" high, 22-1/16" wide, 30" deep (1841 x 560 x 762 mm).

Weight: net 456 lbs (206 kg); shipping 552 lbs (248 kg).
Price: HP Model 4568B, \$5160.

Options

- | | |
|---|-----------------|
| 06 ECG input facility; add | \$200 |
| 08 50 Hz operation | no extra charge |
| 09 Adds 230 volt transformer 66A-10; specify in cabinet or loose; add | \$100 |
| 13 Add slides for 780-6A scope; add | \$ 25 |
| 14 With 8-channel signal cable for 780-6A Option 01; add | \$ 50 |

4508BT Ultra-violet recording system

The 4508BT system features a special ultra-violet sensitive recording paper whose latent image may be developed simply by exposure to fluorescent illumination. The chart paper roll may be loaded under normal room lighting, and is developed by the built-in post-exposure fluorescent lamp, so the multi-channel data may be viewed a few seconds after it is recorded. The system uses any eight of the "350" series preamplifiers, for a recorded frequency response from dc to 500 Hz (to 1 kHz with 350-1700C) unless limited by the preamplifier. The recorder provides nine pushbutton selected speeds in the range of 2.5 to 1000 mm/sec. Data channels may be separate, or may overlap to the full width of the eight-inch chart. Time and amplitude lines are recorded with the data, for maximum accuracy.

Power requirements: 115 V, 60 Hz, 1600 watts (approx.).
Overall size: 72½" high, 22-1/16" wide, 30" deep (1841 x 560 x 762 mm).

Weight: net 19 lbs (85,5 kg); shipping 250 lbs (113 kg).
Price: HP Model 4508BT, \$7100.

Options

- | | |
|---|-----------------|
| 06 ECG input facility; add | \$200 |
| 08 50 Hz operation | no extra charge |
| 09 Adds 230 volt transformer 66A-10; specify in cabinet or loose; add | \$100 |
| 13 Add slides for 780-6A scope; add | \$ 25 |
| 14 With 8-channel signal cable for 780-6A Option 01; add | \$ 50 |

RESEARCH



MAGNETIC TAPE RECORDING

High performance, moderate cost, compatible
Models 3907B, 3914B, 3917B, 3924B

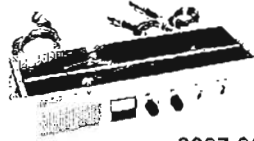

3907-06A
Voice Channel Amplifier

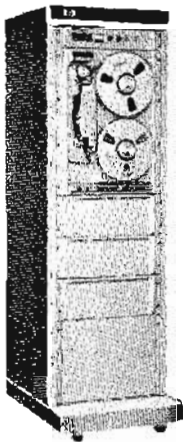

3900 Series
Vertical
Mobile
Cabinet

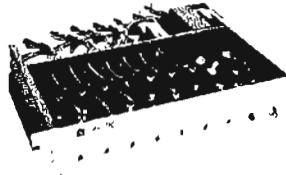

3907-07A
Input Coupling Amplifier

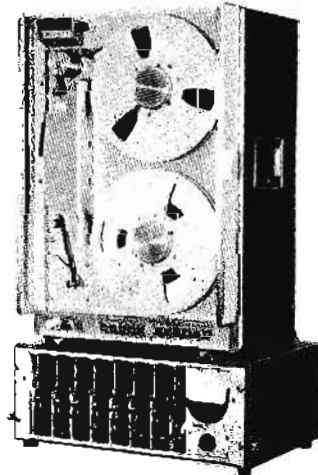

3907B Option 02
Portable Cases
For Transport
And Amplifiers

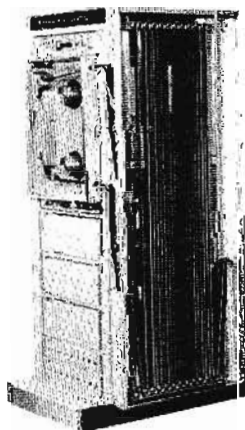

3907-04B Tape Loop Adapter



3907-11A
Remote
Control Unit

System Choices—Performance Features. HP 3900-series magnetic tape record/reproduce systems are available with 7 or 14 analog data recording channels, plus one edge-channel for recording voice commentary, 6 standard speeds from $1\frac{7}{8}$ ips to 60 ips, with user's choice of plug-in circuit cards for direct, FM or pulse-mode recording. Standard bandwidth systems (3907B, 3914B) have a max. frequency response in direct mode of 100 kHz; intermediate bandwidth systems (3917B, 3924B), response to 250 kHz max. As shown at left, system may be housed in vertical mobile cabinet, or tape transport and electronics packaged in separate portable cases.

Performance of these systems is compatible with the widely-accepted standards of the Inter-Range Instrumentation Group, making it possible to playback 3900-tapes on other IRIG-compatible systems, and vice-versa. Representative specifications include: 0.2% p-p flutter (dc to 200 Hz, at 30 and 60 ips); extremely low inter-channel crosstalk (even when direct and FM channels are mixed on the same head stack); 40 db or better signal-to-noise ratio; direct connection of single-ended inputs from 0.5 to 10 V rms (direct) and ± 1.2 to ± 3 V p-p (FM), 20 k input resistance; 4 sec. max. start time and 2 sec. max. stop time; max. interchannel time displacement error ± 1 microsec. at 60 ips.

Advantages in Medical/Biophysical Applications. Magnetic tape instrumentation offers the clinical and research investigator a unique means of obtaining *all* physiologic data from a procedure—economically, in a compact medium, and in its original dynamic form. Moreover, it enables him to *reproduce* the original data seconds or days later, either at its original frequency or over a longer or shorter time interval, by oscilloscope display, graphic recording, or for further processing by instruments such as electronic integrators, differentiators, spectrum analyzers, or analog-to-digital converters for computers analysis. The Hewlett-Packard system in one hospital heart station, for example, puts all measured data on tape with simultaneous monitoring by scope; tape playback is occasionally used during the procedure for a "second look" at significant events, and at a later time to review all data to select specific portions for permanent graphic recording. The laboratory also uses a second 3907B system, in conjunction with data-analyzing instruments, to tape record derivations of the original data while preserving the original tapes.

An important advantage to the purchaser of magnetic tape recording systems for OR and laboratory facilities such as these is the *compatibility* of 3900 systems with all other Hewlett-Packard equipment in the system. This characteristic, described in the examples on the facing page, is augmented by such other benefits as ease of tape reel loading; system alignment without elaborate equipment or special skills; rapid location of data by precision footage counter; virtually no maintenance of tape transport mechanism; availability of optional tape speeds; purchase of only those circuit plug-ins needed for desired operating mode; and the wide choice of accessories shown at left.

SYSTEMS CAPABILITIES



RESEARCH

The photograph at right and the functional block diagram below show two of many systems using 3900-series magnetic tape instrumentation, in conjunction with other Hewlett-Packard signal conditioning/recording/display instruments, which have been designed, built and installed by Hewlett Packard. The system at right is designed for a Cardiovascular Research Laboratory of an 800 bed hospital, and is capable of displaying up to eight phenomena simultaneously on a 17" oscilloscope; photographically recording six variables from dc to 500 Hz; recording and reproducing 7 variables from magnetic tape. One of the system's important functional elements is a signal distribution and control unit (Model 568-2000 Control Panel, below signal conditioners in left cabinet): it enables the operator to select either the signal conditioner outputs or tape recorded data for display and/or graphic recording; attenuate, position, remove and calibrate each signal according to the needs of a specific procedure and for uniform correlation among traces—from a single, compact, self-powered unit which is a standard HP product and integral to the system.

The systems engineering capabilities represented by the block diagram are applicable to the monitoring/recording requirements of a catheterization laboratory. Maximum information with minimum equipment and clutter in the cath. lab itself (dotted outline) are provided by features such as waveform and numerical displays at both ends of the room, all patient signal leads fed to other instrumentation (in an adjoining room) through a junction box on the OR table, and a max. signal display capacity of 10 patient variables. This system also employs both 350 and 760-series signal conditioners because of the number and nature of the physiologic variables, and in certain instances, to derive additional data from these variables. As in the system above, the Control Panel affords the operator convenient and complete control and adjustment of signals and desired signal paths.

Although these two configurations are representative of many different systems, each specifically oriented to the needs of a particular OR, hospital laboratory or research center, they provide their users with advantages no other company can offer: a *complete* choice of medical electronic instrumentation for all needed functions; *standard* instruments, cabinetry and cabling designed to be electrically and mechanically compatible with

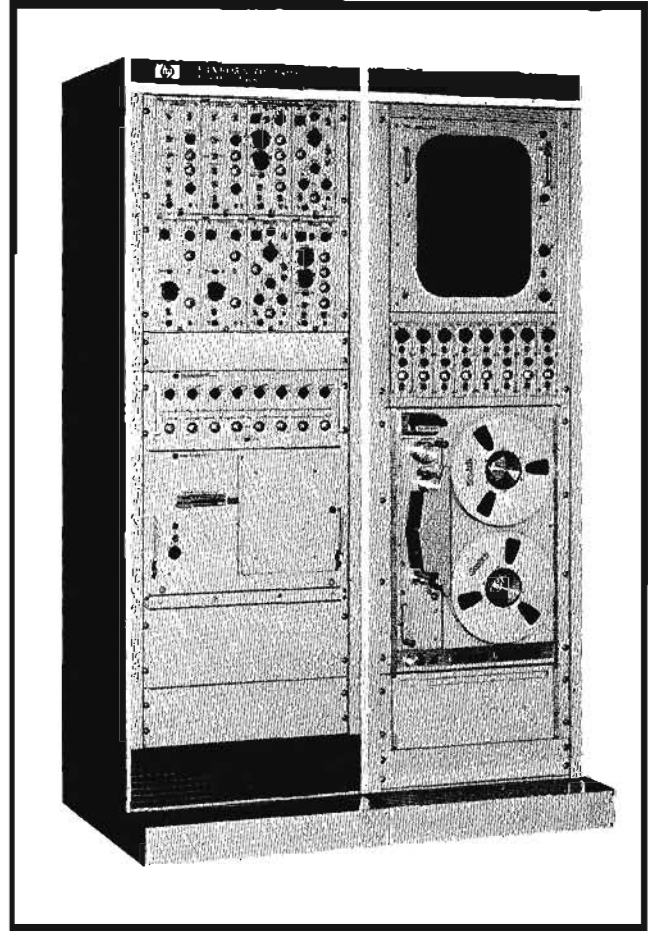

each other; a *single*, highly-experienced source of total system design, manufacture and check-out of all system components, and responsibility for proper operation; and constantly available service from people completely familiar with every element of the system.

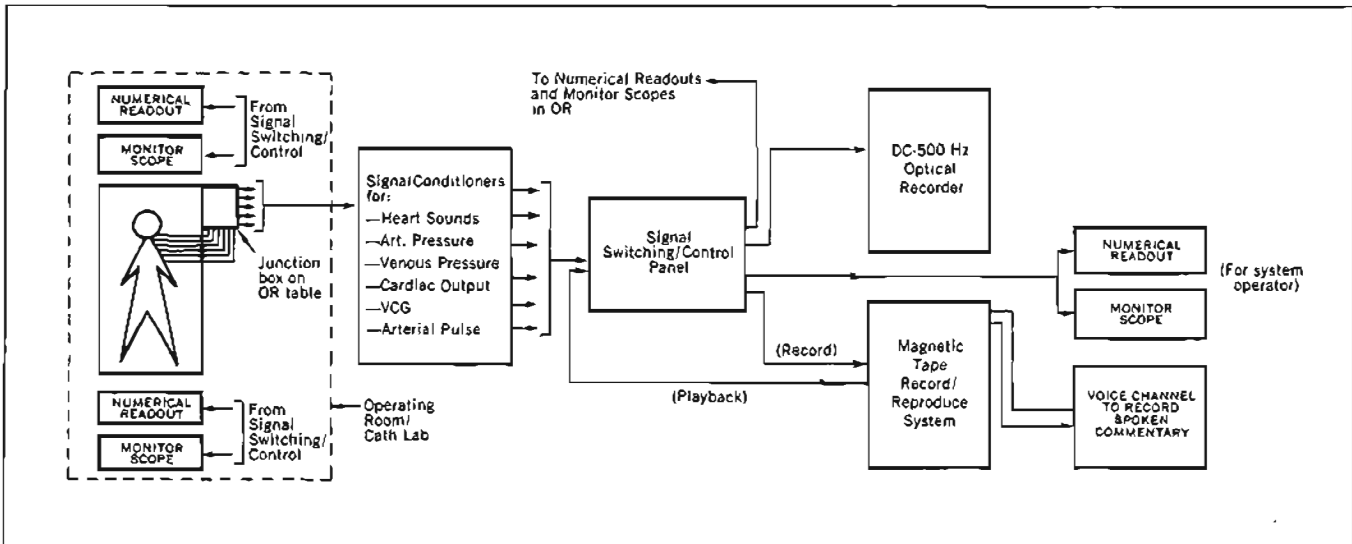



PATIENT MONITORING

Readout: thermal dilution; cardiac computer
Models 5601A; 350-15A; 130

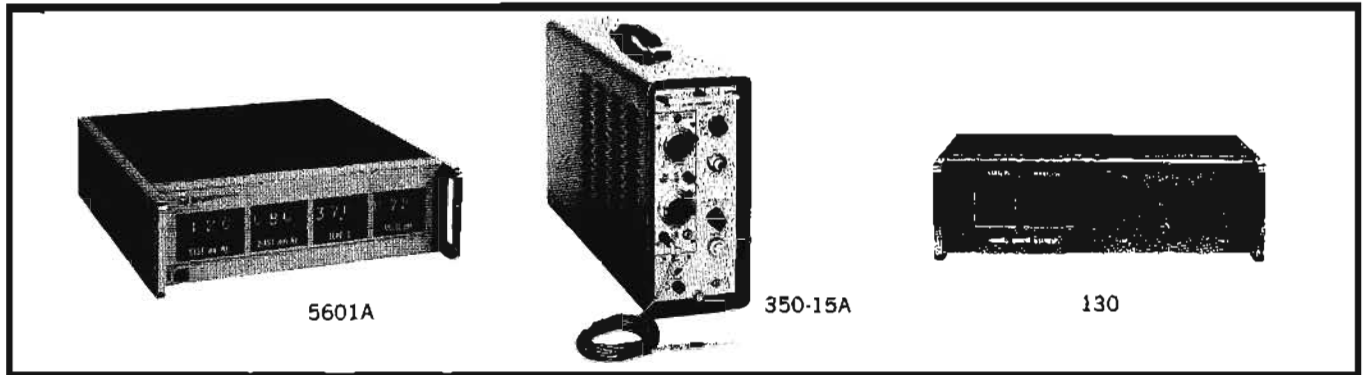

Model 5601A Numerical Readout

Model 5601A Numerical Readout displays 3-digit values of four slowly-changing phenomena such as blood pressures; heart, pulse and respiration rates; and temperature. Each channel samples phenomena at a rate adjustable from once every 1.5 sec. to once every 10 sec. Input can be from 780-series monitors; 350, 760 or most other medical signal conditioners. Highly visible lighted numerals 0.6" high display values; left-hand channel can have a fourth digit, the numeral "1" only, as the most significant figure for temperature in °F (see Option 10). Illuminated decimal point in each channel can be manually positioned, and will blink to show rate of phenomena when connected to rate signal from 760-3, or suitable 780-series monitor. Instrument can be ordered with user's choice of sequence and type of phenomena according to options listed, and easily modified for other types or sequences by Hewlett-Packard field office. For multiple display, several units may be synchronized by interconnection. Outputs available for HP Model 562A Digital Recorder. Size: 16 $\frac{3}{4}$ " wide, 5-9/16" high, 16 $\frac{3}{8}$ " deep (426 x 141 x 422 mm). Weight: 30 lbs (13,5 kg). Power: 115/230 V, 50-60 Hz, 40 watts. Prices: 5601A sub-system (w/out readout modules), blue case, white panel, \$700. Option 01, gray panel, add \$25. Following options are readout modules, any four of which added to sub-system make a complete unit: 02, Systolic, 0-300 mm Hg: \$350; 03, Diastolic, 0-300 mm Hg: \$350; 04, Venous, 0-30 mm Hg: \$350; 05, Pulse, 0-300/min: \$350; 06, Heart Rate, 0-300/min: \$350; 07, Mean, 0-300 mm Hg: \$350; 08, Temp, 10-40°C: \$450; 09, Temp, 30.0-45.0°C: \$450; 10, Temp, 90.0-105.0°F (Ch. 1 only): \$450; 11, Resp, 0-75/min: \$350; 20, BCD output: \$250. Specify channel location of each readout module.

Thermal Dilution System

Thermal Dilution System consists of a 14012A calibrated thermistor temperature probe, 350-15A calibrated bridge circuit plug-in used in a 350-1500A Low Level Preamplifier, and for readout an HP multi-channel recorder or Moseley single-channel 5" strip chart recorder. Cardiac output determinations may also be obtained by connection to a Model 130 Cardiac Output Computer (see below). The system permits estimation of left ventricular volume, by rapid and accurate measurement of the thermal dilution occurring at a point downstream from the injection site of

sterile saline in a chamber of the heart. The technique and system allow estimation of left ventricular volume from beat-to-beat data; measurement without withdrawing or re-infusing blood; greater economy than dye dilution methods; excellent patient tolerance of indicator without baseline build-up or recirculation; and fast response to intracardiac dynamic changes. Thermistor probe is aged and selected for stability, individually calibrated and supplied with chart showing absolute temperatures to two decimal places corresponding to one-ohm increments between 1000 and 2999 ohms. Probe is 125 cm long, 1 mm O.D. (0.39") or French scale 3. (For details of 350-1500A and 350-15, see pages 62-63.) Prices: Model 14012A Thermistor Probe, 10' cable, calibration chart: \$190. Model 350-15A Thermal Dilution Plug-In (for 350-1500A): \$265. Model 350-1500A Low Level Preamplifier and 350-500B Power Supply in 450 portable case: (115/230 V, 50-400 Hz): \$790. Less case, deduct \$90. Less Power Supply, deduct \$175.

Model 130 Cardiac Output Computer

Model 130 Cardiac Output Computer, used with most standard densitometer such as Gilford and Waters, or other indicator dilution device, automatically computes the area of the primary circulation curve, provides the calibration factor and continuously displays data in illuminated numerical form. By eliminating the need to re-plot the dye curve and manually compute the area under the curve, it enables the user to make decisions regarding further measurements while the procedure is in progress. Cardiac output in liters/min. is easily obtained by simply dividing totalized integration count by the calibration factor. Continuous "on-line" operation provides all needed data in usable form slightly before completion of dye curve. Additional features of the 130 include: a baseline sensing circuit to assure maximum integration accuracy of the primary circulation curve, and which also eliminates the necessity of zeroing the densitometer at the beginning of each dye curve; sufficient readability of numerals from a distance to permit remote operation of Start and Reset controls; electrical binary coded decimal output suitable for printers, digital computers; and recorder output for graphic recording of the dye curve. Size: 5 $\frac{1}{4}$ " high, 19" wide, 11" deep (133 x 483 x 280 mm). Weight: 21 lbs (9,4 kg). Power: 115/230 V, 50-60 Hz, 70 watts. Price: Model 130 Cardiac Output Computer, \$1850.

Recorders, Data Acquisition Systems, Computers and Peripherals

Computers and Peripherals	102-112
Computers	102
Digital Tape Systems	108
Optical Mark Reader	112
Data Acquisition Systems	90-101
Data Acquisition Systems	96
Digital System Elements	
Analog-to-Digital Converters	93
Comparator	93
Data Linearizer	93
Digital Clock	94
Input Scanners	92
Output Couplers	94
Programmeters	94
Signal Converters	92
Recorders	113-170
Accessories	
Digital Clock	117
Digital-to-Analog Converters	117
Keyboard	135
Line Follower	135
Logarithmic Converters	134
Magnetic Tape Equipment	170
Point Plotters, Character Printers	135
Roll Chart Adapters	135
Transducers	158
Digital	113
Magnetic Tape	161
Oscillographic	136
Amplifiers, Preamplifiers	150
Fluid-Process	146
Optical	149
Technical Information	130
Thermal	138
Strip Chart	129, 131
X-Y	119

DATA ACQUISITION



DIGITAL DATA ACQUISITION SYSTEMS

Instrumentation systems can be categorized into two basic classes: digital and analog. An analog system usually consists of a set of signal conditioning and measuring and recording equipment for each transducer. In a digital instrumentation system, the measuring and recording equipment are sequentially used by the transducers; and for a given type of measurement, signal conditioning equipment may be shared.

Analog data systems are used when wide bandwidth is required or when less accuracy can be tolerated. Digital data acquisition systems are used when the physical process being monitored is slowly varying (narrow bandwidth) and high accuracy and low per-channel cost are required.

Digital systems range in complexity from economical single-channel dc voltage measuring and recording systems to sophisticated, totally automatic multiple-channel systems that measure all electrical parameters, compare against preset limits and perform computation and decisions on the input signal. Systems are available in a wide range of speed and accuracy. Applications span individual data logging to high-speed automatic checkout.

Data system applications

Data acquisition systems, in general, are applied in many of the same situations as digital voltmeters. Systems are used to measure analog signals originating in two different ways:

1) Direct measurement of electrical quantities. This includes dc and ac voltages, frequency and resistance, and applies typically to areas of electronic component and subassembly testing, environmental and QA testing.

2) Signal inputs from transducers which are in common use, i.e., strain gage and thermocouples. Digital systems are generally found wherever multiple installations of transducers or electrical pickups are employed.

Dymec data acquisition systems include five series of standard packages engineered for a variety of input and output situations. Specific advantages resulting from standard system design include:

Quick delivery. Since systems are composed of standard instruments and cables, standard production techniques can be employed.

Better specifications. Each system is a thoroughly engineered and completely

tested package and is completely specified on a data sheet. Ease of system expansion is assured with a wide variety of standard options.

Greater reliability—through the use of production techniques as applied to standard Hewlett-Packard instruments. These techniques have obvious advantages over the "one shot" system that has to be custom engineered and produced.

Low price. Systems are composed of standard, systems-oriented instruments. Special system engineering prices are not required.

Data acquisition systems

The 2010 Series of systems (pages 96, 97) measure dc voltage and frequency with both visual readout and permanent output recorded on printed strip, punched card or tape or magnetic tape. Optional equipment permits measurement of ac voltage, resistance, plus dc measurements of ± 10 mV full scale. Programmable high-low limit comparison can be accomplished on any of the above parameters. System operation can be controlled by either pin-board or punched-tape programming. In this series the measuring element (analog-to-digital converter) is the floated and guarded 2401C Integrating Digital Voltmeter, which permits accurate low-level measurement even in the presence of severe common mode noise and noise superimposed on the measured signal.

2012 Systems operate at a faster measuring rate than the 2010 Systems, and retain high noise rejection. The 2402A Integrating Digital Voltmeter (page 240) combines high speed with high resolution. Output devices include printed strip, typewritten sheet, punched tape or card and magnetic tape. Optional plug-in circuit cards expand the measuring capability to include AC, resistance and frequency inputs.

The economical 2013 Series, which incorporate the 3440A Digital Voltmeter as the measuring device, provide multiple-point scanning capability with output on printed strip, typewritten record or punched card or tape.

The 2017 Series systems parallel the 2010 Series in regard to input and output devices and system auxiliary equipment. All systems incorporate the 2417A Data Linearizer (page 94) to permit direct readout in familiar measurement units. These systems apply to areas of transducer measurement where, for example, display of thermocouple outputs in de-

grees rather than millivolts is needed.

The 2018A Data Acquisition System incorporates a 2116A Digital Computer (pages 102-105) as a system element. Operation of the scanning, measuring and recording devices is under control of the computer and can respond to the input signal in a pre-determined manner. System components and functional operation are basically the same as a 2010 System. This type of data acquisition system offers flexibility in system programming, timing and sequencing, and computation can be done at the time of measurement—operational versatility is expanded manyfold. The system maintains all benefits of the modular system concept common to all Hewlett-Packard digital systems. Additionally, modular software makes system expansion a simple matter.

Digital data system elements

Elements making up a digital system may include all or part of those listed and illustrated. Essential functional operations within a digital system include handling analog signals, making the measurement, handling digital data and internal programming and control. The function of each of the system modules illustrated is:

Transducer. Translates physical parameters to electrical signals acceptable by the data acquisition system. Typical parameters include temperature, pressure, acceleration, weight, displacement and velocity. Electrical quantities such as voltage, frequency or resistance also may be measured directly.

Signal conditioner. Provides excitation power to transducer. As necessary, it also provides balancing, calibration and bridge completion circuitry. An example is a strain gage bridge balance and power supply unit.

Scanner. Accepts multiple analog inputs and sequentially connects the signals to one measuring instrument. Inputs may be in the form of millivolt or high level ac or dc voltage, resistance frequency, period, time interval or events occurring in a specified time interval.

Signal converter. Translates the analog signal to a form acceptable by the analog-to-digital converter. An example is amplification of low-level signals from thermocouples or strain gage bridges.

Analog-to-digital converter. Converts the analog signal to its equivalent digital

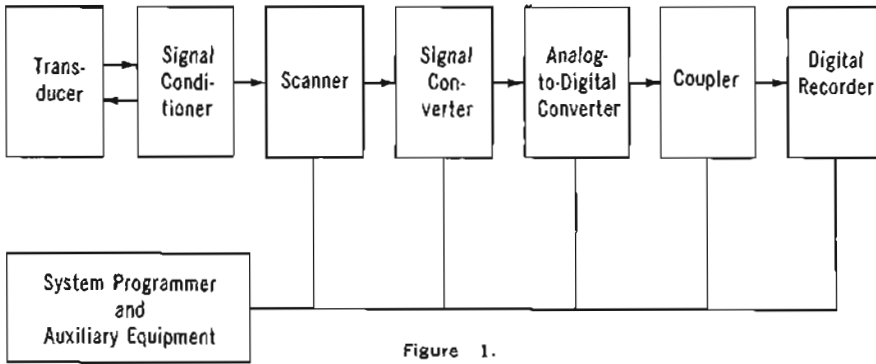

Figure 1.

form. Output is a visual display and voltage outputs for further processing or recording on a digital recorder.

Auxiliary equipment, programmer. Performs system programming and digital data processing functions within a system. Typical auxiliary functions include hi-lo limit comparison, linearizing, time. These functions can be performed by individual instruments or by a computer if one is included in the system during on-line operation.

Coupler. Receives digital information from the analog-to-digital converter and translates it to the proper form for entry into a digital recorder. This conversion function can be performed by a computer or by a coupling instrument.

Digital recorder. Records digital information on punched cards, perforated paper tape, magnetic tape, continuous printed paper strips, typewritten pages or combinations of these media.

Data acquisition systems are used in many cases to measure low-level signals, and often these measurements must be made in the presence of large amounts of noise. A typical case would be the measurement of a millivolt level dc voltage from a thermocouple, which is measured in the presence of tens or even hundreds of volts of common mode.

Other noise sources include electrostatic or electromagnetic pickup, and noise inherent to the transducer. All forms of noise are seen by the digital voltmeter as a periodic and/or random disturbance superimposed on the real signal level.

There are two ways of combatting noise: the voltmeter should be designed to discriminate the real signal from the superimposed noise appearing at its input terminals. Second, effort should be made to prevent these sources of noise from producing superimposed noise at the voltmeter input terminals.

Noise inherent in the transducer will inevitably appear at the voltmeter input as superimposed noise. Electrostatic and electromagnetic pickup on the signal leads, both from the surrounding equipment and the voltmeter power supply circuits, will give rise to superimposed noise unless precautions such as shielding, avoidance of ground loops, etc., are taken. Common mode pickup, which is noise induced in the signal circuit by circulating ac ground currents, requires guarding techniques for its elimination.

Guarding

Induced ac ground currents, usually at the power line frequency, can generate a potential of several volts between the

signal source ground and the voltmeter chassis ground. Unless blocked, these currents will cause a voltage to appear at the voltmeter input which can easily be larger than the signal itself, resulting in a completely erroneous reading. This effect is known as common mode ac pickup. A conventional floating input can reduce common mode pickup to some extent, but it is limited in its effectiveness by the capacitance between the measuring circuit and chassis (Fig. 2a). In addition, current injection from the voltmeter power supply can create a measurement error. Use of a heavy ground buss or shield usually will not reduce common mode pickup appreciably and may even increase it, due to magnetic pickup from the ground loop formed.

Guarding as employed in the 2401C, 2402A, 3460B, H04-3460A, and 3459A completely isolates the floating measuring circuit from the chassis; the guard effectively breaks the common mode loop (see Fig. 2b). With the guard of the 2401C operated at the ground potential of the signal source, the common mode rejection (defined as the ratio between the common mode signal and the spurious voltage it causes to be superimposed on the signal to be measured) exceeds 120 dB at 60 Hz and 160 dB at dc, with a groundleg impedance of 1000 ohms between the source ground and the low side of the voltmeter input.

The 2401C average-reading characteristic further attenuates the common mode voltage. To take a practical example, the combined effect of guarding and averaging is such that a common mode potential of 100 volts will not cause a discernible error in the 2401C reading, even on its most sensitive range.

Guarding provides an absolute solution to the problem of common mode pickup from grounded signal sources. This is especially valuable in systems applications where the alternative solution, floating the signal sources, would be extremely troublesome.

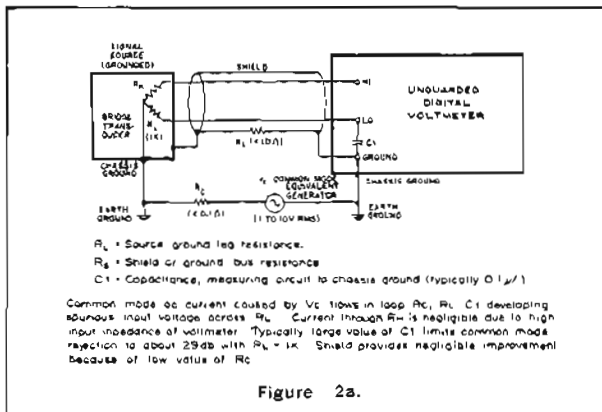

Figure 2a.

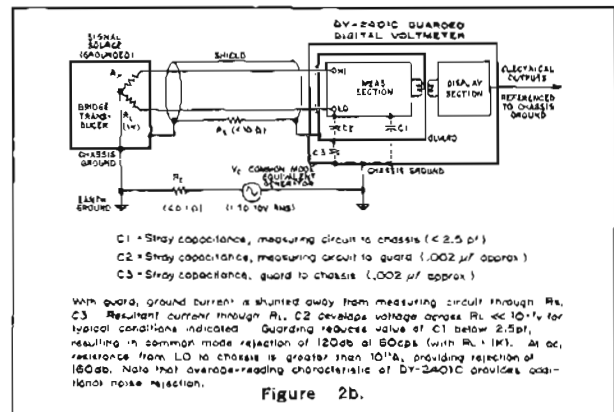

Figure 2b.



Signal conditioners

2480 Series Signal Conditioning Modules (page 624) provide dc excitation and signal conditioning for strain gage transducers, resistance thermometers and other variable resistance devices. They incorporate full floating and guarding, and are particularly useful in data acquisition systems having guarded digital voltmeters and data amplifiers, pro-

viding maximum system accuracy and minimizing common mode noise problems.

Excitation sources and the associated signal conditioning circuitry share the same instrument case. Ten instruments plug into a combining case which occupies 5 1/4" (133 mm) of vertical panel space.

Prices: 2480A Power Supply, \$245; 2480C Excitation Coupler with local regulation, \$110; 2480K Excitation Coupler, \$35; 2481A Resistance Bridge, \$65; 2482N Monitor Function Selector, \$125; 12521A Combining Case, \$500.

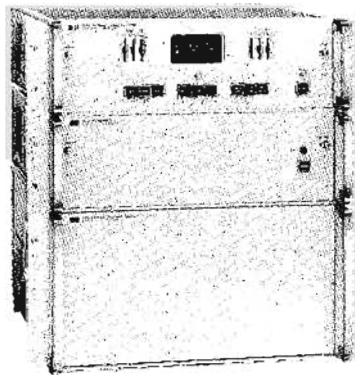

2911A,B,C



2901A

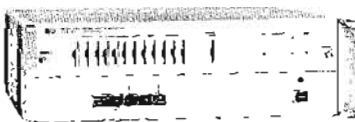

2515A

Input scanners

2911 Guarded Crossbar Scanner for rejection of common mode noise. User may select 600 1-wire, 300 2-wire, 200 3-wire, or 100 6-wire inputs. Lower and upper scan limits selectable at front panel, with random access to any channel. Channel being monitored is indicated by in-line visual display and 4-2'-2-1 BCD (optionally 8-4-2-1) output. Roller-mounted switch withdraws from rear for easy cabling. Maximum scanning rate is 30 channels/second. Panel height 14" (355 mm). Price 2911, \$5,100.

2901A Input Scanner/Programmer scans 25 3-wire inputs and programs all functions of associated system. May be expanded to 100 channels with 2902 Slave Units. Easy system set-up with individual quick-release input connectors and pushbutton selection of channels to be scanned. System functions and measurement delay are programmed individually for each channel with built-in pinboard. Maximum scanning rate is 12 channels/second. Panel height 7" (177 mm). Prices: 2901A Master, \$2,375; 2902 Slaves (25 channels each), \$1,975.

2515A Digital Scanner transmits digital data from multiple digital measuring instruments to a single recording device at a rate up to 10 sources per ms. The 2515A provides for scanning, in programmable sequence, of electronic counters, nuclear scalars, digital voltmeters or complete digital systems. It couples their outputs into a single recording device such as a digital recorder, card or tape punch or magnetic tape recorder.

The basic 2515A accepts up to 12 digits of BCD data (10 data digits, 2 source ID digits) from up to 3 sources. Modifications expand this to 6 sources. By bussing scanner output lines, data from more sources can be transferred to a single recorder. The 2515A interrogates all selected data sources in programmed sequence and transmits this data directly to recorder by solid-state switch. It accommodates a variety of input levels and provides uniform input to recorder. Panel height 5 1/4" (133 mm). Price 2515A, \$4200.

Signal converters

2410B AC/Ohms Converter (page 242) is used in conjunction with 2401C Digital Voltmeter for measurement of ac voltages and resistances. Converter features floated, guarded

input compatible with the voltmeter. Combined common mode rejection is 110 dB at 60 Hz. 2410B is fully programmable for systems use. Converter function and range information included in voltmeter display and recording outputs. Panel height 7" (177 mm). Price: HP 2410B, \$2,250.

2411A Guarded Data Amplifier (page 242). This floated and guarded amplifier provides the 2401C Integrating Digital Voltmeter with a full-scale input of ± 10 mV, overranging to ± 30 mV. Ideal for measurements of thermocouples, strain gage bridges and other low-level signal sources. Input impedance is greater than 10^{10} ohms. Combined common mode rejection with 2401C is 134 dB. 2411A features very low noise and zero drift, short settling time for fast data sampling. Panel height $3\frac{1}{2}$ " (88 mm). Price: HP 2411A, \$1200.

Analog-to-digital converters

2401C Integrating Digital Voltmeter (page 242). Features floated and guarded input and is average-reading, yielding to an effective common mode noise rejection better than 140 dB at all frequencies, including dc. All operating functions maybe controlled manually or by external contact closures to ground, enabling it to be used on the bench or in systems. BCD outputs provided. Panel height 7" (177 mm). Price: 2401C, \$4,100.

2402A Integrating Digital Voltmeter (page 240) combines 40 samples per second measuring speed with 5 digit resolution. Get low-level measurements without preamplification. Common mode noise rejection >120 dB is provided by guarding and integration. Optional plug-in circuit cards for ac, resistance and frequency measurements yield a multimeter useful for both bench and system applications. Panel height $5\frac{1}{4}$ " (133 mm). Price: 2402A, \$4,800.

Auxiliary equipment, programmers

2539A Digital Comparator compares BCD information against single or dual preset limits, providing Hi/Go/Lo lamp indications and electrical outputs. Comparisons take <3 ms. Instrument can be operated either manually or by external signals. The 2539A provides for 12 different comparison conditions, handles any combination of limit relative magnitudes and signs likely to be encountered in practical measurement situations. All solid state, features data storage for fast system operation. Panel height $3\frac{1}{2}$ " (88 mm). Price: 2539A, \$2,600 for 6-digit comparison plus sign.

2417A Data Linearizer. Arithmetic conversion of electrical values produced by transducers into familiar units such as rpm, psi, degrees C or F, is usually accomplished after the measurement either with a computer or manually using charts or tables. The 2417A permits direct display and recording of transducer outputs in engineering units at the time of measurement. Corrections provided are scale factoring, trans-

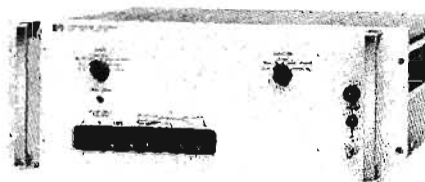

2410B

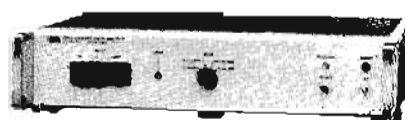

2411A

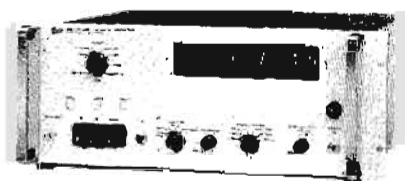

2401C

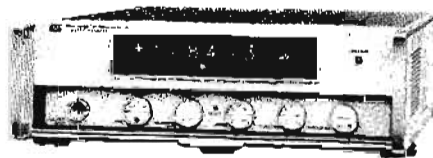

2402A

DATA SYSTEM ELEMENTS *continued*

Instrumentation for system benefit

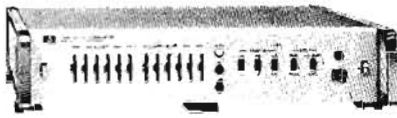

2539A



2417A



2509A



2560A

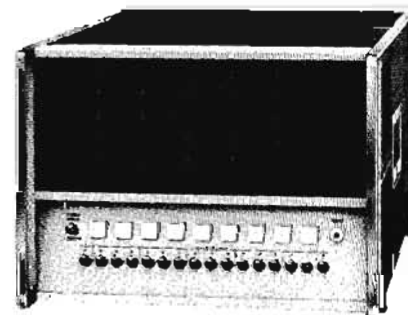

2115A

ducer zero off-set and linearization. Readout is annunciated at the 2401C Digital Voltmeter. Digital techniques are employed and the capability introduces no significant error into the system accuracy. Panel height $5\frac{1}{4}$ " (133 mm). Price: HP 2417A, \$2,650.

2509A Digital Clock is a precision time source used to supply time information to the data system and initiate measurements at predetermined intervals. Time-of-day is available visually and as an electrical output. It supplies time on demand, permitting associated system to operate independently of clock. All solid-state, it features push-button selection of timing outputs at intervals from 1 second to 1 hour. Time reference derived internally or from external 1 pps signal. Provision for 100 kHz external reference optional. Easy manual or remote time set. BCD output. Panel height $5\frac{1}{4}$ " (133 mm). Price: 2509A, \$2,250.

2911C Programmer operates with the 2911 Guarded Crossbar Scanner. It offers a convenient means of storing and selecting, by channel groups, the system measurement function (e.g., ac/dc voltage, resistance, frequency) and DVM range, and also enables channels to be skipped individually. Programming is accomplished by inserting diode pins into internal program boards which are easily accessible from the front panel while the instrument is installed in position. 2911C is all solid-state. Panel height $5\frac{1}{4}$ " (133 mm). Price: HP 2911C, \$3,725.

2560A Programmer reads instructions punched on paper tape and governs all aspects of system operation. Programmer selects measurement functions, scanner input channel on a specific channel or group-channel basis, and controls data recording. Also programs system comparator and governs data recording in accordance with comparison result. Operation of the entire system can be changed simply by changing programming tape. 2560A is all solid-state. Panel height $5\frac{1}{4}$ " (133 mm), tape reader, 7" (177 mm). Price: 2560A, \$4,200 including 2737A tape reader.

2115A Computer (page 102) or 2116A Computer (page 102) provides methods for sophisticated system control. Timing and sequencing of the input scanner, measuring and recording devices is programmed by the computer. It also performs the functions of limit comparison and code conversion usually accomplished by separate instruments. Arithmetic manipulation of data such as solving of multiple variable equations on stored data or measured inputs from one or more channels is easy when the system includes one of these devices. Convenience of operation and system programming and input/output flexibility are paramount in the design of this system element. Price: 2115A with 4096 word memory, \$16,500 including Teletypewriter; 2116A with 4096 word memory, \$22,000.

Output couplers, recorders

2545 Coupler operates with Teletype BRPE 11 Tape

Punch (Tally 420 Punch optional). Recording speed 110 characters/second. Data storage feature permits new reading during recording cycle, for faster data sampling. Standard model accepts 10 input characters, produces IBM 8-level code. Up to 16 input characters and other 5 to 8-level output codes optional. Simultaneous printer operation. All solid-state. Panel height $8\frac{3}{4}$ " (222 mm). Price: 2545 Tape Punch Set, \$4,500 including Teletype BRPE 11 Punch.

Tape punch and spooler available in rack-mount form (2545C). Panel slides up for access. Assembly rolls forward for easy tape loading and unloading. Panel height $12\frac{1}{4}$ " (310 mm). Add \$800 to price of 2545 set.

2526 Coupler operates with IBM 526 Summary Punch. Standard model accepts 10 input characters, stores data to allow new reading during recording cycle for faster system operation. Format flexibility through IBM patchboard. Optional simultaneous operation of printer. All solid-state. Panel height (incl. junction panel) $10\frac{1}{2}$ " (266 mm). Price: HP 2526, \$3,100.

2546 Coupler operates with Kennedy 1406 Incremental Tape Recorder. (Optionally Kennedy 1506). Records in standard IBM 7-channel NRZI code with tape format completely flexible as controlled by a diode pinboard. Accepts up to 12 BCD characters and records at 400 characters/second, synchronous. Data storage permits fast data sampling. Simultaneous printer operation. All solid state. Panel height $5\frac{1}{4}$ " (133 mm) for coupler; $12\frac{1}{4}$ " (310 mm) for tape deck. Price: 2546 Magnetic Tape Set, \$9,450 including Kennedy 1406 Incremental Tape Deck.

2547A Coupler provides the versatility to operate with magnetic tape, punched paper tape, punched card, strip printer, teleprinter, Flexowriter or typewriter output devices. Interchangeable circuit cards permit quick inexpensive conversion from one output medium to another. Digital Clock and manual data entry panels provide optional expansion to many system functions in a single instrument. Accepts up to 20 BCD characters from up to three input sources, includes source selection circuitry. Includes data storage for fast system sampling. Panel height $10\frac{1}{2}$ " (266 mm). Price on request.

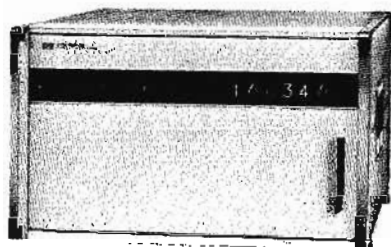

2547A

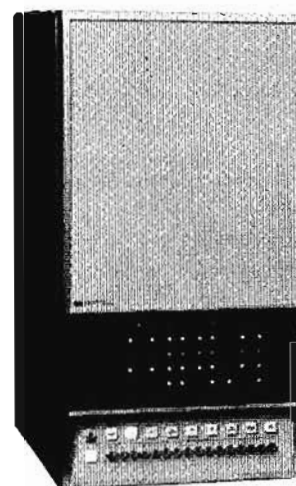

2116A

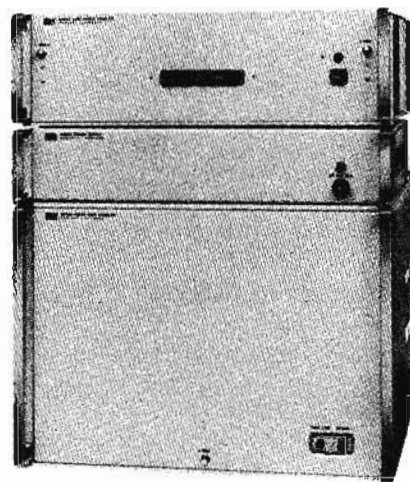

2545



2546

DATA ACQUISITION



DATA ACQUISITION SYSTEMS

Accurate measurement of many analog signals
2010 Series

Features:

- Accurate digital measurements of multiple dc inputs down to a few millivolts
- Frequency measurements to 300 kHz
- Optional ac voltage measurements from 50 Hz to 100 kHz
- Optional resistance measurements from 100 ohms to 10 megohms full scale
- Average-reading characteristics minimizes superimposed noise effects

Application

Data Acquisition Systems measure analog data derived from a number of sources, and display and record this information in digital form. To present the recorded information in its most useful medium, systems are available with a choice of output recording devices. For direct reading by the operator, a printout on paper tape is provided. If the data is to be entered into a computer, it may be recorded on punched paper tape, punched cards, or digital magnetic tape, as appropriate. A standard addition to the basic system allows measurements to be compared digitally against preset upper and lower limits; the comparison result is indicated visually and is included in the data recording. Another standard addition enables time-of-day to be recorded along with the measurement data, and also permits the gathering of data at predetermined time intervals.

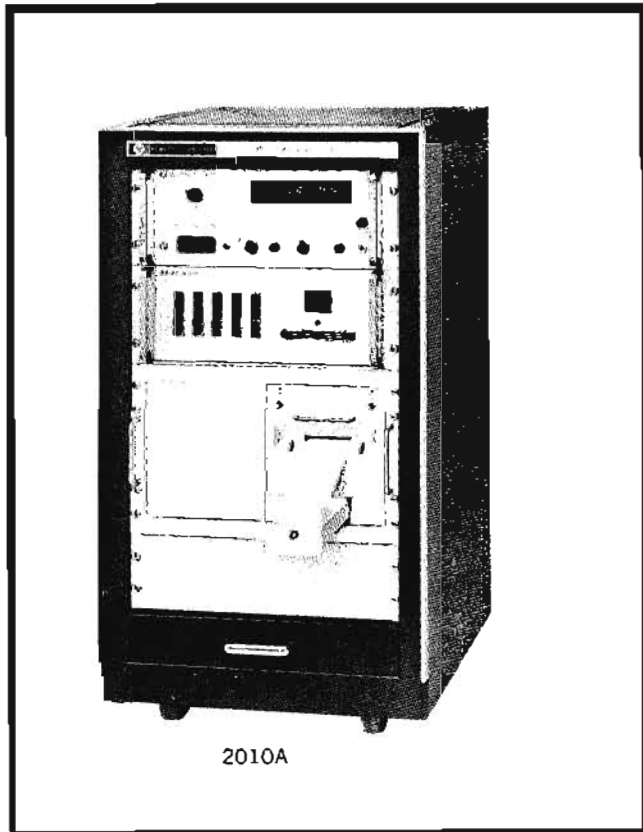

2010A

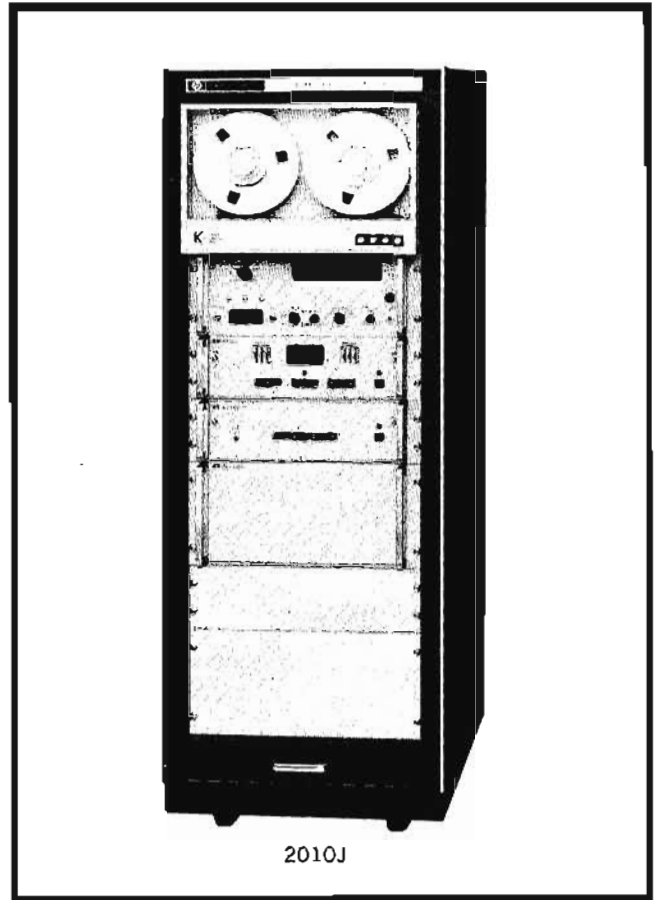

2010J

Typical inputs are dc and ac voltages, frequencies, resistances and physical parameters that are convertible by transducers to these analog forms. Some examples are temperatures, pressures, velocities, accelerations, weights, and displacements.

Digital techniques are used to obtain high measurement resolution and accuracy, high sampling speeds, and the ability to transfer the measured information easily to a wide variety of digital recording devices. In particular, the 2010 series of data acquisition systems utilize the 2401C Integrating Digital Voltmeter as the digitizer. This instrument features a floated and guarded input, permitting accurate low-level measurements in the presence of severe common mode noise—a common problem with grounded transducers.

By virtue of a large choice of standard optional features, the 2010 systems can be tailored to suit a wide range of analog measurement applications, and it is most likely that your requirements can be met by a completely standard, proven system. Meeting your needs with standard equipment means reliability, good delivery and cost savings for you. If a standard 2010 system does not exactly match your requirements, Hewlett-Packard will supply modified versions, or advise other systems in the line that may be closer to your needs.

Specifications, 2010 Series

DC voltage measurements

Noise rejection:

Overall effective common mode rejection (ratio of common mode signal to its effect on digital display): 2010A, B, E, H: 105 dB at all frequencies, 100 dB at dc; 2010C, D, F, J: 130 dB at all frequencies, including dc (0.1 sec sample period); amplifier option reduces CMR by less than 6 dB. Common mode rejection (ratio between common mode signal and voltage it superimposes on source): 2010A, B, E, H: 85 dB at 60 Hz 100 dB at dc; 2010C, D, F, J: 110 dB at 60 Hz 130 dB at dc, with 1000 ohms between ground and low side of input (resistances up to 10 k). Superimposed Noise Rejection (ratio of superimposed noise to its effect on digital display): Combined amplitude of signal and superimposed noise can equal ± 3 times full scale, for any signal amplitude.

Voltage ranges: five ranges from 0.1 V to 1000 V full scale; polarity sensed and indicated automatically; amplifier (option) provides 10 mV full scale; auto-ranging available.

Overranging: to 300% of full scale except on 1000 V range; input attenuator switched to 1000 V range if overload exceeds 310%; reset automatically as scanner advances to next channel, or may be reset manually.

Input impedance: 10^7 ohms on 10, 100, 1000 V ranges; 1 megohm on 1 V range; 100 k on 0.1 V range; 10^6 ohms with amplifier option for inputs up to 10 V.

Resolution: three fixed sample periods of 0.01, 0.1 and 1 sec.

Internal calibration source: ± 1 V internal standard provided for self-calibration; voltage reference is derived from temperature stabilized zener diode; drift less than $\pm 0.006\%$ in 6 months; internal standard may be compared against external standard; factory adjusted to better than $\pm 0.002\%$ absolute accuracy at 25°C; temperature effect $\pm 0.001\%/^{\circ}\text{C}$, 10 to 40°C.

Overall dc accuracy for 2010 Systems: (specifications hold for $\pm 10\%$ line voltage change).

Basic accuracy: $\pm 0.01\%$ reading $\pm 0.005\%$ full scale ± 1 digit (0 to full scale); $\pm 0.025\%$ reading ± 1 digit (at 3X full scale); applies to all ranges, 6 months operation; assumes daily calibration against internal standard, operating at 25°C.

Temperature coefficient: $\pm 0.0015\%$ reading per $^{\circ}\text{C}$, 10 to 50°C, when calibrated against internal standard at operating temperature; $\pm 0.002\%$ reading $\pm 0.0005\%$ full scale per $^{\circ}\text{C}$ (0.1 V range); $\pm 0.002\%$ reading $\pm 0.0002\%$ full scale per $^{\circ}\text{C}$ (1/10/100/1000 V ranges); when not calibrated at operating temperature, over range 10 to 50°C.

Frequency measurements

Range: 5 Hz to 300 kHz.

Sample period: 0.01, 0.1 or 1 sec.

Accuracy: ± 1 digit \pm time base accuracy; stability of internal time base, $\pm 2/10^6$ per week over $\pm 5^{\circ}\text{C}$ temperature range; temperature effect, $\pm 100/10^6$ over 10 to 50°C range; rear BNC and switch provided for external frequency standard; level, 2 V peak to peak into 1.2 k.

Input sensitivity: 0.1 to 100 V rms (front-panel adjustment 0, or 1 V negative pulses, 2 μs min. width).

Impedance: 10^6 ohms shunted by 1000 pF.

AC voltage measurements (optional)

Noise rejection

Common mode rejection: 2010A, B, E, H: 75 dB at 60 Hz; 2010C, D, F, J: 100 dB at 60 Hz with 1000 ohms between ground point of source and low side of system input.

Voltage ranges: same as for dc voltage measurements (optional amplifier not applicable); max. input, 750 V peak.

Input impedance: 10^6 ohms on all ranges, shunted by 1000 pF.

Accuracy (steady state): 50 Hz to 10 kHz $\pm 0.05\%$ full scale $\pm 0.1\%$ of reading; 10 kHz to 30 kHz $\pm 0.06\%$ full scale $\pm 0.2\%$ of reading; 30 kHz to 100 kHz $\pm 0.1\%$ full scale $\pm 0.3\%$ of reading. Temp. effect 0.01%/°C max.

Transient error: normal response (frequencies below 400 Hz) output settles to $\pm 0.2\%$ of final value in 500 ms; fast response (frequencies above 400 Hz); output settles to $\pm 0.2\%$ of final value in 200 ms.

Resistance measurements (optional)

Noise rejection: resistance measurement circuit is guarded; ac common mode pickup on resistance measurements can be reduced to negligible level by connecting guard to grounded end of test resistance.

Ranges: six ranges from 0.1 k to 10 M Ω full scale.

Overranging: to 300% of full scale on all ranges except 10 megohm; input attenuator switched automatically to 10^7 ohms range if overload exceeds 310%; reset automatically as scanner advances to next channel or may be reset manually.

Resistance measurement accuracy

Specifications hold for $\pm 10\%$ line voltage change, 6 months operation. Assume daily calibration against internal standard.

RANGE	MEASUREMENT CURRENT	RELATIVE HUMIDITY (AT 40°C)			
		70%		85%	
		\pm % rdg	\pm % fs	\pm % rdg	\pm % fs
0.1 k	10 mA	.02	.51	.02	.51
1 k	1 mA	.02	.06	.02	.06
10 k	100 μA	.02	.01	.03	.01
100 k	10 μA	.02		.12	
1 M	1 μA	.03		1.0	
10 M	1 μA	.12		10	

Figures do not include ± 1 count display ambiguity. Overrange accuracy: convert % fs error to % rdg, add to existing % rdg error. Temperature effect: .005% rdg = .001% fs, not calibrated at operating temp. (Per $^{\circ}\text{C}$, 10 to 50°C). .004% rdg = .0005% fs, when calibrated at operating temp. Internal settling delay of 100 ms reduces response error to .005% rdg.

General

Display: 6-digit in-line readout; polarity, decimal point measurement units, and overload; storage holds display between readings, switch permits display during count if desired; scanner provides in-line digital indication of channel being monitored.

2010 Series Data Acquisition Systems

HP model	2010A	2010B	2010E	2010H	2010C	2010D	2010F	2010J
Number of input channels	stepping-switch scanner; up to 25 3-wire inputs; to 100 channels with slave scanners				guarded crossbar scanner; up to 200 3-wire inputs; also accepts 100 6-wire, 200 3-wire and 600 1-wire inputs			
Programming	self-programming capability permits measurement of mixed types and levels of signals				pinboard or punched tape programmer may be added to handle mixed types and levels of signals			
Effective common mode noise rejection	105 dB				130 dB			
Measurement speed (max. dc volts meas.)	5 channels per sec	10 channels per sec	1 channel per sec	10 channels per sec	5 channels per sec	9 channels per sec	1 channel per sec	18 channels per sec
Output	printed paper tape	perforated paper tape	punched card (on IBM 526)	digital magnetic tape	printed paper tape	perforated paper tape	punched card (on IBM 526)	digital magnetic tape
Price	\$8,460	\$10,975	\$9,575	\$15,925	\$11,260	\$13,700	\$12,300	\$18,650
Options	time of day; ac/ohms measurements; 10 mV full-scale sensitivity; limit comparison; programmers							



DATA ACQUISITION SYSTEMS

Rapid, accurate measurement; output flexibility
Models 2012A, 2012B

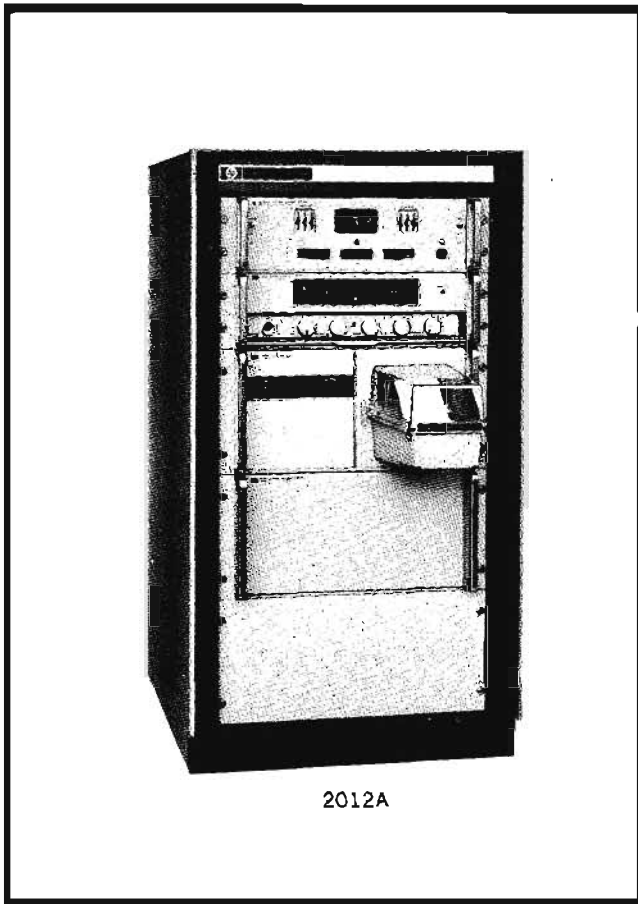

2012A

Application of the 2012A and 2012B Data Acquisition Systems is similar to that of the 2010 Series discussed on page 96. Operations performed by the systems include scanning of multiple inputs using a guarded crossbar scanner, digitizing and measuring the signal with a 2402A Integrating Digital Voltmeter (page 240) and recording the output on a wide variety of devices. Recording media includes magnetic or punched paper tape, printed strip, typewritten sheet with or without simultaneous punched tape, teleprinter and punched card.

The 2402A IDVM provides floated and guarded input circuitry in combination with integration. It uses techniques which permit measuring rates to 43 samples per second while providing noise rejection. The result is a system which can measure low level signals rapidly and accurately—even in the presence of large noise signals, without requiring preamplifier modules or filters.

All DVM operating functions are programmable, and programming does not affect the system's excellent noise rejection properties. An optional autoranger is available to relieve range programming.

Expansion

Standard options permit system expansion from a basic dc measuring system to one accepting ac voltage, resistance and frequency—easily and economically. Circuit cards plug into

the integrating digital voltmeter to add measuring ability without increasing system size or operating complexity. Noise rejection is retained with these additions. Circuit cards may be added by the user at any time without system modification.

Additional standard optional equipment includes digital hi-go-lo comparison equipment, pinboard or paper tape system programmers, digital clock and manual data entry. The latter two devices plug into the output coupler (2012B system) and

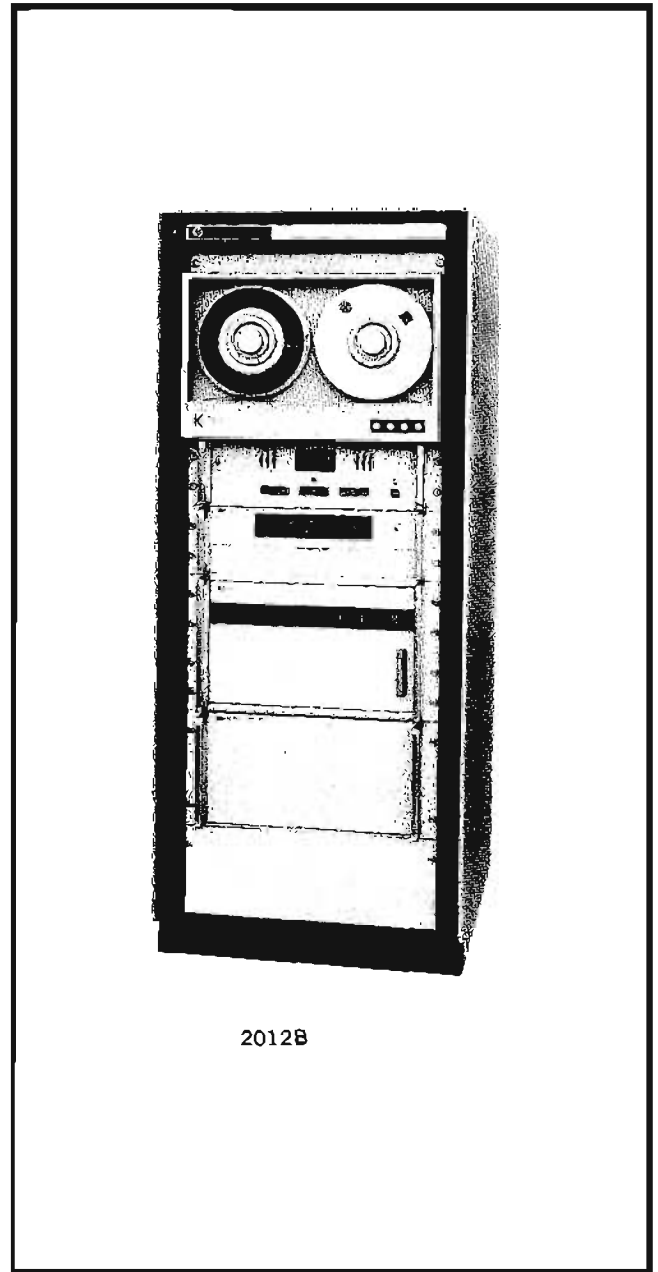

2012B

add to system capability, without adding to size. The digital clock provides visual display and electrical outputs for recording time along with measured data. It also provides the capability to start the system data-gathering sequence at predetermined time intervals.

Tentative Specifications, 2012A, 2012B

DC voltage measurements

Noise rejection: Overall effective common mode rejection (ratio of common mode signal to its effect on digital display): 130 dB at all frequencies, including dc. Common mode rejection (ratio between common mode signal and voltage it superimposes on source): 114 dB at 60 Hz, 130 dB at dc, with 1000 ohms between ground and low side of input (resistance up to 10 kΩ). Superimposed noise rejection (ratio of superimposed noise to its effect on display): >48 dB for 60 Hz noise frequencies.

Voltage ranges: five ranges from 0.1 V to 1000 V full scale; polarity indicated automatically, autoranging available.

Overranging: to 130% of full scale except on 1000 V range; protected from overload if input exceeds 136%; reset automatically as scanner advances to next channel or manually.

Input impedance: 10⁷ ohms on all ranges; 10⁶ ohms on .1 V, 1 V, 10 V ranges optional.

Resolution: 1 part in 130,000 on 6-digit display. Measurement period: 23 ms.

Internal calibration source: internal standard provided for self-calibration derived from temperature stabilized zener diode operating in a constant temperature oven, can be used to maintain specified accuracy for 6 months.

Overall dc accuracy for 2012 Systems: (specifications hold for ±10% line voltage change).

Range	100 mV ①	1 V, 10 V, 100 V, 1000 V
ACCURACY ② (at 25 ±1°C)	.01% rdg ±.005% fs or .015% rdg in overrange	.01% rdg ±.003% fs or .013% rdg in overrange
① Accuracy from 0 to 30 mV is 3 μV ±.015% rdg; above 30 mV, accuracy is as stated above.		
② When 2402A is calibrated at other than 25 ±1°C, add .0006% rdg ±.0001% fs per °C difference from 25°C. For temperature change after calibration, see TEMPERATURE EFFECT below.		
TEMP EFFECT	Per °C change from calibrate temperature	
15 to 40°C	.0015% rdg ±.0006% fs	.0015% rdg ±.00015% fs
10 to 15°C or 40 to 50°C	.002% rdg ±.0006% fs	.002% rdg ±.00015% fs

Frequency measurements (optional)

Range: 5 Hz to 200 kHz.

Sample period: 1 second.

Accuracy: ±1 digit ± time base accuracy; stability of internal time base, ±2/10⁶ per week over ±5°C temperature range; temperature effect, ±100/10⁶ over 10 to 50°C range.

Input sensitivity: 0.1 to 100 V rms (front-panel adjustment 0, or 1 V negative pulses, 2 μs min. width).

Impedance: 10³ ohms shunted by 250 pF.

AC voltage measurements (optional)

Common mode rejection: 100 dB at 60 Hz with 1000 ohms between source ground and low side of system input.

Voltage ranges: 1, 10, 100, 1000 V max. input, 750 V peak.

Input impedance: 9.09 x 10⁶ ohms all ranges, 430 pF shunt.

AC accuracy (steady state):

SIGNAL FREQUENCY ①	50 Hz		100 Hz		10 kHz		80 kHz		100 kHz	
	%rdg	%fs	%rdg	%fs	%rdg	%fs	%rdg	%fs	%rdg	%fs
ACCURACY ② (at 25 ±1°C)	.09	.05	.06	.03	.06	.03	.09	.05	.14	.09
RIPPLE ERROR ③	.03	--	.02	--	--	--	--	--	--	--
TEMPERATURE EFFECT ④ (Per °C change in ambient from 25°C, over 10 to 50°C range)	.004	.003	.004	.003	.004	.003	.007	.003	.013	.003

- ① Straight line interpolation holds for frequencies between points.
- ② Does not include .02% rdg maximum response error, applicable only to step input (received from data system signal scanner); also see response time and measurement speed, below.
- ③ Ripple error decreases 18 dB per octave above 85 Hz, is zero at 60 Hz because of superimposed noise rejection of basic instrument.
- ④ Assumes calibration of 2402A against internal standard at 25°C ambient. Calibration of 2402A at operating temperature decreases % rdg temperature effect .0009%.

Transient error: output settles to ±0.02% of final value in 500 ms.

Resistance measurements (optional)

Noise rejection: resistance measurement circuit is guarded; ac common mode pickup on resistance measurements can be reduced to negligible level by connecting guard to grounded end of test resistance.

Ranges: five ranges from 10⁰ to 10⁷ ohms full scale.

Overranging: to 130% of full scale on all ranges; system switched automatically to 10⁷ ohms range if overload exceeds 136%; reset automatically for next measurement.

Resistance measurement accuracy

Specifications hold for ±10% line voltage change, 6 months operation. Assume daily calibration against internal standard

Range	Measurement current	Relative humidity			
		70%		96%	
		± % rdg	± % fs	± % rdg	± % fs
1 kΩ	1 mA	.01	.01	.01	.01
10 kΩ	1 mA	.01	.005	.02	.005
100 kΩ	100 μA	.01		.10	
1 MΩ	10 μA	.02		1.0	
10 MΩ	1 μA	.12		10.0	

Temperature effect: .004% rdg ±.002% f.s. (per °C, 10 to 50°C). Internal settling delay of 100 ms to rated accuracy.

Input: Guarded crossbar scanner permits up to 200 3-wire inputs; alternatively accepts 100 6-wire, 300 2-wire, 600 1-wire inputs.

Programming: Pinboard or punched tape programmer may be added to handle mixed types and levels of signals.

Output recorder, system speed: 2012A: H006-5050A Digital Recorder produces printed strip, 12-character word length 9 channel/second max. speed.

Note: The 2012B incorporates a 2547A Coupler which accepts any one of six fully-interchangeable output sets, providing a selection of six recorders as follows:

2012B with magnetic tape output: drives a Kennedy 1406 or 1506 Incremental Magnetic Tape Recorder at 400 or 500 character per second rate; records on 1/2-inch magnetic tape in 7 channel NRZI IBM-compatible format. System speed: 18 channels per second.

2012B with high speed punched tape output: drives an HP-2753A Tape Punch at 120 characters per second; records on 1-inch paper tape in IBM 8-level code. System speed: 10 channels per second.

2012B with Teleprinter output: drives an HP-2752A or 2754A Teleprinter at 10 characters per second; records on 1-inch punched paper tape in ASCII 8-level code and on typewritten sheets. System speed: 50 channels per minute.

2012B with electric typewriter output: drives IBM Model B Output Writer at 10 characters per second. System speed 50 channels per minute.

2012B with Flexowriter output: drives Friden Model 2393 Flexowriter, records on 1-inch paper tape in IBM 8-level code and on typewritten sheets at 12 characters per second. System speed: 1 channel per second.

2012B with punched card output: drives IBM 526 Summary Punch; records at 17 characters per second on tab cards in 10-line output code with overpunching necessary to produce special characters; System speed: 1.4 channels per second. Simultaneous recording on a Hewlett-Packard H006-5050A or J66/65-562AR Digital Recorder is available. Recording speed up to 18 words/second (5050A) or 5 words/second (562AR).

General

Display: 6-digit in-line readout; polarity, decimal point measurement units, and overload; storage holds display between readings; scanner provides in-line digital indication of channel being monitored.

Price: HP Models 2012A, 2012B, available on request.

DATA ACQUISITION



DATA ACQUISITION SYSTEM

Computer manipulates data, controls system
Model 2018A

Features

- Measures mixed analog inputs, which can include dc voltages, frequencies, ac voltages and resistances
- Simultaneous data acquisition, reduction, and logging through input/output buffer storage
- Easy programming through standard ASA Basic FORTRAN
- Unique Executive program affords user direct control of sampling rate, data acquisition functions, comparison limits, computation constants—without recompiling.
- System maintains time-of-day clock for real-time control of data-taking and output recording

Application

The 2018A Data Acquisition System measures analog signals from 200 or more sources, processes this raw data as it is taken, and provides an immediate printout of finished answers to measurement problems. It may also provide punched tape and (optionally) magnetic tape outputs suitable for data storage and further processing. With it, projects proceed more quickly because the computerized system provides immediate answers to complicated problems during critical tests. Equipment setups can be changed and tests re-run while necessary conditions prevail.

Signal inputs may be derived directly from electronic equipment—dc/ac voltages, frequencies, and resistances, or indirectly through transducers such as thermocouples, strain gages, load cells, tachometers and flow meters.

Typical computations which can be performed by the 2018A Data Acquisition System include: units conversion such as thermocouple voltages to degrees of temperature; correcting for transducer non-linearity; comparing measurements against high and low limits; converting strain gage rosette readings to principal strains or stresses; calculating mass flow from pressure transducer readings; averaging or deriving rms value of one or several signals; calibrating transducers by the "least squares fitting" method; determining horsepower and efficiency in engine test stand applications.

Input/output features of the 2018A system include free-field input and buffered output. Information may be entered via keyboard or punched tape without regard for character spacing or position of decimal points. Buffered output allows simultaneous data acquisition, reduction and logging on several output devices.

System operation

In the 2018A System, the data acquisition process is completely under computer control, along with data reduction and logging. The user operates the system through the computer, by means of his program (stored in the computer memory) and manually via the Teleprinter keyboard and the computer front panel controls.

The source program to solve a given data acquisition problem is written by the user in standard ASA Basic FORTRAN language. The software operating system for the 2116A Computer is supplemented in the 2018A system by a data acquisition "Executive" program which simplifies the preparation and checkout of source programs, and facilitates operation of the stored program in respect to system timing and computation constants directly through the Teleprinter keyboard, without program recompilation.

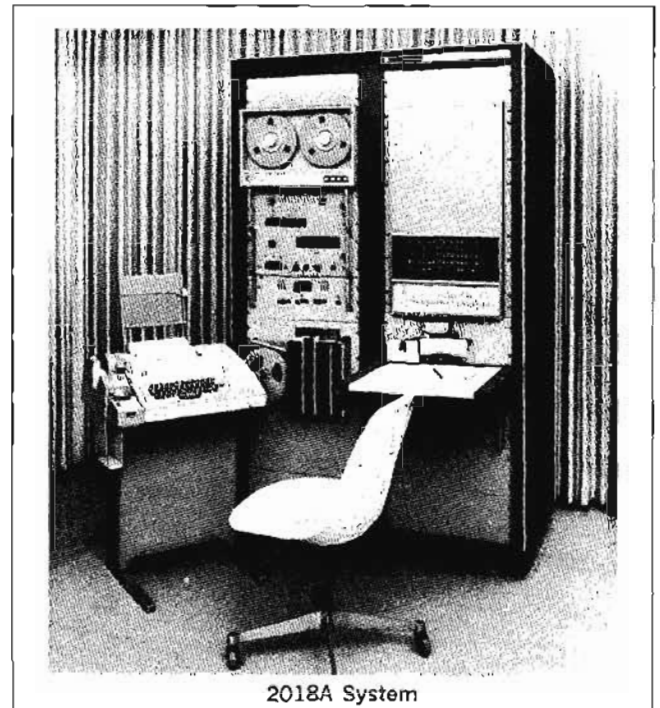

2018A System

Task concept: A "Task" may involve measurements on one channel or a group of channels. The measured data may be recorded directly or converted to engineering units before recording. Data from one or several channels may be entered in computations along with stored constants, and more than one parameter of an input signal may be measured.

Measurements can be compared against limits, with selective logging depending on comparison results. Out-of-limits warning messages can be typed. The frequency with which channels are sampled by the system can be related to the values measured; for example, fewer measurements may be desired while a signal remains within limits.

Data input/output: All information entered into or produced by the 2018A Data Acquisition System is handled through the data input/output channels of the 2116A Computer. The computer provides 16 such channels, prewired to accept plug-in interface cards for coupling to input and output devices such as the Teleprinter, data acquisition sub-system, etc. Six of these channels are occupied in the basic 2018A system, leaving 10 channels for optional capabilities such as high-speed punched tape output and magnetic tape output. These optional capabilities can be added to the basic system at any time; the option includes the peripheral device, interconnecting cables, interface cards, and software. A software configurator is furnished with the 2018A System which enables the user to change his software operating system when peripherals are added or deleted. Up to 48 channels can be utilized for peripheral devices by means of an accessory 2150A Extender Module.

Bi-directional transfer of data between the computer and a user-furnished external device is possible with the optional General Purpose Input/Output Register, which plugs into an I/O slot. This consists of a 16-bit flip-flop register which operates with the computer input/output interrupt system. The flip-flops may be set by the computer or by an external device. One application of this register is to use the output of the

2018A system to control external equipment. More than one such register may be used with the system if desired, however, an auxiliary 2160A Power Supply will usually be needed if more than one GP Register is used.

Frequently applications of the computer require control of external equipment such as motors or pumps. A plug-in Relay Output Register which provides 16 form A contacts is available for this purpose.

Data acquisition specifications

Refer to 2010C, D, F, J specifications page 97, for ac, dc frequency, ohms measurement specifications.

Number of channels: Guarded measurements: 200 3-wire channels (floating signal pair and guard). Pairs of channels may be utilized in 6-wire form (5 wires plus guard) for guarded 4-wire resistance measurements, under program control. More channels can be provided on special order. Signal wires and guard may be operated up to 500 V above chassis ground.

Computer specifications HP-2116A

(See pages 102 - 107 for additional information)

Memory: Type: magnetic core; size: 8192 16-bit words (expandable to 16,384 words on special order). Parity bit included in standard stack for use with optional memory parity check. Addressing: memory organized in four 1024-word pages; up to 2048 words directly addressable.

Speed: 1.6 microsecond cycle time. Memory parity check (optional): Permits parity checking within memory; consists of one plug-in card. Memory test (optional): enables memory to be tested independently of program control; consists of one plug-in card.

Registers: Eight internal flip-flop registers and switch register. Contents of all registers except Instruction and Switch register displayed by front lamps.

Instructions: 70 basic, one-word instructions, in three types: Memory Reference (2-cycle), 14; Register Reference (1-cycle), 43; Input/Output (1-cycle), 13. Register Reference instructions are micro-operations, can be combined to form over 1000 one-word, single-cycle instructions.

Input/output: 16, 16-bit parallel interrupting channels, with priority control, utilized through plug-in I/O interface cards (1 per channel). Accessory 2150A Extender Module provides for up to 48 I/O channels total.

General specifications

Operating conditions: Ambient temperatures 10 to 50°C, relative humidity to 95% at 40°C, except for magnetic tape, which is limited to ambient temperatures from 10 to 32°C (50 to 90°F) at relative humidity to 75%.

Equipment furnished:

2116A Computer (with 8K memory) and following I/O interface cards:
 12531A Teleprinter Input/Output
 12533A DVM Program Output
 12535A Scanner Program Output
 12539A Time Base Generator
 12541A DVM Data Input
 2752A Teleprinter (modified Teletype ASR-33)
 2401C Integrating Digital Voltmeter
 2911A Guarded Crossbar Switch
 2911B Scanner Control

Software furnished:

Software (punched tape) furnished with 2018A system comprises:
 Compiler, ASA Basic FORTRAN (Extended)
 Assembler
 Symbolic Editor
 Basic Control System*
 Data Acquisition Executive
 FORTRAN Library Routines
 Hardware Diagnostics

*Basic Control System is modular, includes configurator (Prepare Control System) to permit adaptation by user to different input/output arrangements. Also includes Program Debugging Routines. Standard Basic Control System includes buffered I/O Control.

Ordering information for 2018A Data Acquisition System

Basic system	Panel height		Power required Watts	Net weight		Shipping weight		Order by T No.	Price \$	
	Inches	MM		lb.	kg.	lb.	kg.		115V, 60 Hz	230V, 50 Hz
DC voltage and frequency analog inputs, teleprinter input/output	5½ ¹	133 ¹	1450	416	189	592	269		47,235	47,435
System options (add price etc. to figures for basic system)										
Autoranging ²	—	—	—	—	—	—	—	T1	250	250
Amplifier	3½	89	16	17	8	26	12	T2	1,200	1,200
AC voltage measurements	7	178	110	43	20	60	27	T3	1,850	1,850
Resistance measurements	7	178	110	43	20	60	27	T4	1,650	1,650
AC voltage and resistance measurements	7	178	110	43	20	60	27	T5	2,250	2,250
Heavy-duty teleprinter	—	—	120	148	67.3	178	81.2	T6	2,600	Not avail.
High-speed punched tape reader	7	178	150	15	7	25	11	T7	2,100	2,200
High-speed tape punch	14	356	450	59	27	82	37	T9	4,100	5,150
Magnetic tape unit (1200 ft. reels)	12¼	311	110	50	23	68	31	T10	6,250	6,400
Magnetic tape unit (2400 ft. reels)	24½	622	110	65	29	88	40	T11	7,500	7,650
General purpose register	—	—	—	—	—	—	—	T12	950	950
Memory parity check	—	—	7	—	—	—	—	T13	1,000	1,000
Memory test	—	—	11	—	—	—	—	T14	420	420
Frequency measurements to 1 MHz	—	—	—	—	—	—	—	T15	250	250
Period measurements	—	—	—	—	—	—	—	T16	250	250

¹Excludes teleprinter, which is separate console.

²Available only with original order; cannot be field-installed subsequently.

COMPUTERS AND PERIPHERALS



COMPUTERS

For general computation and instrument systems

Models 2115A, 2116A

Hardware advantages:

- 16 bit word length
- 4096 word memory, expandable to 8192 in main frame
- 1024 word page size, 2048 words directly addressable
- Dual, directly addressable accumulators
- 70 basic one-word instructions

Hardware advantages, Model 2115A:

- 2 μ s memory cycle time
- 8 individually-buffered I/O channels with multichannel priority interrupt; expands to 40 channels with extender
- Operates from +10 to +40°C, humidity to 95%

Hardware advantages, Model 2116A:

- 1.6 μ s memory cycle time
- 16 individually-buffered I/O channels with multichannel priority interrupt; expands to 48 channels with extender
- Memory expands to 16,384 words with extender
- Operates from 0 to 55°C, humidity to 95%

Software features, Models 2115A and 2116A:

- Extended ASA basic Fortran compiler, operable in 4K memory
- ALGOL compiler operable in 8K memory
- Modular control system for device-independent programming
- Linking, relocating loader
- Assembly language programs may be linked to compiler-generated code at execution time
- Utility routines—software configurator, debugging package, hardware diagnostics

The 2115A and 2116A are versatile general-purpose digital computers, particularly suited in computational power and input/output flexibility to scientific and industrial measurement applications. Each may be used as a free-standing system for solving scientific and engineering design problems, or in in-

strumentation systems, in combination with Hewlett-Packard measuring instruments, or many other devices to provide complete solutions in a broad spectrum of measurement tasks.

The 2115A and 2116A are compact, flexible, and fast. They differ only in degree. The 2115A is packaged in two small instruments: a 12 $\frac{1}{4}$ "-tall processor and a 10 $\frac{1}{2}$ "-tall power supply, interconnected by a cable. The 2116A is packaged in a single 31 $\frac{1}{2}$ "-tall module. The essential differences between the two instruments are: maximum memory size and cycle time, the number of priority interrupts, environmental tolerance, and price. The 2115A may be ordered with either 4K or 8K memory, whereas the 2116A can be expanded from 4K to 8K at any time on a plug-in basis, and expanded further to 12K or 16K using a 2150A Extender. Main frame capacity of the 2115A is 8 I/O channels, expandable to 40 channels with a 2150A Extender. The 2116A main frame accommodates 16 I/O channels, and is expandable to 48 channels using a 2150A.

Optional equipment to expand the power and versatility of the 2115A/2116A is available on a plug-in basis. This includes disc memory, direct memory access and an extended arithmetic unit which significantly reduces multiply and divide time, and also provides variable length long shifts and rotate instructions.

Both of the computers offer a flexible instruction repertoire of 70 basic one-word instructions, with the capability of extensive microprogramming through one-word combinations of register reference instructions.

The 2115A and 2116A are completely software compatible. The software package includes ASA basic Fortran (extended) and ALGOL compilers, assembler, symbolic editor, and basic control system. Software is also furnished for reconfiguring the basic control system to accommodate changes in the I/O hardware system, program debugging, and diagnosing hardware malfunctions. All software except the ALGOL compiler is fully operable in the minimum hardware configuration, consisting of 4096 word memory and teleprinter I/O. The ALGOL compiler requires 8K memory (available with both computers).

Interface with peripherals

The computers operate through standard plug-in interfaces, with virtually all Hewlett-Packard measurements providing a digital data output. This broad range of instruments includes:

Digital voltmeters, electronic counters, nuclear scaler timers, quartz thermometers, analog input scanners.

Plug-in interfaces are also available for the whole range of computer peripherals, such as:

Teleprinters, high-speed card readers, tape readers and tape punches, line printers, digital plotters, oscilloscope displays, continuous and incremental magnetic tape decks, and Data Phones.

General purpose plug-in interfaces are also available which enable the customer to operate a wide variety of devices of his own choosing with the computer.

Input/output flexibility

Besides the convenience of plug-in interface cards, the 2115A/2116A provide as standard features unique channel identification and service priority interrupt with every input/

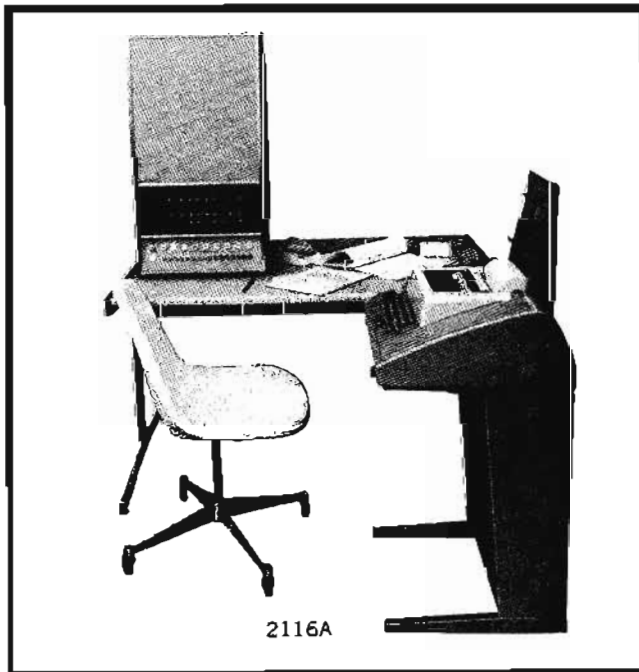

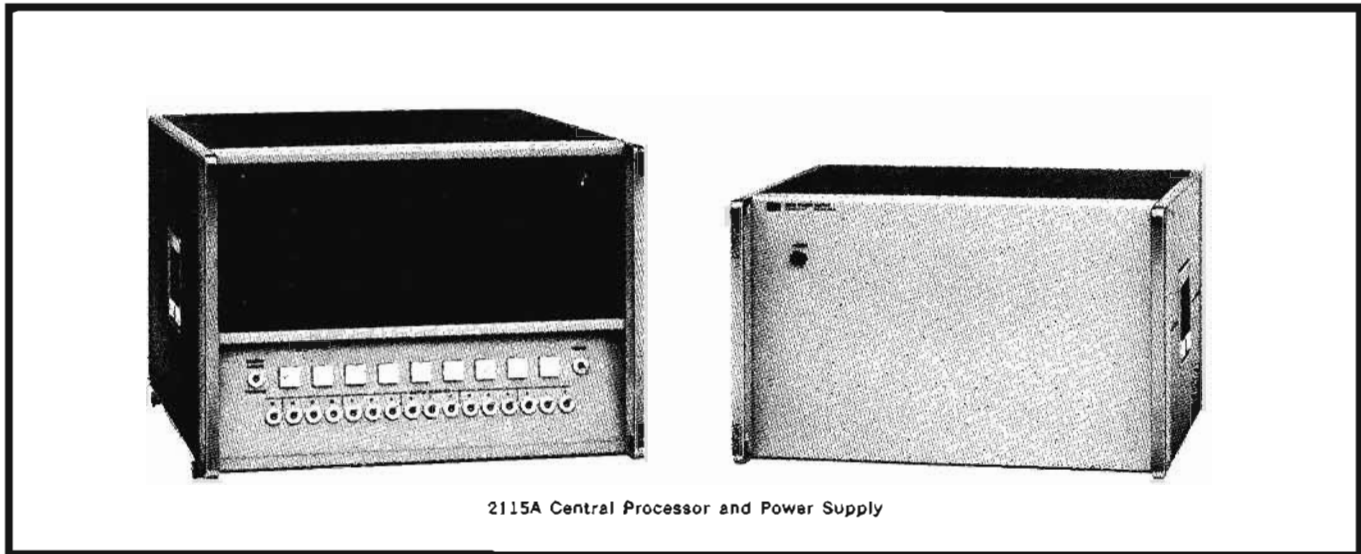

2115A Central Processor and Power Supply

output channel used. Priority levels can be altered simply by interchanging the positions of interface cards.

The I/O software has been designed to make full use of hardware flexibility. A modular control system allows source programs to be written without concern for specific operating requirements of peripheral devices. A software configurator is furnished that allows the user to easily modify his control system to fit different input/output hardware configurations. Systems can be upgraded (e.g. switching from a low speed to a high speed tape punch) without changing the source program. The computers thus offer programming which is very nearly independent of the I/O devices used.

Input/output channels may be run one at a time under program control, or simultaneously under interrupt control. Peripherals can be added, upgraded, or deleted, and service priorities changed on a plug-in basis—no wiring changes are involved. Interface circuitry to run a specific peripheral is contained on one or more cards that plug into any I/O slot in the 2115A/2116A main frame (or 2150A Extender). To achieve this, all interface cards have identical pin assignments and the computer backplane is uniformly wired. Interconnecting cables mate directly with the I/O interface cards (see photo, page 104), reducing the number of mechanical connections in the system and minimizing the possibility of noise injection from the I/O device into the backplane. All peripherals draw their power directly from the power line; the interface cards are powered from the computer's internal power supply.

The accessory 2150A Extender has the same physical configuration as the 2116A Computer (omitting front panel display and controls). It provides slots for 32 plug-in interface cards, that are utilized in the same manner as those in the main frame.

Multichannel priority interrupt capability is a standard hardware feature in the 2115A/2116A; an interrupt channel associated with a unique memory location is provided with each I/O interface. That is, an interrupt request from an I/O device directly executes a location in memory uniquely associated with that I/O channel. This interrupt location will typically contain the entry instruction for a subroutine to service the I/O device. Priority level is determined by the I/O slot into which the interface card is installed, so priority levels can be rearranged simply by moving cards into different slots. Peripherals can also be programmed 'in' or 'out' of the interrupt chain by enabling or disabling the control bit associated with their I/O address. (The interrupt system can also be bypassed and all peripherals run under direct program control.)

Interrupts are recognized by the end of the current machine cycle. More important, overall response is fast. In a multidevice

system, a service request by a higher priority device causes the first 'useful' instruction which communicates with that device to be executed in less than 7 microseconds for the 2116A. When operating with only one I/O device, the response time is less than 3 microseconds. Times required by the 2115A are 8 and 4 μ s respectively. The multichannel interrupt feature and fast response promote efficient operation in a real time environment, as in instrumentation systems.

Machine organization

The 2115A/2116A Computers both have nine internal registers. Eight of these are flip-flop (integrated circuit) registers and the ninth consists of toggle switches for manual data entry. Contents of all but one of the flip-flop registers are available to the programmer, and are displayed on the front panel.

T register (memory transfer): All data transferred into or out of memory is routed through the T register. The T register display indicates the information that went into or out of a memory cell during the preceding memory cycle.

P register (program counter): Holds address of next instruction to be fetched from memory (or address of current instruction in the case of a multiphase instruction). The P register increments by one after the execution of each instruction (or by two if executing a skip instruction). A jump instruction can set the P register to any core location.

M register (memory address): Holds address of next memory cell to be accessed.

A and B registers (accumulators): The A and B registers execute and hold the results of arithmetic and logical operations performed by programmed instructions. The registers operate independently, allowing the programmer considerable freedom in program design. While they are flip-flop registers, they may be addressed by any memory reference instruction as location 00000 and 00001 respectively, thus permitting interregister operations such as "add (B) to (A)," "compare (B) with (A)," etc., using a single-word instruction.

E register (extend): A 1 bit register, used to link A and B registers by rotate instructions or to indicate a carry from bit 15 of the A or B register by any add or increment instruction (only) which references these registers.

OV register (arithmetic overflow): This 1 bit register indicates if an add or increment instruction referencing the A or B register has caused one of these accumulators to exceed the

COMPUTERS *continued*

For general computation and instrument systems
Models 2115A, 2116A

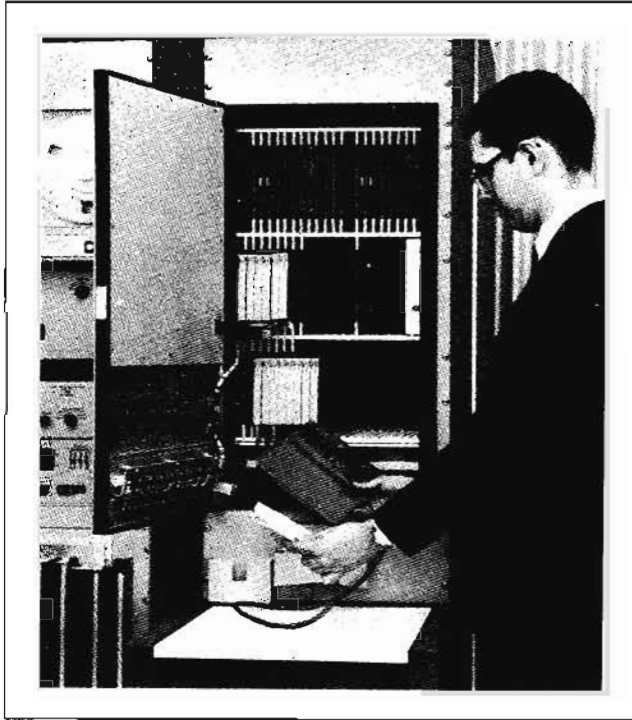

I/O interface cards can be installed or moved simply by swinging open the 2116A front panel.

maximum positive or negative number which can be contained (+32767 or -32768, decimal). By program instructions, the overflow bit is not complemented if a second overflow occurs before it is cleared. It is not set by shift or rotate instructions.

I register (instruction): Decodes each of the memory reference instructions, and identifies the register reference and input/output instruction types. The I register also holds indicators to direct the computer to page zero or remain on the current page, and to denote direct or indirect addressing. (Contents of I register are not displayed.)

S register (switch register): A 16 bit register set manually through 16 toggle switches on front panel is described further under "panel controls."

Panel controls

Switch register: Sixteen toggle switches for manually entering information. The setting of the switch register (switch in up position is binary 1) may be transferred into the computer in the following ways:

By program: Into A or B register using a load or merge instruction with the switch register's select code.

Manually: May be (1) loaded simultaneously into the P and M registers, using the load address switch, thus directing the computer to a specific memory cell; (2) loaded into the memory cell specified by the M register, using the load memory switch, thus permitting the user to change the contents of any memory cell (3) loaded into the A or B register, using the load A or load B switch.

Power: controls power input to computer.

Loader: protects block of memory normally occupied by basic binary loader (last 64 locations of memory).

Preset: momentary switch which presets computer to fetch phase, turns off interrupt system and all I/O control bits, sets flag bits, and resets optional parity error indication.

Run: momentary switch to start operation at current state of computer.

Halt: momentary switch to stop computer operation at the end of current phase.

Load memory: momentary switch to store contents of switch register in memory location specified by the address in the M register.

Load A, load B: momentary switches to transfer contents of switch register into the A or B register, respectively.

Load address: momentary switch to transfer contents of switch register into both the P and M registers, directing computer to desired address.

Display memory: momentary switch to display, in T register, contents of the location specified by address in the M register.

Single cycle: momentary switch to execute one machine cycle.

Word formats

Memory reference instructions

15	14	13	12	11	10	9	8	7	6	5	4	3	2	1	0
D/I	Instruction					Z/C	Memory address								

Register reference instructions

15	14	13	12	11	10	9	8	7	6	5	4	3	2	1	0
Reg. ref. instruction				A/B	SR/AS	Micro-instruction									

Input/output instructions

15	14	13	12	11	10	9	8	7	6	5	4	3	2	1	0
I/O instruction				A/B	Instruction					I/O select code					

Full address

15	14	13	12	11	10	9	8	7	6	5	4	3	2	1	0
D/I	Page address					Word address									

D/I Direct/Indirect; Z/C Page Zero/Current Page; A/B Register Identifier; SR/AS Shift-Rotate/Alter-Skip Identifier

Data, fixed point

15	14	13	12	11	10	9	8	7	6	5	4	3	2	1	0
Sign	Integer														

15	14	-----		0	15	-----	8	7	-----	1	0
Mag sign	Magnitude, most sig. bits					Mag, least sig. bits		Ex-ponent		Exp sign	

Instructions

The computers have 70 basic one-word (16 bit) instructions, all executable in one or two machine cycles (plus 1 cycle for each step of indirect addressing). These instructions are grouped in three types:

- Memory reference (2 cycle) 14
- Register reference (1 cycle) 43
- Input/output (1 cycle) 13

The register reference instructions are micro-operations that can be combined to form over 1000 one-word, single-cycle instructions.

Instruction repertoire

Type	Mnemonic	Description	Time Microsec		
Memory Reference Instructions (14)	AND	'And' (M) to A; result in A	3.2		
	XOR	Exclusive 'or' (M) to A; result in A	3.2		
	IOR	Inclusive 'or' (M) to A; result in A	3.2		
	JSB	Jump to subroutine	3.2		
	JMP	Jump, unconditionally	1.6		
	ISZ	Increment (M); skip if result zero	3.6		
	ADA/B	Add (M) to A or B; result in A or B	3.2		
	CPA/B	Compare (M) with A or B; skip if not equal	3.2		
	LDA/B	Load (M) into A or B	3.2		
	STA/B	Store (A) or (B) into M; A, B unchanged	3.2		
Register Reference Instructions (43) Shift-Rotate Group (20)	NOP	No operation	All 1.6*		
	CLE	Clear E-Register			
	SLA/B	Skip if least significant bit of A/B is zero			
	A/BLS	A or B arithmetic left shift one bit			
	A/BRS	A or B arithmetic right shift one bit			
	RA/BL	Rotate A or B left one bit			
	RA/BR	Rotate A or B right one bit			
	A/BLR	A or B left shift one bit (sign cleared)			
	ERA/B	Rotate E right one bit with A or B			
	ELA/B	Rotate E left one bit with A or B			
	A/BLF	Rotate A or B left four bits			
	Register Reference Instructions (19) Aller-Skip Group (15)	CLA/B		Clear A or B	All 1.6*
		CMA/B		Complement A or B (ones complement)	
CCA/B		Clear, then complement A or B (sets A/B to -1)			
CLE		Clear E-Register			
CME		Complement E-Register			
CCE		Clear, then complement E-Register (sets E to 1)			
SEZ		Skip if E-Register is zero			
SSA/B		Skip if sign of (A) or (B) is zero (A/B positive)			
SLA/B		Skip if least significant bit of (A) or (B) is zero			
INA/B		Increment (A) or (B) by one			
Overflow (4)**	SZA/B	Skip if (A) or (B) is zero	All 1.6		
	RSS	Reverse skip sense			
	STO	Set arithmetic overflow			
	SOS	Skip if arithmetic overflow set			
I/O Instructions (13)	HLT	Halt program	All 1.6		
	STF	Set flag bit of selected channel			
	CLF	Clear flag of selected channel			
	SFC	Skip if flag clear			
	SFS	Skip if flag set			
	MIA/B	Merge contents of selected channel into A or B (inclusive 'or')			
	LIA/B	Load contents of selected channel into A or B			
	OTA/B	Output from A or B to selected channel			
	STC	Set control bit of selected device			
CLC	Clear control bit of selected device				

*Register Reference Instructions can be combined to execute in 1.6 μ s. This allows, for example, shifts and rotations up to 8 places in 1.6 μ s total.

**Coded under I/O group.

(M) = Contents of memory Location M.

Programming

The 2115A and 2116A Computers are supported by a full range of software, furnished in the form of punched tape or magnetic tape. The following software packages are available:

FORTRAN compiler	Symbolic editor
ALGOL compiler	Basic control system
Assembler	Hardware diagnostics

With the exception of ALGOL, software packages will run in the minimum hardware configuration—4K memory and teleprinter input/output. ALGOL requires 8K of memory. Programs written in FORTRAN, ALGOL or assembly language are independent of the hardware I/O configuration. All I/O devices are identified by logical unit numbers which the programmer uses to specify I/O operations. At execution time the basic control system relates these logical unit numbers to physical numbers that correspond to the I/O slots occupied by the cards for the I/O device in question. The basic control system is therefore configured to suit a particular system. An auxiliary software package, prepare control system, is furnished which

allows the user to change his basic control system to fit different input/output arrangements. A dynamic program debugging package is also supplied.

FORTRAN compiler: Accepts source programs written in American Standards Association Basic FORTRAN. It produces a relocatable machine language object program that can be loaded and executed under control of the basic control system. In addition to the ASA Basic FORTRAN language, FORTRAN includes a number of features that extend the flexibility of the system.

ALGOL compiler: Accepts source programs written in ALGOL. It produces a relocatable machine language object program that can be loaded and executed under control of the basic control system. Operable in 8K memory.

Assembler: Translates symbolic source language instructions into an object program for execution on the computer. The source language provides operation codes, assembly-directing pseudocodes, and symbolic addressing. The assembled program may be absolute or relocatable. The source program may be assembled as a complete entity or it may be divided into several subprograms (or a main program and several subroutines), each of which may be assembled separately. The loader of the basic control system loads and links relocatable programs (at execution time): the basic binary loader loads absolute programs.

Symbolic editor: Enables the user to edit and update a symbolic file tape that can be an assembler program, a compiler program, or a data file. The editor produces an updated tape from the source tape and change instructions. Individual characters and entire source statements can be inserted, deleted, or replaced. The editor will also provide a listing of a symbolic file (sequentially numbering the statements). Diagnostic messages are produced for errors detected in format of edit control statements.

Basic control system: Provides an efficient loading, input/output control and debugging capability for relocatable programs produced by the assembler, FORTRAN compiler, or ALGOL compiler. The system is modular in design and may be constructed or modified to fit the user's particular hardware configuration. The following modules are provided:

Relocating loader: Loads, links, and initiates the execution of relocatable object programs produced by the assembler or compiler

Input/output control: Provides for general input/output device control and software buffered data transmission between I/O devices and computer memory.

Input/output drivers: Provide the instructions necessary to operate specific input/output devices, and serve as an interface between the I/O control system and the peripheral devices.

Two other software packages are associated with the basic control system. These are:

Prepare control system: Combines the basic control system component modules—loader, I/O control, and I/O drivers together with equipment tables—to generate a basic control system for a particular hardware configuration.

Debugging package: A relocatable program that interprets and executes machine instructions. Functions to be performed are normally selected by typing in control statements on the teleprinter.

Subroutines: The basic control system loads and links object code library subroutines according to calls generated by assembler or compiler programs. The following subroutines are available:

Fixed point multiply and divide

Floating point add, subtract, multiply, and divide

Double-word load and store

Conversion from integer to real, and real to integer

Math functions—exponential, natural log, sine, cosine, tan, tanh, arctan, square root

COMPUTERS *continued***For general computation and instrument systems**
Models 2115A, 2116A

Boolean functions—AND, OR, NOT
Test individual switches of switch register
Position magnetic tape

Hardware diagnostics: These routines allow computer system to be checked out in its principal operating modes.

General specifications

Type: general-purpose digital computer, with I/O system and modular software organized for on-line instrumentation systems.

Memory:

Type: magnetic core.

Size: 4096 16 bit words; 2115A alternately available with 8192 word memory; 2116A memory expandable to 8192 words with optional plug-in 4K module and associated cards, further expandable to 16,384 words with 2150A Extender (parity bit included in standard stack for optional memory parity check).

Addressing: memory is organized in 1024 word pages, 2048 words directly addressable.

Speed: 2.0 μ s cycle time, 2115A; 1.6 μ s, 2116A.

Loader protection: last 64 locations of memory reserved for basic binary loader, front panel switch in 'protect' position prevents alteration of contents of these locations.

Memory parity check (optional): permits parity checking within memory; consists of one plug-in card for each 4K of memory.

Memory test (optional): enables memory to be tested independently of program control; consists of one plug-in card.

Arithmetic: parallel, binary, fixed point, two's complement.

Speed: figures below are maximum times (in μ s) applicable to 2116A; corresponding figures for 2115A are extended by factor of 1.25; except for add, arithmetic operations are performed by subroutines; figures in parentheses apply to optional hardware extended arithmetic unit.

Add	3.2 μ s
Subtract	4.8 μ s
Multiply	150 μ s (19)
Divide	310 μ s (21)
Floating point add	900 μ s
Floating point subtract	900 μ s
Floating point multiply	750 μ s (344)
Floating point divide	1500 μ s (448)

Registers (contents of all except I and S registers displayed by front panel lamps):

A register: overflow register, indicates overflow from A or B register (1 bit).

T register: transfer register, temporarily holds data transferred in or out of memory (16 bits).

P register: program counter (15 bits).

M register: memory address register, holds address of next memory location to be accessed (15 bits).

I register: instruction register, decodes memory reference instructions, holds indicators for zero/current page, direct/indirect addressing (6 bits, 10-15).

S register: toggle switches on front panel for manual data entry; contents of register indicated by switch positions (16 bits).

Instructions:

70 basic, one-word instructions, in three types:

Memory reference (2 cycle)	14
Register reference (1 cycle)	43
Input/output (1 cycle)	13

The register reference instructions are microoperations that can be combined to form over 1000 one-word, single cycle instructions.

Input/output (2115A): 40, 16 bit interrupting channels with priority control, utilized through plug-in cards (1 per channel); 8 channels in main frame; servicing of interrupt request begins within 4 μ s with one I/O channel, 8 μ s for highest priority channel in multiple-channel systems.

Input/output (2116A): 48, 16 bit interrupting channels with priority control utilized through plug-in I/O interface cards (1 per channel); main frame accommodates 16 cards; servicing of interrupt request begins within 3 μ s with one I/O channel, 7 μ s for highest priority channel in multiple-channel systems.

Software: software (punched tape or magnetic tape) furnished consists of:

- Compiler, ASA basic FORTRAN (extended)
- Compiler, ALGOL
- Assembler
- Symbolic editor
- Basic control system
- Hardware diagnostics

Physical specifications, 2115A

Ventilation: intake at rear, exhaust at sides of both central processor and power supply; air flow 200 cfm each unit; total heat dissipation 5500 BTU/hr.

Service access: top of central processor removes for access to input/output cards, bottom removes for back plane access; power supply top and bottom remove.

Power: 115/230 V \pm 10%, 50 to 60 Hz; power consumption with internal supply loaded to capacity by plug-in options, 1600 W max.

Environmental conditions: operates in ambient temperatures from +10 to +40°C; relative humidity to 95% at 40°C.

Installation: two fully enclosed units for use on bench, or mounted in standard 19-inch rack, using adapters furnished; requires no special wiring subflooring or other installation preparation.

Dimensions: central processor: 16 $\frac{3}{4}$ " wide, 12 $\frac{3}{4}$ " high, 24 $\frac{3}{8}$ " deep overall (425 x 311 x 593 mm); power supply: 16 $\frac{3}{4}$ " wide by 10 $\frac{1}{2}$ " high by 20 $\frac{1}{2}$ " deep overall (425 x 266 - 533 mm).

Weight (with all plug-in options installed): central processor, net 65 lbs (29.2 kg), shipping 100 lbs (45.4 kg); power supply, net 100 lbs (45.4 kg), shipping 150 lbs (68.1 kg).

Price: HP Model 2115A, \$16,500 including 2752A Teleprinter.

Physical specifications, 2116A

Ventilation: intake on sides and back at bottom, exhaust at top; air flow 400 cfm; heat dissipation 5500 BTU/hr.

Service access: front panel hinged at left side, permitting front access to input/output cards and connectors, test switches, plug-in circuit boards, and panel wiring; main chassis slides forward out of cabinet and swings to right—permits front access to back plane wiring, power supply, fuses, and 115/230 V jumpers.

Power: 115/230 V \pm 10%, 50 to 60 Hz; main unit power consumption with internal supply loaded to capacity by plug-in options, 1600 W max.

Environmental conditions: operates in ambient temperatures from 0 to +55°C; relative humidity to 95% at 40°C.

Installation: fully enclosed for use on bench, or may be mounted in standard 19-inch rack using adapters furnished; requires no special wiring, subflooring, or other installation preparation.

Dimensions: 16 $\frac{3}{4}$ " wide, 31 $\frac{1}{2}$ " high, 18 $\frac{3}{8}$ " deep behind panel (425 x 782 x 467 mm).

Weight (with all plug-in options installed): net 230 lbs (104 kg), shipping 330 lbs (150 kg).

Price: HP Model 2116A, \$22,000.

Input/output options

I/O options consists of interface kit (which includes software) and peripheral. I/O options K1 through K9 include peripheral; options K10 through K25 do not include peripheral. I/O options may be ordered by option number, either with original purchase or subsequently. Later orders must state serial number so that proper software is furnished. Computer field service assistance is recommended for installation of I/O options subsequent to original purchase; consult computer sales engineer or factory for service charge involved. Auxiliary HP 2160A power supply may be needed when using most of the available I/O slots; consult computer sales engineer or factory.

I/O option	Capability	I/O slots used	Interface kit	Peripheral	Option No.	Price \$	
						115 V, 60Hz	230 V, 50 Hz
Teletypewriter Input/output	Computer records on typewriter and punched tape, and inputs from keyboard and punched tape, at 10 characters/sec (ASCII code)	2	12531A	HP-2752A Teletypewriter (modified Teletype ASR-35)	K1	2,000	2,200
Heavy-duty teletypewriter input/output	Similar to Option K1 above, except heavy-duty Teletypewriter is furnished. Recommended where use exceeds 5 hrs/day or 30 hrs/week	2	12531A	HP-2754A Teletypewriter (modified Teletype ASR-35)	K2	4,600	Not available
High-speed punched tape input	Computer inputs from punched tape at 300 characters/sec (ASCII code)	1	12532A	HP-2737A Punched Tape Reader (with accessory 12525A Tape Holder)	K3	2,100	2,200
High-speed punched tape output	Computer records on punched tape at 120 characters/sec (ASCII code)	1	12536A	HP-2753A Tape Punch	K5	4,100	4,150
Incremental magnetic tape output (1200 ft reels)	HP-2116A records on IBM-compatible, 1/2-inch, 7 channel NRZI tape. Bit density 200 bpi. Recording speed 400 characters/sec. Reel capacity 1200 feet.	1	12537A	Kennedy 1406 Incremental Tape Transport	K6	6,250	6,400
Incremental magnetic tape output (2400 ft reels)	Similar to Option K6 above, but reel capacity 2400 feet	1	12537A	Kennedy 1506 Incremental Tape Transport	K7	7,500	7,650
Low density magnetic tape input/output	Computer records on, and reads from, IBM-compatible 1/2-inch 7-channel NRZI tape. Bit density 200 bpi. Speed 30 ips.	2	12538A	HP (M26) 2020A Magnetic Tape Unit	K8	12,500	12,700
Dual density magnetic tape input/output	Similar to Option K8 above, but HP-2116A records and reads at both 200 and 556 bpi.	2	12538A	HP (M26) 2020B Magnetic Tape Unit	K9	15,000	15,200

Following I/O options K10 through K25 do not include the peripheral

Time base generator	Generates real time intervals in decade steps from 100 μ s to 1000 sec (derived from crystal oscillator). Used as source of timed interrupts for software clock	1	12539A	None required	K10	1,000	1,000
Data Phone interface	Interfaces computer with Bell System Data Phone Service	1	12540A	Bell System Data Set 103A	K11	1,000	not available
Digital voltmeter data input (HP-2401C)	Computer accepts bcd (8421) data output from HP-2401C Integrating Digital Voltmeter	1	12541A	HP-2401C Integrating Digital Voltmeter (with mod. M21)	K12	750	750
Digital voltmeter data input (HP-3440A)	Computer accepts bcd (8421) data output from HP-3440A Digital Voltmeter	1	12543A	HP-3440 Digital Voltmeter (with 8421 output)	K14	750	750
Counter/thermometer data input (8 digits)	Computer accepts bcd (8421) data output from 8-digit electronic counter and the quartz thermometer	1	12544A	HP-5245L Electronic Counter (with option 02). HP-2801A Quartz Thermometer (with mod. M6)	K15	750	750
Counter data input (7 digits)	Computer accepts bcd (8621) data output from 7-digit electronic counters	1	12545A	HP-5244L, 5275A Electronic Counters (with option 02)	K16	750	750
Counter data input (6 digits)	Computer accepts bcd (8421) data output from 6-digit electronic counters	1	12546A	HP-5201L, 5202L, 5203L, 5232A, 5233L, 5532A, Counters (with option 02)	K17	750	750
Counter data input (5 digits)	Computer accepts bcd (8421) data output from 5-digit electronic counters	1	12547A	HP-5212A, 5214L, 5233L, 5512A Counters (with option 02)	K18	750	750
Counter data input (4 digits)	Computer accepts bcd (8421) data output from 4-digit electronic counters	1	12548A	HP-5211A/B Counters (with option 02)	K19	750	750
Digital voltmeter program output (HP-2401C)	Enables computer to select function, range, etc., of HP-2401C Integrating Digital Voltmeter	1	12533A	HP-2401C Integrating Digital Voltmeter (with mods. M21, 146)	K20	750	750
Digital voltmeter program output (HP-2401C/2411A)	Same as Option K20 above, except HP-2411A Data Amplifier included	1	12550A	HP-2401C (M21, 146) Digital Voltmeter and HP-2411A Data Amplifier	K21	750	750
Crossbar scanner program output (HP-2911)	Enables computer to select channel, settling delay, for HP-2911 Guarded Crossbar Scanner	1	12535A	HP-2911A Guarded Crossbar Switch and 2911B(M33) Scanner Control	K23	1,000	1,000
General purpose register	16-bit flip-flop register. Permits bidirectional transfer of information between computer and external devices. (Accessory kit includes 48-pin mating connector)	1	12549A	Determined by user	K24	750	750
Relay output register	Provides 16 form A contacts for operating external devices. (Accessory kit includes 48-pin mating connector)	1	12551A	Determined by user	K25	600	600

COMPUTERS AND PERIPHERALS



DIGITAL MAGNETIC TAPE RECORDING

Digital Magnetic Tape Units—universally accepted as a primary information storage device in digital data processing applications.

Tape units of this type find use in three broad areas of application, as shown in Fig. 1: (1) the writing of digitally-coded data on magnetic tapes for later processing on a computer, (2) on-line with a computer, for data input, auxiliary memory, or data output; and (3) off-line processing of digital data previously written on magnetic tape by a computer or other digital device.

In each of the above application areas there is a need for mass storage of sequential information in digital format. This information must be transferred between the tape unit and the digital system at rates from a few characters per second to tens of thousands of characters per second. The higher data transfer rates find primary use on-line with computers and with high speed printers; lower data rates are used for data acquisition systems, data transmission, and relatively slow electro-mechanical input/output devices.

Types of digital magnetic tape units

Tape Units used in digital applications

are of two types: *synchronous* and *incremental*. The 2020 and 3030 Series are of the *synchronous* type.

Incremental is a special type of digital tape unit, used where the data input is at a relatively slow rate, and cannot be presented in a synchronous manner. Instead, the tape unit is commanded to step ahead (increment) for each digital character to be recorded. In this way, each character is equally and precisely spaced along the tape.

Synchronous tape units, on the other hand, are used where data inputs are at precise rates up to tens of thousands of characters per second. To record such data, the tape is rapidly brought up to the rated speed (say 30 ips), where it remains in constant motion. A large number of synchronous data characters are recorded, then the tape is brought to a fast stop. In this way a block of characters (a record) is written, each character within that record being equally spaced along the tape. Blocks of data are separated from each other by an erased area of tape called an inter-record-gap (IRG). The synchronous tape unit is normally commanded to start and stop the tape for each block of data to be recorded.

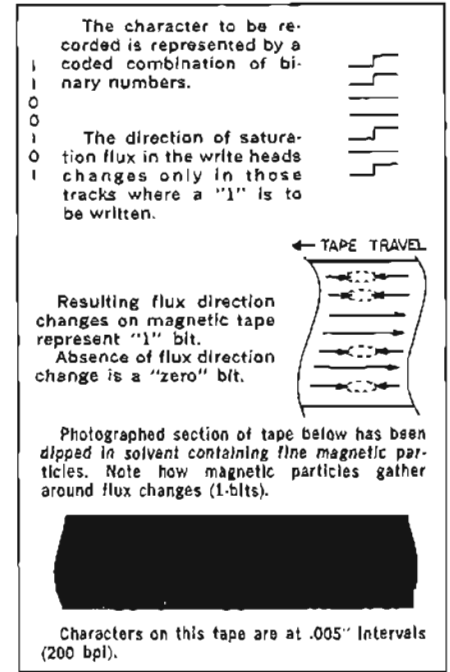

Figure 2. NRZI digital recording technique (IBM and ASCII compatible).

Recording information in digital form

All digital tape units offered by HP write and read data in the industry-accepted IBM format. The NRZI recording technique is used with 7 or 9 tracks—on 1/2 inch magnetic tape.

The tape is magnetically saturated at all times; only the flux direction changes when a 1-bit is to be recorded (Fig. 2). A zero-bit is represented by the absence of a flux-change in that particular character position along the tape track.

Characters are represented on magnetic tape by a coded combination of 1-bits in the appropriate tracks across the tape's width. Both 7-track and 9-track IBM coding is used, depending on the particular application.

Current applications

The Hewlett-Packard 2020 and 3030 Series of Digital Magnetic Tape Units have found wide acceptance in systems sold by manufacturers of data communications equipment, computers, data acquisition systems, digitally controlled plotters, microfilm printers, test stands, etc. In addition, special engineering project requirements are being economically and reliably satisfied by HP Digital Magnetic Tape Units.

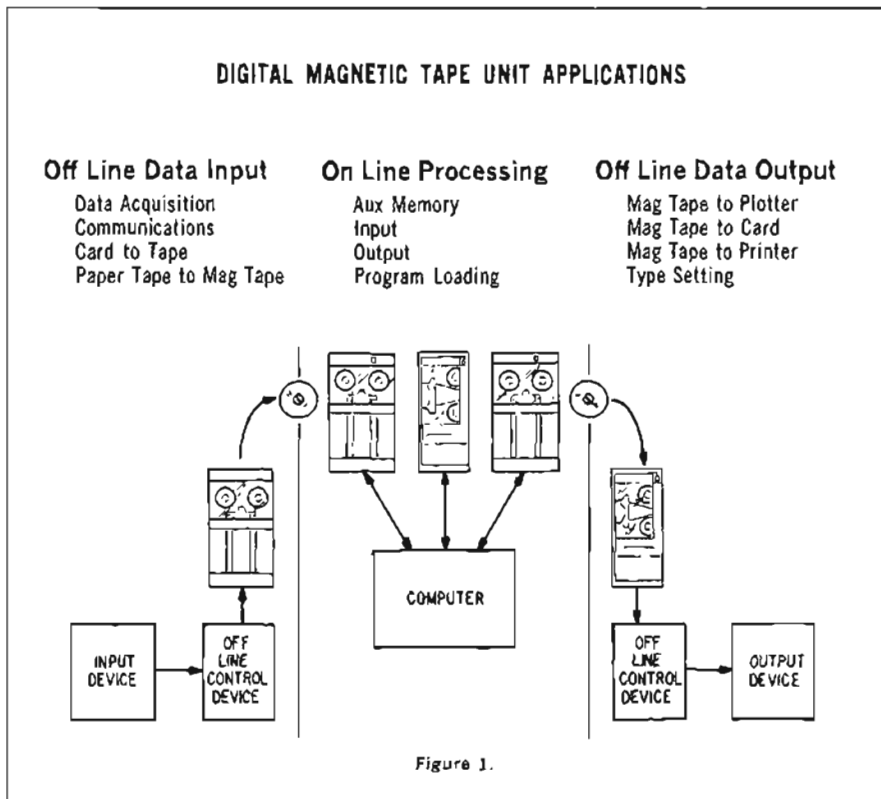

Figure 1.

DIGITAL MAGNETIC TAPE UNITS

For interfacing to digital systems
2020 and 3030 Series



COMPUTERS
AND PERIPHERALS

Both the 2020 and 3030 Series tape units are system oriented, designed as highly reliable, economical peripherals for computers and other digital systems.

The **2020 Series** are slow-to-medium speed tape units, offering tape speeds to 45 ips—rack-mountable with the other components of your system (optional cabinet available). 2020's offer the maximum in economy, with prices starting at \$4,500.

The **3030 Series** offer tape speeds to 75 ips, providing data transfer rates in the medium-speed range (to 60,000 cps). Each tape unit in the 3030 series is self-contained in a 30" wide free-standing castered cabinet. Prices start at \$7,000.

All Hewlett-Packard Digital Magnetic Tape Units are standardized on the industry-compatible IBM 7- or 9-track $\frac{1}{2}$ " digital tape formats, with NRZI recording. Your information, recorded on a 2020 or a 3030, can readily meet the industry requirements for the exchange of digital data between computers or digital systems. Regardless of the Application area (see Figure 1, opposite page), your recorded data will be compatible with that of others. Over 95% of all computer-compatible tapes are presently written in the IBM formats.

Digital tape units are designed primarily for control by external equipment—your digital system. Ease of interface design is, therefore, of a major consideration when incorporating peripheral devices. Choices of data and control logic (Figure 3) may be made at the time of order to assure optimum compatibility with the requirements of your interface. Negative-true logic is the most common; positive true is also standard. (For other I/O logic, contact factory.)

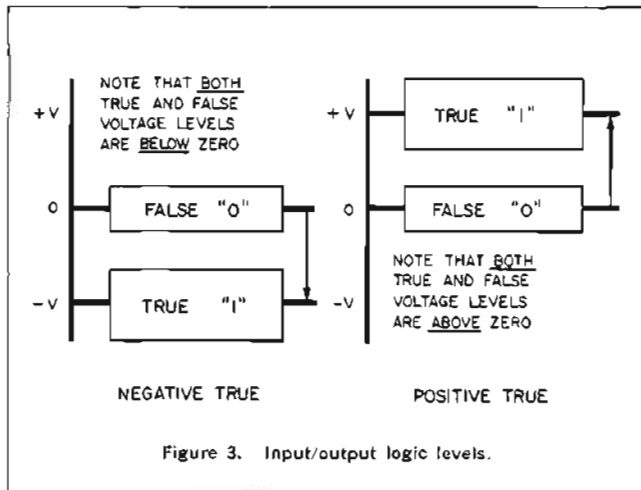
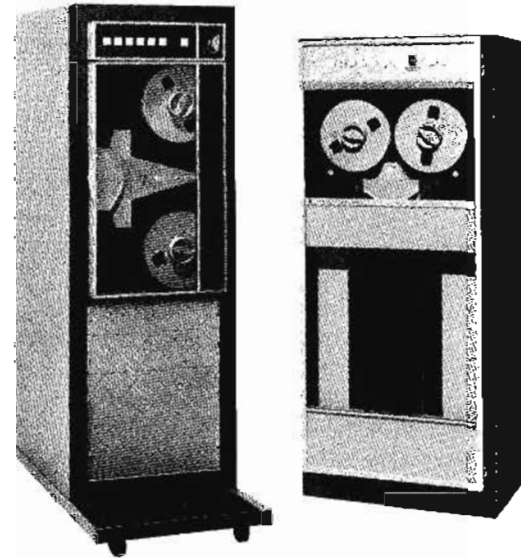

Figure 3. Input/output logic levels.

Tape Unit INPUT requirements are quite flexible, accepting relatively broad voltage limits from the controlling equipment. OUTPUT voltages, on the other hand, are much more precisely defined, again to ease the requirements placed on interface design.

Digital magnetic tape units
of proven reliability for
interfacing to digital systems



2020 Series

3030 Series

To provide a tape unit with the exact capabilities required by your digital system, four production configurations are available: Standard, Master & Slave, and Base tape units.

The **Standard** tape unit is complete with Operator Control Panel, Transport (with Control Electronics), and Data Electronics, interconnected and ready for operation by external control.

A **Master** tape unit includes electronic switching circuitry for both Data and Control Electronics; **Slaves** include everything but the Data Electronics, which is contained in the Master, and shared with the Slaves as required for reading or writing data. Combining a Master with up to three Slaves provides substantial system economy by allowing sequential multi-unit operation without the added expense of redundant Data Electronics in each tape unit.

Base tape units are similar to Standard tape units, but without Data Electronics. These are designed especially for those who wish to include the data electronics elsewhere in the system; the magnetic head assembly is cabled directly to a connector for routing to external equipment.

HP is also able to provide **special versions** of the 2020 or 3030 Series, to meet the widely diversified needs of the digital equipment market. Whatever your requirement, contact Hewlett-Packard.

DIGITAL MAGNETIC TAPE UNITS *continued*

For Interfacing to digital systems
2020 and 3030 Series

The 2020 and 3030 Series are complete Digital Magnetic Tape Units tailored to the requirements of your digital system from standard production building blocks. A tape unit is readily provided that includes the exact functions required by your system to read and/or write digital data on magnetic tape.

Consider these features:**1. Operator control panel**

Convenient Unit-Designate and Density Selection controls.

Backlighted pushbuttons for operator convenience.
Models available for *Single* or *Multiple* tape unit operation.

2. Tape transport

Fast, convenient tape threading.

Hubs that accept standard computer tape reels.

Tape handling that eliminates excessive tape wear.

Photosensing of reflective tape markers.

File Protect capability, preventing inadvertent loss of previously written data.

3. Magnetic head assemblies

7- or 9-track operation.

Write and read, plus optional Full Saturation DC Erase Read-only operation.

All assemblies include vacuum-cleaning tape-guides to minimize read/write errors due to dirt or loose oxide particles on tape surface.

4. Data electronics

7- or 9-track operation.

Reliable, all solid-state circuitry.

Data electronics cards have color-coded test points, accessible from front panel.

Interchangeable printed circuit cards for troubleshooting ease.

Self-contained: includes power supplies and data control circuitry.

Available for write/read or read-only operation

Optional Dual-Speed operation.

Provides optional functions to simplify control unit construction: Lateral Parity, Longitudinal Parity, and CRCC.

5. Ease of Interfacing

To obtain the required data transfer rate, tape speed may be specified at any single speed between 7½ and 45 ips on 2020, and up to 75 ips on 3030 models (dual-speeds, optional).

Input/output logic levels may be specified at time of order for optimum compatibility and ease of interface design within the controlling device. (See Fig. 3, Pg. 109.)

It is, of course, the function of the controlling device to appropriately command the tape unit, such that the data is properly formatted on tape. All tape unit specifications (Pg. 111) have been specifically chosen to assure reliable reading and writing of the IBM tape formats.

Interface information, to help in your design of the controlling device, is readily available from Hewlett-Packard.

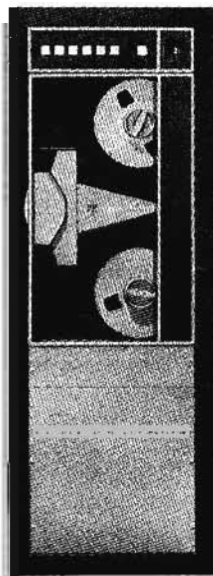

2020 Series

Features common to 2020 and 3030's**Standard**

- 7- or 9-track operation (most field convertible)
- NRZI Recording Technique (flux reversal for 1-bit)
- 3 Standard Densities (200, 556, & 800 char./in.)
- Forward and Reverse Drive (read in both directions)
- High Speed Rewind (<3 min. for a 2400' reel)
- Photosensing of *Load-Point* & *End-of-Tape* markers
- File Protect ring sensing avoids over-writing tapes

Optional

- Dual Speed Operation (up to 10:1 speed ratio)
- Read-Only Operation (no Write or Erase)
- Capstan Servo Operation (line freq. independent)
- Lateral Parity: parity-bit generate and check
- Longitudinal Parity: LRCC generate and check
- CRC Character Generation (for 9-track operation)
- Special Paint (to match *your* system)

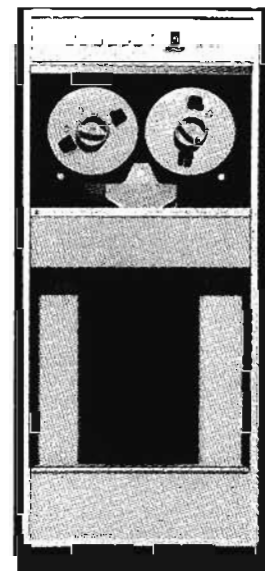

3030 Series

Specifications for 2020 Series—only*

- Single speed:** from 7.5[†] ips to 45 ips. (Speed is specified at time of order.)
- Dual speed:** (optional) any two speeds between 7.5[†] ips and 45 ips. (Speeds are specified at time of order.)
- Recording density:** low density models, 200 characters per inch. Dual density models, 200 and 556 cpi. Triple density models, 200, 556 and 800 cpi.
- Start time:** 5 ms (forward or reverse) to within $\pm 5\%$ of normal speed, after receipt of start command.
- Start distance (at 45 ips):** 0.108 ± 0.032 inch during 5 ms start period. At other tape speeds, tape travel $= 0.0024 V \pm 0.0007$, where $V =$ tape speed in ips.
- Stop time:** less than 1.5 ms after forward or reverse drive command is removed.
- Stop distance (at 45 ips):** 0.045 ± 0.010 inch during the 1.5 ms stop period. At other tape speeds, tape travel $= 0.001 V \pm 0.00022$, where $V =$ tape speed in ips.
- Skew:** *Static*, less than 10 μ s at 45 ips; at other tape speeds, $450/V$ μ s maximum. *Dynamic*, less than 8 μ s at 45 ips on low and dual density models ($360/V$ μ s, max. at other tape speeds); less than 6 μ s at 45 ips on triple density models ($270/V$ μ s, max. at other tape speeds). Refer to Skew Compensation specification.

Specifications for 3030 Series—only*

- Single speed:** from 45[†] ips to 75 ips. (Speed is specified at time of order.)
- Dual speed:** (optional) any two speeds from 7.5[†] ips to 75 ips. (Speeds are specified at time of order.)
- Recording density:** all models are triple density: 200, 556 and 800 characters per inch, selectable.
- Start time:** 5 ms (forward or reverse) to within $\pm 5\%$ of normal speed, after receipt of start command.
- Start distance (at 75 ips):** 0.185 ± 0.025 inch during 5 ms start period.
- Stop time:** less than 2.5 ms after forward or reverse drive command is removed.
- Stop distance (at 75 ips):** 0.100 ± 0.015 inch during 2.5 ms stop period.
- Skew (at 75 ips):** *Static*, less than 6 μ s. *Dynamic*, less than 3.6 μ s. Refer to Skew Compensation specification.

Specifications common to 2020 and 3030 Series

- Recording mode:** NRZI (non-return to zero IBM).
- Reel brakes:** disk type electro-mechanical. Positive braking on power failure.
- Magnetic head assemblies:** track spacing and read-to-write gap spacing are IBM-compatible for both 7- and 9-track assemblies.
- Speed deviation:** average long term speed deviation will be less than $\pm 1\%$ ($\pm 3\%$ with dual speed or 48-62 Hz options). Speed deviation from average will be less than $\pm 1\%$ when measured over tape lengths as short as 1.5 inches, and less than $\pm 1\frac{1}{2}\%$ when measured over tape lengths as short as 0.135 inches.
- Skew compensation:** static skew is eliminated in Dual and Triple Density models by compensation circuits in the Data Electronics. All models *clock* the reproduced data prior to output in order to present a deskewed character.
- Rewind time:** less than three minutes for a full 2400 foot reel.
- Power requirements:** standby—600 watts. Operating—750 watts, average. Peak—970 watts.

Input-output requirements

- (for Data, Control, and Tape Unit Status signals.)
- Tape motion commands:** no sequence of commands or combination of simultaneous commands will cause tape damage. 5 ms must be allowed between forward/reverse drive and/or stop commands to maintain start-stop specifications.
- Logic:** selected at time of order to be compatible with the electronics of the controlling device.
- Voltage levels:** all required interface voltages are between +15 volts and -15 volts (request current Technical Data Sheet for details).
- Input power:** 105 to 126 V ac (117 V ac nominal), 60 Hz single phase (50 Hz operation, optional).
- Temperature:** 32°F to 110°F ambient operating temperature.
- Humidity:** 20% to 95% relative humidity operating.
- Altitude:** to 10,000 feet above sea level.
- Prices:** depending on model and options specified at time of order, tape unit prices will range from \$5,000 to \$15,000. Actual prices are readily quoted upon determination of the specific tape unit configuration required by the controlling digital system.

*Specifications apply to units operating from a precise 60 Hz or 50 Hz ac power line. All specifications except Speed Deviation will be met with a ± 2 Hz line frequency variation.

†Lower speeds on special order.

COMPUTERS AND PERIPHERALS



OPTICAL MARK READER

For data entry and communication

Model 2760A

The 2760A Optical Mark Reader is a low cost, desk top remote data transmission terminal which reads punched and marked tabulating cards. It is designed for use with standard telephone data sets in communication networks where limited information must be gathered from many sources; or where it is desirable to use the original document as direct input to the system, rather than punched cards, perforated paper tape, or manually entered information by key-stroke.

The Reader is a human-oriented data entry system that takes advantage of two common and portable data entry devices—pencil and paper. The input document is a standard tabulating card, coded by marking lines through pre-printed boxes with a regular soft lead pencil. Thirty-nine characters of alphanumeric information may be marked on a single card.

Since the tab cards are hand-marked, and are read directly as marked, keypunch operations are bypassed. This eliminates the cost, error potential, and noise associated with keystroke equipment, and speeds delivery of data to the receiving terminal.

In application, immediate data transmission can speed input of orders, payroll charges, inventory entries, shipments, billings, and similar operating data to a central data processor. Because the 2760A is a low-cost portable unit, it is practical to locate units for data entry at many remote points.

Tab Card Specifications

Data entry documents: Standard tabulating cards, printed with reflective ink visible to the eye, but not to the photo-sensors of the 2760A. A row of 'clock' marks printed on the cards synchronize reading by the 2760A with the data entry marks on the card.

Card design: The information can be arranged in almost any manner, with considerable positional freedom in the horizontal direction. For example, the cards can be divided into data fields; they can include printed instructions for data entry; and space can be provided for handwritten information not to be read by the 2760A.

Coding Formats: Models of the 2760A are available to read any one of three formats:

Hollerith Punch Format: The standard 2760A reads holes and marks interchangeably, and both on the same card. Mark positions occupy the punch positions of a standard tab card. Accepts 39 columns of information (every other column of the 80 column card).

Hollerith Mark-Sense Format: Mark positions are higher on the card, located midway between the rows of Hollerith punch positions. This format is offered for applications where cards already in use in this form cannot be changed.

Dial Code Format: Hewlett-Packard's new 'dial' code uses a simple alphabetic coding, arranged in a manner like a familiar dial telephone.

Marking cards: Data is written on the cards by marking diagonal lines in pre-printed boxes enclosing the characters to be read, using a regular soft black lead pencil. Skipping a column enters a space. A black mark across a single box provides a numeric character on the card. Letters or punctuation require two marks, one in a numeric position and one in a zone position at the top of the column.

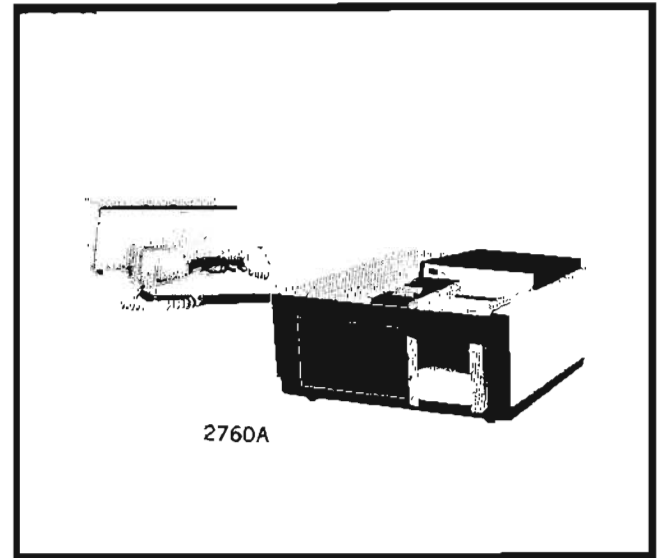

Correction of entries: A feature of the optical mark system is easy correction of errors. When undesired marks are erased completely they are not read; new marks entered correctly will be read instead.

Pre-punched cards: Cards can be pre-punched or pre-printed with identifiers and routine information for turn-around applications, reducing the amount of hand-entered data, and assuring correct identification of the turn-around document.

Reader Specifications

Installation: The 2760A requires only connection to AC power and an interface cable between Reader and Data Set.

Receiver compatibility: The 2760A Optical Mark Card Reader transmits at 105 characters/second (optionally 10 cps) to receiving terminals equipped to accept data transmissions from Bell Telephone System type 202C or 103A Dataphones, or equivalent common carrier data transmission equipment. Many receiving terminals are compatible, including AT & T Data-speed Type 11 and Teletype Telespeed 1050 Tape Receivers; and Teletype 33 and 35 Teleprinters. Many digital computers, including Hewlett-Packard's 2116A are compatible for direct input, making possible multi-terminal networks, automatic polling, multiplexing, and preliminary processing.

Environment and reliability: The 2760A Reader is a rugged, electrically-conservative unit designed to operate not only in office environments, but also in construction sites, machine shops; marine weather stations, and other locations where dirt, vibration, temperature, and humidity conditions are far from ideal. The Reader operates from 0 to 55°C; relative humidity to 95% at 40°C; after 4 inch drop to a hard surface. The 2760A is designed for MTBF exceeding 2000 hours at 25°C.

Overall dimensions: 12¾" wide, 6⅞" high, 19½" deep (330 x 175 x 495 mm)

Weight: net 22 lbs (10,0 kg); shipping 29 lbs (13,2 kg).

Price: HP Model 2760A for Hollerith punch format, \$2500; Hollerith mark-sense format adds \$50; dial code format adds \$50; optional 10 character per second rate, no charge.

DIGITAL RECORDERS AND ACCESSORIES



RECORDERS

Digital recorders

It frequently is expedient or necessary to obtain permanent records of rapidly changing phenomena measured by electronic counters, digital voltmeters or other digital devices. Often it is desirable to relate this permanent data record to time or translate it to analog form. Hewlett-Packard digital recorders and accessories are designed for this purpose.

Hewlett-Packard digital recorders are electro-mechanical devices which provide printed records of digital information from electronic counters, digital voltmeters, scaler-timers, etc. The two major HP digital recorder categories are the 20 line/s Model 5050A, and the 5 line/s Models 561B, 562A and 565A. The common characteristics of all HP digital recorders are (1) parallel entry (i.e., the input data for all digits must be present at the time printing is commanded); (2) a manual paper advance aids observation of last printout; (3) paper is 3" wide fan-folded tape (561B, 562A and 565A also use roll paper) and is easily changed; (4) holdoff signals from the recorders (except 565A) prevent external equipment from changing input data while print wheels are being positioned, and a print command pulse is required from the data source to initiate a recorder print cycle; (5) standby, momentary and print-on-command operation is manually selectable; (6) the recorders are designed for continuous unattended operation; the printing mechanisms are designed for simplicity, durability, and trouble-free operation with little maintenance required.

An analog output, suitable for driving either potentiometer or galvanometer recorders is optional for those 562A's with either 4-2-2-1 or 8-4-2-1 BCD column boards installed. Analog output is very useful for continuous analog plots of data variations such as oscillator drift where the important information is in the printed record's last few digits. HP can also supply separate digital-to-analog converters (Models 580A and 581A, page 117).

20 line/s Model 5050A

This recorder prints up to 18 columns at 20 lines/second. It can accept a total of 20 columns of 4 bit BCD data from 1 or 2 sources.

The user can easily change the code base of his recorder to use the 4-2-2-1 "1" state positive or 8-4-2-1 "1" state positive or negative codes. The Model

5050A is a simple code comparator which uses an inexpensive, substitutable code disc as a reference. The same column boards are used with all code discs.

The user can easily substitute different print wheels to use mixed codes, that is, to have a different code base and/or character set in each column.

The Model 5050A has two, general purpose character suppression features which have many uses. A typical use is to suppress the printing of leading zeros. By arranging plug-in diodes, the user can suppress the printing of any one of the 16 possible characters in any column (a different character can be suppressed in each column). The other feature (using plug-in jumper wires) makes the suppression of a character conditional—the character is suppressed only if it is a leading character (an insignificant "zero" for example).

The 5050A operates very reliably, due mainly to the simplicity of its design. By being based on an optical code comparator scheme, the 5050A is electrically simple and has very few moving parts.

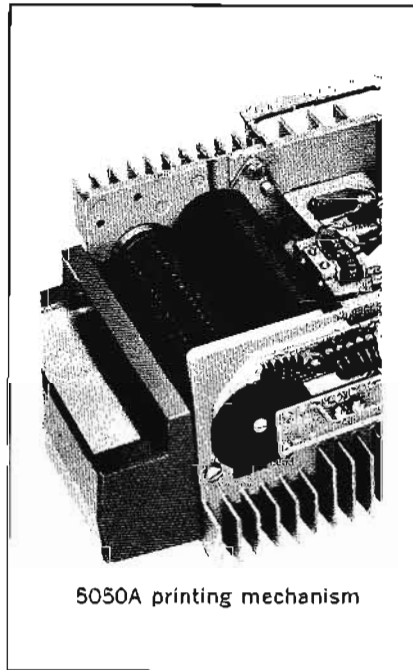

5050A printing mechanism

5 line/s printers

(Models 562A, 561B and 565A)

These printers record up to 11 columns of data (12 on special order) and all utilize the same basic printing mechanism. Model choice is usually based upon the flexibility required, input codes, and the cost of equipping the instrument to

operate with the printer. A wide variety of special print wheels is available.

Model 562A

This printer requires a parallel-entry, 4-line, binary-coded-decimal input (or 10-line decimal; see options on page 115). The 562A (utilizing plug-in column board input circuitry) is extremely flexible, allowing operation from two unsynchronized sources. Interchangeability of column boards allows complete mixing of the available codes among the columns. A unique storage feature in the 562A permits the driving source to transfer BCD data into the 562A binaries in 2 milliseconds, thus freeing the source to initiate a new measurement.

Model 561B

The 561B requires a "10-line" input for each column of information from the data source; thus, each print wheel position is controlled by a separate line. Digital recorder kits for field installation in HP counters are available to permit operation with the 561A: for 521D and 521E counters, kit 521D-95B, \$45; for 523C, kit 523C-95B, \$65; for 524C, kit 524C-95B, \$165.

Model 565A

The HP Model 565A is the basic printer mechanism used in the 562A and 561B digital recorders. Data entry is parallel, and one line is needed for each position on each print wheel. Control cables and driving electronics must be fabricated for each 565A application. Front panel appearance of the 565A is similar to the right-hand half of the 561B, and is 9/4" deep behind the front panel.

Digital clock

For providing time-of-day reference to recorded data, the 561B and 562A can have a digital clock installed. The 571B Digital Clock is used with the 561B Digital Recorder, and a special clock, the H03-571B, is used with the 562A Digital Recorder. These clocks indicate time to 23 hours, 59 minutes and 59 seconds in an in-line display. All time digits are available for printing. The location and number of time digits on the printed record are determined by connector arrangements on the rear of the digital recorders. Clocks also issue timing signals.

RECORDERS



DIGITAL RECORDER

Rapid printing rates; mixed code operation

Model 5050A

Advantages:

- Prints at 20 lines/sec
- 18 column capacity
- Inexpensive mixed codes column by column
- Versatility of quick-change code discs
- Few moving parts
- Quiet operation
- Storage option in early 1968

This latest HP Digital Recorder has been designed to be fully compatible with existing HP solid state equipment. A significant advance has been made in print capacity and rate; this recorder will accept up to 20 columns of 4 line BCD data from one or two sources, and prints up to 18 of these columns at rates up to 20 lines per second.

The user can easily change the code base of his 5050A to use the 8421+, 8421-, or 4221+ code. The code base is defined by an inexpensive, substitutable code disc. In addition, the user can easily substitute different print wheels to use mixed codes, that is, to have a different code base and/or character set in each column.

The 5050A has a versatile character suppression feature. The feature allows the user to determine which character is suppressed in each column and whether or not only leading characters are suppressed. A typical use is to suppress leading zeros.

The print drum (18 print wheels with 16 printing positions each) rotates continuously, eliminating the stop-start operation of slower printers; an inked roller presses against the drum, constantly renewing the ink on the drum characters (pressure sensitive paper operation is optional). The print cycle begins with a print command from the data source, a BCD code for each print position of the drum being compared with the BCD signal from the data source. In any column where the two agree, the print hammer is momentarily activated, pressing the paper against the character.

The reduction in moving parts resulting from this system leads to ultra reliable operation and easy maintenance. Particular attention has been paid to ensuring that the recorder operates quietly.

The data source is inhibited through the print cycle.

Data storage Option will be offered in early 1968.

Specifications

Accuracy: identical to input device used.

Printing rate: 20 lines per second, maximum.

Column capacity: to 18 columns.

Print wheels: 16 positions, numerals 0 through 9, —, +, A, V, Ω , *; other symbols available.

Input requirements

Data input: parallel entry, BCD (8-4-2-1+, 4-2-2-1+, or 8-4-2-1- are standard; other code discs available) "1" state must differ from "0" state by at least 4.5 V but by no more than 75 V; input impedance approx. 1 M Ω .

Reference voltages: BCD codes require both "0" and "1" state references; reference voltages may not exceed ± 150 V to chassis; "0" and "1" references must differ by at least 4.5 V.

Hold-off signals: both polarities are available simultaneously for BCD codes and are diode-coupled; 10 mA maximum load ± 15 V open circuit from 1 k Ω source.

Print command: + or - pulse, 4.5 to 20 volts amplitude, 1 V/ μ s minimum rise time, 20 μ s or greater in width, ac coupled; input impedance approx. 1500 Ω .

Transfer time: 50 ms.

Paper required: HP folded paper tape (15,000 prints per packet with minimum spacing) HP Stock No. 9281-0386 or folded pressure sensitive paper, Stock No. 9281-0387.

Line spacing: adjustable, 3.5 to 4.5 lines/inch.

Inking: ink roller or pressure sensitive paper.

Operating temperature: -20°C to +55°C with pressure sensitive paper, +10°C to +40°C with ink roller.

Power: 115 or 230 V $\pm 10\%$, 50 to 60 Hz, approx. 100 W idle, 190 W at 20 lines/sec. 50 Hz model with 20 prints/sec available.

Dimensions: cabinet: 16 $\frac{3}{4}$ " wide, 8 $\frac{1}{2}$ " high, 18 $\frac{3}{8}$ " deep (426 x 226 x 467 mm).

Weight: net 40 lbs (18 kg).

Accessories furnished: one packet fan fold paper, one packet folded pressure sensitive paper, one ink roller, rack mounting kit.

Price: HP 5050A, \$1750. Column Boards (one required for each two columns to be operated), \$70. Input cables, \$35. (Accommodate 10 input columns.) Input cable for use with 5216A, 5221B, \$65. 50 Hz operation, \$15.

Accessories available: fan fold paper HP 9281-0386, \$1.50. Pressure sensitive paper HP 9281-0387, \$4.00. Ink roller (black) 9260-0071, \$10.00.

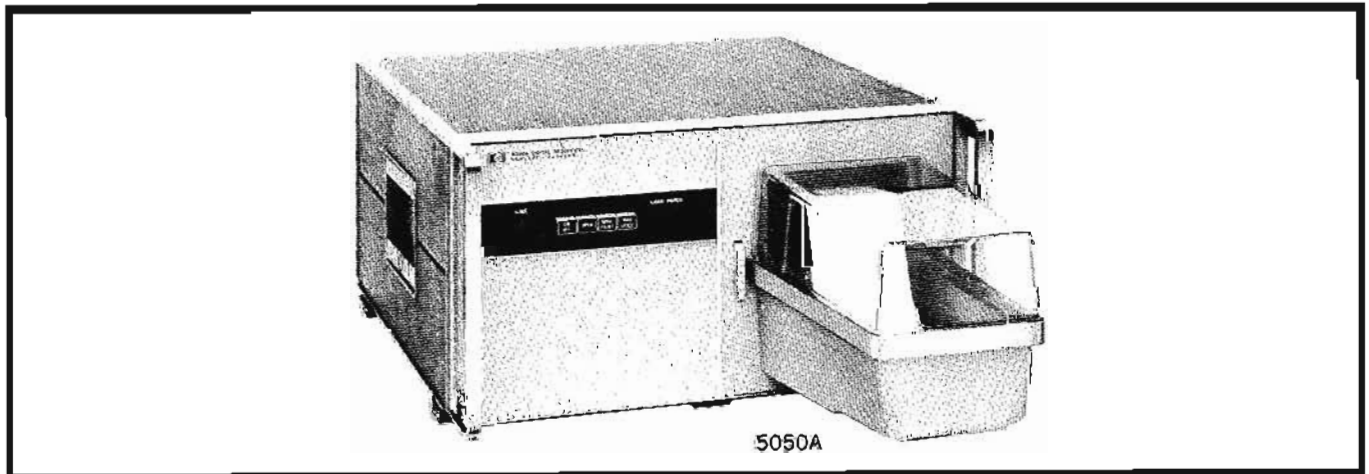

DIGITAL RECORDER

Flexible data input with information storage
Model 562A



RECORDERS

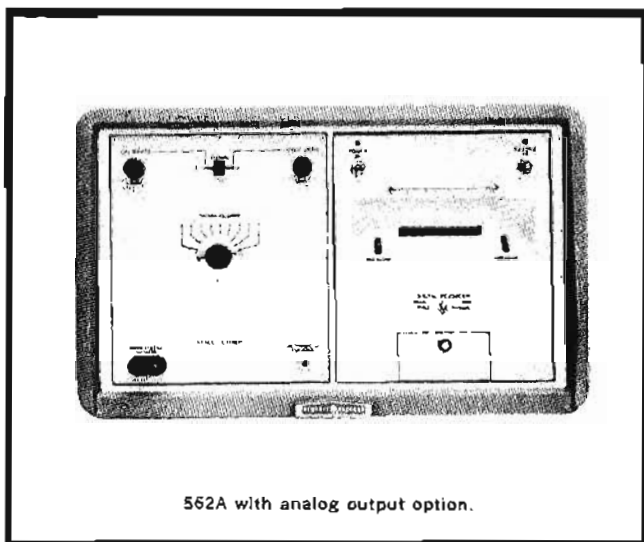

562A with analog output option.

HP Model 562A Digital Recorder is a solid-state electro-mechanical device providing a printed record of digital data from any of a number of sources. Parallel data entry and low-inertia moving parts allow printing rates as high as 5 lines per second, each line containing up to 11 digits. Twelve-digit capacity is available on special order.

Data enter the unit through rear-mounted 50-pin connectors. Internal plug-in connectors route the information to any desired sequence of print wheels. A separate storage binary unit is associated with each individual print wheel for 4-line BCD input codes.

Model 562A may be equipped to translate 1-2-2-4 BCD, other 4-line codes or 10-line code by substituting plug-in column boards and input connector and cable assemblies.

Specifications

Accuracy: identical to input device used.

Printing rate: 5 lines per second, maximum.

Column capacity: to 11 columns (12 available on special order).

Print wheels: 12 positions, numerals 0 through 9, a minus sign and a blank; other symbols available.

Input requirements

Data input: parallel entry, BCD (1-2-2-4, 1-2-4-8 or 1-2-4-2) or 10-line, see Options; "1" state must differ from "0" state by at least 4 Volts but by no more than 75 Volts.

Reference voltages: BCD codes require both "0" and "1" state references; 10-line codes require reference voltage for "0" state; reference voltages may not exceed ± 150 V to chassis; input impedance is approximately 270 K ohms.

Hold-off signals: both polarities are available simultaneously for BCD codes and are diode-coupled; 10 mA maximum load ± 15 V open circuit from 1 K source, -5 V open circuit from 2.2 K source (160 msec hold-off is provided for 10-line codes).

Print command: + or - pulse, 6 to 20 volts amplitude, 1 V/ μ s minimum rise time, 20 μ s or greater in width, ac coupled.

Analog output (optional): (from 1-2-2-4 or 1-2-4-8 boards) accuracy is $\pm 0.5\%$ of full scale or better; 100 mV for potentiometer recorder; 50 K ohm minimum load resistance; 1 mA into 1.5 K ohm maximum for galvanometer recorder.

Transfer time: 2 ms for BCD codes.

Paper required: HP folded paper tape (15,000 prints per packet with single spacing) HP Stock No. 560A-131A or standard 3-inch roll tape.

Line spacing: single or double.

Power: 115 or 230 V $\pm 10\%$, 50 to 60 Hz, approx. 130 W. (4 prints/sec at 50 Hz; 50 Hz model with 5 prints/sec available.)

Dimensions: cabinet: 20 $\frac{3}{4}$ " wide, 12 $\frac{1}{2}$ " high, 18 $\frac{1}{2}$ " deep (527 x 318 x 470 mm); rack mount: 19" wide, 10-15/32" high, 16 $\frac{1}{2}$ " deep (483 x 266 x 419 mm).

Weight: net 35 lbs (16 kg), shipping 80 lbs (36 kg) (cabinet); net 30 lbs (13 kg), shipping 63 lbs (31 kg) (rack mount).

Price: HP 562A, \$1085 (cabinet); HP 562AR, \$1060 (rack mount); basic unit with 11-column capacity; column boards, input connector assemblies and cables required for operation are not included, see Options.

Options, Group 1

(Completely equips 562A for operation with Hewlett-Packard and Dymec instruments.)

Option 11. For 6-column operation from 1-2-2-4 "1" state positive code, add \$540

Option 12. For 9-column operation from 1-2-2-4 "1" state positive code, add \$765.

Option 13. For 11-column operation from 1-2-2-4 "1" state positive code, add \$993.

Option 14. For operation with 5245L; 10-column operation; prints measurement unit and indicates decimal position — e.g., 16942.496 kHz would be printed as 3 kHz 16942496; the first digit shows how far to move the decimal to the left; add \$865.

Options, Group 2, column boards

Option 21. 1-2-2-4 "1" state positive, \$75 each.

Option 22. 1-2-4-8 "1" state positive, \$75 each.

Option 23. 1-2-4-8 "1" state negative, \$75 each.

Option 24. 1-2-2-4 "1" state negative, \$75 each.

Option 25. 10-line "1" state positive (no storage), \$50 each.

Option 26. 10-line "1" state negative (no storage), \$50 each.

Option 27. 1-2-4-2 "1" state negative, \$75 each.

NOTE: Input connector assemblies and input cables (Group 3 options) are required for use with Group 2 column boards.

Options, Group 3, connector assemblies

Option 30. BCD input connector assembly for up to 9 columns, \$55.

Option 31. BCD input connector assembly for up to 6 columns, \$43.

Option 32. Input cable, for up to 10 BCD columns or three 10-line columns, \$35.

Option 33. 10-line input connector assembly for up to 3 columns, \$35.

Option 34. BCD input connector assembly for up to 10 columns, \$60.

Option 35. Input cable for use with 5216A, 5221B, \$65.

NOTE: More than one input connector assembly and input cable are required for: 1. more than nine BCD columns; 2. operation from two sources; 3. more than three 10-line columns.

Options, Group 4

Option 41. Analog output (from 1-2-2-4 boards), \$175.

Option 42. Analog output (from 1-2-4-8 boards), \$175.

RECORDERS



DIGITAL RECORDERS

Print 10-line data at 5 lines/sec
Models 561B, 565A

The 561B Digital Recorder accepts only 10-line decimal code inputs, but is otherwise similar in operation to the HP 562A. The HP 565A Printer Mechanism, mechanically similar to the mechanism in the 561B and 562A, is available for use in custom systems.

Specifications, 561B

Column capacity: 11 columns (12 available on special order).

Print rate: 5 lines per second.

Print wheels: 12 positions having numerals 0 through 9, a minus sign and a blank; other symbols are available on special order.

Input: decimal code, 10 lines plus 2 lines for blank and minus sign for each column.

Driving sources: HP electronic counters (521D, 521E, 523C) with recorder kits, 405CR Digital Voltmeter, stepping switches, relays, beam switching tubes, contact closures, or -15 to -100 volts connected to appropriate input wire.

Print command signal: ± 15 volts peak, 10 μ s or greater in width, 1 V/ μ s minimum slope; manual control with momentary-contact switch.

Line spacing: zero, single or double; in "zero" does not print, paper does not advance.

Paper required: 560A-131A folded paper tape or standard 3" roll; tape sufficient for 15,000 single-spaced lines.

Power: 115 or 230 volts $\pm 10\%$ approximately 75 W, 50 to 60 Hz (4 prints/s maximum at 50 Hz); 50 Hz model available which retains 5 print/s capability.

Dimensions: 20 $\frac{3}{4}$ " wide, 12 $\frac{3}{4}$ " high, 18 $\frac{1}{2}$ " deep (527 x 324 x 470 mm) (cabinet); 19" wide, 10-15/32" high, 16 $\frac{1}{2}$ " deep (483 x 266 x 419 mm) (rack mount).

Weight: 561B, net 35 lbs (19,7 kg), shipping 70 lbs (31,5 kg) (cabinet mounted); 561BR, net 30 lbs (18 kg), shipping 65 lbs (29,2 kg) (rack mounted).

Accessories furnished: 9281-0018 folded paper tape, one packet, 9283-0002 inked ribbon, 560A-95N Digital Recorder Service Kit; 561B-16A Cable, accommodates 6 columns, connects to Option 02.-equipped vacuum tube counters.

Price: HP 561B, \$1150 (cabinet); HP 561BR, \$1135 (rack mount).

Accessories available: 560A-131A folded paper tape, 24-packet carton \$19.50. Inked ribbon 9283-0002, \$3.50; 561B-16A Cable, 6 ft., 6 columns, \$100, 561B-95D Connectors (mates with J101 or J102), \$8.50.

Specifications, 565A

Number of columns: 11 (12 available on special order).

Data entry: parallel entry to all columns; one line required for each position of each print wheel to be operated.

Maximum print rate: 5 lines per second.

Standard characters: 0 through 9, minus sign and blank (others available on special order); dimensions: approximately 0.085" wide, 0.1" high.

Column spacing: $\frac{1}{4}$ ".

Line spacing: 5/32" single space; 5/16" double space.

Power

Motor: 115 V $\pm 10\%$, 60 W, 50 to 60 Hz (50 Hz provides 4 prints/s max.).

Clutch solenoid: 240 to 260 V dc, 75 mA (operates for approx. 15 ms to start printing cycle); coil designed for vacuum tube switching networks; lower voltage coils are recommended and available on special order for transistor switching.

Pawl magnets: 60 to 70 V dc, 15 mA (operate when needed during printing cycle); coils designed for vacuum tube switching networks; lower voltage coils are recommended and available on special order for transistor switching.

Dimensions: 9 $\frac{3}{4}$ " high, 8 $\frac{3}{8}$ " wide, 9 $\frac{3}{4}$ " deep (248 x 213 x 248 mm).

Weight: net 15 lbs (7 kg); shipping 20 lbs (9 kg).

Price: HP 565A (with high-voltage clutch and pawl coils for vacuum tube drive), \$750; for 115 V, 50 Hz operation with 5 prints/s capability specify H27-565A, \$765; for 230 V, 50 Hz operation with 5 prints/s capability specify H24-565A, \$775.

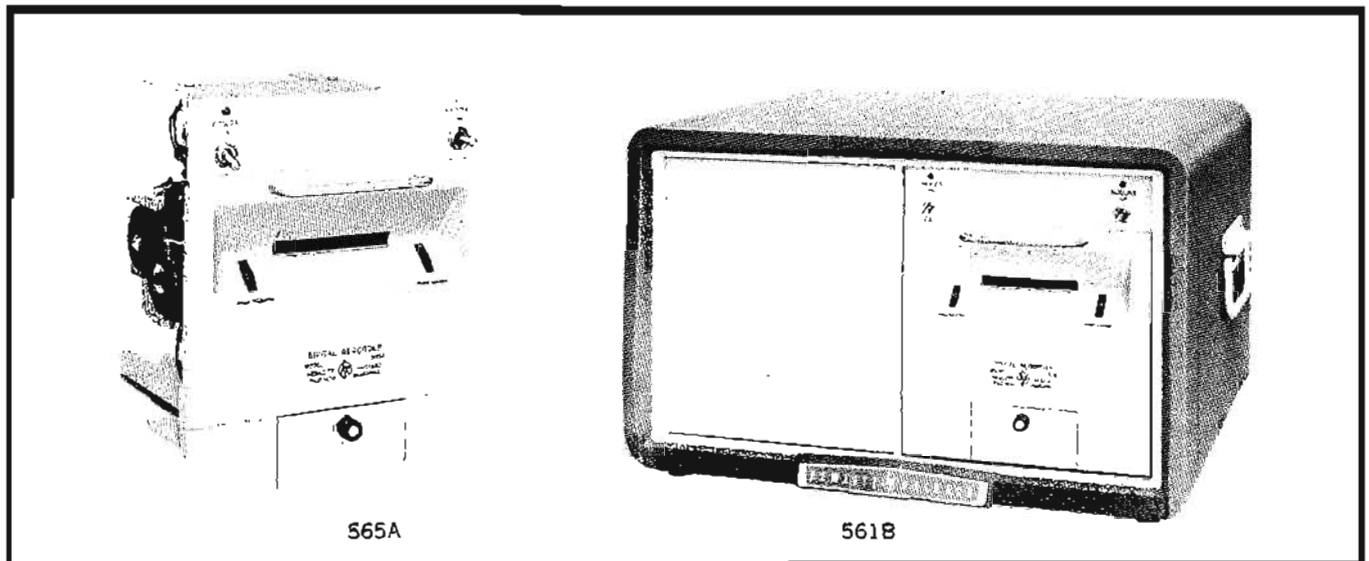

565A

561B

D/A CONVERTERS; DIGITAL CLOCK

High resolution recording; time recording

Models 580A, 581A; 571B



RECORDERS

Digital-to-Analog Converters make possible automatic, high-precision analog records from electronic counters, digital voltmeters and other devices providing the proper 4-line BCD output code. These converters operate directly with HP Quartz Thermometers, HP Nuclear Scalers and most HP solid-state counters; output kits are available for HP vacuum tube counters. Since the digital-to-analog converters tolerate a wide range of input voltages, they are suitable for use with other tube and solid-state devices.

Output signals for strip-chart or x-y recorders of both the potentiometer and galvanometer types are available, and controls for recorder calibration and zero adjustment are provided. A 50-pin connector accepts 4-line data from a maximum of nine decade counting units. This information is transferred to storage binary units upon receipt of a command pulse from the counting source. The stored data are then translated and weighted to provide the proper analog output voltage or current.

Specifications, 580A, 581A

Accuracy: 0.5% of full scale or better.

Potentiometer output: 100 mV full scale; minimum load resis-

tance 20 K; calibrate control; dual banana plugs front and rear; typical 5 mV residual output at "000".

Galvanometer output: 1 mA full scale into 1500 ohms; zero and calibrate controls; phone jack front and rear.

Driving source: parallel entry 4-line BCD, 1-2-2-4 (9 digits maximum); "1" state +4 to +75 Volts with reference to "0" state.

Reference voltages: reference voltages required for both the "0" and "1" state, reference voltages not to exceed ± 150 V to chassis.

Command pulse: positive or negative pulse, 20 μ s or greater in width, 6 to 20 Volts amplitude.

Transfer time: 1 millisecond.

Power: 115 or 230 volts $\pm 10\%$, 50 to 1000 Hz, 11 W.

Dimensions: 580A (rack mount): 16 $\frac{3}{4}$ " wide, 3-15/32" high, 11 $\frac{1}{4}$ " deep (425 x 88 x 286 mm); 581A: 7-25/32" wide, 6-3/32" high, 8" deep (198 x 155 x 203 mm).

Weight: 580A: net 13 lbs (6 kg), shipping 16 lbs (7,2 kg); 581A: net 8 lbs (3,5 kg), shipping 13 lbs (6 kg).

Accessory furnished: 562A-16C Cable, 6' (1830 mm) long with an Amphenol 57-30500 connector at each end.

Price: HP 580A, \$525; HP 581A, \$525.

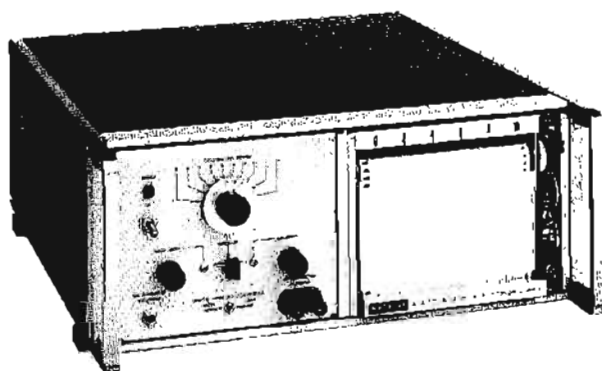

581A, Moseley 580 Recorder

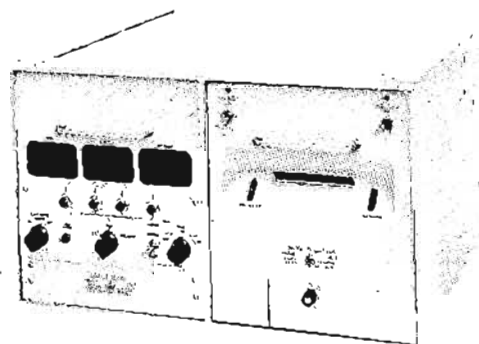

571B with 561BR Recorder

The 571B Digital Clock, which mounts in the left side of the 561B Digital Recorder (page 116), provides time-of-day information and controls the rate at which measurements are made. Time is indicated in hours, minutes and seconds (24-hour basis) in an in-line display which is available for printing. If desired, clocks may be ordered installed in the recorders at the time of purchase. In addition, a modified 571B (H03-571B) is available for use with the HP562A Digital Recorder (page 115).

Specifications, 571B

Indication: 6-in-line digital display tubes indicate to 23 hours, 50 min, 59 s; 12-hour format available on special order.

Time base: front-panel time-base switch selects: (1) 60 Hz (50 Hz available on special order), (2) counter (1 pps, HP vac. tube

counters), (3) external (5 V positive pulses, 200 μ s long, 1 pps; input impedance approximately 500 ohms).

Time print format

561B: six time digits recorded in right-hand columns of 561B with clock connected to J101 on 561B; with clock connected to J102, time records in the five left-hand columns without tens-of-hours.

562A: recording format (all columns) is set-up by plug-in connectors and column boards in 562A.

Weight: net 20 lbs (9 kg); shipping 28 lbs (13 kg).

Power: ac and dc supplied by digital recorder, approximately 15 watts (normally wired to operate on 60 Hz).

Price: HP 571B, \$1000.

Because of many options for the 571B, please contact your nearest HP sales office when ordering.



X-Y, Strip Chart, and Oscillographic Recorders



X-Y RECORDERS



RECORDERS

The Cartesian coordinate graph is one of the most efficient means ever devised to portray related data clearly. Modern x-y recorder speed data interpretation by producing such graphs quickly. An x-y recorder automatically and conveniently plots the value of an independent variable versus a dependent variable, directly on conventional graph paper, working from readily derived electrical signals.

Many years of experience in pioneering and manufacturing x-y recorders has provided features which make Hewlett-Packard recorders the most useful of their kind. Among advanced features are:

- Autogrip® electric paper hold-down, with no moving parts
- inputs with 1-megohm null loading
- calibrated multi-scale ranges
- dc sensitivity to 100 μ V/inch
- ac sensitivity to 5 mV/inch
- zero offset up to 4 scale lengths
- 140 dB dc common mode rejection
- 120 dB ac common mode rejection

Basic operation of x-y recorders

The x-y recorder uses electrical servo systems to produce a pair of crossed motions, moving a pen so as to write precise x-y plots. It consists of basic balancing circuits, plus auxiliary elements to make the instrument versatile.

A self-balancing potentiometer circuit compares an unknown external voltage with a stable internal reference voltage. The difference between these voltages is amplified and applied to a servo motor to drive a potentiometer in a direction that will null any difference or error voltage. Accuracy of plots made by this principle is typically 0.1%. The sensitivity of high performance recorders for each axis is 0.1 mV/inch. Thus, the output of many low-level devices, such as thermocouples and strain gages, may be plotted directly without additional amplification.

A stepped attenuator or range selector is included for each axis, so voltages as high as 500 volts may be handled directly. Input resistance is at least 200,000 ohms per volt, with higher values, including constant 1-megohm input resistance, available on some models. Sensitivity may be as high as 100 μ V per inch for dc, 5 mV per inch for ac.

Zeroing potentiometers permit the user to locate the plotting origin as desired by inserting an offset voltage. With these

controls the zero of either axis, or both, can be extended or suppressed up to four full-scale lengths on some models, so plotting may be carried out in any desired quadrant.

To fit the range of the recorder's response exactly to the coordinates of the paper in use, or to the units of measurement desired, a continuously adjustable range control may be switched in as a substitute for the calibrated control. Thus, the response range of the recorder can be adjusted smoothly to match, for example, some calibrated maximum from a transducer, so the paper's coordinates directly correspond to the desired units of measurement (psi, °C, etc.).

Since it is often desirable to plot a function against time, a time base sweep circuit is supplied or made available as an accessory. (Model 17108A)

Accessories and options

The available accessories include curve follower, Roll chart adapter, character printers for point plotting, Logarithmic converters, keyboard control for plotting tabular data, and a self contained external time base.

Options include rack mounting, metric calibration and scaling, special input characteristics, rear connections and others. The range of accessories is constantly being augmented. The user may be sure his Hewlett-Packard x-y recorder will be adaptable to the widest possible variety of future needs, without added initial cost.

Selecting an x-y recorder

Hewlett-Packard x-y recorders may be selected among models in two basic chart

sizes, 8½"x11" or 11"x17". Three basic levels of performance are available depending upon measurement needs. For general purpose applications where high dynamic performance is not required the newly designed inexpensive recorders (Models 7035B, 7005A) represent an extremely good value in x-y recorders.

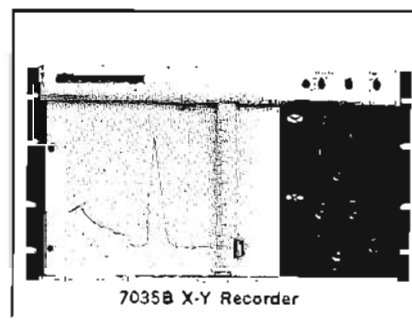

7035B X-Y Recorder

Two pen models are available, capable of simultaneously plotting two curves. Certain models have high sensitivity, high common mode rejection and high input resistance. Models are available with and without ac and time sweep capability. Metric models are available with scaling and calibration equivalent to that shown below but in metric units.

Model 7004A 11" x 17" Recorder is available with plug-in input modules. This approach provides versatility, allowing inexpensive plug-ins to be purchased to accommodate changing applications. All plug-in modules may be purchased with the recorder or they may be purchased later as the need arises. A variety of plug-ins such as Null Detector, Amplifiers, Time Bases, DC offset, Filters, etc. are available.

Hewlett-Packard X-Y Recorders

Model	Chart size	Performance level	Pens	Sensitivity mV/inch	Input resistance (maximum sensitivity)	AC	Time sweep	Rack model	Price
7035B	8½ x 11	general purpose	1	1 10	Potentiometric 100 k	no	internal—no external—yes (Model 17108A)	same	\$945
135	8½ x 11	medium	1	0.5	*200 k/volt	no	yes	same	1650
135A	8½ x 11	medium	1	0.5	*1 meg	no	yes	same	1650
136A	8½ x 11	medium	2	0.5	*1 meg	no	yes	same	2650
7030A	8½ x 11	high	1	0.1	*1 meg	no	yes	same	1895
7005A	11 x 17	general purpose	1	1 10	Potentiometric 100 k	no	internal—no external—yes (Model 17108A)	same	1195
7004A	11 x 17	high	1	0.5**	*1 meg	no	yes**	same	1295†
2FA	11 x 17	medium	2	0.5	*1 meg	no	yes	2FRA	3375
7000A	11 x 17	high	1	0.1 dc 5 ac	*1 meg	yes	yes	7000AR	2495
7001A	11 x 17	high	1	0.1 dc	*1 meg	no	yes	7001AR	2175

**Depends on plug-in. † (less plug-in)

RECORDERS



8½ x 11 X-Y RECORDER

Low cost — multiple use

Model 7035B

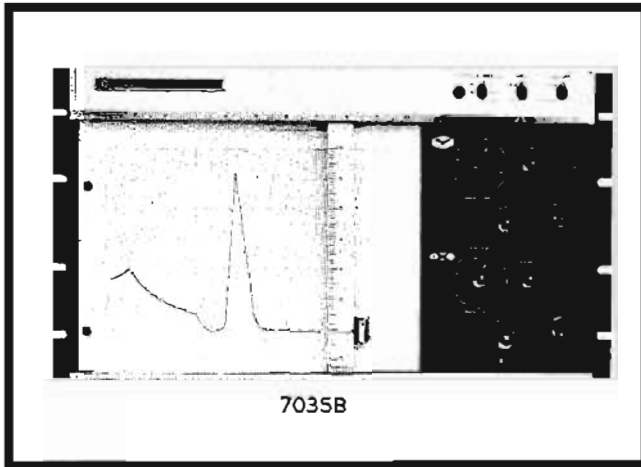

7035B

The Model 7035B is a high performance, low cost, solid state X-Y Recorder for general purpose applications. Each axis has an independent servo system with no interaction between channels. The recorder will draw a graph of two related functions from two dc signals representing each of these functions. The ultra-compact design is convertible to rack mounting with only the addition of two wing brackets which are supplied. Metric scaling and calibration are optional.

The input terminals accept either open wires or plug-type connectors. Five calibrated ranges from 1 millivolt/inch to 10 volts/inch are available in each axis. A variable range control allows any voltage, within the recorder limits, to be adjusted for full scale deflection. Standard features include high input impedance of one megohm (all but the first two ranges), floating and guarded input, 0.2% accuracy, Autogrip electric paper holddown, electric pen lift, adjustable zero set, lockable zero and variable range controls, and rear input connector. A plug-in time base (Model 17108A) is available and operates on either axis to provide five sweep speeds from 0.5 to 50 seconds per inch.

Each closed loop servo system employs a high gain solid-state servo amplifier, Hewlett-Packard manufactured servo motor, long life balance potentiometer, photochopper, low pass filter, guarded inputs, precision attenuator and balance circuit. Model 7035B is designed for easy maintenance with most components mounted on a printed circuit board and accessible by removing only the rear cover. Both balance potentiometers are accessible for inspection or cleaning by simply removing a trim strip requiring no tools. Also included are snap-on side panels and maintenance free Autogrip paper holddown.

Specifications

Input ranges: 5 fixed calibrated ranges: Standard: 1, 10, 100 mV/in., 1 and 10 V/in.; Metric: 0.4, 4, 40, 400 mV/cm, and 4 V/cm. 5 variable ranges: Continuous range adjustment from 1 mV/in. to 25 V/in. (0.4 mV/cm to 10 V/cm) provided by a high resolution control.

Type of inputs: floating differential. All input terminals may be placed up to 500 V dc from ground. Critical circuit areas are guarded with guard terminal on front panel.

Input isolation: dc—500 megohms (min) to ground at 500 V dc (all terminals). ac—Guard to ground: 0.05 μ F.

Effective guarded capacity: < 300 pF (capacity between + and - terminals, and chassis ground with guard shield driven).

Input resistance:

Range	Input resistance
1 mV/in. (.4 mV/cm) variable	Potentiometric (essentially infinite at null) 11 k
10 mV/in. (4 mV/cm) variable	100 k 100 k
100 mV/in. (40 mV/cm) variable	1 meg 1 meg
1 V/in. (400 mV/cm) variable	1 meg 1 meg
10 V/in. (4 V/cm)	1 meg

Interference rejection: conditions for the following data is line frequency with up to 1 k ohm between the negative input and the point where the guard is connected. Maximum ac common mode voltage is 500 volts peak. Maximum dc common mode voltage is 500 volts.

Range		DC(CMR)	AC(CMR)
Standard	Metric		
1 mV/in.	0.4 mV/cm	130 dB	100 dB
10 mV/in.	4 mV/cm	110 dB	80 dB
100 mV/in.	40 mV/cm	90 dB	60 dB
1 V/in.	400 mV/cm	70 dB	40 dB
10 V/in.	4 V/cm	50 dB	20 dB

Input filter: > 20 dB at 60 Hz; -18 dB/octave above 60 Hz.

Maximum allowable source impedance: no restrictions except on fixed 1 mV/in. (.4 mV/cm) range. Up to 20 k ohm source impedance will not alter recorder's performance.

Accuracy: $\pm 0.2\%$ at full scale.

Linearity: $\pm 0.1\%$ of full scale.

Dead band: $\pm 0.1\%$ of full scale.

Standardization: continuous electronic zener reference with temperature stability better than 0.002%/°C.

Zero set: zero may be placed anywhere on the writing area or electrically set off scale up to one full scale from zero index. Adjustable by a high resolution control.

Stewing speed: 20 inches/sec, 50 cm/sec, nominal at 115 V. (Typically 17 inches/sec at 103 V, 21 inches/sec at 127 V.)

Paper holddown: Autogrip electric paper holddown grips charts 8½" x 11" or smaller. Writing area: 7" x 10" (18 x 25 cm).

Pen lift: electric pen lift capable of being remotely controlled.

Dimensions: 10-15/32" deep, 17½" wide, 4¾" high.

Weight: approximately 16 lbs (net); shipping 22 lbs.

Power: 115 or 230 V $\pm 10\%$, 50 to 60 Hz, approximately 45 watts.

Time base accessory: Model 17108A self-contained external time base has five sweep speeds. Price: \$175.

Accessories supplied:

- Accessory kit: containing slidewire cleaner, slidewire lubricant, 2 pens, 1 bottle green ink, 1 bottle red ink, ink filling syringe, remote pen lift mating connector.
- Appropriate graph paper.
- Power cord (7').
- Rack mounting brackets.
- Flexible plastic dust cover.
- Instruction manual.

Price:

Model 7035B (Standard)

\$945

Model H10-7035B

\$895

Options:

- Metric calibration
- Retransmitting potentiometer on X axis
Total resistance: 5 k $\pm 3\%$
Linearity (independent): $\pm 0.1\%$
Resolution: 0.04%

n/c

\$75

8½" x 11" X-Y RECORDER

High-sensitivity to 100 $\mu\text{V}/\text{inch}$
Model 7030A



RECORDERS

Assembled on a sturdy aluminum cast frame, the 7030A X-Y Recorder accepts dc signals with much greater sensitivity and higher common mode rejection than previously possible in one instrument. Guarded and shielded input circuitry has 1-megohm resistance at null on each of 17 ranges from 100 $\mu\text{V}/\text{inch}$ to 20 V/inch, with continuous flexibility of each range for arbitrary full-scale voltages. The 5 most sensitive ranges may be operated in potentiometric mode which draws practically no current at null. The unit has an electronic time sweep with automatic reset or recycle, if desired, at the end of the sweep. The Model 7030A can be used on the bench or rack mounted. A metric model (7030AM) is available with metric scales.

Special multi-contact flat mandrel balancing potentiometers maintain trouble-free operation without frequent cleaning. Zero offset controls for each axis are calibrated in continuously adjustable 5-inch steps which cover 3 full scale lengths on x and 4 full scale lengths on y. Recording accuracy is better than 0.2% of full scale on all ranges, this accuracy being maintained from range to range. Extremely good retrace performance assures high dynamic accuracy and resettability.

The paper holddown system is the exclusive HP Autogrip which operates on an electronic principle, has no moving parts, is quiet, reliable and efficient on any paper size up to the capacity of the platen.

Specifications

Input ranges: 17 calibrated ranges: 0.1, 0.2, 0.5, 1, 2, 5, 10, 20, 50 mV/inch, 0.1, 0.2, 0.5, 1, 2, 5, 10, 20 V/inch.

Metric: 0.05, 0.1, 0.25, 0.5, 1, 2.5, 5, 10, 25 mV/cm; 0.05, 0.1, 0.25, 0.5, 1, 2.5, 5, 10 V/cm. Plus continuously variable mode.

Type of inputs: floating up to 500 V above ground; guarded and shielded.

Input resistance: one megohm at null on all calibrated and variable ranges. Potentiometric input on 5 most sensitive ranges by disconnecting an internal buss wire. Potentiometric switch optional.

Maximum allowable source impedance: up to 10 K ohm source impedance will not alter recorders performance on the five most sensitive ranges (0.1, 0.2, 0.5, 1, 2 mV/in.). Higher source impedances will cause an increase in dead zone and a decrease in pen speed. No source impedance restrictions on ranges above 2 mV/in.

Interference rejection: dc common mode rejection 140 dB on 2 most sensitive ranges; 120 dB at power line frequency on 2 most sensitive ranges.

Radio frequency interference: meets specifications of MIL-I-6181D.

Slewing speed: 20 inches/second, maximum, each axis for 60 Hz; 16 inches/second, maximum, for 50 Hz.

Time sweeps: may be applied to either axis in 8 calibrated ranges: 0.5, 1, 2, 5, 10, 20, 50, 100 sec/in; Metric models: 0.25, 0.5, 1, 2.5, 5, 10, 25, 50 sec/cm. Adjustable sweep length; may be reset or recycled at any point manually or automatically.

Accuracy: $\pm 0.2\%$ at full scale; Time sweep: $\pm 2\%$ of full scale.

Linearity: $\pm 0.1\%$ of full scale; Time sweep: $\pm 1\%$ of full scale.

Dead band: $\pm 0.1\%$ of full scale.

Zero offset: continuously adjustable with 5" calibrated steps for up to 3 full scale lengths on X and 4 on Y. Zero-check push-button switches on each axis.

Reference voltage: continuous electronic reference, zener diode controlled. Temperature stability better than 0.005%/°C.

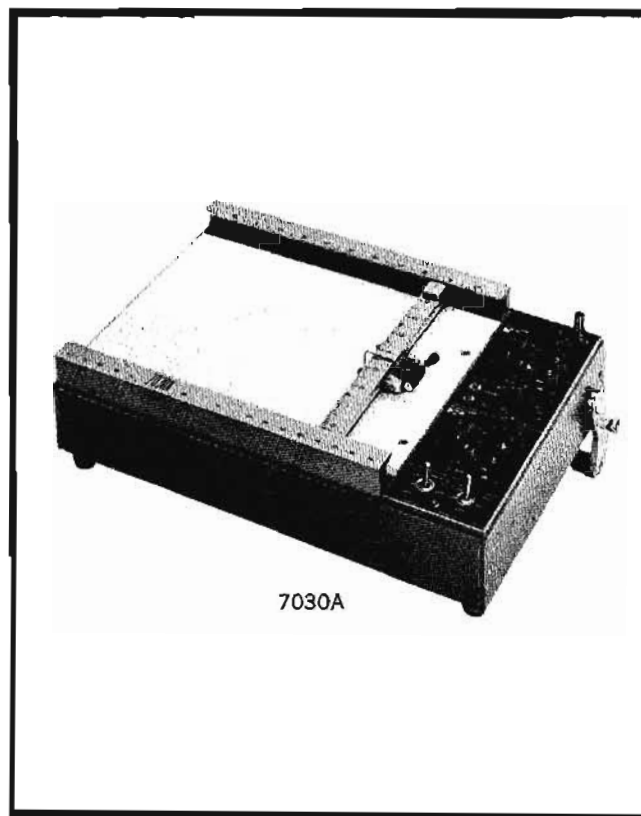

7030A

Writing mechanism: independent isolated servo mechanism for each axis. Liquid ink pen with visually monitored cartridge.

Paper holddown: Autogrip® electric paper holddown grip charts 8½" x 11" or smaller; quiet and maintenance free with no moving parts.

Pen lift: local and remote pen lift.

Accessories supplied:

1. Accessory Kit: Contains spare fuse, slidewire cleaner, slidewire lubricant, 2 pens, 12 cartridge-green ink, 12 cartridge-red ink, 12 cartridge-red ink.
2. Appropriate graph paper.
3. Power cord (7').
4. Flexible plastic dust cover.
5. Instruction manual.
6. Rack mounting brackets.
7. Carrying handle.

Power: 115 or 230 V, 50 to 60 Hz, 75 volt-amperes.

Dimensions: table model: 12-1/16" deep, 4¾" high, 17⅞" long (306 x 120 x 454 mm). Rack model: 4¾" deep, 10-15/32" high, 19" long (120 x 265 x 482 mm).

Weight: approximately 20 lbs (9 kg).

Prices: Model 7030A (standard)

Model 7030AM (metric)

\$1895

Options:

- | | |
|--|------------|
| 01 Potentiometric switch for five most sensitive ranges | add \$ 55 |
| 05 5 K linear retransmitting potentiometer in the X axis | add \$ 150 |
| 06 Rear input terminals | add \$ 50 |
| 07 3.5 K linear retransmitting potentiometer in the Y axis | add \$ 150 |
| 08 Retransmitting potentiometers in both axes | add \$ 300 |
| 09 Remote sweep capability | add \$ 75 |

RECORDERS



8½ x 11 X-Y RECORDER

Multi-range, general-purpose plotter
Model 135 Series

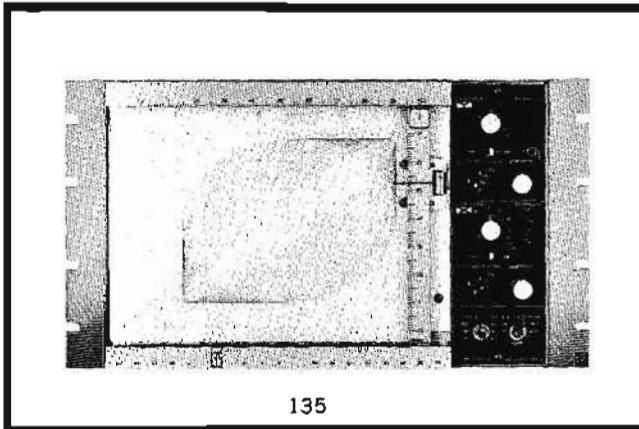

Available in two basic models, these 8½" x 11" x-y plotters are adaptable to almost any laboratory, field or system application. In the first group, the 135 and the 135M (metric) feature 16 dc input ranges on each axis with a minimum input resistance of 200,000 ohms/V full scale (10"); in the second group, the 135A and 135AM (metric) feature 11 calibrated ranges with 1-megohm resistance at null.

Unique construction permits instant adaptation to desk or bench positioning in a horizontal, inclined or vertical plane, or rack mounting by the addition of brackets in only 10½" of panel space. A detachable handle doubles as a tilt support or carrying aid. Standard features include advanced transistor circuitry, calibrated time base on the x-axis, zero set and zero suppression, potentiometric input mode, scale factor vernier and Autogrip® electric paper holddown which has no moving parts, holds any chart 8½" x 11" or smaller, is quiet and maintenance-free.

Modular construction of major assemblies insures maximum flexibility and ease of maintenance. The control module incorporates all input circuitry with conveniently grouped operating controls. A panel group for each axis includes input terminals which accept either open wire or banana plugs, ground terminal, range selector with scale factor vernier, function switch and zero control. High-gain servo amplifiers are plug-in units, isolated and free of ground. Special HP servo motors control the ink pen via a pantograph mechanism which is accurate and non-interacting. The pen may be controlled locally or remotely by an electric lift. The "drop-in" pen mounting facilitates easy changing or cleaning. Calibrated scales along each axis align with standard paper markings.

Specifications

Input ranges:

Model 135: 16 calibrated ranges: 0.5, 1, 2, 5, 10, 20, 50 mV/inch; 0.1, 0.2, 0.5, 1, 2, 5, 10, 20, 50 V/inch.

Model 135M: 16 calibrated ranges: 0.2, 0.5, 1, 2, 5, 10, 20, 50, 100 mV/cm; 0.2, 0.5, 1, 2, 5, 10, 20 V/cm.

Model 135A: 11 calibrated ranges: 0.5, 1, 5, 10, 50 mV/inch; 0.1, 0.5, 1, 5, 10, 50 V/inch.

Model 135AM: 11 calibrated ranges: 0.2, 0.5, 2, 5, 20, 50 mV/cm; 0.2, 0.5, 2, 5, 20 V/cm.

All models: stepless range control permits arbitrary full scale range setting. Potentiometric mode on Y-axis, obtainable on X-axis by removing strap on input circuit board. (Operates on most sensitive range of Model 135; four most sensitive ranges of Model 135A).

Type of inputs: floating up to 500 V above ground.

Input resistance:

Model 135: 200,000 ohms/volt full scale (10") through 1 V/inch range; 2 megohms on all higher ranges.

Model 135M: 200,000 ohms/volt full scale (25 cm) through 0.5 V/cm range; 2.5 megohms on all higher ranges.

Models 135A, 135AM: one megohm at null on all fixed ranges. When in variable range control mode, 100,000 ohms on four most sensitive range steps and one megohm on all other steps. Potentiometric input draws essentially zero current at null.

Maximum allowable source impedance: (Model 135A) up to 10 k ohm source impedance will not alter recorder's performance on the four most sensitive ranges (0.5, 1, 5, 10 mV/in). Higher source impedances will cause an increase in dead zone and a decrease in pen speed. No source impedance restrictions on ranges above 10 mV/in. Model 135: up to 1 k ohm source impedance will not alter recorder's performance on potentiometric input. Higher source impedances will cause an increase in dead zone and a decrease in pen speed. No source impedance restrictions on any calibrated ranges.

Radio frequency interference: meets specifications of MIL-I-6181D.

Slewing speed: 20 inches/second, maximum, each axis for 60 Hz; 16 inches/second, maximum, for 50 Hz.

Time sweeps: (X-axis only) **Model 135:** 0.5, 1, 2, 5, 10, 20, 50 s/inch. **Model 135M:** 0.2, 0.5, 1, 2, 5, 10, 20 sec/cm.

Model 135A: 0.5, 1, 5, 10, 50 s/inch. **Model 135AM:** 5 calibrated sweeps: 0.2, 0.5, 2, 5, 20 s/cm.

Accuracy: 0.2% at full scale; Time sweep: 5% of full scale.

Linearity: 0.1% of full scale.

Dead band: 0.1% of full scale.

Zero set: continuously adjustable to any point on the graph paper or up to one full scale, from zero, off the chart paper.

Reference voltage: continuous electronic reference, zener diode controlled. Temperature stability better than 0.002%/°C.

Writing mechanism: independent isolated servo mechanisms for each axis. Liquid ink pen with ample ink supply. Visually monitored cartridge pens available as option.

Paper holddown: Autogrip electric paper holddown grips charts 8½" x 11" or smaller; quiet and maintenance free with no moving parts.

Pen lift: local and remote pen lift.

Accessories supplied:

- (1.) **Accessory kit:** contains spare fuse, slidewire cleaner, slidewire lubricant, 2 pens, 1 bottle of green ink, 1 bottle of red ink, syringe.
- (2.) Appropriate graph paper.
- (3.) Power cord (7').
- (4.) Flexible plastic dust cover.
- (5.) Instruction manuals.
- (6.) Rack mounting brackets.
- (7.) Carrying handle.

Power: 115 or 230 V, 50 to 60 Hz, 120 volt-amps.

Dimensions: table model: 17¾" wide, 10-15/32" high, 4¾" deep. Rack model: 19" wide, 10-15/32" high, 4½" deep.

Weight: approximately 20 lbs (9 kg); shipping 32 lbs.

Prices:

Models 135/135M/135A/135AM \$1650

Options:

- | | | |
|----|---|-----------|
| 02 | Rear input connectors (with mating connector) | \$15 |
| 04 | Cartridge ink supply | N/C |
| 05 | 5 k ohm retransmitting potentiometer (X-axis) | add \$100 |
| 06 | 3.5 k ohm retransmitting potentiometer (Y-axis) | add \$100 |
| 07 | Retransmitting potentiometer (both axes) | add \$200 |

TWO-PEN X-Y RECORDER

Three channels for plotting two curves
Model 136A Series



RECORDERS

The Model 136A is a two-pen three channel (x , y_1 , y_2), $8\frac{1}{2}$ " x 11" X-Y Recorder, identical electrically and physically to the 135A except for the added second pen with its associated circuitry and controls. The two pens traverse the full vertical axis independently with not less than 0.1 inch horizontal separation, and the horizontal axis simultaneously over the complete recording area of the paper. Input circuitry and controls for each axis are constructed in modular form, electrically isolated and free of ground. Advanced transistor circuitry insures high accuracy and stability. Units are available with metric scales.

The controls for each channel are conveniently grouped with input connectors accepting either banana plugs or open wire. Eleven calibrated steps cover voltage ranges from 0.5 mV/inch to 50 V/inch with continuously variable expansion control for fitting arbitrary voltage limits within the paper margins. One-megohm input resistance at null is a feature of all calibrated ranges. Five time sweeps are provided on the x axis and potentiometric mode on the four most sensitive ranges of both y axes. Potentiometric operation on the x axis is obtainable by removing an internal strap. Zero controls operate without affecting calibration and provide full scale zero set and one full scale of zero suppression.

Reliable paper holddown is provided by Autogrip® electric platen, which has no moving parts, is quiet and effective on any size chart $8\frac{1}{2}$ " x 11" or smaller. Pens are capillary fed from a generous reservoir, are "drop-in" mounted, easily changed for color variation or cleaning.

Specifications

Input ranges: 11 calibrated ranges: 0.5, 1, 5, 10, 50 mV/inch; 0.1, 0.5, 1, 5, 10, 50 V/inch. Metric: 0.2, 0.5, 2, 5, 20, 50 mV/cm; 0.2, 0.5, 2, 5, 20 V/cm. Stepless range control permits arbitrary full scale range setting. Potentiometric mode on Y_1 and Y_2 axis, obtainable on X -axis by removing strap on input circuit board operates on four most sensitive ranges of Model 136A.

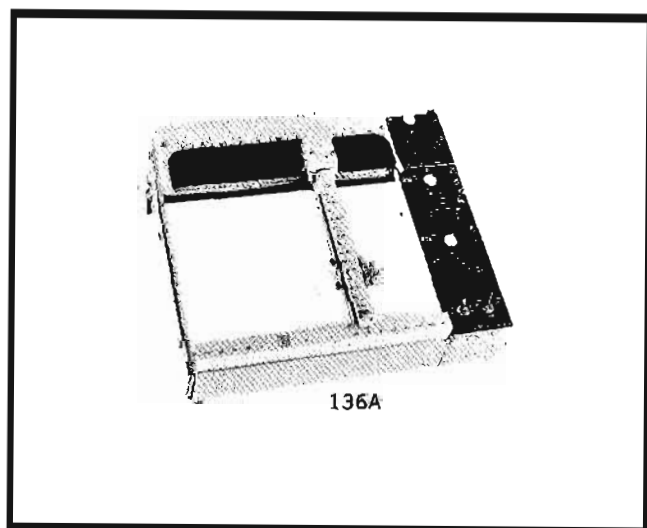

136A

Types of inputs: floating up to 500 V dc above ground.

Input resistance: one megohm at null on all fixed ranges. When in variable range control mode, 100,000 ohms on four most sensitive range steps and one megohm on all other steps. Potentiometric input draws essentially zero current at null.

Maximum allowable source impedance: up to 10 k ohm source impedance will not alter recorder's performance on the first four ranges (0.5, 1, 5, 10mV/in). Higher source impedances will cause an increase in dead zone and a decrease in pen speed. No source impedance restrictions on ranges above 50 mV/in.

Radio frequency interference: meets specifications of MIL-I-6181D.

Response time: 0.6 s maximum, full scale.

Time sweeps: 5 calibrated sweeps: 0.5, 1, 5, 10, 50 s/inch. Metric: 0.2, 0.5, 2, 5, 20 s/cm.

Accuracy: 0.2% at full scale; time sweep: 5% of full scale.

Linearity: 0.1% of full scale.

Dead band: 0.1% of full scale.

Zero set: continuously adjustable to any point on the graph paper or up to one full scale off the chart paper.

Reference voltage: continuous electronic reference, zener diode, controlled. Temperature stability better than 0.002%/°C.

Writing mechanism: independent isolated servo mechanisms for each axis. Liquid ink pen with ample ink supply.

Paper holddown: Autogrip electric paper holddown grips charts $8\frac{1}{2}$ " x 11" or smaller; quiet and maintenance free with no moving parts.

Pen lift: local and remote pen lift.

Accessories supplied:

1. Accessory Kit: Contains spare fuse, slidewire cleaner, slidewire lubricant, 2 pens, 1 bottle of green ink, 1 bottle of red ink, syringe.
2. Appropriate graph paper.
3. Power cord (7').
4. Flexible plastic dust cover.
5. Instruction manuals.
6. Carrying handle and wing brackets.

Power: 115 or 230 V, 50 to 60 Hz, 140 volt-amperes.

Dimensions: table model: 14" high, $17\frac{7}{8}$ " wide, $4\frac{3}{4}$ " deep; (355 x 443,4 x 120,7 mm). Rack model: 14" high, 19" wide, $4\frac{3}{4}$ " deep; (355 x 483 x 120,7 mm).

Weight: approximately 34 lbs (15,3 kg); shipping 47 lbs (21,2 kg).

Prices:

Models 136A/136AM \$2650

Options:

- | | | |
|--|-----|-------|
| 02 Rear input terminals (2 sets with mating connectors) | add | \$15 |
| 03 5 k ohm linear retransmitting potentiometer in the X axis | add | \$100 |

RECORDERS



11" x 17" X-Y RECORDER

Low cost, multiple use

Model 7005A

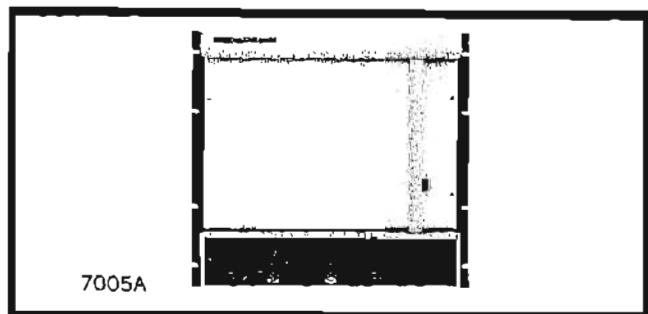

The 7005A will draw a graph of two related functions from two dc signals representing each of these functions. The instrument is convertible to rack mounting with only the addition of two wing brackets which are supplied with the model. Also available is a metrically scaled model (7005AM).

The input terminals accept either open wires or plug-type connectors. Five calibrated ranges from 1 millivolt/inch to 10 volts/inch are available in each axis. A variable range control allows any voltage, within the recorder limits, to be adjusted for full scale deflection. Standard features include high input impedance of one megohm (all but the first two ranges), floating and guarded inputs 0.2% accuracy, Autogrip electric paper holddown, electric pen lift, and adjustable zero set.

Extra cost options include locks for zero controls and for variable range controls, rear input connector, and retransmitting potentiometer. An external time base (Model 17108A) is also available and operates on either axis to provide five sweep speeds from 0.5 to 50 seconds per inch.

Each closed loop servo system employs a high gain solid state servo amplifier, Hewlett-Packard manufactured servo motor, long life balance potentiometer, photochopper, low pass filter, guarded inputs, precision attenuator and balance circuit. Model 7005A is designed for easy maintenance with most components mounted on a printed circuit board and accessible by removing only the rear cover. Both balance potentiometers are accessible for inspection or cleaning by simply removing a trim strip, requiring no tools. Also included are snap-on side panels and maintenance free Autogrip paper holddown.

Specifications

Input ranges: 5 fixed calibrated ranges: standard: 1, 10, 100 mV/in., 1 and 10 V/in.; metric: 0.4, 4, 40, 400 mV/cm, and 4 V/cm; 5 variable ranges: continuous range adjustment from 1 mV/in. to 25 V/in. (0.4 mV/cm to 10 V/cm) provided by a high resolution control.

Type of inputs: floating differential. All input terminals may be placed up to 500 V dc from ground. Critical circuit areas are guarded with guard terminal on front panel.

Input resistance:

Range	Input Resistance
1 mV/in. (.4 mV/cm) variable	Potentiometric (essentially infinite at null) 11 k
10 mV/in. (4 mV/cm) variable	100 k 100 k
100 mV/in. (40 mV/cm) variable	1 meg 1 meg
1 V/in. (400 mV/cm) variable	1 meg 1 meg
10 V/in. (4 V/cm) variable	1 meg 1 meg

Input isolation: DC: 500 megohms (min) to ground at 500 V dc (all terminals). AC, Guard to Ground: 0.05 μ F.

Effective guarded capacity: 300 pF (capacity between + and - terminals, and chassis ground with guard shield driven).

Interference rejection: conditions for the following data is line frequency with up to 1 k ohm between the negative input and the point where the guard is connected. Maximum ac common mode voltage is 500 volts peak. Maximum dc common mode voltage is 500 volts.

Range		DC (CMR)	AC (CMR)
Standard	Metric		
1 mV/in	0.4 mV/cm	130 dB	95 dB
10 mV/in	4 mV/cm	110 dB	75 dB
100 mV/in	40 mV/cm	90 dB	55 dB
1 V/in	400 mV/cm	70 dB	35 dB
10 V/in	4 V/cm	50 dB	15 dB

Input filter: >20 dB at 60 Hz; -18 dB/octave above 60 Hz.

Maximum allowable source impedance: no restrictions except on fixed 1 mV/in. (.4 mV/cm) range. Up to 20 k ohm source impedance will not alter recorder's performance.

Accuracy: $\pm 0.2\%$ at full scale.

Linearity: $\pm 0.1\%$ of full scale.

Dead band: $\pm 0.1\%$ of full scale.

Standardization: continuous electronic zener reference with temperature stability better than 0.002%/°C.

Zero set: zero may be placed anywhere on the writing area or electrically set off scale up to one full scale from zero index. Adjustable by a high resolution control.

Stewing speed: 15 inches/s, 37 cm/s nominal at 115 V. (Typically 13 inches/s at 103 V, 16 inches/s at 127 V.)

Paper holddown: Autogrip electric paper holddown grips charts 11" x 17" or smaller. Writing area: 10" x 15" (25 cm x 37 cm).

Pen lift: electric pen lift capable of being remotely controlled. Connector supplied (#57-30240).

Dimensions: 17 1/2" wide, 7 1/2" high, 4-5/16" deep.

Weight: net approximately 18 lbs; shipping 24 lbs.

Power: 115 or 230 V $\pm 10\%$, 50 to 60 Hz, approximately 45 W.

Accessories supplied:

- (1) Accessory Kit: containing slidewire cleaner, slidewire lubricant, 2 pens, 1 bottle green ink, 1 bottle red ink, ink filling syringe, remote pen lift mating connector.
- (2) Appropriate graph paper.
- (3) Power Cord (7').
- (4) Rack mounting brackets.
- (5) Flexible plastic dust cover.
- (6) Instruction Manual.

Price:

Model 7005A	(Standard)	\$1195.
Model 7005AM	(Metric)	\$1195.

Options:

- 02 Lockable zero and variable range controls (both axes) \$15.
- 03 Retransmitting potentiometer on X axis
Total resistance: 5 k $\pm 3\%$
Linearity (independent): $\pm 0.1\%$
Resolution: 0.04% \$75.
- 05 Rear input connector in parallel with front terminals \$15.

11" x 17" HIGH SENSITIVITY
 100 $\mu\text{V}/\text{in}$ dc; 5 mV/in ac (7000A only)
 Models 7000A, 7001A



RECORDERS

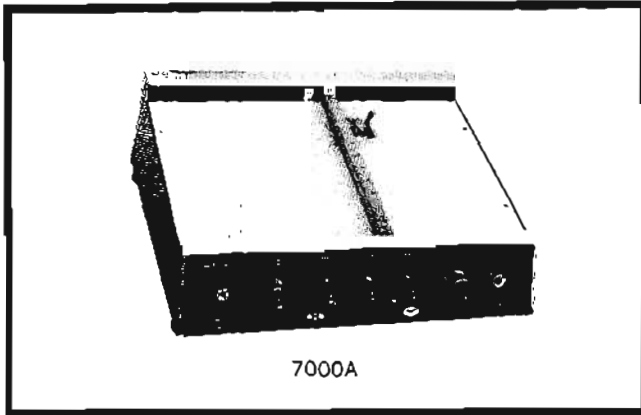

The 7000A X-Y recorder accepts dc or ac signals on either or both axes with high sensitivity and common mode rejection. The 7001A is identical to the 7000A except for the omission of ac input ranges. Specially guarded and shielded circuitry provides one megohm input resistance at null on all ranges. Units are available for rack mounting and with metric scales.

Any chart 11" x 17" or smaller may be held smoothly and firmly in the Autogrip electric platen which is silent in operation and maintenance-free. Flexibility is built into the electronic time base which may be switched to operate in either axis. Features include automatic reset, adjustable sweep length, and automatic recycling.

The plotting mechanism is greatly simplified by mounting the Y servo motor on the X carriage. Zero offset for each axis may be preset in calibrated 5-inch steps up to 4 full scale lengths in Y and 3 full scale lengths in X with continuous adjustability between steps. A dc accuracy of 0.2% of full scale holds when switching between ranges, making recalibration unnecessary during operation. All 7000A and 7001A models display extremely good retrace characteristics.

An ac sensitivity up to 5 mV/in (2.5 mV/cm) is a convenience when using Hewlett-Packard Model 1110A and 465A ac clip-on current probes for plotting low currents without additional amplification.

Specifications

DC input ranges: 17 calibrated ranges: 0.1, 0.2, 0.5, 1, 2, 5, 10, 20, 50, mV/in; 0.1, 0.2, 0.5, 1, 2, 5, 10, 20 V/in. Metric models: 0.05, 0.1, 0.25, 0.5, 1, 2.5, 5, 10, 25 mV/cm; 0.05, 0.1, 0.25, 0.5, 1, 2.5, 5, 10 V/cm. Plus continuously variable mode.

AC input ranges (7000A only): 12 calibrated ranges: 5, 10, 20, 50 mV/in; 0.1, 0.2, 0.5, 1, 2, 5, 10, 20 V/in. Metric models: 2.5, 5, 10, 25 mV/cm; 0.05, 0.1, 0.25, 0.5, 1, 2.5, 5, 10 V/cm. The continuously variable mode is available on the dc ranges only.

Type of inputs: dc floating up to 500 V above ground; guarded and shielded. AC input (7000A only) is single-ended, capacitor coupled.

Input isolation: guard to ground capacity 0.002 mfd.

DC input resistance: one megohm at null on all calibrated and variable dc ranges. Potentiometric input on 6 most sensitive ranges by disconnecting an internal buss wire. Potentiometric switch optional.

AC Input Impedance: (7000A only): one megohm on all calibrated ac ranges.

Maximum allowable source impedance: up to 10 k ohm source impedance will not alter recorder's performance on the first six ranges (0.1, 0.2, 0.5, 1, 2, 5 mV/inch). Higher source impedances will cause an increase in dead zone and a decrease in pen speed. No source impedance restrictions on ranges above 5 mV/in.

Interference rejection: dc common mode rejection 140 dB on 3 most sensitive ranges; 120 dB at power line frequency on 2 most sensitive ranges.

Radio frequency interference: meets specifications of MIL-I-6181D.

Slewing speed: 20 in/s, maximum, each axis for 60 Hz; 16 in/s, maximum for 50 Hz.

Time sweeps: may be applied to either axis in 8 calibrated ranges: 0.5, 1, 2, 5, 10, 20, 50, 100 s/in. Metric models: 0.25, 0.5, 1, 2.5, 5, 10, 25, 50 s/cm. Adjustable sweep length; may be reset or recycled at any point manually or automatically. Local and remote sweep controls.

Accuracy: dc: 0.2% at full scale; ac: 0.5% of full scale, 20 to 100,000 Hz; time sweep: 2% at full scale.

Linearity: dc: 0.1% of full scale; ac: 0.2% of full scale; time sweep: 1% of full scale.

Dead band: 0.1% of full scale on all ranges.

Zero set (dc range only): continuously adjustable with 5" calibrated steps for up to 3 full scale lengths on X and 4 on Y. Zero-check push button switches on each axis.

Reference voltage: continuous electronic reference, zener diode controlled. Temperature stability better than 0.005%/°C.

Writing mechanism: independent isolated servo mechanisms for each axis. Liquid ink pen with visually monitored cartridge.

Paper holddown: Autogrip electric paper holddown grips charts 11" x 17" or smaller; quiet and maintenance free with no moving parts.

Pen lift: local and remote pen lift.

Accessories supplied:

- (1.) Accessory Kit: contains spare fuse, slidewire cleaner, slidewire lubricant, 2 pens, 12 cartridges green ink, 12 cartridges red ink.
- (2.) Appropriate graph paper.
- (3.) Power cord (7').
- (4.) Flexible plastic dust cover.
- (5.) Instructional manual.

Power: 115 or 230 V, 50 to 60 Hz, 85 volt-amperes.

Dimensions: bench model: 17½" wide, 15½" high, 6½" deep (445 x 382 x 165 mm); Rack model: 17½" inside rack clearance, 17½" panel height, 6½" maximum depth (444 x 444 x 165 mm).

Weight: net 38 lbs (17.1 kg); shipping 46 lbs (20.7 kg).

Prices: 7000A (standard bench); 7000AR (standard rack); 7000AM (metric bench); 7000AMR (metric rack): \$2495
 7001A (standard bench); 7001AR (standard rack); 7001AM (metric bench); 7001AMR (metric rack): \$2175

Options:

- | | | |
|---|-----|-------|
| 01. Potentiometric switch for 6 most sensitive ranges: | add | \$55 |
| 04. 5 k ohms linear retransmitting slidewire on X-axis: | add | \$75 |
| 05. Rear input terminals | add | \$50 |
| 06. 5 k ohms linear retransmitting slidewire on Y-axis: | add | \$75 |
| 07. Retransmitting slidewire on both axes: | add | \$150 |
| 09. Event Marker (X-axis) | add | \$100 |

RECORDERS



11 x 17 X-Y RECORDER Plug-in versatility Model 7004A

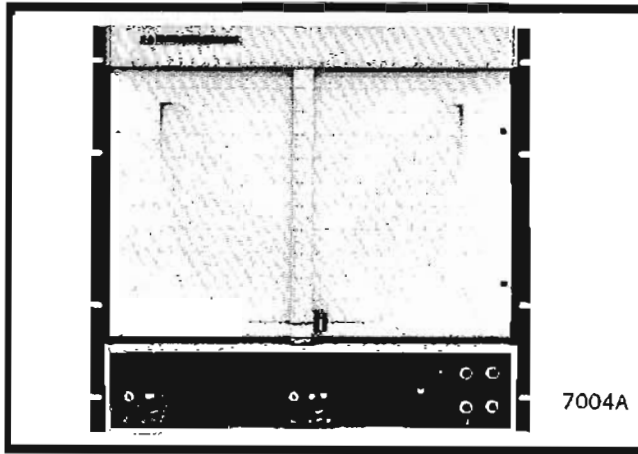

The 7004A is designed with flexibility for the constantly changing requirements of laboratory measurements. Plug-in models plus a variety of accessories provide a versatile X-Y Recorder with high dynamic performance. Common electronic circuits in the 7004A main frame means more buying value by paying for only essential electronics in each plug-in. All the plug-in modules may be purchased with the 7004A or individually as required.

The high dynamic performance of the 7004A Recorder is best illustrated by the high slewing speed and rapid acceleration. With an acceleration of better than 1000 in/s², and slewing speed of 30 in/s, the 7004A records more phenomena than previously possible with an X-Y Recorder.

The 7004A is designed with the most advanced technology and integrated circuits available. In addition to silicon solid state circuitry, the 7004A has the proven solid state electrostatic paper holddown system Autogrip.

Autogrip provides noise-free operation with the entire paper surface (no special paper required) being firmly held to the platen. No maintenance other than occasional cleaning of the platen surface is required.

In order to fully utilize the superior performance of the 7004A, guarded circuits are provided. Guarding eliminates the effects of unwanted ac and dc common mode voltages which can be troublesome in some types of recordings and applications. These voltages are particularly troublesome when recording from thermocouples, strain gages and any similar low voltage sources accompanied by common mode voltages.

The availability of plug-in modules provides a versatile X-Y Recorder for a variety of applications. If your application changes, in many cases measurement capability is available by the simple addition of an inexpensive plug-in. In addition to the plug-in advantages, the high dynamic performance allows the 7004A to be used in practically any X-Y Recorder application with complete satisfaction.

The wide range of available plug-ins meets most measurement requirements. This flexibility offered by the selection of plug-ins is even further enhanced by combining plug-in modules. Since the 7004A is designed to accept two plug-ins for each axis, the functions of both plug-ins provide more measurement capability.

Point plotting: The 7004A, equipped with the 17173A Null Detector (plug-in) and 17012B Point Plotter is capable of high speed plotting up to 50 points/second. High dynamic response and rapid point plotting are necessary for applications

such as a high speed readout for a multi-channel pulse height analyzer. The 17011A Point Plotter allows remote controlled two-color printing up to 50 pps.

Incremental and continuous chart recording: The 17005A chart advance accessory provides the 7004A with the additional capabilities of incremental chart advance in increments as small as 0.005 inch or capability of strip chart recording. The stepping drive motor allows very slow chart speed or speeds up to one inch per second. A combination of the 17005A and plug-in 17172A Time Base allows segmented strip chart recording. The graph is plotted along the Y axis which is the time mode.

Automatic frame advance: The 17005A accessory in addition to providing strip chart capabilities also provides individual frame positioning of a continuous roll of charts. The advance cycle can be controlled externally to provide automatic operation.

Fan fold paper: The 17005A01 allows the 7004A to plot on fan fold paper. The use of this paper allows quick reference to any position of the graph. The complete graph or graphs can be conveniently bound in a notebook, filed in a cabinet, stored flat on a shelf, or torn off in separate chart segments.

Specifications

Number of plug-ins: frame will accept the equivalent of four single width plug-ins, two per axis.

Types of inputs: floating differential. All input terminals may be placed up to 500 V dc from ground. Critical circuit areas guarded. Guards are available at terminals on front panel or rear connector. Mating rear connector supplied.

Standardization: continuous electronic zener reference with temperature stability better than 0.002%/°C.

Zero set: zero may be placed anywhere on the writing area or electrically set off scale up to one full scale from zero index. Adjustable by a lockable ten-turn high resolution control.

Range vernier: control with a locking dial to change sensitivity from x 1 to x 2.6 times basic sensitivity.

Slewing speed: >30 in/s (75 cm/s).

Acceleration: >1000 in/s².

Paper holddown: Autogrip electric paper holddown grips charts 11" x 17" or smaller. Writing area 10" x 15" (25 cm x 38 cm). Special paper not required.

Pen lift: electric pen lift capable of being remotely controlled.

Dimensions: 17½" wide, 17½" high, 4-5/16" deep.

Weight: approximately 20 lbs net, shipping 27 lbs.

Power: 115 or 230 V ±10%, 50 to 1000 Hz, approximately 50 watts depending on the plug-in used.

Accessories supplied:

1. **Accessory kit:** containing slidewire cleaner, slidewire lubricant, 2 pens, 1 bottle green ink, 1 bottle of red ink, ink filling syringe, mating rear connector.
2. Appropriate graph paper.
3. Rack mounting brackets.
4. Flexible plastic dust cover.
5. Two plug-in filler panels.
6. Plug-in extender cards.

Price:

Model 7004A (less plug-ins)

\$1295

Options:

01 Metrically scaled and calibrated

n/c

02 X-axis retransmitting potentiometer

\$ 75

17170A dc Coupler Plug-in

The dc coupler provides direct coupling of the input signal to the recorder frame. The single input range of 100 mV/in. may be adjusted from 100 to 260 mV/in. with a vernier control on the 7004A front panel.

Input range: single fixed calibrated range, 100 mV/in. (40 mV/cm). Main frame Range Vernier control allows adjustment from 100 mV/in. to 260 mV/in. (40 mV/cm to 104 mV/cm).

Input resistance: one megohm.

Input isolation: 500 megohms (min.) to ground at 500 V dc (all terminals).

Interference rejection: common mode rejection with up to 1 k Ω between the negative input and the point where the guard is connected to dc CMR 120 dB; ac CMR 100 dB (50 to 400 Hz).

Maximum dc common mode voltage: 500 volts.

Maximum allowable source impedance: no restriction.

Accuracy: $\pm 0.2\%$ at full scale.

Linearity: $\pm 0.1\%$ of full scale.

Deadband: $\pm 0.1\%$ of full scale.

Price: Model 17170A, \$50.

17171A dc Pre-Amplifier Plug-in

The dc preamplifier is a stable, low noise dc amplifier and attenuator. The 7004A main frame's vernier control supplements the 14 calibrated input ranges to provide a continuously variable range from 0.5 mV/in. to 26 V/in.

Input range: 14 fixed calibrated ranges: Standard: 0.5, 1, 2, 5, 10, 20, 50 mV/in., 0.1, 0.2, 0.5, 1, 2, 5, 10 V/in. Metric: 0.25, 0.5, 1, 2.5, 5, 10, 25 mV/cm, 0.05, 0.1, 0.25, 0.5, 1, 2.5, 5 V/cm. Continuously variable with the main frame range vernier.

Input resistance: one megohm.

Input isolation: dc-500 megohms (min.) to ground at 500 V dc (all terminals). AC-guard to ground: 0.05 μ F. Effective guarded capacity: 300 pF (capacity between + and - terminals, and chassis ground with guard shield driven).

Interference rejection: common mode rejection with up to 1 k Ω between the negative input and the point where the guard is connected is: ac and dc CMR 120 dB (50 to 500 Hz) maximum dc common mode voltage is 500 volts.

Maximum allowable source impedance: 10 k Ω on six most sensitive ranges. Higher source impedance on these ranges up to 1 megohm results in increased zero drift and pen jitter, but does not affect linearity, deadband and dynamic performance.

Accuracy: $\pm 0.2\%$ at full scale.

Linearity: $\pm 0.1\%$ of full scale.

Deadband: 0.1% of full scale.

Price: Model 17171A, \$250.

Option: 01 metrically scaled and calibrated.

17172A Time Base Plug-in

The time base plug-in makes Y-T or X-T recordings possible with the 7004A. It is designed with most recent integrated circuits. Eight speeds from 0.5 s/in. to 100 s/in., automatic reset sweep test capabilities, high linearity and remote control are standard features.

Sweep speeds: 8 calibrated ranges: Standard: 0.5, 1, 2, 5, 10, 20, 50, 100 s/in.; Metric: 0.25, 0.5, 1, 2.5, 5, 10, 25, 50 s/cm. Automatic reset at end of full scale. Local and remote sweep control with the remote control provided through the 7004A frame's rear connector.

Accuracy: $\pm 1\%$ of full scale on the five fastest ranges; $\pm 2\%$ on other ranges.

Linearity: 0.5% of full scale.

Price: Model 17172A, \$200.

Option: 01 metrically scaled and calibrated.

17173A Null Detector Plug-in

The null detector, with the 17012B or 17011A Point Plotter, permits the plotting of analog data in point form up to speeds to 50 points per second. The null detector activates the point plotter

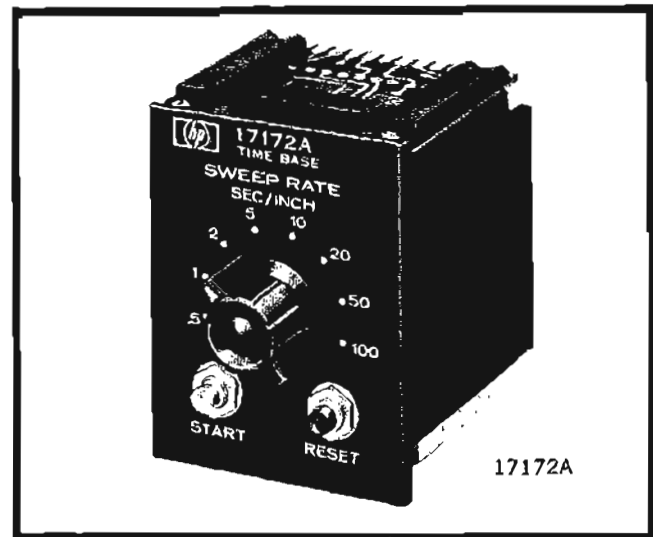

when the recorder attains balance and provides maximum plotting speed in a closed-loop system. The 17011A Point Plotter allows remote controlled programmable, two-color plotting.

Plot rate: up to 50 plots/s using HP Model 17012B or 17011A Point Plotter. Limited to recorder response.

Seek signal: pulse height: +3 volts (min.); +20 volts (max.).

Pulse width: 1 microsecond (min.).

Input impedance: 10 k Ω .

Completed plot pulse

Pulse height: +10 volts.

Pulse width: 100 microseconds.

Rise time: less than 1 microsecond.

Maximum permissible capacity load: 0.005 μ F.

Output impedance: less than 400 ohms.

Forced plot: if null is not reached within 1 second, a plot is actuated.

Enable—disable

Required disable voltage: +3 volts, dc.

Required enable voltage: 0 volts dc or no connection.

17011A pen selection: 0 V dc for pen 1, +3 V dc for pen 2.

Inputs: all inputs, including X and Y, are available through a single rear connector on the plug-in. Mating connector supplied.

Price: Model 17173A, \$200.

17174A dc Offset Plug-in

The dc offset plug-in provides the 7004A recorder with the capabilities of recording a signal superimposed on a steady state dc voltage. The offset plug-in bucks out the steady state dc voltage allowing the recorder sensitivity to be increased, thus expanding the desired signal plot to full scale of the recorder. The dc offset is adjustable up to 1 volt.

Offset: continuously adjustable from 0 V to 1 V.

Controls: two lockable ten-turn controls (0-10 mV and 0-1 V).

Stability: voltage stability better than 0.005%/°C.

Price: Model 17174A, \$100.

17175A Filter Plug-in

This active filter has a response approximating a twin T with upper frequency roll-off. It improves normal mode rejection by insertion prior to the dc preamplifier or it will further improve the common mode rejection by insertion after the dc preamplifier. With a filter in each axis, the recorder can be made to draw straight line segments between points.

Input voltage: 10 V dc maximum.

Maximum source impedance: 1 k Ω . Higher impedance decreases filter's response time.

Attenuation: -35 dB at 50 Hz and higher ($\frac{1}{4}$ s rise time) or -70 dB at 50 Hz and higher (1 s rise time) switch selected.

Price: Model 17175A, \$75.

RECORDERS



TWO-PEN X-Y RECORDER

Three-channel for plotting two curves

Model 2FA series

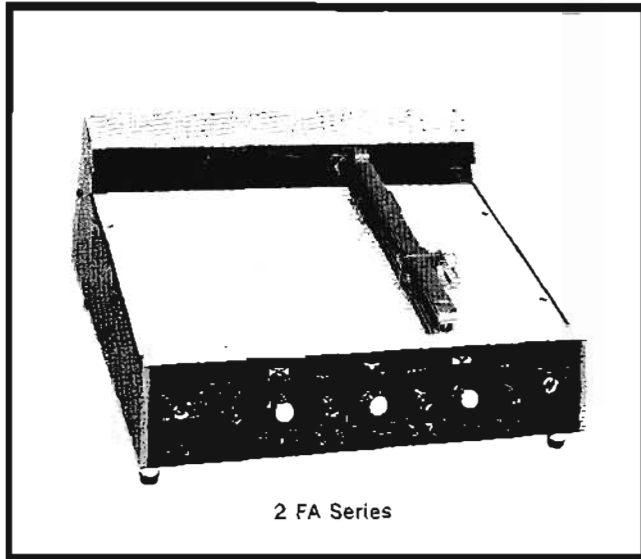

2 FA Series

The 2FA is a three channel two-pen 11" x 17" graphic recorder, each channel presenting 1-megohm input resistance at null. It is available for rack mounting (2FRA) and with metric (2FAM, 2FRAM) instead of English scaling. Standard facilities include a time base on the x axis, 11 voltage ranges with continuous expansion feature, full scale zero set and suppression, local and remote electric pen lift and potentiometric capability.

Two drop-in mounted pens with integral ink reservoir traverse the full y axis with no less than 0.1 inch horizontal separation. Writing range for both pens is 10 inches vertically and 15 inches horizontally. Servo drives are independent and free of electrical ground. Servo amplifiers and power supply are combined in a single compact plug-in unit. A simplified self-balancing system uses linear slidewires and a continuous zener-controlled reference.

Each input range has a calibrated (fixed) and continuously variable mode. The variable mode may be used to fit arbitrary maximum voltages within the recording limits of the paper. Potentiometric operation on the four most sensitive ranges of each axis may be easily established by removing linkages on the input circuit boards. The built-in time base operates on the x axis, with five calibrated sweeps from 7.5 to 750 seconds for full-scale pen travel.

The exclusive electric paper holddown provides positive grip of charts 11" x 17" or smaller. Operation is silent with no moving parts and is maintenance free.

Specifications

Input ranges: 11 calibrated ranges (each axis): 0.5, 1, 5, 10, 50 mV/inch; 0.1, 0.5, 1, 5, 10, 50 V/inch. Metric Models: 0.2, 0.5, 2, 5, 20, 50 mV/cm; 0.2, 0.5, 2, 5, 20 V/cm. Variable range mode all positions. Potentiometric input available on four most sensitive ranges of each axis by removing internal attenuator straps.

Type of inputs: dc floating up to 500 V above ground.

Input resistance: one megohm at null on all fixed ranges. When in variable range mode, 100,000 ohms on four most sensitive ranges and one megohm on all others. Potentiometric input operation draws essentially zero current at null.

Maximum allowable source impedance: up to 10 k ohm source impedance will not alter recorder's performance on the first four ranges (0.5, 1, 5, 10 mV/inch). Higher source impedances will cause an increase in dead zone and a decrease in pen speed. No source impedance restrictions on ranges above 10 mV/in.

Radio frequency interference: meets specifications of MIL-I-6181D.

Response time: 1 s full scale on X-axis; 0.5 s full scale on Y¹ and Y², maximum.

Time sweeps: 5 calibrated rates on X axis only: 0.5, 1, 5, 10, 50 s/inch; metric: 0.2, 0.5, 2, 5, 20 sec/cm.

Accuracy: 0.2% of full scale. Time sweep: 5% of full scale.

Linearity: 0.1% of full scale.

Dead band: 0.1% of full scale on all ranges.

Reference voltage: continuous electronic reference, zener diode controlled. Temperature stability better than 0.002%/°C.

Writing mechanism: independent isolated servo mechanisms for three channels, X, Y¹, Y².

Paper holddown: Autogrip® electronic paper holddown grips charts 11" x 17" or smaller; quiet and maintenance free with no moving parts.

Pen lift: local and remote pen lift.

Accessories supplied:

1. Accessory kit: contains spare fuse, slidewire cleaner, slidewire lubricant, 4 pens, 1 bottle green ink, 1 bottle red ink, ink filling syringe.
2. Appropriate graph paper.
3. Power cord (7').
4. Flexible plastic dust cover (bench models only).
5. Instruction manual.

Power: 115 or 230 V, 50 or 60 Hz, approximately 120 volt-amperes.

Weight: net approximately 42 lbs (18.9 kg); shipping 55 lbs (24.75 kg).

Dimensions: Bench Model: 18.87" (479 mm) deep, 17.50" (444 mm) wide, 8.25" (209 mm) high; Rack Model: 8" (203 mm) deep, 19" (483 mm) wide, 19.22" (488 mm) high.

Price:

- Model 2FA (standard bench)
- Model 2FRA (standard rack)
- Model 2FAM (metric bench)
- Model 2FRAM (metric rack), \$3375.

Options:

01. With rear input terminals (mating connector supplied), add \$15
02. With installed event marker, add \$100

RECORDERS

Strip chart and oscillographic recorders



RECORDERS

Much of the instrumentation which extends, refines or supplements human perception produces information in the form of electrical analog signals. Records of such data are, of course, often required. Electrical data acquired in serial fashion, comprising a chain of meaningful changes in a signal, record naturally on continuous instruments such as strip chart recorders or oscillographic recorders. The character of the signal will determine the appropriate recording instrument. Analog records of slowly changing (<1 Hz) values are conveniently made by Hewlett-Packard servo-driven strip chart recorders.

Laboratory and industrial type recorders are available and produce records in rectilinear co-ordinates with considerable accuracy — typically 0.2%. Two-pen models permit both channels to realize the full resolution of the chart width simultaneously, since the pens can overlap on the same chart without interference. Active research on strip chart recorders has yielded high reliability, improved writing systems and other advances. Important features are: solid state circuitry, reliability, electric writing, optical slidewires, modular construction, versatile multi-range performance for laboratory applications.

Basic operation

Each Hewlett-Packard servo-driven strip-chart recorder uses an individual electrical servo system for each channel employed. All servos are similar. Each consists of a basic balancing circuit, plus auxiliary elements for instrument versatility.

The self-balancing potentiometer circuit compares an unknown external voltage with a stable internal reference voltage. The difference between these voltages is amplified and applied to a servo motor to drive a potentiometer in a direction that will null any difference or error voltage. Accuracy of plots made by this principle is typically 0.2%. The full-scale span of the recorder for each channel is obtained with input signals as low as one millivolt. Thus, the output of many low-level devices, such as thermocouples and strain-gages, may be plotted directly without additional amplification.

A stepped attenuator or span selector is included for each channel, so voltages as high as 100 volts full scale may be handled directly. Input resistance is at least 200,000 ohms per volt, with higher values, including constant 1-megohm in-

put resistance, available on most models. Sensitivity may be as high as 100 microvolts per inch.

Zero controls provide adjustment of electrical zero to any position on the chart and one full scale zero suppression.

Types of writing systems

Hewlett-Packard strip chart recorders provide three types of writing systems: ink, pressure stylus, and electric writing.

Ink recording is standard. Hewlett-Packard recorders employ the capillary ink feed system in which the ink supply is a cartridge or tank. After priming, flow is maintained by the capillary process. Disposable pen tips are optionally available. There are two basic types—high speed and low speed tips.

The low speed tip operates basically the same as the standard pen. Its advantage is the capability of changing pen tips when the application changes and allowing quick and inexpensive replacement of worn pen tips.

The high speed pen tip is designed for high speed recording. It is composed of nylon fibers, which create many ink passages to insure a sufficient ink flow for high speed writing.

Electric writing is also available on strip chart recorders. With the elimination of ink refilling, long term unattended recording with maximum reliability is possible. Electric writing features crisp, clean, permanent records with the advantage of instant start-up. It is not sensi-

tive to light or pressure, eliminating special handling; it is permanent, without processing.

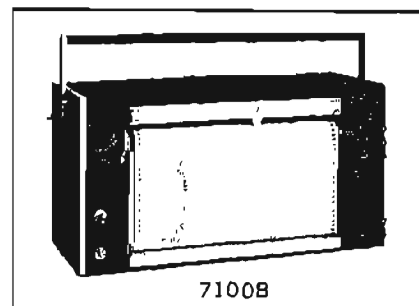

Options and accessories

A variety of options and accessories is available to customize the recorder for individual applications. Options include event markers, retransmitting potentiometers, remote electric pen lift, remote chart drive switch, disc integrator, limit switches, etc.

Also optionally available for the Model 680 is the photo slidewire. This unique balance slidewire employs optical coupling to eliminate mechanical contacts, thus reducing wear and noise and increasing reliability.

Available accessories include input filters, logarithmic converters, BNC adapters, etc.

Most special applications can be satisfied by using one or more of the available options and accessories.

Hewlett-Packard strip-chart recorders

Model	Use	Writing width	Pens	Price	Chart speeds	Speed range	Voltage range (full-scale)
680	Laboratory	5"	1	\$750	8	8"/min - 1"/hr	5 mV to 100 volts
H01-680	Laboratory	5"	1	\$800	8		1 mV to 100 volts
7101B	Laboratory	10"	1	\$1000 (main frame only)	12	2"/sec - 1"/hr	Input Models 17500A: 5 mV - 100 V, \$250 17501A: 1 mV - 100 V, \$350 17502A: single span to match thermocouple, \$250 17530A: single span; 1 mV, \$250 17504A: single span; 5 mV - 100 V, \$200
7100B	Laboratory	10"	2	\$1300 (main frame only)	12	2"/sec - 1"/hr	
7127A	Laboratory-Industrial	10"	1	\$850 (main frame only)	4	1/4"/min - 2"/min or 6"/hr - 48"/hr or, 1.5"/hr - 12"/hr.	
7128A	Laboratory-Industrial	10"	2	\$1150 (main frame only)	4	Same as 7127A	
*H10-7127A	Gas chromatography	10"	1	\$1100	4	Same as 7127A	1 mV
*H10-7128A	Gas chromatography	10"	2	\$1650	4	Same as 7127A	1 mV

* See page 50.

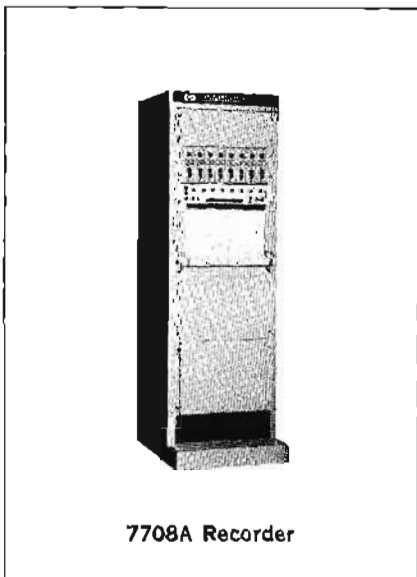
RECORDERS *continued***Strip chart and oscillographic recorders****7708A Recorder****Direct-writing galvanometer recorders, systems**

A considerable proportion of data recording requirements is for continuous, visible analog records of signals with maximum significant frequency content in the range dc to 150 Hz. These needs are well filled by direct-writing instruments operating on the galvanometer principle, to produce rectilinear chart traces on matched thermo-sensitive Permapaper® by the hot stylus method. Linearity of 0.5% full scale, resolution of 4 cycles/mm of paper travel even at small amplitudes, and reliable operation without attention to the writing medium

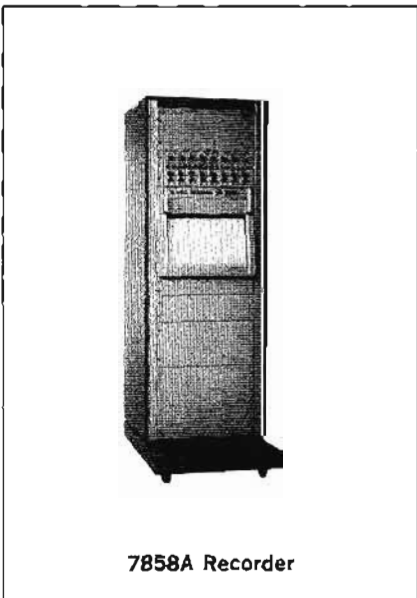
**7858A Recorder**

are significant advantages of the thermal writing method. Standard versions are available with 1, 2, 4, 6 and 8 channels.

Also available are portable one- and two-channel systems, suitable for use either in the lab or in the field. Of these, Model 7701A provides over twice the signal resolution from its 100-mm wide chart, with a full-scale response from dc to 30 Hz.

Fluid-process recorders, systems

Fluid-process recorders produce rectilinear traces in instant-drying ink on Hewlett-Packard Z-fold paper or rolls. This compact, solid-state eight-channel recorder utilizes a pen tip position feedback technique providing greater accuracy for true rectilinear recording of analog signals for applications involving telemetry systems, medical instrumentation systems and analog computers. A pressurized ink system, with plug-in ink reservoir produces ultra-clear traces throughout a speed range of .025 to 200 mm/sec. These feature a frequency response of dc-160 Hz (-3 dB) at 10 div pp deflection and dc-60 Hz (max.), for full-scale deflection. Linearity is 0.5% full-scale.

These recorders are well suited for data recording applications in scientific and industrial research, production and environmental testing, quality control, communications, telemetry, and process control. In the medical field, they are designed for use in cardio-pulmonary and catheterization laboratories, and a wide range of research, clinical and teaching applications.

Optical recorders, systems

Hewlett-Packard optical recorders provide continuous analog records of signals in the range dc-5 kHz. These systems are ideal for monitoring and recording such variables as temperature, pressure, force, displacement, strain, computer and power supply outputs in missile and engine analysis, analog recording, production testing, control applications and nuclear tests. They employ compact, high-speed galvanometers to direct light beams, recording at amplitudes up to 8" on light sensitive paper. Rectilinear charts are produced, and traces may overlap. Standard versions are available up to 25 channels. One series of these highspeed HP optical recorders writes with high-intensity ultra-violet light, to produce visible traces

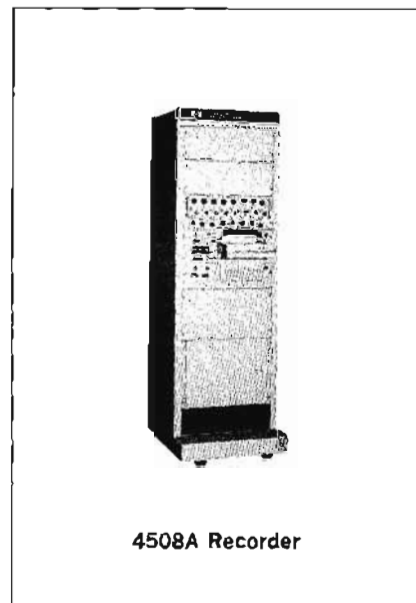
**4508A Recorder**

which require no chemical development; another series writes with light originating in incandescent lamps, producing traces of high contrast on light-sensitive paper stock of lower cost, but requiring chemical development. This, however, may be accomplished rapidly and continuously by an optional automatic rapid developer attachment to the recorder.

Amplifiers and signal conditioners

A broad line of Hewlett-Packard amplifiers and signal conditioners match the recorder to the signal source. This source may be an electrical signal from an external circuit, or from a transducer to represent some physical variable such as pressure, force, flow, velocity, displacement, etc. These amplifiers and signal conditioners include the miniaturized all-solid-state 8800 Series Plug-in Preamplifiers (8 models) and the multi-channel 650 Series and 8820 Series amplifiers which provide 6 or 8 channels of identical amplification on a common panel. Wide choice of amplifiers and signal conditioners is provided for the thermal, fluid, and optical systems.

Recording chart papers

Recording chart papers are available for all recording systems, with excellent recording characteristics assured by matching the paper design to the recorder, and by careful quality control. Paper is in standard roll lengths for all recorders, as well as in Z-fold packs for the fluid-process recorders.

5" STRIP CHART RECORDER

Multi-speed servo recorder
Model 680



RECORDERS

The Models 680 and 680M, 5" strip-chart recorders provide a wide range of performance for general or specialized use. The 680 is equipped with multi-range input, multi-speed chart transport, full-range zero set, and electric pen lift; features essential for general purpose applications. The instrument is available with standard (English) or metric scaling (680M) and extra cost options such as retransmitting potentiometers, event markers, limit switches, and dual rack adapter for rack mounting in pairs. It is useful for recording the output of HP Digital recorders such as the Model 562A when equipped with two D/A converters such as the Model 581A.

The recorder features modular construction with all transistor circuitry, high accuracy, fast response, synchronous motor chart drive and full view tilting chart magazine. Standard facilities include instant chart speed transfer, local and remote pen lift control, tear-off or chart roll storage, and a choice of cartridge-fed ink pen or pressure stylus. Optional electric writing provides crisp, clean, permanent records for long-term unattended recording capability.

Specifications

Recording mechanism:

Ink: servo actuated ink pen drive, free of ground, with local and remote pen lift and full scale zero adjustment.

Pressure sensitive: similar to ink mechanism except a stylus for pressure sensitive paper is furnished in place of the ink pen.

Electric: similar to ink mechanism except a stylus for electrosensitive paper and the associated electronics are furnished in place of the ink pen.

Chart requirements:

Ink: 6" by 100' roll charts, 5 inch (12 cm) writing width. Approximately 4" by 6" visible chart area during operation.

Pressure sensitive: 6" by 80' roll charts, 5" (12 cm) writing width.

Electrosensitive: 6" by 80' roll charts, 5" (12 cm) writing width.

Response time: one-half second or less for full scale.

Chart speeds: eight-synchronous motor controlled speeds at 1, 2, 4, 8 inches per minute; 1, 2, 4, 8 inches per hour. Metric model: 2.5, 5, 10, 20 centimeters per minute; 2.5, 5, 10, 20 cm per hour. Speeds in a ratio of 16 to 1 may be supplied at additional cost.

Spans: ten calibrated spans of 5, 10, 50, 100, and 500 millivolts; 1, 5, 10, 50, and 100 V full scale. Metric model has spans of 6, 12, 60, 120, and 600 millivolts; 1.2, 6, 12, 60, and 120 V. An extra span of 1 millivolt, full scale, is available at extra cost (1.2 mV on metric).

Input resistance: 200,000 ohms per volt (166,666 ohms/volt on metric models) full scale, through 10 volt spans; 2 megohms on all others. Potentiometric input on most sensitive span permits operation with essentially zero current drain at null. Constant 100,000 ohm input resistance on all spans available at extra cost on both models.

Standardization: continuous electronic reference from zener diode controlled power supply.

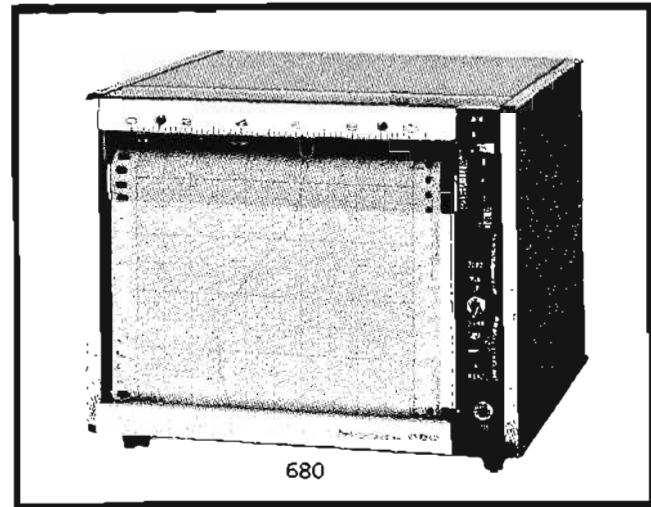

Accuracy: better than 0.2% of full scale. Resettability: 0.1% of full scale.

Interference rejection: dc common mode rejection better than 100,000 to 1 on 5 millivolt span.

Power requirements: 115/230 V, 60 Hz, 22 volt-amperes, 50 Hz models available at no extra cost, Option 10.

Physical dimensions: 6½" (165 mm) high, 8-3/5" (219 mm) deep, 7¾" (197 mm) wide. Rack mounting requires 7 inches of vertical space.

Weight: net approximately 11 lbs (5 kg); shipping 17 lbs (7,6 kg).

Accessory kit supplied: spare fuse, pen cleaning wire, slide-wire cleaner and lubricant, 2 ink cartridges (red and blue), and a roll of appropriate chart paper.

Prices:

Models 680 (standard) or 680M (metric):	\$750
Model H01-680 or H01-680M (with added span of 1 mV on H01-680 or 1.2 mV on H01-680M):	\$800
Model H02-680 or H02-680M (with 100,000 ohms input resistance on all spans):	\$825

Options:

—01 With installed 5k, 0.1% linearity retransmitting potentiometer:	add	\$50
—02 With installed event marker:	add	\$25
—03 With installed limit switches:	add	\$90
—08 With 16 to 1 instead of 60 to 1 speed reducer:	add	\$25
—09 With remote chart drive switch:	add	\$25
—10 For 115/230 V, 50 Hz operation:	n/c	
—11 With special scale markings:	add	\$10
—12 With stylus for pressure sensitive paper:	n/c	
—13 For operation with Logarithmic Converter:	add	\$25
—14 Glass door with lock:	add	\$45
—15 Electric writing:	add	\$75
—16 Electric writing event marker:	add	\$35
—17 Photoslidewire (not available for Models H01-680 and H01-680M):	add	\$100

RECORDERS



STRIP CHART RECORDERS

For laboratory and industrial use

Models 7100B, 7101B, 7127A, 7128A

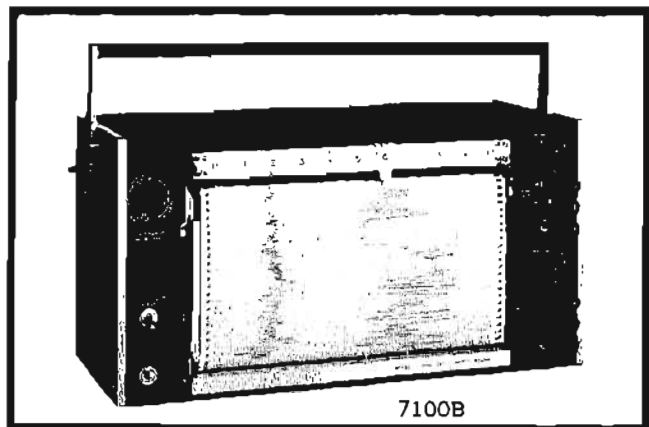

Description

The 10" strip chart recorders can be used in a wide range of laboratory and industrial applications. They feature high performance, low cost, and solid state construction for reliability, compactness, and light weight. Models 7100B and 7128A have two independent servo pen drives and require two input modules. The 7101B and 7127A are single pen units and take one input module. Ordering information should specify basic frame and exact input module or modules required.

Each main frame is equipped with instantly selected chart speeds (4 for 7127A, 7128A; 12 for 7100B, 7101B) and a modular chart magazine. The chart magazine will swing out at a 10° or 30° angle for convenient note writing. An optional integrator for simultaneously and accurately computing the area under the chart curve is also available.

Specifications

Recording mechanism: servo activated ink pen drives; manually operated pen lift.

Response time: maximum 0.5 second (50 Hz operation 0.6 second). (Reduce for some input modules.)

Chart capacity: 120' chart rolls 11" wide with 10" calibrated writing width.

Chart speeds

7127A/7128A (Standard)—1/4, 1/2, 1, 2 in/min.

H01-7127A/H01-7128A—6, 12, 24, 48 in/hr.

H02-7127A/H02-7128A—1 1/2, 3, 6, 12 in/hr.

7100B/7101B (Standard)—1, 2 in/hr; 0.1, 0.2, 0.5, 1, 2 in/min; 0.1, 0.2, 0.5, 1, 2 in/s.

7100BM/7101BM (Metric)—2.5, 5, 15, 30, cm/hr; 1.25, 2.5, 5, 15, 30 cm/min; 1.25, 2.5, 5 cm/s.

Power: 115 or 230 V ±10%, 60 Hz, 65 volt-amperes for 7100, 7128A. 42 volt-amperes for Models 7101B and 7128A. 115 or 230 V, 50 Hz models available as option.

Weight: 7100B, net 22 lbs (9.9 kg), shipping 30 lbs (13.5 kg); 7101B, net 21 lbs (9.45 kg), shipping 28 lbs (12.6 kg). All weights include input modules.

Accessories supplied:

- Accessory kit contains: ink cartridge—4 each of red and 4 each of blue, balance potentiometer lubricant, balance potentiometer cleaner, syringe and tube for ink system cleaning, extra pen for each channel, rear input mating connector, and pen cleaning wire.
- Appropriate graph paper (one 120' roll)
- Power cord (7')
- Instruction Manual

Dimensions: 16 3/4" long, 8-11/16" high, 7 1/4" deep.

Radio frequency interference: meets specifications of MIL-I-6181D.

Prices: (basic frame less input module)

Two channel models:

7100B (Standard)/7100BR (std. rack)/7100BM (Metric)/7100BMR (Metric rack)	\$1300
7128A/H01-7128A/H02-7128A	\$1150

Single channel models:

7101B (Standard)/7101BR (std. rack)/7101BM (Metric)/7101BMR (Metric rack)	\$1000
7127A/H01-7127A/H02-7127A	\$ 850

Options (7100B, 7101B only):

02 With 10 to 1 remote speed reducer:	add \$ 85
04 With 5000 ohm retransmitting potentiometer in channel #1:	add \$ 50
05 With high-low limit switches (7101B and channel one on 7100B):	add \$ 50
06 Electric pen-lift with remote control:	add \$ 50
07 With remote on-off chart control:	add \$ 25
10 For 115 or 230 V, 50 Hz operation:	n/c
11 With latching glass door:	add \$ 50
12 With left mounted event marker:	add \$ 35
*With two event markers:	add \$ 70
*15 With Disc Integrator:	add \$585
*16 With 5000 ohm retransmitting potentiometer in channel #2:	add \$ 50
17 With high-low limit switches (channel #2 on 7100B):	add \$ 50
18 With high-low limit switches (both channels of 7100B):	add \$100
19 Electric writing:	add \$ 75
20 Scale with "0" right side:	n/c
21 Gray Control Panel:	n/c

Options (7127A, 7128A):

01 With high-low limit switches (7128A and channel one on 7128A):	add \$ 50
02 With remote on-off chart control:	add \$ 25
03 For 115 or 230 V, 50 Hz operation:	n/c
04 With left mounted event marker:	add \$ 35
*06 With two event markers:	add \$ 70
*07 With disc integrator:	add \$585
08 Remote controlled electric pen lift:	add \$ 50
09 With high-low limit switches (channel two on 7128A):	add \$ 50
10 With high-low limit switches (both channels on 7128A):	add \$100
11 With carrying handle:	add \$ 25
†12 Mounted in cabinet compatible with F & M chromatograph systems:	add \$ 50
†13 With locking glass door:	add \$ 50
14 With 5 k ohm retransmitting potentiometer (7127A and channel #1 on 7128A):	add \$ 50
*15 With 5 k ohm retransmitting potentiometer (channel #2 7128A):	add \$ 50
*16 With 5 k retransmitting potentiometers (channel #1 and #2 7128A):	add \$100
17 Electric writing:	add \$ 75
18 Scale marked for use with integrator (integrator not supplied) calibrated writing width 8":	add \$ 15
20 Scale with "0" right side:	n/c
21 Gray control panel:	n/c

*Options 14 and 16 cannot be installed when Option 15 is installed.

Input modules

For use with all 7100 and 7127A Series Basic Frames

Description (17500A)

The 17500A has ten calibrated spans from 5 mV to 100 V full scale.

Specifications (17500A)

Voltage spans: ten spans at 5, 10, 50, 100, 500 mV; 1, 5, 10, 50, 100 V, full scale; continuously variable mode on all spans and potentiometric operation on four most sensitive spans by removal of internal buss wire.

Accuracy: $\pm 0.2\%$ of full scale.

Linearity: terminal-based: 0.1% of full scale.

Dead band: 0.1% of full scale.

Input resistance: 1-megohm at null on all fixed calibrated spans; when in variable mode, 100,000 ohms on four most sensitive spans, 1-megohm on all others.

Interference rejection: dc common mode, 120 dB on four most sensitive ranges; line frequency, 100 dB on four most sensitive ranges.

Zero-set: continuously adjustable over full scale, plus one full scale of suppression.

Maximum source impedance: up to 10 k ohm source impedance will not alter recorder's performance on the first four ranges (5, 10, 50, 100 mV/fs). Higher source impedances will cause an increase in dead zone and a decrease in pen speed. No source impedance restrictions on ranges above 100 mV/fs.

Reference supply: continuous electronic reference, zener diode controlled.

Weight: net 4 lbs., shipping 7 lbs.

Price: Model 17500A \$250

Description (17501A)

This multiple span plug-in has sixteen spans from 1 mV to 100 V full scale.

Specifications (17501A)

Voltage spans: sixteen spans: 1, 2, 5, 10, 20, 50, 100, 200, 500 mV; 1, 2, 5, 10, 20, 50, 100 V full scale. Continuously variable mode on all spans and potentiometric operation on six most sensitive spans by removal of internal buss wire. The high sensitivity is obtained by using a single nuvister and associated circuitry.

Accuracy: $\pm 0.2\%$ of full scale.

Linearity: terminal based: 0.1% of full scale.

Dead band: 0.1% of full scale.

Input resistance: 1-megohm at null on all fixed and variable spans.

Interference rejection: dc common mode, 120 dB on three most sensitive ranges; line frequency, 100 dB on three most sensitive ranges.

Zero-set: continuously adjustable over full scale, plus one full scale of suppression. Extended 5-scale suppression available at extra cost.

Maximum source impedance: up to 10 k ohm source impedance will not alter recorder's performance on the first six ranges (1, 2, 5, 10, 20, 50 mV/fs). Higher source impedances will cause an increase in dead zone and a decrease in pen speed. No source impedance restrictions on ranges above 100 mV/fs.

Reference supply: continuous electronic references, zener diode controlled.

Weight: net 4 lbs., shipping 7 lbs.

Price: Model 17501A \$350

Description (17502A)

Temperature measuring input module with single span selected to match thermocouple. Built in compensation junction. The module converts input to a linear function of temperature.

Specifications (17502A)

Voltage spans: single span to match cold-junction thermocouples of types and ranges as listed in Figure 1.

Accuracy: $\pm 1/2\%$ or $\pm 1^\circ\text{C}$ (whichever is greater), refer to NBS CIR 561, dtd 1948.

Input resistance: potentiometric input.

Reference supply: continuous electronic reference, zener diode controlled.

Interference rejection: dc common mode, 120 dB; line frequency, 100 dB.

Weight: net 4 lbs., shipping 7 lbs.

Price: Model 17502A (single span, T-C match) \$250

Description (17503A)

The 17503A plug-in is equipped with special circuitry for gas chromatography use. A single span of one millivolt full scale is provided with potentiometric input. A high performance input filter allows the recording of signals with differential noise.

Specifications 17503A

Voltage spans: single span to match cold-junction thermocouples.

Accuracy: $\pm 0.2\%$ of full scale.

Linearity: terminal based: 0.1% of full scale.

Dead band: 0.1% of full scale.

Input resistance: potentiometric.

Interference rejection: dc common mode, 120 dB. Line frequency common mode 100 dB. Contains filter for attenuation of noise and line frequency pickup.

Zero set: continuously adjustable over full scale, plus one full scale of zero suppression.

Maximum source impedance: up to 5 k ohm source impedance will not alter recorder's performance. Higher source impedance will cause an increase in dead zone and a decrease in pen speed.

Frequency: 60 Hz (line frequency) 50 Hz operation optional.

Price: Model 17503A \$250

Description (17504A)

Single span plug-in module. Single span from 5 mV to 100 V full scale. Removal of jumper wire allows potentiometric input on four most sensitive range cards (5 mV to 200 mV) with essentially zero current drain at null.

Specifications (17504A)

Voltage spans: 10 range cards available, which allow any span from 5 mV to 100 V full scale. Specify range card (part number) or span required when ordering.

Accuracy: $\pm 0.2\%$ of full scale.

Linearity: terminal-based: 0.1% of full scale.

Dead band: 0.1% of full scale.

Input resistance: 1 megohm at null. Potentiometric input on first four range cards (5 mV to 200 mV) permits operation with essentially zero current drain at null.

Interference rejection: dc common mode 120 dB on 4 most sensitive range cards. AC (line freq.) common mode 100 dB on 4 most sensitive range cards. Combination low pass, line frequency notch filter minimizes differential signal noise effects.

Zero set: continuously adjustable over full scale and one full scale of zero suppression.

Maximum source impedance: up to 10 k ohm source impedance will not alter recorder's performance.

Reference supply: continuous electronic reference, zener diode controlled.

Frequency: 60 Hz (line frequency) 50 Hz operation optional.

Weight: net 4 lbs., shipping 7 lbs.

Price: Model 17504A (with one range card) \$200
(specify range card)

Additional range cards \$25



LOGARITHMIC CONVERTERS

Convert ac or dc signal to logarithmic scale

Models 7560A and 7561A

Models 7560A and 7561A are completely self-contained dual and single channel instruments, respectively. They produce dc output voltages in logarithmic relationship to dc input voltages or the peak or average amplitude of ac input voltages over a 1000 to 1 amplitude range.

Model 7562A is a single channel logarithmic converter designed to produce dc output voltages in logarithmic relationship to dc input voltages or the true rms amplitude of ac voltages in a 10,000 to 1 amplitude range.

The output signal of one channel may be applied directly to one axis of an X-Y recorder to produce curves representing logarithmic values as a function of an independent variable applied to the second axis. Since the logarithmic scale compresses the high amplitudes with respect to the lower ones, the presentation has the advantage of plotting over wide amplitude

ranges with constant accuracy of reading at all levels. All three models employ solid state circuitry.

The 7562A contains a true rms detector. It is the first logarithmic converter offered with this feature. The operating frequency ranges from 100,000 Hz to 0.5 Hz. The dc mode risetime is 2 μ s which enables use with oscilloscopes. The high dynamic range of 80 dB is an increase by a factor of three or more over most log converters.

Typical applications are: plotting the frequency characteristics of filters, transformers, amplifiers, networks, and similar devices; vibration testing; pulse height analyzer readouts; computers; and any applications requiring wide dynamic range or logarithmic relationships. The 7562A operates directly with Hewlett-Packard X-Y and strip chart recorders and oscilloscopes.

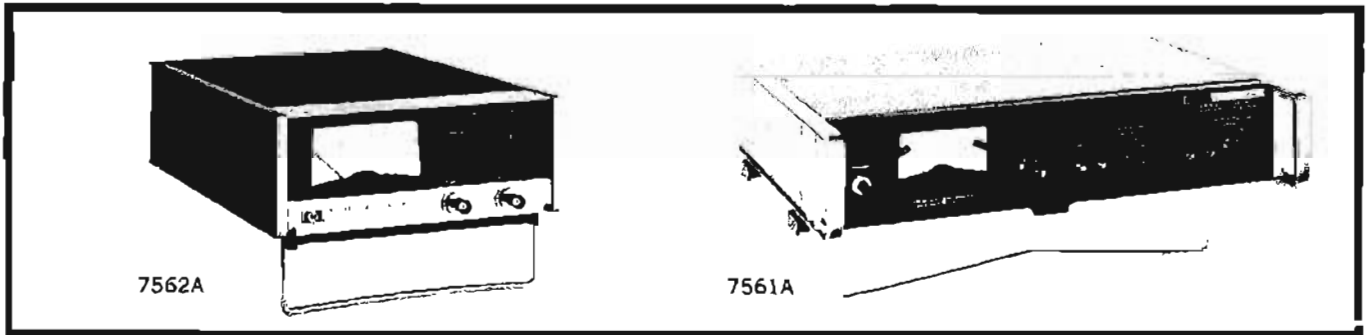

Specifications, 7560A and 7561A

Input ranges:

Input attenuation	AC Input range (sine wave, rms)	DC Input range
0	0.001 to 1.0 V	0.00316 to 3.16 V
-10	0.00316 to 3.16	0.01 to 10.0
-20	0.01 to 10.0	0.0316 to 31.6
-30	0.0316 to 31.6	0.10 to 100.0
-40	0.10 to 100.0	0.316 to 316.0

Frequency range: 20 to 100,000 Hz (ac input).

Dynamic range: 60 dB (1000 to 1), ac or dc.

Output range: 5, 10, or 20 dB/in into 20,000 ohm load (10 mV/in recorder range); metric unit: 2, 5, 10, dB/cm into 10,000 ohm load (2 mV/cm range of most metrically scaled recorders).

Response speed: up to 1 second for input change of 20 dB.

Calibration stability: ± 0.5 dB (better than ± 0.2 dB over any 24 hour period).

Input impedance: approx 2 megohms, 35 pF (either ac or dc).

Accuracy: ± 0.5 dB up to 50 kHz; and ± 1.0 dB up to 100 kHz; with continuous signal changes less than 2 dB/s.

Specifications, 7562A

Input

Dynamic range: 80 dB.

Voltage range: 1 mV to 10 V or 10 mV to 100 V selectable by front panel switch; accepts either ac or dc signals.

Input impedance: AC Mode: 1 megohm approximately 50 pF.

DC Mode: 100 k ohms approximately 50 pF. Single ended.

Output

Voltage: 0 to 800 mV dc corresponding to 10 mV/dB.

Output impedance: 100 ohms.

DC Mode accuracy: ± 0.25 dB.

DC Mode risetime:

Signal level		Maximum rise time
1 mV - 10 V range	10 mV - 100 V range	
1 V or more	10 V or more	2 μ s
100 mV - 1 V	1 V - 10 V	4 μ s
10 mV - 100 mV	100 mV - 1 V	20 μ s

AC Mode accuracy and frequency response:

Low freq. limit switch position	Frequency range	Accuracy - dB
50 Hz	100 Hz - 50 kHz	± 0.5 dB
	50 Hz - 200 Hz, 50 kHz - 100 kHz	± 1.0 dB
5 Hz	10 Hz - 50 kHz	± 0.5 dB
	5 Hz - 20 Hz, 50 kHz - 100 kHz	± 1.0 dB
0.5 Hz	1 Hz - 50 kHz	± 0.5 dB
	0.5 Hz - 2 Hz, 50 kHz - 100 kHz	± 1.0 dB

AC Mode slewing speed:

Low freq. limit switch position	Minimum slewing speed dB / s
50 Hz	200
5 Hz	20
0.5 Hz	2

Detection: true rms.

Crestr factor: 5—except max input voltage is ± 25 V peak (± 250 V peak in the 10 mV - 100 V range).

Meter accuracy: ± 1.0 dB.

Oscilloscope output: approx 0.5 V rms regardless of input, maintaining input signal waveform suitable for monitoring with oscilloscope.

Price

Dual channel: Model 7560A	\$975
Single channel: Model 7561A	\$595
Single channel: Model 7562A	\$995

RECORDER ACCESSORIES



RECORDERS

Roll chart adapters

Model 17005A is an extremely versatile accessory compatible with most Hewlett-Packard 11" x 17" bench recorders. It has basically two modes of operation: Incremental Chart Advance and Continued Chart Advance. Modes of operation include Incremental Advance, Major Division Advance, Automatic Frame Advance, adaptation of X-Y Recorders to strip chart recording, segmented strip chart and optional fan fold operation.

Specifications, 17005A

Compatible recorders: most bench model 2D, 2FA and 7000A Series HP X-Y Recorders.

Incremental advance mode

Plot density/rate

Plot density (plots/inch) 200, 100, 50, 20, 10.
Max. advance rate (plots/sec) 100, 100, 100, 40, 20.

Time base mode

Speeds: 1, 5, 10, 100 sec/inch.
Accuracy: $\pm 2\%$.

Frame advance mode

Advance distance: 24 inches.
Accuracy: ± 0.005 inches (nonaccumulative).
Advance time: 14 seconds.

Major division advance

Advance distance: selectable major divisions are in 3 inch increments.
Accuracy: ± 0.005 inch (nonaccumulative).
Advance time: 2 s (maximum).

Price: Model 17005A \$895

Model 17006A permits manual chart advance by operating a hand crank. A crank handle also is provided on the supply reel for rewind purposes. Included is a tear-off wire attachment for chart "pull through, tear off."

Price: Model 17006A \$125

Point plotters and character printers

The Hewlett-Packard Character Printers and Point Plotters are specially designed to replace the pen on compatible HP 11" x 17" X-Y Recorders to identify points or curves when plotting families of digital information.

The 17009A/B identify points of information with a character. Ten different characters are available. The 17011A, 17012A, and 17012B identify points of information with a point (dot). The 17011A has two electrically isolated solenoids in tandem, providing the capabilities of printing two colors. The 17012A and 17012B have a single solenoid.

Specifications

17009A, 17009B: up to 6 points per second (with G-2 Null Detector).

17011A: up to 50 points per second (with 17173A Null Detector).

17012A: up to 6 points per second (with G2 Null Detector).

17012B: up to 50 points per second (with 17173A Null Detector).

Power source: supplied from associated recorder.

Actuating source: external contact closure, or manually operated penlift control of recorder.

Prices:

17009A, 17009B	\$ 95
17011A	\$175
17012A	\$ 95
17012B	\$ 95

F-3B line follower system

The F-3B Line Follower, available factory-installed on HP 11" x 17" X-Y Recorders, regenerates original data directly from previously recorded curves. Any line prepared with pencil or

pigment-type ink will be followed automatically with high accuracy by means of an optical photo-electric sensing element which replaces the pen of the recorder.

Displacement analog output: F-3B: with external signal supplied; proportional to head displacement.

Straight-line accuracy: $\pm 0.03''$ 0° to 45° and time sweeps through 0.5 s/in) angular ranges from 0° up to 85° up to 5 s/in; square waves or spike functions of 0.1 inch maximum amplitude will remain within the scanned area at time sweeps up to 10 s/in.

Scanned area: 0.1 inch on either side of its center line and 0.05 inch along its center line.

Power: 115 or 230 volts, 56 to 60 Hz, single phase; F-3B 5 watts.

Price: F-3B \$895

40D keyboard

The Hewlett-Packard 40D is a full keyboard-type accessory for use with compatible HP X-Y Recorders to plot tabular data in point-graph form. Operating power is derived from an X-Y Recorder through a cable and plug connector which also carries servo-positioning information back to the recorder. Keyboard for each axis includes polarity, hold, clear and calibrate keys. Panel selectors control circuits for zero suppression, points/inch calibration and logarithmic plotting.

Keyboard: two 3-column, nine-row arrays and unit "1000" keys. Numbers from 0 to ± 1999 on each axis; function keys provide x hold, y hold, calibrate, clear and main clear.

Output attenuator (linear mode): 5 fixed steps at 10, 20, 50, 100, 200 pts/inch (5, 10, 25, 50, 100 pts/cm on metric model); provision for variable attenuation between steps up to 500 pts/inch (200 pts/cm on metric model).

Accuracy: $\pm 0.1\%$.

Power: 115 or 230 V, 50 to 60 Hz, single phase, approximately 12 volt-amperes (derived from associated recorder).

Dimensions: $9\frac{3}{8}''$ wide, $5\text{-}3/16''$ high, $13\text{-}11/16''$ deep (244 x 132 x 348 mm).

Weight: net 16 lbs (7,2 kg); shipping 30 lbs (13,5 kg).

Price: Moseley 40D or 40DM (metric), \$1275; specify model and serial number of existing recorder.

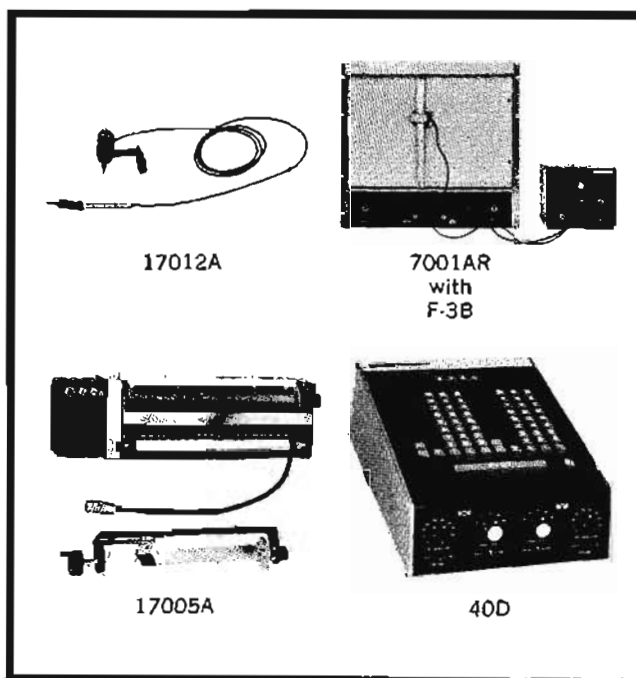

RECORDERS**THERMAL & FLUID RECORDERS**

Summary of HP systems for permanent, graphic records of measurements

Plug-in individual preamplifiers

The 8800 Series of plug-in preamplifiers are used with both the thermal (7700 Series) and the fluid (7800 Series) HP oscillographic recording systems. Preamplifiers include low-gain dc, medium-gain dc, high-gain dc, ac-dc converter, phase sensitive demodulator, carrier, general-purpose dc, and logarithmic units for use as plug-in signal conditioners in the system. See pages 150-155 for these preamplifiers, as used in thermal and fluid systems. See pages 138-142 for thermal systems using these preamplifiers, and pages 146-148 for fluid systems.

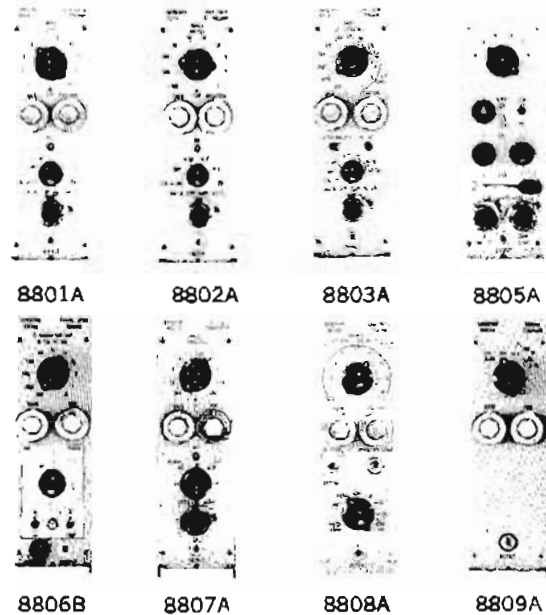
**Identical-channel amplifiers**

The 8820A and 8821A Amplifiers simplify the recording of similar measurements. The rated sensitivities of 50 mV/div (8820A) and 1.0 mV/div (8821A) are available for a wide range of measurements. Each channel has its own set of controls, which are identical for all channels. These amplifiers find extensive use in HP systems applications in telemetry, computer read-out, and multi-variable analyses. See page 156 for amplifier information. See pages 141, 142 for thermal systems using these amplifiers, and pages 146-148 for fluid systems.

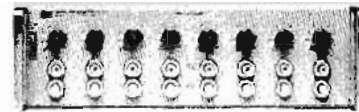

8820A

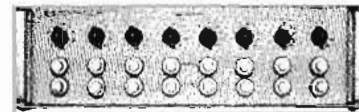

8821A

Reliable, general purpose recorders

A "briefcase size" recorder ideal for use by field engineers and test technicians. This 21-pound solid-state recorder occupies less than 1/2 cubic foot and operates in any position. Two versions are available—10 mV/div or a universal carrier system.

299A
301**100 mm wide chart recorder**

With 2 to 3 times the resolution of other units, this recorder accurately displays critical levels of force, velocity, strain, displacement and other measurements. Sanborn "8800 Series" solid-state plug-in preamplifiers provide large-system versatility, but with 100 mm channel width.



7701B

	7704A		7706B		7858A	<p>7800 Series (fluid) with 8800 Preamplifiers</p>
					7708A	<p>7700 Series (thermal) with 8800 Preamplifiers</p>

	7878A	<p>7800 Series (fluid) with 8820A/21A Amplifiers</p>
	7727A	<p>7700 Series (thermal) with 8820A/21A Amplifiers</p>
	7729A	

Portable, rack mount or mobile 2-channel system

A dual-channel solid-state recorder only 8¾" high with "8800 Series" performance in portable case, rack-mount or mobile cart units. Two 50 mm wide charts display signals clearly with heated stylus writing. Four chart speeds are standard with choice of 4 additional speeds optional.

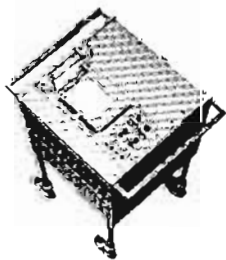

7702B

Portable, 2-channel general purpose or carrier recording

Hewlett-Packard offers a choice of 3 lightweight, dual-channel recorders that provide quick, accurate on-the-spot recording. Available in models for general purpose dc-ac inputs in a variety of sensitivities. Two 50 mm channels.

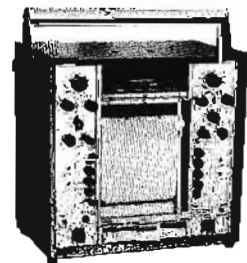

321

RECORDERS



1-CHANNEL RECORDER

Wide channel for greater resolution

Model 7701B

Model 7701B provides two to three times the signal resolution of a standard width recorder and can be used with any of the versatile solid-state 8800 interchangeable plug-in signal conditioners. Frequency response is dc to less than 3 dB down at 30 Hz independent of amplitude, damping set for 4% overshoot with a 40 division p-p square wave. The

low-impedance ruggedly constructed galvanometer employs velocity feedback for damping and the power amplifier has adjustable electrical limiting over span from ± 12 divisions to beyond edge of chart coordinates to protect recording stylus. Up to 2000 hours of continuous unattended recording at 0.5 mm/min is possible without changing chart roll.

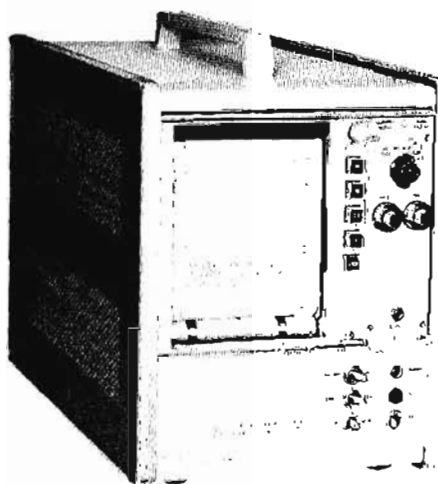

7701B

Specifications

(See page 152 for performance specifications with 8800 Series Plug-in Preamplifiers.)

Paper speeds: 4 mm/s speed standard (0.5, 2.5, 10 and 50 mm/s), mechanically shifted and selected by front-panel pushbuttons; four additional speeds 0.5, 2.5, 10 and 50 mm/min can be added as Option 03.

Event marker: right margin, manually operated from front panel; 1 s or 1 min plug-in timer and second event marker optional.

Front-panel controls: stylus heat control, pushbutton paper speed selectors, remote-local switch, timer-off-marker switch, mm/sec-mm/min switch, power switch and galvanometer damping adjustment

Paper: 200 ft roll of 10 cm wide-channel standard Permapaper® (651-217); time lines every 5 mm, amplitude lines every 2 mm (50 div full scale).

Paper take-up: automatic paper take-up standard (concealed in recorder).

Power: 115 volts $\pm 10\%$, 60 Hz, 100 watts; 115 or 230 volts $\pm 10\%$, 50 Hz, 100 watts (Option 08).

Dimensions: 7701B, in carrying case: 13½" high, 10" wide, 18⅛" deep (343 x 254 x 460 mm); without case: 10½" high, 8-11/16" wide, 17½" deep (269 x 221 x 445 mm); rack mounting adapter (mounts 2 wide-channel recorders): 14" high, 19" wide, 17½" deep (356 x 483 x 445 mm).

Weight: 7701B in carrying case, includes typical 8800 Series Preamplifier: net 32½ lbs (14,5 kg), shipping 42 lbs (18,9 kg); rack mount adapter: net 20 lbs (9,1 kg), shipping 30 lbs (13,5 kg).

Accessories: 1-channel, 100 mm (50 div) 200 ft roll Permapaper (651-217-1), \$14 (consult local HP sales office for quantity prices); 412-4 Analog Stylus, \$15; 411-9 Marker Stylus, \$9.

Prices: Model 7701B, 115 V 60 Hz, less Preamplifier, \$1490; Option 01: Regulator Card, 440 Hz, required when an 8803A Preamplifier is used with the recorder. (With this card, the recorder can be used with any "8800" Preamplifier except 8805A), add \$35; Option 02: Regulator Card, 2400 Hz, required when an 8805A Preamplifier is used with the recorder. (With this card, the recorder can be used with any "8800" Preamplifier except 8803A), add \$35; Option 03: mm/minute Speed Reduction Kit (60:1, 60 Hz), add \$110; Option 04: Left Event Marker, add \$45; Option 05: One-Minute Timer, add \$30; Option 06: One-Second Timer, add \$20 (for Model 7701B); add \$25 (for Model 7701B Option 08); Option 07: less Portable Case, deduct \$90; Option 08: 115/230 V 50 Hz, add \$50.

Note 1: Add price of preamplifier to the above basic assembly prices for complete system cost. See pages 150-152 for specifications and prices.

DUAL-CHANNEL RECORDER

Mount in cart, cabinet or portable case
Model 7702B



RECORDERS

This handy Hewlett-Packard dual-channel recorder can be mounted in a cabinet, mobile cart or portable carrying case. It uses the same plug-in preamps as 6- and 8-channel assemblies. The recorder chart paper runs horizontally. Assembly consists of fully solid-state individual current feedback power amplifiers and single power supply. Frequency response is dc to less than 3 dB down at 125 Hz for chart

deflection of 10 divisions p-p. Damping is set for 4% overshoot with a 10 division p-p square wave. Response time is less than 5 msec for 10 to 90% of a 10 division square wave with damping set for 4% overshoot. The power amplifier features adjustable electrical limiting over a span from ± 12 divisions to beyond edge of the chart coordinates.

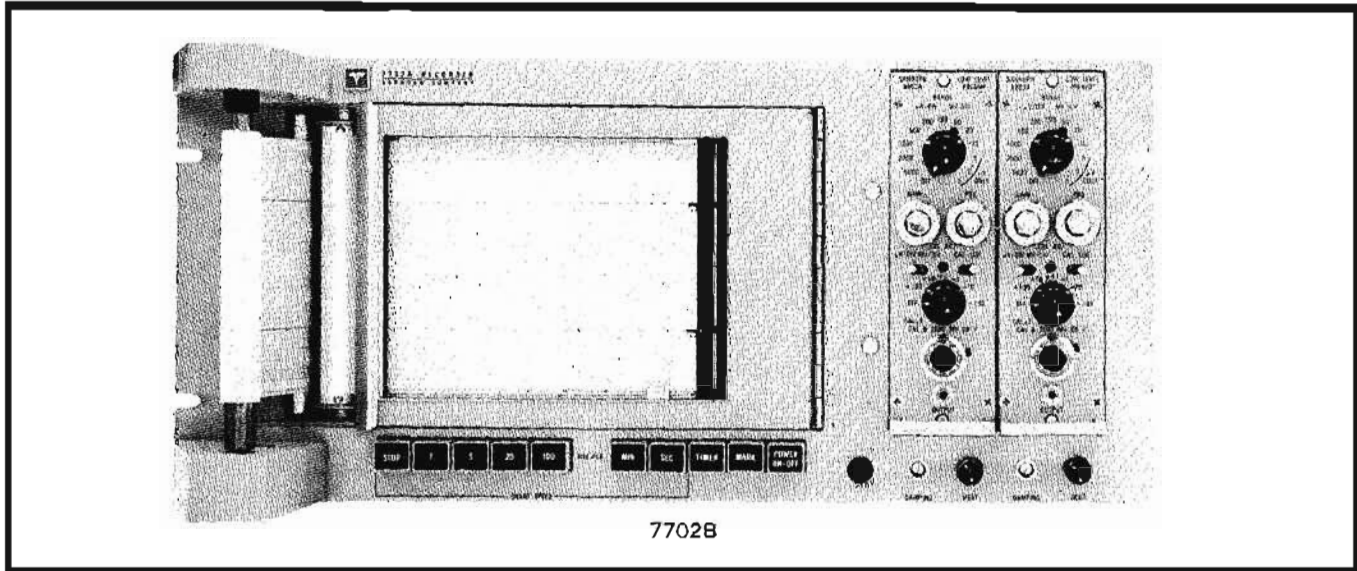

Specifications

(See page 153 for performance specifications with 8800 Series Plug-in Preamplifiers.)

Paper speeds: standard recorders are supplied with 4-speeds (1, 5, 20 and 100 mm/sec) mechanically shifted and selected by front-panel pushbuttons; other speed combinations are available as options (see Options 10, 11 and 12 under Prices); provision is made for optional remote control of chart drive from suitable 115 V ac source.

Timer-off-marker: separate stylus marks edge of chart (paper) 1 sec pulses in "time" position (timer motor) or with 60 Hz signal operator can use as a reference mark in "mark" position; remote marking provision at rear connector by simple contact closure (115 V ac); an extra marker is available as optional accessory.

Panel controls: individual stylus heat controls; pushbuttons for power, timer, marker and speed selection; and individual galvanometer damping adjustments (screwdriver).

Paper: standard 200 ft rolls of 5 inch wide 2-channel Permapaper® (651-52), easily loaded from the recorder panel; one channel only may be used with 1-channel Permapaper (651-51); translucent Permapaper (651-182) is available for making multiple copies of recording on contact copier (Ozalid, etc.).

Paper take-up: automatic paper take-up standard equipment.

Power: 115/230 volts $\pm 10\%$, 60 Hz, 200 watts; 115/230 volts $\pm 10\%$, 50 Hz, as Option 08.

Dimensions: 7702B, rack mounted: 8 $\frac{3}{4}$ " high, 19" wide, 17 $\frac{1}{4}$ " deep (222 x 483 x 438 mm); portable case Option 02: 9 $\frac{1}{4}$ " high, 19 $\frac{5}{8}$ " wide, 21 $\frac{1}{2}$ " deep (235 x 498 x 546); mobile cart Option 05: 39 $\frac{1}{4}$ " high, 26 $\frac{3}{4}$ " wide, 20 $\frac{1}{2}$ " deep (997 x 680 x 521 mm).

Weight (approx): typical with 2 preamplifiers, rack mounted: net, 60 lbs (27.2 kg), shipping, 86 lbs (38.7 kg); portable case Option 02: net, 89 lbs (40.4 kg), shipping, 135 lbs (60.8 kg); mobile cart Option 05: net, 130 lbs (59 kg); shipping, 172 lbs (77.4 kg).

Accessories: 2-channel, 5 cm (50 div) channels 200 ft Permapaper roll (651-52), green coordinates on opaque white paper, \$12.50. 1-channel, 5 cm (50 div) 200 ft Permapaper roll (651-51), green lines on white, \$6.90 (consult local HP sales office for quantity prices); 398 Analog Writing Arm, \$7.15; 411-10 Event Writing Arm, \$6.65 ea.

Optional accessory equipment: 462-189 Extra Marker (center margin), \$76. 7702-14A Portable Case (7702-01A recorder) \$195.

Prices: Model 7702B, less Preamplifiers, \$1675; Option 02: in portable case, add \$195; Option 05: in mobile cart, add \$195; Option 08: 50 Hz operation, add \$50; Option 10: chart speeds of 2.5, 5, 25, and 50 mm/s, specify 50 Hz or 60 Hz, no extra charge; Option 11: 60:1 speed reduction, 60 Hz, add \$150; Option 12: 60:1 speed reduction, 50 Hz, add \$150; Option 13: one-minute timer, 60 Hz, available only when Option 11 is taken, add \$34; Option 14: one-minute timer, 50 Hz, available only when Option 12 is taken, add \$34; Option 15: extra marker, add \$76.

Note 1: add price of preamplifiers to the above basic assembly prices for complete system cost; see pages 150, 151, 153 for specifications and prices.

RECORDERS



4-CHANNEL RECORDERS

Pullout table-top facilitates chart noting
Model 7704B

This Hewlett-Packard recorder provides the convenience of horizontal table-top chart marking, the flexibility and high performance of the solid-state interchangeable, individual-channel preamplifiers (used in 6- and 8-channel assemblies) and the economy of a 4-channel system. Individual power amplifiers have adjustable electrical limiting over span from ± 12 divisions to beyond edge of chart coordinates to protect recording stylus, and current feedback circuits which virtually eliminate drift. Variables appear sharp and clear, in true rectilinear coordinates on 5 cm wide Permapaper®. Frequency response is dc to less than 3 dB down at 125 Hz for chart deflection of 10 divisions p-p, damping set for 4% overshoot with a 10 division square wave.

Specifications

(See page 133 for performance specifications with 8800 Series plug-in Preamplifiers.)

Paper speeds: 0.25, 0.5, 1, 2.5, 5, 10, 25, 50 and 100 mm/s.

Markers: right side marker is standard; a second marker mounted between channels 1 and 2 is available as an accessory. Amplitude of trace approx. 1.5 mm. With front panel switch or external contact closure in MARK position, marker pulses at line frequency. In TIME position, marker pulses at line frequency for a few cycles every second.

Front-panel controls: individual stylus heat controls, speed selector handle motor starting switch, timer-off-marker switch, remote control plug.

Paper type: 4-channel green recoding Permapaper. Width 10 inches (254 mm), grid 5 cm wide per channel with amplitude lines every 1 mm, 50 divisions full scale, time lines every 1 mm.

Paper take-up: front panel loading with front panel concealed paper take-up.

Paper footage indicator: indicates paper footage remaining on the supply roll, located on right side of recorder.

Power: 115 volts $\pm 10\%$, 60 Hz, approx. 180 watts (less preamplifiers); 115 volts $\pm 10\%$, 50 Hz, specify Option 08; 230 volts $\pm 10\%$, 50 Hz, specify Option 09.

Cooling: cabinet vented top and bottom for convection cooling. Temperature inside of cabinet should not exceed 40°C.

Dimensions: 7704B mobile cabinet mount: 72½" high, 22-1/16" wide, 30" deep (1841 x 560 x 762 mm); rack mount Option 01 — 28" high (rack mounting height), 19" wide, 20¾" deep maximum (711 x 483 x 527 mm). Option 02 — consult factory.

Weight: (typical) 4-channel recorder with 4 amplifiers in cabinet mount, viz. 7704B: net, 408 lbs (185 kg) less preamplifiers, shipping, 504 lbs (228,2 kg); rack mount Option 01: approx. net, 200 lbs (91 kg), shipping, 275 lbs (124,9 kg).

Accessories: 4-channel 5 cm wide channels (50 div), green coordinates, 200 ft. Permapaper roll (651-54-1), \$18.20 (consult local Hewlett-Packard sales office for quantity prices); 4-channel, translucent for contact reproductions, 200 ft. roll (651-184-1), \$29.10 (consult local Hewlett-Packard sales office for quantity prices); 398 Analog Stylus \$7.15; 411-10 Marker Stylus \$6.65.

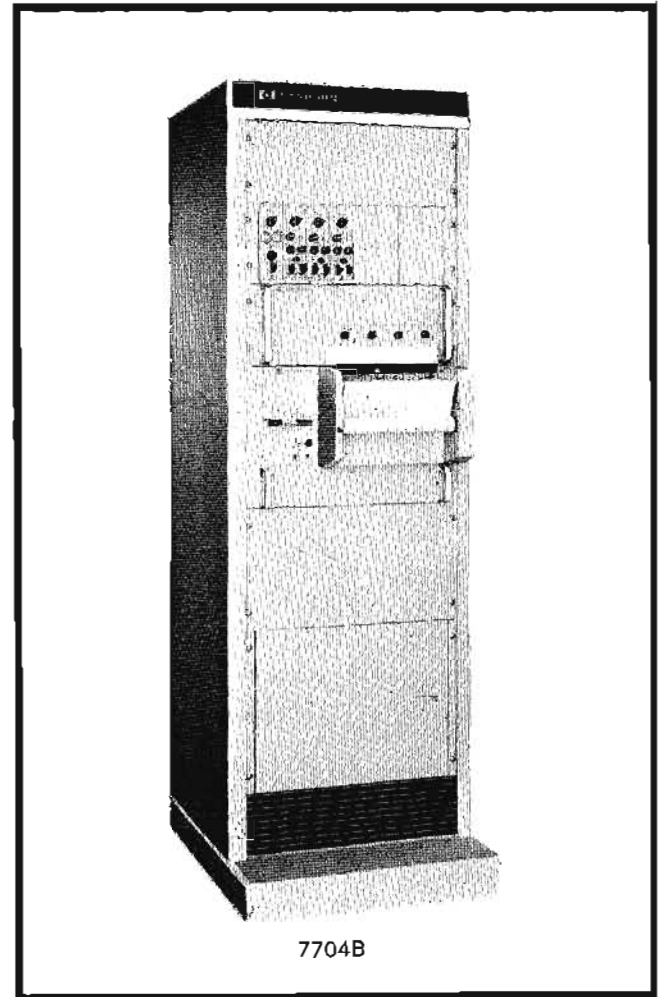

Optional accessory equipment: 608-100-C11 Extra Event Marker, \$70; 188AP DC Marker Driver Amplifier (produces over 1 mm Event Marker deflection with +1.5 volt, 0.5 mA signal input), \$80; 188APM DC Marker Driver Amplifier (produces over 1 mm Event Marker deflection with ± 1.5 volt, 0.5 mA signal input), \$108; Mobile System Cabinet, \$725.

Prices (Note 1): Sanborn 7704B, 4-channel Thermal Writing System, consisting of cabinet with master power control, power amplifiers and power supply, recorder assembly, preamplifier power supply, \$4020.

Option 01 (Note 1): less cabinet plus 1069-03A master power panel, \$3645.

Option 02: portable cases, consult factory.

Option 08: 115 volt, 50 Hz model, add \$50.

Option 09: 230 volt, 66A-10 Transformer installed in cabinet or loose (specify), add \$100.

Option 15: extra marker between channels 1, 2 (specify other locations), add \$70.

Note 1: add price of preamplifiers to the above basic assembly prices for complete system cost; see pages 150, 151, 153 for specifications and prices.

6- AND 8-CHANNEL SYSTEMS

Record 6 or 8 variables simultaneously

7700 Series



RECORDERS

Advantages:

- Extremely versatile input capacity
- Completely integrated: signal input to galvanometer
- Field-proved electronics, recorder
- True rectilinear inkless recording
- Clear resolution to 4 Hz/mm, 0.25 div non-linearity

Uses:

- Record 6 or 8 variables simultaneously
- Select the signal conditioners and system packaging best suited to the application

Hewlett-Packard 6- and 8-channel basic assemblies offer complete versatility for making accurate, permanent records of multiple variables simultaneously. These basic assemblies accept 6 or 8 channels of interchangeable preamplifiers designed to condition and control simple or complex signals. Variables appear as sharp, clean, permanent traces on Permapaper® charts (opaque, or translucent for copying). They can be analyzed independently, compared immediately with accurate timer pulses, or marked for identification, and stored for later use. Frequency response of the recorder is 0 to 125 Hz on 5 cm wide (6-channel) assemblies; 0 to 150 Hz on 4 cm wide (8-channel) assemblies. Rise time is 4 ms on 8-channel systems, 5 ms on 6-channel. The basic assemblies all use the same flush-front recorder with fully solid-state power amplifiers, which have adjustable electrical limiting over span from ± 12 divisions to beyond edge of chart coordinates to protect recorder syli accuracy, and feedback circuits to virtually eliminate drift. These systems also can be purchased in optional rack mounts and portable cases.

Compact plug-in 8800 Preamplifiers

For Models 7706B and 7708B systems the 8800 series of solid-state plug-in preamplifiers provide extreme versatility where up to eight channels of dissimilar information must be measured and recorded. Eight channels of 8800 Series Preamplifiers occupy only 7" by 19" of panel space.

Economical, multi-channel 8820A/21A Amplifiers

For Model 7727A and 7729A systems the 8820A and 8821A Amplifiers are ideal for applications where many channels of similar real-time or stored data must be monitored simultaneously and there is no need to change individual channels. Two dc 8-channel dc amplifiers are available in this series (see page 156). Each amplifier channel is complete from signal input to galvanometer output and all channels receive power from a single power supply. The 7727A and 7729A when combined with the 8820A, 8821A allow multiple channels of telemetry and computer outputs as well as a wide variety of relatively high level ac-dc outputs, with the versatility, simplicity and reliability required in multi-channel recording systems. Operation is simple—

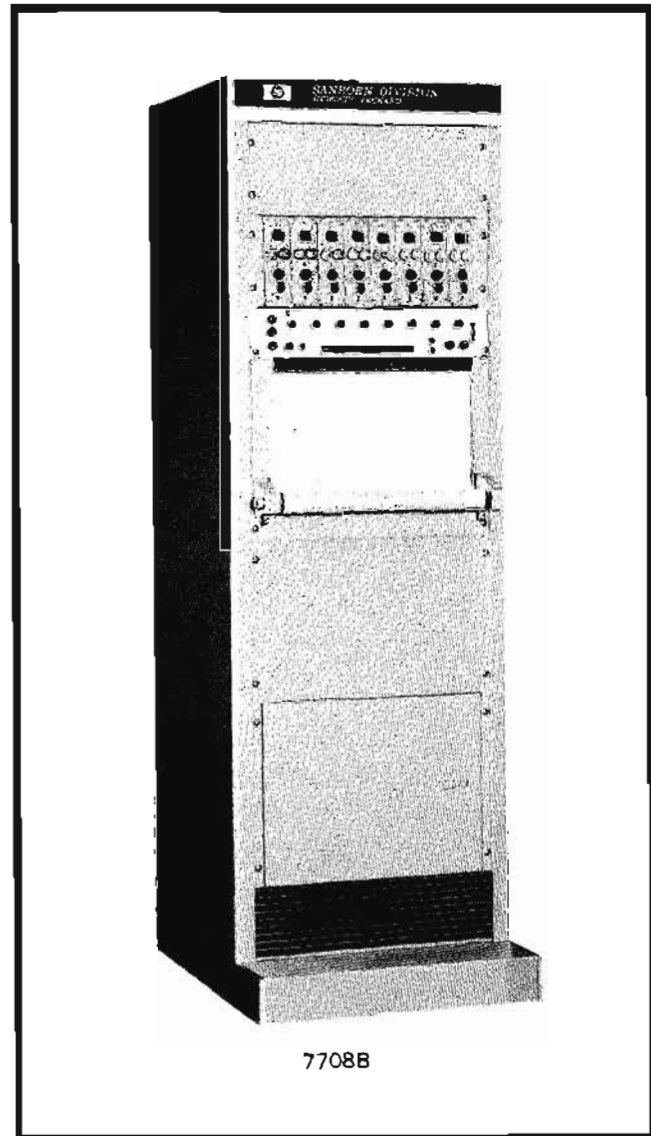

only four steps are required for operation once the system is turned on. The 8820A allows polarity for each channel to be changed by turning a switch.

Specifications (all models)

See page 154 for performance specifications with 8800 Series Plug-in Preamplifiers (systems 7706B, 7708B); see page 156 for performance specifications with multi-channel Amplifiers (systems 7727A, 7729A).

Paper speeds: standard recorders are supplied with 9 speeds: 0.25, 0.5, 1, 2.5, 5, 10, 25, 50 and 100 mm/s, electrically shifted and selected by front-panel pushbuttons; optional "D" version recorders have 9 additional speeds, 0.25, 0.5, 1, 2.5, 5, 10, 25, 50 and 100 mm/min; provision is made for optional remote operation of paper speeds and paper drive.

Event marker: right margin; built-in timer provides 1 sec timing marks; provision for manual or remote event marking from external contact closure; "D" version recorders provide 1 sec and 1 min timing markers; optional second event marker (Option 15) can be installed between channels #1 and #2 and actuated by external contacts; also, solid-state marker driver amplifiers for dc event marking are available (188AP, +dc input and 188APM, \pm dc input) and require 1.5 V at 0.5 mA at input to produce slightly over 1 mm deflection.

Front-panel controls: individual stylus heat controls; push-button speed selectors; motor starting switch; timer-off-marker switch.

Paper footage indicator: front-panel indicator shows number of feet remaining on the supply roll.

Paper length: standard roll 200 feet long; supply adapter (1069-05A) allows the use of special 1000 foot rolls: adapter requires 8 $\frac{3}{4}$ " (222 mm) of panel space.

Paper takeup: standard paper takeup (up to 275 feet) on front panel; concealed takeup (358-800-1) is available on option and occupies additional 8 $\frac{3}{4}$ " (222 mm) of panel space.

Power: recorder: 115 volts \pm 10%, 60 Hz, 230 watts; 115 or 230 volts, 50 Hz available on special order; systems: 7708A, 390 watts; 7728A, 515 watts.

Dimensions

7706B, 7708B: mobile cabinet mount: 72 $\frac{1}{2}$ " high, 22-1/16" wide, 30" deep (1841 x 560,4 x 762 mm); rack mount Option 01: (recorder) 17 $\frac{1}{2}$ " high, 19" wide, 24 $\frac{1}{8}$ " deep (445 x 483 x 613 mm); (amplifier) 7" high, 19" wide, 20 $\frac{1}{2}$ " deep (178 x 483 x 621 mm); portable cases Option 02: (recorder) 19 $\frac{3}{4}$ " high, 20" wide, 21 $\frac{1}{2}$ " deep (502 x 508 x 546 mm); (amplifier) 7-9/16" high, 22" wide, 21 $\frac{1}{2}$ " deep (193 x 559 x 546 mm).

7727A, 7729A: mobile cabinet mount: same as 7706B, 7708B; rack mount Option 01: (recorder) same as 7708B; (amplifier) 5 $\frac{1}{4}$ " high, 19" wide, 18" deep (133 x 483 x 457 mm).

Weight, typical (for all systems in cabinet): 8-channel recorder with 8 amplifiers in cabinet mount, viz. 7708B: net 590 lbs (265,5 kg), shipping 755 lbs (339,8 kg); rack mount Option 01: recorder, all systems: net 210 lbs (94,5 kg), shipping 250 lbs (112,5 kg); 8800 Preamplifiers (8): net 100 lbs (45 kg), shipping 120 lbs (54 kg), subtract 12 lbs (5,4 kg) for 6-channels; 8820A/21A Amplifier, viz. 7729A: net 85 lbs (38,3 kg), shipping 95 lbs (42,8 kg); 8820A/21A Amplifier, viz. 7727A:

no charge for 6 channels; portable cases Option 02: recorder, all systems: net 300 lbs (125 kg), shipping 340 lbs (153 kg); 8800, 8820A/21A Amplifiers viz. 7708B, 7729A: net 120 lbs (54 kg), shipping 140 lbs (63 kg).

Accessories: 8-channel, 4 cm (50 div), 200 ft Permapaper® roll 651-58, \$23.50; 6-channel, 5 cm (50 div) 651-57, \$21.80; (consult HP sales office for 1000 ft rolls and price for quantity purchases of 200 ft rolls); 399 Analog Writing Arm (8-channel), \$6.65; 398 Analog Writing Arm (6-channel) \$7.15; 411-3 Marker Arms (8-channel), \$6.65; 401-10 Marker Arms (6-channel), \$6.65.

Optional accessory equipment: 358-800-1 Concealed Paper Take-up, \$350; 1069-05A 1000 ft Supply Adapter, \$178; 608-100-C11 Extra Event Marker, \$70; 188AP Marker Driver Amplifier (+1.5 V dc input), \$80; 188APM Marker Driver Amplifier (\pm 1.5 V dc input), \$108; 358-1400 Recorder Carrying Case, \$250; 858-1400 (7706A, 7708A, 7728A) Amplifier Carrying Case, \$250.

Prices (Note 1): Model 7706B (6-channel cabinet assembly, less 8800 Amplifiers), \$4820; Model 7708B (8-channel cabinet assembly, less 8800 Amplifiers), \$5495; cabinet consists of master control panel, blower system preamplifier rack(s), recorder assembly with power amplifiers and power supply, and preamplifier power supplies; Model 7729A (8-channel cabinet assembly, less 8820A/21A Amplifier), \$4705; cabinet assembly consists of master control panel and cabling, 8-channel recorder; Model 7727A, same except six channels, \$4030.

Option 01: (all models) less cabinet. 7706B Option 01, \$4425; 7708B Option 01, \$5100; 7727A Option 01, \$3605; 7729A Option 01, \$4280.

Option 02: (all models) less cabinet, mounted in portable cases: 7706B Option 02, no extra charge; 7708B Option 02, no extra charge; 7727A Option 02, consult local HP office; 7729A Option 02, consult local HP office.

Option 08: (all models) 50 Hz operation, add \$50.

Option 09: 230-volt operation, add \$100.

Option 11: adds nine mm/min speeds, add \$250.

Option 15: extra marker between channels 1 and 2, specify other location, add \$70.

Note 1: add price of plug-in preamplifiers (for 7706B, 7708B) or multi-channel amplifiers (for 7727A, 7729A) to above prices for total system cost; see pages 150, 151, 154 for preamplifier specifications and prices; see page 156 for amplifiers.

1-CHANNEL PORTABLES

For medium-gain dc/ac or carrier measurements
Models 299A, 301



RECORDERS

These single-channel, 25 lb recorders are widely used by engineers and technicians for measuring and recording the results of equipment checkout and servicing, in the field and in the laboratory. They possess most of the features found in larger systems and produce high resolution traces on a 32 mm (40 div) wide channel. Four inches of chart

are displayed at all times for study and marking. Model 299A is very useful for medium-gain broad dc and ac measurements; 301 (with built-in excitation source) for carrier inputs from resistance bridges, variable reluctance devices, differential transformers and other ac transducers.

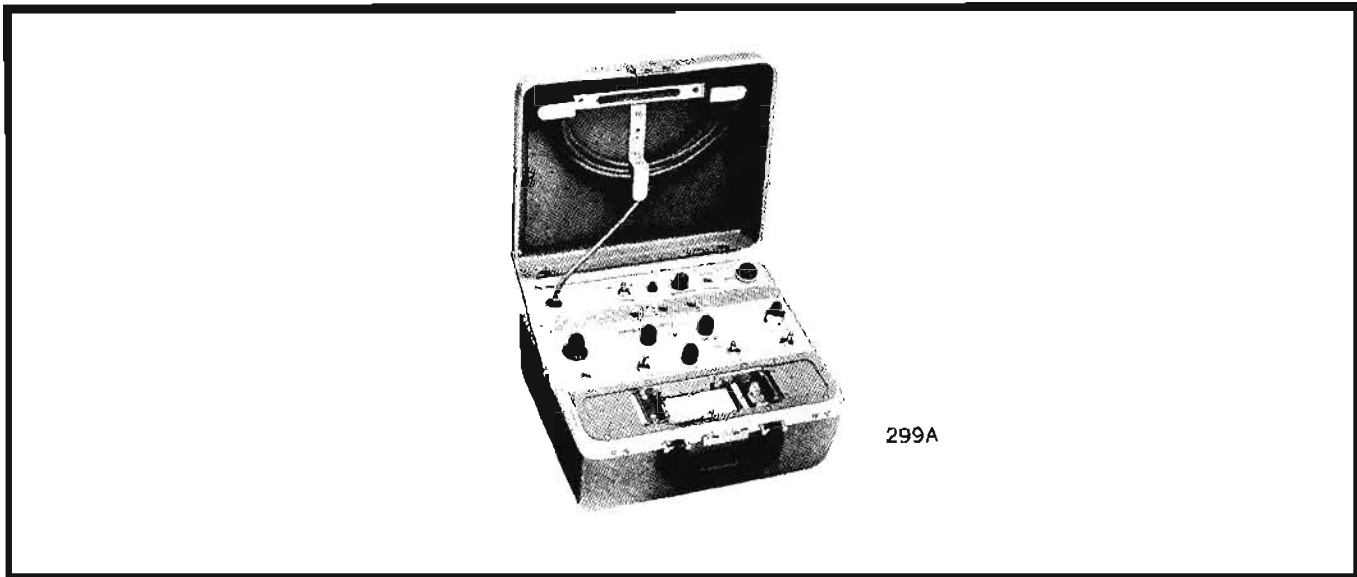

Specifications, single-channel*

Recorder model	Model 299A	Model 301†
Sensitivity (maximum)	10 mV rms/div (each div = 1/32")	10 μ V rms/div (each div = 1/32")
Sensitivity range (attenuation)	10, 20, 50, 100, 200, 500 mV/div and 1, 2, 5 and 10 V/div; attenuator error = 2% max.	X1, 2, 5, 10, 20, 50, 100 and 200 attenuation factors; attenuator error = 2% max.
Input circuit	5 megohms each side, balanced to ground	6000 ohms min. resistance, 13 K min. reactance—measured with full zero suppression and R & C balance; 7000 ohms resistance, 13 K reactance—with R & C balance control centered and zero suppression out; transducer impedance, 100 ohms min.
Common mode or quadrature rejection ratio	50:1 on most sensitive ranges; 25:1 on other ranges	quadrature rejection ratio is greater than 100 to 1
Common mode or quadrature voltage tolerance	\approx 2.5 V max. on most sensitive range, higher on other ranges to \approx 500 V max. 10X the differential signal which causes 25 div deflection up to 500 V max.	quadrature tolerance: quadrature rejection is in specification if input signal amplitude does not exceed 2X that of an inphase signal which causes stylus deflection from chart center to chart edge with zero suppression off.
Zero suppression	\approx 2 V max., from mercury cells, in series with output of input attenuator, and used for both single-ended and balanced inputs; corresponds to max. suppression of 10 times center of chart to either edge	5-step switch, center out, two positions for both positive and negative signal, each step equivalent to approx. 5 turns of R-Bal control
Frequency response (-3 dB max. at 10 div p-p) (-3 dB max. at full scale)	dc to 100 Hz dc to 50 Hz	dc to 100 Hz dc to 50 Hz
Zero drift Temperature, 0 to 50°C Line voltage variation, —103 to 127 volts Time	0.5 div/10°C 0.25 div 0.5 div/hr, 2 div/24 hrs	0.25 div/10°C 0.1 div
Noise (peak-to-peak max.)	0.1 div	0.25 div
Calibration (internal)	0.2 V, \approx 1%	40 μ V/excitation volt., \approx 1% (200 μ V/20 div deflection)

†Carrier frequency 2400 Hz, internally supplied; carrier voltage 4.5 to 5.5 V rms, not adjustable. *See page 145 for prices and options.

RECORDERS



2-CHANNEL PORTABLES

For recording dc or carrier variables

Models 320, 321, 322A

These complete recording systems are extremely useful in the field when two similar variables must be simultaneously analyzed and permanently recorded. They operate in any position, record signals on two 50-mm wide channels, have electrical limiting to protect recording styli and current feedback circuits to reduce drift. Model 320 has guarded and floating inputs designed for broad dc and ac signals even when complicated by excess noise due to ground loops. Model 322A has two general-purpose direct-coupled amplifier channels, each with calibrated zero suppression, which can be used for single-ended and balanced inputs. Model 321, with built-in 2400 Hz carrier excitation source, is designed to measure signals from resistance bridges, variable reluctance devices, differential transformers and other ac transducers.

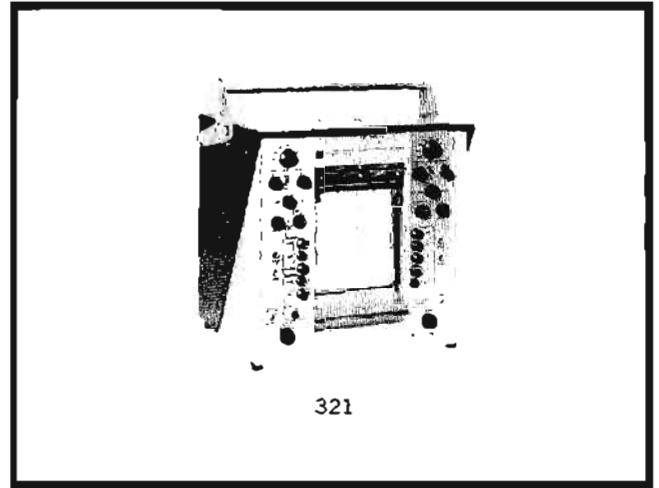

321

Specifications, dual-channel*

Recorder model	Model 320	Model 321†	Model 322A
Maximum sensitivity	0.5 mV/div (each div = 1 mm)	10 μ V/div (each div = 1 mm)	10 mV/div (each div = 1 mm)
Attenuation range	0.5, 1, 2, 5, 10, 20 mV/div and V/10 div; attenuator error \approx 2% max.	X1, 2, 5, 10, 20, 50, 100 and 200 attenuation factors; attenuator error \approx 2% max.	10, 20, 50, 100, 200, 500 mV/div and 1, 2, 5 and 10 V/div; attenuator error \approx 2% max.
Input circuit	0.5 megohm on mV/div and 1 megohm on V/10 div; floating and guarded with channel-to-channel isolation; dc source resistance should be below 10 K on mV ranges only	6000 ohms min. resistance, 13 K min. reactance, measured with full zero suppression and R & C balance; 7000 ohms resistance, 13 K reactance, with R & C balance control centered and zero suppression out; transducer impedance, 100 ohms min.	5 megohms each side balanced to ground
Common mode or quadrature rejection ratio	140 dB max. at dc; 120 dB min. at 60 Hz with no input unbalance; 100 dB min. at 60 Hz with 5000 ohms unbalance	Quadrature rejection ratio is greater than 100 to 1	50:1 on most sensitive range, 25:1 on other ranges
Common mode or quadrature voltage tolerance	\approx 500 volts max.	Quadrature tolerance: Quadrature rejection is in specification if input signal amplitude does not exceed 2X that of an inphase signal which causes stylus deflection from chart center to chart edge with zero suppression off.	\approx 2.5 volts max. on most sensitive ranges; higher on other attenuator positions to \approx 500 volts max.
Zero suppression	None	5-step switch, center out, two positions for both positive and negative signal, each step equivalent to approx. five turns of R-Bal controls	\approx 2.5 V max. from mercury cells, in series with output of input attenuator, and used for single-ended and balanced inputs; corresponds to max. suppression of ten times center of chart to either edge
Frequency response (-3 dB max. at 10 div p-p)	dc to 125 Hz	dc to 125 Hz	dc to 125 Hz
	dc to 50 Hz	dc to 50 Hz	dc to 50 Hz
Zero drift Temp., 0 to 50°C;	0.25 div/10°C	0.25 div/10°C	0.5 div/10°C
Line voltage variation, 103 to 127 V	0.1 div	0.1 div	0.25 div
Time	—	—	0.5 div/hr, 2 div/24 hrs
Noise (p-p max.)	0.25 div	0.25 div	0.1 div
Internal calibration	10 mV, \approx 2%	40 μ V/excitation volt, \approx 1% (200 μ V 20 div deflection)	0.2 volt \approx 1%

†Carrier frequency 2400 Hz, internally supplied; carrier voltage 4.5 to 5.5 V rms, not adjustable. *See page 145 for prices and options.

Specifications (1, 2-channel portables)

Gain stability: better than 1% to 50°C on all models; better than 1% for line voltage variations from 103 to 127 V ac, all models.

Non-linearity: 0.25 div. max. with respect to straight line through centerline and calibration point 20 div. from chart center, all models.

Response time: 5 msec, 10% to 90% with 4% or less overshoot over center ten divisions.

Paper speeds: single-channel 299A, 301: two speeds (5 and 50 mm/sec); dual-channel 320, 321, 322A: four speeds (1, 5, 20 and 100 mm/sec); other speeds are available on any model by option.

Channel width: single-channel models, 1.25" divided into 40 div, 1/32" apart; dual-channel models, 2" divided into 50 div, 1 mm apart.

Timer-marker: single-channel models have separate stylus for edge marking (60 Hz excitation); on dual-channel models, 1 second timers are internal and extra event marker can be added on special order; jacks are provided on all models for remote operation of marker coil by contact closure.

Input connectors: single-channel, 3-pin contact male connector on front panel; dual-channel models in portable cases have 3-pin contact male front-panel connectors, rear connectors when rack mounted (optional binding post adapters available).

Monitor output connectors: miniature phone jack on front panels provide approx. 40 mV div across min. external load of 100 k.

Electrical limiting: single-channel, approx. 125% of full scale; dual-channel, approx. 115% of full scale.

Power requirements: single-channel, 115 volts \pm 10% 60 Hz, 45 watts; dual-channel, 115 volts \pm 10% 60 Hz, 100 watts; 115-230 volts 50 Hz available in all models by option.

Dimensions: single-channel models: 7" high, 12" wide, 10½" deep (178 x 305 x 267 mm); dual-channel models in portable cases: 13¾" high, 14¼" wide, 9½" deep (349 x 361 x 241 mm); rack mounts: 14" high, 19" wide, 16" deep (356 x 483 x 406 mm); paper takeup 320-300 for dual-channel portable is 4¾" high, 14½" wide, 9½" deep (121 x 370 x 241 mm) and 320R-300 on rack mount adds only 5¼" (133 mm) to recorder height.

Weight, approx: single-channel models: net 22 lbs (10 kg), shipping 25 lbs (11.3 kg); dual-channel models: net 55 lbs (24 kg), shipping 66 lbs (29.7 kg).

Accessories: 1-channel: Permapaper®, 1¼" wide (40 div), 125 ft roll (651-202-1), \$4.60 ea (consule Hewlett-Packard sales office for quantity prices); 403A Analog Writing Stylus, \$6.65; 411-1 Marker Stylus, \$6.65; dual-channel: Permapaper (651-52-1) 5 cm (50 div), 200 ft roll, \$12.50; 398 Analog Writing Stylus, \$7.15; 4-11-10 Marker Stylus, \$6.65.

Optional accessory equipment: paper takeup 299-300 for single-channel 299A, 301, \$41; paper takeup 320-300 for dual-channel 320, 321, 322A (in portable cases) \$150; 320R-300

for dual-channel (rack mounts), \$175; binding post adapter (to make it easier to connect banana plugs, spade lugs, clip leads, bare wires, etc.): 299-200-C10 for 299A and 322A, \$10; 301-200-C11 for 301, \$9; 320-100-C31 for 320 and 321, \$11 extra marker 462-189 (center-margin) for dual-channel models, \$76.

Prices: 299A Single Channel DC Recorder, \$800.
301 Single Channel Carrier Recorder, \$850.

Options:

02 (301 only):	add harmonic filter, required with 267/268 transducers	n/c
08:	115/230 volt 50 Hz,	add \$ 25.
12:	60 Hz, speeds 2.5 and 25 mm/s,	add \$ 50.
13:	50 Hz, speeds 2.5 and 25 mm/s,	add \$ 50.
16:	60 Hz, speeds 10 and 100 mm/s,	add \$150.
17:	50 Hz, speeds 10 and 100 mm/s,	add \$150.
18:	60 Hz, speeds 1 and 10 mm/s,	add \$135.
19:	50 Hz, speeds 1 and 10 mm/s,	add \$135.
20:	60 Hz, speeds 0.5 and 5 mm/s,	add \$135.
21:	50 Hz, speeds 0.5 and 5 mm/s,	add \$135.
22:	60 Hz, speeds 5 and 50 mm/min.	add \$150.

Prices: 320 Two Channel DC Amplifier-Recorder, \$1950
321 Two Channel Carrier Amplifier Recorder, \$1950.
322A Two Channel DC Coupling Recorder, \$1750.

Options:

01 (321 only):	adds harmonic filter, required with 267/268 transducers,	n/c
02 (322A only):	adds zero suppression both channels,	add \$100.
03:	rack mount,	add \$150.
08:	115/230 volt, 50 Hz,	add \$ 25.
12:	60 Hz, speeds 2.5, 5, 25, 50 mm/s,	n/c
13:	50 Hz, speeds 2.5, 5, 25, 50 mm/s,	n/c
15:	462-189 extra marker,	add \$ 76.
16:	60 Hz, speeds 2, 10, 40, 200 mm/s,	add \$125.
17:	50 Hz, speeds 2, 10, 40, 200 mm/s,	add \$125.
18:	60 Hz, speeds 0.5, 2.5, 10, 50 mm/s,	add \$175.
19:	50 Hz, speeds 0.5, 2.5, 10, 50 mm/s,	add \$175.
20:	60 Hz, speeds 0.1, 0.5, 2, 10 mm/s,	add \$195.
21:	50 Hz, speeds 0.1, 0.5, 2, 10 mm/s,	add \$195.
22:	60 Hz, speeds 1, 5, 20, 100 mm/min.,	add \$175.
23:	50 Hz, speeds 1, 5, 20, 100 mm/min.,	add \$175.

Model 53 Battery Converter

This handy accessory is a portable, stable source of ac power that will operate single- and dual-channel recorders in most field applications. It will supply 128 volts, 60 Hz at 125 watts continuously for 2 hours, and with a 35 watt load, battery life between charges is 7 hours. Model 53 is a combination charger/converter/storage battery packed in a flameproof carrying case 9" high, 14" wide, 5" deep (246 x 372 x 137 mm). Weight 30 lbs (6.7 kg). Model 53, without battery, 115 V 60 Hz output, \$225.

Option 01: with battery (acid not furnished), \$271.

Option 02: 115 V 50 Hz output, add \$10.



FLUID PROCESS RECORDER

New system records on Z-fold paper or rolls
7800 Series

Features:

- Reliable, inexpensive, non-smear, non-splatter, non-clog rectilinear writing
- Sharp, high-resolution, consistent traces from dc to 160 Hz
- Easily reproducible recording by inexpensive means
- Eight plug-in solid state signal conditioners to choose from
- Numbered Z-fold chart for convenient access to entire record

Uses:

- Accurate, permanent recording of up to 8 variables from a wide range of inputs

The 7800 Series are integrated, 8-channel rectilinear fluid-process recording systems designed to deliver greater accuracy than present-day recorders. The recorder has a self-contained power supply and modular type solid-state electronics. The chart viewing area is $15\frac{5}{8}$ " wide with a length of ten inches. Its low-pressure fluid feed system produces ultra-clear traces throughout the recorder's electrically-controlled speed range—from .025 to 200 millimeters per second. The paper chart moves from top to bottom from an internal supply and take-up roll or from an internal Z-fold paper supply. A wide selection of amplifiers and preamplifiers provide signal conditioning to the driver-amplifiers which drive the recording pens of the multi-channel recorder. Front panel pushbuttons assure ease of operation. The frequency response of the recorder is 160 Hz for 10 div p-p deflection and 50 Hertz maximum for full scale deflection. Maximum ac or dc non-linearity is less than ± 0.25 divisions.

System components

The 7858A system consists of: "8800" Series Preamplifiers, as ordered; 8-channel position-feedback fluid-process recorder; Preamplifier Power Supply; Cabinet.

The 7878A system uses an 8820A or 8821A Amplifier in place of plug-in Preamplifiers with their Power Supply; Recorder and Cabinet are the same as in the 7858A system.

Option 01 (all models) omits the cabinet; option 02 (all models) mounts the system in portable cases.

System characteristics

See page 155 for performance specifications with 8800 Series Plug-in Preamplifiers (system 7858A); see page 156 for performance specifications with multi-channel amplifiers (system 7878A).

System power: 115 volts $\pm 10\%$, 60 Hertz, 600 watts. Other voltages and frequencies on option.

Size: $72\frac{5}{8}$ " high, $27\frac{7}{8}$ " wide, $35\frac{3}{4}$ " deep (1844 x 606 x 906 mm). Option 01 uses only $24\frac{1}{2}$ " (632 mm) panel height.

Option 02 uses Recorder Carrying Case 20" high, $19\frac{3}{4}$ " wide, $21\frac{1}{2}$ " deep (508 x 502 x 546), plus Amplifier Carrying Case 22", high, $7\text{-}9/16$ " wide, $21\frac{1}{2}$ " deep (762 x 195 x 546).

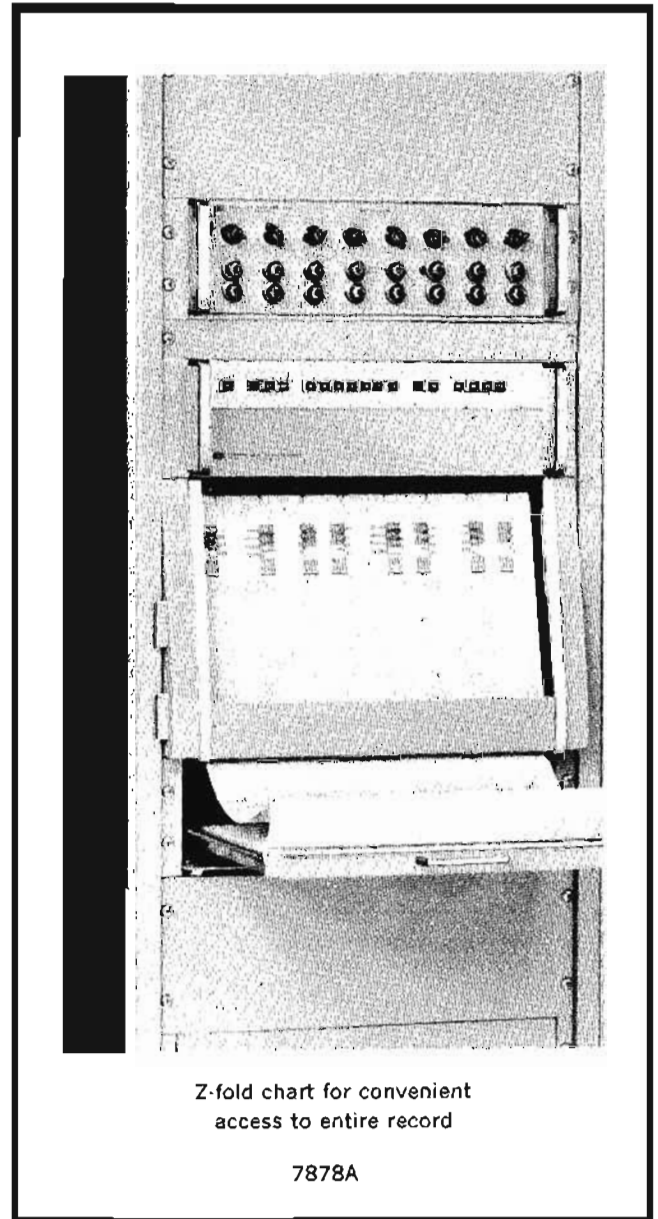

Z-fold chart for convenient access to entire record

7878A

Weight: approx. 550 lbs (249 kg) including Amplifier or Preamplifiers and Cabinet or Carrying Case. Exact weight depends on equipment selected.

Portability: four large casters permit moving standard system as needed. Carrying Case Option 02 permits moving system to site of field measurements.

Cooling: cabinet vented top and bottom for natural air ventilation. Maximum ambient temperature outside case must not exceed 40°C.

Environment: system is designed to operate reliably in any location reasonably free from vibration, dust, corrosive or explosive gases or vapors, extremes of temperature, etc.

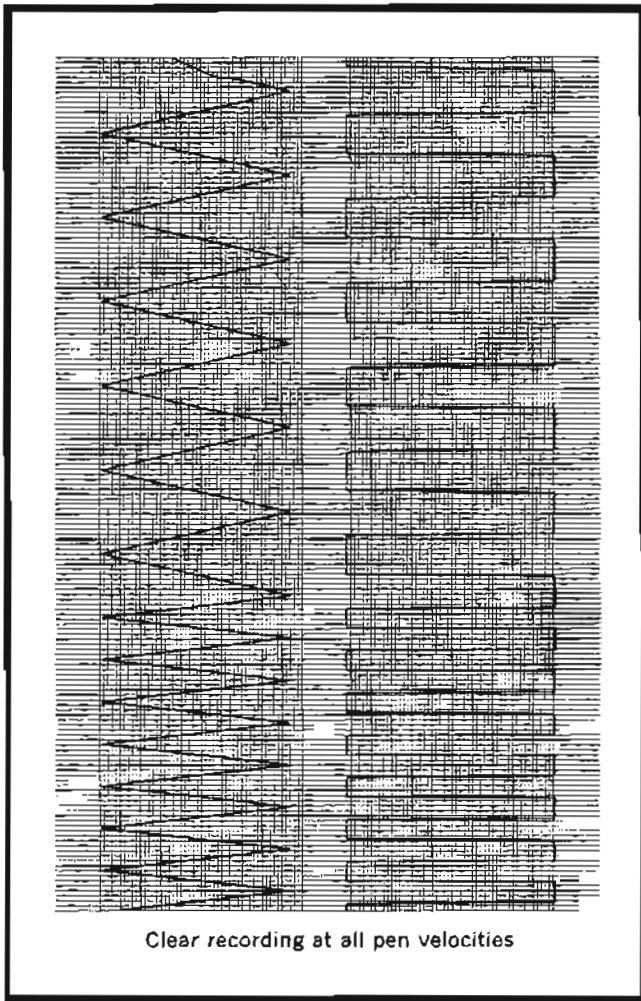

Clear recording at all pen velocities

Component description

Fluid-process recorder: the recorder displays the system read-out data on a multi-channel recording chart. The illuminated recording is visible as soon as it is made, with the most recent ten inches remaining in view at all times. The recording process provides instantaneous, permanent, inked recording in rectilinear coordinates on HP Fluid Process Recording Charts.

The recorder features include: 14 electrically-controlled chart speeds, selected by pushbuttons on the front panel; built-in paper take-up; low fluid supply warning light; plug-in fluid supply cartridge that may be replaced while recorder continues to operate; simple paper loading from the front and regulated modulated-pressure fluid system. The Take-Up Drawer for Z-fold paper is standard. The recorder also has enclosed individual moving coil penmotors with adjustable electrical damping and limiting; contactless pen tip position feedback; provision for remote control of paper drive, paper speeds and markers; and a signal for low fluid or end of roll is indicated on front panel and brought out to a remote connector.

Driver amplifier: one driver amplifier is provided for each recording penmotor. The combination of driver-amplifier and penmotor simulate the characteristics of a simple galvanometer with 71% of critical damping, with negative velocity-voltage feedback from the galvanometer damping control, in conjunction with the position feedback circuit.

Driver amplifier and recorder power supply: the Power Supply provides operating power for up to eight Driver Amplifier modules. Power is also supplied for all recording functions and is integral with recorder.

Recorder specifications including driver amps

Frequency response: 160 Hz for 10 div p-p deflection or 50 Hz maximum for full scale deflection.

Response time: from 10% to 90% amplitude—

Total Deflection	Response Time
10 chart divisions	3 milliseconds
25 chart divisions	4 milliseconds
50 chart divisions	6 milliseconds

Drift: less than 1/10th chart division over temperature range from 20°C to 50°C and for line voltage variation of $\pm 10\%$.

Gain stability: 0.1 div. from 20°C to 55°C and over line voltage range of $\pm 10\%$.

Sensitivity: ± 2.5 volts full scale (4 cm channel width).

Hysteresis: previous signals do not affect recorded data by more than 0.25 divisions.

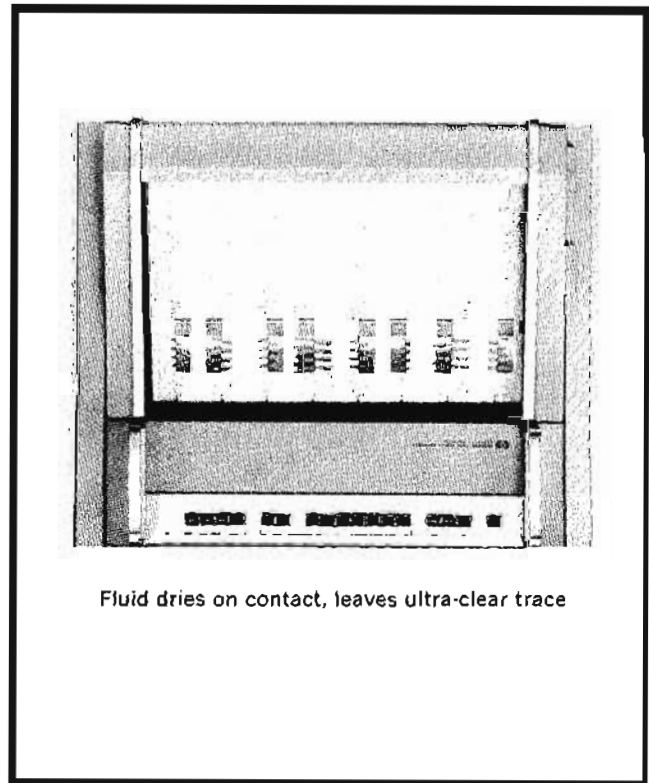

Fluid dries on contact, leaves ultra-clear trace

Penmotor: one per recording channel, high-torque, moving coil drive. Single-ended drive coil plus a velocity-voltage feedback winding. Drive coil winding approximately 16 ohms and velocity coil approximately 35 ohms at room temperature. Sensitivity is approximately 16 mA/div.

Limiting: electrical limiting separately adjustable from ± 12 div. to 2 div. beyond full scale. Mechanical stops set beyond 2 divisions.

Noise: less than 0.1 div. p-p, with driver input shorted.

FLUID PROCESS RECORDER *continued*

New system records on Z-fold paper or rolls
7800 Series

Chart: 500 ft. rolls 15 $\frac{5}{8}$ " wide, 4 cm, 50-division channel width rectilinear coordinate paper. Also available in 500 sheet folded pack 11.9" x 15 $\frac{5}{8}$ ".

Chart speed: 14 speeds selected by seven pushbutton switches in conjunction with 1x and 100x pushbuttons. A remote pushbutton transfers all speeds and OFF-ON functions to a remote station and also provides a voltage which can be used to indicate remote readiness. Speeds: .025, .05, .10, .25, .50, 1.0, 2.0, 2.5, 5, 10, 25, 50, 100 and 200 mm/sec.

Paper take-up: internal roll. Accessible by pivoting the writing table down from the top. Z-fold drawer is below recorder.

Trace width: recorded trace .010" wide. Base lines up to .020" wide during standby or for very slow chart speeds.

Fluid system: pressurized in proportion to the instantaneous velocity of the pen tip. Five-ounce supply is capable of writing 1000 miles of line.

Fluid: permanent, non-smudging and dries on contact with Hewlett-Packard Fluid-Process Recording Paper.

Stylus: stainless steel tubular stylus supported by a light-weight frame containing a sensing element for position sensing. Design life: over 40,000,000 full scale cycles.

Timer/marker: left margin marker provides timing pulse every minute or every second. Right margin marker provides positive deflection for event marking. Provision is made for markers between each channel.

Remote operation: connector provided for remote operation of chart drive, selection of chart speeds and operation of timer/markers.

Recorder size: 17 $\frac{1}{2}$ " high, 19" wide, 23" deep (444 x 482 x 585 mm). (Including power supply and driver amps.)

Weight: approximately 170 lbs (77,1 kg).

Power requirements: 115 volts, 60 Hertz, 500 watts including Driver Amplifiers and Power Supply with synchronous motor chart drive.

Fuses: protection is provided for the galvanometers, driver amplifiers, power supply and drive motor. Failure in any channel will not affect operation of the other channels. Fuses for the line, power supply and drive motor are accessible when the recorder is extended.

Mounting: on latch slide and frame assembly. Recorder locks in normal or extended positions.

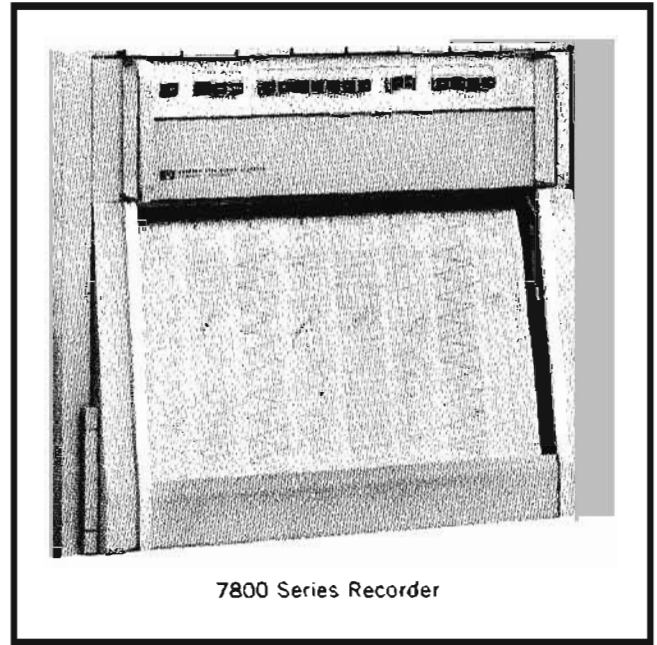

7800 Series Recorder

Plug-in preamplifier description

The "8800" Series Preamplifiers (used in 7858A system) are compact, solid-state modules which plug into the system from the front to mate with the Preamplifier Power Supply. All connections to the Preamplifier are made at the Power Supply rear, although preamplifier outputs may be monitored from the front panel. AC excitation voltages are supplied to the Preamplifier as needed from plug-in oscillator circuit cards in the Power Supply. Preamplifier characteristics are shown on pages 150, 151, 155.

Multi-channel amplifier description

The 8820A and 8821A Amplifiers (used in the 7878A system) provide identical, multiple channels of amplification with a single panel which mounts separate, identical controls for each channel. All operating power, including ac excitation voltages, are generated within the amplifier. Amplifier characteristics are shown on page 156.

Prices:

Model 7858A, 115 V, 60 Hz, uses 8800 Series Preamplifiers, \$9750 without Preamps. Model 7878A, same except use 8820A or 8821A Amplifier, \$8700 without Amplifier. Option 01 (all models), less cabinet, deduct \$425. Option 02 (all models), in portable cases, no extra charge. Option 08 (all models), 50 Hz operation, add \$50. Option 09 (all models), 230 volt operation, add \$150.

Note 1: Add price of plug-in Preamplifiers (for 7858A) or multi-channel amplifier (for 7878A) to above prices for total system cost. See pages 150, 151, 155 for Preamplifier specifications and prices; see page 156 for Amplifiers.

OPTICAL RECORDER

For high-frequency, high-speed applications
4500 Series



RECORDERS

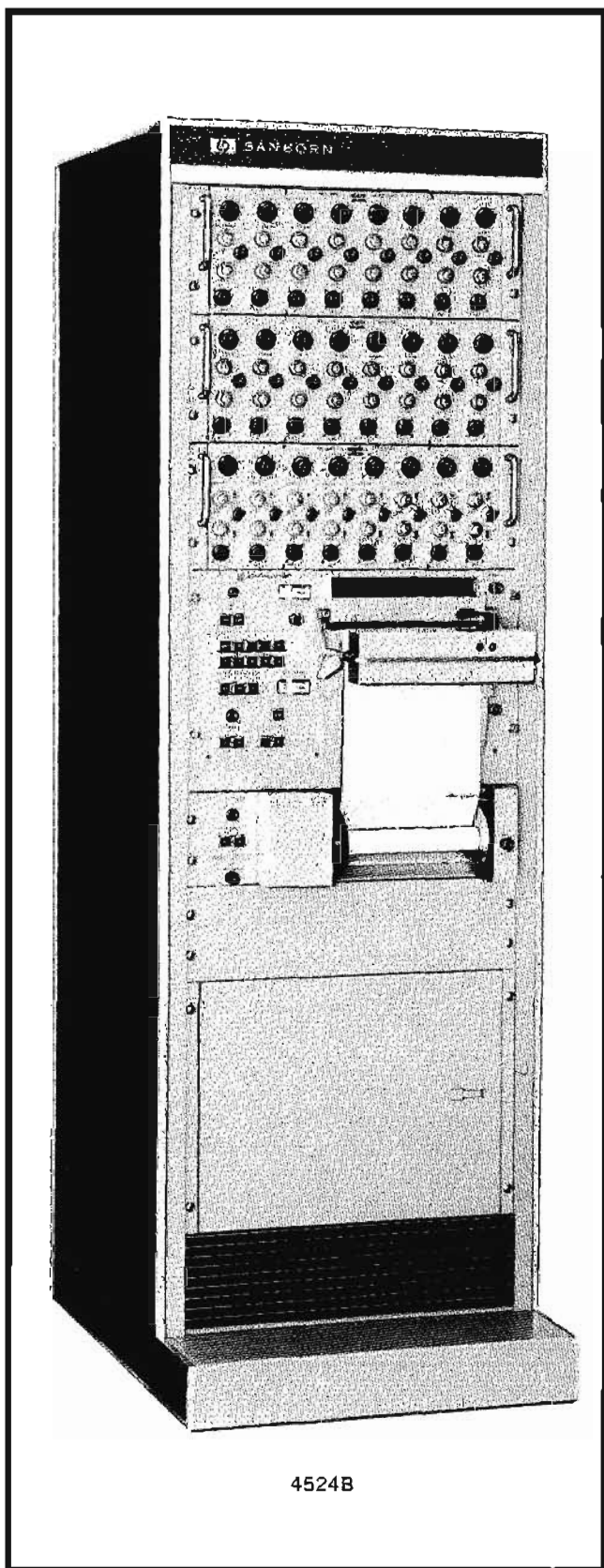

Advantages:

- Up to 25 channels
- One basic galvanometer for all frequencies
- Internal calibration
- Galvanometer protected by current limiting
- DC to 5 kHz (-3 dB) at 4" p-p deflection
- Individual multi-position attenuator in each channel
- Trace positioned electrically anywhere on chart

Uses:

- Telemetry recording
- 400-cycle power measurements
- Transients measurements
- Measuring data sampled at high pulse rates

The HP 4500 Optical Recorder is a completely integrated system for high-speed, permanent recordings of multiple variables, in the dc-5 kHz range. Recordings are made at any of nine speeds (0.25 to 100 mm/s) on ultraviolet sensitive paper, and promptly developed under an attached development lamp. Nine chart speeds together with time and amplitude lines recorded along with the data provide a high order of recording accuracy and convenience. Systems may use 650 Series Amplifiers (4508B, 4524B), or 8800 Series Preamplifiers (special order) or combinations. The 650 Series Amplifiers are available with maximum sensitivities of 2.5, 50, and 625 mV/in, with and without zero suppression. Each 650 Series Amplifier consists of eight identical modular channels of electronics, with a common power supply. Twenty-four channel systems are driven by three 8-channel amplifiers.

Additional features include: full-width timing lines (0.01 and 0.1 s), amplitude lines (removable over part or all of the recording), sequential light beam interruption for trace identification, event marker, a lamp power control and meter, and a meter to indicate remaining paper footage. Special frequency boost and compensation circuits extend the frequency response of 2 kHz galvanometers to a 5 kHz range (-3 dB). Current feedback in the matching network between amplifier and galvanometer stabilizes frequency response of galvanometers over a wide frequency range. Other natural frequency galvanometers may be obtained (special order) to be driven directly by the user.

Dimensions: in vertical mobile cabinet, 72-1/2" high x 22-1/16" wide x 30" deep (841 x 560, 4 x 762 mm).

Weight: in vertical mobile cabinet, net 554 lbs (247,5 kg), shipping 650 lbs (202,5 kg).

Prices:

4508B UV Recording System, 8 channels, 115 V 60 Hz, for 650 Amplifiers, less amplifiers, galvanometers, \$4200.

4524B UV Recording System, 24 channels, 115 V 60 Hz, for 650 Amplifiers, less amplifiers, galvanometers, \$4400.

Option 01 (both models) less cabinet, deduct \$475.

Option 02 (both models) portable case, deduct \$240.

Option 09 (both models) 230 V operation, add \$100.

650-900 paper take-up, \$900.

Note 1: add price of amplifiers and galvanometers (1120-1296, \$126 ea.) to above prices for total system cost; see page 157 for amplifier specifications and prices.



PREAMPLIFIERS

Plug in signal conditioners for recording
8800 Series

Specifications

Pre-amplifier type	Features	Maximum calibrated sensitivity & maximum full scale input	Sensitivity ranges	Input circuit and input frequency range
8801A Low Gain DC	Differential inputs; 5 mV/div sensitivity; calibrated zero suppression; internal calibration source; wide attenuation range	5 mV/div (gain, 20) 250 volts	5, 10, 20, 50, 100, 200, 500, 1000, 2000 and 5000 mV/div; accuracy = 1%	Resistance 500 k ohms \pm 1% each side balanced to ground; in parallel with approx. 100 pF DC to 10 kHz
8802A Med. Gain DC	Differential inputs; 1 mV/div sensitivity; calibrated zero suppression; internal calibration source; wide attenuation range	1 mV/div (gain, 100) 50 volts	1, 2, 5, 10, 20, 50, 100, 200, 500, and 1000 mV/div; accuracy = 1%	Resistance 180 k ohms \pm 1% each side balanced to ground, in parallel with approx. 100 pF DC to 10 kHz
8803A High Gain DC	High sensitivity, 1 μ V/div; low drift chopper amplifier circuit; guarded floating input; high input impedance; calibrated zero suppression up to 2000X full scale; internal calibration source	1 μ V/div (gain, 100,000) 250 volts	1, 2, 5, 10, 20, 50, 100, 200, 500, 1000, 2000 and 5000 μ V/div; 10, 20, 50, 100, 200, 500, 1000, 2000 and 5000 mV/div; accuracy = 1% on 5000 μ V/div to 20 μ V/div ranges, = 2% on 10 μ V/div to 1 μ V/div; accuracy of X 1000 attenuator = 1%	1 megohm min on microvolt range, independent of gain; 5 megohms on millivolt range; floating and guarded DC to 110 Hz
8805A Carrier	Calibrated zero suppression; calibration factor control; high ac-dc gain, 10 μ V/div sensitivity; internal transducer excitation drive	10 μ V rms/div (gain, 10,000 rms ac to dc) 100 mV rms	X 1, 2, 5, 10, 20, 50 100 and 200; attenuation accuracy = 2%	Approx. 10 k ohms; single ended transducer impedance; 5 k ohm max., 100 ohms minimum 2400 Hz carrier standard
8806B Phase Sens. Demod.	50 Hz to 40 kHz carrier (reference) frequency range; plug-in adjustable phase shift modules for optimum quadrature rejection; broad-band plug-in, 50 Hz to 40 Hz has uncalibrated phase shifter single-carrier-frequency plug-ins have calibrated phase shifter; high impedance, transformer— isolated, signal and reference inputs	0.5 mV rms/div, (gain, 200 rms ac to dc) 25 volts rms	Signal input: 0.5, 1, 2, 5, 10, 20, 50, 100, 200 and 500 mV rms/div; = 1%, 50 Hz to 10 kHz = 2%, 10 kHz to 20 kHz; = 3%, 20 kHz to 40 kHz Reference voltage: 3-133 volts rms in two overlapping ranges, internal range switch	Signal input: transformer isolated, floating and guarded; resistance approx. 1 megohm Reference input: differential, transformer coupled; resistance approx. 500 k ohms each side to ground, may be used single ended 50 Hz to 40 kHz in bands with uncalibrated plug-in; 60 Hz, 400 Hz and 5 kHz calibrated phase shift plug-ins; special order phase shift plug-ins 50 Hz to 40 kHz
8807A AC/DC Conv.	Fast envelope response time; calibrated zero suppression; scale expansion for 0.02% resolution; floating and guarded 1 megohm input; internal calibration source	1 mV rms/div (gain, 100 rms ac to dc) 20 mV rms/div with X1 scale expansion 500 volts rms	0.02, 0.05, 0.1, 0.2, 0.5, 1, 2, 5, and 10 volts rms/div, = 2% (midband) scale expansion: X1, X2, X5, X10, and X20, = 2%	Approx. 1 megohm resistive in parallel with 10 pF and stray cable capacitance; floating and guarded Standard model: 330 Hz to 100 kHz; option 01: 50 Hz to 100 kHz
8808A Log Level	100 dB and 50 dB detection spans; = 1 dB detection accuracy; thirteen ranges; 100 μ V maximum sensitivity (bottom scale); internal calibration source	100 μ V rms sine wave corresponds to bottom scale output, -80 dB below 1 volt 320 volts rms	50 dB span: bottom scale at -80, -70, -60, -50, -40, -20, -10 and 0 dB below 1 volt (i.e., 100 μ V, 320 μ V, 1, 3.2, 10, 32, 100, 320 mV and 1 volt) 100 dB span: bottom scale at -80, -70, -60 and -50 dB below 1 volt	Single ended, resistance 1 megohm min. 5 Hz to 100 kHz for less than 3 dB down from mid-band level on "slow" response range; 500 Hz to 100 kHz on "fast" response range
8809A Spec. Purpose DC	Switch selected input impedance; 0 to 1 mA into 1.5 k ohm input impedance for edge-to-edge chart deflection; full scale positioning; internal calibration source	30 mV/div (gain, 3.33) 0 to +2.5 V or 0 to -2.5 V	Continuously adjustable from 20 to 50 mV/div	Switch selected: 1500 ohms \pm 2% or 100 k ohms min, incremental; single ended (floating in 7701A only) DC to 5 kHz

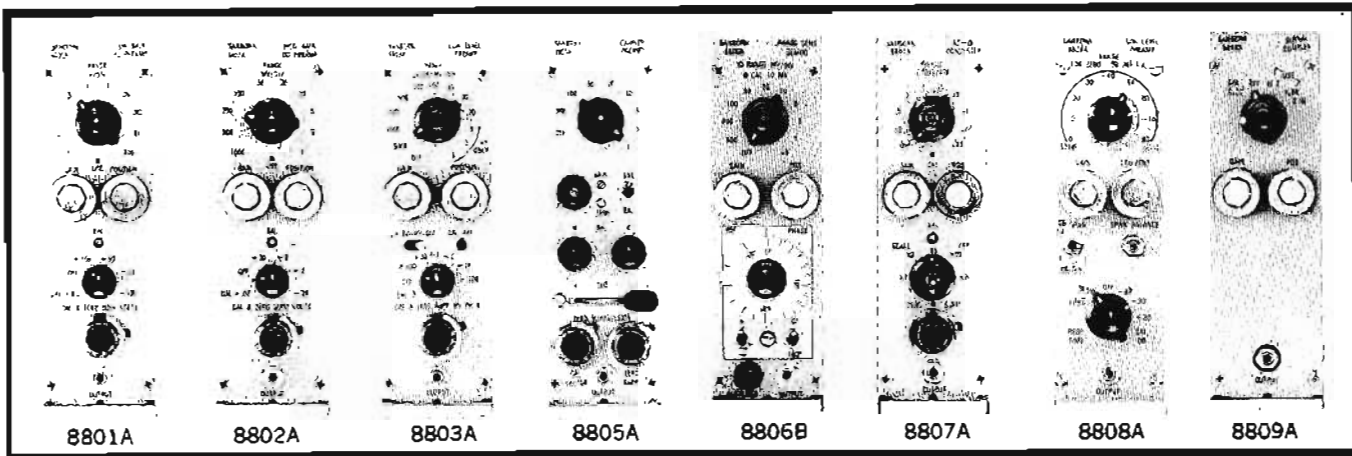

Pre-amplifier type	Zero suppression	Calibration (referred to input)	Common mode rejection and tolerance	Price
8801A Low gain dc	± 10 and ± 100 volts for single-ended or differential signals; 10-turn potentiometer sets precise values of zero suppression voltages, ± 50 volts max suppression on 5, 10, 20 mV/div ranges; max error of suppression: $\pm 0.5\%$ of suppression range and 1% of indicated suppression	100 mV, $\pm 1\%$ internal	48 dB min dc to 150 Hz; ± 50 volts on 5, 10, 20 mV/div ranges; ± 500 volt max on other ranges for less than $\pm 1\%$ change in differential sensitivity	8801A, \$275 Opt. 1, bench-top add \$310
8802A Med. gain dc	± 2 volts and ± 20 volts for single-ended or differential signals; 10-turn potentiometer sets precise values of zero suppression voltages; ± 12.5 volts max suppression on 1, 2, 5 mV/div ranges; max error of suppression: $\pm 0.5\%$ of suppression range and 1% of indicated suppression	20 mV, $\pm 1\%$ internal	48 dB min dc to 60 Hz, 1000 mV/div range; 48 dB min dc to 150 Hz all other ranges; $\pm 12\frac{1}{2}$ volts on 1, 2, 5 mV/div ranges; ± 125 volts on 10, 20, 50 mV/div ranges; ± 500 volts max other ranges for less than $\pm 1\%$ change in differential sensitivity	8802A, \$325 Opt. 01, bench-top add \$310
8803A High gain dc	μ V ranges: ± 1 , ± 10 , ± 100 mV; mV ranges: ± 1 , ± 10 , ± 100 volts; 10-turn potentiometer sets precise values of zero suppression voltages; accuracy $\pm 1\%$ of full scale	200 μ V $\pm 1\%$ internal on μ V/div range 200 mV $\pm 1\%$ internal on mV/div range	μ V range, max source unbalance of 1 k ohms: 160 dB min at dc, 120 dB min at 60 Hz; mV range, max source unbalance of 500 k ohms: 100 dB min at dc, 60 dB min at 60 Hz DC: 300 V peak; 60 Hz: 1 μ V/div, 10 V rms; 2 μ V/div, 20 V rms; 5 μ V/div, 50 V rms; 10 μ V/div and 10 mV/div, 100 V rms; 20 μ V to 5000 μ V/div and 20 mV to 5000 mV/div, 220 V rms	8803A, \$695 Opt. 01, bench-top add \$325
8805A Carrier	0-100% of transducer full load rating, 10-turn potentiometer with calibrated dial; accuracy: one dial division $\pm 0.5\%$ of full scale	2% $\pm 0.02\%$ of transducer full scale output; CAL signal in μ V may be read from the CAL factor dial	Quadrature rejection and tolerance: greater than 40 dB; tolerance: error less than $\pm 2\%$ full scale when quadrature voltage is equal to twice in-phase signal required for full output	8805A, \$400 Opt. 01, bench-top add \$325 Opt 02, harmonic filter add \$30
8806B Phase sens. demod.	No zero suppression; phase shift plugs allow control of reference phase over 360°; fixed frequency: 0° - 90° dial, 2° graduations; any one of four quadrants by panel switches; dial accuracy within $\pm 1^\circ$ at standard frequencies; variable frequency: continuous adjustment through 360°	1 volt rms internal at carrier reference frequency; $\pm 1\%$ 50 Hz to 10 kHz; $\pm 2\%$ 10 kHz to 20 kHz; $\pm 3\%$ 20 kHz to 40 kHz	Common mode: greater than 40 dB up to 10 kHz; 500 V rms, max; quadrature tolerance: equal to the amplitude of a full scale in-phase signal	8806B, \$495 Opt 01, bench-top add \$310 Opt 02 50 Hz - 40 kHz add \$175 Opt 03, 60 Hz add \$125 Opt 04, 400 Hz add \$125 Opt 05, 5 kHz add \$125
8807A ac/dc conv.	Zero suppression: up to 100% of full scale on any range can be suppressed; 10-turn potentiometer with calibrated dial; scale expansion: 5, 10, 20, or 50% of full scale can be expanded to cover full chart	1 volt internal $\pm 1\%$; approximately 500 Hz	60 dB min at 60 Hz; 40 dB min at 400 Hz with up to 10 k source unbalance; ± 500 volts peak	8807A 400 Hz - 100 kHz \$700 Opt 01 50 Hz - 100 kHz no extra charge Opt 02, dc no extra charge Opt 03, bench-top add \$310
8808A Log level	None	Internal -80, -30 and +20 dB V; dB V referred to 1 volt (100 μ V, 32 mV and 10 V full scale)	None	8808A, \$625
8809A	None	600 mV $\pm 2\%$, internal	50,000:1 at dc; ± 50 volts max (7701A, B only)	8809A, \$110

Preamplifier/Model 7701B Recorder System Specifications
(Specifications apply only when Permapaper® is used)

Pre-amplifier type	Output linearity (less trace width)	Output noise max (less trace width)	Output frequency response (10 cm) do to less than 3 dB down at	Risetime (10 div, 10-90% 4% overshoot)	Gain stability 20° to 40°C, 103 to 127 volts	Zero drift (less trace width) 20° to 40°C, 103 to 127 volts
8801A Low gain dc	0.25 div after setting mechanical zero of stylus within ± 1 div of chart center and calibrating for zero error at center scale and ± 20 div	0.2 div p-p	30 Hz	20 ms	Temp: 0.35%/10°C Line voltage: 0.6%	Temp: 1.25 div/10°C; 0.5 div/8 hr, constant ambient Line voltage: 0.35 div
8802A Med gain dc	0.25 div after setting mechanical zero of stylus within ± 1 div of chart center and calibrating for zero error at center scale and ± 20 div	0.2 div p-p	30 Hz	20 ms	Temp: 0.35%/10°C Line voltage: 0.6%	Temp: 1.25 div/10°C; 0.5 div/8 hr, constant ambient Line voltage: 0.35 div
8803A High gain dc	1 μ V range 0.35 div; other ranges 0.25 div after setting mechanical zero of stylus within ± 1 div of chart center and calibrating for zero error at center scale and ± 20 div	1 div p-p max gain; 0.1 div p-p min gain	30 Hz	20 ms	Temp: 0.35%/10°C Line voltage: 0.75%, 1 mV/div to 5 mV/div; 0.55% all other ranges	Temp: μ V range: 1 μ V/10°C referred to input ± 0.65 div/10°C for full scale output mV range: 1 mV/10°C referred to input, ± 0.26 div/10°C for 0 output and ± 0.65 div/10°C for full scale output Line voltage: 0 output 0.27 div; full scale output 0.45 div
8805A Carrier	0.4 div after setting mechanical zero of stylus within ± 1 div of chart center and calibrating for zero error at center scale and ± 20 div	0.25 div p-p $\pm 1\%$ of chart deflection	30 Hz	20 ms	Temp: 0.45%/10°C Line voltage: 0.75%	Temp: 0.45 div/10°C Line voltage: 0.35 div
8806B Phase sens. demod.	0.4 div after setting mechanical zero of stylus within ± 1 div of chart center and calibrating for zero error at center scale and ± 20 div	7 μ V x square root of combined 8806B recorder frequency response, p-p, referred to input	With fixed frequency plug-ins: at f_c 60 Hz, 3 dB down at 10 Hz; at f_c 400 Hz, 3 dB down at 27 Hz; at f_c 5,000 Hz, 3 dB down at 30 Hz	With fixed frequency plug-ins: at f_c 60 Hz, 54 ms; at f_c 400 Hz, 23 ms; at f_c 5,000 Hz, 20 ms	Temp: 0.5%/10°C Line voltage: 0.6%	Temp: 0.5 div/10°C Line voltage: 0.35 div
8807A ac/dc conv	0.55 div ± 0.05 div x scale expansion 60 Hz to 5 kHz after setting mechanical zero of stylus within ± 1 div of chart center and calibrating for zero error at lower and upper ends of printed coordinates	Baseline offset and/or noise 2 mV rms referred to input plus 0.025 div x scale expansion	27 Hz Option 01: 9 Hz	22 ms Option 01: 73 ms (approx 10% overshoot)	Temp: 0.2%/10°C x scale expansion $\pm 0.45\%/10^\circ\text{C}$ Line voltage: 0.24% x scale expansion $\pm 0.75\%$	Temp: 0.03 div/10°C x scale expansion ± 0.35 div/10°C; 0.005 div/hr x scale expansion at constant ambient Line voltage: 0.005 div x scale expansion plus 0.30 div
8808A Log level	Departure from log characteristic 50 dB: 1.5 div; 100 dB: 1.0 div after setting mechanical zero of stylus within ± 1 div of chart center and calibrating for zero error at lower and upper ends of printed coordinates	50 dB range: 0.8 div p-p; 100 dB range: 0.4 div p-p (Max noise at bottom of recording chart)	Does not apply	Fast: 28 ms (825 dB/s) Slow: 2 s (9 dB/s)	Temp: 50 dB range 2.13 dB/10°C; 100 dB range 2.25 dB/10°C Line voltage: 50 dB range 0.75 dB 100 dB range 1.0 dB (Max gain at bottom of recording chart)	Does not apply (with input shorted output is off-scale at bottom of chart)
8809A Spec purpose dc	0.4 div after setting mechanical zero of stylus within ± 1 div of chart center and calibrating for zero error at center scale and ± 20 div	0.1 div p-p	30 Hz	20 ms	Temp: 0.75%/10°C Line voltage: 1%	Temp: 0.4 div/10°C at 30 mV sensitivity Line voltage: 0.50/div

Preamplifier/Model 7702B, 7704B Recorder System Specifications
(Specifications apply only when Permapaper® is used)

Pre-amplifier type	Output linearity (less trace width)	Output noise max (less trace width)	Output frequency response (10 div) do to less than 3 dB down at	Risetime (10 div, 10-90% 4% overshoot)	Gain stability 20° to 40°C, 103 to 127 volts	Zero drift (less trace width) 20° to 40°C, 103 to 127 volts
8801A Low gain dc	0.25 div after setting mechanical zero of stylus within ± 1 div of chart center and calibrating for zero error at center scale and +20 div	0.2 div p-p	125 Hz	5 ms	7702B: temp. 0.35%/10°C; line volts 0.6% 7704B: temp 0.2%/10°C; line volts 0.25%	Temp: 1.25 div/10°C; 0.5 div/8 hr, constant ambient Line volts: 7702B, 0.70 div; 7704B, 0.15 div
8802A Med gain dc	0.25 div after setting mechanical zero of stylus within ± 1 div of chart center and calibrating for zero error at center scale and +20 div	0.2 div p-p	125 Hz	5 ms	7702B: temp 0.35%/10°C line volts 0.6% 7704B: temp 0.2%/10°C line volts 0.25%	Temp: 1.25 div/10°C; 0.5 div/8 hr, constant ambient Line volts: 7702B, 0.70 div; 7704B, 0.15 div
8803A High gain dc	1 μ V range 0.35 div other ranges 0.25 div, after setting mechanical zero of stylus within ± 1 div of chart center and calibrating for zero error at center scale and +20 div	1 div p-p max gain; 0.1 div p-p min gain	90 Hz	7 ms	7702B: temp 0.35%/10°C; line volts 0.75% on 1 to 5 mV/div ranges; 0.55% all other ranges 7704B: temp 0.2%/10°C; line volts 0.4% on 1 to 5 mV/div ranges, 0.2% all other ranges	Temp: μ V range: 1 μ V/10°C referred to input ≈ 0.65 div/10°C for full scale output mV range 1 mV/10°C referred to input ≈ 0.65 div/10°C for full scale output Line volts: 7702B, full scale output 0.45 div; 7704B, full scale output 0.35 div
8805A Carrier	0.4 div after setting mechanical zero of stylus within ± 1 div of chart center and calibrating for zero error at center scale and +20 div	0.25 div p-p +1% of chart deflection	110 Hz	5.6 ms	7702B: temp 0.45%/10°C; line volts 0.75% 7704B: temp 0.3%/10°C; line volts 0.4%	Temp: 0.45 div/10°C Line volts: 7702B, 0.35 div; 7704B, 0.25 div
8806B Phase sens demod	0.4 div after setting mechanical zero of stylus within ± 1 div of chart center and calibrating for zero error at center scale and +20 div	7 μ V x square root of combined 8806B recorder frequency response, p-p, referred to input	With fixed frequency plug-ins: at f_c 60 Hz, 3dB down at 12 Hz; at f_c 400 Hz, 3 dB down at 65 Hz; at f_c 5,000 Hz, 3 dB down at 125 Hz	With fixed frequency plug-ins: at f_c 60 Hz, 50 ms; at f_c 400 Hz, 9 ms; at f_c 5,000 Hz, 5 ms	7702B: temp 0.5%/10°C; line volts 0.6% 7704B: temp 0.35%/10°C; line volts 0.25%	Temp: 0.5 div/10°C Line volts: 7702B, 0.35 div; 7704B, 0.25 div
8807A ac/dc conv	.055 div +0.5 div x scale expansion, 60 Hz to 5 kHz; after setting mechanical zero of stylus within ± 1 div of chart center and calibrating for zero error at lower and upper ends of printed coordinates	Baseline offset and/or noise: 2mV referred to input plus 0.025 div x scale expansion	54 Hz Option 01: 9 Hz	11.2 ms Option 01: 70 ms (approx 10% overshoot)	7702B: temp 0.2%/10°C x scale expansion + 0.45%/10°C; line volts 0.25% x scale expansion + 0.75% 7704B: temp 0.2%/10°C x scale expansion + 0.3%/10°C; line volts 0.24% x scale expansion + 0.4%	Temp: 0.03 div/10°C x scale expansion + 0.35 div/10°C; 0.005 div/hr x scale expansion at constant ambient Line volts: 7702B, 0.005 div x scale expansion plus 0.30 div; 7704B, 0.005 div x scale expansion plus 0.10 div
8808A Log level	Departure from log characteristic 50 dB: 1.5 div; 100 dB: 1.0 div after setting mechanical zero of stylus within ± 1 div of chart center and calibrating for zero error at lower and upper ends of printed coordinates	50 dB range: 0.8 div p-p; 100 dB range: 0.4 div p-p (Max noise at bottom of recording chart)	Does not apply	Fast: 20.5 ms (875 dB/s) Slow: 2 s (9 dB/s)	7702B: temp 50 dB 2.13 dB/10°C; line volts 50 dB range 0.75 dB 100 dB range 1.0 dB 7704B: temp 50 dB 2.05 dB/10°C, 100 dB, 2.1 dB/10°C; line volts 50 dB range 0.58 dB, 100 dB range 0.65 dB (max gain at bottom of recording chart)	Does not apply. (With input shorted output is offscale at bottom of chart)
8809A Spec. purpose dc	0.4 div after setting mechanical zero of stylus within ± 1 div of chart center and calibrating for zero error at center scale and +20 div	0.1 div p-p	125 Hz	5 ms	7702B: temp 0.75%/10°C; line volts 1% 7704B: temp 0.6%/10°C; line volts 0.65%	Temp: 0.4 div/10°C at 30 mV sensitivity Line volts: 7702B, 0.50 div; 7704B, 0.30 div

Preamplifier/Models 7706B, 7708B Recorder System Specifications
(Specifications apply only when Permapaper® is used)

Pre-amplifier type	Output linearity (less trace width)	Output noise maximum (less trace width)	Output frequency response (10 div) dc to less than 3 dB down at	Rise time (10 div, 10-90%, less than 4% overshoot)	Gain stability	Zero drift (less trace width)
8801A Low gain dc	0.25 div after setting mechanical zero of stylus within ± 1 div of chart center and calibrating for zero error at center scale and +20 div	0.2 div p-p	7706B: 125 Hz 7708B: 150 Hz	7706B: 5 ms 7708B: 4 ms	Temp: 0.2%/10°C, 10° to 40°C Line voltage: 0.25%, 103 to 127 V	Temp: 1.05 div/10°C, 10° to 40°C; 0.5 div/8 hr, constant ambient Line voltage: 0.15 div, 103 to 127 V
8802A Med gain dc	0.25 div after setting mechanical zero of stylus within ± 1 div of chart center and calibrating for zero error at center scale and +20 div	0.2 div p-p	7706B: 125 Hz 7708B: 150 Hz	7706B: 5 ms 7708B: 4 ms	Temp: 0.2%/10°C, 10° to 40°C Line voltage: 0.25%, 103 to 127 V	Temp: 1.05 div/10°C, 10° to 40°C; 0.5 div/8 hr, constant ambient Line voltage: 0.15 div, 103 to 127 V
8803A High gain dc	1 μ V range: 0.35 div other ranges: 0.25 div after setting mechanical zero of stylus within ± 1 div of chart center and calibrating for zero error at center scale and +20 div	1 div p-p max gain; 0.1 div p-p min gain	7706B: 90 Hz 7708B: 100 Hz	7706B: 7 ms 7708B: 6.4 ms	Temp: 0.2%/10°C, 20° to 40°C Line voltage: 0.4%, 1 mV/div to 5 mV/div; 0.2%; other ranges; 103 to 127 V	Temp: 20° to 40°C; μ V range: 1 μ V/10°C referred to input, ± 0.06 div/10°C for 0 output and ± 0.45 div/10°C for full scale output mV range: 1 mV/10°C referred to input, ± 0.06 div/10°C for 0 output and ± 0.45 div/10°C for full scale output Line voltage: 0 output: 0.07 div; full scale output: 0.35 div, 103 to 127 V
8805A Carrier	0.4 div after setting mechanical zero of stylus within ± 1 div of chart center and calibrating for zero error at center scale and +20 div	0.25 div p-p +1% of chart deflection	7706B: 110 Hz 7708B: 120 Hz	7706B: 5.6 ms 7708B: 4.75 ms	Temp: 0.3%/10°C, 0° to 40°C Line voltage: 0.4%, 103 to 127 V	Temp: 0.25 div/10°C, 0° to 40°C Line voltage: 0.25 div, 103 to 127 V
8806B Phase sens demod	0.4 div after setting mechanical zero of stylus within ± 1 div of chart center and calibrating for zero error at center scale and +20 div	7 μ V x square root of combined 8806B recorder p-p frequency response, referred to input	7706B: with fixed-frequency plug-ins: f_c 60 Hz, -3 dB at 12 Hz; f_c 400 Hz, -3 dB at 65 Hz; f_c 5,000 Hz, -3 dB at 125 Hz 7708B: with fixed-frequency plug-ins: f_c 60 Hz, -3 dB at 12 Hz; f_c 400 Hz, -3 dB at 70 Hz; f_c 5,000 Hz, -3 dB at 150 Hz	7706B: with fixed-frequency plug-ins: at f_c 60 Hz, 50 ms; at f_c 400 Hz, 9 ms; at f_c 5,000 Hz, 5 ms 7708B: with fixed-frequency plug-ins, at f_c 60 Hz, 50 ms; at f_c 400 Hz, 8.5 ms; at f_c 5,000 Hz, 4 ms	Temp: 0.35%/10°C, 0° to 40°C Line voltage: 0.25%, 103 to 127 V	Temp: 0.3 div/10°C, 0° to 40°C Line voltage: 0.25 div, 103 to 127 V
8807A ac/dc conv	0.55 div + 0.05 div x scale expansion, 60 Hz to 5 kHz, after setting mechanical zero of stylus within ± 1 div of chart center and calibrating for zero error at lower and upper ends of printed coordinates	Baseline offset and/or noise: 2 mV rms referred to input plus 0.025 div x scale expansion	7706B: 8807A: 54 Hz 8807A: Opt 01: 9 Hz 7708B: 8807A: 55 Hz 8807A: Opt 01: 9 Hz	7706B: 8807A: 11.2 ms 8807A: Opt 01: 70 ms 7708B: 8807A: 10.8 ms 8807A: Opt 01: 70 ms (approx 10% overshoot)	Temp: 0.2%/10°C x scale expansion + 0.3%/10°C, 10° to 50°C Line voltage: 0.24% x scale expansion + 0.4%, 103 to 127 V	Temp: 0.03 div/10°C x scale expansion + 0.15 div/10°C, 10° to 50°C; 0.005 div/hr x scale expansion at constant ambient Line voltage: 0.005 div x scale expansion + 0.1 div, 103 to 127 V
8808A Log level	Departure from log characteristic 50 dB: 1.5 div; 100 dB: 1.0 div after setting mechanical zero of stylus within ± 1 div of chart center and calibrating for zero error at lower and upper ends of printed coordinates	50 dB range: 0.8 div p-p; 100 dB range: 0.4 div p-p (Max noise at bottom of recording chart)	Does not apply	7706B/7708B: Fast: 20.5 ms (875 dB/s) Slow: 2 s (9 dB/s)	Temp: 0° to 40°C; 50 dB range 2.05 dB/10°C; 100 dB range 2.1 dB/10°C Line voltage: 103 to 127 V; 50 dB range 0.58 dB; 100 dB range 0.65 dB (Max gain at bottom of recording chart)	Does not apply (with input shorted output is offscale on bottom of chart)
8809A Spec purpose dc	0.4 div after setting mechanical zero of stylus within ± 1 div of chart center and calibrating for zero error at center scale and +20 div	0.1 div p-p	7706B: 125 Hz 7708B: 150 Hz	7706B: 5 ms 7708B: 4 ms	Temp: 0.6%/10°C, 10° to 40°C Line voltage: 0.65%, 103 to 127 V	Temp: 0.2 div/10°C at 30 mV/div sensitivity, 0° to 40°C Line voltage: 0.3 div, 103 to 127 V

Preamplifier/Model 7858A Recorder System Specifications
(Specifications apply only when HP fluid-process recording paper is used)

Pre-amplifier type	Output linearity (less trace width)	Output noise max (less trace width)	Output frequency response (10 div) do to less than 3 dB down at	Risetime (10 div, 10-90% 4% overshoot)	Gain stability 20° to 40°C, 103 to 127 volts	Zero drift (less trace width) 20° to 40°C, 103 to 127 volts
8801A Low gain dc	0.25 div after calibrating for zero error at center scale and + 20 div	0.2 div p-p	160 Hz	3 ms	Temp: 0.2%/10°C Line voltage: 0.25%	Temp: 1.25 div/10°C; 0.5 div/8 hr, constant ambient Line voltage: 0.15 div
8802A Med gain dc	0.25 div after calibrating for zero error at center scale and + 20 div	0.2 div p-p	160 Hz	3 ms	Temp: 0.2%/10°C Line voltage 0.25%	Temp: 1.25 div/10°C; 0.5 div/8 hr, constant ambient Line voltage: 0.15 div
8803A High gain dc	1 μ V range 0.35 div; other ranges 0.25 div after calibrating for zero error at center scale and + 20 div	1 div p-p max gain 0.1 div p-p min gain	> 100 Hz	Approx 5.5 ms	Temp: 0.2%/10°C Line voltage: 0.4%, 1 mV/div to 5 mV/div; 0.2% all other ranges	Temp: μ V range: 1 μ V/10°C referred to input \pm 0.06 div/10°C for 0 output and \pm 0.45 div/10°C for full scale output mV range 1 mV/10°C referred to input \pm 0.06 div/10°C for 0 output and \pm 0.045 div/10°C for full scale output Line voltage: 0 output 0.07 div full scale output 0.35 div
8805A carrier	0.4 div after calibrating for zero error at center scale and + 20 div	0.25 div p-p + 1% of chart deflection	> 110 Hz	Approx 4 ms	Temp: 0.3%/10°C Line voltage: 0.4%	Temp: 0.25 div/10°C Line voltage: 0.25 div
8806B Phase sens demod	0.4 div after calibrating for zero error at center scale and + 20 div	7 μ V x square root of combined 8806B recorder frequency response, p-p, referred to input	With fixed-frequency plug-ins: f_c 60 Hz, 12 Hz; f_c 400 Hz, 71 Hz; f_c 5,000 Hz, 160 Hz	With fixed-frequency plug-ins: f_c 60 Hz, 50 ms; f_c 400 Hz, 8 ms; f_c 5,000 Hz, 3 ms	Temp: 0.35%/10°C Line voltage: 0.25%	Temp: 0.3 div/10°C Line voltage: 0.25 div
8807A ac/dc conv	.055 div + 0.5 div x scale expansion, 60 Hz to 5 kHz, after calibrating for zero error at lower and upper ends of printed coordinates	Baseline offset and/or noise: 2 mV referred to input plus 0.025 div x scale expansion	54 Hz Opt 01: 9 Hz	11.2 ms Opt 01: 70 ms (Approx 10% overshoot)	Temp: 0.2%/10°C x scale expansion + 0.3%/10°C Line voltage: 0.24% x scale expansion + 0.4%	Temp: 3 mV/10° x scale expansion + 0.15 div/10°C; at constant ambient 0.5 mV/hr, referred to input Line voltage: 0.005 div x scale expansion plus 0.1 div
8808A Log Level	Departure from log characteristic 50 dB: 1.25 div; 100 dB; 1 div after calibrating for zero error at lower and upper ends of printed coordinates	50 dB range: 0.8 div p-p; 100 dB range: 0.4 div p-p (Max noise at bottom of recording chart)	Does not apply	Fast: 20.5 ms (875 dB/s) Slow: 2 s (9 dB/s)	Temp: 50 dB range: 2.05 dB/10°C; 100 dB range: 2.1 dB/10°C Line voltage: 50 dB range: 0.58 dB; 100 dB range: 0.65 dB (Max gain at bottom of recording chart)	Does not apply (with input shorted output is offscale on bottom of chart)
8809A Spec purpose dc	0.4 div after calibrating for zero error at center scale and +20 div	0.1 div p-p	160 Hz	3 ms	Temp: 0.6%/10°C Line voltage: 0.65%	Temp: 0.2 div/10°C at 30 mV sensitivity Line voltage: 0.3 div

RECORDERS



MULTICHANNEL AMPLIFIERS

Economical, variable gain for data recording
Models 8820A, 8821A

Model	8820A	8821A
Amplifier type	low-gain, general-purpose	medium gain, general-purpose
Max sensitivity	0 - 0.05 V input per div	1 mV input per div
Attenuation range	0.05, 0.1, 0.2, 0.5, 1, 2.5 V/div; attenuation error \approx 2% max	1, 2, 5, 10, 20, 50, 100, 200, 500, 1000, 2000, 5000 mV/div; attenuation error \approx 0.5% max on ranges 1 to 50 mV/div; \approx 1% max on ranges 100 to 5000 mV/div
Input circuit	single-ended, 1 meg	9 meg floating and guarded on ranges 1 to 50 mV/div; 4.5 meg each side to ground differential on ranges 100 to 5000 mV/div; may be used single-ended on all ranges
Common mode rejection ratio	does not apply; common ground of inputs may be isolated from chassis when load does not provide return to chassis; recorders normally supply return	100 dB at 60 Hz, 1 mV/div sensitivity, 1 k source unbalance; decreases to 74 dB at 50 mV/div; 60 dB at 60 Hz, 100 to 5000 mV/div sensitivities, 5 k source unbalance
Common mode voltage tolerance	does not apply; see note on common mode rejection ratio	\approx 20 V on 1 to 50 mV/div ranges; \approx 250 V on 100 to 5000 mV/div ranges
Zero drift (time, temp, and volt variations), not including drift of recorder and its drive circuits	less than \approx 0.25 div/8 hrs; less than \approx 0.5 div/10°C in range 0 to 50°C; less than \approx 0.25 div for line volts 103 to 127	0.5 div/10°C max at calibrated gain; less than \approx 0.15 div, 103 to 127 V; less than \approx 0.25 div/8 hours
Gain stability (time, temp, and volt variations), not including drift of recorder and its drive circuits	less than \approx 0.1%/8 hrs; less than \approx 0.05%/C°, 0 to 50°C; less than \approx 0.1%, 103 to 127 V	less than \approx 0.05%/C°; less than \approx 0.1%, 103 to 127 V; less than \approx 0.1%/8 hrs
Noise (at calibrated gain)	not visible on recording; 5 mV at amplifier output connector over 400 kHz bandwidth	with input shorted: approx 0.1 div on chart; approx 25 μ V rms r.t.i. on 6 most sensitive ranges over full amplifier bandwidth
Nonlinearity (max)	\approx 0.3 div after calibration at chart center and +20 div	\approx 0.3 div after calibration at chart center and +20 div
Internal calibration	two, 1 V reference provided in each channel, plus second common 1 V reference for all channels; accuracy at each: \approx 1%	+0.02 volt \approx 1% on 6 least sensitive ranges; has same effect as 2 V introduced at input
Frequency response and risetime	frequency response: 7727A: dc to -3 dB at 125 Hz 7729A: dc to -3 dB at 150 Hz 7878A: dc to -3 dB at 160 Hz risetime: 7727A: 5 ms 7729A: 4 ms 7878A: 3 ms	frequency response: 7727A: dc to -3 dB at 125 Hz 7729A: dc to -3 dB at 150 Hz 7878A: dc to -3 dB at 160 Hz risetime: 7727A: 5 ms 7729A: 4 ms 7878A: 3 ms
Price	\$1150	\$2500

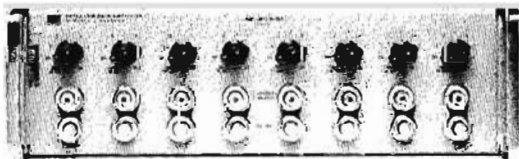

8820A

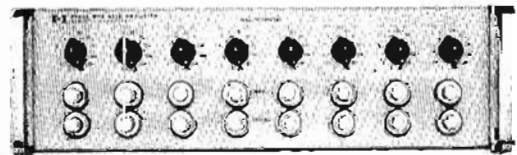

8821A

MULTICHANNEL AMPLIFIERS

Solid-state ampl/drivers for Optical Recorders
650 Series for 4500 Optical Systems



RECORDERS

Model	658-2000	658-2900	658-3400
Amplifier type	galvanometer driver, general-purpose	low-gain, general-purpose	medium-gain, general-purpose
Max. sensitivity	625 mV/in (5 V for 8" trace)	50 mV/in (400 mV for 8" trace)	2.5 mV/in (20 mV for 8" trace)
Attenuation range	X1, 2, 4, 10, 20, 40; smooth gain 2.5-to-1 adj.; up scale and down scale output switch; attenuation error = 2% max.	X1, 2, 5, 10, 20, 50, 100, 200, 500, 1000; smooth gain 2.5-to-1 adj.; attenuation error = 2% max.	X1, 2, 5, 10, 20, 50, 100, 200, 500, 1000, 2000, 5000; smooth gain 2.5-to-1 adj.; attenuation error = 3% max.
Input circuit	single ended, 100 k	bal. to gnd.; 1 megohm each side	floating and guarded, 100 k
Zero suppression	none	follows attenuator switch and pre-	none
Common mode rejection ratio	N/A	34 dB X1 range, 28 dB other ranges	140 dB at dc, 120 dB at 60 Hz bal., 110 dB at 60 Hz 1000 ohms unbal.
Common mode voltage tolerance	N/A	± 2.5 V on X1 range, multiply att. range X2.5 to max. of = 500 V	= 500 volts
Frequency response (within 3 dB point)	0 to 5 kHz (4" p-p) 0 to 3 kHz (8" p-p)	0 to 5 kHz (4" p-p) 0 to 3 kHz (8" p-p)	0 to 5 kHz (4" p-p) 0 to 3 kHz (8" p-p)
Response time (10% to 90%)	80 μs 4% or less overshoot	80 μs 4% or less overshoot	80 μs 4% or less overshoot
Zero drift (time, temp. and line voltage variations)	0.025"/10°C max., 0 to 50°C; 0.02" max., 103 to 127 volts	0.1"/10°C max., 0 to 50°C; 0.02" max., 103 to 127 V; 0.1"/hr.	0.05"/10°C max., 0 to 50°C; 0.02" max., 103 to 127 volts
Gain stability (temp. and line volt variations)	better than 1%, 0 to 50°C; better than 1%, 103 to 127 volts	better than 1%, 0 to 50°C; better than 1%, 103 to 127 volts	better than 1%, 0 to 50°C; better than 1%, 103 to 127 volts
Noise (max. p-p at calibrated gain)	0.02" p-p max.	0.02" p-p max.	0.02" p-p max.
Max. non-linearity	= 1.5% full scale (8")	= 1.5% full scale (8")	= 1.5% full scale (8")
Internal calibration	2.5 volts = 1%	0.2 volt = 1%	10 mV = 2%
Size, weight	7" high, 19" wide, 20½" deep (178 x 483 x 520 mm); Option 02 increases depth to 23¾" (593 mm); net weight 80 lbs (35 kg), shipping weight 90 lbs (40.5 kg)		
Price, options	658-2000, \$2200; Option 01 6-channel, deduct \$140; Option 02* with cooling fan, add \$145	658-2900, \$2895; Option 01 6-channel, deduct \$260; Option 02* with cooling fan, add \$145	658-3400, \$3780; Option 01 6-channel, deduct \$260; Option 02* with cooling fan, add \$145

ft./min minimum), or order amplifier Option 02.

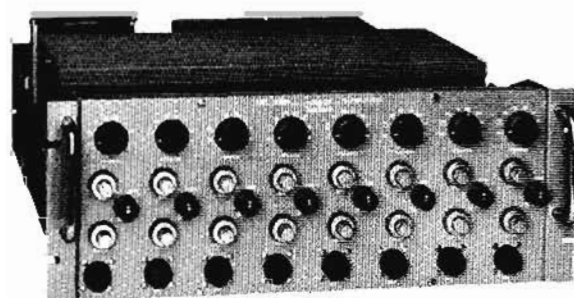

658-2000

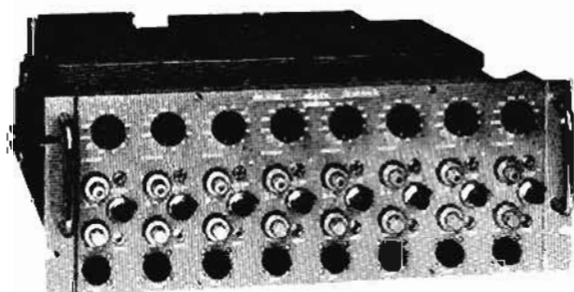

658-2900

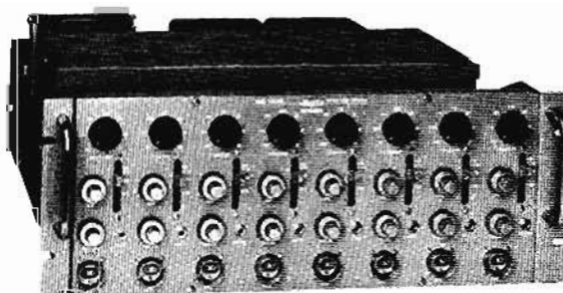

658-3400



TRANSDUCERS

Sensors of linear motion, force, size and pressure
Models 7LV, 585, FTA, 1281, DCDT, 311-A

Linear Displacement (DC excitation)

7DCDT and 24DCDT dc excited, dc output linear displacement ($\pm 0.05"$ to $\pm 3"$) transducers are extremely convenient to use for measuring, monitoring or controlling mechanical displacement. No external carrier system is required, and phase shift and balancing adjustments are not necessary. Each DCDT has a built-in carrier oscillator and phase-sensitive demodulator which produces a high-level dc output voltage proportional to the linear displacement of the core. Both series have extremely high resolution, zero hysteresis and non-linearity less than $\pm 0.5\%$ of total stroke. The 24DCDT's have approximately three times the sensitivity of the 7DCDT's and operating temperature to 250°F (7DCDT, 140°F). Excitation of 7DCDT models is 6 volts dc (max 7, min 5), and of 24DCDT models is 24 volts dc (max 28, min 20)

Model	Model 7DCDT/24DCDT						
	-060	-100	-260	-500	-1000	-3000	
Stroke (range) (in)	± 0.05	± 0.1	± 0.25	± 0.5	± 1	± 3	
Output, volts f.s.	7 DCDT 24 DCDT	1.5 5.0	2.8 9.0	1.5 7.0	3.3 12.5	4.8 18.0	5.0 13.0
Output impedance	7 DCDT 24 DCDT	2.2 k 2.5 k	3.0 k 3.5 k	5.0 k 5.2 k	5.3 k 5.5 k	5.5 k 5.6 k	5.0 k 5.6 k
Dimensions, inches (mm)	0.75 (19.2)						
diameter	7 DCDT 24 DCDT						
length	7 DCDT 24 DCDT	0.81 (20.6) 0.87 (22.2)	1.06 (27.0) 1.12 (28.5)	3.00 76.2 3.21 (81.8)	3.50 89.2 3.71 (94.2)	4.50 (115) 4.71 (120)	10.50 (267) 10.52 (286)
Weight (gm)	Armature Assembly	1.6	2.1	3.4	3.8	4.3	8.1
Weight (gm)	net shipping	23 84	28 84	68 168	78 168	100 196	210 308
Price:	7 DCDT 24 DCDT	\$ 99 \$146	\$104 \$151	\$119 \$164	\$132 \$177	\$141 \$186	\$162 \$207

Linear Displacement (AC excitation)

Linearsyn® (585DT, 595DT) Transducers produce an electrical output proportional to any physical parameter which is capable of conversion to a relative displacement between the transducer's core and coil assembly. A wide stock selection of transducers is available for Hewlett Packard or equivalent carrier amplifiers, linear displacements to $0.000001"$ may be resolved. Non-linearity error will not exceed 1.0% of total stroke; temperature range, -50° to 205°F . Linearsyns are shielded, immersible in non-corrosive fluids without damage, resistant to shock and vibration and void of friction and mechanical hysteresis. Standard carrier frequency is 2.4 kHz, with a range of 400 Hz to 10 kHz (585DT), or 20 kHz (595DT).

Model	585DT				595DT		
	-060	-250	-500	-1000	-060	-250	-100
Stroke range (inches)	0.05	0.25	0.5	1	0.005	0.025	0.1
Sensitivity* (V/in./Vex)	4.8	1.7	1.1	0.79	2.2	3.4	2.7
Impedance* (ohms)							
primary:	163	151	332	157	93	303	330
secondary:	2140	176	370	247	154	365	365
Vex* (max)	21	17	25	30	5	11.5	13
Size— inches (mm)							
diameter:	0.75 (19)	0.75 (19)	0.75 (19)	0.75 (19)	0.375 (10)	0.375 (10)	0.375 (10)
length:	1.63 (41)	3.31 (84)	4.88 (124)	6.88 (155)	0.90 (23)	1.09 (28)	1.09 (28)
Weight (gm) armature assembly	5	7	12	18	0.10	0.25	0.29
Weight (gm)							
net	47	104	132	178	7.1	7.9	7.9
shipping	227	227	227	227	84	84	84
Price	\$25	\$41	\$50	\$60	\$30	\$27.50	\$35

* At standard carrier frequency.

Linear Velocity (No excitation)

LVsyn® Linear Velocity Transducers are remarkably simple to set-up and use for sensitive measurements of relative velocity. The basic LVsyn design eliminates the need for external excitation. DC voltages are generated by moving a high flux density permanent magnet in the bore of differentially wound coils. The voltage amplitude is proportional to core velocity. Resolution of an LVsyn output is nearly unlimited—sensitivity over the rated stroke range is constant within 5%—temperature range between -50°F to $+200^\circ\text{F}$. They can be operated single-ended or push-pull; while immersed in non-corrosive fluids; without end stops or displacement limits. Each transducer is supplied with a calibration record. No excitation is required.

Model	3LVA6	3LV1	6LV1	6LV2	6LV3	6LV4	6LV8	7LV9	7LV20
Sensitivity (mV/in./sec)	120 40*	90 35*	500 250*	500 250*	500 250*	500 250*	350 150*	350 150*	20 7*
Resistance (k ohms)	2	2.5	13	19	25	32	11.5	17	3
Inductance (henrys)	0.085	0.065	1.6	2.9	3.2	4	1.9	2.8	0.035
Stroke inches (mm)	0.5 (13)	1 (25)	1 (25)	2 (51)	3 (76)	4 (101)	6 (152)	9 (229)	20 (508)
Size— inches (mm)									
diameter:	0.37 (10)	0.37 (10)	0.63 (16)	0.63 (16)	0.63 (16)	0.63 (16)	0.75 (19)	0.75 (19)	0.75 (19)
length:	3.16 (80)	4.22 (108)	5 (128)	7 (178)	9 (230)	11.25 (275)	15.75 (400)	22.75 (580)	30 (760)
Weight (gm) armature assembly	3.5	4.5	11	15	17	22	54	69	40
Weight net coil (grams) core shipping	20 3.5 84	25 4.5 84	110 11 224	150 15 252	200 17 308	250 22 336	420 54 505	610 69 756	800 50 900
Price	\$40	\$45	\$50	\$55	\$60	\$65	\$85	\$100	\$120

* Output with non-breakable magnet cores (-N models); to order add suffix -N to basic model number, e.g., 3LVA5-N, 3LV1-N, etc. Prices same as standard models.

Model	FTA-1-1	FTA-10-1	FTA-100-1
Force (range, gm)	±1	±10	±100
Displacement (full scale, in)	±0.01	±0.01	±0.01
Sensitivity (full scale, mV/vex)	8	8	8
Natural freq (Hz)	65	130	390
Sensitivity (g) (% of f.s./g)			
radial:	0	0	0
axial:	21	5	0.6
Dimensions, inches (mm)	1.37 lg, 0.75 dia (35 x 19)		
Weight (gm)	net 153, shipping 760		
Price	\$200		

Low Level Force (AC excitation)

FTA low-level tension and compression sensing transducers (±1 to ±100 gm) are ideal for measuring buoyancy, discrete weights, small bearing torques, displacements and angles, as well as muscle contractions and other physiological motion. These miniature "Microforce" transducers provide an economical way to measure uni- or bi-directional forces with infinite resolution, linearity to 0.2% of full scale and hysteresis as low as 0.1% of applied force. FTA's have 400% overload capacity, low tracking force (no bearing friction) and excellent thermal stability over 0° to +170°F. Nominal excitation is 5 volts at 2.4 kHz.

Model	1281-01A	1281-02A	1281-03A	1281-04A	1281-05A
Range (psi)	15	100	300	1,000	3,000
Overload (psi)	50	300	900	3,000	4,500
G Sens. (%FS)	0.1	0.02	0.005	0.002	0.001
Natural Freq	Above 1 kHz				
Sensitivity	8 mV/V (nominal)				
Impedance	320 ohms input, 500 ohms output				
Non-linearity	0.5% (max)				
Hysteresis	0.1% (max)				
Volume displ	0.001 in ³ at full scale (max)				
Zero shift	0.01%/C° (max)				

Medium and High Pressure (AC excitation)

1281-series Pressure Transducers are heavy-duty units designed for use in either gas or liquid systems at low or high viscosities, with maximum pressures of 15 to 3,000 psi depending on the model. The unit matches the input requirements of Hewlett-Packard Carrier Preamplifiers such as 8805A, 350-1100C, 301, 321, and 311A, and will provide a fast response to rapidly changing pressures. The 1281 series finds many industrial and laboratory applications in fields such as hydraulics, material processing, and pressure monitoring, as well as in systems designed to control a manufacturing process, as is found in the petroleum and chemical industries. The unit is designed for either tube or flush mounting. Nominal excitation is 5 volts at 2.4 kHz.

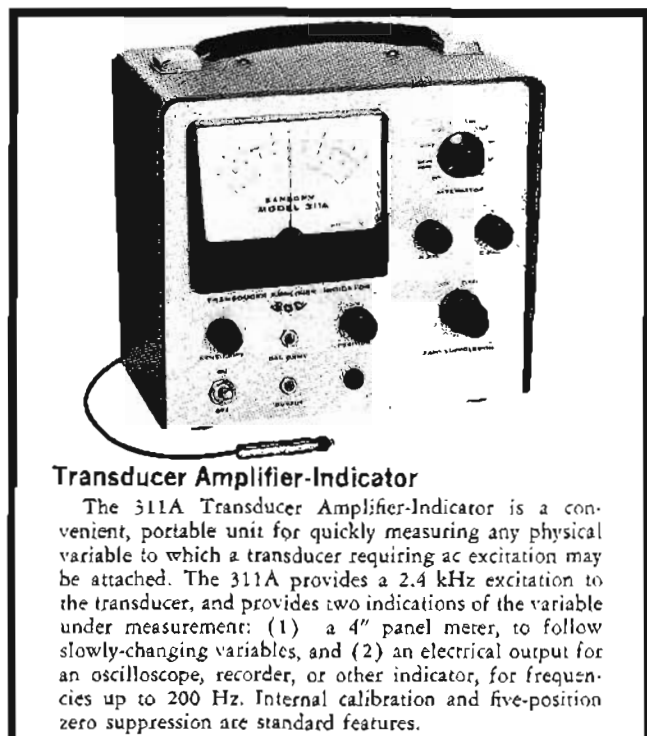
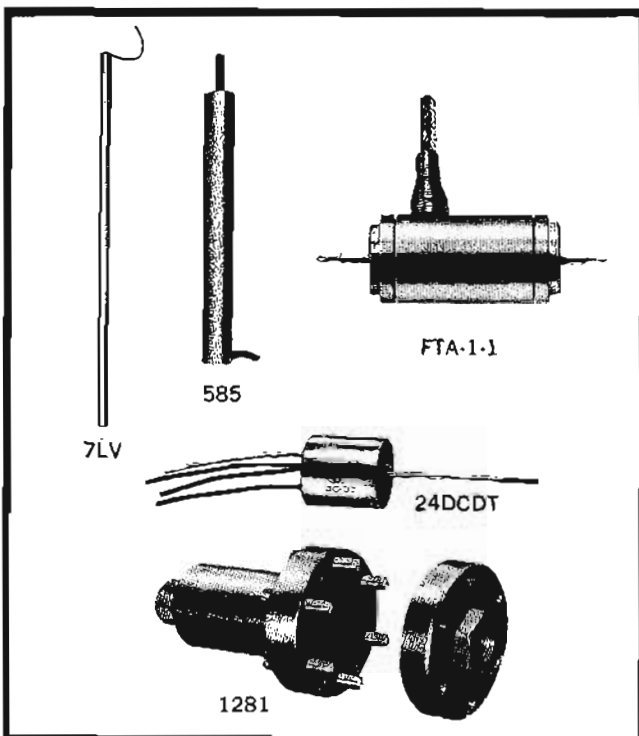

Transducer Amplifier-Indicator

The 311A Transducer Amplifier-Indicator is a convenient, portable unit for quickly measuring any physical variable to which a transducer requiring ac excitation may be attached. The 311A provides a 2.4 kHz excitation to the transducer, and provides two indications of the variable under measurement: (1) a 4" panel meter, to follow slowly-changing variables, and (2) an electrical output for an oscilloscope, recorder, or other indicator, for frequencies up to 200 Hz. Internal calibration and five-position zero suppression are standard features.



Analog Magnetic Tape Recorders

INSTRUMENTATION MAGNETIC TAPE RECORDING



RECORDERS

Magnetic tape recording is used in all walks of life, to record and reproduce information of various kinds. In the case of the familiar *audio* home tape recorder and business dictating machine, that information is voice and music, converted to electrical form by a microphone. Another type, the *video* tape recorder, finds daily use in today's television programming. Your bank account is most likely recorded on a *digital* tape unit, used extensively with computer systems for the mass storage of digitized data (see page 108). All of the above are considered *special purpose* in that each is designed for a specific application.

The instrumentation recorder is, on the other hand, a *general-purpose instrument*, used in any scientific field where there is a need to preserve analog data for later evaluation. The data may already be in electrical form (from dc to 1.5 MHz) or may be one of an almost unlimited variety of physical or scientific phenomena that are convertible to electrical form by a transducer.

Standards for instrumentation recording were established within the field of telemetry by the Inter-Range Instrumentation Group (IRIG). These standards are rigidly adhered to throughout the instrumentation magnetic tape recording industry. Compatibility and exchange of recorded data between various magnetic recording systems demand such standardization, regardless of the specific area of application. "IRIG Telemetry Standards," Document No. 106-66 dated March 1966, represents the latest publication of these standards and is referenced throughout the industry. (Copies are obtained from the Defense Documentation Center for Scientific and Technical Information, Cameron Station, Alexandria, Virginia 22314.)

Three categories of instrumentation recorders were established by IRIG: low-band, intermediate-band and wide-band. Each of these provides for increasingly greater recording bandwidths, to 1.5 MHz.

Three recording methods have been specified to meet various requirements: *Direct recording*, *Frequency Modulation recording*, and *Pulse recording*. Direct and FM recording meet the needs of the majority of applications; Pulse recording is used for more specialized purposes.

Standardized tape speeds are 1 $\frac{1}{8}$, 3 $\frac{3}{4}$, 7 $\frac{1}{2}$, 15, 30, 60, and 120 inches per

second. Naturally, the higher tape speeds are used for recording greater bandwidths; the slower tape speeds for the maximum in recording time.

Direct recording provides the greatest bandwidth available from a magnetic tape recorder, and requires only relatively simple, moderately priced electronics.

With this recording method, the intensity of magnetization on tape is made proportional to the instantaneous *amplitude* of the input signal.

In the *reproduce* process, however, a signal is induced from tape to heads *only* in response to *changes* in flux on the recorded tape; the direct record process cannot, therefore, extend down to dc.

This direct recording method is also characterized by some amplitude instability, caused primarily by random surface inhomogeneities in the tape. These variations are normally a few percent at the lower recording frequencies, and can exceed as much as 10% near upper bandwidth limits. Occasional momentary signal decreases of over 50% may occur; these are commonly referred to as "drop-outs."

Uses for direct recording, then, have a common requirement: economy, with a maximum bandwidth, in applications where amplitude variation errors are not critical. Typical applications include audio recording, where the human ear averages any amplitude variation errors, or recordings where the signal's frequency, not amplitude, is of primary importance.

Frequency modulation recording (FM) overcomes some of the basic limitations of the direct recording process, but at the expense of high frequency bandwidth; response does, however, extend down to dc. This recording technique significantly improves the signal amplitude stability, since it is now proportional to carrier deviation, rather than the intensity of magnetization on tape.

In the FM recording method, a carrier oscillator is frequency-modulated by the input signal. The oscillator's center frequency corresponds to a zero-level input, with deviation from that center frequency being proportional to the amplitude of the input signal; the polarity of the input signal determines the direction of deviation.

FM recording is used primarily when the dc component of the input signal is to be preserved, or when the amplitude variations of the direct recording method cannot be tolerated. Accuracy of reproduced signal is another factor in favor of FM recording, being in the order of 1%, vs 5% for the direct recording process.

For more information on magnetic recording, request a copy of Hewlett-Packard Application Note No. 89, "Magnetic Tape Recording Handbook."

Advantages of magnetic recording

Recording on magnetic tape is an economical, time-saving method of preserving almost any type of information for later analysis. Once converted to electrical form and recorded, it is available indefinitely. It can be easily compared or studied alone by means of X-Y or strip-chart recorders, oscilloscopes, wave analyzers, digitizing systems, and the like. Since the information can be reliably played over and over again, it is readily analyzed in several different ways.

Time compression or expansion techniques (record at one tape speed; play back at another) offer unique opportunities for data analysis on measuring instruments of your choice. For example: slowly varying phenomena, too slow for oscilloscope viewing, may be recorded at a slow tape speed, then reproduced at tape speeds up to 32 times faster... now acceptable for oscilloscope viewing. Conversely, high frequency information can be recorded at high tape speeds, then reproduced at a slower tape speed with a concurrent downward frequency-translation: 200 KHz recorded at 60 ips is translated to 6,250 Hz (200 KHz \div 32) when reproduced at 1 $\frac{1}{8}$ ips. At this lower speed, low-frequency test equipment is readily used for analysis of a relatively high frequency signal.

Continuous monitoring is another of the more important advantages of magnetic tape recording. Unexpected and/or unpredictable events are preserved; if no significant phenomenon occurs, the tape is simply erased and reused. Continuous monitoring can, therefore, record such irreplaceable data as power-line transients, seismic tremors, the effects of atomic blasts, etc.

Time relationships among several rapidly occurring events are readily evaluated, each event being simultaneously recorded on one of up to 14 data channels. Later analysis finds this capability extremely important in establishing cause and effect relationships among the recorded phenomena.

Recorded information is immediately available for reproduction; there is no delay for processing of any kind. On the other hand, tapes can be stored for long periods without degradation of the recorded material; thus, events separated widely in time can be compared easily.

Predetection recording of telemetered data exemplifies another important advantage of magnetic tape recording. As the name implies, data is preserved in its transmitted form, then the best method of detection is determined *after the fact*, with a minimum possible loss of information.

Since the carrier and all its sidebands are present in the recording, repeated analyses can be made using different detection equipment to achieve the best possible signal recovery.

Applications

Instrumentation magnetic tape recording finds wide application in all fields of scientific endeavor . . . wherever there is a need to preserve data for later evaluation. The need for magnetic tape recording occurs in the fields of medicine, industrial measurement, nuclear and geological investigations, oceanography, and aerospace telemetry.

These applications are but a few; the total number is constantly expanding. The Hewlett-Packard magnetic tape recording systems described on the following pages are dependably and reliably meeting these needs.

HP magnetic tape recording systems

Instrumentation magnetic tape recording systems consist of three basic parts: (1) the tape transport, (2) the magnetic head assemblies, and (3) the record/reproduce electronics. In addition, the magnetic tape, itself, while not an integral part of the system, is an extremely important factor in overall system operation. In some instances, it is the tape that imposes the limitations of performance; *care* in selecting tape to match recording requirements is well justified.

The tape transport moves the tape past the head assemblies at a precise and constant speed.

HP transports do this with low wow and flutter, using a rugged, uncomplicated mechanism. By using a high degree of mechanical filtering in the form of viscous-damped flywheels, and controlled friction elements, each element along the tape path contributes toward uniform tape movement past the magnetic head assemblies.

The magnetic tape is reeled in a manner that insures no loss of valuable data from tape stretching, tearing, or other accidents. Fail-safe brake design, with optimum braking torque on each reel regardless of the direction of tape motion, assures fast, smooth starts and stops. Even during a power failure, there's no danger of tape spillage or stretching.

Any of six tape speeds are selected simply by depressing the appropriate pushbutton; no capstan or belt changes are required. *Snap-on* reel hub design allows one-handed mounting of tape reels; tape threading is quick thru the simple, uncluttered tape path.

The tape footage counter has consistently enabled users to locate specific data on tape with accuracies equivalent to 0.05%, even after repeated high-speed end-to-end shuttlings of a reel of tape.

No maintenance is required other than the normal cleaning of the heads and tape guides to remove tape oxide dust; even this is accomplished in a matter of *seconds*. The rugged cast aluminum transport frame, precision finished on numerically-controlled machine tools, assures proper alignment and interchangeability of all parts in the tape drive system; complex alignment or adjustments have been eliminated.

Magnetic head assemblies have both record and reproduce sections, one impressing the input data onto the tape as variations in magnetization, the other converting these variations back into electrical signals.

Instrumentation recorders use magnetic head assemblies with four head stacks: two for recording, two for reproducing. The tape first passes the head stack where the *odd*-numbered data channels are recorded, then past the next stack for recording the *even*-numbered channels. Likewise, the two following stacks reproduce the respective data tracks. It is this IRIG-compatible head-stack configuration that keeps interchannel crosstalk to a minimum; spacing between individual heads in each stack is maximized, while still recording 7 data channels on 1/2-inch tape, or 14 on 1-inch tape.

Hewlett-Packard designed and manufactured magnetic heads are uniquely coupled to current-sensing preamplifiers; it is this combination that offers users of HP tape systems an unprecedented signal-to-noise ratio at frequencies up to 1.5 MHz. All four head stacks are mounted on a single precision baseplate and prealigned for easy replacement in the field. Precision machining of all mating parts has eliminated the need for adjustments. (On the wideband, 1.5 MHz assemblies, minor azimuth adjustments of the reproduce heads assure optimum performance.)

Conversion from 1/2- to 1-inch tape width (to 14 channels) is straightforward and easily made at any time after original purchase. Only the head assembly, tape guides, pinch roller, and reel hubs need be changed. Kits are available for field conversion, thus, a system originally equipped for 7-channel operation is readily expanded to fourteen merely by installing the appropriate conversion kit and adding another 7 channels of record/reproduce electronics.

The record and reproduce electronics within a recording system applies the input data to the record heads and recovers the data from the reproduce heads. Direct, FM, and pulse electronics are used in present-day applications.

Record electronics presents a nominally high impedance to the data source to minimize loading; it also shapes the frequency response appropriately to assure a constant-flux recording characteristic over the required bandwidth. Record level meters are provided for data channel monitoring.

Reproduce electronics raises the microvolt-level signals from the reproduce heads to a usable output signal. Since these low-level signals are subject to noise pickup, the outstanding signal-to-noise ratio of the HP reproduce electronics becomes an even more important factor in the reliable reproduction of low level input signals.

Two types of electronics are used in Hewlett-Packard magnetic tape recording systems:

- 1) *Interchangeable* electronics, in the low cost 3907B, 3914B, 3917B, and 3924B systems.
- 2) *Manually switchable* electronics, in the more versatile, low-noise 3950 and 3955 Series systems.

For additional information on these, refer to the following pages.

MAGNETIC TAPE SYSTEMS

IRIG-compatible instrumentation recording

Series 3900, 3950, 3955



RECORDERS

The primary features of the Hewlett-Packard line of instrumentation magnetic recording systems are briefly highlighted on this page. The table, below, summarizes the basic capabilities of each system, with reference to specifics on the following pages.

All IRIG-compatible bandwidths are covered by HP systems, as shown to the right. In addition, the 3917B and 3924B systems (pages 164-165) offer *low-cost* intermediate-band recording for medical and industrial applications.

Features:

- Simple tape-threading, for operator convenience
- Tape-path cleaned in a matter of *seconds*
- A truly *accurate* tape-footage counter; precisely locate data previously recorded on tape
- All operational controls are front-panel accessible
- IRIG-compatible recording, for reproducing data on or from other tape systems
- Basic design concept: rugged construction for reliable operation; easy to service
- No cooling required by solid-state electronics
- Field convertible from 1/2" to 1" tape; provides for future 14-channel operation
- Wideband (1.5 MHz) direct recording with *phase equalization*, for optimum fidelity of reproduced signal

Two types of record/reproduce electronics are used in Hewlett-Packard magnetic tape recording systems:

(1) Low-cost electronics, with circuitry for each data-channel mounted on a *single* Insert card. These interchangeable, printed

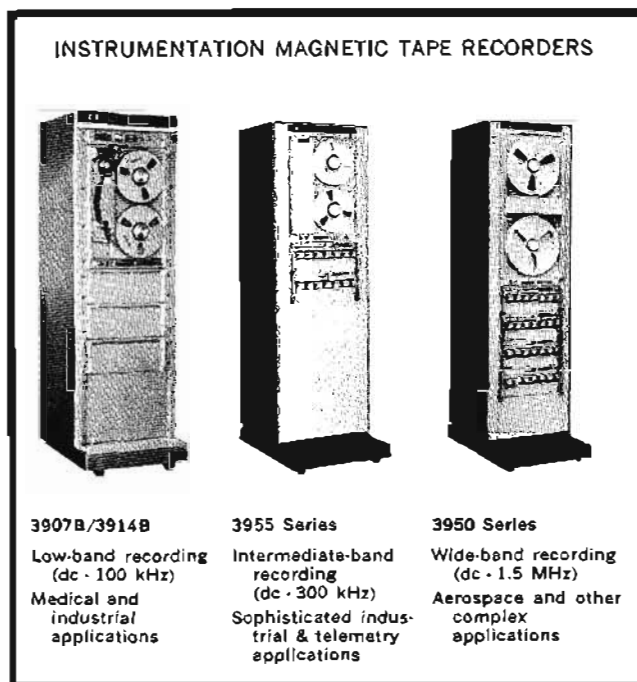

circuit cards may be selected for Direct, FM, or Pulse recording. Speed equalization is via front-panel-changeable plug-in networks. (Used with Models 3907B, 3914B, 3917B and 3924B.)

(2) The more flexible, multi-speed manually-switchable electronics offers greatly improved signal-to-noise ratios. The Record Amplifiers and Reproduce Amplifiers are separately packaged; this provides greater system flexibility and economy where, for example, there is need for fewer reproduce than record data-channels. Amplifiers, available for Direct or FM recording, house 3 of the 6 speed-equalization networks, selectable by front-panel push-bar operation. (Used with 3950 Series and 3955 Series systems.)

SYSTEM CAPABILITIES										
IRIG band	Bandwidth				Tape speed (max)	Reel size (max)	Number of tracks	tape width	model	see page
	Direct recording		FM recording							
	B.W.	S/N (dB)	B.W.	S/N (dB)						
LOW	100 Hz to 100 kHz	40*	dc-10 kHz	45*	60 ips	10 1/2"	7	1/2"	3907B	164-165
					60 ips	10 1/2"	14	1"	3914B	164-165
INTERMEDIATE	300 Hz to 250 kHz	35*	dc-20 kHz	45*	60 ips	10 1/2"	7	1/2"	3917B	164-165
					60 ips	10 1/2"	14	1"	3924B	164-165
	300 Hz to 300 kHz	40*	dc-20 kHz	48	60 ips	15"	14	1"	3955A	166-167
					60 ips	15"	7	1/2"	3955B	166-167
					60 ips	10 1/2"	14	1"	3955C	166-167
					60 ips	10 1/2"	7	1/2"	3955D	166-167
WIDE	400 Hz to 1.5 MHz	30*	dc-400 kHz	30	120 ips	15"	14	1"	3950A	168-169
					120 ips	15"	7	1/2"	3950B	168-169

* Measured with bandpass filter at output. Corner frequencies are those of specified bandwidth; rolloff is 18 dB/octave.

MAGNETIC TAPE SYSTEMS *continued*

Low-cost instrumentation recording
3900 Series (3907B, 3914B, 3917B, 3924B)

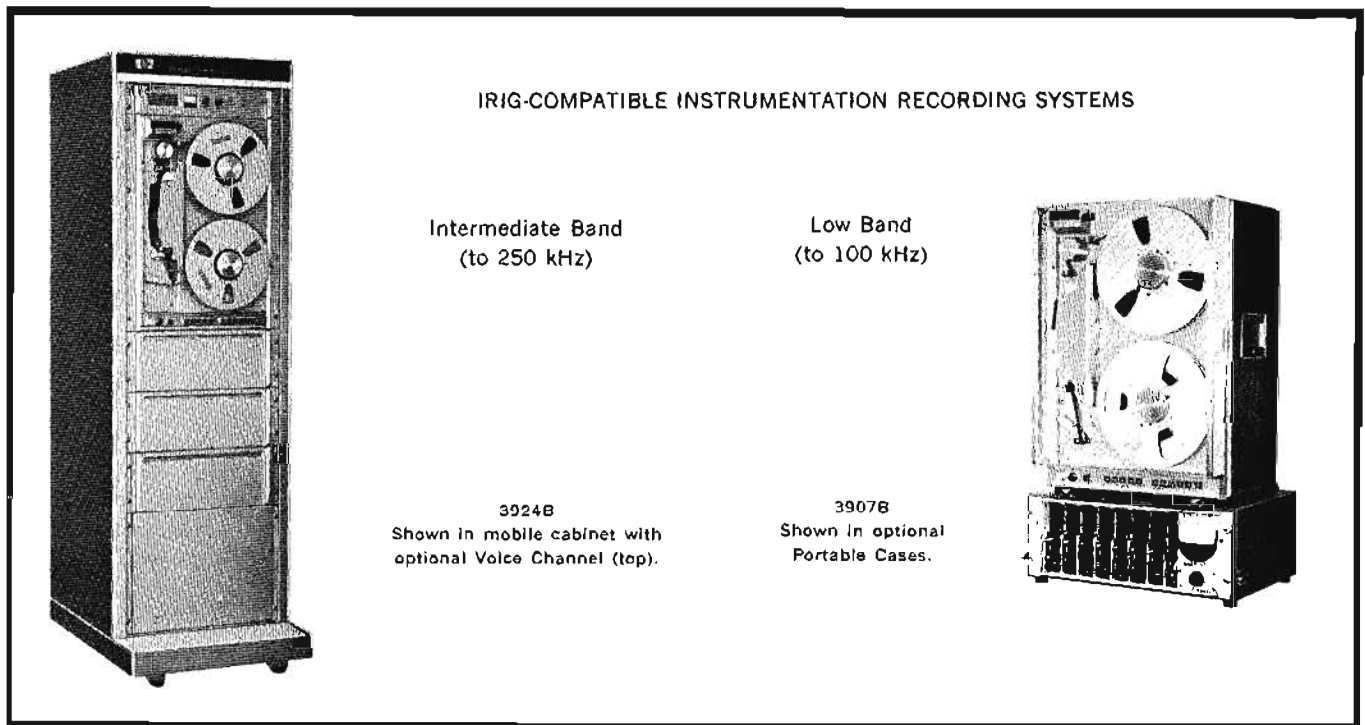

IRIG-COMPATIBLE INSTRUMENTATION RECORDING SYSTEMS

Intermediate Band
(to 250 kHz)

3924B
Shown in mobile cabinet with
optional Voice Channel (top).

Low Band
(to 100 kHz)

3907B
Shown in optional
Portable Cases.

Hewlett-Packard **Low-Band**, and low-cost **Intermediate Band** Instrumentation Recording is provided by the models described on this and the following page (also see the Table on page 163).

Both 7- and 14-channel operation are offered, with IRIG-compatible tape-speeds and recording bandwidths.

The **primary features** of these systems evolve from their use of low-cost, simplified electronics, making them especially suited to Medical and Industrial applications, plus general laboratory testing. It is all solid-state and mounted on front-panel-accessible printed-circuit cards for ease in making recording-mode changes.

Both the *Record* and the *Reproduce* electronics for a data-channel are on a single printed-circuit *Insert Card*. This combination offers more compact electronics, at lower cost.

Data-Channel Insert Cards are available for **Direct**, **FM**, and **Pulse** modes of recording, and can be all alike or mixed as desired to meet the requirements of data to be recorded on each of the 7 (or 14) channels.

For operation at the different tape-speeds, the data-channel electronics is compensated by sliding a small, sub-module "Direct-Equalization" or "FM Tuning" *Plug-in* printed circuit card into the appropriate Insert Card (none is required for Pulse recording). With the appropriate Plug-ins, the Insert Cards are ready for operation of any of the six standard tape speeds.

FM Flutter-Compensation is provided by channel 3 (3 and/ or 10 in 14-channel systems) to cancel the small amount of

noise induced by the transport. By placing the Compensation Switch to "ON", a signal is fed to the output of each of the other channels, effectively canceling the flutter signal; this feature improves the signal-to-noise ratio, over the bandwidth, at all tape speeds.

The **Insert Rack and Transfer Chassis**, located directly below the Tape Transport, contains the power supplies and all data-channel electronics; up to 8 Record/Reproduce Amplifier Inserts (one for the edge-track) are accommodated in each unit. It also provides built-in, switchable metering for data-channel set-up and monitoring; front-panel test points are provided for power-supply voltage testing.

Voice-channel commentaries are readily made using edge-track recording, by incorporating the Model 3907-06A Voice Channel Amplifier into your System (see 3924B photo). The magnetic heads on all models have the additional edge-track, and may be used for voice commentaries or time-coded data.

Transport Operating Controls include pushbuttons for **LINE** (power), **STOP**, **PLAY**, **REVERSE**, (*fast*) **FORWARD**, and **RECORD**. Both Record and Reproduce can be performed simultaneously for immediate display of the data being recorded. All Transport tape-speeds, 1 $\frac{7}{8}$ ips through 60 ips, are selected electrically by front-panel push-buttons. A remote-control connector is provided for complete recorder operation from another location.

The Transport can be easily converted in the field to accommodate either 1 $\frac{1}{2}$ " or 1" wide tape.

Complementary Instruments

Input Signal Coupler: Adapts 7 single-ended system inputs for use with push-pull transducers. **Price:** HP Model 3907-07A, \$395.

Control Panel: A central signal-distribution point for up to eight data-channels. Source data is from Tape or a preamplifier; outputs drive single-ended inputs of recorders or monitors, such as Poly-Beam Recorders, Thermal Recorders, Viso-Scopes, or a Magnetic Tape Recorder. **Price:** HP Model 568-2000A, \$1,750.**

Remote Control Panel: Includes all functions for Tape Recorder operation from another location. With 25' cable. Rack mounting optional. (See photo, pg. 170.)
Price: HP Model 3907A-11A, \$385.

Voice Channel Amplifier: Provides for edge-track recording of commentaries at same time data is being recorded. Edge-track is on all transports; only a Reproduce Preamplifier and Direct Record/Reproduce Insert must be added. Includes microphone.
Price: HP Model 3907-06A, \$250.

System Prices

(add appropriate Record/Reproduce Electronics)

Model 3907B , 7-track, Low-Band Systems	\$6,185
Model 3914B , 14-track, Low Band System	\$8,415
Model 3917B , 7-track, Intermediate-Band System	\$6,435
Model 3924B , 14-track, Intermediate-Band System	\$8,915

System Options

Less Cabinet; includes all hardware for 19" rack-mounting. Option 01:	\$505
Mounted in Portable Cabinets, (see photo, opposite page). Option 02: 7-channel systems	\$200
14-channel systems	no-change

Record-Reproduce Electronics

Direct Record-Reproduce Insert: Each *Direct recording* channel will require one data-amplifier *Insert*, plus a reproduce equalization *Plug-in* (listed below) for each tape speed to be used.
Price: HP Model 3900-12B, \$155 ea.

Direct Equalization Plug-Ins: These slide into Direct Insert (listed above) to equalize the reproduce electronics for particular tape speed to be used. Available for all six tape speeds.
Price: HP Model (depends on tape speed), \$40 ea.

FM Record-Reproduce Insert: Each *FM recording* channel will require one data-amplifier *Insert*, plus an FM carrier frequency tuning *Plug-in* (listed below) for each tape speed to be used.
Price: HP Model 3900-13B, \$198 ea.

FM Frequency plug-ins: These slide into FM Insert (listed above), to tune the FM carrier frequency appropriately for tape speed to be used. Available for all six tape speeds.
Price: HP Model (depends on tape speed), \$41 to \$45 ea.

Pulse Record-Reproduce Insert: (no plug-ins are required). Each Pulse recording data-channel will require one of these amplifier *Inserts*.
Price: HP Model 3900-14A, \$125 ea.

Reproduce Preamplifier: For use with Voice Channel Amplifier (Model 3907-06A). **Price:** HP Model 3900-10A, \$41 ea.

Power, Weight and Dimensions (all models)

System Power: 105 to 125 Volts RMS, 60 Hz. Approx. 350 watts.

System Weight: Approximately 500 lbs (225 Kg), net.

System Dimensions:
72 $\frac{3}{8}$ " high x 22-1/16" wide x 30" deep (1832 x 561 x 762 mm).

** Does not include system cables.

Condensed Specifications

(Common to Models 3907B through 3924B)

Note: for complete Specifications, request current Technical Data Sheet. Speed-dependent Specifications are shown (at 60 ips).

Tape Transport

Magnetic Tape: 3600 feet of 1-mil tape on 10 $\frac{1}{2}$ " reel.

Tape Speeds: 60, 30, 15, 7 $\frac{1}{2}$, 3 $\frac{3}{4}$ and 1 $\frac{7}{8}$ inches per second.

Drive Speed Accuracy: $\pm 0.25\%$ of nominal capstan speed with 60 Hz $\pm 0.03\%$ line; speed is directly proportional to line frequency.

Maximum Interchannel Time Displacement Error: $\pm 1 \mu s$ at 60 ips, between two adjacent tracks on same head stack.

Start Time: Approximately 4 seconds, maximum.

Stop Time: 1 second, maximum. Power-failsafe braking.

Rewind Time: approximately 150 seconds for 3600 foot reel.

Peak-to-Peak Flutter Characteristics (at 60 ips):

0.2% over 0 to 200 Hz bandwidth

0.3% over 0 to 1.5 kHz bandwidth

0.6% over 0 to 10 kHz bandwidth

Direct Electronics

Record Amplifier Input: 20,000 ohms input resistance, single ended. 0.5 to 10 V rms, adjustable.

Reproduce Amplifier Output: output impedance 100 ohms, max., single ended. Level adjustable from 1 V rms to 2.1 V rms at ± 3 mA. DC level adjustable ± 1.5 V.

Third Harmonic Distortion (conforms to IRIG stds.):

3907B and 3914B: 1% typical at 1 kHz, 60 ips.

3917B and 3924B: 1% typical at 500 Hz, 30 ips.

Bandwidth (at 60 ips):

3907B and 3914B: ± 3 dB, 100 to 100,000 Hz.

3917B and 3924B: ± 3 dB, 300 to 250,000 Hz.

Signal-to-Noise Ratio (at 60 ips):

3907B and 3914B: 40 dB* over 100 Hz to 100 kHz bandwidth.

3917B and 3914B: 35 dB* over 250 Hz to 250 kHz bandwidth.

FM Electronics

Record Amplifier Input: 20,000 ohms input impedance, single-ended, ± 2.5 V dc nominal, adjustable from ± 1.2 V to ± 3 V.

Reproduce Amplifier Output: output impedance 200 ohms, max. Single ended output is ± 2.5 V dc, nominal (at ± 3 mA, max.); adjustable from ± 1.2 V to ± 5 V. DC position adjustable ± 2 V.

Drift: $\pm 0.25\%$ max for 10°C change, 15°C to 35°C. $\pm 0.25\%$ max for 10 V line voltage change.

Linearity: maximum departure from a straight line, using 0% and +30% frequency deviation as reference points, will be:

3907B and 3914B: $\pm 1\%$

3917B and 3924B: $\pm 1.5\%$

Bandwidth (at 60 ips):

3907B and 3914B: +0, -1 dB from dc - 10 kHz

3917B and 3924B: +0, -1 dB from dc - 20 kHz

Signal-to-Noise Ratio (at 60 ips):

3907B and 3914B: 45 dB* over dc - 10 kHz bandwidth,

(48 dB* with Flutter Compensation).

3917B and 3924B: 45 dB* over dc - 20 kHz bandwidth.

Total Harmonic Distortion (at 60 ips):

3907B and 3914B: 1.2%

3917B and 3924B: 1.5%

FM Center Carrier Frequency (at 60 ips):

3907B and 3914B: 54 kHz, nominal.

3917B and 3924B: 108 kHz, nominal.

Pulse Electronics

Record Amplifier Input: 10,000 ohms input impedance, single ended. Rectangular, zero-based, negative-going pulse, -7 $\frac{1}{2}$ V to -30 V final amplitude.

Reproduce Amplifier Output: output impedance of 1,000 ohms; may be loaded. Single ended output of approx -11.8 V into open circuit is zero-based, rectangular pulse.

Pulse Characteristics (at 60 ips): (for 3907B and 3914B; specifications for 3917B and 3924B are shown in parentheses).

Maximum Rise Time: 4 (3) μs .

Minimum Input Pulse Duration:

50 (25) μs for output pulse reproduction accuracy.

10 (2) μs for any output pulse.

Pulse Reproduction Accuracy: ± 5 (± 10) microseconds.

* S/N ratio, as measured with external bandpass filter at output. Corner frequencies are those of specified bandwidth; rolloff is 18 dB/octave.

MAGNETIC TAPE SYSTEMS *continued*

Intermediate band (to 300 kHz) recording
3955 Series

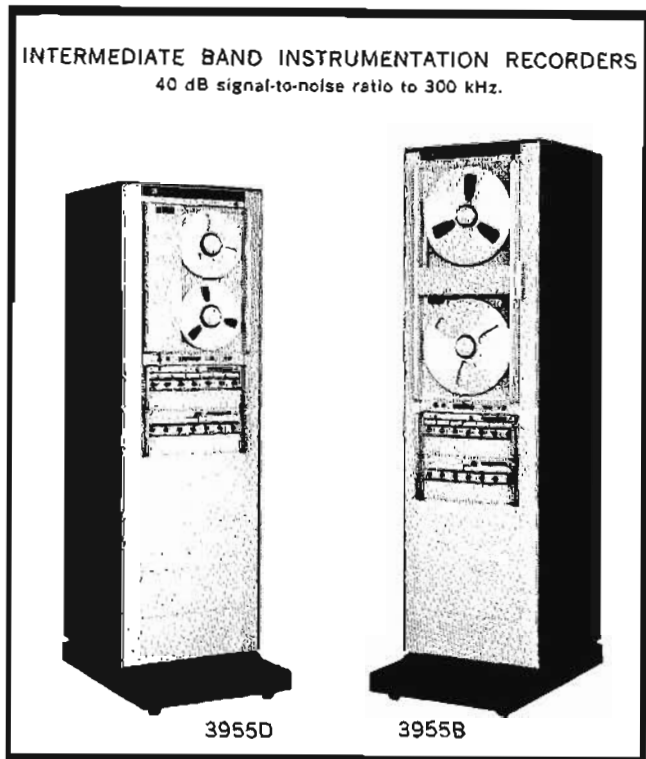

The HP 3955 Series Magnetic Tape Recorders provide you with highly flexible, yet easy-to-operate systems to record and/or reproduce electrical signals in their original form. Both 7- and 14-channel capacity is available; plug-in electronics (Direct and FM) can be intermixed as desired. Maximum bandwidth at 60 ips is 300 kHz for Direct recording, and 20 kHz for FM recording.

Each 3955 System includes a high-performance Tape Transport and a number of interchangeable Record and Reproduce Amplifiers, offering an extremely wide latitude in determining the exact system configuration. You can choose 7- or 14-track capability in *either* of two basic tape transports.

The smaller transport, which can handle tape reels up to 10½" in diameter, provides economy as well as performance. This transport is for applications requiring average recording times.

The larger transport accepts tape reels up to 15" in diameter to provide over 19 hours of recording time at a tape speed of 17/8 ips.

The 7- and 14-track Record and Reproduce Head Assemblies conform to the generally accepted industry-standards for magnetic heads and tape format, as specified by IRIG (Inter-Range Instrumentation Group). In addition, for best alignment, the head stacks are mounted on a single precision baseplate. Because they are prealigned, head assemblies are easily field replaceable.

Tape reels snap on and off specially-designed hubs, and the open tape path allows quick, convenient tape threading.

All operating controls for the system are located on the transport chassis. Pushbuttons are utilized throughout to obtain the desired mode of operation. Rear connectors are provided for remote control operation, accessories, and interconnecting cabling.

The transparent cover door completely encloses the reels and tape drive path to protect these parts from dust and damage. The control buttons are left uncovered for ready access when changing operating modes.

The transports are slide-mounted. When withdrawn, they can be tilted in either direction for complete front-of-system accessibility of all parts for maintenance purposes.

The outstanding electrical and mechanical performance of the tape transports used in the 3955 Series Tape Systems is inherent in their simple, straightforward design. The rugged cast aluminum transport frame is precision-finished on automated machine tools to insure proper alignment of all parts of the tape drive system. Close tolerances in the computer-controlled machining process assure parts interchangeability without need for complex alignment, adjustments, or shims in the transport mechanism.

Test Signals are provided by the Record Mainframe; 7 pushbuttons (see Figure 2) introduce test signals to the desired track. To apply a test signal, simply connect it to the front panel TEST INPUT jack and depress the appropriate pushbutton. This removes the normal data-signal and inserts the test-signal into the desired Record Amplifier.

In the Record mode the recorded test signal is simultaneously reproduced with a delay equal to 3.5 inches of tape length, and is available at the output of the appropriate Reproduce Amplifier. It can be monitored by depressing the channel pushbutton on the Reproduce Mainframe (see photo, page 169); this connects the reproduce monitor meter and front panel OUTPUT jack to the desired Reproduce Amplifier. Using this technique, it is easy to quickly check all channels for proper operation from the front panel.

With all their flexibility, the 3955 Systems are extremely easy to operate and maintain.

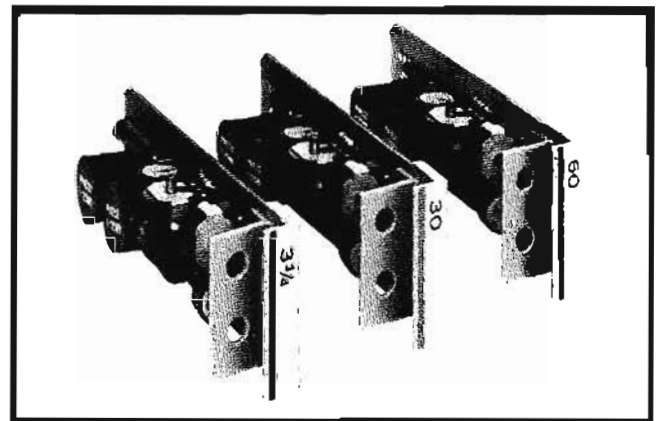

Figure 1. Tape-speed networks, changeable from front-panel.

Record and Reproduce Electronics

The solid-state Record and Reproduce Amplifiers for the 3955-Series are separately packaged, modular units, designed as front-panel plug-ins. Supply voltages, signal connections, and metering for all amplifiers are provided by the Record and Reproduce Mainframes. Two mainframes are used in 7-channel systems; four in 14 channel systems.

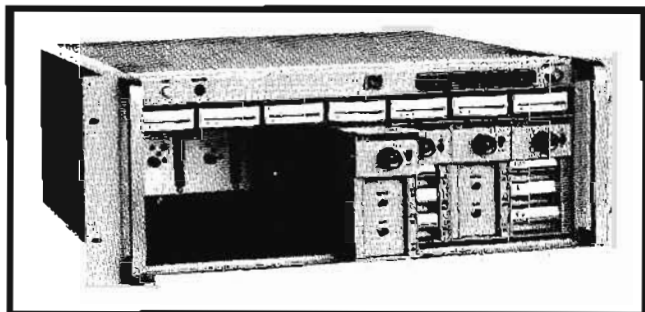

Figure 2. Record Mainframe, showing plug-in Record Amplifiers (Reproduce Mainframe is shown on Page 169).

A metal cover-door opens downward for Amplifier adjustment or removal (as shown in photo, above).

Direct electronics, with 300 kHz bandwidth, and FM electronics, with dc to 20 kHz bandwidth, is provided for the 3955-Series (see listing, below; also shown on page 168).

The Reproduce Amplifiers used in 3955 systems are especially well suited to the magnetic head characteristics. The HP pre-amplifier, which evolved from other areas of magnetic development in Hewlett-Packard laboratories, gives an *outstanding signal-to-noise performance*.

Different equalization is used for each tape speed. Each equalizer circuit is mounted on a convenient plug-in circuit card (Figure 1). The push-bar indicates with the tape speed numerically, as well as by a colored stripe to match the color of the speed pushbutton on the Tape Transport. Amplifiers accommodate equalizers for three tape speeds. The desired equalizer is selected by pushing on the equalizer push-bar. A mechanical "teeter-totter" automatically removes the previously operating equalizer from the circuit. The plug-in design of the equalizers allows reliable and rapid front-panel substitution of units for any speed, or of any entirely new set.

Prices for Record and Reproduce Electronics

Direct electronics: (to 300 kHz)

Direct Record Amplifier: HP Model 3534A, \$125 ea.
(no equalization plug-ins required).

Direct Reproduce Amplifier: HP Model 3537A, \$100 ea.
Direct Reproduce Equalizers**, \$25 ea.

FM electronics (dc to 20 kHz)

FM Record Amplifier: HP Model 3535A, \$210 ea.
FM Record Tuning Units**, \$15 ea.

FM Reproduce Amplifier: HP Model 3538A, \$170 ea.
With FM flutter compensation, Option 01, \$ (on request).
FM Reproduce Filter Units**, \$40 ea.

System Prices

System prices depend on number and type of record and reproduce amplifiers, plus complementary equipment included. The following include 7- or 14-channels of direct record and reproduce electronics; 3-speed equalization; no complementary equipment:

Model 3955A: 14-channel system; 15" max reel dia	\$14,500
Model 3955B: 7-channel system; 15" max reel dia	\$10,050
Model 3955C: 14-channel system; 10½" max reel dia	\$14,000
Model 3955D: 7-channel system; 10½" max reel dia	\$ 9,550

Condensed Specifications

(common to all 3955-Series models)

Note: for complete specifications, request current technical data sheet. Speed-dependent specifications are shown (at 60 ips).

Tape Transport

Magnetic tape: 3955A/B: 9200 feet of 1-mil tape on 15" reel (max). 3955C/D: 3600 feet of 1-mil tape on 10½" reel (max).

Tape speeds: 60, 30, 15, 7½, 3¾ and 1⅞ inches per second.
Drive speed accuracy: ±0.25% of nominal capstan speed with 60 Hz ±0.03% line; speed is directly proportional to line frequency.

Maximum time base error (TBE) (at 60 ips): 0.4 μs p-p jitter, max. over a 0.1 ms time interval.

Maximum interchannel time displacement error (ITDE): ±1 μs at 60 ips between two adjacent tracks on the same head stack.

Start time: within speed limits in approximately 6 seconds.

Stop time: 1 second, maximum. Power-failsafe braking.

Rewind time (approx): 4 min for 9200 feet; 2 min for 3600 ft.

Peak-to-Peak flutter characteristics (at 60 ips):

Within specs approx 10 seconds after start.

0.2%, p-p, over 0 to 200 Hz bandwidth.

0.3%, p-p, over 0 to 1.5 kHz bandwidth.

0.6%, p-p, over 0 to 10 kHz bandwidth.

Footage counter: 5 digits, ±0.05% accuracy.

Direct Electronics

Record amplifier input (3534A): input impedance: 20 K ohms min, shunted by 150 pF, unbalanced. Input signal level: 0.15 to 10 V rms, adjustable for IRIG-specified record level.

Reproduce amplifier input (3537A): output impedance: 50 ohms, nominal. Unbalanced output signal adjustable from zero to 1 V rms (0.5 V rms into 50Ω); IRIG-specified record level on tape.

Total harmonic distortion (with 3534A and 3537A amplifiers): 1.2% THD, or less, when recording at IRIG-specified level.

Bandwidth (at 60 ips): ±3 dB, 300 Hz to 300 kHz.

Signal-to-noise ratio (at 60 ips):

40 dB*, or better, over 300 Hz to 300 kHz bandwidth. (System noise is limited by the magnetic tape used.)

FM electronics

Record amplifier input (3535A): input impedance: 20 K ohms min, shunted by 150 pF, unbalanced. Input signal level: ±0.7 to ±15 volts peak, adjustable for ±40% carrier deviation.

Reproduce amplifier output (3538A): output impedance: 600 ohms, nominal. Unbalanced output signal is ±2.8 V p-p into matched load (5.6 V p-p, open ckt); adjustable down to 0.3 V p-p. DC position adjustable to 0 V dc at zero deviation.

Drift:

±0.4% max, for 10°F change, 32°F to 131°F.

±0.25% max, for 10 V line voltage change.

±0.5% of p-p output max, per 8 hrs (after 20 min warmup).

Linearity: ±1% max departure from a zero-based straight line.

Bandwidth (at 60 ips): +0.5, -1 dB from dc to 20 kHz, with 600 ohm load and output filter adjusted for flat amplitude response (also adjustable for best squarewave response).

Signal-to-noise ratio (at 60 ips): >48 dB over dc - 20 kHz bandwidth. (Further improved with FM flutter compensation ampl).

Total harmonic distortion (at 60 ips): 1.5%, maximum.

FM center carrier frequency (at 60 ips): 108 kHz.

Power, weight and dimensions

System power: 115 V ±10%, 60 Hz (230 V, 50 Hz optional).
440 to 460 watts, approx (14-track models); 330 to 350 watts, approx (7-track models).

System weight: (depends on number of channels and complementary equipment included; the following are typical):
675 lbs (304 kg), net, for in-cabinet 14-channel system.
575 lbs (257 kg), net, for in-cabinet 7-channel system.

System dimensions: (standard cabinet, with base with casters).
82½" h. x 23¾" w. x 35-11/16" d. (2099 x 607 x 907 mm).

* S/N ratio measured using bandpass filter at output. Corner frequencies are of specified bandwidth; rolloff is 18 dB/octave.

** Amplifiers accept three (3) tape speed compensating plug-ins, simultaneously. Part number depends upon tape speed specified; plug-ins are available for all six tape speeds.

MAGNETIC TAPE SYSTEMS *continued*

Wide-band (to 1.5 MHz) recording
3950 Series

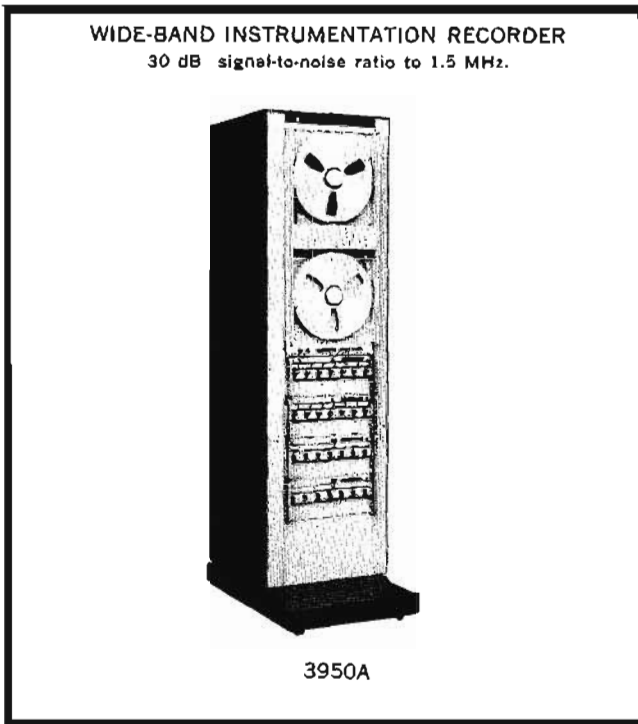

The 3950 Series Magnetic Tape Recorders are a versatile and reliable means for recording and/or reproducing large amounts of data. With up to fourteen record and reproduce channels, six electrically switchable operating speeds, and tape reel capacity up to 15 inches in diameter, these systems provide a wide choice of operating modes.

Each 3950 system includes a high-performance Tape Transport, plus Record and Reproduce Amplifiers for the number of data-channels desired.

Simple and straightforward design of both the Tape Transport and the amplifiers assures reliable operation with a minimum of routine adjustment and maintenance. System flexibility permits arrangement of its parts in any desired quantity and configuration. Systems can be expanded or rearranged quickly and easily at field locations.

Bandwidth of each Direct-recording channel is 400 Hz to 1.5 MHz, providing 17 minutes of recording time when using 15-inch reels and operating at the fastest speed of 120 ips. At its lowest standard speed of $3\frac{3}{4}$ ips, the system will record 400 Hz to 47 kHz for over 9 $\frac{1}{2}$ hours. With FM electronics, the bandwidth is from dc to 400 kHz at 120 ips, and dc to 5 kHz at $3\frac{3}{4}$ ips.

Outstanding electrical and mechanical performance is inherent in the simple, straightforward tape transport designed and built by Hewlett-Packard. The rugged cast aluminum transport frame is precision finished on automated machine tools to assure proper alignment of all parts of the tape drive system. Close tolerances in the computer-controlled machining process assure parts interchangeability without need for complex alignment or adjustments in the transport mechanism.

Exceptionally good motional stability is achieved by a tape drive system that is easy to thread and requires a minimum of maintenance.

The 7 and 14-track Magnetic Head Assemblies conform to generally accepted industry-standards for magnetic heads and tape format, as specified by IRIG (Inter-Range Instrumentation Group). The head stacks are mounted on a single precision baseplate. The prealigned head assemblies are easily field replaceable, within 10 minutes.

Tape reels snap on and off specially-designed hubs for maximum operator convenience.

All operating controls for the system are located on the transport chassis. Pushbuttons are utilized throughout to obtain the desired mode of operation. Rear connectors are provided for remote control operation, accessories, and interconnecting cabling.

A transport cover door completely encloses the reels and tape drive path to protect these parts from dust as well as possible damage. Control buttons are left uncovered for ready access to quickly change transport operating modes.

The transport is slide-mounted. When withdrawn from the rack, it can rotate in either direction from the vertical to provide complete front-of-system accessibility of both top and bottom of the transport for maintenance purposes.

Test Signals are provided by the Record Mainframe; 7-pushbuttons (see photo, page 167) introduce test signals to the desired track. To apply a test signal, simply connect it to the Record Mainframe front-panel TEST INPUT jack, and depress the appropriate pushbutton. This removes the normal data-signal and inserts the test-signal into the desired Record Amplifier.

In the Record mode, the recorded test signal is reproduced with a delay equal to 3.5 inches of tape length and is available at the output of the appropriate Reproduce Amplifier. It can be monitored by depressing the channel pushbutton on the Reproduce Mainframe (see Figure 2); this connects the reproduce monitor meter and front panel OUTPUT jack to the desired Reproduce Amplifier. Using this technique, it is easy to quickly check all channels for proper operation from the front panel.

The flexible 3950-Series systems are extremely easy to operate and maintain.

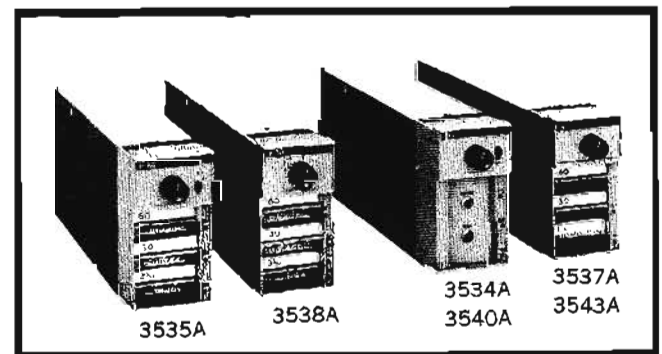

Figure 1. Record and reproduce amplifiers.

Record and Reproduce Electronics

Solid state Record and Reproduce Amplifiers for HP 1.5 MHz Recorders are modular units designed for front-panel plug-in mounting in the system Mainframes (see Figure 2). Two Mainframes are used in 7-channel systems; four in 14-channel systems. Each seven-channel Mainframe provides power supply voltages, signal connections and metering for all amplifiers.

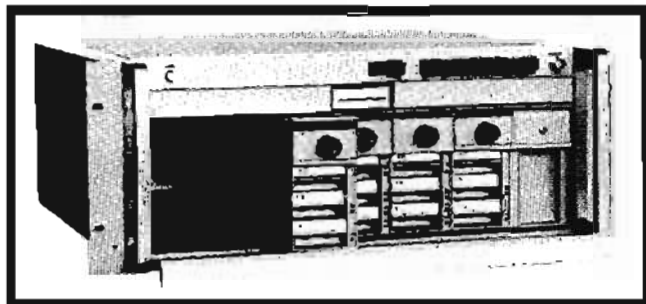

Figure 2. Reproduce Mainframe, showing plug-in Reproduce Amplifiers. (Record Mainframe is shown on page 167.)

A metal cover door opens downward (as shown in Figure 2) for access to adjustments, and easy removal of the amplifiers.

Direct electronics, with 1.5 MHz bandwidth, is provided for the 3950-Series (see listing, below). **FM electronics**, also used with the 3955-Series Systems (pages 166-167), provides dc to 20 kHz FM recording. Wideband FM Electronics (dc to 400 kHz) is available on special order.

A radical new kind of **Reproduce Amplifier**, especially well suited to magnetic head characteristics is used with the 3950-Series Systems. Also, the HP preamplifier, which evolved from other areas of magnetic development in Hewlett-Packard Laboratories, gives an *outstanding signal-to-noise performance*.

Different equalization is used for each tape speed. Each equalizer circuit is mounted on a convenient plug-in circuit card (shown on page 166). The push-bar indicates the tape speed numerically, as well as by a colored stripe to match the color of the speed pushbutton on the Tape Transport. The amplifiers accommodate equalizers for three tape speeds. The desired equalizer is selected by pushing on the equalizer push-bar. A mechanical "teeter-totter" automatically removes the previously operating equalizer from the circuit. The plug-in design of the equalizers allows reliable and rapid front-panel substitution of units for any speed, or of any entirely new set.

Prices for Record and Reproduce Electronics

Direct electronics (to 1.5 MHz)

Direct Record Amplifier: HP Model 3540A, \$170 ea. (no equalization plug-ins required).

Direct Reproduce Amplifier: HP Model 3543A, \$160 ea. Direct Reproduce Equalizers***, \$40 ea.

FM electronics (dc to 20 kHz)**

FM Record Amplifier: HP Model 3535A, Option 01, \$210 ea. FM Record Tuning Units***, \$15 ea.

FM Reproduce Amplifier: HP Model 3538A, \$170 ea. With FM flutter compensation, Option 01, \$ (on request). FM reproduce filter units***, \$40 ea.

System Prices

System prices depend upon the number and type of record and reproduce amplifiers, plus complementary equipment included. The following represent a full 7 or 14-channels of direct record and reproduce electronics; 3-speed equalization; no complementary equipment:

Model 3950A: 14-channel system; 15" max dia reels \$19,700
Model 3950B: 7-channel system; 15" max dia reels \$13,350

Condensed Specifications

(Common to both 3950A and 3950B)

Note: for complete specifications, request current technical data sheet. Speed-dependent specifications are shown (at 120 ips).

Tape Transport

Magnetic tape: (transports accept 10½", 14", or 15" NARTB reels).

4,600 feet of 1-mil tape (0.18 mil† oxide) on 10½" reel.

9,200 feet of 1-mil tape (0.18 mil† oxide) on 14" reel.

10,800 feet of 1-mil tape (0.18 mil† oxide) on 15" reel.

Tape speeds: 120, 60, 30, 15, 7½, and 3¾ inches per second.

Drive speed accuracy: ±0.25% of nominal capstan speed with 60 Hz ±0.03% line; speed is directly proportional to line frequency.

Maximum time base error (TBE) (at 120 ips): 3 μs p-p jitter, max, over a 0.1 ms time interval.

Maximum interchannel time displacement error (ITDE): ±0.5 μs at 120 ips (±1 μs at 60 ips) between two adjacent tracks on the same head stack.

Start time: within speed limits in approximately 6 seconds.

Stop time: 1 second, maximum. Power-failsafe braking.

Rewind time: approximately 4½ min for 9200 ft; 5 min for 10,800 ft.

Peak-to-peak flutter characteristics (at 120 ips):

0.2%, p-p, over 0 to 200 Hz bandwidth.

0.3%, p-p, over 0 to 1.5 kHz bandwidth.

0.6%, p-p, over 0 to 10 kHz bandwidth.

Footage counter: 5 digits, ±0.05% accuracy.

Direct Electronics

Record amplifier input (3540A):

Input impedance: 100 ohms, shunted by 70 pF, unbalanced.

Input signal level: 0.25 to 30 V rms, adjustable for IRIG-specified record level.

Reproduce amplifier output (3543A):

Output impedance: 75 ohms, unbalanced.

Output signal level: adjustable up to 1 V rms into 75 ohms with IRIG-specified record level on tape.

Total harmonic distortion (with 3540A and 3543A amplifiers): 1.2% THD, or less, when recording at IRIG-specified levels.

Bandwidth (at 120 ips):

±4 dB, 400 Hz to 1.5 MHz.

±3 dB, 10 kHz to 1.5 MHz.

Maximum rise time (at 120 ips): 0.4 μs with fundamental of squarewave at 150 kHz.

Signal-to-noise ratio (at 120 ips): 30 dB*, or better, over 400 Hz to 1.5 MHz bandwidth. (System noise is limited by the magnetic tape used.)

FM Electronics

The FM record and reproduce amplifiers used with the 3955 Series Magnetic Tape Systems (pages 166-167) are also plug-in compatible with the 3950 Series, offering a dc to 20 kHz bandwidth. Wideband (dc to 400 kHz) FM electronics is available on special order.

Pulse recording

The direct electronics includes an adjustable all-pass network for phase compensation of pulse response.

Power, weight and dimensions

System power: 115 V ±10%, 60 Hz (230 V, 50 Hz optional).

3950A: 600 watts (approx); 14-channel system.

3950B: 520 watts (approx); 7-channel system.

System weight: depends on number of channels, and complementary equipment included; the following are typical:

675 lb (302 kg), net, for 14-channel Model 3950A.

575 lbs (257 kg), net, for 7-channel Model 3950B.

System dimensions: (cabinet, including extended base with casters). 82¾" high x 23¾" wide x 35-11/16" deep (2099 x 607 x 907 mm).

* S/N ratio, as measured using bandpass filter (at output) with corner frequencies of specified bandwidth; rolloff is 18 dB/octave.

** Wideband FM Electronics, dc-400 kHz, available on special order.

*** Amplifiers accept three (3) tape speed plug-ins, simultaneously. Part number depends upon tape speed specified; plug-ins are available for all six tape speeds.

† Normally used for wideband recording applications.

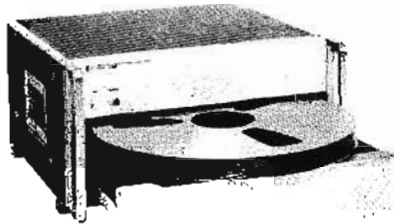
MAGNETIC TAPE RECORDERS *continued***Complementary Instrumentation**

Automatic
Tape Degausser
Model 3603A

Voice Channel
Model 3604A



AC Power Supply
Model 3680A



Tape Servo
Model 3681A

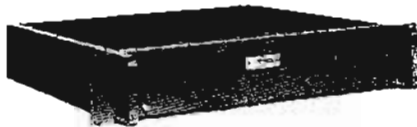

Remote Control Unit
Model 3907-11A

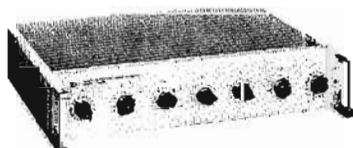

Reproduce
Track Selector
Model 11539A

Automatic Tape Degausser, HP Model 3603A \$900

Degausses magnetic tape to 90 dB below saturated recorded level. Automatic operation; complete erasure every time. Designed for continuous operation. Accepts 3" to 15" diameter reels; ¼" to 1"-wide tape. Use in rack or on table top.

Voice Channel, HP Model 3604A \$550

Records voice commentaries along with data. Provides for edge-track or multiplex recording. Multiplex operation combines voice with data for recording on any direct-record channel. Includes loudspeaker and retractable microphone.

FM Frequency Source (not shown), HP Model 3605A

Provides precise carrier-frequency signals for alignment of Model 3538A FM Reproduce Amplifiers. \$(on request)

AC Power Supply, HP Model 3680A \$875

Used to obtain crystal-controlled drive speed accuracy when system is operated from variable-frequency (47-63 Hz) power source. Eliminates minor tape speed changes resulting from abnormal frequency variations in the ac power line. Amplifier is driven from either an internal crystal or an external frequency source. Ideal for laboratory or field use, supplying up to 100 watts, 115 volts, at any frequency from 30 Hz to 1.5 kHz.

Tape Servo, HP Model 3681A \$(on request)

Generates IRIG-specified speed-control signal for recording on tape with data. When the tape is replayed, the reproduced speed-control signal drives the 3680A AC Power Supply (above); it, in turn, controls the tape speed such that data signals are reproduced at exactly the same frequency as recorded.

Remote Control Unit

Includes all functions for tape recorder operations from another location. With 25' cable. Rack mounting optional.

HP Model 3907-11A (for 10½" reel systems) \$385

HP Model 3907-11A, Option 02 (for 15" reel systems) \$395

Reproduce Track Selector

Permits system economy by using less than a full complement of Reproduce Amplifiers. Each front-panel switch connects any of the 14 recorded data-tracks to the input of a single Reproduce Amplifier. With seven switches available, only one Reproduce Mainframe, and from 1 to 7 Reproduce Amplifiers may be used with a 14 channel system.

HP Model 11539A, Option 01 (for 10½" reel systems) \$340

HP Model 11539A, Option 02 (for 15½" reel systems) \$340

Pack Sensor (not shown) HP Model 11553A \$350

Senses the remaining tape-pack on both supply and take-up reels. Permits system to be stopped before tape runs off end of reel; used for recycling tape, or turning on a second tape recording system before the first one runs out of tape. For 15" reel systems, only.

Continuous Loop Adapter (not shown)

Permits continuous recording or reproduction, using a tape-loop of from 6 to 125 feet in length. Mounts over take-up reel hub on 15" tape-reel systems (only). Window in cover door allows visual check of tape.

HP Model 13110A (for ½" tape) \$(on request)

HP Model 13111A (for 1" tape) \$(on request)

Electronic Instrumentation and Components

Amplifiers	438-448	Impedance	245-274
AC Precision Amplifier	446	Bridge, Q, and RX Meters	262-266
Data and Differential Amplifiers	440-442	Network Analyzers	255-260
General Purpose and Fast Pulse	443-447	Scattering Parameter Test Set	250
Microwave Amplifiers	448	Slotted Sections	272-274
Technical Information	438-439	SWR and Ratio Meters	270-271
Analyzers	416-437	Technical Information	245-249, 261, 267-268
Distortion Analyzers	418-421	Vector Impedance Meters	251-254
Loudness Analyzer	416-417	Leak, Friction Detectors	626-630
Spectrum Analyzers	430-437	Mixers, Modulators, Attenuators	397-405
Wave Analyzers	423-428	Noise Figure	414-415
Cabinets, Hardware	631-632	Nuclear	610-621
Coaxial, Waveguide	275-292	Detectors, HV Power Supply	619
Coaxial Instrumentation Chart	278-279	Multichannel Analyzer	612
Technical Information	275-276	Nuclear Instrument Modules	614
Waveguide Instrumentation Charts	280-285	Single Channel Analyzer	616
Communications Test Equipment	293-316	Oscilloscopes	449-506
Cable Fault Locators	296-298	Accessories	474, 479, 482, 503
Microwave Link Test Set	307-309	Cameras	504-506
Telephone Test Equipment	299-306	Instruments	454-501
TV Monitors, Cable Testing	310-316	<i>See also</i>	73, 74, 310-316
Ultrasonic Translators	293-295	Technical Information	449-553
DC Power Supplies	507-543	Power	406-413
Condensed Listing	509-511	Precision Analog Voltmeters	
Instruments	514-543	and Sources	182-195
Selection Guide	508	Instruments	186-195
Frequency	545-585	Technical Information	182-185
Auto Frequency Divider	582	Signal Sources	317-396
Digital Frequency Meter	567	Digital Noise Generator	330-331
Electronic Counters	551-579	Function Generators and Oscillators	332-350
Frequency Converters	580	Navigational Test Sets	371-375
Frequency Meters	583-585	Pulse and Square Wave Generators	318-329
IC Counters	564-566	Signal Generators	352-376
Plug-ins for		Sweep Generators	377-396
5245L-5247M	558-562	Solid State Devices	172-181
524 Series	577	Temperature-Physical Measurements	622-625
Technical Information and		Voltage, Current, Resistance	196-244
Selection Guide	545-550	Analog Meters	
Wavemeter	585	Instruments	201-222
Frequency, Time Standards	586-609	Technical Information	196-200
Cesium Beam Standards	590-592	Digital Meters	
Digital Clock	600	Instruments	227-242
Frequency Synthesizers	602-609	Technical Information	223-226
Quartz Oscillators	594-597	<i>See also:</i>	
Standby Power Supplies	593	Precision Analog Voltmeters	
Technical Information	586-509, 601	and Sources	182-195
VLF Comparator	598-599		
Complete Indexes	633-649		

SOLID STATE DEVICES



HP COMPONENTS

Successful production of quality components for tomorrow's electronic instruments and systems is greatly dependent on a delicate balancing of science, technology and manufacturing. HP has achieved this important balance, and as a result, has become a recognized leader in solid-state technology and manufacture of highly specialized devices. Our prime objective is the invention, engineering and production of devices unexcelled in contribution to the state of the art, in reliability and in total performance. Our organization has been optimized to achieve objectives with minimum time delay and expenditure of manpower. HP has already obtained the status of world leadership in the metal-on-semiconductor technology and is following in other technologies, such as optoelectronics, photoconductor, and microwave components.

The standard HP devices described on the following pages are available in the packages shown below. Other package configurations are, of course, available on request.

Step recovery diodes

HP introduced the Step Recovery Diode and continues to set the pace in

this technology. The recently announced 5082-0300 S-band diode was the first of a new generation of step recovery diodes. An X-band diode, the 5082-0320 is now available and a C-band diode, the 5082-0310, will soon follow.

Hot carrier diodes

Another HP development, the hot carrier diode has, in a few short years, proven its performance and reliability in major U.S. space programs and in critical instrument and industrial applications.

New production techniques have reduced the cost of these devices making them available for applications in TV tuners, commercial communication limiters, detectors and mixers, and for multiplexing in signal processing. New families of general purpose hot carrier diodes will be introduced in 1968.

Microwave mixer diodes

The constantly growing line of HPA microwave mixer and detector diodes described on page 174 is also available in matched pairs and matched quads. The 5082-2350 Series is designed for use to 2.5 GHz, the 5082-2520 Series for use to 6 GHz and the 5082-2600 Series for use

through 8 GHz. A new 5082-2700 Series is now available for use to 9.375 GHz.

Microwave devices

Since introducing its first microwave reflective switch two years ago, HPA has developed a broad line to meet the requirement of today's varied applications for solid-state switch/attenuators. In addition to their unique combined features of broad bandwidth, fast switching speed, high isolation, and high reliability, HP microwave switches are available with Type N, TNC, OSM, and stripline connector styles. HPA also offers single-pole-single-throw and single-pole-double-throw configurations. Last year HP introduced modular microwave mixers and limiters, as well as a new series of coaxial switches using a modular construction approach making possible N pole-N throw switching.

The state of the art

Throughout 1968 HP will also introduce new microwave comb generators, PIN absorptive modulators, broadband SPDT switches and modulators, and other hybrid integrated devices, including stripline and coaxial modules.

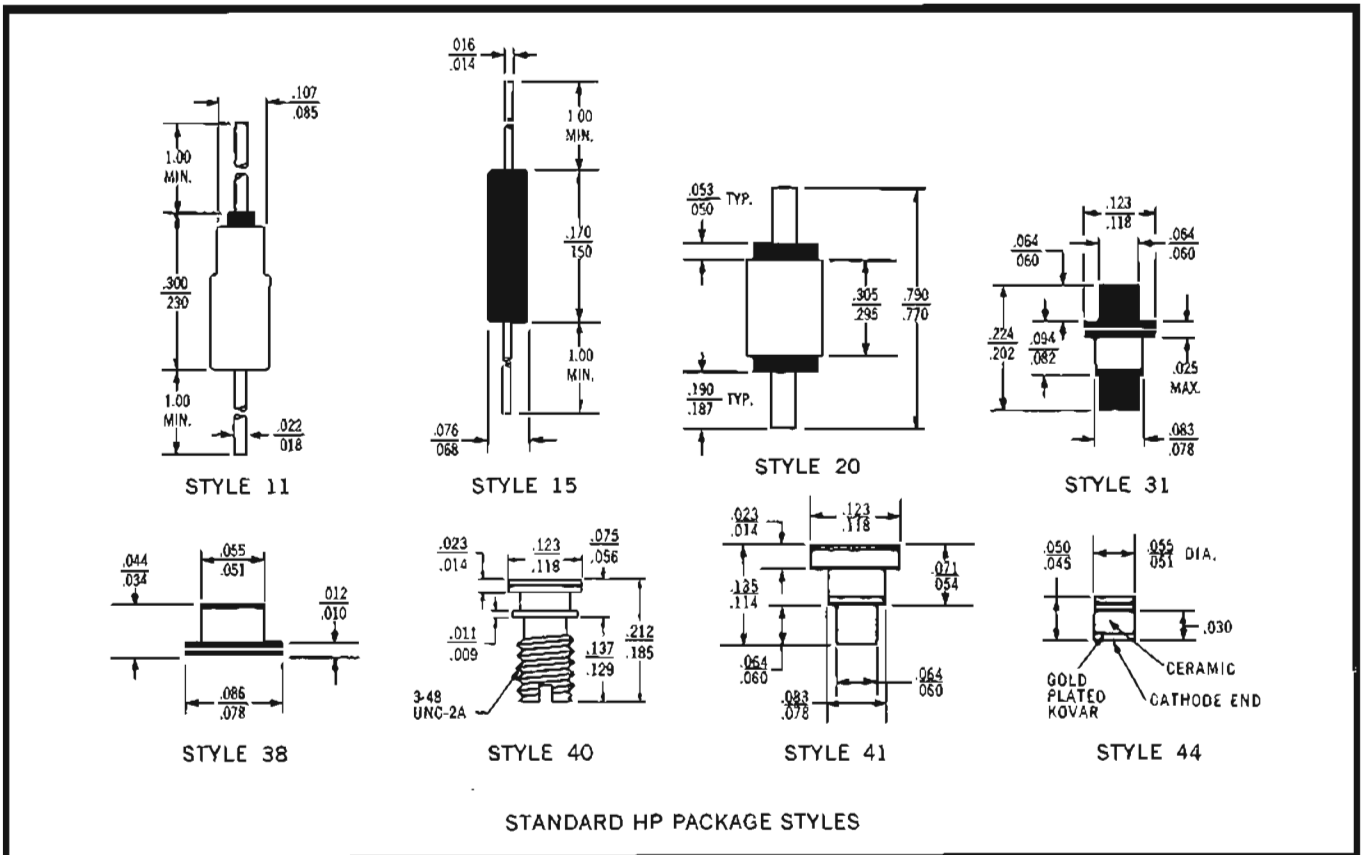

STEP RECOVERY DIODES

Pulse generation, shaping and pulse delay
Single stage, x 10, frequency multiplication



SOLID STATE DEVICES

HP step recovery diodes are epitaxial, surface-passivated silicon devices with abrupt junctions. Process control of the very abrupt junction gradient permits controlled charge storage. Environmental tests are performed to insure that they will meet the latest revisions of MIL-STD-750, MIL-STD-202, and MIL-S-19500.

These step recovery diodes, while conducting in the forward direction, store charge. When the reverse drive voltage depletes the stored charge (Figure 1), the diode appears as a high impedance. During this high impedance condition, a voltage impulse is generated (Figure 2). These pulses occur at a rate equal to the drive frequency. When this series of pulses is terminated in a resistive load, a comb spectrum is generated (Figure 3). By terminating the pulses in a resonant load, the spectrum is optimized at the desired output frequency for harmonic generation (Figure 4).

This device allows highly efficient generation of power at frequencies up to 12 GHz. The step recovery diode thus allows an exceptionally stable signal source by having the driving source a crystal oscillator.

The step recovery diode, as a pulse generating device, can provide pulses with less than 1 nanosecond rise and fall times and pulse amplitudes in excess of 10 volts into 50 ohms.

The pulse repetition rate is equal to that of the driving signal. Pulse sampling, stretching, storage and shaping can also be accomplished using extremely simple circuitry.

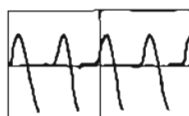

Figure 1. Step Recovery Diode Current



Figure 2. Step Recovery Diode Voltage



Figure 3. Comb Generation

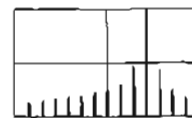

Figure 4. Harmonic Generation

HP Device	Package Style	Max. V_F @ I_F		C_0 Max.	V_{BR} Min.	Max. I_R @ V_R		τ Min.	Max. t_t @ I_F		θ_{JC} Max.
		V	mA			nA	V		ns	ps	
5082-0112	11	1.0	150	3.0	35	50	-30	50	300	15	300
5082-0132	31	1.0	150	3.0	35	50	-30	50	300	15	100
5082-0113	11	1.0	200	10.0	35	50	-30	90	500	10	300
5082-0133	31	1.0	200	10.0	35	50	-30	90	500	10	75
5082-0114	11	1.0	300	10.0	35	50	-30	125	400	10	300
5082-0134	31	1.0	300	10.0	35	50	-30	125	400	10	75
5082-0151	15	1.0	40	1.6	15	10	-10	20	150	15	600
5082-0251	31	1.0	40	1.6	15	10	-10	20	150	15	250
5082-0152	15	1.0	40	2.1	15	10	-10	20	150	15	600
5082-0252	31	1.0	40	2.1	15	10	-10	20	150	15	250
5082-0153	15	1.0	40	1.1	25	10	-10	20	150	15	600
5082-0253	31	1.0	40	1.1	25	10	-10	20	150	15	250
5082-0154	15	1.0	40	1.1	25	10	-10	20	200	15	600
5082-0254	31	1.0	40	1.1	25	10	-10	20	200	15	250
5082-0180	11	1.0	250	8.0	65	10	-30	100	500	10	300
5082-0240	31	1.0	450	8.0	65	10	-30	100	500	10	60
5082-0181	11	1.0	350	8.0	65	10	-30	100	500	10	300
5082-0241	31	1.0	600	8.0	65	10	-30	100	500	10	60
5082-0182	15	1.0	75	2.0	35	10	-10	30	200	15	600
5082-0242	31	1.0	100	2.0	35	10	-10	30	200	15	100
5082-0183	15	1.0	125	2.0	35	10	-10	30	150	15	600
5082-0243	31	1.0	150	2.0	35	10	-10	30	150	15	100
TEST CONDITIONS				$V_R = 0\text{ V}$ $f = 1\text{ MHz}$	$I_R = 10\ \mu\text{A}$			$I_F = 1.7\ I_R$			Note 1

Note 1: $P_{DISS} = \frac{175^{\circ}\text{C} - T_{case}}{\theta_{JC}}$ HP Style 11 and 15 packages are mounted on a printed circuit board in still air; HP Style 31 package is mounted on an infinite heat sink.

HP Device	Package Style	P_{OUT} @ 2 GHz		V_F @ I_F Max.		C_0		C_{VR}		V_{BR} Min.	τ Min.
		W		V	mA	pF Min.	pF Max.	pF Min.	pF Max.		
5082-0300	40	2.0		1.1	1000	3.0	11.0	2.5	6.5	65	100
TEST CONDITIONS		$P_{IN} = 15\text{ W @ } 200\text{ MHz}$				$f = 1\text{ MHz, } V_R = 10\text{ V}$		$f = 1\text{ MHz, } V_R = 10\text{ V}$		$I_R = 10\ \mu\text{A}$	$I_F = 1.7\ I_R$

HP Device	Package Outline	P_{OUT} @ 10 GHz		C_{VR}		V_{BR} MIN	τ MIN	θ_{JC} MAX
		mW		pF Min	pF Max			
5082-0320	41	150		0.7	1.3	20	10	50
TEST CONDITIONS		$P_{IN} = 2\text{ W @ } 2\text{ GHz}$		$f = 1.0\text{ MHz, } V_R = 10\text{ V}$		$I_R = 10\ \mu\text{A}$	$I_F = 1.7\ I_R$	Note 2



Microwave mixing diodes

Advantages:

- Low and stable noise figure
- High tangential sensitivity
- Uniform and repeatable RF characteristics
- High pulse burnout resistance
- Large dynamic range at high LO powers

Microwave mixer diodes employing metal semiconductor (Schottky) barriers offer improvements in noise figure, re-

liability, and dynamic range when compared to conventional point contact diodes. Conversion loss and noise figure are 1 to 2 dB lower than corresponding parameters of the best available point contact microwave devices and 1/f noise is better than 25 dB lower. Ruggedness, both physical and electrical, is superior, as is the basic device reliability. Consistent mixer performance can be readily attained with HP microwave mixer diodes because of (1) the relative ease with which they can be matched to 50 ohms and (2) the uniformity of the product resulting from advanced production techniques.

Test frequency		2.0 GHz			3.0 GHz				8.0 GHz			9.375 GHz
		15	19	20	15	19	20	38	15	19	20	44
NF ₀ †	Single	5082-2400	5082-2406	5082-2403	5082-2565	5082-2561	5082-2563	5082-2511	—	—	—	5082-2701
	Pair*	5082-2401	5082-2407	5082-2404	5082-2566	5082-2562	5082-2564	5082-2516	—	—	—	5082-2706
	Quad*	—	—	—	—	—	—	—	—	—	—	—
NF ₀	Single	5082-2365	5082-2415	5082-2366	5082-2550	5082-2556	5082-2553	5082-2512	5082-2601	5082-2611	5082-2621	5082-2702
	Pair*	5082-2418	5082-2416	5082-2417	5082-2551	5082-2557	5082-2554	5082-2517	5082-2606	5082-2616	5082-2626	5082-2707
	Quad*	—	—	—	5082-2552	5082-2558	5082-2555	—	—	—	—	—
NF ₀	Single	5082-2350	5082-2413	5082-2353	5082-2520	5082-2526	5082-2523	—	5082-2602	5082-2612	5082-2622	5082-2703
	Pair*	5082-2351	5082-2414	5082-2354	5082-2521	5082-2527	5082-2524	—	5082-2607	5082-2617	5082-2627	5082-2708
	Quad	5082-2374	—	—	5082-2522	—	—	—	—	—	—	—
Max VSWR		1.3			1.5				1.5			1.5
Z _{IF} (OHMS) Min-Max		100-250			100-250				125-250			250-400

†The Noise Figure stated is a single sideband receiver Noise Figure using a 30 MHz 1.5 dB IF amplifier. Local oscillator power is 1 mW.

*Noise Figure Match ΔNF₀ 0.3 dB max. IF Impedance Match ΔZIF 25 ohms max.

HOT CARRIER DIODES

For high speed switching



SOLID STATE DEVICES

Switching diodes

Advantages:

- Majority carrier conduction
- Low leakage
- High conductance
- Low forward threshold voltage
- High pulse power capability

These diodes utilize a closely controlled metal semiconductor junction which provides virtual elimination of charge storage. The result is extremely fast turn-on and turn-off times with

excellent diode forward and reverse characteristics. This process results in lower noise characteristics and wider dynamic range (conversion loss and noise figure are relatively insensitive to local oscillator power variations over the range of 0.5 mW to 20 mW). They are especially useful for mixer and detector applications to improve receiver sensitivity. Improved resolution in ultra-high speed sampling and switching networks is possible by combining the pico-second lifetimes, low capacitance and excellent forward to reverse characteristics of the device.

Single diodes

Device	Package outline	Max forward voltage	Min forward current	Max forward voltage	Min forward current	Min breakdown voltage V_{BR}	Max reverse current I_R	Max capacitance C_D	Max effective minority carrier lifetime τ
		V_{F1}	I_{F1}	V_{F2}	I_{F2}				
5082-2301	15	0.4 V	1.0 mA	1.0 V	50 mA	30 V	300 nA	1.0 pF	100 ps
5082-2302	15	0.4 V	1.0 mA	1.0 V	35 mA	30 V	300 nA	1.0 pF	100 ps
5082-2303	15	0.4 V	1.0 mA	1.0 V	35 mA	20 V	500 nA	1.2 pF	160 ps
5082-2305	15	0.4 V	1.0 mA	1.0 V	75 mA	30 V	300 nA	1.0 pF	100 ps
Test conditions						$I_R = 10 \mu A$	$V_R = 15 V$	$V_R = 0 V$ $f = 1.0 MHz$	
5082-2900	15	1.0 V	20 mA	0.4 V	1.0 mA	10 V	100 nA	1.5 pF	120 ps
Test conditions						$I_R = 10 \mu A$	$V_R = 5.0 V$	$V_R = 0 V$ $f = 1.0 MHz$	

Matched pairs and quads

Device	Package outline	Min breakdown voltage V_{BR}	Max reverse current I_R	Min forward current		Max forward voltage match ΔV_F	Max capacitance C_D	Max capacitance match ΔC_D	Max effective minority carrier lifetime τ
				I_{F1}	I_{F2}				
5082-2306 (matched pair 5082-2301, unencapsulated, unconnected)	15	30 V	300 nA	1.0 mA	50 mA	20 mV	1.0 pF	0.2 pF	100 ps
5082-2308 (matched pair 5082-2303, unencapsulated, unconnected)	15	20 V	500 nA	1.0 mA	35 mA	20 mV	1.2 pF	0.2 pF	100 ps
5082-2356 (matched bridge quad, epoxy encapsulated)		†	†	1.0 mA	35 mA	20 mV	†	0.2 pF	†
5082-2370 (matched quad, unencapsulated, unconnected)	15	20 V	500 nA	1.0 mA	35 mA	20 mV	1.0 pF	0.2 pF	100 ps
5082-2396 (matched ring quad, epoxy encapsulated)		†	†	1.0 mA	35 mA	20 mV	†	0.2 pF	†
Test conditions		$I_R = 10 \mu A$	$V_R = 15 V$	$V_{F1} = 0.4 V$ max	$V_{F2} = 1.0 V$ max	$I_F = 0.75$ to 20 mA	$V_R = 0$ $f = 1.0 MHz$	$V_R = 0$ $f = 1.0 MHz$	

Device	Min breakdown voltage V_{BR}	Max reverse current I_R	Max forward voltage		Max forward voltage match ΔV_F	Max capacitance C_D	Max effective minority carrier lifetime τ	
			V_{F1}	V_{F2}				
5082-2912 (matched pair 5082-2900, unencapsulated, unconnected)	10 V	100 nA	0.4 V	1.0 V	30 mV	1.2 pF	120 ps	
5082-2970 (matched quad, unencapsulated, unconnected)	10 V	100 nA	0.4 V	1.0 V	30 mV	1.2 pF	120 ps	
5082-2996 (matched ring quad, epoxy encapsulated)	†	†	0.4 V	1.0 V	30 mV	†	†	
5082-2997 (matched bridge quad, epoxy encapsulated)	†	†	0.4 V	1.0 V	30 mV	†	†	
Test conditions		$I_R = 10 \mu A$	$V_R = 5.0 V$	$I_{F1} = 1.0 mA$	$I_{F2} = 20 mA$	$I_F = 1.0$ to 10 mA	$V_R = 0 V$ $f = 1.0 MHz$	



Advantages:

- DC to 18 GHz bandwidth.
- Solid state hybrid integrated units.
- Low insertion loss.

HP passive microwave devices are versatile elements, ideally suited for a broad range of applications. Switches cover a range from dc to 18 GHz—and are available in coaxial-connected modules, stripline and coaxial integrated configurations. HP's new broadband limiter modules operate at any frequency between 400 MHz and 12.4 GHz with typical SWR of 1.5:1; they protect sensitive receiver elements against momentary power surges.

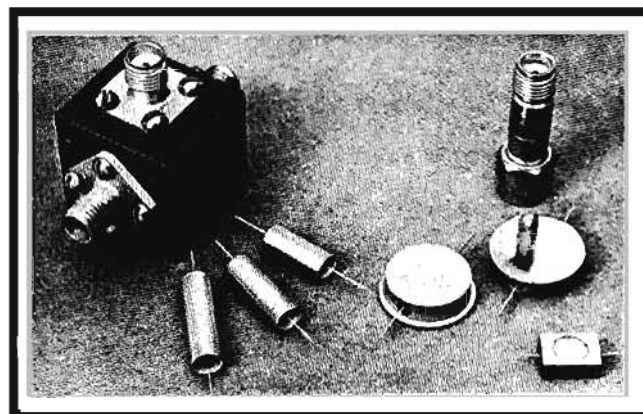

Switches with connectors

Device	Bias terminal	RF terminal	Bias polarity for switch OFF	Frequency range	Switching time	Insertion loss	Isolation	Price 1 - 9
33501A series	BNC	Optional TNC or N	Optional pos or neg	200 MHz to 12.4 GHz	100-300 ns	0.5 to 1.5 dB	25 to 45 dB	\$275
33550A series	3mm coax	3mm coax	Optional pos or neg	200 MHz to 12.4 GHz	100-300 ns	0.5 to 1.5 dB	25 to 45 dB	295
33560A series	3mm coax	3mm coax	Optional pos or neg	12.4 GHz to 18 GHz	100-300 ns	2.0 dB	45 dB	295
33570A series	BNC	Optional TNC or N	Pos	1 GHz to 12.4 GHz	10 ns	1.5 to 2.0 dB	30 to 35 dB	275
33580A	BNC	N	Neg	4 GHz to 8 GHz (SPDT)	15 ns	1.6 to 2.5 dB	70 to 90 dB	495
33006A	Sealectro	3mm coax	Neg	400 MHz to 18 GHz (SPDT)	100 ns	2.0 dB	50 dB	450

Switching modules/hybrid integrated

Device	Bias terminal	RF terminal	Bias polarity for switch OFF	Frequency range	Switching time	Insertion loss	Isolation	Price 1 - 9
33530A	Stripline integrated unit, wire leads		Neg	DC to 12.4 GHz	50 ns	0.5 to 1.5 dB	24 to 45 dB	\$125
33531A			Neg	12 to 18 GHz	50 ns	1.5 dB	45 dB	125
33535A			Neg	DC to 18 GHz	50 ns	0.5 to 1.5 dB	24 to 45 dB	125
33540A			Pos	DC to 12.4 GHz	10 ns	0.5 to 2.0 dB	20 to 45 dB	125
33602A	Coaxial integrated unit, wire leads		Neg	DC to 18 GHz	50 ns	0.7 dB	40 dB	100
33603A			Neg	DC to 18 GHz	75 ns	0.8 dB	60 dB	150
33604A			Neg	DC to 12.4 GHz	100 ns	1.0 dB	80 dB	175
33622A			Pos	DC to 18 GHz	10 ns	0.7 dB	33 dB	100
33623A			Pos	DC to 12.4 GHz	15 ns	0.7 dB	45 dB	150
33624A			Pos	DC to 12.4 GHz	25 ns	0.6 dB	60 dB	175

Device	RF terminal	VSWR	Insertion loss	Limiting threshold	CW power leakage	Pulse power flat leakage	Spike leakage	Price 1 - 9
33701A	Coaxial integrated unit, wire leads	1.5:1	0.8 dB	10-15 mW	50-60 mW	150 mW	0.1 erg	\$100
33711A	One male, one female 3mm coax connector	1.5:1	0.8 dB	10-15 mW	50-60 mW	150 mW	0.1 erg	125

MICROWAVE DEVICES

Mixer/detectors, hybrid integrated devices



SOLID STATE DEVICES

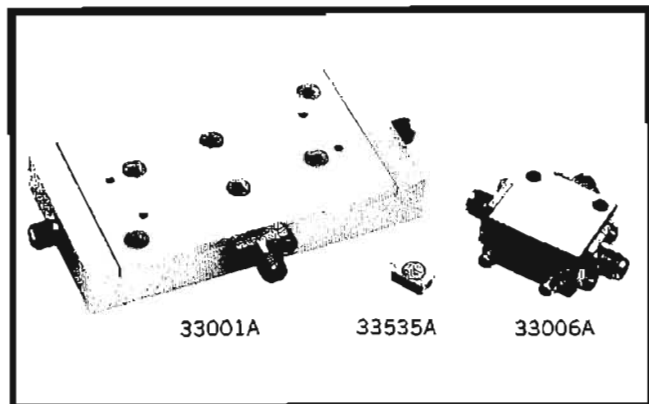

HP's new mixer/detector modules operate from 2 to 12.4 GHz with a typical SSB noise figure of 7.5 dB. They are available as singles or matched pairs. Also available now are new PIN absorptive modulators, single-pole-double-throw switches and modulators, as well as other hybrid integrated devices.

Mixer/detectors

Device	RF terminal	Output	SSB NF ₀	Δ NF ₀	Z _{IF}	Δ Z _{IF}	VSWR	Tangential sensitivity	Price 1 - 9
33801A	One male, one female 3mm coax connector	Neg	7.5 dB		80 Ω		1.7:1	-50 dBm	\$125
33802A	One male, one female 3mm coax connector	Pos	7.5 dB		80 Ω		1.7:1	-50 dBm	125
33803A	Matched pair of 3801 and 3802			0.3 dB		25 Ω	1.7:1		275

PIN absorptive modulators

Device	Bias terminal	RF terminal	Bias polarity for max. attenuation	Frequency range	Power handling capability	Residual attenuation	Dynamic range	Price 1 - 9
33000A	3mm coax	3mm coax	Neg	800 MHz to 4.2 GHz	2 W CW 100 W peak	1.5 dB	40 dB	\$395
33001A	3mm coax	3mm coax	Neg	8 GHz to 18 GHz	2 W CW 100 W Peak	2.0 dB	40 dB	395

Comb generators

Device	Input frequency	RF terminals	Output frequency	Power Input	Power output of discreet line spectra	VSWR max		Price 1 - 9
						Input	Output	
33002A	100 MHz \pm 10%	3mm coax	All integral multiples of input frequency	to 12.4 GHz	500 mW -6 dBm to 4 GHz -28 dBm @ 12.4 GHz	3:1	3:1	\$175
33003A	250 MHz \pm 10%	3mm coax		to 15 GHz	500 mW -6 dBm to 6 GHz -20 dBm @ 15 GHz	3:1	3:1	175
33004A	500 MHz \pm 10%	3mm coax		to 18 GHz	500 mW -6 dBm to 8 GHz -20 dBm @ 18 GHz	3:1	3:1	175
33005A	1 GHz \pm 10%	3mm coax		to 10 GHz	500 mW -6 dBm to 10 GHz -15 dBm @ 20 GHz	3:1	3:1	175



High Conductance Diodes

Advantages:

- High conductance
- Low capacitance
- Nanosecond turn-on and turn-off

The HP 1000 Series of high conductance diodes feature planar silicon epitaxial construction to provide high conduc-

tance, low capacitance, and nanosecond turn-on and turn-off. Process control of the diode manufacture enables specification of effective minority carrier lifetime. Turn-on time and voltage overshoot are minimized in these diodes of low conductivity modulation. These diodes are ideally suited for applications such as thin film memory drives, pulse generation, input gates, or wherever high conductance is required without loss of speed.

HP Type No.	Package outline	Forward Current I_{F1} min	Forward Current I_{F2} min	Breakdown Voltage V_{BR} min	Reverse Current I_{R1} max	Reverse Current I_{R2} max (160°C)	Capacitance C_D max	Reverse Recovery Time t_{rr} max	Turn-on Time t_{on} max	Rectification Efficiency R.E. Typ	Price	
											1-99	100-999
5082-1001	11	150 mA	500 mA	35 V	200 nA	200 μ A	1.5 pF	1.5 ns	2.5 ns	65%	\$4.25	\$3.20
5082-1002	11	300 mA	800 mA	35 V	200 nA	200 μ A	3.0 pF	2.0 ns	2.5 ns	65%	4.40	3.30
5082-1003	11	100 mA	300 mA	25 V	200 nA	200 μ A	2.0 pF	1.5 ns	2.0 ns	65%	3.10	2.35
5082-1004	11	200 mA	600 mA	25 V	200 nA	200 μ A	4.0 pF	2.0 ns	2.0 ns	65%	3.35	2.50
5082-1006	11	150 mA	500 mA	50 V	200 nA	200 μ A	1.1 pF	1.5 ns		65%	5.15	3.85
Test conditions		$V_F = 1.0$ V (Note 1)	$V_F = 1.4$ V (Note 1)	$I_R = 10$ μ A	(Note 2)	(Note 2)	$V_R = 0$ V $f = 1.0$ MHz					

Note 1: Measured at a repetition rate not to exceed the power dissipation.

Note 2: $V_R = 35$ V for 1006; $V_R = 30$ V for 1001, 1002; $V_R = 20$ V for 1003, 1004.

PIN Diodes

Advantages:

- New method of modulating/switching microwave signals.
- Surface passivated for improved stability and reliability.

These devices make possible a new method of modulating microwave signals. When placed across a transmission line, the device acts as an absorption-type attenuator and allows sine-wave, square-wave and pulse modulation with no frequency pulling of the signal source. Turn-on times of less than 20 nsec for an on-off ratio of greater than 30 dB are possible. Planar passivation insures long-term stability and reliability. The HP PIN diodes are especially useful where the lowest possible residual series resistance and junction capacitances are required for high on-to-off switching ratios.

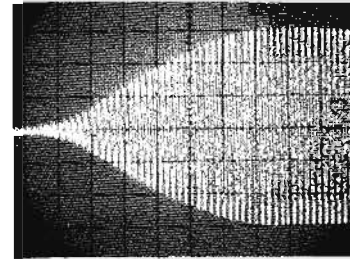

This oscilloscope shows a 100 mV RF carrier modulated by PIN diodes. It is shown turning on in less than 20 ns. Sweep speed is 5 ns/cm.

HP Type No.	Package outline	Min breakdown voltage V_{BR}	Max total capacitance C_{VFR} (Note 1)	Max residual dual series resistance R_S	Min effective minority carrier lifetime τ	Price	
						1-9	10-99
5082-3001	15	150 V	0.30 pF	1.5 Ω	100 ns	\$13.35	\$11.35
5082-3002	15	200 V	0.25 pF	1.5 Ω	100 ns	15.65	13.30
5082-3039	15	100 V	0.40 pF	2.0 Ω	75 ns	5.50	5.00
5082-3101	38	150 V	0.32 pF	1.5 Ω	100 ns	27.00	23.00
5082-3102	38	200 V	0.30 pF	1.5 Ω	100 ns	30.00	25.50
5082-3201	31	150 V	0.35 pF	1.5 Ω	100 ns	22.00	18.75
5082-3202	31	200 V	0.32 pF	1.5 Ω	100 ns	25.00	21.25
Test conditions		$I_R = 10$ μ A	$V_R = 50$ V	$I_F = 100$ mA	$I_F = 50$ mA		

Note 1: Forward voltage specification is at 100 mA for the HP 3001, 3101, and 3201; 150 mA for the HP 3002, 3102, and 3202

PHOTOCONDUCTOR DEVICES

Photocells, photochoppers, photo controlled resistors



SOLID STATE DEVICES

Advantages:

- Long life
- Low noise and offset
- High efficiency
- Low driving power consumption
- High stability
- Large dynamic range

HP photoconductor devices utilize specially designed, hermetically sealed photocells manufactured by HP. The photocells are illuminated with self-contained neon glow lamps (incandescent bulbs in the HP 4510), stabilized and selected to provide long life and reliable operation. The photochoppers (HP 5082-4511/12/13/14) contain two synchronous SPDT switches for applications requiring series-shunt modulation and demodulation, while the photomodulators contain one SPDT switch for applications requiring modulation only. The HP 4507 and 4508 PCR's are ideally suited for applications where SPST switching is required, while the 4510 is suited for applications requiring electrically controlled resistances.

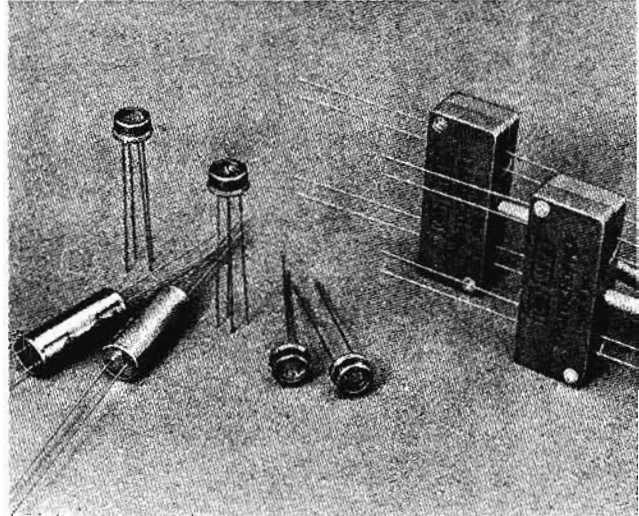

Photocells

The 5082-4600 series are Cadmium Sulfo-Selenide photocells optimized for speed and stability for use in switching, chopping, and control circuits. The cells are hermetically sealed in a TO-5 package and have an optional integral electrostatic shield. Electrical specifications are given at 25°C. The HP 5082-4610 Dual Photocell contains two completely independent and isolated photocells in a hermetically sealed TO-5 package with an integral electrostatic shield. Uses for the HP 5082-4610 include full-wave choppers where offset, drift, and small size are important — and control areas where tracking of two independent photocells is important with respect to time, temperature, and light level.

Device	Shield	R _{LIT} kΩ = 60%	R _{DARK} MΩ typ	Delay time msec typ	Price	
					1 - 9	10 - 99
5082-4601		100	500	1.2	\$2.90	\$2.45
5082-4603	yes	120	500	1.2	3.05	2.60
5082-4602		4	500	1.2	2.90	2.45
5082-4604	yes	5	500	1.2	3.05	2.60
5082-4606		10	500	1.2	2.90	2.45
5082-4608	yes	12	500	1.2	3.05	2.60
5082-4610	yes	15	500	0.7	6.00	5.10

Photo Controlled Resistors

Device	Description	Typical impedances	Drive	Price	
				1 - 9	10 - 99
5082-4507	SPST, High Z	"ON" R 150 kΩ "OFF" R 100 MΩ	150 V peak 1 kHz max	\$8.00	\$6.80
5082-4508	SPST, Low Z	"ON" R 6.8 kΩ "OFF" R 100 MΩ	150 V peak 1 kHz max	8.00	6.80
5082-4510	SPST, Low Z	"ON" R 1 kΩ "OFF" R 100 MΩ	12 V peak	8.00	6.80

Photochoppers

Device	Modulator				Demodulator			Price	
	R _S	R _P	α	Offset	R _S	R _P	α	1 - 9	10 - 99
5082-4511 Min Typ Max	360 kΩ 1.8 MΩ	72 kΩ 290 kΩ	15 25	1.0 μV	15 kΩ 75 kΩ	3 kΩ 12 kΩ	15	\$25.00	\$21.00
5082-4512 Min Typ Max	15 kΩ 75 kΩ	3 kΩ 12 kΩ	15 25	1.0 μV	15 kΩ 75 kΩ	3 kΩ 12 kΩ	15 25	25.00	21.00
5082-4513 Min Typ Max	360 kΩ 1.8 MΩ	72 kΩ 290 kΩ	15 25	1.0 μV				18.00	15.25
5082-4514 Min Typ Max	15 kΩ 75 kΩ	3 kΩ 12 kΩ	15 25	1.0 μV				18.00	15.25



Ultrafast, low-noise silicon PIN photodiodes

The HP silicon planar PIN photodiodes are ultrafast light detectors for visible and near infrared radiation. Their response to blue and violet is unusually good for low dark current silicon photodiodes.

The speed of response of these detectors is less than 1 nanosecond. Laser pulses shorter than 0.1 nanosecond may be observed. The frequency response is dc to 1 GHz.

The low dark current of these planar diodes enables detection of very low light levels. The quantum detection efficiency is constant over six decades of light intensity, providing an excellent dynamic range.

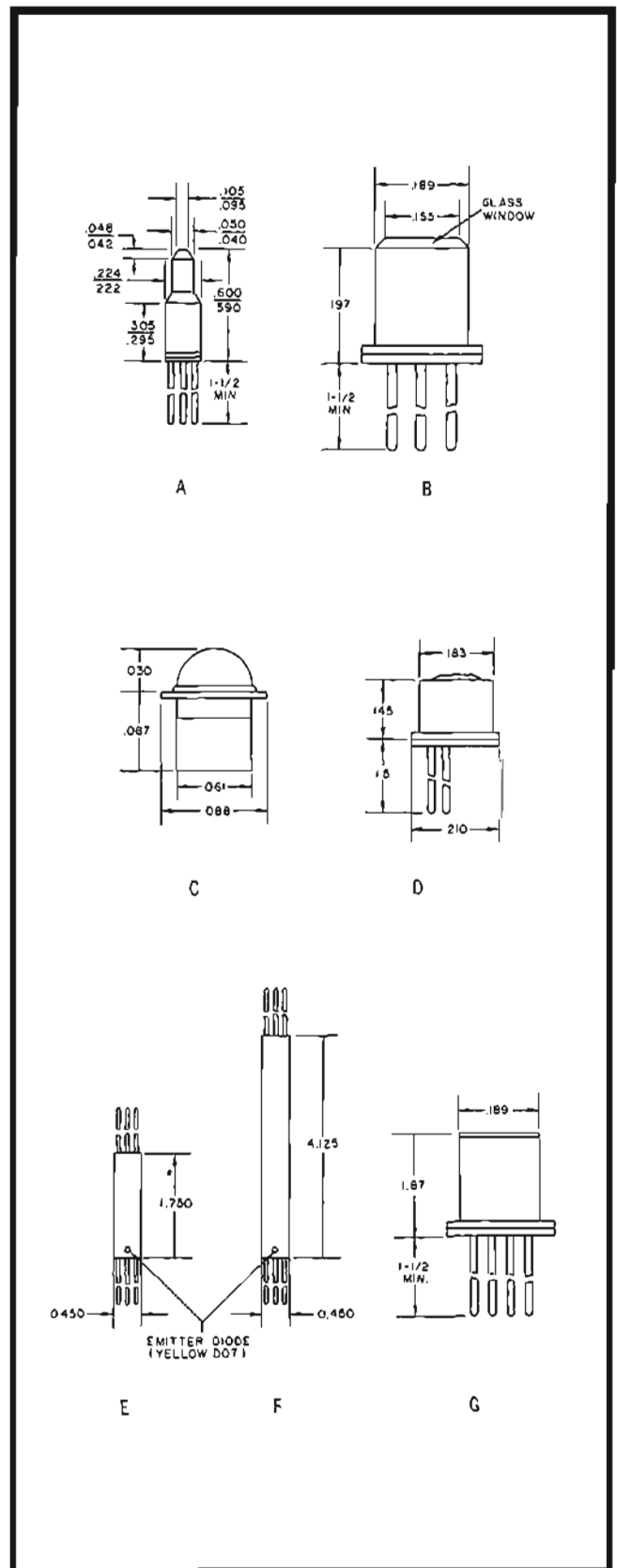

Gallium arsenide infrared sources

The HP gallium arsenide electroluminescent diode, when forward biased, radiates at very high intensity a narrow band of infrared light at about 900 Angstroms.

The HP 5082-4100 Series can be used in conjunction with the 5082-4200 Series to form fast photon coupled pairs for convenient use in card and tape readers, encoders, and similar applications.

Photon coupled isolators

The HP photon coupled isolator is a wide bandwidth dc coupling device consisting of a gallium arsenide electroluminescent diode infrared source and a silicon PIN photodiode. Electrical input signals are applied to the GaAs diode, which emits infrared radiation in proportion to the instantaneous forward current. This radiation is detected by the photodiode, which is well insulated from the emitter. The electrical signals resulting at the photodiode can thereby be controlled from an input in a separate and electrically isolated circuit. The isolation between input and output is typically 10^{11} ohms. The device will operate on both ac and dc signals and has a bandwidth > 3.5 MHz.

GaAs Sources

Device	5082-4104	5082-4108	5082-4107	5082-4120	Units
Total power output P	120	200	100	100	μ W
Modulation risetime	70	100	100	100	ns
Package outline	A	B	C	D	

PIN Photodiodes

Device	5082-4201	5082-4203	5082-4204	5082-4205	5082-4207	5082-4220	Units
Response at 7700 Å	1.0	1.0	1.0	1.5	4.0	1.0	μ A/mW/cm ²
Sensitive area diameter	2×10^{-3} 0.020	2×10^{-3} 0.020	2×10^{-3} 0.020	3.0×10^{-3} 0.010	8×10^{-3} 0.040	2×10^{-3} 0.20	cm ² inches
Speed of response	<1	<1	<1	<1	<1	<1	ns
Dark current (max)	2000	2000	400	150	1000	5000	pA
Package outline	A	B	B	C	B	D	

Photon Coupled Isolators

Device	5082-4303	5082-4309	5082-4310	5082-4320	Units
DC current transfer I_2/I_1	0.0004	0.0004	0.002	0.0015	
Cutoff frequency of current transfer	3.5	3.5	3.5	3.5	MHz
Coupling capacitance	0.01	0.01	2	2	pF
Isolation voltage	20,000	50,000	200	200	Volts
Package outline	E	F	G	G	

PRECISION ANALOG VOLTMETERS AND SOURCES



PRECISION ANALOG VOLTMETERS & SOURCES

As industrial and military electronics become more sophisticated, measurements require greater precision in normal working environments. To help alleviate today's measurement demands, Hewlett-Packard offers a broad line of precision instruments.

Traceable to NBS

The absolute accuracy of Hewlett-Packard's precision instruments and calibrators is traceable to the National Bureau of Standards, as shown in the flow chart, Figure 1. Special care has been taken to develop instruments with state-of-the-art stability so that specified accuracy and traceability can be maintained for long periods of time.

0.02% ac source

Available for the first time, ac voltages can be calibrated over a continuous wide band of frequencies with the accuracy of a dc calibration system.

The HP Model 745A AC Calibrator with a continuous frequency of 10 Hz to 110 kHz has a voltage accuracy of $\pm 0.02\%$ from 20 Hz to 20 kHz. Long-term stability is $\pm 0.01\%$ over a 6-month calibration period. Six voltage ranges from 1 mV to 100 V full scale (1 additional range reserved for future 1000 V amplifier) are available with a 6-digit readout and 10% overrange capability. The error of the instrument under test can be read directly in percent of reading without time-consuming calculations.

The 745A is programmable for both frequency and voltage ranges. Provision for local or remote sensing is obtained through a front-panel switch with separate sense-output terminals for remote sensing.

The accuracy of this ac calibrator is dependent on an ultra stable Zener

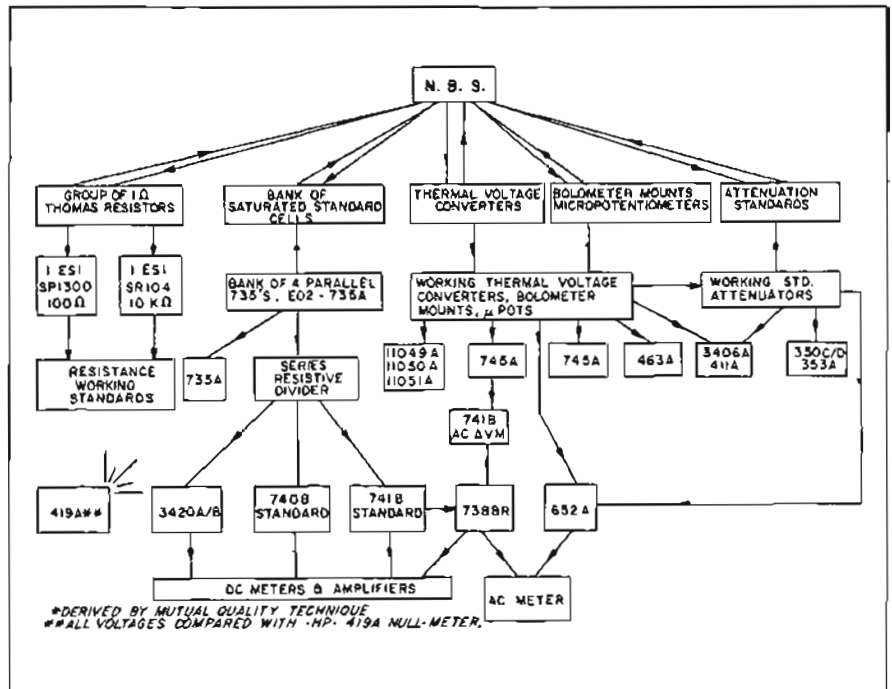

Figure 1. HP Instrument traceability to NBS.

diode in a temperature-controlled oven. This Zener diode is a reference for two voltages; +9.9 V and -9.9 V. These voltages are used to generate a square wave with a special circuit (patent pending) that maintains the basic accuracy of the two dc voltages in the square wave (refer to the block diagram, Figure 2). The accuracy of the rms value of the square wave thus generated is approximately 0.001%. A magnetic divider is used to obtain a 1.1 V rms square wave which is applied to the input of a 6-place magnetic divider to provide 6 digits

of settability from 0.1 V to 1.1 V rms. The output of the calibrator is compared to this reference either directly or through an attenuator by the sampling amplifier. The 100 V range attenuator is a precision resistive divider manufactured by Hewlett-Packard. It has an excellent T.C. and long-term stability. All other range attenuators are inductive dividers. The output of the 1 V range is compared directly to the reference square wave. Figure 3 shows the long-term stability of a 745A reference supply. The rms value of the square wave is compared to the rms

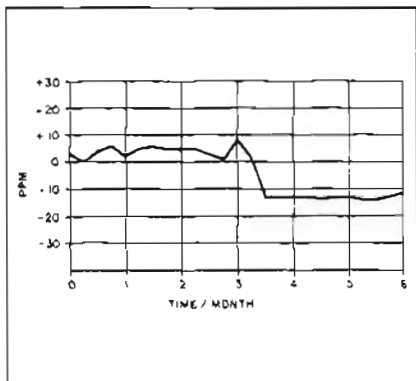

Figure 3. 6 month stability of a 745A reference supply.

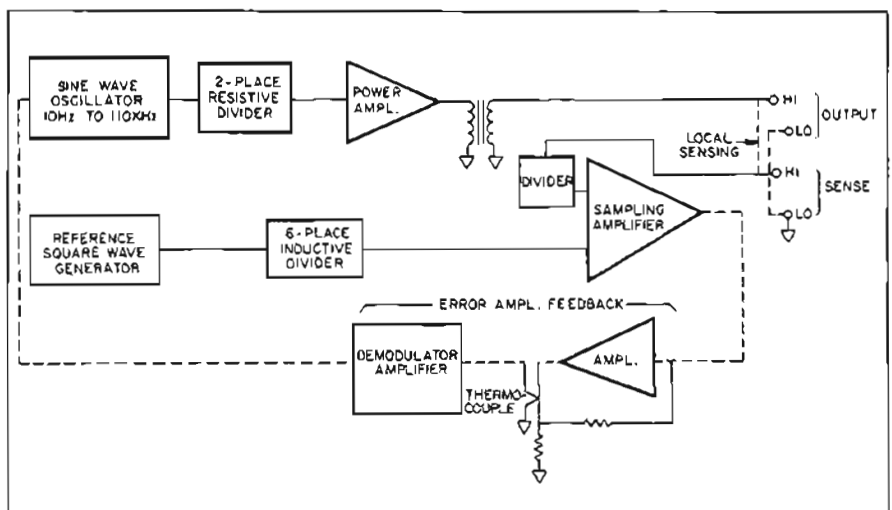

Figure 2. Simplified block diagram of 745A.

value of a portion of the sinewave output through a single thermocouple. The effects of the thermocouple drift and the ac-to-dc transfer error are eliminated, since this thermocouple is essentially an ac-to-ac transfer comparison. The error signal is demodulated, amplified, and fed back to the oscillator to correct the voltage at the output.

The sinewave oscillator of the 745A Calibrator uses a beat-frequency technique combined with frequency dividers. The output from a 5 MHz crystal oscillator is divided by a factor of 9, resulting in an output of 555 kHz. This signal is heterodyned with a variable-frequency oscillator of 545 kHz to 445 kHz. The difference, or beat frequency, is the output frequency on the upper range (10 kHz to 110 kHz). Each successive lower range is a result of heterodyning different frequencies and using a 10:1 divider. This variable-frequency oscillator is locally tuned on the front panel by a variable air dielectric capacitor or remotely controlled by a varying dc voltage.

The output of the sinewave oscillator is amplified and transformer-coupled to the output terminals. Two sense terminals make it possible to locally sense at the output terminals, or to sense remotely, merely by pressing a front-panel button switch and making the necessary remote connections.

The 745A is easily calibrated. The decade dividers and all but one of the range dividers are magnetic and need no adjustment. The output voltage accuracy is assured over the mid-range frequencies once the dc reference voltages are set to +9.9 V and -9.9 V, and the ratio of the 100 V range resistor divider is properly adjusted.

These three adjustments can be made with an accurate dc voltmeter and ratio-meter. The stability of the 745A is 0.002% for 24 hours, 0.005% for 30 days, and 0.01% for 6 months.

DC precision sources

The long-term accuracy and stability of the Hewlett-Packard dc precision sources are dependent on selected Zener diodes. Three distinct steps are necessary to provide a reliable reference diode: 1) process control in its original fabrication, 2) design of a compatible circuit, and 3) a 100% thorough test of the completed circuit.

To achieve the stability and accuracy necessary for the HP precision dc sources, a selected Zener diode and its associated circuitry is housed in a temperature-controlled oven. The inner-oven temperature is held nominally at $80^{\circ}\text{C} \pm 0.01^{\circ}\text{C}$ during normal room variations.

The HP 735A Transfer Standard uses

this reference supply to obtain accurate stable voltages of 1.000 volts, 1.018 to 1.020 volts, and 0 to 1000 μV . It is quickly calibrated by a front-panel adjustment using a standard cell (or another 735A) and a null meter.

This precision voltage source transfers standard-cell voltages to 1.000 volts with an accuracy of 10 ppm and a stability of 10 ppm per month.

Transfer accuracy between saturated standard cells or unsaturated standard cells is 2 ppm.

The E02-735A is a bank of four 735A's combined with a switch and terminals that make it possible to compare an external voltage with any one of the four 735A's or to compare an external voltage with the arithmetical mean of the four 735A outputs.

Included with each E02-735A is a graph on the 1.018 position showing that 95% of the time, the mean of the four 735A's vary from a straight line less than $\pm 1 \mu\text{V}$, over a period of 120 days.

The HP 740B and 741B DC Standards use the oven-reference supply for a reference voltage to generate the 0 to 1000-volt accurate, stable output. This reference voltage is applied to a precision resistive divider, which is the input to an amplifier chain, as shown in Figure 4.

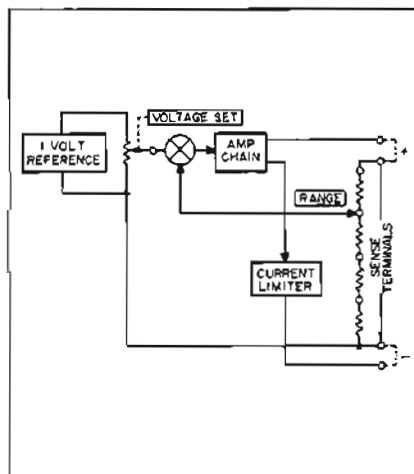

Figure 4. HP simplified dc standards diagram.

The summing point compares the input of the amplifier to an attenuated sample of the output taken from the range voltage divider. The current limit control is nominally adjusted for the protection of the output load.

Precision dc differential voltmeters

Measurements made by the differential voltmeter technique (sometimes called a potentiometric or manual voltmeter) are recognized as one of the most accurate means of relating an unknown voltage to a known reference. These measurements are made by adjusting a precision

resistive divider to divide down an accurately known reference voltage. The divider is adjusted to the point where the divider output equals the unknown voltage, as shown by the null voltmeter (Figure 5).

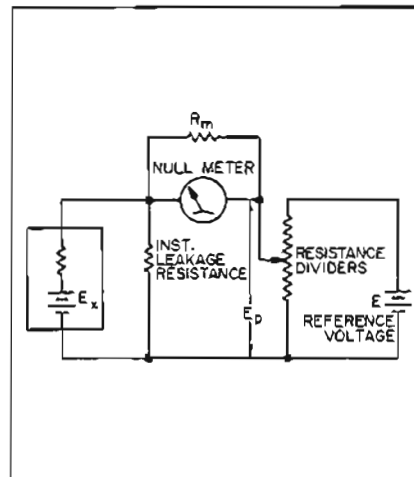

Figure 5. Classic differential voltage measurement.

The unknown voltage is determined to an accuracy limited only by the accuracies of the reference voltage and the resistive divider: the meter serves only to indicate any residual differential between the known and unknown voltage.

The differential method is highly accurate (Hewlett-Packard currently offers $\pm 0.002\%$ accuracy).

A high-voltage standard is required to measure high voltage. This need may be overcome by inserting a voltage divider between the source and the null-meter (Figure 6). This, however, results

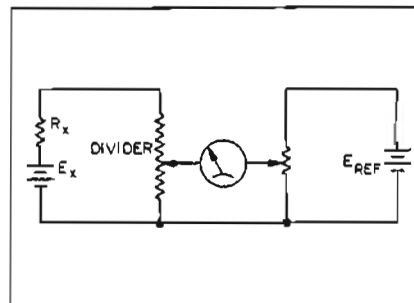

Figure 6. Potentiometric method of measuring unknown voltages.

in relatively low-input resistance for voltages higher than the reference standard. This low-input resistance is undesirable because accurate measurements may not be obtained if substantial current is drawn from the source being measured. Most differential voltmeters used today offer input resistance approaching infinity only at a null condition, and then only if an input voltage divider is not used.

To overcome these limitations, Hewlett-Packard has developed an input isolation stage which develops an input resistance exceeding 10^{10} ohms and mea-

measures voltages up to 1000 volts dc. This high resistance is maintained independent of null condition.

As shown in the block diagram of Figure 7, the HP 740B DC Standard/

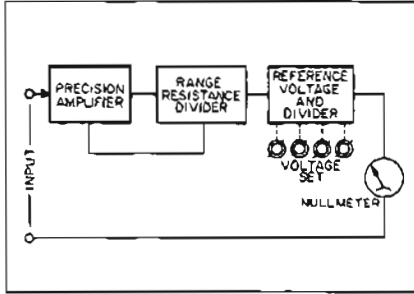

Figure 7. Simplified diagram of dc standard, differential voltmeter in differential voltmeter mode.

Differential Voltmeter has the principal parts of the conventional differential voltmeter.

In a marked departure from conventional differential voltmeter design, the circuitry also includes a high-gain feedback amplifier as an impedance converter between the measured voltage source and the measurement circuits. The amplifier insures that the high-input impedance is maintained regardless of whether the instrument is adjusted for a null reading.

A further advantage provided by the amplifier is that the resistive voltage divider which enables voltages as high as 1000 volts to be compared to a precision 1-volt reference may be placed at the output of the amplifier rather than being in series with the measured voltage source. The isolation provided by the amplifier between the input and the range "stick" thus enables the instrument to have high-input impedance on all ranges.

The range dividers, amplifier, and voltage reference supply are used in the 740B and 741B for both the precision dc source and the differential voltmeter.

Precision ac differential voltmeter

Highest accuracy in ac voltage measurements is accomplished by using an ac differential voltmeter.

The HP 741B uses a precision rectifying circuit to convert the unknown ac directly to dc (equivalent to the average value of the ac), and the resulting dc is read to 5-place resolution by a potentiometric voltmeter technique. The measurement is straightforward in that the ac remains connected to the converter at all times and can be monitored continuously. Besides being a precision ac/dc differential voltmeter, the instrument is also an ultrastable, high-resolution dc standard source. Refer to page 190 for additional information.

The accuracy of ac measurements is enhanced by the high-impedance probe attached to the instrument. The input impedance is 1 M Ω shunted by <5 pF.

The low-input capacitance is important in measurements where capacitance loading is critical. Using the 741B, it is possible to measure high ac voltages without drawing large reactive currents.

A block diagram of the HP 741B in the ac differential voltmeter mode of operation is shown in Figure 8.

With compensation for both the frequency and the amplitude of the input signal, it has been possible to accomplish accurate ac-to-dc conversion that is linear over an amplitude range from 1/10 full scale to full scale throughout a broad frequency range. With proper calibration procedures, it is possible to reduce errors to less than $\pm 0.02\%$ end scale between 100 Hz and 100 kHz under normal laboratory conditions.

Differential voltmeter/ratiometer

Recently introduced, the HP 3420A/B carries a 0.002% accuracy specification with stability of 1 ppm per hour (of range) and 5 ppm per day. Nullmeter resolution is 0.2 ppm of range on all ranges. These specifications set new standards in the state of the art for differential voltmeters.

To make 0.002% accuracy meaningful, the HP Models 3420A/B have six ten-digit decade dividers, plus the usual last-digit meter, and $\pm 10 \mu\text{V}$ full-scale sensitivity. A further feature is rechargeable battery operation, available in the 3420B version. A self-contained power source is important when it is necessary to measure dc voltages with common-mode noise. Because the instrument can be completely isolated from the power line, these common-mode voltages do not influence the reading.

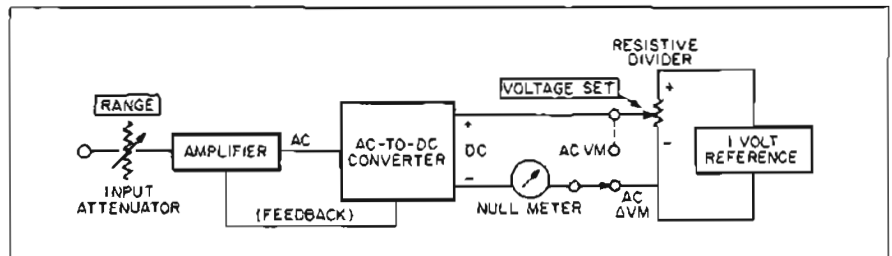

Figure 8. Simplified block diagram of an ac differential voltmeter.

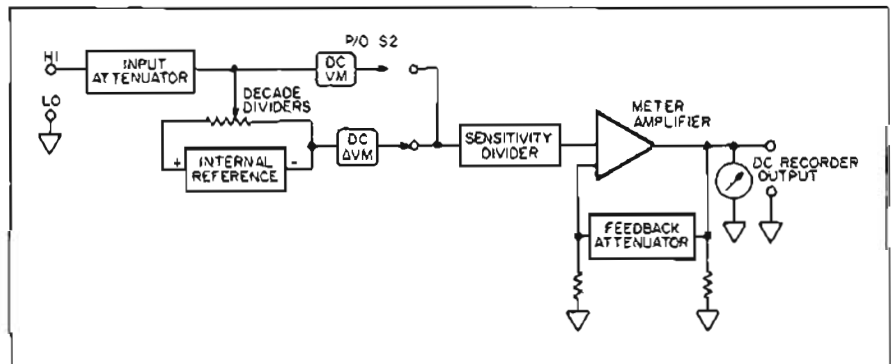

Figure 9. HP 3420A/B DC Differential Voltmeter mode.

A block diagram of the HP 3420A/B is shown in Figure 9. DC voltage measurements in the 1 and 10-volt ranges are performed by the differential voltmeter technique, comparing the input voltage to a known internal voltage. This comparison is performed by a nullmeter. On the 100 and 1000-volt ranges, the input voltage is scaled to the 1-volt level by a precision 10 M Ω resistance divider.

The outstanding accuracy of the instrument is controlled by the internal voltage reference supply and the precision resistor networks. To enable the instrument to operate on battery power, an oven was not used. A technique was developed to adjust the dc temperature coefficient of the 11-volt reference to 1 ppm/ $^{\circ}\text{C}$ over the range $+20^{\circ}\text{C}$ to $+30^{\circ}\text{C}$ (<2 ppm/ $^{\circ}\text{C}$ from $+10^{\circ}\text{C}$ to $+40^{\circ}\text{C}$).

All six decades are binary-coded dividers. The first decade has a 10% over-range capability to aid in measuring standard cells and other voltages that occur slightly above full scale. This feature enables the user to determine measurements with a resolution of <1 ppm.

The combination of high stability in the voltage reference supply, high resolution and zero stability in the null detector, and six-decade divider gives a useful sensitivity of 0.2 ppm of range on all ranges.

Besides being a precision differential voltmeter, the 3420A/B is also a precision ratiometer.

When making dc voltage measurements, there are cases where the absolute value of the voltage is of little interest. Instead, the point of interest is its value in relationship to some other voltage level or the ratio of it to some other level, i.e.,

$$N = \frac{V/1}{V/2} = \frac{V_b}{V_a} = \text{ratio}$$

This ratio appears often in engineering work. Examples are resistor dividers, potentiometer linearity, and power at various voltage levels.

Hewlett-Packard's precision differential voltmeters are multifunction instruments. Table 1 summarizes these instruments, giving the functions of each with the major specifications. By selecting the accuracy and stability necessary in anticipated tests and the functions most useful for specific needs, a precision instrument can be selected.

Thermal converters

Hewlett-Packard thermal converters are true rms detectors, yielding a dc output proportional to the temperature rise resulting from the ac input power. The Models 11049A, 11050A, and 11051A

offer an exceptionally flat response and nearly constant impedance (50Ω) over a frequency range of 5 Hz to 10 MHz. Option 01 has a frequency range from 5 Hz to 60 MHz, and Option 02 has a frequency range from 5 Hz to 100 MHz. Each thermal converter is shipped with a calibration report with statement of uncertainty traceable to NBS. Each option has an additional individual correctional data sheet attached to the calibration report.

A quick way of checking the frequency response of a voltmeter calibrator, an oscillator, or an ac amplifier is to connect its output to a thermal converter. The output of the thermal converter is then monitored by the use of a dc standard and a nullmeter.

AC/DC meter calibration systems

The HP E02-738BR Voltmeter Calibration System includes the Model 652A

Test Oscillator and the Model 738BR Voltmeter Calibrator, mounted in a convenient cabinet. This system was designed specifically for calibrating high-impedance voltmeters and oscilloscopes.

The 738BR provides a 400 Hz rms or peak-to-peak ac voltage and a dc voltage output from 300 μ V to 300 volts. The accuracy is better than 0.1% dc and 0.2% ac. The 652A provides a frequency response, by using the expand position of the meter, from 10 Hz to 10 MHz with a flatness of $\pm 0.25\%$.

The HP Harrison Division Model 6920B Meter Calibrator is an easily portable, simple device used to calibrate ac and dc meters from 0.01 volt to 1 kV, and from 0.01 mA to 5 A. The output setting of voltage or current is adjusted by means of a three-digit, ten-turn readout on any volt, milliampere, or ampere range. The dc accuracy is 0.2%, and ac accuracy is 0.4% of output.

Table 1. HP Multifunction Precision Analog Instruments

Features	Model 740B (pg 188)	Model 741B (pg 190)	Model 3420A/B (pg 192)
DC STANDARD	Yes	Yes	No
Ranges	4 (1 V to 1000 V)	4 (1 V to 1000 V)	
Accuracy	$\pm 0.002\%$ setting $+0.0004\%$ range	$\pm 0.01\%$ setting or $\pm 0.001\%$ range	
Remote sensing	Yes	Yes	
Current limit	5 to 50 mA	4 to 20 mA	
DC Δ VOLTMETER	Yes	Yes	Yes
Ranges	7 (1 mV to 1000 V)	7 (1 mV to 1000 V)	4 (1 V to 1000 V)
Accuracy	$\pm 0.005\%$ reading $+0.0004\%$ range	$\pm 0.02\%$ reading or $\pm 0.002\%$ range	$\pm 0.002\%$ reading $+0.0002\%$ range
AC Δ VOLTMETER	No	Yes	No
Voltage range		7 (1 mV to 1000 V)	
Frequency range		20 Hz to 100 kHz	
Accuracy		$\pm 0.02\%$ reading $+0.01\%$ range) 400 Hz to 5 kHz for 50 mV 100 V to $\pm 0.2\%$ read- ing $+0.02\%$ range)	
HIGH IMPEDANCE VM	Yes	Yes	Yes
Range	10 (1 μ V to 1000 V dc)	7 (1 mV to 1000 V) ac and dc	9 (10 μ V to 1000 V) dc
Accuracy	$\pm 2\%$ range $+0.1 \mu$ V)	$\pm 2\%$ ac and dc $+200$ μ V for 1 mV - 50 mV (20 Hz - 50 kHz)	$\pm 3\%$
DC RATIO METER	No	No	Yes
Ranges			4 (X1 to X.001)
Accuracy			$\pm 0.002\%$ reading $+0.0004\%$ range)
GENERAL			
Readout	5-digit display tubes and meter	4-digit readout and meter	6-digit readout and meter
Stability	± 15 ppm setting $+2$ ppm range/mo.)	dc 10 ppm setting $+1$ ppm range/day ac < 50 ppm/day (20 Hz to 20 kHz)	± 5 ppm/day
Floating	Yes	Yes	Yes
Guarding	Yes	No	No
Recorder output	1 V dc max at 1 mA end scale	1 V dc max at 1 mA end scale	1 V dc at 1 mA end scale
Amplifier output	Yes	Yes	No
Voltage gain	60 dB max (1 V to 1000 V dc)	Unity (0 to 1 kV dc)	

Note: Refer to pages 234-238 to obtain information on Hewlett-Packard Precision Digital Instruments.

PRECISION ANALOG VOLTMETERS AND SOURCES



AC CALIBRATOR Programmable ac source Model 745A



Uses:

- Production-line calibration and maintenance testing of precision ac instruments and devices
- Transfer or secondary ac laboratory standard
- Testing wide-band precision amplifiers and attenuators
- Precision ac source for calibration systems
- Quality control and environmental testing

Description

AC voltages can now be provided automatically over a continuous wide-band of frequencies with the accuracy formerly available only under tightly controlled environmental conditions and with tedious operations and expensive equipment. The Hewlett-Packard Model 745A AC Calibrator is a calibrated ac source with a continuously-adjustable frequency output from 10 Hz to 110 kHz. The output voltage can be set from 0.1 mV to 100 V in steps as small as 1 nV over the entire frequency range.

The output frequency is selectable in four overlapping decade ranges and is read from a high-resolution slide rule dial with an accuracy of $\pm 1\%$ of setting. The slide rule dial and frequency-range switches are color-coded and back-lighted for quick and easy identification.

The output voltage is provided in six decade ranges with 10% overrange capability displayed with a seventh digit. The overrange digit is blanked when the overranging capability is not being used. The voltage-range switches and the voltage digits are color-coded and back-lighted for easy identifications.

An error range, error-measurement control and a %-error scale provide the capability of making error measurements without going through laborious calibration-error calculations. The calibration error is displayed directly in percent of reading on the back-lighted color-coded %-error scale.

The output voltage is available through binding-post connectors on the front panel with local or remote sensing. In the local sense mode of operation, the sense leads are automatically internally connected to the outside terminals. Also, a rear-panel output connector is provided as a standard feature.

Programmability

In production-line testing, much time is often consumed in setting the necessary equipment to proper operating points. This provides opportunities for operator error which can be

very costly. In order to minimize these problems, the frequency and voltage range of the HP 745A can be programmed through simple closures to ground. Any frequency within a frequency range can be selected by a voltage level or by a resistance between the programming input and ground. An auxiliary constant level output (approximately 2.2 V rms) is available at a rear terminal for frequency monitoring.

Traceability

The output voltage of the 745A is calibrated against a 5 mA thermocouple certified by the National Bureau of Standards. The absolute accuracy of the 745A is $\pm 0.02\%$ between 20 Hz and 20 kHz over a temperature range of 20°C to 30°C for a period of 30 days.

%-error measurement

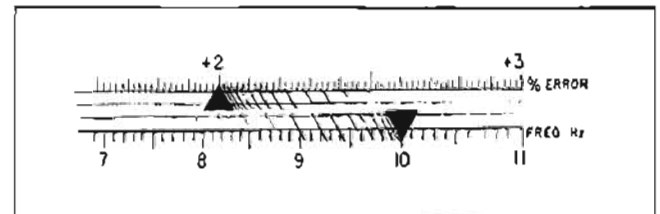

When checking the calibration of an instrument, it is often desirable to know the error in percent of reading rather than the magnitude of error. A special and unique feature of the 745A allows percent-error measurements to be made. For example, assume it is desirable to know the error of an ac-measuring instrument at 0.7 V. Simply select the 745A's 1 V range, set digital voltage dials to 0.700000, select either the $\pm 0.3\%$ full-scale range or the $\pm 3\%$ range and dial the percent-error measurement dial until the instrument under test indicates exactly 0.7 V. The error (in percent of setting and sign) is then read directly from the error-measurement scale.

Automatic fall safe operation

Automatic protection is provided for instruments and circuits under test. The 745A AC Calibrator automatically selects the 1 mV voltage range, 1 kHz frequency range, 0% error, and local sense at turn-on, regardless of the previously selected range. These features automatically protect any instrument or device under test.

Automatic overload recovery

Recovery from overloads are automatic. The need for manual resets or replacing fuses has been eliminated.

Electronic pushbutton switches

Momentary-contact switches are used to activate reed relays through logic circuits. This provides fast, reliable switching in selecting voltage, frequency, error-measurement ranges, and local or remote sensing for the output.

Front-panel controls are conveniently grouped for fast and easy operation. Range pushbuttons and scales are color-coded and back-lighted for quick and positive identification.

Easy calibration

The 745A is easily calibrated. The decade dividers and all but one of the range dividers are magnetic and need no adjustment. The specified output voltage accuracy is assured once the dc reference voltages are set to +9.9 V and -9.9 V, and the ratio of the 100 V range resistor divider is properly adjusted. These three adjustments can be made with an accurate dc voltmeter and ratiometer.

Tentative Specifications

Ranges

Output voltage ranges: 6 ranges* with 10% overrange as follows:

Range	Settability
1 mV	.100000 mV to 1.099999 mV in 1 nV step
10 mV	1.00000 mV to 10.99999 mV in 10 nV steps
100 mV	10.0000 mV to 109.9999 mV in 100 nV steps
1 v	.100000 V to 1.099999 V in 1 μ V step
10 V	1.00000 V to 10.99999 V in 10 μ V step
100 V	10.0000 V to 109.9999 V in 100 μ V steps

Output frequency ranges: continuously adjustable from 10 Hz to 110 kHz in 4 decade ranges with 10% overlap.

%-error measurement: 2 ranges with zero center dial, $\pm 0.3\%$ or $\pm 3\%$.

Performance rating

Accuracy: accuracy met after a 1-hr warmup period at 25°C $\pm 5^\circ\text{C}$ with <95% R.H. for a 30-day period.

Voltage: specifications are relative to a 5 mA thermocouple calibrated by the National Bureau of Standards.

Range	Accuracy
50 Hz to 20 kHz	$\pm(0.02\%$ of setting $+0.002\%$ of range $+10 \mu\text{V}$)
20 Hz to 50 Hz	$\pm(0.05\%$ of setting $+0.005\%$ of range $+50 \mu\text{V}$)
20 kHz to 110 kHz	$\pm(0.1\%$ of setting $+0.005\%$ of range $+50 \mu\text{V}$)

Frequency: $\pm 1\%$ of setting.

Error Measurement: $\pm 0.5\%$ of error range.

Temperature coefficient:

Voltage: $\pm 0.0003\%$ of range per $^\circ\text{C}$ from 0°C to $+55^\circ\text{C}$.

Frequency: $\pm 0.02\%$ of full scale per $^\circ\text{C}$ from 0°C to $+55^\circ\text{C}$.

Voltage stability: (stability met after 1 hour warmup period at constant temperature with less than 95% relative humidity).

Long term: $\pm 0.01\%$ of setting for 6 months.

Short term: $\pm 0.002\%$ of setting for 24 hours.

Cycle-to-cycle: $\pm 0.01\%$ of setting.

Output characteristics

Total Distortion and Noise: $\pm(0.05\%$ of setting $+25 \mu\text{V}$) on all ranges. Will cause $< \pm 0.005\%$ of error when used

* Companion amplifier providing a 1000 V range to be announced.

to calibrate an average-responding or true rms-responding instrument from 1 mV to 110 V.

R.F.I.: meets MIL-I-6181D when using shielded output connectors.

Load regulations: (no load to full load) $\pm 0.01\%$ of voltage setting on 1, 10, 100 mV range, 3 k Ω minimum load resistance. $\pm 0.002\%$ of voltage setting on 1, 10, 100 V range for output current equal to or less than that shown in diagram below.

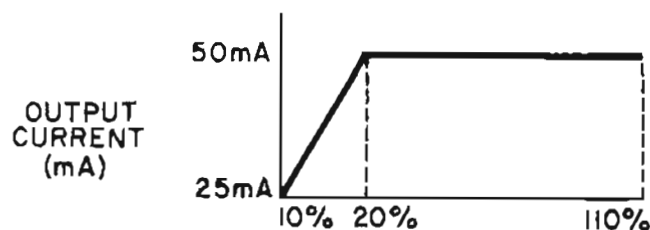

Maximum capacitive load: 1000 pF on all ranges.

Line regulation: less than $\pm 0.001\%$ of setting change in output voltage for a $\pm 10\%$ change in line voltage.

Overload protection: all power supplies and output are actively current limited. Output protected against short circuits. Front panel overload indicator with automatic reset.

Output Terminals: high and low output terminals can be floated ± 500 V dc above chassis ground.

Counter output: rear panel frequency counter output, 2.2 V, protected against short circuits.

Remote programming: all voltage, frequency, and %-error measurement ranges programmable.

Programming methods	Requirements
Contact closure	Less than 400 Ω
NPN transistor	Open circuit voltage 5 V Short circuit current 2 mA Maximum voltage on programming line at closure 0.8 V
Reed switch through diode	
NPN transistor through diode	

Frequency vernier programmable

Programming method	Requirements minimum to maximum of range
Analog voltage	+1 V to +10 V dc
Resistance to ground	500 Ω - 10 k Ω

General

Power requirements: 115/230 V ac $\pm 10\%$, 50 Hz to 400 Hz, 70 W nominal, 100 W maximum.

Operating temperature: 0°C to $+55^\circ\text{C}$.

Storage temperature: -40°C to $+75^\circ\text{C}$.

Dimensions: 16 $\frac{3}{4}$ " wide, 8 $\frac{1}{2}$ " high, 18 $\frac{1}{4}$ " deep (425 x 216 x 464 mm) rack mount kit (HP Part No. 5060-0777) furnished with instrument.

Weight: net 65 lbs (29.3 kg); shipping 75 lbs (33.8 kg).

Accessories furnished: rack mount kit, HP Part No. 5060-0777.

22 pin printed circuit board extender (HP Part No. 5060-0630).

15 pin printed circuit board extender (HP Part No. 5060-0049).

Accessories available: rear output mating plug, (HP Part No. 1251-0469, Deutsch Part No. 6641).

Price: HP Model 745A, \$4,500.

PRECISION ANALOG VOLTMETERS AND SOURCES



DC STANDARD / Δ VOLTMETER

Four instruments in one
Model 740B

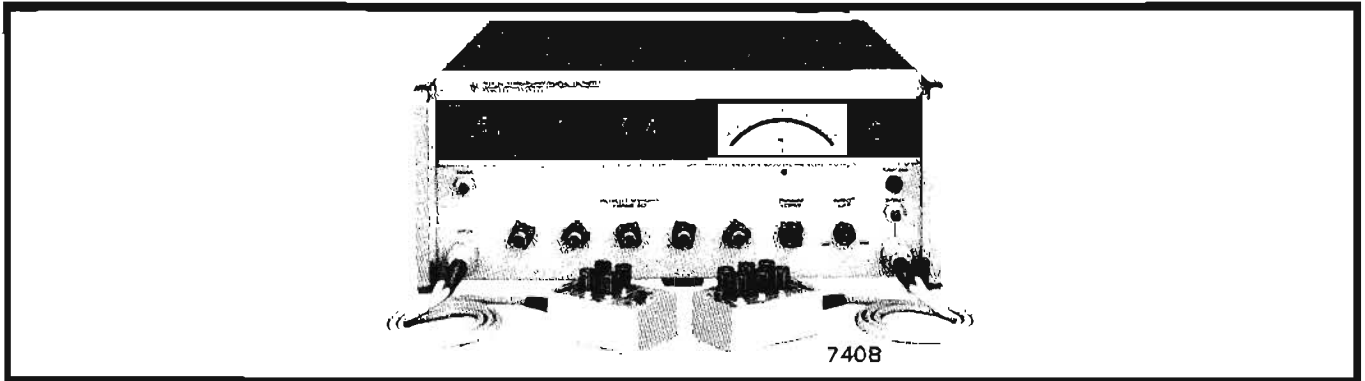

DC standard

The 740B is an ultra-stable, high-resolution dc calibration source which delivers output voltage from zero to 1000 V with specified accuracy of $\pm(0.002\%$ of setting $+0.0004\%$ of range). Designed for calibrating digital voltmeters, differential voltmeters, potentiometers, voltage dividers and for general standards lab application, the 740B has 6-digit resolution with discrete steps of 1 ppm at full scale.

The 740B will deliver current up to 50 mA and may be set at any desired limit between 5 mA and 50 mA by a continuously adjustable front-panel control. A front-panel indicator displays overload conditions as the load current exceeds the current limit setting. Low output impedance is maintained by remote sensing terminals which control the output voltage at the load. The entire circuit is floating and guarded.

The stability of the 740B is dependent primarily on the stability of the reference source and the stability of the precision wire-wound resistors which comprise the decade and range dividers. The heart of the reference voltage supply is a temperature-compensated Zener diode which, with other critical components, is housed in a proportionally controlled oven.

Differential voltmeter

As a differential voltmeter, the 740B measures voltage from 0 to 1000 V dc with an input resistance of $>10^{10}\Omega$ independent of null condition. Meter sensitivity pushbuttons allow input voltages to be measured to 6 digits for a maximum resolution of 1 ppm of range, with a maximum usable sensitivity of 1 μ V full scale. Specified accuracy is $\pm(0.005\%$ of reading $+0.0004\%$ of range $+1 \mu$ V).

As a differential voltmeter, the 740B is unique in maintaining an input impedance of $>10^{10}\Omega$ (on all ranges above 10 mV) regardless of whether or not the voltage dials are nulled. This feature simplifies operation by eliminating any calculations of loading error by the voltmeter. In addition, the high-input impedance simplifies the measurement or comparison of standard cells or other devices that are sensitive to small current drains.

Voltage setting is indicated by 5 digital display tubes plus an individually calibrated taut-band meter.

High-impedance voltmeter

The HP 740B is also a $\pm 2\%$ floating and guarded voltmeter with ranges from 1 μ V to 1 kV. Input impedance is $>10^{10}\Omega$ on most ranges.

Precision DC amplifier

The instrument can be used as a dc power amplifier, in differential voltmeter or voltmeter modes, by connecting the source to the input terminals and taking the output from the terminals that normally supply the standard calibrated voltages. It is thus possible to augment the capabilities of a standard cell, for example, by using the amplifier as an impedance converter to provide power amplification. The available gain depends on the selected voltage range. The 740B functions as a unity gain amplifier on the 1 V and higher ranges, but on lower ranges the gain increases in 20 dB steps to a maximum of 60 dB on the 1 mV range. Gain accuracy is $\pm 0.01\%$.

By taking output from a rear-panel recorder connector, the 740B supplies up to 120 dB of voltage gain (depending upon range).

Specifications

DC Standard

Ranges

Output voltage: 0 to 1000 V* in 4 decade ranges with outputs as follows: 0 to 1.000000 V in 1 μ V steps, 0 to 10.00000 V in 10 μ V steps, 0 to 100.0000 V in 100 μ V steps, 0 to 1000.000 V in 1 mV steps.

Performance rating

Accuracy (relative to the US Legal Volt):** $\pm(0.002\%$ of setting $+0.0004\%$ of range) at $23^\circ\text{C} \pm 1^\circ\text{C}$, $<70\%$ R.H., constant load. This accuracy is met after 1-hr warmup period, with a 30-day calibration cycle.

Relative stability (under same conditions as called out in Accuracy section):**

period	ppm of setting	ppm of range
1 hr	0	1.0
1 day	5.0	1.0
30 days	15.0	2.0
90 days	30.0	2.0
6 mo	50.0	2.0

Zero stability: ± 1 ppm of range/hr ± 5 ppm of range/30 days. Re-zeroing may be required if the range of the 740B is changed.

Temperature coefficient: $<(2$ ppm of setting or 1 ppm of range, whichever is greater) per $^\circ\text{C}$, 10°C to 40°C .

*A maximum of -500 V dc with respect to line ground can be applied to or obtained from the HP 740B.

**Independent of zero drift.

Output characteristics

Output current: current limiter continuously adjustable 5-50 mA nominal. Max. output current, 50 mA decreasing linearly to 20 mA at 1000 V output.

Output resistance: $< (0.0002 + 0.0001 E_o) \Omega$ at dc.

Load regulation: $< (0.0005\% + 10 \mu\text{V})$ change, no load to full load.

Line regulation: $< \pm (0.0005\%$ of setting $+ 0.0001\%$ of range) for 10% line voltage change.

Noise and hum: 0.01 to 1 Hz, < 1 ppm of range; 1 Hz to 1 MHz, 100 dB below full scale or 100 μV rms, whichever is greater.

Output terminals: plus and minus output, plus and minus sense, circuit guard and chassis ground. Banana jacks mounted on remote terminal box (Accessory 11055B furnished). Output and sense terminals are solid copper, gold flashed. A maximum of 500 Vdc may be applied between chassis ground and guard or circuit ground.

Zero control limits: $\pm 0.001\%$ of range nominal.

Readout: 5 digital display tubes indicate first 5 digits, meter displays position of the 6th voltage set switch.

DC Differential Voltmeter

Voltage ranges: 1 mV to 1000 V* dc in 7 decade ranges.

Resolution: null ranges give full-scale indication of $\pm 0.01\%$ range. Max. resolution 1 ppm at full scale. Max. usable null sensitivity: 1 μV full scale.

Performance rating

Accuracy:** $\pm (0.005\%$ of reading $+ 0.0004\%$ of range $+ 1 \mu\text{V}$) at $23^\circ\text{C} \pm 1^\circ\text{C}$, $< 70\%$ R.H. Rated accuracy is met after a 1-hr warmup period with a 30-day calibration cycle.

Stability:** same relative stability specifications as stated in the DC Standard section.

Zero stability: (1 ppm of range $+ 2 \mu\text{V}$)/day, (4 ppm of range $+ 5 \mu\text{V}$)/30 days. Re-zeroing may be required if the range of the 740B is changed.

Temperature coefficient: $< \pm (2 \text{ ppm} + 1 \mu\text{V})/^\circ\text{C}$, $+ 10^\circ\text{C}$ to $+ 40^\circ\text{C}$.

Line regulation: $< \pm (0.001\% + 2 \mu\text{V})$ change for 10% line voltage change.

Input characteristics

Input resistance: $> 10^{10} \Omega$, 100 mV to 1000 V ranges; $> 10^9 \Omega$, 10 mV range; $> 10^8 \Omega$, 1 mV range; independent of null condition.

Superimposed ac noise rejection: $< 0.001\%$ error for ac voltages above 60 Hz equal to dc signal (25 V rms max.).

Ac common-mode rejection: > 120 dB effective rejection at 60 Hz with 1 k Ω unbalance.

Input terminals: plus, minus, guard and chassis ground. Banana jacks mounted on remote terminal box. Plus and minus terminals are solid copper, gold flashed. 500 V dc max. may be connected between chassis ground and guard or circuit ground.

High-Impedance Voltmeter

Voltage ranges: 1 μV to 1000 V* end scale in 10 zero-centered ranges (1 μV to 100 μV ranges obtained by using null sensitivity pushbuttons).

*A maximum of -500 Vdc with respect to line ground can be applied to or obtained from the HP 740B.

**Independent of Zero Drift.

Performance rating

Accuracy: $\pm (2\%$ of end scale $+ 0.1 \mu\text{V})$, 10°C to 40°C .

Input characteristics

Input resistance: $> 10^{10} \Omega$, 100 mV to 1000 V ranges; $> 10^9 \Omega$, 10 mV range; $> 10^8 \Omega$, 1 μV to 1 mV ranges.

Zero control limits: $\pm 10 \mu\text{V}$ nominal.

Zero drift: $< 2 \mu\text{V}$ per day after 30-minute warmup.

Superimposed ac rejection: ac voltages above 60 Hz, 60 dB greater than end scale affects reading $< 2\%$ (25 V rms max.).

Recorder output: adjustable 0 to ± 1 V dc at 1 mA for end-scale meter indication, 120 dB maximum gain. Recorder negative terminal common with input negative terminal.

Amplifier

Voltage gain (output terminals): 60 dB on 1 mV range, 40 dB on 10 mV range, 20 dB on 100 mV range, unity on 1 V to 1000 V ranges.

Performance rating (output terminals):

Gain accuracy: $\pm (0.01\% + 5 \text{ ppm of range} + 2 \mu\text{V})$ referred to input.

Linearity: $\pm 0.002\%$ of any range.

Output current: same as DC Standard.

Bandwidth: dc to 0.2 Hz.

Input resistance: same as Δ VM.

Line regulation: $< 0.0005\% + 2 \mu\text{V}$ referred to input for 10% line voltage change.

Noise: 0.01 Hz to 1 Hz (referred to input) $< 0.5 \mu\text{V}$ p-p at 60 dB, $< 1.0 \mu\text{V}$ p-p at 40 dB gain. $< 3 \mu\text{V}$ p-p at 20 dB gain. Unity gain (1 V range and above) same as DC Standard. 1 Hz to 1 MHz: 1 V to 1000 V ranges: same as DC Standard. Below 1 V range: $< 100 \mu\text{V}$ rms.

General

Operating temperature: $+ 10^\circ\text{C}$ to $+ 40^\circ\text{C}$.

Storage temperature: $- 40^\circ\text{C}$ to $+ 65^\circ\text{C}$.

RFI: meets MIL Spec 6181Df.

Power supply: 115 or 230 V ac $\pm 10\%$, 50 to 1000 Hz, 125 W max.

Dimensions: 7" high, 16 $\frac{3}{4}$ " wide, 18 $\frac{3}{4}$ " long (117.8 x 425 x 476 mm).

Weight: net 47 lbs 4 oz (21.3 kg); shipping 60 lbs 12 oz (27.3 kg).

Accessories furnished: 5060-0776 Rack Mounting kit; 11054A Input Cable for 740A/B; 4 banana jacks mounted on terminal box with 3-ft cable and mating connector. Terminals include positive and negative input, circuit guard, and chassis ground. Positive and negative terminals are solid copper, gold flashed. A switch allows reduction of input resistance to 2 M Ω . 11055B Output Cable for 740B; 6 banana jacks mounted on terminal box with 3-ft cable and mating connector. Terminals include positive and negative output, positive and negative sense, circuit guard and chassis ground. Output and sense terminals are solid copper, gold flashed.

Price: HP Model 740B, \$2350.

†Positive or negative output terminals of the output box (HP 11055B) connected to chassis, and guard and chassis terminals of the input box (HP 11054A) connected together.

PRECISION VOLTMETERS AND SOURCES



AC-DC Δ VM/DC STANDARD

Multi-purpose calibration tool
Model 741B

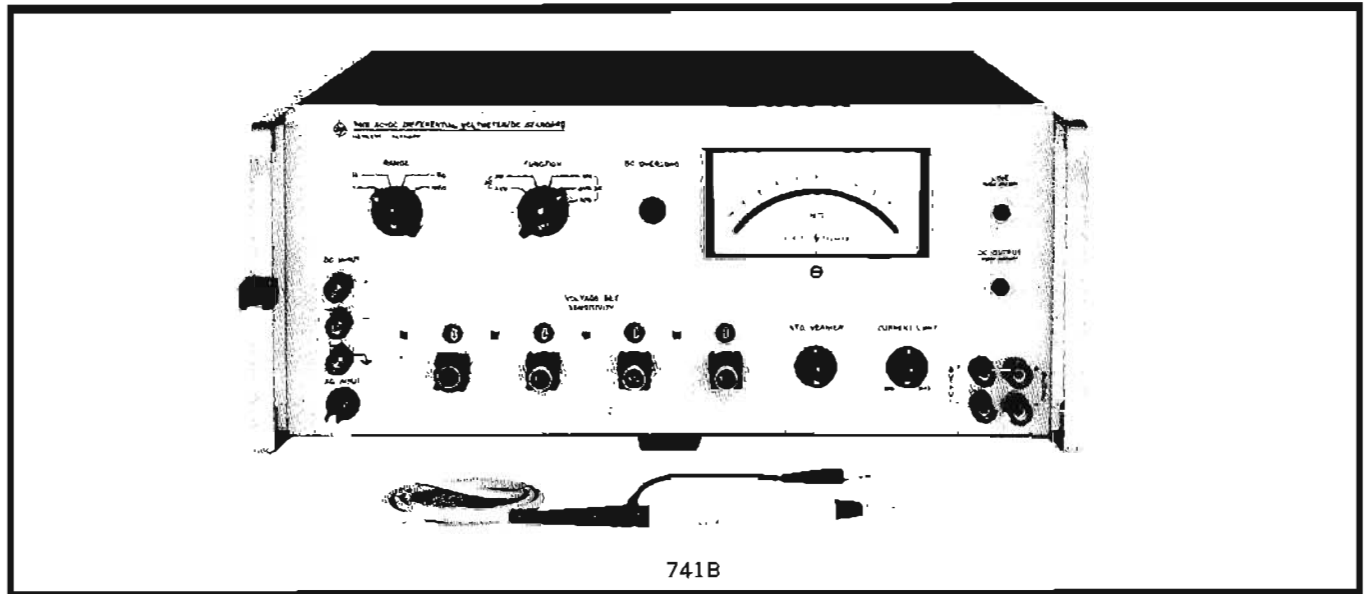

741B

AC differential voltmeter

As an ac differential voltmeter, the 741B is unique in maintaining a low input capacitance of <5 pF. The low input capacitance is important in measurements where capacitance loading is critical. Using the 741B, it is possible to measure high ac voltages without drawing large reactive currents.

DC differential voltmeter

As a dc differential voltmeter, the HP 741B measures dc voltages from 0 to 1000 V in 4 ranges with an accuracy of $\pm 0.02\%$ of reading* or $\pm 0.002\%$ of range.

The 741B makes it possible to make ac and dc differential voltage measurements in fewer steps and without the environmental restrictions or precautionary measures required of thermocouple measurements.

DC standard source

The 741B is an ultra-stable, high-resolution dc standard source which delivers output voltage from 0 to 1000 V with an accuracy of $\pm 0.01\%$ of reading or $\pm 0.001\%$ of range.

Amplifier

As a voltage amplifier, up to 60 dB gain is available at the recorder terminals.

As a $\pm 0.02\%$ power amplifier, the HP 741B provides unity voltage gain from 0 to 1000 V at the output terminals.

High impedance ac or dc voltmeter

The Model 741B is a $\pm 2\%$ floating dc voltmeter with ranges from 1 mV to 1000 V. It is also a $\pm 2\%$ floating ac voltmeter from 50 mV to 1000 V, with reduced accuracy to the 1 mV range.

Specifications

DC differential voltmeter

Input voltage ranges: 1, 10, 100, 1000 V end scale; with null ranges end scale, 1 mV to 1000 V.

Voltage resolution: 0.002% of range.

Performance rating

Accuracy:* $\pm 0.02\%$ of reading or $\pm 0.002\%$ of range, whichever is greater. Relative humidity $<80\%$.

Stability: rated accuracy is met after 1 hour warmup period, with a 90 day calibration cycle.

Short term stability: ± 10 ppm for a 24 hour period.

Line regulation: $< \pm 0.002\%$ change for $\pm 10\%$ line voltage change.

Temperature coefficient: < 3 ppm/ $^{\circ}\text{C}$ from 0°C to $+50^{\circ}\text{C}$.

Input impedance: $> 10^9 \Omega$ on all ranges (independent of null).

Input: floating (up to 500 V dc max).

Zero offset: < 20 ppm of range.

Superimposed ac noise rejection: $< 0.01\%$ error (above 50 Hz) for ac rms voltage equal to 50% of input dc or 25 V rms whichever is less.

DC standard

Ranges: output voltage: 0 to 1000V** in 4-decade ranges with outputs as follows:

0 to 1 V with 1 μV resolution.

0 to 10 V with 10 μV resolution.

0 to 100 V with 100 μV resolution.

0 to 1000 V with 1 mV resolution.

Performance rating

Accuracy:* $\pm 0.01\%$ of indicated setting or $\pm 0.001\%$ of range whichever is greater. Relative humidity $<80\%$.

Stability: rated accuracy is met after 1 hour warmup period, with a 90 day calibration cycle.

Short term stability: 10 ppm of setting + 1 ppm of range for a 24 hour period.

Output characteristics

Output current: 0 to 20 mA, output current limiter continuously variable from 4 to 20 mA (nominal) 0 to $+40^{\circ}\text{C}$. Reduced to 10 W maximum from $+40^{\circ}\text{C}$ to $+50^{\circ}\text{C}$.

*741B Option 01 provides $\pm 0.02\%$ dc standard accuracy and $\pm 0.01\%$ dc differential voltmeter accuracy.

**A maximum of -500 V dc with respect to line ground can be applied to or obtained from the HP 741B.

DC standard

- Output resistance:** $< (0.0005 + 0.0005 E_o)$ ohms at dc.
- Load regulation:** less than 10 ppm + 10 μ V no load to full load.
- Line regulation:** less than $\pm(10 \text{ ppm} + 10 \mu\text{V})$ for $\pm 10\%$ line voltage change.
- Remote sensing:** permits output regulation at the point of application.
- Temperature coefficient:** less than 3 ppm/ $^{\circ}$ C from 0 $^{\circ}$ C to +50 $^{\circ}$ C.
- Noise and hum:** dc to 1 Hz, 100 dB below full scale; 1 Hz to 1 MHz, 100 dB below full scale or 200 μ V rms, whichever is greater.
- Output:** floating (up to ± 500 V).
- Readout:** 4 digits plus individually calibrated taur band meter.
- Zero offset:** < 20 ppm of range.

AC differential voltmeter

- Input voltage ranges:** 1, 10, 100, 1000 V end scale; with null ranges end scale, 1 mV to 1000 V.
- Voltage resolution:** 0.004% end scale.

Performance rating

Accuracy

\pm Accuracy (% of reading)	50 mV-1 kV	1 mV-50 mV	50 mV-100 V
0.02% + 0.01% of range			400 Hz-5 kHz
0.04% + 0.01% of range	100 Hz-10 kHz		
0.1% + 0.01% of range	50 Hz-50 kHz		
0.15% + 0.01% of range	30 Hz-50 Hz		
0.2% + 0.01% of range	20 Hz-30 Hz 50 kHz-100 kHz		
0.2% + 0.02% of range		20 Hz-50 kHz	
$< 80\%$ relative humidity			

- Stability:** rated accuracy is met after 1 hour warmup period, with a 90 day calibration cycle from 20 Hz to 20 kHz and a 30 day calibration cycle from 20 kHz to 100 kHz.
- Short-term stability:** better than 50 ppm per day 20 Hz to 20 kHz.
- Line regulation:** $< \pm 0.01\%$ change for $\pm 10\%$ line-voltage change.
- Temperature coefficient**
 - < 20 ppm/ $^{\circ}$ C, 20 Hz-10 kHz: 5-40 $^{\circ}$ C.
 - < 60 ppm/ $^{\circ}$ C, 10 kHz-100 kHz: 5-40 $^{\circ}$ C.
 - < 40 ppm/ $^{\circ}$ C, 20 Hz-10 kHz: 0-50 $^{\circ}$ C.
 - < 80 ppm/ $^{\circ}$ C, above 10 kHz: 0-50 $^{\circ}$ C.

Input characteristics

- Input impedance:** 1 M Ω shunted by less than 5 pF.
- Input:** probe with 3 ft. cable. Can be floated to ± 500 V dc maximum.

High impedance ac/dc voltmeter and power amplifier*

General

- Recorder output:** available for all modes of operation. Recorder voltage output directly proportional to meter deflection, 60 dB gain (max.), 1 mA into 1 k Ω load.
- Power supply:** 115 or 230 V $\pm 10\%$, 50 Hz to 1000 Hz, 125 W max.
- Dimensions:** 6 $\frac{7}{8}$ " high, 16 $\frac{3}{4}$ " wide, 18 $\frac{1}{4}$ " deep (175 x 425 x 464 mm).
- Weight:** net 42 lbs (18,9 kg); shipping 55 lbs (24,8 kg).
- Price:** HP 741B, \$1675. HP 741B, option 01, \$1675.

* For complete specifications, refer to Data Sheet.

Thermal Converters

Models 11049A, 11050A, 11051A

Hewlett-Packard Thermal Converters are true rms indicators, yielding a dc output voltage proportional to the temperature rise resulting from the input power. The Models 11049A, 11050A and 11051A offer an exceptionally flat response and nearly constant impedance over a wide frequency range. These characteristics make the thermal converters ideal to check the response of precision ac voltmeters, oscilloscopes and amplifiers.

Specifications

- Maximum input voltage:** 11049A: 3 V rms; 11050A: 1 V rms; 11051A: 0.45 V rms.
- Input impedance:** 50 ohms ± 0.15 ohms to 10 MHz.
- Output voltage for maximum input voltage:** 7.5 mV dc (nominal).
- Output impedance:** less than 10 Ω .

Calibration accuracy

Frequency range	In reference to std.	Standard measurement uncertainty
20 Hz to 20 kHz	within $\pm 0.01\%$	$\pm 0.02\%$
20 kHz to 50 kHz	within $\pm 0.01\%$	$\pm 0.03\%$
50 kHz to 1 MHz	within $\pm 0.01\%$	$\pm 0.06\%$
5 Hz to 20 Hz and 1 MHz to 10 MHz	within $\pm 0.05\%$	$\pm 0.12\%$
10 MHz to 30 MHz		$\pm 0.25\%$
30 MHz to 60 MHz		$\pm 0.50\%$
60 MHz to 100 MHz		$\pm 1.50\%$

- Dimensions:** 3" wide, 1 $\frac{3}{4}$ " high, 1 $\frac{1}{2}$ " deep (7,6 x 4,4 x 3,8 cm).
- Weight:** net 2.2 oz (62 g); shipping 1 lb (450 g).
- Price:** HP Model 11049A*, \$125; HP Model 11050A*, \$125; HP 11051A*, \$125.
- Option 01*:** calibration to 60 MHz, add \$25.
- Option 02*:** calibration to 100 MHz, add \$50.

* Includes individual calibration report with statement of uncertainty, traceable to NBS. Options include individual correctional data sheet attached to calibration report.

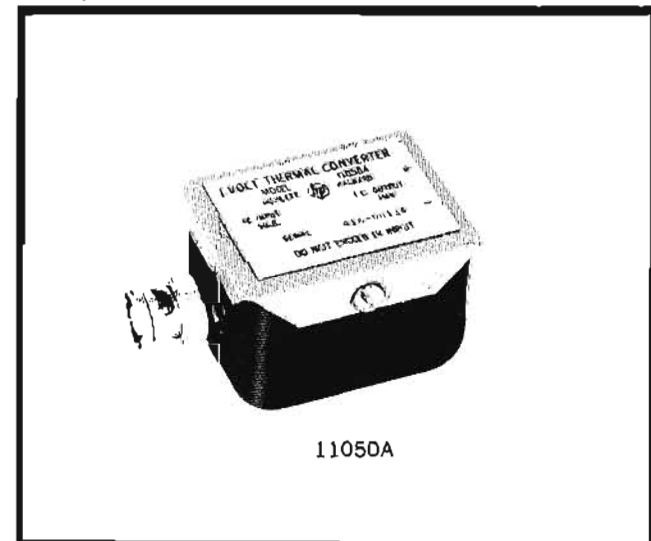

11050A

PRECISION ANALOG VOLTMETERS AND SOURCES



VOLTMETER RATIOMETER

1 ppm stability with $\pm 0.002\%$ accuracy
Models 3420A/B

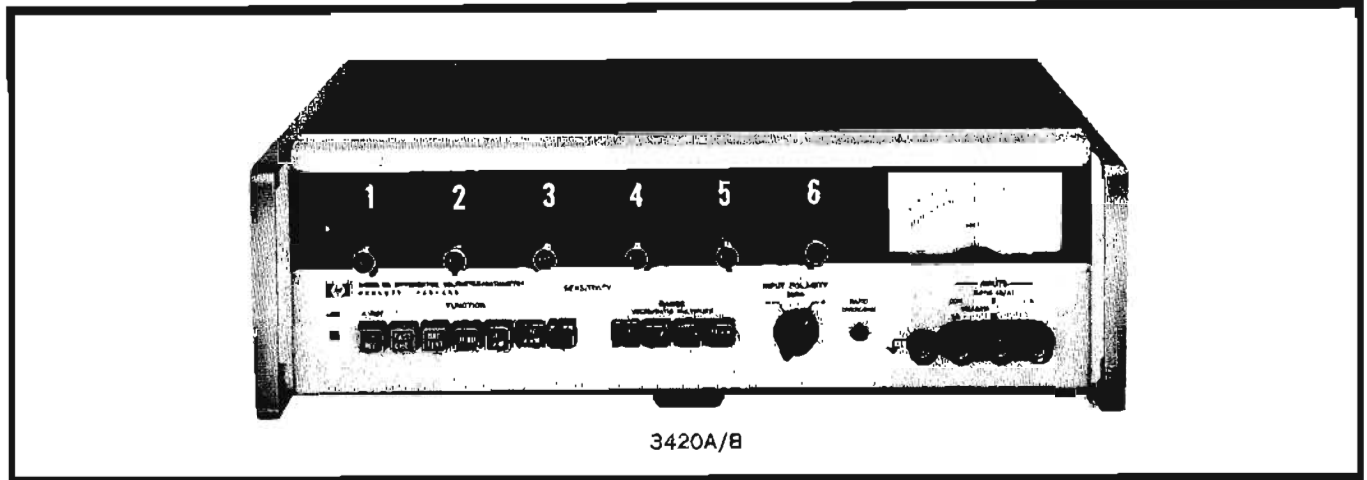

Differential voltmeter

As a dc differential voltmeter the HP 3420A/B measures dc voltages in four ranges: 1 V, 10 V, 100 V and 1000 V full scale with an accuracy of $\pm(0.002\%$ of reading + 0.0002% of range) with a 10% over-range on all ranges.

The 3420A/B has infinite ($>10^{11}$ ohms) input resistance at null on 1 V and 10 V ranges with at least 10 M Ω off null on all ranges. The 6-digit in-line read-out plus meter gives a meter resolution of 0.2 ppm of range.

Ratiometer

The HP 3420A/B may be used to measure resistance divider ratios and voltage ratios rapidly without using conventional, tedious, mathematical computations. Voltage and resistance ratios can be measured from $10^3:1$ to 1:1 in four ranges; X1, X0.1, X0.01 and X0.001. The resolution is 0.2 ppm of range. Accuracy is 20 ppm of reading + 4 ppm of range.

Specifications*

DC differential voltmeter

Ranges: ± 1 , ± 10 , ± 100 and ± 1000 V with up to 10% over-ranging available on all ranges.

Resolution: six dials provide 1 ppm (parts per million) of range. Null meter provides full scale indication of 10 ppm of range with maximum resolution of 0.2 ppm on all ranges.

Performance rating

Accuracy: $\pm(0.002\%$ of reading + 0.0002% of range) at $23^\circ\text{C} \pm 1^\circ\text{C}$, less than 70% R.H. (relative humidity).

Stability: rated accuracy is met after a 1 hour warmup period, with a 30 day calibration cycle. $\pm 0.005\%$ accuracy within 30 seconds of turn on.

Short term: 1 ppm/h, 5 ppm/day exclusive of zero drift.

Zero stability: 0.5 ppm per day of range.

Isolation parameters

Input: floating binding posts on the front panel may be operated up to ± 1200 V dc with respect to chassis ground (700 V rms).

Battery operation (3420B): provides complete isolation from external circuits.

Line operation (3420A/B): common mode rejection is the ratio of common mode signal to resultant error in read-out, with 1 k Ω unbalance.

At dc: >140 dB on all ranges at less than 70% R.H.

At 60 Hz and above: >150 dB on all ranges.

DC ratiometer

Ranges: X1, X.1, X.01, and X.001 with six digit in-line readout.

Resolution: same as Δ VM.

Performance rating

Accuracy: $\pm(0.002\%$ of reading + 0.0004% of highest decade setting) at $23^\circ\text{C} \pm 1^\circ\text{C}$, less than 70% relative humidity.

Stability: rated accuracy is met after 30 second warmup period, with a 60-day calibration cycle.

Short term: 0.5 ppm/h, exclusive of zero drift.

Zero stability: 0.5 ppm of range/day.

Temperature coefficient: X1 range: 1 ppm/ $^\circ\text{C}$, X0.01 range and above: 5 ppm/ $^\circ\text{C}$, to 40°C .

Input characteristics

Input: 3 terminals: A, B, Common

$$\text{Ratio} = \frac{\text{B to Common}}{\text{A to Common}}$$

With $A > B$ and same polarity

General

Input power: 3420A, 115 or 230 V $\pm 10\%$, 50 to 1 kHz, 2 W. 3420B, Battery-Line Operation, rechargeable batteries (8 furnished). 30 hours operation per recharge.

Instrument may be operated during normal recharge from ac line. Provision is made for testing the battery condition and selecting a fast (15 hour) charging rate. Input for battery charging 115 or 230 V $\pm 10\%$, 50 to 1000 Hz, 3 W.

Dimensions: (HP full module) 5" high x $16\frac{3}{4}$ " wide x $13\frac{1}{4}$ " long (127 x 425 x 324 mm).

Weight: net 20 lbs (9 kg); shipping 25 lbs (11.3 kg).

Price: HP 3420A, \$1175. HP 3420B, \$1300.

* For complete specifications, refer to Data Sheet.

DC TRANSFER STANDARD

Portable instrument transfers std. voltages
Model 735A



PRECISION ANALOG VOLTMETERS AND SOURCES

The HP 735A is a general-purpose laboratory transfer standard. It may be used as a 1 V standard output with standard cell accuracy, a standard cell comparator with seven digits, or as a 0 to 1000 μV standard source for dc and potentiometric measurements.

Specifications

Standard outputs: 1.00000 V; 1.018 $\pm \Delta^*$; 1.019 $\pm \Delta^*$; 0 to 1000 μV Δ^* .

Transfer accuracy: (after 30 min. warmup) 2 ppm between saturated standard cells or unsaturated standard cells; 10 ppm standard cell to 1 V; 10 ppm saturated standard cell to unsaturated standard cells (typically better than 5 ppm).

Stability: (after 30 min. warmup) better than 10 ppm/month.

Line regulation: $< 1 \mu\text{V}$ for 10% line change.

Output impedance: 1 k Ω $\pm 1\%$.

Short-circuit current: $< 1.5 \text{ mA}$.

Temperature coefficient: $< 1 \text{ ppm}/^\circ\text{C}$, 0° to $+50^\circ\text{C}$.

Variable output

Range: 0 to 1000 μV .

Accuracy: 0.1% to $\pm 1.5 \mu\text{V}$.

Resolution: 1 μV .

Output impedance: 146 Ω $\pm 1\%$.

Output noise: dc to 1 Hz $< 1 \mu\text{V}$ p-p. 1 Hz to 1 MHz: $< 100 \mu\text{V}$ rms.

Output: floating and guarded.

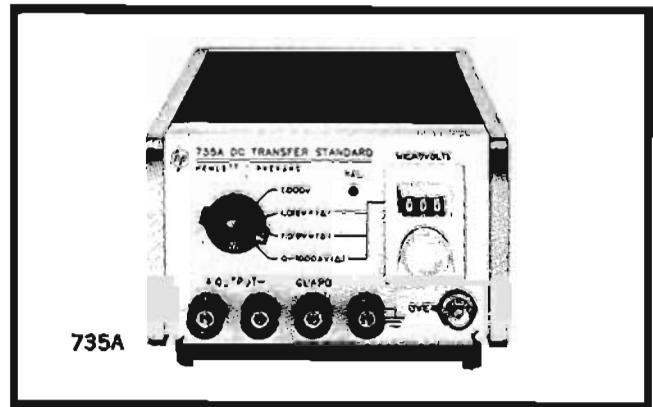

Power: 115 or 230 V $\pm 10\%$, 50 to 1000 Hz, 12 W.

Output terminals: four 5-way binding posts. Positive, negative, circuit-guard shield, and chassis ground, positive and negative terminals are solid copper with gold flash. A maximum of 500 V dc may be connected between chassis ground and guard or circuit ground.

Dimensions: standard 1/3 module: 5 $\frac{1}{8}$ " wide, 3" high, 11" deep (130,2 x 76,2 x 279,4 mm).

Weight: net 5 $\frac{1}{2}$ lbs (2,5 kg); shipping 8 lbs (3,6 kg).

Price: HP 735A DC Transfer Standard, \$375.

Δ^* 3-digit direct-reading 0 to 1000 V offset voltage.

ULTRA-ACCURATE TRANSFER STANDARD

Mean of four 735A's with 120 days calculated drift

Model E02-735A

The Model E02-735A consists of four 735A Transfer Standards, with a nine position switch, mounted in a 1052A combining case. The four instruments can be connected in parallel to the output terminals resulting in the arithmetical mean of the four voltages. In the 1.018 position of the function switch, a graph is furnished with the instrument showing drift deviation from a straight line over a 120 day period. With this graph, the accuracy of the bank of 735A's can be predicted within a fraction of a ppm for a 120 day calibration period. An external voltmeter can be inserted in the circuit so that when the output terminals are connected to a saturated standard cell or another external voltage, the meter will read the difference between the mean of the four 735A's and the external voltage.

In other positions of the E02-735A switch, the (No. 1) 735A can be connected opposing each of the other 735A's so that the meter reads the difference of the two voltages. Each of the four 735A's can also be connected to the output terminals so that an external source can oppose any one of the 735A's with the meter reading the difference in voltages.

Specifications

(In addition to the specifications of the Model 735A.)

A graph is furnished with each E02-735A showing that the arithmetical mean of the four 735A's in the 1.018 position of the function switch has a drift deviation from a straight line of $< \pm 1 \mu\text{V}$, 95% of the time, for 120 days.

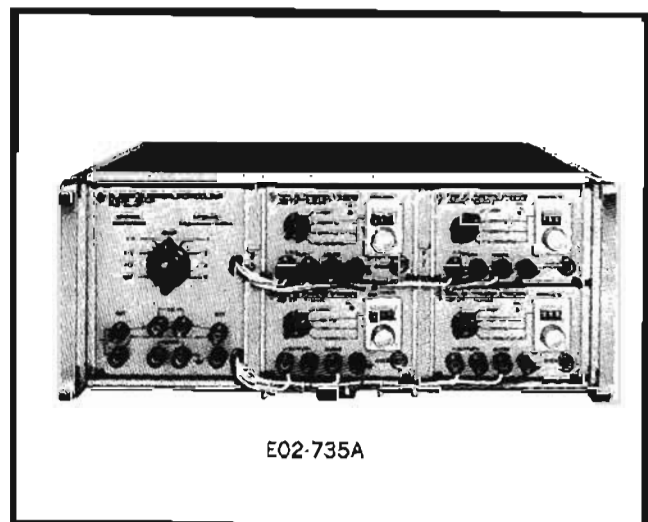

Power: 115 or 230 V $\pm 10\%$, 50 to 1000 Hz, approximately 48 W.

Dimensions: 16 $\frac{3}{4}$ " wide, 7 $\frac{1}{4}$ " high, 18 $\frac{3}{4}$ " deep (425 x 185 x 467 mm).

Weight: net 35 lbs (15,8 kg); shipping 42 lbs (18,9 kg).

Price: HP E02-735A, \$2355.

PRECISION VOLTMETERS AND SOURCES



VOLTMETER CALIBRATOR

DC, rms and p-p volts; flatness 10 Hz-10 MHz
Model E02-738BR

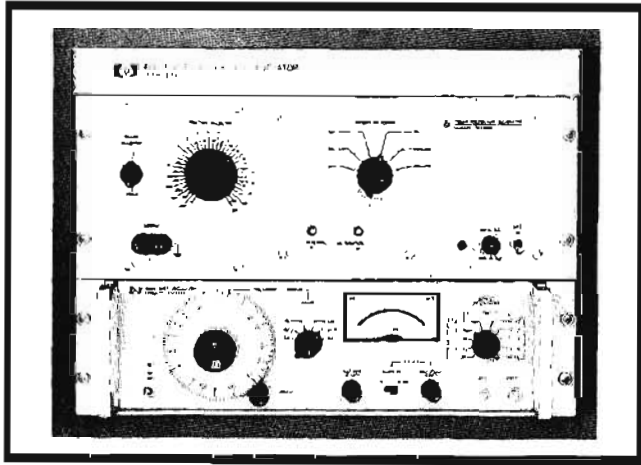

Description

The 652A Test Oscillator and the 738BR Voltmeter Calibrator calibrates high-impedance voltmeters and oscilloscopes for both frequency response and voltage accuracy. The system combines two moderately priced basic Hewlett-Packard instruments that calibrate for ac and dc voltage levels from 300 μ V to 300 V in precise preselected steps and calibrate for frequency response from 10 Hz to 10 MHz.

The two instruments are available individually or in a single enclosure provided with a rear-access door and power strip as the E02-738BR.

The 738BR is a highly stable precision voltage source with drift less than 0.1% per week for dc voltage, less than 0.2% per week for ac voltage. The 652A provides a convenient con-

stant-amplitude ac output voltage at an adjustable frequency from 10 Hz to 10 MHz. The instrument's expanded meter scale monitors the frequency response rapidly and accurately with $\pm 0.25\%$ flatness.

Specifications

E02-738BR Voltmeter Calibration System

738BR

Voltage range: 300 μ V to 300 V, dc or ac (rms and p-p, 400 Hz).

Levels: calibration voltage 300 μ V to 300 V in steps of 1, 3, 1.5 and 5; tracking voltages 0.1 to 1 V in 0.1 V steps and 0.05 to 0.5 V in 0.05 V steps.

Accuracy: 300 V working voltage into attenuator, accurate within 0.1% dc and 0.2% ac, after a 30-minute warmup.

Attenuator accuracy: within $\pm 0.1\%$ or $\pm 2.5 \mu$ V, whichever is larger, open circuit.

Long-term stability: less than 0.1% dc drift per week, less than 0.2% ac drift per week.

Power: 115 or 230 V $\pm 10\%$ 50 to 60 Hz, 350 watts.

Dimensions: 19" wide, 7" high, 15 $\frac{3}{4}$ " deep behind panel (483 x 178 x 400 mm).

Weight: net 38 lbs (7 kg); shipping 53 lbs (24 kg).

Price: HP 738BR, \$950 (rack mount).

652A

Specifications are listed on page 349 of this catalog.

General

Dimensions: 20 $\frac{1}{2}$ " wide, 15 $\frac{3}{8}$ " high, 18 $\frac{1}{2}$ " deep (521 x 397 x 470 mm).

Weight: net 75 lbs (33.8 kg); shipping approx 95 lbs (42.8 kg).

Price: HP E02-738BR, \$1960.

PORTABLE DC NULL VOLTMETER

18 ranges, 0.1 μ V resolution

Model 419A

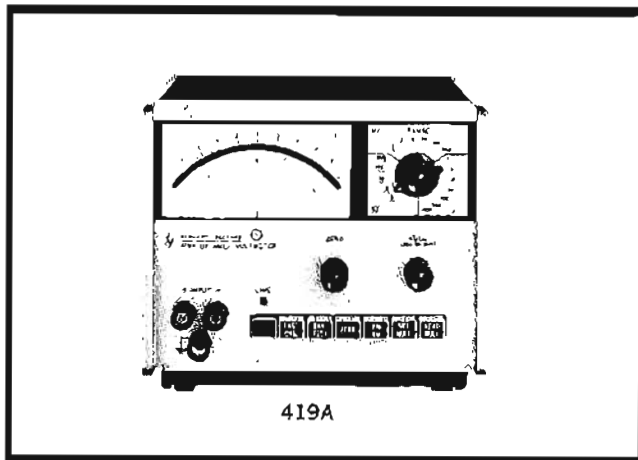

The Model 419A DC Null Meter is a solid-state, battery operated micro-voltmeter with 0.1 μ V resolution.

The 419A is an excellent dc null detector for comparing a standard voltage with another source voltage, resistive divider or amplifier. By connecting the two voltages to the + and - floating input terminals, the voltages oppose each other and the instrument under test may be adjusted to the exact dc voltage of the standard instrument. This is accom-

plished by nulling the difference between the two sources on the 419A's 3 μ V range with a resolution of 0.1 μ V. Internal noise is very low, even at this resolution.

The 419A is operated from a rechargeable battery-power source so that it can be isolated from the ac power line, eliminating ground loops.

The 419A offers a feature not available in any other dc null meter... an adjustable internal nulling supply. An infinite input impedance is obtained (even on the 3 μ V range) when used as a null detector with the internal nulling supply.

Additional applications

(1) The 419A, because of its high-input impedance and sensitivity, may be used for measurements where a voltage must be read, compared or adjusted across a resistor.

(2) Collector voltages may be measured in transistor circuits.

(3) Voltages may be measured across a resistive divider.

(4) Because of its high sensitivity, the 419A may be used to measure thermocouple voltages and other low-level transducer sources.

(5) Nerve potentials in biology and medicine, as well as chemically-generated emf may be measured.

For complete specifications, see page 215.

AC/DC METER CALIBRATOR

Four calibrators in one case
Model 6920B



**PRECISION ANALOG
VOLTMETERS AND SOURCES**

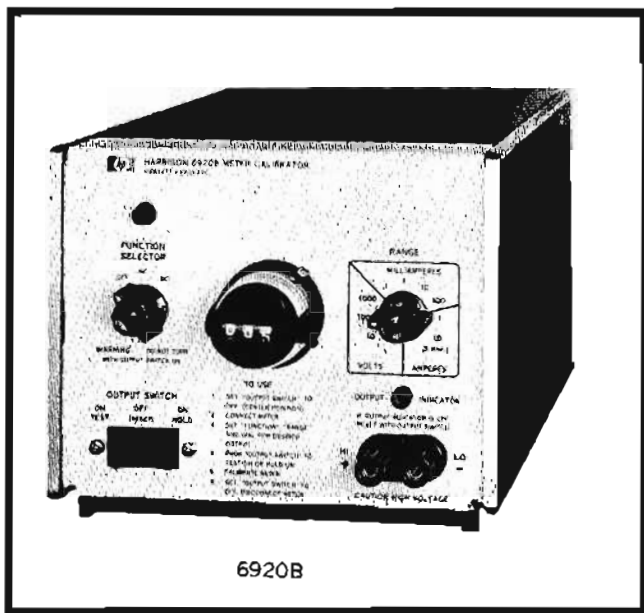

Can be used to check:

1. DC Voltmeters up to 1000 volts
2. AC Voltmeters up to 1000 volts
3. DC Ammeters up to 5 amps
4. AC Ammeters up to 5 amps

Description

Model 6920B is a versatile ac/dc meter calibrator, capable of both constant voltage and constant current output. Its absolute accuracy makes it suitable for laboratory or production testing of panel meters, multimeters, and other meters having accuracy of the order of 1.0% or higher. This calibrator has been designed for convenience, and combines in one instrument all the outputs needed to test the more commonly used meters. Model 6920B has been packaged in an HP cabinet module suitable for bench or rack use. For more information on mounting accessories, see pages 631 and 632.

Output switch

An output switch selects the safest mode of operation for the particular type of meter being tested. A "lock" position leaves the testing parameters in operation to free both hands for attaching and disconnecting successive meters. A "test" position, springloaded so that the meter calibrator output is presented to the terminals only while finger pressure is applied, facilitates testing meters with several full-scale values and reduces the danger of burn-out.

AC Output waveshape

When the function switch is set on "AC", the output waveshape is sinusoidal (to a first approximation) and has the same frequency as the input line power applied to the instrument. The feedback loop which controls and regulates this AC is actually monitoring the average value of the ac output, although the front panel controls are calibrated in terms of rms. Thus this calibrator is suitable for use with average reading ac voltmeters scaled in rms. Moreover, it is

not improper to use this calibrator with true rms meters provided the input line waveshape has a negligible amount of harmonic distortion. The meter calibrator's contribution to the total harmonic distortion present in its output is small compared to its overall accuracy.

Specifications

Input: 115 V ac $\pm 10\%$, single phase, 58-62 Hz, 0.7 A, 65 W max.

Output voltage ranges:

0.01-1 V	current capability 0-5 A
0.1-10 V	current capability 0-1 A
1-100 V	current capability 0-100 mA
10-1000 V	current capability 0-10 mA

Above output voltage ranges and maximum current capabilities for each range apply in full for either dc or 60 Hz, operation.

Output current ranges: (5 A maximum output)

1-100 μ A	voltage capability 0-500 V
0.01-1 mA	voltage capability 0-500 V
0.1-10 mA	voltage capability 0-500 V
1-100 mA	voltage capability 0-50 V
0.01-1 A	voltage capability 0-5 V
0.1-10 A	voltage capability 0-0.5 V

Above output current ranges and maximum voltage capabilities for each range apply in full for either dc or 60 Hz, operation.

Output accuracy: DC—0.2% of set value plus 1 digit. AC—0.4% of set value plus 1 digit. Above accuracy applicable over a temperature range from 15°C to 35°C and over full input voltage range.

Controls:

FUNCTION SWITCH—This is a 3-position switch: "OFF", "AC", and "DC". In the "OFF" position the ac power input is disconnected from the unit. In the "AC" position the meter calibrator produces an ac output; similarly, in the "DC" position the calibrator produces a dc output.

RANGE SWITCH—10 positions, one for each voltage and current range.

CALIBRATED OUTPUT CONTROL—Digital potentiometer readout control (3 significant digits) determines exact value of output.

OUTPUT SWITCH—Switch described above.

Output terminals: two front panel terminals are provided; these are the output terminals for both ac and dc operation. In voltage ranges, the negative terminal is grounded.

Ripple: in dc operation the output ripple is typically less than 1.0% rms of the output range switch setting.

Operating temperature range: 0-50°C.

Size: 6 $\frac{3}{4}$ " (172 mm) H x 7-13/16" (198 mm) W x 11" (279 mm) D.

Weight: 15 lbs (6,8 kg) net, 17 lbs (7,71 kg) shipping.

Price: \$695.

Option 05: 50 Hz ac input regulation realignment, add \$25.

Option 28: 230 V ac $\pm 10\%$, single phase input, add \$10.

VOLTAGE, CURRENT, RESISTANCE



ANALOG MEASURING EQUIPMENT

Voltage, current and resistance measurements are easy, fast and accurate with electronic instruments using meter movements. Most electronic voltmeters, ammeters and ohmmeters use rectifiers, amplifiers and other circuits to generate a current proportional to the quantity being measured, which then drives a meter movement. Devices of this type are called analog instruments.

Meter Movements—the meter-movement readout should continue to be popular since it is economical and suitable for many jobs. It also lends itself well to special, nonlinear scales such as dB scales.

The pivot-jewel suspension is being replaced more and more by taut-band suspension. This has resulted in excellent repeatability with hysteresis virtually eliminated. This repeatability, in turn, makes practical the individually calibrated meter scale. Both of these improvements are standard in most HP analog voltmeters.

Figure 1 shows scales for two different meters printed on one face by Hewlett-Packard's calibrator. By combining an HP-produced taut-band meter movement with custom calibration, outstanding ruggedness and precision are inherent in all meter movements used in Hewlett-Packard's electronic instruments.

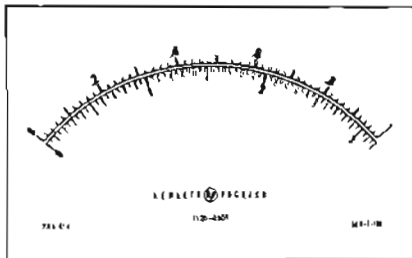

Figure 1. Scales for two different meters printed on one face by Hewlett-Packard's calibrator.

DC voltage measurements

The dc voltmeter represents a straightforward application of electronics to measuring instruments. This instrument usually has a dc amplifier preceding the meter movement.

Dc amplifiers can be classified as (a) direct-coupled and (b) chopper stabilized.

Direct-coupled amplifiers are attractive for their economy and find application in lower-cost electronic voltmeters.

The direct-coupled amplifier is used to obtain sensitive ranges and higher input impedance than can be realized with non-electronic types of voltmeters.

An amplifier also limits the maximum current supplied to the meter movement so that there is little danger that unexpected overloads will burn out the meter movement. The HP 427A is representative of this class of instruments.

To supply ranges of a few millivolts or microvolts full scale, chopper stabilized amplifiers are generally used. Hewlett-Packard choppers convert the input dc to a proportional ac with zero offsets of 1 μ V or less. The ac signal is first amplified and then converted to dc (demodulated). The HP 410C uses this technique to minimize the drift characteristics of direct-coupled amplifiers.

The HP solid-state 419A DC Null Voltmeter also uses a chopper-stabilized amplifier and has 0.1 μ V resolution with 18 ranges from 3 μ V to 1000 V. An internal, adjustable, bucking voltage allows the operator to null the input signal with a front-panel control, making the input impedance effectively infinite. This dc null voltmeter is powered by rechargeable batteries.

Automatic polarity and range selection features are available. The operator can detect polarity and measure any voltage within the range of the instrument without setting controls. The meter indication is automatically maintained between 1/3 and full scale, while the range also is automatically displayed. These features are offered in the HP 414A Autovoltmeter.

DC current measurements

For most dc current measurements, the meter movement, by itself, serves the purpose admirably. In these cases, the meter coil requires relatively few turns to generate sufficient magnetic flux for deflecting the meter pointer. For lower current measurements, the sensitivity of the meter movement must be increased. This is usually accomplished by adding more turns on the coil. These added turns increase the resistance of the current path which can be troublesome in low-impedance circuits.

Electronic instruments overcome this difficulty by measuring the small voltage drop across a low-value resistance placed in series with the current to be measured. The HP 412A and 425A Voltmeters are equipped with internal-calibrated shunt resistors for reading dc currents without accessory equipment.

Current measurements using a series resistor have the obvious disadvantage of interrupting the circuit under test. In

many applications insertion of a resistance in the line of current flow may alter the current being measured or even alter the circuit operation. To overcome this difficulty the HP 428B Clip-On DC Milliammeter uses a current probe which clips around the current-carrying wire and measures current without interrupting the circuit. Sensitivity is such that even transistor base current can be measured.

The HP Model 3528A Current Probe used with the HP 428B allows current measurements in conductors up to 2 1/2 inches in their maximum dimensions. Such conductors are not limited to wires, but can be pipes, multi-conductor cables, lead-sheathed cables or microwave waveguides. With this large aperture probe, difficult-to-measure quantities like corrosion current in small structural members, circulating dc and low-frequency currents in ground straps and waveguides can easily be determined.

Resistance measurements

Resistance is customarily determined through the familiar Ohm's relation: $E = IR$. By applying a known voltage, E , to the unknown resistance, R , and then measuring the current, I , passing through it, R can be computed.

A modified procedure for doing this is incorporated in the HP 410B, 410C, 412A, and 427A multi-function voltmeters.

The HP 414A employs a feedback-stabilized current source, allowing the use of a linear ohms scale and avoiding a special meter scale for resistance measurements. The resulting meter scales are easy to read with good resolution at lower-resistance values.

To measure extremely low resistances such as found in short lengths of large wire, relay and switch contacts, earth ground terminals or in commutator brushes, the HP 4328A Milliohmeter is recommended. (See page 218.) Recently introduced, the HP 4328A measures resistance from 0.001 to 100 ohms full scale over 11 ranges with $\pm 2\%$ accuracy. Four terminal measurement resolution is obtained with only two probes. Resistance measurements in the 4328A are accomplished in two major circuits. (Figure 2.) One is a 1 kHz constant-current oscillator which supplies a constant current to the resistance under test. The other is a voltmeter which senses voltage drop across the resistance under test and indicates the magnitude in ohms. The voltmeter in-

incorporates a phase-discriminator eliminating errors that may be caused from series reactance when making a measurement.

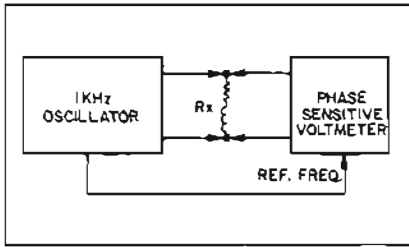

Figure 2. Simplified block diagram of HP 4328A Milliohmmeter.

AC voltage measurements

Electronic instruments for measuring ac voltages also use an amplifier with the meter movement. Analog ac voltmeters are ac-to-dc converters which derive a dc current proportional to the ac input being measured, employing this current for meter deflection. In some situations, conversion to dc by use of external probe diodes precedes amplification. The required amplifiers must then be dc amplifiers, either direct-coupled or chopper type. In other cases, the dc may be derived as a final step with sufficient power available to directly drive the meter movement of the voltmeter. Any ac amplifier may readily be a broadband dc amplifier preceded by an input-blocking capacitor. For detailed information on dc amplifiers, refer to Hewlett-Packard Application Note 69.

Analog (meter) indicating ac voltmeters fall into three broad categories: average-responding, peak-responding, and rms-responding. Ac voltmeters in general use are average and peak-responding types, although rms values are of principal interest.

Average-responding voltmeters

Probably the most widely used measurement technique combining acceptable accuracy and reasonable cost is the average-responding (absolute average) method. Figure 3 shows a typical arrangement for making an average measurement. The signal is amplified (or attenuated) and

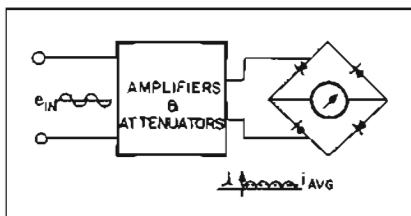

Figure 3. Average-responding voltmeter.

fed to the meter circuit through a diode bridge. For good linearity, the amplifier should be a current source at all frequencies of interest.

The average value of an ac voltage is simply the average value of voltage measured point by point along the waveform. For a sine wave and any waveform symmetrical about zero, the true average value is zero. However, a resistive load is heated by both the positive and negative current excursions in proportion to the absolute average of voltage above and below zero. Accordingly, when we speak of average voltage, we mean the average value of a full-wave rectified voltage. This value for sine wave is 0.636 times the peak voltage.

For a sinusoidal waveform, then, the rms value can easily be calibrated on a meter responding to the average value because the rms value is greater by the constant $k = 0.707/0.636 = 1.11$. Many waveforms encountered in electronic measurements are sinusoidal; in these instances, the average-responding meter, calibrated in the rms value of a sine wave, provides an accurate indication of the rms value. The widely used HP 400 series Voltmeters are average-responding voltmeters.

Average-responding voltmeter error due to harmonic distortion is low—less than 3% for about 10% harmonic distortion.

AC microvoltmeter

Most broadband average-responding voltmeters are limited in sensitivity (100 μV full scale) by inherent noise and spurious signals. An extension of the average-responding voltmeter, the new HP 3410A uses a synchronous phase-lock detector to read very low-level signals (3 μV full scale) obscured in other instruments by noise. Noise and spurious signals up to 20 dB above full scale can be tolerated.

The block diagram in Figure 4 illustrates the basic operation of the HP 3410A AC Microvoltmeter. The circuit

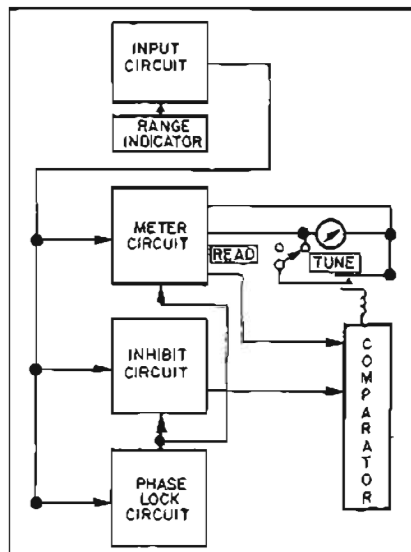

Figure 4. Block diagram of HP 3410A AC Microvoltmeter.

consists of four major sections: the input or signal conditioning circuit, the phase-lock loop, an inhibit circuit and a meter circuit. When tuned to any discrete frequency between 5 Hz and 600 kHz, the meter indicates the rectified average value of the signal. All noise and non-harmonically related signals are rejected. Most voltmeters using this technique require a clean, high-level reference signal input from the test signal source, or that the system under test use the local oscillator output of the voltmeter. When using the HP 3410A, such a hook-up is not necessary. By using a phase-lock oscillator to drive the synchronous detector, the need for a reference input is eliminated. Some useful 3410A applications are measuring frequency of signals in noise, separating closely-spaced coherent signals, measuring power supply ripple, measuring signal-to-noise ratios, calibrating attenuators and measuring summing junction voltages. Refer to HP Journal, Vol. 18, No. 9.

RF voltmeters

Conventional voltmeters responding to the absolute average or the true rms value of an ac waveform are sometimes limited in sensitivity and bandwidth by the input impedance converter, amplifier and detector. These restrictions may be relieved by sampling the signal prior to amplification and detection. This technique constructs low-frequency equivalents of high-frequency signals and permits voltmeters to make measurements over wide frequency and voltage ranges.

The HP 3406A uses an incoherent sampling technique. Unlike coherent sampling, it requires neither a triggering source nor that the input signal be periodic. The sampling voltmeter operates equally well with sinusoidal, pulsed, random or frequency-modulated signals.

The HP 3406A Sampling Voltmeter responds to the absolute-average values of unknown voltages and is calibrated to read both the rms value of a sine wave and dBm in 50 ohm systems. Its sensitivity is high enough to measure voltages as small as 50 μV over a 25 kHz to >1 GHz frequency range. Voltage scales are linear, and resolution is 20 μV on the 1 mV range. Unlike some RF voltmeters with peak detectors that are rms-responding on the lower ranges and gradually change to peak-detecting on the higher ranges, the HP 3406A is average-responding on all ranges. This means that measurements of non-sinusoidal voltages are more accurate because its detector law does not change with the amplitude of the input signal.

An output connector from the zero-order hold circuit is available at the rear panel of the instrument for connection to other measuring equipment. Since the

statistics available at this point are the same as those of the input signal, properties such as peak, average and rms can be measured by instruments with narrow bandwidth capabilities. Peak voltages, amplitude modulation envelopes, true rms values, pulse height information, and probability density functions of broad-band signals can be determined by observing the output of the zero-order hold circuit. Much of this information has never before been accessible for broad-band signals. For a detailed description of applications and operation of the HP 3406A Sampling RF Voltmeter, ask for a copy of the HP Journal, Volume 17, No. 11.

Recently introduced, the HP 8405A RF Vector Voltmeter, can measure amplitudes and phase angles simultaneously from 1 to 1000 MHz. The 8405A RF Vector Voltmeter operates on the principle of coherent sampling.

Peak-responding voltmeter

Peak-responding voltmeters can perform over a bandwidth extending to several hundred MHz. They have a low-shunt capacitance to minimize circuit loading. Good linearity is possible for input sinusoidal signals of 0.5 volts and above. For signals smaller than 0.5 volts, special compensation techniques must be used to achieve linear meter indications.

The indication of the peak-responding voltmeter block diagram shown in Figure 5 places the rectifier in the input circuit where it charges the small input capacitor to the peak value of the input signal. This voltage is passed to a dc amplifier, which drives the meter.

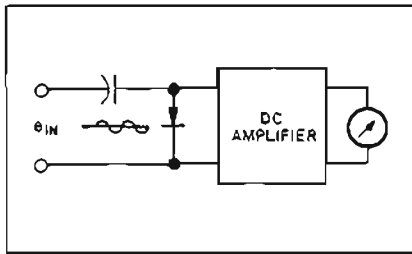

Figure 5. Peak-responding voltmeter.

Since ac-to-dc conversion is usually accomplished in the peak-responding voltmeter at the input, a dc meter circuit is required. Often dc volts, ohms and ampere scales are added to make the peak-responding meter a multi-function instrument as is the HP 410C.

Like the average-responding voltmeters, peak-responding voltmeters are usually calibrated in the rms value of a sine wave. The average-responding type, therefore, indicates 1.11 times higher than the average voltage, while the peak-responding type indicated 0.707 times the peak voltage. Consequently, both meters

may be in error if the measured signal is not a pure sine wave. Peak-reading instruments are generally sensitive to harmonic distortion, and care must be taken in the interpretation of the measured peak value of a non-sinusoidal waveform. For a detailed discussion of the limits of error introduced into peak and average-responding voltmeters by various harmonics, refer to HP Application Note 60.

RMS-responding voltmeter

The true-rms measurements technique is most often used when a high degree of accuracy is required. Instrument indication is proportional to the rms heating value of the impressed waveform. Mathematically, the root-mean-square (rms) value of any complex quantity is obtained by summing the squares of each component and taking the square root of the sum, defined as the equivalent heating power of the waveform.

This operation is performed by sensing the waveform's heating power, which is proportional to $(E_{\text{rms}})^2$. The indicating circuitry responds to the square root of the heating power. Heating power is measured by feeding an amplified version of an input waveform to the heater of a thermocouple. The voltage output is proportional to the waveform's heating power.

The HP 3400A True RMS Voltmeter uses two matched thermocouples mounted in the same thermal environment to overcome nonlinear behavior of thermocouples. Nonlinear effects in the measuring thermocouple are cancelled by similar nonlinear operations of the second thermocouple.

The block diagram shown in Figure 6 indicates one form of a true-rms instrument (the HP 3400A) that makes use of a servo loop to yield a linear output display. The thermocouple elements form a bridge which is initially unbalanced by the signal current present in the heater element in the ac-amplifier output. The

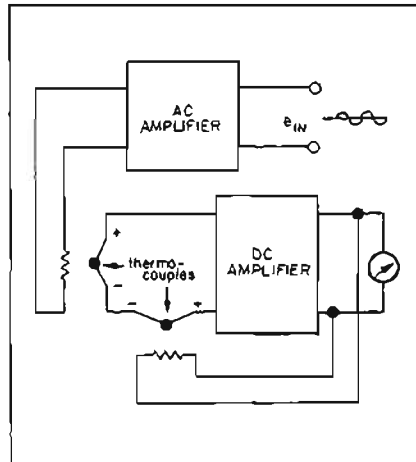

Figure 6. True rms-responding voltmeter.

couple unbalance is amplified by the dc amplifier and fed back to the heater element in the second thermocouple, re-establishing bridge balance. The dc current flowing in one heater element is then directly proportional to the rms value of the ac signal current in the other element and may be read out directly on a dc meter.

The true rms value is measured independently of the wave-shaped provided that the peak excursions of the measured waveform do not exceed the dynamic range of the instrument. Distortion is not an error-contributing factor. This arrangement allows the Model 3400A to provide accurate readings of the rms value of complex waveforms having crest factors (ratio of peak-to-rms) as high as 10:1 at full scale. At 10% of full scale deflection, where there is less likelihood of amplifier saturation, waveforms with crest factors as high as 100:1 are accommodated.

Voltmeter considerations

The most appropriate instrument for ac or dc voltage measurement is the instrument reliably giving the performance needed for the existing conditions. Some considerations are:

ACCURACY—Before we can discuss meter accuracy we must have a familiarity with the various meter scales available. Many instruments have meter scales marked in both volts and decibel (dB) units. It should be noted that dB and voltage are complements of each other. That is, if a voltage scale is made linear, the dB scale on the same meter face will be logarithmic or nonlinear. Likewise, if the dB scale is made linear, then the voltage scale becomes nonlinear. The term "linear-log scale" is applied to an instrument that has a linear dB scale and therefore a nonlinear voltage scale. Several different types of meter faces are illustrated in Figure 7.

Accuracy specifications are usually expressed in one of three ways: 1. (percent of the full-scale value) 2. (percent of the reading) 3. (percent of full-scale + percent of reading). The first is probably the most commonly used accuracy specification. The second, (percent of reading) is more commonly applied to meters having a logarithmic scale. The last method has been used more recently to obtain a tighter accuracy specification on a linear-scale instrument.

To understand the relative value of applying several accuracy specifications to any given instrument, percent uncertainty should be understood. Percent uncertainty can be defined as the ratio (in percent) of the calculated reading uncertainty to the actual meter reading, both expressed in the same scale units.

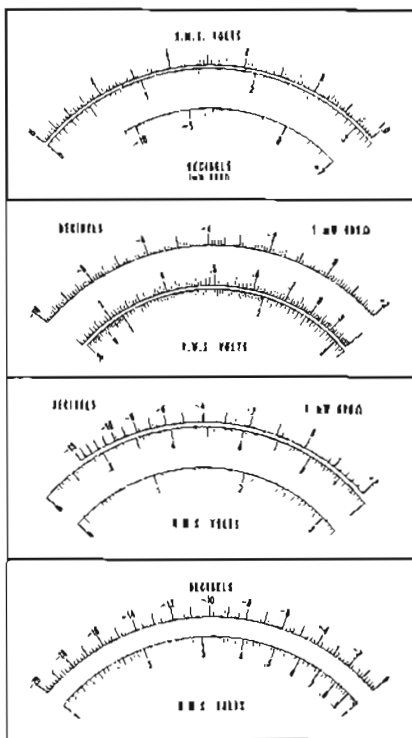

Figure 7. Four different types of meter scales available. (a) Linear 0-3 V and 0-10 V scales plus a dB scale. (b) Linear dB scale plus nonlinear (logarithmic) voltage scales. (c) dB scale placed on larger arc for greater resolution. (d) Linear -20 to 0 dB scale useful for acoustical and communications applications.

If the uncertainty is calculated from the (percent of reading) spec and then divided by the reading, the percent uncertainty will be constant for all readings and, thus, have the same value as the accuracy spec. Applying this type of accuracy specification to an instrument is practical only if the lower end of the scale is greatly expanded.

The (percent-of-reading) spec is employed for instruments having a log scale. If this type of spec is employed for linear-scale instruments, the percent uncertainty will be unrealistically small for the lower portion of the scale. Many linear-scale instruments commonly employ (percent of full-scale) specification. However, most meters of this type are capable of better accuracy than the percent uncertainty indicates. Hewlett-Packard uses the two-part accuracy specification to take advantage of the upper-scale accuracy and yet maintain a reasonable specification for the lower portion of the scale. (See Figure 8.)

Downranging is a method by which the improved upper-scale accuracy is utilized. In Figure 8 note that the knee of the curve for the two-part accuracy specification occurs at about 30 percent of full-scale. Thus, it is convenient to design voltage ranges in a 1-3-10 sequence. With this approach, all readings can be made on the upper two-thirds of the scale

where accuracy is best. Downranging is illustrated by the inset in Figure 8 showing a case where a maximum uncertainty of approximately 2 percent can be attained.

For a thorough evaluation of accuracy, the following should be considered: Does it apply at all input-voltage levels up to maximum overrange point? (Linearity specifications may be added to qualify this point.) Does it apply to all frequencies throughout its specified bandwidth? Does it apply on all ranges? Does it apply over a useful temperature range for the application? If not, is temperature coefficient specified?

An affirmative answer to all items is required for a complete accuracy specification. Accuracy ratings generally apply for a zero-impedance source; the same accuracies can be achieved for higher source impedances by calculating the loading effect of the input impedance on the source. Complex impedances may limit the usefulness of this technique with ac voltmeters.

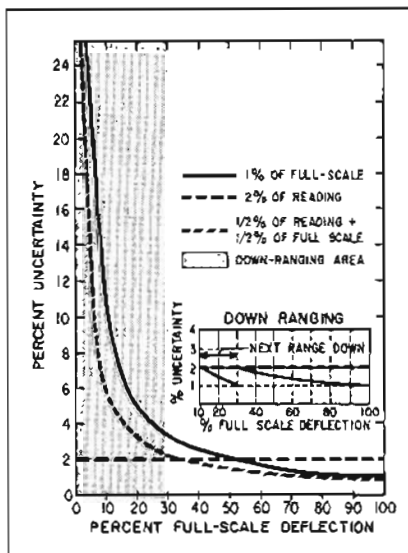

Figure 8. Percent uncertainty for three methods of specifying accuracy.

OUTPUTS—Some voltmeters provide several analog outputs besides the meter reading. For instance, there may be both ac and dc output proportional to the pointer deflection. The ac output is useful for monitoring the waveform on an oscilloscope or to lower the output impedance of the circuit under test. The dc output can be used to drive a strip chart or X-Y recorder for a permanent record, or to drive a dc digital voltmeter to increase accuracy and resolution of broad-band instruments.

BATTERY OPERATION—For field work, an instrument powered by internal batteries is necessary. If an area contains troublesome ground loops, a battery

powered instrument should be used to remove the ground path.

SENSITIVITY VS. BANDWIDTH—Noise is a function of bandwidth. A voltmeter with a broad bandwidth will pick up and generate more noise and is less sensitive than one operating over a narrow range of frequencies. For example, an instrument with a bandwidth of 10 Hz to 10 MHz typically can have a sensitivity of 1 mV. On the other hand, a voltmeter with bandwidth extending only to 500 kHz could have a sensitivity of 100 μ V.

AC current measurements

The HP 456A Current Probe enables ac current to be measured without disturbing the circuit. This probe clips around the wire carrying the current to be measured and, in effect, makes the wire the one-turn primary of a transformer formed by ferrite cores and a many-turn secondary within the probe. The signal induced in the secondary is amplified and can be applied to any suitable ac voltmeter for measurement. The amplifier constants are chosen so that 1 mA in the wire being measured produces 1 mV at the amplifier output. Current is read directly on the voltmeter.

Summary

The basic specifications for Hewlett-Packard analog voltmeters are summarized in Table I. To help you select a voltmeter suitable to your needs, our guidelines are restated as follows:

(1) For measurements involving dc applications, select the instrument with the broadest capability meeting your requirements.

(2) For ac measurements involving sine waves with only modest amounts of distortion (<10%), the average-responding voltmeter provides the best accuracy and most sensitivity per dollar.

(3) For ac measurements involving low-level signals that may be obscured by noise or other unrelated signals, the tuned voltmeter provides the best accuracy and most sensitivity per dollar.

(4) For high-frequency measurements (>10 MHz), the peak-responding voltmeter with the diode-probe input is the most economical choice. Peak-responding circuits are acceptable if inaccuracies caused by distortion in the input waveform can be tolerated.

(5) For measurements where it is important to determine the effective power of waveforms that depart from a true sinusoidal form, the true rms-responding voltmeter is the appropriate choice.

(6) For very wide bandwidths (up to 1 GHz) and high-sensitivity measurements of sinusoidal or non-sinusoidal waveforms, the new Sampling Voltmeter is the proper choice.

Table 1 Hewlett-Packard Analog Voltmeters

DC VOLTMETERS	Voltage Range	Frequency Range Typical Accuracy	Input Impedance	Model	See Page
DC NULL VOLTMETER Internal nulling supply battery operation dc amplifier, Ammeter 30 pA-30 mA	$\pm 3 \mu\text{V} - \pm 1 \text{ kV}$ end scale 0.1 μV resolution (18 ranges)	dc $\pm 2\% + 1 \mu\text{V}$	100 k - 100 M Ω depending on range (infinite when nulled)	419A	215
DC NULL VOLTMETER Amplifier	$\pm 1 \text{ mV} - \pm 1 \text{ kV}$ end scale (13 ranges)	dc $\pm 2\%$	10M - 200 M Ω depending on range	413A	214
AC VOLTMETERS	Voltage Range	Frequency Range Typical Accuracy	Response Input Impedance	Model	See Page
BATTERY OPERATED AC VOLTMETER	1 mV - 300 V (12 ranges)	1 Hz - 1 MHz $\pm 3\% - \pm 5\%$	Average 2 M Ω /15 - 40 pF	403A	207
RECHARGEABLE BATTERY AC VOLT- METER	1 mV - 300 V (12 ranges)	5 Hz - 2 MHz $\pm 2\% - \pm 5\%$	Average 2 M Ω /25 - 50 pF	403B	207
VACUUM-TUBE VOLTMETER, also useful as ac amplifier	1 mV - 300 V (12 ranges)	10 Hz - 4 MHz $\pm 2\% - \pm 5\%$	Average 10 M Ω /15 - 25 pF	400D	206
Similar to 400D except has 1% accuracy		$\pm 1\% - \pm 5\%$		400H	206
Similar to 400H except has linear 12 dB log scale	-70 dB - +52 dB (12 ranges)	$\pm 2\% - \pm 5\%$		400L	206
FAST-RESPONSE AC VOLTMETER 100 kHz low-pass filter ac amplifier	100 μV - 300 V (14 ranges)	20 Hz - 4 MHz $\pm 1\% - \pm 4\%$	Average 10 M Ω /10 - 25 pF	400F	202
Similar to 400F except has linear 12 dB log scale	-90 dB - +52 dB	$\pm 1\% - \pm 4\%$		400FL	202
HIGH ACCURACY dB VOLTMETER 20 dB log scale (0 dB = 1 V)	-100 dB - +60 dB (8 ranges)	20 Hz - 4 MHz $\pm 2\% - \pm 4\%$	Average 10 M Ω /10 - 25 pF	400GL	203
HIGH ACCURACY AC VOLTMETER has dc output ($\pm 0.5\%$) for driving records	1 mV - 300 V (12 ranges)	10 Hz - 10 MHz $\pm 1\% - \pm 4\%$	Average 10 M Ω /8 - 21 pF	400E	204
Similar to 400E except has linear 12 dB log scale uppermost	-70 dB - +52 dB (12 ranges)	$\pm 1\% - \pm 4\%$		400EL	205
AC MICROVOLTMETER; measures signals obscured by noise	3 μV - 3 V (13 ranges) -110 dBm to +10 dBm	5Hz - 600 kHz $\pm 3\%$ to $\pm 10\%$	Average 10 M Ω /10 - 20 pF	3410A	201
RMS VOLTMETER provides rms readings of complex signals. Has dc output for driving DVM's or recorders	1 mV - 300 V (12 ranges)	10 Hz - 10 MHz $\pm 1\% - \pm 5\%$	10 M Ω /15 - 40 pF	3400A	208
SAMPLING RF VOLTMETER provides true rms measurements when used with 3400A. Many accessories	1 mV - 3 V (8 ranges)	10 kHz - > 1.2 GHz $\pm 3\% - \pm 8\%$	Statistical Average: Input Z depends on probe tip used	3406A	212
RF MILLIVOLTMETER	10 mV - 10 V (7 ranges)	500 kHz - 1 GHz $\pm 3\% - \pm 12\%$	Average Input Z depends on probe tip used	411A	213
VECTOR VOLTMETER phase and ampli- tude measurements	100 μV - 10 V (9 ranges)	1 MHz - 1 GHz $\pm 0.5 \text{ dB} - \pm 1 \text{ dB}$	Average 0.1 M Ω /2.5 pF	8405A	249
MILLOHMETER; two probes used when making 4 terminal measurements	0.001 to 100 Ω F.S. (11 ranges)	1 kHz (fixed) $\pm 2\%$ F.S.	Max. output Voltage: 20 mV	4328A	218
MULTIFUNCTION METERS	Voltage Range (Accuracy)	Current Range (Accuracy)	Resistance Range (Accuracy)	Model	See Page
AUTOVOLTMETER has automatic ranging and polarity; input impedance 10 - 100 M Ω	DC: $\pm 5 \text{ mV} - \pm 1500 \text{ V}$ ($\pm 0.5\%$ f.s., $\pm 0.5\%$ rdg) 12 ranges		5 Ω - 1.5 M Ω ($\pm 1\%$ rdg, $\pm 0.5\%$ f.s.) 12 ranges	414A	214
BATTERY-OPERATED MULTIFUNCTION METER has 10 M Ω dc input impedance and 10 M Ω /20 pF ac input impedance	DC: $\pm 100 \text{ mV} - \pm 1000 \text{ V}$ ($\pm 2\%$) 9 ranges AC: 10 mV - 300 V 10 Hz - 1 MHz ($\pm 2\%$) 10 ranges		10 Ω - 10 M Ω midscale ($\pm 5\%$) 7 ranges	427A	209
VERSATILE VOLTMETER has 100 M Ω dc input impedance and 10 M Ω /1.5 pF ac impedance	DC: $\pm 15 \text{ mV} - \pm 1500 \text{ V}$ ($\pm 2\%$) 11 ranges AC: 0.5 V - 300 V 20 Hz - > 700 MHz ($\pm 3\%$ at 400 Hz) 7 ranges	DC: $\pm 1.5 \mu\text{A}$ to $\pm 150 \text{ mA}$ ($\pm 3\%$) 11 ranges	10 Ω - 10 M Ω midscale ($\pm 5\%$) 7 ranges	410C	210
VACUUM-TUBE VOLTMETER has 122 M Ω dc input impedance and 10 M Ω /1.5 pF ac impedance	DC: $\pm 1 \text{ V} - \pm 1000 \text{ V}$ ($\pm 3\%$) 7 ranges AC: 1 - 300 V 20 Hz - 700 MHz ($\pm 3\%$ at 400 Hz) 6 ranges		0.2 Ω - 500 M Ω ($\pm 5\%$) 7 ranges	410B	211
DC VACUUM-TUBE VOLTMETER has 200 M Ω input impedance	DC: $\pm 1 \text{ mV} - \pm 1000 \text{ V}$ ($\pm 1\%$) 13 ranges	DC: $\pm 1 \mu\text{A}$ to $\pm 1 \text{ A}$ ($\pm 2\%$) 13 ranges	1 Ω - 100 M Ω ($\pm 5\%$ midscale) 9 ranges	412A	216
DC MICROVOLT-AMMETER has 1 M Ω input impedance	DC: $\pm 10 \mu\text{V} - \pm 1 \text{ V}$ ($\pm 3\%$) 11 ranges	DC: $\pm 10 \text{ pA}$ to $\pm 3 \text{ mA}$ ($\pm 3\%$) 18 ranges		425A	217
CURRENT METERS	Current Range	Accuracy	Frequency Range	Model	See Page
DC MILLIAMMETER with clip-on probe eliminates direct connection	0.1 mA - 10 A f.s. (9 ranges)	$\pm 3\%$	dc-400 Hz	428B	219
AC CLIP-ON CURRENT PROBE makes measurements without breaking circuit	1 mA - 1 A rms (to 25 A with divider)	$\pm 2\%$ to 3 dB	25 Hz - 20 MHz	456A	221

AC MICROVOLT METER

Measure signals obscured by noise
Model 3410A



**VOLTAGE, CURRENT,
RESISTANCE**

Uses:

- Measure amplitude of signal buried in noise
- Measure amplitude of ripple frequency
- Measure amplitude of superimposed frequency
- Use as a Preamp/Noise Discriminator for frequency measurements

The HP Model 3410A AC Microvoltmeter is a tuneable, phase lock voltmeter designed to measure low level repetitive signals obscured by noise or in the presence of other non-harmonically related signals. Its sensitivity is $3 \mu\text{V}$ to 3 V full scale in 13 ranges over a frequency range of 5 Hz to 600 kHz . Signals obscured by noise 20 dB above full scale can be detected and measured with no degradation in accuracy.

Frequency of low level and noise repetitive signals can be accurately measured using a frequency counter connected to the local oscillator output on the rear panel of the 3410A. This signal is a 5 V square wave, phase locked to the tuned input signal. Counter sensitivity can be increased to better than 300 nanovolts (at the point at which phase lock is lost on the 3 microvolt range) with excellent noise discrimination.

A dc recorder output enhances the usefulness of the 3410A as a sensitive detector for graphic recording.

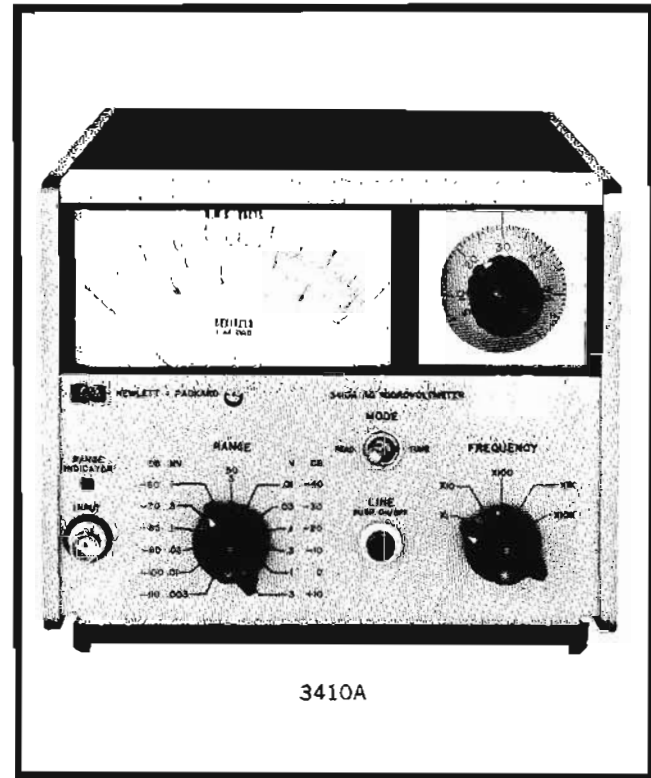

3410A

Specifications

Voltage range: $3 \mu\text{V}$ full scale to 3 V full scale in 13 ranges.

Voltage accuracy: (% of full scale).

Frequency

	5 Hz	10 Hz	25 Hz	100 Hz	50 kHz	600 kHz
30 μV TO 3V	$\pm 10\%$			$\pm 3\%$		$\pm 5\%$
10 μV	$\pm 15\%$	$\pm 10\%$		$\pm 3\%$		$\pm 5\%$
3 μV		$\pm 20\%$	$\pm 10\%$	$\pm 3\%$		$\pm 10\%$

*At lower frequencies and microvolt signal levels, meter fluctuations in the READ MODE may give the impression of an unstable lock condition. However, the 3410A will lock and track at these lower frequencies and provide a usable voltage indication.

Frequency range: 5 Hz to 600 kHz in 5 decade ranges.

Frequency dial accuracy: $\pm 10\%$ full scale (unlocked).

Phase lock range: pull in $\pm 1\%$ of full scale frequency.
Track $\pm 5\%$ of full scale frequency. Tracking speed 0.5% of full scale frequency/second.

Maximum noise rejection: 20 dB rms above full scale on all ranges for rated accuracy.

Input impedance: 10 mV to 3 V range, $10 \text{ M}\Omega$ shunted by 10 pF . $3 \mu\text{V}$ to 3 mV range, $10 \text{ M}\Omega$ shunted by 20 pF .

Meter indication: responds to average value of input waveform; calibrated in rms value of sine wave. Linear voltage scales 0 to 1 and 0 to 3; dB scale -12 to $+2 \text{ dB}$ ($0 \text{ dB} = 1 \text{ mW}$ into 600Ω).

Local oscillator output: 5 V square wave into 1000Ω at the same frequency as the phase locked input signal.

DC output: 1 V into 1000Ω for full scale, proportional to meter deflection; $\pm 0.5 \text{ V}$ adjustable offset level.

AC power: 115 or $230 \text{ V} \pm 10\%$, 50 to 1000 Hz , 22 W .

Weight: net 10 lbs ($4,5 \text{ kg}$); shipping 12.5 lbs ($5,6 \text{ kg}$).

Dimensions: $6\frac{1}{2}''$ high, $7\frac{3}{4}''$ wide, $11''$ deep ($165 \times 196,9 \times 279,4 \text{ mm}$).

Accessories available: HP 11074A Voltage Divider Probe. Provides $10:1$ division ratio to extend 3410A input to 30 V rms full scale, \$50.

Price: HP 3410A, \$800. HP 3410A Option 01, dB scale uppermost, \$810.

VOLTAGE, CURRENT, RESISTANCE



AC VOLTMETER

Measure 20 Hz to 4 MHz, 100 μ V to 1 kV

Models 400F, FL, GL

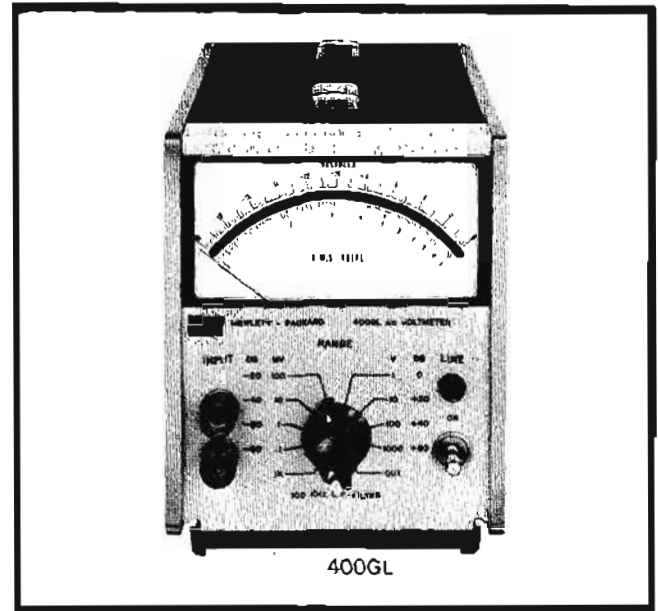
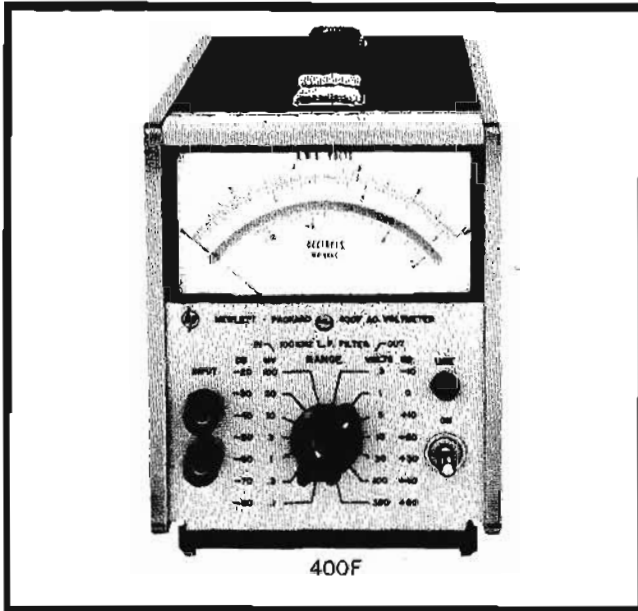

General Description

The HP 400F/FL/GL solid-state ac voltmeters are ruggedly-built precision instruments for measuring ac voltages from 100 mV to 300 V rms full scale (100 μ V-1 kV rms full scale using the 400 GL). They cover a frequency range from 20 Hz to 4 MHz and have constant 10 M Ω input resistance on all ranges. Input capacity is 25 pF on the 100 μ V to 300 mV range (100 μ V to 100 mV for the 400 GL) and 10 pF on the 1 V to 300 V range (1 V to 1 kV for the 400 GL). The instruments are simple to operate and give direct voltage and dBm readings.

These ac voltmeters have exceptional long-term stability because their calibration is not dependent on active component parameters which are subject to aging. The 400F/FL/GL may also be used as stable, high-gain ac amplifiers with up to 80 dB amplification.

The chart on the next page shows the specifications for these compact, lightweight, solid-state voltmeters.

100 kHz Low Pass Filter

In order to reduce the effect of unwanted high frequencies (noise, etc.) on the accuracy of measuring lower frequency signals, a 100 kHz low-pass filter is provided. It may be activated by a front-panel switch. The filter is effective on all ranges but will be of greater use on more sensitive ranges. It has 3 dB of attenuation at 100 kHz \pm 5 kHz.

Battery Operation

The Models 400F/FL/GL can be operated from two 35-to-55-volt batteries connected to the rear-panel battery terminals. This feature is ideal for communications usage or when ground loops cause trouble.

Model 400F

The 400F has all the characteristics mentioned in the

general description with $\frac{1}{2}\%$ of reading plus $\frac{1}{2}\%$ of full-scale accuracy on a $4\frac{1}{2}$ " mirror-backed taut-band meter. The meter is individually calibrated with 100 divisions to provide greater resolution. The Model 400F Option 01 with dB scale uppermost is recommended for greater resolution in dB measurements.

Model 400FL

The 400FL has all the characteristics mentioned in the general description with 1% of reading accuracy on a linear 12 dB logarithmic scale. This meter is also individually calibrated with 120 divisions and is ideal for dB measurements. It incorporates an HP taut-band, mirror-backed, logarithmic meter. A range switch changes sensitivity in 10 dB steps which, combined with the 12 dB scale, provides the overlap desirable in decibel-level measurements.

Model 400GL

The 400GL has all the characteristics mentioned in the general description with the capability for measuring ac voltages from 100 microvolts to 1 kV rms full scale. It incorporates an HP taut-band, mirror-backed, logarithmic meter. For utmost accuracy, the meter scale is individually calibrated, using the new HP logarithmic meter calibrator. The meter scale provides maximum readability and ± 0.2 dB of reading accuracy. The decibel scale is more than $4\frac{3}{8}$ " long, and the voltage scale spreads across the full length. A front-panel range switch which changes sensitivity in 20 dB steps, combined with the dB calibration of the meter, permits reading of dB directly without calibration or conversion in the range -100 to +60 dB (0 dB = 1 volt).

400F/FL/GL

HP MODEL 400F		ACCURACY* % Full Scale Plus % Reading					
300 μ V to 300 V RANGES	20 Hz	40 Hz	100 Hz	1 MHz	2 MHz	4 MHz	
	$\pm(2 +2)$	$\pm(1 +1)$	$\pm(1/2 +1/2)$	$\pm(1 +1)$	$\pm(2 +2)$		
100 μ V RANGE	30 Hz	60 Hz	100 kHz	500 kHz			
	$\pm(2 +2)$	$\pm(1 +1)$	$\pm 1 +0 -7$				
HP MODEL 400FL		ACCURACY* % Reading					
300 μ V to 300 V RANGES	20 Hz	40 Hz	100 Hz	1 MHz	2 MHz	4 MHz	
	± 4	± 2	± 1	± 2	± 4		
100 μ V RANGE	30 Hz	60 Hz	100 kHz	500 kHz			
	± 4	± 2	$+1 -8$				
HP MODEL 400GL		ACCURACY* % Reading					
1 mV - 1000 V** Ranges	20 Hz	40 Hz	500 kHz	2 MHz	4 MHz		
	± 0.4 dB	± 0.2 dB	± 0.4 dB	$+0.2$ dB -0.8 dB			
100 μ V Range	30 Hz	60 Hz	100 kHz	500 kHz			
	± 0.4 dB	± 0.2 dB	$+0.2$ dB -0.8 dB				

** For input voltages greater than 300 volts, the high frequency range is limited to 100 kHz.

Frequency range: 20 Hz to 4 MHz.

Voltage range

400F/FL: 100 μ V to 300 V full scale, 14 ranges.
400GL: 100 μ V to 1000 V full scale, 8 ranges.

Calibration: reads rms value of sine wave; voltage indication proportional to absolute average of applied wave.

- 400F: dB scale -10 to +2 dB, 10 dB between ranges; 100 divisions on 0 to 1 scale.
- 400FL: linear dB scale -10 dB to +2 dB, 10 dB between ranges; log voltage scales 0.25 to 1 and 0.8 to 3; 120 divisions from -10 to +2 dB.
- 400GL: linear dB scale -20 dB to 0 dB, 20 dB between ranges; log voltage scales 0.1 to 1; 100 divisions from -20 to 0 dB.

Noise referred to input (1000 Ω termination)

	Filter In	Filter Out
300 μ V - 300 V [†]	5 μ V	30 μ V
100 μ V Range	5 μ V	15 μ V

Note: Noise adds to the signal approximately by the relation:
Reading = $\sqrt{(\text{signal})^2 + (\text{noise})^2}$ 400GL: 1 mV - 1 kV

Input impedance: 10 M Ω shunted by 25 pF on the 100 μ V - 300 mV ranges (400GL, 100 μ V - 100 mV ranges), and 10 M Ω shunted by 10 pF on the 1 V - 300 V ranges (400GL, 1 V - 1 kV ranges).

Amplified ac output: 1 V rms open circuit (full scale) and is proportional to meter indication on the voltage scale; output impedance, 600 Ω ; frequency response, 20 Hz to 4 MHz.

Recovery from payload: <2 s for 80 dB overload; 300 V max. input (400GL, 1200 V max. input).

Meter response: <0.7 s after application of signal.

AC power: 115 or 230 V $\pm 10\%$, 50 to 1000 Hz, approximately 5 W.

Temperature range: 0 to +55 $^{\circ}$ C.

External battery operation: terminals are provided on rear panel. Positive and negative voltages between 35 V and 55 V are required; current drain from each voltage is approx. 45 mA. External switching and on/off monitoring should be used for battery operation.

Dimensions: (standard HP 1/3 module) 6 1/2" high, 5 1/8" wide, 11" deep (165.1 x 130.2 x 279.4 mm).

Weight: 400F/FL; net 5 lbs 10 oz (2.54 kg), shipping 7 lbs 10 oz (3.45 kg). 400GL; net 6 lbs (2.7 kg), shipping 8 lbs (3.6 kg).

Accessories available: 11076A Carrying Case (refer to page 631 for details); \$45.

Price: 400F, \$300; 400FL, \$310; 400GL, \$290.

Option 01 (400F only): reads directly in volts and dB with dB scale uppermost; add \$10.

H10-400F/FL: constant input capacity (10 M Ω shunted by 22 pF) available on special order.

VOLTAGE, CURRENT, RESISTANCE



AC VOLTMETERS

Measure 10 Hz to 10 MHz, 1 mV to 300 V
Models 400E, EL

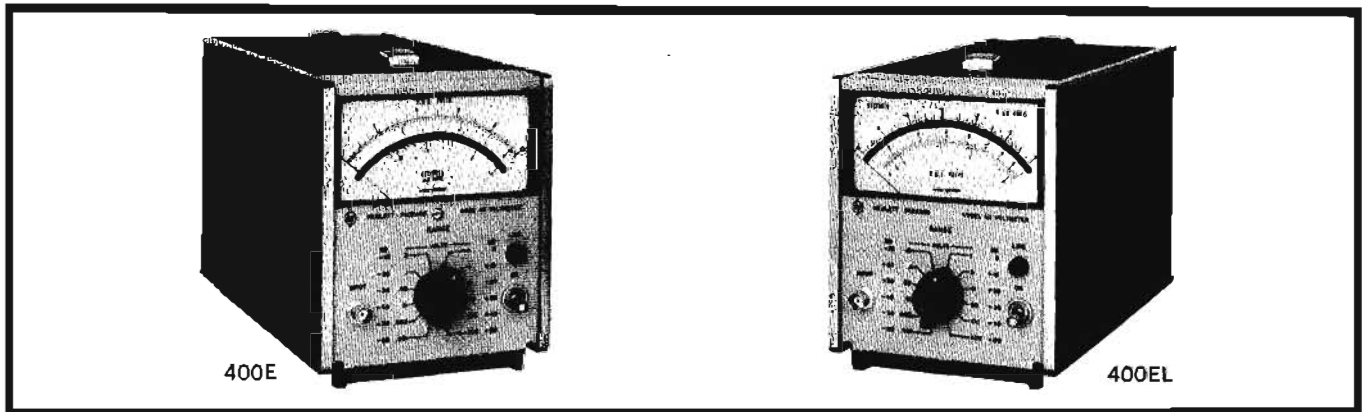

Description

The HP 400E/EL Solid-State AC Voltmeters are ruggedly built precision instruments for measuring ac voltages from 1 millivolt to 300 V rms full scale. They cover a frequency range from 10 Hz to 10 MHz and have constant 10 megohm input resistance on all ranges. Input capacity is 21 pF on the 1 mV to 1 volt range and 8 pF on the 3 volt to 300 volt range. The instruments are simple to operate and give direct voltage and dBm readings.

These ac voltmeters have exceptional long-term stability because their calibration is not dependent on active component parameters which are subject to aging. The 400E/EL may also be used as stable, high-gain ac amplifiers or ac-to-dc converters.

The 400E has all the characteristics mentioned above with 1% of reading accuracy on a 4½" mirror-backed, taut-band meter. The meter is individually calibrated with 100 divisions to provide greater resolution.

The 400EL has all the characteristics above with 1% of reading accuracy on a linear 12 dB logarithmic scale. This meter is also individually calibrated with 120 divisions and is ideal for dB measurements.

Battery operation

The Models 400E/EL can be operated from two 35 to 55-volt batteries connected to the rear panel battery terminals. This feature is ideal for communications usage or when troublesome ground loops are prevalent.

Options

Special dB-measuring option—The Model 400E reads directly in volts and dB, with the voltage scale uppermost. The Model 400E (Option 01) with dB scale uppermost is recommended for greater resolution in dB measurements.

High gain amplifier

Additionally, the 400E and 400 EL provide a stable low-distortion, high-gain, wideband ac amplifier with a 50-ohm output impedance.

AC-to-DC converter

The Models 400E/EL provide a linear dc output (1 volt dc for full-scale meter deflection) proportional to meter deflection which can be used to drive a potentiometer or galvanometer recorder. The accuracy is $\pm 0.5\%$ making the 400E/EL an excellent ac-to-dc converter. This dc output is available at the rear panel of the instrument; see specifications described below.

Specifications, 400E, EL

AC - TO - DC CONVERTER OUTPUT

3 MV to 300 V RANGES	Accuracy % of reading							
	Frequency	10 Hz	20 Hz	40 Hz	100 Hz	500 kHz	2 MHz	10 MHz
At full scale	± 4	± 2	± 1	$\pm 0.5^*$		± 1	± 2	$\pm 5^\dagger$
At 1/3 full scale	+4 -10	+2 -4		± 1		± 2	+2 -4	+3 -10

1 MV RANGE	Accuracy % of reading								
	Frequency	10 Hz	20 Hz	40 Hz	100 Hz	100 kHz	600 kHz	2 MHz	6 MHz
At full scale	+4 -10	± 2	± 1	$\pm 0.5^*$		± 1	± 2	± 4	+4 -10
At 1/3 full scale	+4 -10	+2 -4		± 1		± 2	+2 -4	+3 -10	
At 1/10 full scale		-4 -15	+4 -10	± 4		+4 -10	+4 -15	+4 -30	

*For 15°C-40°C on 1 mV-1 volt ranges only.

†For 100 and 300 volt ranges +4, -10%.

Specifications

Model	400E	400EL
Voltage range	1 mV to 300 V full scale, 12 ranges	
Frequency range	10 Hz to 10 MHz	
Calibration	Reads rms value of sine wave; voltage indication proportional to absolute average value of applied wave; dB scale -10 to +2 dB, 10 dB between ranges; 100 divisions on 0 to 1 scale.	Reads rms value of sine wave; voltage indication proportional to absolute average value of applied wave; linear dB scale -10 dB to +2 dB, 10 dB between ranges; logarithmic voltage scales 0.3 to 1 and 0.8 to 3; 120 divisions from -10 to +2 dB.

Model 400E

3 MV to 300 V RANGES		Accuracy % of reading						
Frequency	10 Hz	20 Hz	40 Hz	500 kHz	2 MHz	1 MHz	4 MHz	10 MHz
At full scale	±4	±2	±1			±2	±5†	
At 1/3 full scale	+4 -10	+3 -5	±3			+3 -4	+3 -5	+4 -10

1 MV RANGE		Accuracy % of reading						
Frequency	10 Hz	20 Hz	40 Hz	100 Hz	100 kHz	500 kHz	2 MHz	8 MHz
						200 kHz	1 MHz	4 MHz
At full scale	+4 -10	±2	±1			±2	±4	+4 -10
At 1/3 full scale	+4 -10	+3 -5	±3			+3 -4	+3 -5	+3 -10
At full scale		+10 -20	+10 -15	±10	+10 -15	+10 -20	+10 -30	

Model 400EL

3 MV to 300 V RANGES		Accuracy % of reading						
Frequency	10 Hz	20 Hz	40 Hz	500 kHz	2 MHz	1 MHz	4 MHz	10 MHz
At full scale	±4	±2	±1			±2	±2	±5†
At 1/3 full scale	+4 -10	+2 -4	±1.5			±2	±2 -4	+3 -10

1 MV RANGE		Accuracy % of reading							
Frequency	10 Hz	20 Hz	40 Hz	500 kHz	2 MHz	6 MHz	1 MHz	4 MHz	
							200 kHz	1 MHz	4 MHz
At full scale	+4 -10	±2	±1			±2	±4	+4 -10	
At 1/3 full scale	+4 -10	+2 -4	±1.5			±2	+2 -4	+3 -10	

†For 100 and 300 volt ranges -4, -10%.

Specifications, 400E, EL

Input impedance: 10 M Ω shunted by 21 pF on the 1 mV to 1 V ranges, and 10 M Ω shunted by 8 pF on the 3 V to 300 V ranges.

Amplifier ac output: 150 mV rms for full-scale meter indication; output impedance 50 Ω , 10 Hz to 10 MHz (105 mV on the 1 mV range); accuracy $\pm 10\%$, 10 Hz to 4 MHz.

AC-DC converter output: 1 V dc output for full-scale meter deflection (linear output).

Output resistance: 1000 Ω .

Response time: 2 s to within 1% of final value for a step change.

Meter response time: <1 s, 0 to full scale.

Temperature range: 0 to +55°C (except where noted on accuracy charts).

AC power: 115 or 230 V $\pm 10\%$, 50 to 1000 Hz, 5 W.

External battery operation: terminals are provided on rear panel; positive and negative voltages between 35 V and 55 V are required; current drain from each voltage is 54 mA (external switching and on/off monitoring should be used for battery operation).

Dimensions: standard 1/3 module 6 1/2" high, 5 1/8" wide, 11" deep (165,1 x 130,2 x 279,4 mm).

Weight: net 6 lbs (2.7 kg); shipping 8 lbs (3,6 kg).

Accessories available: 11076A Carrying Case (refer to page 631 for details), \$45.

Price: HP 400E, \$310; HP 400EL, \$320.

Option 01 (400E only): reads directly in volts and dB with scale uppermost, add \$10.

H05-400E/EL: constant input capacity available on special order, price on request.

**VOLTAGE, CURRENT,
RESISTANCE**



VACUUM TUBE VOLTMETERS

Quality linear and log voltmeters

Models 400D, 400H, 400L

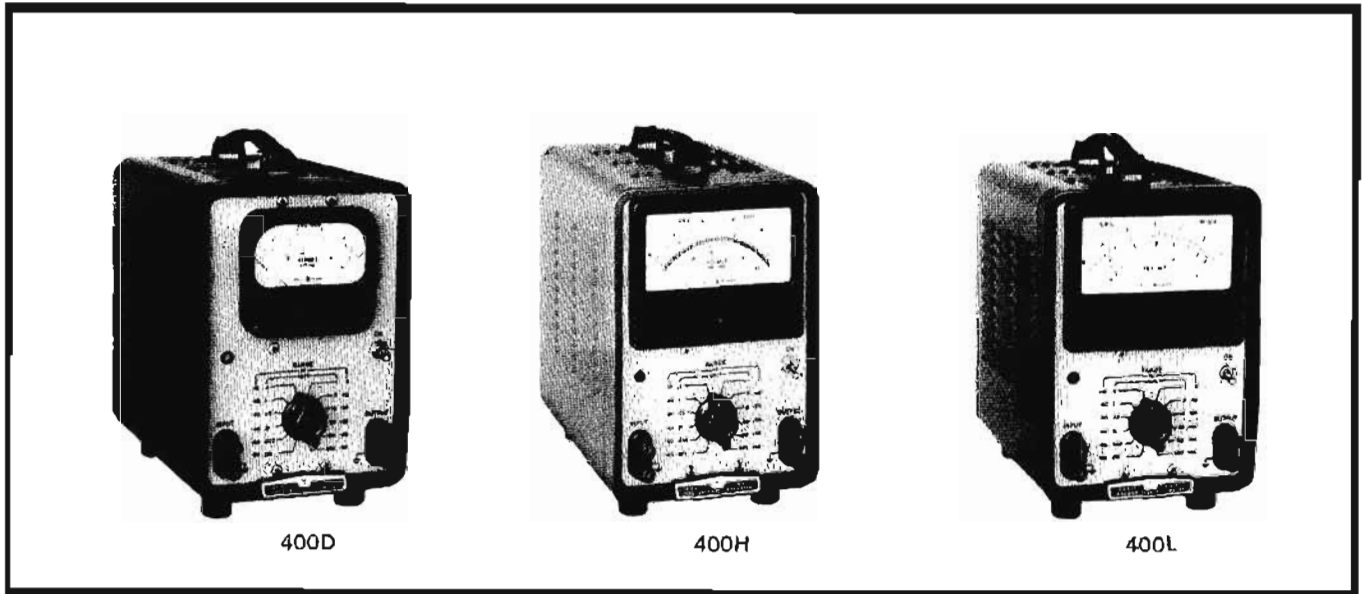

Description

Model 400D is essentially a low-priced precision voltmeter offering wide voltage range, 2% accuracy and the broad frequency coverage 10 Hz to 4 MHz.

Model 400H is an adaptation of Model 400D but offering individual meter-face calibration and 1% accuracy on an extra large 5" mirror-scale meter.

Model 400L, a logarithmic version of Model 400D, has an

accuracy of $\pm 2\%$ of reading or $\pm 1\%$ of full scale, whichever is more accurate. The 5" meter is mirror-backed.

Special dB-measuring options

As normally supplied, Models 400D and 400H read direct in volts and dB, with the voltage scale uppermost. For greater resolution in dB measuring, these instruments are available as Models 400D Option 01, and 400H Option 01 (\$25 extra) with the dB meter scale uppermost.

Specifications

	400D,DR	400H,HR	400L,LR
Voltage range:	1.0 mV to 300 V full scale, 12 ranges	1.0 mV to 300 V full scale, 12 ranges	-70 dB to +52 dB in 12 ranges 1.0 mV to 300 V full scale, 12 ranges
Frequency range:	10 Hz to 4 MHz		
Accuracy:	$\pm 5\%$ f.s., 10 Hz to 20 Hz $\pm 2\%$ f.s., 20 Hz to 1 MHz $\pm 3\%$ f.s., 1 MHz to 2 MHz $\pm 5\%$ f.s., 2 MHz to 4 MHz	$\pm 5\%$ f.s., 10 Hz to 20 Hz $\pm 2\%$ f.s., 20 Hz to 50 Hz $\pm 1\%$ f.s., 50 Hz to 500 kHz $\pm 2\%$ f.s., 500 kHz to 1 MHz $\pm 3\%$ f.s., 1 MHz to 2 MHz $\pm 5\%$ f.s., 2 MHz to 4 MHz	10 Hz to 20 Hz: $\pm 5\%$ of rdg. 20 Hz to 50 Hz: $\pm 3\%$ of rdg. or $\pm 2\%$ of f.s.† 50 Hz to 500 kHz: $\pm 2\%$ of rdg. or $\pm 1\%$ of f.s.† 500 kHz to 1 MHz: $\pm 3\%$ of rdg. or $\pm 2\%$ of f.s.† 1 MHz to 2 MHz: $\pm 4\%$ of rdg. or $\pm 3\%$ of f.s.† 2 MHz to 4 MHz: $\pm 5\%$ of rdg.
Long-term stability:	reduction in Gm of amplifier tubes to 75% of nominal value results in error of less than 0.5%, 50 Hz to 1 MHz		
Calibration:	reads rms value of sine wave; voltage indication proportional to average value of applied wave; linear voltage scale 0 to 3 and 0 to 1; dB scale -12 to +2 dB (0 dB = 1 mW in 600 ohms); 10 dB interval between ranges		reads rms value of sine wave; logarithmic voltage scale 0.3 to 1 and 0.8 to 3; linear dB scale, -10 dB to +2 dB (based on 0 dB = 1 mW in 600 ohms); 10 dB intervals between ranges
Input impedance:	10 megohms shunted by 15 pF on ranges 1 to 300 V; 25 pF on ranges 0.001 to 0.3 V		
Amplifier:	output 0.15 V max.; internal impedance 50 ohms; max. gain 150 on 0.001 range		
Power:	115 or 230 volts = 10%, 50 to 1,000 Hz; 80 watts (100 watts for 400 H,L)		
Dimensions:	cabinet mount: 7½" wide, 11½" high, 12" deep (191 x 292 x 305 mm) rack mount: 19" wide, 7" high, 10¼" deep behind panel (483 x 389 x 276 mm)		
Weight:	net 18 lbs (8,1 kg), shipping 19 lbs (8,6 kg) (cabinet mount); net 21 lbs (9,45 kg), shipping 31 lbs (14 kg) (rack mount)		
Price:	HP 400D, \$250* HP 400DR, \$255**	HP 400H, \$350* HP 400HR, \$355**	HP 400L, \$360* HP 400LR, \$365**

*Cabinet. † % of full scale (f.s.) or % of reading (rdg.) whichever is more accurate.

**Rack mount.

AC VOLTMETERS

Solid-state, battery-operated, portable
Model 403A, B



**VOLTAGE, CURRENT,
RESISTANCE**

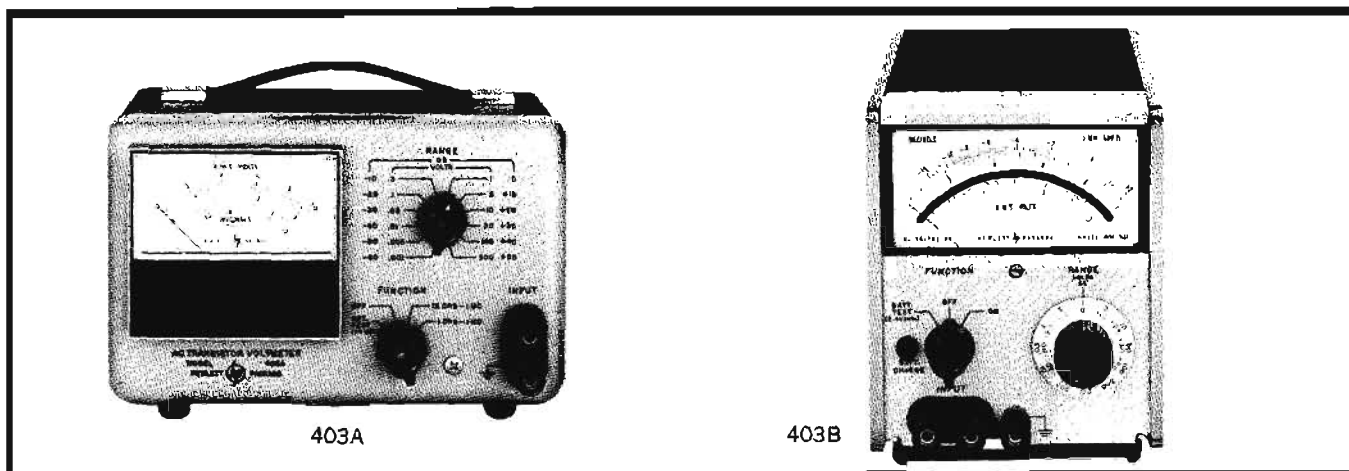

Description

Models 403A and 403B ac voltmeters are versatile, general-purpose instruments for laboratory and production work and are ideal for use in the field, since they are solid-state, battery-operated and portable.

Both measure from 100 microvolts to 300 volts, the 403A covering 1 Hz to 1 MHz and the 403B covering 5 Hz to 2 MHz. Both operate from internal batteries and, thus, may be completely isolated from the power-line and external grounds, permitting accurate measurements at power-line frequency and its harmonics without concern for beat effects. Isolation from external ground also permits use where ground loops are troublesome. Turnover effect and waveform errors

are minimized because the meters respond to the average value of the input signal.

The 403B operates from an ac line as well as from the internal battery pack, and batteries recharge during ac operation. Battery charge may be easily checked with a front-panel switch to assure reliable measurements. Normally, about 15 hours of ac operation recharges the batteries; but an internal adjustment is provided which nearly doubles the charging rate. You can use the Model 403B while its batteries charge. A sturdy taut-band meter eliminates friction and provides greater precision and repeatability.

For improved resolution in dB measurements, the 403B Option 01 is available. This version spreads out the dB scale by making it the top scale of the meter.

Specifications

HP Model	403A	403B	403B (Option 01.)
Range	0.001 to 300 V rms full scale, 12 ranges, in a 1, 3, 10 sequence.		
Meter	responds to average value of input waveform, calibrated in the rms value of a sine wave.		
Frequency range	1 Hz to 1 MHz	5 Hz to 2 MHz	5 Hz to 2 MHz
Accuracy	within $\pm 3\%$ of full scale, 5 Hz to 500 kHz; within $\pm 5\%$ of full scale, 1 to 5 Hz and 500 kHz to 1 MHz	within $\pm 2\%$ of full scale from 10 Hz to 1 MHz; within $\pm 5\%$ of full scale from 5 to 10 Hz and 1 to 2 MHz, except $\pm 10\%$ 1 to 2 MHz on the 300 V range (0 to 50°C)*	within ± 0.2 dB of full scale from 10 Hz to 1 MHz; within ± 0.4 dB of full scale from 5 to 10 Hz and 1 to 2 MHz, except ± 0.8 dB 1 to 2 MHz on the 300 V range (0 to 50°C)*
Input impedance	2 megohms ($\pm 5\%$) shunted by < 40 pF, 0.001 to 0.1 V ranges; < 25 pF on 0.3 to 300 volt ranges	2 megohms; shunted by approx. 50 pF; 0.001 to 0.03 V ranges; 25 pF, 0.1 to 300 V ranges	same as 403B
Maximum input	600 V peak, 0.3 V and higher ranges; 25 V rms on 0.1 V and lower ranges	600 V peak, 0.3 to 300 V range; 25 V rms, 60 V peak, 0.001 to 0.1 V ranges	same as 403B
Power	5 standard radio-type mercury cells, battery life approx. 400 hours	4 rechargeable batteries, 40 hours' operation per recharge, up to 500 recharging cycles; self-contained recharging circuit functions during operation from ac line	same as 403B
Dimensions	8 $\frac{1}{4}$ " wide, 5 $\frac{1}{2}$ " high, 6 $\frac{3}{8}$ " deep (210 x 140 x 162 mm)	5 $\frac{1}{8}$ " wide, 6-3/32" high, 8" deep (130 x 160 x 203 mm)	same as 403B
Weight	net 4 $\frac{1}{4}$ lbs (2.1 kg); shipping 7 lbs (3.2 kg)	net 6 $\frac{1}{2}$ lbs (2.9 kg); shipping 8 lbs (3.6 kg)	same as 403B
Price	\$290	\$310	\$335

*Use 10001A 10:1 Divider and 10111A Adapter to retain $\pm 5\%$ (± 0.4 dB) accuracy while measuring up to 425 V rms at 1 to 2 MHz.

VOLTAGE, CURRENT, RESISTANCE



RMS VOLTMETER

Fast, accurate rms measurements

Model 3400A

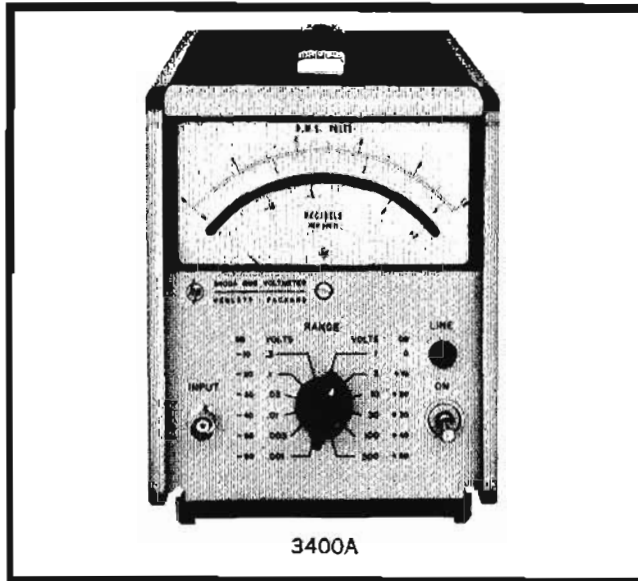

Description

The Hewlett-Packard Model 3400A is a true root-mean-square (rms) voltmeter, providing a meter indication proportional to the dc heating power of the input waveform. In addition to its meter indication, the Model 3400A provides a dc output proportional to meter deflection making it a useful true rms detector for graphic recording and digitizing with a dc digital voltmeter, such as the HP Model 3440A.

Versatility

Versatility of the Model 3400A is enhanced by its wide 10-Hz to 10-MHz frequency response, high crest factor, 1-mV to 300-Volt full-scale sensitivity and 10-M Ω input impedance. Six-decade frequency coverage makes the 3400A extremely flexible for all of your audio and most rf measurements and permits the measurement of broadband noise and fast-rise pulse. A wide range of sensitivity (12 ranges) allows you to measure any thing from "down in the grass" signal and noise, to transmitter and amplifier outputs (with 30-dB overload protection). Pulses or other non-sinusoids with crest factors (ratio of peak to rms) up to 10:1 can be measured full scale. Crest factor is inversely proportional to meter deflection, permitting up to 100:1 crest factor at 10% of full scale. The ability of the 3400A to accept waveforms with such large crest factors insures accurate noise and pulse measurements, without the need for correction factors. Permanent plots of measured data and higher resolution measurements can be obtained by connecting an X-Y plotter, strip chart recorder or digital voltmeter to the convenient rear-panel dc output. The dc output provides a linear 0 to 1-volt drive, proportional to meter deflection.

True-rms current measurements can be made conveniently by using the HP Model 456A Current Probe with the Model 3400A. See page 220.

Specifications

Voltage range: 1 mV to 300 V, 12 ranges.

DB range: -72 to +52 dBm.

Meter scales: voltages: 0.1 to 1 and 0.3 to 3.2 Decibel, -12 to +2 dBm (0 dBm = 1 mW, 600 Ω). Scales are individually calibrated to the meter movement.

Frequency range: 10 Hz to 10 MHz.

Response: responds to rms value (heating value) of the input signal for all waveforms.

Meter accuracy: % of full scale (20°C to 30°C)*

10Hz 50Hz 1MHz 2MHz 3MHz 10MHz

±5% ±1% ±2% ±3% ±5%

Ac-to-dc converter accuracy: % of full scale (20°C to 30°C)*

10Hz 50Hz 1MHz 2MHz 3MHz 10MHz

±5% ±0.75% ±2% ±3% ±5%

Crest factor: (ratio of peak amplitude to rms amplitude):

10 to 1 at full scale (except where limited by maximum input) inversely proportional to pointer deflection, (e.g., 20 to 1 at half-scale, 100 to 1 at tenth scale).

Maximum input: ac: 800 V peak; dc: 600 V.

Input impedance: from 0.001 V to 0.3 V range: 10 M Ω shunted by 40 pF. From 1.0 V to 300 V range: 10 M Ω shunted by 15 pF.

Response time: for a step function, <5 seconds to respond to final value.

Ac overload: 30 dB above full scale or 800 V peak, whichever is less, on each range.

Output: negative 1 V dc open circuit at full-scale deflection, proportional to pointer deflection. (From 10-100% of full scale.) 1 mA maximum; nominal source impedance is 1000 Ω . Output noise <5 mV p-p.

Power: 115 or 230 V \pm 10%, 50 to 1000 Hz, approximately 7 W.

Dimensions: 5 $\frac{1}{8}$ in. wide, 6 $\frac{1}{2}$ in. high, 11 in. deep (1/3 module). (130 x 165 x 279 mm.)

Weight: net: 7 $\frac{1}{4}$ lbs (3,3 kg); shipping: 10 lbs (4,5 kg).

Accessories furnished: 10110A Adapter, BNC to dual banana jack.

Accessories available: 11001A Cable, 45 in. long, male BNC to dual banana plug, \$6.00. 10503A Cable 4 ft. long, male BNC connectors, \$7.00. 11002A Test Lead, dual banana plug to alligator clips, \$8.00. 11003A Test Leads, dual banana plug to probe and alligator clip, \$10. 11076A Carrying Case (refer to page 631), \$45.00. HP Model 456A AC Current Probe, 1 mV/1mA, \$225.

Options:

HP Model 3400A (Option 01) spreads out the dB scale by making it the top scale of the meter, \$550.

HP Model C30-3400A, rear terminal (accuracy on 300 V range degraded to \pm 8%, 3 to 10 MHz), \$560.

Price: HP 3400A, \$525.

*TC: \pm 0.1% overrange of 0°C to 20°C and 30°C to 55°C.

MULTI-FUNCTION METER

Low-cost, solid state, battery operated
Model 427A



**VOLTAGE, CURRENT,
RESISTANCE**

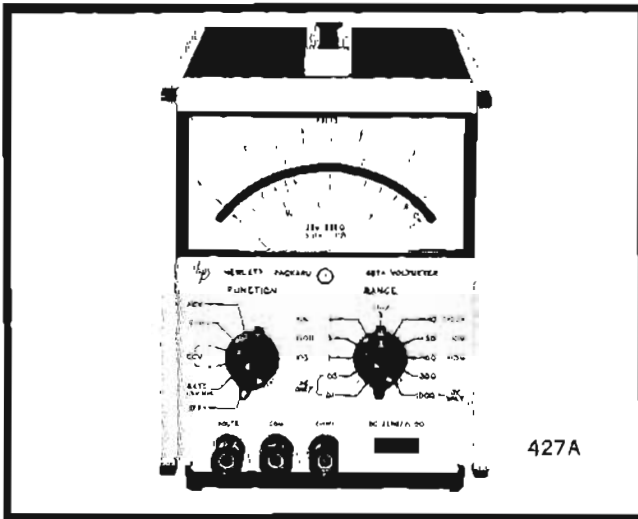

Features:

- Multiple function
- Ten ranges of ac voltage measurements
- Nine ranges of dc voltage measurements
- Seven ranges of ohms measurements
- 10 megohm input impedance
- Floating input
- All solid state
- Battery operation
- AC line and battery operation with Option 01
- Taut band meter individually calibrated

Description

The new all solid-state Hewlett-Packard 427A Voltmeter offers a broad measuring capability at moderate cost. This instrument measures: dc voltages from 100 mV full scale to 1 kV full scale, ac voltage from 10 mV full scale to 300 V full scale, and resistance from 10 ohms center scale to 10 megohms center scale. A dBm scale is included and is calibrated so that 0 dBm is 1 mW into 600 ohms.

This versatile HP 427A will be valuable in any laboratory, production line, service department, or in the field. Operation is from one internal battery, a 22½ volt dry cell, which provides more than 300 continuous hours of typical operation. AC line and battery operation is available as an option.

Low zero drift and maintenance of calibration of the circuit are retained when making measurements so that only an occasional adjustment of the zero control is needed.

Specifications dc voltmeter

Voltage ranges: ± 100 mV to ± 1000 V full scale in a 1, 3, 10 sequence (9 ranges).

Accuracy: $\pm 2\%$ of full scale on any range (0°C to 50°C).

Input resistance: 10 megohms on all ranges.

AC rejection: superimposed peak ac voltages (60 Hz and above) 100 times greater than full scale affects reading less than 1% for 60 Hz and above. 450 volts peak maximum.

Overload: 1200 V dc on any range.

AC voltmeter

Voltage ranges: 10 mV to 300 V rms full scale in a 1, 3, 10 sequence (10 ranges).

Frequency range: 10 Hz to 1 MHz. (500 MHz with HP 11096A High Frequency Probe.)

Accuracy: (0°C to 50°C).

Range	$\approx 2\%$ of full scale
.01 V-30 V	10 Hz-1 MHz
100 V-300 V	10 Hz-100 kHz

Frequency response: (10 mV to 30 V ranges).

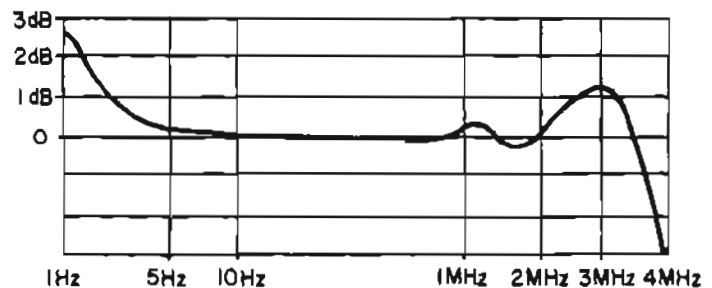

Input Impedance: 10 megohms shunted by 40 pF on 10 mV to 1 V ranges; 20 pF on 3 V to 300 V ranges.

Response: responds to the average value of the input; calibrated in rms volts for a sine wave input.

Overload: 300 V/rms momentarily, 1 V range and below. 425 V/rms maximum above 1 V range.

Ohmmeter

Resistance ranges: 10 ohms center scale to 10 megohms center scale (7 ranges).

Accuracy: $\pm 5\%$ of reading at midscale (0°C to $+50^\circ\text{C}$).

Source current: 0.1 μA to 10 mA depending upon range.

Open circuit voltage 0.1 V to 1 V depending upon range.

Polarity: common terminal negative.

General

Floating Input: may be operated up to 500 V dc above ground. (Ohms input open in any function except ohms—volts input open when instrument is in off position).

Power: 22½ volt dry cell battery. (non-rechargeable Eveready No. 763 or RCA VS102).

Option 01: battery operation and ac line operation (selectable on rear panel). 115 or 230 V $\pm 20\%$, 50 Hz to 1000 Hz, ½ W.

Weight: net, 5¼ lbs (2,36 kg); shipping: 6½ lbs (2,9 kg).

Dimensions: 5¼" wide, 6-3/16" high, 8" deep (130,2 x 154,8 x 203,2 mm).

Accessories available: HP 11096A High Frequency Probe converts 427A into AC voltmeter capable of measuring signals in a range from 100 kHz to 500 MHz. \$45. See page 221. HP 11075A Carrying Case, \$45. See page 631.

Price: HP 427A, \$225, HP 427A Option 01, \$250.

**VOLTAGE, CURRENT,
RESISTANCE**



MULTIFUNCTION VOLTMETERS

Models 410C, 410B

ELECTRONIC VOLTMETER

Zero drift multi-function meter

Model 410C

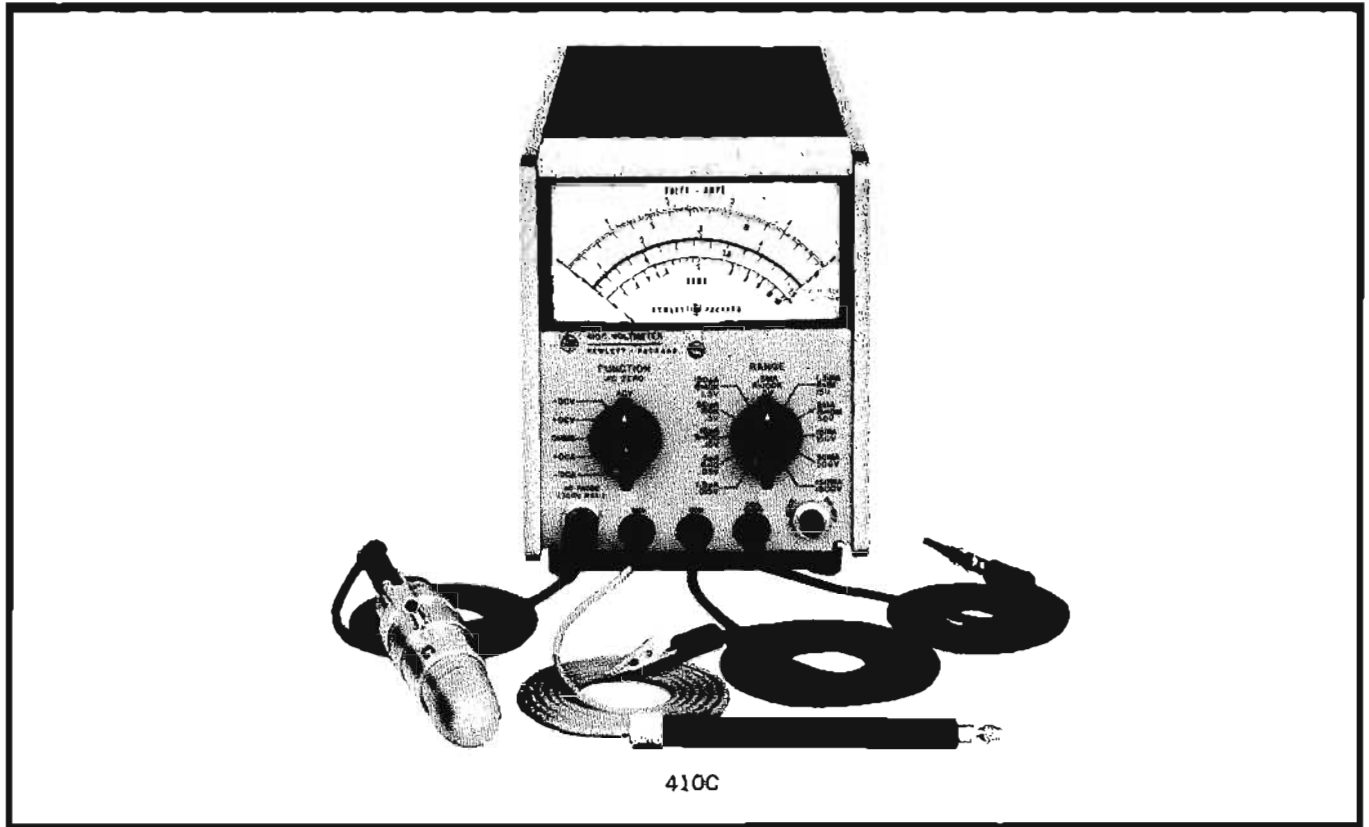

Description

The HP Model 410C is an extremely versatile general-purpose instrument for use anywhere electrical measurements are made. This one instrument measures: dc voltages from 15 mV to 1500 volts, direct current from 1.5 microamps to 150 mA, and resistance from 0.2 ohm to 500 megohms. With a standard plug-in-probe, ac voltages at 20 Hz to 700 MHz from 50 mV to 300 volts and comparative indications to 3 GHz are attainable.

These measurements are made with laboratory precision previously not available in a single instrument. The versatile easy-to-use HP 410C will be valuable in any laboratory, production line, or service department.

Specifications

DC voltmeter

Voltage ranges: ± 15 mV to ± 1500 V full scale in 15, 50 sequence (11 ranges).

Accuracy: $\pm 2\%$ of full scale on any range.

Input resistance: 100 megohms $\pm 1\%$ on 500 mV range and above.

10 megohms $\pm 3\%$ on 15 mV, 50 mV, and 150 mV ranges.

DC ammeter

Current ranges: ± 1.5 μ A to ± 150 mA full scale in 1.5, 5 sequence (11 ranges).

Accuracy: $\pm 3\%$ of full scale on any range.

Input resistance: decreasing from 9 k ohms on 1.5 μ A scale to approximately 0.3 Ω on the 150 mA scale.

Special current ranges: ± 1.5 , ± 5 and ± 15 nanoamps may be measured on the 15, 50, and 150 millivolt ranges using the voltmeter probe, with $\pm 5\%$ accuracy and 10 megohm input resistance.

Ohmmeter

Resistance range: resistance from 10 ohms to 10 megohms center scale (7 ranges).

Accuracy: zero to midscale: $\pm 5\%$ of reading or $\pm 2\%$ of midscale, whichever is greater.

$\pm 7\%$ of midscale to scale value of 2.

$\pm 8\%$ from scale value of 2 to 3.

$\pm 9\%$ from scale value of 3 to 5.

$\pm 10\%$ from scale value of 5 to 10.

410C Specifications Continued

Amplifier

Voltage gain: 100 maximum.

AC rejection: 3 dB at 1/2 Hz; approximately 66 dB at 50 Hz and higher frequencies for signals less than 1600 V peak or 30 times full scale, whichever is smaller.

Isolation: impedance between common and chassis is >10 meg Ω in parallel with 0.1 μ F. Common may be floated up to 400 V dc above chassis for dc and resistance measurements.

Output: proportional to meter indication; 1.5 V dc at full scale, maximum current, 1 mA.

Output Impedance: less than 3 ohms at dc.

Noise: less than 0.5% of full scale on any range (p-p).

DC drift: less than 0.5% of full scale/year at constant temperature. Less than 0.02% of full scale/ $^{\circ}$ C.

Overload recovery: recover from 100:1 overload in <3 sec.

AC voltmeter

Ranges: 0.5 V full scale to 300 V in 0.5, 1.5, 5 sequence (7 ranges).

Accuracy: $\pm 3\%$ of full scale at 400 Hz for sinusoidal voltages from 0.5 to 300 V rms. The ac probe responds to the positive peak-above-average value of the applied signal.

Frequency response: $\pm 2\%$ from 100 Hz to 100 MHz (400 Hz ref.) $\pm 10\%$ from 20 Hz to 100 Hz and from 100 MHz to 700 MHz.

Frequency range: 20 Hz to 700 MHz.

Input Impedance: input capacity 1.5 pF, input resistance >10 megohms at low frequencies. At high frequencies impedance drops off due to dielectric loss.

Safety: the probe body is grounded to chassis at all times for safety. All ac measurements are referenced to chassis ground.

Meter: individually calibrated taut-band meter. Responds to positive peak-above-average. Calibrated in rms volts for sine wave input.

General

Maximum input: (see Overload Recovery) DC: 100 V on 15, 50, and 150 mV ranges; 500 V on 0.5 to 15 V ranges; 1600 V on higher ranges. AC: 100 times full scale or 450 V peak, whichever is less.

Power: 115 or 230 V $\pm 10\%$. 50 to 1000 Hz, 13 W (20 W with 11036A AC Probe).

Dimensions: 6 1/2" high, 5 1/8" wide, 11" deep (165 x 130,2 x 320,7 mm) behind panel. Fits 5060-0797 Rack Adapter and 1050 Series combining cases.

Weight: net 8 lbs (4,0 kg); shipping 12 lbs (5,44 kg) (5,44 kg).

Accessories furnished: detachable power cord, NEMA plug.

Accessories available: 11076A Carry Case (see page 631).

Price: 11076A, \$45.

Option 02: HP Model 410C less AC Probe.

Price: HP 410C, \$425; Option 02, \$375.

VACUUM TUBE VOLTMETER

All-purpose instrument measures to 700 MHz

Model 410B specifications

Ranges: 1 to 300 V full scale in 6 ranges: 1, 3, 10, 30, 100 and 300 V ac or dc and 1,000 V range dc. Resistance 0.2 Ω to 500 M Ω in seven ranges. Mid-scale reading of 10, 100, 1,000, 10,000, 100,000 Ω , 1 M Ω , and 10 M Ω .

Accuracy: $\pm 3\%$ of full scale on all ranges for sinusoidal ac voltages at 400 Hz and for dc voltages. The ac portion of the instrument is peak responding, calibrated in rms volts. Ohmmeter accuracy is $\pm 1\%$ at midscale of Rx1 range, $\pm 5\%$ at midscale of all other ranges.

Frequency response: ± 1 dB, 20 Hz to 700 MHz. Probe resonant frequency is about 1,250 MHz and an indication can be obtained up to 3,000 MHz.

Input Impedance: input capacity is 1.5 pF, input resistance is 10 M Ω at low frequencies. At high frequencies resistance drops off due to dielectric losses. DC input resistance is approximately 122 M Ω for all ranges.

Power: 115 or 230 V $\pm 10\%$, 50 to 1000 Hz, 40 W.

Dimensions: 7 3/8" wide, 11 1/2" high, 8 3/4" deep (187 x 292 x 223 mm) (cabinet); 19" wide, 6-31/32" high, 6" deep behind panel (483 x 177 x 152 mm) (rack mount).

Weight: net 12 lbs (5,4 kg); shipping 13 lbs (5,9 kg) (cabinet); net 12 lbs (5,4 kg); shipping 19 lbs (8,6 kg) (rack mount).

Accessories available: 11039A Capacitive Voltage Divider, 25 kV max., \$185, requires 11018A Adapter, \$35; 11040A Capacitive Voltage Divider, 2 kV max., \$35; 11042A Probe Coax T Connector for Type "N" systems, \$50; 11043A Probe Coax N Connector adapts to Type "N" systems, \$38; 11044A DC Divider, 30 kV max., \$50.

Price: HP 410B, \$275 (cabinet). HP 410BR, \$295 (rack mount).

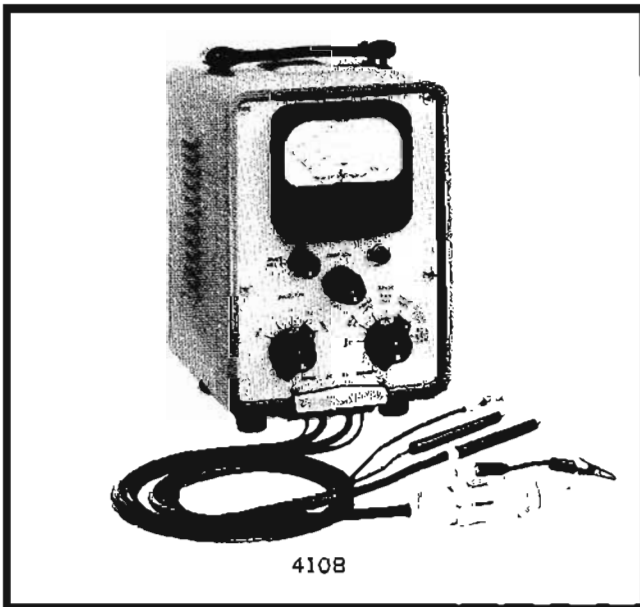
**Description**

Because of the large number of tasks it will perform, the 410B Vacuum Tube Voltmeter can play a uniquely valuable role in any laboratory, broadcast station or production test department. It combines in one instrument an ac voltmeter covering the frequency range from audio to radar frequencies, a dc voltmeter with 100 M Ω input impedance, and an ohmmeter capable of measuring resistance, 0.2 Ω to 500 M Ω . It is easy to use, compact, and lightweight.

**VOLTAGE, CURRENT,
RESISTANCE**



SAMPLING VOLTMETER

Absolute average readings of RF signals
Model 3406A

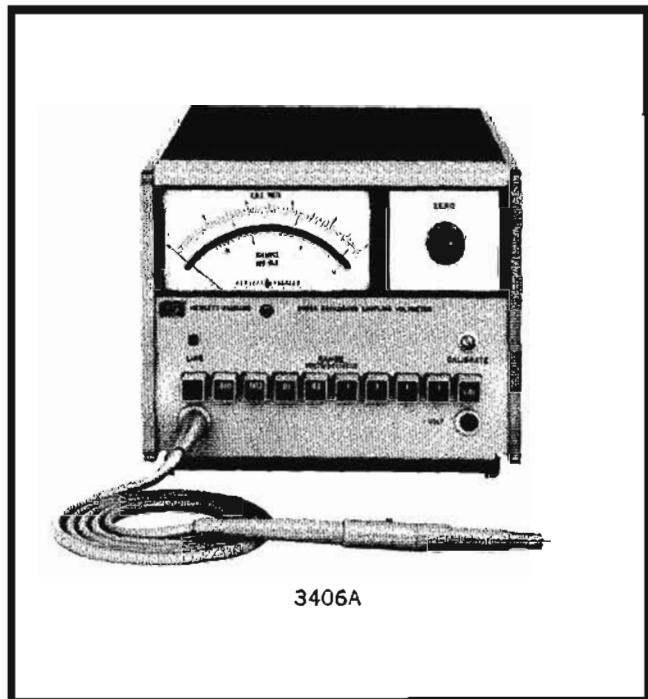

3406A

Description

Absolute average readings (calibrated in rms of a sine wave) of high frequency signals previously impractical can now be made easily with the HP 3406A Sampling Voltmeter. Employing incoherent sampling techniques, the HP 3406A has extremely wide bandwidth (10 kHz to 1.2 GHz) with high input impedance. Signals as small as 50 μV can be resolved on the sampling voltmeter's linear scale. Full scale sensitivity from 1 mV to 3 V is selected in eight 10 dB steps and may be read directly from -62 dBm to $+23$ dBm for power measurements. Accessory probe tips make the HP 3406A suitable for voltage measurements in many applications such as receivers, amplifiers and coaxial transmission lines.

Measurement indications can be retained on the 3406A meter by depressing a push-button located on the pen-type probe. This feature is useful when measurements are made in awkward positions where the operator cannot observe the meter indication and probe placements at the same time. Other features include a dc recorder output and sample hold output for connection to oscilloscopes, and peak or true rms voltmeters if other than absolute average measurements are required.

Specifications

Voltage range: 1 mV to 3 V full scale in 8 ranges; decibels from -50 to $+20$ dBm (0 dBm = 1 mW into 50 Ω); absolute average-reading instrument calibrated to rms value of sine wave.

Frequency range: 10 kHz to 1.2 GHz; useful sensitivity from 1 kHz to beyond 2 GHz.

Full-scale accuracy (%) with appropriate accessory: (after probe is properly calibrated).

10 kHz	20 kHz	25 kHz	100 kHz	100 MHz	700 MHz	1 GHz	1.2 GHz
± 13	± 8	± 5	± 3	± 5	± 8	± 13	

Input Impedance: input capacity and resistance will depend upon accessory tip used. 100,000 Ω shunted by <2.1 pF at 100 kHz with bare probe; <10 pF with 11072A isolator tip supplied.

Sample Hold Output

Provides ac signal whose unclamped portion has statistics that are narrowly distributed about the statistics of the input, inverted in sign (operating into >200 k Ω load with <1000 pF).

Noise: <225 μV rms.

Accuracy (after probe is properly calibrated): 0.01 V range and above: same as full scale accuracy of instrument.

0.001 V to 0.003 V range: value of input signal can be computed by taking into account the residual noise of the instrument.

Jitter: typically $\pm 2\%$ peak of reading 95% of time (as measured with HP 3400A True RMS Voltmeter).

RMS crest factor: 0.001 V to 0.3 V, 20 dB; 1 V, 13 dB; 3 V, 3 dB.

Meter

Meter scales: linear voltage, 0 to 1 and 0 to 3; decibel, -12 to $+3$. Individually calibrated taut-band meter.

Response time: indicates within specified accuracy in <3 sec.

Jitter: $\pm 1\%$ peak (of reading).

General

DC recorder output: adjustable from 0 to 1.2 mA into 1000 ohms at full scale, proportional to meter deflection.

Overload recovery time: meter indicates within specified accuracy in <5 sec (30 V p-p max.).

Maximum Input: ± 100 V dc, 30 V p-p.

RFI: conducted and radiated leakage limits are below those specified in MIL-6181D and MIL-1-16910C except for pulses emitted from probe. Spectral intensity of these pulses are nominally 50 nV/ $\sqrt{\text{Hz}}$; spectrum extends beyond 2 GHz.

Temperature range: instrument, 0 $^{\circ}\text{C}$ to $+55^{\circ}\text{C}$; probe, $+10^{\circ}\text{C}$ to $+40^{\circ}\text{C}$.

Power: 115 or 230 V $\pm 10\%$, 50 Hz to 1000 Hz, nominally <20 W.

Dimensions: 8 $\frac{7}{8}$ " wide, 6 $\frac{1}{2}$ " high, 11 $\frac{1}{2}$ " deep (225 x 165 x 292 mm); $\frac{1}{2}$ module.

Weight: net 12 lbs (5,4 kg); shipping 14 lbs (6,4 kg).

Price: HP 3406A, \$650.

Accessories furnished

Nut Driver, HP Part Number 8710-0084: nut driver for tip replacement, \$1.

11072A Isolator Tip: eliminates the effect of source impedance variations when the 11063A "T" and 10:1 divider are not used. Frequency range, 10 kHz to 250 MHz; input capacitance, <10 pF; \$15.

10213-62102 Ground Clips
5020-0457 Replacement Tips
5060-4991 Ground Lead

Accessories available

11064A Accessory Probe Kit: consists of the following: 11063A 50Ω "T" 11061A 10:1 divider tip; 10218A BNC adapter; 0950-0090 50Ω termination; 10213-62102 ground clips (2 ea.); 5020-0457 probe tip (5 ea.); 5060-4991 ground leads (2 ea.). Price HP 11064A, \$100.

11063A "T": should be used whenever measurements are made in 50Ω systems; useful to about 1.5 GHz.

VSWR: <1.15 at 1 GHz (bare probe in "T").

Insertion loss: <1 dB up to 1 GHz. Price: HP 11063A, \$55.

10218A BNC Adapter: probe to male BNC adapter. Frequency range: 10 kHz to 250 MHz. Price: HP 10218A, \$6.

11061A 10:1 Divider: as well as dividing the input voltage by a factor of ten, this accessory eliminates the effects of source impedance variations.

Accuracy (divider alone): ±5% 1 kHz-400 MHz.
±12% 400 MHz-1 GHz.

Maximum input: 150 V p-p ac, 600 V dc. Price: HP 11061A, \$35.

50 ohm termination: (0950-0090) Price: \$39.50.

Ground clips: 2 each (10213-62102) Price: \$1

Probe tips: 5 each (5020-0457) Price: \$1.

Ground leads: 2 each (5060-4991) Price: \$2.30.

11071A Accessory Probe Kit: consists of all the 11064A accessories plus 11073A Pen Type Probe (with 11073-62101 ground lead); 10219A Type 874A Adapter; 10220A

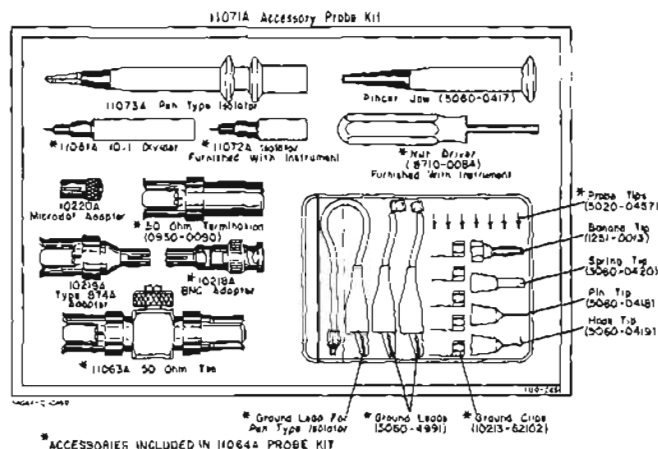

Microdot Adapter; 5060-0418 Pen Tip. 5060-0419 Hook Tip; 5060-0420 Spring Tip; 5060-0417 Pincer Jaw; 1251-0013 Banana Tip. Price: HP 11071A, \$185.

11073A Pen Type Isolator: frequency range is 10 kHz to 50 MHz. Various accessories adapt the 11073A to alligator jaws and other tips which facilitate point-to-point measurements. Input capacitance: <10 pF. Price: HP 11073A, \$45.

10219A Type 874A Adapter: Price: HP 10219A, \$15.

10220A Microdot Adapter: Price: HP 10220A, \$4.00.

Pincer jaw: (5060-0417). Price: \$4.

Ground lead for pen type Isolator: (11073-62101). Price: \$2.70.

Ground leads: 2 each (5060-4991). Price: \$2.30.

Ground clips: 5 each (10213-62102). Price: \$1.

Probe tips: 7 each (5020-0457). Price: \$1.

Banana tip: (1251-0013). Price: \$0.50.

Spring tip: (5060-0420). Price: \$0.50.

Pin tip: (5060-0418). Price: \$0.50.

Hook tip: (5060-0419). Price: \$0.50.

RF MILLIVOLTMETER

Measurements, 10 mV to 10 V, 500 kHz to 16 MHz
Model 411A

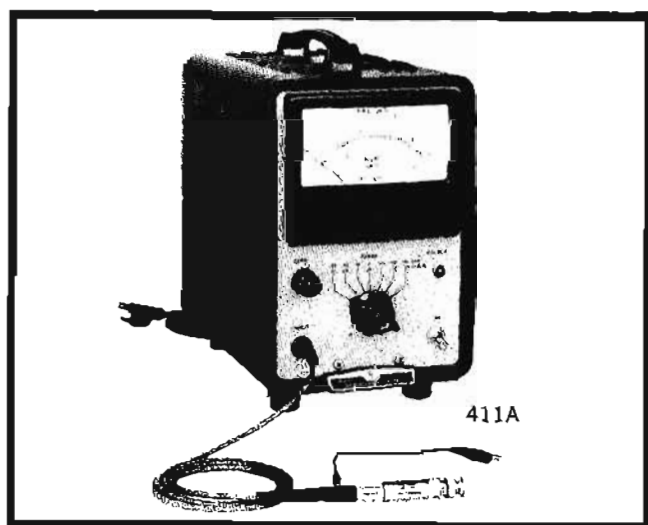

Description

RF voltmeter offers millivolt sensitivity and two easy-reading linear voltage scales in 1-to-3 ratio. Range is 10 mV to 10 V full scale rms, 500 kHz to 1 GHz. DB scale is calibrated from +3 to -12 dB. Accuracy is ±3% of full scale to ±1 dB, depending upon frequency and probe used. Five probe tips increase versatility. The probe tips, available individually, are offered along with a spare diode cartridge as a complete set in a compact kit. Galvanometer recorder output. For detailed information and complete specifications, refer to data sheet.

Price: HP 411A, \$450 (cabinet); HP 411AR, \$455 (rack). HP 11071A Probe Kit includes BNC open circuit probe tip, furnished with instrument, to a pen-size probe having retractile alligator jaws for probing conveniently into restricted areas; \$153.

VOLTAGE, CURRENT, RESISTANCE



AUTOVOLTMETER

Automatic voltage and resistance measurements
Model 414A

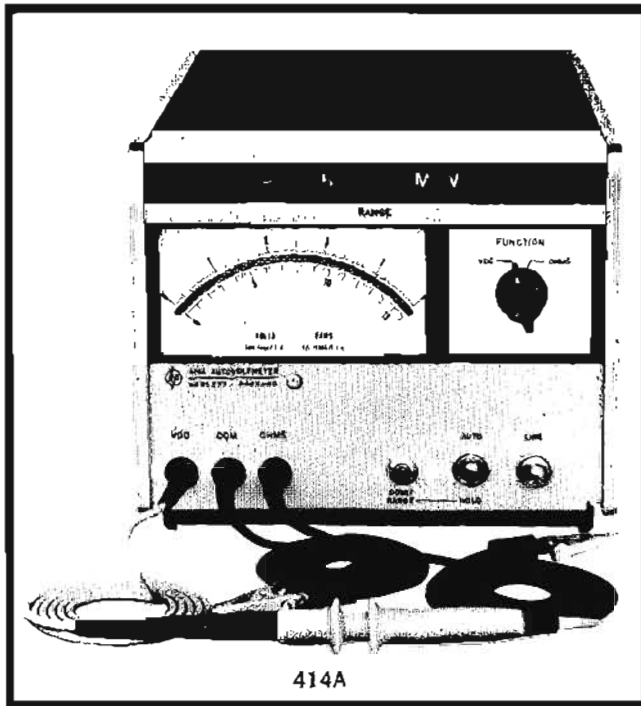

Description

The 414A is a 12-range, all solid-state dc volt-ohmmeter which provides accurate measurements immediately because of its automatic range selection. Operation is simply touch and read. Both range and polarity are displayed by illuminated characters and the meter pointer indicates the correct reading for the range that has been automatically selected.

DC NULL VOLTMETER

Floating, high-impedance input; 1 mV end-scale sensitivity
Model 413A

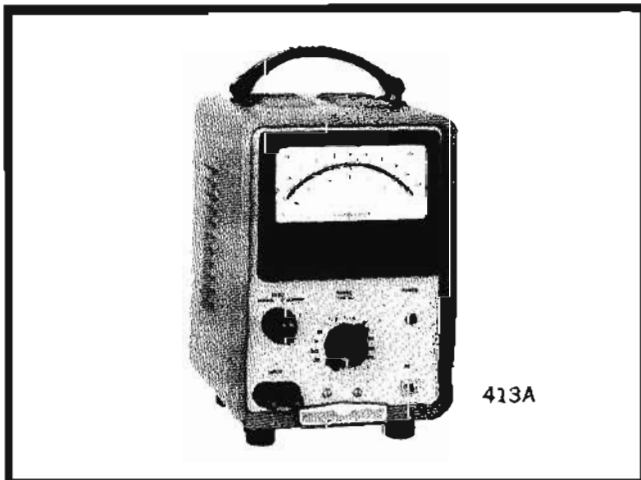

The 413A has 13 zero-centered ranges running from 1 mV to 1000 V end scale.

High-input impedance (10 M Ω on the most sensitive range, 200 M Ω on the 300 mV range and above) makes the 413A especially valuable in resistance bridge measurements. Accuracy of this instrument is within 2% of end scale; drift and noise are virtually imperceptible.

Specifications

DC voltmeter

Voltage range: ± 5 mV to ± 1500 V full scale in 12 ranges (manual or autoranging).

Accuracy: \pm (0.5% of reading + 0.5% of full scale).

Input resistance: 100 M Ω on 50 mV range and above, 10 M Ω on 5 and 15 mV ranges.

Ohmmeter (linear scale)

Resistance range: 5 Ω to 1.5 M Ω in 12 ranges (manual or autoranging with linear scale).

Accuracy: \pm (1% of reading + 0.5% of full scale).

Source current: up to 5 k Ω , 1 mA; above 5 k Ω , 1 μ A.

General

Automatic range selection: automatically selects correct voltage and resistance range in less than 300 ms.

Manual range selection: down-ranges one range each time down-range button is pressed. Starts over at 1500 V from 5 mV range.

Polarity selection: automatic in either manual or auto mode.

Meter: individually calibrated taut-band meter with mirror scale. Linear scales 0 to 5 and 0 to 15.

Isolation resistance: at least 100 M Ω shunted by 0.1 μ F between common terminal and case (power line ground).

Floating Input: may be operated up to 500 V dc above ground.

Power: 115 or 230 V $\pm 10\%$, 50 to 1000 Hz, 18 W.

Dimensions: (1/2 module) 6 1/2" high, 7 3/4" wide, 11" deep (165 x 197 x 279 mm).

Weight: net 10 1/4 lbs (4,6 kg); shipping 13 lbs (6,4 kg).
Price: HP 414A, \$650.

Specifications

Voltmeter

Range: positive and negative voltages from 1 mV to 1000 V end scale in 13 zero-centered ranges.

Accuracy: $\pm 2\%$ of end scale.

Limits of zero control: more than \pm end scale on any range when using expanded scale.

Input Resistance: 10 M Ω on 1, 3 and 10 mV ranges; 30 M Ω on 30 mV range; 100 M Ω on 100 mV range; 200 M Ω on 300 mV range and above.

AC rejection: a voltage at power line or twice power-line frequency 40 dB greater than end scale affects reading $< 1\%$; peak voltage must not exceed 1500 V.

Amplifier (refer to data sheet for detailed specifications)

Gain: 0.001 to 1000 in 13 steps.

General

Input terminals: dual banana jacks.

Input isolation: > 100 M Ω shunted by 0.1 μ F to case (power-line ground).

Common signal rejection: may be operated with up to 500 V dc or 130 V ac above ground.

Power: 115 or 230 V $\pm 10\%$, 50 to 60 Hz, approx. 35 W.

Dimensions: cabinet 11 1/2" high, 7 1/2" wide, 10" deep (292 x 191 x 254 mm); rack mount 5 7/8" high, 19" wide, 6 3/8" deep (134 x 483 x 168 mm).

Weight: cabinet net 12 lbs (5,4 kg), shipping 14 lbs (6,4 kg); rack net 12 lbs (5,4 kg), shipping 19 lbs (8,6 kg).

Price: HP 413A, \$385 (cabinet); HP 413AR, \$390 (rack).

DC NULL VOLT-AMMETER

Floating, 18 ranges, 0.1 μV resolution
Model 419A



**VOLTAGE, CURRENT,
RESISTANCE**

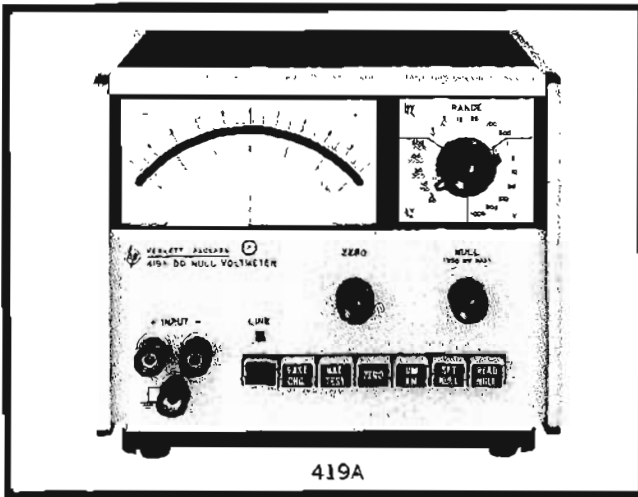

Eighteen voltage ranges with 0.1 μV resolution on the lowest range set this HP solid state DC Null Voltmeter apart from previous dc null meters. The accuracy of this rechargeable battery-operated instrument is $\pm 2\%$ of end scale $\pm 0.1 \mu\text{V}$ on all ranges. Noise is less than 0.3 μV p-p, and drift is less than 0.5 $\mu\text{V}/\text{day}$.

An internal bucking source allows input voltages up to 300 mV to be nulled giving an infinite input impedance. Input impedance above the 300 mV range is 100 megohms.

Pushbutton selection provides convenience-versatility

Seven pushbuttons allow the operator to select rapidly the desired function of the HP 419A. This dc null voltmeter operates from the ac line or from the internal rechargeable batteries. During operation from the ac line the batteries are trickle-charged. A fast-charge pushbutton is provided to increase the charging rate, recharging the batteries in approximately 16 hours. Battery voltage may be easily checked with the battery-test pushbutton. The ZERO pushbutton enables the operator to compensate for any internal offsets before making a measurement. When this pushbutton is depressed, the positive leg of the voltmeter is disconnected from the positive input terminal and connected to the negative input terminal.

When the VM pushbutton is depressed the HP 419A functions as a zero-center scale 3 μV to 1000 Vdc voltmeter.

When the AM pushbutton is depressed, the HP 419A functions as a zero-center scale 30 pA to 30 nA ammeter.

Specifications

Voltmeter

Ranges: $\pm 3 \mu\text{V}$ to ± 1000 volts dc end scale in 18 zero center ranges.

Accuracy: $\pm (2\%$ of end scale $+ 0.1 \mu\text{V})$ 0 to $+ 50^\circ\text{C}$.

Limits of zero control: $\pm 15 \mu\text{V}$.

Input resistance: 3 μV to 3 mV ranges: 100 k ohms (infinite when nulled). 10 mV to 30 mV ranges: 1 megohm (infinite when nulled). 100 mV to 300 mV ranges: 10 megohms (infinite when nulled). 1 volt to 1000 volt ranges: 100 megohms.

Internal null voltage: approximately $\pm 120\%$ end scale, 3 μV to 300 mV range.

Response time: 95% of final reading within 3 s on the 3 μV range. 95% of final reading within 1 s on the 10 μV to 1000 V ranges.

Superimposed ac rejection: ac voltages 60 Hz and above: 80 dB greater than end scale—affects reading less than 2%. Peak ac voltage not to exceed max. overload voltage.

Noise:* $< 0.3 \mu\text{V}$ peak-peak (input shorted).

Drift: $< 0.5 \mu\text{V}/\text{day}$ after 30 minutes warm-up. T.C. $< .05 \mu\text{V}/^\circ\text{C}$ from 0° to $+ 50^\circ\text{C}$.

Amplifier

Gain: 110 dB maximum at recorder output terminals. Gain depends on range.

Output: 0 to ± 1 volt at 1 mA max. for end scale reading. Output level is adjustable for convenience when used with recorders.

Output impedance: depends on setting of output level control. < 35 ohms when output level is set to maximum.

Noise: 0.01 Hz to 5 Hz: Same as voltmeter (referred to input). > 5 Hz: rms noise < 10 mV (referred to output).

DC Ammeter

Current ranges: ± 30 pA, ± 100 pA, ± 300 pA, ± 1 nA, ± 3 nA, ± 10 nA, and ± 30 nA.

Accuracy: $\pm 3\%$ of end scale ± 1 pA.

Input R: 100 k Ω .

Noise:* < 3 pA p-p (input shorted).

Drift: < 5 pA/day after 30-minute warmup.

Temperature coefficient: < 0.5 pA/ $^\circ\text{C}$ from 0° to $+ 50^\circ\text{C}$.

General

Overload voltage: 50 V dc max, 3 μV to 3 mV ranges; 500 V dc max., 10 mV to 300 mV ranges; 1200 V dc max. on 1 volt range and above.

Overload recovery time: meter indicates within 3 seconds for a 10^6 overload.

Input terminals: Positive and negative terminals are solid copper, gold flashed.

Input isolation: $> 10^{10}$ ohms shunted by 250 pF. May be operated up to 500 V dc or 350 V ac (rms) above ground.

Operating humidity: less than 70% R.H.

Operating temperature: 0° to $+ 50^\circ\text{C}$.

Storage temperature: -20°C to $+ 50^\circ\text{C}$.

Power source: 4 internal rechargeable batteries (furnished). Thirty hour operation per recharge. The 419A may be operated during recharge from ac line. 115 or 230 V $\pm 10\%$, 50 to 1000 Hz, approximately 3 watts.

Dimensions: standard HP $1/2$ module; $6\frac{1}{8}$ " high, $7\frac{3}{4}$ " wide, 8" deep (152 x 197 x 203 mm).

Weight: net: $8\frac{1}{4}$ lbs (3.7 kg). Shipping: $10\frac{1}{4}$ lbs (5.4 kg).

Price: HP 419A, \$450.

* Noise amplitude approximates Gaussian distribution. Standard deviation (rms): 0.075 μV (0.75 pA). Peak to peak deviation: $< 0.3 \mu\text{V}$ (3 pA), 95% of the time.

VOLTAGE, CURRENT, RESISTANCE



DC VOLT-OHM-AMMETER

1% accuracy vtvm is also ohmmeter, ammeter
Model 412A

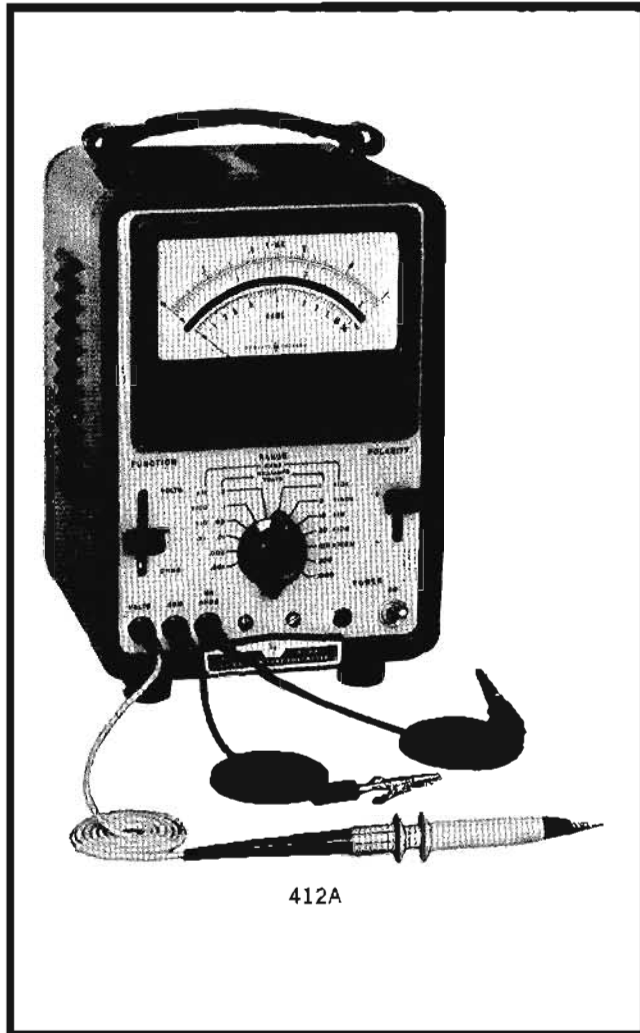

412A

Description

The HP Model 412A is a multipurpose meter designed to measure dc voltage, current, and resistance with laboratory accuracy and yet be of great utility in production-line test-bench work. Simplicity of operation and low cost permit its use wherever dc measurements are made.

Model 412A may also be used as a stable 60 dB amplifier which has an output proportional to meter indication.

There are only three controls; a lever-type function selector, a 13-position range switch, and a lever-type polarity switch. The extreme stability of the 412A makes it easier to use by eliminating the need for constantly re-zeroing the meter. The stability of the HP 412A is such that the usual front-panel, zero-set control has been eliminated.

The precision six-inch meter has two scales used for both voltage and current and a third scale which is calibrated in ohms. The meter face has a mirror back for greatest accuracy in reading.

Features:

- Versatile, measures voltage, resistance, current
- Floating input
- High input resistance
- Use as a 60 dB amplifier
- Individually calibrated meter minimizes tracking error

Specifications

Voltmeter

Voltage range: pos. and neg. voltages from 1 mV to 1000 V full scale, 13 ranges.

Accuracy: $\pm 1\%$ of full scale on any range.

Input resistance: 10 megohms $\pm 1\%$ on 1 mV, 3 mV and 10 mV ranges; 30 megohms $\pm 1\%$ on 30 mV range; 100 megohms $\pm 1\%$ on 100 mV range; 200 megohms $\pm 1\%$ on 300 mV range and above.

Ammeter

Current range: pos. and neg. currents from 1 μ A to 1 A full scale, 13 ranges.

Accuracy: $\pm 2\%$ of full scale on any range.

Input resistance: decreasing from 1000 ohms on 1 μ A scale to 0.1 ohm on 1 A scale.

Ohmmeter

Resistance range: resistance from 1 ohm to 100 megohms center scale, 9 ranges.

Accuracy: $\pm 5\%$ of reading at center scale.

Amplifier

Voltage gain: 1000 maximum.

DC bandwidth: dc to 0.7 Hz on all voltage ranges.

Output: proportional to meter indication; 1 V at full scale; max. current, 1 mA (full scale corresponds to 1 on upper scale).

Output impedance: less than 2 ohms at dc.

Noise: less than 2.0 μ V rms referred to the input.

Drift: negligible.

General

Common mode rejection: may be operated up to 500 V dc, or 130 V ac above ground.

Power: 115 or 230 volts $\pm 10\%$, 50 to 60 Hz, 35 watts.

Dimensions: cabinet: 11 $\frac{1}{2}$ " high, 7 $\frac{1}{2}$ " wide, 10" deep (292 x 191 x 254 mm); rack mount: 5-7/32" high, 19" wide, 7 $\frac{1}{2}$ " deep behind panel (134 x 483 x 191 mm).

Weight: net: 12 lbs (5,5 kg); shipping: 14 lbs (6,4 kg) (cabinet); net 12 lbs (5,5 kg); shipping: 20 lbs (9,1 kg) (rack mount).

Price: HP 412A, \$450 (cabinet).

HP 412AR, \$455 (rack mount).

DC MICROVOLT-AMMETER

Portable with direct reading of 1 pA and 1 μ V
Model 425A



**VOLTAGE, CURRENT,
RESISTANCE**

Description

Hewlett-Packard 425A DC Microvolt-Ammeter makes measurements of extremely small dc voltages and currents, even in the presence of relatively strong ac signals.

Since the 425A measures dc voltages from 1 μ V to 1 V and dc currents from 1 pA to 3 mA, it is an extremely useful tool in all branches of scientific measurement. For example, it can be used to study nerve potentials for the biologist and medical researcher, to study chemically generated emf, minute voltages in thermocouples and current in ionization chambers.

Since currents as small as 1 pA can be measured directly, the Model 425A is valuable for measuring vacuum tube grid currents and photomultiplier currents in ionization chambers. Thus, this meter has great utility in physics research, as well as in electronics. Further, its current and voltage sensitivity permit measurement of both extremely high and very low resistances.

Model 425A is provided with output terminals so that it may be used as a dc amplifier having 100 dB (10^5) voltage gain. Output from the amplifier is 1 V for an end-scale deflection or 1 mA into approximately 1000 ohms, so that it will operate either a potentiometer or galvanometer recorder to make permanent records of measurements.

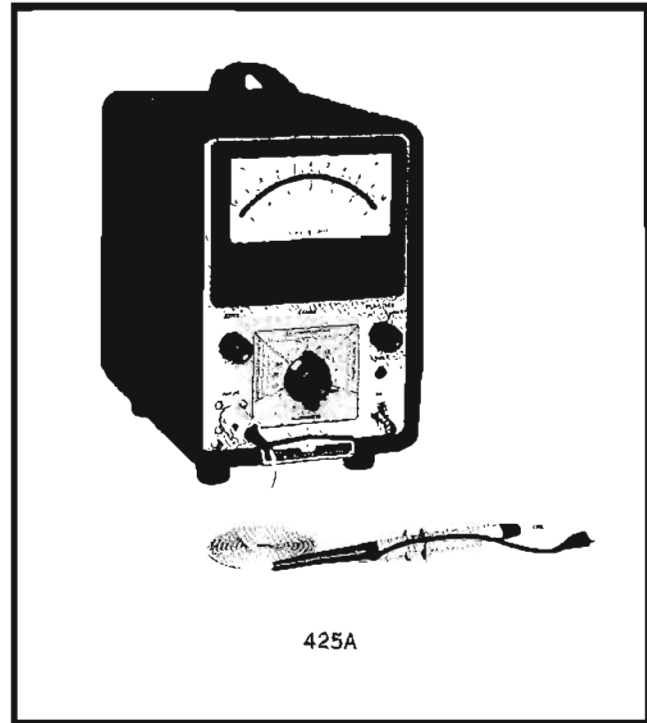

425A

Specifications

Microvolt-ammeter

Voltage range: pos. and neg. voltages from 10 μ V end scale to 1 V end scale, 11 steps, 1, 3, 10 sequence.

Current range: pos. and neg. currents from 10 pA end scale to 3 mA end scale, 18 steps, 1, 3, 10 sequence.

Input impedance: voltage ranges, 1 megohm $\pm 3\%$; current range, depends on range, 1 megohm to 0.33 ohm.

Accuracy: within $\pm 3\%$ of end scale; line frequency variations ± 5 Hz affect accuracy less than $\pm 2\%$.

Amplifier

Gain: 100,000 maximum.

DC bandwidth:

dc to 0.1 Hz on 10 μ V range.

dc to 0.3 Hz on 30 μ V range.

dc to 0.7 Hz on 100 μ V range and above.

Output: 0 to 1 V for end-scale reading, adjustable (5000-ohm shunt potentiometer), 1 mA maximum at 1 V output.

Output impedance: depends on setting of output potentiometer; 10 ohms when potentiometer is set for maximum output.

Noise: 0 to 1 Hz: $< 0.2 \mu$ V rms referred to input. > 1 Hz: < 5 mV rms referred to output.

Drift: after 15 minutes' warm-up, drift is less than $\pm 4 \mu$ V per day referred to input.

General

Power: 115 or 230 volts $\pm 10\%$, 60 Hz, 40 W; 50 Hz operation on special order.

Dimensions: cabinet: 7 $\frac{3}{8}$ " wide, 11 $\frac{3}{4}$ " high, 12" deep (186 x 299 x 305 mm); rack mount: 19" wide, 7" high, 11" deep behind panel (483 x 178 x 279 mm).

Weight: net 17 lbs (7.7 kg); shipping 18 lbs (8.2 kg) (cabinet); net 21 lbs (9.5 kg); shipping 29 lbs (13.2 kg) (rack mount).

Accessories available: 11021A 1000:1 Divider Probe, increases range of 425A to 1000 volts; division accuracy $\pm 2\%$, input resistance 10 megohms, \$55.

Option 01: for operation from 50 Hz power, no extra charge.

Price: HP 425A, \$500 (cabinet). HP 425AR, \$505 (rack mount).

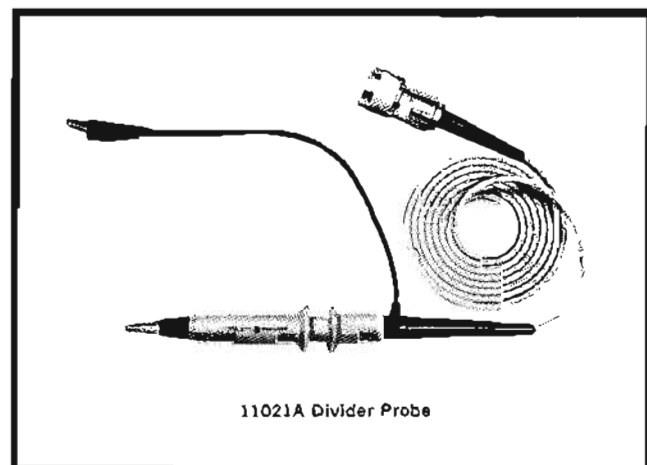

11021A Divider Probe

VOLTAGE, CURRENT, RESISTANCE



MILLIOHMETER

Convenient two probe measurements
Model 4328A

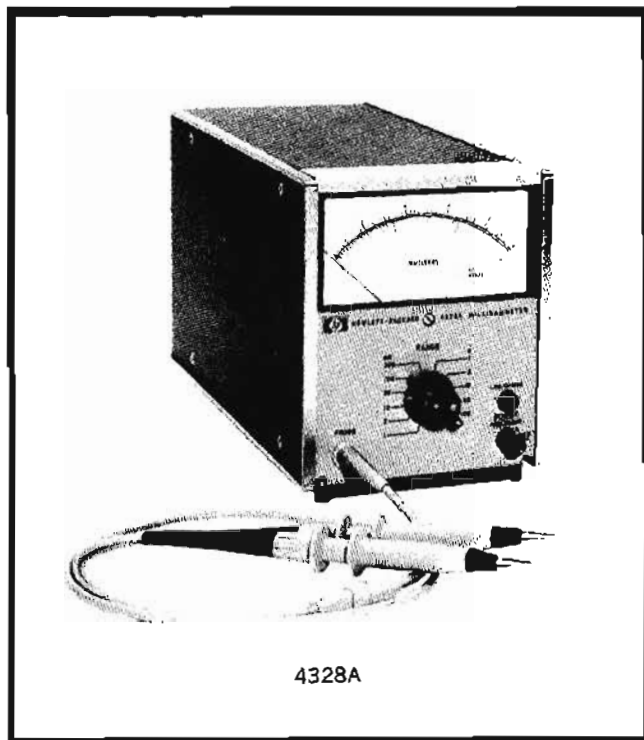

Description

The HP 4328A Milliohmeter is a portable instrument for measurement of low resistances. It uses a Kelvin Bridge method to obtain its high sensitivity but has incorporated both the current and voltage drives into one probe, so that only two probes are needed in the actual measurement.

The range of the 4328A extends from 100 ohms to 1 milliohm full scale. Maximum sensitivity is 20 μ ohms, making it ideal for measuring the contact resistance of switches, relays, and connectors.

A unique phase discriminator in the meter circuit permits accurate resistive measurements on samples with a series reactance up to twice full scale resistance.

The milliohmeter is internally driven by a 1 kHz signal. With an ac drive signal, dc bias up to 150 V can be superimposed without affecting the accuracy of the measurement. Hence, the 4328A can make dynamic resistance measurements in back-biased diodes.

Maximum voltage across any sample with the proper range selection is less than 200 μ V peak. In case of incorrect range setting, a maximum voltage of 20 millivolts peak will never be exceeded, so that explosive devices such as fuses and squibs can be safely checked.

The basic 4328A is line operated. With Option 01 it can be operated from four rechargeable batteries for 15 continuous hours. A recorder output provides an output proportional to the meter deflection.

Specifications

Range: 0.001 to 100 ohms full scale in a 1, 3, 10 sequence.
Accuracy: $\pm 2\%$ of full scale. No additional error is caused by series reactance of samples up to 2 times full scale.

Measuring Frequency: 1000 Hz \pm 100 Hz.

Voltage Across Sample: 200 μ V peak at full scale.

Maximum Voltage Across Sample: 20 mV peak in any case.

Superimposed DC: 150 V dc maximum may be superimposed on samples from an external source.

Recorder Output: 0.1 V dc output at full scale meter deflection.

Range (ohms)	Applied Current (mA)	Maximum Dissipation in Samples (μ W)
0.001	150	23
0.003	50	8
0.01	15	2.3
0.03	5	0.8
0.1	1.5	0.23
0.3	0.5	0.08
1	0.15	0.023
3	0.05	0.008
10	0.015	0.0023
30	0.005	0.0008
100	0.0015	0.00023

General

Power Requirements: 115/230 V switch $\pm 10\%$, 50 to 60 Hz, 1.5 W.

Weight: 7 lbs. (3.2 kg).

Dimensions: 5 $\frac{1}{8}$ " wide, 6-3/32" high, 11" deep.

Accessories Furnished: Model 16005A Probe, 16006A Probe and 16007A Test Leads. Detachable Power Cord.

Price: HP 4328A, \$450.

Option 01: rechargeable battery operation, add \$25.

Manufactured in Tokyo by Yokogawa-Hewlett-Packard Ltd.

CLIP-ON MILLIAMMETER

Measure without interrupting circuit; probes
Model 428B



**VOLTAGE, CURRENT,
RESISTANCE**

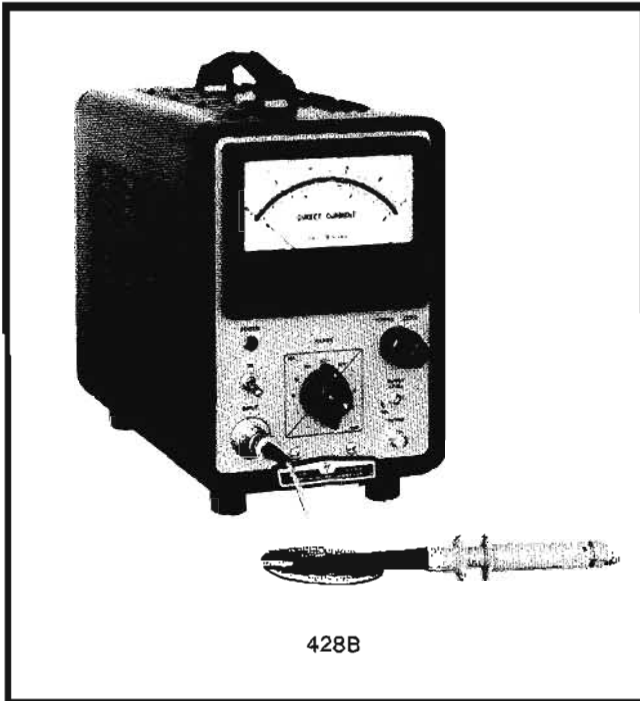

428B

Description

Direct current from .01 milliampere to 10 amps can be measured with the HP 428B without interrupting the circuits and without the error-producing loading of conventional methods.

For any measurement of dc within its range, simply clamp the jaws of the 428B around a wire and read.

This ease and speed of operation are unparalleled, especially for applications where many dc measurements must be made. Wide current range of the 428B will handle most signals directly. For even greater sensitivity, several loops may be put through the probe, increasing the sensitivity by the same factor as the number of loops.

In addition to making current measurements directly, the 428B is also valuable for measuring sums and differences of currents in separate wires. When the probe is clipped around two wires carrying current in the same direction, their sum is indicated on the meter; when one of the wires is reversed, their difference is measured. Thus, current balancing is possible by obtaining a zero difference reading.

Model 428B provides an output voltage proportional to the measured current which is useful for driving recorders or making low-frequency (dc to 400 Hz) current measurements.

Specifications

Current range: 0.1 mA to 10 amperes; nine full-scale ranges from 1 mA to 10 amperes in a 1, 3, 10 . . . sequence.

Accuracy: $\pm 3\%$ of full scale, ± 0.1 mA, from 0°C to $+55^\circ\text{C}$.

Probe inductance: less than $0.5 \mu\text{H}$; no noticeable loading, even up to 1 MHz.

Probe induced voltage: less than 15 mV peak (at 20 kHz and harmonics).

Output: approx. 1.5 V and 1 mA max. for full scale; 100-ohm source; variable linear output level with switch provision for calibrated 1 V (corresponds to full-scale deflection).

Noise level: less than ± 0.015 mA.

AC rejection: ac with peak value less than full scale affects meter accuracy less than 2% at frequencies different from the carrier (approx. 40 kHz) and its harmonics; the above instantaneous current must not exceed full scale below 5 Hz; on the 10 amp range, ac peak value is limited to 4 amps.

Power: 115 or 230 V $\pm 10\%$, 50 to 60 Hz, approx. 70 W.

Operating temperature range: -20°C to $+55^\circ\text{C}$.

Storage temperature: -40°C to $+65^\circ\text{C}$.

Probe insulation: 300 volts maximum.

Probe tip size: approximately $1/2"$ by $21/32"$; aperture diameter $5/32"$.

Dimensions: $7 1/2"$ wide, $11 1/2"$ high, $14 1/4"$ deep (191 x 292 x 272 mm); rack mount: 19" wide, $6-31/32"$ high, 13" deep (483 x 177 x 330 mm).

Weight: net 17 lbs (7,7 kg), shipping 19 lbs (8,6 kg) (cabinet); net 24 lbs (10,8 kg), shipping 33 lbs (14,9 kg) (rack mount).

Options:

01. HP 3528A Current Probe (aperture $2-9/16"$) in lieu of 428A-21A Probe normally supplied, add \$375.
02. HP 3529A Magnetometer Probe in lieu of 428A-21A Probe normally supplied, no extra charge.

Price: HP 428B, \$600. (cabinet)

HP 428BR, \$605. (rack mount)

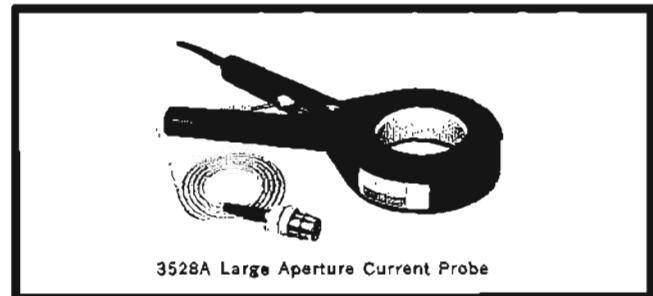

3528A Large Aperture Current Probe

This large aperture current probe permits the 428B to make measurements on any conductor up to $2-9/16"$ in diameter. It is useful for measuring common-mode, ground and electrolysis currents in pipes, multi-conductor cables (including lead-sheathed), ground straps, and even microwave waveguide. Current range of this large diameter probe is the same as the 428B. The bandwidth is dc to 300 Hz. Accuracy is ± 1 mA $\pm 3\%$ of full scale when the probe is calibrated with the instrument. Inductance less than $3 \mu\text{H}$ is introduced into the measured circuit.

Price: HP 3528A, \$525.

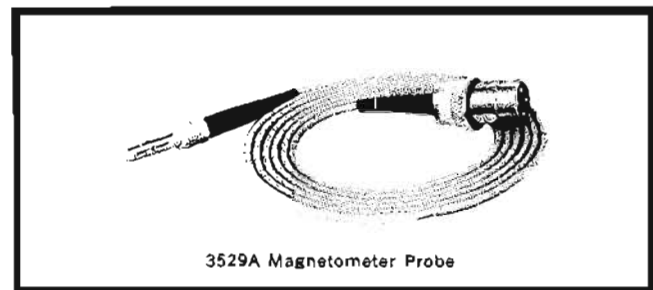

3529A Magnetometer Probe

The HP 3529A Magnetometer Probe is useful in applications where determination must be made of the direction or magnitude of a magnetic field. It is useful in applications ranging from acoustical transducer design to investigations involving the Zeeman effect. Conversion factor is 1:1, producing a reading on the 428B in milliamps which is directly equal to the measured field strength in milligauss. Range is 1 milligauss to 10 gauss with the 428B. The bandwidth is dc to 80 Hz, and accuracy is $\pm 3\%$ of full scale when the probe is calibrated with the instrument.

Price: HP 3529A, \$95.

A special magnetometer probe, the HP C11-3529A (not shown) measures the relative strength of individual bar magnets on twister memory cards used in Western Electric's Electronic Switching Systems. For detailed specifications refer to data sheet.

Price: HP C11-3529A, \$145.00.

VOLTAGE, CURRENT, RESISTANCE



VOLTMETER ACCESSORIES

Voltage dividers, current probe for VTVM's
Model 456A, 11000 Series

456A AC Current Probe

Your conventional voltmeter or oscilloscope can measure current quickly and dependably — without direct connection to the circuit under test or any appreciable loading to the test circuit. The HP 456A AC Current Probe clamps around the current-carrying wire, and provides a voltage output you read on a voltmeter or scope. Model 456A's 1 mA to 1 mV conversion permits direct reading up to 1 ampere rms.

Specifications, 456A

Sensitivity: 1 mV/mA $\pm 1\%$ at 1 kHz.

Frequency response: $\pm 2\%$, 100 Hz to 3 MHz; $\pm 5\%$, 60 Hz to 4 MHz; -3 dB at < 25 Hz and greater than 20 MHz.

Pulse response: rise time is < 20 ns, sag $< 16\%/ms$.

Maximum input: 1 A rms, 1.5 A peak; 100 mA above 5 MHz.

Effect of dc current: no appreciable effect on sensitivity and distortion from dc current up to 0.5 A.

Input impedance: (impedance added in series with measured wire by probe) less than 50 milliohms in series with $0.05 \mu\text{H}$ (this is approximately the inductance of $1\frac{1}{2}$ in. of hookup wire).

Probe aperture: $5/32$ " (4 mm) diameter.

Probe shunt capacity: approx. 4 pF added from wire to ground.

Distortion at 1 kHz: for 0.5 A input at least 50 dB down; for 10 mA input at least 70 dB down.

Equivalent input noise: $< 50 \mu\text{A rms}$ (100 μA when ac powered).

Output impedance: 220 ohms at 1 kHz; approximately +1 V dc component; should work into load of not less than 100,000 ohms shunted by approximately 25 pF.

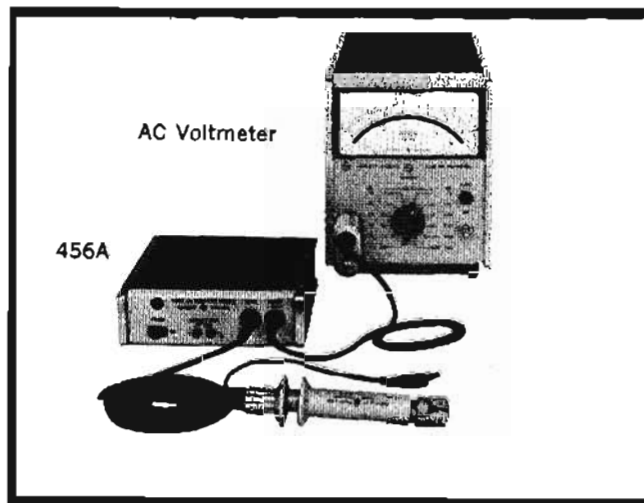

Power: two Mallory Battery Co. TR 233R and one TR 234 batteries (1420-0005 and 1420-0006); battery life approximately 400 hours; ac power supply optional at extra cost, 115 or 230 V $\pm 10\%$ 50 to 1000 Hz approx. 1 W.

Weight: net 2 lbs, 4 oz (1 kg); shipping 3 lbs, 10 oz (1,64 kg).

Dimensions: 5" wide, 6" deep, $1\frac{1}{2}$ " high (127 x 152 x 38 mm); probe cable is 5 ft. long; 2 ft. output cable terminated with dual banana plug.

Accessory available: 456A-11A AC Supply for field installation, \$55. 11028A 100:1 Current Divider for extended range measurements, \$48.

Price: HP 456A with batteries, \$225.

Option 01: AC supply installed in lieu of batteries, add \$20.

11039A capacitive voltage divider

For 400 and 410 series voltmeters. Safely measures power voltages to 25 kV; accuracy $\pm 3\%$. Division ratio, 1000:1. Input capacity, 15 pF ± 1 . Maximum voltage ratings (sea level) 60 Hz, 25 kV; 100 kHz, 22 kV; 1 MHz, 20 kV; 10 MHz, 15 kV; 20 MHz, 7 kV. Usable for dielectric heating, power and ultrasonic voltages. Price: HP 11039A, \$185. (Accessory HP 11018A should be used to connect the 410 series voltmeters.)

11040A capacitive voltage divider

For 410 series voltmeters. Increases range so transmitter voltages can be measured quickly, easily; accuracy, $\pm 1\%$. Division ratio, 100:1. Input capacity, approximately 2 pF. Maximum voltage, 2000 V at 50 MHz, decreasing to 100 V at 400 MHz. Frequency range 10 kHz to 400 MHz. Price: HP 11040A, \$35.

11044A dc voltage divider

For 410B Voltmeter. Gives maximum safety and convenience for measuring high voltages as in television receivers, etc. Accuracy, $\pm 5\%$; division ratio, 100:1. Input impedance, 12 G Ω . Maximum voltage, 30 kV. Maximum current drain, 2.5 μA . Price: HP 11044A, \$50.

11045A dc voltage divider

For 410C Voltmeter. Same as 11044A except input impedance, 10 G Ω . Price: HP 11045A, \$50.

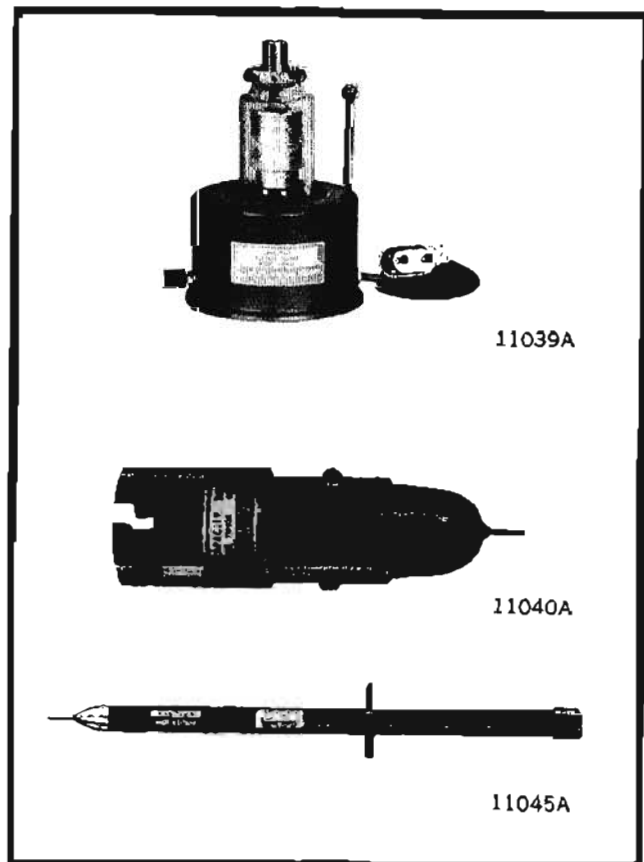

VOLTMETER ACCESSORIES

Extend usefulness, versatility of HP voltmeters



VOLTAGE, CURRENT,
RESISTANCE

11018A Adapter

Connects 410 Series ac probe to dual banana plugs. Price: HP 11018A, \$35.

11033A Shunt Resistor

For 400 Series voltmeters to measure current to 40 mA full scale; accuracy $\pm 1\%$ to 100 kHz, $\pm 5\%$ to 4 MHz; maximum power dissipation, 1 W; maximum voltage 24 V. Price: HP 11033A, \$20.

11036A Probe

AC probe for the 410C. Price: HP 11036A, \$60.

11042A Probe Coaxial "T" Connector

For 410 Series voltmeters. Measures voltages between center conductor and sheath of 50 Ω transmission line. Maximum SWR, 1.1 at 500 MHz, 1.2 at 1 GHz. Male and female Type N fittings. Price: HP 11042A, \$50.

11043A Probe Coaxial "N" Connector

For 410 Series voltmeters. Measures at open end of 50 Ω transmission line (no terminating resistor). Has male Type N fittings. Price: HP 11043A, \$38.

11066A Current Shunt

This current shunt can be used with any ac or dc voltmeter to make current measurements up to 10 A at dc or line frequencies up to 1 kHz. Designed for use with the HP Models 3440A/3443A or 3444A and 3460A Digital Voltmeters and the Model 740B and 741B Differential Voltmeters. Resistance; 0.01 ohm; accuracy; $\pm 0.5\%$; temperature coefficient; ± 100 ppm/ $^{\circ}$ C; power rating; 1.0 W; maximum ambient temperature; 65 $^{\circ}$ C; maximum current; 10 A. Price: HP 11066A, \$30.

11074A Voltage Divider Probe

For 400 Series voltmeters. Provides low-input capacitance and high-input resistance at the point of measurement. Division ratio 10:1 $\pm 2\%$ (400 Hz reference), 10:1 $\pm 2\%$ (100 kHz reference depends on adjustment of compensating capacitor). Bandwidth, dc to 10 MHz. Maximum input voltage 1 kV rms.

Input impedance: 10 M Ω shunted by 10 pF (when connected to an input impedance of 10 M Ω shunted by not more than 25 pF). Price: HP 11074A, \$50.

11096A High Frequency Probe

Converts dc voltmeter with 10 M Ω input resistance to high frequency ac voltmeter. Compatible voltmeters: HP 427A, HP 3430A, HP 3439A and HP 3440A. Voltage range, 0.25 to 30 V rms; transfer accuracy (20-30 $^{\circ}$ C) $\pm 5\%$, 100 kHz to 100 MHz. Usable for relative measurements from 1 kHz to 1 GHz; peak responding, calibrated to read rms value of a sine wave; input impedance, 4 M Ω shunted by 2 pF; max. input, 30 V rms ac, 200 V dc; accessories provided include a straight tip, a hook tip, a ground clip, and a high frequency adapter that fits available HP adapters for BNC (HP 10218A) GR Type 874 (HP 10219A) and Microdot connectors (HP 10220A) and that also fits a 50 Ω tee (HP 11536A). Price: HP 11096A, \$45.

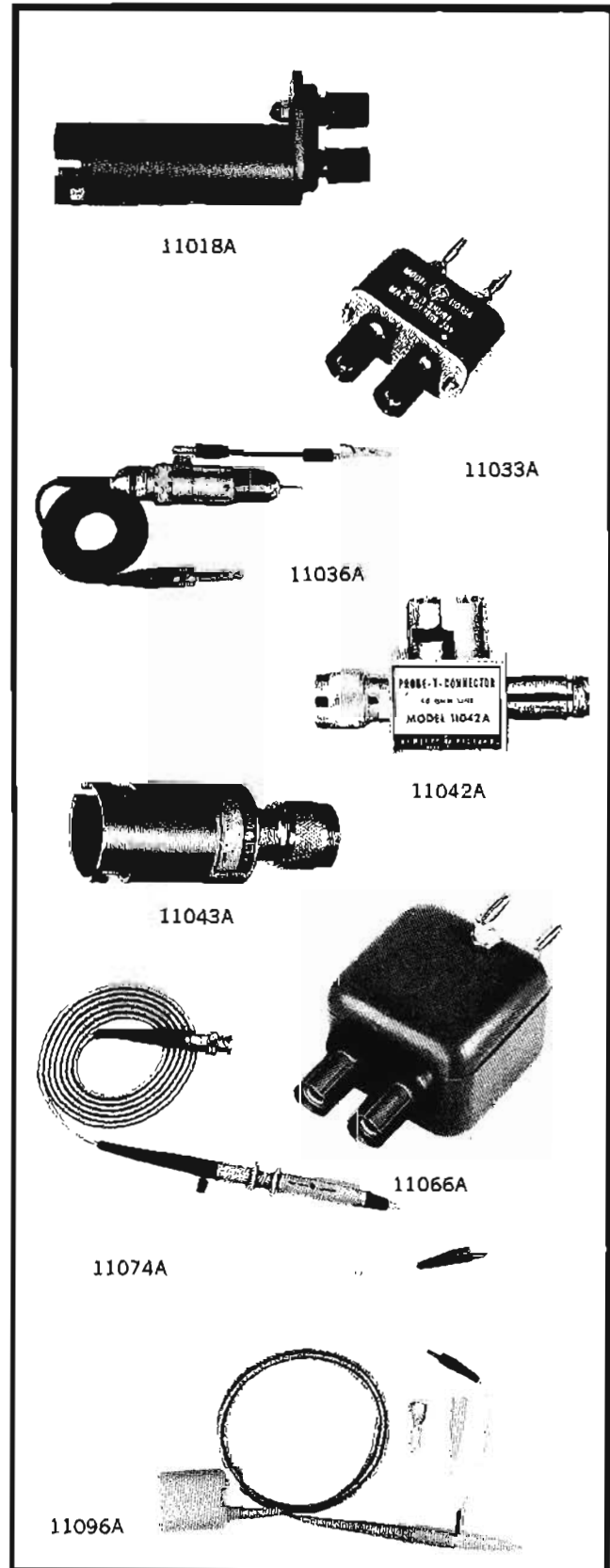

VOLTAGE, CURRENT, RESISTANCE



CABLE ACCESSORIES

Cable assemblies

10501A Cable Assembly

44" of 50-ohm coaxial cable terminated on one end only with UG-88C/U BNC male connector; HP 10501A, \$4 each.

10502A Cable Assembly

9" of 50-ohm coaxial cable terminated on both ends with UG-88C/U BNC male connectors; HP 10502A, \$6 each.

11086A Cable Assembly

24" of 50-ohm coaxial cable terminated on both ends with UG-88C/UBNC male connectors; HP 11086A, \$7 each.

10503A Cable Assembly

4' of 50-ohm coaxial cable terminated on both ends with UG-88C/U BNC male connectors; HP 10503A, \$7 each.

11000A Cable Assembly

Dual banana plugs terminate a section of 50-ohm cable, 44" over-all; plugs for binding posts spaced $\frac{3}{4}$ "; HP 11000A, \$5 each.

11001A Cable Assembly

Identical with 11000A except dual banana plug on one end and UG-88C/U BNC male on the other; HP 11001A, \$6 each.

11002A Test Leads

Dual banana plug to alligator clips, 5'; HP 11002A, \$8 each.

11003A Test Leads

Dual banana plug to probe and alligator clip, 5'; HP 11003A, \$10 each.

11035A Cable Assembly

12" 50-ohm coaxial cable terminated on one end with a dual banana plug and on the other end with a UG-88C/U BNC male connector; HP 11035A, \$6.00 each.

11500A Cable Assembly

6' of specially treated 50-ohm coaxial cable terminated on both ends with UG-21D/U Type N male connectors; HP 11500A, \$15 each.

11501A Cable Assembly

6' of 50-ohm coaxial cable terminated with UG-21D/U Type N male and UG-23D/U Type N female; HP 11501A, \$15 each.

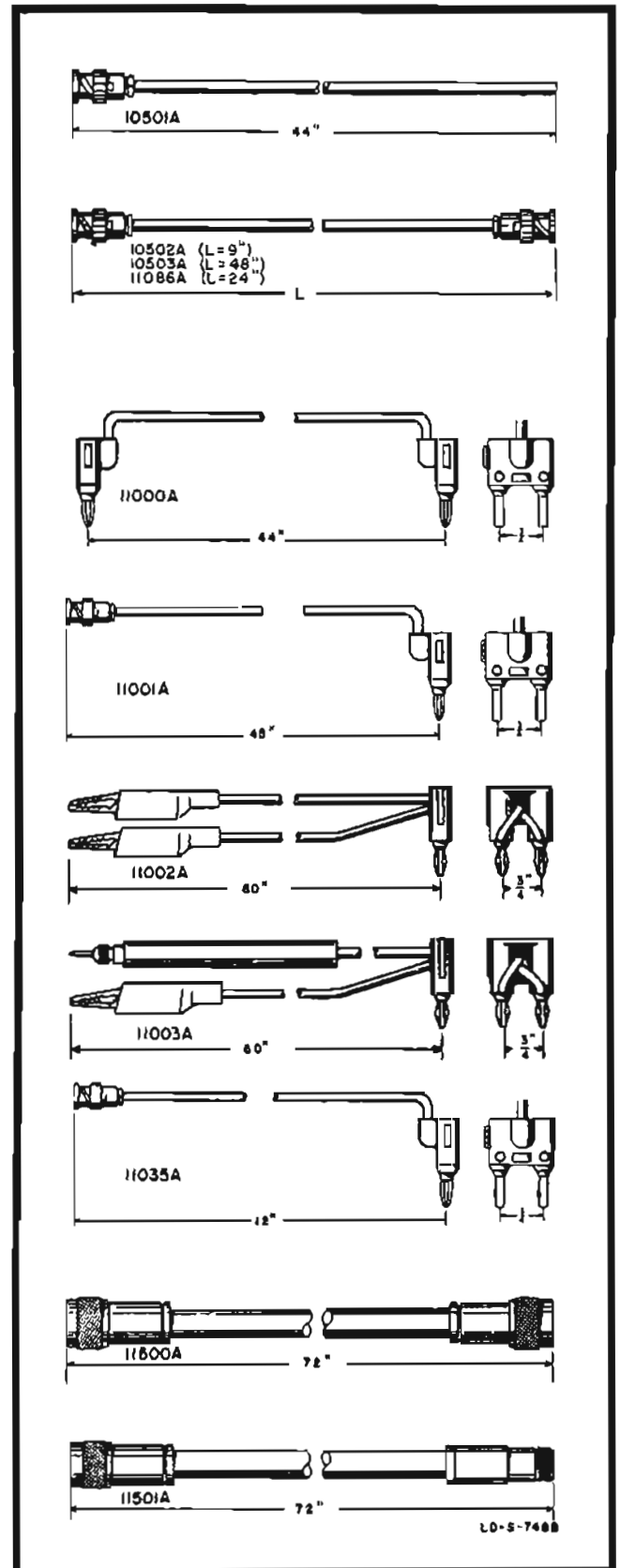

DIGITAL VOLTMETERS



VOLTAGE, CURRENT, RESISTANCE

Digital voltmeters (DVM's) display measurements as discrete numerals, rather than as a pointer deflection on a continuous scale commonly used in analog devices. Direct numerical readout in DVM's reduces human error and tedium, eliminates parallax error and increases reading speed. Automatic polarity and range-changing features reduce operator training, measurement error and possible instrument damage through overload.

Digital instruments are available to measure ac and dc voltages, dc currents resistance and ratio. Other physical variables can also be measured by use of suitable transducers. Many have outputs which can be used to make permanent records of measurements with printers, card and tape punches, and magnetic tape equipment. With data in digital form, it may be processed with no loss of accuracy.

Most popular digital voltmeters on the market today fit into one of the following categories: (1) ramp, (2) staircase ramp, (3) dual ramp integrating, (4) integrating, (5) integrating and potentiometric, (6) successive approximation, and (7) continuous balance.

Types currently in use by HP are described below.

Ramp Types: the operating principle of the ramp digital voltmeter is to measure the time a linear ramp takes to change from the input level to ground (or vice versa). This time period is measured with an electronic time-interval counter and displayed on in-line indicating tubes. The advantages of this type of instrument are low price and simplicity. Conversion of a voltage to a time interval is illustrated by the timing diagram in Figure 1. At the start of a measurement cycle, a ramp voltage is initiated. The ramp is compared continuously with the voltage being measured; at the instant they become equal, a coincidence circuit generates a pulse which opens a gate. The ramp continues until

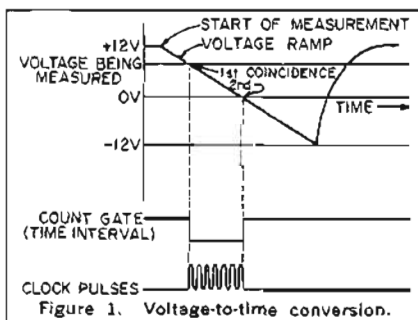

Figure 1. Voltage-to-time conversion.

a second comparator circuit senses that the ramp has reached zero volts. The output pulse of this comparator closes the gate.

The time duration of the gate opening is proportional to the input voltage. The gate allows pulses to pass to totalizing circuits, and the number of pulses counted during the gating interval is a measure of the voltage. Figure 2 illustrates the technique used in the HP 3440A Digital Voltmeter.

The 3440A has an accuracy of $\pm 0.05\%$ of reading with reading rates up to 5 per second. These features, coupled with its capability of 10 μV resolution, 4-digit readout, and plug-in versatility, make it a popular and economical choice.

The HP 3430A is a 3-digit DVM priced not much higher than an analog voltmeter.

The speed, convenience, and accuracy of digital readout now becomes available at a moderate price for general-purpose applications in the laboratory, on production test stands, in repair shops, and at inspection stations. The new DVM has a floating input, a feature not commonly

found in low cost digital voltmeters. An optional version of the instrument permits ratio measurements, a useful feature for normalizing the readings of dc transducer outputs and taking readings using an external reference. A precision dc amplifier output is an additional benefit of this model.

Referring to Figure 3, the 3430A makes voltage measurements by comparing the input voltage to an internally generated "staircase ramp" voltage. When the input and the staircase ramp voltages are equal, a comparator generates a signal to stop the ramp. Then the instrument displays the number of steps necessary to make the staircase ramp equal to the input. At the end of the sample, a reset pulse resets the staircase to zero and the measurement starts over. The display circuits store each reading until a new reading is completed, eliminating any blinking or counting during computation. The sample rate is fixed at two samples per second.

Integrating types: an integrating digital voltmeter measures the true average of the input voltage over a fixed measuring period, in contrast to ramp-types

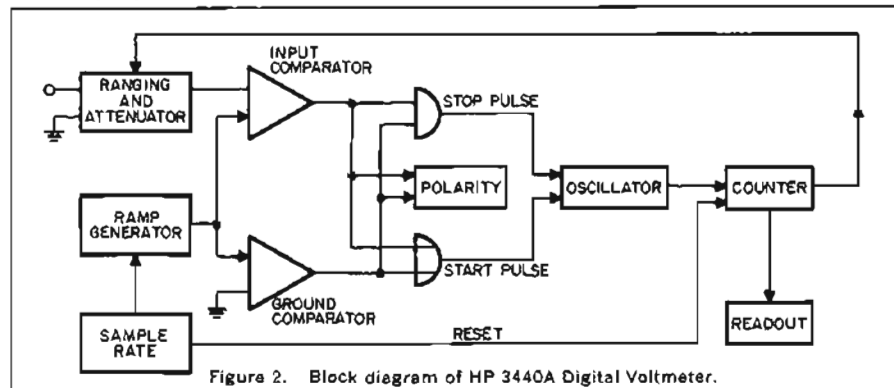

Figure 2. Block diagram of HP 3440A Digital Voltmeter.

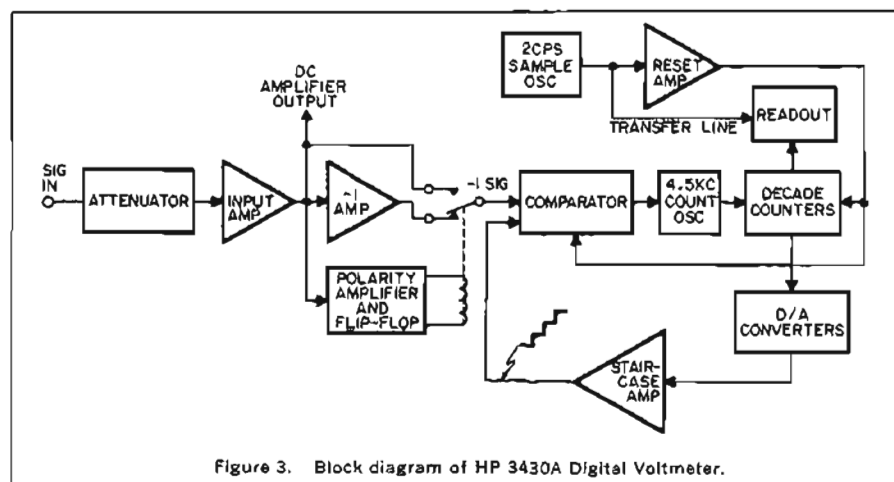

Figure 3. Block diagram of HP 3430A Digital Voltmeter.

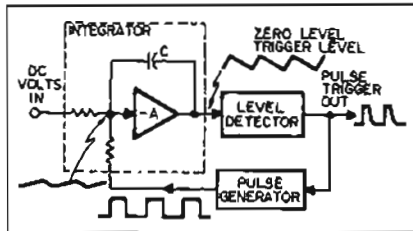

Figure 4. Voltage-to-frequency conversion.

which measure the voltage at the end of the measuring interval. A widely-used technique to accomplish integration is the use of a voltage-to-frequency converter, as indicated in Figure 4. The circuitry functions as a feedback control system which governs the rate of pulse generation, making the average voltage of the rectangular pulse train equal to the dc input voltage.

The major advantage of this type of analog-to-digital conversion is its ability to measure accurately in the presence of large values of superimposed noise, because the input is *integrated* over the sampling interval. The reading represents a true average of the input voltage.

The HP 2402A Integrating Digital Voltmeter, which is in the 0.01%-accuracy class, uses the voltage-to-frequency conversion technique, achieving the ability to reject the effects of superimposed noise. A floated and guarded input circuit eliminates common-mode noise error. Combined, these techniques yield effective common-mode rejection of 126 dB at any frequency.

This model measures the average value of the applied voltage over a 1/60 second sample period. Used in a data system, it provides the benefit of integration and in one second can make more than 43 separate 5-digit measurements with a maximum resolution of 1 part in 130,000. When used on the bench without external triggering, it takes up to 10 readings per second. In addition, it has constant 10-megohm input resistance and is designed for completely programmable operation within a digital data acquisition system.

DC voltage, ac voltage, resistance, frequency and range (or autorange) can all be selected by remote programming. The simplified block diagram illustrated in Figure 5 represents the basic functional components which enable the HP 2402A to accept analog signals and convert it to digital information.

Basically, the instrument consists of a voltage-to-frequency converter and a counter. A dc voltage applied to an integrating amplifier in the converter is changed to a pulse rate proportional to the applied voltage. AC voltage and resistance inputs are converted to dc voltage before being applied to the converter.

During the 1/60-second interval, the output of the V/F converter is applied to the 10² decade (see Figure 5). An

interpolation technique is used after the sampling period when pulses are entered into the 10⁰ decade. These pulses are proportional to the charge remaining on the integrating capacitor after the 1/60-second sampling time. After the interpolation period, the counts present in all decades are displayed by in-line digital readout tubes.

The V/F converter is isolated from the counter by a shielding technique known as guarding, which isolates the input interconnected between the converter and counter sections by thru-guard transformers and thru-guard relays. Each section has its own power supply.

The converter section includes attenuating and switching circuits in addition to the voltage-to-frequency converter. The counter section includes a time-base generator, decade dividers and control logic circuits in addition to the reversible counter.

The HP 2401C Integrating Digital

Voltmeter is also in the 0.01% accuracy class, and uses the voltage-to-frequency conversion technique, achieving outstanding ability to reduce the effects of superimposed noise; it achieves *common-mode* noise rejection by guarding.

This model applies especially well to measurements of extremely noisy signals, even rejecting noise up to 3 x full-scale readings down to 99.999 mV without an accessory amplifier. Complete remote-control ability makes it ideal for system applications. It can also be used as an electronic counter to measure frequency or period.

Integrating/Potentiometric Types: by using techniques exploiting the best qualities of several systems, a totally new result is achieved in the HP 3460B. Besides being an integrating-type voltmeter which continually measures the true average of the input voltage, it is also a potentiometric type providing high accuracy from precision resistance ratios and

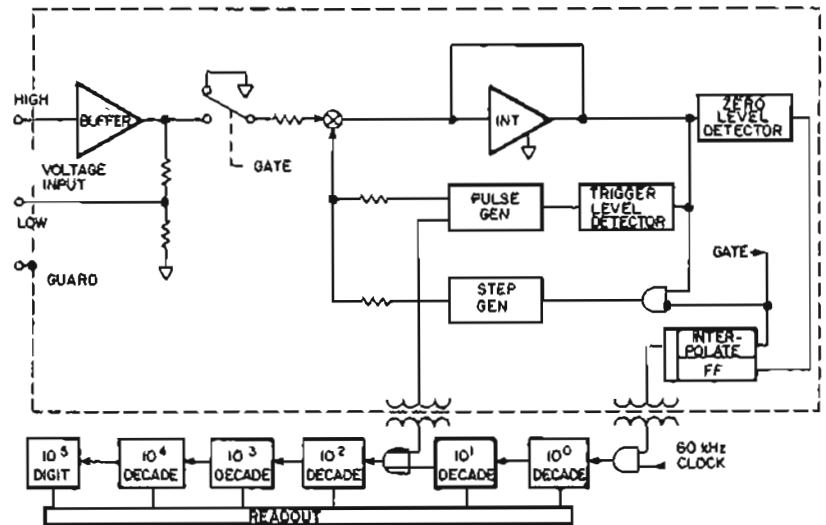

Figure 5. Block Diagram Model 2402A DVM.

Table 1. Hewlett-Packard Digital Voltmeters.

Model (Type)	Accuracy (% of reading)	Number Digits	Overrange %	Speed (Max.) Readings/sec	AC Volts	DC Volts	DC Amps	Ohms	Ratio	Auto Ranging	Floating Input	Guarding (CMRR)	Printer Output	Remote Ranging	Remote Triggering	Plug-ins	Systems Application
Integrating/Potentiometric \$2850 to \$4600																	
H04/3460A (pg 238)	0.005	6	120	1		X				X	X	X	X	X	X		X
3460B (pg 234)	0.004	5	120	15	+	X		+		X	X	X	X	X	X		X
3459A (pg 239)	0.008	5	120	1.7		X				X	X	X	*		X		
Integrating \$4100-\$6600																	
HP-2402A (pg 240)	0.01	5	300	43	▲	X		▲		▲	X	X	X	X	X	▲	X
HP-2401C (pg 242)	0.01	5	200	1**	≠	X		≠		*	X	X	X	X	X		X
Ramp \$595 to \$1195																	
3440A (pg 228)	0.05	4	105	5	●	●	●	●		X	X		X	X	X	●	X
3439A (pg 229)	0.05	4	105	5	X	X	X	X		X	X			X		●	
3430A (pg 227)	0.1	3	160	2		X				X	X						

*Optional: -HP-2410B AC/Ohms Converter; +HP 3481A AC/Ohms Converter.
 **4 digits/9 readings per sec; 3 digits/50 readings per sec.
 ▲ plug-in circuit cards. ● plug-in drawer

a stable reference voltage. A block diagram of the Integrating/Potentiometric Digital Voltmeter is shown in Figure 6.

The HP 3460B is a good choice for applications requiring extremely high accuracy ($\pm 0.004\%$) and high speed with high resolution. The 3460B takes up to 15 readings per second with more than 5-digit resolution (1,20000 full scale). Since the instrument is guarded, all readings can be made in the presence of large common-mode signals. The integration characteristic also allows a maximum reading rate, even with noise superimposed on the signal.

To be useful as the central analog-to-digital converter in an automatic system, a DVM must have several features which are not needed in a bench meter. Among these are binary-coded decimal output and remote controls. If system use is not intended, cost can be reduced by omitting these features.

The HP 3459A, stripped of system features, has accuracy of $\pm 0.008\%$ over a wide range of environmental conditions. With maximum ability to reject the effects of both superimposed and common-mode noise, Model 3459A is also the lowest priced instrument in this accuracy class.

The HP H04-3460A, which also uses the integrating/potentiometric technique, has a resolution of 1 part in 1,200,000 and a sensitivity of $1 \mu\text{V}$ on the 1 volt range. Its measurement accuracy is 0.005% of reading.

Selecting a Digital Voltmeter: If the DVM is to be used in a data acquisition system, binary-coded decimal (BCD) output and remote programming ability are necessities. Compatibility with related equipment (see page 92) should be determined.

When selecting a digital voltmeter to make accurate measurements in the presence of noise, the DVM must discriminate the real signal from the noise appearing at its input terminals. Noise rejection by integration permits high accuracy in the presence of severe noise.

The integrating digital voltmeter reads the average value of the input signal over a fixed sample interval and fits into an attractive price class.

Noise on the signal may be inexpensively reduced by equipping the digital voltmeter with a passive input filter. Filtering need not degrade voltmeter accuracy, but it reduces measurement speed. Consideration of speed must be made if the digital voltmeter is to be used in data acquisition systems.

Common-mode pickup, emf's common to both high and low-terminals, is frequently a severe measurement problem. Guarding, which virtually eliminates the effects of common-mode noise, can be important. The ability to measure signals around zero may be needed, in which case

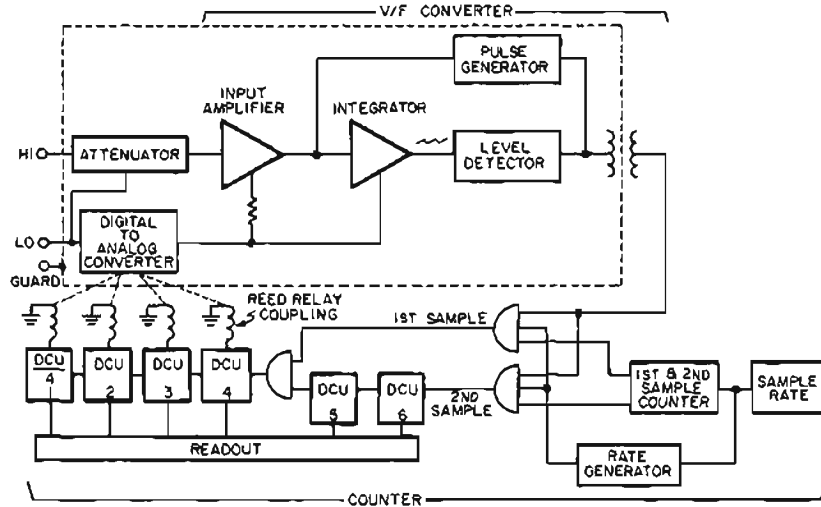
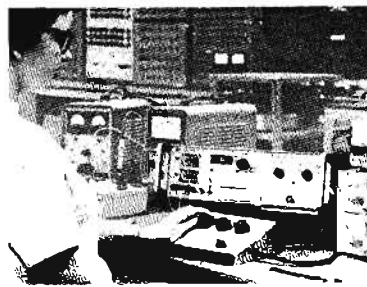

Figure 6. Block diagram of HP 3406B DVM.

inclusion of a bi-directional counter (HP 2401C, HP 2402A and HP 3460B) is desirable. Refer to Table 1—a Hewlett-Packard DVM is available to meet most application requirements.

High-Go-Low Comparator: Many measurement requirements today call for a predetermined sequence of operations. Often with the use of a digital voltmeter, an operator must decide whether the number displayed during each measurement lies between two limits. Typical applications include assembly-line tests, system check-out procedures, inspection, instrument calibration, circuit parameter testing, sorting, batching and matching components including integrated circuits. They range from a simple evaluation of single components to the sequential measurement of many parameters of a circuit, or even of a complete system.



HP 3434A used for production line testing of integrated circuits.

Measurements of this type are often simplified to "Go" (in tolerance or "No Go" (out of tolerance). The "No Go" reading may be broken down into "High" and "Low" readings for more detailed classification of the item under test.

The "Go" or "No Go" decisions may be determined in a number of ways. In relatively complex systems, the decision may require a computer with inputs supplied from a combination of voltmeters, counters, etc. In the simpler systems, a human operator may obtain each measurement to determine acceptability. Between the highly sophisticated computer-type test systems and the manual tests

lies a large area suited to smaller automatic or semi-automatic systems which are simpler than the computer systems but yield faster and easier operation than manual means.

A moderately-priced automatic or semi-automatic system used in place of a manual arrangement can reduce operator fatigue, result in fewer measurement errors, reduce test time and permit operation by less experienced operators.

Designed to bridge this gap, the HP Model 3434A Comparator uses a technique similar to ramp-style digital voltmeters. It generates a linear ramp whose amplitude is compared to three analog voltages by three comparators. Two of these voltages are the limit voltages, and the other is the dc voltage output from a signal-conditioning unit. Signal-conditioning units are the same plug-in units that are used with the HP Model 3440A Digital Voltmeter. Functional capabilities include ac volts, dc volts, resistance and dc current. Limits can be selected automatically or manually. As many as 12 different pairs of limits can be pre-programmed and quickly selected by a 12-position rotary switch or remotely by contact closures as test conditions change. The versatility and low cost of the 3434A makes it attractive for automated testing on low-volume production runs (from 50 to 100 pieces, and it's fast enough (up to 15 decisions per second) to be used on high-volume lines as well. Refer to page 233 for further information on the HP 3434A Comparator.

AC/DC Converters: the ac-to-dc converter (Figure 7) typically produces a dc output voltage between 0 and 1 V dc proportional to the average value of the applied ac voltage calibrated in rms.

The frequency range for precision ac measurements (0.1% or better) has been restricted to the video range but is continually being extended. Measurement speeds for ac voltage depend on the frequency of the voltage and the measurement accuracy desired.

Ohms-to-Dc Converter: the ohms-to-dc converter, frequently an additional function of ac-to-dc converters, produces a dc output voltage between 0 and 1 V dc proportional to the value of the

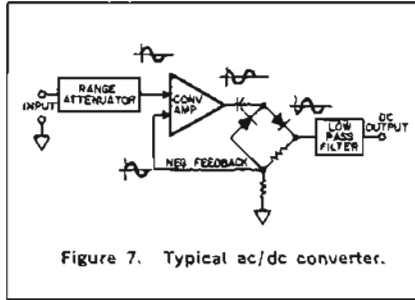

Figure 7. Typical ac/dc converter.

unknown resistance applied. Most ohms-to-dc converters require a high input impedance dc preamplifier.

The HP 3461AC/Ohms Converter DC Preamplifier has total compatibility with the 3460B, and can measure ac voltages up to 1200 V rms, and resistances up to 12 megohms. It is fully guarded, automatic ranging on all functions, and is remotely programmable.

The compatible AC-ohms converter for the 2401C is the HP Model 2410B.

Plug-in AC/DC Converters: the HP 3445A and 3446A Plug-ins are companions to the HP 3439A and 3440A Digital Voltmeters.

Analogue Voltmeters used as AC/DC

Converters: connect any dc DVM with a 1 V dc range to the dc output of an analog voltmeter, such as the HP 400E/EL. The 400E/EL gives good accuracy as an ac-to-dc converter in its mid-frequency range from 50 Hz to 500 kHz. It has typically <0.5% of reading error, even at 1/10 full scale, 200 Hz to 400 kHz.

True rms measurements from 10 Hz to 10 MHz can similarly be made by combining any dc digital voltmeter having a 1-volt range with the HP 3400A RMS Voltmeter.

Typical specifications of Hewlett-Packard ac-to-dc and ohms-to-dc converters are listed in Table 2.

Table 2. Hewlett-Packard AC/Ohms Converters/Preamplifiers.

Converter type (refer to page)	Companion HP DVM	Ranges	Auto ranging	Floating	Guarded	Plug-ins	Remote ranging	Remote triggering	Systems application	Calibration period (days)	Accuracy of measurement at full scale 20°C to +30°C	Can be used with other 1 V range DVM's
AC to DC												
2402A Option M2 (pg 240)	Part of 2402A	1 to 1000 V 4 ranges	X	X	X	**	X	X	X	180↓	(50 Hz to 100 kHz) ±0.12 to ±0.31%	No
3461A (pg 236)	3460B	1 to 1000 V 4 ranges	X	X	X		X	X	X	90	(50 Hz to 100 kHz) ±0.07% to ±0.15%	Yes
2410B (pg 242)	2401C	0.1 to 1000 V 5 ranges	†	X			X	X	X	90↓	(50 Hz to 100 kHz) ±0.175% to 0.5%	Yes
3445A/3446A (pg 232)	3439A/3440A	10 to 1000 V 3 ranges	X	X		X	X	X	X	90↓	(50 Hz to 100 kHz) ±0.1% to ±0.3%	No
457A* (pg 244)		1 mV to 1000 V 4 ranges		X							(50 Hz to 500 kHz) ±1.05%	Yes
3400A* (true rms) (pg 208)	3439A/3440A	1 mV to 300 V 12 ranges									(10 Hz to 10 MHz) ±0.75% to ±5.0%	Yes
400E/EL* (avg) (pg 204)	3439A/3440A	1 mV to 300 V 12 ranges								365	(10Hz to 10 MHz) ±0.5% to ±5.0%	Yes
OHMS to DC												
2402A Option M3 (pg 240)	Part of 2402A	1 kΩ to 10 MΩ 5 ranges	X	X	X	**	X	X	X	180↓	±0.055%	No
3461A (pg 236)	3460B	1 kΩ to 10 MΩ 5 ranges	X	X	X		X	X	X	90	0.016% to ±0.02%	Yes
2410B (pg 242)	2401C	100Ω to 10 MΩ 6 ranges	†	X	X		X	X	X	90↓	±0.089%	Yes
3444A (pg 231)	3439A/3440A	1 kΩ to 10 MΩ 5 ranges		X		X			X	90↓	±0.3% to ±1.0%	No
DC AMPLIFIERS												
3461A (pg 236)	3460B	0.1 V dc to 1 kV dc 5 ranges	X	X	X		X	X	X	90	±0.008% to ±0.011%	Yes
2411A (pg 242)	2401C	+1, +10 gain		X	X		X	X	X	180↓	±0.03%	No
3443A (pg 230)	3439A/3440A	100 mV to 1 kV 5 ranges	X	X		X	X	X	X	90↓	±0.05% to ±0.1%	No
3444A (pg 231)	3439A/3440A	100 mV to 1 kV 5 ranges		X		X		X	X	90↓	±0.05% to ±0.1%	No

†Standard 2410B autoranges with 2401C-M31.

*Accuracy of converter only. Accuracy of readout device should be added to determine accuracy of measurement.

**Options added by plug-in circuit modules and boards.

‡Assumes daily calibration of basic instrument against internal calibration standard after 30 minute warm-up.

DIGITAL VOLTMETER

Precision at the price of analog voltmeters
Model 3430A



**VOLTAGE, CURRENT,
RESISTANCE**

Description

The new Hewlett-Packard Digital Voltmeter offers accurate measurements at the price of analog voltmeters. The 3430A can be used on the bench, and with an adapter can be racked mounted. The 3430's solid-state construction offers continuous service under rigorous operating conditions. This voltmeter is accurate and easy to read—easily operated by inexperienced personnel.

The Hewlett-Packard Model 3430A Digital Voltmeter is a precision instrument permitting dc voltage measurements from ± 100.0 mV full scale to ± 1000 V, with an accuracy of $\pm (0.1\% + 1 \text{ digit})$ within a 90-day calibration cycle. The HP 3430A provides 2 readings/second with up to 60% overranging capabilities on all ranges except the 1000 volt range. Input resistance is a constant 10 megohms on all ranges. In-line digital display tubes and the polarity indicator indicate the voltage measurements. The digital display has a storage feature which prevents the display from changing until a new measurement has been taken.

Voltage ratio option

Three terminal (low side of reference tied to low side of input) ratio is available. The voltmeter indication is then proportional to the ratio of the input voltage (front terminals) and to the reference voltage (rear terminals). A rear-panel slide switch permits either normal or ratio mode operation. When the ratio mode is selected, a front-panel annunciator indicates **RATIO** to minimize the chance of operator error.

Precision dc amplifier

A precision (0.1%) dc output is available at the rear panel. This amplifier can be used while making measurements, provided the load current is 1 mA or less. Additionally, the output of the amplifier can be used to drive dc recorders. This amplifier output is for input signal only and is not proportional to ratio output.

Specifications Voltmeter

Ranges: full scale presentation of ± 100.0 mV, 1000 mV, 10.00 V, 100.0 V, and 1000 V (plus up to 60% overranging indicated with 4th digit). 1000 V maximum input. Manual range selection with automatic decimal point positioning. Polarity selection and indication automatic.

Performance rating

Voltage accuracy: $\pm (0.1\% \text{ of rdg.} + 1 \text{ digit})$ from 15°C to 35°C on all ranges. $\pm (0.25\% \text{ of rdg.} + 1 \text{ digit})$ from 0°C to 15°C and 35° to 50°C on all ranges.

Stability: rated accuracy is met after a 10 minute warmup period. The voltage accuracy is guaranteed for three months. Zero stability is better than 25 $\mu\text{V}/^\circ\text{C}$. Zero should be checked if the operating source resistance is $>100 \text{ k}\Omega$ on the 100.0 mV range.

Response time: input amplifier responds to 99.9% value of a step input in 0.5 seconds.

Input characteristics

Input resistance: 10 M Ω $\pm 3.0\%$.

Superimposed noise rejection: 40 dB at 60 Hz, increasing at 12 dB/octave at higher frequencies.

Isolation parameters

Input: floating; low side (middle terminal on the front panel) may be operated up to ± 500 V dc with respect to chassis ground (350 V rms).

Effective common mode rejection: ratio of common-mode signal to resultant error in readout.

At dc: >90 dB on 100.0 mV range, decreasing 20 dB per range.

At 60 Hz: >90 dB on 100.0 mV range, decreasing 20 dB per range.

DC amplifier: amplifier output ± 16 V dc maximum into 16 k Ω minimum resistance.* (Non-inverting voltage gain is 100 on the 100 mV range, decreasing by a factor of 10 on each higher range.) Gain accuracy $\pm 0.1\%$ (15°C to 35°C) $\pm 0.15\%$ (0°C to 15°C and 35°C to 50°C). Amplifier zero stability: $<0.25\%$ f.s./°C.

*=10 Vdc maximum into 10 k Ω minimum resistance at full output.

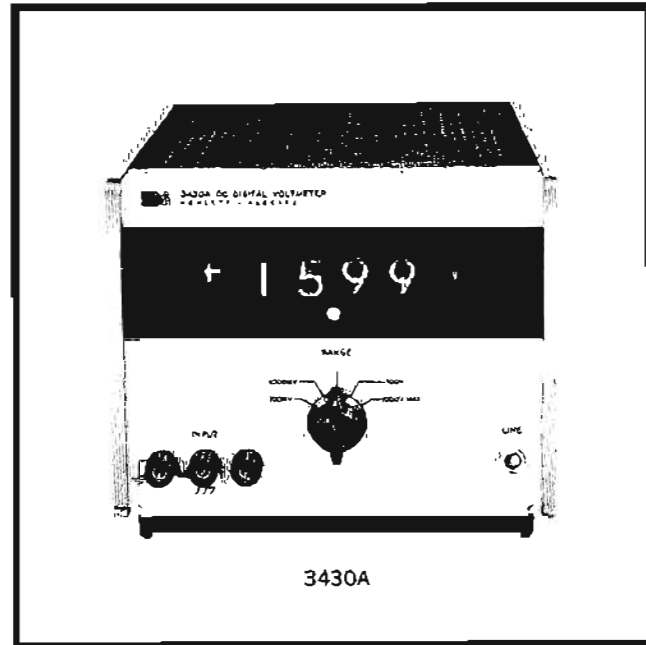

Operational features

Polarity selection: Automatic.

Display storage: continuous reading. No computation blink.

Sampling rate: fixed at 2/second.

Extreme operation conditions

Overload protection: ± 1050 V dc may be applied safely on all ranges except 100.0 mV range, where the limit is ± 700 V dc.

Overload indication: flashing display.

Ratio Option 01

Ratios from 0.0001:1 to 1000:1 can be measured

$$\text{Display volts} = \frac{\text{Input volts}}{\text{Reference volts}}$$

Annunciator indicates **RATIO** when rear-panel **NORMAL-RATIO** switch is set to **RATIO**.

Reference input

Range: 0.8 to 1.2 V either polarity (selected at rear panel) for rated accuracy.

Instrument is usable with reference voltage between 0.2 V and 1.3 volts.

Input resistance: 50 k $\pm 2\%$ for plus reference, 511 k $\pm 2\%$ for minus reference.

Front terminal input

Range: 100 mV full scale nominal on lowest range to 1000 V maximum on highest range.

Polarity: either, with automatic indication.

Input resistance: 10 M Ω on all ranges.

Accuracy

$\pm (0.15\% \text{ of rdg.} + 1 \text{ digit})$ 15°C to 35°C.

$\pm (0.30\% \text{ of rdg.} + 1 \text{ digit})$ 0°C to 15°C and 35°C to 50°C.

Maximum correct indication

1333 for reference inputs between 1.0 and 1.2 V.

1599 for reference inputs between 0.8 and 1.0 V.

General

Power: 115 or 230 volts $\pm 10\%$, 50 to 1000 Hz, approximately 20 watts.

Dimensions: 6-3/32" high, 7-25/32" wide, 11" deep (155 x 190 x 279 mm).

Weight: net 9.75 lbs (4.39 kg); shipping 12 lbs (5.4 kg).

Price: HP 3430A, \$595.

HP 3430A, Option 01, \$675.

**VOLTAGE, CURRENT,
RESISTANCE**



DIGITAL VOLTMETERS
Interchangeable Plug-ins Increase Versatility
Models 3439A/3440A

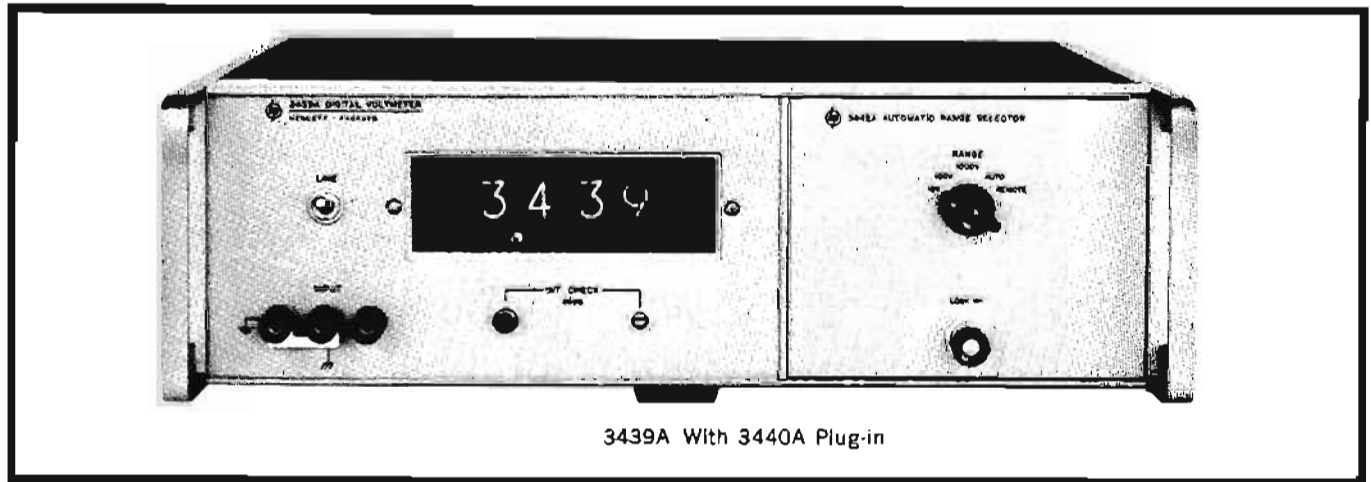

3439A With 3440A Plug-in

Interchangeable Plug-ins Increase Voltmeter Versatility

The HP Models 3439A and 3440A are compact, accurate, rapid and multiple-function digital voltmeters. The choice of automatic ranging, remote and manual operation is obtained by using the 3441A, 3442A, 3443A, 3444A, 3445A or 3446A plug-ins, which are interchangeable with any 3439A or 3440A. The basic voltmeter is solid-state with easy-to-service plug-in circuit cards mounted in the Hewlett-Packard modular enclosure.

DC voltages up to 999.9 V of either polarity are displayed in four significant digits with an accuracy of better than $\pm 0.05\%$ of reading ± 1 digit and with the polarity of the applied signal indicated automatically. Modes of range selection available for the plug-ins include manual, remote and automatic. Refer to Table 1 for data. The bright, easy-to-read display reduces operator fatigue. Readout storage is another feature of the 3439A and 3440A with large rectangular digital display tubes which display the previous reading, changing only if the input voltage changes. A polarized light filter reduces the reflection of external light so that a good contrast results when the digits are lighted.

Accuracy and Speed

The 3439A and 3440A Digital Voltmeters have a dc accuracy of better than $\pm 0.05\%$ of reading ± 1 digit over the ambient temperature of $+15^{\circ}\text{C}$ to $+40^{\circ}\text{C}$ with a line voltage variation of $\pm 10\%$. In addition, specified accuracy is retained to 5% beyond full scale, a feature that permits 5-digit resolution at the decade range change points. The ac input filter has a rejection of 30 dB at 60 Hz and the response time to a step change is 450 ms to read 99.95% of final value without a range change.

The input signal pair may be floated up to 500 V above chassis ground without affecting accuracy. An additional feature which results in high accuracy is the constant 10.2 megohm impedance. This impedance presents a constant load on all voltage ranges.

Plug-in Units

Figure 1 illustrates the features obtained by using the

3441A, 3442A, 3443A, 3444A, 3445A or 3446A plug-ins with any 3439A or 3440A.

Plug-in function chart						
Plug-In*	3441A	3442A	3443A	3444A	3445A	3446A
AC volts 10 V to 1000 V	**	**	**	**	✓	✓
DC volts 10 V to 1000 V	✓	✓	✓	✓	✓	✓
DC volts 100 mV to 1000 V			✓	✓		
DC amps				✓		
Ohms				✓		
Manual ranging	✓	✓	✓	✓	✓	✓
Auto-ranging		✓	✓		✓	
Floating input	✓	✓	✓	✓	✓	✓
Remote ranging		✓	✓		✓	✓
Remote function						✓

*3439A and 3440A require a plug-in to operate.
**Average response measurements: 100 μV to 300 volts, 50 Hz to 500 kHz use HP 457A; 1 mV to 300 volts, 10 kHz to 10 MHz use HP 400 E/EL. True rms measurements: 1 mV to 300 volts, 10 Hz to 10 MHz, use HP 3400A.

Figure 1. Plug-in Function Chart.

BCD Recorder Output (3440A only)

Each of the four digits, with polarity, function and decimal location, is represented by four-line, binary-coded decimal voltages in the 1-2-2-4 weighted code (1-2-4-8 available on special order). The decimal, polarity and the four digits are in parallel-coded form and are completely compatible with the HP 562A Digital Recorder which will print the information in 6 columns.

Performance

The operator can instantly verify the accuracy of the 3439A and 3440A by pressing a front-panel button. Typical performance on the 3440A internal calibration source is better than 0.002%/°C TC with stability typically better than $\pm 0.05\%$ over a 3 month period. The linearity is approximately $\pm 0.01\%$ for the 10, 100, and 1000 V ranges with 0.03% linearity full scale for the 100 mV and 1000 mV range. The stability of reading is approximately ± 1 count.

DIGITAL VOLTMETERS

Interchangeable Plug-Ins Increase Sensitivity
Models 3439A, 3440A



**VOLTAGE, CURRENT,
RESISTANCE**

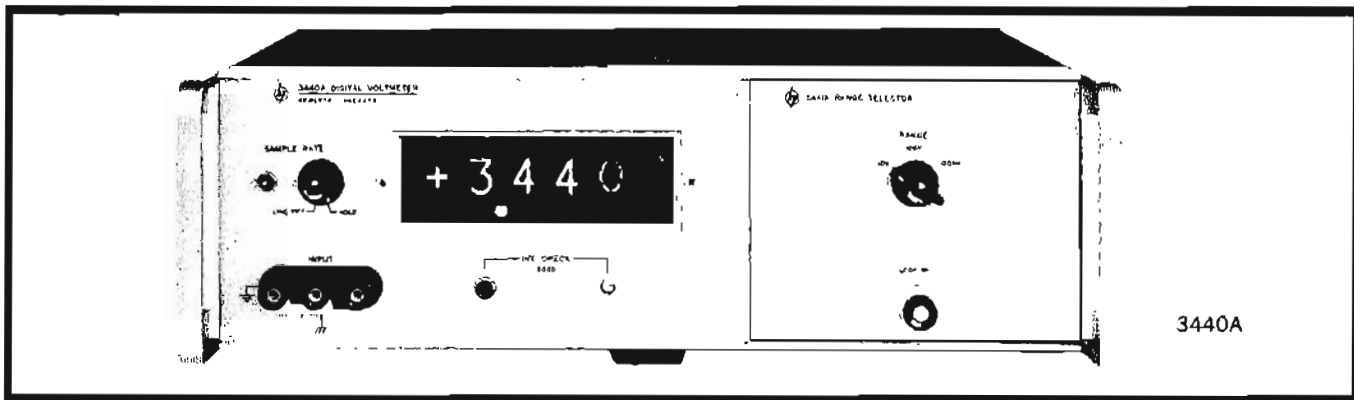

Specifications

(Main Frame HP 3439A and 3440A)

Model	HP 3440A	HP 3439A
Sample Rate:	5 samples per second to 1 per 5 seconds with storage during samples and "Hold." In "Hold" a sample may be initiated by applying a +10-V pulse 20 μ s wide or greater (ac coupled), or by contact closure.	Fixed at between 2 and 3 per second
DC Isolation:	Signal common may be floated up to 500 V dc from chassis ground.	
Printer Output:	4-line BCD (1-2-2-4) 6 columns consisting of 4 digits of data, polarity, function and decimal. 4-line BCD (1-2-4-8) available on special order. Impedance: 120 k Ω maximum, each line. "0" state level—24 V, "1" state level—1 V.	
Reference Levels:	Positive: approximately -2.5 V, 330 ohms source impedance. Negative: approximately -27 V, 920 ohms source impedance.	
Print Command:	Step from -12 V to -2 V dc from a 100 ohm source.	
Hold-off Requirements:	Anywhere from +6 V to +15 V max. from source impedance less than 2000 ohms (provided by HP 562A Digital Recorder).	
Remote Triggering:	+10 V pulse 20 μ s wide or greater, or a contact closure.	
Power:	115 or 230 V \pm 10%, 50 to 1000 Hz, approximately 20 to 30 watts, depending upon plug-in.	
Weight:	Net, 18 lbs (8 kg); Shipping, 22 lbs 10 oz (10,2 kg).	
Dimensions:	16 $\frac{3}{4}$ " wide x 5-7/32" high x 11 $\frac{1}{4}$ " deep (423,5 x 132,5 x 285,6 mm).	
Price:	\$1160	\$950

Accessories Available

HP KOI-3440A Plug-in Extender, \$65.00.
(HP 3440A Only)

HP J74-562A/AR: Digital Recorder for use with HP 3440A accepting 1-2-2-4 BCD code. (Floating Operation to \pm 500 V dc.) Includes special print-wheel, 6 BCD column boards, input connector assembly with cable. Cabinet, \$1693; rack, \$1668.

HP J75-562A/AR: Same as J74-562A/AR except for single character function symbol. Cabinet, \$1673; rack, \$1648.

HP J76-562A/AR: Digital Recorder for use with HP 3440A accepting 1-2-4-8 BCD code. (Floating operation to \pm 500 V dc.) Includes special printwheel, 6 BCD column boards, input connector assembly with cable. Cabinet, \$1693; rack, \$1668.

HP J77-562A/AR: Same as J76-562A/AR except for single character function symbol. Cabinet, \$1673; rack, \$1648.

Note:

If the 3440A is used to drive an HP 562A Printer with a 2nd floating input to the 562A, a special H27-3440A is available. It allows 150 V dc to exist between the 3440A common and the low side of the 2nd input. Up to 500 V dc can exist between the 3440A

common and chassis. Price and delivery will be provided upon request.

Data	Function	Logic 1-2-2-4	Logic 1-2-4-8	Std.	HP 562A Print wheel	
					J76-562A J77-562A	J74-562A J78-562A
0	+ volts	0000	0000	0	+	+V
1	- volts	1000	1000	1	-	-V
2	+ amps	0100	0100	2	A	+A
3	- amps	1100	1100	3	V	-A
4	ac volts	0110		4	~	AC
5	ohms	1110	1010	5	Ω	Ω
6	ac volts		0110	6	~	AC
7	overrange		1110	7	*	**
8				8		
9	overrange	1111		9	*	**

VOLTAGE, CURRENT, RESISTANCE



PLUG-INS FOR 3439A/3440A

Interchangeable plug-ins used also for 3434A
Plug-in Models 3441A, 3442A, 3443A



3441A Range Selector

The HP 3441A Range Selector is a plug-in unit with a range switch to manually select one of three voltage ranges; 10, 100, or 1000 volts.

3442A Automatic Range Selector

HP Model 3442A Automatic Range Selector is also available for use with the 3439A, 3440A Digital Voltmeters or the 3434A Comparator. The 3442A retains the manual range selection and adds automatic and remote range features. Ten percent hysteresis is built into the automatic ranging function of the 3442A.

3443A High Gain/Auto Range Unit

HP Model 3443A High Gain/Auto Range Unit, available for use with the 3439A or 3440A Digital Voltmeters or the 3434A Comparator, features automatic or remote range selection from 100 mV to 1000 volts full scale. A front-panel, zero offset control enables the operator to obtain a zero indication at the DVM to compensate for the thermocouple voltages of external connections. The 3443A has the same ranging capabilities as the 3442A with the additional features of two added ranges and 10 μ V resolution, making it ideal for thermocouple and transducer measurements.

Specifications, 3441A, 3442A

Voltage range: 4-digit presentation of 9.999, 99.99, and 999.9 volts full scale with 5% overrange capability and overrange indicator.

Voltage accuracy: $\pm 0.05\%$ of reading ± 1 digit including line voltage variations of $\pm 10\%$ from nominal. A front-panel adjustment on the 3440A insures accuracy over the temperature range between $+15^\circ\text{C}$ and $+40^\circ\text{C}$ and $\pm 0.1\% \pm 1$ digit over the temperature range of 0°C to $+15^\circ\text{C}$ and $+40^\circ\text{C}$ to $+50^\circ\text{C}$.

Range selection: with 3441A, manual. With 3442A: manual, automatic and remote range change speed. automatic (max.) achieves accurate reading in less than 1 second after new voltage is applied; Remote (max.) will change range with 40 ms.

Voltmeter Input Impedance: constant 10.2 megohms (to dc) all ranges.

Polarity: automatic indication.

Input filter characteristics: response time; less than 450 ms to a step function to within 99.95% of final value (without a range change).

Input filter ac rejection: 10, 100 and 1000 volt ranges: 30 dB at 60 Hz, increasing at 12 dB/octave.

Weight:

3441A: net 1 lb (0,45 kg); shipping 4 lbs (1,8 kg).

3442A: net 1.5 lbs (0,7 kg); shipping 4 lbs (1,8 kg).

Price: HP 3441A, \$40; HP 3442A, \$135.

Specifications 3443A

Voltage range: 4-digit presentation of 99.99 mV, 999.9 mV, 9.999 volts 99.99 volts, and 999.9 volts full scale with 5% overrange capability and overrange indicator.

Voltage accuracy:

9.999 V to 999.9 V full scale: $\pm 0.05\%$ of reading ± 1 digit including line voltage variations of $\pm 10\%$ from nominal. A front-panel adjustment on the 3440A insures accuracy over the temperature range between $+15^\circ\text{C}$ and $+40^\circ\text{C}$ and $\pm 0.1\% \pm 1$ digit over the temperature range of 0°C to $+15^\circ\text{C}$ and $+40^\circ\text{C}$ to $+50^\circ\text{C}$.

99.99 mV and 999.9 mV full scale: $\pm 0.1\%$ of reading ± 1 digit including line voltage variations of $\pm 10\%$ from nominal. A front-panel adjustment on the 3440A insures accuracy over the temperature range between $+15^\circ\text{C}$ and $+40^\circ\text{C}$ and $\pm 0.15\% \pm 1$ digit over the temperature range of 0°C to $+15^\circ\text{C}$ and $+40^\circ\text{C}$ to $+50^\circ\text{C}$.

Range selection: Manual, Automatic and Remote Range Change Speed: Automatic (max.) achieves accurate reading within 1.5 seconds after new voltage is applied; Remote (max.) will change range within 40 ms.

Voltmeter Input Impedance: constant 10.2 megohms (to ac) all ranges.

Polarity: automatic indication.

Input filter characteristics: (to a step function to within 99.95% of final value without a range change) 10, 100, 1000 V dc ranges; response time < 450 ms. 100, 1000 mV ranges; < 1 second.

Input filter ac rejection: 10, 100, and 1000 volt ranges: 30 dB at 60 Hz increasing at 12 dB/octave. 100 and 1000 mV ranges: maximum of 40 mV and 400 mV p-p respectively at 60 Hz for less than 0.1% of full-scale error; allowable ac increasing at 6 dB per octave.

Weight: net 3 lbs (1,35 kg); shipping 5 lbs (2,3 kg).

Price: HP 3443A, \$450.

PLUG-INS FOR 3439A/3440A

Interchangeable plug-ins used also for 3434A
Plug-in Model 3444A



VOLTAGE, CURRENT, RESISTANCE

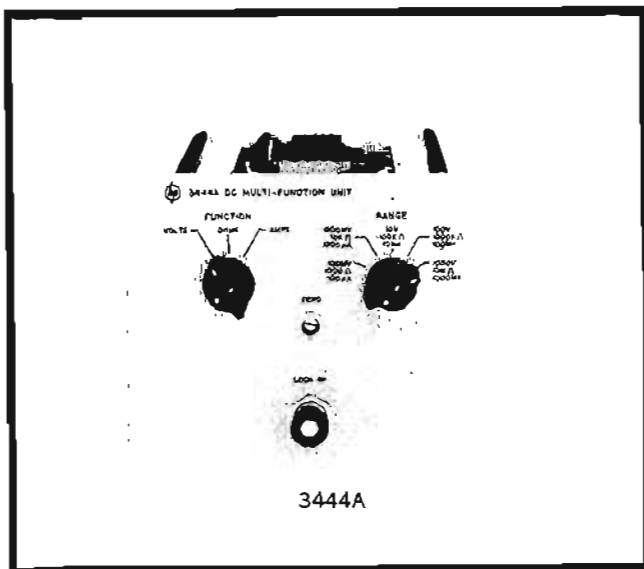

3444A DC Multi-Function Unit

The HP 3444A DC Multi-Function Unit, available for use with the 3439A, 3440A Digital Voltmeters and 3434A Comparator, features voltage, current and resistance-measurement capabilities in one plug-in module.

This plug-in offers manual-ranging dc voltage, dc current and resistance measuring capabilities. Full-scale ranges of 100 mV to 1000 V with 10 μ V resolution make this plug-in ideal for thermocouple and transducer measurements. Full-scale current ranges of 100 μ A, 1, 10, 100 and 1000 mA are available with a maximum sensitivity of 10 nA. Five resistance ranges of 1000 ohms to 10 megohms are provided.

Specifications

Voltage range: 4-digit presentation of 99.99 mV, 999.9 mV, 9.999 volts, 99.99 volts, and 999.9 volts full scale with 5% overrange capability and overrange indicator.

Current range: 4-digit presentation of 99.99 μ A, 999.9 μ A, 9.999 mA, 99.99 mA and 999.9 mA with 5% overrange capability and overrange indicator.

Resistance range: 4-digit presentation of 999.9 ohms, 9.999 k ohms, 99.99 k ohms, 999.9 k ohms and 9.999 megohms with 5% overrange capability and overrange indicator.

Voltage accuracy:

9.999 V to 999.9 V full scale: $\pm 0.05\%$ of reading ± 1 digit including line voltage variations of $\pm 10\%$ from nominal. A front-panel adjustment on the 3440A insures accuracy over the temperature range between $+15^\circ\text{C}$ and $+40^\circ\text{C}$ and $\pm 0.1\%$ ± 1 digit over the temperature range of 0°C to $+15^\circ\text{C}$ and $+40^\circ\text{C}$ to $+50^\circ\text{C}$.

99.99 mV and 999.9 mV full scale: $\pm 0.1\%$ of reading ± 1 digit including line voltage variations of $\pm 10\%$ from nominal. A front-panel adjustment on the 3440A insures accuracy over the temperature range between

$+15^\circ\text{C}$ and $+40^\circ\text{C}$ and $\pm 0.15\%$ ± 1 digit over the temperature range of 0°C to $+15^\circ\text{C}$ and $+40^\circ\text{C}$ to $+50^\circ\text{C}$.

Current accuracy: $\pm 0.2\%$ of reading ± 1 digit with line variations of $\pm 10\%$ from nominal.

Resistance accuracy: $\pm 0.3\%$ of reading ± 1 digit for all ranges up to the 10 megohm range with line variations of $\pm 10\%$ from nominal. $\pm 1\%$ of reading ± 1 digit on the 10 megohm range with line variations of $\pm 10\%$ from nominal.

Ohmmeter current:

Range	Short circuit current
1 k	1 mA
10 k	100 mA
100 k	10 μ A
1 M	1 μ A
10 M	0.1 μ A

Range selection: manual.

Voltmeter Input Impedance: constant 10.2 megohms (to dc) all ranges.

Ammeter Input resistance:

Range	Input resistance
100 μ A	1000 ohms
1000 μ A	100 ohms
10 mA	10 ohms
100 mA	1.3 ohms
1000 mA	0.4 ohms

Polarity: automatic indication.

Input filter characteristics:

Voltage: less than 450 ms to 99.95% of final value for full-scale step function on 10, 100 and 1000 volt ranges. Less than one sec to within 99.95% of final value for a full-scale step function on 100 and 1000 mV ranges.

Current: less than one sec to 99.95% of final value for a full-scale step function on all current ranges.

Resistance: 1000 ohms to 1 megohm; less than 1.0 sec to 99.95% of final value. 10 megohms; less than 5.0 sec to 99.95% of final value.

Input filter ac rejection:

Voltage: 10, 100 and 1000 volt ranges; 30 dB to 60 Hz, increasing 12 dB/octave. 100 and 1000 mV ranges; maximum of 40 mV and 400 mV p-p respectively at 60 Hz for less than 0.1% of full-scale error; allowable ac increasing at 6 dB/octave.

Current: p-p ripple current may be up to 40% of full-scale range at 60 Hz for less than 0.1% of full-scale error; allowable ac increasing at 6 dB/octave.

Weight: net 3 lbs (1.35 kg); shipping 5 lbs (2.3 kg).

Price: HP 3444A, \$575.

VOLTAGE, CURRENT, RESISTANCE



PLUG-INS FOR 3439A/3440A

Interchangeable plug-ins used also for 3434A
Plug-Ins Models 3445A, 3446A



3445A

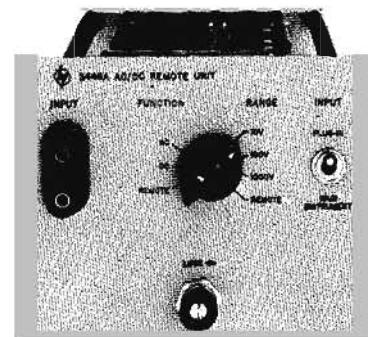

3446A

3445A AC/DC Range Unit 3446A AC/DC Remote Unit

The HP Model 3445A AC/DC Range Unit or the HP Model 3446A AC/DC Remote Unit may be used with the 3439A, 3440A Digital Voltmeters or the 3434A Comparator for ac or dc measurements. These solid-state units have three full-scale ranges for both ac and dc from 10 to 1000 volts. The ac conversion circuit of the 3445A and 3446A produces a dc output voltage proportional to the average value of the applied ac voltage and is calibrated in rms. The table in the specifications illustrates the differences between the 3445A and 3446A Plug-ins.

Combining the HP 463A Precision Amplifier with the 3445A or 3446A increases the sensitivity of either plug-in from 10 volts full scale to as low as 10 mV full scale over a frequency range of 50 Hz to 100 kHz. Because the HP 463A is a direct-coupled amplifier it can be used to increase the dc sensitivity with any 3441A, 3442A, 3445A or 3446A Plug-in with any 3439A or 3440A Digital Voltmeter. For further information refer to the 463A Data Sheet.

	50 Hz	20 kHz	50 kHz 100 kHz
10 V to 1 kV Full Scale	± 0.1 rdg	± 0.1 f.s.	± 0.1 to ± 0.3 linearly derated f.s.

Voltage accuracy (dc): $\pm 0.05\%$ of reading ± 1 digit including line voltage variations of $\pm 10\%$ from nominal. A front-panel adjustment on the 3440A insures accuracy over the temperature range between $+15^\circ\text{C}$ and $+40^\circ\text{C}$ and $\pm 0.1\%$ ± 1 digit over the temperature range of 0°C to $+15^\circ\text{C}$ and $+40^\circ\text{C}$ to $+50^\circ\text{C}$.

Response speed (ac): achieves specified accuracy within 3 sec when on proper range. Allow an extra second for recovery if overloaded.

Floating measurements: signal common may be floated up to 500 V dc above chassis ground.

Input impedance:

10 megohms shunted by 20 pF nominal on all ac ranges;
10.2 megohms on all dc ranges.

Input filter characteristics (dc):

Response time: < 450 ms to 99.95% of final value for a step function.

AC rejection: 30 dB at 60 Hz, increasing 12 dB/octave.

Remote selection: remote selection is made by contact closure to ground through < 100 ohms. Change will be completed < 40 ms. (Refer to table for modes available.)

Table of modes

	3445A	3446A
Input Terminals	Plug-In only	Plug-in & Main Frame selected by Front Panel Switch
Range Selection	Manual, Automatic, Remote	Manual, Remote
Function Selection	Manual	Manual, Remote
Input Impedance (nominal)	10 megohms / 20 pF	Plug-in Input: 10 megohms/35 pF Main-Frame input: 10 megohms/175 pF

Polarity: automatic indication.

Weight: net 2.75 lbs (1.24 kg); shipping 5 lbs (2.3 kg).

Price: HP 3445A, \$525; HP 3446A, \$575.

HIGH-GO-LOW COMPARATOR

Production time saver for repetitive tests
Model 3434A



VOLTAGE, CURRENT,
RESISTANCE

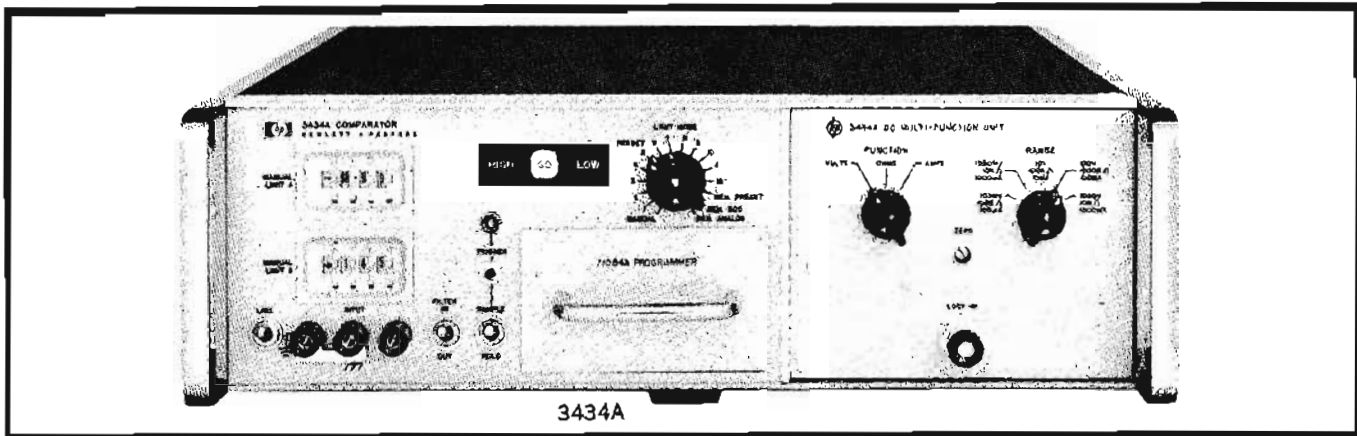

High-go-low

This versatile comparator compares the unknown quantity to preset limit pairs. If its value exceeds (more positive) the high preset limit, the HIGH or red light will glow. If its value is smaller (less positive) than the low preset limit, the LOW or yellow light will glow. If its value is between the preset limits, the GO or green light will glow. Contact closures which operate simultaneously with the corresponding (HIGH-GO-LOW) lights, are available at an output connector. This information is presented until a new comparison has been completed.

If the main test control switch is replaced by a stepping switch or a scanner, the High-Go-Low outputs may be used as control signals to automate a system. The functions and ranges available depend on the plug-in utilized. (See Table No. 1.) Refer to pages 230 through 232 for usable plug-ins. Refer to page 225 for applications of the 3434A in production lines and for other applications including integrated circuit tests.

Plug-in	3441A	3442A	3443A	3444A	3445A	3446A
AC volts 10 V to 1000 V					✓	✓
DC volts 10 V to 1000 V	✓	✓	✓	✓	✓	✓
DC volts 100 mV to 1000 V			✓	✓		
DC amperes				✓		
Ohms				✓		
Manual ranging	✓	✓	✓	✓	✓	✓
Floating input	✓	✓	✓	✓	✓	✓
Remote ranging		✓	✓		✓	✓
Remote function						✓

TABLE 1. PLUG-IN FUNCTION CHART

Specifications*

Functions: provides HIGH-GO-LOW testing for dc volts, ac volts, dc current and ohms with the appropriate plug-in (Table 1). Comparisons up to 15/s can be made.

Performance rating

Accuracy: (from +15°C to +40°C for all accuracy specifications). Limits selected by manual thumbwheels, Preset Programmer (11084A) or remote BCD.

DC voltages: 10 V, 100 V and 1000 V ranges: $\pm 0.02\%$ of reading $\pm 0.03\%$ of full scale.
100 mV and 1000 mV ranges: $\pm 0.05\%$ of reading $\pm 0.03\%$ of full scale.

AC voltages: 10 V, 100 V and 1000 V ranges 50 Hz to 20 kHz: $\pm 0.08\%$ of reading $\pm 0.06\%$ of full scale. 20 kHz to 50 kHz: $\pm 0.12\%$ of full scale. 50 kHz to 100 kHz: linearly derated from $\pm 0.12\%$ of full scale at 50 kHz to $\pm 0.3\%$ of full scale at 100 kHz.

Resistance: 1000 Ω , 10 k Ω , 100 k Ω and 1000 k Ω ranges: $\pm 0.2\%$ of reading $\pm 0.03\%$ of full scale. 10 M Ω range: $\pm 0.8\%$ of reading $\pm 0.03\%$ of full scale.

Current: 100 μ A, 1000 μ A, 10 mA, 100 mA and 1000 mA ranges: $\pm 0.15\%$ of reading $\pm 0.04\%$ of full scale.

Limits selected remotely with external analog voltages: (accuracy with which each limit is compared to the input voltage).

DC voltages: 10 V, 100 V and 1000 V ranges: $\pm 0.01\%$ of reading $\pm 0.02\%$ of full scale. 100 mV and 1000 mV ranges: $\pm 0.05\%$ of reading $\pm 0.02\%$ of full scale.

AC voltages: 10 V, 100 V and 1000 V ranges. 50 Hz to 20 kHz: $\pm 0.08\%$ of reading $\pm 0.04\%$ of full scale. 20 kHz to 50 kHz: $\pm 0.12\%$ of full scale. 50 kHz to 100 kHz: linearly derated

from $\pm 0.12\%$ of full scale at 50 kHz to $\pm 0.3\%$ of full scale at 100 kHz.

Resistance: 1000 Ω , 10 k Ω , 100 k Ω and 1000 k Ω ranges: $\pm 0.2\%$ of reading $\pm 0.02\%$ of full scale; 10 M Ω range, $\pm 0.8\%$ of reading $\pm 0.02\%$ of full scale.

Current: 100 μ A, 1000 μ A, 10 mA, 100 mA and 1000 mA ranges, $\pm 0.15\%$ of reading $\pm 0.03\%$ of full scale.

Response time:

DC voltage: 10 V, 100 V and 1000 V ranges.

Filter in: 240 ms to 99.98% of final value.

Filter out: 140 ms to 99.98% of final value.

Input characteristics

Resistance (dc): main input terminals, 10.2 M Ω on all ranges dc voltage.

Impedance (ac): 10 M Ω shunted by 20 pF of nominal on all ac ranges (3445A, 3446A).

Input filter ac rejection: 10 V, 100 V and 1000 V ranges.

Filter in: 30 dB at 60 Hz, increasing at 12 dB/octave.

Filter out: 15 dB at 60 Hz, increasing at 6 dB/octave.

Power: 115 or 230 V $\pm 10\%$, 50 to 1000 Hz, 30 W.

Dimensions: (full module) 5-7/32" high, 16 $\frac{3}{4}$ " wide, 18 $\frac{3}{8}$ " deep (132.5 x 425.5 x 463 mm).

Weight: net 18 lbs (8 kg); shipping 29 lbs (13 kg).

Price: HP 3434A, basic unit, \$1575.

Plug-ins: HP 11084A Programmer, \$225; HP 3441A Range Selector, \$40; HP 3442A Automatic Range Selector, \$135; HP 3443A High Gain/Auto Range Unit, \$450; HP 3444A DC Multi-Function Unit, \$575; HP 3445A AC/DC Range Unit, \$525; HP 3446A AC/DC Remote Unit, \$575.

* Refer to data sheet for complete specifications.

**VOLTAGE, CURRENT,
RESISTANCE**



DIGITAL VOLTMETER

$\pm 0.004\%$ accuracy, lab precision, systems speed
Model 3460B

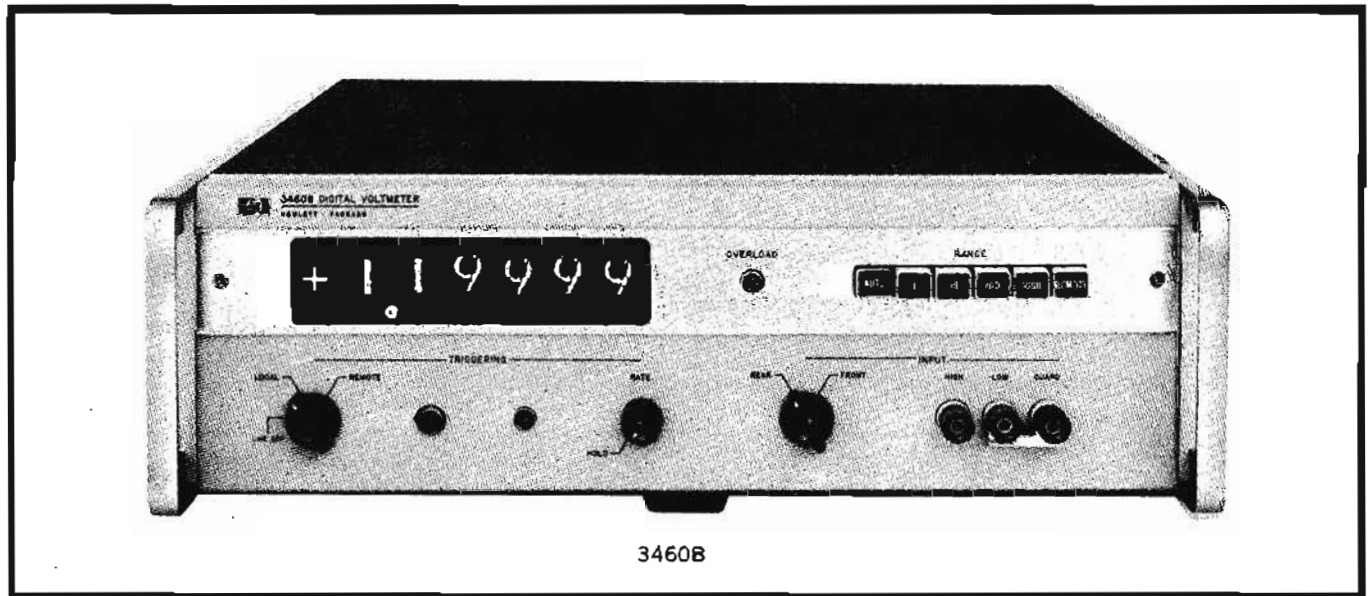

Description

The new all solid-state Hewlett-Packard 3460B Digital Voltmeter offers a broader measuring capability at moderate cost than any other digital voltmeter available. High accuracy and resolution, high reading rate with more than 5-digit readout and constant high-input impedance are insured with the HP 3460B.

This guarded digital voltmeter permits automatic and remote-controlled dc measurements from 1 V to 1000 V full scale. Measurements of .1 volt can be obtained with 10 μ V resolution. A high accuracy of $\pm 0.004\%$ of reading $\pm 0.002\%$ of full scale makes the 3460B ideal for precision measurements. The HP 3460B provides up to 15 readings per second. 20% overranging on all ranges offers full-scale display within specified accuracy (up to 1200 V on the 1000 V range). Another feature is the choice of constant 10 M Ω input impedance or $10^{10}\Omega$ input impedance on the 1 V or 10 V range. In-line digital display tubes and the polarity indicator display voltage measurements from ± 0.00001 to ± 1199.99 V dc. These measurements are made with an absolute accuracy of $\pm 0.004\%$ of reading $\pm 0.002\%$ of full scale over a temperature range from +20°C to +30°C for a period of 90 days. Voltage accuracy temperature coefficient is $\pm 0.0002\%$ of reading/ $^{\circ}$ C over a temperature range of 0°C to +50°C. Four input voltage ranges of 1.00000, 10.0000, 100.000, 1000.00 may be selected by front-panel push-buttons, automatically or by remote control. A decimal point is automatically positioned so that the display always reads directly in volts.

The HP 3460B is fully programmable. Permanent test records of all readings including polarity, decimal location, function and overload are available with accessory HP Model 562A Printer.

Accessory instruments include the floating and guarded HP 3461A for ac voltage and resistance-measuring capa-

bilities plus a preamplifier offering 1 μ V dc sensitivity. See page 236.

Integrating-potentiometric technique

The 3460B is distinctly different from all other types of digital voltmeters. It combines potentiometric and integration techniques and continually measures the true average of the input voltage over a fixed sampling period. It attains $\pm 0.004\%$ accuracy as a result of the potentiometric technique which makes use of resistance ratios and a stable reference voltage. The use of integration in this combined technique results in much of the superimposed noise immunity of integrating DVM's. The voltmeter, in one 5" high, 19" wide convenient rack-mount unit, combines the extreme precision and measurement flexibility expected from laboratory standards with the programming and electronic output features necessary for automatic systems.

Programming the 3460B

The HP 3460B is designed for fully automatic operation within a digital data acquisition system. Measurement function, voltage range and integration period can all be selected by external circuit closures to ground.

To simplify system cabling, signal input connections can also be made at the rear of the instrument. All remote-control lines and electrical outputs are referred to the chassis. Grounding the chassis does not affect the floating capabilities of the input lines and guard.

AC voltage and resistance measurements

AC voltages up to 1200 V rms and resistances to 12 M Ω can be measured with the 3460B using an HP 3461A AC/Ohms Converter-DC Preamplifier. In addition, the 3461A enables measurements with a constant $10^{10}\Omega$ input impedance on the 0.1 V, 1 V, and 10 V ranges to be made. HP 3460B Option 02 is compatible for use with the 3461A. For additional information, refer to pages 236 and 237.

Specifications

Ranges: full scale, ± 1.00000 V, ± 10.0000 V, ± 100.000 V and ± 1000.00 V (up to 20% overranging indicated with 6th digit); range selection may be made automatically remotely, or manually.

Performance rating

Absolute voltage accuracy: $\pm(0.004\%$ of reading + 0.002% of full scale) over a temperature range from +20°C to +30°C for a period of 90 days.

Voltage accuracy temperature coefficient: $\pm(0.0002\%$ of reading + 0.0001% of full scale) /°C over a temperature range of 0°C to +50°C.

Short-term stability: $\pm(0.002\%$ of reading + 0.001% of full scale) at +23°C $\pm 1^\circ$ C and relative humidity up to 50% for a period of 24 hours.

Long-term stability: $\pm(0.008\%$ of reading + 0.001% of full scale) at +23°C $\pm 1^\circ$ C and relative humidity up to 50% for a period of 6 months.

Response times: fixed range, reads within specified accuracy when triggered coincident with step input voltage. Reading period: 66 ms min on 10, 100, and 1000 V ranges, 147 ms min on 1 V range.

Polarity selection: no delay.

Automatic range selection: 33 ms per range change (100 ms max).

Remote range selection: 8 ms.

Input characteristics

Input resistance: $>10^{10}\Omega$ at balance on 1 V and 10 V ranges minimum of 10 M Ω . 10 M Ω $\pm 0.03\%$ on 100 and 1000 V ranges.

Impedance: 40 pF in parallel with 10 M Ω at front panel.

Noise rejection: overall effective common-mode rejection (ratio of indicated error voltage to common-mode voltage) 145 dB at all frequencies (0.1 s sample period); common-mode rejection 160 dB at dc, 120 dB at 60 Hz with 1000 Ω between low side of input and the point where the guard is connected; superimposed noise rejection; >20 dB at 55 Hz for 0.1 s sample period increased 20 dB per decade of frequency; infinite rejection at frequencies divisible by 10 (0.1 s sample period) or 60 (1/60 s sample period).

Isolation parameters

Inputs: floated and guarded signal pair (binding post on front panel or connector on rear panel is selected by front-panel switch); guard may be operated up to ± 500 V dc with respect to chassis ground (350 V rms); low may be operated up to ± 50 V dc with respect to guard.

Input signals

Range selection

Automatic: pushbutton selector or a switch closure to ground with impedance $<100\Omega$ provides auto range operation; 33 ms is required per range change (100 ms max).

Remote: a switch closure to ground with impedance $<100\Omega$ for a period >100 μ s selects range desired within 8 ms.

Manual: pushbutton selector.

External read command: accepts ac or dc trigger of either polarity.

Short integration period: voltmeter normally integrates for 1/10 s; switch closure to ground of $<100\Omega$ selects 1/60 s integration period on 10, 100, and 1000 V ranges (3460B providing 1/50 s integration period for 50 Hz line frequency is available on special order).

Voltmeter reset: switch closure to ground of $<100\Omega$ assures min reset time.

Trigger hold off: hold off level is +3 to +10 V with a max current of 6.3 mA (provided by HP 562A Digital Recorder).

Output signals

Print command: dc coupled.

Print level: -1.0 V with 2 k Ω source resistance.

Print hold off level: -17 V with 7.5 k Ω source resistance (min load resistance is 15 k Ω).

BCD outputs: 4-line BCD (1-2-4-8), 9 columns consisting of function (polarity), decimal location, overload, and 6 digits of data (HP 3460B Option 01 available for 1-2-2-4 BCD).

State	Voltage	Source resistance
0	-24 V	100 k Ω
1	-1 V	100 k Ω
Ref. level	Voltage	Source resistance
Positive	-4 V	380 Ω
Negative	-21 V	900 Ω

Operational features

Trigger selection: front-panel selection of local or remote mode.

Overload Indicator: indicates when input voltage is higher than 120% of range selected.

Sampling indicator: indicates when instrument is digitizing.

General

Power: 115 or 230 V $\pm 10\%$, 50 to 60 Hz, approx 60 W.

Dimensions: 16 $\frac{3}{4}$ " wide, 5 $\frac{1}{2}$ " high, 21 $\frac{1}{8}$ " deep (425,4 x 127,8 x 543 mm).

Weight: net 38 lbs (16 kg); shipping 48 lbs (21,6 kg).

Accessories furnished: rack mounting kit, includes 2 HP Part No. 5060-0049 15-pin plug-in printed circuit board extenders; 1 HP Part No. 5060-0630 22-pin plug-in printed circuit board extender; HP 11065A 6' rear-input cable, guarding preserved, terminated end mates with 3460B; HP 11085A remote control cable.

Accessories available

HP 3461A AC/Ohms Converter-DC Preamplifier

HP 562A/AR Digital Recorder (refer to page 229 for special versions).

Price: HP Model 3460B, \$3600.

Option 01, BCD output, no additional charge.

Option 02, compatible with 3461A AC/Ohms Converter DC Preamplifier, add \$150.

Option 03, same as Option 02 with 1-2-2-4 BCD output, add \$150.

**VOLTAGE, CURRENT,
RESISTANCE**



AC/OHMS CONVERTER/PREAMP
Automatic ranging in all functions
Model 3461A

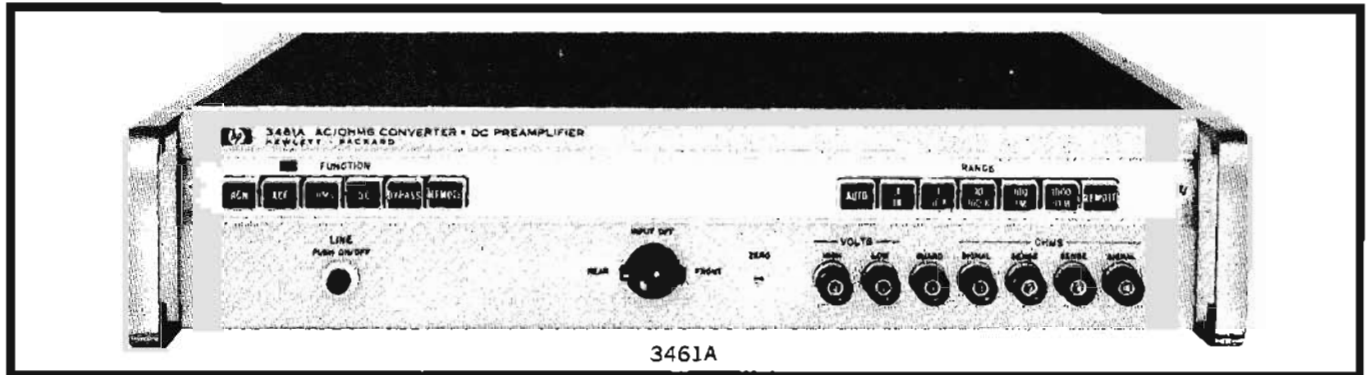

A new signal-conditioning unit, the HP 3461A AC/Ohms Converter/Preamplifier adds ac voltage and resistance measurement capabilities to the HP 3460B Digital Voltmeter. It also extends the dc sensitivity of the 3460B to 1 μ V full scale. The 3461A features complete programmability, auto-ranging, high-input impedance and 20% overranging when used with the 3460B. Although the 3461A is designed specifically for use with the 3460B, some of its features can be used with other dc voltmeters.

Programmability

A combination of the HP 3461A and the HP 3460B provides a totally-programmable multifunction system. Closures to ground permit range and function selection in milliseconds. Four separate lines are available for triggering a reading (\pm dc and \pm ac). An end-of-reading signal is available for advancing a scanner, or it can be used as a print command to a printer. The 3460B in this system provides a BCD code which includes range, function and reading information.

AC, DC and Ohms Measurement Capability—

Optional Combinations

The standard HP 3461A provides both an ac and ohms converter plus a preamplifier. You can purchase options to include a single function or a combination of functions. When the ohms converter option is selected, you receive the preamplifier function with it. Functions not originally purchased can be ordered and easily installed later at your convenience, giving the optimum flexibility to meet your measurement requirements.

Autorangeing

Autorangeing (3461A/3460B combination only) permits you to make measurements without having to take time to change ranges manually when the signal magnitude varies more than full-scale range. Autorangeing applies to all available functions—ac, dc and ohms.

Guarding and Integration

The guarding feature and integrating technique (3461A/3460B combination only) allows accurate measurements to be made where interfering ground loop currents and/or high levels of common-mode and series-mode noise would normally prevent making such measurements.

Frequency range	Specifications
100 Hz - 10 kHz	\pm (0.07% of rdg + 0.01% f.s.)
50 Hz - 20 kHz	\pm (0.09% of rdg + 0.02% f.s.)
20 kHz - 100 kHz	\pm (0.15% of rdg + 0.10% f.s.)

Voltage accuracy temperature coefficient: \pm (0.002% of reading + 0.0006% of full scale)/ $^{\circ}$ C for a temperature of 0 $^{\circ}$ C to +20 $^{\circ}$ C and +30 $^{\circ}$ C to +50 $^{\circ}$ C.

Long-term stability: \pm (0.06% of reading + 0.01% of full scale), 50 Hz to 20 kHz, for a temperature range of +20 $^{\circ}$ C to +30 $^{\circ}$ C and <50% RH for a period of 6 mo.

AC automatic ranging (per range change)

AC fast: 400 ms, 200 Hz to 100 kHz bandwidth.

AC normal: 1.0 s, 50 Hz to 100 kHz bandwidth.

Input characteristics

Front-panel input Impedance: 5 M Ω \pm 0.1% shunted by 40 pF on all ranges.

Rear-panel input Impedance: 5 M Ω \pm 0.1% shunted by 75 pF on all ranges.

Either input may be selected with the front-rear switch on the front panel.

Ohms-to-DC Converter

Ranges: full scale, 1.00000 k Ω , 10.0000 k Ω , 100.000 k Ω , 1.00000 M Ω , and 10.0000 M Ω . Up to 20% overranging on each range. Range selection may be made manually, remotely or automatically when used with the 3460B.

Performance rating

Absolute resistance accuracy: for a temperature range of +20°C to +30°C for a period of 90 days,

Resistance range	Specifications
1.00000 k Ω - 100.000 k Ω	$\pm(0.012\%$ of rdg + 0.004% f.s.)
1.00000 M Ω - 10.0000 M Ω	$\pm(0.016\%$ of rdg + 0.004% f.s.)

Absolute resistance accuracy temperature coefficient: for a temperature range of 0°C to +20°C and +30°C to +50°C,

Resistance range	Specifications
1.00000 k Ω - 100.000 k Ω	$\pm(0.0007\%$ of rdg + 0.0002% f.s.)/ $^{\circ}$ C
1.00000 M Ω - 10.0000 M Ω	$\pm(0.0012\%$ of rdg + 0.0002% f.s.)/ $^{\circ}$ C

Long-term stability: $\pm(0.014\%$ of reading + 0.004% of full scale) for a temperature range of +20°C to +30°C and <50% RH for a period of 6 mo.

Input characteristics: the resistance measurement features a 4-terminal measurement and can be guarded to reduce the effects of common-mode signals. 4-terminal guarded input is also available on rear panel, selected by a Front-Rear switch on the front panel.

DC Preamplifier

Ranges: full scale, ± 0.100000 , ± 1.00000 and ± 10.0000 (preamplifier may be bypassed on the ± 1.00000 and ± 10.0000 V ranges). Up to 20% overranging on each range. Range selection may be made manually, remotely or automatically when used with the 3460B.

Performance rating

Absolute voltage accuracy: for a temperature range of +20°C to +30°C for a period of 90 days.

Range	Specifications
0.1 V	$\pm(0.008\%$ of rdg + 0.003% f.s.)
1.0 V and 10.0 V	$\pm(0.004\%$ of rdg + 0.003% f.s.)

Zero stability: ± 3 μ V with <50% RH.

Noise: 3 μ V p-p maximum.

Absolute voltage accuracy temperature coefficient: for a temperature range of 0°C to +20°C and +30°C to +50°C,

Range	Specifications
0.1 V	$\pm(0.0004\%$ of rdg + 0.0002% f.s.)/ $^{\circ}$ C
1 V and 10 V	$\pm(0.0003\%$ of rdg + 0.0002% f.s.)/ $^{\circ}$ C

Zero stability temperature coefficient: ± 0.1 μ V/ $^{\circ}$ C, 0°C to +50°C.

Long-term stability: for a temperature range of +20°C to +30°C and <50% RH for a period of 6 mo,

Range	Specifications
0.1 V	$\pm(0.016\%$ of rdg + 0.003% f.s.)
1 V and 10 V	$\pm(0.01\%$ of rdg - 0.003% f.s.)

Input characteristics: the input resistance specification applies for either the front or rear-panel input terminals, selected by the Front-Rear switch on the front panel.

Preamplifier mode: always greater than 10^{10} Ω .

Bypass mode: depends upon the range selected on the HP 3460B.

Isolation parameters

Inputs: floated and guarded signal pair. Guard may be operated up to ± 500 V p-p with respect to chassis ground. Voltage applied from low to guard exceeding ± 50 V peak will damage the instrument.

Common-mode rejection: ratio of common-mode signal to resultant superimposed signal: 160 db at dc with 1 k Ω between the low side of the input and the point where the guard is connected; 120 dB at 60 Hz with the same conditions.

Control signals**Function and range selection**

Automatic (when used with the 3460B): pushbutton selector or a switch closure to ground with resistance <100 Ω provides function selection and autorange operation. Time for autorange (per range change).

AC: AC fast—400 ms

AC normal—1 sec

Ohms: 33 ms

Preamplifier: 33 ms

Remote: switch closure to ground with resistance <100 Ω for a period >10 ms selects the function and range desired.

Manual: pushbutton selector.

Output signals

AC: 0.00000 to 1.20000 V dc on all ranges; output resistance, 220 k Ω $\pm 2\%$, calibrated for 10 M Ω load.

Ohms: 0.00000 to 1.20000 V dc (1.00000 k Ω to 1.00000 M Ω ranges); 0.00000 to 12.0000 V dc (10.0000 M Ω range); output resistance, 100 k Ω .

DC preamplifier: 0.00000 to 1.20000 V dc (0.100000V and 1.00000V ranges); 0.00000 to 12.0000 V dc (10.0000V range); output resistance, 100 k Ω when the 3461A is not in the By-pass mode of operation.

Operational features: gold-flashed input terminals; binding posts on front panel or connector on rear panel (high, low, guard for voltage measurements and 4-terminal input for ohms measurements) selected by front-panel switch.

General

Power: 115 or 230 V $\pm 10\%$, 50 to 60 Hz, less than 35 W for standard 3461A.

Dimensions: 16 $\frac{3}{4}$ " wide, 3 $\frac{3}{8}$ " high, 18 $\frac{3}{8}$ " deep (425 x 87 x 477 mm).

Weight: net 24 lbs (10,8 kg); shipping 37 lbs (16,7 kg).

Accessories furnished: HP 11065A Volts Rear Input Cable Assembly; HP 11090A Ohms Rear Input Cable Assembly (only with standard and Option 03 3461A); HP 11091A Output Cable Assembly, terminated end mates with 3460B; HP 11092A Interface Logic Cable Assembly, terminated end mates with 3460B; HP 11093A Remote Control Cable Assembly; Rack Mount Kit, includes 3 printed circuit board extenders, 30 pin, 22 pin and 20 pin.

Accessories available: HP Part No. 5060-0216 Joining Bracket Kit for combining the 3461A and 3460B.

Price: HP 3461A, \$2075 (includes all options).

Option 01: DC Preamplifier, \$1500.

Option 02: AC/DC Converter, \$1300.

Option 03: Ohms/DC Converter-DC Preamplifier, \$1700.

Option 04: AC/DC Converter-DC Preamplifier, \$1800.

**VOLTAGE, CURRENT,
RESISTANCE**



DIGITAL VOLTMETER

DVM resolution, 1 μ V in 1 V, 1 mV in 1000 V
Model H04-3460A

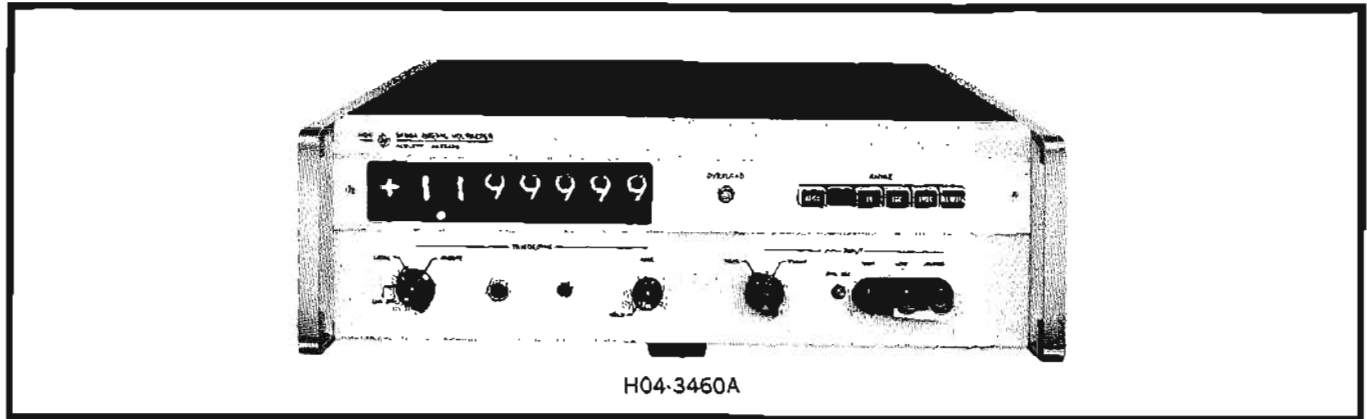

Features

- Resolution: 1 part in 1.2×10^6
- Sensitivity: 1 μ V
- Accuracy: 0.005% of reading
- Guarding reduces the effects of common-mode noise (CMR) by 160 dB at dc
- Four ranges to ± 1000 volts full scale, selected by pushbuttons, automatically or remotely
- 20% overrange capability on all ranges - offering full-scale display within specified accuracy (measures up to 1200 V dc).

Description

The HP Model H04-3460A Potentiometric Integrating Digital Voltmeter is an integrating, guarded digital voltmeter offering high accuracy, resolution, and stability in the presence of noisy signals while retaining a constant input impedance. It offers a resolution of 1 part in 1,200,000—four times more resolution than any other digital voltmeter in its price range. Additionally, the H04-3460A DVM has a sensitivity of 1 μ V and an accuracy of 0.005% of reading or $\pm 0.0005\%$ of full scale. The potentiometric-integrating technique used so successfully in the HP 3460B is also used in the H04-3460A. Using this DVM, measurements from 100 millivolts to 1200 V can be made with better than 0.005% of reading accuracy.

The H04-3460's combination of 1 ppm resolution, high accuracy, constant input impedance, and 20% overranging provide new measurement capabilities. A front-panel zero adjust is provided to compensate for any thermals in connections to external circuitry.

Typical examples where 1 ppm resolution and high accuracy can be used are in semiconductor research and testing and calibration of dc standard power supplies and transfer standards.

Null measurements can be performed with 1 μ V resolution. BCD output capability permits recording of data and remote programmability permits system applications. Transducers and load cell performance can be monitored for incremental changes in their outputs. Accurate determination of Zener diode breakdown voltages as a function of temperature can be made by utilizing the excellent short-term stability of the H04-3460A.

The H04-3460A offers a maximum reading rate of 1.1 seconds/reading on all ranges. The 20% overranging capability on all ranges offers full-scale display within specified accuracy; up to 1200 volts on the 1000 volt range.

Another feature is the constant 10 megohms impedance on all ranges. Four input ranges of 1.000000, 10.00000, 100.0000, and 1000.000 may be selected by front-panel pushbuttons with automatic or remote control left to the option of the operator. The front-panel input terminals are gold-flashed binding posts to reduce thermal electric effects. The front or rear-guarded input terminals may be selected by a front-panel switch. A decimal point is automatically positioned so that the display reads directly in volts. The H04-3460A is fully programmable. Permanent test records of all readings including polarity, decimal location and overload are available by using HP Model 562A printer. The H04-3460A is designed for fully automatic operation with digital acquisition systems.

Programming the H04-3460A

The HP H04-3460A is designed for fully automatic operation within a digital data acquisition system. Voltage range can be selected by external circuit closures to ground.

To simplify system cabling, input connections can also be made at the rear of the instrument. All remote control lines and electrical outputs are referred to chassis ground and do not interfere with the guard.

Recording Output

1-2-4-8* binary-coded decimal voltages (ground referenced) are produced for each measurement and for indication of measurement function, voltage range and polarity. A complete printed record of the HP H04-3460A output information can be obtained by using an HP Model 562A/AR Digital Recorder.

Specifications

Ranges:

Automatic or manual full-scale presentation of ± 1.000000 , ± 10.00000 , ± 100.0000 , and ± 1000.000 (up to 20% overrange indicated with 7th digit). Range selection may be made automatically, remotely or manually.

*1-2-2-4 available with HP H04-3460A Option 01.

Performance rating:

Absolute voltage accuracy.* $\pm 0.005\%$ of reading or $\pm 0.0005\%$ of full scale whichever is greater over a temperature range from $+20^{\circ}\text{C}$ to $+30^{\circ}\text{C}$ for a period of 90 days.

Voltage accuracy temperature coefficient: $\pm 0.0002\%$ of reading/ $^{\circ}\text{C}$ $\pm 0.0001\%$ of full scale/ $^{\circ}\text{C}$ over a temperature range of 0°C to $+50^{\circ}\text{C}$.

Short term stability: $\pm 0.002\%$ of reading or $\pm 0.0004\%$ of full scale, whichever is greater at $23^{\circ}\text{C} \pm 1^{\circ}\text{C}$ and relative humidity up to 50% for a period of 24 hours.

Long term stability:** $\pm 0.008\%$ of reading or $\pm 0.001\%$ of full scale, whichever is greater at $23^{\circ}\text{C} \pm 1^{\circ}\text{C}$ and relative humidity up to 50% for a period of 6 months.

Response time:

On Fixed Range—reads within specified accuracy when triggered coincident with step input voltage.

Reading Period—1.1 s minimum on 1, 10, 100, 1000 volt ranges.

Polarity Selection—No delay.

Automatic Range Selection—60 ms per range change (180 ms maximum).

Remote Range Selection—8 ms.

Isolation parameters:

Inputs: floated and guarded signal pair (special gold-plated binding post on front panel or connector on rear panel are selected by front-panel switch). Guard may be operated up to ± 500 V dc with respect to chassis ground (350 volts rms). Low may be operated up to ± 50 V dc with respect to guard.

Noise rejection: overall effective common mode rejection: 160 dB at all frequencies; common mode rejection: 160 dB at dc, with 1000 ohms between low side of input and the point where guard is connected; superimposed noise rejection: more than 43 dB in the vicinity of 50 Hz increases 20 dB per decade increase in frequency, infinite rejection at frequencies evenly divisible by 1.0.

Input characteristics:

Input resistance: constant 10 megohms $\pm 0.03\%$ all ranges.

Input impedance: 40 pF in parallel with 10 megohms at front panel.

*Relative to the National Bureau of Standards.

**Assumes occasional zero adjust.

Input signals:**Range selection:**

Automatic: pushbutton selector or a switch closure to ground.

Remote: a switch closure to ground (storage).

Manual: pushbutton selector.

External read command: four lines available for remote trigger (two ac and two dc).

Voltmeter reset: switch closure to ground through $< 100\Omega$ assures minimum reading period.

Trigger hold off: hold off level is $+3$ to $+10$ volts with a maximum current of 6.3 mA. (Provided by HP Model 562A Digital Recorder.)

Output signals:

Print command: dc coupled.

BCD outputs: 4-line BCD (1-2-4-8) 9 columns consisting of polarity, overload and decimal location, and 7 digits of data (HP H04-3460A Option 01 is available for 1-2-2-4 BCD).

Operational features:

Input terminals-binding posts on front panel or connector on rear panel (high, low and guard). Selectable by front-panel switch.

Trigger selection: front-panel selection of local or remote. Overload indicator: indicates when input voltage is higher than 120% of range selected.

Sample indicator: indicates when instrument is digitizing.

General

Power: 115 or 230 volts $\pm 10\%$, 50 to 60 Hz. Approximately 60 watts. The HP H04-3460A is available on special order for operation with power line frequencies between 50 and 1000 Hz.

Dimensions: 5" high, 16 $\frac{3}{4}$ " wide, 21 $\frac{3}{8}$ " deep (127 x 425 x 543 mm); rack mount kit furnished with instrument.

Weight: net 38 lbs (16 kg); shipping 43 lbs (19.6 kg).

Accessories furnished:

Rack Mounting Kit includes 3 printed circuit extender boards.

HP 11065A: 6' rear input cable, guarding preserved, terminated end mates with H04-3460A. \$15.

HP 11069A: Remote Control Cable. \$20.

Price: HP H04-3460A, \$4600; Option 01 (1-2-2-4 BCD output), \$4600.

DIGITAL VOLTMETER

Description

Similar to the 3460B (pages 234-235) the HP 3459A provides two readings per second with up to 20% overranging capability on all ranges within specified accuracy. Voltage measurements from ± 0.0001 to ± 1199.99 volts dc are made with an absolute accuracy of $\pm 0.008\%$ of reading $\pm 0.002\%$ of full scale over a temperature range from $+20^{\circ}\text{C}$ to $+30^{\circ}\text{C}$ for a period of 90 days. Voltage accuracy T.C. is $\pm 0.00025\%$ of reading $\pm 0.00015\%$ of full scale/ $^{\circ}\text{C}$ over a temperature range of 0°C to $+50^{\circ}\text{C}$. Three input voltage ranges of 10.00000, 100.000 and 1000.00 full scale can be selected manually by front-panel pushbuttons or automatically.

Price: HP 3459A, \$2975.

Options

01 1-2-2-4 BCD output, add \$140.

02 1-2-4-8 BCD output, add \$140.

Unique new performance at economical price Model 3459A

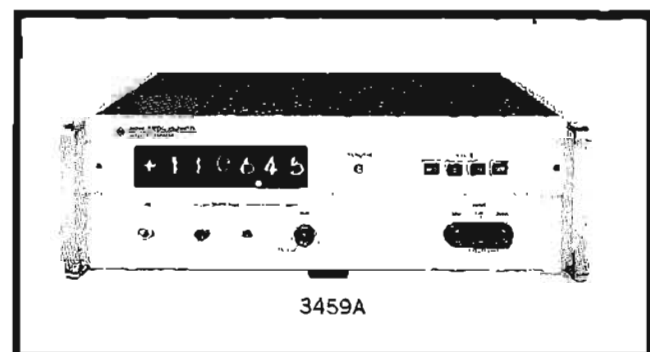

VOLTAGE, CURRENT, RESISTANCE



INTEGRATING DVM

Measurements to 1 μV at rates to 43 per second
Model 2402A

The 2402A Integrating Digital Voltmeter combines 43 measurements per second sampling rate and the precision and measurement flexibility expected from a laboratory instrument with the programming and electrical output features necessary for data acquisition systems use. It achieves high speed and high accuracy at low levels, without preamplifiers.

Special design virtually eliminates errors caused by extraneous noise without imposing any restrictions on the grounding of the signal source, recording device, or programmer, or upon the measuring speed of the instrument. The controls and input/output features of the 2402A are designed to permit maximum versatility of application, yet the instrument is simple and straightforward to use.

High accuracy in a DVM is of little practical value unless this accuracy can be maintained in the presence of noise and under the far from ideal conditions of everyday use. The 2402A is average-reading, which greatly reduces the effects of superimposed noise. A floated and guarded input circuit eliminates common mode noise error. Combined, these techniques yield effective common mode noise rejection greater than 126 dB (2 million to 1) at any frequency, including dc.

By means of active integration, the 2402A reads the average value of the applied voltage over a 1/60 second sample period (provides maximum rejection of superimposed noise at 60 Hz). Alternatively, the 2402A can be equipped to integrate over a 1/50 second sample period for maximum rejection of 50 Hz power line frequency. Since no input filters are employed, it provides both noise rejection capability and the rapid accurate response to step input required for data acquisition system applications. Superimposed noise rejection holds for combined signal plus noise amplitudes to 130% of full scale.

The 2402A also features a guard that completely isolates the floating measuring circuit from the chassis, breaking the common mode loop. To take a practical example of the 2402A

noise rejection, the combined effect of guarding and averaging at 60 Hz is such that a 100V peak-to-peak common mode potential will not cause a discernible error in reading on any range.

The 2402A total measuring time is 23 ms, making possible up to 43 measurements per second. Operated in a data system, it can make as many as 35 to 40 6-digit measurements per second (allowing for program settling and scanner switching times), with resolution to 1 part in 130,000.

Instrument accuracy is commensurate with resolution. For low-level millivolt measurements the 100 mV range has 3 μV $\pm 0.015\%$ rdg accuracy from 0 to 30 mV and 5 μV $\pm 0.01\%$ rdg accuracy from 30 to 100 mV, with ten times the dynamic capability of a 10 mV range.

AC voltages to 750V peak can be measured on four ranges from 1V to 1000V when the 2402A is equipped for optional ac voltage measurement. It is adapted for ac voltage measurement by installation of plug-in ac-to-dc converter and control boards. The converter is average-reading and is calibrated in rms with respect to sinusoidal input. The dc voltage input connectors are also used for ac input. The same guard provides common mode rejection for ac and dc voltage measurements. The overload detection circuit of the basic 2402A protects the ac converter.

Resistance measurements to 13 megohms can be made on five ranges from 1k Ω to 10M Ω when the 2402A is equipped with this option. It is adapted for resistance measurement by installation of plug-in ohms-to-dc converter and control boards and a 4-wire guarded rear panel connector. The converter is installed inside the guard, assuring freedom from common mode effects.

The 2402A may also be equipped for direct frequency measurements to 199.99kHz. Frequency measurement is also a plug-in option.

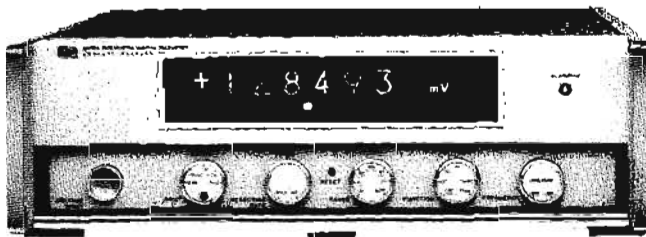

2402A Integrating Digital Voltmeter

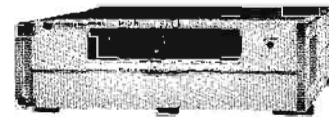

Cover flips up to protect controls in systems use.

(For $\pm 10\%$ line voltage variation and 6 months operation, assuming daily calibration against internal standard after 30-minute warm-up.)

DC voltage measurement

Noise rejection: Overall effective common mode rejection: (ratio of common mode signal to its effect upon readings): 160 dB at dc, decreasing to 126 dB for all frequencies above 30 Hz (infinite rejection cusp gives 168 dB effective cmr at 60 Hz $\pm 15\%$). Overall rejection combines common mode rejection and superimposed noise rejection.

Input circuit: Type: Floated and guarded signal pair. Signal low and guard may be floated up to 500 V above chassis ground with up to 1000 V input signal (maximum low-to-guard voltage is 50 V).

Ranges: 100 mV and 1, 10, 100, and 1000 V full scale selected by front panel switch, external programming or autoranger.

Overranging: to 130% of full scale, except on 1000 V range. Self protected on any range against input voltage to 1000 V. Protective circuits reset automatically for each new reading.

Input Impedance: 10 M Ω $\pm 1\%$ on all ranges is standard. With option, input resistance is greater than 1000 M Ω on 100 mV, 1 V and 10 V ranges; 10 M Ω on 100 and 1000 V ranges.

Internal calibration standard: (independent of measuring circuit). Derived from stabilized reference diode operating in a constant temperature oven; maintain specified accuracy for 6 months. The standard is factory-set at 25°C.

Absolute accuracy: 100 mV range: .01% rdg ± .005% fs or .015% rdg in overrange; 1 V, 10 V, 100 V, 1000 V ranges: .01% rdg ± .003% fs or .013% rdg in overrange. Accuracy from 0 to 30 mV is 3 μV ± .01% rdg; above 30 mV accuracy is as stated above. When calibrated at other than 25 ± 1°C, add .0006% rdg ± .0001% fs per °C difference from 25°C.

Temperature effect per °C change from calibrate temperature: 15 to 40°C: .0015% rdg ± .0006% fs 100 mV range, ± .0015% rdg ± .00015% fs higher ranges; 10 to 15°C or 40 to 50°C: .002% rdg ± .0006% fs 100 mV range; .002% rdg ± .00015% fs higher ranges.

Measurement speed: to 43 measurements per second when triggered externally. Self-triggers at speeds continuously adjustable from 1 measurement every 10 seconds to 10 per second.

Resolution: 1 part in 130,000 on 6-digit display; 100 mV range displays readings to 1 μV.

AC voltage measurement (Option M2)

Common mode rejection: 160 dB at dc, decreasing to 120 dB at 60 Hz and 6 dB per octave for noise frequencies above 60 Hz, with 1 KΩ between low side of source and low side of input.

Input Circuit: Type Floated and guarded signal pair. Signal low and guard may be floated up to 500 V above chassis ground with maximum input voltage applied.

Input voltage limitations: 240 V peak on 1 V range 750 V peak on all other ranges.

Input impedance: 909 kΩ ± 1% shunted by 200 pF (maximum). With option, input resistance is 1 MΩ ± 1%.

AC only operation: Frequency range: 50 Hz to 100 kHz.

Ranges: 1, 10, 100, and 1000 V full scale, selected by front panel switch, external programming or autoranger.

Overranging: to 130% of full scale, except 750 V peak, on 1000 V range.

Accuracy (with respect to standard used for calibration):

SIGNAL FREQUENCY ①	60 Hz		100 Hz		10 kHz		30 kHz		100 kHz	
	%rdg	%fs	%rdg	%fs	%rdg	%fs	%rdg	%fs	%rdg	%fs
ACCURACY ② (at 25 = 1°C)	.09	.05	.06	.03	.06	.03	.09	.05	.14	.09
RIPPLE ERROR ③	.03	-	.02	-	-	-	-	-	-	-
TEMPERATURE EFFECT ④ (Per °C change in ambient from 25°C, over 10 to 50°C range)	.004	.003	.004	.003	.004	.003	.007	.003	.013	.003

- ① Straight line Interpolation holds for frequencies between points.
- ② Does not include .02% rdg maximum response error, applicable only to step input (received from data system signal scanner); also see response time and measurement speed, below.
- ③ Ripple error decreases 18 dB per octave above 85 Hz, is zero at 60 Hz because of superimposed noise rejection of basic instrument.
- ④ Assumes calibration of 2402A against internal standard at 25°C ambient. Calibration of 2402A at operating temperature decreases % rdg temperature effect .0009%.

AC on DC operation: maximum dc component: ±200 V on any range.

Ranging: must start from 1000 V range, proceeds to lower range as required.

Peak input: ac plus dc to 100% of full scale, except 750 V peak maximum on 1000 V range.

Response time and measurement speed: internal 150 ms nominal settling delay (adjustable) for dc output of ac converter to reach .02% of final value following step input from system scanner before measurement starts. Total measurement time permits 1.9 measurements per second. Self-triggered measurement rate adjustable from 1 measurement every 10 seconds to 1.6 per second.

Resolution: 1 part in 130,000 on 6-digit display; 10 μV on 1 V range.

Resistance measurement (Option M3)

Noise rejection: measurement circuit enclosed in same guard as dc circuit, reducing effect of ac common mode noise when guard is connected to low side of test resistance. Double-shielded cable extends guard to test resistance.

Input circuit: guarded, modified four-terminal circuit; unknown resistor can be either grounded or floating.

Ranges: 1 kΩ, 10 kΩ, 100 kΩ, 1 MΩ, and 10 MΩ full scale, selected by front panel switch, external programming or optional autoranger.

Overranging: to 130% of full scale. Self-protected on all ranges against up to 150 V.

Absolute accuracy:

Resistance range	1 kΩ	10 kΩ	100 kΩ	1 MΩ	10 MΩ
Measurement current	1 mA	1 mA	100 μA	10 μA	1 μA
Accuracy at 25°C	% rdg	% fs	.01% rdg = .005% fs		% rdg
	.01	.01			.02
Temperature effect ①	.004% rdg = .002% fs per °C difference of ambient with respect to 25°C over 10 to 50°C range				

① Calibration of 2402A against internal standard at operating temperature decreases % rdg temperature effect .0009% per °C, to .0031% rdg per °C.

Response time and measurement speed: at least 8 externally triggered readings per second. Self-triggered measurement rate is adjustable from 1 measurement every 10 seconds to 4.5 per second.

Resolution: 1 part in 130,000; .01Ω on 1 kΩ range.

Frequency measurement (Option M5)

Frequency range: 5 Hz at 199,999 kHz.

Gate time: 1 second; provides 1 Hz resolution.

Accuracy: (± 1 count ± 1 time base stability): time base aging rate: 2 ppm per week over 20 to 30°C; time base temperature effect: 100 ppm over range 10 to 50°C.

Input

Amplitude range: .1 to 100 V rms.

Pulse or square wave input: negative 1 to 100 V amplitude, 2 μs minimum duration, 50% maximum duty cycle.

Impedance: 1 MΩ shunted by 150 pF.

Maximum voltage: 150 V peak dc plus ac or pulse).

Autorange (Option M1)

Range selection: DC voltage ranges; each time autoranger is programmed, it starts on 1 V range to take advantage of fast up-ranging. While autoranging is continuously programmed, autoranger starts at range selected for previous reading, sequences to higher or lower range as required. AC voltage ranges; autoranger starts at range selected for previous reading, sequences to higher or lower range as required. Up-ranges at 110% of full scale, down-ranges at 10.2%.

General

Display and system interface: 6-digit display, BCD output and program inputs. Polarity, decimal, measurement units, calibration, and overload conditions indicated automatically and included in output as function and decimal digits.

Operating conditions: specifications apply for ambient temperatures 10 to 50°C, relative humidity to 90% at 40°C, altitude to 15,000 feet.

Power: 115 or 230 V ± 10%, 50 to 60 Hz, 150 W.

Dimensions: 16¾" wide, 5¼" high, 19½" deep behind panel (425 x 133 x 494 mm); hardware furnished for 15" wide rack mount.

Weight: net 49 lbs (22.3 kg); shipping 56 lbs (25.4 kg).

Price: 2402A for DC measurements, \$4800; AC adds \$450; resistance adds \$750; frequency adds \$350; autoranging adds \$250.

VOLTAGE, CURRENT, RESISTANCE



INTEGRATING DVM

Precise measurements despite severe noise
Model 2401C

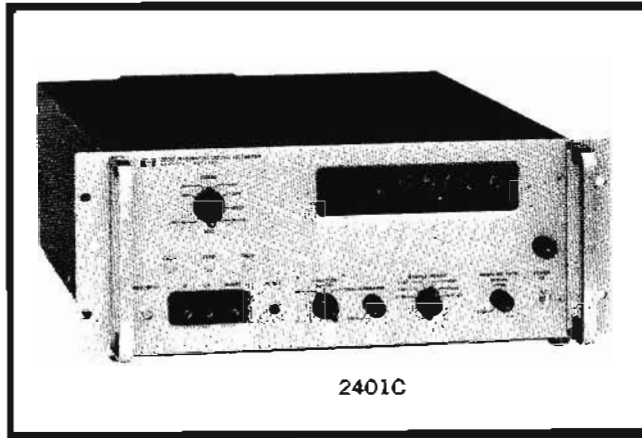

2401C

The 2401C Integrating Digital Voltmeter combines the precision and measurement flexibility of a laboratory instrument with the programming and electrical output features necessary for systems use.

Design features virtually eliminate measurement errors due to extraneous noise superimposed on the signal, without restriction on grounding of the signal source, recorder, or programming device. Signals as small as a few per cent of full scale can be accurately measured even in the presence of noise approaching three times full scale. Controls and input/output

The 2401C measures the average value of the applied voltage over one of three fixed crystal-controlled sample periods. Reversing counter circuits permit signals to be integrated around zero with full instrument accuracy. The 6-place display ensures that resolution will not limit a reading.

Operation of the optional auto-ranger is extremely fast—34 msec maximum range change time. The 2401C with auto-ranging finds excellent application at high sampling rates with varying input signals and at rapid scanning rates when employed in multi-channel systems with widely varying signal levels. The auto-ranger also will select proper range of optional preamp and ac/ohms converter at reduced ranging speeds.

The 2401C is designed for fully automatic operation within a digital data acquisition system. Measurement function, voltage range, sample period, sampling rate and integration interval all can be selected by external circuit closures to ground. While the measurement circuit of the 2401C is guarded, all remote control lines and electrical outputs are referred to chassis ground and do not interfere with the guard. BCD signals for use with output recorders are produced for each measured digit, for measurement function, voltage range and polarity.

AC/Ohms measurement

The Model 2410B AC/Ohms Converter enables ac voltages and resistances to be measured with the 2401C and 3460A Digital Voltmeters. AC voltages up to 750 V peak and resistances up to 10^7 ohms are converted to proportional dc voltages between 0 and 1 volt. Optionally, either the ac voltage or resistance converter section may be omitted from the 2410B.

Guarded data amplifier

The 2411A/2401C combination offers a full scale input range of 10 mV with overranging to 30 mV, ideal for measuring outputs of sources such as thermocouples and strain gages. The low zero drift and noise contributed allow excellent accuracy to be obtained in low-level measurements.

Specifications, 2401C

DC voltage measurements, noise rejection: overall effective common mode rejection: 140 dB at all frequencies 160 dB at dc (0.1 second sample period); superimposed noise rejection; more than 20 dB at 55 Hz for 0.1 second sample period, increases 20 dB per decade increase in frequency, infinite rejection at frequencies evenly divisible by 10.

Input circuit: type: floated and guarded signal pair, may be operated up to 500 V above chassis ground; ranges: 5 from 0.1 to 1000 V f.s., selection by front-panel switch or remote circuit closure to ground, polarity sensed automatically; overranging: to 300% f.s. except 1000 V range; overload: range automatically switched to 1000 V at 310% f.s., reset by next read command; input impedance: 10 M Ω on 10, 100, 1000 V ranges, 1 M Ω on 1 V range, 100 k Ω on 0.1 V range, <150 pF on all ranges.

Accuracy: 0.01% of reading \pm 0.005% f.s. \pm 1 digit at 25°C; temperature coefficient 0.001% of reading per °C, 10 to 40°C.

Internal calibration source: \pm 1 V standard for self-calibration; stability \pm 0.006% per 6 months at 25°C, temperature coefficient +0.001% per °C; reference derived from specially selected temperature-stabilized zener diode.

Measurement speed: fixed sample periods of 0.01, 0.1 or 1 s selected by front-panel switch or remote circuit closure to ground.

Resolution: depends on sample period; max. 1 μ V per digit.

Auto-ranger (optional) voltage ranges: automatically selects range from 5 input ranges of standard instrument (0.1 V to 1000 V f.s.) also selects appropriate gain setting (X1 to X10) when 2401C is used with 2411A Amplifier; 34 ms max. range change time.

DC voltage integration: input signal is integrated over selected sample period; using fixed sample period, integral is average of input.

Frequency measurements

Range: 5 Hz to 300 kHz optionally to 1.2 MHz, gate time 0.01, 0.1, 1 sec. or manual; accuracy: \pm 1 count \pm time base accuracy; time base: stability at constant temperature (\pm °C) is \pm 2/10⁶/week, temperature effect \pm 100/10⁶ over-range 10 to 50°C, provisions for external time base; display time: variable from 0.2 to 7 sec, or held until reset; input sensitivity: 0.1 to 100 V rms; impedance: 1 M Ω shunted by 150 pF.

Period measurements

Ranges: 1, 10, and 100 periods; 5 Hz to 10 kHz; display is directly in ms; resolution referred to single period: 1 period, 100 μ s; 10 periods, 10 μ s; 100 periods, 1 μ s; accuracy is \pm 1 count \pm time base accuracy \pm trigger error divided by number of periods. Sensitivity and impedance same as frequency measurements.

General

Display: 6 digit in-line digital-tube readout; polarity, decimal point, function and overload condition indicated automatically.

Recording outputs: BCD output provided for function and polarity, 1 digit; data, 6 digits; decimal point, 1 digit.

External programming: may be completely programmed by external circuit closures to ground.

Operating conditions: specifications apply for ambient temperatures 10 to 50°C, relative humidity to 95% at 40°C.

Power: 115 or 230 V \pm 10%, 50 to 60 Hz, 150 W.

Dimensions: 19" wide, 7" high, 18 $\frac{3}{8}$ " deep behind front panel (483 x 177 x 467 mm).

Weight: net, 48 lbs (22 kg); shipping, 70 lbs (33.5 kg).

Price: 2401C, \$4100.

V-TO-F CONVERTER

Accurate bipolar, low-level dc V-to-F conversion
Model 2212A



**VOLTAGE, CURRENT,
RESISTANCE**

The HP 2212A is a compact V-to-F converter which is particularly well suited to low-level signal applications. Low input drift and high common mode rejection (120 dB at 60 Hz) have been achieved without a chopper by means of differential circuits. Internal feedback circuits provide an output pulse train with a pulse rate directly proportional to the magnitude of an applied dc voltage. The output pulse rate rises linearly and instantaneously from 0 to 100,000 pulses per second as the dc input level is increased from zero to full scale. These techniques combine to provide outstanding linearity, stability and noise immunity.

The output of the HP 2212A, when connected to a Hewlett-Packard electronic counter provides a convenient method of making digital measurements of dc voltages. The converter also provides a polarity signal. This converter-counter combination can be connected directly to a digital printer or through output couplers to digital recording devices. Computer processing or

storage on punched card, punched tape or magnetic tape can then be accomplished.

The converter-counter combination provides integration of dc voltages over any period of time and can therefore be used to read the average of the input over the selected sample period and provide accurate dc measurements in the presence of noise superimposed on the signal. The instrument is applicable, for example, to high-accuracy FM telemetry systems, gas chromatographs, and wide-range coulometric analysis.

The unique modular package with self-contained power supply allows the 2212A to be used in both bench and systems applications. An inexpensive combining case is available to mount 10 instruments side-by-side in only 5¼" of standard 19" rack panel space.

Other V-to-F converters are available from HP to satisfy a variety of speed, accuracy and resolution requirements. Ask for information on the 2210.

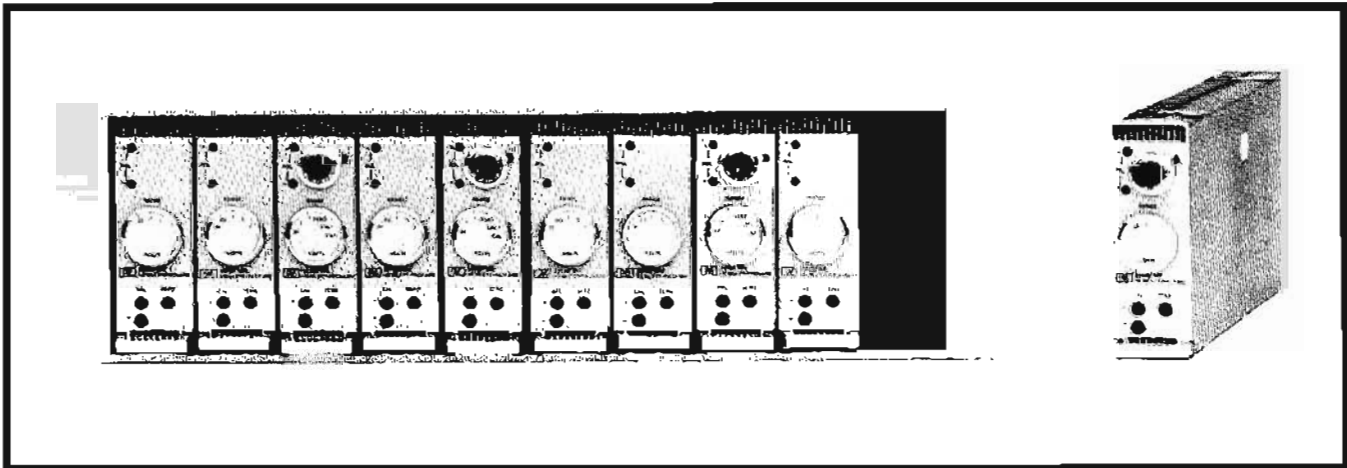

Specifications

(All specifications apply after a 30-minute warm-up in combining case at 25°C ambient, 1 k ohm source resistance, any unbalance. Warm-up period in free air is 1½ hrs.)

Input: dc voltage ranges: 0 to 10 mV, 100 mV, 1 V; up to 250% overranging; optionally 0 to 10 mV, 30 mV, 100 mV, 300 mV, 1 V; other ranges between 10 mV and 1 V available, up to 6 positions; optional vernier to X3.5 range setting.

Range accuracy: (relative to calibrated range): ±0.02% of reading at 25°C ±0.005% per month.

Scale factor: stability at constant temperature: ±0.02% of reading per day; temperature coefficient: ±0.004% of reading per degree C, from 10° to 40°C.

Zero: (referred to input): stability at constant temperature: ±5 μV ±0.5 nA ±0.01% of full scale per day; temperature coefficient: ±1 μV ±0.5 nA/°C ±0.002% of full scale per degree C.

Linearity: ±0.01% of full scale referred to a straight line through 0 and full scale.

Input impedance: 10⁶ ohms min. shunted by 0.001 μF max.

Maximum input signal: ±11 V signal + common-mode.

Common-mode rejection: 120 dB, dc to 60 Hz.

Settling time: 100 μs to within 0.01% of final pulse rate.

Slewing: 10⁶ V/s rti, for less than 0.1% dc offset.

Overload recovery: settling time +100 μs for differential inputs of 10 times full scale or less, less than 5 millisecc for inputs up to 20 V.

Output: pulse train, 0 to 10⁵ pps full scale; overrange to 2.5 x 10⁵ pps; -9 V, 2 μs pulses.

Polarity signal: electrical and visual indication.

Operating conditions: 0 to 55°C ambient temperature range, up to 95% relative humidity at 40°C.

Power: 115 or 230 V ±10%, 50 to 400 Hz, 9 W.

Dimensions: 1-9/16" wide, 4 7/8" high, 15" deep (39.7 x 123.8 x 381 mm).

Weight: net 4 lbs (1,8 kg); shipping 6½ lbs (2,9 kg).

Accessories available: combining case contains up to 10 instruments in 5¼" of standard 19" rack space (mating connectors furnished with amplifier); bench stand, holds one VFC upright and includes input/output connectors, power switch, pilot light, power cord; mating rear connector with power cord, input/output cables.

Optional modifications: special voltage ranges; internal calibration source; vernier range adjust.

Price: HP 2212A, \$995.

**VOLTAGE, CURRENT,
RESISTANCE**



AC TO DC CONVERTERS

Economical AC to DC converters
Models 457A, 400E, 3400A

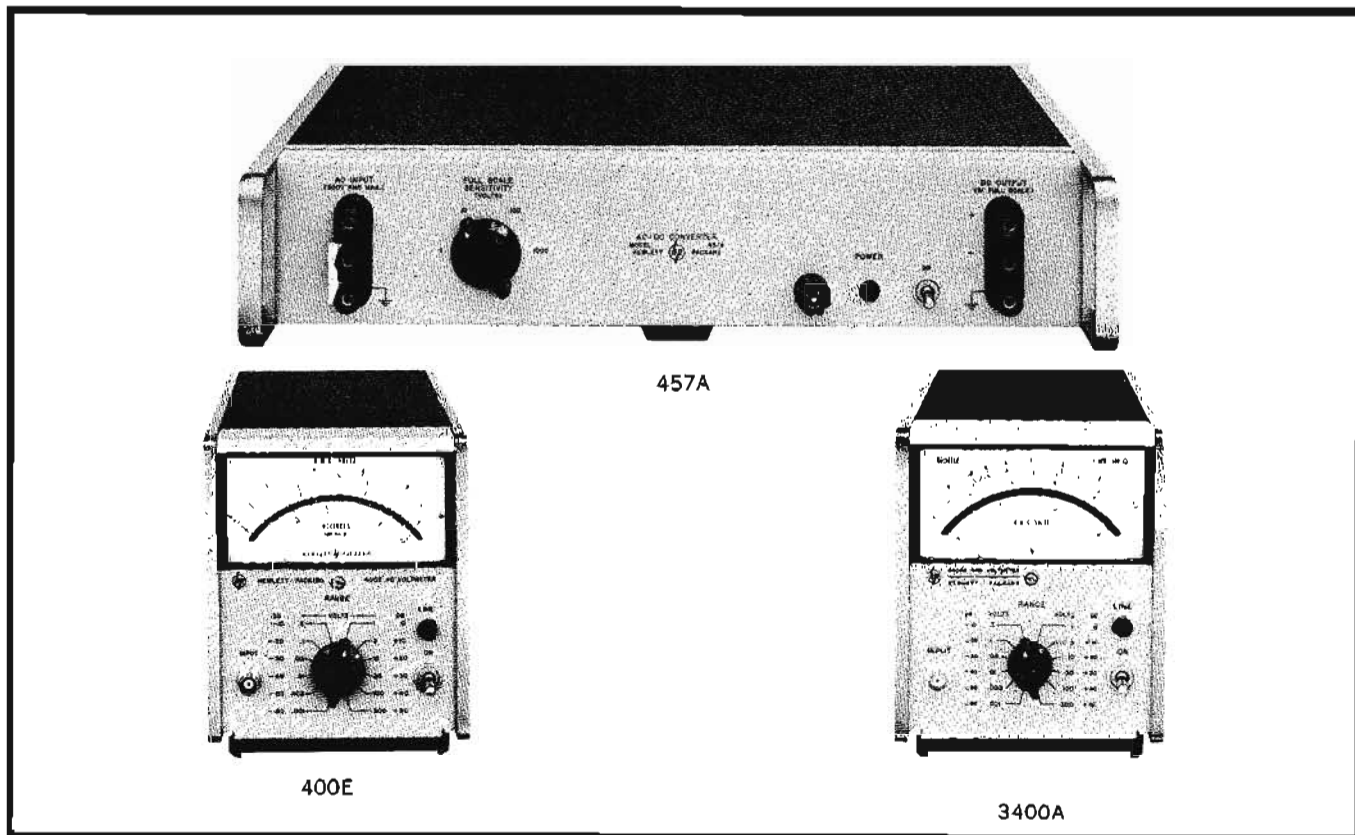

Model 457A is an average-responding, rms calibrated ac-to-dc converter. Thus, a one-volt rms sine wave input provides a one-volt dc output.

A frequency range from 50 Hz to 500 kHz is covered with conversion accuracy of $\pm 1 \text{ mV} \pm 0.75\%$ of full scale; from 50 Hz to 50 kHz, accuracy is $\pm 1 \text{ mV} \pm 0.3\%$ of full scale.

Specifications, 457A

Input range: $100 \mu\text{V}$ to 300 V rms, in 4 decade ranges corresponding to 1, 10, 100 and 1000 V rms full scale; over-ranging to 200% of full scale, all ranges except 1000 V.

Frequency range: 50 Hz to 500 kHz.

Accuracy: $\pm 0.3\% \pm 1 \text{ mV}$ from 50 Hz to 50 kHz; $\pm 0.75\% \pm 1 \text{ mV}$ from 50 kHz to 500 kHz.

Floating Input: permits measurement of ac voltages at dc potentials of $\pm 500 \text{ V}$ above power-line ground.

Output: 0 to 1 Vdc, responding to average value of ac input, with output calibrated as rms value of sine wave; input step attenuation of 1, 10, 100 or 1000.

Output Impedance: 10,000 ohms.

Input impedance: 1 megohm, shunted by 30 pF.

Power: 115 or 230 V $\pm 10\%$, 50 to 1000 Hz, approx. 31 W.

Dimensions: $16\frac{3}{4}$ " wide, $3\frac{3}{4}$ " high, $13\frac{3}{4}$ " deep (426 x 95 x 324 mm).

Weight: net 12 lbs (5.4 kg); shipping 20 lbs (9 kg).

Accessories available: 1110A Current Probe, \$100; 10100B Feed-Through Termination, \$18; 11000A Cable, \$5; 11001A Cable, \$6.

Price: HP 457A, \$450.

Two Hewlett-Packard analog voltmeters provide a dc output voltage that is directly proportional to the meter current and may be used as ac-to-dc converters. By connecting a dc digital voltmeter to the dc output of these instruments, an economical ac digital voltmeter is available. The output voltage of the HP 400E/EL and 3400A is 1 V dc for full-scale deflection.

The HP 3400A may be used as a true rms ac/dc converter. Typical dc output accuracy is $\pm 0.75\%$ of full scale from 50 Hz to 1 MHz. For additional information, refer to page 208.

The 400E/EL may be used with 0.5% accuracy as an ac/dc converter in its frequency range from 100 Hz to 500 kHz. For complete specifications, refer to page 204.

AC/DC Converter Output

400E/EL output: 1 V dc at full-scale deflection, proportional to meter deflection (linear output for Models 400E/EL).

Output resistance: 1000 ohms.

Response time: 1 second to within 1% of final value for a step change.

Price: HP 400E, \$310; HP 400EL, \$320.

3400A output: -1 V dc at full-scale deflection, proportional to meter deflection (from 10 - 100% of full scale).

Output resistance: 1000 ohms.

Price: HP 3400A, \$525.

IMPEDANCE AND PHASE MEASUREMENTS



IMPEDANCE

Impedance measurements are concerned with the magnitude and the nature of the opposition of a component or network to the flow of ac current. Not only is a measure of the total opposition to current flow desired, but it is also important to determine the ratio of reactance to resistance and whether the reactance is inductive or capacitive.

At frequencies below 100 MHz, these qualities are most easily determined by measuring the voltage resulting from the flow of a known ac current into the component or network under test. The voltage amplitude indicates the absolute value of the impedance.

The nature of the reactance can be determined by comparing the phase difference between the current and voltage waveforms at the point of measurement. With the magnitude and phase angle θ thus determined, the ratio of reactance X to resistance R and whether the reactance is inductive or capacitive can be determined (see diagram Fig. 1).

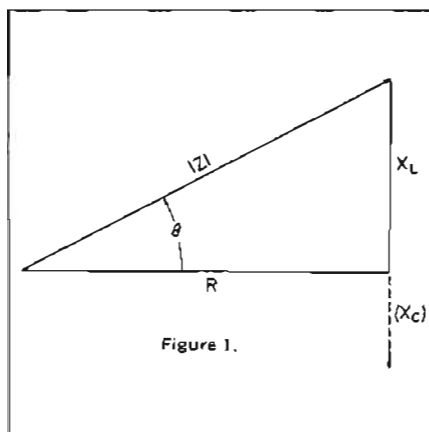

Figure 1.

Such measurements must be made at several frequencies if the component or network is to be fully characterized.

In the past, measurements of impedance at RF frequencies and above required several pieces of test equipment and were time-consuming, requiring many steps to acquire the desired information at each discrete frequency. Recently developed instruments from Hewlett-Packard, however, have greatly simplified the measurement of impedance over a broad range of frequencies. With these instruments, it is possible to make sweep frequency plots of the absolute value of impedance $|Z|$ and phase angle (θ) vs. frequency and in so doing acquire complete coverage within the frequency band of interest.

At frequencies above 100 MHz it becomes more practical to determine impedance by measuring the reflection of an incident signal applied to the device in a coaxial system. Hewlett-Packard has developed Vector Voltmeters and Network Analyzers which make this measurement over a broad range of frequencies, as well as making several other important measurements of interest to the design engineer.

Vector impedance meters

Direct readout of $|Z|$ and θ are presented on adjacent meters by the remarkable new HP 4800A Vector Impedance

Meter, an internal LC oscillator supplies a low-level excitation signal to the circuit under test through a convenient probe attached to a 5-foot cable. A sampling AGC loop maintains the excitation constant at 4 microamps. At the same time, the voltage response of the test circuit is sensed and converted by a second sampling channel, located within the same probe, to read out directly in impedance. A phase detector monitors the difference between the voltage and current channels to yield the phase angle of the impedance vector. One probe, both excites the test circuit and measures its impedance and phase angle.

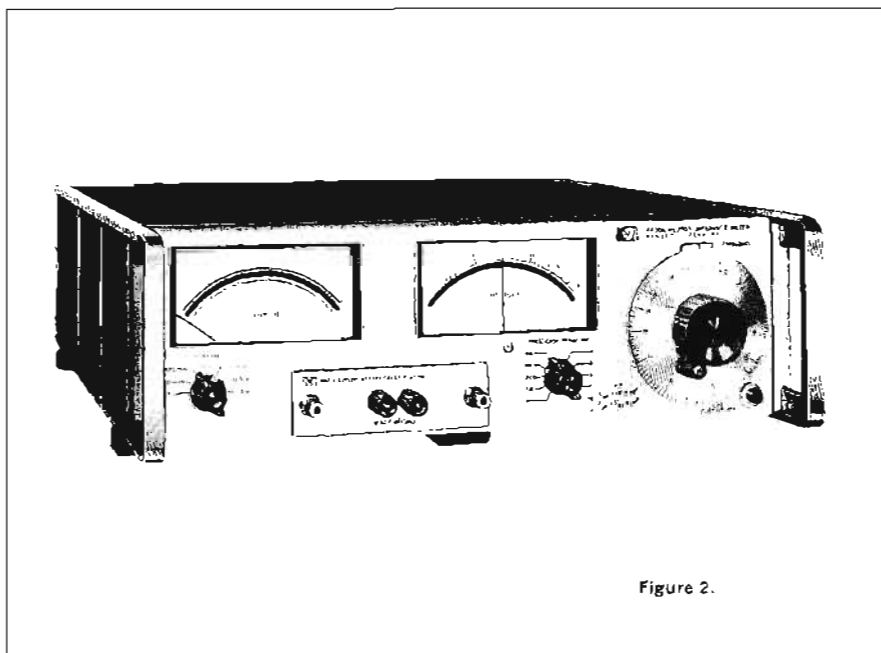

Figure 2.

Meter and the HP 4815A RF Vector Impedance Meter.

The 4800A (Fig. 2) which operates in a frequency range from 5 Hz to 500 kHz, requires only that frequency (and range) be selected; the unknown is connected across front-panel terminals. The magnitude of Z is read in ohms directly on one meter, while the second meter, centered on zero, indicates phase angle and, by needle deflection, whether the reactance is capacitive or inductive.

Outputs at the rear provide dc analog signals proportional to meter deflections for Z , θ , and frequency for convenient recording. The operating range of the Model 4800A is 1 ohm to 10 megohms, $\pm 90^\circ$ phase angle.

Operating range of the 4815A is 500 kHz to 108 MHz, 1 to 100,000 ohms, 0 to 360° phase angle.

The 4815A provides all of the convenience of "probe and read" measurements. In use, the probe is connected directly into the circuit to be evaluated, frequency is selected, and complex impedance is read. This method allows a straightforward adaptation to various jigs and fixtures for special measurements.

Where only component values are to be determined, a quick-mount adapter is provided to allow rapid measurements. For critical component applications, the unit to be evaluated may be mounted directly in its working circuit and its

value determined in its actual environment, at the frequency of interest.

Analog output of frequency, magnitude, and phase angle are provided so that these values may be recorded on an X-Y recorder.

Vector voltmeters and network analyzers

Vector Voltmeters measure the amplitude of a signal at two points in a circuit and simultaneously measure the phase difference between the voltage waveforms at the two points. The HP Network Analyzer is similar to the HP Vector Voltmeter in principle but presents the information in the form of gain or loss between the two points, as well as presenting the phase angle.

The Vector Voltmeters/Network Analyzers can be used for a wide variety of measurements, measurements which formerly were difficult and time-consuming in the frequency ranges in which these instruments operate (to 12.4 GHz). Since these instruments can measure the amplitude of a signal at two different points while simultaneously measuring the phase difference between the signals at these points, they are highly useful for making measurements of amplifier gain and phase shift, complex insertion loss, filter transfer functions, two-port network parameters, and many others.

Because signals at UHF and higher frequencies are almost always transferred from point to point on uniform transmission lines, it is entirely practical to use the Vector Voltmeters/Network Analyzers for measuring impedance by determination of the reflection coefficient of a network. This measurement is made using a dual directional coupler to permit measurement of the incident and reflected waves. The reflection coefficient ρ then gives the magnitude of the input impedance Z to the device by using the well-known formula:

$$Z = \frac{1 + \rho}{1 - \rho} Z_0$$

where Z_0 is the characteristic impedance of the transmission line. The value of magnitude thus provided and the phase angle measured with respect to a reference are then entered into a Smith chart to determine the complex impedance. The HP Network Analyzer system is capable of presenting this information directly as electron beam deflection in a CRT that has a Smith chart overlay for direct readout of impedance.

The Model 8405A Vector Voltmeter is a dual-channel RF millivolt meter and phase meter. It reads the absolute voltages on either of two channels and simultaneously determines the phase relation between them. Its frequency range is 1 to 1000 MHz.

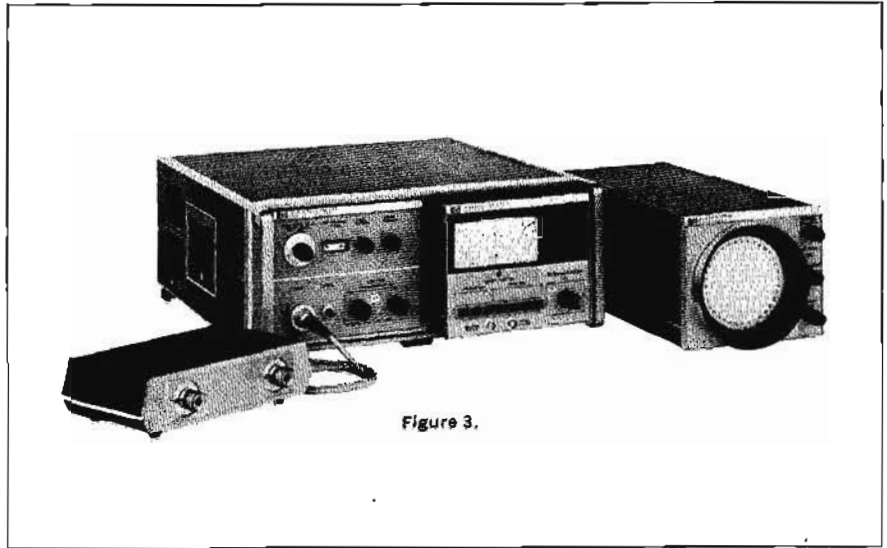

Figure 3.

The Model 8410A Network Analyzer (Fig. 3), and its associated display plug-ins and accessories, also measures magnitude and phase relation between two channels but does so over a frequency range of 100 to 12,400 MHz. It has the capability of displaying these parameters over any octave range between 100 and 12,400 MHz even when swept at a speed as fast as 10 milliseconds.

Plug-in display units for the 8410A provide for measurement of the ratio difference between two channels directly in decibel units, and also the phase shift between these two channels. Readout is direct on a meter face or from output jacks calibrated in units of dB/volt and degrees/volt. The output jacks can be connected to an oscilloscope for a direct visual display of these parameters versus frequency.

Another plug-in display unit has a cathode-ray tube with appropriate polar conversion circuitry to convert the magnitude and phase information to polar coordinates for display on the CRT. A Smith chart overlay is provided for automatically displaying impedance over a wide frequency range.

The 8405A and 8410A are compact instruments housed in standard Hewlett-Packard module cabinets only 7 inches high. This small size has been realized

by the use of sampling techniques which convert RF or microwave frequencies to a lower intermediate frequency. The very wide frequency ranges of these two instruments have also been made possible because of this sampling technique.

These instruments use an automatic phase lock tuning system so that the instruments need only a semi-manual, non-critical adjustment for tuning. Manual tuning of the 8405A consists of selecting any of the 21 overlapping ranges which encompass the input signal frequency; the automatic tuning system then locks to the signal within 10 milliseconds. A front panel light indicates when the unit is locked and operating. Frequencies outside an octave range can be quickly locked in by a quick twist of a knob.

Essentially the same technique is used for the 8410A. A front panel meter indicates the proper position of the coarse frequency control when the unit has automatically locked to the band of frequencies to which the 8410A has been coarsely tuned.

The phase and amplitude measurements are easily read on meters, or, in the case of the 8410 Swept System, directly in calibrated parameters on an oscilloscope face.

From 1 to 1000 MHz the 8405A is con-

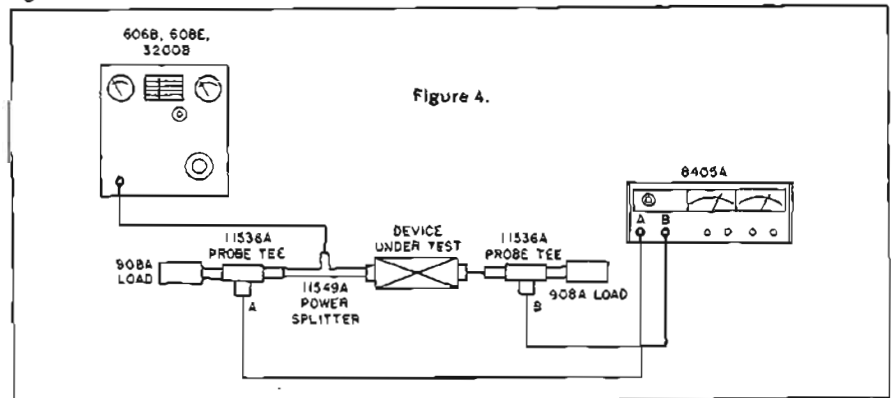

Figure 4.

venient for measuring the phase shift between any two ports. Figure 4 is a block diagram showing the setup of the instrument for this measurement. The setup is first calibrated for a phase reference of 0 degrees by connecting the probe tee of Channel B to the power splitter. Then the device under test is placed between the two components and phase relation is read directly on the phase meter of the

8410A Network Analyzer. With this instrument, measurements can be made on a swept-frequency basis for a visual oscilloscope or X-Y recorder display.

Figure 5 shows a block diagram of a laboratory setup for a typical phase measurement. An accessory transmission unit, the 8740A, is a combination power splitter and line stretcher. Initial calibration is performed by connecting both out-

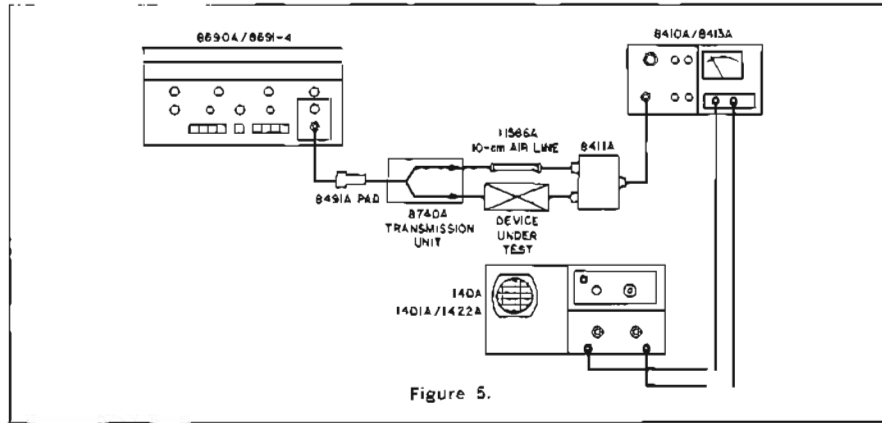

Figure 5.

8405A. Any frequency between 1 and 1000 MHz can now be quickly inserted into the device and the reading made within seconds. Absolute voltage will be read directly on Channel A and B and the calculation of gain or loss can be

puts of the 8740A transmission unit directly into the 8411A Harmonic Frequency Converter. A phase reference of 0 degrees is set on the 8413A Phase-Gain Indicator. The device under test is then placed in the test channel output of the

Impedance

Impedance measurements with these two models are also very easy to make. From 1 to 1000 MHz the Vector Voltmeter can be used as shown in the setups in Figures 7 and 8. In Figure 7, the measurement is made by using probes to sample both the incident and reflected voltages from the device under test. Probe A will sample the incident voltage and probe B the incident plus reflected voltages. The transformation to impedance from reflection coefficient can be made using $Z/Z_0 = \frac{1 + \rho}{1 - \rho}$. The measured data on Channels B and A can be entered on a Smith Chart to read impedance directly. A special slide rule is available from Hewlett-Packard to transfer the vector $1 + \rho$, which is measured on Channel B, directly onto the Smith Chart.

Between 100 MHz and 1 GHz, impedance measurements can be made by measuring reflection coefficient directly from a dual directional coupler.

Channel A measures the incident voltage and Channel B measures reflected voltage from the device under test. Reflection coefficient is the measurement of $\frac{B}{A}$ in magnitude; phase is read directly on the phase meter. The system is first

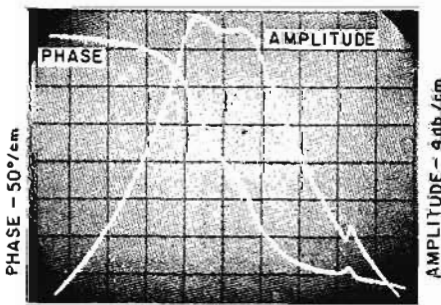

Figure 6

quickly made.

The phase meter has ranges of ± 180 , ± 60 , ± 18 , and ± 6 degrees. A meter offset switch from 0 to ± 180 degrees in precise 10 degree steps allows any angle to be read within 6 degrees on the highest sensitivity range. Thus a resolution of 0.1 degree on the meter is achieved for any angle.

Measurements of phase shift from 110 to 12,400 MHz can be made with the

8740A and the measurement of phase is made directly on the phase indicator or on a swept display basis on an oscilloscope.

Figure 6 shows an oscillogram of the phase shift through a YIG filter, as measured with the system in Figure 5. RF sweep oscillators are also available from Hewlett-Packard to cover the frequency range from 1 to 12.4 GHz. These are the models 8690A Sweep Oscillator with RF plug-ins, 8691 through 8694.

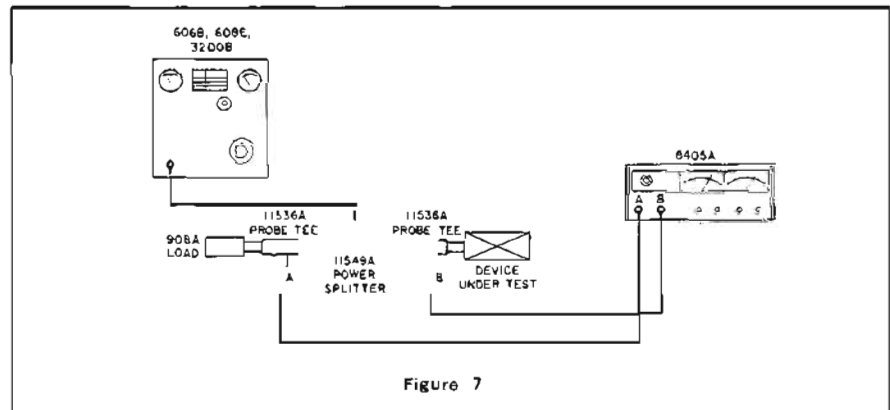

Figure 7

calibrated with a short which sets up a reference reflection coefficient of $1 \angle -180^\circ$. The magnitude and phase of the reflection coefficient of the unknown is then read. This can be plotted on the Smith Chart so that impedance may be read directly.

An example of such a measurement is shown in Figure 9. The magnitude is struck off as a vector originating from the center of the Smith Chart. The angle measured on the phase meter is entered

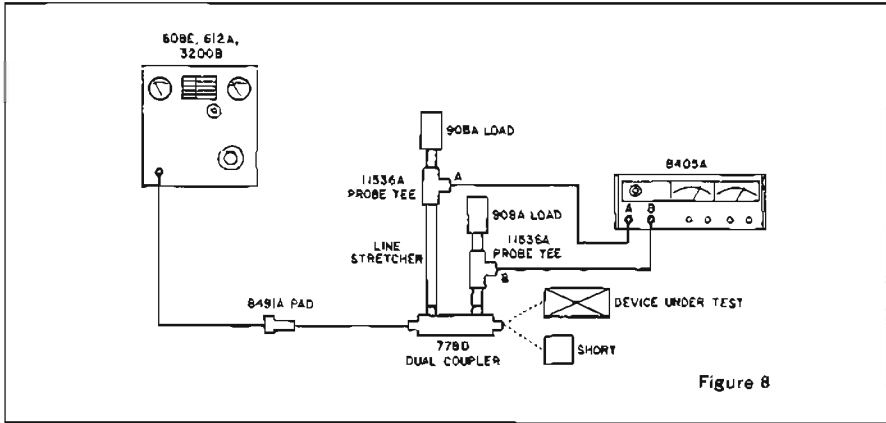

Figure 8

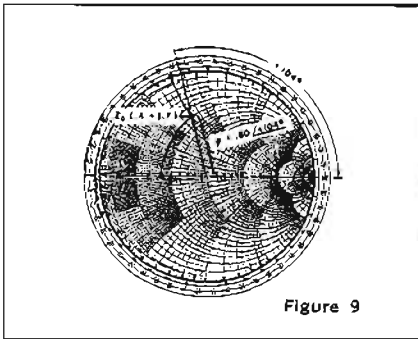
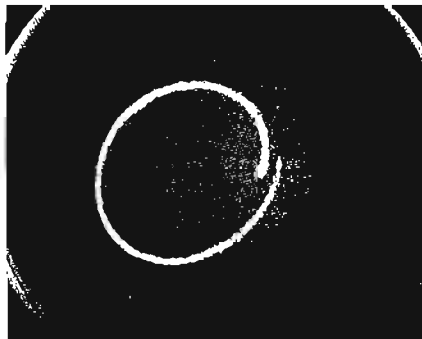

Figure 9



directly on the degree scale on the perimeter of the Smith Chart.

Impedance measurements from 100 MHz to 12,400 MHz are measured automatically on a cathode-ray tube. Figure 11 shows a block diagram and a photo using the 8410A Network Analyzer for this purpose. Two units (Models 8741A, 8742A) are available for measuring the reflection coefficient of a device with this system. They cover the range of 0.11 to 12.4 GHz. Again, the reflection coefficient of the device is measured and then converted to a polar display so that it can be read directly on the face of a cathode ray tube in these coordinates. A Smith Chart overlay for the 8414A Polar Display unit allows impedance to be read directly as the frequency is swept. Figure 10 is a typical swept-frequency plot of impedance.

Characterizing Microwave Devices

Both the 8405A Vector Voltmeter and the 8410A Network Analyzer are ideally suited for determining the properties of linear two-port networks; the 8405A is used at fixed frequencies below 1 GHz, and the 8410A is used in conjunction with a swept source at up to X-band.

The characterization of two-port networks using the common *h*, *y*, or *z* parameters becomes progressively more difficult as frequency is increased above 100 MHz. At these frequencies, the required open and short circuits are increasingly difficult to achieve, if not impossible, even using tuning stubs. Stability can also become a problem. Swept-frequency measurements over wide frequency bands are not practical unless a set of parameters can be chosen that refers the measurements to the characteristic impedance of a transmission line. Such a technique is now available, and the standard configurations of the network-analysis instruments discussed above and on the following pages can be employed in its practice. It involves the use of broadband resistive terminations instead of shorts, opens and tuned stubs. It looks at the waves propagated on the transmission line instead of the voltages and currents present at inaccessible terminals. The method employs the scattering, or "s" parameters, which characterize a network in terms of power flow.

Scattering Parameters

The "s" parameters of a device are derived from measurements of its forward and reverse transfer characteristics, and from the reflection coefficients looking

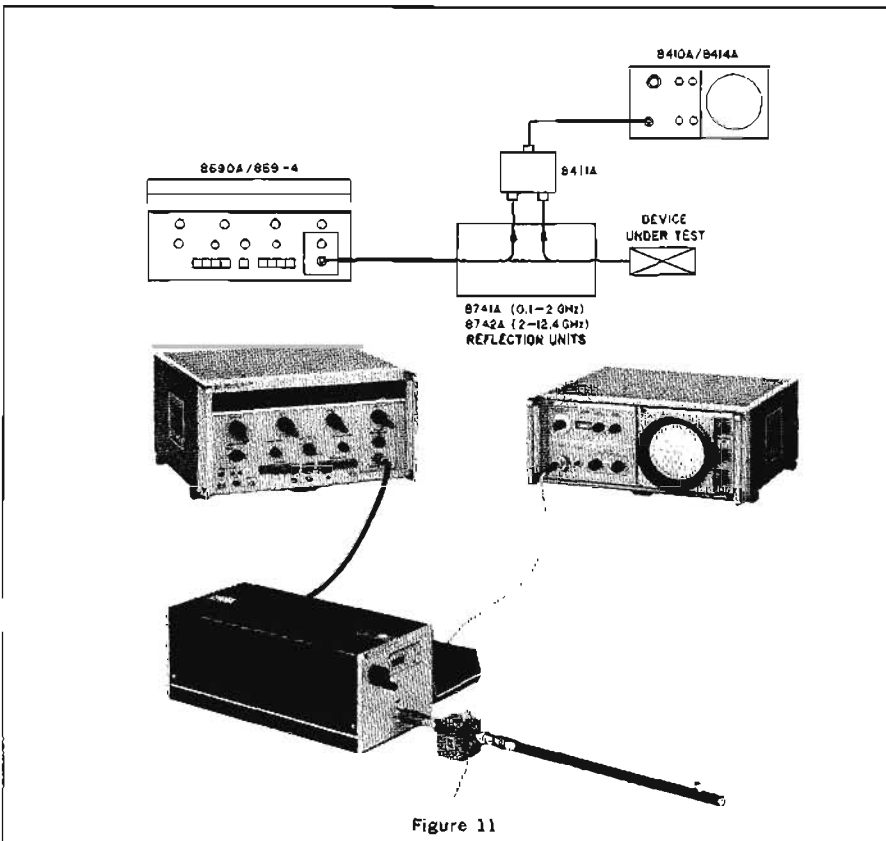

Figure 11

into both the input and output ports. Measurements of s -parameters afford several important advantages over the h , y , and z parameters that have been used in the past to describe active solid-state devices. One is that swept-frequency techniques can be used to make broadband measurements without adjustment or calibrations of any kind once the initial setup has been made. Another advantage stems from the fact that waves traveling on an essentially lossless line terminated in the line's characteristic impedance do not vary in magnitude along the length of the line. Consequently, a device to be tested can be situated at some distance from the transducers used in making the tests (providing that low-loss transmission line is used). A third advantage realized when measuring the characteristics of active devices is that flat termination of the device under test greatly reduces the risk of unwanted oscillation. In microwave design work, s -parameter information is much more easily processed and interpreted. Should they be needed, the h -, y -, and z -parameters can be mathematically derived from the s -parameters.

Measurements of reflection coefficient are particularly easy to use since they relate directly to a primary high frequency/microwave design aid—the Smith Chart. s_{11} and s_{22} are reflection coefficients and relate to impedance through the formula

$$Z = \frac{1 + s_{11}}{1 - s_{11}},$$

which transforms the reflection coefficient polar coordinates to the Smith Chart impedance coordinates.

The scattering parameters are a set of complex numbers that completely characterize both the forward and reverse transfer characteristics and the

input/output impedance of a linear passive or active network. Each of the four parameters of a two-port network has both magnitude and phase angle components. Therefore, these four parameters completely define a two-port network at any frequency.

Figure 12 is a schematic diagram of the four s -parameters of a linear two-port network. This representation is a flowgraph of signal energy that is either transmitted through or reflected from a device. Measurements of s -parameters are made with the HP 8745A Test Set, which samples both the transmitted and reflected signals from a device. The amplitude ratio and phase shift of these signals are measured by either the 8405A Vector Voltmeter or the 8410A Network Analyzer. This data can be read directly from a meter or observed as a visual display versus frequency on a cathode ray tube.

The s -parameters are defined for a Z_0 source and load impedance, usually 50Ω . Under these conditions: s_{21} is the voltage gain from port 1 to port 2, s_{12} is the gain from port 2 to port 1, s_{11} is the input and s_{22} is the output reflection coefficient. Each of the reflection coefficients is directly related to the impedance of its associated port.

High Frequency Transistor Parameters

The s -parameters are particularly convenient for characterization of transistors and other active devices at the higher frequency ranges. Models 11600 and 11602 are accessory fixtures that fit standard TO-18, TO-72, and TO-5, TO-12 transistor packages, respectively. These fixtures accept the full $1\frac{1}{2}$ " length of transistor leads. They connect directly to the 8745A Test Set.

Figure 13 shows the Test Set as it is typically used, with the 8410A Network Analyzer. The oscilloscope photo at the right shows the S_{11} transmission coefficient (magnitude and phase angle) swept over a 1-2 GHz frequency range as it might appear on the 8414 Polar Display.

A complete discussion of scattering parameters and their relation to two port networks is contained in an article by Dr. George E. Bodway, "Two Port Flow Analysis Using Generalized Scattering Parameters," published in the May 1967 issue of the *Microwave Journal*. Reprints are available from any HP Sales Office. Further useful information can be found in the February 1967 issue of the *Hewlett-Packard Journal*, "S-Parameter Techniques for Faster, More Accurate Network Design."

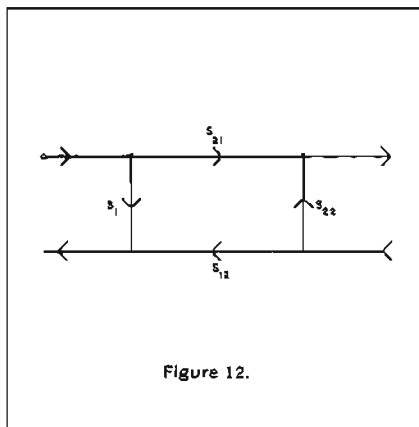

Figure 12.

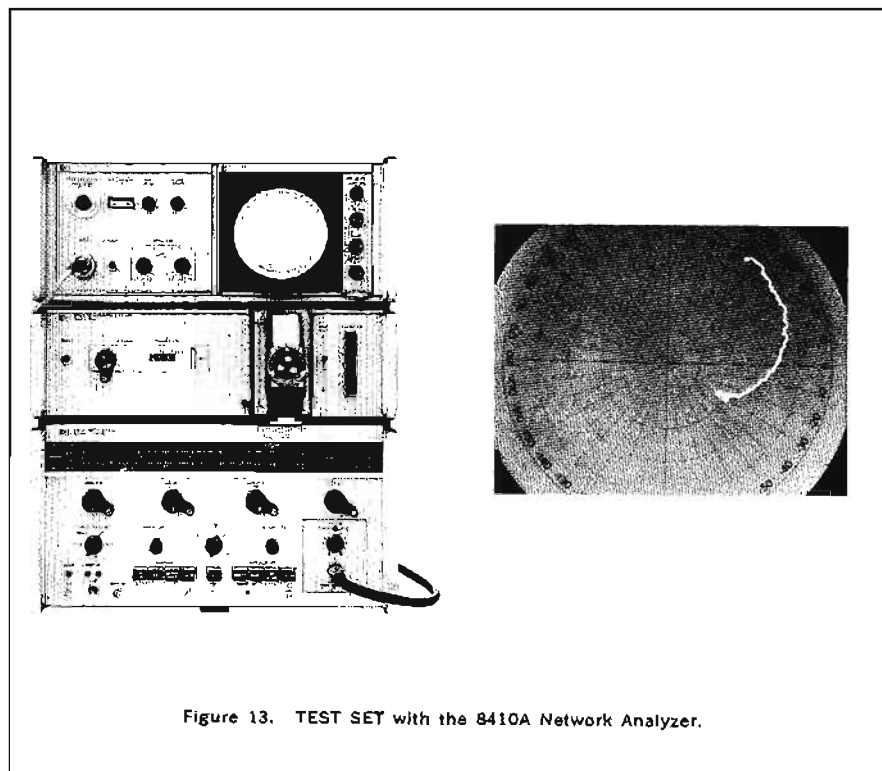
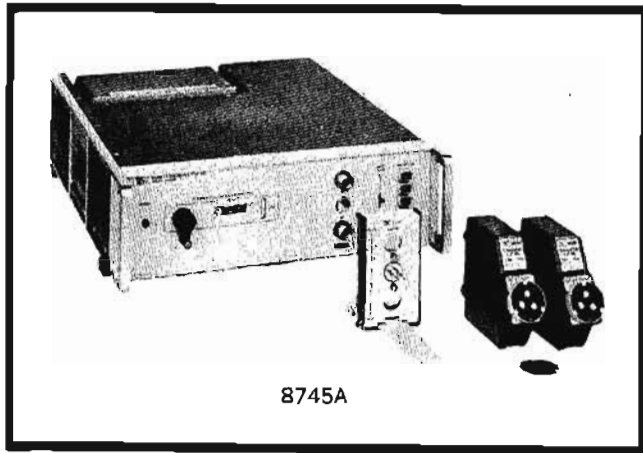

Figure 13. TEST SET with the 8410A Network Analyzer.

IMPEDANCE



S-PARAMETER TEST SET
 Pushbutton s-parameter measurement
 Model 8745A



8745A

Description

Figure 1 is a block diagram of the 8745A S-Parameter Test Set. It consists of two dual directional couplers covering the frequency range from 0.1 to 2 GHz, switches to direct the input signal to and from the appropriate ports of the directional couplers, and a variable 30 cm line stretcher for moving the reference plane of the measurement.

Pushing any of four pushbutton switches, each of which represents a specific s-parameter to be measured, directs the signal flow to and from the appropriate ports of the couplers to the 8405A Vector Voltmeter or 8410A Network Analyzer input ports. Either instrument measures the ratio and phase of signal gain or loss to determine s_{21} or s_{11} . Either also measures the reflection coefficient magnitude and angle which represents the s_{11} and s_{22} parameters. Biasing circuits are built into the switches for the introduction of appropriate

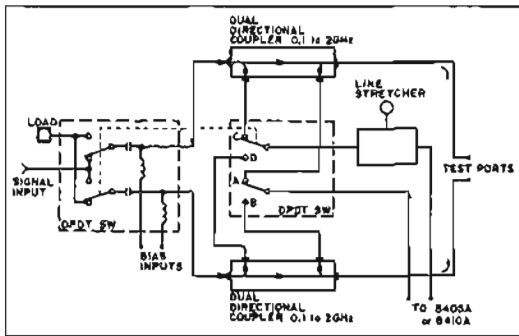

Figure 1. Block diagram of HP 8745A S-Parameter test set.

ate voltages for biasing transistors. The Model 11599A is a quick connect adapter for rapid attachment of the fixtures to the Test Set. Signal inputs for the 8745A can be taken from any signal source or sweep oscillator in the range of approximately 0.1 to 2 GHz.

Before measurement, a calibration for s_{11} and s_{22} is performed by the use of a short or open. A through section of cable connected between the test ports calibrates for s_{11} and s_{22} . Calibration standards for transistor fixtures 11600A and 11602A are also available as Models 11601A and 11603A. The line stretcher is used to provide for movement of the reference plane of the measurement and for line equalization. After calibration, the device to be measured is connected to the test ports and the measurement is made.

Specifications

Function: The 8745A S-Parameter Test Set measures 2-port s-parameters by use of external RF sources and an HP 8405 Vector Voltmeter or 8410A Network Analyzer, or 8540A Automatic Network Analyzer.

Frequency Range: 100 to 2,000 MHz. (8405A range 1 to 1,000 MHz; 8410A range 110 MHz to 12.4 GHz).

Impedance: 50Ω nominal.

Accuracy:
Magnitude Error:

	0.1 to 1 GHz	1.0 to 2.0 GHz
$ \Delta s_{11} $	$\pm (.01 + .07 s_{11} ^2 + .07 s_{12} s_{21})$	$\pm (.02 + .07 s_{11} ^2 + .07 s_{12} s_{21})$
$ \Delta s_{12} $	$\pm s_{12} (.07 s_{11} + .07 s_{22})$	
$ \Delta s_{21} $	$\pm s_{21} (.07 s_{22} + .07 s_{11})$	
$ \Delta s_{22} $	$\pm (.01 + .07 s_{22} ^2 + .07 s_{12} s_{21})$	$\pm (.02 + .07 s_{22} ^2 + .07 s_{12} s_{21})$

Phase Error:

$$\Delta \theta < \sin^{-1} \left| \frac{\Delta S_{m n}}{S_{m n}} \right|$$

Δ = error in parameter for $|\Delta s| \approx s$.

Tracking or Frequency Response:

Magnitude: $\leq \pm .35$ dB

Phase: $\leq \pm 5^\circ$

Maximum RF Power: 2 W

Insertion Loss: (RF input port to test ports) 4 dB nominal

Insertion Loss: (Test ports to outputs to 8405A or 8410A) 20 dB nominal

Maximum Bias Conditions: V_{max} 50 V dc; I_{max} 1.0 A dc

Connectors:

Power Input: type N female

Test Ports: APC-7 precision connectors*

Outputs to 8405A or 8410A: Mates with APC-7 precision connectors*

Remote Programming: Programmable by remote closures to ground (2 lines).

Adapters: Model 11525A, Type N male to APC-7.* Model 11524A, Type N female to APC-7.*

Price: Available on request.

Specifications

(Model 11600A and 11602A Transistor Fixtures)

Function: Accessories for measurement of scattering parameters of bi-polar transistors, FET's, and other semiconductor devices. Used particularly with the HP 8745A S-Parameter Test Set.

Configuration: Accepts device leads up to 1.5" long for transistor configurations listed below. Also accepts any 3 or 4 lead configuration of transistor tor with lead dimensions as shown:

Model 11600A: TO-18 and TO-72

Model 11602A: TO-5 and TO-12

Frequency Range: DC to 2.4 GHz nominal for 11600A; DC to 2.0 GHz nominal for 11602A

Impedance: 50 \pm 2Ω

VSWR: 11600A, ≤ 1.1 from DC to 2.4 GHz; 11602A, ≤ 1.1 from DC to 1.0 GHz; ≤ 1.15 from 1.0 to 2.0 GHz

(measured with through section and one arm terminated in 50Ω.)

Connectors: Input/output: APC-7 precision connectors*

Maximum RF Power: 2 W.

Dimensions: 4 3/8" x 6" x 1 1/2" (12 x 15 x 3.8 cm).

Weight: 2 lb., 2 oz. (504 g).

Price: Available on request.

Specifications

(Models 11601A, 11603A Calibration Standards for Transistor Fixtures)

Function: To be used to calibrate 11600A and 11602A for s_{11} , s_{22} , s_{12} , s_{21} parameters.

Frequency Range:

11601A DC to 2.4 GHz (used with 11600A); 11603A DC to 2.0 GHz (used with 11602A)

Dimensions: 2 3/4" x 2 3/8" x 1 1/8" (standard case) (7 x 7 x 2.9 cm).

Weight: 3 oz. (84 g).

Price: Available on request.

Specifications

(Model 11599A Quick Connect Adapter)

Function: Accepts Models 11600A and 11602A Transistor Fixtures. Connects fixtures to 8745A S-Parameter Test Set with one motion of lever arm for rapid connection and removal of fixtures from 8745A.

Weight: 12 oz. (336 g).

Dimensions: 3" x 5" x 4 1/4" (7.6 x 12.7 x 10.8 cm).

Price: Available on request.

*Amphenol RF Division, Danbury, Connecticut.

VECTOR IMPEDANCE METER

Quickly, easily measure Z & θ , 5 Hz to 500 kHz
Model 4800A



IMPEDANCE

Advantages:

- Reads impedance and phase angle directly
- Easy to operate, no balancing or nulling
- Versatile, plug-in measuring terminals
- Reliable, solid-state circuits

The HP 4800A Vector Impedance Meter will make fast measurements of impedance to 10 megohms and phase to $\pm 90^\circ$ of unknown two-terminal networks. Measurement can be made at a particular frequency or over a continuous range from 5 Hz to 500 kHz. The instrument may be mechanically swept to produce continuous measurements over its full frequency range. Analog outputs of frequency, impedance, and phase are available for X-Y recording. The instrument provides the design engineer with an easy-to-use, one-instrument method for checking components and circuits.

Specifications

Frequency characteristics

Range: 5 Hz to 500 kHz in five bands: 5 to 50 Hz, 50 to 500 Hz, 0.5 to 5 kHz, 5 to 50 kHz, 50 to 500 kHz.

Accuracy: $\pm 2\%$ from 50 Hz to 500 kHz, $\pm 4\%$ from 5 to 50 Hz, $\pm 1\%$ at 15.92 Hz on frequency dial from 159.2 Hz to 159.2 kHz, $\pm 2\%$ at 15.92 Hz.

Monitor output: level: .2 volt rms minimum; source impedance: 600 ohms nominal in series with 50 μ F.

Impedance measurement characteristics

Range: 1 ohm to 10 megohms in seven ranges: 10 ohms, 100 ohms, 1000 ohms, 10 k ohms, 100 k ohms, 1 megohm, 10 megohms full scale.

Accuracy: $\pm 5\%$ of reading.

Phase angle measurement characteristics

Range: $0^\circ \pm 90^\circ$; **Accuracy:** $\pm 6^\circ$; **Calibration:** increments of 5° .

Direct inductance measurement capabilities

Range: 1 μ H to 100,000 H, direct reading at decade multiples of 15.92 Hz.

Accuracy: $\pm 7\%$ of reading for Q greater than 10 from 159.2 Hz to 159.2 kHz; $\pm 8\%$ of reading for Q greater than 10 at 15.92 Hz.

Direct capacitance measurement capabilities

Range: 0.1 pF to 10,000 μ F, direct reading at decade multiples of 15.92 Hz.

Accuracy: $\pm 7\%$ of reading for D less than 0.1 from 159.2 Hz to 159.2 kHz, $\pm 8\%$ of reading for D less than 0.1 at 15.92 Hz.

Measuring Terminal Characteristics

Configuration: electrical: both terminals above ground, ground terminals provided for shielding convenience; mechanical: binding posts spaced $\frac{3}{4}$ " at centers.

Waveshape: sinusoidal.

External Oscillator Requirements: 0.9 V $\pm 20\%$ into 20 k ohms.

Recorder outputs:

Frequency: level, 0 to 1 volt nominal; source impedance, 0 to 1000 ohms nominal; proportional to frequency dial rotation.

Impedance: level, 0 to 1 volt nominal; source impedance, 1000 ohms nominal.

Phase angle: level, 0 ± 9 volt nominal; source impedance, 1000 ohms nominal.

Accessories furnished: 13525A Calibration Resistor, 00610A Terminal Shield.

Dimensions: 16 $\frac{3}{4}$ " wide, 5 $\frac{1}{4}$ " high, 16 $\frac{3}{8}$ " deep (426 x 133 x 416 mm).

Weight: net 24 lbs (10.8 kg), shipping 30 lbs (13.5 kg).

Power: 105 to 125 V or 210 to 250 V, 50 to 400 Hz, 27 W.

Price: HP 4800A, \$1,650.

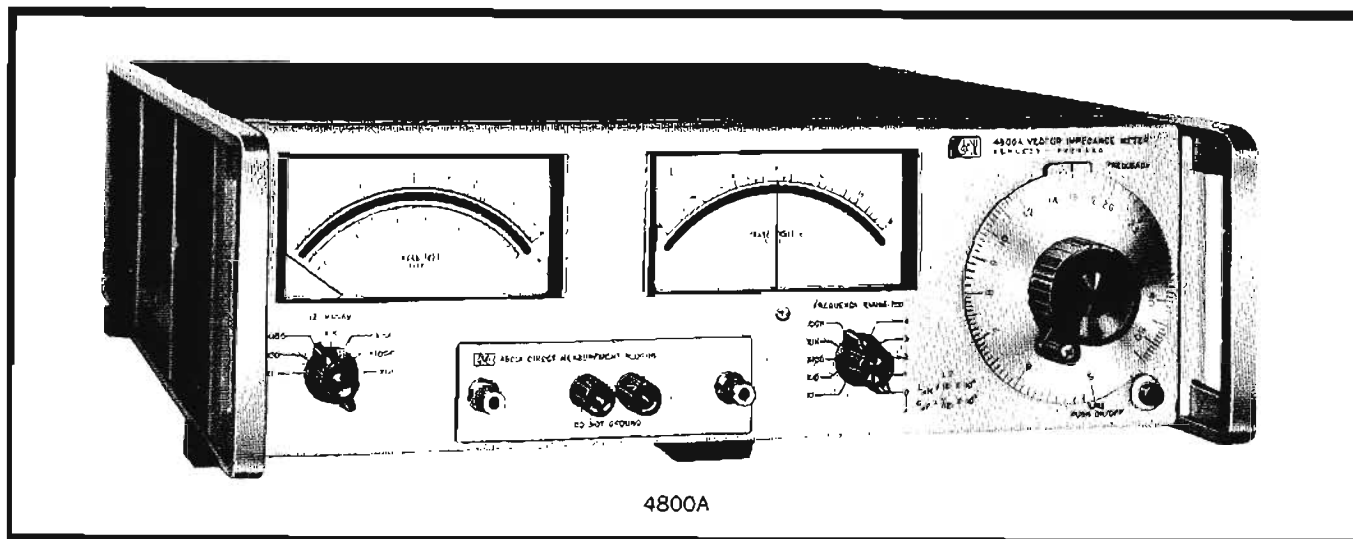

IMPEDANCE



VECTOR VOLTMETER

Measures phase, amplitude from 1 MHz to 1 GHz
Model 8405A

The HP 8405A Vector Voltmeter provides the missing information in rf voltage measurements—PHASE. Since rf voltages are quantities having both magnitude and phase with respect to each other, simple voltage measurements tell only half the story. Most circuit design is virtually impossible without phase information. Both magnitude and phase data is required to define the network parameters needed to optimize design. The HP 8405A allows you to measure, with one instrument, both voltage (magnitude) and phase over the extremely wide frequency range of 1 to 1,000 MHz.

In addition to these unique capabilities, the HP 8405A features high accuracy and resolution, direct readout, and operating convenience. These features enable you to make rf voltage and phase measurements more easily than ever before. By making these measurements simple, the HP 8405A opens the door to new and more effective methods of component, network, and amplifier evaluation. Thus the HP 8405A reduces costs by minimizing equipment requirements, saves time by simplifying measurements, and increases effectiveness by extending capability over a wide frequency range.

1-kHz bandwidth, automatic tuning

The HP 8405A is a two-channel tuned Volt/phasemeter with a 1-kHz bandwidth. Thus it responds only to the fundamental frequency of the input signal, eliminating errors due to harmonics. Yet, the HP 8405A is as easy to operate as any untuned voltmeter, making it well suited for fast production line testing. You simply rotate a front-panel switch to select any of the 21 overlapping octave ranges which include the input signal frequency, and the automatic phase-locked tuning does the rest. To eliminate guesswork, a front-panel light tells you when the voltmeter is properly tuned. The automatic tuning will follow slowly drifting or swept signals so long as they remain within the selected octave range. In addition, the two-channel input of the HP 8405A allows you to make repetitive voltage measurements at two points in a circuit, to check the effects of adjustments, for example, without altering the setup.

The HP 8405A uses the sampling technique to convert the input rf signals to 20-kHz replicas having the same amplitude, waveform, and phase relationship as the input signals. These 20-kHz signals are then filtered so that only 20-kHz sinusoids remain, and the amplitude of and phase difference between these sinusoids are indicated on front-panel meters.

360° phase range, 0.1° resolution

Phase is read on a zero-center meter with end-scale ranges of $\pm 180^\circ$, $\pm 60^\circ$, $\pm 18^\circ$, and $\pm 6^\circ$. The $\pm 6^\circ$ scale provides 0.1° resolution, and a meter offset selectable in precise 10° increments permits this resolution to be realized anywhere in the 360° range. Phase accuracy is $\pm 1.5^\circ$ at fixed frequencies and constant input levels and is quite insensitive to variations in either.

100 μ V fs sensitivity, >90-dB range

Voltages from less than 100 microvolts to 1 Volt can be measured on channel B of the 8405A, from less than 300 microvolts to 1 Volt on channel A. (Channel A requires the higher input to operate the automatic tuning.) External 10:1 dividers are supplied to extend the range of both channels to 10 Volts. This wide range, plus the selective 1-kHz bandwidth enables you to measure gains or losses in excess of 90 dB simply and accurately. Voltage is read on a single front-panel meter; you select which channel voltage is indicated simply by setting a switch. Both Volt and phase meters have rugged, reliable taut-band suspensions with mirror-backed scales individually calibrated to the meter movement.

The input signals are applied through convenient ac-coupled probes which are permanently attached to the instrument. These probes present a high input impedance (0.1 megohm shunted by 2.5 picofarads) for minimum loading effects when probing. The 10:1 dividers increase input impedance to 1 megohm shunted by 2 picofarads. The ac coupling in the probes permits you to measure signals as much as 150 Volts off ground. Output signals include the 20 kHz signals from each channel plus recorder outputs proportional to phase and amplitude.

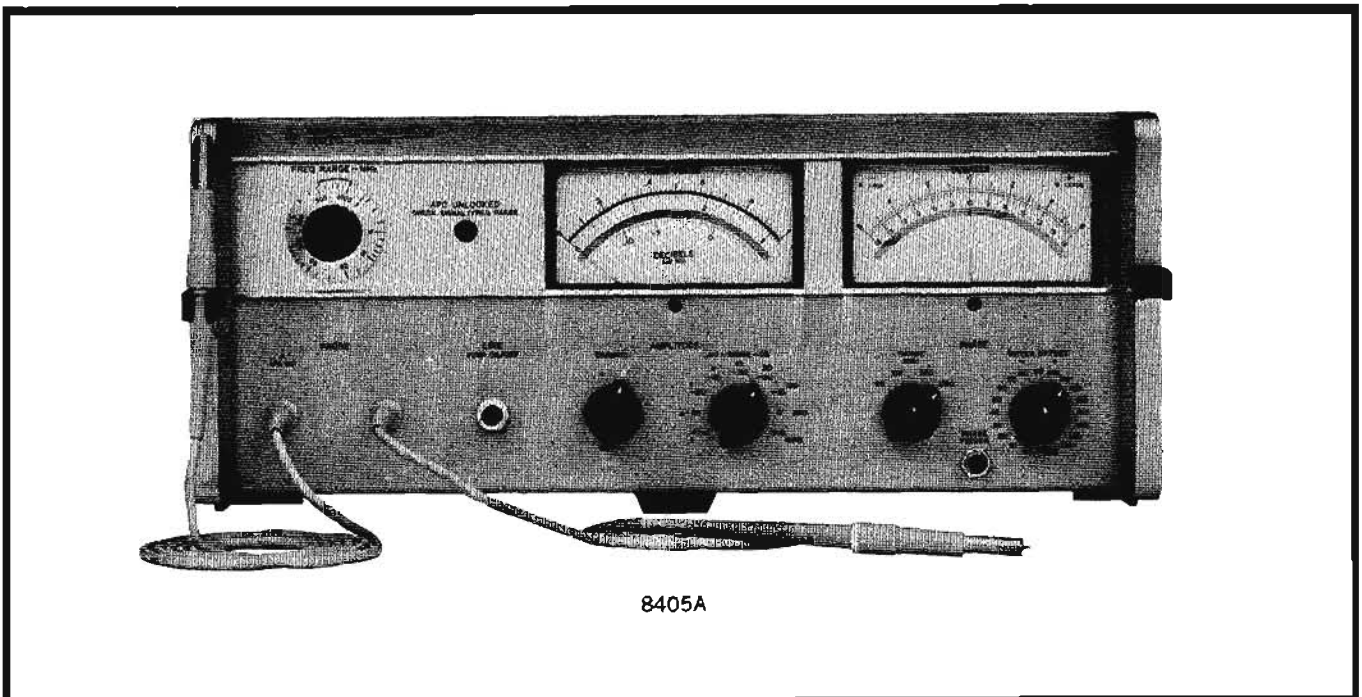

8405A

Specifications

Input Characteristics

Instrument type: two-channel sampling rf millivoltmeter-phasemeter, which measures voltage of two signals and simultaneously displays the phase angle between the two signals.

Frequency range: 1 MHz to 1 GHz in 21 overlapping octave bands (lowest band covers two octaves).

Tuning: Automatic within each band. Automatic phase control (APC) circuit responds to the Channel A input signal. Search and lock time, approximately 10 ms.

Voltage range

Channel A:

1 to 10 MHz: 1.5 mV to 1 V rms.

10 to 500 MHz: 300 μ V to 1 V rms.

500 to 1,000 MHz: 500 μ V to 1 V rms.

Can be extended by a factor of 10 with 11576A 10:1 Divider.

Channel B: 100 μ V to 1 V rms full scale (input to Channel A required); can be extended by a factor of 10 with 11576A 10:1 Divider.

Input impedance (nominal): 0.1 megohm shunted by approximately 2.5 pF; 1 megohm shunted by approximately 2 pF when 11576A 10:1 Divider is used; 0.1 megohm shunted by approximately 5 pF when 10216A Isolator is used. AC coupled.

Isolation between channels:

1 to 300 MHz: greater than 100 dB.

300 to 1,000 MHz: greater than 80 dB.

Maximum ac input: 2 V peak.



Maximum dc input: ± 50 V.

Voltmeter Characteristics

Meter ranges: 100 μ V to 1 V rms full scale in 10-dB steps.

Meter indicates amplitude of the fundamental component of the input signal.

Voltage accuracy: When accessories are used on both probes.

Accessory	Impedance	Frequency	Accuracy
HP 11536A 50 Ω Feed-through Tee	50 Ω	1-100 MHz	$\pm 2\%$ of full scale
	Freq.	100-400 MHz	$\pm 6\%$ of f.s.
	1-750 MHz 1-1000 MHz	<1.15 <1.20	400-1000 MHz $12\%^{**}$ of f.s.
HP 11576A* 10:1 Divider	1 M Ω  2 pF equiv to $Z = \frac{80}{f(\text{MHz})}$ k Ω from 5-100 MHz	1-100 MHz	$\pm 6\%$ of f.s.
HP 10216A* Isolator	100 k Ω  5 pF equiv to $Z = \frac{32}{f(\text{MHz})}$ k Ω from 15-200 MHz	1-200 MHz	$\pm 6\%$ of f.s.

*Accessories furnished with 8405A.

**Above 300 mV and 800 MHz add +5%.

Voltage ratio accuracy: <0.2 dB.

Residual noise: less than 10 μ V as indicated on the meter.

Bandwidth: 1 kHz.

General

20 kHz IF output (each channel): reconstructed signals, with 20 kHz fundamental components, having the same amplitude, waveform, and phase relationship as the input signals. Output impedance, 1,000 ohms in series with 2,000 pF; BNC female connectors.

Recorder output:

Amplitude: 0 to +1 V dc $\pm 6\%$ open circuit, proportional to voltmeter reading in volts. Output tracks voltage reading within $\pm 0.5\%$ of full scale. Output impedance, 1,000 ohms; BNC female connector.

Phase: 0 to ± 0.5 V dc $\pm 6\%$, proportional to phasemeter reading. External load greater than 10,000 ohms affects recorder output and meter reading less than 1%. Output tracks meter reading within $\pm 1.5\%$ of end scale; BNC female connector.

RFI: Conducted and radiated leakage limits are below those specified in MIL-1-6181D and MIL-1-16910C except for pulses emitted from probes. Spectral intensity of these pulses is approximately 60 μ V/MHz; spectrum extends to approximately 2 GHz. Pulse rate varies from 1 to 2 MHz.

Power: 115 or 230 V $\pm 10\%$, 50 to 400 Hz, 35 watts.

Weight: Net, 30 lbs (13,5 kg). Shipping, 35 lbs (15,8 kg).

Dimensions: 18 $\frac{3}{8}$ x 7 x 16 $\frac{3}{4}$ in. (467 x 177 x 425 mm).

Phasemeter Characteristics

Phase range: 360°, indicated on zero-center meter with end-scale ranges of ± 180 , ± 60 , ± 18 , and ± 6 °. Meter indicates phase difference between the fundamental components of the input signals.

Resolution: 0.1° at any phase angle.

Meter offset: ± 180 ° in 10° steps.

Phase accuracy: At single frequency 1.5° (equal signal levels at Channel A and B).

Phase accuracy vs. signal level:

Accessory	Frequency	Voltage range channel A or B	Phase accuracy
HP11536A 50 Ω Feed-through Tee	1-500 MHz	100 μ V to 300 mV	± 3 °
	500-1000 MHz	100 μ V to 100 mV	± 3 °
HP11576A 10:1 Divider	1-100 MHz	1 mV-10 V	± 4 °
HP10216A Isolator	1-200 MHz	100 μ V to 300 mV	± 6 °

Phase jitter vs. Channel B input level

Greater than 700 μ V: Typically less than 0.1° p-p.

125 to 700 μ V: Typically less than 0.5° p-p.

20 to 125 μ V: Typically less than 2° p-p.

Price: Model 8405A, \$2,750.

Option 01. Furnished without 11576A 10:1 Dividers.
Less \$35.00

Option 02. Linear dB scale uppermost on voltmeter.
Add \$25.00

IMPEDANCE



RF VECTOR IMPEDANCE METER

Quickly, easily measure Z & θ , .5 to 108 MHz

Model 4815A

Advantages:

- Direct reading of impedance and phase
- Convenient probe for in-circuit measurements
- Self calibration check provides measurement confidence
- Analog outputs for data recording
- Low-level test signal minimizes circuit disturbance

The HP 4815A RF Vector Impedance Meter provides all of the convenience of "probe and read" measurements. In use, the probe is connected directly into the circuit to be evaluated, frequency is selected, and complex impedance is read. This type measurement allows a straightforward adaptation to various jigs and fixtures for special measurements. Where only component values are to be determined, a quick-mount adapter is provided to allow rapid measurements. For critical component applications, the unit to be evaluated may be mounted directly in its working circuit and its value determined in its actual environment, at the frequency of interest.

Specifications

Frequency

Range: 500 kHz to 108 MHz in five bands: 500 kHz to 1.5 MHz, 1.5 to 4.5 MHz, 4.5 to 14 MHz, 14 to 35 MHz, 35 to 108 MHz.

Accuracy: $\pm 2\%$ of reading, $\pm 1\%$ of reading at 1.592 and 15.92 MHz.

RF monitor output: 150 mV minimum into 50 ohms.

Impedance magnitude measurement

Range: 1 ohm to 100 k ohms; full-scale ranges: 10, 30, 100, 300, 1 k, 3 k, 10 k, 30 k, 100 k ohms.

Accuracy: $\pm 4\%$ of full scale $\pm \left(\frac{f}{30 \text{ MHz}} + \frac{Z}{25 \text{ k ohms}} \right)$

% of reading, where f = frequency in MHz and Z is in ohms; reading includes probe residual impedance.

Calibration: linear meter scale with increments 2% of full scale.

Phase angle measurement

Range: 0 to 360° in two ranges: $0 \pm 90^\circ$, $180^\circ \pm 90^\circ$.

Accuracy: $\pm \left(3 + \frac{f}{30 \text{ MHz}} + \frac{Z}{50 \text{ k ohms}} \right)$ degrees; where f = frequency in MHz and Z is in ohms.

Calibration: increments of 2°.

Adjustments: front panel screwdriver adjustments for Magnitude and Phase Zero.

Recorder outputs

Frequency: 0 to 1 volt from 0 to 1 k ohm source, proportional to dial rotation.

Impedance magnitude: 0 to 1 volt from 1 k ohm source.

Phase angle: 0 \pm 0.9 volt from 1 k ohm source.

Dimensions: 16 $\frac{3}{4}$ " wide, 7 $\frac{1}{4}$ " high, 18 $\frac{3}{4}$ " deep (426 x 185 x 476 mm).

Weight: net 39 lbs (17.6 kg), shipping 55 lbs (24.8 kg).

Power: 105 to 125 V or 210 to 250 V, 50 to 400 Hz, 50 W.

Accessories furnished:

1. 00600A Probe Accessory Kit: contains BNC Type "N" adapter, Probe Socket, 00601A Component Mounting Adapter, 2 probe center pins, probe ground assembly.
2. Rack Mount Kit.

Price: HP 4815A, \$2650.

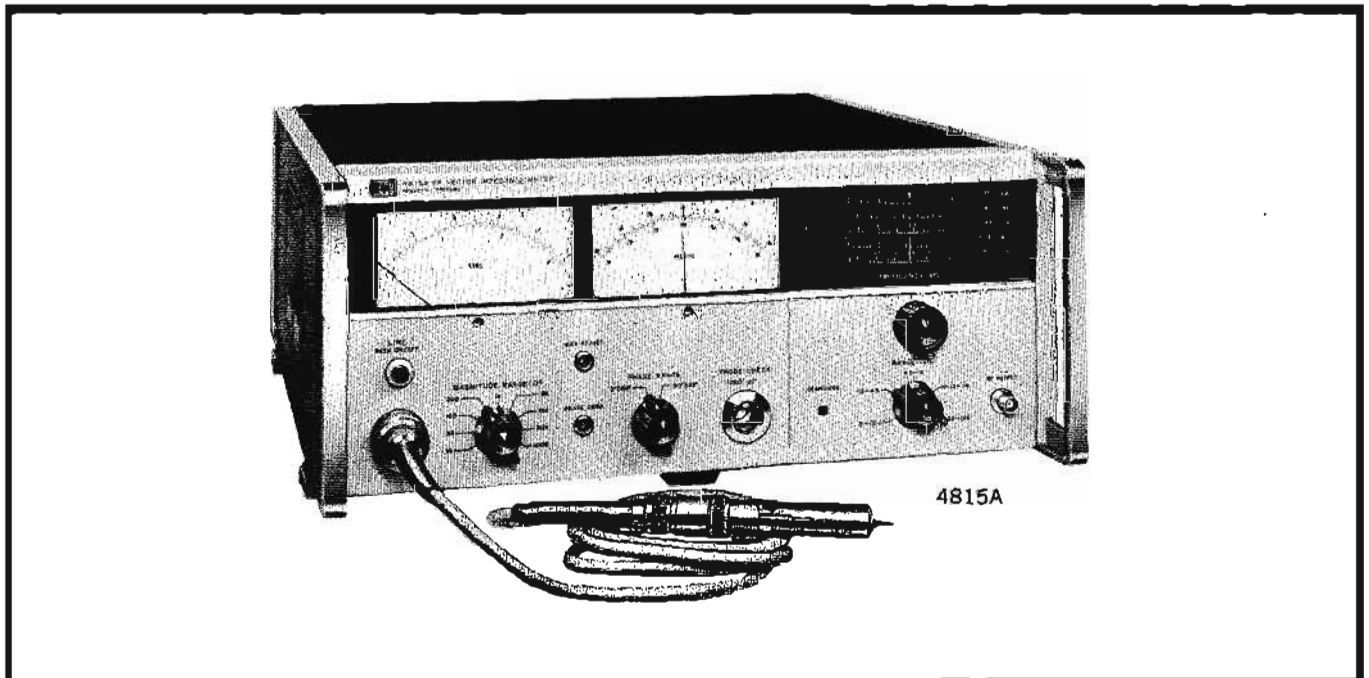

NETWORK ANALYZER

Measure all network parameters, 0.11 to 12.4 GHz
Model 8410A



IMPEDANCE

8410A Network Analyzer

- ATTENUATION • PHASE • GAIN • IMPEDANCE • ADMITTANCE • REFLECTION COEFFICIENT AND ANGLE
- 110 MHz to 12.4 GHz With One Simple System!

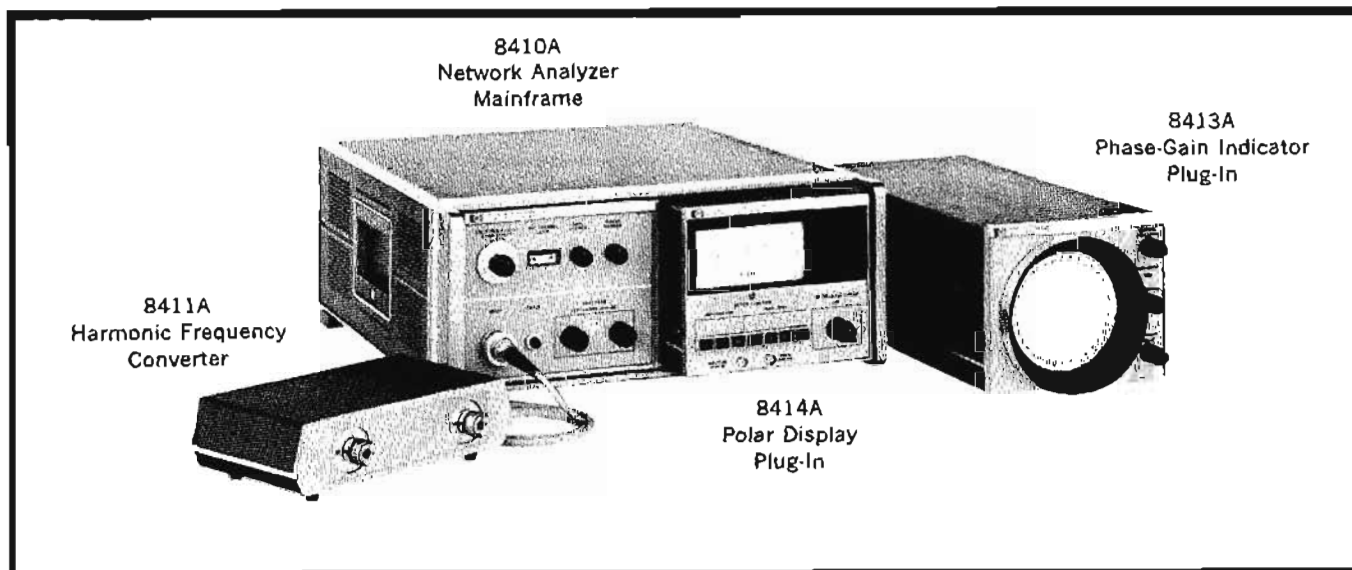

This one compact, low cost system measures all network parameters from 110 MHz to 12.4 GHz.

Complete description of microwave devices

Phase and amplitude data give complete description of microwave devices. A powerful tool for component and systems design and test without ambiguity.

Direct readout with choice of display

Plug-in meter indicates magnitude and phase at spot frequencies. Wideband auxiliary outputs for swept displays on oscilloscope or X-Y recorder.

Plug-in CRT display for swept polar and Smith Chart readout. Auxiliary outputs for higher resolution X-Y plots.

Add display versatility with future plug-ins.

Fast sweeps over octave bands

Swept displays for fast testing over full band. Rapid sweep for dynamic CRT display — make adjustments to devices while viewing overall effects.

Wide dynamic range — high resolution

60 dB amplitude and 360° phase displays. Use precise off-set controls to read amplitude and phase to 0.1 dB and 0.1 degree resolution. No phase ambiguity — meter indicates phase sense directly.

Easy setup

Transmission and reflection units complete the system; all RF hardware is connected and pre-calibrated inside three convenient modules. They provide:

- a calibrated variable measurement plane (line stretcher) to determine electrical and physical length of unknown devices in transmission tests. To eliminate graphical Smith Chart transformations in reflection tests.
- Rigid coaxial air line for stable RF connections. Adjustable RF line length for easy connection to unknown without flexible cables.

—Specified overall system accuracy for easier error analysis.

Accurate

Precision components assure basic system accuracy. Even greater accuracy is possible at spot frequencies because vector errors, such as reflectometer directivity, can easily be calibrated out. This is a direct benefit when measuring both phase and amplitude.

Basic system

The 8410A main frame and 8411A Harmonic Frequency Converter provide basic RF tuning and IF conversion functions. Reference and test channel signals between 0.11 and 12.4 are converted to 20 MHz IF signals by the 8411A. Phase and amplitude relationship between input RF signals is maintained in the 20 MHz IF signals. The two IF signals are then fed through a 5 foot cable to the 8410A main frame. The flexible cable gives more freedom when making RF connection to large test devices. The 8410A main frame includes the automatic frequency tuning circuit, IF amplifiers, precision IF gain control and power supply for the 8411A and plug-in modules. A front panel switch selects the octave range desired between 0.1 and 12.4 GHz and the rest is automatic. The system phase locks to the frequency and follows it even during rapid sweep operation.

Model 8413A Phase-Gain Indicator plugs into the main frame to provide meter readout of relative amplitude and phase shift between the two signals. The meter is calibrated in ± 3 , 10, 30 dB amplitude and ± 6 , 18, 60, and 180 degrees phase. Meter function and range are selected by convenient pushbutton switches. A phase offset switch, calibrated in precise 10 degree steps, allows any angle to be displayed on the ± 6 degree phase scale for 0.1° resolution. Separate dc outputs

NETWORK ANALYZER *continued*

Measure all network parameters, 0.11 to 12.4 GHz
Model 8410A

can be used to display swept frequency plots of amplitude over 60 dB and up to 360° phase on an auxiliary oscilloscope or X-Y recorder.

Model 8414A Polar Display is an alternate plug-in for the 8410A main frame and provides a cathode ray tube readout. Magnitude and phase are displayed in polar coordinate form on a 5 inch internal graticule CRT.

Calibration of the CRT is in five linear amplitude steps (circular lines) and every 10 degrees phase (radial lines) over 360°. CRT overlays are provided for Smith Chart and expanded Smith Chart readout of normalized impedance or admittance. Conveniences include a beam center button to locate and center the trace, variable background illumination for CRT photos without ultraviolet light source in the camera, and X-Y outputs for high resolution polar plots. Two frequency marker signals may be fed into the 8414A from either the HP 8690A or 690C/D-Series Sweep Oscillators. The markers show up as bright spots on the CRT display giving accurate frequency reference points.

Amplitude sensitivity is controlled by the 8410A in precise 10 and 1 dB steps along with a continuous vernier. Using this precise gain control, one can set up a unity ρ Smith Chart, calibrating with a short, then expand for full scale readings of say 0.2. Also, one can compress the scale for reading negative real impedances with a full scale of 3.16. CRT overlays are included for these three scales.

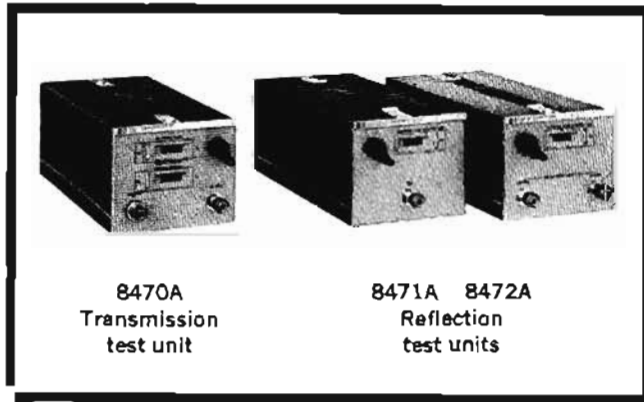

Transmission test unit

Model 8740A Transmission Test Unit provides convenient RF input and signal splitting functions for gain, phase, or attenuation tests with the 8410A. The unit operates over the full 0.11 to 12.4 GHz frequency range of the 8410A thus eliminating RF "hardware" changes when testing broadband coaxial components over several octaves.

RF input power is split into reference and test channel outputs for connection to the unknown and Model 8411A Converter. When a device is inserted between the 8740A and 8411A test channel connectors, a mechanical extension is required in the reference channel equal to the physical length of the test device. This extension is provided up to 10 cm by an adjustable air line in the 8740A. The line's extension is calibrated by a digital indicator.

A calibrated 30 cm line stretcher in the test channel can be used to effectively "stretch" the reference channel signal path. This allows compensation for linear delay in the test device and measurement of its electrical length compared to air line.

Fixed 10 and 20 cm lengths of air line with 7 mm connectors are available for testing devices longer than 10 cm. These fixed lines provide a great deal more system flexibility and are highly recommended accessories, especially when coax adapters are used. One 10 cm and one 20 cm line provide convenient combinations for testing devices up to 40 cm long.

Reflection test units

Model 8741A Reflection Test Unit simplifies RF connections for impedance testing 0.11 to 2.0 GHz. The unit provides a complete phase-balanced reflectometer for swept or fixed frequency impedance tests with the 8410A. The unit includes a wideband dual directional coupler and line stretcher calibrated in centimeters by a digital indicator. Connection to the unknown device is made at a front panel 7 mm precision coax connector. (Adapters available for other types of connectors.) Incident and reflected voltages in the reflectometer are fed out to the Model 8411A Converter. Amplitude ratio and phase is measured by the 8410A/8413A as return loss in dB and angle, as complex impedance (or admittance) or as reflection coefficient and angle using the Model 8414A Polar Display.

A reference short is supplied for system calibration. The line stretcher is adjusted for equal phase shift between the incident and reflected signal paths in the reflectometer. This assures phase accuracy whenever test frequency is swept, or changed during spot frequency tests. The line stretcher can also be used to shift the reference plane. This makes possible direct impedance readings at any plane which would otherwise require graphical Smith Chart transformation.

Model 8742A Reflection Test Unit is a complete ultra-wide band reflectometer for impedance tests 2.0 to 12.4 GHz with the 8410A. A calibrated line stretcher performs the same functions described earlier for the lower range Model 8741A. The unit is the same as the 8741A in function and differs only slightly in outward appearance. Incident and reflected signals from the reflectometer are fed out the front panel. Connection to the unknown device is made on a side panel connector. All RF connections in the measure and reference channels are 7 mm precision coax for highest accuracy and repeatability. A reference short is provided for initial reflectometer calibration.

Accuracy

Transmission test uncertainty **Amplitude, Phase**
 Typical uncertainty introduced in the 8410A/8411A **±0.1 dB, ±2.2°**

Uncertainty caused by mismatch between two connected parts (this can be calibrated out)
 Amplitude = $\pm 20 \log (1 + |\Gamma_1 \Gamma_2|)$
 Phase = $\pm \sin^{-1} (|\Gamma_1 \Gamma_2|)$
 $\Gamma_1 \Gamma_2$ = reflect coeff. of the two ports
 Typically **±0.08 dB, ±0.7°**

Total uncertainty, typical **±0.18 dB, ±2.9°**

Reflection test uncertainty

Amplitude uncertainty (Γ_{μ})
 Including directivity error:
 $\Gamma_{\mu} \approx \pm (a + b|\Gamma_L| + c|\Gamma_L|^2)$
 Cancelling out directivity error with sliding load:
 $\Gamma_{\mu} \approx (b|\Gamma_L| + c|\Gamma_L|^2)$

f (GHz)	a	b	c
.11-1.0	.01	.02	.05
1.0-2.0	.02	.02	.05
2.0-8.0	.032	.052	.036
8.0-12.4	.032	.04	.07

Phase uncertainty $\pm \sin^{-1} (|\Gamma_{\mu} / \Gamma_L|)$
 Γ_L = reflection coeff. of test device
 Typically **Amplitude Phase**
 Including directivity error **±.022 dB ±7.0°**
 Directivity error cancelled **±.006 dB ±1.4°**

Specifications
8410A/8411A Basic Network Analyzer System

Table 1. System Components

Model	Function	Range	Price	Frame- mtes.	Reflect
8410A Network Analyzer	Mainframe for readout modules, includes tuning circuits, IF amplifiers, and precision IF attenuator	11 to 12.4 GHz when used with Model 8411A	\$1,800	✓	✓
8411A Harmonic Frequency Converter	Converts 2 RF input signals 0.11 to 12.4 GHz into 20-MHz IF signals	11 to 12.4 GHz when used with the 8410A. Impedance 50 ohms	\$2,500	✓	✓
8413A Phase-gain Indicator	Plug-in module for 8410A Mainframe provides meter display of relative amplitude and phase between input signals, auxiliary outputs for scope or X-Y Y ₂ , readout of phase-gain/attenuation	Full scale = 3, 10, 30 dB and = 6, 18, 60, 30 degrees. Auxiliary outputs 50 mV/dB and 10 mV/degree	\$850	✓	*
8414A Polar Display	Plug-in module for 8410A Mainframe. CRT polar display of amplitude and phase. X-Y outputs for high resolution polar and Smith Chart impedance plots	Internal graticule CRT or non-parallax viewing. Amplitude calibration in five linear steps. Phase in 10° intervals through 360° with Chart overlays or direct impedance readout (normalized to 50 ohms)	\$985	*	✓
8740A Transmission Test Unit	Simplifies RF input and test device connection for attenuation or gain test. Accepts RF input signal from source and splits into reference and test channels for connection to 8411A and the unknown device. Calibrated line stretcher balances out linear phase shift when test device is inserted	.0 to 12.4 GHz. Impedance 50 ohms	\$1,300	✓	
8741A Reflection Test Unit	Wide-band reflectometer, phase balanced for swept or spot frequency impedance tests below 2 GHz. Accepts RF input and provides connections for unknown test device and 8411A. Movable reference plane	0.11 to 2.0 GHz	\$1,500		✓
8742A Reflection Test Unit	Ultra-wide band reflectometer, phase balanced for impedance tests above 2.0 GHz. Movable reference plane	2.0 to 12.4 GHz	\$1,500		✓
11587A	Accessories normally used for transmission and reflection tests are contained in a sturdy carrying case. Accessories included are: (1) 11566A 10 cm and (1) 11567A 20 cm. Air Line Extension; (2) 11524A female and (2) 11525A male APC-7/N Coax Adapters; (2) 8492A, Option 10, 10 dB and (1) 8492A, Option 30, 30 dB Coax Attenuators; (1) 11511A female and (1) 11512A male type N coax short		\$795	**	**

* Options ** Recommended

Accessories available

Coaxial terminations: 909A fixed, 50 Ω; 907A sliding 50 Ω, APC-7 or type N connectors.

Fixed coaxial attenuators:

8492A, dc to 18 GHz, APC-7 connectors.
Nominal attenuation; Option 03, 3 dB; Option 06, 6 dB; Option 10, 10 dB; Option 20, 20 dB. Max input power 2 W.
8491A, dc to 12.4 GHz; 8491B, dc to 18 GHz, Type N connectors.
Nominal attenuation; Option 03, 3 dB; Option 06, 6 dB; Option 10, 10 dB; Option 20, 20 dB. Max input power 2 W.

Complementary equipment

Sweep oscillators: HP 8690A and plug-in RF units covering 8410A range and beyond. These units provide a directly usable sweep reference voltage for the 8410A.

Oscilloscopes: HP 140A and 1405A Dual Trace and 1420A Horizontal plug-ins.

X-Y Recorders: Moseley 136A two pen recorder, 8½" x 11"; 2 FA two pen recorder, 11" x 17".

X-Y Monitor: HP 1300A, 8" x 10" screen, internal graticule, 1" grid with 0.2" subdivisions, 100 mV/in. sensitivity, and AC coupled bandwidth 2 Hz-20 MHz.

Instrument type: measures relative amplitude and phase of two RF input signals; choice of two plug-in display modules for meter readout (8413A), or CRT polar display (8414A).

Frequency range: 0.11 to 12.4 GHz.

Tuning: automatic over octave band selected by front panel switch.

Swept frequency measurements: automatically tunes to and tracks input frequency over octave bands. Sweep reference input accepts voltage proportional to input frequency for best tracking.*

Input impedance: 50 Ω SWR <1.5 to 8 GHz, <2.0 to 12.4 GHz; connectors precision 7 mm coax (APC-7).

Channel isolation: >65 dB, 0.1 to 8.0 GHz; >60 dB, to 12.4 GHz.

Drift:

With 8413A

Amplitude

Log: <±0.05 dB/°C

Linear: <±5 mV/°C

Phase: <±0.1°/°C

With 8414A

CRT, <±0.2 mm/°C; auxiliary outputs, <±10 mV/°C

Amplitude

Range:

Reference channel: -16 to -44 dBm (≅ 22 to 2.2 mV); meter indicates proper range; 20 dB variation causes less than 1.5 dB and 4° change in amplitude and phase readings.

Test channel: -10 to -80 dBm (≅ 71 mV to 22 μV); not to exceed reference channel power by more than 20 dB.

Maximum RF input to either channel: 50 mV (damage level)

Maximum dc on RF line: ±3 V.

Amplitude control: adjusts gain of test channel relative to reference channel.

Range: 69 dB total in 10 and 1 dB steps; vernier provides continuous adjustment over at least 2 dB.

Accuracy: ±.1 dB per 10 dB step, does not exceed ±0.2 dB cumulative. ±0.06 dB per 1 dB step, does not exceed ±0.1 dB cumulative.

Frequency response: reference and test channels track within ±0.3 dB to 8.0 GHz, ±0.5 dB to 12.4 GHz.

Noise: less than -78 dBm equivalent input noise (measured on 8413A Meter).

Drift: ±.05 dB per degree C.

Phase

Range: 0 to 360°.

Control: vernier provides continuous phase reference adjustment over at least 90°.

Frequency response: reference and test channels track within ±3° to 8.0 GHz, ±5° to 12.4 GHz.

Drift: <±0.1° phase per degree C.

General

Outputs: two rear panel auxiliary outputs provide 278 kHz IF signals; outputs may be used for signal analysis, special applications, and convenient test points; modulation bandwidth nominally 10 kHz.

Reference channel IF: 2 volts peak-to-peak.

Test channel IF: 10 volts peak-to-peak or less, depending on signal level and test channel gain setting.

Sweep reference input: accepts dc voltage proportional to frequency for optimum swept-frequency operation; compatible with 0 to 40 volt per octave (nominal) sweep reference output of 8690-Series Sweep Oscillators.

Power: 115 or 230 volts ±10%, 50 to 400 Hz, 70 W (includes 8411A).

Weight: 8410A, 32 lbs; 8411A, 6¼ lbs (14.3; 2.8 kg).

Dimensions: 8410A 7" high, 8¾" deep, 16¾" wide (17.8 x 21.3 x 42.5 cm); 8411A 2¾" high, 5¾" deep, 9" wide (6.8 x 14.3 x 22.9 cm) exclusive of connectors; 5' cable permanently attached for connection to 8410A.

*HP 8690 and 690 Series Sweep Oscillators supply a directly usable sweep reference voltage.

NETWORK ANALYZER *continued*

Measure all network parameters, 0.11 to 12.4 GHz
Models 8413A, 8414A

8413A phase-gain indicator

Instrument type: plug-in meter display unit for 8410A. Displays relative amplitude in dB between reference and test channel inputs or relative phase in degrees. Pushbutton selection of meter function and range.

Amplitude

Range: ± 30 , 10 and 3 dB full scale.

Accuracy: $\pm 3\%$ of end scale.

Log output: 50 millivolts per dB up to 60 dB total; bandwidth 10 kHz nominal depending on signal level; source impedance 1 k Ω ; accuracy same as meter.

Linear output (rear panel): 0 to 1 V maximum; 10 kHz bandwidth; 250 Ω source impedance.

Phase

Range: ± 180 , 60, 18, 6 degrees full scale.

Accuracy: $\pm 2\%$ of end scale.

Output: 10 millivolts per degree; 10 kHz bandwidth: 1 k Ω source impedance. Accuracy, $\pm 2\%$ of reading on auxiliary display or ± 1 mV, whichever is greater.

Phase offset: ± 180 degrees in 10 degree steps.

Accuracy: ($\pm 0.2^\circ$) $\pm (0.3^\circ/10^\circ \text{ step})$, does not exceed $\pm 1.5^\circ$ cumulative.

Phase response versus signal amplitude: 4 degrees maximum phase change for 60 dB amplitude change in test channel.

General

Power: additional 15 watts supplied by 8410A.

Weight: 11 lbs (4,9 kg).

Dimensions: 6" high, 15-9/16" deep, 7-9/32" wide (15,2 x 39,5 x 18,6 cm) (excludes front panel knobs).

8414A polar display

Instrument type: plug-in CRT display unit for 8410A. Displays amplitude and phase data in polar coordinates on 5" cathode ray tube.

Range: normalized polar coordinate display; magnitude calibration 20% of full scale per division. Scale factor is a function of GAIN setting on 8410A. Maximum scale factor 3.16 (for 0 dB setting) decreasing to .0316 (for 40 dB setting); phase calibrated in 10 degree increments over 360 degree range.

Accuracy: error circle on CRT < 3 mm radius.

Outputs: two dc outputs provide horizontal and vertical components of polar quantity. Maximum output ± 10 volts, $< 100\Omega$ source impedance, bandwidth (3 dB) 10 kHz.

Beam center: pressing BEAM CENTER simulates zero-signal input. Allows convenient beam position adjustment for reference.

Accessories furnished

Smith Chart CRT overlays: plastic overlays for 8414A Polar Display converts readout to normalized impedance or admittance. Full scale = 3.16 (for negative real impedances); 1.0 and 0.2; (furnished with 8414A).

General

CRT: 5 inch, 5 kV post accelerator tube with P-2 phosphor; internal polar graticule.

Marker input (rear panel): accepts frequency marker output pulse from HP 8690-Series and 690-Series Sweep Oscillators, -5 volts peak. Markers displayed as intensified dot on CRT display.

Blanking input (rear panel): accepts -4 volt RF blanking pulse from HP 8690-Series and 690-Series Sweep Oscillators to blank retrace during swept operation.

Background illumination: controls intensity of CRT background illumination for photography. Eliminates need for ultraviolet light source in oscilloscope camera when photographing internal graticule.

Power: additional 35 watts supplied by 8410A.

Weight: 13 lbs (5,8 kg).

Dimensions: 6" high, 15-9/16" deep, 7-9/32" wide (15,2 x 39,5 x 18,6 cm) (excludes front panel knobs).

8740A Transmission Test Unit

Instrument type: RF power splitter and calibrated line stretcher for convenient transmission tests with 8410A. Provides reference and test channel RF outputs for connection to unknown device and the 8411A Converter.

Frequency range: dc to 12.4 GHz.

Frequency response: measurement errors resulting from frequency response variations between reference and test channels $< \pm 0.5$ dB amplitude and $\pm 3^\circ$ phase to 7.0 GHz; 0.75 dB and $\pm 5^\circ$ to 12.4 GHz, including frequency response of 8411A Converter.

Output impedance: 50 ohms, reflection coefficient 0.07 (1.15 SWR, 23 dB return loss) dc to 7 GHz; 0.11 (1.25 SWR, 19 dB return loss) 7.0 to 12.4 GHz.

Maximum RF input power: 1 watt; 0.5 watt when connected directly to 8411A Converter.

Insertion loss: 17 dB nominal.

Connectors: input, compatible Type N female stainless steel; output, APC-7.

Reference plane extension:

Electrical; 0 to 30 centimeters.

Mechanical; 0 to 10 centimeters.

Both extensions calibrated by digital indicators.

Electrical extension indicator adjustable for initial calibration.

Power: passive, no primary power required.

Weight: 17½ lbs (7,8 kg).

Dimensions: 6" high, 16-3/16" deep, 7-9/32" wide (15,2 x 41 x 18,6 cm) (excluding knobs and connectors).

8741A and 8742A Reflection Test Units

Instrument type: wideband reflectometer, phase-balanced for swept or spot frequency impedance tests with 8410A. Calibrated variable reference plane.

Frequency range: 0.11 to 2.0 GHz (8741A); 2.0 to 12.4 GHz (8742A).

Frequency response: incident and reflected outputs from reflectometer track within ± 0.5 dB amplitude, ± 3 degrees phase (± 5 degrees in 8742A).

Impedance: 50 ohms.

Maximum RF input: 30 watts.

Residual reflection coefficient: < 0.01 , 0.1 to 1.0 GHz; < 0.02 , 1.0 to 2.0 GHz (8741A); < 0.03 , 2.0 to 12.4 GHz (8742A).

Connectors: input, Type N female, stainless steel; incident, reflected and unknown reflectometer ports APC-7.

Reference plane extension: 0 to 15 cm (8741A); 0 to 16.5 cm (8742A); calibrated by digital dial indicator. Indicator is adjustable for initial calibration.

Accessories furnished: 11565A APC-7 Short for reflectometer calibration.

Power: passive, no primary power required.

Weight: 16½ lbs (8741A); 15½ lbs (8742A) (7,4 ; 6,8 kg).

Dimensions: 6" high, 16-3/16" deep, 7-9/32" wide (15,2 x 41 x 18,6 cm) (not including connectors and knobs).

AUTOMATIC NETWORK ANALYZER

Production speed with standards-lab accuracy
Model 8540A



IMPEDANCE

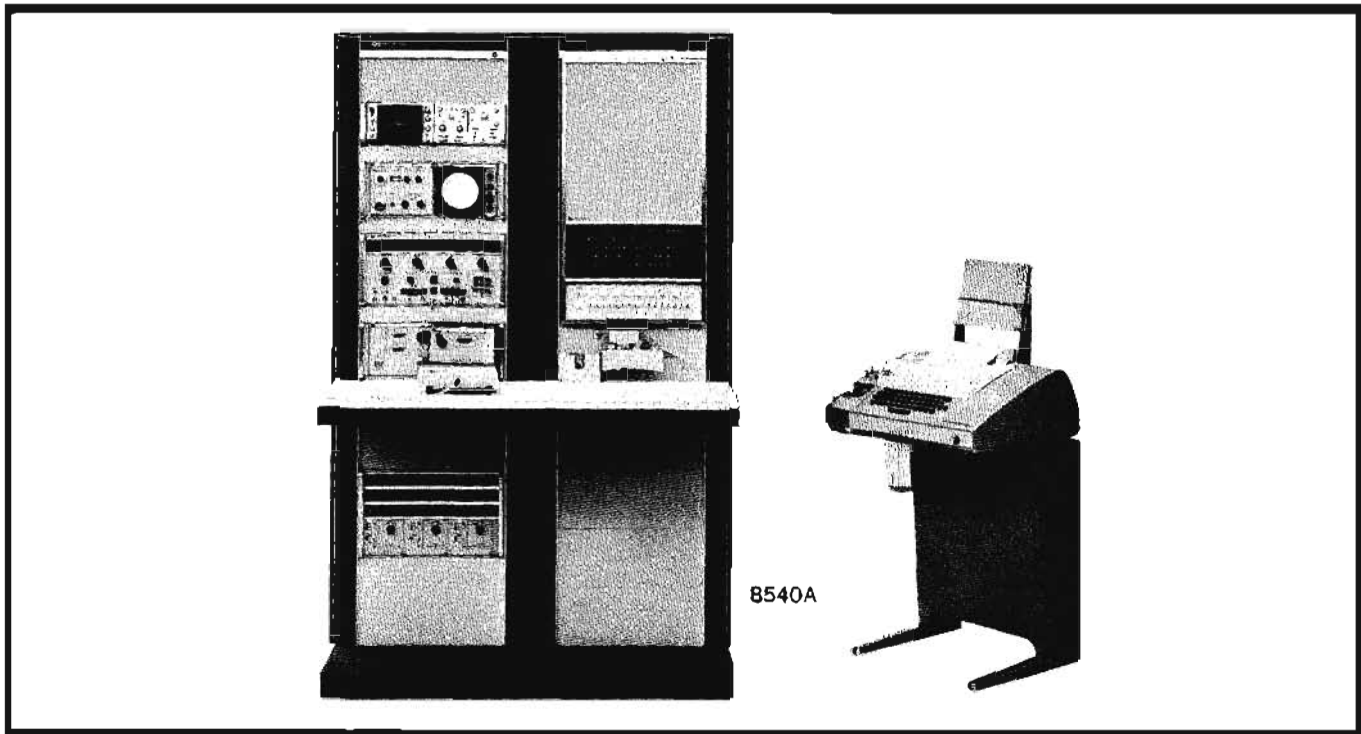

8540A

The 8540A Automatic Network Analyzer System measures the transmission and reflection characteristics of networks and devices from 110 MHz to 12.4 GHz. Basically, it combines two powerful tools—the HP 8410A Network Analyzer System and the HP 2116A Instrumentation Computer. The 2116A Computer automatically operates the 8410A Network Analyzer, the 8690A Signal Generator, and the system's input and output devices. (See Figure 1.) As a result, operator errors in setting switches and controls are eliminated.

Measurement

The measurement sequence has four steps. First, the 8540A Automatic Network Analyzer is programmed to measure and manipulate the data. Next, the system measures and stores its own response to several microwave standards (sliding loads, shorts, etc.). In the third step, the reflection and transmission characteristics of the device under test are measured and corrected for system errors according to the computer program. The final step involves converting the test data to convenient units or parameters, and then displaying the results.

There are several readout options. For digital readout, the data can be recorded by teletypewriter or on magnetic or punched paper tape. The teletype is convenient for permanent records of production test measurements or for tests of measurement standards.

Analog data can be displayed on an oscilloscope, which is convenient for quick observation of test circuit parameters, or can be plotted with an X-Y plotter. Figures 2, 3, and 4 show typical measurement readouts.

Hewlett-Packard can provide general purpose programs for measuring transmission and reflection characteristics from 110 MHz to 12.4 GHz. The characteristics are expressed in commonly used units (such as S parameters, H parameters, reflection coefficient, or return loss).

How it works

The system is controlled by an HP Model 2116A Instrumentation Computer with an 8,192 word memory (16 bits per word). The computer programs the signal source for the test frequency. The signal source RF output is coupled to the device under test through a transmission test unit or a reflection test unit that isolates the signals required to characterize the unknown. The HP Network Analyzer then measures the complex

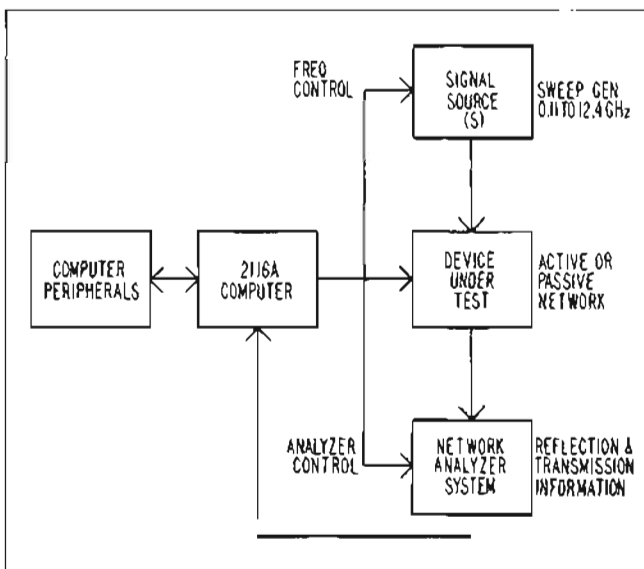

Figure 1

AUTOMATIC NETWORK ANALYZERS *continued*

Production speed with standards-lab accuracy
Model 8540A

ratio of these high frequency signals. This information is fed to the computer through an analog-to-digital interface.

The complex (magnitude and phase) transmission and reflection characteristics are sufficient to describe completely any two-port device under test. The computer converts this information into equivalent forms as required. By this means, the system can compute such parameters as insertion loss, gain, isolation, attenuation, phase-shift, phase and amplitude nonlinearities, group delay, impedance, admittance, reflection coefficient, S, Y, H, or Z parameters, vswr, return loss, mismatch loss, and electrical length.

These tests normally require tedious manual operations with slotted lines where manual reflectometer systems are used. However, with the 8540A Automatic Network Analyzer they can be performed sequentially repeatably, reliably, and more accurately with complete operator control.

Advantages

Automatic operation of this system has three significant advantages. First, it is fast. Second, it requires no technical skill or knowledge to operate the system. Production personnel or test technicians can operate the system without any knowledge of computers. Third, the 8540A System corrects itself for errors in the system, and thus measures more accurately than can be done manually with the individual components.

Speed

The system is so fast that the teletype takes longer to type (at 10 characters per second) the results of a series of complex tests than the computer takes to make the measurements, correct the data for system errors, and then convert the data to the appropriate form for teletype printout.

Simplicity

Automatic operation of the 8540A means that nontechnical production personnel can test VHF, UHF, and microwave devices and networks by simply connecting the device and instructing the system to perform the measurements. The operator then instructs the computer to readout the corrected test results. Figure 2 shows results of production test of a 20 dB attenuator.

FREQUENCY GHz	ATTENUATION dB	REFLECTION COEFFICIENT	
		LEFT	RIGHT
D.C.	20.02	x	x
4	20.1	.010	.035
6	20.1	.045	.065
12	20.0	.075	.095
16			

Figure 2. Production calibration report on precision attenuator taken directly from 8540A output.

Automatic operation also enables designers and engineers to do precise design work on amplifiers, oscillators, and other microwave circuits more easily.

With standard, general purpose programs, the computer prints step-by-step instructions to the operator for fast, accurate measurements without long training, constant practice, or hand

arithmetic. These programs make it possible for noncomputer programmers to make a wide range of measurements. For specialized applications, the computer can be easily reprogrammed in BASIC, FORTRAN, or ALGOL, using standard HP instrument subprograms. This flexibility simplifies the design of complex computer circuits, and saves a great deal of time.

Accuracy

One of the most important features of the Automatic Network Analyzer System is high accuracy, repeatability, and resolution. It calibrates itself so that when it makes a test, it can correct for the errors inherent in the system.

TASKS:

CONNECT DEVICE: 50 OHM REFERENCE CHECKED AGAINST ITSELF

FREQ.	VSWR	RETURN LOSS(DB)	MISMATCH LOSS(DB)
8000.	1.000	76.63	.00
8484.	1.000	75.91	.00
9012.	1.001	70.88	.00
9496.	1.001	70.18	.00
9980.	1.001	70.70	.00
10507.	1.001	69.81	.00
10991.	1.000	92.71	.00
11519.	1.001	71.63	.00
12003.	1.001	70.88	.00
12399.	1.001	70.68	.00

Figure 3. Measurement of reflection coefficient of 50 ohm load.

One indication of the system's repeatability is obtained by remeasuring the 50 ohm standard that was used to calibrate the system. Theoretically, perfect repeatability would give a vswr of 1.0000, or infinite return loss. In practice, the second measurement may differ from the first by the amount of the measurement uncertainty. Figure 3 is a representative printout of such a repeat measurement.

Due to noise, phase shift, and other factors, the system cannot exactly duplicate its own results on a measurement. Notice that, with one exception, the corrected return loss readout is 70 dB or greater.

The self-correction feature is illustrated in Figure 4, which shows a swept-reflection coefficient measurement of a 20 dB attenuator. From 2 to 4 GHz the magnitude of reflection coefficient (ρ) is 0.02 per division or 0.1 full scale. Figure 4(a) shows an uncorrected measurement. Figure 4(b) shows a measurement that has been corrected by the computer for system errors.

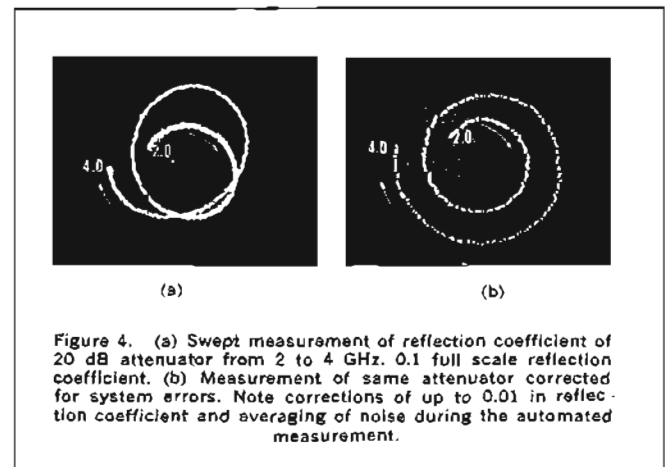

Figure 4. (a) Swept measurement of reflection coefficient of 20 dB attenuator from 2 to 4 GHz. 0.1 full scale reflection coefficient. (b) Measurement of same attenuator corrected for system errors. Note corrections of up to 0.01 in reflection coefficient and averaging of noise during the automated measurement.

For further information on the 8540A System components, refer to the information in this catalog on the 2116A Instrumentation Computer, the 8410A Network Analyzer, and the 8690A Series Sweep Oscillators.

C, R, L, D, & Q MEASUREMENTS



IMPEDANCE

Impedance bridge

Analysis of capacitors, inductors, and resistors for low-frequency applications is commonly made with a universal bridge. Universal bridges have considerable versatility, being able to measure not only resistance, capacitance, and inductance over wide ranges, but also the Q of inductances and the dissipation

factor ($\frac{1}{Q}$) of capacitors.

The HP Model 4260A bridge measures resistance values from 10 milliohms to 10 megohms, inductances from 1 microhenry to 1000 henry, and capacitances from 1 pF to 1000 μ F.

Q is measured, in the series configuration, from 0.02 to 20; Q of R in parallel with L is measurable in a range from 8 to 1000. The dissipation factor (D) of capacitors is measured from 0.001 to 0.12 for series C and R, and from 0.05 to 50.0 with parallel C and R. The accuracy of D and Q measurements is $\pm 5\%$, or better.

Inside the bridge is a driving oscillator, operating at 1 kHz. Other frequencies within a range of 20 Hz to 20 kHz may be used to drive the bridge.

A generalized ac impedance bridge is shown in Fig. 1. The bridge is driven by an ac source across the corners OQ. When the voltage across arm OP equals the voltage across arm OS, the output voltage, expressed across the detector connected to P and S, is zero. The bridge is balanced, or nulled; the product of the impedance across OS and that across PQ is equal to the product of the impedance across SQ and that across OP.

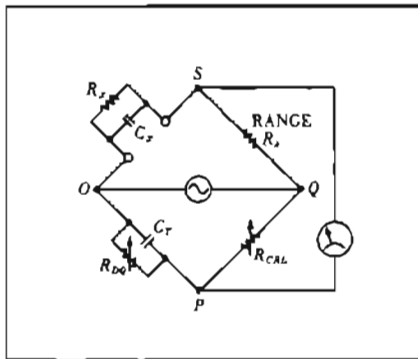

Figure 1. Generalized ac bridge configuration. OQ is bridge driving voltage. OS is fixed by value of unknown component and setting of RANGE switch. OP is determined by R_{CR1} and R_{D0} controls and C_T . When balanced, voltage across PS is zero.

Now the value of any of the four impedances can be calculated if the other three are known.

An internal dc supply is used for measurements of resistance and an internal 1-kHz oscillator drives the bridge for measurements on capacitors and inductors.

Null procedure in Hewlett-Packard's new Model 4260A Universal Bridge uses a feedback control system to make one of the bridge adjustments automatically. C or L can be read directly, after balancing the bridge with only one adjustment of the CRL control.

The dissipation factor for capacitors (D) or quality factor for inductors (Q) is found with only two adjustments; there is no "chasing" of the null through further alternate adjustments of any interacting controls.

Q meters

The Q of a resonant circuit, comprising a variable known capacitor (C_q) contained in the Q meter and an external inductor (L_x), is measured by impressing a signal of known voltage (E_1) and variable known frequency in series in the circuit, and measuring the voltage (E_q)

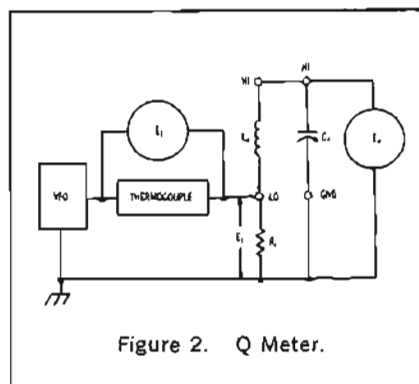

Figure 2. Q Meter.

across the capacitor when the circuit is resonated to the chosen frequency of the impressed voltage. Q of the circuit is the ratio E_q/E_1 . With E_1 known, the voltmeter measuring E_q can be calibrated directly in Q. By inserting low impedances in series with the inductor L_x , or high impedances in parallel with the capacitor C_q , the constants of unknown circuits or components may be measured in terms of their effect on the original circuit Q and tuning capacitance.

To calibrate these meters, Hewlett-Packard provides Q standards which are standard inductors of calibrated Q.

There are two Q meters in the HP family. Model 260A is for the frequency range 50 kHz to 50 MHz which may be extended down to 1 kHz by using a suitable external oscillator with a Model 00564A Coupling Unit. Model 190A serves the range 20 MHz to 260 MHz.

RX meter

The HP Model 250B RX Meter directly presents the parallel resistive and reactive constituents of Z, for two-terminal networks, in the range from 0.5 to 250 MHz.

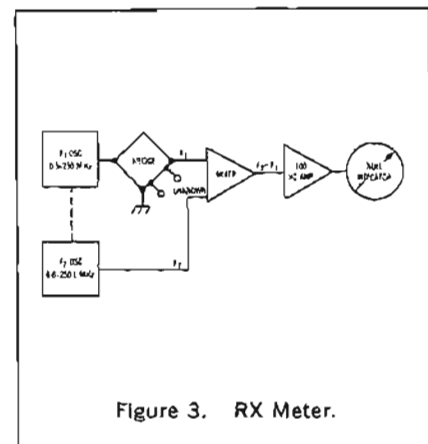

Figure 3. RX Meter.

The output of the 0.5 to 250 MHz test oscillator (F_1) is fed into a Schering bridge. When the impedance to be measured is connected across one arm of the bridge, the equivalent parallel resistance and reactance unbalance the bridge, and the resulting voltage is fed to the mixer. The output of the 0.6 to 250.1 MHz oscillator (F_2), tracking 100 kHz above F_1 , also is fed to the mixer, resulting in a 100 kHz difference frequency proportional in level to the bridge unbalance. This is amplified selectively to provide desired balance sensitivity. When the bridge R and C controls are nulled, their respective dials accurately indicate the parallel impedance components of the test sample.

The instrument's range of measurement is 15 to 100,000 ohms for parallel resistance (0 to 15 ohms by indirect means) for C, and 0.001 μ H to 100 mH for L.



UNIVERSAL BRIDGE

Simplified, easy to read impedance measurement
Model 4260A

Advantages:

- Electronic AUTOBALANCE—single control null
- Digital Readout for C, R, L
- Direction Indicators for fast range selection and balance

Measurements of C, R, L, D (dissipation factor of capacitors), and Q are easily made with the new Model 4260A Universal Impedance Bridge.

The readout for C, R and L is digital with the decimal point automatically positioned. Units of measurement and the equivalent circuit automatically appear with a twist of the function switch. There are no multipliers or confusing non-linear dials which need interpolation.

Operation is simple. Set the function knob for the parameter to be measured, adjust the range switch for an on-scale indication, and obtain a null with the CRL control. There are no interacting controls to adjust and readjust. There are no false nulls. A unique electronic AUTOBALANCE circuit solves all these problems. Components with low Q or high D are as easy to measure as those without loss.

For D or Q measurements, switch out of AUTO and turn the DQ control until another null is obtained. Only one adjustment is needed for each measurement.

Five bridge circuits are incorporated in the 4260A; each is composed of stable, high-quality components for good accuracy and linearity. An internal 1 kHz drives the bridge.

Nulling is easy. Illuminated pointers (\triangleleft CRL \triangleright) automatically tell whether a null is up- or down-scale. Both range and CRL controls can be set watching these pointers.

Components may be biased by connecting a battery to the rear terminals. An external oscillator and detector can be used for measurements in the 20 Hz - 20 kHz range.

The compact modular cabinet is ideal for bench use; and it may be rack mounted using accessory hardware. A tilt stand is provided to raise the viewing angle; it also serves as a convenient carrying handle.

Specifications

Capacitance measurement

Capacitance

Range: 1 pF to 1000 μ F, in 7 ranges.

Accuracy:

- \pm (1% + 1 Digit), from 1 nF to 100 μ F.
- \pm (2% + 1 Digit), from 1 pF to 1 nF and 100 μ F to 1000 μ F.

Dissipation factor

Range:

- LOW D—(of series C): 0.001 to 0.12.
- HIGH D—(of parallel C): 0.05 to 50.

Accuracy: for C > 100 pF.

- LOW D—(of series C): \pm (5% + 0.002) or \pm ONE DIAL DIVISION, whichever is greater.
- HIGH D—1/D (of parallel C): \pm (5% + 0.05) or \pm ONE DIAL DIVISION of LOW Q dial, whichever is greater.

Inductance measurement

Inductance

Range: 1 μ H to 1000 H, in 7 ranges.



Accuracy:

- \pm (1% + 1 Digit), from 1 mH to 100 H.
- \pm (2% + 1 Digit), from 1 μ H to 1 mH and 100 H to 1000 H.

Quality factor

Range:

- LOW Q—(of series L): 0.02 to 20.
- HIGH Q—(of parallel L): 8 to 1000.

Auto-balance

Eliminates need for DQ adjustments in parallel C and series L measurements at 1 kHz.

Accuracy: for D < 1 and Q > 1 add \pm 0.5% to C and L accuracy specifications.

Resistance measurement

Range: 10 milliohms to 10 megohms, in 7 ranges.

Accuracy:

- \pm (1% + 1 Digit), from 10 ohms to 1 megohm.
- \pm (2% + 1 Digit), from 10 milliohms to 10 ohms and 1 megohm to 10 megohms.

Oscillator and detector

Internal oscillator: 1 kHz \pm 2%, 100 mV rms \pm 20%.

Internal detector: tuned amplifier at 1 kHz; functions as a broad-band amplifier for measurements with external oscillator.

General

Power: 115 or 230 volts \pm 10%, 50-60 Hz, approx. 7 watts.

Dimensions: 7-25/32" wide, 6-17/32" high, 11" deep (190 x 166 x 279 mm).

Weight: net, 11 lbs (5 kg). Shipping, 15 lbs (6.8 kg).

Optional accessories:

HP 419A for accurate R measurements < 10 ohms and > 1 M ohms.

HP 204B for measurements 20 Hz - 20 kHz.

HP 140A/1400A or external tuned null detector with 90 dB gain and Z_{in} > 10 k ohms for measurements 20 Hz - 20 kHz.

Price: Model 4260A Universal Bridge, \$550.00.

Manufactured by Yokogawa Hewlett-Packard Ltd., Tokyo.

RX METER

Self-contained rf bridge, 500 kHz to 250 MHz
Model 250B



IMPEDANCE

The HP 250B RX Meter is a completely self-contained instrument for use in measuring the equivalent parallel resistance and capacitance or inductance of two-terminal networks. The instrument's design includes an accurate, continuously tuned oscillator, high-frequency bridge, amplifier-detector and null/RF level indicator.

The oscillator, which is carefully designed to minimize temperature effects, is mounted inside a rigid casting in order to obtain a high degree of accuracy, stability and low leakage. A long-life sub-miniature triode is used, and the unit is carefully shielded to avoid any leakage of signal to the amplifier-detector by any path other than through the

bridge. The high-frequency bridge is also mounted inside a casting and is specially designed to minimize the effects of coupling between arms.

Connections to the unknown impedance are arranged for almost zero lead length. Convenient, easily adjusted bridge balance controls are provided on the front panel. Controls are also provided for adjustment and indication of the relative RF signal level at the test terminals. A connector on the rear panel provides an IF output for a sensitive tuned voltmeter for improved resolution when nulling during reduced signal level operation.

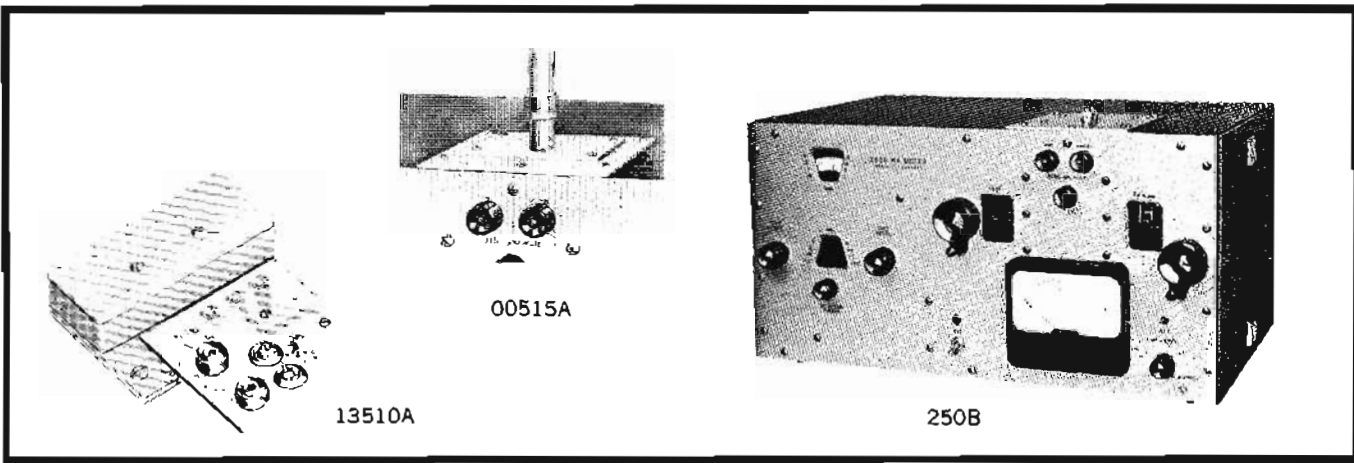

Specifications

Radio frequency characteristics

RF range: total range: 500 kHz to 250 MHz; number bands: 8; band ranges: 0.5 to 1 MHz, 1 to 2 MHz, 2 to 4 MHz, 4 to 9 MHz, 9 to 21 MHz, 21 to 48 MHz, 48 to 110 MHz, 110 to 250 MHz.

RF accuracy: $\pm 2\%$.

RF calibration: increments of approximately 1%.

Resistance measurement characteristics

Resistance range: 15 to 100,000 ohms.

Resistance accuracy: $\pm \left[2 + \frac{F}{200} + \frac{R}{5000} + \frac{Q}{20} \right] \%$
 ± 0.2 ohm; F = frequency (MHz), R = RX Meter R_p reading (ohm), $Q = \omega CR \times 10^{-12}$, where C = RX Meter C_p reading (pF).

Resistance calibration: increments of approximately 3% throughout most of range.

Capacitance measurement characteristics

Capacitance range: 0 to 20 pF (may be extended through use of auxiliary coils).

Capacitance accuracy: $\pm (0.5 + 0.5 F^2 C \times 10^{-6}) \%$
 ± 0.15 pF; F = frequency (MHz), C = RX Meter C_p reading (pF).

Capacitor calibration: 0.1 pF increments.

Inductance measurement characteristics

Inductance range: 0.001 μ h to 100 mh (actual range depends upon frequency; auxiliary resistors employed).

Inductance accuracy: basic accuracy is capacitance accuracy given above.

Measurement voltage level

RF: 0.05 to 0.75 V approx, depending on frequency, with SET RF LEVEL control in NORMAL position. RF level adjustable to below 20 mV; relative level indicated when SET RF LEVEL switch is depressed.

DC: 0 V; (external dc current up to a 50 mA, may be passed through RX meter terminals).

Accessories available: 00515A Coax Adapter Kit (designed to permit connection to the RX meter bridge circuit of any coaxial transmission line or fixture fitted with a Type "N" male connector), \$50; 13510A Transistor Test Jig (provides a convenient means for measuring Y parameters Y_{11b} , Y_{11c} , and Y_{22c} of transistors on the RX meter over the frequency range of 500 kHz to 250 MHz), \$195.

Physical characteristics

Dimensions: 20" wide, 10 $\frac{3}{8}$ " high, 13 $\frac{1}{2}$ " deep (508 x 264 x 343 mm).

Weight: net 40 lbs (18 kg); shipping 50 lbs (22.5 kg).

Power: 105 to 125 volts or 210 to 250 volts, 50 to 1000 Hz, 60 watts.

Price: HP 250B, \$1895.

IMPEDANCE



Q METER

Expanded scale for Q measurements

Model 260A

The direct-reading expanded scale of the HP 260A Q Meter permits measurement of Q down to 10 and also permits reading of very small changes in Q resulting from the variation of the test parameter.

The Q meter was first designed and introduced as a means of measuring the Q or "figure of merit" of coils. Improved models and broadened applications have kept pace with new measuring needs, and today the Q meter is recognized as a flexible general-purpose device with a large number of uses.

Circuit technique

The Q meter consists of a self-contained, continuously variable, stable oscillator, whose controlled and measured output is applied in series with a series-tuned, resonant circuit. A vacuum tube voltmeter with high input impedance is connected across the internal variable capacitor portion of the tuned circuit to measure the reactive voltage in terms of circuit Q. The coil portion of the tuned circuit is connected externally and represents the unknown to be measured. By inserting low impedances in series with the coil or high impedances in parallel with the capacitor, the parameters of unknown circuits or components can be measured in terms of their effect on the circuit Q and resonant frequency.

Usefulness, special features of the 260A

The 260A is typical of these instruments. It is useful for direct reading of circuit Q on its parallax-free meter. From such measurements, the distributed capacitance, effective inductance and self-resonant frequency can be determined. On capacitors, capacitance from 0.1 pF to 100 μ F and Q from 10 to 10,000 can be evaluated from measurements made with and without the component connected. Capacitor self-resonant frequency also can be determined.

Effective RF resistance, inductance or capacitance, and Q of resistors also may be determined, and, used on IF and RF transformers, the 260A will measure effective impedance, Q, coefficient of coupling, mutual inductance and frequency response. The Q meter also is useful for making measurements of dielectric constant and dissipation factor on insulating materials.

The HP 260A utilizes a rugged thermocouple operating at half rated power; oscillator output is factory-adjusted to avoid overload. Both these features guard against accidental thermocouple overload. Through the use of an internal regulating transformer and an electronically regulated power supply, the operation of the instrument is not affected by normal power line fluctuations.

Teflon insulation has been provided for 260A terminals, providing mechanical stability and low electrical loss. The oscillator output is controlled by varying the screen grid voltage of the oscillator tube to obtain smooth operation, as well as good waveshape. A 0.02-ohm annular insertion resistor is used to improve 260A accuracy. Provision is made for use of an external oscillator to supply the Q meter through a matching transformer (HP 00564A) to provide operation below 50 kHz down to 1000 Hz. A scale also is provided to read inductance directly at selected frequencies.

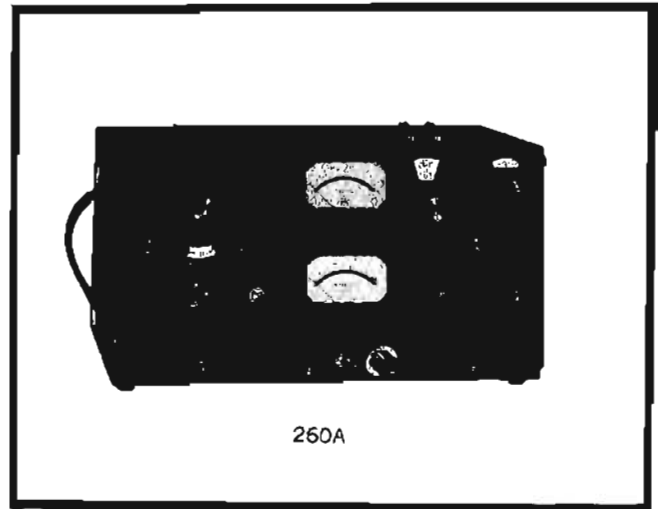

Specifications

Radio frequency characteristics

RF range: total range: 50 kHz to 50 MHz, 1 kHz to 50 kHz (with external oscillator); number bands: 8; band ranges: 50 to 120 kHz, 120 to 300 kHz, 300 to 700 kHz, 700 to 1700 kHz, 1.7 to 4.2 MHz, 4.2 to 10 MHz, 10 to 23 MHz, 23 to 50 MHz.

RF accuracy: $\pm 2\%$.

RF calibration: increments of approximately 1%.

Q measurement characteristics

Q range: total range: 10 to 625; low range: 10 to 60; Δ range: 0 to 50.

Q accuracy: $\pm 5\%$, 50 kHz to 30 MHz; $\pm 10\%$, 30 MHz to 50 MHz (for circuit Q of 250 read directly on indicating meter).

Q calibration: main scale: increments of 5 from 40 to 250; low scale: increments of 1 from 10 to 60; Δ scale: increments of 1 from 0 to 50; XQ scale: increments of 0.1 from 1 to 1.5 and increments of 0.5 from 1.5 to 2.5.

Inductance measurement characteristics

L range: 0.09 μ H to 130 mH, (effective inductance), direct-reading at six specific frequencies.

L accuracy: $\pm 3\%$ (for resonating capacitance > 100 pF and inductance > 5 μ H).

Resonating capacitor characteristics

Capacitor range: main: 30 to 460 pF; vernier: -3 to $+3$ pF.

Capacitor accuracy: main: $\pm 1\%$ or 1 pF, whichever is greater; vernier: ± 0.1 pF.

Capacitor calibration: main: 1 pF increments 30 to 100 pF, 5 pF increments 100 to 460 pF; vernier: 0.1 pF increments.

Physical characteristics

Mounting: sloping front cabinet, for bench use.

Finish: gray wrinkle, engraved panel (other finishes available on special order).

Dimensions: 21 $\frac{1}{4}$ " wide, 11 $\frac{3}{4}$ " high, 10" deep (540 x 298 x 254 mm).

Weight: net 40 lbs (18 kg); shipping 55 lbs (24.8 kg).

Power: 260A: 95 to 130 V, 60 Hz, 65 W; 260AP: 95 to 130 V, 50 Hz, 65 W.

Accessories available: 00103A Inductors, 00513/00518A Q Standards, 00564A Coupling Unit.

Price: HP 260A, AP, \$990.

Q METER ACCESSORIES

Q standards, inductors, coupling transformer
Models 00513A, 00518A, 00103A, 00564A

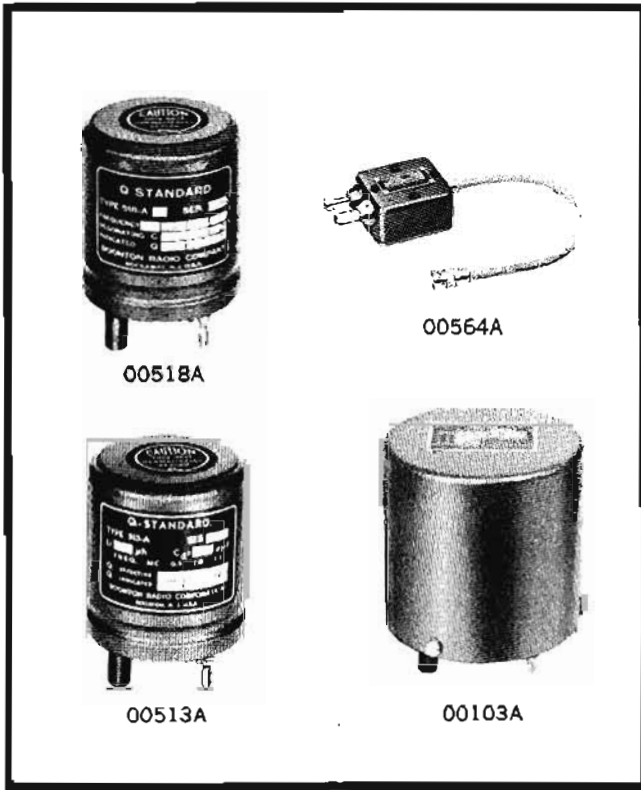

00103A Inductors

The HP 00103A Inductors are designed specifically for use in the Q circuit of the 160A and 260A Q Meters, for measuring the RF characteristics of capacitors, insulating materials, resistors, etc. Price: HP 00103A, \$18 each; HP 00127A, set of 16 inductors for 260A, \$255; HP 00128A, set of 17 inductors for 160A, \$270.

Specifications, 00103A

HP model	Inductance	Approx. resonant frequency for tuning capacitance of:			Approx. Q	Capacitance pF
		400 pF	100 pF	60 pF		
00103-A1	1 μH	8	16	20 MHz	180	6
00103-A2	2.5 μH	5	10	14 MHz	200	6
00103-A5	5 μH	3.5	7	10 MHz	200	6
00103-A11	10 μH	2.5	5	7 MHz	200	6
00103-A12	25 μH	1.5	3	4.5 MHz	200	6
00103-A15	50 μH	1.1	2.2	3 MHz	200	6
00103-A21	100 μH	800	1600	2000 kHz	200	6
00103-A22	250 μH	500	1000	1400 kHz	200	6
00103-A25	500 μH	350	700	1000 kHz	170	7
00103-A31	1 mH	250	500	700 kHz	170	7
00103-A32	2.5 mH	150	300	450 kHz	170	8
00103-A35	5 mH	110	220	300 kHz	160	8
00103-A41	10 mH	80	160	200 kHz	140	9
00103-A42	25 mH	50	100	140 kHz	110	9
		100 pF		35 pF		
00103-A50	0.5 μH	20 MHz		35 MHz	225	5.5
00103-A51	0.25 μH	30 MHz		50 MHz	225	5.5
00103-A52	0.1 μH	45 MHz		75 MHz	225	3.5

00513A Q Standards

HP 00513A Q Standards are shielded reference inductors which have accurately measured and highly stable inductance and Q characteristics. Specifically designed for use with the 160A and 260A Q Meters, the Q standards are particularly useful as a means for checking the overall operation and accuracy of these instruments, as well as for providing precisely known supplementary Q circuit inductance desirable for many impedance measurements by the parallel method. Price: HP 00513A, \$97 each.

Nominal values for HP 00513A				
	L-250 μH		Cd-6 pF	
	0.5 MHz	1 MHz	1.5 MHz	
Q _e	190	250	220	
Q _i	183	234	200	

Actual values of all these quantities are marked on the name plate of the Q standard; with the unit in the Q circuit, approximate resonant frequencies of 500, 1000 and 1500 kHz are obtained with tuning capacitances of 400, 100 and 50 pF, respectively.

00518A Q Standards

HP 00518A Q Standards, used in conjunction with the 00513A Q Standards, provide frequency coverage from 50 kHz to 50 MHz—the entire range of the 260A Q Meter. These units are useful as precision inductors and as a fast, convenient means for checking the overall operating accuracy of Q meters. Price: HP 00518A, \$97 each; HP 00538A, set of five 00518A and one 00513A, \$525.

Specifications, 00518A

HP model	00518-A1	00518-A2	00518-A3	00518-A4	00518-A5
Inductance	0.25 μH	2.5 μH	25 μH	2.5 mH	25 mH
Low freq. data:					
Frequency	15 MHz	5 MHz	1.5 MHz	150 kHz	50 kHz
Resonating C	420 pF	395 pF	440 pF	440 pF	400 pF
Indicated Q	175	195	175	170	90
Middle-freq. data:					
Frequency	30 MHz	10 MHz	3 MHz	300 kHz	100 kHz
Resonating C	100 pF	95 pF	105 pF	100 pF	85 pF
Indicated Q	235	235	225	180	130
High-freq. data:					
Frequency	45 MHz	15 MHz	4.5 MHz	450 kHz	150 kHz
Resonating C	40 pF	40 pF	45 pF	40 pF	35 pF
Indicated Q	225	205	230	135	125

(Table shows nominal values)

00564A Coupling Transformer

The 00564A Coupling Transformer Unit is designed to couple the output of an external oscillator into the 160A or 260A Q Meter for the purpose of extending the operation range of the Q meter to the low-frequency region. By means of the coupling unit and an auxiliary oscillator, the Q meter may be operated down to a low-frequency limit of 1 kHz. The oscillator should supply a variable voltage of 22 volts maximum into an impedance of 500 ohms. Price: HP 00564A, \$40.



Q METER, INDUCTORS

Direct Q measurements, 20 to 260 MHz
Models 190A, 00590A

190A Q Meter

The HP 190A Q Meter finds applications similar to those described for the 260A Q Meter (page 264), but in the VHF range of frequencies. This instrument does not have a thermocouple, but employs a special coupling impedance to introduce voltage across the series-tuned, resonant circuit. This voltage, as well as the reactive voltage developed across the internal Q capacitor, is measured by two high-impedance, low input capacitance vacuum tube voltmeters and indicated on a single front-panel parallax-free meter.

Specifications, 190A

Radio frequency characteristics

RF range: total range: 20 to 260 MHz; number bands: 4; band ranges: 20 to 40 MHz, 40 to 80 MHz, 80 to 160 MHz, 160 to 260 MHz.

RF accuracy: $\pm 1\%$.

RF calibration: increments of approximately 1%.

Q measurement characteristics

Q range: total range: 5 to 1200; low range: 10 to 100; Δ range: 0 to 100.

Q accuracy: $\pm 7\%$ 20 to 100 MHz; $\pm 15\%$ 100 to 260 MHz (for circuit Q of 400 read directly on indicating meter).

Q calibration: main scale: increments of 10 from 50 to 400; low scale: increments of 2 from 10 to 100; Δ scale: increments of 2 from 0 to 100; XQ scale: increments of 0.1 from 0.5 to 1.5, increments of 0.5 from 1.5 to 3.

Resonating capacitor characteristics

Capacitor range: 7.5 to 100 pF.

Capacitor accuracy: ± 0.2 pF, 7.5 to 20 pF; ± 0.3 pF, 20 to 50 pF; ± 0.5 pF, 50 to 100 pF.

Capacitor calibration: 0.1 pF increments.

Accessories available: 00590A Inductors.

Physical characteristics

Dimensions: 14 $\frac{1}{4}$ " wide, 10 $\frac{1}{8}$ " high, 10 $\frac{1}{2}$ " deep (362 x 257 x 267 mm).

Weight: net 25 lbs (11.3 kg); shipping 32 lbs (14.4 kg).

Power: 190A: 95 to 130 volts, 60 Hz, 55 watts; 190 AP: 115/230 volts, 50 Hz, 55 watts.

Price: HP 190A, AP, \$1075.

00590A Inductors

HP 00590A Inductors are designed specifically for use in the Q Circuit of the 190A Q Meter for measuring the radio-frequency characteristics of capacitors, resistors, and insulating materials. They have general usefulness as reference coils and may be used for periodic checks to indicate any considerable change in the performance of the Q meters.

Specifications, 00590A

HP model	Inductance μ H	Capacitance pF	Approx. resonant freq. MHz	Approx. Q	Approx. distributed C pF
00590-A1	0.05	95-7.5	70-230	350	1.5
00590-A2	0.1	95-7.5	50-160	320	1.7
00590-A3	0.25	100-7.5	30-100	380	2.3
00590-A4	0.5	80-7.5	25-70	360	2.3
00590-A5	1.0	60-7.5	20-50	350	2.9
00590-A6	2.5	15-8.0	20-30	330	2.9

Price: HP 00590A, \$18 each; HP 00591A, complete set of six \$95.

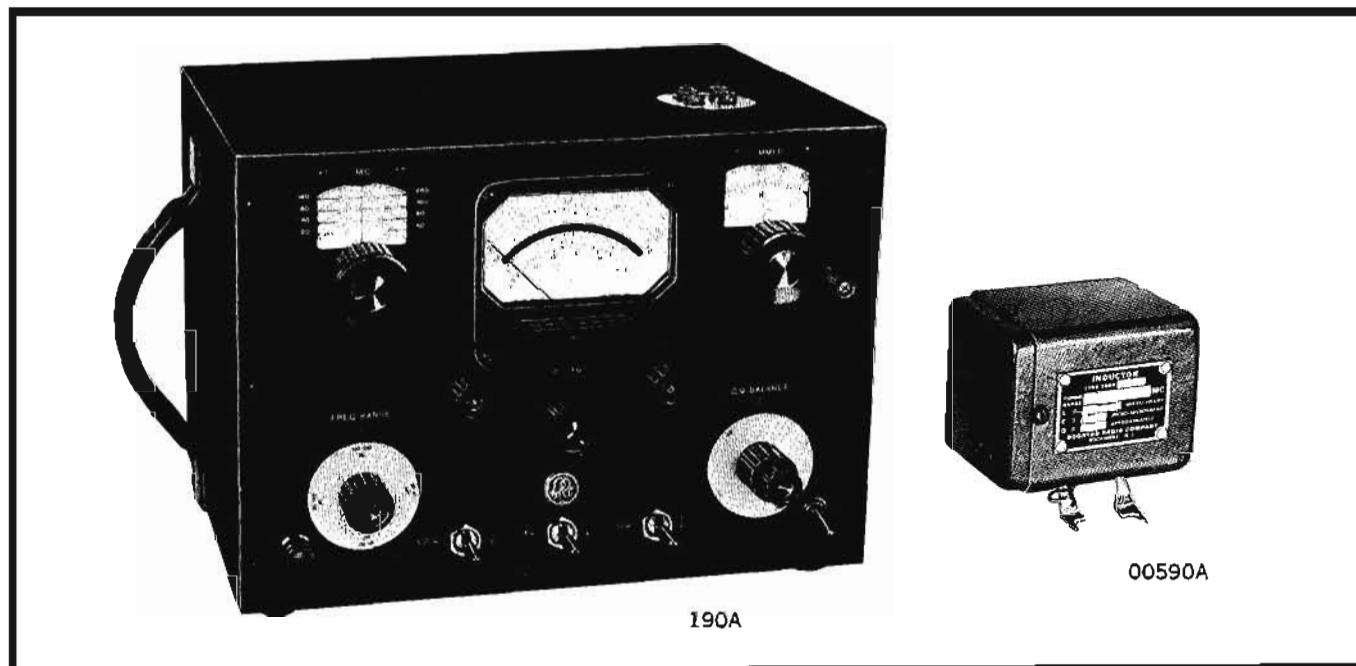

190A

00590A

SWR, REFLECTION COEFFICIENT MEASUREMENT



IMPEDANCE

Impedance-matching a load to its source is one of the most important considerations in microwave transmission systems. If the load and source are mismatched, part of the power is reflected back along the transmission line toward the source. This reflection not only prevents maximum power transfer, but also can be responsible for erroneous measurements of other parameters, or even cause circuit damage in high-power applications.

The power reflected from the load interferes with the incident (forward) power, causing standing waves of voltage and current to exist along the line. The ratio of standing-wave maxima to minima is directly related to the impedance mismatch of the load. The standing-wave ratio (swr), therefore, provides a valuable means of determining impedance and mismatch.

Slotted line measurements

Standing-wave ratio can be measured directly using a slotted line. Until recently, slotted line measurements were limited to fixed frequencies in a setup similar to that illustrated in Figure 1.

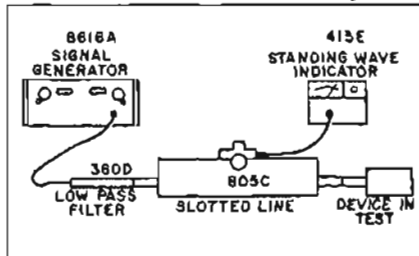

Figure 1. Typical setup for swr and impedance measurements in coax using HP 805C Slotted Line.

The slotted line is placed immediately ahead of the load in test, and the source is adjusted for 1 kHz amplitude modulation at the desired microwave frequency. The slotted line probe is loosely coupled to the RF field in the line, thus sensing relative amplitudes of the standing-wave pattern as the probe is moved along the line. The ratio of maxima to minima (swr) is then read directly on the swr meter.

While this method works very well for fixed-frequency testing, it is very cumbersome for broadband applications. The number of discrete measurements necessary to insure complete coverage across a frequency range is determined by the degree of confidence required that a sharp resonance or hole does not exist, and for a high confidence factor, the number of measurements must be very high.

The solution to broad-band measure-

ments is the swept-frequency technique. This method provides continuous coverage across the frequency range of interest. Measurements of swr of coaxial devices operating below about 2 GHz and waveguide devices is accomplished with the reflectometer (see below). However, the low directivity of coaxial directional couplers operating above 2 GHz seriously limits accuracy in coax at these higher frequencies.

The swept slotted line

A new technique which combines the speed and convenience of swept-frequency measurements and the inherent accuracy of the slotted line is now available. With the fully tested 817A Slotted Line System (816A Coaxial Slotted Line, 809C Carriage with an 11558A Baseplate, and 448A Slotted Line Sweep Adapter) this technique can be used throughout the range from 1.8 to 18 GHz (see page 272). The signal source is a sweep oscillator and the readout device is an oscilloscope.

The measurement technique is much the same as for fixed-frequency measurements. A detecting probe is moved along the slotted line a distance of at least one

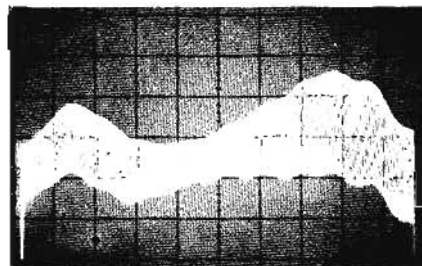

Figure 2. Multi-sweep slotted-line measurement. Vertical scale 0.5 dB/cm (swr=1.12/cm).

half wavelength at the lowest frequency so that both maximum and minimum voltages of the standing waves are sampled. However, instead of the plot being a single vertical line, which would be the case in a fixed-frequency measurement, it is a smear or envelope as shown in Figure 2. At any given frequency, the ratio of the maximum and minimum amplitude of the envelope is the swr.

Measurement of low swr requires sensitive readout devices to resolve the maxima and minima adequately. Therefore, the signal source must be leveled to keep the entire plot on scale. The 448A, comprising a slotted section and two matched detectors, effectively levels the sweeper output and monitors the standing waves in the 816A Slotted Line. No additional probe is required for the 816A.

A storage oscilloscope such as the HP

141A is ideal for these measurements. The entire plot can be generated in a few seconds and retained on the CRT face for evaluation or photography. Time-exposure photography and a conventional oscilloscope such as the HP 140A can also be used. The HP 1416A Swept-Frequency Indicator, a plug-in for both the 140A and 141A Oscilloscopes, provides additional convenience with its logarithmic calibration. No zero-level reference is needed, and swr is indicated directly in dB when the detector is operated in its square-law region. An X-Y recorder such as the Moseley 7035A can also be used to plot swept swr measurements. The recorder can be driven by an HP 415E SWR Meter, which not only provides ample gain but permits direct calibration of the recorder.

Accuracy of slotted-line measurements is limited primarily by the residual swr of the line itself, 1.01 in waveguide and 1.02 to 1.06 in coax depending upon the frequency and type of connector. However, there are other considerations. Penetration of the detector probe into the line should be kept to a minimum to prevent standing waves due to the probe itself. Elimination of harmonics from the signal source is also important. HP 360, 362, and 8430 filters are excellent for this purpose.

Reflectometer techniques

The reflection coefficient (ρ) of a device or system is another useful term in establishing the impedance match of microwave devices. The following relationships of ρ and swr are frequently used in impedance work:

$$|\rho| = \frac{E_{\text{reflected}}}{E_{\text{incident}}} = \frac{\text{swr} - 1}{\text{swr} + 1}$$

The amplitude of reflected voltage with respect to the incident voltage is given in terms of dB *return loss* by the expression: $\text{dB} = -20 \log_{10} |\rho|$. For example, if the reflected signal from a test device is 26 dB below the incident signal level, the reflection coefficient of the device is calculated as 0.05. In a like manner, any reflection coefficient from zero to one can be determined by a measure of the return loss.

The reflection coefficient of a load can be measured by separating the incident and reflected waves propagated in the transmission line connecting the source and load. The reflectometer uses directional couplers to accomplish this separation in both waveguide and coaxial systems. Reflectometers permit continuous oscilloscope displays or permanent



x-y recordings of reflection coefficient across complete operating bands.

Incident power in the improved reflectometer is held constant by the leveling action of the sweep oscillator and crystal detector sampling the incident wave from the forward coupler. With incident power held constant, only the relative amplitude of the reflected wave need be measured to determine reflection coefficient. This technique permits better accuracy than older systems, and fast sweep speeds enabling the use of oscilloscope displays. See Figure 3.

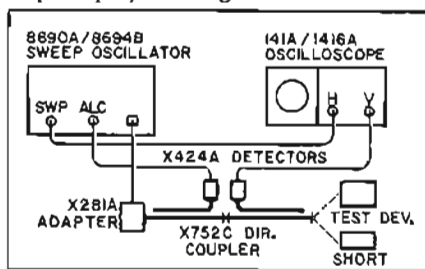

Figure 3. Typical Waveguide Reflectometer.

Reflectometer calibration

To calibrate the reflectometer, a short circuit is placed at the output port, thus reflecting all of the incident power. The detector in the reverse-arm coupler samples the reflected power and provides a proportional dc voltage for readout. By placing a calibrated attenuator ahead of the detector, specific amounts of return loss may be pre-inserted for calibration of the oscilloscope or recorder gain. The attenuator is then returned to zero, the short removed and the test device connected and measured on the pre-calibrated display.

Calibration also is possible without the pre-insertion attenuator if the detector law is known and the vertical response of the readout device constant. Calibration levels with this technique are established with the rf turned off (corresponding to no reflection), then with all of the power reflected by a sliding short. Reflections falling between these limits are then read from the oscilloscope graticule or directly from calibrated transparent overlays such as furnished with HP Application Note 65. The HP 140A Oscilloscope with its 1416A plug-in eliminates the need for overlays. With logarithmic calibration, the 140A/1416A provides return loss directly in dB.

Reflectometer calculator

Time-consuming calculations of return loss and conversion of ρ to SWR may be eliminated by using an HP Reflectometer

Calculator. This slide-rule-type aid provides continuous scales of ρ , SWR and return loss, which may be positioned under a cursor for instant conversion of terms. Other useful information such as ambiguity in reflectometer measurements, mismatch loss and phase and amplitude mismatch errors are included on the calculator. It may be obtained from your HP field engineer upon request.

Reflectometer errors

The overall measurement accuracy of leveled reflectometer systems such as described here may be closely approximated by considering the various sources of error separately, then taking the rms average. These errors may be classified as being due to imperfect components comprising the reflectometer as follows:

- 1) directional couplers
- 2) detectors
- 3) attenuator used in calibration
- 4) display or readout instrument

One of the primary errors introduced by directional couplers is the directivity signal. Directivity of a coupler refers to its ability to distinguish between forward and reverse power flowing in the main arm. Since reflectometry is based on the separation of incident and reflected power by use of the directional couplers, high directivity is essential to accurate measurements. Any incident power passing to the reverse coupler auxiliary output (because of imperfect directivity) will add in unknown phase with the actual reflected signal from the load in test. The result is an ambiguity in the voltage level at the reverse coupler output. The ambiguity caused by reverse coupler directivity can be determined in terms of reflection coefficient by substituting the directivity (in dB) into the return loss equation given earlier. Thus, for a reverse coupler directivity of 40 dB, the ambiguity in ρ is ± 0.01 .

The ambiguity caused by the *forward* coupler directivity also must be considered, particularly when measuring large reflections. If directivity is not infinite, part of the signal reflected from the test load will appear at the auxiliary arm output of the forward coupler. This directivity signal adds vectorially with the incident signal, producing an ambiguity in the incident power level. The ambiguity is proportional to the magnitude of load reflection and forward coupler directivity and may be calculated as follows:

$$\Delta\rho = \pm\rho \left(\log^{-1} \frac{\text{dB}}{20} \right)$$

where dB = coupler directivity
 ρ = reflection coefficient of test load.

Primary factors to be considered in the detectors are frequency response, deviation from square law and mismatch. Using HP 423A or 424A Crystal Detectors, frequency response is typically flat to within ± 0.2 dB per octave and deviation from square law less than ± 0.2 dB over a 20 dB dynamic range. These two errors can be evaluated in terms of reflection coefficient ambiguity by alternately adding and subtracting the dB values to the return loss actually measured. The errors caused by these two factors can be eliminated by using the pre-insertion attenuator for initial system calibration. Error due to mismatch between HP 752 Waveguide Couplers and 424A Detectors is typically less than $\pm 3\%$ of the ρ measured. This includes the total effects of detector mismatch in the incident coupler used for leveling feedback and the reverse arm measuring reflected voltage from the load.

The use of a pre-insertion attenuator for calibration eliminates some detector errors but introduces error of its own. The dial accuracy of the attenuator and mismatch considerations lead to the following expression for the error introduced in the measured reflection coefficient:

$$\Delta\rho = \rho(1 - \rho^{20.02} \pm 0.015)$$

where ρ = reflection coefficient of the test load.

When the attenuator is not used for calibration, the readout or display device causes error in the measured ρ . The effects of non-linearity, instability and resolution are factors which must be considered. When using HP 130C or 140A Oscilloscopes for measuring small ratios (≈ 1), accuracies of 2% are reasonable. Ratios of 30 dB ($\rho \approx 0.03$) can be determined with about 4% accuracy.

The total effects of these errors can be conservatively estimated as follows using the HP equipment mentioned.

1. Using the 382A attenuator pre-insertion technique, $\Delta\rho = \pm(0.01 + 0.05\rho)$.
2. Using the straightforward oscilloscope technique, $\Delta\rho = \pm(0.011 + 0.04\rho)$.

A more complete discussion and error analysis of reflectometer systems is included in HP Application Note 65, "Swept Frequency Techniques."

SWR METER

Reduced noise for greater usable range
Model 415E



IMPEDANCE

The Hewlett-Packard Model 415E SWR Meter is a low-noise tuned amplifier-voltmeter calibrated in dB and swr for use with square-law detectors. It is an extremely useful and versatile instrument, measuring swr, attenuation, gain, or any other parameter determined by the ratio of two signal levels. The standard tuned frequency is 1000 Hz and is adjustable over a range of about 7% for exact matching to the source modulation frequency. Amplifier bandwidth is also adjustable, from 15 to 130 Hz. The narrow bandwidth facilitates single-frequency measurements by reducing noise, while the widest setting accommodates a sweep rate fast enough for oscilloscope presentation.

The 415E has a very low noise figure, less than 4 dB. This represents a 6 to 10 dB improvement over other swr meters. Equally significant is the fact that the noise figure has been optimized for source impedances presented by detectors most often used with swr meters. As a result the 415E has greater measurement range because the reduction in noise permits the measurement of lower-level signals for a given signal-to-noise ratio.

A precision 60-dB attenuator with an accuracy of 0.05 dB/10 dB assures high accuracy in attenuation measurements. In addition, an expand-offset feature allows any 2-dB range to be expanded to full scale for maximum resolution. Linearity on the expanded ranges is ± 0.02 dB, permitting full utilization of the increased resolution; high accuracy is possible on the normal scales as well, for linearity is limited only by meter resolution. The meter itself has individually calibrated, mirror-backed scales plus a rugged taut-band movement for full realization of the inherently high accuracy, resolution, and linearity of the instrument.

The Model 415E operates with either crystal or bolometer detectors. Both high- and low-impedance inputs are available for crystal detectors (see page 287), optimum crystal source impedances being 50 to 200 and 2500 to 10,000 ohms respectively. For operation with bolometers, the 415E provides precise bias currents of 4.5 and 8.7 mA into 200 ohms, as selected at the front panel. This basis is peak limited for positive bolometer protection.

Both ac and dc outputs are provided for use of the 415E as a high-gain tuned amplifier and with recorders. The solid-state 415E can be operated with an internally mounted battery pack (optional extra) for completely portable use or to eliminate ground loops.

Specifications

Sensitivity: 0.15 μ V rms for full-scale deflection at maximum bandwidth (1 μ V rms on high impedance crystal input).

Noise: at least 7.5 dB below full scale at rated sensitivity and 130 Hz bandwidth with input terminated in 100 or 5000 Ω ; noise figure less than 4 dB.

Range: 70 dB in 10- and 2-dB steps.

Accuracy: ± 0.05 dB/10-dB steps; maximum cumulative error between any two 10-dB steps, ± 0.10 dB; maximum cumulative error between any two 2-dB steps, ± 0.05 dB; linearity, ± 0.02 dB on expand scales, determined by inherent meter resolution on normal scales.

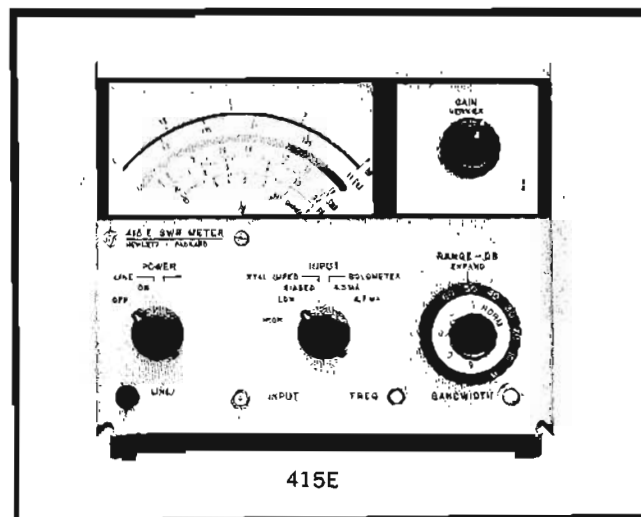

Input: unbiased low and high impedance crystal (50-200 and 2500-10,000 Ω optimum source impedance respectively for low noise); biased crystal (1 V into 1 k Ω); low and high current bolometer (4.5 and 8.7 mA $\pm 3\%$ into 200 Ω), positive bolometer protection; input connector, BNC female.

Input frequency: 1000 Hz adjustable 7%; other frequencies between 400 and 2500 Hz available on special order.

Bandwidth: variable, 15-130 Hz; typically less than 0.5 dB change in gain from minimum to maximum bandwidth.

Recorder output: 0-1 V dc into an open circuit from 1000 Ω source impedance for ungrounded recorders; output connector, BNC female.

Amplifier output: 0-0.3 V rms (Norm), 0-0.8 V rms (Expand) into at least 10,000 Ω for ungrounded equipment; output connector, dual banana jacks.

Meter scales: calibrated for square-law detectors; SWR: 1-4, 3.2-10 (Norm); 1-1.25 (Expand). dB: 0-10 (Norm); 0-2.0 (Expand); battery: charge state.

Meter movement: taut-band suspension, individually calibrated mirror-backed scales; expanded dB and swr scales greater than 4 1/4 in. (108 mm) long.

RFI: conducted and radiated leakage limits are below those specified in MIL-I-6181D.

Power: 115-230 V $\pm 10\%$, 50-400 Hz, 1 W; optional rechargeable battery provides up to 36 hr continuous operation.

Dimensions: 7 25/32 in. wide, 6 3/32 in. high, 11 in. deep from panel (190 x 155 x 279 mm).

Weight: net, 8 lb (3.6 kg), 11 lb (5 kg) with battery; shipping, 11 lb (5 kg), 13 lb (6.3 kg) with battery.

Accessory available: 11057A Handle, fits across top of instrument for carrying convenience, \$5.

Combining cases: 1051A, 11 1/4 in. (286 mm) deep, \$110; 1052A, 16 3/4 in. (416 mm) deep, \$120.

Price: HP Model 415E, \$350.

Options: 01. rechargeable battery installed, add \$100; 02. rear-panel input connector in parallel with front-panel connector, add \$15.



SWR INDICATOR; MOUNTS

For convenient swr measurements

Models 415B; 476A, 485B

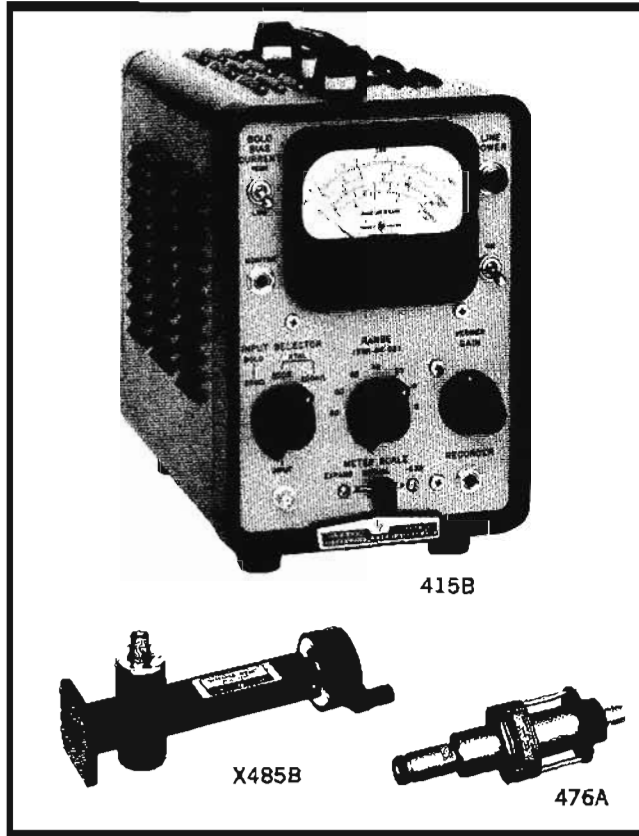

415B Standing Wave Indicator

Similar to the HP 415E, this meter is a tuned voltmeter for swr measurements with HP slotted lines and detector mounts. It also is useful as a null indicator for bridge measurements, with a 200 k Ω input circuit for this use.

A 60 dB attenuator adjustable in 10 dB range steps provides a calibrated range of 70 dB. An output is provided for use with a recording milliammeter, and a special 5 dB attenuator is incorporated to increase resolution through use of the upper portion of the logarithmic meter scale.

Inputs include a 200-ohm termination with bias of 4.3 or 8.7 mA for bolometers, unbiased for crystals, or a 200 k Ω load for null measurements. A jack and monitor cable are provided for connecting an external milliammeter to measure bolometer current.

Specifications, 415B

Input: "Bolo" (200 ohms), bias provided for 8.7 or 4.3 mA bolometer or 1/100 amp fuse; "Crystal" (200 ohms) for crystal rectifier; "Crystal" (200 k Ω) high impedance for crystal rectifier as null detector; BNC connector.

Sensitivity: 0.1 μ V at 200 ohms for full-scale deflection.

Noise: at least 5 dB below full scale when operated from 200-ohm resistor at room temperature.

Frequency: 1000 Hz \pm 2%; other frequencies, 315 to 2020 Hz, available on special order; should not be harmonically related to power line frequency.

Bandwidth: 30 Hz (nominal).

Range: 70 dB; input attenuator provides 60 dB in 10 dB steps, accuracy \pm 0.1 dB per 10 dB step; maximum accumulative error, \pm 0.2 dB.

Scale selector: "Normal", "Expand" and " -5 dB".

Output: jack provided for recording milliammeter having 1 mA full-scale deflection and internal resistance of 1500 ohms or less.

Meter scales: swr 1 to 4, swr 3 to 10, expanded swr 1 to 1.3; dB 0 to 10, expanded dB 0 to 2.

Power: 115 or 230 volts \pm 10%, 50 to 60 Hz, 55 watts.

Dimensions: cabinet: 7 $\frac{1}{2}$ " wide, 11 $\frac{3}{4}$ " high, 12 $\frac{1}{2}$ " deep (191 x 299 x 318 mm); rack mount: 19" wide, 6-31/32" high, 10 $\frac{7}{8}$ " deep behind front panel (483 x 177 x 276 mm).

Weight: net 13 lbs (5.9 kg), shipping 15 lbs (6.8 kg) (cabinet); net 17 lbs (7.7 kg), shipping 27 lbs (12.2 kg) (rack mount).

Accessories available: plug-in filters (specify frequency): 415B-42B (315 to 699 Hz), \$60, and 415B-42C (700 to 2000 Hz), \$50; 10501A Cable Assembly, \$4; 10503A Cable Assembly, \$7.

Price: HP 415B, \$275 (cabinet); HP 415BR, \$280 (rack mount).

476A Bolometer Mount

Model 476A Bolometer Mount covers the 10 MHz to 1 GHz frequency range with very low standing wave ratio. The inherently good square law characteristics of the bolometers used make the 476A especially useful for calibrating attenuators when used with an HP 415 Series Meter.

Specifications, 476A

Nominal impedance: 50 ohms.

Reflection coefficient: 50 to 500 MHz, \leq 0.07 (1.15 swr, 23.1 dB return loss); 25 to 1000 MHz, \leq 0.11 (1.25 swr, 19.1 dB return loss); 10 to 25 MHz, \leq 0.2 (1.5 swr, 14 dB return loss).

Maximum power level: 10 mW.

Bolometer element: four 8.25 mA instrument fuses (supplied with mount); operating level is approximately 200 ohms, positive temperature coefficient.

Replacement elements: Part #2110-0024, \$1 each.

Weight: net 1 lb (0.5 kg); shipping 2 lbs (0.9 kg).

Price: HP 476A, \$85.

485B Detector Mounts

The HP 485B Detector Mounts (5.3 to 12.4 GHz) permit the accurate matching of waveguide sections to a bolometer element. The mounts are tuned by a variable short, and they can be used with a barretter or, where swr is not critical, with a silicon crystal.

Specifications, 485B

HP Model	Frequency range (GHz)	Maximum swr ¹	Fits waveguide size		Length		Price
			(In.)	(EIA)	(In.)	(mm)	
J485B ²	5.85 - 8.2 5.50 - 5.85 5.30 - 5.50	1.25 1.35 1.50	1 $\frac{1}{2}$ x $\frac{3}{4}$	WR137	8 $\frac{3}{4}$	213	\$120
H485B ²	7.05 - 10	1.25	1 $\frac{1}{4}$ x $\frac{3}{8}$	WR112	6 $\frac{3}{8}$	162	\$100
X485B ²	8.2 - 12.4	1.25	1 x $\frac{1}{2}$	WR90	6-7/16	163	\$ 75

¹With Narda N821 barretter

²May use 1N21 or 1N23 for maximum detection sensitivity where swr is not critical

Detector elements are not supplied

RATIO METER

Simplified reflection coefficient measurements

Model 416B



IMPEDANCE

Advantages:

- Eliminates amplitude-variation error
- Operates accurately over 20:1 incident power range

Use:

- Reflection coefficient measurements over broad frequency range, independent of rf power level

The HP 416B is designed for use with unlevelled sweep oscillators and signal sources in the measurement of reflection coefficient. The ratio meter provides valid results inde-

pendent of incident power variations as high as 20:1. Either swept- or fixed-frequency measurements can be made using the Model 416B, and a high-impedance output on the rear of the instrument permits swept-frequency measurements to be presented on an oscilloscope or preserved on a graphic recorder. The panel meter is calibrated in percent reflection and equivalent swr.

The 416B operates with either crystals or bolometers, and a panel switch permits selection of 4.3 or 8.7 mA bias for bolometers. Positive bolometer protection is provided.

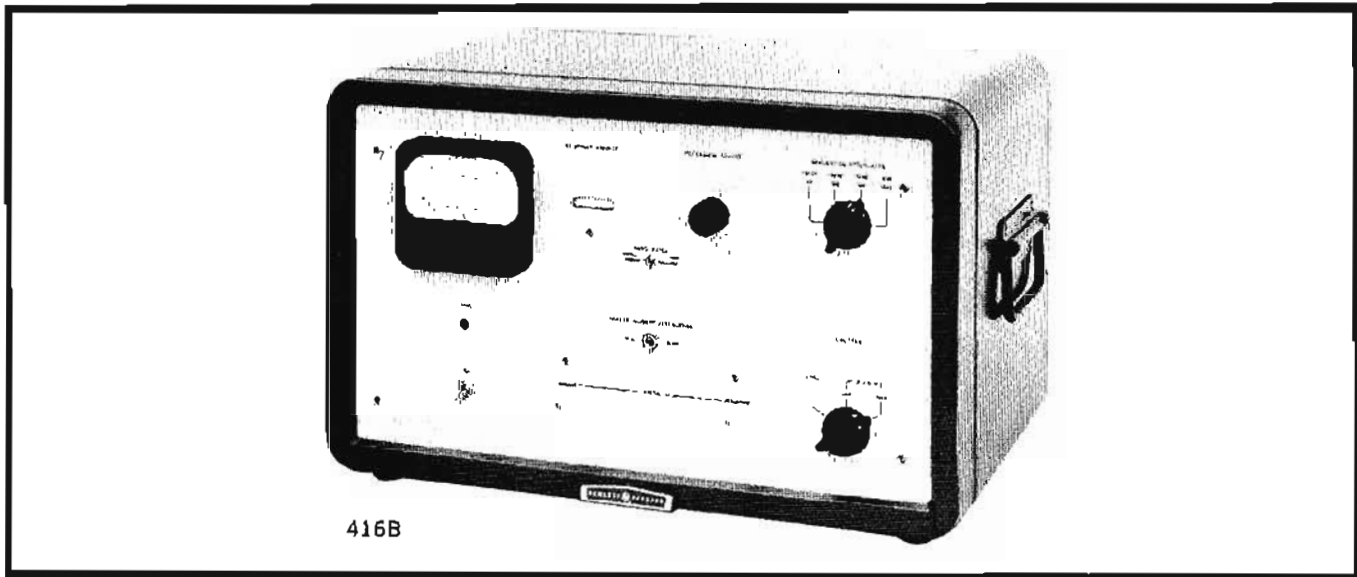

Specifications

Meter presentation

Reflection coefficient (%): four ranges, 100%, 30%, 10% and 3% reflection, equivalent to reflection coefficients of 1, 0.3, 0.1 and 0.03.

Equivalent swr: two ranges, 1.06 to 1.22 and 1.2 to 1.9.

dB: for use with both reflection coefficient and equivalent swr scales; scale calibrated 0 to -10 dB; with ranging, spans 0 to -40 dB in four 10-dB steps.

Accuracy: crystal, $\pm 3\%$ of full scale; bolometer, same as crystal except $\pm 5\%$ for incident input voltage below 1 mV.

Calibration: square law for use with crystal detectors or barretters.

Frequency: 1000 Hz ± 40 Hz (± 20 Hz for bolometer detectors when incident input voltage is < 1 mV rms).

Input voltage (for full-scale deflection):

	Crystal	Bolometer
Incident channel	3 to 100 mV rms	0.3 to 10 mV rms
Reflected channel	3 μ V to 100 mV rms	0.3 μ V to 10 mV rms

Input impedance (both channels): crystal, approximately 75 k Ω ; bolometer, approximately 500 Ω (High Bolo) or 1000 Ω (Low Bolo).

Excess incident attenuation: provision for 10 dB increase of incident channel sensitivity for reflectometers using couplers with different coefficients; under certain circumstances, accuracies can be improved by this procedure.

Output

Open circuit voltage: approx. 10 V dc at full scale.

Source impedance: 100 k Ω ; BNC type connector.

Bolo bias: high range, 8.7 mA; low range, 4.3 mA; bias variable approximately 10% by means of rear-panel control; positive bolometer protection.

RF power monitor: level indicator monitors input amplitude (and frequency, indirectly) to assure proper operating range for the instrument and for crystal detectors.

Power: 115 or 230 volts $\pm 10\%$, 50 to 60 Hz, 115 watts.

Dimensions: cabinet: 20 $\frac{3}{4}$ " wide, 12 $\frac{3}{4}$ " high, 14 $\frac{7}{8}$ " deep (527 x 324 x 378 mm); rack mount: 19" wide, 10 $\frac{1}{2}$ " high, 14" deep behind panel (483 x 267 x 356 mm).

Weight: net 34 lbs (15,3 kg), shipping 45 lbs (20,3 kg) (cabinet); net 28 lbs (12,6 kg), shipping 41 lbs (18,5 kg) (rack mount).

Accessories available: 10503A Cable Assembly, \$7; 11001A Cable Assembly, \$6.

Price: HP 416B, \$675 (cabinet); HP 416BR, \$660 (rack mount).



SLOTTED LINES; DETECTORS

Precision tools for measurements to 40 GHz
Models 805C-817A; 440A-447B, 448A

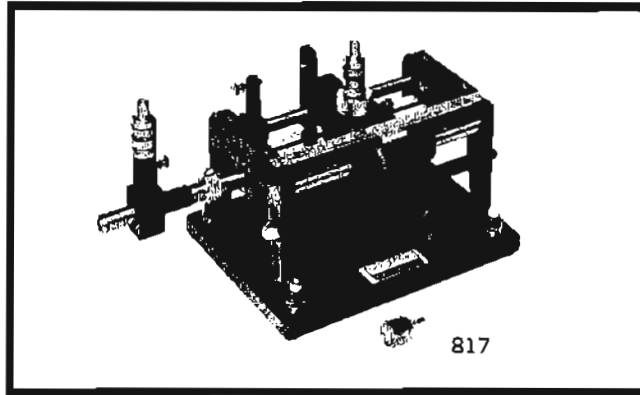

817A Coaxial Swept Slotted Line System

The 817A is a fully tested, complete swept slotted line system that enables you to make accurate swept-frequency swr measurements in coax from 1.8 to 18 GHz. The 817A system consists of an 816A Coaxial Slotted Line, an 809C Carriage with an 11558A Baseplate, and a 448A Slotted Line Sweep Adapter. These items are discussed individually in the succeeding paragraphs. The 817A is provided with Type N female and APC-7 sexless connectors. On an optional basis, both Type N male and female connectors are available.

Specifications

(System consists of 816A Slotted Line, 809C Carriage with 11558A Baseplate, and 448A Slotted Line Sweep Adapter)

Frequency range: 1.8 to 18 GHz.

Impedance: $50\Omega \pm 0.2\Omega$.

Output connector: APC-7 or Type N female, depending upon which end of the 816A is connected to the load (also see option below). Type N connector is stainless steel and mates compatibly with Type N connectors whose dimensions conform to MIL-C-39012 or MIL-C-71.

Residual swr and (reflection coefficient)

APC-7 connector:

1.8 to 8 GHz: 1.02 (0.01).
8 to 12.4 GHz: 1.03 (0.015).
12.4 to 18 GHz: 1.04 (0.02).

Type N connector:

1.8 to 8 GHz: 1.04 (0.02).
8 to 12.4 GHz: 1.05 (0.024).
12.4 to 18 GHz: 1.06 (0.029).

Accessories available: 11524A Adapter, APC-7 to Type N female, \$55; 11525A Adapter, APC-7 to Type N male, \$55.

Dimensions (maximum envelope): 13½ in. long, 7 in. wide, 7 in. high (343 x 178 x 178 mm).

Weight: net 14¾ lbs (6,6 kg); shipping 22 lbs (9,9 kg).

Complementary equipment

HP 8690A Sweep Oscillator with 8692A/B through 8695A RF Unit (page 386).

HP 141A Oscilloscope with 1416A Swept-Frequency Indicator plug-in (page 463).

HP 907A Sliding Load (page 292).

HP 909A Termination (page 292).

Price: Model 817A, \$925.

Option 22: Type N male connector in lieu of APC-7, less \$15.

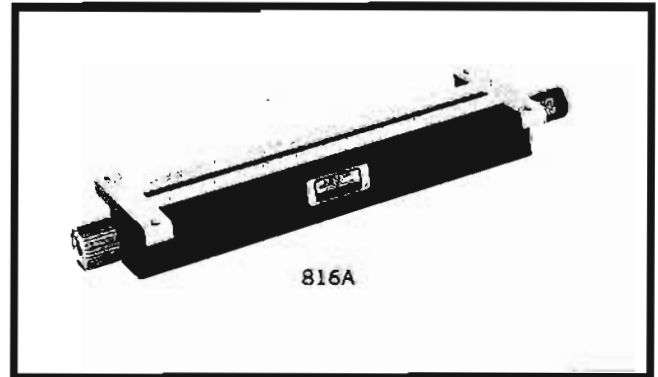

816A Coaxial Slotted Section, 1.8-18 GHz

The 816A enables you to make swept-frequency slotted line measurements from 1.8 to 18 GHz in coaxial systems (HP 448A is required; see below). High accuracy is assured with the low residual swr of the 816A. Thus, you can take advantage of the complete coverage offered by the swept-frequency technique. Fixed-frequency measurements from 2.6 to 18 GHz can also be made using HP 447B Probe (see below). With its broad frequency range, the 816A covers the extremely important X-band (8.2 to 12.4 GHz). In addition, it extends the range of coaxial slotted line measurements through P-band (12.4 to 18 GHz), where there is an increasing use of coaxial devices.

Model 816A consists of two parallel planes and a rigid center conductor. This configuration virtually eliminates slot radiation and minimizes the effect of variation in probe penetration and centering. It also provides greater mechanical stability. The 816A is fitted with one APC-7 and one Type N female connector. On an optional basis, the APC-7 can be replaced with a Type N male connector, or both connectors can be APC-7's. Other combinations are available on special order.

Specifications, 816A

Carriage: fits HP 809C Carriage.

Frequency range: 1.8 to 18 GHz (depends upon probe).

Impedance: $50\Omega \pm 0.2\Omega$.

Connectors: one APC-7, one Type N female; either end can be connected to the load; shorting connectors furnished for load phase angle determination.

SWR: APC-7 connector: 1.02 to 8 GHz, 1.03 to 12.4 GHz, 1.04 to 18 GHz; **Type N female connector:** 1.04 to 8 GHz, 1.05 to 12.4 GHz, 1.06 to 18 GHz.

Slope and irregularities: 0.1 dB per half wavelength, 0.2 dB maximum cumulative when adjusted on 809C Carriage.

Length: 9¾ in. (248 mm).

Weight: net 1¼ lbs (0,6 kg); shipping, 3 lbs (1,4 kg).

Accessories furnished: 11512A Type N male short; 11565A APC-7 short.

Price: HP 816A, \$250.

Option 11: both connectors APC-7, add \$25.

Option 22: Type N male connector in lieu of APC-7, less \$15.

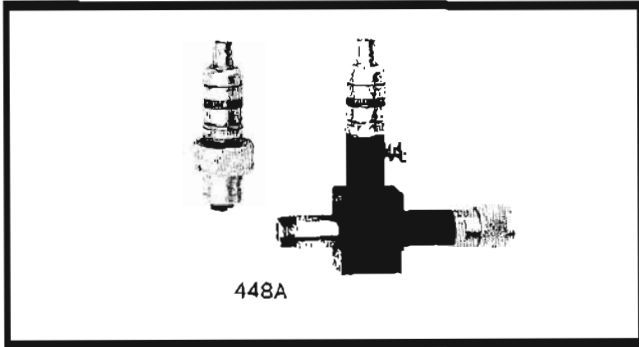

448A

448A Slotted Line Sweep Adapter, 1.8-18 GHz

The HP 448A permits accurate swept-frequency swr measurements in coax from 1.8 to 18 GHz with the 816A Slotted Section. (See pages 255, 256 for a discussion of swept-frequency slotted line measurement techniques.) The 448A includes a short slotted section and two matched detectors with adjustable probes. One detector fits in the slotted section of the 448A, and its output levels the signal source, a sweep oscillator such as the HP 8690A. The other detector monitors the standing waves in the HP 816A Slotted Section.

Specifications, 448A

Frequency range: 1.8 to 18 GHz.

Equipment supplied: one fixed slotted section, one pair of matched detectors with adjustable probes.

Connectors: slotted section, Type N, one male, one female; detectors, BNC female.

Slotted section: HP 816A mounted in HP 809C Carriage.

Weight: net 14 oz (0,39 kg); shipping 2 lbs (0,9 kg).

Price: HP 448A, \$400.

810B, 815B Slotted Sections, 3.95-40 GHz

The 810B Waveguide Slotted Sections also are designed for use with the 809C Carriage. Each is a precision-manufactured section of waveguide in which a small longitudinal slot is cut. A traveling probe on the 809C Carriage samples the waveguide's electric field along the slot and permits precise plotting of variations along the entire length of probe travel. Ends of the slots are tapered to reduce swr to less than 1.01. The waveguide sections are broached and checked with precision gauges for careful control of guide wavelength. Broaching is essentially a linear cutting stroke which eliminates even the minor surface irregularities inherent with milling cutters. Six waveguide sizes are available.

The 815B Waveguide Slotted Sections are designed to fit the 814B Carriage. Like the lower-frequency slotted sections, each 815B is precision-manufactured, broached and checked with precision gauges for careful control of guide wavelength. The slot is tapered to insure a low swr.

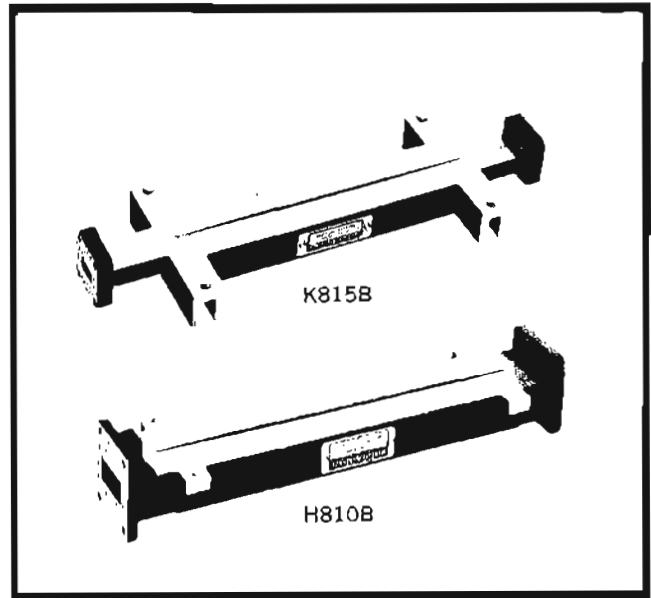

Specifications, 810B

HP Model	Frequency range (GHz)	Fits waveguide size		Equivalent flange	Price
		nom. OD (in.)	EIA		
G810B	3.95-5.85	2 x 1	WR187	UG407/U	\$140
J810B	5.30-8.20	1½ x ¾	WR137	UG441/U	\$125
H810B	7.05-10.0	1¼ x ¾	WR112	UG138/U	\$110
X810B	8.20-12.4	1 x ½	WR90	UG135/U	\$ 90
P810B	12.4-18.0	0.702 x 0.391	WR62	UG419/U	\$110

Carriage: fits 809C Carriage.

Length of all sections: 10¼" (260 mm).

Slope and irregularities: slot discontinuity results in swr < 1.01.

Specifications, 815B

	HP K815B	HP H815B
Frequency range (GHz):	18 to 26.5	26.5 to 40
Residual swr:	1.01	1.01
Equivalent flange:*	UG595/U	UG599/U
Fits waveguide size:	(in.) 1/2 x 1/4 (EIA) WR42	0.360 x 0.220 WR28
Overall length:	7-9/16" (192 mm)	7-9/16" (192 mm)
Price:	\$350	\$400

*Circular flange adapters: K-band (UG425/U) 11515A, \$35 each; R-band (UG381/U) 11516A, \$40 each.

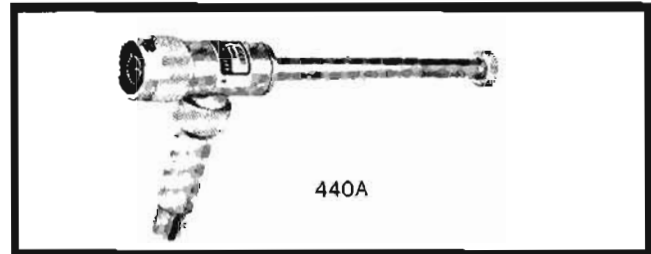

440A

440A Detector Mount

The HP 440A is a tunable, easy-to-use instrument for detecting rf energy in coaxial systems (2.4 to 12.4 GHz) or, in conjunction with the HP 442B, in waveguide or coaxial slotted sections. Just one adjustment is required for tuning. Crystals or bolometers may be used interchangeably in the same holder. A built-in rf bypass is provided. The detector (not supplied) can be a 1N21 or 1N23 Crystal or 821 Series Barreter. Input connector is Type N male; detector output BNC female. Price: HP 440A, \$85.

SLOTTED LINES; DETECTORS *continued*

Precision tools for measurements to 40 GHz
Models 805C - 817A; 440A - 447B; 448A

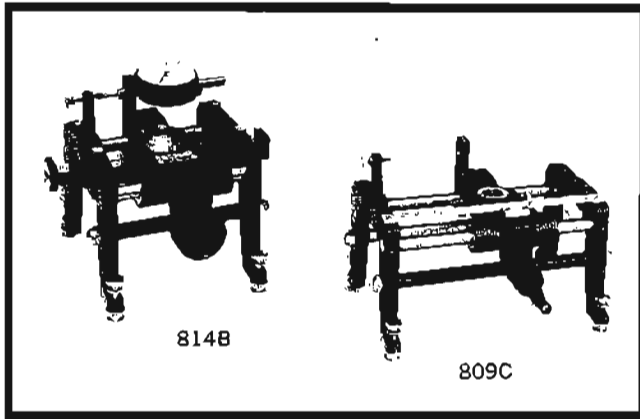
**809C, 814B Carriages**

Model 809C Carriage is a precision mechanical assembly which operates with five HP 810B Waveguide Slotted Sections (3.95 to 18 GHz) and with HP 816A Coaxial Slotted Section (1.8 to 18 GHz). The carriage eliminates the cost of a probe carriage for each frequency band. Sections can be interchanged in seconds. The 809C is designed for use with the HP 444A or 447B Untuned Probe, the HP 442B Broadband Probe, or 448A Slotted Line Sweep Adapter. The carriage has a centimeter scale with a vernier reading to 0.1 mm, and provision also is made for mounting a dial gauge if more accurate probe position readings are required. Price: HP 809C, \$200.

The HP 814B Carriage, also a precision assembly, is designed for use with the HP K and R815B Waveguide Slotted Sections (18 to 40 GHz) and HP 446B Untuned Probe. The carriage is equipped with a dial indicator for accurate reading. Slotted sections are easily interchanged. Price: HP 814B, \$225.

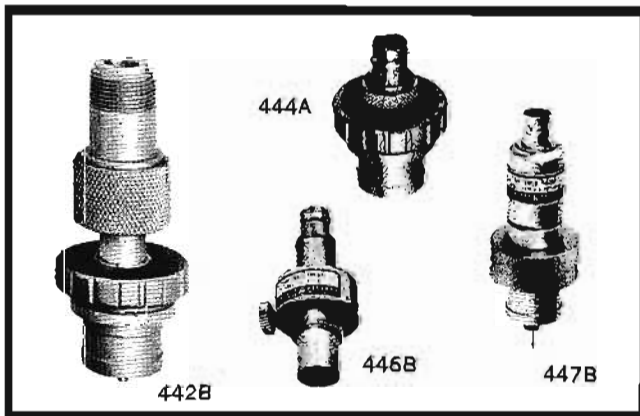
**442B, 444A, 446B, 447B Probes**

Model 442B is a probe whose depth of penetration into a slotted section is variable. Held in position by friction, it may be fixed in place by a locking ring. Sampled rf appears at a Type N jack, permitting direct connection to a receiver, spectrum analyzer or other instrument. It can be connected to a 440A Detector Mount to form a sensitive and con-

venient tuned rf detector for slotted waveguide sections. The 442B fits the 809C Carriage. Price: HP 442B, \$50.

The 444A Untuned Probe consists of a crystal, plus a small antenna in a convenient housing. The probe is held in position by friction or may be fixed by a locking ring. No tuning is required, and sensitivity equals or exceeds many elaborate single- and double-tuned probes. The 444A fits the 809C Carriage or other carriages with a 3/4" (19 mm) mounting hole. Frequency range is 2.6 to 18 GHz. Price: HP 444A, \$55.

The HP 446B is a broadband detector and probe which consists of a modified 1N53 silicon diode in a carefully designed shielded housing. No tuning is required, and probe penetration may be varied quickly and easily. Designed for use with the 814B Carriage, the 446B has a frequency range of 18 to 40 GHz. Price: HP 446B, \$145.

Model 447B consists of a crystal diode detector plus a small antenna probe for sampling energy in coaxial and wave guide slotted sections. The Untuned Probe is extremely sensitive over its entire frequency range of 2.6 to 18 GHz. Such performance is achieved through the use of a unique crystal diode package developed by Hewlett-Packard. With its broad frequency range and high sensitivity, the 447B is ideal for use with HP 816A Coaxial Slotted Section. The Untuned Probe fits HP 809C Carriage or other carriages with a 3/4" (19 mm) mounting hole. Price: HP 447B, \$125.

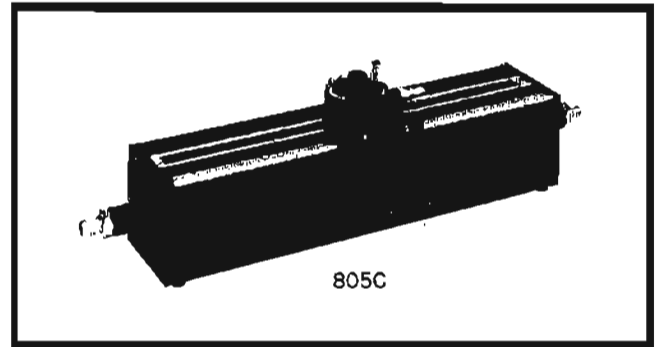
**805C Slotted Line, 500-4,000 MHz**

Model 805C is a coaxial slotted line with an integral probe circuit tunable from 500 to 4,000 MHz. The slotted line consists of two parallel planes and a rigid center connector. This configuration results in negligible slot radiation, minimum sensitivity to variation in probe depth or centering, and greater structural stability.

Specifications, 805C

Frequency range: 500 to 4,000 MHz; minimum frequency determined by usable length of 14 1/2 in. (368 mm).

Impedance: 50Ω; 1.04 swr.

Connectors: Type N, one male, one female; either end may be connected to the load.

Calibration: metric, cm and mm; vernier reads to 0.1 mm.

Detector probe: tunable; element may be 1N21B Crystal (supplied) or 821 Series Barretter or selected 1/100-amp instrument fuse.

Accessories furnished: 11511A female short; 11512A male short.

Price: HP 805C, \$550.

WAVEGUIDE INSTRUMENTATION



COAXIAL, WAVEGUIDE

Coaxial instrumentation

Hewlett-Packard offers a line of coaxial accessories for measurement of swr, attenuation, noise figure, frequency, and other microwave characteristics from dc to 18 GHz. Included in the product line are single and dual directional couplers, thermistor mounts for power meters, frequency meters, slotted lines, pads, loads, filters, and other devices useful in microwave measurements.

Couplers

Flat frequency response couplers, Models 796D-798C, are offered with high directivity for minimizing errors in swept swr reflectometry systems. Flat couplers are very useful for leveling sweep oscillators and can be used to monitor power output of signal sources. The flat frequency response allows the coupler to extend the power range of power meters over broad frequency bands. Dual-directional couplers, Models 774D-777D operate in the range from 215 MHz to 4000 MHz. Model 778D covers the frequency range from 100 MHz to 2000 MHz. It is useful in testing coaxial devices where the frequency range is usually much greater than an octave. Directivity of this coupler exceeds 40 dB to 1000 MHz, 34 dB to 2000 MHz.

Detectors

The Hewlett-Packard 423A and 8470A Crystal Detectors, with flat frequency response from 10 MHz to 12.4 and 18 GHz respectively, offer the optimum in detectors for swept swr and attenuation measurements. These detectors are ideal for sweep oscillator leveling applications because of their very flat frequency response. Also, the flat frequency response of the individual detectors eliminates the need for matched pairs of detectors in most applications. Hewlett-Packard can provide selected pairs with extremely well matched frequency response characteristics if required.

Thermistor mount

Hewlett-Packard Model 478A is a temperature compensated thermistor mount used with the HP 431B and 431 C Power Meters over the frequency range 10 MHz to 10 GHz. Each mount is calibrated for rf efficiency at several points over the band so that power measurements can be

made with the utmost accuracy. In addition, each mount is swept tested over critical parts of the band to ensure that its rf characteristic does not contain "holes", or resonances, over the instrument's bandwidth. A swept frequency test is also made of swr so that mismatch ambiguities can be kept to a minimum.

Frequency meters

Two coaxial frequency meters, Models 536A and 537A, covering the range from 0.96 to 12.4 GHz allow quick and convenient measurement of frequency using the resonant cavity technique. The wavemeter is inserted in the line and tuned until a drop in power is indicated on a detector. The frequency is read directly on the wavemeter's high visibility spiral scale.

Slotted lines

Slotted lines covering the frequency range from 500 MHz to 4 GHz and 2 GHz to 18 GHz (Models 805C and 816A) are available for swr measurements. Residual swr is low for highest accuracy. SWR meters, probes, and detectors, complete the swr measurement setup.

Model 817A can be used for measurements of swr by a swept frequency technique using the 816A Slotted Line. This method presents data of swr versus frequency directly on an oscilloscope. High measurement accuracy is attainable due to the low residual swr of the slotted line. Swept-frequency slotted line measurements are discussed in detail in Application Note 84. This note is available from any HP Field Office upon request.

Attenuators

A deposited resistive thin-film pioneered by Hewlett-Packard is the heart of new wideband flat frequency response pads and attenuators (Models 8491A, B, 8492A and 8493A/B). These components cover the frequency range from dc to 18 GHz. They have excellent frequency response and swr characteristics in this band. Simplified construction techniques and automated swept frequency testing reduce cost so that these precision, quality pads can be provided at a low price.

A full line of these pads is available—3, 6, 10, and 20 dB pads are stock items. Higher attenuation values are available.

The 8492A is furnished with APC-7[®] connectors. These are sexless connectors having an unambiguous mating plane. The sexless connector reduces wear and eliminates the need for male and female adapters. These connectors have low swr up to a frequency of 18 GHz. The 8493A/B uses the OSM[®] connector.

In addition to fixed attenuator pads, a turret attenuator (Model 354A) providing values of 0 to 60 dB in 10 dB steps is available. It is extremely valuable in multi-octave tests which otherwise would require two or more attenuators. It is also useful as an input attenuator for reducing signal drive to mixers or detectors. It operates with a simple knob rotation, i.e., no pull-turn-push sequence is required. These and other coaxial devices are tabulated below. Frequency range of each device and the page on which each item is fully described is listed.

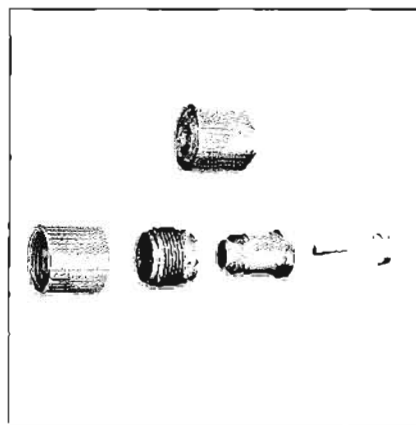

Figure 1. Amphenol APC-7 precision 7-mm coaxial connector.

Waveguide instrumentation

A full line of waveguide instruments is offered by Hewlett-Packard for the measurement of impedance, swr, attenuation, noise figure, power, and many other microwave characteristics. In addition, HP offers components such as waveguide to coax adapters, moving loads and shorts, tuners, low power terminations, etc. These instruments are tabulated by frequency band on the following pages for quick and easy reference. This instru-

[®]Amphenol Precision Connector—7 mm, manufactured by Amphenol RF Division, a division of Amphenol Corporation, Danbury, Conn.

mentation is offered over eight waveguide frequency bands between 2.6 and 40 GHz. Typical operating instrumentation setups are shown in the following pages. In general, the setup shown for one band can be duplicated in other bands.

Construction

Many Hewlett-Packard waveguide instruments are made of die-cast aluminum to attain maximum dimensional and production stability. A broaching technique for cutting the internal waveguide dimensions to very close tolerances can be used on die-cast aluminum. A broach is a long cutting bar similar to a file that is pulled through the casting to cut the interior surfaces. The linear cutting stroke of the broach eliminates minor surface irregularities resulting from use of the milling process. Whereas typical tolerance of milled waveguide tubing is $\pm .003$ inch, precision broaching allows internal dimensions to be controlled to $\pm .001$ inch or less.

The broaching process is very important for instruments such as slotted lines, high directivity directional couplers, sliding loads, and sliding shorts. Smaller tolerances on internal waveguide dimensions provide low swr so maximum accuracy can be obtained in waveguide setups.

Flanges

Each flange of a waveguide instrument is machine lapped after initial sanding belt surface preparation. This process, in addition to ensuring smooth surfaces to obtain the best possible mating, provides a slightly convex surface so that only the innermost area of the mating flanges makes contact. Thus, the tightest possible connection is made between waveguide instruments with the result that leakage is minimized.

Full band testing

Hewlett-Packard performs comprehensive tests of all waveguide instruments to ensure strict conformance to the published specifications over the complete frequency range. Full band testing, pioneered by Hewlett-Packard, makes maximum use of swept-frequency techniques. Unlike spot frequency testing, a full-band swept test gives a complete record over the entire range of the instrument.

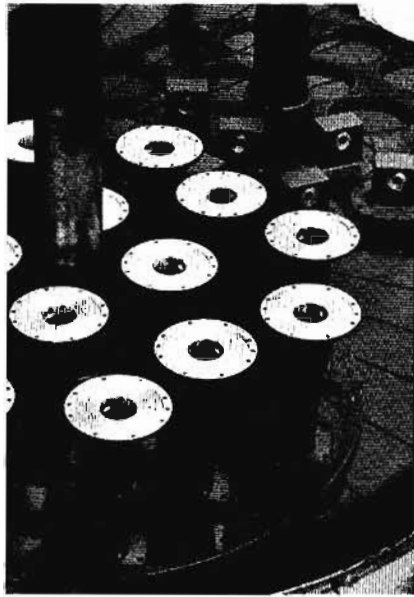

Figure 2. Precise lapping of waveguide flanges insures proper mating.

Most Hewlett-Packard waveguide instruments are full band tested to eliminate the possibility that any Hewlett-Packard instrument does not meet its published specifications. Reflectometry concepts are used almost exclusively at HP for waveguide tests. High directivity

couplers such as the 752 Series, for example, are also swept for directivity, as shown in Figure 3. Directivity in most cases exceeds published specifications by a substantial margin. Hewlett-Packard can provide couplers specifically selected to exceed the published directivity specifications over particular portions of the frequency band.

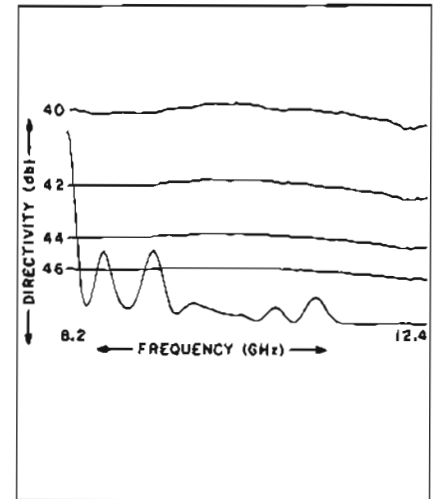

Figure 3. Directivity curve of an X752C.

For more information on swept-frequency techniques, ask for a copy of Application Notes 65 and 84. These application notes describe details, theory, and operating techniques used in swept-frequency microwave measurements. Some of the measurements described are: attenuation, swr, noise figure, cavity Q measurements, wavemeter calibrations, TWT amplifier gain tests, thermistor mount efficiency testing, and waveguide coupler directivity. To obtain a copy of these free Application Notes, contact your nearest HP Sales Office. Locations are listed at the front of this catalog.

HP	Designations		Dimensions Nominal DD (inches)	TE ₁₀ operating range			Free-space wavelength (cm)	Theoretical attenuation dB/100 ft. low to high freq.	Theoretical pk power rating megawatts low to high freq.
	EIA	JAN		Frequency (GHz)	Wavelength (cm)	Cutoff freq. (GHz)			
S	WR 284	RG-48/U	3 x 1½	2.60 - 3.95	19.18 - 8.92	2.078	11.53 - 7.59	1.102 - 0.752	2.2 - 3.2
G	WR 187	RG-49/U	2 x 1	3.95 - 5.85	12.59 - 6.08	3.152	7.59 - 5.12	2.08 - 1.44	0.94 - 1.32
J	WR 137	RG-50/U	1½ x ¾	5.30 - 8.20	9.68 - 4.29	4.301	5.66 - 3.66	2.87 - 2.30	0.56 - 0.71
H	WR 112	RG-51/U	1¼ x ¾	7.05 - 10.0	6.39 - 3.52	5.259	4.25 - 3.00	4.12 - 3.21	0.35 - 0.46
X	WR 90	RG-52/U	1 x ½	8.20 - 12.4	6.09 - 2.85	6.557	3.66 - 2.42	6.45 - 4.48	0.20 - 0.29
M	WR 75	————	0.850 x 0.475	10.0 - 15.0	4.86 - 2.35	7.868	3.00 - 2.00	10.07 - 7.03	0.17 - 0.23
P	WR 62	RG-91/U	0.702 x 0.391	12.4 - 18.0	3.75 - 1.96	9.487	2.42 - 1.67	9.51 - 8.31	0.12 - 0.16
N	WR 51	————	0.590 x 0.335	15.0 - 22.0	3.11 - 1.60	11.571	2.00 - 1.36	17.3 - 12.6	0.08 - 0.107
K	WR 42	RG-66/U	½ x ½	18.0 - 26.5	2.66 - 1.33	14.048	1.67 - 1.13	13.3 - 9.5	0.043 - 0.058
R	WR 28	RG-96/U	0.360 x 0.220	26.5 - 40.0	1.87 - 0.88	21.075	1.13 - 0.749	21.9 - 15.0	0.022 - 0.031

MISCELLANEOUS EQUIPMENT

Increase flexibility of microwave measurements

Models 281A/B, 292A/B, X913A, X930A, P932A, 934A, 11540A-11548A



COAXIAL, WAVEGUIDE

281A,B; 292A,B Adapters

HP 281A,B Adapters transform waveguide impedance into 50-ohm coaxial impedance. Power can be transmitted in either direction, and each adapter covers the full frequency range of its waveguide band with swr less than 1.25. The 281A Adapter is fitted with a cover flange and brass type N female connector; the 281B, with a cover flange and an APC-7 or optional stainless steel type N female connector.

Models 292A,B Waveguide-to-Waveguide Adapters connect two different waveguide sizes with overlapping frequency ranges. The 292A consists of a short tapered section of waveguide. The 292B is broached waveguide with a step transition between waveguide sizes.

Specifications, 281A,B					
HP Model	Maximum swr	Frequency range (GHz)	Fits waveguide size		Price
			OD (In.)	(EIA)	
S281A	1.25	2.60 to 3.95	3 x 1½	WR284	\$50
G281A	1.25	3.95 to 5.85	2 x 1	WR187	\$40
I281A	1.25*	5.30 to 8.20	1½ x ¾	WR137	\$35
H281A	1.25	7.05 to 10.0	1¼ x ¾	WR112	\$30
X281A	1.25	8.20 to 12.4	1 x ½	WR90	\$25
X281B	1.25	8.20 to 12.4	1 x ½	WR90	\$60
P281B	1.25	12.4 to 18	0.702 x 0.391	WR62	\$75

*1.3 from 5.3 to 5.5 GHz.

Specifications, 292A,B					
HP Model	SWR	Length		Frequency range (GHz)	Price
		(In.)	(mm)		
HX292B	1.05	1½	38	8.20 to 10.0	\$40
MX292B	1.05	2½	60	10.0 to 12.4	\$50
MP292B	1.05	2½	60	12.4 to 15.0	\$40
NP292A	1.05	2½	60	15.0 to 18.0	\$40
NK292A	1.05	2½	60	18.0 to 22.0	\$40

X913A Termination

The X913A is a high-power termination which requires no cumbersome water connections. The unit will dissipate 500 watts average, 100 kW peak, and its swr over the full 8.2 to 12.4 GHz range is less than 1.05. Price: X913A, \$125.

X930A Shorting Switch

Model X930A, 8.2 to 12.4 GHz, provides a removable short in a waveguide circuit. SWR is less than 1.02 in the "open" position, greater than 125 in the "short" position. Price: HP X930A, \$160.

934A, P932A Harmonic Mixers

HP 934A, P932A speed and simplify frequency measurements from 2 to 18 GHz. They are also excellent as rf mixers in phase-stabilized signal sources. Both feature high sensitivity, yet require no tuning.

Specifications, 934A, P932A					
Model	Frequency Range (GHz)	Maximum Input	Typical Sensitivity	Min. video output*	Price
934A	2 to 12.4	100 mW	-48 dB at 3.5 GHz -25 dB at 10 GHz	1.4 mV p-p	\$150
P932A	12.4 to 18	100 mW	-10 dB	0.4 mV p-p	\$250

*With 0 dBm input signal.

Waveguide Stand, Waveguide Clamps

Cast and machined from zinc alloy, the 11540A Waveguide Stand locks HP Waveguide Clamp at any height from 2¾" to 5¼" (70 to 133 mm). The stand is 2½" (64 mm) high, and the base measures 4¾" (121 mm) in diameter. Price: 11540A, \$3. The Waveguide Clamps are offered in eight sizes to fit waveguide equipment covering frequencies from 2.6 to 40 GHz (see pages 280-285 for individual listings). They consist of a molded plastic cradle with a center rod. Price: 11541A-11548A, \$3 each.

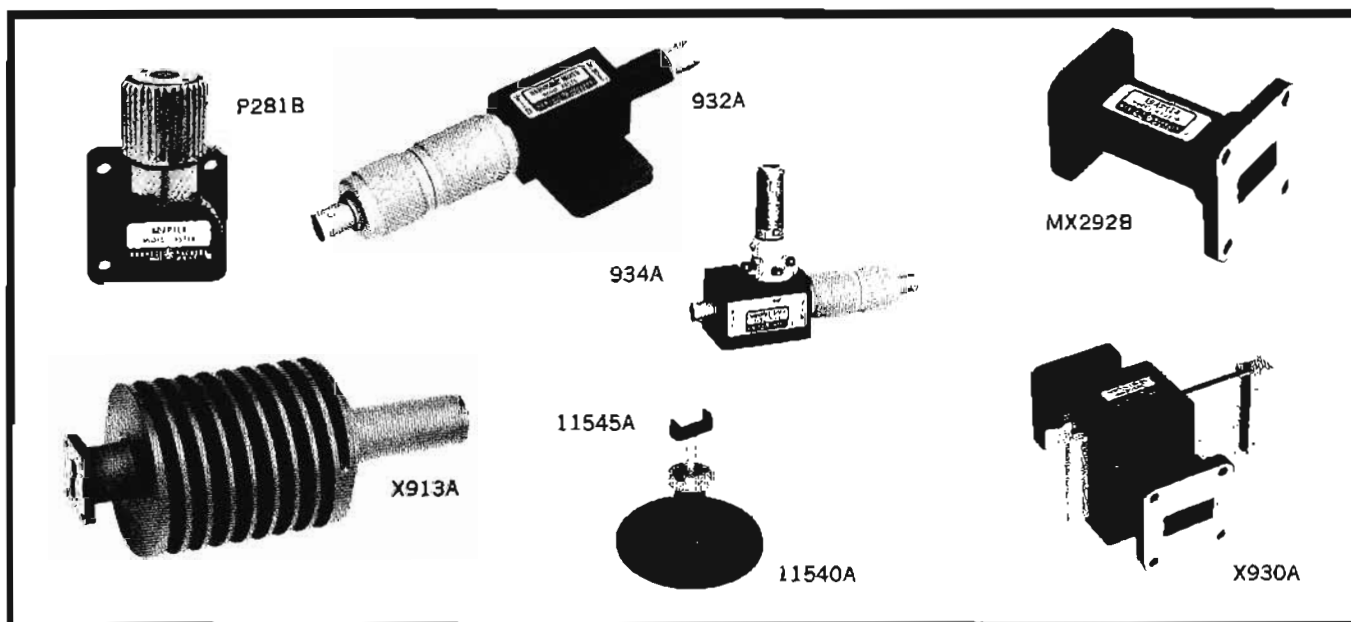

COAXIAL, WAVEGUIDE



COAXIAL INSTRUMENTATION

For coaxial systems operating to 18 GHz

The coaxial slotted line system illustrated here is capable of swept-frequency swr measurements from 1.8 to 18 GHz. In this range coaxial directional couplers suffer from low directivity, limiting the accuracy of swept-frequency reflectometers. On the other hand, conventional fixed-frequency slotted-line measurements are slow and tedious. The swept-frequency slotted line system enables you to realize the accuracy of the slotted line and the complete coverage and time saving of swept-frequency testing.

The system illustrated is set up for measurements in X-band (8.2 to 12.4 GHz). Measurements in other bands can be made by changing the RF Unit in the 8690A Sweep Oscillator. The HP 141A Oscilloscope is the ideal readout device; the entire plot can be generated in a few seconds and retained on the crt face for evaluation or photography. The HP 1416A Swept-frequency Indicator adds convenience with its logarithmic calibration. No zero-level reference is needed, and swr is indicated directly in dB when the detector is operated in its square-law region.

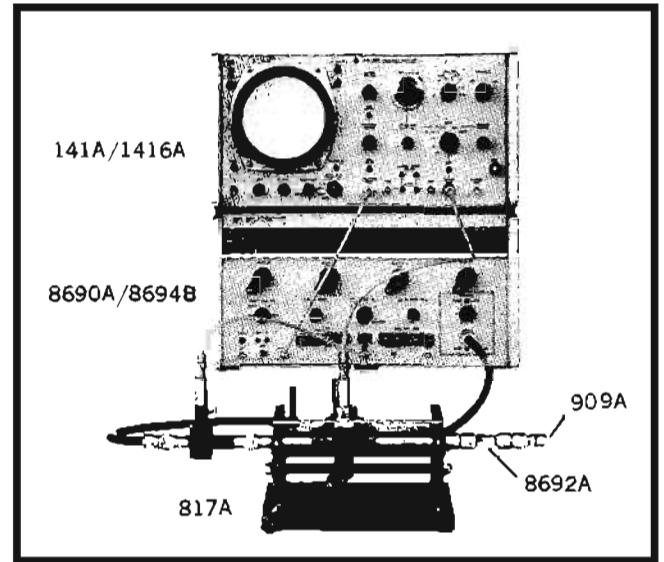

Instrument name	Uses	Frequency coverage by model												Page		
		dc	10 MHz	100 MHz	215 MHz	450 MHz	500 MHz	940 MHz	1 GHz	2 GHz	3 GHz	4 GHz	10 GHz		12.4 GHz	18 GHz
Waveguide-to-coax adapters	Interconnect waveguide and coaxial systems															277
Low-pass filters	Spectrum analyzer preselectors to eliminate signals outside the range of interest; output filters for signal sources to eliminate harmonics															286
Bandpass filters																
Variable attenuators	Measurement of reflection coefficient, insertion loss, transfer characteristics by rf substitution; reduction of power levels; reduction of source mismatch															403
Fixed attenuators																
Detectors	RF detection; reflection coefficient, attenuation measurements															287
																273 270 287



WAVEGUIDE INSTRUMENTATION

Quality equipment for microwave measurements
S-band, 2.60 to 3.95 GHz, and G-band, 3.95 to 5.85 GHz

The swept-frequency system illustrated on the right permits rapid measurement of attenuation (in this example the G375A is being calibrated). The transmission characteristics of the system are accounted for in the initial calibration which is based on the G382A Attenuator.

Complementary Equipment

HP Instrument	Frequency Range (GHz)
8616A Signal Generator	1.8 to 4.5
8616B Signal Source	1.8 to 4.5
618C Signal Generator	3.8 to 7.6
8690A Sweep Oscillator	
8692A RF Unit	2 to 4
8692B RF Unit	2 to 4
8693A RF Unit	4 to 8
8693B RF Unit	4 to 8

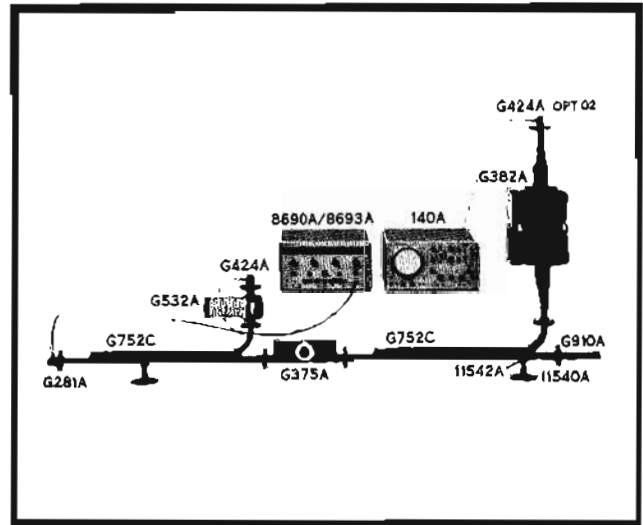

S- and G-band Equipment

HP Model	Description	Accuracy	Range	SWR (max)	Power (watts)	Length		Page Reference	Price
						(in)	(mm)		
S281A	Adapter, waveguide-to-coax			1.25		2 1/2	64	277	\$50
G281A						2 1/8	54	277	\$40
G347A	Noise source, waveguide	≈ 0.5 dB	15.2 dB	1.2		19	483	414	\$310
S375A	Attenuator, flap	± 1 dB at < 10 dB ± 2 dB at > 10 dB	0 to 20 dB	1.15	2	14 1/2	359	405	\$250
G375A						13	330	405	\$200
S382B*	Attenuator, precision variable	$\pm 1\%$ or 0.1 dB to 50 dB $\pm 2\%$ above 50 dB	0 to 60 dB	1.2 below 3 GHz; 1.15 above 3 GHz	10	25 1/4	641	405	\$750
S382C*									\$800
G382A									$\pm 2\%$ of reading or 0.1 dB, whichever is greater
S424A	Crystal detector	sensitivity: > 0.4 mV/ μ W	sensitivity: 0.4 mV/ μ W	1.35		2-7/16	62	287	\$175
G424A						2-1/16	52	287	\$165
S486A	Thermistor mount, compensated		0.001 to 10 mW	1.35		3	76	408	\$195
G486A				1.5		4	102	408	\$180
G532A	Frequency meter, direct reading	dial: $\pm 0.033\%$ overall: $\pm 0.065\%$				6 1/4	159	585	\$400
S752A	Directional couplers, multi-hole	mean: ± 0.4 dB variation: ± 0.5 dB	3 dB	1.1	2 (in aux. guide)	50 1/4	1276	290	\$600
S752C			10 dB	1.05		48	1219		
S752D			20 dB	1.05		48	1219		
G752A			3 dB	1.1		34 1/2	876		
G752C			10 dB	1.05		33	838		
G752D			20 dB	1.05		33	838		
G810B (809C) (444A)	Slotted section, waveguide (Carriage for 810B) (Detector probe for 809C)			1.01		10 1/2	260	272	\$140 (\$200) (\$55)
S870A	Tuner, slide screw	insertion loss: < 2 dB at 20:1 swr	corrects swr of 20			11	279	291	\$350
G870A						8 1/4	210	291	\$275
S910A	Termination, low power			1.04	2	10 1/4	260	292	\$90
G910A						6 3/8	168	292	\$70
S914A	Moving load	load reflection: $< 0.5\%$	$> 1/2$ wavelength	1.01	2	31	787	292	\$150
G914A						20 1/2	521	292	\$120
S920A	Adjustable short		$> 1/2$ wavelength			10-7/16	265	292	\$150
G920A						7-13/16	199	292	\$125
11540A	Waveguide stand							277	\$3
11541A	S-band waveguide clamp							277	\$3
11542A	G-band waveguide clamp							277	\$3

* Degree dial 0 to 90° in 0.1° increments (S382B), in 0.01° increments (S382C).

WAVEGUIDE INSTRUMENTATION

Quality equipment for microwave measurements
J-band, 5.30 to 8.20 GHz



COAXIAL, WAVEGUIDE

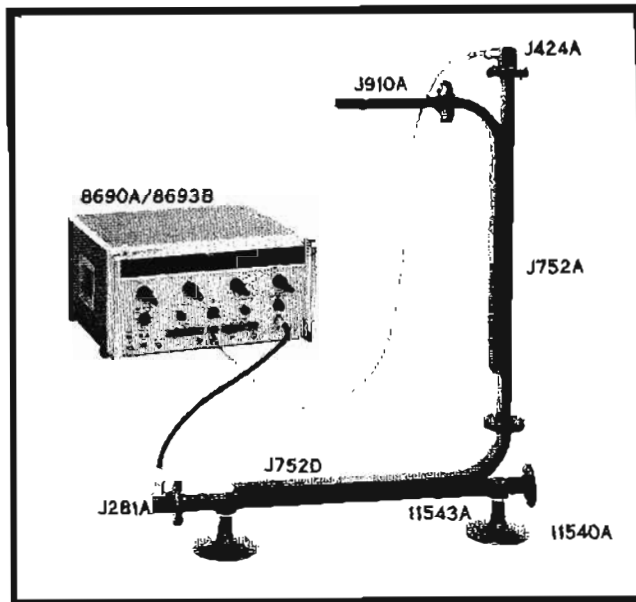

In the illustration leveled output power from the sweep oscillator is obtained through use of the J752 Directional Couplers in the configuration shown. The J424A Crystal Detector, with its extremely flat frequency response, provides the error voltage to the ALC input of the sweep oscillator. The power delivered at the output port of the J752D Coupler is flat to better than $1/2$ dB, and the high directivity of the coupler makes the leveling loop virtually immune to load swr.

Complementary equipment

HP Instrument	Frequency Range (GHz)
618C Signal Generator	3.8 to 7.6
620B Signal Generator	7 to 11
8690A Sweep Oscillator	—
8693A RF Unit	4 to 8
8693B RF Unit	4 to 8
H01-8693B RF Unit	3.7 to 8.3
493A Microwave Amplifier	4 to 8
8733A PIN Modulator	3.7 to 8.3
8733B PIN Modulator	3.7 to 8.3

J-band equipment

HP Model	Description	Accuracy	Range	SWR (max.)	Power (watts)	Length		Page reference	Price
						(in)	(mm)		
J281A	Adapter, waveguide-to-coax			1.25 (1.3 from 5.3 to 5.5 GHz)		2	51	277	\$35
J347A	Noise source, waveguide	≈ 0.5 dB	15.2 dB	1.2		19	483	414	\$300
J375A	Attenuator, flap	≈ 1 dB at < 10 dB ≈ 2 dB at > 10 dB	0 to 20 dB	1.15	2	13	330	405	\$175
J382A	Attenuator, precision variable	$\approx 2\%$ of reading or 0.1 dB whichever ever is greater	0 to 50 dB	1.15	10	25 1/2	638	405	\$375
J424A	Crystal detector	response: ≈ 0.2 dB	sensitivity > 0.4 mV/ μ W	1.35		1 1/8	48	287	\$165
J485B	Detector mount (less detector)			with barretter 1.25 (5.85 to 8.2 GHz) 1.5 overall		8 1/2	210	270	\$120
J486A	Thermistor mount, compensated		0.001 to 10 mW	1.5		3 1/8	86	408	\$170
J487B	Thermistor mount, broadband		0.01 to 10 mW	1.5		1 1/2	45	411	\$90
J532A	Frequency meter, direct reading	dial: $\approx 0.033\%$ overall: $\approx 0.065\%$				6 1/4	159	585	\$375
J752A J752C J752D	Directional couplers, multi-hole	mean: ≈ 0.4 dB variation: ≈ 0.5 dB (5.85 to 8.2 GHz)	3 dB 10 dB 20 dB	1.1 1.05 1.05	1 (in aux. guide)	26 1/2 25-9/16 25-9/16	673 649 649	290	\$220
J810B (809C) (444A)	Slotted section, waveguide (Carriage for 810B) (Detector probe for 809C)			1.01		10 1/4	260	272	\$125 \$200 (\$55)
J870A	Tuner, slide screw	insertion loss: < 2 dB at 20:1 swr	corrects swr of 20			7 1/2	194	291	\$200
J885A	Waveguide phase shifter	lesser of 3° or 10%	-360° to $+360^\circ$	1.35	10	25 1/8	638	291	\$550
J910A	Termination, low power			1.02	1	8 1/8	206	292	\$55
J914A	Moving load	load reflection: $< 0.5\%$	$> 1/2$ wavelength	1.01	2	15 1/2	394	292	\$100
J920A	Adjustable short		$> 1/2$ wavelength			6 1/4	159	292	\$100
I1540A	Waveguide stand							277	\$3
I1543A	Waveguide clamp							277	\$3

COAXIAL, WAVEGUIDE



WAVEGUIDE INSTRUMENTATION

Quality equipment for microwave measurements
H-band, 7.05 to 10 GHz

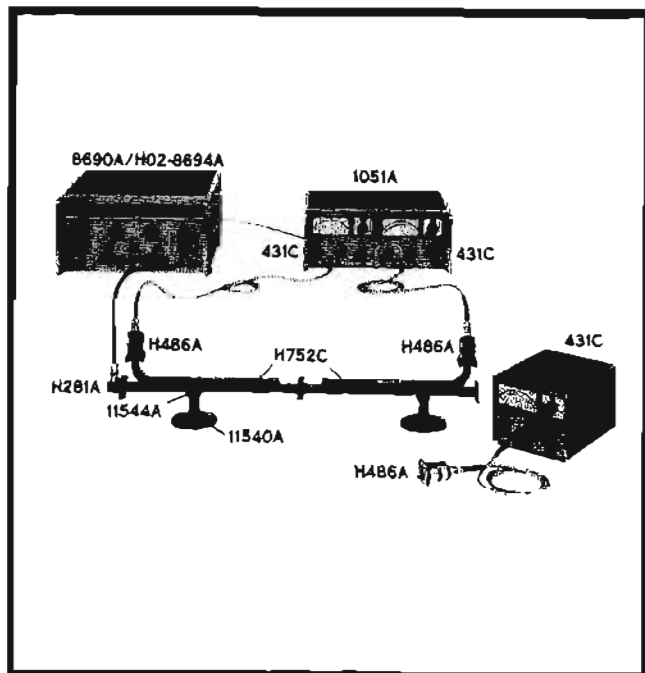

The figure illustrates a swept-frequency system employing power meter leveling, in which the system is arranged to provide leveled net forward power at the mainline output of the right-hand H752C Directional Coupler. Both the incident and reflected powers are monitored, with the recorder outputs of the two 431C Power Meters connected in such a manner that the resultant voltage fed back to the sweep oscillator is related to the power actually absorbed by the load. Typical applications for this type of leveling include measurement of thermistor mount efficiency and antenna radiation characteristics.

Complementary equipment

HP Instrument	Frequency Range (GHz)
620B Signal Generator	7 to 11
8690A Sweep Oscillator	—
HO2-8694A RF Unit	7 to 11
HO2-8694B RF Unit	7 to 11
495A Microwave Amplifier	7 to 12.4
8734A PIN Modulator	7 to 12.4
8734B PIN Modulator	7 to 12.4

H-band equipment

HP Model	Description	Accuracy	Range	SWR (max.)	Power (watts)	Length		Page reference	Price
						(in)	(mm)		
H281A	Adapter, waveguide-to-coax			1.25		1½	41	277	\$30
HX292B	Adapter, waveguide-to-waveguide		8.2 to 10 GHz	1.05		1½	38	277	\$40
H347A	Noise source, waveguide	±0.5 dB	15.7 dB	1.2		16	406	414	\$275
H375A	Attenuator, flap	±1 dB at <10 dB ±2 dB at >10 dB	0 to 20 dB	1.15	2	8¼	210	405	\$150
H382A	Attenuator, precision variable	±2% of reading, or 0.1 dB, whichever is greater	0 to 50 dB	1.15	10	20	508	405	\$350
H424A	Crystal detector	response: ±0.2 dB	sensitivity >0.4 mV/μW	1.35		1-9/16	40	287	\$155
H485B	Detector mount (less detector)			with barretter 1.25		6¾	162	270	\$100
H486A	Thermistor mount, compensated		0.001 to 10 mW	1.5		3¾	86	408	\$165
H487B	Thermistor mount, broadband		0.01 to 10 mW	1.5		1-5/16	33	411	\$80
H532A	Frequency meter, direct reading	dial: ±0.040% overall: ±0.075%				6¼	159	585	\$325
H752A H752C H752D	Directional couplers, multi-hole	mean: ±0.4 dB variation: ±0.5 dB	3 dB 10-dB 20 dB	1.1 1.05 1.05	1 (in aux. guide)	18¾ 17½ 17½	473 445 445	290	\$165
H810B (809C) (444A)	Slotted sections, waveguide (Carriage for 810B) (Detector probe for 809C)			1.01		10¼	260	272	\$110 (\$200) (\$55)
H870A	Tuner, slide screw	insertion loss: <2 dB at 20:1 swr	corrects swr of 20			6	152	291	\$170
H910A	Termination, low power			1.02	1	5-9/16	141	292	\$45
H914A	Moving load	load reflection: <0.5%	>½ wavelength	1.01	1	11½	267	292	\$80
H920A	Adjustable short		>½ wavelength			4¾	124	292	\$85
11540A	Waveguide stand							277	\$3
11544A	Waveguide clamp							277	\$3

WAVEGUIDE INSTRUMENTATION

Quality equipment for microwave measurements
X-band, 8.2 to 12.4 GHz



COAXIAL, WAVEGUIDE

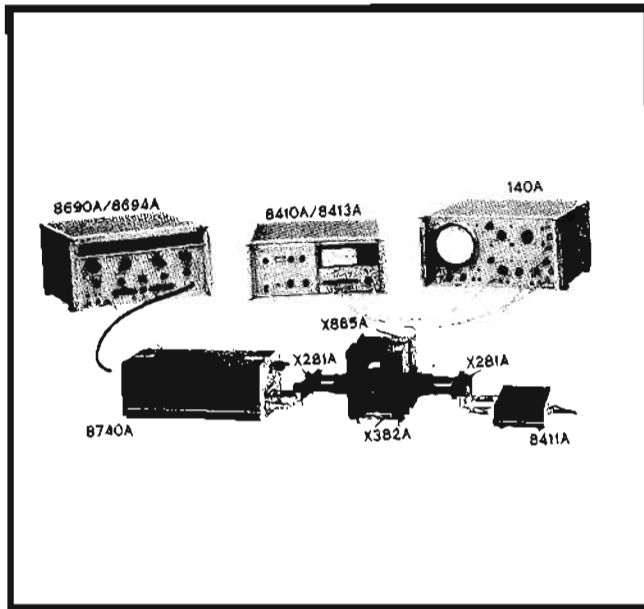

The variation of phase shift with attenuation of the X382A Precision Variable Attenuator is measured in this setup. The new HP 8410A Network Analyzer permits this measurement to be made quickly and easily on a swept-frequency basis.

Complementary equipment

HP Instrument	Frequency range (GHz)
620B Signal Generator	7 to 11
626A Signal Generator	10 to 15.5
8690A Sweep Oscillator	--
8694A RF Unit	8 to 12.4
8694B RF Unit	8 to 12.4
495A Microwave Amplifier	7 to 12.4
8734A PIN Modulator	7 to 12.4
8734B PIN Modulator	7 to 12.4

X-band equipment

HP Model	Description	Accuracy	Range	SWR (max.)	Power (watts)	Length		Page Reference	Price
						(in)	(mm)		
X281A	Adapter, waveguide-to-coax			1.25		1½	35	277	\$25
X281B	Adapter, waveguide-to-coax			1.25		1½	35	277	\$60
HX292B	Adapter, waveguide-to-waveguide		8.2 to 10 GHz	1.05		1½	38	292	\$40
MX292B	Adapter, waveguide-to-waveguide		10 to 12.4 GHz	1.05		2¼	60	292	\$50
X347A	Noise source, waveguide	±0.4 dB	15.7 dB	1.2		1¼	37½	414	\$225
X352A	Low-pass filter	insertion loss, passband: <1dB stopband: >40 dB	passband: 8.2 to 12.4 GHz stopband: 16 to 37.5 GHz	passband 1.3		5-11/32	136	286	\$325
X375A	Attenuator, flap	±1 dB at <10 dB ±2 dB at >10 dB	0 to 20 dB	1.15	2	7-3/16	183	405	\$110
X382A	Attenuator, precision variable	±2% of reading or 0.1 dB whichever is greater	0 to 50 dB	1.15	10	15½	397	405	\$275
X424A	Crystal detector	response: ±0.3 dB	sensitivity >0.4 mV/μW	1.35		1¼	35	287	\$135
X485B	Detector mount (less detector)			with barretter 1.25		6-7/16	164	270	\$75
X486A	Thermistor mount, compensated		0.001 to 10 mW	1.5		2¼	54	408	\$145
X487B	Thermistor mount, broadband		0.01 to 10 mW	1.5		1-3/16	30	411	\$75
X532B	Frequency meter, direct reading	dial: ±0.05% overall: ±0.08%				4½	114	585	\$200
X752A X752C X752D	Directional couplers, multi-hole	mean: ±0.4 dB variation: ±0.5 dB	3 dB 10 dB 20 dB	1.1 1.05 1.05	1 (in aux. guide)	16-11/16 15-11/16 15-11/16	424 389 399	290	\$125
X810B (809C) (444A)	Slotted section, waveguide (Carriage for 810B) (Detector probe for 809C)			1.01		10¼	260	272	\$90 (\$200) (\$35)
X870A	Tuner, slide screw	insertion loss: <2 dB at 20:1 swr <2° at 8.2 to 10 GHz or 10% <3° at 10 to 12.4 GHz or 10%	corrects swr of 20			5½	140	291	\$150
X885A	Waveguide phase shifter		-360° to +360°	1.35	10	15½	397	291	\$425
X910B	Termination, low power			1.015	1	6½	168	292	\$35
X913A	Termination, high power			1.05	500	9½	241	277	\$125
X914B	Moving load	load reflection: <0.5%	>½ wavelength	1.005	1	10½	257	292	\$60
X923A	Adjustable short		>½ wavelength			4½	124	292	\$75
X930A	Waveguide shorting switch	insertion loss "Open": <0.05 dB				3-11/16	94	277	\$180
8735A	PIN modulator		35 dB		1	6¾	171	400	\$350
8735B	PIN modulator		80 dB		1	10½	267	400	\$575
I1504A	Flexible waveguide					12	305		\$35
I1540A	Waveguide stand							277	\$3
I1545A	Waveguide clamp							277	\$3

COAXIAL, WAVEGUIDE



WAVEGUIDE INSTRUMENTATION

Quality equipment for microwave measurements
P-band, 12.4 to 18 GHz

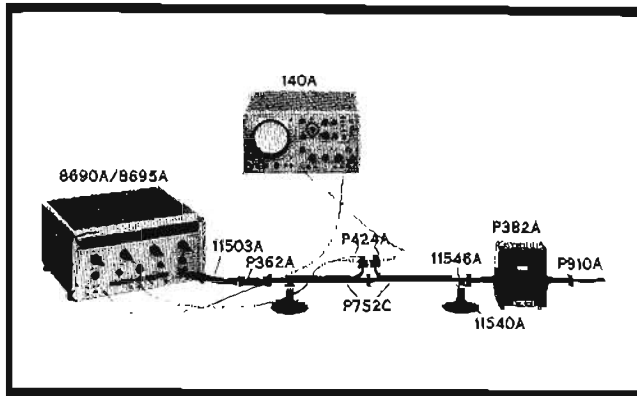

The conventional swept-frequency reflectometer in the illustration is being used to examine the reflection characteristics of the P382A Attenuator. The flat frequency response and excellent square law characteristics of the P424A Crystal Detectors provide accurate measurement results, with the added advantage that reflection characteristics can be displayed directly on the oscilloscope crt.

Complementary equipment

HP Instrument	Frequency Range (GHz)
626A Signal Generator	10 to 15.5
628A Signal Generator	15 to 21
8690A Sweep Oscillator	—
8695A RF Unit	12.4 to 18

P-band equipment

HP Model	Description	Accuracy	Range	SWR (max.)	Power (watts)	Length		Page reference	Price
						(in)	(mm)		
P281B	Adapter, waveguide-to-coax		12.4 to 18 GHz	1.25		1 3/8	35	277	\$75
MP292B	Adapter, waveguide-to-waveguide		12.4 to 15 GHz	1.05		2 3/8	60	277	\$40
NP292A	Adapter, waveguide-to-waveguide		15 to 18 GHz	1.05		2 3/8	60	277	\$40
P347A	Noise source, waveguide	± 0.5 dB	16 dB			1 3/8	375	414	\$275
P362A	Low-pass filter	insertion loss, pass-band: < 1 dB stopband: > 40 dB	pass: 12.4 to 18 GHz stop: 23 to 54 GHz	passband 1.5		3-11/16	94	286	\$350
P375A	Attenuator, flap	± 1 dB at < 10 dB ± 2 dB at > 10 dB	0 to 20 dB	1.15	1	7/8	184	405	\$135
P382A	Attenuator, precision variable	$\pm 2\%$ of reading or 0.1 dB, whichever is greater	0 to 50 dB	1.15	5	1 1/2	318	405	\$300
P424A	Crystal detector	response: ± 0.5 dB	sensitivity > 0.3 mV/ μ W	1.5		15/16	24	287	\$175
P486A	Thermistor mount, compensated		0.001 to 10 mW	1.5		2 1/2	64	408	\$195
P487B	Thermistor mount, broadband		0.01 to 10 mW	1.5		13/16	21	411	\$110
P532A	Frequency meter, direct reading	dial: $\pm 0.068\%$ overall: $\pm 0.1\%$				4 1/2	114	585	\$275
P752A P752C P252D	Directional couplers, multi-hole	mean: ± 0.4 dB variation: ± 0.5 dB	3 dB 10 dB 20 dB	1.1 1.05 1.05	1 (in aux. guide)	1 3/8 1 1/2 1 1/2	349 311 311	290	\$150
P810B (809C) (444A)	Slotted section, waveguide (Carriage for 810B) (Detector probe for 809C)			1.01		10 1/4	260	272	\$110 \$200 (\$55)
P870A	Tuner, slide screw	insertion loss: < 2 dB at 20:1 swr	corrects swr of 20			5	127	291	\$160
P885A	Waveguide phase shifter	lesser of 4° or 10%	-360° to +360°	1.35	5	12-5/16	312	291	\$600
P910A	Termination, low power			1.02	1	4 3/8	111	292	\$40
P914A	Moving load	load reflection: $< 0.5\%$	$> 1/2$ wavelength	1.02	0.5	9 3/4	248	292	\$75
P920B	Adjustable short		$> 1/2$ wavelength			5 3/4	146	292	\$125
P932A	Harmonic mixer				0.1			277	\$250
11503A	Flexible waveguide, P-band					12	305	—	\$48
11540A	Waveguide stand							277	\$3
11546A	Waveguide clamp							277	\$3

WAVEGUIDE INSTRUMENTATION

Quality equipment for microwave measurements
K-band, 18 to 26.5 GHz, and R-band, 26.4 to 40 GHz



COAXIAL, WAVEGUIDE

Illustrated here is a typical fixed-frequency measurement system for K-band. The K870A Slide Screw Tuner tunes the K486A Thermistor Mount to unity swr for improved power measurement accuracy.

Complementary Equipment

HP Instrument	Frequency Range (GHz)
626A Signal Generator and 938A Frequency Doubler Set	20 to 26.5
626A Signal Generator and 940A Frequency Doubler Set	26.5 to 31
628A Signal Generator and 940A Frequency Doubler Set	30 to 40
8690A Sweep Oscillator	—
8696A RF Unit	18 to 26.5
8697A RF Unit	26.5 to 40

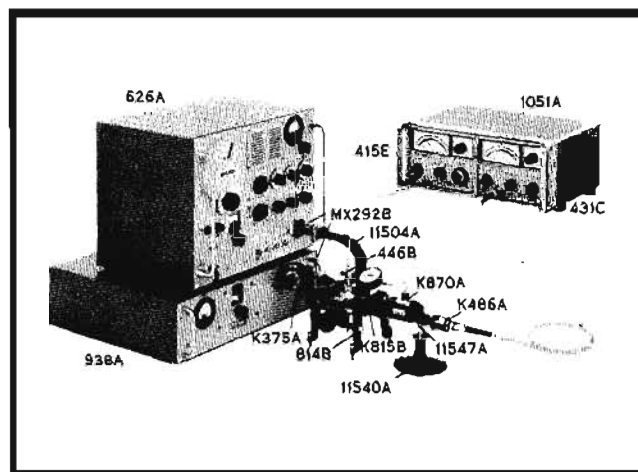

K- and R-band equipment

HP Model*	Description	Accuracy	Range	SWR (max)	Power (watts)	Length		Page Reference	Price
						(in)	(mm)		
K362A	Low-pass filter	insertion loss, pass-band: < 1 dB stopband: > 40 dB	pass: 18 to 26.5 GHz stop: 31 to 80 GHz	passband 1.5		2½	64	286	\$385
R362A		insertion loss, pass-band: < 2 dB stopband: > 35 dB	pass: 26.5 to 40 GHz stop: 47 to 120 GHz	passband 1.8		1½	42		
K375A	Attenuator, flap	= 1 dB at < 10 dB = 2 dB at > 10 dB	0 to 20 dB	1.15	0.5	4½	114	405	\$200
R375A						4¾	111	405	\$225
K382A	Attenuator, precision variable	= 2% of reading or 0.1 dB, whichever is greater	0 to 50 dB	1.15	2	7¾	194	405	\$475
R382A						1	6¾	162	405
K422A	Crystal detector	freq. resp. = ± 2 dB sens: 0.3 mV dc/ μWCW		2.5		2	51	287	\$230
R422A				3					\$540 (matched pair)
K486A	Thermistor mount, compensated		0.001 to 10 mW	2		3	76	408	\$300
R486A									\$375
K532A	Frequency meter, direct reading	dial: = 0.077% overall: = 0.11%				4½	114	585	\$350
R532A		dial: = 0.083% overall: = 0.12%							\$400
K752A	Directional couplers, multi-hole	mean: = 0.7 dB variation: = 0.5 dB (= 0.6 dB, R752D)	3 dB	1.1	0.5 (in aux. guide)	10¾	270	290	\$200
K752C			10 dB	1.05		9-15/16	252		
K752D			20 dB	1.05		9-15/16	252		
R752A			3 dB	1.1		11¾	295		\$250
R752C			10 dB	1.05		8¾	219		
R752D			20 dB	1.05		8¾	222		
K815B	Slotted section, waveguide			1.01		7-9/16	192	272	\$350
R815B									\$400
(814B) (446B)	(Carriage for 815B) (Detector probe for 814B)							272	\$275 \$160
K870A	Tuner, slide screw	insertion loss: < 3 dB at 20:1 swr	corrects swr of 20			4¼	108	291	\$300
R870A						4¾	111		\$325
K914B	Moving load	load reflection: < 0.5%	> ½ wavelength	1.01	0.5	6¾	156	292	\$275
R914B						5¾	130		
K920B						5½	140		
R920B	4½	114	\$175						
11540A	Waveguide stand							277	\$3
11547A	K-band Waveguide clamp							277	\$3
11548A	R-band Waveguide clamp							277	\$3

* Circular flange adapters 11515A (UG-425/U) for K-band, \$35 each; 11516A (UG-381/U) for R-band, \$40 each.

COAXIAL, WAVEGUIDE



LOW-PASS; BANDPASS FILTERS

Effective elimination of undesirable signals

Models 360A-D; 362A; 8430

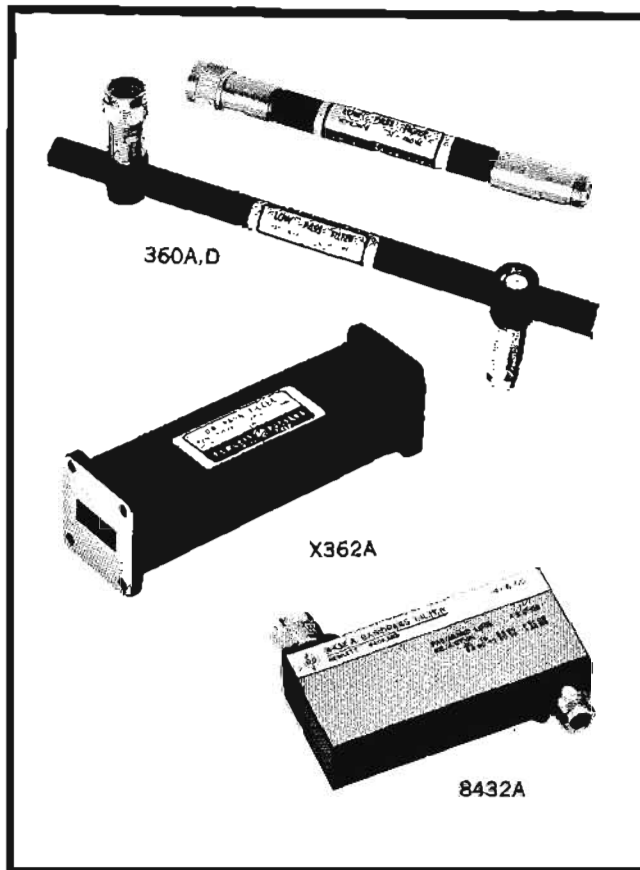

These Hewlett-Packard low-pass and bandpass filters facilitate microwave measurements by eliminating undesirable signals (such as harmonics) from the measurement system. Suppression of such signals is particularly important in applications such as slotted-line measurements, where harmonics generated by the signal source could otherwise impair measurement accuracy. These filters also can be used as preselectors for the HP 851B/8551B Spectrum Analyzer. As such, they permit the maximum utilization of the analyzer's broad spectrum-width capability while assuring virtually spurious-free displays.

Specifications, 360 Series

HP Model	360A	360B	360C	360D
Cut-off frequency	700 MHz	1200 MHz	2200 MHz	4100 MHz
Insertion loss	≤1 dB below 0.9 times cut-off frequency			
Rejection	≥50 dB at 1.25 times cut-off frequency			
Impedance	50 ohms through pass band; should be matched for optimum performance			
SWR	<1.6 to within 100 MHz of cut-off		<1.6 to within 200 MHz of cut-off	<1.6 to within 300 MHz of cut-off
Connectors	Type N, one male, one female			
Overall length (in.) (mm)	10 7/8 (276)	7-7/32 (183)	10-25/32 (274)	7 3/8 (187)
Center line to male end (in.) (mm)	2 1/8 (54)	2 1/8 (54)	—	—
Center line to female end (in.) (mm)	2 1/8 (57)	2 1/8 (57)	—	—
Shipping weight (lbs) (kg)	2 (0,9)	2 (0,9)	2 (0,9)	1 (0,45)
Price	\$75	\$70	\$65	\$60

Specifications, 362A Series

HP Model	X362A	M362A	P362A	K362A*	R362A*
Passband (GHz)	8.2-12.4	10.0-15.5	12.4-18.0	18.0-26.5	26.5-40.0
Stop band (GHz)	16-37.5	19-47	23-54	31-80	47-120
Insertion loss	less than 1 dB	less than 1 dB	less than 1 dB	less than 1 dB	less than 2 dB
Stopband rejection	at least 40 dB	at least 40 dB	at least 40 dB	at least 40 dB	at least 35 dB
SWR	1.5	1.5	1.5	1.5	1.8
Waveguide size, in. (EIA)	1 x 0.5 (WR 90)	0.850 x 0.475 (WR 75)	0.702 x 0.391 (WR 62)	1/2 x 1/4 (WR 42)	0.360 x 0.220 (WR 28)
Length, in. (mm)	5-11/32(136)	4-15/32(114)	3-11/16(94)	2 1/2(64)	1-21/32(42)
Shipping weight, lbs. (kg)	2(0,9)	2(0,9)	1(0,45)	1/2(0,23)	1/2(0,23)
Price	\$325	\$350	\$350	\$385	\$385

* Circular flange adapters: K-band (UG-425/U), HP 11515A, \$35 each; R-band (UG-381/U), HP 11516A, \$40 each.

Specifications, 8430 Series

HP Model	Passband frequency (GHz)	Max. passband insertion loss	Rejection band attenuation				Dimensions		Shipping weight		Price
			Below passband		Above passband		(in.)	(mm)	(lb)	(kg)	
			Frequency (GHz)	Attenuation	Frequency (GHz)	Attenuation					
8430A	1 to 2	2 dB	≤0.8	≥50 dB	2.2 to 20	≥45 dB	5 1/2 x 4 1/4 x 1	140 x 121 x 25	6	2,7	\$210
8431A	2 to 4	2 dB	≤1.6	≥50 dB	4.4 to 20	≥45 dB	5 1/2 x 3 x 1	140 x 76 x 25	3	1,4	\$210
8432A	4 to 6	2 dB	≤3.5	≥50 dB	6.5 to 20	≥45 dB	4 1/2 x 2 x 1	114 x 51 x 25	2	0,9	\$275
8433A	6 to 8	2 dB	≤5.5	≥50 dB	8.5 to 20	≥45 dB	4 x 1 1/2 x 1	102 x 38 x 25	2	0,9	\$275
8434A	8 to 10	2 dB	≤7.5	≥50 dB	10.5 to 17	≥45 dB	4 3/8 x 1 x 1	118 x 25 x 25	2	0,9	\$275
8435A	4 to 8	2 dB	≤3.2	≥50 dB	8.8 to 20	≥45 dB	3 3/8 x 1 1/4 x 1	92 x 45 x 25	2	0,9	\$210
8436A	8 to 12.4	2 dB	≤6.9	≥50 dB	13.5 to 17	≥45 dB	2 1/8 x 1 x 1	73 x 25 x 25	2	0,9	\$210

Connectors: Type N, one male, one female.

CRYSTAL DETECTORS

Flat response, high sensitivity, low swr

Models 8470A, 8471A, 8472A, 420A,B, 422A, 423A, 424A



COAXIAL, WAVEGUIDE

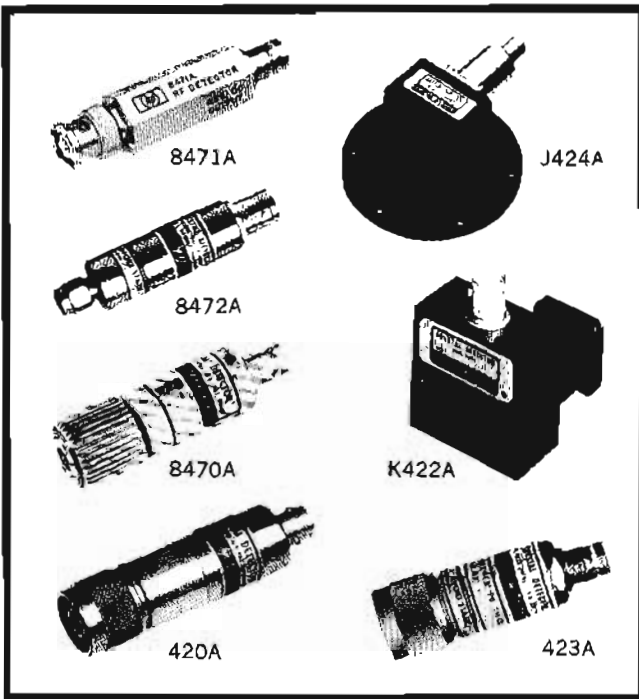

The HP 8470A and 8472A extend the frequency range of coaxial crystal detectors to 18 GHz. Like the 423A and 424A Crystal Detectors, the 8470A and 8472A combine extremely flat frequency response with high sensitivity and low swr, making them extremely useful as the detecting element in closed-loop leveling systems. Matched pairs are available for applications requiring the utmost in detector tracking, and all but the 8472A can be supplied with video loads for optimum conformance to square law over a range of at least 30 dB.

The 422A Crystal Detectors are convenient waveguide detectors which cover K- and R-bands. They have a dynamic range of 40 dB or more, making them suitable for reflectometer as well as general-purpose applications.

The 420A is a low-cost crystal detector which covers the coaxial range from 10 MHz to 12.4 GHz, making it ideal for general purpose video detection. The 420B is essentially the same unit as the 420A with the addition of a selected video load for optimum square-law characteristics in the 1 to 4 GHz range. Price: HP 420A, \$50; HP 420B, \$75.

RF Detector

The 8471A is a low-cost rf detector which covers the frequency range from 100 kHz to 1.2 GHz. This unit is a broad-band, flat detector with a built-in filter. It is extremely well suited for use with the HP 8690A/8698A Sweep Oscillator/RF Unit (page 386).

HP Model	Frequency range (GHz)	Frequency resp. ¹ (dB)	Low-level sensitivity (mV/μW)	Maximum swr	RF input	Matched pair available	Square law load available	Length		Shipping weight		Price
								(In)	(mm)	(lbs)	(kg)	
8471A	100 kHz 1.2 GHz	±0.6; typ ±0.1 over 100 MHz	>0.5	typically 1.3	BNC male	no	no	2¼	70	1	0.5	HP 8471A, \$ 50
423A	0.01-12.4	±0.2/octave to 8 GHz; ±0.5 overall	>0.4	1.2 to 4.5 GHz; 1.35 to 7 GHz; 1.5 to 12.4 GHz	Type N male	yes ²	yes ³	2-15/32	63	1	0.5	HP 423A, \$125
8470A	0.01-18	±0.2/octave to 8 GHz; ±0.5 to 12.4 GHz; ±1 overall	>0.4	1.2 to 4.5 GHz; 1.35 to 7 GHz; 1.5 to 12.4 GHz; 1.7 to 18 GHz	APC-7	yes ²	yes ³	2½	63	1	0.5	HP 8470A, \$150
8472A	0.01-18	±0.2/octave to 8 GHz; ±0.5 to 12.4 GHz; ±1 overall	>0.4	1.2 to 4.5 GHz; 1.35 to 7 GHz; 1.5 to 12.4 GHz; 1.7 to 18 GHz	OSM [®] type male	Yes	no	2½	64	1	0.5	HP 8472A, \$160
S424A	2.60-3.95	±0.2	>0.4	1.35	Wave- guide cover flange	yes ⁴	yes ³	2-7/16	62	2	0.9	HP S424A, \$175
G424A	3.95-5.85	±0.2	>0.4	1.35		yes ⁴	yes ³	2-1/16	52	2	0.9	HP G424A, \$165
J424A	5.30-8.20	±0.2	>0.4	1.35		yes ⁴	yes ³	1-7/8	48	1	0.5	HP J424A, \$165
H424A	7.05-10.0	±0.2	>0.4	1.35		yes ⁴	yes ³	1-9/16	40	1	0.5	HP H424A, \$155
X424A	8.20-12.4	±0.3	>0.4	1.35		yes ⁴	yes ³	1-3/8	35	1	0.5	HP X424A, \$135
M424A	10.0-15.0	±0.5	>0.3	1.5		yes ⁴	yes ³	1	25	1	0.5	HP M424A, \$250
P424A	12.4-18.0	±0.5	>0.3	1.5		yes ⁴	yes ³	15/16	24	1	0.5	HP P424A, \$175
K422A ⁶	18.0-26.5	±2	≈0.3	2.5		yes ⁵	yes ³	2	51	1	0.5	HP K422A, \$230
R422A ⁶	26.5-40.0	±2	≈0.3	3		yes ⁵	yes ³	2	51	1	0.5	HP R422A, \$230

For all models

Maximum input: 100 mV peak or average, (8471A: 4.2 V pk).
Detector element: supplied.

Output polarity: negative (positive output available with 423A, 8470A, 8471A, 424A);
specify Option 03; no additional charge; 8472A, available on special order, add \$20).
Output connector: BNC female.

¹As read on a 416 Ratio Meter or 415 SWR Meter calibrated for square law detectors.

²Frequency response characteristics (excluding basic sensitivity) track within ±0.2 dB per octave from 10 MHz to 8 GHz, ±0.3 dB from 8 to 12.4 GHz, and (8470A and 8472A) ±0.5 dB from 12.4 to 18 GHz; specify Option 01., add \$40 per pair. (8472A, available on special order, add \$50 per pair).

³±0.5 dB variation from square law up to 50 mV peak output into >75 kΩ; sensitivity typically >0.1 mV/μW; specify Option 02.; add \$20.

⁴Frequency response characteristics (excluding basic sensitivity) track within ±0.2 dB for S-, G-, J- and H-band units, ±0.3 dB for X-band units, and ±0.5 dB for M- and P-band units; specify Option 01.; add \$40 per pair.

⁵Matched pair of units fitted with square-law loads. Frequency response characteristics (excluding basic sensitivity) track within ±1 dB for power levels less than approx. 0.05 mW; specify Option 01.; add \$80 per pair.

⁶Circular flange adapters: 11515A (UG-425/U) for K-band, \$35 each; 11516A (UG-381/U) for R-band, \$40 each.



DETECTORS, COUPLERS

High directivity for increased accuracy
770, 780, 790 Series

778D Dual Directional Coupler

HP 778D is a new concept in coaxial couplers. Designed with an exponential coupling array, this dual 20-dB coupler has a frequency range of 100 MHz to 2 GHz. High directivity (40 dB below 1 GHz, 34 dB above) and close tracking (typically 0.7 dB and 4°) of the auxiliary arms make it ideal for measurement of complex reflection coefficient in broadband reflectometers. Maximum error in such measurements is shown below:

Frequency Range (GHz)	Maximum Error E	
	Swept Frequency	Fixed Frequency
0.1 - 1	$0.01 + 0.02 \Gamma_L + 0.05 \Gamma_L ^2$	$0.01 + 0.05 \Gamma_L ^2$
1 - 2	$0.02 + 0.02 \Gamma_L + 0.05 \Gamma_L ^2$	$0.02 + 0.05 \Gamma_L ^2$

where Γ_L is the unknown reflection coefficient. Errors include directivity, source match, and tracking. Although the coupling factor increases 6 dB/octave below 100 MHz, directivity remains 40 dB. Thus the coupler can be used below 100 MHz as well as above.

774D-777D Dual Directional Couplers

The economical HP 774D - 777D Couplers cover frequency spreads of more than two-to-one, each centered on one of the important vhf/uhf bands. With high directivity, these couplers are also excellent for reflectometer applications. In addition, these units can handle fairly high power and have low insertion loss, so they can be permanently installed in coaxial lines for monitoring power, system flatness, etc.

780 Directional Detectors

The HP 780 Directional Detectors are directional couplers with built-in crystal detectors. In each case the coupler itself has extremely flat frequency response and good directivity,

while the detector also has very good frequency response plus high sensitivity. The configuration of the directional detector reduces the number of ambiguities over the standard system of separate directional coupler and detector and makes possible tighter correlation between main-arm power and detected signal. The directional detector is well suited for closed-loop leveling applications, particularly with sweep oscillators such as the HP 8690A.

790 Directional Couplers

The 790 Directional Couplers are ultra-flat, high directivity couplers which are ideal for power-monitoring applications in coaxial systems. Output coupling (ratio of output power from main and auxiliary arms) is specified, rather than coupling factor. Thus, no correction factor is required to account for insertion and coupling losses in the main arm. With a power meter such as the HP 431C connected to the auxiliary arm, a calibrated, absolute power level can be conveniently established at any point in a system, and the output of the 431C Power Meter can be used as a leveling signal for sweep oscillators.

Specifications, 778D

Frequency range: 100 MHz to 2 GHz.

Minimum directivity: 40 dB to 1 GHz, 34 dB to 2 GHz.

Coupling attenuation (each auxiliary arm): 20 dB nominal.

Auxiliary arm tracking: typically within 0.7 dB and 4°.

Max. primary and secondary line swr (50Ω terminations): 1.1.

Power-handling capacity: 50 W average, 10 kW peak.

Primary line connectors: type N, one male (input), one female (output).

Auxiliary arm connectors: type N female.

Length: 16¾" (426 mm).

Shipping weight: 5 lb (2.3 kg).

Price: Model 778D, \$450.

Option 11. Furnished with APC-7 output connector, type N female input connector, add \$25.

Option 12. Furnished with type N male output connector, type N female input connector, no additional charge.

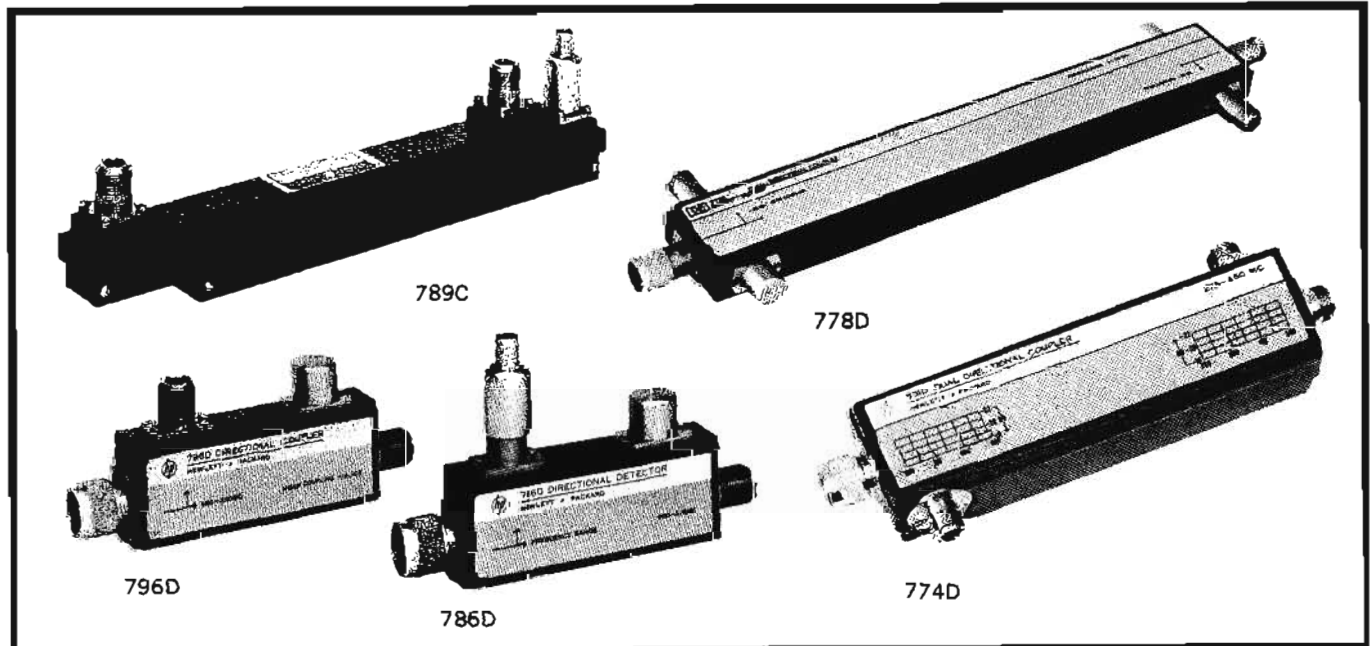

Specifications, 774D — 777D

HP Model	774D	776D	776D	777D
Frequency range	215 to 450 MHz	450 to 940 MHz	940 to 1900 MHz	1900 to 4000 MHz
Minimum directivity ¹	40 dB	40 dB	40 dB	30 dB
Coupling attenuation (each auxiliary arm)	20 dB	20 dB	20 dB	20 dB
Accuracy of coupling (each auxiliary arm)	mean coupling level within 0.5 dB of specified values			
Max. coupling variation (50-ohm terminations)	±1 dB	±1 dB	±1 dB	±0.4 dB
Auxiliary arm tracking ²	—	—	≤0.3 dB	≤0.5 dB
Max. primary line swr ¹ (50-ohm terminations)	1.15	1.15	1.15	1.2
Max. auxiliary arm swr (50-ohm terminations)	1.2	1.2	1.2	1.25
Power-handling capacity	50 watts avg. 10 kW peak	50 watts avg. 10 kW peak	50 watts avg. 10 kW peak	50 watts avg. 10 kW peak
Primary line insertion loss	approx. 0.15 dB	approx. 0.2 dB	approx. 0.25 dB	approx. 0.6 dB
Primary line connectors	Type N, one male, one female			
Auxiliary arm connectors	Type N, female			
Accessories available	11511A Type N Female Shorting Jack, \$4; 11512A Type N Male Shorting Plug, \$5			
Length	9-1/16" (230 mm)	9-1/16" (230 mm)	6-5/16" (161 mm)	8-7/8" (225 mm)
Shipping weight	4 lbs (1.8 kg)	4 lbs (1.8 kg)	3 lbs (1.4 kg)	3 lbs (1.4 kg)
Price	\$225	\$225	\$225	\$275

¹Measured with HP 906A Sliding Termination or K01-7700 Line Length Set.

²Maximum change in the coupling curve of one auxiliary arm relative to the other.

Specifications, 780 Series

HP Model	Frequency range (GHz)	Freq. resp. (dB) ^{1,2}	Low-level sens. (μV/μW)	Directivity (dB) ¹	Equiv. source match ^{1,3}	Max. swr	Max. input (W, peak or avg.)	Insertion loss (dB) ⁴	Length		Shipping weight		Price
									(in)	(mm)	(lbs)	(kg)	
786D	0.96 to 2.11	±0.2	>4	30	1.13	1.15 ¹	10	0.25	6	152	2	0.9	\$300
787D	1.9 to 4.1	±0.2	>4	26	1.16	1.15 ¹	10	0.35	4 7/8	124	2	0.9	\$300
788C	3.7 to 8.3	±0.3	>40	20	1.25	1.20	1	0.6	4 7/8	124	2	0.9	\$325
789C	8.0 to 12.4	±0.5	>20	17	1.25	1.40	1	0.7	11 3/4	295	2	0.9	\$350
X781A	8.0 to 12.4	±0.5	>20	17	1.07	1.25 ¹	1	0.7	15 3/4	400	2	0.9	\$350

¹Swept-frequency tested.

²As read on a 416 Ratio Meter or 415 SWR Meter calibrated for square-law detectors.

³The apparent swr at the output of an rf generating system, such as the output of a directional detector when it is used in a closed-loop leveling system.

⁴Includes loss due to coupling.

For all models

Detector output impedance: 15 kΩ max. shunted by approx. 10 pF.

Detector element: supplied.

Noise: <200 μV peak to peak with CW power applied to produce 100 mV output.

Detector output polarity: negative.

Detector output connector: BNC female.

RF connectors: Type N, one male (input), one female (789C: both female; X781A: input, Type N female);

output, precision cover flange, fits 1" x 1/2" waveguide, EIA WR90).

Options

02. Furnished with load resistor for optimum square law characteristics at 24°C (75°F), <±0.5 dB variation from square law over a range of at least 30 dB from low level up to 50 mV peak output (working into external load >75 kΩ); sensitivity typically one-fourth of unloaded sensitivity; add \$20.

03. Positive polarity detector output; no additional charge.

Specifications, 790 Series

HP Model	Frequency range (GHz)	Mean output coupling (dB) ¹	Output coupling variation (dB) ²	Directivity (dB) ²	Equiv. source match ^{2,3}	Max. primary line swr	Max. aux. arm swr	Max. input (W)	Insertion loss (dB) ⁴	Length		Shipping weight		Price
										(in)	(mm)	(lbs)	(kg)	
796D	0.96 to 2.11	20 ±0.5	±0.2	30	1.13	1.15 ²	1.20 ²	50	0.25	6	152	2	0.9	\$200
797D	1.9 to 4.1	20 ±0.5	±0.2	26	1.16	1.15 ²	1.25 ²	50	0.35	4 7/8	124	2	0.9	\$200
798C	3.7 to 8.3	10 ±0.3	±0.3	20	1.25	1.20	1.20	10	0.6	4 7/8	124	2	0.9	\$225

For all models: rf connectors: primary line: type N, one male (input), one female; auxiliary arm: type N female.

¹Difference in dB between power out of primary line and auxiliary arm.

²Swept-frequency tested.

³The apparent swr at the output port of a directional coupler when it is used in a closed-loop leveling system.

⁴Includes loss due to coupling.

COAXIAL, WAVEGUIDE



DIRECTIONAL COUPLERS

Easy-to-use, precision instruments

Model 752A,C,D

The HP 752 Directional Couplers are important tools in waveguide measurements. They can be used to monitor power, measure reflections, mix signals, or isolate signal sources or wavemeters.

Each coupler has an overall directivity of better than 40 dB (including reflection from built-in termination and flange) over its entire range. Performance characteristics are unaffected by humidity, temperature or time, thus making these units especially useful in microwave "standards" measurements. Coupling factors are 3, 10 and 20 dB; mean coupling accuracy is ± 0.4 dB (± 0.7 dB for K- and R-bands); and coupling variation vs frequency is ± 0.5 dB (± 0.6 dB for R752D).

Used together and connected back to back, two couplers are most useful with the HP 8690A Sweep Oscillator (see Signal Sources) in broadband reflection and swr measurements. One directional coupler samples power traveling toward the load, and the detected sample can be used to

maintain a constant forward power. The output of the auxiliary arm of the second coupler, which samples power reflected from the load, is then a direct indication of reflection coefficient and swr. After detection, this signal can be viewed on an oscilloscope or permanently recorded on an x-y recorder. The HP 424A Series Crystal Detectors are ideal for use with the 752 couplers.

In the system described above, the variation in coupling with frequency of the two couplers tends to cancel. This cancellation effectively improves the leveling of the signal source and increases the accuracy of the measurement. For applications in which the actual variations in source output must be minimized, matched pairs of couplers for the leveling loop are available on special order. The pair comprises a 3- and 10- or 20-dB coupler. The 3-dB coupler is connected to the auxiliary arm of the 10- or 20-dB coupler, reducing coupling variation to less than ± 0.2 dB. Swept-frequency techniques are described in detail in Application Note 65, available from any HP field office.

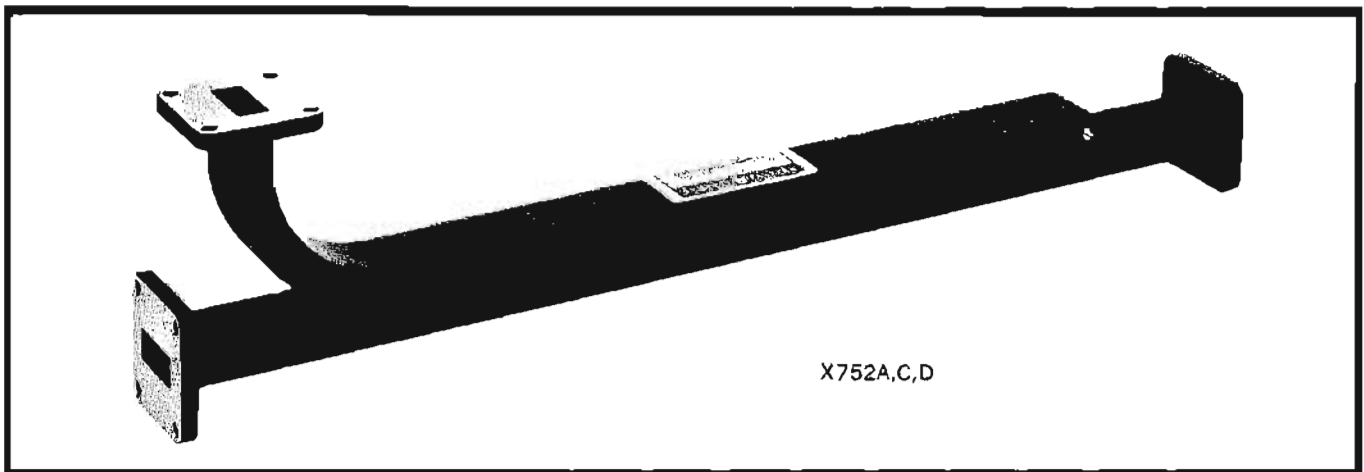

Specifications, 752 Series

Band ^{1,2} (prefix)	Frequency (GHz)	Flts waveguide size (in)	Mean coupling accuracy (dB) ^{3,4}	SWR ^{5,6} main guide		Average power aux. guide load (W)	Length (in)			Shipping weight		Price
				762A	762C,D		A	C	D	(lbs)	(kg)	
S	2.6-3.95	3 x 1½	±0.4	1.1	1.05	2	50¼	48	48	38	17.1	\$600
G	3.95-5.85	2 x 1	±0.4	1.1	1.05	2	34½	33	33	16	7.4	\$325
J*	5.85-8.2	1½ x ¾	±0.4	1.1	1.05	1	26½	25-9/16	25-9/16	13	5.8	\$220
H	7.05-10	1¼ x ¾	±0.4	1.1	1.05	1	18¾	17½	17½	4	1.8	\$165
X	8.2-12.4	1 x ½	±0.4	1.1	1.05	1	16-11/16	15-11/16	15-11/16	3	1.4	\$125
P	12.4-18	.702 x .391	±0.4	1.1	1.05	1	13¾	12¾	12¾	2	0.9	\$150
K†	18-26.5	½ x ¼	±0.7	1.1	1.05	½	10¾	9-15/16	9-15/16	1	0.45	\$200
R†	26.5-40	.360 x .220	±0.7	1.1	1.05	½	11¾	8¾	8-23/32	1	0.45	\$250

¹When ordering, specify suffix letter to indicate nominal coupling: A for 3 dB, C for 10 dB, D for 20 dB (example: S-band, 3 dB coupling, Model S752A).

²Directivity is at least 40 dB; swept-frequency tested.

³Mean coupling is the average of the maximum and minimum coupling values in the rated frequency range.

⁴Coupling variation over rated frequency range is not more than ± 0.5 dB about mean coupling (± 0.6 dB for R752D).

⁵Auxiliary arm swr is 1.15 (1.2 for P-, K- and R-band units).

⁶Swept-frequency tested.

*J752 Couplers operate to 5.3 GHz with reduced performance.

†Circular flange adapters: K-band (UG425/U), HP 11515A, \$35 each; R-band (UG-381/U), HP 11516A, \$40 each.

TUNERS, PHASE SHIFTERS

Precision instruments for lab or general use
Models 870A, 885A



COAXIAL, WAVEGUIDE

870A Slide-Screw Tuners

Slide-screw tuners are used to match loads, terminations, etc., to the characteristic impedance of the transmission system. The HP 870A tuners consist of a waveguide slotted section with a precision carriage that supports an adjustable probe. The position and penetration of the probe is adjusted to set up a reflection which cancels an existing reflection in the system. An SWR of 20 can be corrected to 1.02, and small SWR's may be corrected exactly. Eight models cover the 2.6 to 40 GHz range. Price: HP 870A, \$150 to \$350.

Specifications, 870A

Model	Freq. range (GHz)	Length (In) (mm)	Correctable SWR	Max. Insertion loss (dB) at corrected SWR of 20	Price
S870A	2.6- 3.95	11 279	20	2	\$350
G870A	3.95-5.85	8¼ 210	20	2	275
J870A	5.3- 8.20	7 194	20	2	200
H870A	7.05-10.0	6 152	20	2	170
X870A	8.20-12.4	5½ 140	20	2	150
P870A	12.4-18.0	5 127	20	2	160
K870A*	18.0-26.5	4¾ 108	20	3	300
R870A*	26.5-40.0	4 111	20	3	325

*Circular flange adapters: For K-band specify HP 11515A (UG-425/U), \$35 each.
For R-band specify HP 11516A (UG-381/U), \$40 each.

885A waveguide phase shifters

HP 885A Phase Shifters provide accurate, controllable phase variation in the J-, X-, and P-band frequency ranges. They are particularly useful in microwave bridge circuits where phase and amplitude must be adjusted independently. They also are used in the study of phased arrays.

The instruments are differential phase devices; that is, they add or subtract a known phase shift from the total phase shift which a wave undergoes in traveling through the device.

The instruments have high accuracy over their entire phase range, -360 to $+360$ electrical degrees, have low power absorption, are simple to operate, and require no charts or interpolation. They are sturdily built, comprising two rectangular-to-circular waveguide transitions with a dial-driven circular waveguide mid-section. These waveguide phase shifters are housed in cast aluminum containers for extreme rigidity and durability.

Specifications, 885A

HP Model	Frequency range (GHz)	Accuracy	Maximum Insertion loss	Power (rating watts)	Price
J885A	5.30 - 8.20	3°	2 dB	10	\$550
X885A	8.20 - 12.4	2°, 8.2 - 10 GHz 3°, 10-12.4 GHz	1 dB, 8.2-10 GHz 2 dB, 10-12.4 GHz	10	\$425
P885A	12.4 - 18.0	4°	3 dB	5	\$600

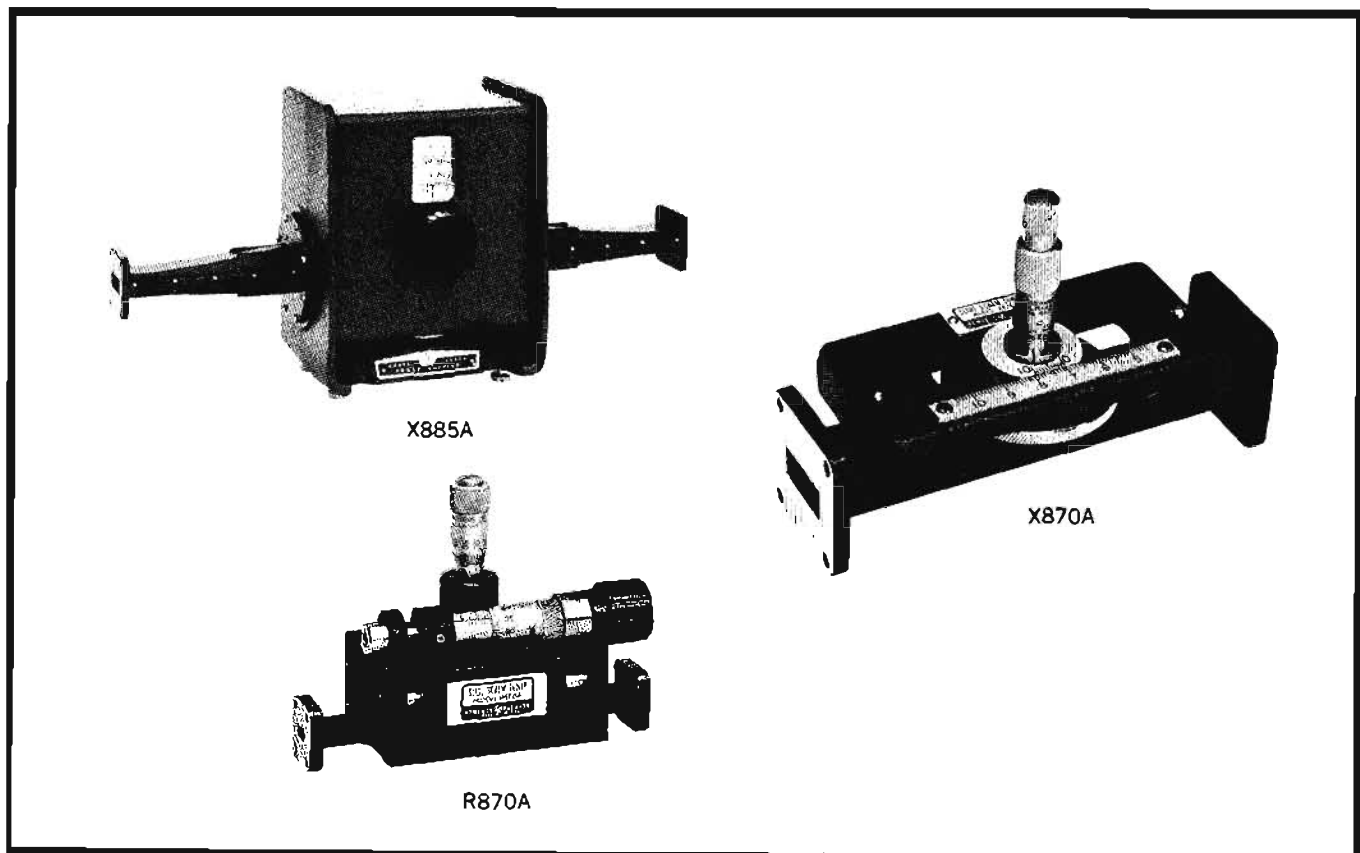

COAXIAL, WAVEGUIDE



TERMINATIONS AND SHORTS

Versatile, convenient microwave instruments
Models 907A-914B and 920,X923A

907,914 loads

The HP 907A Coaxial Sliding Load is a moveable, low-reflection termination for 50-ohm systems. It covers the frequency range of 1 to 18 GHz, and is ideal for use with the HP 8410A Network Analyzer for improving accuracy of complex impedance measurements. Model 914 Moving Load consists of a section of waveguide in which is mounted a sliding tapered low-reflection load. Eight models cover the frequency range from 2.6 to 40 GHz.

907A, 914 Specifications

Model	Frequency Range (GHz)	SWR load	Fits waveguide size OD (in.)	EIA	Price
907A	1.0 - 18.0	1.1 from 1 to 1.5 GHz 1.05 from 1.5 to 18 GHz	See Note 1		\$275
S914A	2.6 - 3.95	1.01	3 x 1½	WR 284	\$150
G914A	3.95 - 5.85	1.01	2 x 1	WR 187	\$120
J914A	5.3 - 8.2	1.01	1½ x ¾	WR 137	\$100
H914A	7.05 - 10	1.01	1½ x ¾	WR 112	\$ 80
X914B	8.2 - 12.4	1.01	1 x ½	WR 90	\$ 60
P914A	12.4 - 18	1.01	0.702 x 0.391	WR 62	\$ 75
K914B	18 - 26.5	1.01	½ x ¼	WR 42	\$275
R914B	26.5 - 40	1.01	0.360 x 0.220	WR 28	\$275

Note 1: Furnished with adapters and connectors for use with APC-7 and Type N connectors.

908A, 909A, 910 terminations

The 908A and 909A Terminations are low-reflection loads for terminating 50-ohm coaxial systems in their characteristics impedance. Model 909A is extremely broadband, covering the frequency range from dc to 18 GHz. Combining economy with utility, the 908A covers the range from dc to 4 GHz.

Model 910 is designed for terminating waveguides sys-

tems operating at low average powers. The terminations are carefully designed to absorb virtually all of the applied power and assure a low SWR.

908A, 909A, 910 Specifications

Model	Frequency Range (GHz)	SWR	Power Ratings	Fits waveguide size OD (in.)	EIA	Price
908A	dc-4.0	1.05	½ watt avg.	See note 1		\$35
909A	dc-18.0	1.05 to 4 GHz; 1.1 from 4 to 12.4 GHz; 1.25 from 12.4 to 18 GHz.	2 watts avg.	See note 2		\$75
S910A	2.60-3.95	1.04	2 watts	3 x 1½	WR 284	\$90
G910A	3.95-5.85	1.04	2 watts	2 x 1	WR 187	\$70
J910A	5.3-8.2	1.02	1 watt	1½ x ¾	WR 137	\$55
H910A	7.05-10	1.02	1 watt	1½ x ¾	WR 112	\$45
X910B	8.2-12.4	1.015	1 watt	1 x ½	WR 90	\$35
P910A	12.4-18	1.02	1 watt	0.701 x 0.391	WR 62	\$40

Note 1: Type N connector.

Note 2: APC-7 (standard), Type N male (Option 12, less \$15), or Type N female (Option 13, less \$15).

X923A, 920A,B waveguide shorts

Models X923A and 920A,B are convenient instruments for introducing a variable element in waveguide systems. Operating in X-band (8.2 to 12.4 GHz), the X923A combines fast phasing capability with a reference plane which is independent of frequency. The 920A,B are phased with a lead screw.

X923A, 920A, B Specifications

Model	Frequency Range (GHz)	Fits waveguide size OD (in.)	EIA	Price
S920A	2.6-3.95	3 x 1½	WR 284	\$150
G920A	3.95-5.85	2 x 1	WR 187	\$125
J920A	5.3-8.2	1½ x ¾	WR 137	\$100
H920A	7.05-10.0	1½ x ¾	WR 112	\$ 85
X923A	8.2-12.4	1 x ½	WR 90	\$ 75
P920B	12.4-18	0.702 x 0.391	WR 62	\$125
K920B	18.0-26.5	0.500 x 0.250	WR 42	\$155
R920B	26.5-40.0	0.360 x 0.220	WR 28	\$175

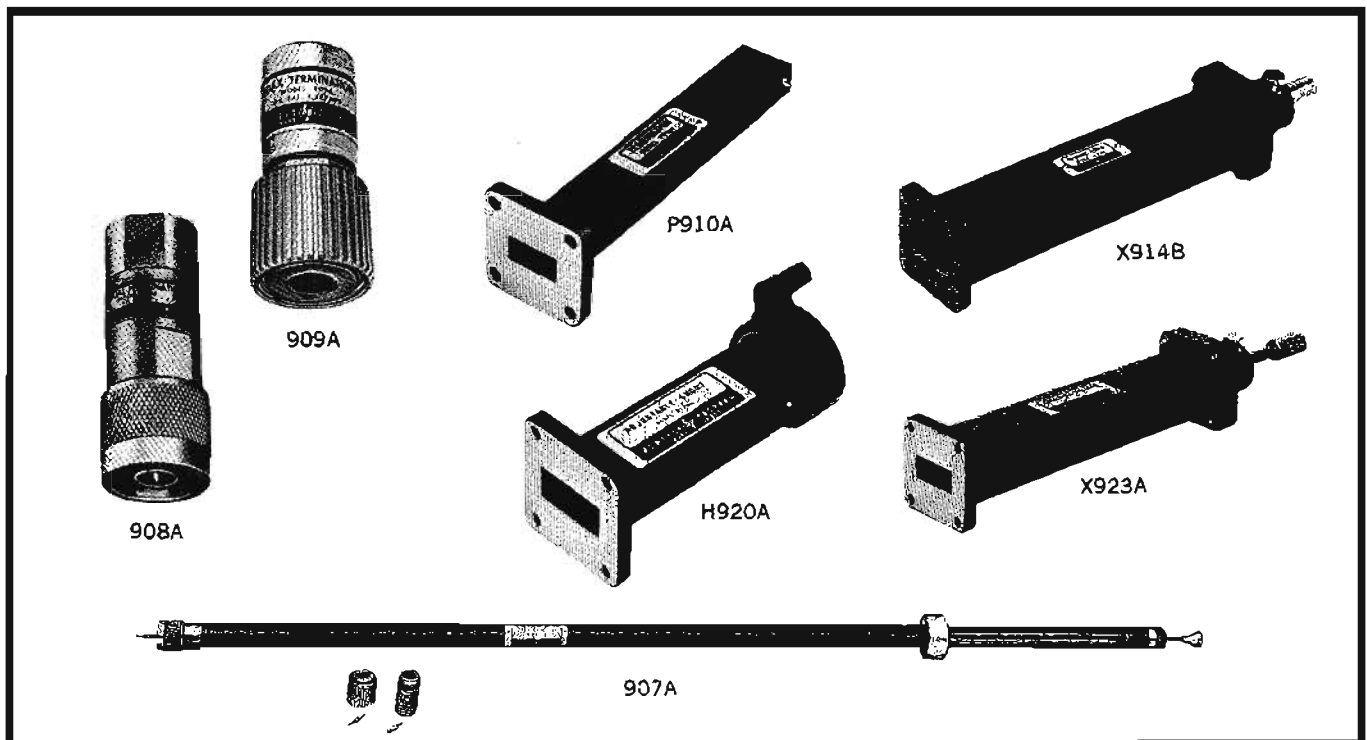

LOCATING LEAKS IN PRESSURIZED COMMUNICATIONS NETWORKS



COMMUNICATIONS TEST EQUIPMENT

The aerial and underground pressurized cable plant of the modern telephone operating organization is an excellent example of a very extensive industrial pressure vessel system which lends itself to ultrasonic maintenance. Gaining momentum after World War II, cable pressurization has resulted in overall reduction in outlay for cable plant maintenance. This is particularly true in the reduction of emergency repair time formerly encountered when moisture entered the cable sheath to result in widespread service disruption. Modern telephone practice calls for the installation of pole mounted compressor/dryer units supplying cable pressure. Flow indicators provide telephone maintenance crews with constant readings as to the integrity of the cable sheath. Additionally, contractor terminals are employed throughout the plant.

The most common causes of leaks in cable plant are corrosion (particularly in coastal areas), electrolysis, squirrels, boring beetles, abrasion from wind and weather, hunters, and outside workmen. Abrasion (during installation) and corrosion are the most frequent causes of cable sheath trouble in cable installed in underground (ducted) passages.

Before the advent of ultrasonic leak detection, it was necessary on aerial cable for the craftsman to apply soap solution from the ground or from a suspended platform and to watch for bubbles to indicate leaking cable.

Ultrasonic inspection

Although the highly portable ultrasonic translator detector permits telephone craftsmen to locate sheath damage in pressurized cable from the ground, prudent supervisory management has established preinspection procedures to

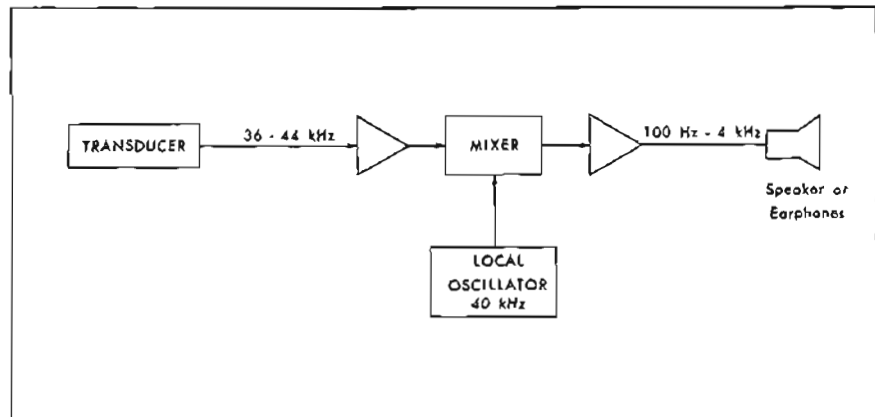

speed the operation further. It is typical practice, for example, for a splicer to perform the following preliminary steps on a cable failing to maintain a nominal 10 psi pressure.

(1) Place nitrogen cylinders, set to discharge 10 psi, at strategic locations along the right-of-way (r.o.w.). Such cylinders often are allowed to remain 24 hours or longer in order to stabilize pressure within the cable.

(2) Take air pressure readings at selected points along the r.o.w. This practice is particularly important on such cables as cross-country toll lines which often traverse a line-of-sight r.o.w. across precipitous terrain.

(3) The readings taken at each pressure point are then plotted on graph paper. Each grid on the paper is selected by the craftsman to represent a known distance as determined from his cable plant maps.

(4) An alternative method of narrowing down the location of the leak is the cable pressurization computer, or gas pressure slide rule, as it is often called.

After the craftsman has narrowed down the location of the leak, or leaks, to within the length of 5 to 10 sections (between utility poles) or less, he commences his ultrasonic inspection in any of the following ways:

If he has isolated the trouble to within two city blocks or less, he would normally walk the route, using either the handheld probe or an 18002A ultrasonic probe extension fitted to a standard tree pruner section or the wheeled assembly ultrasonic probe (18003A). These accessories have 10 kv isolation transformers for the safety of the craftsman.

In certain instances, an area-wide infestation of boring beetles will cause extensive damage and multiple leaks. In such cases, the inspection is often done from a moving vehicle. The telephone splicing cable car is still required for ultrasonic inspection on cables where the r.o.w. traverses canyons or deep gullies.

Estimates by officials at various telephone operating companies as to the economies achieved by the use of ultrasonic leak detection range from 50 to 80 percent.

Although the Delcon Ultrasonic Translator detector's transducer is responsive only to a 36 to 44 kHz acoustic bandwidth, the characteristic sounds of a phenomenon are preserved through translation and amplification. Thus, a typical 10 psi compressed air or nitrogen leak in pressurized cable, when translated, sounds exactly like the familiar hissing sound of a punctured innertube. Human experience, then, is the only data processing required.

Training

The training of personnel in the use of ultrasonic leak detectors is minimal—the journeyman craftsman's common sense and work experience assure success. However, the ability to hear inaudible sounds is a new experience and it is recommended that cable maintenance personnel receive a brief introduction to the instrument. Such an introduction can readily be set up by a telephone operating center. Some centers use cable vaults adjoining the central office. The foreman conducting the session will loosen air pressure valves to simulate leaks and then allow each of the craftsmen to find all of the leaks. The foreman instructs each craftsman to coordinate the direction of the probe with the sonic intensity.

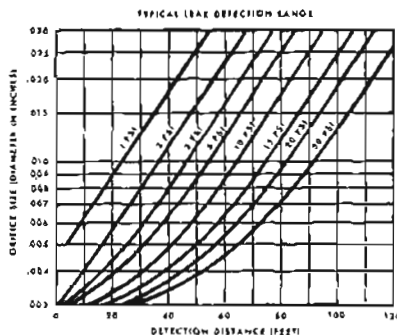

Typical leak detection ranges of HP ultrasonic translators. Curves give typical leak detection distances for orifice type leads versus pressure and orifice size.



ULTRASONIC LEAK DETECTORS

Instruments for maintaining pressurized cable
Models 4916A and 4905A

Model 4916A

The Model 4916A Ultrasonic Translator detector is a lightweight system which consists of the basic detector unit, a directional probe, 6-foot coil cord, matching headphones, and a leather utility case. Information readout is through top quality headset, which provides craftsmen with readily interpreted and easily analyzed signal. The instrument is

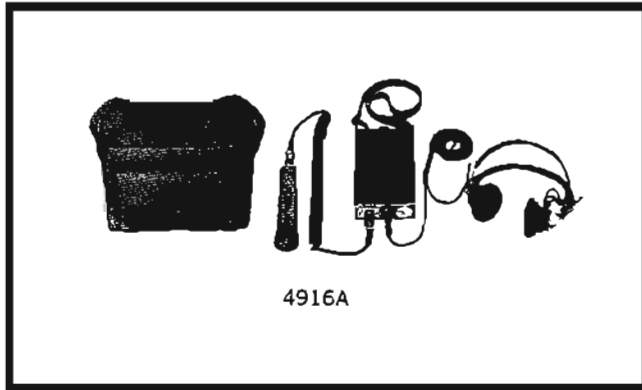

4916A

shipped with mercury batteries which provide from 360 to 500 hours of dependable operation. The detector is carried by the web carrying strap.

Specifications, 4916A

Construction: rugged aluminum construction throughout entire instrument. Separate battery compartment permits battery replacement without disassembly. MIL-specification glass reinforced epoxy printed circuit board. Cabinet has detachable side plates for major servicing.

Circuitry: completely transistorized 4.5-volt circuitry for long battery life. Pull-Push switch and volume control are combined.

Response: frequencies between 36 kHz and 44 kHz are translated into audible sounds, while sounds within the human hearing range are not detected by this instrument.

Probe and coil cord: hand-held; shielded against rf interference; output impedance 180 ohms; transistorized pre-amplifier; conical response ± 11 degrees at 3 dB points. Supplied with a 6-foot coil cord. Probe size: $1\frac{3}{8}$ " dia. by $6\frac{1}{4}$ " long.

Jack output: 1 milliwatt into 600-ohm matched headphone. One volt rms.

Dimensions: 4" wide, $7\frac{1}{2}$ " high, $1\frac{3}{4}$ " deep (10,2 x 19,1 x 4,45 cm).

Batteries: 3 cells of mercury type Everready E-120 or equivalent.

Battery life: 360-500 hours.

Weight: net 6 lbs (3,2 kg); shipping 8 lbs (3,6 kg).

Price: Delcon Model 4916A complete, \$525.

Model 4905A

This lightweight, portable device is designed expressly for use in applications requiring a high degree of mobility. Offering operators hand-free efficiency, the 4905A has a built-in speaker and a reference meter. The speaker permits craftsmen to wear hard hats. The design of the 4905A is simple, functional, and it is easily used.



4905A

Specifications, 4905A

Construction: rugged aluminum chassis and case; stainless steel hardware throughout; MIL-specification printed circuit board; quick-access battery compartment; detachable cabinet side-plate for servicing.

Circuitry: broad-range 4.5 V transistorized circuitry with RF filter, circuit gain controlled by a single knob.

Frequency response: translates frequencies between 36 and 44 kHz into audible sounds; other sounds within audio range are screened out.

Probe and coil cord: hand-held; shielded against RF interference; conical response ± 11 degrees at 3 dB points. Supplied with a six-foot coil cord. Probe size: $1\frac{3}{8}$ " dia. x $6\frac{1}{4}$ " long.

Meter: ultrasonic sound intensity measured by output meter sealed and gasketed to lock out dirt and contaminants. Scale length 1.75 inches with 0-100 for logging relative measurements.

Speaker: incorporates 2.5 inch speaker; sealed against moisture; nominal power to speaker 25 mW. Disconnected when headset in use.

Temperature range: oscillator stability ± 15 Hz and signal-to-noise ratio within ± 1 dB from 0-55 degrees C.

Headset jack: auxiliary 600-ohm output headset jack.

System weight: net 6 lbs (2,7 kg); shipping weight 8 lbs (3,6 kg).

Batteries: 3 cells of Mercury type Everready E-12 or equivalent.

Battery life: 360-500 hours.

Dimensions: $8\frac{1}{2}$ " wide x $4\frac{1}{2}$ " high x $2\frac{1}{4}$ " deep (20,9 x 11,4 x 5,71 cm).

Price: Model 4905A, \$595.

REFLECTOR, SEARCH WAND

Accessories for use with ultrasonic detectors
Models 18002A, 18003A



**COMMUNICATIONS
TEST EQUIPMENT**

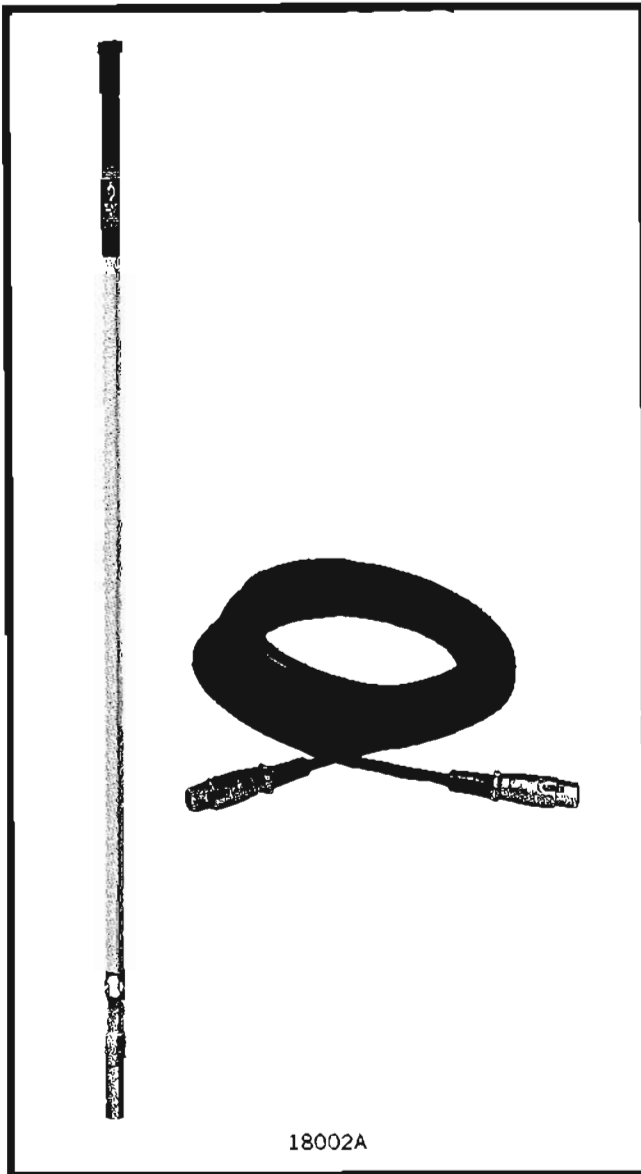

18002A



18003A

Accessories shown in this catalog can be used with all models of Delcon Ultrasonic Translator detectors.

Model 18002A Quick-Search Wand

The 18002A is a high-gain probe on a 5-foot long fiberglass pole designed to mate with standard telephone tree pruner poles and is provided with a 25-foot cord for connection to the Ultrasonic Translator Detector. Incorporating a preamplifier and 10 kV insulation, the 18002A permits a close inspection of overhead cables and terminals and for surveillance of manholes for leaks in cable, sleeves and splice cases.

Overall length: 5 ft 11 in.

System weight: net 5 lbs (2,3 kg); shipping 7 lbs (3,2 kg).

Price: 18002A, \$185.

Model 18003A Mobile Reflector

Designed to ride aerial cable, this unit is used with standard telephone tree pruner poles and is provided with a 25-foot cord for connection to the Ultrasonic Translator Detector. Preamplifier and local battery located in top housing. Unit equipped with two-wheel removable bridge assembly and sonic reflector. Insulation provided for 10 kV operator protection.

Overall length: 5 ft 1/2 in.

Systems weight: net 8 lbs (2,3 kg); shipping 10 lbs (4,5 kg).

Price: 18003A, \$225.



CABLE FAULT LOCATING

Faulted cable can generally be classified as one of two major categories: (1) open pairs, or (2) grounds, crosses, and shorts. After the initial trouble report has been made, the field craftsman is ready to locate the fault. At this point, time is of utmost importance for restoration of service and to minimize direct labor costs; however, only by careful analysis of the fault can the craftsman proceed in an organized and systematic manner. This, then, requires the proper instrument to perform both the important step of analysis as well as actually locating the fault.

Selecting proper instruments

Grounds, crosses, and shorts are sometimes found by using a whole family of test sets—some of which may be obsolete. The HP Cable Fault Locators (4900 Series) are designed to eliminate the need for several instruments. For example, cables can be analyzed for resistance of the fault by using the built-in ohmmeter feature on the Model 4901A. Without a jumble of accessories or extensive technical knowledge on the part of the user, faults can be pinpointed easily and accurately.

Basically, the 4900 Series system consists of a battery powered transmitter unit to produce a distinctive, pulsed signal; an inductive probe and a conductive probe which serve as directional pickups; and a compact receiver unit with high sensitivity and narrow band pass filtering to reproduce the signal on its speaker and reflect its intensity on the meter.

Versatility of the 4900 Series Cable Fault Locators enable the operator to shoot trouble on aerial, buried, or underground cable. Aerial wire faults also can be pinpointed quickly. In addition to fault locating, the path and depth of buried or underground cable can be determined accurately without signal "spill over" to other buried facilities.

High sensitivity of the 4900A and 4901A makes them very practical instruments for use on all types of communications cable—PIC, lead and coaxial.

Non-communications uses

Power companies and utilities have found the Cable Fault Locator particularly valuable for use on underground residential distribution circuits (URD).

Series circuits such as street lighting or airport lighting are examples where the HP Cable Fault Locators can be

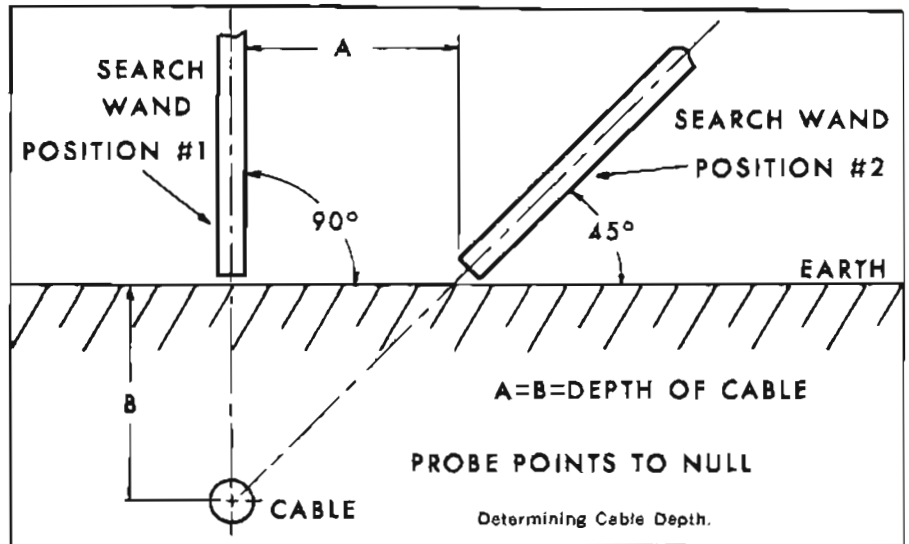

used. Path and depth can be determined on all types of power cables.

Contractors are able to determine the path and depth of non-metallic duct or pipe by the simple procedure of inserting a flexible metal push rod the length of the course. Tone is applied to the rod and located with the wand.

Open pairs

When the reported trouble indicates the faulted cable pair to be open, the craftsman must further analyze the fault. First, he must have a basic understanding of cable makeup and related interconductor capacity. Exchange cable is designed and manufactured to have a mutual capacitance of .083 microfarad per mile. Cable pair capacity will vary from this nominal value depending upon the tolerance established at the time of manufacture as well as the percentage

of working pairs within the cable. The 4910B has been designed to accommodate a wide range of pair capacitances by the incorporation of an adjustable "D" Factor control and reference.

A "D" Factor reference of 1.0 has been established for a nominal cable capacitance of .083 microfarad per mile in an average use condition. Some cables, most common being quadded toll, are designed to have a lower capacitance of .067 microfarad per mile. Buried service wire and multiple line wire have pair capacities which differ from both the standard and low capacitance cable.

Principles of operation

The 4910B is a capacitance meter that is unaffected by the inductance or resistance that is present in all lines.

The technique employed is "automatic charge sampling" which relates the charge placed on a length of wire to its capacitance and hence the length. A dc voltage is applied to the test pair and the charge retained on the pair is then automatically transferred to a reference capacitor within the 4910B and the resulting voltage developed across this capacitor represents the length of the conductor under test. Final readout of the conductor length is provided by a high impedance voltmeter having an output meter indicating directly in feet.

The 4910B system measures total capacitance of a circuit including bridge taps and built-in capacitors. Trouble shooting must, therefore, take these factors into account.

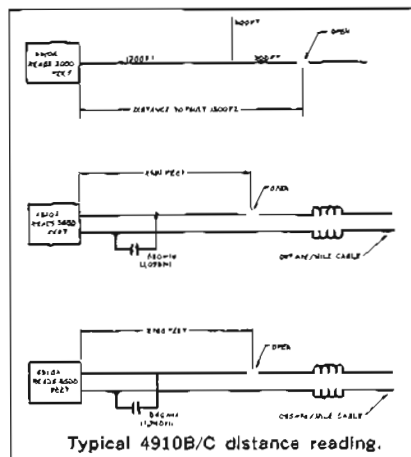

CABLE FAULT LOCATORS

Shorts, grounds, crosses, earth returns
Models 4900A, 4901A



COMMUNICATIONS
TEST EQUIPMENT

Operating on the principles of electromagnetic induction and earth voltage gradients, the series 4900A/4901A Fault Locators provide the craftsman a highly efficient means of troubleshooting. These instruments perform analysis and locating procedures which previously required several instruments. Field experience by operating companies show considerable savings in cable maintenance due to faster circuit restoration. Rugged construction makes the instruments ideal for all working and weather conditions.

The instruments are identical except that the Model 4901A has an ohmmeter to assist the craftsman in preliminary analysis, proper grounding point selection, and in determining "drying

out" of resistance. Series 4900A/4901A instruments are shipped complete with all accessories necessary for troubleshooting buried cable plant. Also included is a 30-foot lead for use on aerial and block cable. A special jack on the receiver permits utilization of standard explorer coils already in telephone organizations' inventories. An ordinary lantern cell powers the transmitter and an interlock switch automatically prevents battery drain when the set is not in use. Battery voltage is regulated for optimum performance throughout the battery life. The accompanying instruction manual provides a short course in cable maintenance techniques in language and diagrams easily understood by all craftsmen.

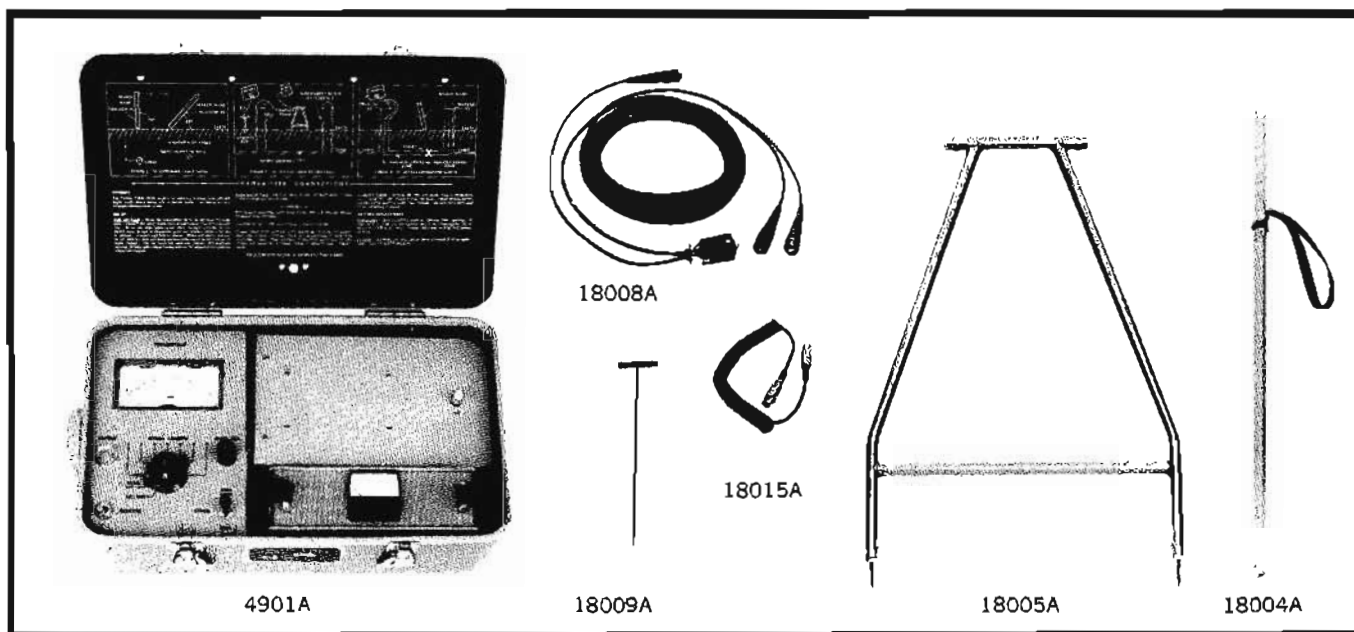

Specifications

Transmitter (Model 4900A)

- Output signal:** 990 Hz \pm 10 Hz pulsed at 7 pps; 50% duty cycle.
- Output power:** adjustable to 2.2 W with a 6 Vdc supply.
- Output impedance:** variable, 4 to 4,000 ohms, by seven position switch.
- Power supply:** 6 V lantern battery, internal regulation.

Transmitter (Model 4901A)

- Output signal:** 900 Hz \pm 10 Hz pulsed at 7 pps; 50% duty cycle.
- Output power:** adjustable to 2.2 W with a 6 Vdc supply.
- Output impedance:** variable, 5 to 4,000 ohms, by seven position switch.
- Ohmmeter resistance range:** two ranges, 0-1K (25 ohm mid-scale) and 0-1 Meg (25K mid-scale).
- Ohmmeter accuracy:** \pm 3% of mid-scale readings (0 degrees to 50 degrees C).
- Power supply:** 6 V lantern battery, internal regulation.

Receiver

- Center frequency:** 900 Hz \pm 20 Hz.
- Bandwidth:** 3 dB 70 Hz.
- Sensitivity:** a 1.25 μ V 600 ohm source shall produce a 10 dB reading on the receiver meter.
- Meter scales:** 0-100 linear logging scale, 0-30 dB scale.
- Power supply:** three 1.35 V batteries in series.

Dimensions: 7 $\frac{3}{4}$ x 2 $\frac{1}{2}$ x 4 $\frac{1}{2}$ in.

Weight: 2 $\frac{1}{2}$ lbs.

Earth contact frame

- Type:** voltage gradient detection probe.
- Sensitivity:** 4.7 μ V/meter for a 10 dB reading on the receiver meter.
- Construction:** lightweight welded tubular aluminum with stainless steel tines.
- Dimensions:** 31 $\frac{1}{2}$ H x 21 $\frac{3}{4}$ W x $\frac{3}{4}$ D inches.

Search wand

- Type:** inductive pick-up probe.
- Sensitivity:** 2.0 μ gauss for 10 dB reading on meter.
- Construction:** lightweight aluminum tubing, contains a pick-up coil wound on a ferrite core.
- Dimensions:** 33 inches long, $\frac{3}{4}$ inch diameter.

Carrying case

- Stows the receiver, built-in transmitter, lantern battery, test cables, and ground rod. Constructed of heavy gage aluminum.
- Dimensions:** 9 $\frac{1}{2}$ x 9 x 15 inches.

System weight: net 22 lbs (10 kg); shipping 25 lbs (11.4 kg).

Price: Model 4900A complete, \$595.
Model 4901A complete, \$695.

**COMMUNICATIONS
TEST EQUIPMENT**

OPEN PAIR FAULT LOCATOR

Pinpoints exact location of open pair
Models 4910B, 4910C

This lightweight portable instrument is designed for the accurate location of open conductors in telephone cable pairs as distant as 100,000 feet (or 30,000 meters) from the test point. Standard or comparison pairs are not required, and the instrument indicates distance to the fault point directly in feet (or meters) on a durable, taut-band, mirrored meter. Employing the latest automatic charge sampling technique for maximum accuracy and minimum effect from cable induction, the all solid state 4910B/C is self-calibrating for use on all types of telephone cables. Simple to operate, the 4910B/C incorporates a line select switch permitting the tip and ring of a pair to be tested separately without the necessity of manually reversing test leads.

Special features:

Instrument automatically analyzes cable leakage re-

sistance on each distance range to determine if test is valid

Internal voltmeter tests cable pair for presence of foreign voltage

Line select switch permits instantaneous testing of either conductor

Completely self-calibrating and self-testing circuitry assures accurate test results

Exclusive "D-Factor" to adjust for varying cable capacitances

Monitor circuit automatically locks out reading when battery voltage falls below dependable operating level

Interlock circuit automatically turns off all internal batteries when test cable is removed from instrument

Test cable length is automatically subtracted providing readings in net distance to fault

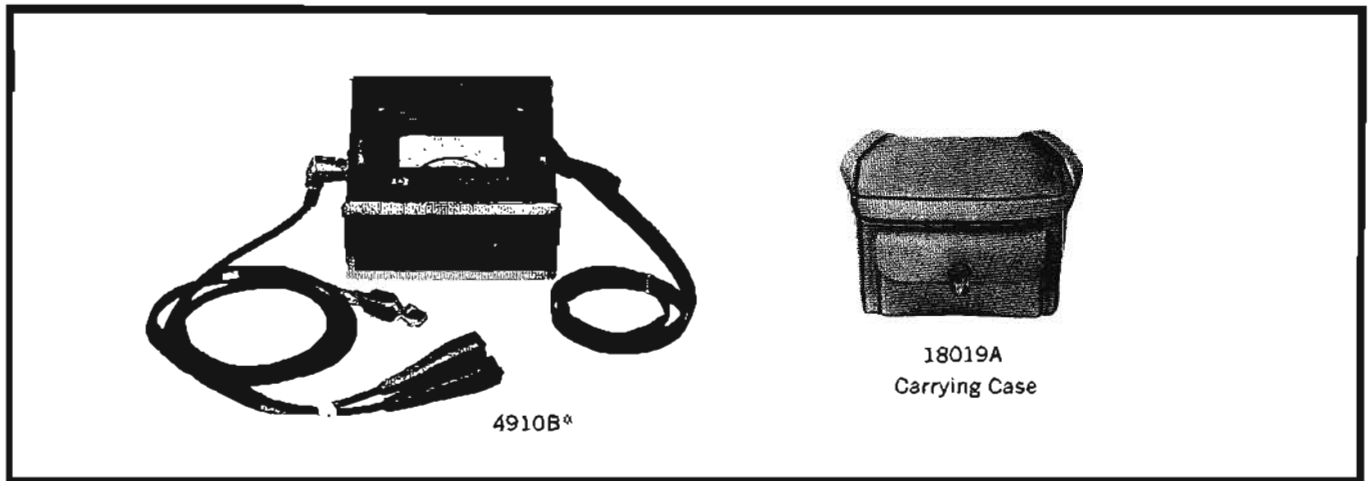
Specifications

Distance measurement: for cables having a pair capacitance from 0.056 to 0.138 microfarad per mile, from 0 to 100,000 feet (7 ranges).

Voltage measurement: indicates presence of any voltage from 1 to 100 volts on line. Automatically displays ac and either polarity of dc voltage on a GO/NO-GO type scale.

Resistance measurement: indicates when cable pair leakage resistance will affect distance readings. Reading is on a GO/NO-GO type scale.

Distance ranges: 4910B

Scale	Accuracy
0-100 feet	± 1 foot
0-300 feet	± 3 feet
0-1000 feet	± 10 feet
0-3000 feet	± 30 feet
0-10,000 feet	± 100 feet
0-30,000 feet	± 300 feet
0-100,000 feet	± 5000 feet

Meter: taut-band meter movement for rugged field use. Mirror-backed scale for precision readings.

Distance ranges: 4910C

Scale	Accuracy
0-30 meters	± 0.3 meter
0-100 meters	± 1 meter
0-300 meters	± 3 meters
0-1000 meters	± 10 meters
0-3000 meters	± 30 meters
0-10,000 meters	± 100 meters
0-30,000 meters	± 1500 meters

Batteries: four standard 8.4 volt tubular Eveready E-126.

Battery life: 10,000 line tests (one year average service).

Weight: net 5 lbs (2,27 kg); shipping 10 lbs (4,54 kg).
Size: 7" x 5³/₄" x 5" (17,8 cm x 14,5 cm x 12,5 cm).

Price: Model 4910B, \$575. Model 4910C, \$575.

*Both instruments are identical except for meter scales. The 4910B is calibrated in feet; the 4910C is the metric counterpart.



The telegraph was the first method of electrical communication. In 1844 the first message was sent over a circuit; shortly after this, the telephone was invented. Since then, electrical communications have been changed to electronic communications. Hewlett-Packard has designed equipment specifically for testing communication systems. The following information pertains only to test equipment designed to simplify and expedite communications service.

These objectives have been accomplished several ways: 1) One instrument, or combination of instruments in one carrying case, will perform the duties of several previous instruments. 2) One function may be transferred to another by merely changing a switch position. 3) Battery-operated test equipment permits operation in the field. 4) A number of standard Western Electric terminals connected in parallel permit connection to different types of line equipment.

Generally, in the United States, subscribers' loops are of nominal 900-ohm impedance. 600 ohms is an accepted trunk and tollboard impedance and is found in the many miles of open-wire carrier still in use. The CCITT* does not recognize 900 ohms as a subscriber-loop impedance but recommends 600 ohms. Wire-cable carrier, typically short-haul, uses 135-ohm cable. Many higher capacity systems use 135 ohms as an interface impedance on a group or super-group basis. The CCITT equivalent of this impedance is 150 ohms. Long-haul coaxial-cable carrier systems use 75 ohms in the United States and in the CCITT recommended systems.

Since a holding function is desirable in many measurements, a holding coil is provided which may be switched into the circuit on the 600 Hold and 900 Hold position. This provides an off-hook condition to hold the dialed line.

Connections are provided for attaching a lineman's handset for dialing. Once the connection has been established, the test instrument may be switched to one of the Hold positions. This will maintain the dialed connection but will remove the talking function and substitute the measuring circuit. The input and output jacks accept standard 241, 309 and 310 Western Electric plugs, as well as the special connectors to receive the lineman's handset and dual banana binding posts for attaching wires.

The theory of message-circuit noise measurement is based on a relative inter-

facing effect of the noise on the subscriber's hearing. Because of the frequency response of the telephone subset and the fact that the human ear responds differently to noise of various frequencies, a weighting function is assigned to each frequency in proportion to its contribution to the interfering effect.

The weighting curve currently accepted as a U.S. standard is the Bell System C-Message weighting (see Figure 1). The unit used to define noise measured in this manner is dBRNC, meaning decibels above Reference Noise, C-Message weighted. Reference noise is -90 dBm at 1 kHz. The CCITT recommendation is psophometric weighting, which has a slightly different curve and is referenced to 800 Hz. The measuring units for this weighting are picowatts psophometric, or pWp. A flat weighting refers to the broadband or flat voltmeter function, and a 3kHz flat weighting provides for

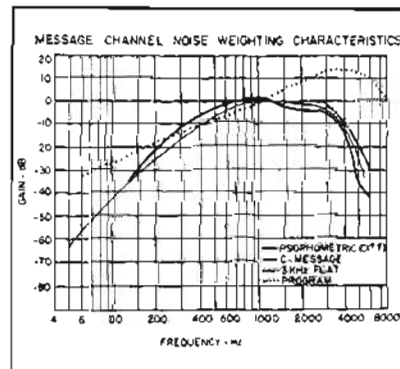

Figure 1. Noise weighting curves.

weighting over the range of voice frequencies only. Radio and television studio-transmitter and studio-remote audio links require a different weighting known as program weighting because of the different sending and receiving equipment characteristics. This program weighting curve is also shown in Figure 1.

Since noise-measuring sets are designed to duplicate the response of the ear, the dynamic response time and the law of combination of tones should be the same. This requires a 200 ms meter-response time and rms response. Average-responding meters will read 1.05 dB low compared to an rms meter on Gaussian noise (providing no overload occurs on the peaks).

The CCITT recommendation specifies rms response for noise measurements and calls out a method for testing meters for rms response.

In addition to the quantitative measurement of noise, it is important to identify the source of the noise. Some indication of this can be obtained by noting the difference in noise on the 3 kHz flat and the C-Message weighting functions. A substantially higher reading in the 3 kHz flat mode usually indicates excessive power-line noise. Aural monitoring of the noise using a headphone is also used.

The noise meter should also be a level meter, as these two measurements are most frequently made. Since field use accounts for a major part of the service of such a device, portability and battery operation are essential. Rugged case construction, able to withstand the rigors of outside operation, is desired. Monitor and recorder outputs for aural monitoring and long-term recording of noise and level should be provided along with a damping switch to lengthen the integrating time constant of the meter for rapidly fluctuating noise.

The HP Telephone Testmeter incorporates these important features.
3555A

The HP Model 3555A Telephone Testmeter combines the functions of a broadband level meter and a message-circuit noise meter. As a broadband rms-level meter, a frequency range of 30 Hz to 3 MHz is covered with a maximum sensitivity of standard telephone jacks and is fully balanced with impedances of 75, 135, 150, 600 and 900 ohms, both bridging and terminated (Figure 2). The balanced input impedances are accomplished by a differential amplifier eliminating the normal repeat coil. This technique gives impedances of over 100 k Ω bridging with less than 0.05dB bridging loss. Provisions are made for dial-through and hold.

As a noise-measuring set, the 3555A contains filters which perform the C-Message, 3kHz Flat and Program weighting functions (CCITT weighting filter and others are available on special order). The meter circuit contains an rms detector which adds the noise voltages on a power basis. Indication of noise levels down to 0 dBm as well as noise-to-ground and noise-metallic measurements can easily be made. The amplifier output may be connected to a recorder for long-term noise records or will allow aural monitoring of the character of the noise.

This instrument in a rugged, portable carrying case features internal battery operation as well as CO battery or ac power. It operates reliably over a 0°F to +120°F temperature range at humidity

*Consultative Committee on International Telephone and Telegraph.

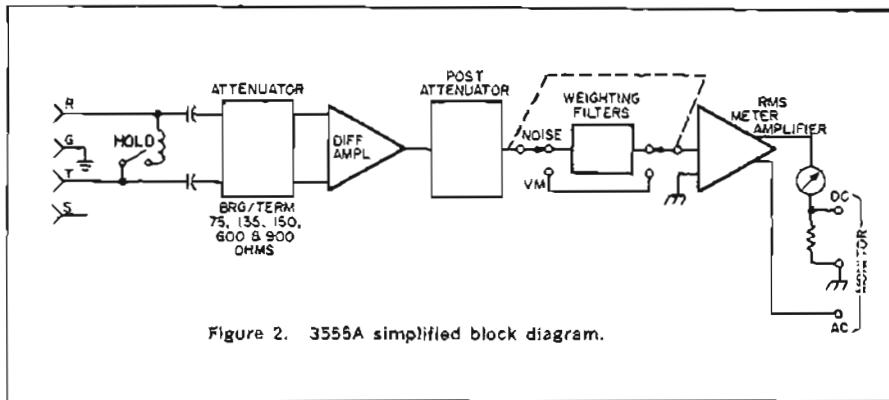

Figure 2. 3555A simplified block diagram.

ties up to 95% R.H. An interlock turns the power switch off when the cover is replaced.

Using the 3555A Telephone Testmeter in conjunction with the HP 236A Telephone Test Oscillator makes a universal transmission test set that can be used for all types of telephone equipment.

236A

The HP Model 236A Telephone Oscillator has all of the above-mentioned Western Electric connectors for dialing and output. It incorporates the holding function for 600- and 900-ohm output impedances. It provides a 50 Hz to 20 kHz frequency range in the 600- and 900-ohm balanced output and a 5 kHz to 560 kHz frequency range on the 135-ohm balanced output. Its power source may be a 115/230 V $\pm 10\%$, 50 to 1000 Hz external source or a 45 V dry cell internal battery.

An interlock turns the power switch off when the cover is replaced. The oscillator's output level is adjustable from +10 to -31 dBm in 0.1 dB steps. The attenuator precedes the output transformer so the output impedance is not affected by the attenuation.

The HP 236A consists of an oscillator-amplifier, attenuator, power supply, me-

ter circuit and a selective output circuit. Figure 3 shows the block diagram of this instrument.

The oscillator-amplifier operates as a typical solid-state HP RC oscillator (refer to page 335 of the oscillator section of this catalog). The front-panel output calibrator adjustment controls the output amplitude. Accurate metal-film resistors are used to insure exact attenuations.

The output circuitry consists of a low- and a high-frequency output transformer, a holding coil, and parallel Western Electric output and dial connectors to insure a proper connection for any lineman's equipment.

3550A

The HP 3550A Portable Test Set was designed specifically for transmission-line testing and for such applications as alignment and maintenance of multi-channel communication systems. The test set consists of a wide-range oscillator, an electronic voltmeter and a patch panel containing attenuators and line-matching transformers. The instruments are operated from a rechargeable battery power source, making it usable in the field.

The heart of this test set is the 353A Patch Panel which adapts the oscillator

and voltmeter to specific telephone usage. The patch panel has input and output sections acting as a source and receiver for the transmission line. The output section has an attenuator and both sections have an impedance-matching device which matches the oscillator and voltmeter 600-ohm impedance to 135, 600 and 900 transmission-line impedances. The center-tapped transformers give balanced outputs and inputs with bridging or terminated capabilities. The accurate attenuator gives 110dB attenuation in 1dB steps.

The H20-204B Option 02 Oscillator frequency is 5 Hz to 560 kHz in five ranges, and the 403B Option 01 Voltmeter has ranges from 0.001 to 300 V full scale in 12 ranges. Thus, a complete telephone measuring set is contained in one portable package.

The H02-353A Patch Panel has special telephone jacks which will accommodate Western Electric 309 and 310 plugs. The Hold function is included along with a selectable 23dB attenuation position.

The H03-353A Patch Panel will accommodate Western Electric 309-310 and 241 plugs, and a lineman's handset. The Hold function is included along with a 23 dB attenuator.

The H05-332A and H05-334A are standard HP Models 332A and 334A Distortion Analyzers modified for use in the broadcast industry. The front-panel voltmeter reading is in dBm, and a switchable low-pass 30 kHz filter is added.

312A/313A

The low noise and wide dynamic range of the 312A Wave Analyzer makes it useful for many telephone applications including measurement of system flatness, analysis of distortion and intermodulation (cross-talk) in carrier systems, and measurement of noise levels. Input impedances of 50, 60, 75, 124, 135, 150, and 600 ohms or bridging, balanced or unbalanced, are selectable at the front panel. Amplitude response vs. frequency can be measured when using the Model 313A Tracking Oscillator. Semi-automatic plots of amplitude vs. frequency can be made using the Model 297A Sweep Drive and an X-Y recorder (refer to page 423 for further technical information on the 312A/313A Wave Analyzer and Tracking Oscillator, and to page 428 for specifications).

Included in the oscillator, amplifier and voltmeter sections of this catalog are many instruments which can be used in the communications industry.

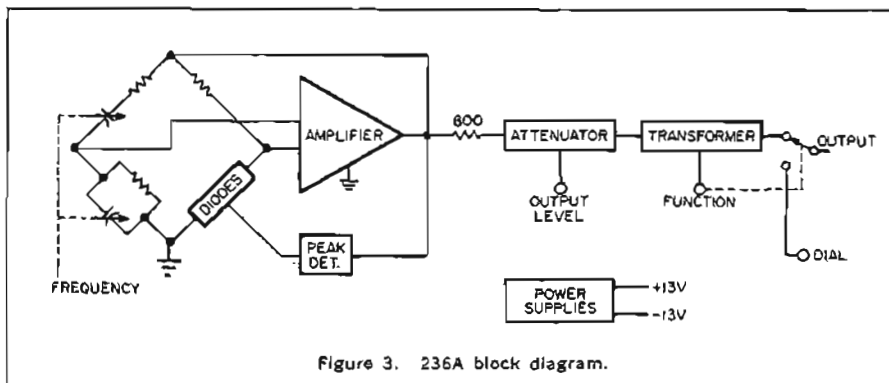

Figure 3. 236A block diagram.

WAVE ANALYZERS

Selective Voltmeters and Tracking Oscillator
Models 312A/313A, 302A, 310A



COMMUNICATIONS
TEST EQUIPMENT

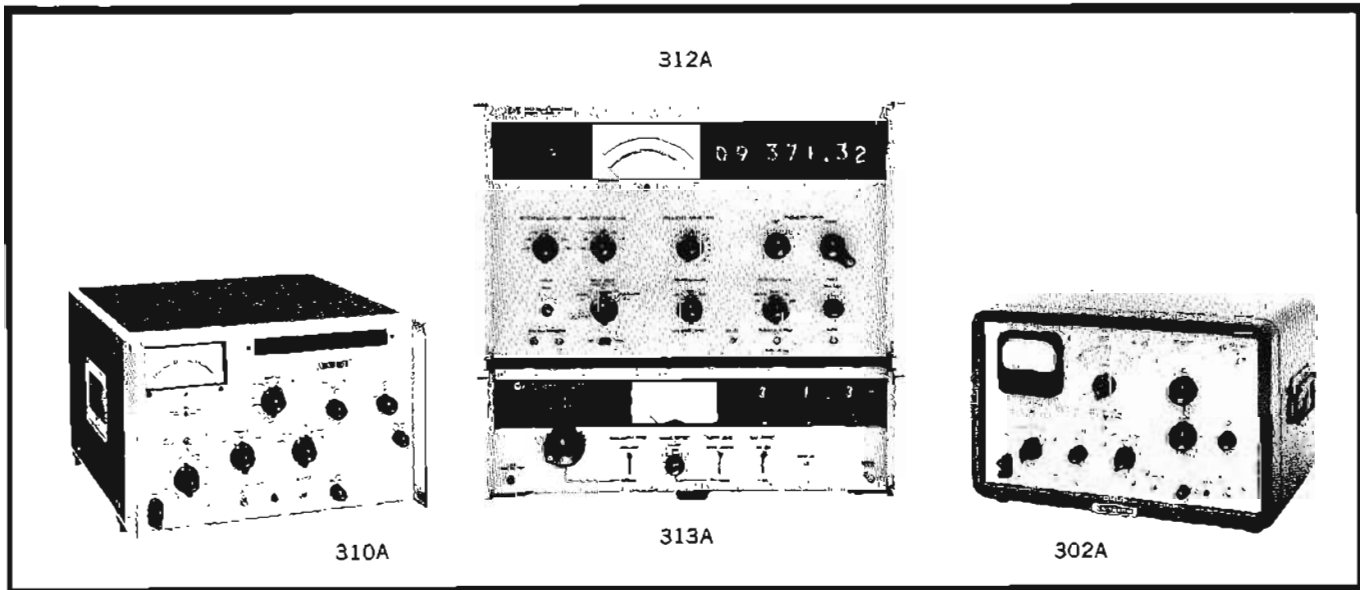

Description

These Hewlett-Packard wave analyzers or selective voltmeters are particularly useful for testing multiplex communications systems. They can measure levels of carriers, pilots, signaling tones, intermodulation distortion, power tone frequency noise components and noise. A restored frequency or a tracking oscillator output furnishes a signal at the frequency selected for measurement on the analyzer.

The 302A with its narrow (7 Hz) bandwidth is particularly useful for measuring power line frequency noise components and narrow-spaced, voice-band telegraph and telemetry signals. The 310A is useful in multiplex systems up to about 300 channels. The 312A is useful in multiplex systems up to about 3600 channels and most radio systems. The 312A is a versatile measuring set with time-saving features.

Specifications, 302A

Frequency range: 20 Hz to 50 kHz.
Voltage range: -120 dB to +50 dB full scale (15 ranges).
Residual FM and hum: 75 dB down.
Selectivity (bandwidth): 7 Hz, 50 Hz and 140 Hz.
Input impedance: 100 k Ω unbalanced (<100 pF shunt) on 4 most sensitive ranges, 1 M Ω unbalanced (<20 pF shunt) on all other ranges.
Restored-frequency output: 1 V across 600 Ω unbalanced at output terminals at full-scale meter deflection. Output voltage proportional to meter deflection.
Price: HP 302A (cabinet) \$1800; (rack mount) \$1785. (For complete specifications, refer to page 425.)

Specifications, 310A

Frequency range: 1 kHz to 1.5 MHz (200 Hz bandwidth), 5 kHz to 1.5 MHz (1000 Hz bandwidth), 10 kHz to 1.5 MHz (3000 Hz bandwidth).
Voltage range: -130 dB to +40 dB V full scale in 10 dB steps.

Noise and spurious response: at least 75 dB below a full-scale reference on 0 dB position of range switch.

Selectivity (3 IF bandwidths): 200 Hz, 1000 Hz and 3000 Hz.

Input impedance: 10 k Ω unbalanced on most sensitive ranges, 30 k Ω unbalanced on next range, 100 k Ω unbalanced on all other ranges; shunted by <100 pF on three most sensitive ranges, <50 pF on other ranges.

Restored-frequency output: 0.25 V at full meter deflection across 135 Ω unbalanced, with 30 dB of level control.

Price: HP 310A, \$2350.

(For complete specifications, refer to page 426.)

Specifications, 312A/313A

Frequency range: 10 kHz to 18 MHz in 18 overlapping bands. Usable to 1 kHz with 200 Hz bandwidth.

Amplitude range: -97 to +23 dBm full scale (-107 to +13 dB for 600 Ω impedance), 3 μ V to 3 V full scale (50 Ω impedance); selected in steps of 10 dB or 3, 1 V sequence.

Noise level, referred to input: 50 to 150 Ω , -120 dBm (200 Hz bandwidth); 600 Ω , -130 dBm (200 Hz bandwidth).

Selectivity (3 IF bandwidths): 200 Hz, 1000 Hz and 3000 Hz.

Input impedances: 50, 60, 75, 124, 135, 150, 600 Ω or bridging, balanced or unbalanced; input capacitance <18 pF balanced, <35 pF unbalanced.

Automatic frequency control

Dynamic hold - in range: \pm 3 kHz.

Tracking speed: 100 Hz/sec.

Locks on to signals as low as 60 dB below zero reference with amplitude range switch set at 0 dB.

Frequency readout: 7 digits with 10 Hz resolution.

Frequency range (313A Tracking Oscillator): same as 312A. Usable to 3 kHz; tracks 312A tuning; internal oscillator, 10 kHz to 22 MHz in one band.

Output: 0 to +10 dBm max; attenuator, 3 sections provide 0 to 99.9 dB attenuation in 0.1 dB steps.

Price: HP 312A, \$3900; HP 313A, \$1250.

(For complete specifications, refer to page 428.)

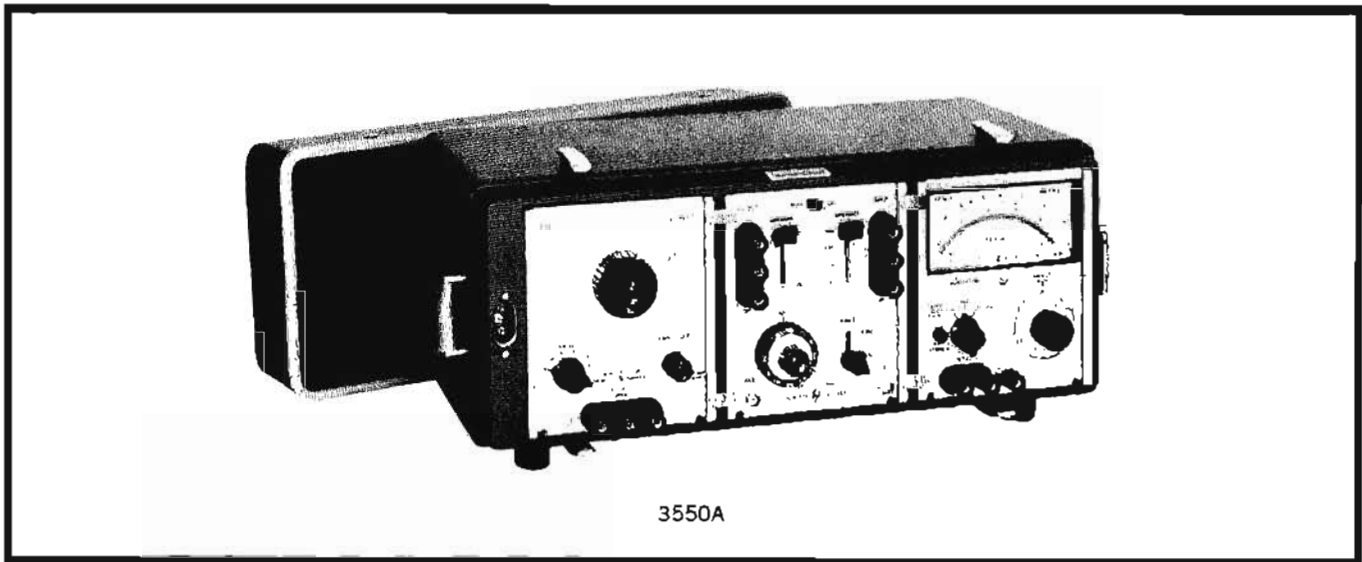
PORTABLE TEST SET
 Measures transmission line characteristics
 Model 3550A

3550A

Features:

- Oscillator—battery or ac operated, 5 Hz to 560 kHz.
- Voltmeter—battery or ac operated. 5 Hz to 2 MHz; reads in volts and dBm from -75 to $+52$ dBm.
- Patch Panel (353A)—matches both oscillator and voltmeter to 135, 600 and 900-ohm systems; provides 110 dB attenuation in 10-dB and 1-dB steps.

Uses:

- Align and maintain multichannel communication systems.
- Align and maintain long distance and local telephone circuits, both wet and dry.
- Measure gain, attenuation and frequency response.
- Measure amplifier characteristics without troublesome ground loops.
- Excellent source of balanced μ V signals for testing differential amplifiers.

Description

The HP Model 3550A Portable Test Set is designed specifically to measure transmission line and system characteristics such as attenuation, frequency response or gain. It is particularly useful for lineup and maintenance of multichannel communication systems. Model 3550A contains a wide-range oscillator, a voltmeter, and a patch panel to match both the oscillator and the voltmeter to 135, 600 and 900-ohm lines. These instruments are mounted in a combining case equipped with a splash-proof cover. In addition, the oscillator, voltmeter and patch panel may be used separately whether they are in or removed from the combining case.

Both the oscillator and voltmeter are transistorized and operate from their internal rechargeable batteries or from the ac line. The batteries provide 40 hours of operation between charges and are recharged automatically during operation from the ac line.

Versatile components

The oscillator has a frequency range of 5 Hz to 560 kHz, and its output is fully floating isolated from instrument case and power line (see 204B, page 344).

The voltmeter (see 403B, page 207) features a sensitive range, 1 mV full scale, for measuring voltages as small as 100μ V rms from 5 Hz to 2 MHz. A dB scale, which is at the top of the meter face for better resolution, also permits measurement from -75 to $+52$ dBm.

The patch panel portion of the test set (353A) includes a precision attenuator, variable in 1 dB steps to 110 dB and two sets of impedance-matching transformers which match both oscillator and voltmeter to 135, 600 and 900-ohm lines. One set of transformers also terminates the line in 10 k ohms for bridging measurements.

Telephone versions

Two special versions of the 353A are the HP Model H02-353A and H03-353A Patch Panels designed specifically for the telephone industry. Models H02 or H03 offer convenience in testing of telephone circuits, both active and passive. Both versions provide matching to 135, 600 and 900-ohm balanced lines and can be mounted in place of the 353A in the 3550A Portable Test Set (H02-3550A, H03-3550A).

The H02-353A features a holding coil at the Send terminals, and the H03-353A features holding coils at the Rec and Send terminals which permit testing of active telephone lines at voice, as well as carrier frequencies. A single-step 23 dB attenuator enables the operator to select standard telephone levels of $+7$ dBm and -16 dBm. Jacks have been supplied to accept standard telephone type plugs.

Specifications, 3550A
Oscillator (H20-204B Option 02)

- Frequency range: 5 Hz to 560 kHz in 5 ranges, vernier.
- Dial accuracy: $\pm 3\%$.
- Frequency response: ± 0.25 dB into rated load.
- Output impedance: 600 ohms.
- Output: 10 mW (2.5 V rms) into 600 ohms; 5 V rms open circuit; completely floating (isolated).
- Distortion: less than 1%.
- Hum and noise: less than 0.05%.
- Temperature range: -20°C to $+50^{\circ}\text{C}$.
- Price: HP H20-204B Option 02, \$405 when purchased separately.

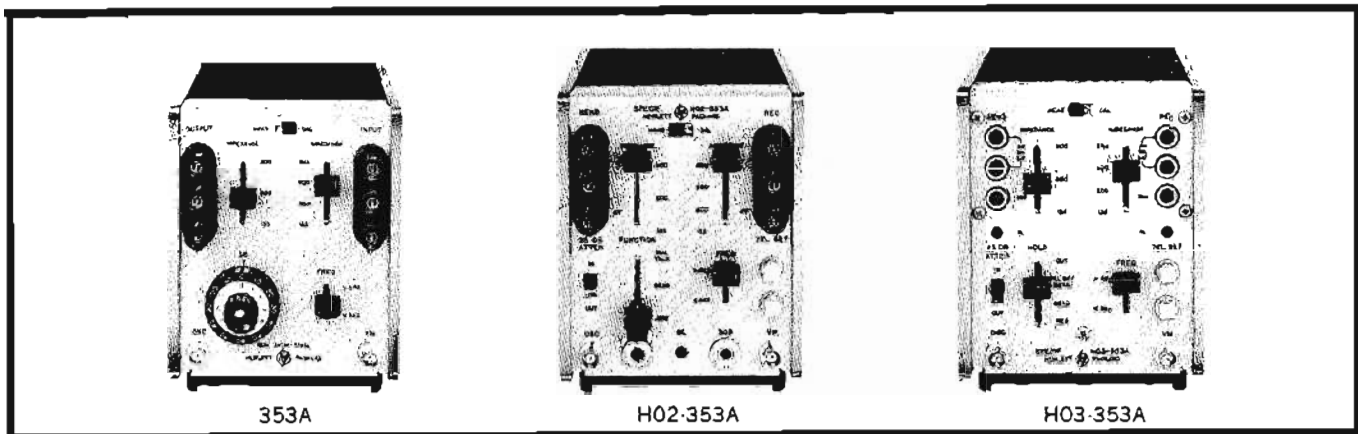

Voltmeter (403B Option 01)

Range: 0.001 to 300 V rms full scale.

Frequency range: 5 Hz to 2 MHz.

Accuracy: within ± 0.2 dB of full scale from 10 Hz to 1 MHz; within ± 0.4 dB of full scale from 5 to 10 Hz and 1 to 2 MHz, except ± 0.8 dB 1 to 2 MHz on the 300 V range (0°C to $+50^\circ\text{C}$).

Meter: individually calibrated, taut band. Responds to average value of input waveform and is calibrated in the rms value of a sine wave.

Nominal input impedance: 2 megohms; shunted by 50 pF on 0.001 V to 0.03 V ranges, 25 pF on 0.1 V to 300 V ranges.

DC isolation: signal grd. may be ± 500 V dc from chassis grd.
Price: HP 403B Option 01, \$335 when purchased separately.

Patch panel (353A)

Input (receiver)

Frequency range: 50 Hz to 560 kHz.

Balance: better than 70 dB at 60 Hz for 600 ohms and 900 ohms; better than 60 dB at 1 kHz for 600 and 900 ohms; better than 40 dB over entire frequency range for 135, 600 and 900 ohms.

Frequency response: ± 0.5 dB, 50 Hz to 560 kHz.

Impedance: 135, 600, 900 ohms and Bridging (10 k); center-tapped.

Insertion loss: less than 0.75 dB at 1 kHz.

Maximum level: $+22$ dBm (10 V rms at 600 ohms).

Output (source)

Frequency range: 50 Hz to 560 kHz.

Balance: same as Input (receiver).

Frequency response: ± 0.5 dB, 50 Hz to 560 kHz.

Impedance: 135, 600 and 900 ohms, center-tapped.

Insertion loss: less than 0.75 dB at 1 kHz.

Distortion: less than 1%, 50 Hz to 560 kHz.

Maximum level: $+22$ dBm (10 V rms at 600 ohms).

Attenuation: 110 dB in 1 dB steps; accuracy, 10 dB section: error less than ± 0.25 dB at any step; accuracy, 100 dB section: error is less than ± 0.5 dB at any step.

Connectors: two 3-terminal binding posts for external circuit connection and two BNC female connectors for oscillator and voltmeter connection.

Accessories available: 11075A Carrying Case (refer to page 631), \$45.

Price: HP 353A, \$260 when purchased separately.

Available Telephone Patch Panels

Patch panel (H02-353A)

(Same as Model 353A except as indicated below.)

Attenuator: 23 dB ± 0.5 dB (1-step slide switch).

Hold circuit (Send terminals)

Frequency response: 300 Hz to 3 kHz ± 0.5 dB, 1 kHz reference.

DC resistance*: 240 ohms NOMINAL.

Maximum dc current: 100 mA.

Maximum dc voltage: 150 volts.

Connectors: special telephone jacks to accept Western Electric No. 309 and 310 plugs. Sleeve jack is connected to sleeve of jacks 309 and 310.

Two 3-terminal binding posts for external connection.

Two-terminal (TEL SET) connector for handset.

Two BNC female connectors for Oscillator and Voltmeter.

Price: HP H02-3530A (H20-204B Option 02, H02-353A, and 403B Option 01), \$1270. H02-353A, \$380.

Patch panel (H03-353A)

(Same as Model 353A except as indicated below.)

Hold circuit (Rec terminals)

Frequency response: 300 Hz to 3 kHz ± 0.5 dB, 1 kHz ref.

DC resistance*: 240 ohms NOMINAL.

Maximum dc current: 100 mA.

Maximum dc voltage: 150 volts.

Attenuation: 23 dB ± 0.5 dB (1-step slide switch).

Hold circuit (Send terminals)

Frequency response: 300 Hz to 3 kHz ± 0.5 dB, 1 kHz ref.

DC resistance*: 240 ohms NOMINAL.

Maximum dc current: 100 mA.

Maximum dc voltage: 150 volts.

Connectors: special telephone jacks to accept Western Electric No. 309, 310 and 241 at Send and Rec terminals. Sleeve jack is connected to sleeve of jacks 309 and 310.

Two-terminal (TEL SET) connector available for handset.

Two BNC female connectors for Oscillator and Voltmeter connection.

Price: HP H03-3530A (H20-204B Option 02, H03-353A and 403B Option 01), \$1270. H03-353A, \$380.

General

Power: (identical specifications in both voltmeter and oscillator): 4 rechargeable batteries (furnished); 40-hour operation per recharge, up to 500 recharging cycles; recharging circuit is self-contained and functions automatically when instrument is operated from ac line (115 or 230 volts $\pm 10\%$, 50 to 1000 Hz, approx. 3 watts).

Dimensions: 8 $\frac{3}{8}$ " high, 19 $\frac{1}{4}$ " wide, 13 $\frac{1}{4}$ " deep (with cover installed) (213 x 489 x 367 mm).

Weight: net 30 lbs (13.5 kg); shipping 40 lbs (18 kg).

Accessories available: 10503A Cable, BNC-to-BNC, \$7; 11002A Test Leads, banana-plug-to-alligator clip, \$8.

Accessories furnished: detachable power cord; two 11035A Cables (1 foot long, dual banana-plug-to-BNC); splash-proof cover and storage compartment.

Price: HP 3530A (H20-204B Option 02, 353A and 403B Option 01), \$1150.

*If additional dc resistance is required in the holding coil circuit, a resistor in series with the holding coil may be added.



TELEPHONE TEST METER

Transmission Test Set with 236A Oscillator
Model 3555A

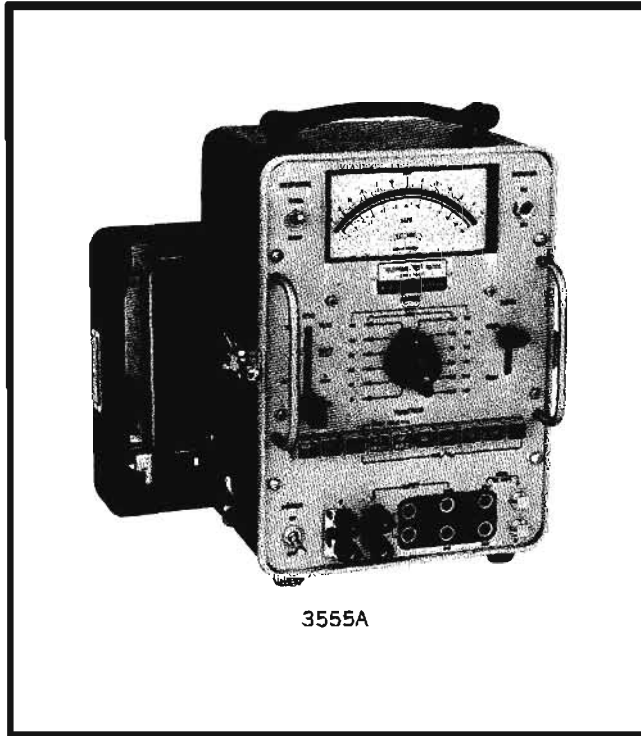

3555A

Description

The HP Model 3555A Telephone Test Meter is a combination transmission/noise measuring set designed especially for telephone plant maintenance. Its wide range of sensitivity, selection of input impedances and variety of weighting filters make it a universal tool for virtually all telephone level and noise measurements. Rugged, compact design, selection of ac line, internal battery or 48 V CO battery operation and a convenient selection of input connectors make the 3555A ideally suited for inside and outside plant applications. Combined with the 236A Telephone Test Oscillator, this 3555A makes a complete transmission test set. Refer to pages 299 and 300 for additional information.

Specifications

Level measurements

Range: -80 dBm to +30 dBm full scale

Frequency range: 30 Hz to 3 MHz

Level accuracy:

RANGE (dBm)	FREQUENCY									
	30 Hz	100 Hz	200 Hz	20 kHz	50 kHz	100 kHz	300 kHz	1 MHz	2 MHz	3 MHz
+30	±.5dB*	±.5dB	±.1dB	±.2dB						
+20	±.5dB*	±.5dB	±.1dB	±.2dB	±.5dB					
+10	±.5dB*	±.5dB	±.1dB	±.2dB	±.5dB					
0 to -40	±.5dB*	±.5dB	±.1dB	±.2dB	±.5dB			±.5dB*	±.1dB*	
-50 to -80	±.5dB*	±.5dB	±.2dB	±.5dB						

* 600 Ω and 900 Ω inputs only.

Temperature range: 0°F to +120°F.

Input impedance

Terminated: 75, 135, 150, 600, 900 Ω ±2%, balanced.

Bridging: -80 to -20 dBm ranges, 100 k Ω balanced.

-10 to +30 dBm ranges, 200 k Ω balanced.

(Meter automatically indicates in dBm for the impedance selected. 0 dBm = 1 mW dissipated into the impedance.)

Noise measurements

Range: +10 dBm to +120 dBm full scale in 12 ranges.

Accuracy: ±1 dB.

Weighting networks: 3 kHz Flat, C message and program, selectable with front-panel switch (CCITT and other networks available on special order). Filter characteristics comply with the joint standards of Bell System and Edison Electric Institute.

Input Impedance

Noise-metallic:

Terminated: 75, 135, 150, 600, 900 Ω ±2% balanced.

Bridging: 0 to 60 dBm ranges, 100 k Ω balanced. 70 to 110 dBm ranges, 200 k Ω balanced.

Noise-to-ground: 80 k Ω across line; 100 k Ω to ground.

General

Meter Indication: indicates rms value of input signal.

Meter response: 200 ms ±50 ms to +0 dBm (norm), 500 ms ±100 ms to +0 dBm (damp)

Input balance: >70 dB, 30 Hz to 30 kHz; >60 dB, 30 kHz to 100 kHz; >40 dB, 100 kHz to 600 kHz.

Max. input voltage: tip to ring, 300 V peak; tip or ring to ground, 200 V peak. (NOTE: this is maximum instantaneous voltage and includes both ac and dc.) Input circuit will withstand 48 V dc CO battery with superimposed 90 V rms 20 Hz ringing voltage, or ±130 V carrier supply.

Max. longitudinal input level: -80 to -20 dBm ranges, 5 V rms. -10 to +30 dBm ranges, 150 V rms.

(NOTE: this is the maximum noise-to-ground that can be tolerated without causing error when making level or noise-metallic measurements.)

DC holding coil: 700 Ω ±10% dc resistance; 60 mA maximum loop current at 100 Hz.

AC monitor: 1.4 V rms with 10 k Ω output impedance (output available at DIAL/AC MONITOR jacks).

DC monitor: -1 V with 2 k Ω output impedance. Jack accepts 310 plug.

Input jacks: accepts Western Electric 241, 309 and 310 plugs.

Binding posts accept banana plugs, spade lugs, phone tips for bare wires. Removable shorting bar between sleeve and ground binding posts.

Dial jacks: accepts standard 309 and 310 plugs. Clip posts accept Western Electric 1011B lineman's handset clips.

Power requirements:

Line: 115/230 V ±10% ac, 50 to 1000 Hz, approximately 1 W.

Internal battery: single NEDA 202 45 V "B" battery (included).*

48 V CO battery: 310 jack (tip negative), approximately 15 mA.

Battery life: 150 hr on a 3 hr/day duty cycle at 77°F.

Dimensions: 7¼" wide, 10½" high, 8" deep (197, 267, 203 mm).

Weight: net 12 lbs, 8 oz (5,6 kg).

Complementary equipment available: HP Model 236A Telephone Test Oscillator, \$525 (refer to page 305).

Price: HP Model 3555A, \$525.

*Rechargeable battery supply available on special order.

TELEPHONE OSCILLATOR

Wide-range telephone test oscillator
Model 236A



COMMUNICATIONS
TEST EQUIPMENT

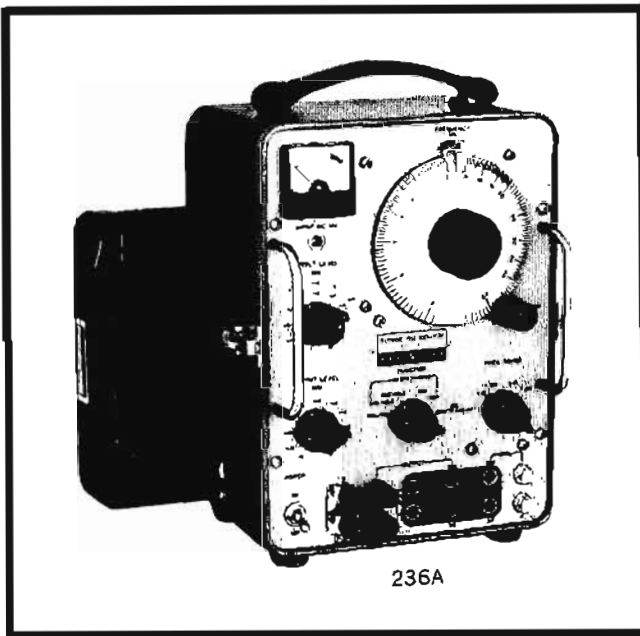

236A

The solid-state HP 236A Telephone Test Oscillator is designed specifically to deliver transmission test signals. It is particularly useful for line-up and maintenance of telephone voice and carrier systems.

Any frequency between 50 Hz and 560 kHz may be selected in four ranges to an accuracy of $\pm 3\%$. Frequency response is flat over the entire range at any attenuator setting. The oscillator is fully transistorized, and internal heat production is small, resulting in unusually low warmup drift. Advanced feedback techniques insure excellent frequency and amplitude stability even under temperature extremes. Its output is fully floating and balanced, isolated from power-line ground and instrument case. Low-current drain, solid-state circuitry results in exceptionally long battery life with hum and noise 65 dB below total output.

Output jacks are standard telephone types to facilitate patching into standard test boards. A front-panel switch selects 135, 600 or 900-ohm output impedance. These outputs are balanced to ground and the impedance of each is controlled over the specified frequency range. The phase angle of the output impedance is low to maintain a true resistive source.

The output circuit includes two transformers preceded by step attenuators which, together, adjust output power over a 41 dB range (+10 to -31 dBm), in 10 dBm, 1 dBm, and 0.1 dBm steps having an overall accuracy of 0.1 dB over the entire range.

A front-panel control permits calibration of the output power level. Frequency response of the instrument is better than ± 0.3 dB.

A front-panel meter monitors the 45 volt dry cell battery or the 115/230 V ac regulated power supply. The dry cell will provide in excess of 180 hours of operation of the oscillator on a 3 hr/day discharge cycle at 70°F.

Features:

- Flat frequency response
- +10 to -31 dBm output in 0.1 dBm steps
- Balanced outputs, 135-600-900 ohms
- Standard telephone jacks
- Hookswitch control
- Holding coil and dial jacks
- Operates from battery or ac line
- Lightweight, portable, transistorized design

Uses:

- Align, test and maintain telephone circuits, both wet and dry
- Align, test and maintain carrier systems
- Test manual switchboards and PBX systems
- Make accurate and reliable measurements even at temperature and humidity extremes
- Balanced signal source for bridges

Specifications

Frequency range: 50 Hz to 560 kHz in 4 ranges.

Frequency dial accuracy: $\pm 3\%$.

Frequency response: ± 0.3 dB, 50 Hz to 560 kHz, 60°-80°F.
 ± 0.5 dB, 50 Hz to 560 kHz, 32°-120°F.

Output power: +10 to -30 dBm in 0.1 dBm steps.

Output power accuracy: ± 0.2 dB at 1 kHz, 60°-80°F.

Output level accuracy: ± 0.2 dB, +10 to -31 dBm.

Distortion: at least 40 dB below fundamental output.

Noise: at least 65 dB below total output or -90 dBm, whichever is greater.

Output circuit: balanced and floating. May be operated up to ± 500 V dc above case ground.

Output impedance: 600 and 900 ohms $\pm 5\%$, 50 Hz to 20 kHz, 135 ohms $\pm 10\%$, 5 kHz to 560 kHz.

Output balance: 600 and 900 ohms; 70 dB at 100 Hz, 55 dB at 3 kHz, 135 ohms; 50 dB at 5 kHz, 30 dB at 560 kHz.

Output connectors: jacks to accept WESTERN ELECTRIC No. 241, 309 and 310 plugs. Standard banana jacks on $\frac{3}{4}$ " spacing for tip, ring, sleeve and case ground with removable shorting link between sleeve and ground terminals.

Dial connectors: jacks to accept WESTERN ELECTRIC 309 and 310 plugs. Clip posts on $\frac{3}{4}$ " centers for WESTERN ELECTRIC 1011B lineman's handset clips.

Hold circuit: 600 and 900 ohms only, 100 Hz to 20 kHz, 700 ohms dc resistance, 60 mA max. current.

Power supply: 115 or 230 V $\pm 10\%$, 50 to 1000 Hz, 1 watt. Internal 45 V dry cell (furnished) gives 180 hr. operation on a 3 hr/day discharge cycle at 70°F.

Dimensions: $7\frac{3}{4}$ " wide, $10\frac{1}{2}$ " high, $8\text{-}1\frac{1}{16}$ " deep (196,9 x 266,7 x 204,8 mm).

Weight: net 13.5 lbs (6,1 kg); shipping 16 lbs (7,2 kg).

Price: HP 236A, \$525.

COMMUNICATIONS TEST EQUIPMENT



COMMUNICATIONS EQUIPMENT

Analyzers, oscillators, voltmeters and probe
H05-334A, H20-200CD and C11-3529A

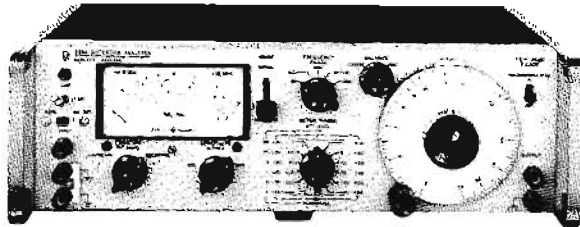

H05-334A

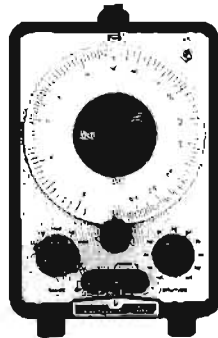

H20-200CD

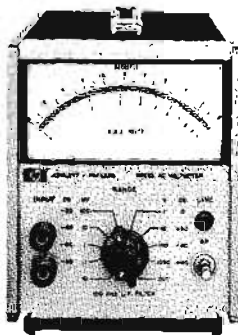

400GL

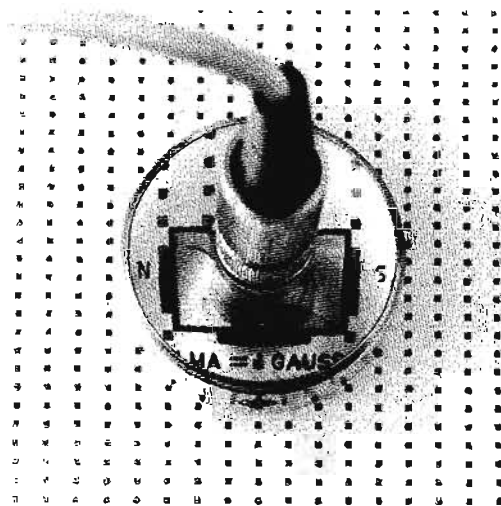

C11-3529A

H05-332A, H05-334A

Two solid-state distortion analyzers offer extended frequency range, greater set level sensitivity, improved selectivity, greater overall accuracy, and unprecedented ease of use. The units meet FCC requirements on broadcast distortion levels. Both models measure total distortion down to 0.1% full scale. The Model H05-334A features automatic fundamental nulling. The H05-332A and 334A have a switchable low pass filter to reduce the effect of unwanted high frequencies (noise, etc.) when measuring lower frequency signals with high accuracy. Refer to data sheet for further information.

H20-200CD wide range oscillator

This special oscillator is a standard 200CD Oscillator (refer to page 342) that has selected components to provide low-output distortion. The total distortion, including harmonic distortion and noise, is less than 0.06% (-64 dB) on the X10, X100 and X1 k ranges; 0.1% on the X1 and X10 k ranges except 5 Hz to 20 Hz and 400 kHz to 600 kHz where the distortion is 0.5%. The standard 200CD Wide Range Oscillator may be used wherever this extremely low distortion is not necessary.

Multi-function meters

When it is important to make a variety of measurements with one instrument, select a versatile multi-function meter from Hewlett-Packard. The low cost 427A solid-state, battery-operated meter gives maximum value in general testing . . . while the 410C or 412A with its higher impedance is ideal for troubleshooting and calibrating magnetic tape equipment and for airline radio maintenance. Refer to the voltage/current/resistance section, pages 196 through 244.

AC voltage measurements

Hewlett-Packard ac voltmeters offer measurements over a wide frequency range, 10 Hz to 1 GHz, at sensitivities from 3 μ V to 1000 V with high-input resistances and low-input capacitances. The 400 Series can be used for magnetic tape testing, gain and loss measurements, and other applications in the broadcasting and telephone industries where a general-purpose, wide-band voltmeter is needed. The 3406A is a unique sampling voltmeter which lets you measure 1 mV to 3 V accurately, from 10 kHz to 1 GHz. Refer to pages 201 through 213.

Magnetometer probe

The C11-3529A is a special magnetometer probe used to convert the Hewlett-Packard 428A or 428B DC Milliammeter into a direct reading magnetometer (1 G = 1 mA indication on 428A/B meter). The C11-3529A Magnetometer Probe is specifically designed to measure the relative magnetic field strength of individual bar magnets on twistor memory cards used in the Western Electric No. 1 Electronic Switching System (No. 1 ESS). Refer to data sheet for further information.

MICROWAVE LINK ANALYZER

Checkout 1800 channel systems at IF
Models 3701A, 3702A, 3703A



COMMUNICATIONS
TEST EQUIPMENT

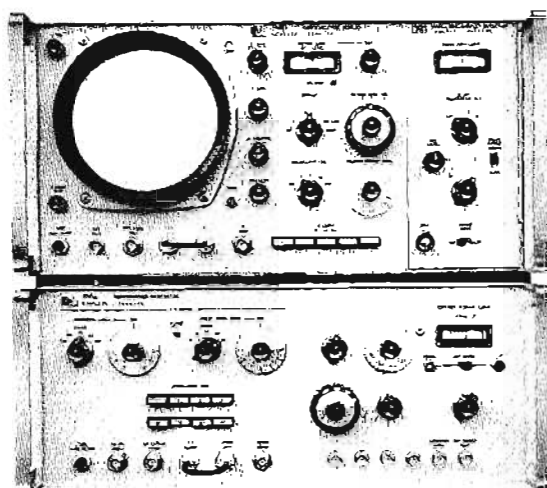

3701A, 3702A, 3703A

Features:

- Measures group delay with 10 picosecond resolution
- Measures modulators and demodulators separately
- Spectrum display at 70 MHz
- Displays group delay and linearity simultaneously
- 50 MHz sweep width capability

Measurements:

- Group delay
- Modulator/demodulator linearity
- Modulator/demodulator sensitivity
- Return loss measurements at fixed or swept IF

Description

The Hewlett-Packard Models 3701A Transmission Generator, 3702A Demodulator Display, and 3703A Group Delay Detector form the Microwave Link Analyzer. This system provides measurements of group delay, band flatness, power, gain, and attenuation to meet the needs of engineers involved in the development, production tests, and on-site IF measurements of microwave link equipment.

Systems with up to 1800 channels capacity can be checked at a fixed or swept IF. For measurement of group delay, baseband response, and linearity, the IF can be modulated with internal baseband frequencies of 83.3, 250, or 500 kHz. For measurement of modulator and demodulator, sensitivity by the Bessel Zero method can be used when operating in the spectrum mode. Measurements are displayed on a crt in which the swept IF forms the X-axis.

The 3701A Transmission Generator utilizes two UHF oscillators which assures modulation index constancy as the IF is swept. IF drift is minimized by housing both UHF oscillators and mixer in the same thermal environment. IF level is monitored by a front panel meter and is levelled to ± 0.075 dB via a PIN diode ALC loop. Linking the IF output through a 99 dB attenuator allows amplitude control in 1 dB steps. An internal sinusoidal sweep of the IF is provided at a 70 Hz rate.

Crystal derived baseband frequencies are available to internally modulate the IF for deviations between 100 and 500 kHz. They are also available as a separate calibrated output for through-link and baseband to IF tests.

The HP 3702A Demodulator Display consists of a linear IF demodulator, spectrum analyzer, IF and baseband detectors, and return loss and calibration circuitry for amplitude, group delay, and frequency measurements. The display contains two vertical channels. One channel is used for IF response, modulator/demodulator linearity, return loss with swept IF, and spectrum analysis of modulator/demodulator sensitivity. The second channel displays group delay or it can be used as a reference trace carrying the IF calibration markers.

The HP 3703A Group Delay Detector Plug-in contains the group delay measurement circuits. The varying phase of the received baseband is compared against a precision crystal reference identical to that used in the 3701A Transmission Generator which originates the received baseband. Phase lock is indicated by a front panel meter. Maximum rate of change of group delay with swept IF is observed when using the 83.3 kHz baseband frequency. Resolution of group delay to 0.1 ns is possible at 500 kHz baseband frequency. The 250 kHz baseband frequency is optimum for observing both maximum rate of change and maximum resolution of group delay.

MICROWAVE LINK ANALYZER *continued*

Checkout 1800 channel systems at IF
Models 3701A, 3702A, 3703A

System specifications**Swept frequency**

Measurement	Back-to-back swept band at 70 MHz			Test sensitivity
	38 MHz	40 MHz	50 MHz	
IF band flatness	±0.075 dB			0.02 dB
IF group delay	±0.2 ns	±0.3 ns	±0.5 ns	0.1 ns
Mod/demod group delay	±0.05 ns			0.1 ns
Mod group delay	±0.1 ns	±0.15 ns	±0.25 ns	0.1 ns
Demod group delay	±0.1 ns	±0.15 ns	±0.25 ns	0.1 ns
Mod/demod linearity	±0.1%	±0.1%	±0.2%	0.1%
Mod linearity	±0.1%	±0.1%	±0.2%	0.1%
Demod linearity	±0.05%			0.1%

Fixed frequency

Measurement	Max	Min	Accuracy	Frequency band
BB power	-10 dBm	-32 dBm	0.2 dB	50 kHz to 12 MHz
BB gain	78 dB	0 dB	0.5 dB	83.3, 250, 500 kHz
BB insertion loss	43 dB	0 dB	0.5 dB	50 kHz to 12 MHz
IF power	+12 dBm	-10 dBm	0.5 dB	45 MHz to 95 MHz
IF gain	101 dB	0 dB	0.5 dB	45 MHz to 95 MHz
IF insertion loss	22 dB	0 dB	0.5 dB	45 MHz to 95 MHz
Mod sensitivity	$\frac{-49 \text{ dBm}}{140 \text{ kHz}}$	$\frac{-10 \text{ dBm}}{140 \text{ kHz}}$	$\frac{0.2 \text{ dB}}{1 \text{ kHz}}$	45 MHz to 95 MHz
Demod sensitivity	$\frac{-10 \text{ dBm}}{130 \text{ kHz}}$	$\frac{-32 \text{ dBm}}{210 \text{ kHz}}$	$\frac{0.2 \text{ dB}}{1 \text{ kHz}}$	45 MHz to 95 MHz
Klystron mode center	—	—	5 kHz	All bands

Return loss

Method	Max	Min	Accuracy	Frequency band
Hybrid	10 dB	32 dB	0.2 dB	45 MHz to 95 MHz
Long cable	0 dB	46 dB	1.0 dB	45 MHz to 95 MHz

3701A Transmission Generator**Description**

Mode switch controls baseband modulation and sweep applied to IF.

Setting	Sweep rate	Baseband (kHz)
Manual	Use IF fine	83.3, 250, 500, ext
Auto	70 Hz	—
Line	Line	83.3, 250, 500, ext
BB + sweep	70 Hz	83.3, 250, 500, ext
BB + ext sweep	External	83.3, 250, 500, ext

Specifications

IF range: 50, 60, 70, 80, 90 MHz with ±5 MHz on vernier; accuracy ±0.5%.

IF output: +8 dBm to +12 dBm with SET LEVEL; accuracy ±5% leveled to better than ±0.075 dB over 45 to 95 MHz band.

70 MHz output: +11 dBm, adjustable with SET LEVEL; crystal derived; accuracy ±0.01%.

Meter: reads IF or 70 MHz OUTPUT, +8 dBm to +12 dBm.

IF sweep rates: power line, 70 Hz, manual (IF FINE) or external; internal sweep widths 0 to 50 MHz with step and vernier, centered on IF; external sweep: frequencies 40 Hz to 20 kHz at EXT SWEEP INPUT.

Baseband: frequencies: 83.3, 250, 500 kHz or external; output: +11 dBm ±0.5 dB; stability: ±13 ppm, 0°C to +50°C. aging rate: ±0.2 ppm per month; external baseband frequencies 10 kHz to 12 MHz; modulation sensitivity: -35 dBm input gives 200 kHz rms deviation ±0.1% over IF band.

Deviation: range 100 kHz to 500 kHz rms continuous with internal baseband; accuracy ±1%.

BB + sweep output: output is baseband frequencies combined with sweep frequency; sweep variable 0 to 5 V peak; baseband -49 dBm to -10 dBm stepped at 1 dB.

Attenuator: range 99 dB in 1 dB steps; accuracy ±1% of dB setting; insertion loss <0.4 dB; frequency dc to 250 MHz.

3702A Demodulator Display

Description

Display mode: Two channels are displayed on a crt. In most measurements one channel is the reference channel. Max crt sensitivity 0.025 dB/cm, 0.25%/cm, and 0.33 ns/cm.

Modes of operation include:

Setting	Function	Calibration
IF	IF amplitude	0.1, 0.3, 1 dB
BB	BB amplitude	0.1, 0.3, 1 dB
Delay	Group delay	1, 3, 10 ns
Spectrum	Spectrum	
Ext	External	See EXT INPUT
Ret loss	Return loss	--
Playback	Slaving	dB or ns

Specifications:

IF range: 45 MHz to 95 MHz at IF INPUT; sensitivity -10 dBm to $+12$ dBm; 22 dB step attenuator (± 0.3 dB) compensates for powers greater than -10 dBm.

Automatic frequency control: ± 1.5 MHz capture range at 70 MHz; 45 MHz to 95 MHz dynamic hold-in range; tracking loop bandwidth is 100 Hz.

BB output: connector gives baseband demodulated from IF; internally coupled to 3703A for group delay measurements; demodulation sensitivity -20 dBm/200 kHz rms.

BB input: 50 kHz to 12 MHz; sensitivity -32 dBm to -10 dBm; accuracy ± 0.2 dB.

Ext Input: 5 Hz to 100 kHz (3 dB); sensitivity 5 to 60 mV/cm (Y GAIN).

Meter: zero centered, calibrated -0.5 to $+0.5$ dB; when set to read zero by IF ATTENUATOR, these controls are direct reading; establishes RETURN LOSS reference via SET RETURN LOSS control.

Return loss input: 45 MHz to 95 MHz; return loss range 10 to 32 dB.

Spectrum: display of fixed IF and sidebands for Bessel Zeros; spectrum sweep is 55 Hz; max spectrum is 5 MHz, minimum is 1 MHz, with SPECTRUM WIDTH control.

Calibration: 0.1, 0.3, 1 dB selected by CALIBRATION control; accuracy $\pm 10\%$; frequency selected by MARKER OFFSET, one center marker at 70 MHz ($\pm 0.01\%$) and two sliding markers up to 50 MHz separation.

3703A Group Delay Detector

Description

Output (internally connected to 3702A) is dc voltage proportional to instantaneous value of group delay on baseband frequency of 83.3, 250, or 500 kHz.

Group delay

Sensitivity: 0.1 ns at 500 kHz
0.2 ns at 250 kHz
0.6 ns at 83.3 kHz

Above sensitivity obtained during back-to-back tests at IF with 200 kHz rms deviation.

Display: total of 80 ns on one channel, 40 ns on the other; min measurable phase difference of 3703A is 0.01° .

Calibration: 1, 3, or 10 ns on display; accuracy $\pm 10\%$.

Phase detector: mean-phase tracking between the reference baseband of the 3703A and the group delay baseband is achieved by means of a phase-lock loop.

Reference baseband: 83.3, 250, or 500 kHz, crystal derived; stability and aging same as for 3701A baseband specifications.

General System specifications

General: impedance is 75 Ω and return loss better than 30 dB unless otherwise stated.

Weight: Net 78 lb (35.4 kg); shipping 98 lb (44.5 kg).

Power: 115/230 V switch, 45 to 100 Hz 223 W.

Dimensions: 15 $\frac{1}{2}$ " high, 16 $\frac{3}{4}$ " wide, 18 $\frac{3}{8}$ " deep (398 x 425 x 467 mm).

Price: HP 3701A, \$2,700.
HP 3702A, \$3,750.
HP 3703A, \$750.



Vertical-Interval Test Signals check quality

The television networks, the individual TV broadcasting stations, and the Bell System are all concerned with improving the quality of the picture seen by the viewing public. In the day-to-day operation of the television networks, many changes are made in the interconnection of these transmission facilities. This includes changes in broadcasters' facilities, changes in local Telephone Company facilities, and changes in inter-exchange channels. Although designed for long term stable performance, no part of the overall network is immune to trouble. Since many of these troubles are temporary or transient, it is desirable that they be located quickly, while they are present. This means that trouble location must be done on an in-service basis, rather than by tests made on an out-of-service basis after the program is over.

In addition, it is often difficult either to identify or to diagnose troubles from observation of the normal picture signal. Some more rigorous test signal is needed. The technique which seems to come closest to meeting these requirements and seems to hold the most promise is the use of Vertical Interval Test Signals (VITS).

Vertical Interval Test Signals

VITS are signals generated and transmitted by equipment provided by the broadcasters. They are keyed into designated lines during the vertical blanking interval of the picture. These signals are then transmitted along with the normal picture signal. They may be observed, and/or photographed, at appropriate existing monitoring locations by network, Telephone Company, and local station personnel.

Vertical Interval Test Signals may be inserted on any of the lines between 16 and 20 of either or both fields. The three VITS waveforms are:

1. **Multiburst:** White bar followed by bursts of 0.5 MHz, 1.5 MHz, 2.0 MHz, 3.0 MHz, 3.6 MHz, and 4.2 MHz. This signal gives a quick check of the amplitude vs. frequency response of the channel. The six bursts have equal amplitudes if the response is correct, and vice versa. To check that the multiburst baseline is at the same level for each burst, the sine waves are removed with a low pass filter.

2. **Sine-Squared Pulse and Bar:** Pulse with sine-squared shape and half-amplitude duration of either 0.125 μ s (T pulse), 0.0625 μ s (T/2 pulse), or 0.25 μ s (2 T pulse), followed by bar with sine-squared leading and trailing edges and duration of one-half line. A symmetrical sine-squared pulse indicates that the phase characteristic of the channel is correct, and vice versa. Droop on the top of the bar indicates poor mid-frequency response. Overshoots or ringing indicate poor transient response.

3. **Modulated Stairsteps:** 10 equal steps going from black level to white level with burst of 3.58 MHz sine wave on each step. This signal is used for checking the channel for differential gain (variations in gain with signal amplitude) and differential phase. Low frequency differential gain is checked by filtering out the 3.58 MHz sine waves with a low pass filter and checking the steps for equal amplitudes. Differential gain at 3.58 MHz is checked by filtering out the steps with a band pass filter and checking the bursts for equal amplitudes.

Types of distortion

Both black-and-white and color television are degraded by distortion in the following characteristics of the transmission system:

1. **Frequency response (amplitude vs. frequency):** High frequency rolloff which starts at too low a frequency or occurs at too fast a rate causes the TV picture to look soft and lack detail. Color

TV viewing tests have indicated that viewers can detect amplitude variations of only 1 or 2 dB in the frequency response, if the variations occur near the color subcarrier frequency.

2. **Phase Response (phase vs. frequency):** The phase response of a transmission system should be linear with frequency (constant time delay for all frequencies) up to 4.2 MHz and beyond. Deviations will cause lack of clarity and, in color, hue shift. Phase delay distortions as small as $\pm 0.1 \mu$ s at the higher frequencies are easily detected by viewers.

3. **Transient Response:** Transient response includes both amplitude and phase response. If the phase characteristics of the system are not ideal, a black bar may appear at the leading or trailing edge of a sharp black-to-white transition. In a color picture, hue will be shifted with respect to outline; e.g., the red of an apple will be shifted with respect to the outline of the apple. Poor low-frequency response may cause streaking in the picture.

4. **Differential Gain and Differential Phase (gain and phase vs. signal amplitude):** Variations in gain with signal amplitude will cause white or black areas to shift towards gray, or color desaturation and a washed-out appearance. Variations in phase with amplitude are most harmful to color signals, and result in hue shift as a function of signal amplitude: saturated yellow, for example, may appear green or orange, so that a dress which appears yellow in dim light may change to green or orange in bright light.

In the VITS system, frequency response is checked by the multiburst signal, phase and transient responses are checked by the sine-squared pulse and bar, and differential gain and phase are detected by modulated stairsteps.

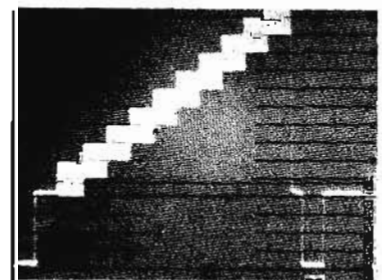
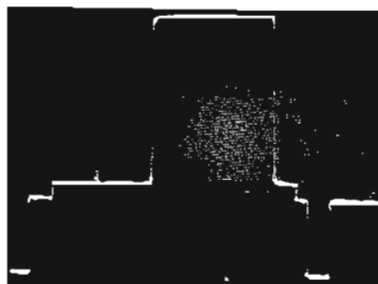
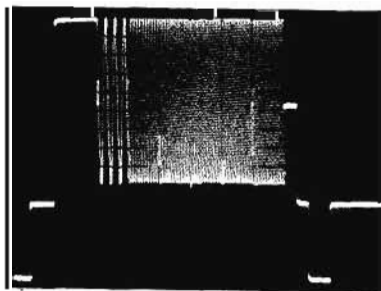

Oscillograms made with HP Model 191A TV Waveform Oscilloscope displaying Vertical Interval Test Signals; Multiburst Signal (left), Sine-squared Pulse and Bar (center), and Modulated Stairstep (right).

TV WAVEFORM OSCILLOSCOPE

Independent Relayers' Oscilloscope

Model 193A



**COMMUNICATIONS
TEST EQUIPMENT**

The Model 193A Television Waveform Oscilloscope is especially designed to meet both the Bell System and the independent relayers' requirements. WECO Type 477B feed-through connectors are provided on both the front and side of the oscilloscope. The vertical amplifier has five carefully defined response filters for accurate, reliable VITS and video setup measurements. Four different sweep modes permit optimum examination of fields, individual lines, and video setup.

Specifications

Vertical amplifier

Input circuit: 75 ohms unbalanced; 124 ohms balanced; WECO Type 477B feed-through connectors.

Input impedance: 12.5 k ohms unbalanced; 25 k ohms balanced; 40 dB return loss at 4.5 MHz; 27 dB return loss at 20 MHz; power off-on transient less than 5 mV; 100 volts transient input protection.

Common mode rejection: 46 dB to 2 MHz, decreasing 6 dB per octave to 20 MHz.

Gain control: selectable, fixed or variable; variable provides 140 IRE deflection for input levels from 0.2 V pk-pk to 2.0 V pk-pk; fixed sets the vertical amplifier gain for 100 IRE with 0.714 volt, $\pm 1\%$ pk-pk input signal.

DC restorer: On, restores to the back porch with 3 dB point at 10 Hz, color burst effect on the display will be less than 1.5 IRE unit; Off, restores to average value of the signal.

Calibrator: with input selector set to Cal: automatically switches vertical channel to flat filter mode, horizontal sweep to 2 H mode, and applies a 22 kHz, 0.714 V $\pm 0.5\%$ signal to the vertical amplifier.

Filters

Flat: $+15^{\circ}\text{C}$ to $+35^{\circ}\text{C}$: ± 0.05 dB from 100 Hz to 1.5 MHz, decreasing to -0.05 ± 0.05 dB at 4.5 MHz, -3 dB at 10 MHz, and -20 dB at 20 MHz; rise time less than 50 nsec; less than 1% tilt on 60 Hz squarewave with dc restorer off; 0°C to $+50^{\circ}\text{C}$: meets KS19763 specifications.

IRE: standard roll-off as specified by IRE (1958 IRE journal, page 23.S1).

Chrominance: band-pass filter with Q of 4 and center frequency of 3.58 MHz.

Differential gain: same response as Chrominance with 14 dB additional gain.

Low pass: more than 30 dB down at 0.500 MHz ± 0.015 MHz; 40 dB down at 1.5, 2.0, 3.0, 3.6, and 4.2 MHz; less than 2 dB down at 0.15 MHz.

Horizontal sweep

Internal sweep:

2V (0.125 V/cm): $\pm 5\%$ for X1, X5, and X25 magnification.
2H (0.125 H/cm): $\pm 3\%$ for X1 and X5; $\pm 5\%$ for X25 magnification.

Free Run (0.125 H/cm): envelope display for video setup.

H-Line Select (0.125 H/cm): discrete line selection for lines 16 through 21; variable line selection for all lines in the entire field.

Linearity: $\pm 5\%$ of full scale.

Field select: positive selection of either field; circuit is insensitive to noise pulses.

Blanking: decoupled to remove trace with no signal input.

CRT display

Cathode ray tube: post-accelerator, 20 kV accelerating potential; aluminized P31 phosphor; high writing rate for viewing of sine-squared T/2 pulse.

Graticule: 8 cm x 10 cm parallax-free internal graticule; 140 IRE units = 7 cm; vertical and horizontal trace alignment controls.

Spot size: (including noise) less than 1 IRE.

Bezel: provision for external transparent plate with graticule markings; provision for illumination of both internal and external graticules.

General

Design: all solid state (except for crt) on plug-in printed circuit boards.

Power: 115 or 230 V $\pm 10\%$, 50 to 400 Hz, approx. 70 W (no fan).

Temperature: operating range 0°C to 50°C .

Stability: less than 1% drift in 24 hours.

Altitude: operates at 15,000 feet above sea level.

Line bright output: 1 volt ± 5 mV into 75 ohms, in variable line select mode.

Camera: HP Model 197A camera mounts direct, adapters for other cameras available.

Rack mount: rack mount kit supplied with all instruments.

Weight: net, 34 lbs (15.3 kg); shipping, 39 lbs (17.6 kg).

Dimensions: 16 $\frac{3}{4}$ " wide, 5-7/32" high, 21 $\frac{3}{8}$ " deep overall (425 x 133 x 543 mm).

Price: HP Model 193A, \$1550.

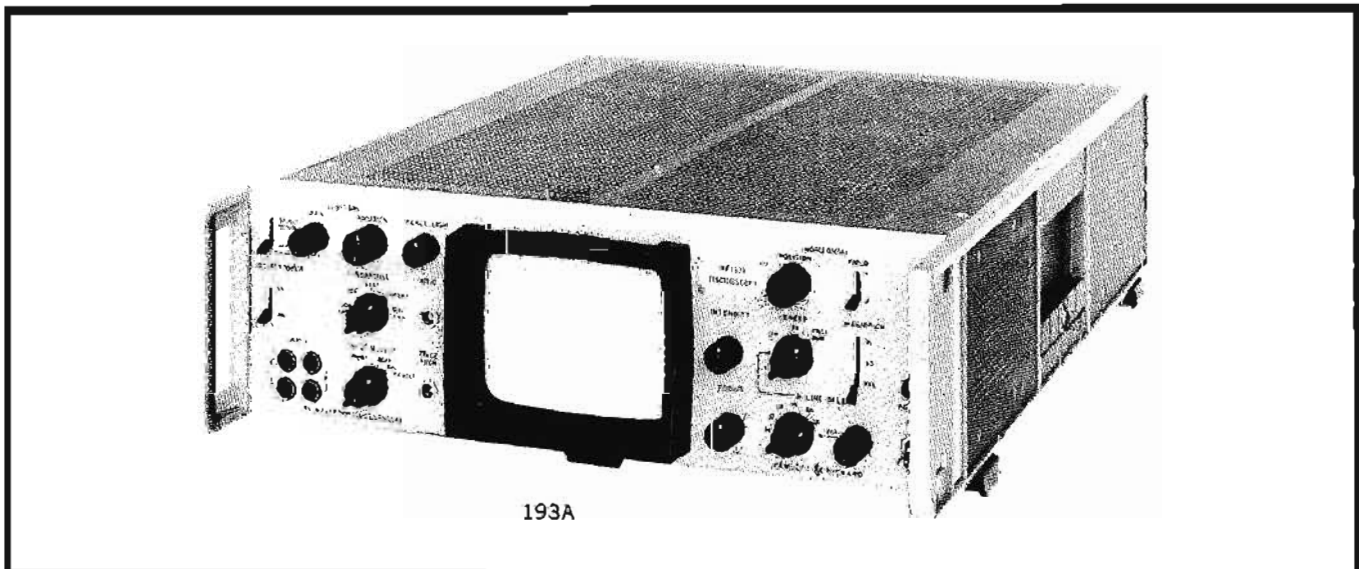



TV WAVEFORM OSCILLOSCOPE

Precision Measurement of VITS and Video Signals
Model 191A

Displaying the TV video waveform and the new test signals, and making accurate measurements of them, calls for an oscilloscope with special capabilities, plus unusual accuracy and stability. These requirements are met by the HP Model 191A Television Waveform Oscilloscope which displays and measures black-and-white and color TV video signals and VITS.

Video and test signals

TV picture information occurs at a rate of 30 pictures, or frames, per second, each frame consisting of two fields of $262\frac{1}{2}$ lines each. Lines 1 to 21 of each constitute the vertical blanking interval, which produces the black areas between frames on a TV receiver. The other lines contain the picture signals. Each line consists of a horizontal sync pulse of maximum carrier amplitude followed by the picture signals, which are used to intensity modulate the electron beam (or beams, in color receivers) of the TV picture tube.

Precision measurements with 1% accuracy

The Model 191A is a precision instrument of advanced design. It is capable of measuring signal amplitudes with 1% accuracy, which is a capability not usually found in oscilloscopes of any type. It produces bright, sharp displays of fast pulses that have low repetition rates. Its frequency response and phase characteristics are carefully controlled not only within the nominal bandwidth, but also on the roll-offs or skirts of the response curves. Its differential input amplifier has high common mode rejection over an unusually wide frequency range. Transient response is also controlled to insure high-fidelity reproduction of the test signals.

The 1% accuracy of the Model 191A is achieved by means of stable, wideband amplifiers and passive filters of special design, by a mesh-type CRT with extremely constant deflection sensitivity over the entire display, by an internal graticule with a new type of flood gun illumination, and by an advanced CRT gun structure which produces a sharper spot. Brightness is 7.5 times that of most oscilloscopes, made possible by the new gun structure, which delivers more current to the screen in a sharper spot, and by the mesh structure, which makes it possible to use a 20 kV accelerating potential without losing deflection sensitivity.

The Model 191A displays VITS and video signals without

discernible jitter. This results from the use of logic circuits for positive selection of the portion of the waveform to be displayed, and from the use of a special synchronizing circuit which works well even with very noisy input signals.

Front panel controls permit easy selection of the displays that are needed in television testing. Discrete selection is provided for the parts of the video signal which contain the VITS. Five special vertical-amplifier gain-filter combinations are available for distortion tests using VITS waveforms.

For minimum size and weight and maximum reliability, the oscilloscope is all solid-state except for the CRT. It is designed to operate at temperatures between -20°C and $+65^{\circ}\text{C}$ and at high altitudes, so that it can be used in hot locations which are crowded with electronic equipment or in mountain-top radio relay stations.

TV waveform oscilloscopes like the Model 191A are used in the Television Operating Centers of the intercity TV network where video signals are adjusted and switched to the proper channels. Television broadcasting stations also use TV waveform oscilloscopes in their master control consoles, in video tape recorders, in adjusting both black-and-white and color cameras, and in monitoring incoming network programs.

Specifications

Vertical amplifier

Input circuit: loop through type.

Terminated: 75 ohms unbalanced; 124 ohms balanced.

Unterminated: 12.5 k ohms unbalanced; 25 k ohms balanced.

Power off-on transient: less than 5 mV.

Transient protection: 100 V with rise time no less than 1 μs .

Common mode rejection: -40 dB from 0 to 2 MHz; decreasing at 6 dB/octave from 2 MHz to 20 MHz.

Gain control: selectable, fixed or variable; variable provides 140 IRE deflection for composite TV video signal from 0.2 V to over 2 V pk-pk amplitude.

DC restorer: On, restores to the back porch, color burst effect on the display will be less than 2 IRE; Off, restores to the average value of the input signal.

Calibrator: with input switch set to Cal, automatically switches vertical channel to flat filter mode, horizontal

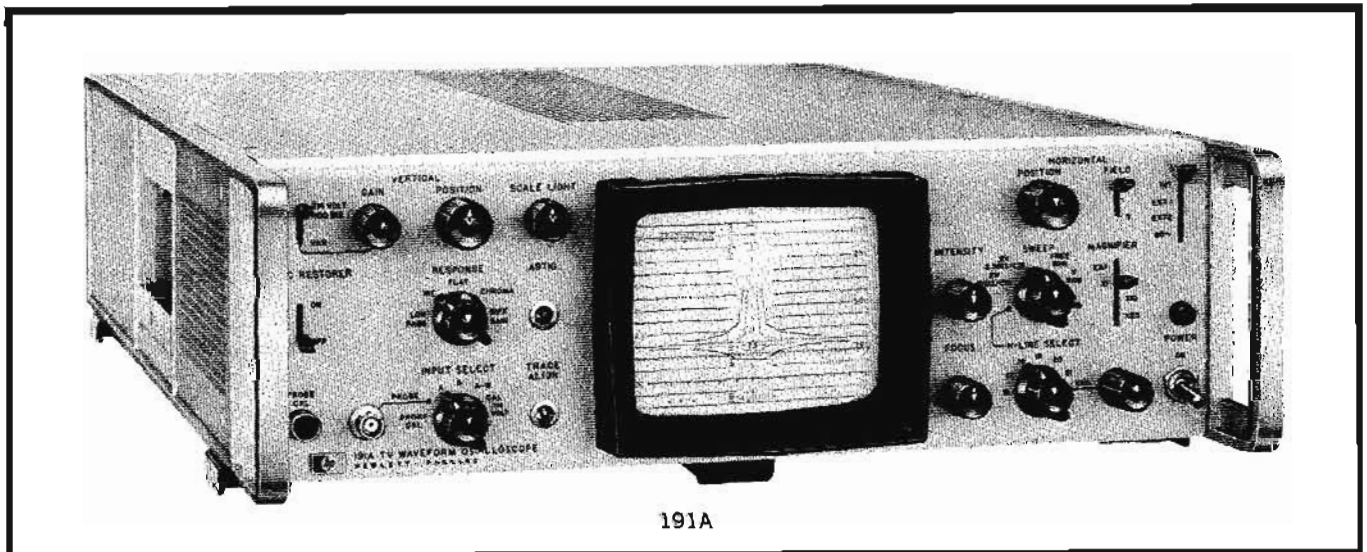

sweep to 2 V mode, and applies a 120 Hz, 0.714 volt $\pm 1\%$ signal to the vertical amplifier.

Probe Input: input RC, 1 megohm shunted by 25 pF; when used with X10 attenuation probe, 10 megohms shunted by 10 pF.

Filters

Flat: $+15^{\circ}\text{C}$ to $+35^{\circ}\text{C}$: ± 0.05 dB from 100 Hz to 1.5 MHz decreasing to -0.05 ± 0.05 dB at 4.5 MHz; -20°C to $+65^{\circ}\text{C}$: decreasing to ± 0.15 dB from 100 Hz to 1.5 MHz. -0.1 ± 0.2 dB at 4.5 MHz, -3 dB at 10.5 MHz, and -20 dB at 20 MHz; rise time less than 50 nsec; less than 1% tilt on 60-Hz square-wave with dc restorer off.

IRE: standard roll-off as specified by IRE (1958 IRE Journal, page 23.S1); 20 dB down at 3.58 MHz.

Chrominance: band-pass filter with Q of 4 and center frequency of 3.58 MHz.

Differential gain: same response as Chrominance with 14 dB additional gain.

Low pass: more than 30 dB down at 0.500 MHz ± 0.015 MHz; 40 dB down at 1.5, 2.0, 3.0, 3.6, and 4.2 MHz; less than 2 dB down at 0.15 MHz.

Horizontal sweep

Internal sweep:

2 V (2.5 ms/cm): $\pm 5\%$ for X1, X10, and X25 magnification.

2H (10 $\mu\text{s/cm}$): $\pm 3\%$ for X1 and X10; $\pm 5\%$ for X25 magnification.

H-Line select (10 $\mu\text{s/cm}$): discrete line selection for lines 16 through 21; variable line selection for all lines in the entire field.

Free run (10 $\mu\text{s/cm}$): envelope display for video setup.

External inputs: two inputs to sync oscilloscope to external TV sync generators; staircase input to accept a 4-step staircase for WRGB (may be modified to accept a 3-step staircase).

RGB operation:

H-RGB: displays 3 or 4 line parade.

V-RGB: displays 3 or 4 field parade.

Expand mode allows 10-cm overlay display.

Field select: positive selection of either field; circuit is insensitive to noise pulses.

Blanking: decoupled to remove trace with no signal input.

Linearity: $\pm 1.0\%$ of full scale.

CRT display

Cathode ray tube: post-accelerator, 20 kV accelerating potential; aluminized P31 phosphor; high writing rate for viewing of sine-squared T/2 pulse.

Graticule: 8 cm x 10 cm parallax-free internal graticule; 140 IRE units = 7 cm; vertical and horizontal trace alignment controls; external graticules available for sine-squared pulse-and-bar, video modulation, etc.

Bezel: provision for external transparent plate with graticule markings; provision for illuminating both internal and external graticules.

General

Design: all solid state (except for CRT on plug-in printed circuit boards).

Power: 115 or 230 volts $\pm 10\%$, 50 to 400 Hz; approx. 70 W (no fan).

Temperature: operating range from -20°C to $+65^{\circ}\text{C}$ unless otherwise noted.

Environmental: meets Bell Telephone Laboratories KS-19763 environmental specifications.

Altitude: operates at 15,000 feet above sea level.

Line bright output: supplies both video and line bright gate to the associated picture monitor; line bright gate pulse is supplied in variable H-line select only.

Accessories supplied: two plug-in extender boards for servicing, and rack-mount kit.

Dimensions: 16 $\frac{3}{4}$ " wide, 5 $\frac{1}{4}$ " high, 21 $\frac{1}{2}$ " deep overall (426 x 133 x 546 mm); hardware furnished for quick conversion to 5" x 19" (127 x 483 mm) rack mount.

Price: HP Model 191A, \$1475.

Special order: chassis slides and adapter kit; fixed slides, order HP Part No. 1490-0714, \$32.50; pivot slides, order HP Part No. 1490-0720, \$37.50; slide adapter kit for mounting slides on scope, order HP Part No. 1490-0721, \$20.

Accessories available

Camera: HP Model 197A Camera mounts direct, adapters available for other cameras. Model 197A, \$540.

Front panel cover: cover attaches to front of scope for protection during storage or transportation, order HP Part No. 5060-0437, \$25.

Amplifier boards: consists of three printed circuit boards for calibration of the Model 191A vertical amplifier, order HP Part No. 00191-69501, \$240.

Model 10009A probe: probe tip is WECO Type 477B connector; input RC, 10 megohms shunted by 10 pF; when attached to Model 191A Probe Input, input signal at 0.2 V to 4 V will provide 140 IRE display; probe combined with X10 gain input amplifier in the Model 191A gives unity gain, $\pm 10\%$; (other standard X10 probes may also be used with the Model 191A); price, Model 10009A, \$50.

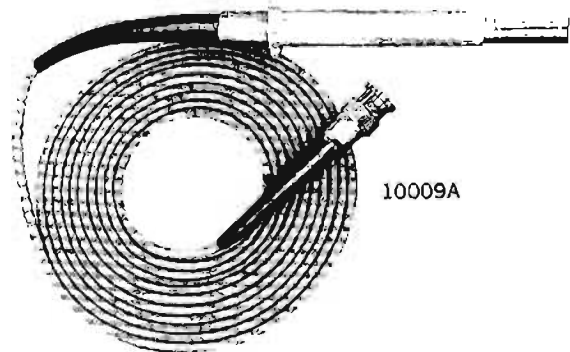

External graticules:

2T-4 MHz HP Part No.

00191-62801 \$10

2T-8 MHz HP Part No.

00191-62802 \$10

Dual HP Part No. 00191-

62803 \$10

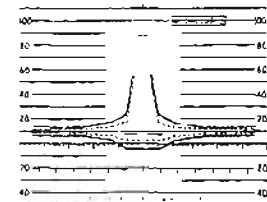
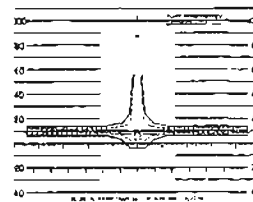
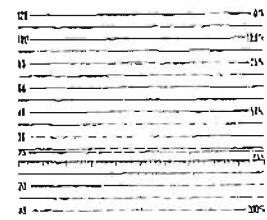
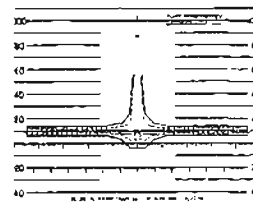

COMMUNICATIONS TEST EQUIPMENT



TV PICTURE MONITOR

Unexcelled picture quality

Models 6945A, 6946A

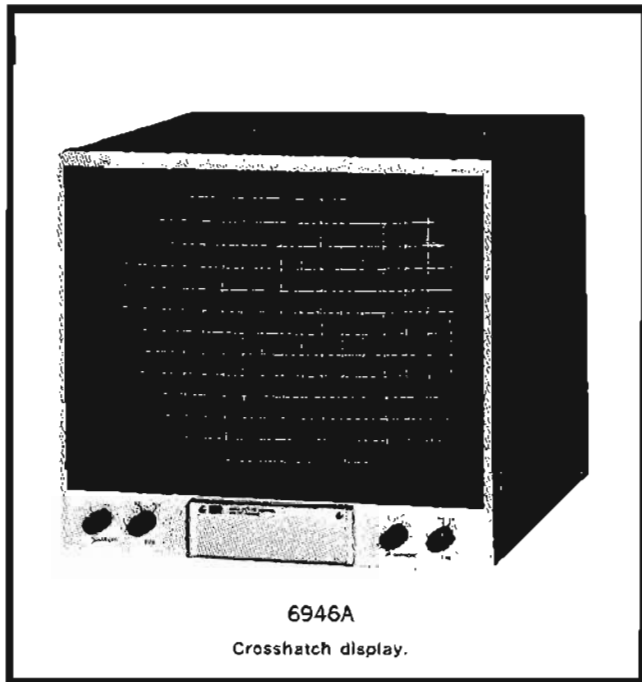

6946A

Crosshatch display.

Advantages:

- All-silicon solid state circuitry
- Unity interlace
- Greater than 1000 line resolution
- Constant-delay wideband video amplifier
- Excellent stability—feedback employed in video, horizontal, and vertical circuits
- Less than 1.5% geometric raster distortion (Less than 1% over center 80% of screen)
- Circularly polarized safety glass
- Display size reduction—switchable to 80% for examination of raster edges (without affecting linearity)
- Maintains all specifications throughout operating temperature range of -20°C to $+55^{\circ}\text{C}$
- Operates at 50 or 60 Hz field rate, 625 or 525 lines
- Displays sine² T/2 pulse without distortion
- Optional sync pulse cross display

Description

Model 6946A, TV Picture Monitor, is a high-quality all solid-state, monochrome monitor designed for checking the quality of broadcast television channels, TV tape machines, transmitters, and video switching system output lines. In combination with the HP Model 191A TV Oscilloscope, the TV Monitor forms a complete television monitoring system. Both instruments meet the specifications of the Bell System for its measurement of interstate television networks.

The quality of the components used in the TV Monitor and the conservative design assure excellent reliability. The display has less than 1% geometric distortion over the center 80%,

and 1.5% geometric distortion over the entire picture area. Refer to crosshatch display here. The TV Monitor achieves this linearity by retaining feedback control over the entire usable sweep. In addition, display linearity is independent of size and centering adjustments.

The all solid-state video amplifier employs feedback over the entire bandwidth. The response is flat up to 4.5 MHz with controlled attenuation increasing slowly and smoothly (monotonic) to 3 dB at 11.6 MHz and 18.5 dB at 20 MHz. The controlling element is a passive network designed to insure a linear phase signal characteristic to beyond 16 MHz. With constant-delay performance, a 62.5 nanosecond video pulse applied to the input remains symmetrical and undistorted at the control element of the picture tube.

Unity interlace factor is automatically obtained by deriving the vertical sweep from the stabilized AFC horizontal oscillator. No vertical or horizontal hold controls are required for either U.S. or CCIR standards. In fact, horizontal and vertical sync are maintained with a composite picture signal-to-noise ratio of 12 dB.

Circularly polarized safety glass covers the 17" picture tube face to improve the reproduced contrast ratio of the displayed pictures. It is easily removed to clean the face of the picture tube.

Specifications

Video circuits

Input circuit: 75 ohms unbalanced to ground; UHF connectors with loop-through facility. 124 ohms balanced to ground; UHF connectors with loop-through facility. Return loss greater than 40 dB from dc to 4.5 MHz. Protection for up to 100 V peak transients appearing on input balanced line. Input impedance (unterminated) —12 K ohms.

Input level: 0.25 to 2 volts peak to peak for 50-volt signal at kinescope.

Common mode rejection (longitudinal balance): 46 dB from 0 to 2 MHz; decreasing at 6 dB/oct from 2 MHz to 20 MHz.

Frequency response: flat up to 4.5 MHz; decreases monotonically (smoothly) to greater than —18 dB at 20 MHz as determined by a linear-phase low pass network. Refer to multiburst display, p. 315. **Sine-squared Response—Overshoot symmetry** is better than 1% on a 62.5 nanosecond input pulse appearing on the picture tube control grid. Maximum overshoot is less than 5% of pulse amplitude. Refer to sine² pulse display, p. 315. **Rise Time:** Less than 50 nanoseconds for a step change input viewed at the picture tube modulating grid.

Signal-to-noise ratio: rms visible noise is greater than 50 dB below p-p signal present at picture tube when a 0.25 volt sinusoid is applied to the input.

Differential gain: less than 3% over specified input level (0.25 to 2 V p-p). Refer to staircase display, p. 315.

DC restoration: keyed back-porch clamp. **Black level shift:** Less than 1% for a full change in input signal level.

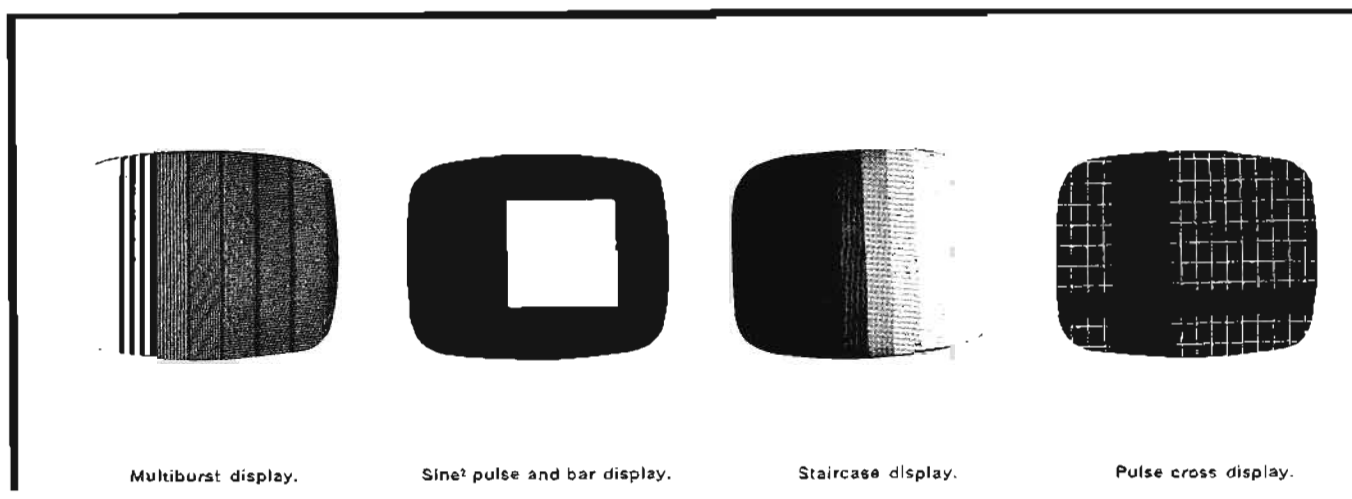

Specifications (continued)

Horizontal deflection circuits

Horizontal AFC: locks on either 525 or 625 line systems. Horizontal sync is maintained with a composite picture signal-to-noise ratio of 24 dB.

Horizontal width: more than 5% overscan of the usable visible area of the kinescope; horizontal width control range is 15% of horizontal dimension.

Vertical deflection circuits

Field rate: vertical lock and interlace is automatic. Front panel switch maintains the picture aspect ratio for either 50 or 60 Hz field rate. Vertical sync is maintained with a composite picture signal-to-noise ratio of 12 dB.

Vertical height: more than 5% overscan of the usable visible area of the kinescope; vertical height control range is 15% of vertical dimension.

Display

Display size: switchable from 100% to 80% of full picture size with no change in linearity.

Geometric raster distortion: less than 1.5% overall; less than 1% in safe title area (80% of full picture size). Refer to crosshatch display on previous page.

Interlace factor: unity (equal spacing between raster lines)

Resolution: greater than 1000 lines over the entire area of the raster.

Line brightening: separate raster line brightening input: A line brightening gate produced by a TV Oscilloscope can brighten any selected raster line (1-525) on TV Picture Monitor.

Picture tube: 17" rectangular tube, type 17DWP4 with medium short persistence P-4 phosphor, aluminized.

Safety glass: circularly polarized laminated safety glass is standard on all units. Polarization increases reproduced picture contrast.

General

External sync inputs: sync switch selects one of the external sync inputs (rear panel jacks) or internal sync input. Sync input range is -1 V to -8 V.

Temperature ratings: operating: -20°C to $+55^{\circ}\text{C}$. Storage: -20°C to $+75^{\circ}\text{C}$.

Altitude: operating: up to 15,000 ft. Storage: up to 50,000 ft.

Controls: front-panel, exposed: off-on ac switch, contrast, brightness, size switch. Front-panel, concealed: 50/60 Hz field rate switch, focus, height, width, sync switch.

Input power: 115 V ac $\pm 10\%$, 50-400 Hz, 75 W nominal.

Dimensions: 17-7/16" W x 15 1/2" H x 20 1/8" D. 44.3 cm W x 39.4 cm H x 51.1 cm D.

Rack mount: rack mounting kits, consisting of two angle brackets, are provided with each unit.

Weight: net 63.5 lbs (30.6 kg); shipping 90 lbs (40.8 kg).

Price: 6946A, \$950.

Accessories

14526A: 15 1/2"—High Tilt Rack Mounting Tray and Brackets. Price, \$55.

14528A: 15 1/2"—High Flush Rack Mounting Brackets. Price, \$10. One set is included with each monitor at no charge.

14529A: 15 1/2"—High Tilt Rack Mounting Brackets. Price, \$10.

Options

28: 230 V ac $\pm 10\%$, Single Phase Input. Factory modification consists of reconnecting the multi-tap input power transformer for 230-volt operation. Price, \$10.

46: Pulse Cross Display (refer to illustration above). Enables inspection of the relative phasing and duration of the synchronizing information transmitted with the video signal. The vertical interval is expanded so that the individual scanning lines may be observed and measured easily. A front panel switch activates the pulse cross circuit board located within the monitor. Price, \$45.

Model 6945A Video Monitor

Model 6945A is designed to meet Bell System specification. Model 6945A is identical to Model 6946A except: the input connectors are WECO 477B instead of UHF, external sync is not included, and Option 46 Sync Pulse Cross Display is not available. Model 6945A: price, \$1350.

COMMUNICATIONS TEST EQUIPMENT



CUT COST ON CABLE INSTALLATION AND MAINTENANCE

Quick location of faults

Time domain reflectometry (TDR) speeds maintenance by locating faults such as shorts, opens, loose connectors, troublesome tap-offs, mismatched terminations, and poor cable splices. The information is presented on a cathode ray tube and discloses both the location and nature of each discontinuity. Problems of locating smashed or water damaged sections of underground cable are quickly resolved. Troubles are isolated to specific locations on the line.

Improve picture quality

TDR reveals the quality of the transmission system by directly measuring reflection. Since reflection ghosts are an even greater annoyance to color TV viewers than to monochrome viewers, color transmission requires a higher degree of precision. CATV transmission is subject to reflection anywhere along the cable, at connectors, tapoffs, and terminations. The high sensitivity of the Model 1415A TDR plug-in can locate even the smallest ghost-causing reflection.

Time domain reflectometry principle

TDR employs a closed loop radar method to examine cables. Cables can be easily tested in the same way a transmitted signal would see it. By sending a step voltage through the cable and measuring the reflected voltage with a high-speed sampling oscilloscope, a time profile is obtained revealing the characteristics of each point along the cable.

Checks cables to 3000 feet

The CRT is calibrated directly in distance for air and polyethylene dielectric cables.

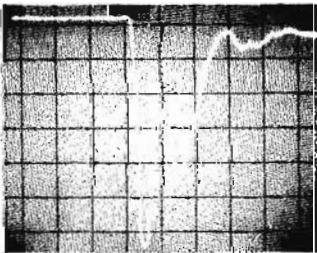

WET CONNECTOR: Highly magnified display of a wet connector. Multiple reflections from the faulty connector cause a reflection coefficient of -0.4 .

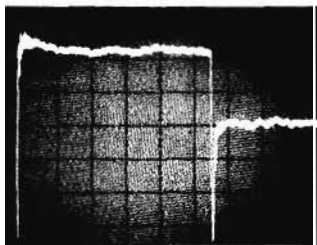

IMPEDANCE MISMATCH: Reflection caused by cables of different impedance. With the vertical calibrated in $.02 \mu/cm$ and the first cable known to be 75Ω , the second cable is quickly found to be 69Ω using the TDR slide rule. From scope readout, the mismatch is located 55 ft down the 75Ω cable.

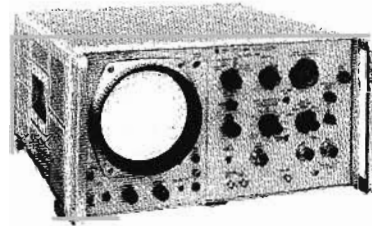

The Model 1415A can test polyethylene cable to 600 feet with 5% accuracy. The long line version, Option 14, will test to 3000 feet. A special slide rule is furnished to convert the distance scale to other dielectrics. Special techniques can double the range and pinpoint discontinuities at long distances. If both ends are accessible, measurements can be taken at each end permitting 6000 feet to be checked. Accuracy can be improved two ways. The first is to close-in on the fault by measuring at successively closer connections. The other is to compare distances to a standard cable connected in parallel. With these techniques, faults can be isolated within inches of the trouble spot. The 150 ps ($1 \text{ ps} = 10^{-9} \text{ s}$) step rise time of the Model 1415A is great enough to resolve nearby discontinuities that are less than an inch apart. The high resolution is useful to examine faulty connectors.

Specifications, Model 1415A TDR plug-in

(Refer to page 481 for details)

Distance scale is calibrated to relate centimeters of CRT display to centimeters of transmission cable. For polyethylene line with a dielectric constant of 2.25, the CRT is calibrated to represent 200, 500, 1000, or 2000 cm line/cm display. The long line version, Option 14, will extend the range to 10000 cm line/cm display. For air line with a dielectric constant of 1, the calibration is 300, 750, 1500, or 3000 cm line/cm display. Option 14 extends calibration to 15000 cm line/cm display. Also, each calibrated display can be magnified X1 to X200 in 1, 2, 5 sequence with 5% accuracy.

Reflectometer sensitivity: reflection coefficients as small as 0.001 can be observed, corresponding to an SWR of

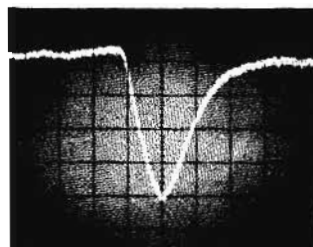

PINCHED CABLE: Magnified display of a pinched cable resulting from sharp radius of curvature. The calibrated CRT indicates a reflection coefficient of -0.04 .

1.002; this is equivalent to a mismatch of less than 0.2 ohms in a 75-ohm line.

Distance resolution: system rise time is less than 150 ps and permits discontinuities separated by less than one inch (in polyethylene cable) to be resolved.

Reflection coefficient calibration: 0.5 μ/cm to 0.005 μ/cm in 1, 2, 5 sequence; attenuator accuracy, $\pm 3\%$.

Characteristic impedance: 50 ohms feed-through type; 75-ohm adapter available.

Output connector: GR Type 874.

Maximum external signal level: up to 1 V pk-pk may be safely applied to the Signal Out connector.

Recorder output: 50-ohm BNC female connectors for X and Y axis.

Accessories furnished: 2 GR Elbows Type 874-EL; 1 GR to Type N Adapter; 1 Type N to BNC Adapter.

Price: HP Model 140A, \$595; Model 1415A, \$1050; Model 1415A Option 14, \$1150.

Rise time converters

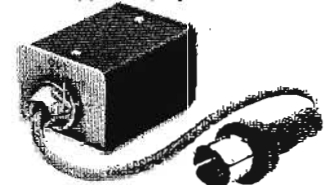

Models 10452A through 10456A Rise Time Converters slow down the step from the Model 1415A in order to eliminate reflections caused by frequencies beyond the bandwidth of interest. Rise times are 0.5, 1, 2, 5, and 10 ns. Refer to page 481 for complete specifications.

75-ohm adapters



Models 10457A and 10458A Adapters convert the Model 1415A output connector to 75-ohm systems. Refer to page 482 for complete specifications.

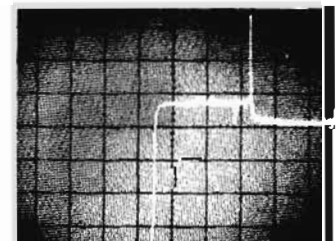

SYSTEM PROFILE: Reflection pattern as seen by looking down a transmission system. The pattern reveals a low impedance cable (off screen) connected to a 69Ω cable, 27 ft from the connector is an inductive defect; 20 ft farther along is a capacitive defect from a pinched cable; 8 ft from the pinch is a 67Ω termination.



Signal Sources





Pulse and square wave generators most often are used with an oscilloscope as the measuring device. Waveform shapes as seen by the oscilloscope, either at the output or at pertinent points within a system under test, provide both qualitative and quantitative evaluations of system or device performance.

Square waves or pulses

The fundamental difference between pulse and square wave generators concerns the signal duty cycle. Square wave generators have equal "on" and "off" periods, this equality being retained as the repetition frequency is varied. The duration of a pulse generator "on" period, on the other hand, is independent of pulse repetition rate. The duty cycle of a pulse generator can be made quite low so that these instruments are generally able to supply more power during the "on" period than square wave generators. The HP Model 214A, for instance, supplies up to 200 watts in its output pulse.

Short pulses reduce power dissipation in the component or system under test. For example, measurements of transistor gain are made with pulses short enough to prevent junction heating and the consequent effect of heat on transistor gain.

Square wave generators are used where the low-frequency characteristics of a system are important, such as in the testing of audio systems. Square waves also are preferable to short pulses if the transient response of a system requires some time to settle down.

Pulse generators

In the selection of a pulse generator, the quality of the output pulse is of primary importance. High-quality test



Figure 1. Carefully controlled pulse shapes insure accurate measurements.

pulses insure that degradation of the displayed pulse may be attributed to the test circuit alone.

The pertinent characteristics of a test pulse, shown in Figure 2, are controlled and specified accurately in HP pulse generators. Rise and fall times should be

significantly faster than the circuits or systems to be tested. Any overshoot, ringing and sag in the test pulse should be known, so as not to be confused with similar phenomena caused by the test circuit.

The range of pulse width control should be broad enough to fully explore the range of operation of a circuit. Narrow pulse widths are useful in determining the minimum trigger energy required by some circuits.

Maximum pulse amplitude is of prime concern if appreciable input power is required by the tested circuit, such as a magnetic core memory. At the same time, the attenuation range should be broad enough to prevent overdriving the test circuits, as well as to simulate actual circuit operating conditions.

The range of pulse repetition rates is of concern if the tested circuits can operate only within a certain range of pulse rates, or if a variation in the rate is needed. The HP Model 216A is capable of rep rates to 100 MHz for testing fast circuits and has a pulse burst feature which allows trains of pulses rather than a continuous output to be used to check systems more thoroughly.

Triggering

The trigger requirements for synchronizing a pulse generator should be evaluated in light of the triggers available in anticipated measurement set-ups. Most Hewlett-Packard pulse generators have versatile trigger circuits similar to oscilloscopes. These circuits synchronize on most waveforms of more than 1 V amplitude.

Hewlett-Packard pulse generators also supply fast rise output triggers for operation of external equipment. The output triggers may be timed to occur either before or after the main output pulse.

Source impedance

Generator source impedance is an important consideration in fast pulse systems. This is because a generator which has a source impedance matched to the connecting cable will absorb reflections resulting from impedance mismatches in the external system. Without this match, reflections would be re-reflected by the generator, resulting in spurious pulses or perturbations on the main pulse.

DC coupling of the output circuit is necessary when retention of dc bias levels in the test circuit is desired in spite of variations in pulse width, pulse amplitude or repetition rate.

Applications of pulse and square wave generators

Pulse generators with fast rise times are widely used in the development of digital circuitry. Teamed with a suitably fast oscilloscope, these generators enable evaluation of transistor and diode switching times.

Pulse generators are used as modulators for klystrons and other rf sources to obtain high peak power while maintaining low average power.

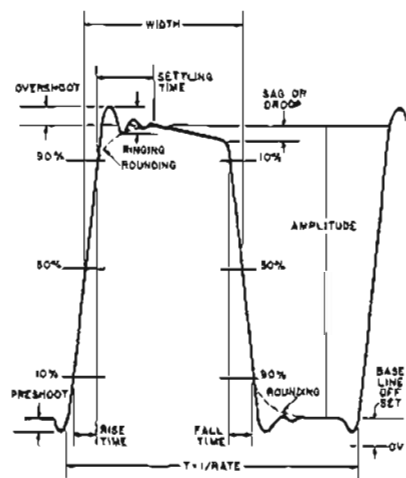

Figure 2. Test pulse description in terms of primary characteristics.

Pulse generators also are used for impulse testing. A very short pulse is rich in harmonic frequency components, so that impulse testing amounts to simultaneous frequency response testing of components or systems.

A relatively new application of fast pulse instruments is the testing of transmission lines, discussed in more detail on page 442. Very fast pulse generators (HP Models 213B, 215A and 1105A/1106A) used with fast oscilloscopes (HP Models 1430A or 1432A) also can measure the stray inductances and capacitances of components.

Tests of linear systems with pulse or square wave generators and oscilloscopes are dynamic tests which quickly analyze system performance.

Hewlett-Packard designs pulse generators with the fast rise times, matched source impedance, flexible pulse width and amplitude control, and versatile triggering capabilities required by a wide range of measurements. Particular attention has been paid to the quality of the output pulse, with all aspects of pulse shape carefully controlled and specified in detail.

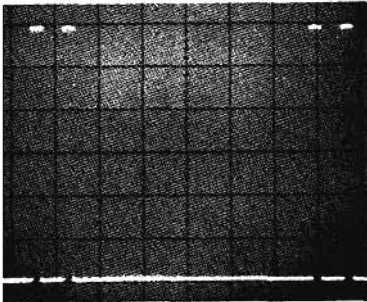

The double pulse is useful for testing memory cores, counter circuits and other applications that require a double pulse at a low duty cycle.

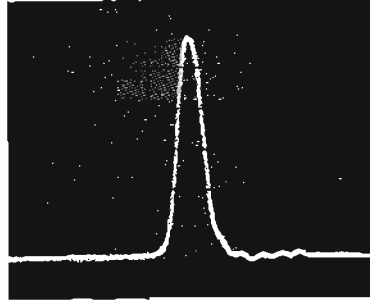

Since the impulse has a wide flat frequency spectrum it is useful in obtaining frequency-domain information.

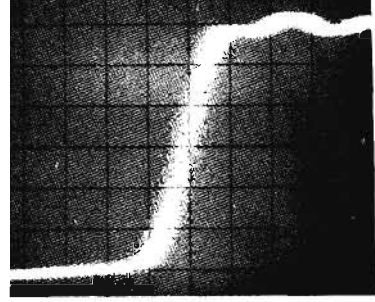

Fast rise time pulses are used as standards to check the rise time of oscilloscopes, amplifiers, and components.

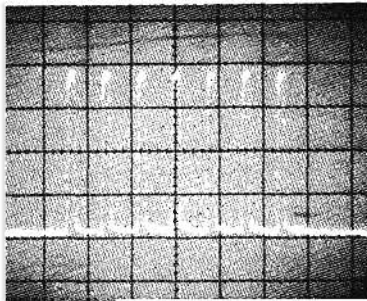

Pulse bursts are used to test many types of logic circuits.

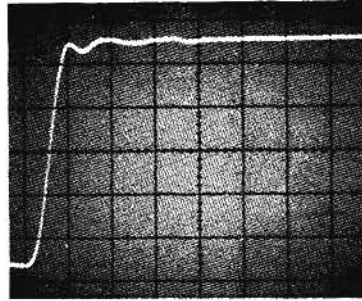

The step is useful in Time Domain Reflectometry to locate and identify cable faults.

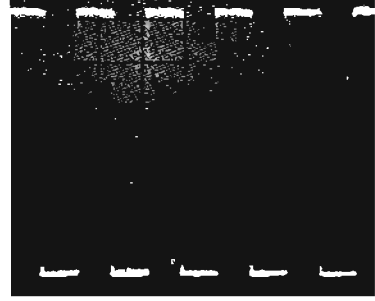

The square wave is useful in amplifier testing and calibration, and attenuator checking.

Type	Sq. wave generator				Fast rise pulser				General purpose pulser					
	211A	211B	217A	220A	213B	1105A/ 1106A	1105A/ 1108A	8000A	214A	215A	216A	222A	8001A	8003A
Output impedance	75/600	50/600	50	50	50	50	50	50	50	50	50	50	50	50
Volts into 50 ohms	-3.5/ -27	-5/ -30	-5	-5	±0.175	+0.2	+0.2	±10	±100	±10	±10	±10	±10	±5
Rise time ns	20/100	5/70	5	10	0.1	0.02	0.05	1	15	1	2.5	4	1	5
Max. rep. rate (MHz)	1	10/1	10	10	0.1	0.1	0.1	0.1	1	1	100	10	0.2	10
Pulse width	sq	sq	sq	sq	fixed	fixed	fixed	fixed	var	var	var	var	var	var
Pulse delay								fixed	var	var	fixed	var	var	fixed
Double pulse									•					
Internal gating														
External gating														
Price	350	450	350	195	250	750	450	340	875	1875	1775	690	990	470
Page no.	320	321	321	320	324	324	324	322	326	327	328	329	322	322



SQUARE WAVE GENERATORS

General purpose testing

Models 211A, 220A

Model 211A Square Wave Generator

The Model 211A Square Wave Generator is a versatile wide-range instrument particularly designed for testing video and audio amplifier performance, or for use as a trigger generator. It provides complete coverage of all frequencies from 1 Hz to 1 MHz, and has a rise time of 0.002 microsecond. There are two separately variable outputs—a 3.5-volt peak 75-ohm impedance circuit for television measurements, and a 27-volt peak 600-ohm output for a high-level work. The generator may be operated free-running or externally synchronized.

Specifications, 211A

- Frequency range:** 1 Hz to 1 MHz, continuous coverage.
- Low impedance output:** —3.5 volts peak across 75-ohm load; —7 volts open circuit, zero level clamped to chassis; rise time less than 0.02 μ s.
- High impedance output:** —27 volts peak across 600-ohm load; —55 volts open circuit, zero level clamped to chassis; rise time less than 0.1 μ s.
- Relative phase:** 180° phase difference between high- and low-impedance output signals.
- Amplitude control:** low impedance output, potentiometer and 60 dB attenuator, variable in 20 dB steps; high impedance output, potentiometer.
- Frequency control:** dial calibrated "1 to 10" and decade multiplier switch; six bands.
- Symmetry control:** allows exact square-wave balance.
- Sync input:** positive-going pulse or sine wave signal, minimum amplitude 5 volts peak.
- Power:** 115 or 230 volts \pm 10%, 50 to 60 Hz, 225 watts.
- Dimensions:** cabinet: 9 $\frac{3}{4}$ " wide, 15 $\frac{1}{4}$ " high, 14 $\frac{5}{8}$ " deep (238 x 388 x 372 mm); rack mount: 19" wide, 8 $\frac{3}{4}$ " high, 13 $\frac{3}{8}$ " deep behind panel (483 x 222 x 340 mm).
- Weight:** net 26 lbs (11,7 kg); shipping 29 lbs (13 kg) (cabinet); net 24 lbs (10,8 kg); shipping 35 lbs (15,8 kg) (rack mount).
- Price:** HP Model 211A, \$350 (cabinet); HP Model 211AR, \$355 (rack mount).

Model 220A Square Wave Generator

The all solid state Model 220A is an inexpensive general purpose square wave generator. It features a 50-ohm source impedance and a frequency range from 1 Hz to 10 MHz with an output voltage of 5 volts into 50 ohms. 10 V open circuit.

Specifications, 220A

- Rise time:** less than 10 ns.
- Amplitude:** 0 to —5 V into 50-ohms, continuously variable.
- Source impedance:** 50 ohms.
- Rep rate:** 1 Hz to 10 MHz.
- Symmetry:** variable from 40% to 60%.
- Power:** 115 or 230 volts \pm 10%, 50 to 400 Hz, 9 watts.
- Dimensions:** 5 $\frac{1}{8}$ " wide, 3-7/16" high, 11 $\frac{5}{8}$ " deep (130 x 87 x 295 mm).
- Weight:** net 4 lbs (1,8 kg); shipping 6 lbs (2,7 kg).
- Price:** HP Model 220A, \$195.

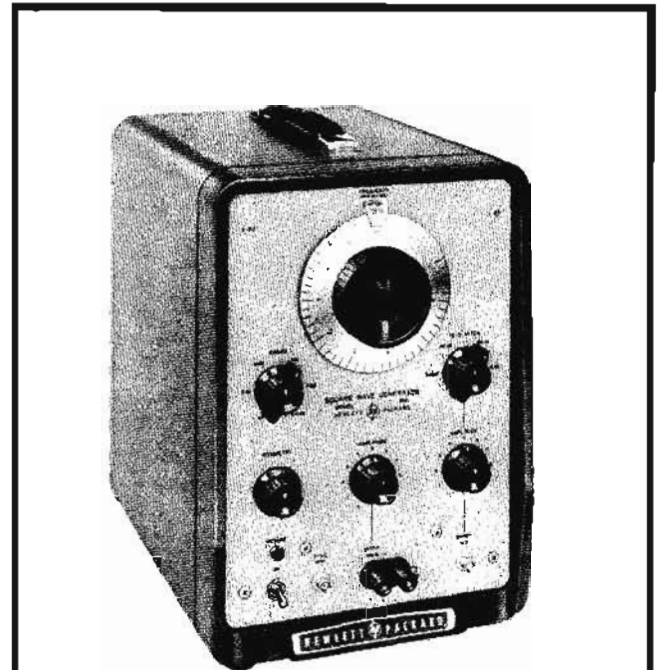

211A

—55 VOLT OUTPUT

1 Hz to 1 MHz

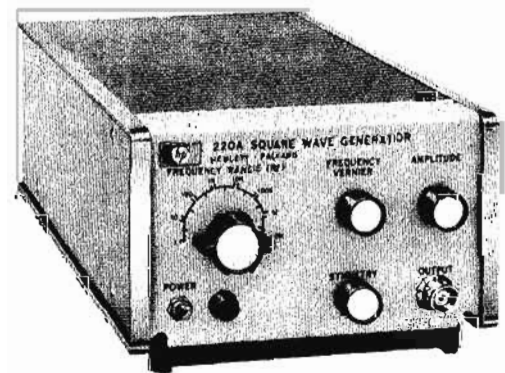

220A

ALL SOLID STATE

1 Hz to 10 MHz

10 ns rise time

SQUARE WAVE GENERATORS

Fast undistorted square waves

Models 211B, 217A



SIGNAL SOURCES

Model 211B Square Wave Generator

The Model 211B is a compact, fully transistorized Square Wave Generator designed for general purpose laboratory and production line applications. It provides frequency coverage from 1 Hz to 10 MHz in seven decade ranges with a linearly calibrated dial for continuous adjustment on all positions. A constant repetition frequency is maintained as the symmetry control varies the "on" time from 25-75% of the period.



Specifications, Model 211B

Symmetry control: variable from 25-75% duty cycle.

Polarity: negative.

Source: 50 ohms $\pm 3\%$ shunted by approximately 15 pF.

Pulse Shape: (measured at 5V into 50 ohms).

Rise and fall times: less than 5 ns.

Amplitude:

Peak voltage: 5 V into 50 ohms, 10 V into an open circuit; output circuit protected, cannot be damaged by shorting.

Attenuator: 0.05 to 5 V, in a 1, 2.5, 5 sequence.

Vernier: provides continuous adjustment between ranges.

600 ohm Source: 600 ohms $\pm 10\%$.

Rise and fall times: less than 70 ns into 600 ohms, less than 140 ns into an open circuit; decreased amplitude setting will improve rise time.

Amplitude:

Peak voltage: at least 30 V into 600 ohms, at least 60 V into an open circuit.

Attenuator: provides continuous adjustment from full output to less than 0.3 V into 600 ohms.

Repetition rate and triggering

Internal:

Repetition rate:

50 ohm output: 1 Hz to 10 MHz, 7 ranges.

600 ohm output: 1 Hz to 1 MHz, 6 ranges.

Period jitter: less than 0.2% at any duty cycle and rep rate setting.

External:

Sync input: sine waves or positive pulses from 1 Hz to 10 MHz; frequency of synchronizing signal must be 105-140% of dial setting.

Sensitivity: dc coupled positive pulses, 2 V peak; sine waves, 4 V peak-to-peak.

Input resistance: approximately 500 ohms.

Trigger output pulse: (suitable for synchronizing with another Model 211B).

Width: 10 (± 5) ns at 50% points.

Amplitude: at least 2 V into 50 ohms.

Timing: coincident with leading edge of 50 ohm pulse.

Polarity: positive or negative.

Power: 115 or 230 V $+10\%$ -15% ; 50 to 400 Hz; 23 W.

Dimensions: 7 $\frac{3}{4}$ " wide, 6 $\frac{1}{8}$ " high, 11" deep overall (190 x 155 x 279 mm).

Weight: net 9 lbs (4 kg); shipping 11 lbs (5 kg).

Price: HP Model 211B, \$450.

Model 217A Square Wave Generator

The Model 217A Square Wave Generator with fast, undistorted square waves and a 10 MHz repetition rate is ideal for fast switching applications. Pulses as narrow as 30 ns with rise and fall times less than 5 ns can be generated.

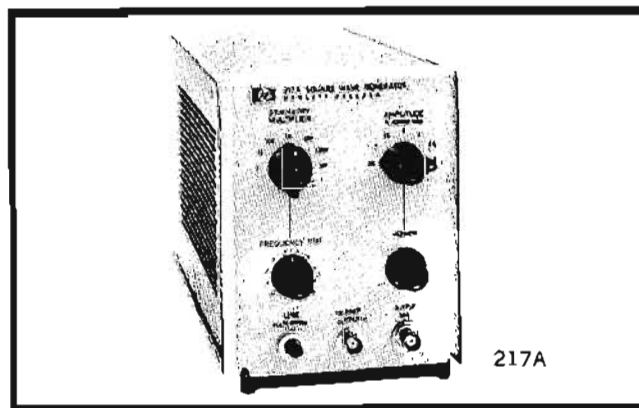

Specifications, Model 217A

(Same as 211B, except)

600 ohm source impedance and external input not provided on 217A.

Source impedance: 50 ohms $\pm 3\%$ shunted by 20 pF.

Trigger output pulse

Amplitude: 2 volts across 50 ohms.

Polarity: Positive.

Power: 115/230 V switch $+10\%$, -15% , 50 to 400 Hz, 15 W.

Dimensions: 5 $\frac{1}{8}$ " wide, 6 $\frac{3}{32}$ " high, 11" deep (130 x 155 x 279 mm).

Weight: Net, 5.5 lbs (2.5 kg); shipping, 7.5 lbs (3.3 kg).

Price: HP Model 217A, \$350.

Manufactured in West Germany by Hewlett-Packard GmbH



PULSE GENERATORS

Ideal pulsers for fast circuit work

Models 8000A, 8001A, 8003A

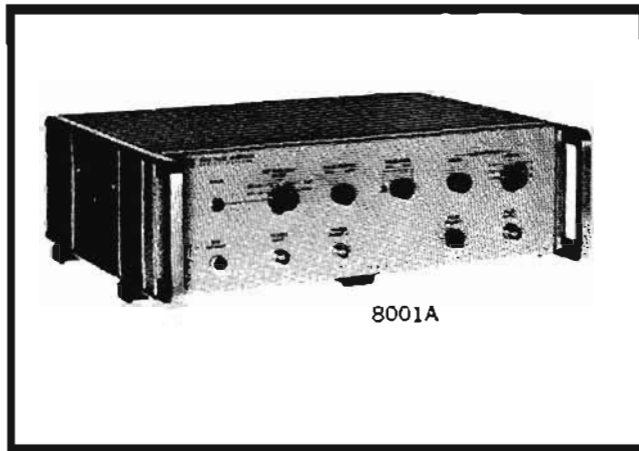

Model 8001A Pulse Generator

The Model 8001A Pulse Generator provides pulses with 1 nanosecond rise and fall times and with exceptionally well controlled shape. Variable amplitude, delay, width, and repetition rate make it an ideal pulse source for testing high speed semiconductor devices and broadband circuits.

The output is carefully specified in every respect for accurate dependable measurements. A vernier and step attenuator allows continuous adjustment of pulse amplitude from 0.04 V to 10 V. Internal repetition rates from 100 Hz to 200 kHz can be selected in three overlapping ranges. The 8001A may also be triggered externally for repetition frequencies from dc to 270 kHz. A countdown circuit enables synchronization up to 10 MHz.

Low-priced 1 ns pulser, Model 8000A

The HP Model 8000A Pulser provides 1 nanosecond rise time pulses at a 100 kHz repetition rate. Fast rise time and clean pulse shape make this instrument particularly suitable for accurate determination of the pulse response of high-speed components, circuits and instruments. Amplitude is adjustable in 1, 2, 5 sequence from 0.1 volts to 10 volts, either polarity. An advanced trigger is available 200 ns in advance of the pulse, so the pulser may be used with sampling oscilloscopes without delay lines.

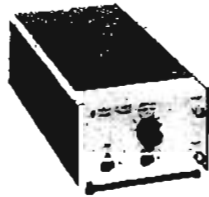

8000A

Specifications, 8000A

Output pulse

Rise time: <1 nanosecond for negative pulses; <1.2 nanoseconds for positive pulse.

Amplitude: 0.1 V to 10 V into 50 ohms, adjustable in 1, 2, 5 sequence.

Polarity: positive or negative.

Shape: overshoot and pulse top variations $< \pm 2\%$.

Width: flat top maintained for at least 100 nanoseconds.

Fall time: <20 nanoseconds.

Repetition rate: 100 kHz $\pm 20\%$.

Source impedance: 50 ohms nominal.

Trigger pulse

Timing: 200 nanoseconds advance $\pm 20\%$.

Jitter: <100 picoseconds, trigger to output.

Rise time: <6 nanoseconds.

Amplitude: 0.5 V into 50 ohms.

Polarity: negative.

Width: 20 nanoseconds $\pm 20\%$ (between 10% points).

General

Power: 115 V/230 V switch $\pm 10\%$, 50 to 400 Hz.

Dimensions: 5 $\frac{1}{8}$ " wide, 3-7/16" high, 11 $\frac{3}{8}$ " deep (130 x 87 x 295 mm).

Weight: net 4 lbs (1,8 kg); shipping 6 lbs (2,7 kg).

Price: HP Model 8000A, \$340.

Specifications, 8001A

Pulse shape

Leading edge characteristics:

Rise time: <1 ns.

Overshoot and ringing: <3% peak of pulse amplitude.

Perturbation on flat top: <2% of pulse amplitude.

Trailing edge characteristics:

Fall time: <1 ns.

Overshoot and ringing: <6% peak of pulse amplitude.

Amplitude

Max. voltage: 10 volts across 50 ohms.

Attenuator: provides seven steps from 0.1 to 10 volts in a 1, 2, 5 sequence.

Vernier: provides continuous adjustments between ranges, minimum output less than 0.04 volts across 50 ohms.

Polarity: positive or negative.

Source impedance: 50 ohms nominal.

Pulse width: continuously variable from 100 ns to 500 ns.

Repetition rate and trigger

Internal:

Repetition rate: 100 Hz to 200 kHz in 3 ranges, continuously variable.

Manual: pushbutton for single pulse.

External:

Triggering: dc-coupled; pulses or sine waves from 0-270 kHz; either positive or negative slope.

Count down: counts down frequencies up to 10 MHz.

Trigger output pulse

Polarity: positive.

Amplitude: at least 2 volts across 50 ohms.

Width: 20 (± 5) ns at 50% points.

Timing: main pulse adjustable from 100 ns advance to 300 ns delay with respect to output pulse.

General

Power: 115 V/230 V switch $\pm 10\%$, 50-60 Hz 35 watts.
Dimensions: 16 $\frac{3}{4}$ " wide, 5 $\frac{1}{2}$ " high, 13 $\frac{1}{4}$ " deep (425 x 140 x 336 mm).

Weight: net 17 lbs (7,5 kg); shipping 23 lbs (10 kg).

Price: HP Model 8001A, \$990.

Programmable rep rate and pulse width, Model 8003A

The model 8003A combines 5 ns rise time, 10 MHz rep rate, and simultaneous positive and negative outputs in a multi-purpose pulse generator.

The combination of fast rise time and long pulse duration permits wide frequency testing. With an excellent wave shape having long useful duration, the pulser is ideal for testing analog devices like wideband amplifiers, filters, and other linear circuits. With its ability to generate 30 ns width pulses at 10 MHz repetition rate, it is also ideal for fast-switching applications.

Simultaneous positive and negative outputs are available for synchronous gating and logic. Each output is continuously variable from 0.02 to 5 V in a 1, 2.5, 5 sequence across 50 ohms.

Remote programming of repetition rate, pulse width, and amplitude is offered with Option 01. Contact closure programs both the repetition rate and pulse width. Resistive changes program the vernier adjustments for repetition rate, pulse width, and amplitude.

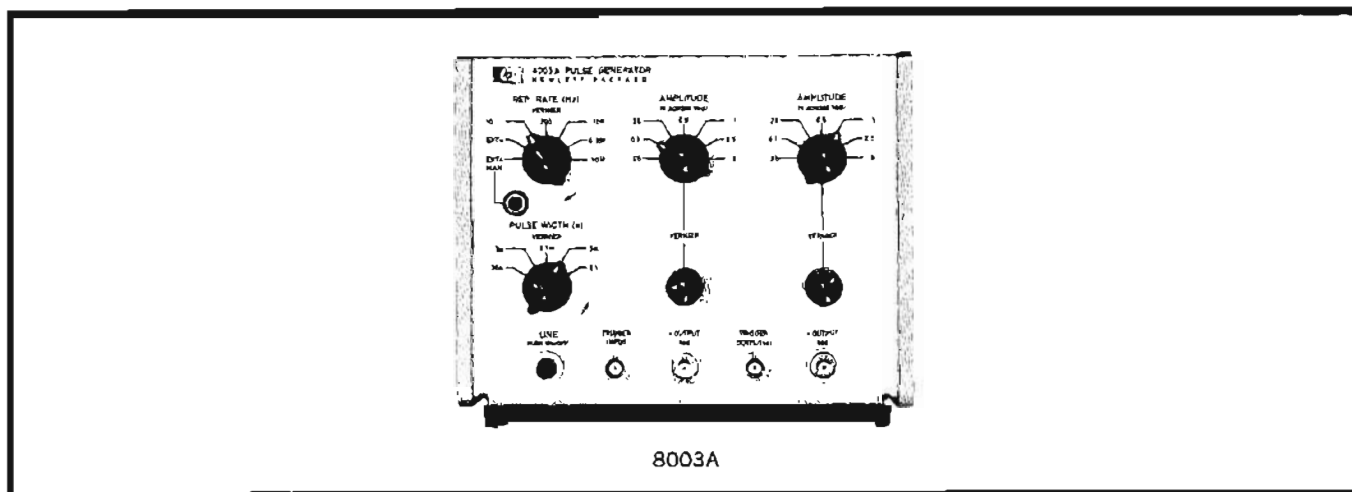

Specifications, Model 8003A

Source impedance: 50 ohms $\pm 3\%$ shunted by typically 20 pF at any output voltage.

Output pulse shape: (measured at 5 V across 50 Ω).

Rise and fall time: < 5 ns.

Amplitude: (positive and negative output can be independently set).

Maximum output: 5 V across 50 Ω , 10 V across an open circuit. Output circuit protected, cannot be damaged by shorting. With internal load disconnected (switch provided), 10 V across 50 Ω with rise and fall time < 7 ns.

Attenuator: provides 7 steps from 0.5 V to 5 V in a 1, 2.5, 5 sequence.

Vernier: provides continuous adjustment between ranges.

Polarity: positive and negative simultaneously within 5 ns.

Pulse width

Range: continuously variable from 30 ns to 3 s in 5 ranges.

Maximum duty cycle: > 90% from 0.3 Hz - 1 MHz.

> 50% from 1 MHz - 10 MHz.

Width jitter: < 0.1% of pulse width at any width setting.

Delay: 150 ns fixed delay between Trigger Output and both Pulse Outputs. Slide switch permits switching out the 140 ns delay line.

Internal

Repetition rate: continuously variable from 0.3 Hz to 10 MHz in 5 ranges.

Period jitter: 0.1% of period at any repetition rate setting.

Manual: pushbutton for single pulse.

Triggering

Trigger input: dc coupled. Sine waves, or pulses of either positive or negative polarity, up to 10 MHz.

Sensitivity: sine waves, 2 V p-p minimum.

External pulses: at least 1 V, and at least 15 ns wide.

External trigger delay: approximately 35 ns between leading edge of external input pulse and leading edge of trigger output pulse.

Input impedance: approximately 1 k Ω .

Trigger output pulse: (suitable for triggering another Model 8003A).

Width: 15 ns ± 5 ns at 50% amplitude points.

Amplitude: > 2 V across 50 Ω .

Polarity: positive.

Synchronous gating: dc coupled. Gates ON with a negative pulse. BNC input on rear-panel and slide switch.

Sensitivity: at least -2 V.

Input impedance: approximately 1 kilohm.

Remote programming: Option 01: Programming of repetition rate, pulse width and amplitude. Repetition rate and pulse width programmed by contact closure to ground. Rep rate, pulse width, and amplitude verniers programmed by resistance changes. The amplitude switch is not programmable.

Power: 115 V or 230 V switch $\pm 10\%$, 50 Hz - 400 Hz, 30 W.

Dimensions: 6-17/32" high, 7-25/32" wide, 11" deep (166 x 190 x 279 mm).

Weight: net 9 lbs (4 kg); shipping 11 lbs (5 kg).

Price: Model 8003A, \$470. Option 01, price upon request.

Pulsers Manufactured in West Germany by Hewlett-Packard GmbH.

SIGNAL SOURCES



PULSE GENERATORS

Fast rise pulsers

Models 1105A/1106A, 1105A/1108A, 213B



Model 1105A/1106A 20 ps Pulse Generator

The Model 1105A/1106A produces a pulse of 20 ps rise time, ideal for fast circuit testing or high resolution TDR. The pulser is made up of two parts: The Model 1105A Pulse Generator Supply and the Model 1106A Tunnel Diode Mount. The Model 1106A may also be used with the Model 1104A Countdown Supply to form an 18 GHz trigger countdown.

Specifications, Model 1105A/1106A

Output

Rise time: approximately 20 ps; less than 35 ps observed with HP Model 1411A/1430A 28 ps Sampler and HP Model 909A 50 Ω termination.

Overshoot: less than $\pm 5\%$ as observed on Model 1411A/1430A with Model 909A.

Droop: less than 3% in first 100 ns.

Width: approximately 3 μ s

Amplitude: greater than +200 mV into 50 Ω .

Output characteristics (Model 1106A):

Mechanical: precision 7 mm (Amphenol APC-7) connector.

Electrical: dc resistance, 50 $\Omega \pm 2\%$; source reflection, less than 10%, using a 40 ps TDR system; dc offset voltage, approximately 0.1 V.

Triggering:

Amplitude: at least ± 0.5 V peak required.

Rise time: less than 20 ns required; jitter less than 15 ps when triggered by 1 ns rise time sync pulse from Model 1424A or 1425A Sampling Time Base sync pulse; jitter increased with slower trigger rise times.

Width: greater than 2 ns.

Maximum safe input: 10 volts.

Input impedance: 200 Ω , ac coupled through a 20 pF capacitor.

Repetition rate: 0 to 100 kHz; free runs: approximately 100 kHz.

Accessories provided (with Model 1105A): one 6-ft 50 Ω cable with male Type N connectors, HP Model 10132A.

Weight:

Model 1105A: net, 3 lbs (1.4 kg); shipping, 8 lbs (3.6 kg).

Model 1106A: net, 1 lb (0.5 kg); shipping, 3 lbs (1.4 kg).

Price: HP Model 1105A, \$200; HP Model 1106A, \$550.



Model 1105A/1108A 60 ps Pulse Generator

The Model 1105A/1108A is similar to the 1105A/1106A in that the 60 ps rise time pulse can be used for circuit testing and TDR. When used with the 1104A Countdown Supply the 1108A is a 10 GHz trigger countdown.

Specifications, Model 1105A/1108A

Output

Rise time: less than 60 ps

Overshoot: less than $\pm 5\%$

Droop: less than 3% in first 100 ns

Width: approximately 3 μ s

Amplitude: greater than plus 200 mV into 50 Ω .

Output Characteristics (1108A):

Mechanical: GR-874 connector

Electrical: dc resistance, 50 $\Omega \pm 2\%$. Source reflection less than 10%, using a 40 ps TDR dc system. DC offset voltage—approximately 0.1 V.

Triggering:

Amplitude: ± 0.5 V peak minimum

Rise time: less than 20 ns required. Jitter less than 15 ps when triggered by 1 ns rise time sync pulse from 1424A or 1425A Sampling Time Base. Slow risetimes produce more jitter.

Width: greater than 2 ns.

Maximum Safe Input: 10 volts

Input Impedance: 200 Ω , ac coupled through 20 pF.

Repetition Rate: 0 to 100 kHz; free runs at approximately 100 kHz, nominal.

Accessories Provided (with Model 1105A): one 6-ft. 50 Ω cable with male Type N connectors, HP Model No. 1032A.

Weight:

1105A: net, 3 lbs (1.4 kg). Shipping, 8 lbs (3.6 kg).

1108A: net, 1 lb (0.5 kg). Shipping, 3 lbs (1.4 kg).

Price:

1105A, \$200.

1108A, \$250.

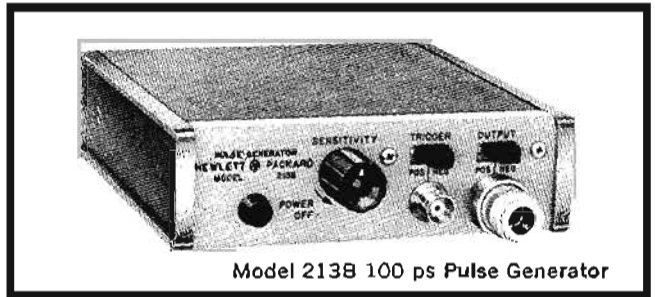

Model 213B 100 ps Pulse Generator

The outstanding performance of the Model 213B makes it convenient for many small amplitude pulse test applications ranging from circuit rise time testing and bandwidth determinations to the measurement of transistor switching speeds.

Specifications, Model 213B

Output

Rise time: less than 100 ps.

Top droop: less than 2% in first 100 ns following the rise.

Width: approximately 2 μ s.

Amplitude: greater than 175 mV into 50 Ω , 350 mV open circuit, either polarity.

Source: 50 Ω .

Jitter: less than 20 ps when triggered with the sync pulse from a Model 1424A or 1425A.

Repetition rate: free runs at a rate greater than 100 kHz, or may be triggered.

Trigger Input

Amplitude: 0.5 volt peak, either polarity.

Rise time: 20 ns or faster.

Width: at least 2 ns.

Maximum current: 200 mA peak.

Impedance: 200 Ω for signals less than 0.75 volt peak; limiting lowers impedance to larger signals.

Repetition rate: 0 to 100 kHz.

General

Power: 115 or 240 V $\pm 10\%$, 50 to 1000 Hz, approximately 1 W.

Dimensions: 1 1/2" high, 5 1/2" wide, 5" deep (38 x 130 x 127 mm).

Weight: net 2 lbs (0.9 kg); shipping, 4 lbs (1.8 kg).

Price: HP Model 213B, \$250.

DIGITAL DELAY GENERATOR

Digitally controlled time intervals, pulses
Model 218AR



SIGNAL SOURCES

The HP 218AR Digital Delay Generator is designed to generate precise time intervals and single, double or superimposed pulses. It is useful as a general-purpose laboratory pulse generator and because of its versatile plug-in pulse generators, it often can take the place of several special-purpose instruments.

The 218AR consists of (1) a pulsed crystal oscillator which is started in known phase by the initial trigger (start) pulse, eliminating the ± 1 count error; (2) a dual-preset digital counter which counts the crystal or externally applied frequency, and operates (3) two preset gates which pass the selected pulses.

Plug-ins include the 219A Dual Trigger Unit to supply

trigger pulses for controlling auxiliary equipment, \$125; the 219B Dual Pulse Unit to deliver fast-rise-time, high-power pulses that are digitally delayed, \$490; and the 219C Digital Pulse Duration Unit, which produces a high-power output pulse whose delay and duration may be digitally controlled, \$375. Output pulses of the 219A are identical to the sync output of the 218AR. The 219B pulses are individually adjustable, 0 to ± 50 V peak open circuits from a 50Ω source. Pulses from the 219C are 90 V peak (or more), open circuit, from a 500Ω source or adjustable from 0 to 15 V peak from a 90Ω source. The positive excursion of the pulses is clamped to ground, and both positive- and negative-going pulses are available simultaneously.

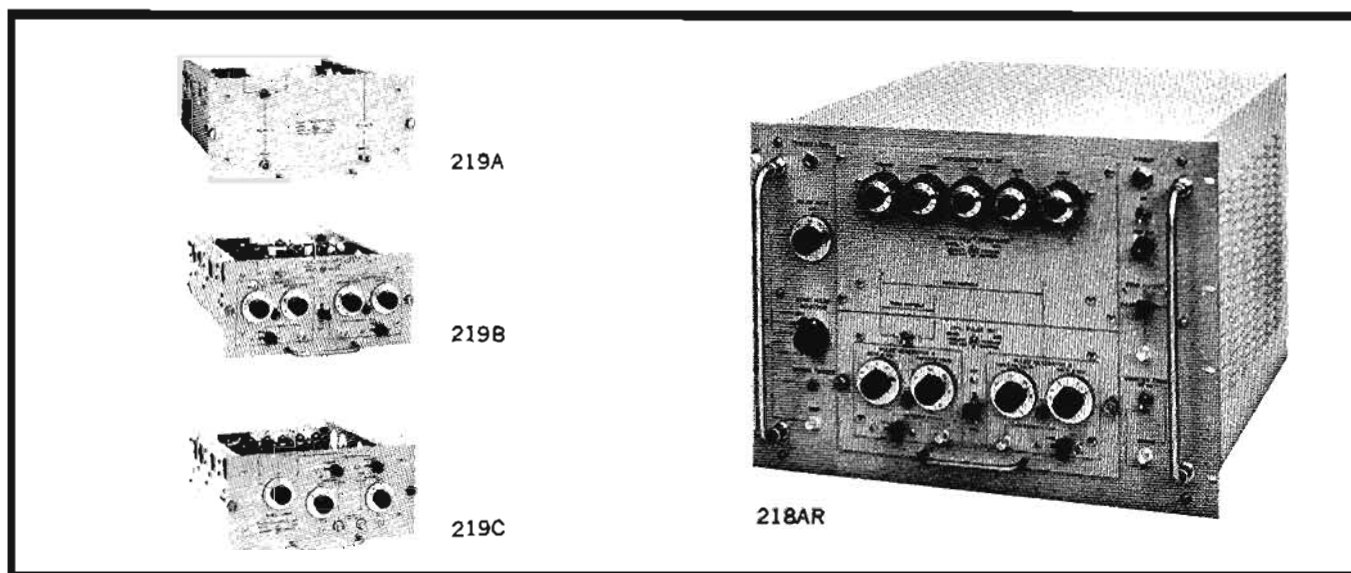

Specifications

(Plug-in necessary to operate)

Time interval range: (T_0 to T_1 and T_0 to T_2) 1 to 10,000 μ s; accuracy $\pm 0.1\mu$ s $\pm 0.001\%$ of time interval selected.

Digital adjustment: 1 to 9999 μ s in 1 μ s steps.

Interpolation: continuously adjustable; adds 0 to 1 μ s to digital setting.

Input trigger: internal: 10 Hz to 10 kHz, 3 decade ranges; external: sine wave, 10 to 100 Hz, 5 to 40 V rms, 100 Hz to 10 kHz, 2 to 40 V rms; pulse, 0 to 10 kHz, positive or negative, 2 to 40 V peak; for trigger rise time of 0.05 μ s or less, delay between external trigger and T_0 is less than 0.5 μ s; manual: pushbutton operation initiates single pulse cycle.

Jitter: 0.02 μ s or less.

Recovery time: 70 μ s or 10% of selected interval, whichever is greater.

Sync output: positive pulse, 50 to 70 V peak, open circuit,

0.1 μ s rise time; width more than 1.5 μ s; available at T_0 , T_1 , or T_2 as selected by a switch.

1 MHz output: 1 MHz positive pulses (1 V from 500Ω source) provide timing comb synchronized to start pulses; available at panel connector for duration of longer delay when counting internal 1 MHz oscillator.

External counting: external sine waves, 100 Hz to 1 MHz, 2 V rms minimum; 10 to 100 Hz, 5 V rms minimum, and positive pulses, periodic or random, 0 to 1 MHz, 2 V peak, can be counted instead of internal standard; time interval range becomes 3 to 9999 periods in 1-period steps, and accuracy is $\pm 0.1\mu$ s ± 1 period.

Power: 115 or 230 V $\pm 10\%$, 50 to 60 Hz, 555 W.

Dimensions: 14" high, 19" wide, 21 $\frac{3}{4}$ " deep behind panel (355 x 483 x 553 mm).

Weight: net 74 lbs (34 kg); shipping 103 lbs (47 kg).

Price: HP 218AR, \$2250 (requires HP 219A,B,C Series plug-in units).



PULSE GENERATOR

Economical general-purpose testing
Model 222A

The Model 222A combines many features normally found only on more expensive instruments to provide an easy-to-use, yet versatile, general-purpose pulse generator. The 4 nsec rise time and full complement of controls permit a wide variety of pulse testing, including square wave testing. Oscilloscope-type triggering, variable pulse width, repetition

rates to 10 MHz, closely specified pulse shape and many other features provide accurate, dependable measurements. The Model 222A, like other HP pulse generators, has a 50-ohm output impedance for eliminating error-producing reflections. The output pulse may be delayed from the trigger output by up to 5 ms for further measurement convenience.

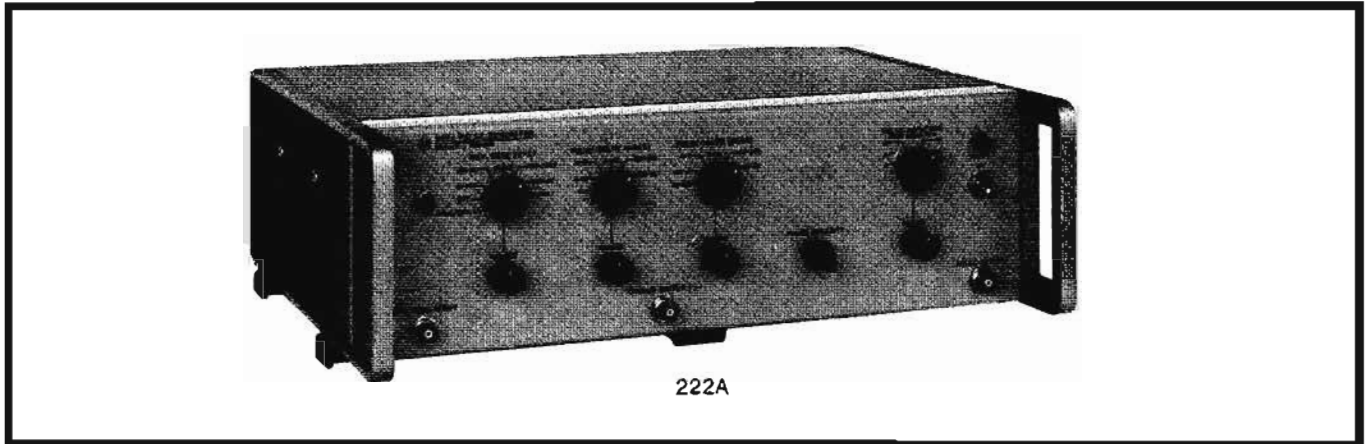

Specifications

Output pulse

Source RC: 50 ohms shunted by approximately 15 pF throughout specified output voltage range.

Amplitude

Peak voltage: 10 volts across 50 ohms; approximately 12 volts maximum.

Amplitude control: step attenuator provides 0.1, 0.2, 0.5, 1, 2, 5, 10 volts across 50 ohms; continuously variable between steps; minimum output less than 0.05 volts.

Polarity: positive or negative.

Pulse width

Range: 30 ns to 5 ms in 6 ranges, continuously variable between ranges.

Duty cycle: maximum duty cycle >50% from 100 Hz to 10 MHz; for maximum stability at high duty cycles, select width range which allows maximum clockwise rotation of width vernier; duty cycle from 10 to 100 Hz limited by 5 ms maximum pulse width.

Width jitter: <0.2% of maximum range width.

Pulse shape

Leading edge only (measured at 10 volts into 50 ohms)

Rise time: <4 ns.

Overshoot and ringing: <4% peak of pulse amplitude.

Corner rounding: occurs no sooner than 95% of pulse amplitude.

Time to settle within 3% of flat top: approximately 20 ns.

Preshoot: <2%.

Trailing edge only (measured at 10 volts into 50 ohms)

Fall time: <4 ns.

Overshoot and ringing: <4% peak of pulse amplitude.

Corner rounding: occurs no sooner than 95% of pulse amplitude.

Time to settle within 2% of base line: less than 20 ns.

Preshoot: <4%.

Perturbations on flat top: <3% of pulse amplitude.

Pulse delay: pulse delayed from trigger output by <100 ns to 5 ms in 6 ranges, continuously variable between ranges.

Delay jitter: <0.2% of maximum delay.

Repetition rate and trigger

Internal

Repetition rate: 10 Hz to 10 MHz in 6 ranges, continuously variable between ranges.

Jitter: period jitter in any frequency range <0.2% of maximum period of that range.

Manual: pushbutton single pulse.

External

Triggering: ac coupled; sine wave from 10 Hz to 10 MHz, pulse from 0 to 10 MHz, either positive or negative slope.

Sensitivity: 1 volt p-p minimum; external pulses must be at least 10 ns wide; maximum input 20 volts peak; 0.25 watt maximum average power.

Input resistance: approximately 500 ohms.

External trigger delay: less than 20 ns between leading edge of external trigger input pulse and leading edge of trigger pulse.

Trigger output pulse:

Width: 22 (± 8) nsec at 50% points.

Amplitude: >1 volt into 50 ohms.

Rise time: <10 ns.

Polarity: negative.

General

Power: 115 or 230 V $\pm 10\%$, 50 to 60 Hz, 80 W.

Dimensions: 16 $\frac{3}{4}$ " wide, 5 $\frac{1}{2}$ " high, 13 $\frac{1}{4}$ " deep (425 x 140 x 336 mm); hardware furnished for quick conversion to 5 $\frac{1}{4}$ " x 19" rack mount, 11 $\frac{3}{4}$ " deep behind panel (133 x 483 x 298 mm).

Weight: net 18 lbs (8 kg); shipping 23 lbs (10.4 kg).

Price: HP Model 222A, \$690.

PULSE GENERATOR

Delivers 200 watts pulse power
Model 214A



SIGNAL SOURCES

The HP Model 214A features 200 watts pulse power, controlled pulse shape, external trigger slope and level selection, and a 50-ohm source impedance for general-purpose lab and production measurements.

The 200-watt (2 amps peak) pulse power is particularly suited for testing current-driven devices such as magnetic memory cores, as well as high-power modulators. At output levels below 50 volts, the pulse generator has a matched source impedance of 50 ohms, eliminating error-producing reflections. The pulse characteristics are carefully controlled, and pulse rate, width and delay jitter are kept to a minimum

to insure accurate, dependable test results.

The 214A offers an extremely wide range of trigger control for syncing on external signals. In addition, slope and level may be selected so that triggering occurs at a given point on the trigger waveform. Also provided is a variable delay or advance trigger output signal for use in synchronizing external equipment.

The pulse generator may be gated to provide bursts of pulses. This feature is especially useful for computer logic measurements. Also, a double pulse feature is provided for pulse resolution tests of amplifiers and memory cores.



214A

Specifications

Output pulse

Source resistance: 50 ohms on the 50 V and lower ranges; approximately 1500 ohms on the 100 V range.

Pulse shape:

Rise and fall time: <13 ns on the 20 V and lower ranges and the -50 V range, <15 ns on the +50 V range; typically <10 ns with the vernier set for maximum attenuation, and typically 15 ns on 100 V range.

Pulse amplitude: 100 V into 50 ohms. An attenuator provides 0.2 to 100 V in a 1, 2, 5, 10 sequence (9 ranges); vernier reduces output of 0.2 V setting to 80 mV and provides continuous adjustment between ranges.

Polarity: positive or negative.

Overshoot: <5%, both leading and trailing edges.*

Pulse top variations: <5%.

Droop: <6%.

Preshoot: <2%.

Pulse widths: 50 ns to 10 ms in 5 decade ranges; continuously adjustable vernier.

Width jitter: <0.05% of pulse width +1 nsec.

Pulse position: 0 to 10 ms advance or delay with respect to trigger output (5 decade ranges) continuously adjustable vernier.

Position jitter: <0.05% of advance or delay setting +1 ns (between trigger pulse and output pulse).

Repetition rate and trigger

Internal

Repetition rate: 10 Hz to 1 MHz (5 ranges), continuously adjustable vernier.

Rate jitter: <0.5% of the period.

Manual: pushbutton single pulse, 2 Hz maximum rate.

External

Repetition rate: dc to 1 MHz.

Sensitivity: <0.5 V peak.

Slope: positive or negative.

Level: adjustable from -40 V to +40 V.

Delay: delay between input trigger and leading edge of pulse out is approx. 250 ns in Pulse Advance mode (approx. 420 ns minimum in Pulse Delay mode).

External gating: +8 V signal gates pulse generator on; maximum input, 40 V peak.

Double pulse

Minimum spacing: 1 μ s on the 0.05 to 1 μ s pulse width range and 25% of upper limit of width range for all other ranges.

Trigger output

Amplitude: >10 V open circuit.

Source resistance: approximately 50 ohms.

Width: 0.05 μ s nominal.

Polarity: positive or negative.

General

Maximum duty cycle: 10% on 100 and 50 V ranges; 25% on 20 V range; 50% on 10 V and lower ranges.

Power: 115 or 230 V \pm 10%, 50 to 60 Hz, 325 W.

Dimensions: 16 $\frac{3}{4}$ " wide, 7 $\frac{1}{4}$ " high, 18 $\frac{3}{8}$ " deep overall (425 x 184 x 466 mm); hardware furnished for quick conversion to 7" x 19" rack mount, 16 $\frac{3}{8}$ " deep behind panel (178 x 483 x 416 mm).

Weight: net 35 lbs (15.8 kg); shipping 41 lbs (18.5 kg).

Price: HP 214A, \$875.

*Measured on a 50 MHz oscilloscope.



PULSE GENERATOR

Controlled, fully specified output pulses
Model 215A

The Model 215A Pulse Generator combines in one compact unit the many capabilities desired for fast pulse testing. The fast rise and fall time and extremely low pulse jitter make the Model 215A particularly useful in measuring transition storage times of semiconductors, logic circuits and thin film memory units.

The output pulse of the Model 215A is carefully controlled to approximate an ideal pulse shape and is specified in every respect for accurate, dependable measurements. One nano-

second rise and fall time pulses of either polarity with nearly an ideal pulse shape, combined with calibrated pulse width and delay controls, adjustable pulse amplitude, variable pulse rate to 1 MHz and a true 50-ohm source impedance provide maximum measurement capabilities.

The true 50-ohm source impedance insures clean output pulses, regardless of the load impedance, since any reflection from the circuit under test will be absorbed by the 50-ohm generator impedance.

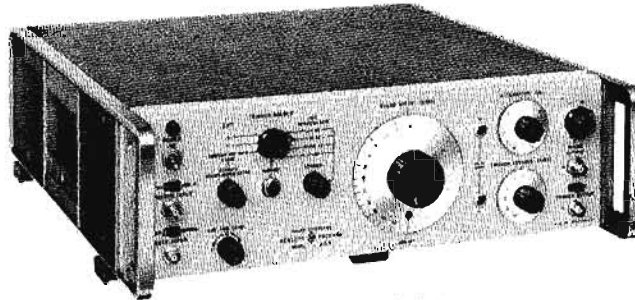

215A

Specifications

Source impedance: 50 ohms $\pm 3\%$; 3% maximum reflection when driven by a pulse with 1 ns rise time from an external 50-ohm system.

Leading edge only

Rise time: < 1 nsec (10 to 90% points).

Overshoot and ringing: overshoot, $< 5\%$ peak; ringing, $< \pm 5\%$ of pulse amplitude.

Corner rounding: occurs no sooner than 95% of pulse amplitude. Time to achieve flat top: < 6 nsec.

Trailing edge only

Fall time: < 1 ns (10 to 90% points).

Overshoot: $< 5\%$.

Rounding: occurs no sooner than 95% of fall.

Time to settle within 2% of baseline: 10 to 25 ns, varies with width setting.

Baseline shift: $< 0.1\%$ under all conditions.

Preshoot: $< 1\%$.

Perturbations on flat top: $< 2\%$ of pulse amplitude.

Peak voltage: > 10 volts into 50 ohms; > 20 volts open circuit.

Polarity: positive or negative.

Attenuator: 0 to 12 dB in 1 dB steps, absolute accuracy within ± 0.1 dB.

Pulse width (between 50% points): continuously adjustable to 100 ns; dial accuracy within $\pm 5\%$ ± 3 ns width jitter less than 50 ps.

External bias; up to ± 100 mA (± 5 V dc) may be safely applied to the output; at 0 dB attenuator setting, up to 10 mA (0.5 V dc) may be applied without significant change in pulse shape (5% droop), increasing to 40 mA at 12 dB; in most cases, adjusting the front-panel pulse-shape controls will restore original pulse shape.

Repetitive rate sources

Internal repetition rate: < 100 Hz to > 1 MHz in 4 ranges, continuously variable between ranges; period jitter $< 3 \times 10^{-3}$ of one period.

Manual: pushbutton single pulse.

Trigger timing: adjustable from 10 ns delay to 140 ns advance with respect to leading edge of output pulse; dial accuracy within $\pm 10\%$ ± 5 ns; jitter < 50 ps.

External triggering: ac coupled, sine waves from 10 Hz to 1 MHz; pulses from 0 to 1 MHz, either positive or negative slope.

Trigger level: external trigger level continuously variable, from approximately +8 to -8 volts.

Sensitivity: 1 V peak to peak min.; external pulses must be at least 30 ns wide; max. input 50 V peak, 0.5 W max. average power.

Input resistance: approx. 50 ohms or High Z available by front-panel switch; High Z is approx. 100 k Ω for negative slope setting approx. 5 k Ω for positive slope setting.

Countdown: counts down from frequencies to 100 MHz, 2 V rms amplitude; resulting pulse repetition rate is always < 1.3 MHz; jitter is $< 10\%$ of one period of the triggering signal.

External trigger delay: approximately 250 ns between leading edge of trigger pulse (2 volt step, 2 ns rise time into 50 ohms) and leading edge of output base; < 50 ps jitter.

External gating: gates on with a +1 volt pulse; maximum input 50 V peak, 20 V rms.

Trigger output pulses

Width: 50 ns, nominal.

Amplitude: > 1 volt peak into 50 ohms.

Rise time: < 6 ns.

Polarity: positive or negative.

Power: 115 or 230 volts $\pm 10\%$, 50 to 60 Hz, 60 W.

Dimensions: 5 $\frac{1}{2}$ " high, 16 $\frac{3}{4}$ " wide, 18 $\frac{3}{8}$ " deep (175 x 425 x 466 mm); hardware furnished for quick conversion to 5 $\frac{1}{4}$ " x 19" rack mount, 16 $\frac{3}{8}$ " deep behind panel (134 x 483 x 416 mm).

Weight: net 34 lbs (15.3 kg); shipping 41 lbs (18.5 kg).

Accessories furnished: Model 10120A cable, 3 feet, BNC-to-BNC, 50 ohms ± 0.5 ohm.

Accessories available: Model 10122A cable, 3 feet, BNC-to-Type N, 50 ohms ± 0.5 ohm, \$10; Model 908A, 50-ohm Coaxial Termination, \$35; Model 10451A Multipulser generates pulse bursts to simulate 15 to 200 MHz rep rate, \$150; Model 10240A Blocking Capacitor, 0.1 μ F, isolates Model 215A from up to 200 V dc, \$70.

Price: HP Model 215A, \$1875.

PULSE GENERATOR

Fast-rise 100 MHz pulses

Model 216A



SIGNAL SOURCES

The Model 216A offers pulse repetition rates up to 100 MHz for testing fast circuits, yet retains a nearly ideal pulse shape with 2.5 ns rise time for accurate, dependable measurements. In addition, bursts of pulses may be produced internally to simulate pulse trains for logic circuit testing.

Pulse height is continuously variable, allowing exact pulse amplitudes to be selected for precise testing. The dc-coupled output eliminates baseline shift with changes in rep rate, and the 50-ohm output impedance prevents multiple reflections, insuring clean, easy-to-interpret waveforms.

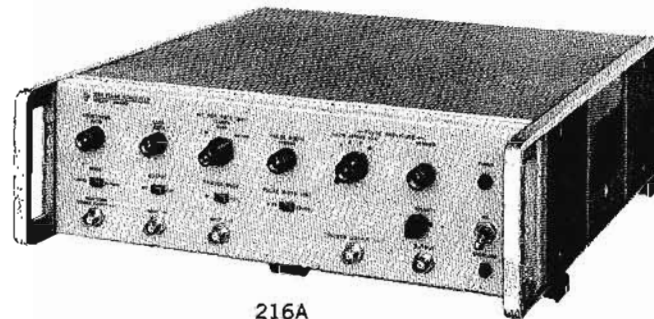

216A

Specifications

Source RC: 50 ohms, $\pm 3\%$, shunted by approximately 10 pF throughout specified output voltage range.

Leading edge only (at 10 V output into 50-ohm load).

Rise time: < 2.5 ns.

Overshoot and ringing: overshoot $< 4\%$ peak, ringing $\pm 4\%$ p-p of pulse amplitude.

Corner rounding: occurs no sooner than 96% of pulse amplitude.

Time to achieve flat top: approximately 20 ns.

Preshoot: $< 3\%$.

Trailing edge only (at 10 V output into 50-ohm load).

Fall time: < 2.5 ns.

Overshoot: $< 4\%$.

Corner rounding: occurs no sooner than 96% of fall.

Time to settle within 2% of base line: approx. 20 ns.

Preshoot: $< 5\%$.

Perturbations on flat top: $< 3\%$ of pulse amplitude.

Peak voltage: > 10 volts into 50 ohms to 100 MHz, (15 volts maximum amplitude into open circuit).

Attenuator: 1, 2, 5, 10 volt steps.

Polarity: positive or negative.

Vernier: provides continuous adjustment from approximately 0.3 volts to 10 volts.

Pulse width: continuously variable in two ranges, from approximately 5 ns to 25 ns and from 25 ns to 100 ns; width jitter < 100 psec $+ 0.3\%$ of pulse width with countdown ratio set for minimum jitter.

Maximum duty cycle: $> 45\%$ up to 50 MHz decreasing to approximately 20% at 100 MHz.

Internal repetition rate: 1 MHz to 100 MHz in 3 ranges.

External triggering

Frequency: sine waves from 1 MHz to 100 MHz, negative pulses from 0 to 100 MHz; pulse rise time < 100 ns; pulse width > 2 ns.

Sensitivity: at least 0.5 volt peak minimum; maximum input, 10 volt peak.

Input impedance: approximately 50 ohms, ac coupled.

External trigger delay: approximately 140 ns $\pm 10\%$ between leading edge of input trigger pulse and leading edge of output pulse.

Trigger output pulse

Width: 3.5 ns ± 1 ns.

Amplitude: > 0.7 volts peak into 50 ohms.

Polarity: negative.

Trigger timing: approximately 130 ns $\pm 10\%$ advance with respect to leading edge of output pulse.

Countdown trigger output

Amplitude: > 0.5 volt peak into 50 ohms.

Polarity: positive.

Countdown frequency: variable from approximately 250 kHz to 450 kHz.

Gating of pulse bursts

Internal

Gate width: variable from approx. 20 ns to 750 ns.

Gate repetition rate: variable from approximately 250 kHz to 450 kHz.

External: gates on with +2 volt pulse having rise and fall times of < 5 ns; maximum input, 10 volts.

Perturbations: perturbations on gate envelope $< 5\%$ into 50 ohms, above 50 MHz width varies slightly from pulse to pulse.

General

Power: 115 or 230 volts $\pm 10\%$, 50 to 60 Hz, 120 W.

Dimensions: 5½" high, 16¾" wide, 18⅜" deep (175 x 425 x 466 mm), hardware furnished for quick conversion to 5¼" x 19" rack mount, 16⅜" deep behind panel (134 x 483 x 416 mm).

Weight: net 25 lbs (11 kg); shipping 31 lbs (14 kg).

Accessories available: Model 10120A Cable, 3 feet, BNC-to-BNC, 50 ohms ± 0.5 ohm, \$10; Model 10122A Cable, 3 feet, BNC-to-Type N, 50 ohms ± 0.5 ohm, \$10; Model 908A 50-ohm Coaxial Termination, \$35; Model 10240A Blocking Capacitor, 0.1 μ F, isolates Model 216A from up to 200 V dc, \$100.

Price: HP Model 216A, \$1775.



Under normal operation, almost every system is subject to random disturbances. It is therefore often appropriate, and sometimes essential, to test a system with random test signals rather than with sine-waves. Although adequate theories have been developed, the introduction of test methods based on these theories has been delayed by a lack of convenient test equipment. Conventional noise generators employ natural noise sources. The statistics of the noise signals produced by such sources often are not stable, well defined, or controllable. The problem, furthermore, is most severe at very low frequencies, where much of the interest in noise testing is focused.

The Hewlett-Packard Model 3722A Noise Generator is an instrument that synthesizes noise signals which differ from those produced by any previous instrument in two important ways: 1) the statistics of the signal are always positively known, and 2) the rms value of the output signal remains constant, regardless of the frequency bandwidth chosen. Moreover, the instrument is capable of producing pseudo-random noise signals which can be precisely repeated at will.

Specifying noise

Simple signals are easily specified. DC is specified in one parameter. Sinewaves can be specified completely by three: amplitude, frequency, and phase. Truly random signals, however, can only be completely specified by an infinite number of parameters. Therefore, one resorts to statistical descriptions of their average behavior.

The simplest statistic to a noise signal is its mean-square (rms) value. This is meaningful only if the averaging process is long enough to reduce the statistical variance of the measurement to a small value.

A second meaningful statistic is power density spectrum. This tells how noise power is distributed over the frequency spectrum. In noise theory, it is conventional to express it in units of V^2 (rather than watts) per Hz. Noise which contains equal amounts of all frequencies is called "white" noise, by analogy to white light. The term, however, is relative, since noise of infinite bandwidth is not found. Noise is usually called "white" if it has a flat power density spectrum over the band of interest.

A third statistical measure, of importance, is the probability density function (pdf). The probability density function and the power density spectrum are two different, *totally unrelated*, statistical descriptions of a signal. Probability density function tells us what proportion of time, on the average, is spent by the signal *at various amplitudes*. The most familiar pdf shape probably is the bell-shaped Gaussian curve, of the general form $Y = e^{-x^2}$. (The fact that a "Gaussian" filter has an impulse response of the same shape is coincidental; the two should not be confused.) A noise signal with Gaussian pdf will be one whose variety in energy level is centered about some mean value, with excursions above and below distributed as chance allows. However, Gaussian noise need not be white noise, nor need white noise be Gaussian.

Noise as a test signal

A classic way to test a system is to feed in a known signal, then measure at the system output the changes which occur in the signal. Often analysis of wideband or impulse response is most wanted. Measuring response to noise signals, if their statistics are known, can yield both. Correlation methods apply, and theory is well developed. Analog computers are commonly used for the purpose. If a known noise signal is used as the driving signal and it is cross-correlated with the output, a display of system impulse response can be obtained. Similar correlation methods will yield a direct display of system delay (phase) effects and of wideband distortion products. Not only may these results be obtained on a continuous basis, they may also be made concurrently on a system which is performing its usual functions.

Pseudo-random noise

The very randomness, i.e., unpredictability, of random noise is a source of difficulty in using it as a test signal. If truly random noise is used as a test signal, each repetition of a given experiment will yield a somewhat different result. This statistical variance will occur because the time for each experiment is not indefinitely long. The HP Model 3722A Noise Generator can produce a variety of test signals which have the desirable properties of random noise, i.e., broad, flat spectrum and Gaussian pdf, but *not*

the randomness. Such signals look and act like random noise, although they are *in fact periodic*.

The pseudo-random waveforms of the instrument consist of completely defined patterns of selectable lengths, repeated over and over. Their statistics are entirely known.

Now, if the elapsed time per measurement is made equal to the length of one pseudo-random test pattern, the results of an experiment *will* be identical on every repetition, as long as nothing else changed. There will be no statistical variance. It is, of course, important to select a pattern duration which will be adequate to exercise the system under test at all of the frequencies and all of the levels which may be of concern.

The ability of the HP Model 3722A Noise Generator to produce signals of constant, known rms value, regardless of bandwidth chosen, is new and of considerable importance. Often the stimulus to test a structure, mechanism, or electrical system must be limited to very low frequencies. In these cases limiting the bandwidth of a naturally-generated noise signal, by means of filtering, has been impractical since the output level is likely to be so small; amplifying such a signal was not a solution since unwanted disturbances such as dc drift caused distortion.

On the other hand, the low-pass *digital* filter used in the HP Model 3722A is not subject to the same limitations as a conventional filter. Indeed, its lowest filter cutoff frequency can be made about 1 cycle per hundred minutes!

The main use of very-low-frequency noise, perhaps in the 0 to 50 Hz range, is in testing systems which have long time constants. These include such things as massive mechanical arrays, nuclear reactors, and chemical processes, where the effect of changing any parameter of the process takes a long time to become evident. When testing these systems, the lowest frequency content of the test signal must be comparable with the system time constant. This also holds true when the system is being simulated on an analog computer, where the ability to repeat noise test signals precisely, time after time, is especially useful. In such service, the noise generator can provide realistic simulation of road roughness, air turbulence, earthquakes, storms at sea, target evasive action, controlled-variable fluctuations, and so on.

NOISE GENERATOR

Produces calibrated noise patterns
Model 3722A



SIGNAL SOURCES

The Model 3722 Noise Generator uses computer techniques to synthesize broadband noise patterns from dc to 50 kHz. Each noise pattern can be repeated exactly as it occurred at an earlier time, and is of constant power regardless of selected bandwidth. Hence, using noise as a test signal, evaluation of the output of a device under test can give both frequency response and cross-modulation products.

Since the 3722A provides random variations in amplitude, it can be used to simulate natural occurring phenomena such as earth tremors, vibration, air turbulence, etc, which are of interest in the design of structures, aircraft, automobiles, and ships. The 3722A provides controlled stimuli to control systems as well as binary signals for PCM and other communications applications.

A shift register matrix, programmed either with feedback or by a random noise source generates repetitive or nonrepetitive (pseudorandom or random) noise patterns on the 3722A. The patterns are available in either binary or gaussian outputs both fixed and variable.

All sampling and triggering operations of the 3722A are timed by a 3 MHz crystal controlled clock. An external 1 MHz clock may also be used to obtain selected settings of clock period.

The noise bandwidth of the gaussian signal is directly proportional to the switching rate of the shift register. Noise bandwidth may be varied, in 18 steps, from dc to 50 kHz with constant power spectrum.

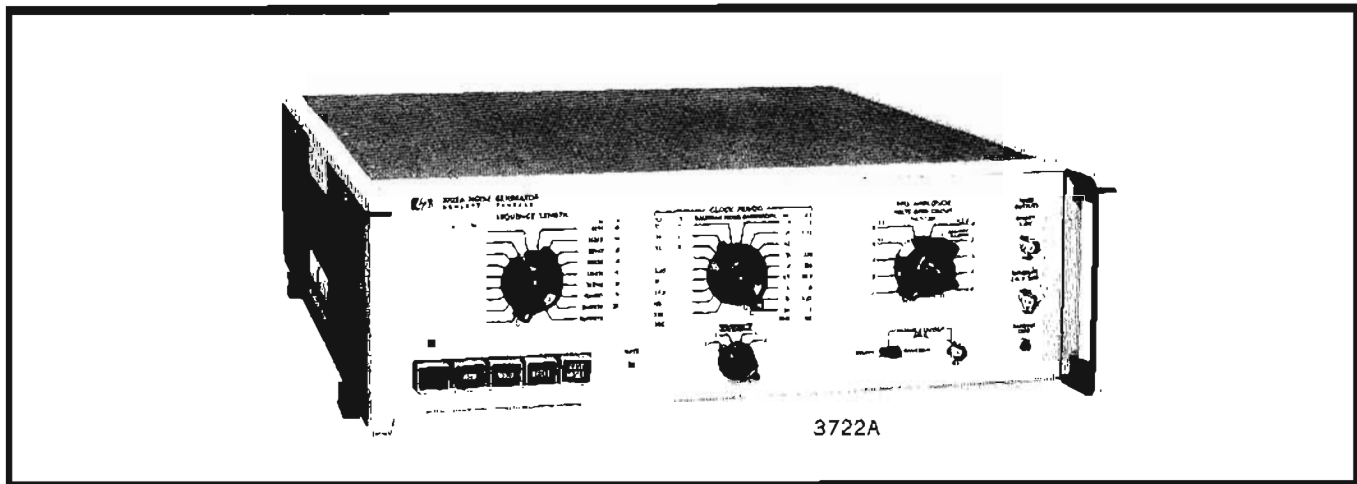

Specifications

Clock

INT/EXT switch on rear panel selects source of trigger pulses—either internal or external clock.

Internal clock: crystal frequency is 3 MHz. Stability $< \pm 25$ parts in 10^6 from 0° to 55°C .

Clock period: selectable in 1, 3.33, 10 sequence, from 1 μs to 222 s in 18 periods.

External clock: input frequency is 1.5 MHz maximum.

Input level: nominal trigger level of input circuit +4 V; negative-going level change from +5 V to +3 V initiates clock pulse.

Binary (fixed output): pseudorandom or random binary output is available at binary connectors on front and rear panels (connectors are in parallel).

Number of clock periods in pseudorandom sequence: selectable from 15 to 1,048,575; i.e., $2^n - 1$ where n is between 4 and 20.

Output amplitude: ± 10 V.

Power density: nominally equal to clock period \times 200 volts²/Hz.
Load impedance: 1 $k\Omega$ minimum.

Gaussian (fixed output): pseudorandom or random output is available at gaussian connectors on front and rear panels (connectors are in parallel).

Output amplitude: 3.16 V rms.

Zero level: preset by gaussian zero control on front panel.

Zero drift: less than 5 mV change in zero level in any 10°C range from 0° to $+55^\circ\text{C}$.

Output impedance: less than 1Ω .

Noise bandwidth: half-power (-3 dB) frequency f_0 switchable in 15, 50, 150 sequence from 0.00015 Hz to 50 kHz.

Power density: nominally equal to clock period \times 190 volts²/Hz.

Power density spectrum: flat to within ± 0.3 dB from zero frequency to $1/2 f_0$, and more than 25 dB down at $2 f_0$.

Crest factor: up to 3.75, according to sequence length.

Variable output (binary or gaussian)

Amplitude (open circuit)

Binary: 4 ranges ± 1 V, ± 3 V, ± 3.16 V, and ± 10 V, with ten steps in each range, from $\times 0.1$ to $\times 1.0$.

Gaussian: 3 ranges, 1 V rms, 3 V rms, and 3.16 V rms, with ten steps in each range, from $\times 0.1$ to $\times 1.0$.

Output impedance: $600\Omega \pm 1\%$.

Secondary outputs

Sync: negative-going (+12.5 V to +1.5 V) sync pulse occurring once per pseudorandom sequence duration: equal to selected clock period.

Gate signal: indicates start and completion of a selected number of pseudorandom sequences: number of sequences selectable from 1, 2, 4, and 8.

Binary output relay

Relay switching is synchronous with random-binary output signal.

Remote control

Manual run-hold-reset-gate reset controls on front panel are OR-gated with remote control inputs through 36-way receptacle on rear panel.

Dimensions: $16\frac{3}{4}$ " wide, $5\text{-}7/32$ " high, $16\frac{3}{8}$ " deep (425 x 132.6 x 416 mm).

Weight: net 23 lbs (10.5 kg); shipping 30 lbs (13.5 kg).

Price: \$2,650.

Option 01, zero moment option: shifts relative position of sync pulse and pseudorandom binary sequence, add \$50.

Manufactured in Scotland by Hewlett-Packard Ltd.



This section contains technical information for function generators and oscillators, covering frequencies from 0.00005 Hz to 32 MHz. Table 1 illustrates the frequency range and power output of Hewlett-Packard oscillators and function generators. The following explanations are divided into two parts. First will be the lower frequency multi-output function generators and the next the higher frequency sine-wave oscillators.

FUNCTION GENERATORS

A function generator is a signal generator that delivers a choice of different waveforms with frequencies adjustable over a wide range. The keynote of the modern function generator is versatility. The function generators now produce sine, triangle, square-wave and sawtooth waves with a provision to sweep or analog program frequency up to four decades. This is useful for automatic testing systems and sweeping audio amplifiers, filters and servo systems.

HP's function generators extend from a low frequency of 0.00005 Hz (HP 203A Option 02) up to a high frequency of 100 kHz.

A modern innovation is the plug-in function generator. One may use a single main frame and several plug-ins to achieve maximum versatility at a minimum cost. Function generators now have several outputs available at the same time, each having a choice of wave shapes. By providing a square wave and a triangle wave at the same time, linearity measurements and gating may be achieved simultaneously.

Function generators that provide single or multiple-cycle outputs have simplified many measurements. A theoretically infinite on-off ratio can now be attained in pulse burst operation. To vary the starting phase of a single cycle or pulse burst and end at the same phase is also val-

uable for underwater research and other applications.

The capability of the function generator to phase lock to an external source opens new possibilities for making audio measurements. By using two function generators, an adjustable phase sine output or a square or triangle wave output with adjustable delay may be obtained. In addition, one function generator may be phase locked to a harmonic of the sine wave of another; and almost any waveform desired may be obtained by summing the harmonics and fundamental, and adjusting the phase and amplitude of the harmonics. One can also phase lock the function generator to a frequency standard and generate all wave shapes with the frequency, accuracy and stability of the stable source.

Besides the many uses mentioned, the function generator is being used extensively in medical research projects for nerve stimulation and electroanesthesia. As medical electronic research continues to grow, the function generator will find more and more applications in this field.

HP 3300A

Since the low frequency of an RC oscillator is limited, an entirely different approach is used in the 3300A Function Generator.

The main frame of this instrument delivers sine, triangular and square waves with a frequency range of 0.01 Hz to 100 kHz. The circuit outlined in Figure 1 uses a frequency control network governed internally by the frequency dial or externally through the rear-panel, frequency-control terminal.

The frequency-control voltage regulates the current sources driving the triangle generator. An increase or decrease in current increases or decreases the slope of the triangular wave. Frequency will increase if the + and - slopes are increased. The voltage comparator multi-vibrator changes state at predetermined limits on the positive and negative slopes of the triangular integrator's output. This change of state reverses the current into the triangular integrator, reversing the slope of the triangular output.

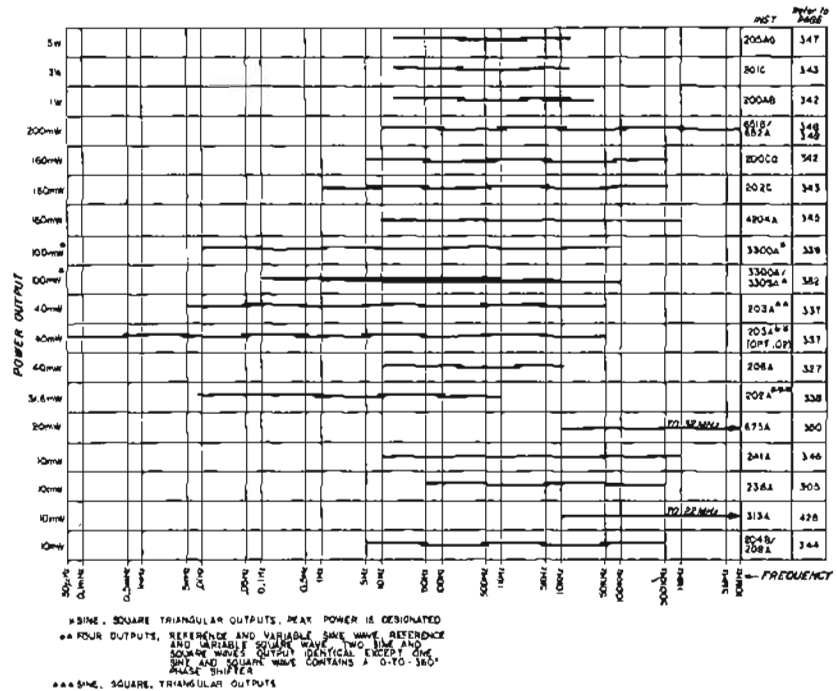

Table 1. Frequency range and power output of HP oscillators. Line segments show span of each range.

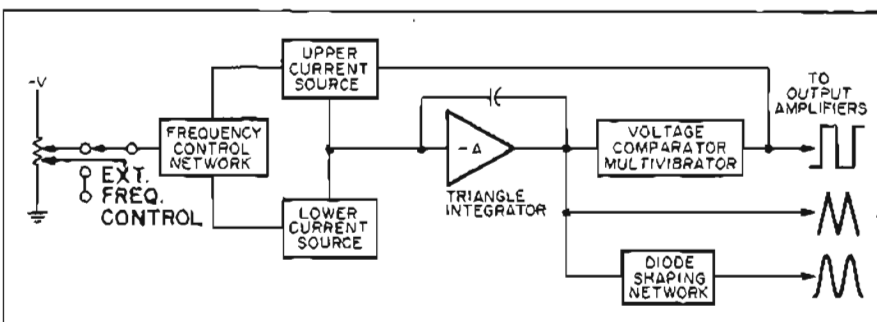

Figure 1. 3300A Function Generator.

The circuit produces low-frequency square and triangular waves. The triangular wave is synthesized into a sine wave by a diode-resistance network. The synthesizing circuitry of Figure 2 shows how the slope of the triangular wave is altered as its amplitude changes, resulting in a sine wave with less than 1% distortion.

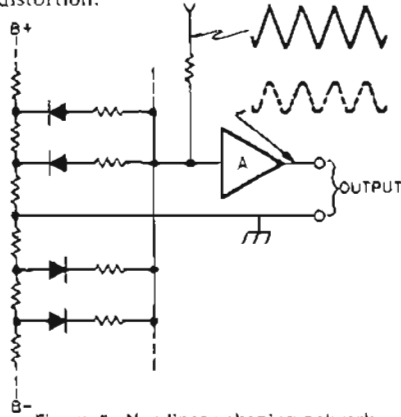

Figure 2. Non-linear shaping network

The entire oscillator circuitry is floating. The ground may be established at any desired voltage level. A special feature of this oscillator is that waveform amplitude is controlled by the reference voltages, rather than by a long-time-constant AGC circuit. As a result, there are no transients when switching between ranges or tuning to other frequencies. Another feature of the HP 3300A is two output amplifiers that provide simultaneous, individually selected outputs of any of the waveform functions.

3300A Plug-ins

The 3300A is made more versatile by the use of plug-ins (the 3300A must have a plug-in to operate). The HP Model 3301A Auxiliary Plug-in, 3302A Trigger/Phase Lock Plug-in, the 3304A Sweep/Offset Plug-in and the 3305A Sweep Plug-in are now available. The HP 3301A Auxiliary Plug-in provides internal connections for the basic operation of the unit, as described in the specifications for the 3300A Function Generator.

The HP Model 3302A Trigger/Phase Lock Plug-in enables the Model 3300A Function Generator to produce either a single cycle or a burst of cycles of any of the output waveforms in response to an input trigger. The waveform bursts may also be frequency modulated.

The plug-in employs two basic operating principles. In the "Trigger" mode, it suppresses waveform generation in the main frame circuits, thus restricting the generator output to a single waveform cycle or burst of cycles. In the "Phase-Lock" mode, it contributes a correction voltage to the Function Generator frequency-control circuits, phase-locking the

output frequency to an external frequency source.

A front-panel meter indicates when phase lock is achieved. The phase relationship between the input and output signals can be adjusted by the front panel PHASE control over a range of 0° to 180° (180° to 360° by using the inverted output or by reversing the input polarity switch). The phase multivibrator acts as a detector (see Figure 3) which is set by the input signal and reset by the main frame square wave. These pulses are filtered to derive a dc control voltage.

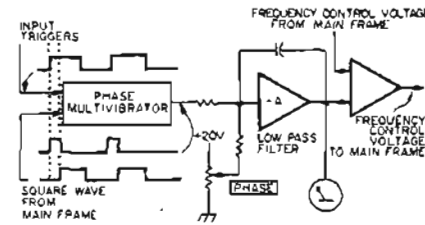

Figure 3. Block diagram of 3302A plug-in phase lock mode.

Thus, the 3300A frequency is continuously locked to the input. The 3300A may be locked to a harmonic of the input signal.

When the MODE switch is set to "Free Run", the plug-in circuits are disabled and the function generator operates in its basic manner. With the MODE switch set to either "Single" or "Multiple", the plug-in circuits stop the generation of waveforms by clamping the output of the triangle integrator to its input at a selected phase (see Figure 4). The waveform generating circuits are released by pressing the MANUAL TRIGGER button on the plug-in or by applying a trigger pulse or gate to the plug-in input. The point in the waveform at which waveform generation starts and stops is determined by the START/STOP-PHASE control, which can be adjusted over a range of -90° to +90° of the waveform.

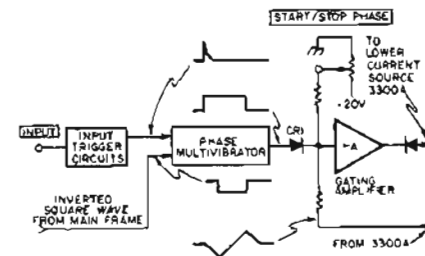

Figure 4. Block diagram of 3302A plug-in shown in single and multiple modes.

The HP 3304A Sweep/Offset Plug-in provides internal sweeping up to a decade of frequency. It generates a sawtooth waveform and delivers it to either of the 3300A output terminals, and it also pro-

vides an offset square wave and a dc offset for all of the signals generated by the 3300A and 3304A.

For the sawtooth mode of operation, the 3304A uses a sawtooth generator, a

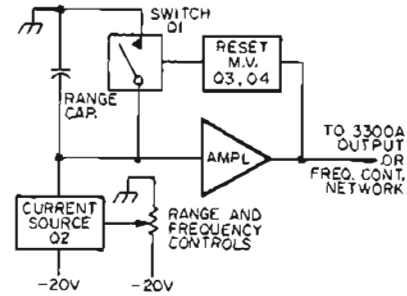

Figure 5. Simplified sawtooth generator.

RANGE switch, a FREQUENCY control and a ± SAWTOOTH selector switch. Figure 5 shows a simplified block diagram of the sawtooth generator.

A capacitor is charged from a constant current source, Q2, which is controlled by a voltage, adjusted by the frequency control. Two signals, of different polarity selected by a ± SELECTOR switch, may be connected to the 3300A output amplifier.

For the internal sweeping of the 3300A output functions, the 3304A uses the negative sawtooth output. The start frequency is set by the 3300A FREQUENCY dial and RANGE selector (it may be by remote control). The summing amplifier adds the start frequency control voltage and the negative sawtooth ramp. The negative voltage swing of the ramp is controlled by the 3304A SWEEP WIDTH control. The rate of the sweep is controlled by the 3304A sawtooth frequency.

For the dc offset which is applied to all output functions of the 3300A, the 3304A applies a dc voltage between output ground and circuit ground. This dc offset voltage is controlled by a front-panel + and - switch and by a fine and coarse adjustment.

The 3305A is a Sweep Plug-in for the 3300A main frame which sweeps frequencies from 0.1 Hz to 100 kHz in three overlapping ranges (each range covers four-decades of frequency: 0.1 Hz to 1 kHz, 1 Hz to 10 kHz and 10 Hz to 100 kHz). Here, a low-frequency logarithmic sweeper can be obtained merely by purchasing another plug-in for the 3300A Function Generator.

The 3305A Sweep Plug-in is basically a controlled-current generator for the 3300A main frame. It provides automatic sweep, manual sweep, triggered sweep and it may be programmed by an external analog voltage.

The start and stop frequencies can be independently adjusted to any point on

any range. The sweep of the preset frequencies allows logarithmic frequency plots to be made and a good approximation to a linear sweep can be obtained when the sweep width is small. A linear sawtooth output is available for the X-axis of oscilloscopes or X-Y recorders. After the X-axis of the recorder is set up, the sweep width, the start position, the range and the sweep time can be changed without necessitating re-adjustment of the horizontal sweep. This Sweep Plug-in also includes signal blanking and pen lift during retrace.

Any of the 3300A outputs: sine, square or triangular, can be swept logarithmically over four decades at either channel A or channel B of the 3300A main frame.

For additional information on this 3305A Sweep Plug-in, refer to the Sweep Generator technical information, page 377, and the product pages 341 and 382.

Because of its versatility, the HP 3300A with its various plug-ins may be used for all of the applications listed in the first few paragraphs of this section.

HP 203A

Another HP function generator is the 203A Variable Phase Function Generator. This instrument has a sine wave and square wave output with a second channel that can be phase-shifted continuously through a full 360° range.

Although this function generator is intended primarily for low-frequency work, it has a frequency range extending from 60 kHz down to 0.005 Hz or, with options, down to as low as 0.00005 Hz (5 hours for 1 cycle). All four output signals are supplied simultaneously and all have individual 40 dB attenuators.

For a stable, low-distortion sine wave source, the 203A is ideal, for it has less than 0.06% combined harmonic distortion, hum and noise at full output.

The 203A uses beat frequencies combined with divider techniques. This allows the phase-shifting device to be placed in a fixed frequency channel.

The highest frequency range (5 to 60 kHz) is obtained by dividing down a crystal oscillator frequency by a factor of 9. This fixed-frequency output (FFO) is heterodyned with the variable frequency oscillator (VFO) signal in a double-balanced mixer to derive the output signal. The lower frequency ranges are derived by successive decade frequency dividers and mixers.

The square-wave output is obtained by applying the output sine wave to a clipping amplifier and improving the rise time of the resulting square-wave in a dc-coupled regenerative circuit.

The phase-shifted outputs are obtained by a goniometer with two stator field windings at right angles to each other and a pick-up coil that can rotate within the stator fields.

OSCILLATORS

Signal sources have been described by various names—oscillators, test oscillators, audio signal generators, etc. Different names are applied, depending on the design and intended use of the source. The oscillator is basic to all the sources and generates sine-wave signals of known frequency and amplitude. In the recently developed transistorized sources, the name "test oscillator" has been used to describe an oscillator having a calibrated attenuator and output monitor. The term "signal generator" is reserved for an oscillator with modulation capability.

Basic oscillator requirements

In selecting an oscillator, the user will be most interested in its frequency coverage. The question to be answered here is, "Will the instrument supply both the lowest and highest frequencies of interest for anticipated tests?" As shown in Table 1, page 332, Hewlett-Packard manufactures a broad range of oscillators and function generators covering the frequency spectrum from 0.00005 Hz to 32 MHz.

The user's next concern will be with the available output power or voltage. Some tests require large amounts of power, while others merely require sufficient voltage output. For almost any application, there is an Hewlett-Packard oscillator capable of delivering the desired voltage output into a high-impedance load or of supplying the desired power into lower-impedance loads.

Some Hewlett-Packard oscillators have a low internal impedance. This low impedance can easily be converted to a desired output impedance with a resistive network. This assures a constant impedance over a wide frequency range. In most HP oscillators, transformer coupling is used to provide a balanced and isolated output. Some instruments have transformer taps for supplying the wide variety of impedances encountered in normal test work. Since many audio-range oscillators are used with 600-ohm systems, several include 600-ohm adjustable attenuators on the output.

Besides frequency range and power output, the user will be interested in the oscillator's stability, its dial resolution and the amount of harmonic distortion, hum and noise in the output signal.

Dial resolution and accuracy

In the ideal case, the user should be able to set the tuning dial of his oscillator

to a particular frequency with assurance that the oscillator will deliver that frequency at all times. Most Hewlett-Packard oscillators have dial accuracies of $\pm 2\%$. The dials may be precisely set by a vernier control, and the calibration marks are easily read. The accuracy with which the frequency tracks the tuning dial enters into the overall accuracy figure.

Frequency stability

The frequency stability of the oscillator determines the ability of the instrument to maintain a selected frequency over a period of time. Component aging, power-supply variations and temperature changes all affect stability. The Hewlett-Packard designed RC oscillator circuits, described later, assure stability by using large amounts of negative feedback. Carefully chosen components, such as precision resistors and variable capacitors in the frequency-determining networks, contribute to long-term stability. Oscillator stability is included in the overall 2% dial accuracy figure.

Amplitude stability

Amplitude stability is important in certain oscillator applications. Amplitude stability is inherent in the Hewlett-Packard RC oscillator circuit because of the large negative feedback factor and the amplitude stabilizing techniques. The "frequency response," or amplitude variation as the frequency is changed, is of special interest when the oscillator is used for response measurements throughout a wide range of frequencies.

Distortion

Distortion in the oscillator's output signal is an inverse measure of the purity of the oscillator's waveform. Distortion is undesirable in that a harmonic of the test signal may feed through the circuits under test, generating a false indication at the output. If the oscillator is used for distortion measurements, the amount of distortion that it contributes to the measurements should be far less than that contributed by the circuits under test.

The Hewlett-Packard Wien bridge RC oscillator is a low-distortion, sine-wave generator; all Hewlett-Packard Wien bridge oscillators have less than 1% distortion (typically 0.25%). Where 0.25% distortion may be too large, a selective amplifier following the oscillator will reduce this to less than 0.1%. A tuned, selective amplifier is used in the HP 206A Low-Distortion, Audio-Signal Generator for this purpose. The 203A Function Generator is another ideal source with

low distortion and wide frequency coverage. See page 337.

Hum and noise

Hum and noise can be introduced at a variety of points in oscillator circuits; but when the circuit operates at a relatively high level, the amount of hum and noise introduced into the device under test is usually negligible. Hum and noise introduced by a power amplifier usually remain constant as the output signal amplitude is diminished. Hence, even though the hum and noise power may be quite small compared to the rated output, these spurious signals sometimes become a significant portion of low-level output signals. To overcome such a limitation, many Hewlett-Packard oscillators have their amplitude control on the output side of the power amplifier so that hum and noise are reduced proportionally with the signal when low-level signals are desired for test purposes.

Theory of operation

The Wien bridge RC oscillator has become the standard oscillator circuit for adjustable frequency test signals. These oscillators are far less cumbersome than the LC types and far more stable than the beat-frequency types formerly used for the below-rf range.

The basic Hewlett-Packard Wien bridge oscillator circuit, shown in Figure 6, is a two-stage amplifier with both negative and positive feedback loops. Positive feedback for sustaining oscillations is applied through the frequency selective network, $R_1C_1-R_2C_2$, of the Wien bridge.

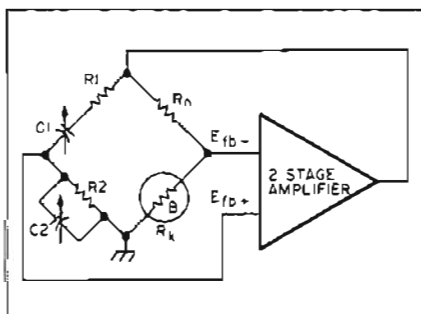

Figure 6. Basic HP Wien bridge RC oscillator circuit.

The amplitude and phase characteristics of the network, with respect to its driving voltage, are shown in Figure 7. These curves show the amplitude response is maximum at the same frequency at which the phase shift through the network is zero. Oscillations are therefore sustained at this frequency. The resonant frequency, f_0 , is expressed by the equation:

$$f_0 = \frac{1}{2\pi RC} \text{ when } R_1 = R_2 \text{ and } C_1 = C_2.$$

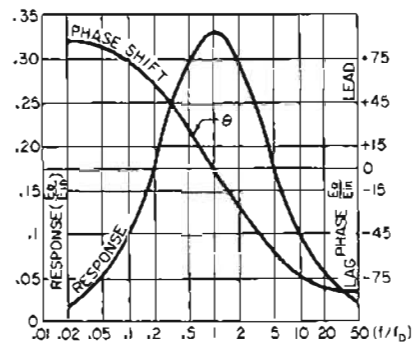

Figure 7. Characteristics of frequency-determining network.

Unlike LC circuits, where the frequency varies inversely with the square root of C , the frequency of the Wien bridge oscillator varies inversely with C . Thus, frequency variation greater than 10-to-1 is possible with a single sweep of an air-dielectric tuning capacitor. Range switching usually is accomplished by switching the resistors.

The negative feedback loop involves the other pair of bridge arms, R_n and R_k . In a Wien bridge RC oscillator, R_k is often a temperature-sensitive resistor with a positive temperature coefficient. It is an incandescent lamp operated at a temperature level lower than its illumination level. This lamp, being sensitive to the amplitude of the driving signals, adjusts the voltage division ratio of the branch accordingly. Thus, as the amplitude of oscillations increases, the resistance of R_k increases. The negative feedback also increases, reducing the gain of the amplifier and restoring the amplitude to normal.

The amplitude of oscillations in any oscillator increases because of the positive feedback until some form of limiting occurs. The Hewlett-Packard Wien bridge RC oscillator depends on the temperature-sensitive resistor for amplitude control. Thus the amplifier may be operated entirely within the linear portion of its transfer characteristic, resulting in a low-distortion, sinusoidal output.

A different type of amplitude stabilization is used in the solid-state Hewlett-Packard RC oscillators, such as the 204B, 208A, 651B and the 652A. Because the current drawn by a lamp would be incompatible for use with transistors and battery power sources, these instruments use a peak-detector circuit which provides a bias voltage proportional to the oscillator output voltage.

(See Figure 8). The output of the amplifier is applied to a transistor biased so that it conducts only with the positive or negative peaks of the oscillations. When these peaks exceed a set level, a reference diode breaks down, causing a reduction in forward bias of CR1 and CR2. The decrease in forward bias causes

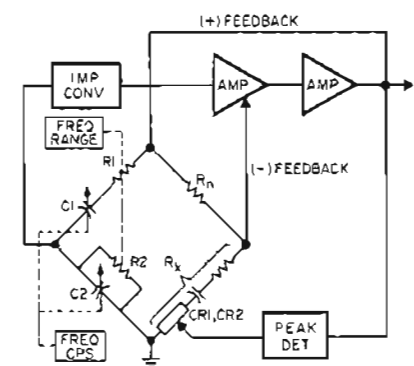

Figure 8. Solid-state RC oscillator.

the diodes to conduct less, increasing the dynamic resistance of R_k . The increase in the impedance of R_k increases the negative feedback, reducing the amplitude of the oscillator output signal.

The Wien bridge RC oscillator is capable of stable oscillations with low distortion output. With the addition of a power amplifier to isolate the oscillator from the load, this circuit is capable of providing useful test signals for a broad variety of purposes. The low-cost HP Model 200AB Oscillator uses such an arrangement.

Pushbutton tuning

Pushbutton oscillator tuning is possible with a modified Wien bridge, as shown in Figure 9. Here, the resistive branches of the frequency-selective network are made up of parallel combinations of resistors. The 241A Pushbutton Oscillator has three pushbutton, decade-switch selectors for changing the resistors in the frequency selective network. Each decade selects resistive value for one pair of resistors in the frequency-determining network.

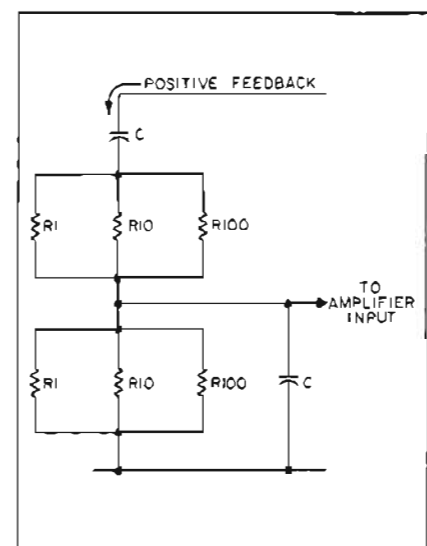

Figure 9. Frequency-selective network for pushbutton oscillator.

Ranges are switched by changing capacitors with a five-position pushbutton switch. Total frequency range of the 241A Oscillator is from 10 Hz to 1 MHz in 4500 discrete steps. An overlapping vernier control permits setting to intermediate frequencies.

Pushbutton tuning enables the frequency to be changed by precise increments. Frequency selection to three-digit resolution with 1% accuracy and resettability to within 0.02% are possible.

Digital Oscillator

Another HP oscillator is the 4204A Digital Oscillator. This instrument has five switches enabling $\pm 0.2\%$ selection from any of 36,900 discrete frequencies between 10 Hz and 999.9 kHz. An overlapping vernier control permits setting of intermediate frequencies and extension of the top range to over 1 MHz. An output monitor allows accurate determination of output levels. This instrument provides the functions of an audio oscillator, ac voltmeter, and an electronic counter, in applications requiring an accurate frequency source of known amplitude. Refer to page 345 for complete specifications.

Balanced RC oscillator

A more refined circuit, the balanced Wien bridge RC oscillator, is shown in Figure 10. This circuit provides several advantages over the basic single-ended oscillator circuit.

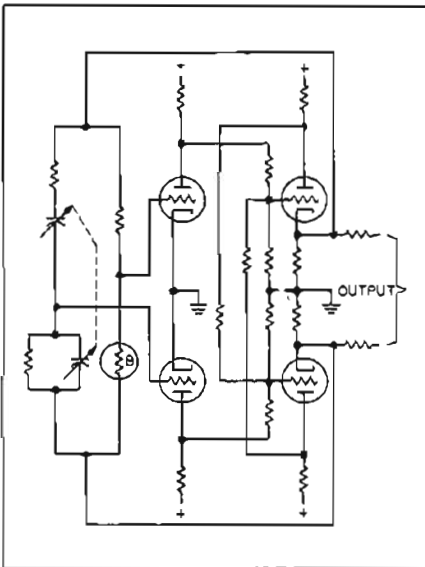

Figure 10. Balanced RC oscillator.

The circuit has zero-output impedance because of the positive feedback from the plate of each output tube to the control

and screen grids of the opposite output tube. Zero output impedance means that the circuit is insensitive to load changes. Positive feedback effectively increases the amplifier gain, A , to infinity. From the equation, $Z_o = Z_o / (1 + A\beta)$, where Z_o is the output impedance without feedback and β is the stabilizing negative feedback factor, it can be seen that the output impedance Z_o becomes zero if A is infinite. Series resistors are inserted in the output leads to present a 600-ohm impedance load and also to prevent short circuiting of the power tubes' cathodes.

In the balanced circuit, no dc passes through the lamp circuit; the lamp current is pure ac. This means that lamp heating occurs at twice the oscillating frequency, enabling the circuit to be operated down to half of the low-frequency limit of the single-ended oscillator. In addition, the capacitor-tuning rotors are near ground potential, reducing leakage effects in these capacitors and permitting larger resistors to be used in the RC circuits for low-frequency operation. This improved circuit is used in the 200CD Wide-Range Oscillator and 202C Low-Frequency Oscillator.

Special purpose oscillators

The 236A Telephone Test Oscillator was designed to meet specific requirements in the telephone industry covering the frequency range of 50 Hz to 560 kHz. Transformer coupling provides a balanced output with multiple secondary taps for matching to 135, 600 and 900 ohms. The oscillator output is connected to a multiple arrangement of telephone jacks for convenient connection to a switchboard or telephone line. When the function switch is in the dial position, the output jacks are disconnected from the oscillator and connected in parallel to a separate set of jacks to enable the operator to dial a telephone line. After a line is obtained, the function switch is used to disconnect the lineman's handset and place a test signal on the line while holding the dialed connection. The oscillator can be operated from power line or internal battery for field use. Refer to page 305 for additional information.

High-frequency oscillator

The high-frequency limit of the RC oscillator is imposed by the amplitude and phase characteristics of the oscillator-amplifier. An amplifier phase shift of just a fraction of a degree causes 1% error in calibration. A modified Wien bridge os-

cillator is used on all the ranges of the HP 651B, instead of phase-shift oscillators which are commonly used above 100 kHz. This is made possible through the use of a wide-band, transistorized oscillator-amplifier with the phase shift controlled several octaves past the oscillator's upper 10-MHz limit. An impedance converter provides a high impedance in series with the input of a differential amplifier on the first four frequency ranges (X10 to X10 k). The added high impedance prevents the RC bridge circuit from being loaded by the low input impedance of the differential amplifier on lower frequency ranges. A complementary symmetry circuit is used to provide power gain and to increase the dynamic voltage range of the oscillator. The output circuit of the Hewlett-Packard solid-state 10 Hz to 10 MHz oscillator is shown in Figure 11.

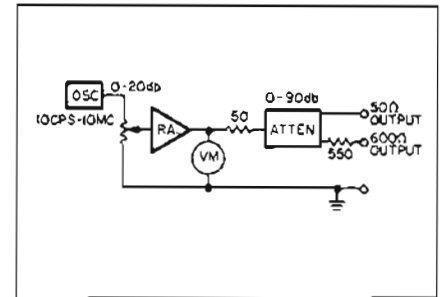

Figure 11. RC high-frequency oscillator output.

Another Hewlett-Packard high-frequency oscillator, Model 313A, is a beat-frequency oscillator. The output is derived from mixing a local oscillator frequency of 30 MHz to 52 MHz with a 30-MHz crystal oscillator, resulting in an output frequency of 10 kHz to 22 MHz in one band. This output has an extremely flat frequency response. The 313A has an output attenuator of 109.9 dB adjustable in 10 dB, 1 dB and 0.1 dB steps.

This oscillator is also a tracking generator for the 312A Wave Analyzer.

The oscillator circuits described here are used in Hewlett-Packard's broad line of signal sources. These signal sources span a frequency range of 0.00005 Hz to 32 MHz, encompassing the subsonic, audio, ultrasonic, video and rf ranges. All of the Hewlett-Packard oscillators and test oscillators described in this catalog have been designed with the requirements of a maximum number of applications in mind. The various techniques were chosen in order to maximize the performance offered while minimizing the cost so that a Hewlett-Packard oscillator is available to meet your application.

VARIABLE-PHASE GENERATOR

Sine- and square-waves 0.00005 Hz to 60 kHz
Model 203A



SIGNAL SOURCES

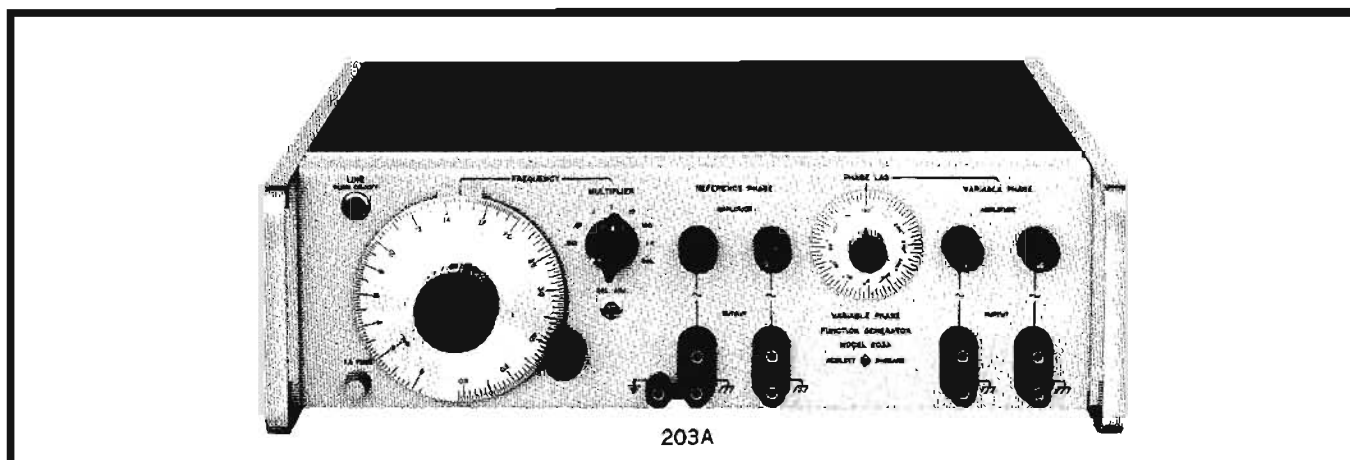

The solid-state HP Model 203A Low-Frequency Function Generator provides two transient-free low-distortion square and sinusoidal test signals particularly useful for a wide variety of low-frequency applications. Field and laboratory testing of servo, geophysical, medical and high-quality audio equipment become practical when using the 203A.

The 203A frequency range of 0.005 Hz to 60 kHz is covered in 7 overlapping bands (2 additional ranges available on special order, offering frequency range to 0.00005 Hz). Accurate $\pm 1\%$ frequency setting is provided by 180 dial divisions. A vernier drive allows precise adjustment.

30 volt output

The 203A provides a maximum output voltage of 30 V peak-to-peak for all waveforms. The sinusoidal signals have a distortion that is less than 0.06% and provide virtually transient-free outputs when frequency and operating conditions are varied rapidly. The four output circuits of the 203A have individual 40 dB continuously variable attenuators.

Outputs consist of a reference sine and square wave, and a variable-phase sine and square wave. The two sine- and square-wave outputs are electrically identical except that one sine- and square-wave output contains a 0-to-360 degree phase-shifter. These four signals (two reference phase and two variable phase) are available simultaneously from the 203A. The output system is floating with respect to ground and may be used to supply an output voltage that is terminal grounded, or may be floated up to 500 volts dc above chassis ground. The output impedance is 600 ohms for all outputs.

Special features

A front-panel calibration provision permits the user to easily calibrate the oscillator frequency to the environment in which the instrument is used. The HP 203A features a unique method of mixing, filtering and dividing the frequency to maintain an exact decade relationship. Interchangeable decade modules provide greater reliability and ease of servicing.

Specifications, 203A

Frequency range: 0.005 Hz to 60 kHz in seven decade ranges.*

Dial accuracy: $\pm 1\%$ of reading.

Frequency stability: within $\pm 1\%$ including warmup drift and line voltage variations of $\pm 10\%$.

Output waveforms: sine and square waves are available simultaneously; all outputs have common chassis terminal.

Reference phase: sine wave, 0 to 30 V peak-to-peak; square wave, 0 to 30 V peak-to-peak (open circuit).

Variable phase: sine wave, 0 to 30 V peak-to-peak; square wave, 0 to 30 V peak-to-peak; continuously variable, 0 to 360°; phase dial accuracy, $\pm 5^\circ$ sine wave, $\pm 10^\circ$ square wave (open circuit).

Output impedance: 600 ohms.

Output power: 5 volts into 600 ohms (40 mW); 40 dB continuously variable attenuation on all outputs.

Distortion: total harmonic distortion hum and noise > 64 dB below fundamental ($< 0.06\%$) at full output.

Output system: direct-coupled output is isolated from ground and may be operated floating up to 500 V dc.

Frequency response: $\pm 1\%$ referenced to 1 kHz.

Square wave response: rise and fall time, < 200 ns; overshoot, $< 5\%$ at full output.

Power: 115 or 230 volts $\pm 10\%$, 50 to 1000 Hz, approximately 25 W.

Dimensions: cabinet: 5 $\frac{1}{4}$ " high, 16 $\frac{3}{4}$ " wide, 11 $\frac{1}{2}$ " deep (133 x 425 x 286 mm); rack mount kit (00203-84401) furnished with instrument.

Weight: net 20 lbs (9,17 kg); shipping 28 lbs (12,6 kg).

Price: HP 203A, \$1200; Option 01, add \$40; Option 02, add \$80.

*Two lower ranges of 0.0005 Hz (Option 01) and 0.00005 Hz (Option 02) are available on special order.
Manufactured by Yokogawa-Hewlett-Packard Ltd., Tokyo.



LOW-FREQUENCY GENERATOR

0.008 Hz to 1.2 kHz; sine-square-triangular waves
Model 202A

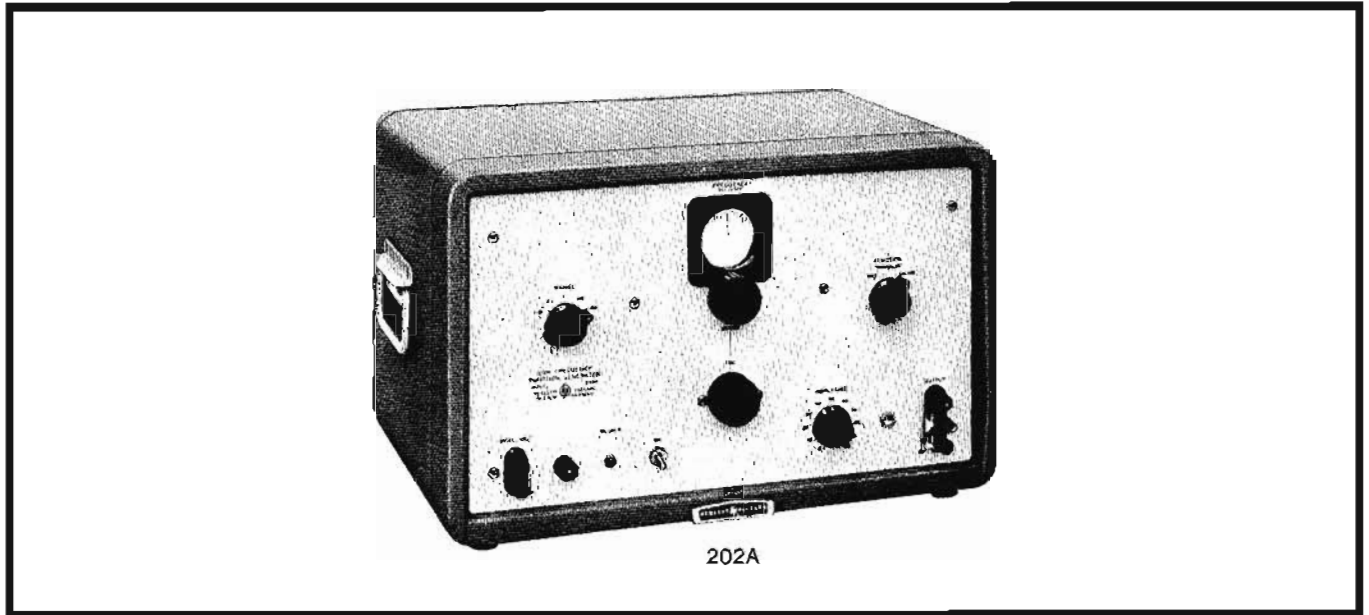

202A

The HP 202A Low-Frequency Function Generator is a compact, convenient, multi-purpose source of transient-free test voltages. It is particularly useful for testing servo, geophysical and medical equipment and for the electrical simulation of mechanical phenomena.

Output frequency is continuously variable from 0.008 Hz to 1200 Hz in 5 bands. Model 202A offers exceptional stability and distortion of less than 1% over most of the band. Any of three desired waveforms—sine, square or triangular—may be selected by a front-panel switch. Output is high—30 volts peak-to-peak—for all three waveforms and is essentially constant over the entire frequency range.

The HP 202A differs from conventional low-frequency oscillators in that the sine wave is electronically synthesized. A controlled bi-stable circuit generates a rectangular wave. This wave is passed through a special integrator, providing a true triangular wave.

The triangular wave then enters a shaping circuit designed exclusively for this equipment. In this circuit, 12 crystal diodes modify or "shape" the wave and provide a sine wave. This sine wave has a distortion of less than 1%, and the synthesizing circuit provides virtually transient-free output even when frequency and operating conditions are rapidly varied. It is not necessary to wait long periods for the circuits to stabilize, as is the case with conventional low-frequency oscillators. The circuit inherently maintains constant amplitude over the entire frequency range.

The output system of the 202A is fully floating with respect to ground and may be used to supply a balanced voltage or an output voltage with either output terminal grounded. The equipment will deliver 10 volts rms into a load of 4000 ohms or greater. Output impedance is only 40 ohms. There are no coupling capacitors in the output system, and a high degree of dc balance is achieved.

Specifications

- Frequency range:** 0.008 to 1,200 Hz in five decade ranges
- Dial accuracy:** $\pm 2\%$ from 1.2 to 12; $\pm 3\%$ from 0.8 to 1.2.
- Frequency stability:** within 1%, with line voltage variations of $\pm 10\%$.
- Output waveforms:** sinusoidal, square and triangular.
- Maximum output voltage:** 30 volts peak-to-peak across rated load (4,000 ohms) for all three waveforms (10.6 volts rms for sine wave).
- Output impedance:** 40 ohms over entire range.
- Sine wave distortion:** 1% on X0.01, X0.1, X1, and X10 ranges; 2% on X100 range.
- Output system:** output is isolated from ground and may be operated balanced or with either side grounded; output system is direct-coupled; dc level can be adjusted to zero by a front-panel control.
- Frequency response:** ± 0.2 dB.
- Hum level:** 0.05% of output.
- Sync pulse:** 10 volts peak negative, less than 5 μ s duration; sync pulse occurs at crest of sine and triangular wave output.
- Power:** 115 or 230 volts $\pm 10\%$, 50 to 1000 Hz, 150 watts.
- Dimensions:** cabinet: 20 $\frac{3}{4}$ " wide, 12 $\frac{3}{4}$ " high, 14 $\frac{5}{8}$ " deep (528 x 324 x 372 mm); rack mount: 19" wide, 10-15 $\frac{32}{100}$ " high, 13" deep (483 x 266 x 330 mm).
- Weight:** net 42 lbs (18,9 kg), shipping 52 lbs (23,4 kg) (cabinet); net 37 lbs (16,6 kg), shipping 45 lbs (20,3 kg) (rack mount).
- Accessories available:** 11000A Cable Assembly, \$5.00; 11001A Cable Assembly, \$6.00.
- Price:** HP 202A, \$590 (cabinet); HP 202AR, \$575 (rack mount).

FUNCTION GENERATOR

Plug-ins, multiple outputs, versatility
Model 3300A & 3301A plug-in



SIGNAL SOURCES

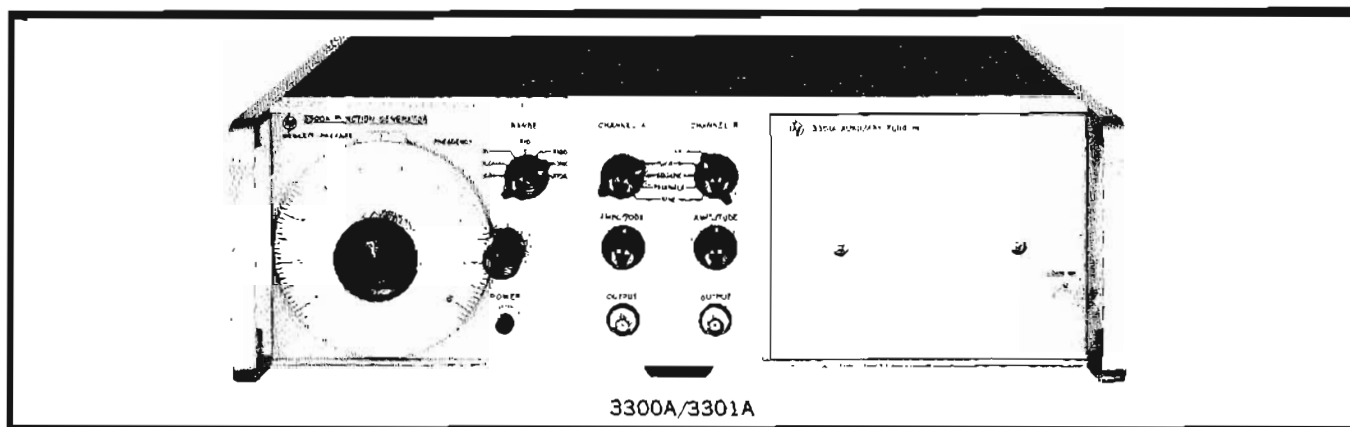

Description

Plug-ins and multiple outputs set the HP 3300A Function Generator apart from other function generators. Any two of three waveforms—sine, square or triangular—may be selected by a front-panel switch over the frequency range from 0.01 Hz to 100 kHz, continuously adjustable in seven decade ranges. This solid-state, multi-purpose source provides simultaneous signals of any two waveforms over the entire frequency range with independent variable amplitudes.

Plug-ins, which insert directly into the front panel, include the HP 3301A Auxiliary Plug-in to provide internal connections for basic unit operation. The 3302A plug-in provides single and multiple-cycle operation with adjustable start-stop phase. A phase-lock loop in the 3302A permits synchronizing the 3300A with an external signal and gives adjustable phase control. The HP 3304A Sweep/Offset Plug-in provides internal sweeping, dc offset, sawtooth waves and offset square waves. The 3305A Sweeper Plug-in supplies internal log sweep and manual sweep over four decades with calibrated variable start-stop frequency control within four decades. Sweep width is continuously adjustable. It has manual or external triggering. Sweep can be analog-programmed, with horizontal sweep available for driving scopes or recorders.

The frequency of the HP 3300A can be controlled by either the front-panel frequency dial or an external voltage applied to a rear-terminal connector. This feature is useful for sweeping filters, amplifiers and other frequency-dependent devices and for externally programming frequencies for production testing.

The output system of the HP 3300A is dc coupled and fully floating with respect to power-line ground. An internal shield reduces radiated interference and provides common-mode rejection with floating output. It can be used to supply a balanced output, using both output amplifiers. Each output amplifier will deliver 35 V p-p into an open circuit.

Specifications

Output waveforms: sinusoidal, square and triangular selected by panel switch (any two outputs available simultaneously).

Frequency range: 0.01 Hz to 100 kHz in 7 decade ranges.

Frequency response: $\pm 1\%$, 0.01 Hz to 10 kHz; $\pm 3\%$, 10 kHz to 100 kHz on the X10 k range.

Dial accuracy: $\pm 1\%$ of maximum dial setting (1 minor division), 0.01 Hz to 10 kHz at $+25^\circ\text{C}$; $\pm 2\%$ of maximum dial setting, (2 minor divisions), 10 kHz to 100 kHz on the X10 k range. T.C.; $0.1\% \pm/^\circ\text{C}$.

Maximum output per channel: >35 V p-p open circuit; >15 V p-p into 600Ω ; >2 V p-p into 50Ω .

Output attenuators (both channels): 40 dB range.

Sine-wave distortion: $<1\%$, 0.01 Hz to 10 kHz; $<3\%$, 10 kHz to 100 kHz on the X10 k range.

Square-wave response: <250 ns rise and fall time on all ranges; <400 ms in $-A$ position; $<1\%$ sag, $<5\%$ overshoot at full output; $<1\%$ symmetry error.

Triangle-linearity error: $<1\%$, 0.01 Hz to 10 kHz; $<2\%$, 10 kHz to 100 kHz; $<1\%$ symmetry error.

Sync-pulse output: >10 V p-p open circuit, <5 μs duration. Sync pulse occurs at crest of sine and triangular wave output.

Output impedance (both channels): 600Ω nominal.

DC stability: drift; $<\pm 0.25\%$ of p-p amplitude over a period of 24 hours (after 30-min. warmup).

Remote frequency control: 0 to -10 V will linearly change frequency >1 decade within a single range. Frequency resetability with respect to voltage $\pm 1\%$ of maximum frequency on range selected.

Power: 115 or 230 V $\pm 10\%$, 50 to 1000 Hz, approx. 50 W.

Dimensions: standard HP full module 5" high, $16\frac{3}{4}$ " wide, 11" deep (127 x 425 x 279 mm).

Weight: net 20 lbs (9 kg); shipping 24 lbs (10.8 kg).

Plug-ins available

HP 3301A Auxiliary Plug-in, \$30.

HP 3302A Trigger Plug-in (see page 340).

HP 3304A Sweep/Offset Plug-in (see page 340).

HP Model 3305A Sweeper Plug-in (see page 341).

Price: HP 3300A Function Generator, \$625.



FUNCTION GENERATOR PLUG-INS

Variable phase, phase lock, dc sweeper, offset
Models 3302A, 3304A



The HP 3302A Trigger/Phase Lock Plug-in is designed to provide single-cycle, multiple-cycle and phase-lock operation. The instrument can be triggered over the entire frequency range, either manually or by applying an external voltage.

In single-cycle operation, one cycle of any function can be obtained by pushing the manual trigger or applying a voltage to the external trigger input.

In the multiple-cycle mode of operation, any number of complete cycles of any function can be obtained by holding the manual trigger depressed, or by applying an external gate voltage.

The 3300A may be phase-locked to any periodic signal with a frequency from 10 Hz to 100 kHz to obtain sine, triangle and square wave outputs with frequency characteristics of the externally-applied signal.

The HP 3304A Sweep/Offset Plug-in provides internal sweeping, dc offset, sawtooth waves and offset square waves. Up to ± 16 V of dc offset is available for all signals generated in the main frame and plug-in. In addition, the independently frequency-controlled sawtooth wave may be switched internally to the frequency control circuit of the HP 3300A Function Generator to permit sweeping over a decade of frequency within a single range.

Specifications, 3302A

Modes of operation: single cycle, multiple cycle, phase lock, free run.

Trigger requirements

Single cycle: manual or external, dc coupled. Requires at least 0.5 V to trigger externally. May be triggered with positive or negative input voltage (± 20 V peak max.).

Multiple cycle: manual or external start/stop, dc coupled. Requires at least 0.5 V to start, 0 V to stop. May be triggered with either positive or negative input voltage (± 20 V peak max.).

Phase lock: 10 Hz to 100 kHz (upper 4 ranges only), dc coupled. Requires 0.5 V p-p to lock, 10 V p-p for specified accuracy with sine-wave input. The 3302A will lock on a fundamental or harmonic of the input signal.

Phase dial accuracy: $\pm 10^\circ$ from 10 Hz to 10 kHz; $\pm 20^\circ$ from 10 kHz to 100 kHz on X10 k range (fundamental only).

Introduced distortion: $< 1\%$, 10 Hz to 10 kHz; $< 3\%$, 10 kHz to 100 kHz on X10 k range (fundamental only).

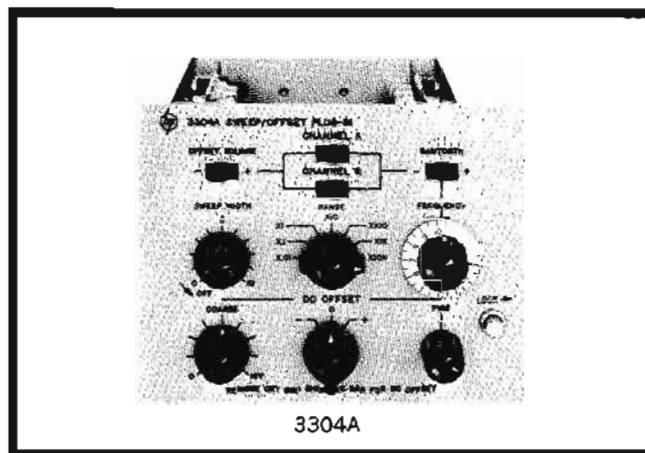

Dimensions: 4 $\frac{3}{4}$ " high, 6-1/16" wide, 10 $\frac{1}{4}$ " deep (120,7 x 153,9 x 260,4 mm).

Weight: net 3 lbs (1,4 kg); shipping 5 lbs (2,5 kg).

Price: HP 3302A Trigger/Phase Lock Plug-in, \$190.

Specifications, 3304A

DC offset

Voltage range: adjustable 0 to ± 16 V open circuit and a ± 1 V vernier control.

DC stability: ± 50 mV over a 24-hr. period (after 30-min. warm-up).

Offset square wave

Output polarity: positive or negative, from dc offset voltage or ground potential.

Amplitude: > 15 V p-p open circuit; continuously adjustable with 3300A amplitude control.

Rise time: < 400 ns.

Overshoot: $< 5\%$ at full output.

Sag: $< 1\%$.

Sawtooth waveform

Frequency range: 0.01 Hz to 100 kHz, continuously adjustable over 7 decade ranges.

Dial accuracy: $< \pm 10\%$ full scale, 0.01 Hz to 1 Hz; $< \pm 5\%$ full scale, 1 Hz to 100 kHz.

Amplitude: > 15 V p-p open circuit; continuously adjustable over a 40 dB range with 3300A amplitude control.

Frequency response: $< 2\%$, 0.01 Hz to 10 kHz; $< 5\%$, 10 kHz to 100 kHz.

Output polarity: positive or negative, from dc to offset voltage or ground potential.

Linearity: $< 1\%$, 0.01 Hz to 10 kHz; overshoot, $< 5\%$; $< 2\%$, 10 kHz to 100 kHz; overshoot, $< 5\%$.

Flyback time: $< 5\% + 250$ ns.

Internal sweep

Controls: start frequency set by 3300A frequency dial; sweep range set by sweep width control on plug-in.

Sweep rate: determined by sawtooth frequency setting.

Sweep width: adjustable from 0 to at least 1 decade on any one range.

Dimensions: 4 $\frac{3}{4}$ " high, 6-1/16" wide, 10 $\frac{1}{4}$ " deep (120,7 x 153,9 x 260,4 mm).

Weight: net 4 lbs (1,8 kg); shipping 6 lbs (2,7 kg).

Price: HP 3304A Sweep/Offset Plug-in, \$250.

SWEeper PLUG-IN FOR 3300A

Four-decade logarithmic sweep

Model 3305A



SIGNAL SOURCES

Uses:

Swept subsonic-audio-ultrasonic testing
 Amplifier, filter design
 Vibration studies
 Medical research

Features:

Four-decade logarithmic sweep
 Frequency programmability
 Calibrated independent start-stop frequency control
 Adjustable sweep time
 Sweep output independent of sweep width
 Auto, triggered (remote or manual), and manual sweeps

Description

The 3305A Sweep Plug-in with the 3300A Function Generator is an automatic, manual or externally triggered 4-decade sweeper. It is also a signal source programmable over 4-decades with an external voltage.

Four-decade logarithmic sweep

The 3300A/3305A will sweep logarithmically, repetitively between any two frequencies in one of the three (4-decade ranges): 0.1 Hz to 1 kHz, 1 Hz to 10 kHz, and 10 Hz to 100 kHz. Calibrated independent START-STOP controls greatly simplify setting desired sweep end points. Adjustable sweep time from 0.01 to 100 seconds provides sweep times slow enough for accurate response testing of low-frequency high-Q systems and fast enough for good visual displays of higher frequency responses. A frequency range greater than the audio band can be swept without any range switching or display equipment readjustment.

The manual sweep, vernier adjustment of frequency between the start-stop limits, allows close observation of a small portion of a response curve. This manual control also permits measurement of a critical frequency with counter accuracy and simpler set-ups for oscilloscopes or X-Y recorders.

Programming

For automated testing, the 3300A/3305A frequency can be analog-programmed over any one of the (4-decade) ranges. Also, a single sweep can be externally triggered.

Sweep output

X-axis readjustment is eliminated since the sweep output amplitude is independent of start-stop, sweep time and sweep width settings.

Tentative specifications

Frequency range: 0.1 Hz to 100 kHz in three overlapping ranges.

Sweep width: limits adjustable 0 to 4 decades in any of three (4-decade) bands: 0.1 Hz to 1 kHz, 1 Hz to 10 kHz, 10 Hz to 100 kHz.

Start-stop dial accuracy: $\pm 5\%$ of setting, 0.1 Hz to 20 kHz; $\pm 7\%$ of setting, 20 kHz to 100 kHz.

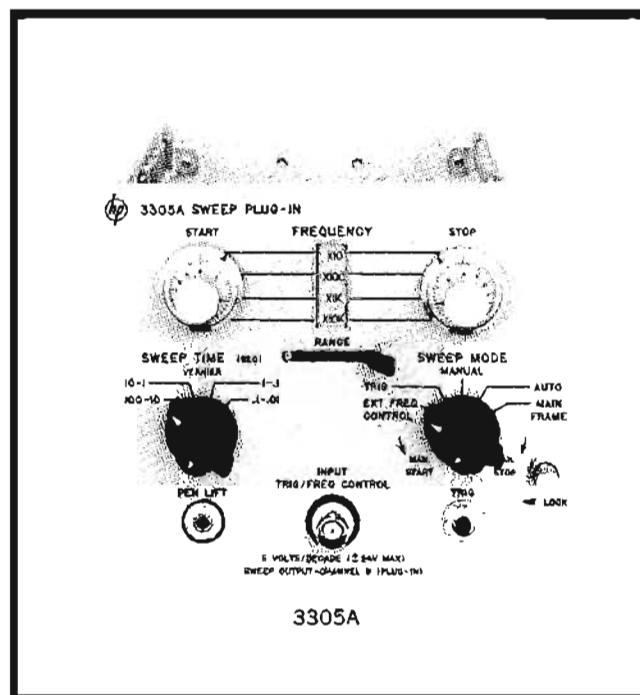

Sweep modes

Automatic: repetitive logarithmic sweep between start and stop frequency settings.

Manual: vernier adjustment of frequency between start and stop frequency settings.

Trigger: sweep between start and stop frequency settings and retrace with application of external trigger voltage or by depressing front-panel trigger button.

Trigger requirements: ac coupled, positive going at least 1 V peak with > 2 V per ms rise rate. Max. input, ± 90 V peak.

Sweep time: 0.01 s to 100 s in 4 decade steps, continuously adjustable vernier.

Retrace time: 0.001 s for 0.1 to 0.01 s sweep times, 0.01 s for 1 to 0.1 s sweep times, 2 s for 100 to 1 s sweep times.

Blanking: sine and triangle outputs, 0 V during retrace.

Pen lift: terminals shorted during sweep; open during retrace in auto and trigger modes for 100 to 1 s sweep times.

Sweep output: linear ramp at CHANNEL B OUTPUT (PLUG-IN); amplitude adjustable independently of sweep width; max. output > 15 V p-p into open circuit, > 7 V p-p into 600 Ω .

External frequency control

Sensitivity: 6 V/decade (referenced to START setting), ± 24 V max.

V-to-F conversion accuracy: for each 6 V change in programming voltage, frequency changes 1 decade $\pm 5\%$ of final frequency.

Input impedance: 400 k Ω .

Maximum rate: 100 Hz.

General

Dimensions: 6-1/6" wide, 4 3/4" high, 10 1/4" deep (153.9 x 120.7 x 260.4 mm).

Weight: net 4 lbs 6 oz (2 kg); shipping 6 lbs 6 oz (2.9 kg).

Price: HP 3305A, \$975.

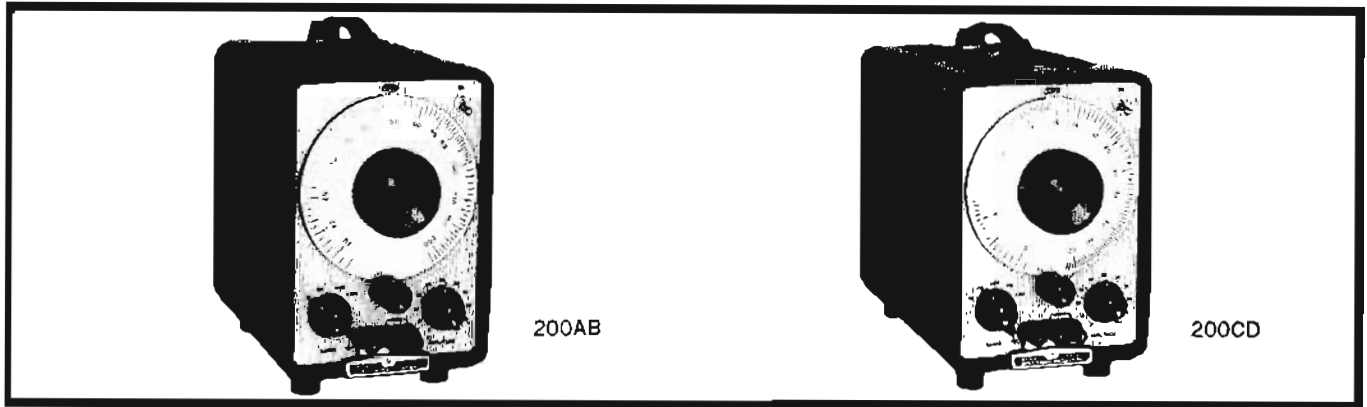
SIGNAL SOURCES
AUDIO OSCILLATORS
 Exceptional value, highest quality
 Models 200AB, 200CD
**Features:**

- No zero setting, high stability
- Constant output, low distortion
- Wide frequency range, log scale
- No frequency change with load variation

Hewlett-Packard RC oscillators have long been basic tools for making electrical and electronic measurements of precise accuracy. These world-famous test instruments give you the most compact, dependable, accurate and easy-to-use commercial oscillators available.

The HP 200 Series Oscillators have high stability and accurate, easily resettable tuning circuits. Low-impedance operating levels, together with superior insulation, guarantee peak performance throughout years of trouble-free service. The instruments have wide frequency range and long dial lengths and feature an improved vernier frequency control. Operation is simplified — just three controls are required. Instruments are compact, light in weight and enclosed in a convenient, aluminum case with carrying handle. They occupy minimum bench space and are easily portable. Rack mounting is available on order.

200AB Audio Oscillator, Low Cost, 20 Hz to 40 kHz

This basic oscillator is a compact, convenient source of precision audio test voltages, which is offered at an extremely low price. Frequency coverage is 20 Hz to 40 kHz in four overlapping bands. The 63" effective scale length and 90 dial divisions insure accurate, direct frequency setting. Output of 1 W or 24.5 V into a 600 ohm load is balanced for dependable driving of transmission systems. With less than 1% distortion, and hum level at least 66 dB below maximum output, the 200AB is ideal for amplifier testing, as a bridge voltage source, for testing transmitter modulator response, modulating signal generators and making loudspeaker resonance tests. HP 200AB, \$195 (cabinet); HP 200ABR, \$200 (rack mount).

200CD Wide-Range Oscillator, Multi-Purpose, 5 Hz to 600 kHz

One of the most popular of all HP oscillators, Model

200CD covers the range of 5 Hz to 600 kHz in five overlapping decade bands. Accurate frequency setting is provided by 112 dial divisions and an effective scale length of 78 inches. A vernier drive allows precise adjustment.

The 200CD gives a maximum sinewave output of at least 10 volts across its rated load of 600 ohms and at least 20 volts open circuit. Its distortion rating is very low, less than 0.2% from 20 Hz to 200 kHz. A special feature of the 200CD is that its waveform purity does not depend on load. The output impedance is nominally 600 ohms. The output transformers are balanced within 0.1% at the lower frequencies and within approximately 1% at the higher frequencies. The 200CD is particularly useful for testing servo and vibration systems, medical and geophysical equipment, audio amplifiers, sonar and ultrasonic apparatus, carrier telephone systems, video frequency circuits, etc. Waveform purity is maintained with extremely low loads. Frequency is covered in 5 decade ranges, and accuracy is $\pm 2\%$ including warm-up, aging, tube changes, etc. Frequency response is ± 1 dB full range. A convenient panel grounding terminal is provided to ground one of the output terminals when single-ended operation is desired. A simple bridged T Attenuator is provided to control output power. Where a well-balanced adjustable output source is desired, the HP 11004A Line Matching Transformer can be used. HP 200CD, \$225 (cabinet); HP 200CDR, \$230 (rack mount).

The H20-200CD is a standard 200CD modified to have an extremely low distortion output. Refer to the Table of Specifications, page 343. HP H20-200CD, \$280.

201C Audio Oscillator, High Power, 20 Hz to 20 kHz

Particularly designed for amplifier testing, transmission line measurements, loudspeaker testing, frequency comparison and other high fidelity tests, this audio oscillator meets every requirement for speed, simplicity and pure waveform. The frequency range, 20 Hz to 20 kHz, is covered in 3 bands; response is ± 1 dB full range. Output is 3 watts or 42.5 volts into 600 ohms; an attenuator adjusts output 0

AUDIO OSCILLATORS
 Exceptional value, highest quality
 Models 201C, 202C

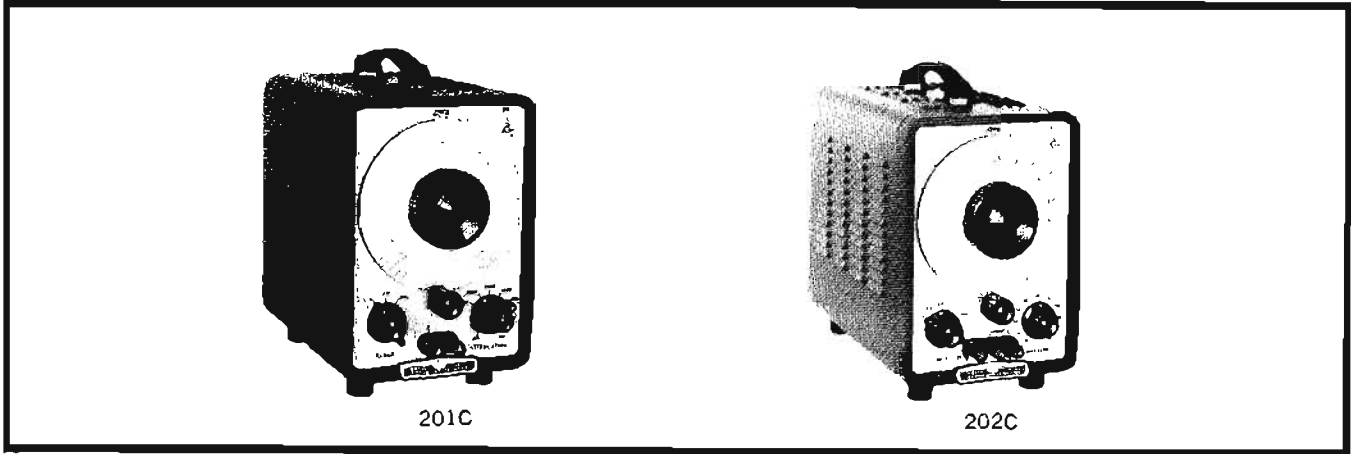

to 40 dB in 10 dB steps and provides either low impedance or constant 600-ohm impedance. Distortion at 1 watt output and above 50 Hz is less than 0.5%. HP 201C, \$250 (cabinet); HP 201CR, \$255 (rack mount).

**202C Low-Frequency Oscillator, Excellent Waveform
 1 Hz to 100 kHz**

Model 202C brings to the low-frequency spectrum the accuracy and stability you associate with audio measurements. It provides excellent waveforms in the subsonic, audio and ultrasonic frequency ranges, and has broad applicability for industrial, field or laboratory use. Specifically, it may be used for these important tests: vibration or stability characteristics of mechanical systems; electrical simulation of

mechanical phenomena; determining electro-cardiograph and electro-encephalograph performance; seismograph response; making vibration checks of structural components; obtaining performance characteristics of geophysical prospecting equipment; making operational checks of servo-mechanism systems and general audio measurements.

The transformer-coupled, balanced output of the Model 202C enables it to meet the signal source requirements for tests of a wide variety of systems. The instrument provides an output of at least 10 volts across its rated load of 600 ohms and at least 20 volts open circuit. A special feature is that waveform purity does not depend upon load. Distortion is less than 0.5%; hum voltage is less than 0.1%, and recovery time is extremely short—5 seconds at 1 Hz. HP 202C, \$325 (cabinet); HP 202CR, \$330 (rack mount).

Specifications

HP Model	Frequency range	Calibration accuracy	Output to 600 ohms	Output impedance	Maximum distortion	Maximum hum and noise*	Input power (watts)	Weight—lb (kg)		Size—Inches (mm)			Price
								net	shlp	W	H	D	
200AB	20 Hz to 40 kHz (4 bands)	±2%	1 W (24.5 V)	75 ohms (mid-freq)	1% 20 Hz to 20 kHz; 2% 20 kHz to 40 kHz	0.05%	70	15 (5.3)	16 (7.2)	7½ x 11½ x 12 (191 x 292 x 305)		\$195	
200CD	5 Hz to 600 kHz (5 bands)	±2%	160 mW (10 V)	600 ohms	0.2% 20 Hz to 200 kHz; 0.5% 5 Hz to 20 Hz and 200 kHz to 600 kHz	L60dB below 0.1% rated output	90	22 (9.9)	24 (10.8)	7½ x 11½ x 14¾ (187 x 292 x 365)		\$225	
H20-200CD			7.5 V								* =		\$230
201C	20 Hz to 20 kHz (3 bands)	±1%	3 W (42.5 V)	600* ohms	0.5% †	0.03%	75	16 (7.2)	19 (8.6)	7½ x 11½ x 12½ (191 x 292 x 318)		\$250	
202C	1 Hz to 100 kHz (5 bands)	±2%	160 mW (10 V)	600 ohms	0.5% §	0.1%	75	27 (12.2)	28 (12.6)	7½ x 11½ x 14¼ (191 x 292 x 368)		\$325	

* Internal impedance approx. 600 ohms with output attenuator at 10 dB or more, approx. 75 ohms below 5000 Hz with attenuator at zero. † Internal non-operating controls permit precise calibration of each band, ±0.5% Hz, 50 Hz to 20 kHz at watt output; 1% over full range at 3 watts output. § Above 5 Hz.
 ** Same as 200CD except: distortion; 0.06% 80 Hz to 50 kHz, 0.1% 20 Hz to 50 Hz and 50 kHz to 400 kHz, 0.5% 5 Hz to 20 Hz and 400 kHz to 600 kHz. Output: 7.5 V into 600 ohm load.
 †† Measured with respect to full rated output.

General:

Frequency response: flat ±1 dB over instrument range; reference level at 1 kHz.
Size and weight: maximum overall size and weights are given for cabinet models; 19" rack models also available.

Power: 115 or 230 volts ±10% at 50 to 1000 Hz

Accessories available: 11000A Cable Assembly, \$5; 11001A Cable Assembly, \$6; 11004A, 11005A Line Matching Transformers, see page 351.



PORTABLE TEST OSCILLATORS

Solid-state, battery-operated, floating output
Models 204B, 208A

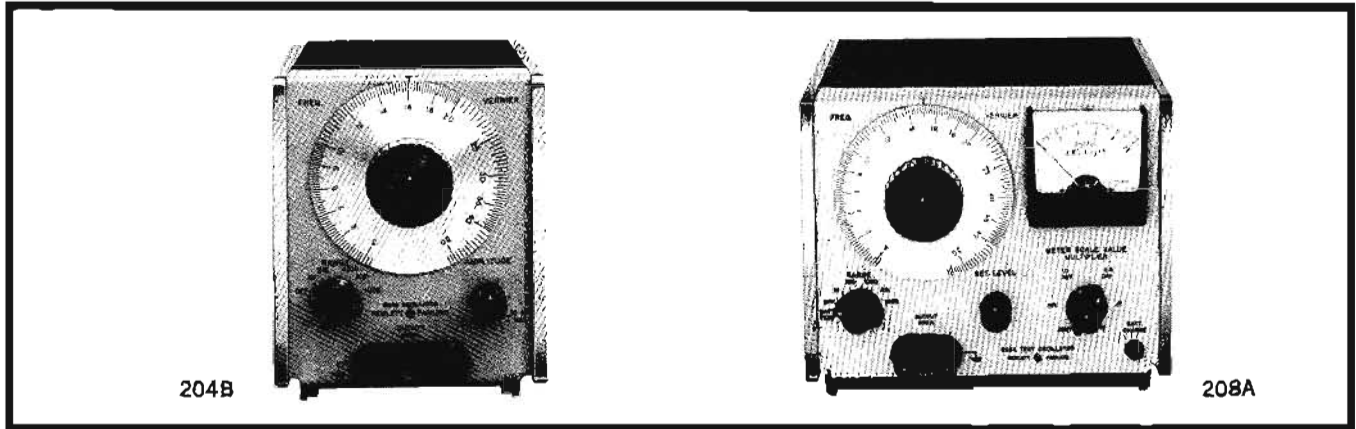

Fully solid-state and battery-operated HP 204B and 208A Oscillators are extremely useful for both field and laboratory work. Internal heat production is small, resulting in unusually low warm-up drift. Stable, accurate signals are instantly available over a frequency range from 5 Hz to 560 kHz.

Balanced and unbalanced loads, plus loads referenced either above or below ground, can be driven by these versatile oscillators; their output is fully floating and isolated from power line ground when battery operated. Completely balanced output is easily obtained with a simple external matching network. There is excellent frequency stability, even with rapidly changing loads; low-impedance circuits drive the 600-ohm output, effectively isolating the oscillator stage.

The solid-state design, light weight, modular construction, and battery operation of these oscillators contribute to their portability. Rapid attenuation selection and monitored oscillator levels ideally suit the 208A Oscillator to transmission line work, production line tests and similar situations where output levels must be known.

Model 208A is calibrated in volts and has a 6-position attenuator (Meter Scale Value switch) with 10:1 steps from 0.01 mV to 1 V. Another attenuator (Multiplier switch) changes the output by a factor of 2.5, increasing maximum output to 2.5 V rms. The 208A (Option 01) is calibrated in dBm and has a 110 dB attenuator adjustable in 1 dB steps.

Specifications, 204B

Frequency range: 5 Hz to 560 kHz in 5 ranges; 5% overlap between ranges, vernier control.

Dial accuracy: $\pm 3\%$ of setting.

Frequency response: $\pm 3\%$, with rated load.

Output impedance: 600 ohms.

Output: 10 mW (2.5 V rms) into 600 ohms; 5 V rms open circuit; completely floating.

Output control: continuously variable bridged "T" attenuator with at least 40 dB range.

Distortion: less than 1%.

Noise: less than 0.05% at maximum output ac or battery operated.

Power: 4 batteries at 6.75 V each, 7 mA drain, life at least 300 hours.

Dimensions: 6-3/32" high, 5 1/8" wide, 8" deep (155 x 130 x 203 mm).

Weight: net 6 lbs (2,7 kg); shipping 8 lbs (3,6 kg).

Accessories available: HP 11075A Carrying Case, \$45. See page 631.

Price: HP 204B (with mercury batteries), \$315.

Options

01. AC power supply installed in lieu of batteries, add \$35.

02. Up to 40 hours operation per recharge with furnished rechargeable batteries (self-contained recharging circuit functions automatically when instrument is connected to ac line; 115 or 230 V $\pm 10\%$, 50 to 1000 Hz, approx. 3 W); expected battery life 20,000 hours, add \$75.

Specifications, 208A

(Same as 204B, except:)

Output attenuator: meter scale value, 0.01 mV to 1 V full scale in 6 steps; X2.5 multiplier, concentric with Meter Scale Value switch, to obtain 0.025 mV to 2.5 V.

Output attenuator accuracy: 5 Hz to 100 kHz, error is less than $\pm 3\%$ at any step; from 100 kHz to 560 kHz, error is less than 5% at any step; specifications include multiplier accuracy.

Output monitor: solid-state voltmeter monitors level at input to attenuator and after set level; accuracy $\pm 2\%$ of full scale into 600 ohms.

Set level: continuously variable bridged "T" attenuator with 10:1 voltage range.

Operating temperature range: 0°C to +50°C.

Power: up to 30 hours operation per recharge with furnished rechargeable batteries (self-contained recharging circuit functions automatically when instrument is connected to ac line; 115 or 230 V $\pm 10\%$, 50 to 1000 Hz, approx. 3 W); oscillator may be used during recharge from ac line; expected battery life, 20,000 hours.

Dimensions: 6-3/32" high, 7-25/32" wide, 8" deep (155 x 198 x 203 mm).

Weight: net 8 1/4 lbs (3,5 kg); shipping approximately 11 lbs (5 kg).

Price: HP 208A, \$525.

Specifications, 208A (Option 01.)

(Same as 208A, except:)

Output attenuator: 0 to 110 dB in 1 dB steps.

Accuracy, 10 dB section: from 5 Hz to 100 kHz, error is less than ± 0.125 dB at any step; from 100 kHz to 560 kHz, error is less than ± 0.25 dB at any step.

Accuracy, 100 dB section: from 5 Hz to 100 kHz error is less than ± 0.25 dB at any step; from 100 kHz to 560 kHz, error is less than ± 0.5 dB at any step.

Output monitor: solid-state voltmeter monitors level at input to attenuator, and after set level; scale calibrated -10 dBm to +11 dBm; accuracy ± 0.25 dB at +10 dBm into 600 ohms.

Set level: continuously variable bridged "T" attenuator with 20 dB minimum range.

Price: HP 208A (Option 01.), \$535.

DIGITAL OSCILLATOR

Four digit frequency resolution, 10 Hz to 1 MHz

Model 4204A



SIGNAL SOURCES

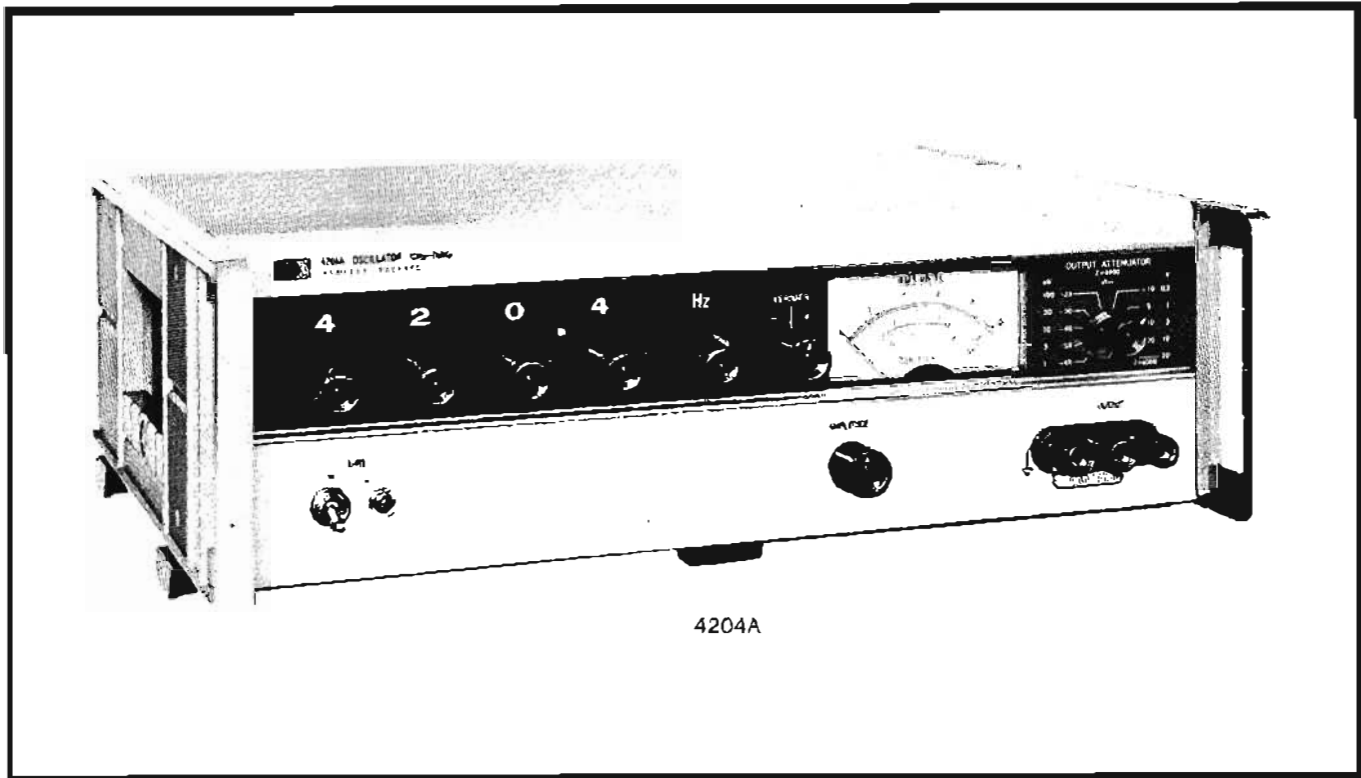

Advantages:

- Simple, rapid 0.2% frequency selection
- Flat frequency response, 10 Hz to 1 MHz
- 0.01% frequency repeatability
- Excellent stability

Uses:

- Production line and repetitive testing
- Standard source for calibrating ac to dc converters
- Response testing of wide or narrow band devices
- Filter checkout

The HP 4204A Digital Oscillator provides accurate, stable test signals for both laboratory and production work. This one instrument does the jobs of an audio oscillator, and ac

voltmeter, and an electronic counter, in applications requiring an accurate frequency source of known amplitude.

Any frequency between 10.00 Hz and 999.9 kHz can be digitally selected with an in-line rotary switch, to four significant figures. As many as 36,900 discrete frequencies are available. Infinite resolution is provided by one vernier control, which also extends the upper frequency limit to 1 MHz. Frequency accuracy is better than $\pm 0.2\%$ and repeatability is typically better than $\pm 0.01\%$.

A built-in high impedance voltmeter measures the output. The meter is calibrated to read volts or dBm into a matched 600 ohm load. (0 dBm = 1 mW into 600 ohms.) The output attenuator has an 80 dB range, adjustable in 10 dB steps with a 20 dB vernier. Maximum output power can be increased to 10 volts (22 dBm) into 600 ohms.

Specifications

- Frequency range:** 10 Hz to 1 MHz, 4 ranges.
- Frequency accuracy:** $\pm 0.2\%$ or ± 0.1 Hz (at 25°C).
- Frequency stability:**
 - $\pm 10\%$ line voltage variation: Less than $\pm 0.01\%$.
 - Change of frequency with temperature: $< \pm 100$ ppm/°C.
- Frequency response:** flat within $\pm 3\%$.
- Output:** 10 V (22 dBm) into 600 ohms, (160 mW). 20 V Open Circuit.
- Output attenuators:** 80 dB in 10 dB steps; $< \pm 0.5$ db error.

Distortion: less than 0.3%, 30 Hz to 100 kHz. Less than 1%, 10 Hz to 1 MHz.

Hum and noise: less than 0.05% of output.

Dimensions: cabinet; 5¼" high, 16¾" wide, 11¼" deep. (134 x 426 x 286 mm).

Power: 115 V; 230 V switch, $\pm 10\%$, 10 watts, 50 to 60 Hz.

Weight: net, 19 lbs (8.5 kg); shipping, 28 lbs (11 kg).

Price: \$695.

Option 01: Output monitor top scale calibrated in dBm/600Ω; bottom scale calibrated in volts; add \$10.

Manufactured by Yokogawa-Hewlett-Packard Ltd., Tokyo.

SIGNAL SOURCES



PUSHBUTTON OSCILLATOR

Three-digit frequency resolution, 10 Hz to 1 MHz

Model 241A

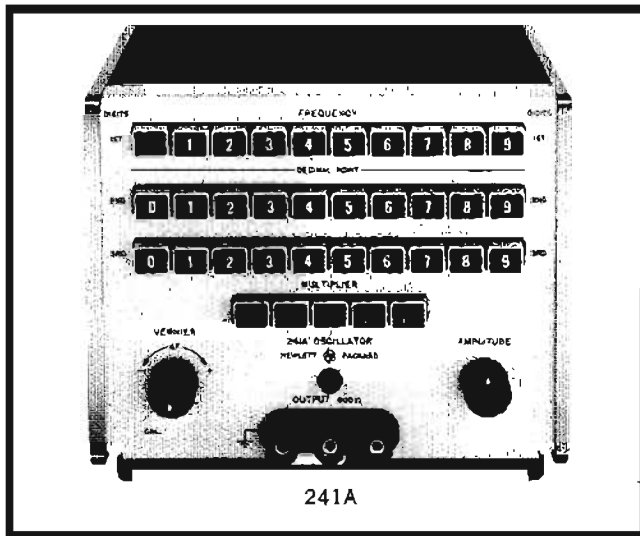

Features:

- Three-digit frequency resolution
- Simple, rapid, accurate frequency selection
- Compact, lightweight, portable
- Flat frequency response, 10 Hz to 1 MHz
- Accurate repeatability

Uses:

- Production line and repetitive testing
- Standard source for calibrating ac-to-dc converters
- Response testing at audio and communication frequencies; narrow- or wideband devices
- Low distortion source in the presence of shock, vibration or hf radiation.

The solid-state HP Model 241A Pushbutton Oscillator provides accurate, stable test signals for laboratory or production measurements.

Any frequency between 10 Hz and 999 kHz can be selected to three significant figures by simply pushing the three appropriate frequency pushbuttons and one of five decade multipliers. These pushbuttons control 900 base frequencies in increments of 0.1 Hz from 10.0 to 99.9 Hz, providing 4500 discrete frequency settings. Infinite resolution is provided by a vernier control, extending the upper frequency to 1 MHz.

Since each discrete frequency setting is a digital function effectively isolated from every other setting, a high degree of calibration dependability is achieved — a major advantage for user convenience. Accuracy is within $\pm 1\%$ of selected value on any range.

Frequency response is flat $\pm 2\%$ over the entire range at any attenuator setting. This is obtained by using special, fixed-precision resistors and large amounts of negative feedback in a unique biased-diode control circuit. A front-panel control adjusts the bridged-tee attenuator for output levels of -30 dBm to $+10$ dBm presenting a constant output impedance of 600 ohms. The attenuator, capacitively de-

coupled from the amplifier circuit, eliminates the need for a dc balance adjustment at the output.

Hum and noise are reduced below 0.05% of the output by the use of low-impedance, solid-state circuitry, shielded power supply transformer, and floating output. These features not only isolate the oscillator from stray field pickup, but also allow the oscillator's use in environments where test setups themselves are subject to pickup. The solid-state design, which contributes to superior stability, inhibits the effect of shock or vibration that is often present in test areas. Instabilities in both frequency and amplitude are virtually eliminated in the solid-state circuitry and fixed tuning elements. During the first two hours the frequency stability at 100 Hz is better than .01%, and at 100 kHz the frequency stability is approximately .02% after initial turn-on. Once warmed up, and in normal laboratory environment where ambient temperature does not change more than 3 or 4 degrees Centigrade over a 24-hour period, the frequency stability is typically better than .04% from day to day.

Convenience - Versatility

The 241A's clean design, functional utility, and lightweight modular construction contribute to its easy portability. Instant frequency selection, lack of tedious dial interpolation, and elimination of frequency ambiguity ideally suit the oscillator to production line work or similar situations where repetitive measurements are made. Here, the frequency repeatability, which is typically better than 0.01%, enables measurements to be made quickly without sacrificing accuracy. And the ability to make a positive accurate frequency selection eliminates the need for any separate frequency indicator; consequently, test procedure is simplified, since a frequency check is unnecessary.

Careful attention to human engineering has resulted in highly visible rectangular pushbuttons for reduction of user fatigue and ease of operation. Frequency ambiguity is prevented by mechanical interlocks inhibiting all but one pushbutton in a given row.

Specifications

Frequency range: 10 Hz to 1 MHz, 5 ranges, 4500 frequency increments per range, with vernier overlap.

Calibration accuracy: $\pm 1\%$.

Frequency response: $\pm 2\%$ into rated load.

Output Impedance: 600 ohms.

Distortion: 1% maximum.

Hum and noise: .05% of output.

Output: $+10$ to -30 dBm into 600 ohms (2.5 volts maximum).

Power: 115 or 230 volts, 50 to 1000 Hz, 1 watt.

Dimensions: standard $\frac{1}{2}$ module 7-25/32" wide x $6\frac{1}{2}$ " high x 8" deep (196 x 166 x 206 mm).

Weight: net $7\frac{3}{4}$ lbs (3.5 kg); shipping 10 lbs (4.5 kg).

Accessory furnished: detachable power cord, NEMA plug.

Price: HP 241A, \$490.

AUDIO SIGNAL GENERATORS

Versatile instruments, 20 Hz to 20 kHz

Models 205AG, 206A



SIGNAL SOURCES

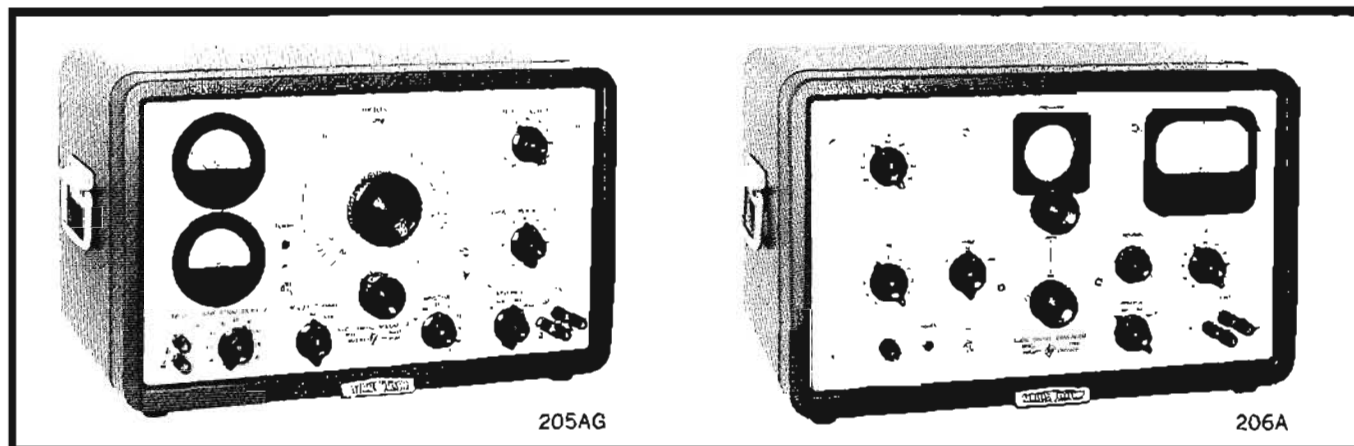

The 205AG Audio Signal Generator materially speeds and simplifies a variety of audio testing jobs where sizable amounts of power are required.

Two voltmeters measure input and output of the device under test. The output level is adjusted by means of the step attenuators, and output impedance can be instantly changed by means of a selector switch to commonly used impedances.

Specifications, 205AG

- Frequency range:** 20 Hz to 20 kHz in three decade ranges.
- Dial accuracy:** $\pm 2\%$ under normal temperature conditions. (Including warm up and changes due to aging of tubes and components.)
- Output:** five Watts maximum into resistive loads of 50, 200, 600 and 5000 ohms; output circuit is balanced and center-tapped; any terminal may be grounded.
- Frequency response:** ± 1 dB, 20 Hz to 20 kHz at output levels up to +30 dBm with output meter reading held constant at +37 dB; ± 1.5 dB, 20 Hz to 20 kHz at output levels above +30 dBm with output meter reading held constant at +37 dB (reference 1000 Hz).
- Output impedances:** 1/6 load impedance with zero attenuator setting; approaches the load impedance with attenuator settings of 20 dB or more.
- Distortion:** less than 1% at frequencies above 30 Hz.
- Hum level:** more than 60 dB below the output voltage or 90 dB below 0 dBm, whichever is the larger.
- Output meter:** calibrated directly in Volts at 600 ohms and dBm (0 dBm = 1 mW in 600 ohms); voltage scale: 0 to 65 V, dB scale +20 to +37 dBm.
- Input meter:** calibrated in dBm from -5 to +8 dBm and in Volts from 0 to 2 V rms; voltage accuracy is $\pm 5\%$ of full scale.
- Input attenuator:** extends meter range to +48 dBm and to 200 V rms in 5 dB steps; accuracy ± 0.1 dB.
- Output attenuator:** 110 dB in 1 dB steps.
- Power:** 115 or 230 Volts $\pm 10\%$, 50 to 1000 Hz, 150 Watts.
- Dimensions:** cabinet: 20 $\frac{3}{4}$ " wide, 12 $\frac{3}{4}$ " high, 15 $\frac{1}{2}$ " deep (527 x 324 x 394 mm); rack mount: 19" wide, 10 $\frac{1}{2}$ " high, 14" deep behind panel (483 x 267 x 356 mm).
- Weight:** net 56 lbs (25.2 kg), shipping 67 lbs (30 kg) (cabinet); net 49 lbs (22.1 kg), shipping 63 lbs (28.3 kg) (rack mount).
- Price:** HP 205AG, \$700 (cabinet); HP 205AGR, \$685 (rack mount).

The HP 206A Audio Signal Generator provides a source of continuously variable audio-frequency voltage at a total distortion level of less than 0.1%. This unusually low distortion, coupled with simple, straightforward circuitry, rugged construction and typical HP ease of operation, makes this signal generator ideal for use in the maintenance of FM broadcasting units and high fidelity audio systems.

The 206A Generator includes an output-matching transformer which allows it to be matched to resistive loads of 50, 150, and 600 ohms. This output system is balanced to ground, and each winding is center-tapped. The internal impedance matches the load impedance. A single-ended 600-ohm output is provided which bypasses the line-matching transformer.

Specifications, 206A

- Frequency range:** 20 Hz to 20 kHz in three decade ranges.
- Dial accuracy:** $\pm 2\%$ including warmup drift.
- Output:** +15 dBm into impedances of 50, 150 and 600 ohms; 10 volts are available into an open circuit.
- Output Impedances:** the generator has a matched internal impedance, and the selection of output impedances includes 50, 150 and 600 ohms center-tapped and balanced, and 600 ohms single-ended.
- Frequency response:** better than ± 0.2 dB at all levels, 30 Hz to 15 kHz, when the output meter reading is held constant.
- Distortion:** less than 0.1% at frequencies above 100 Hz and less than 0.25% from 20 Hz to 100 Hz.
- Hum level:** at least 75 dB below the output signal or more than -100 dBm, whichever is larger.
- Output meter:** calibrated in dBm and also in volts at 600 ohm level, (0 dBm equals 1 mW in 600 ohms).
- Output attenuators:** 111 dB in 0.1 dB steps.
- Power:** 115 or 230 Volts $\pm 10\%$, 50 to 1000 Hz, 140 Watts.
- Dimensions:** cabinet: 20 $\frac{3}{4}$ " wide, 12 $\frac{3}{4}$ " high, 15" deep (527 x 324 x 381 mm); rack mount: 19" wide, 10 $\frac{1}{2}$ " high, 14" deep behind panel (483 x 267 x 356 mm).
- Weight:** net 57 lbs (25.6 kg), shipping 66 lbs (29.7 kg) (cabinet); net 50 lbs (22.5 kg), shipping 62 lbs (27.9 kg) (rack mount).
- Price:** HP 206A, \$975 (cabinet); HP 206AR, \$960 (rack mount).



TEST OSCILLATOR

Solid state, 10 Hz — 10 MHz, 50, 600 Ω outputs
Model 651B

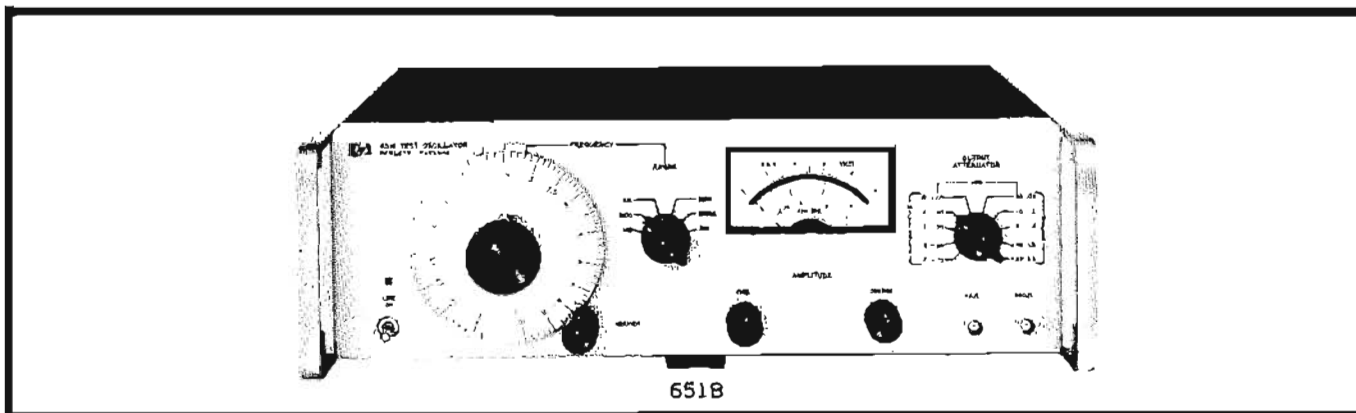

The solid-state HP Model 651B Test Oscillator provides accurate, stable test signals for laboratory or production measurements. This instrument covers a wide frequency range from 10 Hz to 10 MHz continuously variable across six bands.

Two output impedances are available from the front panel, providing 200 mW into 50 Ω or 16 mW into 600 Ω . This capacitance-tuned oscillator delivers a flat output throughout the entire frequency range. This is obtained by using precision components and peak detector AGC circuitry.

Hum and noise are reduced below 0.05% of the output by use of low-impedance, solid-state circuitry and shielded power supply transformer. The solid-state design, which contributes to superior stability, reduces the effect of shock or vibration that is often present in test areas.

Output Monitor and Attenuator

An internal voltmeter measures the output of the power amplifier. The meter is calibrated to read volts or dBm into a matched load. The output attenuator has a 90 dB range, adjustable in 10 dB steps, with a 20 dB range coarse and fine amplitude control. This allows a precise setting of the output voltage. For any attenuator setting, true output is obtained by relating the attenuator reading to the output voltmeter reading. Both the 50 and 600 Ω outputs are available separately on the front panel. The standard 651B output monitor is calibrated to read dBm for 50 Ω (0 dBm = 1 mW into 50 Ω). The Model 651B Option 01 is calibrated to read dBm for 600 Ω (0 dBm = 1 mW into 600 Ω). The Model 651B Option 02 has a 75 Ω and 600 Ω output. The output monitor is calibrated to read dBm for 75 Ω (0 dBm = 1 mW into 75 Ω). Output impedances not listed are available to meet your particular requirements. Discuss your application with your HP field engineer.

Uses

Employing essentially the same modified Wein bridge design as other HP audio oscillators, this wide-band solid-state HP Model 651B is ideally suited for laboratory and production jobs where fast, accurate, wide-band measurements are required. It is specifically designed for the testing of television amplifiers, audio amplifiers, filter networks,

tuned circuits and telephone and telegraphic carrier equipment. It is useful when making loop gain plots on amplifiers, and is excellent for calibrating voltmeters because of its accurate attenuator and output monitor.

Specifications

Frequency range: 10 Hz to 10 MHz; 6 bands; dial calibration, 1 to 10.

Frequency response: flat within $\pm 2\%$, 100 Hz to 1 MHz; $\pm 3\%$, 10 Hz to 100 Hz; $\pm 4\%$, 1 MHz to 10 MHz.*

Dial accuracy (including warmup drift and $\pm 10\%$ line variations): $\pm 2\%$, 100 Hz to 1 MHz; $\pm 3\%$, 10 Hz to 100 Hz and 1 MHz to 10 MHz.

Output: 200 mW (3.16 V into 50 Ω); 16 mW (3.16 V into 600 Ω); 6.32 V open circuit.

Attenuator

Range: 90 dB in 10 dB steps.

Overall accuracy: ± 0.1 dB, -60 dBm to +20 dBm; ± 0.2 dB, -70 dBm to -60 dBm.

Amplitude control: 20 dB range, coarse and fine.

Output monitor: voltmeter monitors level at input of attenuator in volts or dB. Top scale calibrated in volts, bottom scale calibrated in dB.

Accuracy: $\pm 2\%$ of full scale.

Flatness: $\pm 1\%$ of full scale, 20 Hz to 4 MHz; $\pm 2\%$ of full scale, 10 Hz to 20 Hz and 4 MHz to 10 MHz.

Distortion: less than 1% 10 Hz to 5 MHz, 2% at 10 MHz.

Hum and noise: less than 0.05% of maximum rated output.

Temperature range: 0°C to +50°C.

Power: 115 or 230 V $\pm 10\%$, 50 to 1000 Hz, 30 W.

Dimensions: 5-7/32" high, 16 3/4" wide, 13 1/4" deep (132,6 x 425 x 336 mm).

Weight: net 16 lbs (7,3 kg); shipping 21 lbs (9,6 kg).

*This specification applies only at 50 or 75 Ω output. The response above 1 MHz at the 600 Ω output is affected by capacitive loads.

Accessories available

HP 11004A Line Matching Transformer has a frequency range of 5 kHz to 600 kHz, providing fully-balanced 135 or 600 Ω outputs; \$60.

HP 11005A Line Matching Transformer has a frequency range of 20 Hz to 45 kHz, providing fully-balanced 600 Ω output; \$80.

HP 11001A Cable is a male BNC to dual banana plug which provides connection to HP accessories 11004A and 11005A and to the HP 651B; \$6.00.

HP 11048B 50 Ω Feed-Thru Termination; \$10.

Price: HP 651B, \$590.

Option 01: HP 651B Output Monitor, top scale calibrated in dBm/600 Ω , bottom scale calibrated in volts; \$615.

Option 02: HP 651B Output, 75 Ω and 600 Ω . Output Monitor top scale calibrated in dBm/75 Ω , bottom scale calibrated in volts; \$615.

Note: other output impedances above 50 Ω are available on special order.

TEST OSCILLATOR
Make frequency response measurements rapidly
Model 652A

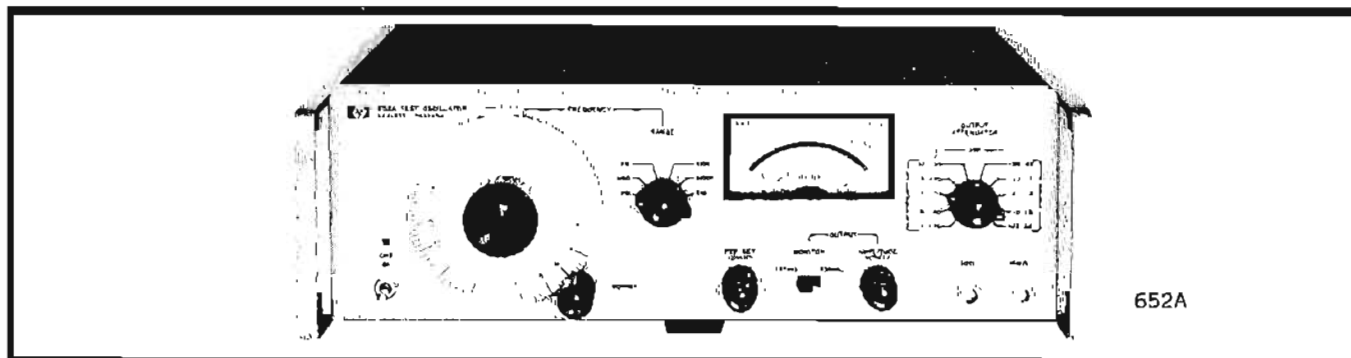

The solid-state HP Model 652A Test Oscillator simplifies frequency response determination by providing a constant amplitude reference voltage of adjustable frequency. Frequency response of voltmeters, oscilloscopes, video amplifiers and filters from 10 Hz to 10 MHz can be quickly and easily measured.

Output Monitor

The HP 652A and HP 651B specifications coincide, except that the 652A offers a different output monitor to make frequency response measurements rapidly with greater resolution.

The monitor is calibrated to read volts or dBm into a matched load when the monitor is in the normal position. True output is obtained by adding the attenuator setting to the output monitor reading.

X20 Expanded Scale

The 652A frequency response is $\pm 0.25\%$ from 10 Hz to 10 MHz when using the EXPAND position of the meter. The monitor meter may only be expanded for voltages between 2.8 to 3.2 V or from 0.9 V to 1.0 V. The expanded meter circuit is located before the output attenuator.

Refer to the E02-738BR, page 194 for use as a voltmeter calibrator.

Specifications

Frequency range: 10 Hz to 10 MHz; 6 bands; dial calibration, 1 to 10.

Dial accuracy (including warmup drift and $\pm 10\%$ line voltage variation): $\pm 2\%$, 100 Hz to 1 MHz; $\pm 3\%$, 10 Hz to 100 Hz and 1 MHz to 10 MHz.

Flatness: $\pm 2\%$, 100 Hz to 1 MHz; $\pm 3\%$, 10 Hz to 100 Hz; $\pm 4\%$, 1 MHz to 10 MHz.*

Amplitude stability: $\pm 2\%$ per mo, +20 $^{\circ}$ C to +30 $^{\circ}$ C.

Output

Maximum: 3.16 V into 50 Ω or 600 Ω ; 6.32 V open circuit; +23 dBm into 50 Ω .

Ranges: 0.1 mV to 3.16 V full scale, 10 steps in 1-3-10 sequence, coarse and fine adjustable; -70 dBm to +23 dBm (50 Ω output) full scale, 10 dB per step, coarse and fine adjustable.

Output monitor (monitors voltage at input to attenuator):
Normal scale

Accuracy: $\pm 2\%$ of full scale.

Frequency response: $\pm 1\%$ of full scale, 20 Hz to 4 MHz; $\pm 2\%$ of full scale, 10 Hz to 20 Hz and 4 MHz to 10 MHz.

Expand scale (expands reference voltage of the Normal Scale from 0.9 to 1.0 or 2.8 to 3.2).**

Frequency response: $\pm 0.25\%$ of reference voltage, +15 $^{\circ}$ C to +35 $^{\circ}$ C (1 mV to 3 V ranges); $\pm 0.5\%$ of reference voltage, 0 $^{\circ}$ C to +50 $^{\circ}$ C (0.1 mV to 3 V ranges).

Attenuator accuracy: $\pm 1\%$, 0.3 mV to 3 V ranges; $\pm 2\%$, 0.1 mV range.

Distortion: <1%, 10 Hz to 5 MHz; <2%, 5 MHz to 10 MHz.

Hum and noise: <0.05% of maximum rated output.

Temperature range: 0 $^{\circ}$ C to +50 $^{\circ}$ C.

Weight: net 17 lbs (7.65 kg); shipping 22 lbs (9.9 kg).

Power: 115 or 230 V $\pm 10\%$, 60 to 1000 Hz, 30 W.

Accessories furnished: HP 11048B 50 Ω Feed-Thru Termination.

Accessories available

HP 738BR Voltmeter Calibrator, \$950.

HP 355C Attenuator, 0 to 12 dB in 1 dB steps, \$150.

HP 11095A 600 Ω Feed-Thru Termination, \$10.

Price: HP 652A, \$725.

HP H02-652A: 75 Ω and 600 Ω outputs, meter calibrated for 75 Ω outputs; \$775. (HP 11094A 75 Ω Feed-Thru Termination furnished.)

*This specification applies only to the 50 Ω output.

**Other voltages can be obtained using HP 652A output attenuator and if desired, an external 1 dB attenuator.



SWEEP SIGNAL GENERATOR

Continuous frequencies from 10 kHz to 32 MHz
Model 675A

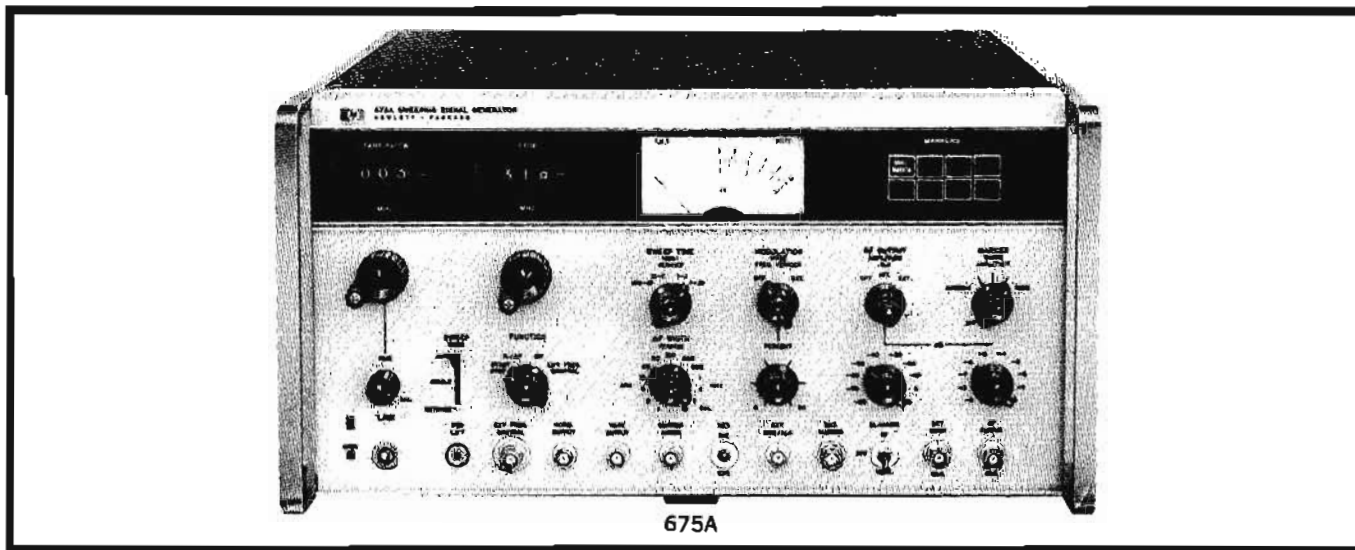

Features:

- 10 kHz to 32 MHz in one range
- 0.15 dB flatness
- CW dial accuracy 0.5% of full scale

Signal Generator (CW)

The CW dial accuracy, low residual and spurious FM, low distortion at all voltage levels, and excellent frequency settable make it ideal for signal generator applications. The CW signal can be internally amplitude modulated by a 1 kHz \pm 15 Hz sine wave with percentage modulation adjustable up to 50%. External amplitude modulation and frequency modulation (ext. freq. control) provide added versatility for communications receiver and transmitter testing. Refer to pages 383 and 384 for sweeper specifications.

Tentative Specifications

Frequency range: 10 kHz to 32 MHz in one range.

Output: maximum +13 dBm (1 V rms into 50 Ω , 2 V rms open circuit); continuously adjustable; impedance, 50 Ω .

RF Flatness	10 kHz	50 kHz	200 kHz	1 MHz	10 MHz	32 MHz
Unleveled:	\approx 1 dB					
Internally leveled:	\approx 1 dB		\approx 0.15 dB		\approx 0.15 dB	
Externally leveled:	\approx 0.15 dB					

System Flatness

Using internal RF

Detector, internally leveled:	10 kHz	50 kHz	200 kHz	10 MHz	32 MHz
	\approx 1 dB	\approx 0.4 dB	\approx 0.25 dB		

Using External RF

Detector, Externally leveled:	10 kHz	100 kHz	1 MHz	10 MHz	32 MHz
	\approx 0.25 dB				

Internal Detector Output (Vertical): at least 1.2 V dc for 1 V rms.

Signal Generator Functions

CW dial accuracy: \pm 0.5% of full scale.

CW settability: 1 kHz.

CW resolution: 20 kHz.

Internal AM: 0 to 50% sinusoidal, 985 to 1015 Hz continuously adjustable.

External AM: 0 to 50%, dc to 1 kHz leveled; 0 to 50%, 50 Hz to 600 kHz unleveled.

External frequency control and external FM

Sensitivity: 1 MHz/V.

Input Impedance: 1 M Ω .

Rate: dc to 4 kHz. Above 4 kHz the range and sensitivity decreases 20 dB/decade.

Attenuator

Range: 99 dB in 10 and 1 dB steps.

Accuracy: \pm 0.3 dB, +10 dB to -10 dB steps, 0 dB to -2 dB steps; \pm 0.4 dB +6 μ V, -20 dB to -80 dB steps, -3 dB to -9 dB steps.

Output monitor

Range: -3 to +3 dB (0.5 V to 1 V).

Accuracy: \pm 0.3 dB, 200 kHz to 32 MHz.

Distortion

Harmonic: >30 dB down from fundamental.

Spurious: >50 dB down from fundamental.

Residual (line related) FM: <70 Hz peak.

Spurious FM: <60 Hz rms.

Frequency drift: <1 kHz/hr, <3 kHz/ $^{\circ}$ C.

Auxiliary output (rear panel): 100 MHz to 132 MHz unleveled.

General

Temperature range: 0 $^{\circ}$ to +50 $^{\circ}$ C.

Power: 115 or 230 V \pm 10%, 50 to 1000 Hz, 80 W max.

Dimensions: 16 $\frac{3}{4}$ " wide, 8 $\frac{3}{4}$ " high, 18 $\frac{3}{8}$ " deep (425 x 221 x 467 mm).

Weight: net 46 lbs (20.8 kg); shipping 51 lbs (23.2 kg).

Accessories furnished: HP 11048A 50 Ω Feed-Thru Termination.

Accessories available

HP 11300A Single-Frequency Marker (frequency must be specified), \$75 (add \$25 for those factory installed).

HP 11097A RF Detector, \$30.

HP 11098A Leveling Detector, \$30.

Price: HP 675A, \$2250.

Option 01: 1 MHz harmonic comb marker, \$2325.

Option 02: 100 kHz harmonic marker, \$2325.

Option 03: 100 kHz and 1 MHz harmonic markers, \$2375.

ATTENUATORS, ACCESSORIES

Match 600, 500 or 135-ohm lines

Models 350C,D; 11004A, 11005A



SIGNAL SOURCES

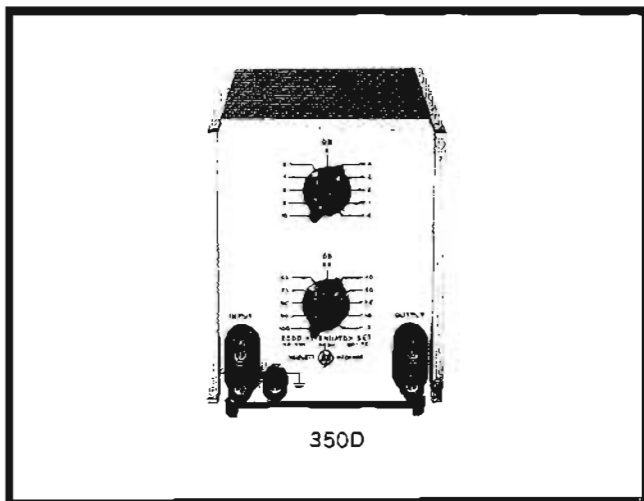

350D

When a high order of accuracy, wide frequency response, large power-handling capacity or special features are required, HP 350 Series Attenuators are of great value and convenience. They are particularly useful in attenuating output of audio and ultrasonic oscillators, measuring gain and frequency response of amplifiers, measuring transmission loss and increasing the scope and usefulness of other laboratory equipment.

Specifications

Attenuation: 110 dB in 1 dB steps.

Accuracy: 10 dB section:

	0 dB	10 dB
dc to 100 kHz	< ±0.125 dB/step	
100 kHz to 1 MHz	< ±0.25 dB/step	

Accuracy: 100 dB section:

	0 dB	70 dB	100 dB
dc to 100 kHz	< ±0.25 dB	< ±0.5 dB/step	
100 kHz to 1 MHz	< ±0.5 dB	< ±0.75 dB/step	

Power capacity: 350C, 500 ohms; 5 W (50 Vdc or rms) maximum, continuous duty. 350D, 600 ohms; 5 W (55 Vdc or rms) maximum, continuous duty.

DC isolation: signal ground may be ±500 Vdc from external chassis.

Dimensions: 5 1/8" wide, 6-3/32" high, 8" deep (130 x 155 x 203 mm).

Weight: net 4 lbs (1,8 kg); shipping 5 lbs (2,3 kg).

Accessories available: HP 11000A Cable Assembly, 44" of RG-58C/U 50Ω coaxial cable terminated by dual banana plugs, \$5. HP 11001A Cable Assembly, as above but with one BNC male connector, \$6. 11075A Carrying Case (refer to page 631), \$45.

Price: HP 350C; 500Ω attenuator, \$140. HP 350D; 600Ω attenuator, \$140.

Oscillator Accessories

11004A Line-Matching Transformer

The 11004A Transformer, with a frequency response between 5 kHz and 600 kHz, provides fully balanced 135 or 600Ω output from single-ended input. Maximum level +22 dBm. HP 11004A, \$60.

11005A Line-Matching Transformer

The 11005A Transformer, with a frequency response between 20 Hz and 45 kHz, provides a fully balanced 600Ω output from single-ended input. Maximum level is +15 dBm. HP 11005A, \$80.

10110A, 10111A BNC-to-Binding-Post Adapters

These adapters mate with a BNC or binding post receptacle, respectively, and provide either binding post or BNC output connectors. The 10110A is a BNC male-to-binding-post adapter; the 10111A is a BNC female-to-banana-plug adapter. Spacing between binding posts is 3/4". HP 10110A, \$5; HP 10111A, \$7.

11048B 50-ohm Feed Thru

11094A 75-ohm Feed Thru

11095A 600-ohm Feed Thru

Precision feed-thru termination with male and female connectors. HP 11048B, \$10; HP 11094A, \$10; HP 11095A, \$10.

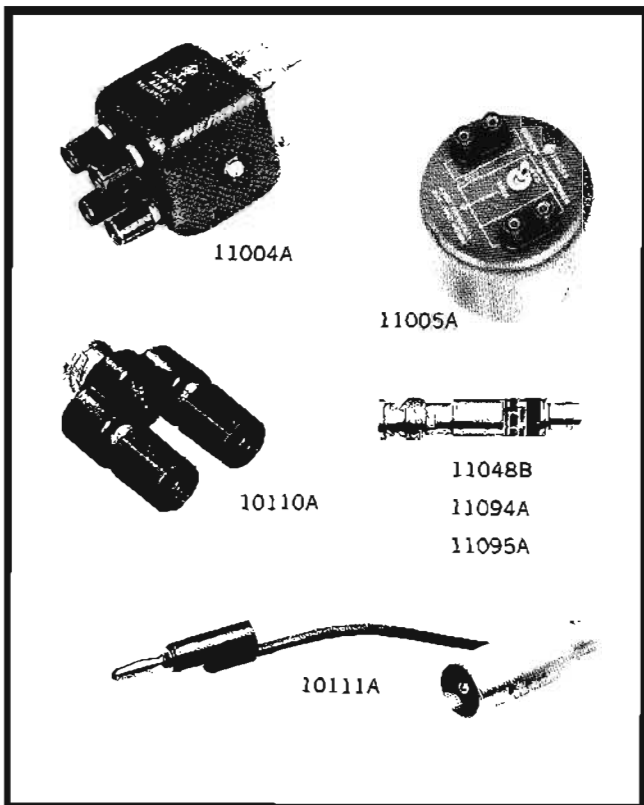

11004A

11005A

10110A

11048B

11094A

11095A

10111A

SIGNAL SOURCES



SIGNAL GENERATORS TO 40 GHz

Essential to practically all microwave measurement applications is signal generating equipment. This section describes the variety of Hewlett-Packard instruments—signal generators and sources, microwave amplifiers, frequency stabilizing equipment, and special-purpose instruments.

Signal generators

Hewlett-Packard offers a complete line of easy-to-use hf, vhf, uhf, and shf signal generators, precision instruments covering frequencies between 50 kHz and 40 GHz. Each HP generator incorporates the following:

(1) accurate, direct-reading, frequency calibration

(2) variable output, accurately calibrated and direct reading

(3) constant output impedance, well matched

(4) varied modulation capabilities

(5) low rf leakage

(6) low harmonic content

(7) freedom from spurious or incidental modulation.

This assures utmost convenience and accuracy for all kinds of measurements, including receiver sensitivity, selectivity or rejection, signal-to-noise ratio, gain bandwidth characteristics, conversion gain, antenna gain, transmission line characteristics, as well as for driving bridges, slotted lines, filter networks, etc.

Table 1 lists the individual Hewlett-Packard signal generators and their major characteristics.

HF to uhf signal generators

These signal generators, including HP 606B, 608E, 608F, and 612A, collectively cover frequencies from 50 kHz to 1.23 GHz and are characterized by extremely low drift and incidental frequency modulation. All may be amplitude (sine, square, pulse) modulated. A feedback loop in the 606B keeps its output and percent modulation constant as frequency is varied. The 608E and 608F also offer level power output resulting in significant time saving as well as operator convenience when the generator is being used to conduct tests at several

Table 1

Model	Frequency range	Characteristics	Page
606B Signal Generator	50 kHz to 65 MHz	output 3 V to 0.1 μ V, mod. BW dc to 20 kHz, low drift and noise, low incidental FM, low distortion, auxiliary rf output, stabilized phase lock capability	354
608E Signal Generator	10 to 480 MHz	output 1 V to 0.1 μ V, into 50-ohm load; AM, pulse modulation, direct calibration, leveled power output, aux rf output	356
608F Signal Generator	10 to 455 MHz	output 0.5 V to 0.1 μ V into 50 ohms, amplitude, pulse modulation, direct calibration, low incidental FM and drift, leveled output, aux rf output, stabilized phase lock capability	356
8708A Synchronizer	50 kHz-455 MHz	Companion lock-box for 606B or 608F permitting $2/10^7$ continuous setability & stability, fm and phase modulation	358
612A Signal Generator	450 to 1230 MHz	output 0.5 V to 0.1 μ V into 50-ohm load; AM, pulse or square-wave modulation, direct calibration	361
614A Signal Generator	0.8 to 2.1 GHz	output at least 0.5 mW to -127 dBm (0.1 μ V) into 50 ohms, pulse or frequency modulation, direct calibration	364
8614A Signal Generator	0.8 to 2.4 GHz	output $+10$ to -127 dBm into 50 ohms, leveled below 0 dBm; internal square-wave; external pulse, AM and FM; auxiliary rf output	362
8614B Signal Source	0.8 to 2.4 GHz	output 15 mW; precision attenuator 130 dB range; internal square-wave, external pulse and FM; auxiliary rf output	362
616B Signal Generator	1.8 to 4.2 GHz	output 1 mW to -127 dBm (0.1 μ V) into 50-ohm load, pulse or frequency modulation, direct calibration	364
8616A Signal Generator	1.8 to 4.5 GHz	output $+3$ to -127 dBm into 50 ohms, leveled below 0 dBm; internal square-wave, external pulse, AM and FM; auxiliary rf output	362
8616B Signal Source	1.8 to 4.5 GHz	output 3 mW; precision attenuator 130 dB range; internal square-wave, external pulse and FM; auxiliary rf output	362
618C Signal Generator	3.8 to 7.6 GHz	output 1 mW to -127 dBm (0.1 μ V) into 50 ohms, pulse, frequency or square-wave modulation, direct calibration, ext FM and pulse modulation, auxiliary rf output	366
620B Signal Generator	7 to 11 GHz	output 1 mW to -127 dBm (0.1 μ V) into 50 ohms, pulse, frequency or square-wave modulation, direct calibration, ext FM and pulse modulation, auxiliary rf output	366
626A Signal Generator	10 to 15.5 GHz	output $+10$ dBm to -90 dBm; pulse, frequency or square-wave modulation, direct calibration	368
628A Signal Generator	15 to 21 GHz	output $+10$ dBm to -90 dBm; pulse, frequency or square-wave modulation, direct calibration	368
938A Frequency Doubler	18 to 26.5 GHz	driven by 9 to 13.25 GHz source, HP 626A, 8690A or klystrons; 100 dB precision attenuator	370
940A Frequency Doubler	26.5 to 40 GHz	driven by 13.25 to 20 GHz source, HP 628A, 8690A or klystrons; 100 dB precision attenuator	370

frequencies. The 606B, 608E, and 608F offer an auxiliary rf output. This fixed-level CW signal can be applied to an HP 5245L Counter for very accurate indication of carrier frequency.

Stabilized rf signal generation

The HP 606B and 608F contain voltage variable capacitors in their oscillator tank circuit enabling phase-locked operation with the HP Model 8708A RF Lock Box obtaining 2/10⁷ settability and stability. Phase-locked operation of the HP 606B and 608F Signal Generators can be obtained without compromise of the instruments' modulation or attenuation characteristics while phase-locked. The HP 8708A Synchronizer enables continuous tuning between lock points, permitting continuous frequency response examination of devices such as highly-selective, steep-skirt, narrow-band filters. The HP 8708A Synchronizer provides the additional benefit of phase and frequency modulation capability with the 606B and 608F signal generators.

Signal sources above 10 MHz

Signal generators available from Hewlett-Packard include general-purpose oscillators and amplifiers, FM signal generators, and specialized signal generators for aircraft navigation systems.

The 3200B VHF Oscillator is a compact, versatile source in the 10 to 500 MHz range suitable for driving bridges, slotted lines, and general-purpose laboratory work. The 230A Signal Generator Power Amplifier provides a convenient means of obtaining power levels up to 4.5 watts in the 10 to 500 MHz range when operated in conjunction with a signal generator.

HP's FM signal generators offer unusual modulation linearity and stability. The 202H FM-AM Signal Generator operates in the 54 to 216 MHz range and is designed to serve the broadcast FM, vhf-tv, and mobile communications markets. The 202J Telemetering Signal Generator is specifically designed for vhf telemetry and covers the 195 to 270 MHz frequency range. An accessory 207H Converter provides additional rf and IF coverage when used with either the 202H or 202J Signal Generators.

The 211A Signal Generator is specifically designed for the testing and

Special purpose signal sources

Application	Frequency range	Modulation	Output	Model	Page
Down converter for 202H	100 kHz to 55 MHz	See specifications		207H	373
Test, calibrate FM receivers	54 to 216 MHz	FM, AM	0.2 V	202H	371
Telemetry tests	1430 to 1540 MHz 2150 to 2310 MHz	FM	-10 to -127 dBm	3205A	372
VOR/ILS tests	88 to 140 MHz	AM	0.2 V	211A	375
ILS tests	329.3 to 335 MHz	AM	0.2 V	232A	
DME/ATC tests	962 to 1213 MHz	Pulse	-10 dBm	8925A	374
Receiver, Transmitter Tests	5280 to 7780 MHz ¹	FM, AM	1 mW	623B	365
	7100 to 8500 MHz	FM, AM	31.6 mW	5636	
	8500 to 10,000 MHz	FM, AM	1 mW	624C	

¹Not continuous coverage, see specifications.

calibration of aircraft VOR omni-range and ILS localizer receivers; an external modulator, such as the Collins 479-F3, is required to provide simulated course and bearing. The 232A Glide Slope Signal Generator is specifically designed for the testing and calibration of ILS glide slope receivers. The 8925A DME/ATC Test Set is designed to provide complete facilities for the testing and calibration of aircraft DME radios and ATC transponders; suitable external modulators are required, such as the Collins 578D-1 and 578X-1, to simulate ground station operation.

UHF to shf signal generators and sources

This group of instruments, covering 800 MHz to 21 GHz, features extremely simple operation. The 614A, 616B, 618C, 620B, 626A and 628A Signal Generators provide large, direct-reading frequency and attenuator dials. They may be pulse, square-wave, and frequency modulated. Their versatility makes them useful for measuring signal-to-noise ratio, receiver sensitivity, swr and transmission line characteristics.

The HP 8614A and 8616A Signal Generators are particularly easy to use. Frequency and attenuation are set on direct-reading digital dials, and push-buttons permit fast, easy selection of function (cw, square-wave modulation or external amplitude, pulse or frequency modulation). Leveled output enables

frequency response testing without time-consuming readjustment of the generator at each new frequency. Each unit contains a unique PIN diode modulator which permits such a wide range of amplitude modulation that remote control of output level or precise leveling with external equipment is possible.

The 8614B and 8616B Signal Sources can be used in many applications previously requiring signal generators. The sources have precision attenuators for relative measurements such as insertion loss, and they have pulse and square-wave capability.

Frequency doublers

Broadband frequency doublers, HP 938A and 940A, provide low-cost signal generator capability in the 18 to 40 GHz range. Designed to be driven by signal sources in the 9 to 20 GHz range, the frequency doublers preserve the versatility and stability of the driving source. Thus, the signals may be cw, pulsed or swept. An output monitor and precision attenuator provide a metered output, even though the input signal is uncalibrated.

In addition to the HP models listed here, the Dymec Division manufactures several rf test sets; each one consists of a signal generator, frequency meter and power meter. Thus, a complete testing system is available in one unit for checking communication and radar systems. Details are given on page 365.



HF SIGNAL GENERATORS

New convenience and performance 50 kHz-65 MHz
Models 606B, 606A

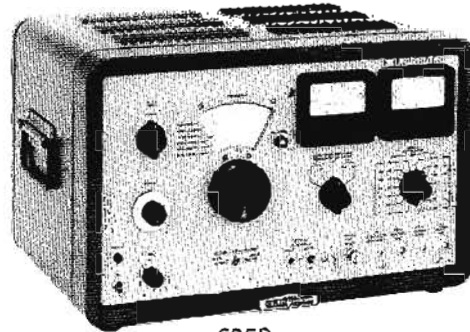

606B

Description

The Hewlett-Packard 606B Signal Generator provides you with high quality, versatile performance with distinctive ease of operation in the important and widely used 50 kHz to 65 MHz frequency range. Output signals are stable and accurately known, output amplitude can be precisely established over a very wide dynamic range, and versatile modulation capabilities are incorporated to satisfy virtually all measurement requirements. Convenient size and form factor, together with a simple, straightforward control panel layout, make the 606B well suited for production line usage as well as laboratory or field applications.

Design

The 606B is a master oscillator-power amplifier (MOPA) design with a broadband buffer amplifier stage between the oscillator and power amplifier circuits for isolation. The MOPA design permits optimization of the oscillator circuit for highest stability including low drift, minimum residual FM, low harmonics, etc., without restricting the modulation characteristics. Modulation is applied to the power amplifier circuit with negligible effect on the oscillator frequency (because of the buffer stage). Very fine frequency settability is achieved through incorporation of a ΔF control which provides better than 10 ppm resolution.

Highest frequency stability

While the basic frequency stability of the 606B is excellent (less than 0.005% drift over a 10 minute period after warm-up), the inclusion of frequency control circuitry in the 606B makes it possible to achieve 250 times greater stability by phase-locking the 606B with the HP 8708A Synchronizer. The 8708A, which is fully compatible with the 606B in every respect, can stabilize the 606B at any frequency (not just at discrete points) with a resultant stability of $2 \times 10^{-7}/10$ minutes and a very high degree of spectral purity. The combination of the 606B and 8708A also permits you to perform narrow band frequency- or phase-modulation of the 606B carrier with very low modulation distortion. The 8708A is described on page 358.

Simplified operation

An outstanding feature of the 606B is the employment of feedback in the RF power amplifier section which results in superior performance characteristics and true ease of operation. The feedback circuit maintains both the output level and the percentage of modulation essentially constant over the entire frequency range, thus making it unnecessary to readjust

controls when changing the operating frequency. The use of feedback also enables you to change the output level without affecting the degree of modulation. The constant output, constant modulation feature results in significant time saving as well as operator convenience, making the 606B an ideal choice for production line operations where semi-skilled personnel can make meaningful measurements.

Versatile amplitude modulation

The use of feedback in the power amplifier section also yields excellent amplitude modulation characteristics. Up to 95% modulation can be achieved with modulating frequencies ranging from dc to 20 kHz. Envelope distortion is very low, less than 1% at 30% AM and less than 3% at 70% AM; this allows you to make more accurate measurements of the distortion characteristics on receivers or detectors. Internal modulation oscillators of 400 Hz and 1000 Hz are provided, and the modulation percentage can be set and read directly on the accurate front panel modulation meter. The wide modulation bandwidth (dc to 20 kHz) means the 606B may be modulated with squarewaves or other complex signals including tone-burst modulation, or you can remotely program the output amplitude. The buffer stage between the master oscillator and power amplifier holds incidental FM with AM to a minimum, assuring accurate measurements.

Accurate output level

The output level from the 606B is continuously adjustable from 3 volts to 0.1 microvolts rms into a 50 ohm load. Direct calibration is provided in both volts and dBm (+23 to -120 dBm) and the output calibration is accurate to within 1 dB at any frequency or level setting. The output system of the 606B is a well matched 50 ohm circuit which minimizes mismatch ambiguities as a factor in overall measurement accuracy. The extremely wide range of output amplitude control makes the 606B very useful for driving bridges and filters as well as complete receiver measurements including sensitivity, selectivity, and image rejection.

The 606B provides an auxiliary RF output; this fixed level (100 millivolts rms minimum) CW signal is for use with the 8708A Synchronizer and can also be applied to an HP 5245L Counter for very accurate indication of carrier frequency. Using the auxiliary RF output does not place any restriction on the modulation capabilities nor on the main RF output level. The 606B also contains a crystal calibrator to provide accurate frequency checkpoints at every 100 kHz or 1 MHz throughout the frequency range of the instrument.

Specifications, 606B

Frequency characteristics

Range: 50 kHz to 65 MHz in 6 bands (50-170 kHz, 165-560 kHz, 0.53-1.8 MHz, 1.76-6 MHz, 5.8-19.2 MHz, 19-65 MHz); total scale length approximately 95 in.

Accuracy: $\pm 1\%$.

Drift: (attenuator on 1 volt range and below) less than 50 parts in 10^6 (or 5 hertz, whichever is greater) per 10 minute period after 2 hour warmup; less than 10 minutes to restabilize after changing frequency.

Stability when used with 8708A Synchronizer: 5×10^{-5} /minute, 2×10^{-7} /10 minutes, 2×10^{-6} /day; $2 \times 10^{-7}/^{\circ}\text{C}$, 0° to 55°C ; 2×10^{-1} /10% line voltage change.

Resettability: vernier control resettability better than 0.15% after initial warmup.

ΔF control: ultra-fine frequency vernier provides better than 10 parts in 10^6 settability; total range of ΔF control approximately 0.1%.

Crystal calibrator: provides frequency checkpoints every 100 kHz and 1 MHz; headphone jack provided for audio frequency output (headphone not included); crystal frequency accuracy better than 0.01% from 0° to 50°C ; cursor on frequency dial adjustable over small range to aid in interpolation adjustment; calibrator may be turned off when not in use.

Residual FM: less than ± 1 part in 10^6 or ± 20 hertz, whichever is greater.

Frequency control input: BNC female connector for "frequency control output" from 8708A Synchronizer; can also be used for external frequency control: voltage change from -2 to -32 volts changes frequency approximately 0.2% at low end of each band and approximately 6% at high end; nominally 4 k Ω input impedance, direct-coupled; voltage limits: 0 volt \leq applied voltage ≤ 50 volts negative.

Output level: continuously adjustable from 0.1 microvolt to 3 volts into 50 ohm resistive load; output attenuator calibrated in 10 dB steps from 3 volt full scale to 1.0 microvolt full scale (into 50 ohms), also calibrated in dBm (0 dBm=1 milliwatt in 50 ohms); vernier control provides continuous adjustment of voltage between full scale ranges; output level indicated on RF Output Meter calibrated in volts (0 to 1 and 0 to 3 volts) and dBm (-10 to $+3$ dBm).

Frequency response and output accuracy (attenuator range 1 volt and below; 50 ohm resistive load): at any output voltage setting, output level variation with frequency change is less than 2 dB, total, across entire frequency range; output accuracy better than ± 1 dB at any frequency.

Impedance: 50 ohms, SWR less than 1.2 on 0.3 volt attenuator range and below.

RFI: meets all conditions specified in MIL-I-6181D; permits receiver sensitivity measurements down to at least 0.1 microvolt.

Harmonic output: at least 30 dB below the carrier.

Spurious AM: hum and noise sidebands are 70 dB below carrier down to thermal level of 50 ohm output system.

Auxiliary RF output: fixed level CW signal from RF oscillator provided at front panel BNC female connector for use with HP 8708A Synchronizer or other external equipment (e.g., frequency counter). Minimum output: 100 mV rms into 50 ohms from 50 kHz to 19.2 MHz, 200 mV rms from 19 to 65 MHz.

Modulation characteristics

Internal AM:

Frequency: 400 and 1000 Hz, $\pm 5\%$; modulation signal available at front panel BNC female connector for synchronization of external equipment.

Modulation level: 0 to 95% on 1 volt range and below; 0 to at least 30% on 3 volt range.

Carrier envelope distortion: less than 1% at 30% AM; less than 3% at 70% AM (attenuator on 1 volt range and below).

Incidental frequency modulation (attenuator on 1 volt range and below, 30% modulation): less than $5 \times 10^{-6} + 100$ Hz peak.

External AM:

Frequency: dc to 20 kHz maximum, dependent on carrier frequency (f_c) and percent modulation as tabulated:

Maximum modulation frequency:

30% Mod:

$0.06f_c$;

70% Mod:

$0.02f_c$;

Squarewave Mod:

$0.003f_c$ (3 kHz max).

Modulation level: 0 to 95% on 1 volt attenuator range and below, 0 to at least 30% on 3 volt range.

Input required: 4.5 volts peak produces 95% modulation (maximum input 50 volts peak); input impedance 1000 ohms.

Carrier envelope distortion: less than 1% at 30% AM, less than 3% at 70% AM (attenuator on 1 volt range and below).

Modulation meter accuracy: $\pm 5\%$ of full scale, 0 to 90%, for modulation frequencies to 10 kHz, $\pm 10\%$ of full scale for frequencies from 10 kHz to 20 kHz.

Modulation level constancy (internal or external AM; attenuator on 1 volt range and below): modulation level stays constant within $\pm 1/2$ dB regardless of carrier frequency and output level changes.

General

Power: 115 or 230 V $\pm 10\%$, 50 to 400 Hz, 135 W.

Dimensions: cabinet mount, 20 $3/4$ " wide, 12 $1/2$ " high, 14 $3/4$ " deep, (527 x 318 x 370 mm).

Weight: cabinet mount, net, 55 lbs (24.8 kg); shipping, 65 lbs (29.3 kg); rack mount, net, 50 lbs (22.5 kg); shipping, 63 lbs (28.4 kg).

Accessories available:

11507A Output Termination, provides 3 positions: 50 ohms (for use into high impedance); 5 ohms (10:1 voltage division); IEEE Standard Dummy Antenna (driven from 10:1 divider); price, \$70.

11509A Fuse Holder, provides protection for output attenuator when 606B is used for transceiver tests; price, \$25.00.

10514A Mixer, for use as nanosecond pulse modulator; price, \$250.

Price: Model 606B (cabinet mount), \$1550.; Model 606BR (rack mount), \$1535.

Model 606A

The Model 606A covers the same frequency ranges as the 606B, but does not include the frequency control input feature that allows frequency stabilization by the Model 8708A Synchronizer. Model 606B specifications apply to the 606A with the following exceptions: an auxiliary uncalibrated RF output is not included; harmonic output is less than 3%; the crystal calibrator provides check points at 100 kHz (useful to 6 MHz) and 1 MHz intervals; output power level frequency response is ± 1 dB over the entire frequency range.

Price: HP 606A (cabinet), \$1,350; HP 606AR (rack mount) \$1,335.



VHF SIGNAL GENERATORS

Improved versatility and value 10-480 MHz

Models 608C/D/E/F; 8708A

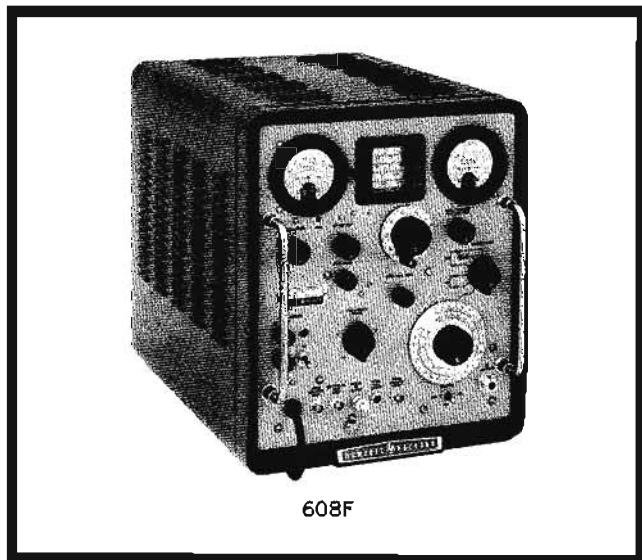

Description

Models 608E and 608F provide high-quality, versatile performance with distinctive ease of operation. The 608E provides an output of up to 1 volt over the range from 10 to 480 MHz, and the 608F provides an output of up to 0.5 volt from 10 to 455 MHz.

The 608E is an improved version of the popular and time-proven HP 608C/D Signal Generators. The instrument is a master oscillator-power amplifier (MOPA) type with a broadband buffer amplifier stage between the oscillator and power amplifier circuits for isolation. The MOPA design permits optimization of the oscillator stage for high stability of 0.005% per 10 minutes, minimum residual FM, and low harmonics without restricting the modulation characteristics. Modulation is applied to the power amplifier stage with negligible effect on the oscillator frequency.

Modulation capability

The use of feedback in the power amplifier section yields excellent amplitude modulation characteristics. Up to 95% modulation can be achieved with modulating frequencies ranging from 20 Hz to 20 kHz. Envelope distortion is very low, less than 2% at 30% AM and less than 5% at 70% AM; thus you can make more accurate measurements of the distortion characteristics on receivers or detectors. Internal modulation oscillators of 400 Hz and 1000 Hz are provided, and the modulation percentage can be set and read directly on the accurate front panel modulation meter. The buffer amplifier stage between the master oscillator and power amplifier holds incidental FM with AM to a minimum, assuring accurate measurements.

Accurate output level

Output levels of the Models 608E/F are accurately attenuated to provide continuously adjustable calibrated output from 0.1 microvolt to 1 volt rms (608E) or 0.5 volt rms (608F) into a 50 ohm load. Direct calibration is provided in both volts and dBm (to -127 dBm) and the output calibration is accurate to within 1 dB at any frequency or level setting. The output system of the 608E/F is a well matched 50 ohm circuit which minimizes mismatch ambiguities as a factor in overall measure-

ment accuracy. The extremely wide range of output amplitude control makes the 608E/F very useful for driving bridges and filters as well as complete receiver measurements including sensitivity, selectivity, and image rejection.

Models 608E/F provide an auxiliary RF output; this fixed level (180 millivolts rms minimum) CW signal is for use with an HP 5245L Counter for very accurate indication of carrier frequency. On the 608E, this output is also for use with the 8708A Synchronizer. Using the auxiliary RF output does not place any restriction on the modulation capabilities nor on the main RF output level. The units also contain a crystal calibrator to provide accuracy frequency checkpoints at every 1 or 5 MHz throughout the frequency range.

High settability

The fine frequency vernier is an electronic fine tuning adjustment of the output frequency. Frequency settability with better than 10 ppm resolution is possible to obtain precise settings for critical tests. When used with the internal crystal calibrator, 608E frequency accuracy can be increased by a factor of 50 (factor of 100 for the 608F) over the main dial calibration of 1% without the use of an external frequency meter.

608F/8708A combination

The Model 8708A Synchronizer is an easy-to-use frequency stabilizer that allows the 608F to be phase-locked at any frequency. Full AM and output level features of the 608F are retained during phase-lock. The 8708A increases frequency stability by a factor of 250 with the extra benefit of 8708A precise tuning resolution for settability to 2 parts in 10^7 . The 608F/8708A combination also permits narrowband frequency and phase modulation to be applied with very low distortion.

Specifications, 608E/F

Frequency characteristics

Range: 608E: 10 - 480 MHz in 5 bands (10-21, 21-43, 43-95, 95-215, and 215-480 MHz. 608F: 10 - 455 MHz in 5 bands (10-21, 21-44, 44-95, 95-210, and 210-455 MHz).

Accuracy: 608E: $\pm 0.5\%$. 608F: $\pm 1\%$.

Drift: 608E: less than 50 parts in 10^6 per 10 minute period after one hour warmup. Less than 10 minutes to restabilize after changing frequency. 608F: less than 50 parts in 10^6 per 10 minute period after one hour warmup; less than 10 minutes to restabilize after changing frequency; stability when used with 8708A Synchronizer: 5×10^{-8} /minute; 2×10^{-7} /10 minutes; 2×10^{-6} /day; $2 \times 10^{-7}/^{\circ}\text{C}$ (0° to 55°C); 2×10^{-7} /10% line voltage change.

Frequency control input (608F ONLY): BNC female connector for "Frequency Control Output" from 8708A Synchronizer can also be used for external frequency control; voltage change from -2 to -32 volts changes frequency approximately 0.2% at low end of each band and approximately 2% at high end; nominal $k\Omega$ input impedance, direct-coupled; voltage limits, 0 to -50 V.

Resettability: 608E: main frequency control resettability better than $\pm 0.1\%$ after initial warmup; Fine Frequency Adjust provides approximately 25 kHz settability at 480

MHz (proportionately finer adjustment at lower frequencies). 608F: main frequency control resettability better than $\pm 0.1\%$ after initial warmup; Fine Frequency Adjust provides approximately 25 kHz settability at 455 MHz (proportionately finer adjustment at lower frequencies).

Tuning control: frequency control mechanism provides a main dial calibrated in megacycles and a vernier dial for interpolation purposes; total scale length, approximately 45 inches; calibration, every other megahertz 130 to 270 MHz; every 5 MHz above 270 MHz.

Crystal calibrator: provides frequency check points every 1 MHz up to 270 MHz or every 5 MHz over the range of the instrument; headphone jack provided for audio frequency output (headphones not included); crystal frequency accuracy better than 0.01% at normal room temperatures; cursor on frequency dial adjustable over small range to aid in interpolation adjustment; calibrator may be turned off when not in use.

Residual FM: less than ± 5 parts in 10^7 peak.

Harmonic output: at least 35 dB below the carrier for harmonic frequencies below 500 MHz.

Output characteristics

Output level: 608E: continuously adjustable from 0.1 μV to 1.0 volt into a 50 ohm resistive load; output attenuator calibrated in volts and dBm (0 dBm = 1 mW in 50 ohms).

608F: continuously adjustable from 0.1 μV to 0.5 volt into a 50 ohm resistive load; output attenuator calibrated in volts and dBm (0 dBm = 1 mW in 50 ohms).

Accuracy: within ± 1 dB of attenuator dial reading at any frequency when RF Output Meter indicates "ATTENUATOR CALIBRATED."

Levelling: internal feedback circuit retains "ATTENUATOR CALIBRATED" reference on RF Output Meter over wide frequency ranges (typically octave bands); adjustment of front panel AMP. TRIMMER control (only) for maximum RF output indication automatically restores initial carrier level for greater frequency changes.

Impedance: 50 Ω with a maximum SWR of 1.2 for attenuator setting below -7 dBm.

RFI: meets all conditions specified in MIL-I-6181D; permits receiver sensitivity measurements down to at least 0.1 μV .

Auxiliary RF output: 608E: fixed level CW signal from RF Oscillator (minimum amplitude 180 mV rms into 50 ohms) provided at front panel BNC female connector for use with external equipment (e.g., frequency counter).

608F: fixed level CW signal from RF Oscillator (minimum amplitude 180 mV rms into 50 ohms) provided at front panel BNC female connector for use with HP 8708A Synchronizer or other external equipment (e.g., frequency counter).

Modulation characteristics

(Front panel AMP TRIMMER control adjusted for maximum indication on RF Output Meter and RF Output Meter set to "ATTENUATOR CALIBRATED.")

Internal AM

Frequency: 400 and 1000 Hz, $\pm 10\%$; modulation signal available at front panel BNC female connector for synchronization of external equipment.

Modulation level: 608E: 0 to 95%, modulation at carrier

levels 0.5 volt and below; continuously adjustable with front panel MOD LEVEL control.

608F: 0 to 95% modulation with Output Attenuator at 0.224 volt (1 mW) or below; continuously adjustable with front panel MOD LEVEL control.

Carrier envelope distortion: less than 2% at 30% AM and less than 5% at 70% AM.

External AM

Frequency: 20 Hz to 20 kHz.

Modulation level: 608E: 0 to 95% modulation at carrier levels of 0.5 volt and below; continuously adjustable with front panel MOD LEVEL control; input required, 1-10 volts, rms (1000 Ω input impedance).

608F: 0 to 95% modulation with Output Attenuator at 0.224 volt (1 mW) or below; continuously adjustable with front panel MOD LEVEL control; input required, 1-10 volts, rms (1000 Ω input impedance).

Carrier envelope distortion: less than 2% at 30% AM, less than 5% at 70% AM.

External control of carrier level can be achieved through application of dc voltage in EXT AM mode.

Modulation meter accuracy: $\pm 5\%$ of full scale 0 to 80%, $\pm 10\%$ from 80% to 95% (for INT AM or 20 Hz to 20 kHz EXT AM).

Incidental frequency modulation (at 400 and 1000 Hz modulation): less than 1000 Hz peak at 50% AM for frequencies above 100 MHz; for frequencies below 100 MHz, less than 0.001% at 30% AM.

External pulse modulation:

Rise and decay time: from 40 MHz to 220 MHz, combined rise and decay time less than 4 μs ; above 220 MHz combined rise and decay time less than 2 μs .

On-off ratio: at least 20 dB for pulsed carrier levels of 0.5 volt and above.

Input required: positive pulse, 10-50 volts peak, input impedance 2000 Ω .

General:

Power: 115 or 230 V $\pm 10\%$, 50 to 400 Hz; approximately 220 W.

Dimensions: cabinet: 13 $\frac{1}{4}$ " wide, 16 $\frac{5}{8}$ " high, 21" deep (337 x 416 x 533 mm); rack mount: 19" wide, 13-31/32" high, 18 $\frac{3}{8}$ " deep behind panel (483 x 335 x 467 mm).

Weight:

Cabinet mount: net, 62 lbs (28 kg); shipping, 74 lbs (33,4 kg).

Rack mount: net, 62 lbs (28 kg); shipping, 83 lbs (37,4 kg).

Accessories available:

11508A output cable provides 50 ohms termination and standard binding posts at the end of a 24-inch (610 mm) length of cable; allows direct connection of the signal generator to high impedance circuits. \$18.00.

11509A Fuse Holder provides protection for the output attenuator when the Model 608E/F is used for transmitter tests. \$25.00.

10514A Mixer for use as nanosecond pulse modulator or balanced modulator. \$180.00.

Price: Model 608E (cabinet), \$1450.00; Model 608ER (rack mount), \$1470.00; Model 608F (cabinet), \$1600.00; Model 608FR (rack mount), \$1620.00.

VHF SIGNAL GENERATORS *continued*

Improved versatility and value 10-480 MHz
Models 608C/D/E/F; 8708A

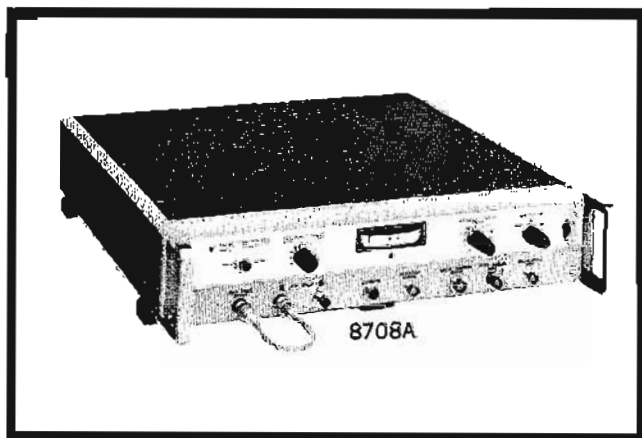
**HP Model 8708A Synchronizer**

The 8708A Synchronizer is a phase-lock frequency stabilizer that allows you to obtain crystal-oscillator frequency stability in the 606B and 608F Signal Generators at any frequency within their ranges. The outstanding AM and output level control capabilities of the signal generators are retained. Phase-locking eliminates microphonics and drift, resulting in a frequency stability of 2×10^{-7} per 10 minutes, an increase by a factor of 250. The 8708A includes an ultrafine frequency vernier which can tune the reference oscillator over a range of $\pm 0.25\%$ permitting frequency settability to 2 parts in 10^7 . This high order stability and settability can be achieved at any frequency in the 606B and 608F range, eliminating phase-locking at only discrete frequencies. This provides a very stable, yet tunable signal generator that satisfies many critical applications including measurements on SSB and narrowband receivers.

An external 20 MHz frequency reference can be used; the resultant stability is that of the external reference. Use of an external reference, however, results in just fixed discrete lock points (unless the reference is frequency tunable $\pm 0.25\%$ around 20 MHz).

Narrowband frequency and phase modulation with very low distortion (better than 1% linearity) of the 606B and 608F Signal Generators can be applied through the 8708A. Narrowband sweeping of the carrier under very stable conditions is valuable for filter or amplifier skirt response tests as well as Q studies of frequency selective circuits.

Specifications, 8708A

Frequency range: 50 kHz to 500 MHz; phase-locks 606B or 608F Signal Generator at any carrier frequency*, with 2×10^{-7} settability.

Input signal level (signal to be stabilized): proper signal level automatically provided by 606B and 608F; general requirements:

50 kHz to 20 MHz: 0.1 to 2 V rms into 50Ω ; 10 to 500 MHz, 180 to 400 mV rms (<20% distortion), into 50Ω .

Frequency reference: internal or external 20 MHz ($\pm 0.25\%$); external reference requirements; (a) when signal to be synchronized is between 50 kHz and 20 MHz, 180 to 400 mV rms (<20% distortion), into 50Ω ; (b) when signal to be synchronized is between 10 and 500 MHz, 0.1 to 2 V rms into 50Ω .

Internal frequency reference stability:

Short term (RMS deviation): 5×10^{-8} /minute; 2×10^{-7} /10 minutes.

Long term: 2×10^{-6} /day.

With temperature: $2 \times 10^{-7}/^\circ\text{C}$, 0 to 55°C .

With line voltage: $2 \times 10^{-7}/10\%$ line voltage change.

(Note: stability in "External Reference" mode is that of external reference source).

Spectral purity (stabilized RF output of 606B or 608F Signal Generator):

Spurious signals: non-harmonically related signals greater than 60 dB below carrier.

Signal-to-AM noise ratio:** >70 dB.

Signal-to-phase noise ratio:** >60 dB, 10 MHz and below;
>60 dB $-20 \log \frac{f \text{ MHz}}{10}$, above 10 MHz.

RMS fractional frequency deviation: less than 5×10^{-8} averaged over 10 ms (30 kHz noise bandwidth).

Frequency control output: frequency control voltage directly compatible with 606B and 608F Signal Generators; output voltage range, -2 to -32 volts (max).

Modulation

Frequency modulation: maximum modulation rates and frequency deviation for $\leq 1\%$ distortion:

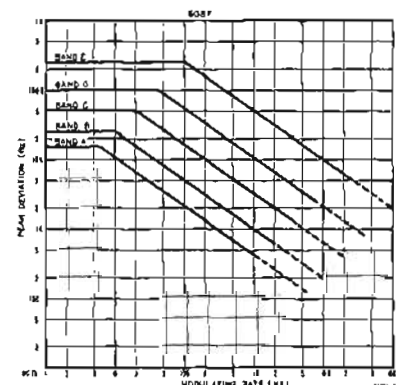
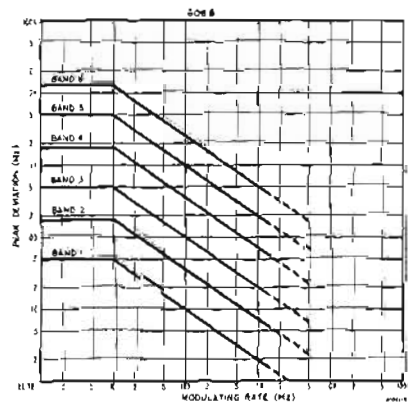

Modulation sensitivity (ac or dc—Mod. level control at maximum): (0.5 kHz/V) (carrier freq. in MHz).

Note: dc input limits, 0 to 10 volts (input connector biased at +10 V from a 10 k ohm source).

Phase modulation: maximum modulation rate and phase deviation for $\leq 1\%$ distortion:

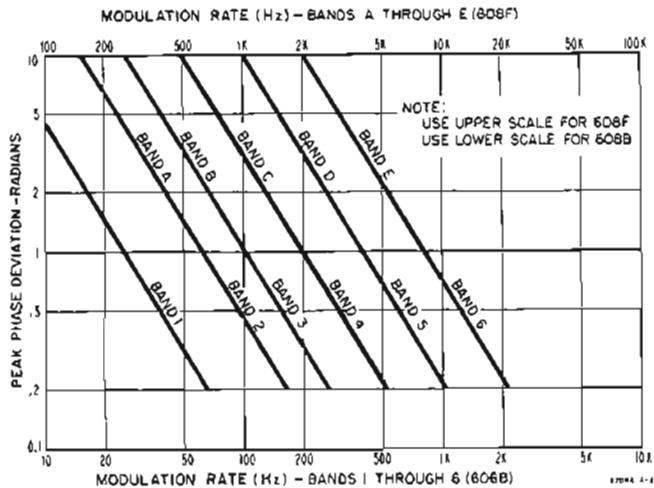

Modulation sensitivity (ac only—Mod. level control at maximum): (0.01 radian/V) (carrier freq. in MHz).

Deviation monitor: dc output voltage which is proportional to frequency and phase deviation; output voltage, deviation ratio varies with carrier frequency, output voltage range approximately -1 to +3 V.

RFI: meets all conditions specified in MIL-I-6181D.

Warm-up time: 1½ hr.

Power: 115 or 230 V $\pm 10\%$, 50 to 400 Hz; approximately 48 W.

Dimensions: 16¾" wide, 3-25/32" high, 18⅜" deep (425 x 96 x 467 mm); hardware furnished for rack mount, 19" wide, 3-15/32" high, 16⅜" deep behind panel (483 x 88 x 416 mm).

Furnished: interconnecting cables for use with 606B and 608F Signal Generators.

Weight: net, 27 lbs (12,2 kg); shipping, 31 lbs (14 kg).

Price: Model 8708A, \$1800.00.

VHF Signal Generators Models 608C and 608D

The Model 608C/D are designed as broadly applicable VHF signal generators. Both units feature internal modulation of 400 and 1000 Hz standard test tones for routine AM applications, and can be externally modulated up to 95%. Versatile

*Using 8708A Internal Reference, or external reference adjustable over 0.5% frequency range. With fixed frequency external reference, interval between lock points varies from 62.5 Hz at 50 kHz to 500 kHz above 210 MHz.

** (In a 30 kHz band centered on the carrier, excluding a 1 Hz band centered on the carrier).

modulation capabilities allow pulse and transient testing of VHF receivers. Accuracy of measurements is enhanced by 608C/D minimum incidental FM with AM, modulation distortion, and frequency drift. Models 608C/D feature calibrated RF output attenuation down to 0.1 μ V, and provide high quality pulses as short as 1 μ s at RF frequencies above 100 MHz.

The Model 608C is a high power, stable and very accurate generator for general lab and field use, providing 1 volt maximum RF output and broad frequency coverage from 10 to 480 MHz.

Maximum output of the 608D is 0.5 volt through the range of 10 to 420 MHz. A built-in crystal calibrator provides accurate frequency check points at 1 and 5 MHz intervals.

Major specifications, 608C,D

Frequency range: 608C, 10 to 480 MHz in 5 bands; 608D, 10 to 420 MHz in 5 bands.

Frequency dial calibration accuracy: 608C, $\pm 1\%$; 608D, $\pm 0.5\%$.

Resettability: better than $\pm 0.1\%$ after warm-up.

Frequency drift: $< 0.005\%$ over a 10 minute interval after initial warm-up (15 to 35°C ambient).

Output level: 608C, 0.1 μ V to 1 V into 50 Ω ; 608D, 0.1 μ V to 0.5 V into 50 Ω ; attenuator dial calibrated in volts and dBm; (0 dBm equals 1 mW).

Output voltage accuracy: ± 1 dB into 50 Ω .

Generator impedance: 50 ohms; maximum swr 1.2.

Internal AM: 400 Hz $\pm 10\%$ and 1000 Hz $\pm 10\%$.

External AM: 0 to 95% at output levels of 0 dBm and below at modulation frequencies 20 Hz to 20 kHz; input requirements, 0.5 V rms across 15 k Ω .

Modulation meter accuracy: $\pm 10\%$ of full scale, 30% to 95% modulation.

Envelope distortion: less than 5% at 30% sine-wave modulation; less than 10% at 50% sine-wave modulation.

External pulse modulation: positive 5 V peak pulse required; 40 to 220 MHz, combined rise and decay time of RF pulse less than 4 μ s, above 220 MHz, combined rise and decay time of RF pulse less than μ s; pulse on-off ratio at least 20 dB.

Incidental FM: 608C, $< 0.0025\%$ at 30% AM, 21 to 480 MHz; 608D, < 1000 Hz peak at 50% AM above 100 MHz, $< 0.001\%$ at 30% AM below 100 MHz.

Price: HP 608C, \$1250 (cabinet); HP 608CR, \$1270 (rack mount); HP 608D, \$1350 (cabinet); HP 608DR \$1370 (rack mount).

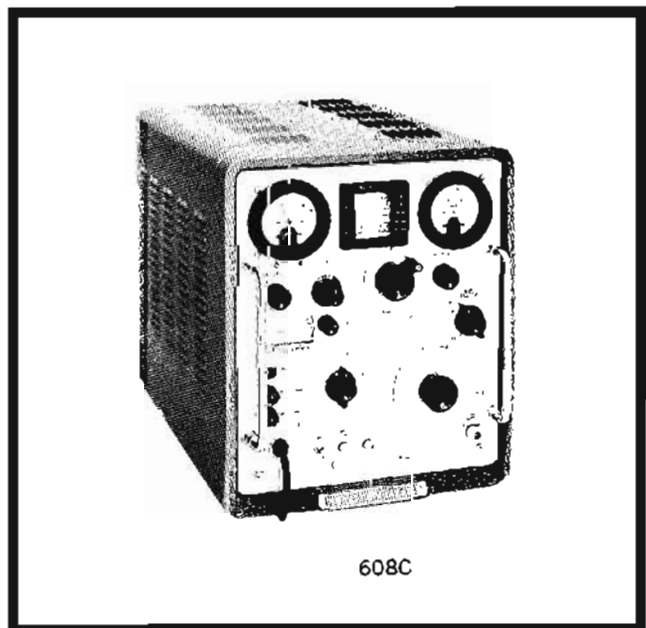

608C

SIGNAL SOURCES



VHF OSCILLATOR

10 to 500 MHz; to 1000 MHz with Accessory Probe
Model 3200B

The HP 3200B VHF Oscillator provides low cost, stable, 10 to 500 MHz RF for testing receivers and amplifiers, and driving bridges, slotted lines, antennas, and filter networks. Good pulse modulation sensitivity allows standard audio oscillators to be used to provide usable square-wave modulation; a 2.5-volt sine wave will provide adequate drive for this type application. The 3200B can also serve as a local oscillator for heterodyne detector systems and as a marker source for swept systems. An optional accessory Frequency Doubler Probe, HP 13515A, provides additional frequency coverage from 500 to 1000 MHz.

Though the oscillator stability is specified as .002% for a 5-minute period after warmup, typical data indicates that,

under controlled conditions, stabilities of 0.0001% are attainable at some frequencies.

Effective RF shielding permits measurements at levels down to 1 μ V.

A front panel vernier control varies the plate voltage in the oscillator, electrically refining the attenuator piston setting.

RF is read on an expanded slide-rule type scale. The oscillator may be precisely tuned by means of a mechanical vernier activated by the main tuning control.

The 3200B is well suited for bench use and may be adapted for standard 19-inch rack mounting.

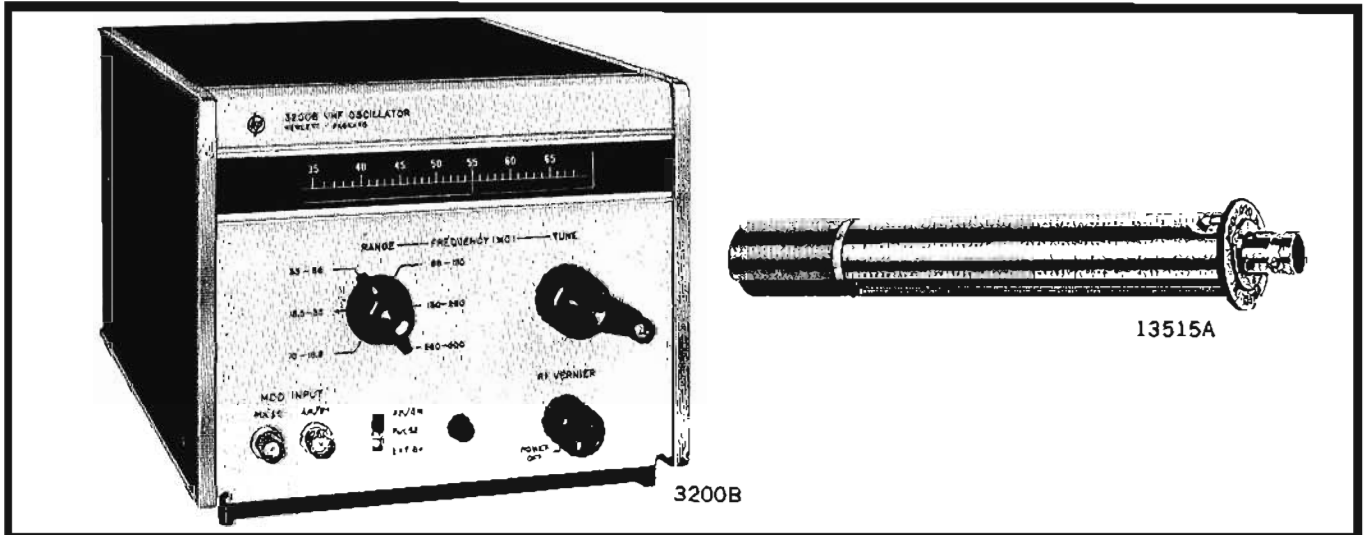

Specifications

Frequency range: 10 to 500 MHz in six bands: 10 to 18.8 MHz; 18.5 to 35 MHz; 35 to 68 MHz; 68 to 130 MHz; 130 to 260 MHz; 260 to 500 MHz.

Frequency accuracy: within $\pm 2\%$ after $\frac{1}{2}$ hour warmup.

Frequency calibration: increments of less than 4%.

Frequency stability (after 4-hour warmup under 0.2 mW load): short term (5 minutes) $\pm 0.002\%$; long term (1 hour) $\pm 0.02\%$; line voltage (5-volt change) $\pm 0.001\%$.

RF output:

Maximum power (across 50-ohm external load): >200 mW (10 to 130 MHz); >150 mW (130 to 260 MHz); >25 mW (260 to 500 MHz).

Range: 0 to >120 dB attenuation from maximum output.

Load impedance: 50 ohms nominal.

RF leakage: sufficiently low to permit measurements at 1 μ V. RFI: meets requirements of MIL-I-6181D.

Amplitude modulation: externally modulated.

Range: 0 to 30%.

Distortion: <1% at 30% AM.

External requirements: approximately 20 volts rms into 600 ohms for 30% AM, 200 Hz to 100 kHz.

Pulse modulation: externally modulated.

External requirements: 2.5-volt negative pulse into 2000 ohms.

Power: 105 to 125 V or 210 to 250 V, 50 to 1000 Hz, 30 W.

Dimensions: 7 $\frac{5}{8}$ " wide, 6 $\frac{1}{2}$ " high, 13 $\frac{1}{8}$ " deep (194 x 165 x 333 mm).

Weight: net 15 lbs (6.8 kg), shipping 19 lbs (8.6 kg).

Accessories available: 13515A Frequency Doubler Probe; 00501B, 00514B, 00517B Output Cables; 00502B, 00506B Patching Cables.

Price: HP 3200B, \$525; HP 13515A, \$95.

UHF SIGNAL GENERATOR

All-purpose uhf signal generator, 450 to 1230 MHz
Model 612A



SIGNAL SOURCES



612A

Here is an all-purpose, precision signal generator particularly designed for utmost convenience and applicability throughout the important uhf-tv frequency band. It is ideally suited for measurements in uhf-television broadcasting, studio-transmitter links, citizen's radio and public service communications systems. The HP 612A also covers the important frequencies used in aircraft navigation aids such as DME, TACAN and airborne transponders. Accessory modulators, available from many of the manufacturers of these navigational aids, enable the 612A to provide the complex modulation patterns required for testing and aligning these systems. In the laboratory, the 612A is a convenient power source for driving bridges, slotted lines, antennas and filter networks. In addition, the HP 8731 PIN Modulators can be used with the 612A to obtain rf pulses with 30 ns rise time and 0.1 μ s minimum duration—with on-off ratios approaching 80 dB.

MO-PA circuit

The master oscillator-power amplifier circuit in HP 612A provides 0.5 volt into 50 ohms over the full frequency range of 450 to 1230 MHz. There is very low incidental FM (less than 0.002% at 30% AM) and excellent modulation capabilities by all frequencies from 20 Hz to 5 MHz. The degree of modulation is easily read from the large Percent Modulation meter. The instrument can be amplitude modulated (either

internally or externally), and provision is made for external pulse modulation, as well. Pulse modulation can be applied to the amplifier, or directly to the oscillator when high on-off signal ratios are required (signal may be completely cut off between pulses). Modulation can be up or down from preset level to simulate tv modulation characteristics accurately.

Advanced design

The oscillator-amplifier circuit in the 612A employs high-frequency pencil triodes in a cavity-tuned circuit for precise tracking over the entire band. Non-contacting cavity plungers are die cast to precise tolerances, then injection molded with a plastic filler for optimum Q. The frequency drive is a direct screw-operated mechanism, free from backlash. A waveguide-beyond-cutoff piston attenuator and crystal monitor circuit are used to insure accurate, reliable output down to 0.1 μ V. The attenuator is calibrated over a range of 131 dB and has been carefully designed to provide a constant impedance-versus-frequency characteristic. The swr of the 50-ohm output system is less than 1.2 over the complete frequency range.

Specifications

- Frequency range:** 450 to 1230 MHz in one band; scale length approximately 15" (381 mm).
- Calibration accuracy:** within $\pm 1\%$; resettability better than 5 MHz at high frequencies.
- Output voltage:** 0.1 μ V to 0.5 V into 50-ohm load; calibrated in V and dBm (0 dBm = 1 mW).
- Output accuracy:** ± 1 dB, 0 to -127 dBm over entire frequency range.
- Internal impedance:** 50 ohms; maximum reflection coefficient, 0.091 (1.2 swr, 20.8 dB return loss).
- Amplitude modulation:** above 470 MHz, 0 to 90% at audio frequencies, indicated by panel meter; accuracy $\pm 10\%$ of full scale, 30 to 90% modulation.
- Incidental FM:** less than 0.002% for 30% AM.
- Internal modulation:** 400 and 1000 Hz $\pm 10\%$; envelope distortion less than 3% at 30% modulation.
- External modulation:** 20 Hz to 5 MHz; above 470 MHz, 2 V rms produces 85% AM at modulating frequencies up to 500 kHz, at least 40% AM at 5 MHz; modulation may be up or down from the carrier level or symmetrical about the carrier level; positive or negative pulses may be applied to increase or decrease rf output from the carrier level.
- Pulse modulation**
 - Pulse 1 (pulse applied to amplifier): positive or negative pulses, 4 to 40 V peak produce an rf on-off ratio of at least 20 dB; minimum rf output pulse length, 0.2 μ s.
 - Pulse 2 (pulse applied to oscillator): positive or negative pulses, 4 to 40 V peak; no rf output during off time; minimum rf output pulse length, 1 μ s.
- RFI:** conducted and radiated leakage limits are below those specified in MIL-I-6181D; permits receiver sensitivity measurements down to 1 μ V.
- Power:** 115 or 230 volts $\pm 10\%$, 50 to 400 Hz, 215 watts.
- Dimensions:** cabinet: 13 $\frac{1}{2}$ " wide, 16 $\frac{1}{2}$ " high, 21 $\frac{1}{2}$ " deep (343 x 419 x 546 mm); rack mount: 19" wide, 13-31/32" high, 20 $\frac{1}{4}$ " deep behind panel (483 x 355 x 514 mm).
- Weight:** net 56 lbs (25.4 kg), shipping 68 lbs (30.5 kg) (cabinet); net 56 lbs (25.4 kg), shipping 77 lbs (34.4 kg) (rack mount).
- Accessories available:** 11500A RF Cable Assembly, \$15; 10503A Video Cable Assembly, \$7; 360B Low-Pass Filter (may be used where harmonic output must be reduced to a minimum, as in slotted line measurements), \$70.
- Price:** HP 612A, \$1500 (cabinet); HP 612AR, \$1520 (rack mount).

SIGNAL SOURCES**SIGNAL GENERATORS; SOURCES**

Stable, easy to use, cover 800 to 4500 MHz

Models 8614A, 8616A; 8614B, 8616B

Advantages:

- High frequency accuracy, digital dial
- Precision attenuator, digital dial
- Amplitude modulation capability and automatic power leveling in the signal generators
- At least 10 mW output
- Compact, only 5¼" (133 mm) high

Use to measure:

- Receiver sensitivity, signal-to-noise ratio
- Standing wave ratios
- Transmission line, antenna characteristics
- Conversion gain

The HP 8614A and 8616A Signal Generators are easy-to-use instruments which provide stable, accurate signals from 800 to 2400 MHz (8614A) and from 1800 to 4500 MHz (8616A). Both frequency and attenuation are set on direct-reading digital dials, while function is easily selected by pushbuttons. Selectable functions include cw, leveled output, square-wave modulation, and external amplitude, pulse or frequency modulation. Amplitude, frequency and square-wave modulation can be accomplished simultaneously with or without leveling.

Two outputs

Two rf power outputs are simultaneously available from separate front-panel connectors. One provides at least 10

mW (2 mW above 3000 MHz) or a leveled output from 0 to -127 dBm. The leveled output is flat within ± 0.5 dB (8614A) or ± 0.8 dB (8616A) across the respective bands with no resetting of the attenuator or power monitor.

The second output is at least 0.5 mW across the band and is independent of attenuator setting. This signal can be used for phase locking the signal generators when extreme stability is desired, or it can be monitored with a frequency counter for extreme frequency resolution. In any case, the second output can be utilized without adversely affecting the primary output.

Modulation capabilities

A unique PIN diode modulator permits amplitude modulation from dc to 1 MHz or furnishes rf pulses with a 2 μ s rise time. This broad modulation bandwidth permits remote control of output level or precise leveling using external equipment. The internal leveling is also obtained by using a PIN modulator.

When up to one watt output is required above 1 GHz, the HP 489A (1 to 2 GHz) or HP 491C (2 to 4 GHz) Microwave Amplifiers (see Amplifiers) serve as ideal power boosters. The HP 8731 and 8732 Series PIN Modulators, driven by the HP 8403A Modulator (see Mixers, Modulators, Attenuators), also are available for use with the signal generators when a sophisticated high-speed, low-jitter modulation system is required.



8614A



8614B

Signal Sources

The HP 8614B and 8616B retain the convenience of the "A" models. Functions are selected by pushbuttons, and frequency and attenuation are set on digital dials. Although the signal sources do not have power monitors or internal PIN diode modulation, relative power measurements can be made, using the precision attenuator. Modulation capabilities include internal square-wave modulation, plus external pulse and frequency modulation. For added convenience, a friction clutch arrangement permits setting the attenuator dial to any suitable reference while output power is held constant. Thus the attenuator can be calibrated directly in dBm or insertion loss.

The versatility of the HP 8614B and 8616B makes them suitable for both laboratory and general-purpose measurements. Indeed, these signal sources can be used in many applications previously requiring signal generators.

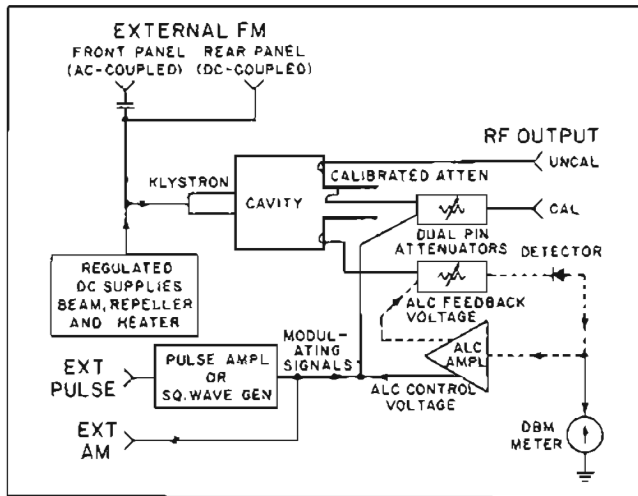

Simplified block diagram of hp 8614A and 8616A Signal Generators. The dashed line shows the leveling control circuit.

Specifications

Frequency range: 8614A and 8614B, 800 to 2400 MHz; 8616A and 8616B, 1800 to 4500 MHz.

Leveled output: constant within ± 0.5 dB (8614A) and ± 0.8 dB (8616A) across entire frequency range at any attenuator setting below 0 dB; output power can be adjusted from the normal calibrated level with the Automatic Level Control; not available with 8614B and 8616B.

Frequency calibration accuracy: 8614A, ± 5 MHz; 8614B, ± 5 MHz or $\pm 0.5\%$, whichever is greater; 8616A, ± 10 MHz; 8616B, ± 10 MHz or $\pm 0.5\%$, whichever is greater.

Vernier: ΔF control has a minimum range of 1.5 MHz for fine tuning.

Frequency stability

With temperature: approximately 0.005%/°C change in ambient temperature.

With line voltage: less than 0.003% change for line voltage variation of $\pm 10\%$.

Residual FM: 8614A and 8616A, less than 2500 Hz peak; 8614B, less than 0.0003% peak; 8616B, less than 6 kHz peak.

RF output power

8614A: +10 dBm (10 mW) to -127 dBm (0.1 μ V) into a 50-ohm load; output attenuator dial directly calibrated in dBm from 0 to -127 dBm.

8614B: at least 15 mW max., controlled by attenuator.

8616A: +10 dBm (10 mW) to -127 dBm (0.1 μ V) into a 50-ohm load, 1800 to 3000 MHz; +3 dBm (2 mW) to -127 dBm (0.1 μ V) into a 50-ohm load, 3000 to 4500 MHz; output attenuator directly calibrated in dBm from 0 to -127 dBm.

8616B: at least 15 mW maximum, 1800 to 3000 MHz; at least 3 mW maximum, 3000 to 4500 MHz; controlled by attenuator.

All models: a second, uncalibrated rf output (approximately 0.5 mW) is provided on the front panel.

RF output power accuracy (with respect to attenuator dial)

8614A: ± 0.75 dB + attenuator accuracy from 0 to -127 dBm, including leveled output variations.

8616A: ± 1 dB + attenuator accuracy from 0 to -127 dBm, including leveled output variations.

Attenuator accuracy

8614A: +0, -3 dB from 0 to -15 dBm; ± 0.2 dB ± 0.06 dB/10 dB from -15 to -127 dBm.

8614B and 8616B: ± 0.2 dB ± 0.06 dB/10 dB below -10 dBm.

8616A: +0, -1 dB from 0 to -10 dBm; ± 0.2 dB ± 0.06 dB/10 dB from -10 to -127 dBm.

All models: direct-reading linear dial, 0.2 dB increments.

Internal impedance: 50 ohms nominal.

Reflection coefficient:

8614A: less than 0.33 (2.0 swr, 9.5 dB return loss).

8614B: less than 0.2 (1.5 swr, 14 dB return loss).

8616A: less than 0.33 (2.0 swr, 9.5 dB return loss).

8616B: less than 0.26 (1.7 swr, 11.7 dB return loss).

Modulation

Internal square wave: 950 to 1050 Hz.

Square-wave sync: square wave can be synchronized with a +1 to +10 volt signal applied to the Pulse input.

External AM (8614A and 8616A only): dc to 1 MHz.

Incidental FM (8614A and 8616A only): negligible for power levels below -10 dBm.

External pulse:

8614A and 8616A: 50 Hz to 50 kHz, 2 μ s rise time, +20 to +100 volts input.

8614B and 8616B (below 4000 MHz): 50 Hz to 500 kHz; +25 to +50 volts peak input; minimum rf pulse width, 300 ns; rf rise time, typically 200 ns.

External FM: (a) front-panel connector capacitively coupled to klystron repeller; input impedance, 220 K Ω shunted by approximately 300 pF; (b) rear-panel connector is dc-coupled to the klystron repeller.

Power: 115 or 230 volts $\pm 10\%$, 50 to 60 Hz, approximately 125 watts.

Dimensions: 16 $\frac{3}{4}$ " wide, 5 $\frac{1}{2}$ " high, 18 $\frac{3}{8}$ " deep (426 x 141 x 467 mm); hardware furnished for conversion to rack mount 19" wide, 5-7/32" high, 16 $\frac{3}{8}$ " deep behind panel (483 x 133 x 416 mm).

Weight: 8614A: net 42 lb (18.9 kg); shipping 48 lb (21.6 kg), 8614B and 8616B: net 38 lb (17.1 kg); shipping 43 lb (19.4 lb), 8616A: net 44 lb (19.8 kg); shipping 50 lb (22.5 kg).

Price: HP 8614A, \$2200; HP 8614B, \$1450; HP 8616A, \$2200; HP 8616B, \$1450.

Option 01: External modulation input connectors on rear panel in parallel with front-panel connectors; rf connectors on rear panel only; add \$25.

SIGNAL SOURCES



UHF SIGNAL GENERATORS

Direct reading, direct control, 800 to 4200 MHz
Model 614A, 616B

Ease of operation, direct-reading one-dial frequency control, high stability and accuracy and broad frequency coverage are all advantages of these widely used signal generators.

The 614A covers frequencies from 800 to 2100 MHz, has constant internal impedance with less than 1.6 swr, and output accuracy of ± 1 dB over the range of -10 dBm to -127 dBm. The 616B gives complete coverage of frequencies from 1.8 to 4.2 GHz, has constant internal impedance with less than 1.8 swr, and output accuracy of ± 1.5 dB from -7 dBm to -127 dBm.

On both instruments, operation is extremely simple. Carrier frequency is set and read directly on the large tuning dial. No voltage adjustments are necessary during operation because of the coupling device which causes oscillator repeller voltage to track frequency changes automatically. Oscil-

lator output is set and read directly on a simplified dial. Output may be continuous or pulsed, or frequency modulated at power line frequency. Pulse modulation may be provided externally or internally. Internal pulsing may be synchronized with either positive or negative external pulses, or sine waves.

The oscillator portion of both the 614A and 616B consists of a reflex klystron in an external coaxial resonator. Frequency of oscillation is determined by a movable plunger which varies the resonant frequency of the resonator. Oscillator output is monitored by a temperature-compensated thermistor bridge circuit which is virtually unaffected by ambient temperature conditions. Voltage output is read directly. A logging scale on the frequency dial provides a resettability of 0.1%.

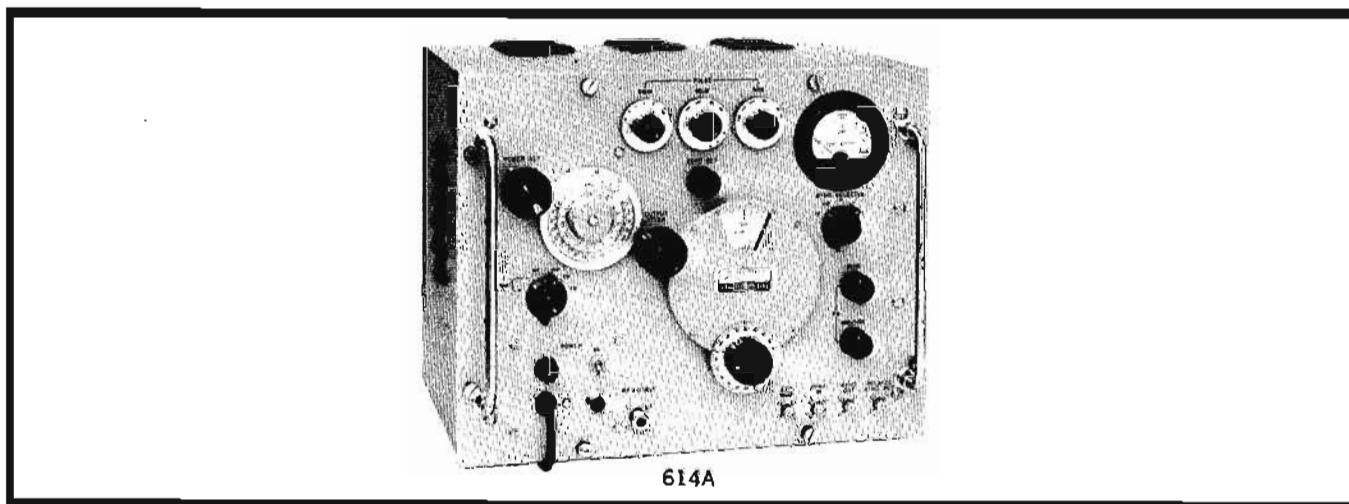

Specifications

Frequency range: 614A, 800 to 2100 MHz; 616B, 1.8 to 4.2 GHz.

Frequency accuracy: $\pm 1\%$.

Frequency stability: 0.005%/°C change in ambient temperature; line voltage changes of $\pm 10\%$ cause 0.01% frequency change.

Output power range (into 50-ohm load): 614A, 0.5 mW or 0.158 volt to 0.1 μ V (-3 to -127 dBm) from 800 to 900 MHz, 1 mW or 0.224 volt to 0.1 μ V (0 to -127 dBm) from 900 to 2100 MHz; 616B, 1 mW or 0.224 volt to 0.1 μ V (0 to -127 dBm).

Power accuracy (at the end of 6 ft output cable, terminated in 50-ohm load): 614A, within ± 1 dB from -10 to 127 dBm; 616B, within ± 1.5 dB from -7 to -127 dBm.

Internal impedance: 614A, 50 ohms, reflection coefficient less than 0.23 (1.6 swr, 12.7 dB return loss); 616B, 50 ohms, reflection coefficient less than 0.285 (1.8 swr, 10.9 dB return loss).

Modulation: internal or external pulse or FM.

Internal pulse modulation: pulse repetition rate variable from 40 to 4000 per sec; pulse length variable from 1 to 10 μ s; delay variable from 3 to 300 μ s between synchronizing signal and rf pulse.

External pulse modulation: ext $-$: -40 to -70 V, 1 to 2500 μ s wide, ext $+$: $+40$ to $+70$ V, 1 to 400 μ s wide, square wave: ± 40 to ± 70 V p-p, 40 to 4000 Hz.

Trigger pulses out: (1) simultaneous with rf pulse; (2) in advance of rf pulse, variable from 3 to 300 μ s (both approximately 1 μ s rise time, amplitude $+10$ to $+50$ volts).

External synchronization: pulses, ± 10 to ± 50 volts, 1 to 20 μ s wide; may also be synchronized with sine waves.

Frequency modulation: oscillator sweeps at power line frequency; deviation and phase adjustable; maximum deviation approx. 3 MHz p-p.

RFI: Conducted and radiated leakage limits are below those specified in MIL-I-6181D.

Power: 115 or 230 volts $\pm 10\%$, 50 to 400 Hz, approx. 160 watts.

Dimensions: cabinet: 17 $\frac{1}{4}$ " wide, 13 $\frac{5}{8}$ " high, 13 $\frac{1}{2}$ " deep (438 x 346 x 343 mm); rack mount: 19" wide, 13-31/32" high, 12 $\frac{1}{8}$ " deep behind panel (483 x 355 x 308 mm).

Weight: net 59 lbs (26.5 kg); shipping 72 lbs (32.4 kg).

Accessory furnished: 11500A RF Cable Assembly.

Accessories available: 614A: 360C Low-Pass Filter, $f_c = 2200$ MHz, \$65; 10503A Video Cable Assembly, \$7; 616B: S281A Waveguide-to-Coax Adapter, 2.6 to 3.95 GHz, \$50; G281A Waveguide-to-Coax Adapter, 3.95 to 5.85 GHz, \$40; 360D Low-Pass Filter, $f_c = 4.1$ GHz, \$60.

Price: HP 614A or HP 616B, \$1950 (cabinet); HP 614AR or HP 616BR, \$1970 (rack mount).

RF TEST SETS

For testing transmitters, receivers
Models 623B, 624C, 5636



SIGNAL SOURCES

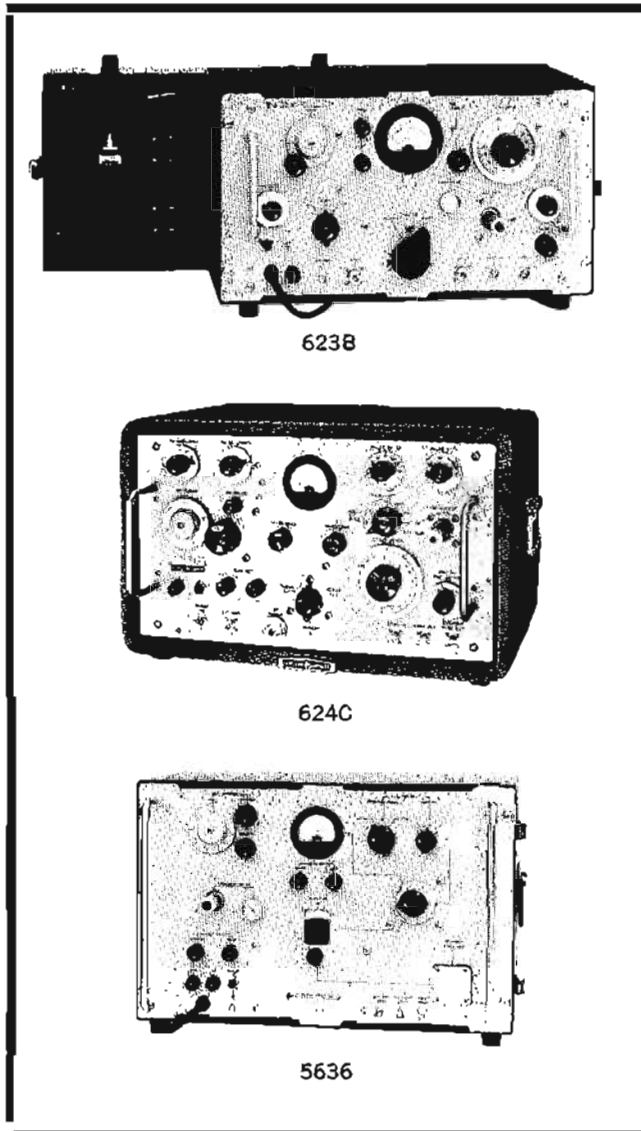

Advantages:

- Direct reading of power, frequency
- Stable accurate input, output attenuators
- Compact package for portability in field

Uses:

- Measure receiver sensitivity, selectivity
- Test transmitter tuning power level

Each of these test instruments consists of a combination signal generator, frequency meter and power meter and permits measurement of receiver sensitivity and selectivity, transmitter tuning and power level. Each is easy to use, fast and accurate.

The HP model 623B SHF Test Set is an ideal one-piece unit for measuring receiver sensitivity or selectivity, transmitter tuning or power level. It is particularly adapted to testing complete communications, control, and video relay station equipment in the range of 5925 to 7750 MHz, using any of 3 klystrons. Its klystron source can be frequency modulated and externally pulse modulated.

From 8.5 to 10.0 GHz, the 624 X-Band Test Set provides a one-piece unit particularly adaptable for testing complete radar, gunfire control systems, or radio beacon equipment. It has internal frequency modulation capability to 1 kHz and provision for a 30 Hz to 3.5 kHz pulse, FM, or square wave external modulation.

Nearly overlapping the frequency ranges of the 623B and 624C, the 5636 H-Band-Test Set more than covers the entire government communications band. It performs the same task but offers greater output power and a wider power measurement range than the 623B and 624C.

Model	Frequency range (MHz)	Frequency meter range (MHz)	Output power (dBm)	Output attenuator range (dB)	Internal modulation	External modulation	Power measurement range (CW)	Panel height	Shipping Weight Price
623B	5925-6575 or 6575-7175 or 7125-7750	5820-7780	0 (1 mW)	70	FM, 1 kHz	FM, pulse, square-wave, 30 Hz to 100 kHz	-6 to +3 dBm	11½" (292 mm)	76 lbs. \$2850 (transit case)
5636	7100-8500	7100-8500	15 (30 mW)	100	FM, 1 kHz	FM, pulse, square-wave, 30 Hz to 100 kHz	-6 to +40 dBm	14" (355 mm)	98 lbs. \$4250 (transit case)
624C	8500-10,000	8500-10,000	0 (1 mW)	100	FM at power line frequency; pulse, 35 to 3500 pps	FM, pulse, square-wave, 35 to 3500 Hz	-6 to +28 dBm	10½" (266 mm)	78 lbs. \$2850 (cabinet or rack)

SIGNAL SOURCES



SHF SIGNAL GENERATORS

Multiple-purpose instruments, 3.8 to 11 GHz
Models 618C, 620B

Advantages:

- Direct-reading frequency dial
- Direct-reading output in voltage or dBm
- Internal FM, CW, pulsed or square-wave modulation
- Broadband coverage
- Wide frequency range
- High stability, high accuracy

Use to measure:

- Receiver sensitivity
- Selectivity or rejection
- Signal-to-noise ratio
- Antenna gain
- Transmission line characteristics

The Models 618C and 620B SHF Signal Generators provide versatility, accuracy, and stability in the range from 3.8 to 11 GHz. Thus such measurements as sensitivity, selectivity, signal-to-noise ratio, swr, and antenna gain are made with ease. Frequency is set on a large, direct-reading dial. A ΔF vernier control provides ultra-fine tuning capability. There is also a provision for remote fine tuning.

A calibrated output from 0 to -127 dBm (0.224 volts to 0.1 microvolt) is also set on a large, direct-reading dial. The dial is calibrated in both dBm and volts, permitting measurements in terms of either and eliminating any computation in converting from one to the other. In addition, the zero set control for the power monitor has been eliminated, simplifying measurements by reducing the number of steps required. A second, uncalibrated output is available. This auxiliary output is at least 0.3 milliwatt and is independent of attenuator setting. Thus it can be used for phase locking the signal generator when crystal-oscillator stability is required, or it can be monitored with a frequency counter for extreme frequency resolution.

Reflex klystron oscillator

The 618C and 620B Generators both feature oscillators of the reflex klystron type, with external resonant cavity. Oscillator frequency is determined by a movable plunger which varies the length of the cavity. Oscillator output is monitored by a temperature-compensated detector circuit. This circuit operates virtually unaffected by ambient temperature conditions. Identical piston attenuators couple power to the monitor and output terminal. The power monitor attenuator is linked to the output attenuator cursor to compensate for klystron output variation as frequency is changed.

Broad modulation capabilities

Modulation includes internal pulse, square-wave, and frequency modulation plus external pulse and frequency modulation. Internal pulse and square-wave repetition rates are continuously variable from 40 to 4000 pps, and pulse width is variable from 0.5 to 10 microseconds. Synchronization pulses are available simultaneously with the rf pulse or in

advance of the rf pulse from 3 to 300 microseconds. The internal pulse and square-wave modulation can be synchronized with external sine waves or pulses of either polarity, or external pulses can themselves be used as the modulating signal.

For internal frequency modulation, each generator has a sawtooth sweep variable from 40 to 4000 Hz with deviation adjustable up to about 5 MHz peak-to-peak. External FM is accomplished through one of two input connectors. The front-panel input is capacitively coupled to the repeller of the klystron oscillator for standard FM applications. The rear-panel input is dc coupled to the klystron to permit phase locking of the oscillator.

Specifications

Output

Frequency range: 618C: 3,800 to 7,600 MHz covered in a single band; 620B: 7 to 11 GHz covered in a single band; repeller voltage automatically tracked and proper mode automatically selected.

Calibration: direct reading; frequency calibration accuracy better than $\pm 1\%$.

Vernier: ΔF control has a minimum range of 0.5 MHz for fine tuning; remote ΔF connector on rear panel permits fine tuning with external potentiometer; tuning range at least 1.5 MHz with potentiometer ≥ 2 megohms.

Frequency stability: with temperature: less than 0.006%/°C change in ambient temperature; with line voltage: less than 0.02% change for line voltage variation of $\pm 10\%$; residual FM: < 15 kHz peak.

Output range: 1 milliwatt or 0.224 volt to 0.1 microvolt (0 dBm to -127 dBm) into 50 ohms; directly calibrated in microvolts and dB; coaxial type N connector.

Output accuracy: within ± 2 dB from -7 to -127 dBm, within ± 3 dB from 0 to -7 dBm, terminated in 50-ohm load; temperature-compensated detector circuit monitors rf oscillator power level; an auxiliary, fixed-level rf output (at least 0.3 mW) is provided on the front panel for use with other equipment such as a frequency counter or phase-lock instrumentation.

Source impedance: 50 ohms nominal; reflection coefficient less than 0.33 (2 swr, 9.6 dB return loss).

Modulation

Modulation: internal or external pulse, FM, and square wave.

Internal pulse modulation: repetition rate variable from 40 to 4,000 pps, pulse width variable $1/2$ to 10 microseconds.

Sync out signals: simultaneous with rf pulse, positive; in advance of rf pulse, positive, variable 3 to 300 microseconds (better than 1 microsecond rise time and 25 to 100 volts amplitude into 1,000-ohm load).

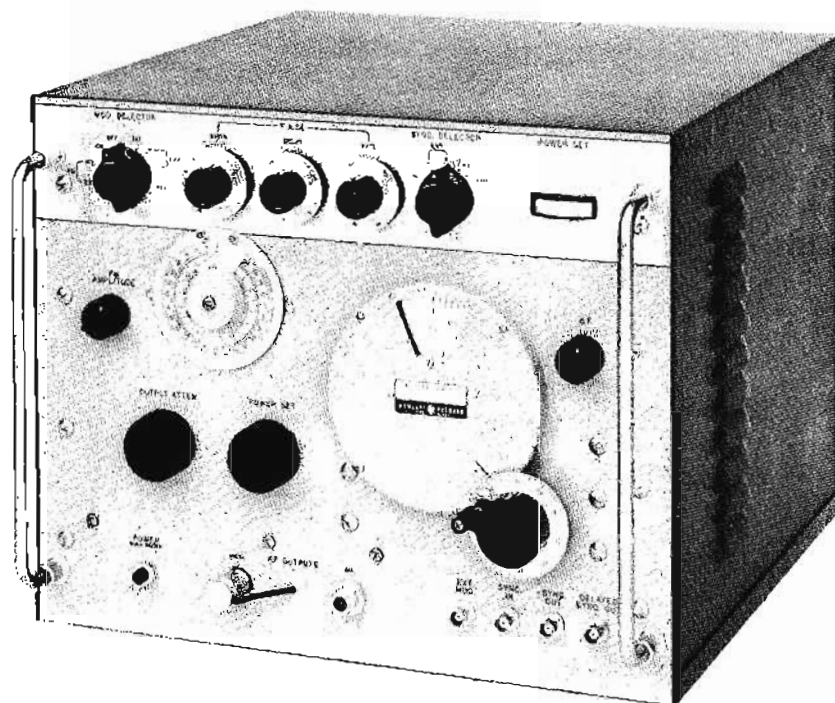

618C

External synchronization: sine wave: 40 to 4,000 Hz, 5 to 50 V rms; pulse: 40 to 4,000 pps, 5 to 50 V peak, positive or negative, 0.5 to 5 μ sec wide, 0.1 to 1 μ sec rise time.

Internal square wave modulation: variable 40 to 4,000 Hz, controlled by "pulse rate" control.

Internal frequency modulation: sawtooth sweep rate adjustable 40 to 4,000 Hz; frequency deviation to 5 MHz peak-to-peak over most of the frequency range.

External pulse modulation: pulse requirements: amplitude from 5 to 50 volts positive or negative, width 0.5 to 2,500 microseconds.

External FM: frequency deviation approximately 5 MHz peak-to-peak over most of the band; sensitivity approximately 20 V/MHz at front-panel connector, approximately 10 V/MHz at rear panel connector (mating connector supplied); front-panel connector is capacitively coupled to klystron repeller; rear-panel connector is dc coupled to klystron repeller and is suitable for phase-lock control input.

General

RFI: conducted and radiated leakage limits are below those specified in MIL-I-6181D.

Power source: 115 or 230 volts $\pm 10\%$, 50 to 60 Hz, 230 watts.

Dimensions: cabinet: 17 $\frac{1}{2}$ in. wide, 13 $\frac{7}{8}$ in. high, 19 $\frac{5}{8}$ in. deep behind panel (445 x 353 x 499 mm); rack mount: 19 in. wide, 13 $\frac{31}{32}$ in. high, 19 in. deep behind panel (483 x 355 x 483 mm).

Weight: net, 69 lbs (31,1 kg); shipping 90 lbs (40,5 kg).

Accessory furnished: 11500A Cable Assembly, 6 feet (1830 mm) of specially treated RG-214A/U 50-ohm Coax, terminated on each end by type N male connectors.

Price: Model 618C (cabinet mount), \$2,250. Model 618CR (rack mount), \$2,270. Model 620B (cabinet mount), \$2,250. Model 620BR (rack mount), \$2,270.



SHF SIGNAL GENERATORS

Direct reading, high power, 10 to 21 GHz
Models 626A, 628A

Advantages:

- Direct-reading frequency control
- Direct-reading output control
- 10 mW output over full range
- CW, FM or pulse modulation
- Internal square-wave modulation
- Broad pulsing capabilities
- Low internal swr
- High stability
- Operate to 40 GHz with HP 938, 940 Frequency Doubler Sets

Use to measure:

- Receiver sensitivity
- Selectivity or rejection
- Signal-to-noise ratio
- Transmission line characteristics

Here are two HP signal generators which extend the measuring versatility, convenience and accuracy of HP VHF signal generators to 21 GHz. The 626A covers frequencies 10 to 15.5 GHz, and the 628A covers frequencies 15 to 21 GHz. In design and operation, the instruments are similar to HP generators for lower frequency ranges. Operation is very simple. Carrier frequency is set and read directly on the large tuning dial. No voltage adjustment is necessary during tuning because repeller voltage is tracked with frequency changes automatically. Oscillator output also is set and read directly, and no frequency correction is necessary throughout operating range. A frequency logging scale permits frequency to be reset within 0.1%.

The high power output of these signal generators make them ideally suited for driving HP 938A and 940A Frequency Doubler Sets (18 to 26.5 GHz and 26.5 to 40 GHz respectively). These doubler sets retain the modulation and stability of the driving source and have accurate power monitors and attenuators.

Versatile modulation

Both the 626A and 628A offer internal and external pulse modulation, as well as internal square-wave modulation and FM. Pulse repetition rate is continuously variable from 40 to 4000 pps, and pulse width is variable from 0.5 to 10 μ s. Sync out signals are simultaneous with the rf pulse, or in advance of the rf pulse by any time span from 3 to 300 μ s. The pulse generators may be synchronized with an external sine wave and also with positive or negative pulse signals.

For internal FM, both instruments feature a sine wave sweep at power line frequency. Frequency deviation is variable up to 10 MHz peak-to-peak. For external FM, the generators have capacitive couplings to the klystron oscillator repeller.

Figure 1 shows the basic circuits of the HP signal generators. The reflex klystron oscillator is tuned by a plunger driven by the direct-reading frequency dial and control. Repeller voltage is automatically tracked, so that correct operating potentials are maintained over the entire frequency range. Klystron output is introduced into a power monitoring meter. The directional coupler provides uniform coupling over the entire frequency range. A rotary attenuator which follows the coupler assures high accuracy and stability, because the attenuation is governed by a precise

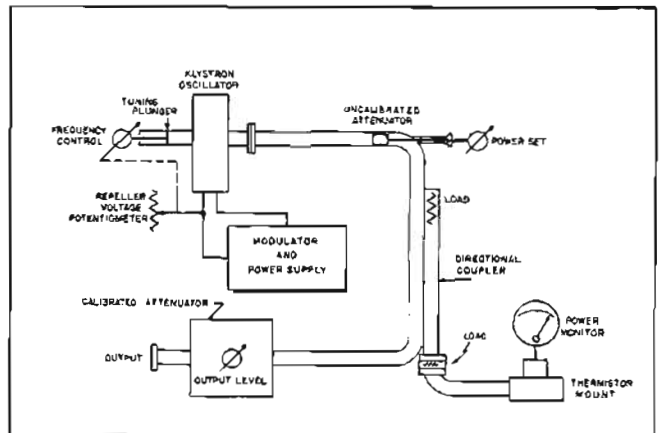
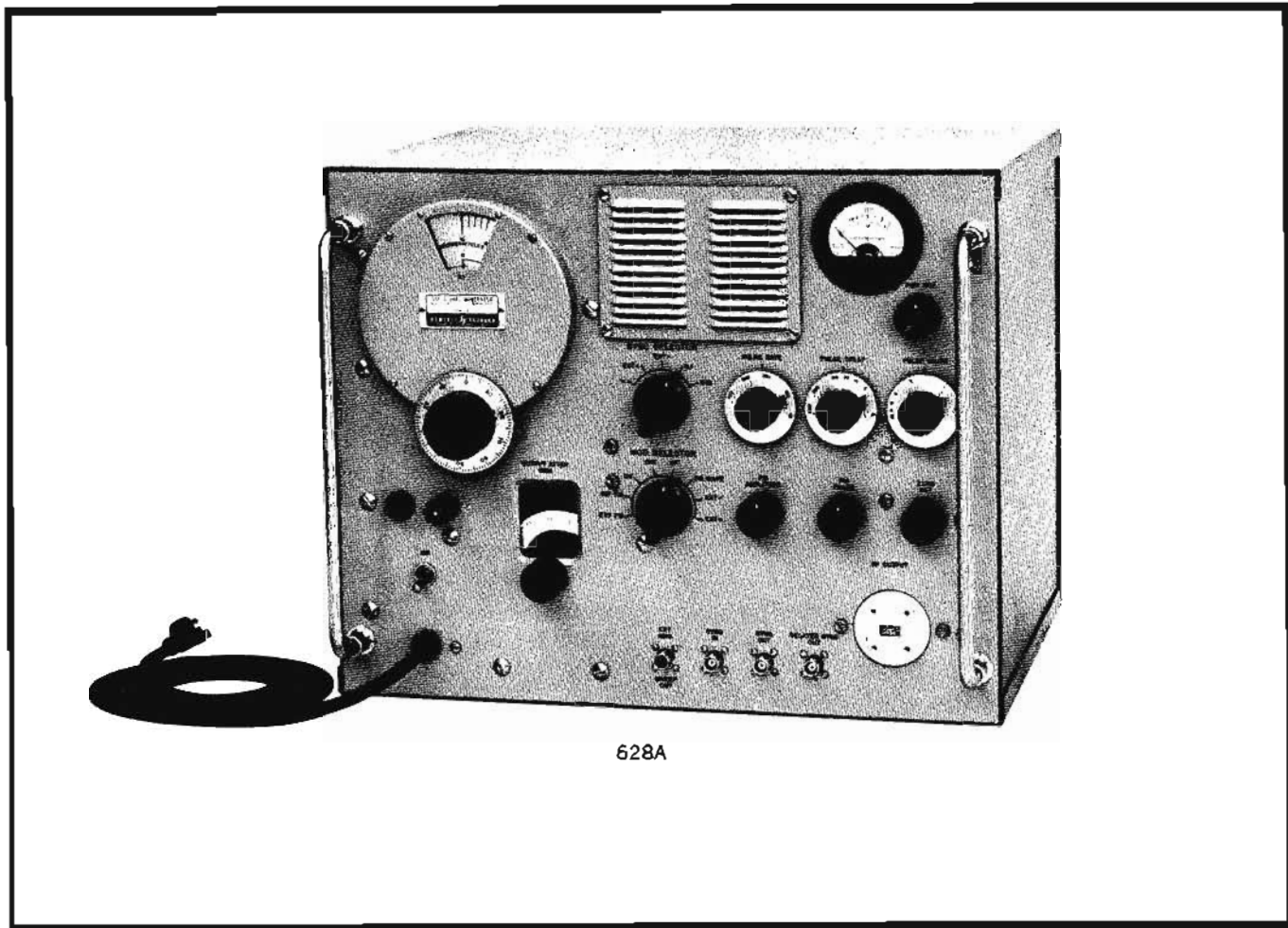

Figure 1. Basic circuit, HP 626A, 628A.

mathematical law related to the angular rotation of the attenuator. The conductivity of the attenuating film does not affect the attenuation; thus, the output of the generator is independent of humidity, temperature or the effect of long-term aging. The attenuator also provides low swr over the complete frequency range. On both HP 626A and 628A, the output connector is waveguide. Adapters furnished permit the instruments to be connected to WR-42, WR-62 or WR-90 waveguide. Thus, the generators can be employed with all EIA (RETMA) and JAN guides suitable for the 10 to 21 GHz range.

Specifications

- Frequency range:** 626A, 10 to 15.5 GHz; 628A, 15 to 21 GHz.
- Frequency calibration:** dial direct reading in GHz, accuracy better than $\pm 1\%$.
- Output range:** 10 mW to 1 nW (+10 dBm to -90 dBm, 0 dBm = 1 mW); attenuator dial directly calibrated in output dBm.
- Source Impedance:** 50 ohms nominal; reflection coefficient: 626A, less than 0.43 (2.5 swr, 7.3 dB return loss) at +10 dBm, 0.15 (1.35 swr, 16.5 dB return loss) at 0 dBm and below; 628A, less than 0.43 (2.5 swr, 7.3 dB return loss) at +10 dBm, 0.091 (1.2 swr, 20.8 dB return loss) at 0 dBm and below.



628A

Output monitor accuracy: better than ± 1 dB; temperature-compensated thermistor bridge circuit monitors rf oscillator power level.

Output connector: 626A: 0.850 x 0.475 in. waveguide, WR75, flat cover flange; 628A: 0.590 x 0.335 in. waveguide, WR51, flat cover flange.

Output attenuator accuracy: better than $\pm 2\%$ of attenuation in dB introduced by output attenuator.

Leakage: less than minimum calibrated signal generator output.

Modulation: internal or external pulsed, FM, or square-wave.

Internal pulse modulation: repetition rate variable from 40 to 4000 pps; pulse width variable 0.5 to 10 μs .

Internal square-wave modulation: variable 40 to 4000 cps controlled by "pulse rate" control.

Internal frequency modulation: power line frequency, deviation up to 10 MHz p-p.

External pulse modulation: pulse requirements: amplitude 15 to 70 volts peak positive or negative; width 1 to 2500 μs .

External frequency modulation: provided by capacitive coupling to repeller of klystron; maximum deviation approximately 10 MHz p-p.

Sync out signals: positive 20 to 50 volts peak into 1000-ohm load; better than 1 μs rise time; (1) simultaneous with rf pulse, positive; (2) in advance of rf pulse, positive, variable 3 to 300 μs .

External synchronization: (1) sine wave, 40 to 4000 Hz, amplitude 5 to 50 volts rms; (2) pulse signals 0 to 4000 pps, 5 to 50 volts amplitude, positive or negative; pulse width 0.5 to 5 μs ; rise time 0.1 to 1 μs .

Power: 115 or 230 volts $\pm 10\%$, 50 to 60 Hz approx. 200 watts.

Dimensions: cabinet: 17" wide, 14" high, 15" deep (432 x 356 x 381 mm); rack mount: 19" wide, 14" high, 12-13/16" deep behind panel (483 x 356 x 313 mm).

Weight: 626A,AR: net 61 lbs (28,1 kg), shipping 76 lbs (34,2 kg); 628A,AR: net 57 lbs (26,4 kg), shipping 76 lbs (34,2 kg).

Accessories furnished: 626A (a) MX 292B Waveguide Adapter, WR-75-to-WR-90 guide; (b) MP 292B Waveguide Adapter, WR-75-to-WR-62 guide; 628A (a) NP 292A Waveguide Adapter, WR-51-to-WR-62 guide; (b) NK 292A Waveguide Adapter, WR-51-to-WR-42 guide.

Accessories available: 10503A Video Cable Assembly, \$7; for 626A: M362A Low-Pass Filter, \$350.

Price: HP 626A or 628A, \$3600 (cabinet); HP 626AR or 628AR, \$3620 (rack mount).



FREQUENCY DOUBLER SETS

Generate stable signals to 40 GHz

Model 938A, 940A

Hewlett-Packard Model 938A and Model 940A Frequency Doubler Sets bring you low-cost signal-generation capability in K- and R-bands (18 to 40 GHz). Model 938A supplies power from 18 to 26.5 GHz when it is driven by a 9 to 13.25 GHz source; Model 940A supplies power from 26.5 to 40 GHz when it is driven by a 13.25 to 20 GHz source.

These frequency doubler sets consist of broadband crystal harmonic generators suitably mounted in a waveguide section, a power monitor, a broad stopband low-pass filter and a precision attenuator. They may be driven by klystrons, by signal generators, such as HP Models 626A and 628A or by sweep oscillators such as HP Model 8690A with 8694A,B or 8695A RF Units.

Since Model 938A and Model 940A are broadband instruments, the input signal may be cw, pulsed or swept. Thus, the frequency doubler sets retain all the versatility of the driving source.

Output monitor

Models 938A and 940A have power monitors and pre-

cision rotary-vane attenuators for accurately setting output level over a range from 0 to -100 dB. Output power depends on input power and is typically 0.5 to 1 mW when a 626A, 628A, or 8690A is used as a driving source. Further, since Models 938A and 940A contain a power monitor, output power is known even though an uncalibrated signal source is used.

Signal generator or swept-frequency operation

Models 938A and 940A have the same output versatility as the driving source. For instance, if you drive Model 938A with Model 626A you may have cw output, pulse-modulated output with a repetition rate from 40 to 4000 pps, square-wave modulated output with modulation frequencies from 40 to 4000 Hz, or 60 Hz (power line frequency) FM output. In addition, pulsed output may be synchronized with external signals or output may be externally pulse or frequency modulated.

To obtain a swept-frequency output, you simply drive the frequency doubler set from a swept-frequency source such as Model 8690A with 8694A,B or 8695A RF Unit.

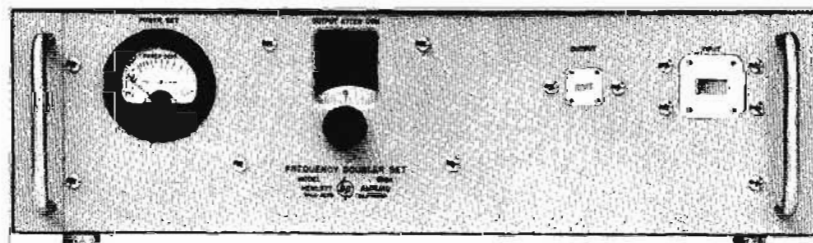

938A

Specifications

Frequency range: 938A, 18 to 26.5 GHz, 940A, 26.5 to 40 GHz.

Conversion loss: less than 18 dB at 10 mW input.

Output power: depends on input power supplied; approx. 0.5-1 mW when used with typical 626A, 628A Signal Generators.

Input power required: 10 mW design center.

Maximum input power: 100 mW.

Output monitor accuracy: ± 2 dB.

Output attenuator accuracy: $\pm 2\%$ of reading or ± 0.2 dB, whichever is greater.

Attenuator range: 100 dB.

Output reflection coefficient: approximately 0.33 (2 swr, 9.5 dB return loss) at full output; less than 0.2 (1.5 swr, 14 dB return loss) with attenuator set to 10 dB or more attenuation.

Input flange: 938A, M-band flat cover flange for WR-75 waveguide; 940A, N-band flat cover flange for WR-51 waveguide.

Output flange: 938A, UG-595/U flat cover flange for WR-42 waveguide (K-band); 940A, UG-599/U flat cover flange for WR-28 waveguide (R-band).

Dimensions: cabinet: 19 $\frac{1}{4}$ " wide, 5 $\frac{3}{8}$ " high, 18" deep (489 x 137 x 457 mm); rack mount: 19" wide, 5-7/32" high, 16 $\frac{1}{2}$ " deep behind panel (483 x 133 x 419 mm).

Weight: net 20 lbs (9 kg); shipping 35 lbs (15.8 kg).

Accessories available: 938A, X281A Waveguide-to-Coax Adapter, 8.2 to 12.4 gc, \$25; MX292B and MP292B Waveguide-to-Waveguide Adapters, \$50 and \$40 respectively (1 each furnished with 626A); 11504A X-band Flexible Waveguide, \$35; 11503A P-band Flexible Waveguide, \$48; 940A, MP292B and NP292A Waveguide-to-Waveguide Adapters, \$40 each (1 each furnished with 628A); 11503A P-band Flexible Waveguide, \$48.

Complementary equipment: 938A, 626A Signal Generator; 8690 Sweep Oscillator with 8694A,B and 8695A RF Unit. 940A, 626A and 628A Signal Generators; 8690A Sweep Oscillator with 8695A RF Unit.

Price: HP 938A or HP 940A, \$1700 (cabinet); HP 938AR or HP 940AR, \$1720 (rack mount).

FM-AM SIGNAL GENERATOR

FM, AM, CW and pulse coverage 54 to 216 MHz
Model 202H



SIGNAL SOURCES

The HP 202H FM-AM Signal Generator covers the frequency range from 54 to 216 MHz and is designed for the testing and calibration of FM receiving systems in the areas of broadcast FM, VHF, TV, mobile and general communica-

tions. The generator consists of a three-stage RF unit, together with a modulating oscillator and power supply, all housed in a single cabinet which may be readily adapted for rack mounting.



202H

Specifications

Radio frequency characteristics

RF range: total range: 54 to 216 MHz; number bands: 2; band ranges: 54 to 108 MHz 108 to 216 MHz.

RF accuracy (after 1 hour warm-up): main dial: $\pm 0.5\%$; electronic vernier: $\pm (10\% + 1 \text{ kHz})$.

RF stability: $< 0.01\%$ per hour (after two hour warm-up).

RF output: range: 0.1 μV to 0.2 V (across external 50-ohm load at panel jack); accuracy: $\pm 10\%$, 0.1 μV to 50 K μV ; $\pm 20\%$, 50 K μV to 0.2 volts; auto level set: holds RF monitor meter to "red line" over band.

Impedance: 50 ohms.

VSWR: < 1.2 .

Spurious output: All spurious RF output voltages are at least 30 dB below desired fundamental.

RF leakage: sufficiently low to permit measurements at 0.1 μV .

Amplitude modulation characteristics

AM range: internal: 0 to 50%; external: 0 to 100%.

AM accuracy: $\pm 10\%$ of reading at 400 Hz at 30% and 50% AM.

AM calibration: 30, 50, 100%.

AM distortion: $< 5\%$ at 30%, $< 8\%$ at 50%, $< 20\%$ at 90%.

AM fidelity: $\pm 1 \text{ dB}$, 30 Hz to 200 kHz.

External AM requirements: approximately 60 volts rms into 500 ohms for 100% AM.

Frequency modulation characteristics

FM deviation range: internal or external, 0 to 250 kHz in 4 ranges.

FM deviation accuracy: $\pm 5\%$ of full-scale (for 400 Hz sine wave).

FM calibration: 0 to 7.5 kHz in increments of 0.5 kHz, 0 to 25 kHz in increments of 1 kHz, 0 to 75 kHz in increments of 5 kHz, 0 to 250 kHz in increments of 10 kHz.

FM distortion (at 400 Hz mod. freq.): $< 0.5\%$ at 75 kHz (100 MHz), $< 1\%$ at 75 kHz (54 to 216 MHz), $< 10\%$ at 250 kHz (54 to 216 MHz).

FM fidelity: $\pm 1 \text{ dB}$, 5 Hz to 200 kHz.

Signal-to-noise ratio: $> 50 \text{ dB}$ below 10 kHz (31.6 Hz peak deviation).

External FM requirements: < 3 volts rms into 2 K ohms for 250 kHz deviation.

DC FM input: permits control of output frequency over a limited range with an external dc voltage.

Pulse modulation characteristics

PM source: external, PM rise time: $\geq 0.6 \mu\text{s}$.

PM decay time: $< 0.8 \mu\text{s}$.

Modulating oscillator characteristics

OSC frequency: 50 Hz, 400 Hz, 1000 Hz, 3000 Hz, 7.5 kHz, 10 kHz, 15 kHz, 67 kHz.

OSC accuracy: $\pm 5\%$.

OSC distortion (at FM terminals): $< 0.5\%$, 50 Hz to 15 kHz; $< 1.0\%$, 67 kHz.

Physical characteristics

Dimensions: 16 $\frac{3}{4}$ " wide, 10 $\frac{1}{4}$ " high, 18 $\frac{3}{8}$ " deep (425 x 260 x 467 mm).

Weight: net 45 lbs (20.3 kg), shipping 66 lbs (29.7 kg).

Power: 105 to 125 or 210 to 250 V, 50 to 400 Hz, 100 W.

Accessory furnished: 00502B Patching Cable.

Price: HP 202H, \$1475.



FM SIGNAL GENERATOR

Tests and calibrates telemetry receivers
Model 3205A

The Model 3205A FM Signal Generator is a self-contained, completely solid-state instrument that covers the frequency ranges 1430 to 1540 MHz and 2150 to 2310 MHz. It is designed for use in the measurement and calibration of FM telemetry receivers in the frequency bands 1435 to 1535 MHz and 2200 to 2300 MHz. A modulation oscillator in the generator permits selection of channels 1 through 21 of the standard IRIG (Inter-range Instrumentation Group) subcarrier frequencies used for telemetry systems. Peak FM deviation of the RF output on one of five different ranges is indicated on a calibrated deviation meter.

Basically, the 3205A RF output is derived by mixing a CW signal from a variable frequency oscillator with a CW

or FM 55 MHz signal from a voltage controlled oscillator. The difference signal is then multiplied to provide the desired output frequency. Frequency modulation of the 55 MHz VCO signal is obtained by means of the internal modulation oscillator or an external modulation source. Mixing a modulated 55 MHz carrier with a variable CW signal in this manner to derive the RF output assures constant deviation sensitivity and excellent linearity over the entire RF band.

The 3205A has its own deviation meter calibration system that does not require external instrumentation. A calibrated RF output level, adjustable from -10 dBm to -127 dBm is also included.

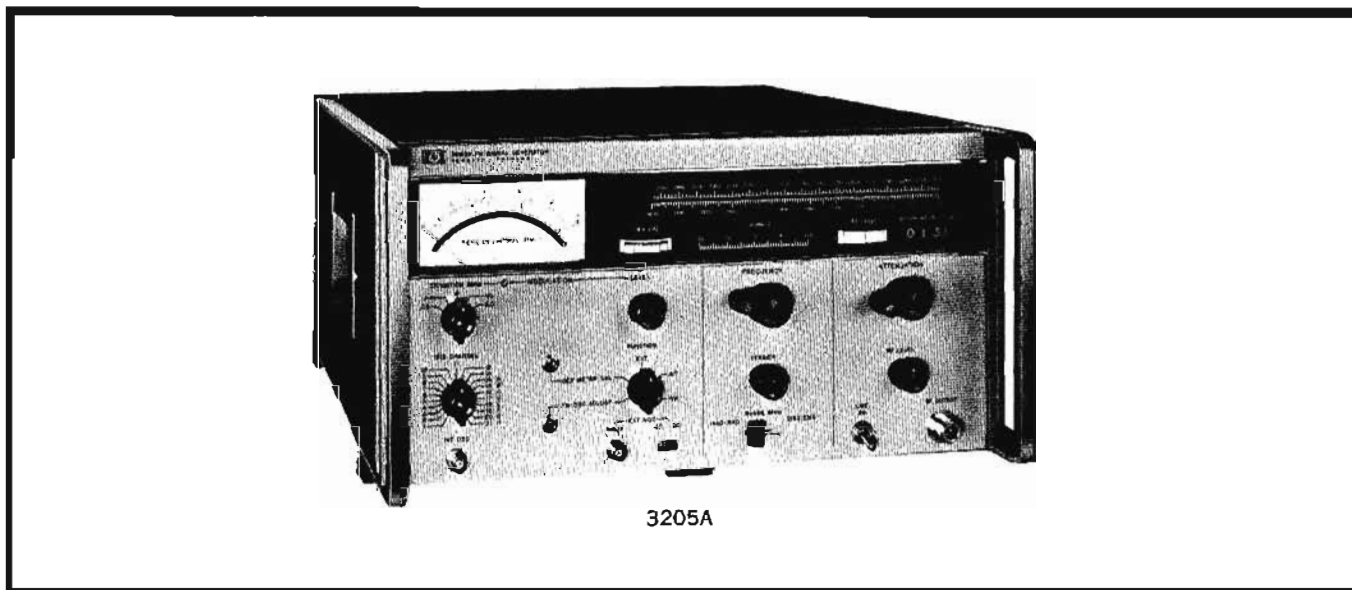

3205A

Specifications

RF characteristics

Tuning range: band 1, 1430 to 1540 MHz; band 2, 2150 to 2310 MHz.

RF output

Main output: -10 to -127 dBm.

Auxiliary output: -5 dBm minimum (fixed).

Output calibration accuracy (main output): ± 1 dB; direct reading linear dial, 0.2 dB increments.

Spurious output: in band, > 50 dB below main output; out of band, > 30 dB below main output.

Levelling: 1.5 dB pk-pk maximum excursion across each band.

FM characteristics

FM deviation: ± 3 MHz peak.

Ranges: 0 to .03, .10, .30, 1.0, and 3.0 MHz f.s.

Accuracy: $\pm 5\%$ of f.s. at modulation frequency to 500 kHz; Bessel calibrator, utilizing 34.653 modulation rate, provides 1% calibrate point at 1.0 MHz deviation band 2, at 0.66 MHz deviation band 1.

Frequency response: dc coupled, dc to 1.0 MHz; ac coupled, 5 Hz to 1.0 MHz; within $+1$ to -2 dB referenced to 10 kHz; less than 3 dB down to 2.0 MHz.

FM nonlinearity: $< 0.5\%$ at ± 0.5 MHz deviation, F_{mod} to 0.5 MHz; $< 1.0\%$ at ± 1.0 MHz deviation, F_{mod} to 1.0 MHz; $< 5.0\%$ at 3.0 MHz deviation.

Modulation input: impedance, 600 ohms shunted by less than 30 pF; sensitivity, 1.5 V rms maximum for ± 1.0 MHz deviation.

Internal modulation oscillator

Frequencies: IRIG channels 1 to 21.

Frequency accuracy: $\pm 2\%$.

THD: 0.5% maximum.

Dimensions: $16\frac{3}{4}$ " wide, $8\frac{3}{4}$ " high, $18\frac{3}{8}$ " deep, 425 x 222 x 467 mm).

Weight: 45 lbs (20.3 kg); shipping 60 lbs (27 kg).

Power: 115 or 230 V $\pm 10\%$, 50 to 400 Hz, 50 watts.

Price: \$ 5,750.

UNIVERTER

0.1 to 55 MHz for 202H Signal Generator

Model 207H



SIGNAL SOURCES

The HP 207H Univerter, a frequency converter with unity gain, is designed for use with HP 202H FM-AM Signal Generator (page 371) to provide additional frequency coverage from 100 kHz to 55 MHz, including commonly used intermediate frequencies.

The univertter consists essentially of a semi-fixed frequency, 200 MHz heterodyne oscillator, a wideband amplifier and a self-contained regulated power supply. In operation, the internal heterodyne oscillator beats with the output signal of the 202H (199.9 to 145 MHz), and the difference frequency is passed through the wideband amplifier to the output system.

The output frequency of the univertter is easily determined by subtracting the 202H frequency dial reading from 200 MHz. In addition, a front-panel incremental frequency control, calibrated in 5 kHz increments, provides

continuous control over a ± 300 kHz range. External adjustments are provided for setting the overall gain of the instrument to unity and for adjusting the center frequency of the local oscillator to zero beat with the 200 MHz dial calibration of the 202H.

To use the univertter, it is only necessary to connect the RF output of the associated 202H Signal Generator to the input of the univertter; three separate outputs are provided. The X1 output provides unity gain, under the control of the signal generator attenuator, and is suited for most general-purpose applications. The X0.01 output attenuates the input signal level, as well as the random noise power output, 40 dB, and is specifically provided for receiver measurements in the low microvolt region. An uncalibrated, high-level output provides a minimum of one volt into a 300-ohm load, with 0.1 volt input.

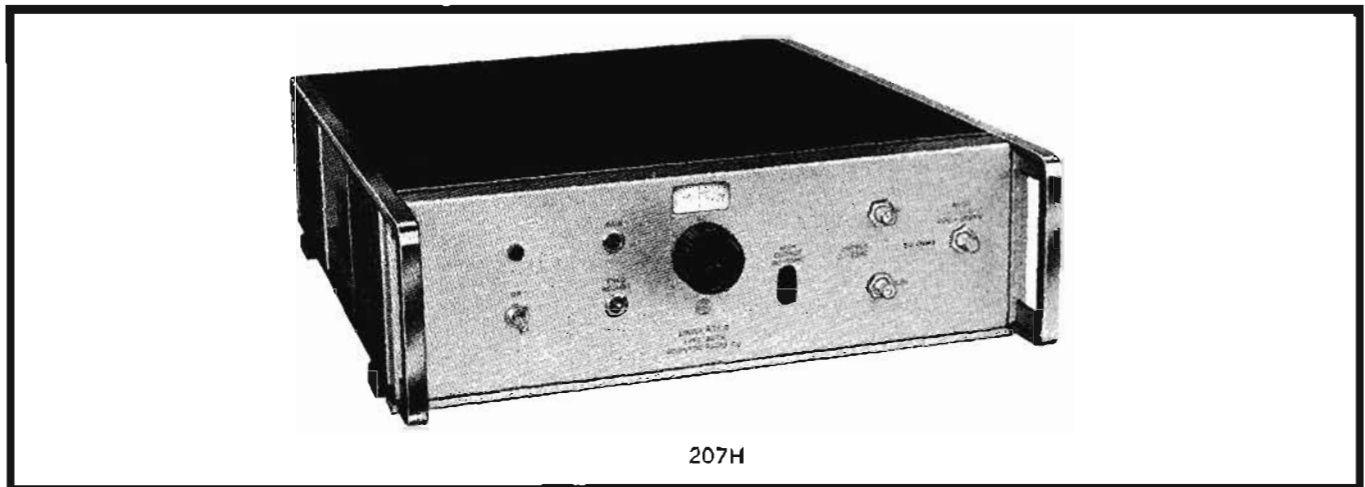

207H

Specifications

(when used with 202H Signal Generator)

Radio frequency characteristics

RF range: 100 kHz to 55 MHz (with 199.9 to 145 MHz input from 202H).

RF calibration: incremental range, ± 300 kHz; incremental calibration, increments of 5 kHz; incremental accuracy, $\pm (3\% + 1 \text{ kHz})$.

RF stability: short-term, $< 0.001\%^\dagger$ (5 minutes); long term, $< 0.005\%^\dagger$ (1 hour); line voltage, $< 400 \text{ Hz/V}$.

RF output

Range: (A) $1 \mu\text{V}$ to 0.1 V^* (X1); (B) $0.01 \mu\text{V}$ to 1 mV^* (X0.01); (C) $> 1 \text{ V}^{**}$, high output.

Accuracy: (A) reproduces output of 202H $\pm 1 \text{ dB}$; (B) reproduces output of 202H $\pm 2 \text{ dB}$.

Impedance: (A) 50 ohms nominal; (B) 50 ohms nominal; (C) 300 ohms nominal.

Spurious output: all spurious output voltages are better than 25 dB \ddagger below desired output; spurious output of 207H alone consists of random noise and 200 MHz local oscillator; at X0.01 output, noise power essentially equivalent to 50-ohm resistor at room temperature.

Modulation characteristics

Range: duplicates FM and AM modulation of 202H.

Distortion: FM, no appreciable distortion; AM, no appreciable distortion for input levels $< 0.05 \text{ V}$.

Accessories furnished: 00524A Patching Cable; high-output plug.

Accessories available: 00501B Output Cable, \$16; 00502B Patching Cable, \$7; 00506B Patching Cable, \$7; 00514B Output Cable, \$16.

Physical characteristics

Mounting: cabinet for bench use; readily adaptable for 19" rack mounting.

Finish: gray panel; blue cabinet (other finishes available on special order).

Dimensions: $16\frac{3}{4}$ " wide, $5\text{-}33/64$ " high, $18\frac{1}{8}$ " deep (425 x 140 x 467 mm).

Weight: net 18 lbs (8.1 kg); shipping 30 lbs (13.5 kg).

Power: 105 to 125 V or 210 to 250 V, 50 to 1000 Hz, 50 W.

Price: 207H, \$595.

† after one-hour warm-up.

* across external 50-ohm load at panel jack

** with 0.1 V input and 300-ohm output load.

‡ for input levels < 0.05 volts.



DME/ATC TEST SET

Calibrates DME and ATC equipment
Model 8925A

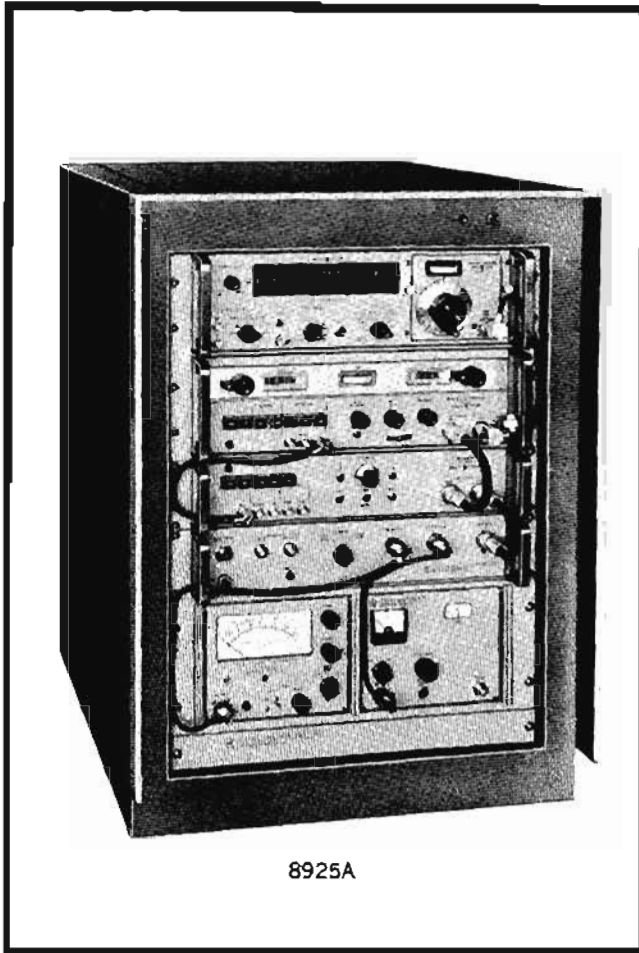

8925A

The HP 8925A DME/ATC Test Set is specifically designed for testing and calibrating DME (Distance Measuring Equipment) and ATC (Air Traffic Control) transponder aircraft equipment. When used with suitable modulators, the test set will also simulate some TACAN and IFF signals. Completely self-contained (except for video modulators), the system consists of a continuously tuneable signal generator (HP H01-8614A), direct-reading frequency counter (HP 5245L), solid-state modulator (HP H01-8403A), frequency converter (HP 5254A), wavemeter (HP 8905A), peak power measuring system (HP 8900B), and all necessary circuitry for interconnection to the radio set under test (HP 13505A).

Specifications

Radio frequency characteristics

RF range: 962 to 1213 MHz.

RF accuracy: determined by ability to set to desired reading on counter.

RF settability: better than 100 kHz.

RF stability: temperature, approx 0.005% per degree C; line voltage, <0.003% ($\pm 10\%$ line voltage change).

RF output: range: -10 to -100 dBm cross external 50-ohm load at output jack. accuracy:

Attenuator setting	ATC (1015 to 1045 MHz)	DME (962 to 1213 MHz)
-10 to -17 dBm	$+0.7$ to 1.2 dB	$+1.1$ to 1.6 dB
-17 dBm	± 0.6 dB	± 1 dB
-17 to -100 dBm	$\pm (0.8 + 0.06$ per 10 dB) dB	$\pm (1.2 + 0.06$ per 10 dB) dB

Leveled output: (fixed atten. position) ATC, ± 0.2 dB; DME, ± 0.6 dB; impedance: 50 ohms; VSWR: 1.35:1.

Pulse modulation characteristics

PM source: suitable external video modulators.

Pulse shape: with suitable modulators, meets general requirements of DME/ATC.

Side-lobe suppression: the second pulse of a train of 2 (or 3) pulses may be varied $+1$ to -10 dB from the first pulse when its leading edge is ≥ 2 μ s from the first pulse leading edge; calibrated SLS control accurate to ± 0.5 dB.

Simulated bearing input: audio frequency input to BNC jack under TACAN button will simulate bearing modulation to a depth of 55% max. (3.8 dB above pulse tips).

Power measurement characteristics

RF range: 962 to 1213 MHz; RF power range: 100 to 2000 watts peak (ARINC units), 10 to 200/100 to 200 watts peak (Gen. Aviation and ARINC units) available as factory modification with accessory attenuator; RF power accuracy: ± 1.2 dB from calibration curve).

Frequency measurements characteristics

RF range: 1070 to 1110 MHz; RF accuracy: ± 0.5 MHz; direct meter indication for peak power 250 to 1000 watts at 25°C; video output for external scope indication for input peak power down to approx 10 watts.

Monitor characteristics

Signal generator monitor (Monitor-Sig Gen), heterodyne monitor (Het Mon): frequency range: 1018 to 1032 MHz (for beating oscillator 1023 ± 1 MHz); output level: 0.5 volts peak min at -10 dBm RF level (at IF center frequency); load impedance: 150 ohms nominal; bandwidth: 9 MHz nominal (equivalent low-pass bandwidth 4 MHz); linearity: ± 0.5 dB (-10 to -20 dBm RF level).

Diode monitor (Diode Mon): frequency range: 962 to 1213 MHz; output level: 0.1 V peak min at -10 dBm RF level; low-pass bandwidth: 5 MHz nominal.

Transmitter monitor (Monitor-Xmtr): output level: approx 0.2 V peak for 200 watts peak input (100 to 2000 watts peak power range), 20 watts peak input (10 to 200 watts peak power range); load impedance: 150 ohms nominal; bandwidth: 10 MHz nominal; linearity: ± 1 dB for 200 to 2000/20 to 200 watts peak input; transmitter interlock: terminals are provided for de-energizing the transmitter when the system internal load is removed from the transmitter antenna.

Dimensions: 23" wide, 32 $\frac{1}{4}$ " high, 26" deep (584 x 819 x 660 mm).

Weight: net 310 lbs (139.5 kg); shipping 350 lbs (157.5 kg).

Power: 105 to 125 or 210 to 250 volts, 50 to 60 Hz, 400 W.

Price: HP 8925A, \$12,135.

Options: 01: less 5245L/5254A Counter, \$8,860; 02: less cabinet, \$12,045; 03: dual power range (10 to 200/100 to 2000 watts), add \$100; 04: HP 5246L Counter instead of HP 5245L. \$11,435; specify by option number.

SIGNAL GENERATORS

Test and calibrate aircraft VOR and ILS
Models 211A, 232A



SIGNAL SOURCES

211A Signal Generator

The HP 211A Crystal-Monitored Signal Generator is specifically designed for the testing and calibrating of aircraft VOR and ILS localizer radio receiving equipment operating within the frequency range from 88 to 140 MHz. It also may be used for laboratory and development work where a precision-type amplitude-modulated RF signal source is required.

232A Signal Generator

The FAA Instrument Landing System for aircraft includes a glide slope receiver for indicating the proper rate of descent. The HP 232A Glide Slope Signal Generator was designed for use in testing and calibrating these glide slope receivers.

Specifications, 211A

Radio frequency characteristics

RF range: master oscillator: 88 to 140 MHz in one range; crystal oscillator: 110.1 and 114.9 MHz.

RF output: range: 0.1 μ V to 0.2 volt (across external 50-ohm load); impedance: 50 ohms; spurious output: all spurious RF output voltages are better than 40 dB below desired output.

Amplitude modulation characteristics: AM range, 0 to 100% in two ranges.

Physical characteristics

Dimensions: 211A and 211AP1 (Power Supply): 19 $\frac{1}{2}$ " wide, 10 $\frac{1}{2}$ " high, 9 $\frac{1}{2}$ " deep (495 x 267 x 241 mm).

Weight: net 63 lbs (28,4 kg); shipping 86 lbs (38,7 kg).

Power: 105 to 125 V, 50 to 60 Hz, 150 W.

Price: HP 211A, 211AP1, \$2190.

Specifications, 232A

Radio frequency characteristics

RF range: (A) 329.3 to 335 MHz in increments of 0.3 MHz; (B) 20.7 MHz; other frequencies between 15 and 30 MHz available on special order.

RF accuracy: $\pm 0.0065\%$ (crystal controlled).

RF output: range: 1 μ V to 0.2 V (across external 50-ohm load); accuracy: $\pm 10\%$ approximately; impedance: 50 ohms.

RF leakage: sufficiently low to permit measurement at 1 μ V.

Amplitude modulation characteristics

AM range: internal: 0 to 100% in two ranges; external: 0 to 100% in two ranges.

AM calibration: increments of 2%, 0 to 50%; increments of 10%, 0 to 100%.

Demodulated output: available at front-panel posts through 2 μ F capacitor.

Modulating oscillator characteristics

OSC frequency: (A) 1000 Hz; (B) 90 to 150 Hz in the following tone ratios: 0 dB, ± 0.5 dB, ± 1 dB, ± 2 dB, ± 3.3 dB, \pm infinite dB (calibrate).

Physical characteristics

Dimensions: 20 $\frac{7}{8}$ " wide, 10 $\frac{1}{2}$ " high, 12" deep (511 x 267 x 305 mm).

Weight: net 64 lbs (28,8 kg); shipping 75 lbs (33,8 kg).

Power: 105 to 125 V, to 60 ± 1 Hz, 150 W

Price: HP 232A, \$2495.

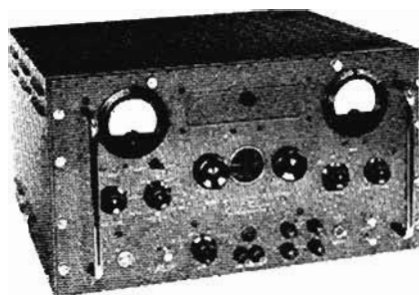

232A

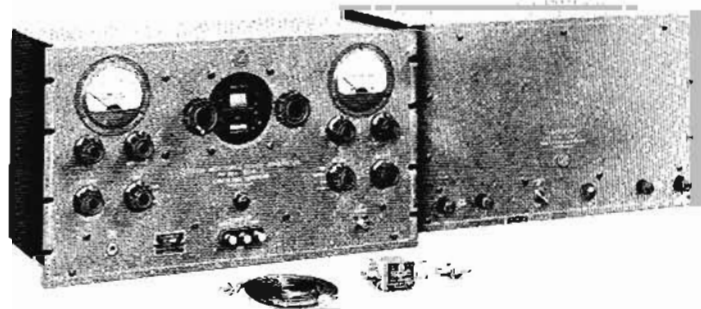

211A



SPECTRUM GENERATOR/DOUBLER

Versatile broadband operation
Models 10511A, 10515A

HP 10511A Spectrum Generator

The Hewlett-Packard 10511A Spectrum Generator is a passive device that generates a train of 1 nanosecond wide pulses when driven by a sinusoidal signal source. The 10511A was specifically designed as an accessory to the HP 5100A Frequency Synthesizer. However, it is useful with any 50Ω source that can provide the proper input signal.

With a sine wave input, in the frequency range of 10 MHz to 75 MHz, a spectrum of harmonics is generated. This spectrum contains all harmonics of the input frequency to the 1 GHz region. To extract a desired harmonic, a 50Ω bandpass filter can be cascaded with the 10511A to give a sinusoidal output. The HP 230A Power Amplifier (tuned) may be used for higher level outputs for harmonics up to 500 MHz.

Operation of the 10511A with the 5100A without a bandpass filter on the output produces a pulse train whose repetition rate is precisely controlled. The 10511A, with a tuned filter, produces precise CW frequencies between 50 MHz and 500 MHz.

Specifications 10511A

Input requirements

Frequency range: 25 to 50 MHz.*

Drive level: 1 to 3 volts RMS available to 50Ω.

Output

Pulse width: 1 nanosecond, $\pm 15\%$ at mid-amplitude.

Pulse height: 0.75 volt minimum for minimum drive level.

Impedance: 50Ω (nominal).

Available harmonic power: -19 dBm minimum for any harmonic number between 1 and 10.

General

Dimensions: 3 in. long, 1 $\frac{5}{8}$ in. dia. (76 x 41 mm).

Weight: net, 3 oz (85 grams). Shipping, 1 lb (0.45 kg).

Price: \$150.

*Useful operation is obtained for input frequencies from 10 MHz to 75 MHz.

HP 10515A Frequency Doubler

The Hewlett-Packard Model 10515A Frequency Doubler is an ideal accessory for use in extending the usable frequency range of signal generators, frequency synthesizers or other signal sources. Operating on input frequencies of 0.5 MHz to 500 MHz it provides a doubled output in the range of 1 MHz to 1 GHz. This 50 ohm device uses a full-wave rectifier circuit which is extremely flat over its entire frequency range. The frequency response is very flat ($< \pm 1$ dB over entire range typically), and undesired harmonics are very well suppressed.

The output of this unit does not have an internal dc return so that it will provide a very broadband ac to dc conversion only if not dc terminated. This mode of operation is useful for detection of low level amplitude modulations.

The 10515A may be used with the following Hewlett-Packard instruments (this is only a partial listing):

5100A Frequency Synthesizer	606A Signal Generator
5102A Frequency Synthesizer	3200B VHF Oscillator
5103A Frequency Synthesizer	608 Signal Generators
5105A Frequency Synthesizer	

Specifications 10515A

Frequency range: 0.5-500 MHz input; 1-1000 MHz output.

Impedance: 50Ω nominal (source and load).

Input signal voltage: 0.5 - 3.0 V_{RMS}.

Input signal power: 180 mW (maximum).

Conversion loss:*

< 12 dB (typically < 11 dB) for > 1 volt

< 13 dB (typically < 12 dB) for > 0.5 volt

Suppression of 1st and 3rd harmonic of input:*

> 30 dB for 0.5 to 50 MHz input (typically > 35 dB).

> 10 dB for input to 500 MHz (typically > 15 dB).

Connectors: input: BNC male; output: BNC female.

Dimensions: diameter: 0.7" (18 mm); length: 2.5" (64 mm).

Weight: approximately 2 oz (56 grams).

Price: \$120.

*With a 50 ohm resistive load and a single input frequency. Suppression values are referred to the desired output level.

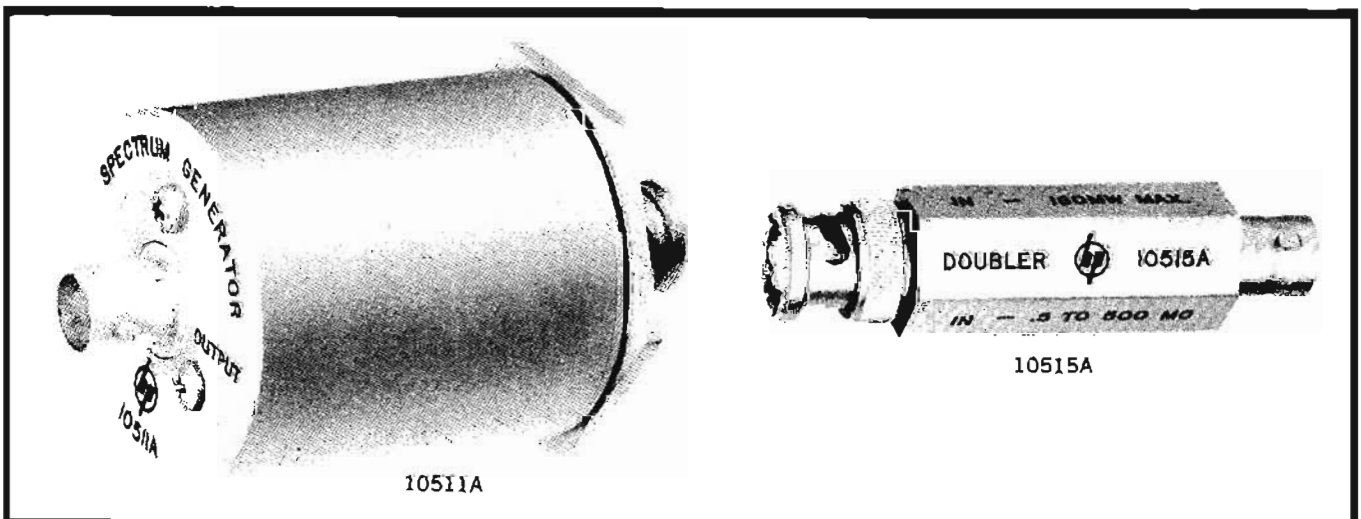

SWEEPERS



SIGNAL SOURCES

A sweep signal generator is a valuable tool in laboratory design, in production testing, and for making incoming inspections. When a sweeper is used in testing circuits, it can quickly provide important information that might otherwise require laborious time consuming tests.

When selecting a sweeper, first consider the characteristics needed: sweep frequency range, stability, flatness, dial accuracy, linear or log sweep, variable sweep time, blanking, and pen lift.

Hewlett-Packard sweepers include frequencies from 0.1 Hz to 40 GHz, and all of the above mentioned requirements are specifically described in the instrument's specifications. Table 1 on page 381 briefly describes the characteristics of all HP sweepers and associated plug-in units. The following paragraphs discuss these sweepers beginning with the lowest frequency models.

Model 3305A

The 3305A is a sweep plug-in for the 3300A Function Generator mainframe. This combination provides a low frequency wideband sweep generator in addition to the other features of a versatile plug-in function generator.

The 3305A sweeps up to 4 decades in a single sweep covering frequencies from 0.1 Hz to 100 kHz in three overlapping ranges (0.1 Hz - 1 kHz, 1 Hz - 10 kHz, 10 Hz - 100 kHz). The start and stop frequencies can be independently adjusted to any point on any one range. The sweep of the preset frequencies allows logarithmic frequency plots to be made, and a good approximation to a linear sweep can be obtained when the sweep width is small. A linear sawtooth output is available for the X-axis of oscilloscopes or X-Y recorders. After the X-axis of the recorder is set up, the sweepwidth, the start and stop positions, the range, and the sweep time may be changed without readjustment of the horizontal sweep. This sweep plug-in also includes signal blanking and pen lift during retrace.

The 3305A has four modes of operation: 1) repetitive sweeps can be made automatically, 2) a single sweep per trigger pulse (local or remote) can be obtained, 3) the frequency output between the start and stop frequencies can be manually controlled by a potentiometer, and 4) the 3305A can be remotely programmed or swept up to 4 decades of frequency by setting the start control to

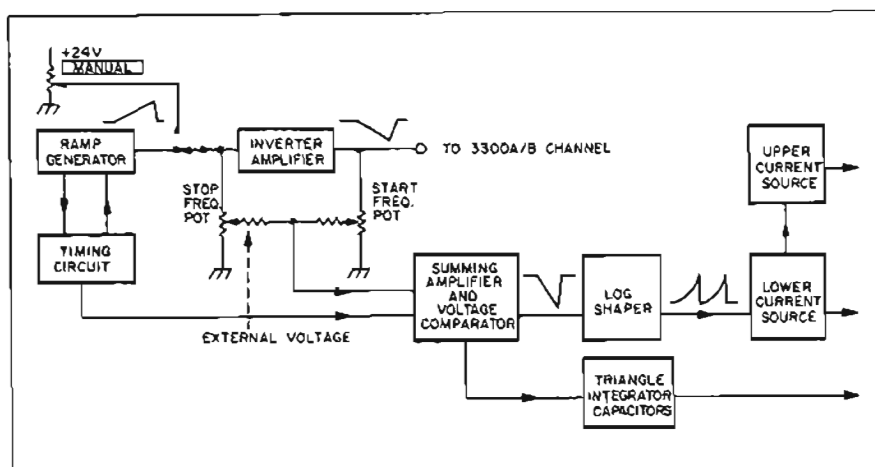

Figure 1. HP 3305A block diagram.

a desired frequency and applying an external voltage.

The 3305A Sweep Plug-in circuit originates a sweep by generating a ramp as shown in the block diagram in Figure 1. The ramp duration or sweep time is continuously variable over a range of 0.01 sec to 100 sec. The ramp generator serves two purposes. It is used for the horizontal sweep output for the X-axis of a recorder, and it supplies the voltage to the stop potentiometer and the start potentiometer by way of an inverting amplifier. The two potentiometer outputs form a positive-going and a negative-going ramp respectively. These two ramps are summed to form a resultant ramp with its amplitude, slope, and dc level determined by the start and stop settings.

When sweeping up over the full 4 decades of frequency, the ramp is negative-going from 0 to -20 volts. Whatever the amplitude of the resultant ramp, it is fed to the shaper amplifier to be converted into a form that will sweep the 3300A to produce logarithmic frequency plots directly. This shaper goes through two cycles or a portion of two cycles dependent on the start and stop settings. During the second shaper cycle, the 3300A integrator capacitor is 1/100 of its value during the first shaper cycle. This switch point does not affect the continuous sweep of frequencies over 4 decades. If this point is noticeable on a narrow sweep, the sweep ranges are overlapping so that the same sweep on another range not containing this switch point can be used.

Any of the 3300A outputs (sine, square, or triangular) may be swept over

4 decades at either channel A or channel B of the 3300A mainframe.

Model 675A

Hewlett-Packard has introduced a sweep generator that will sweep continuously from 10 kHz to 32 MHz with a linearity better than $\pm 0.5\%$ of sweepwidth and a flatness of ± 0.15 dB. Broadband amplifiers and attenuators can be tested over a $3\frac{1}{2}$ decade range in one sweep.

This sweeping signal generator can also be used to sweep narrowband circuits, high-Q tank circuits, and crystal filter circuits without individually calibrating each sweep setting. The start-stop frequencies for the sweep have a three digit readout at a $\pm 1\%$ endpoint accuracy and a low temperature drift of 3 kHz/ $^{\circ}$ C. These calibrated endpoint accuracies, along with a highly linear sweep, allow frequency determination directly from the oscilloscope graticule. Residual FM (frequency variations due to 60 Hz line interference) is less than 70 Hz peak, and spurious FM (due to noise) is less than 60 Hz rms. This makes it possible to make narrowband frequency vs amplitude measurements on an oscilloscope or an X-Y recorder without jitter.

Faster and easier frequency identification is possible with the optional or accessory frequency markers. The HP 675A Option 01 provides a 1 MHz harmonic comb marker, Option 02 provides a 100 kHz comb marker, and Option 03 provides both 1 MHz and 100 kHz markers. Accessory 11300A is a single frequency crystal marker at any frequency selected for a specific application. These

markers can be switched off and on by front panel pushbuttons and can be adjusted in amplitude and width.

In order to resolve the markers on a steep vertical slope of a narrowband response, the marker can be tilted horizontally with the horizontal marker pushbutton.

When a signal generator with high stability and low residual FM is needed, the 675A can be operated in the CW mode. In CW operation, the signal generator can be amplitude modulated internally and can be both amplitude and frequency modulated externally. FM receiver and transmitter alignments can be made as well as IF strip alignments.

For quick repetitive production tests or for use in systems, this 675A Sweep Generator can be remotely programmed (in both frequency and amplitude) by external analog voltages.

The operator performing a multitude of tests finds most of his needs in one instrument. For example, the 675A is a sweeper with internal detector, a signal generator, and also an analog programmable source.

Wideband RF and microwave sweepers

Application Note 65 covering the use and accuracy of swept frequency techniques for attenuation, impedance, power, and frequency calibration measurement provides an up-to-date compendium of the latest developments in microwave swept measurements. This Note may be obtained from any Hewlett-Packard field office at no charge.

The HP 8690 Series Sweep Oscillators cover the frequency range 100 kHz to 110 MHz and 1 to 40 GHz. They provide calibrated broad and narrow sweeps, and markers which amplitude-modulate the RF may be used on either. The markers also may be used as end points of a second broadband sweep. Manual sweep reduces X-Y recorder set-up time, and push-buttons greatly simplify operation. The RF output frequency may be swept slowly enough for presentation on an X-Y recorder or fast enough for no-flicker presentation on an oscilloscope.

The 8690 Series sweep oscillators have been designed to incorporate plug-in RF units enabling the operator to change frequency bands quickly. This eliminates the need for duplicate equipment to cover each RF or microwave band. The 8690A Main-frame provides two independent broad-band sweeps, start-stop, marker

sweep, and one precision narrow band sweep, a calibrated Δf sweep. Included is internal square-wave modulation with a range of 950 to 1,050 Hz plus external AM and FM. External FM permits frequency-programming, including externally controlled sweeps over the whole range or any part of it.

The HP 8698A low-frequency RF unit covering 100 kHz to 110 MHz contains a transistorized frequency comparator-type voltage-tuned oscillator covering a three-decade frequency range. This instrument is a swept signal generator containing an output attenuator and offering leveled power output across its entire frequency range. Calibrated power output (+10 dBm to -110 dBm), very low residual FM and excellent frequency accuracy and setability place the 8698A in the signal-generator performance class; it will fill a number of signal generator applications when used on a CW basis. The 8698A RF Unit extends the calibrated sweep capability previously associated only with microwave sweepers into the RF range. Its excellent frequency accuracy and linearity provide calibrated sweep displays, eliminating the need for markers to determine frequency at either intermediate or end points in the sweep display.

Models 8691A/B through 8697A RF Units contain voltage tuned backward wave tubes covering the frequency range 100 MHz to 40 GHz. RF units in the 1 to

12.4 GHz range can be provided with PIN diode attenuators which permit all of the amplitude modulation functions, including leveling, to be performed independently of the backward-wave tube. The result is virtual elimination of frequency pulling, which, in turn, results in extremely high frequency accuracy and linearity and very low incidental FM.

Control unit and RF unit holder

The first simple and inexpensive solution to the problem of broadband sweep capability (more than an octave) is offered by Hewlett-Packard's Model 8706A Control Unit with the Model 8707A RF Unit Holder shown in Figure 2. When used with the Model 8690A Sweep Oscillator and appropriate RF units, a compact, benchtop multiband source is formed.

The Model 8706 Control Unit, with its nine band selector buttons, replaces the usual RF unit as a plug-in for the sweep oscillator mainframe. It supplies power for and controls as many as three Model 8707A RF Unit Holders, each of which accommodates three RF units. A system with three Model 8707A's can be used to select instantly all or part of the complete 100 kHz to 40 GHz range.

Units may be programmed by either front panel control unit pushbutton selection or sequentially by remote contact closure to ground. The 8706A also can

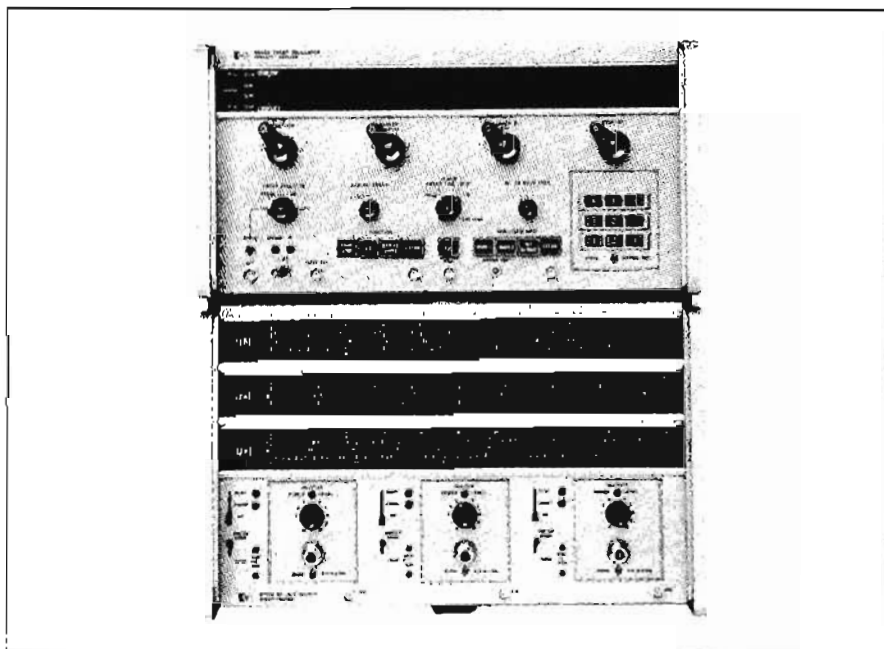

Figure 2. Models 8706A Control Unit and 8707A RF Unit Holder with 8690A Sweep Oscillator.

provide voltages for control of remote circuits, relays, etc. By utilizing these voltages to program a coaxial switch, for example, you can channel the output signals of several RF units through a single system output connector. Multi-band tests can then be made quickly and easily; changing RF units and cable connections is handled automatically at the touch of a button.

Unnecessary operation of BWO tubes should be avoided to prolong their life. At the same time it is desirable to have the output of any RF unit quickly available. The 8706A/8707A sweep system maintains the BWO's on standby, removing the high voltage when not in use to extend tube life. When a single band is not to be used over some period of time, for example, during a laboratory setup procedure, an individual RF unit may be easily turned off, minimizing all aging effects.

Leveled output from sweep oscillators

The development of closed-loop feedback systems for leveling sweep oscillator output power has greatly expanded the practical scope of swept-frequency measurements. The basic closed-loop system is shown in Figure 3.

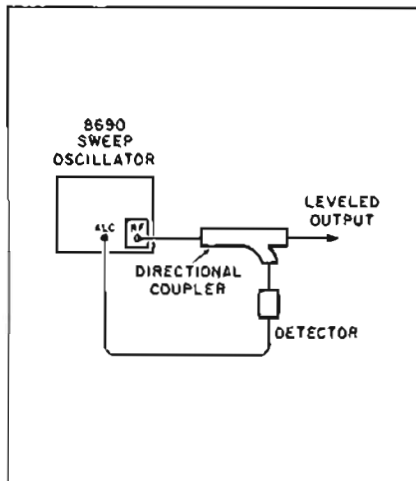

Figure 3. Basic closed-loop leveling system.

The HP 8690 Series Sweep Oscillators contain a leveling amplifier for automatic level control (ALC); the power variation that occurs at the system output is primarily determined by coupler and detector variation. Leveling can be accomplished with either a crystal detector or thermistor mount/power meter as the

detector. For coaxial systems, Hewlett-Packard has developed the 780 Series Directional Detectors (page 288) which consist of a high directivity, flat directional coupler combined with a high sensitivity, flat-response crystal detector. System flatness of better than ± 0.3 dB over octave bandwidths is typical, using Hewlett-Packard directional detectors. For power meter leveling in coax, HP 790 Series Flat Directional Couplers (page 288) can be used in conjunction with the HP 478A Coax Thermistor Mount and 431C Power Meter (page 408). Power meter leveling allows setting of known absolute power levels, and the 431C's range switch can serve as a very accurate attenuation control.

To level output power in waveguide systems, HP 752 Series Waveguide Directional Couplers (page 290) and 424A Series Waveguide Crystal Detectors (page 287) are used. With better than 40 dB directivity, 752 Series Couplers in leveled systems provided good equivalent source match — nominally 1.02 swr. Waveguide couplers will typically exhibit ± 0.5 dB coupling variation over the band. In conventional reflection or transmission measurement systems employing two couplers, this variation of coupling with frequency is of little consequence because both couplers demonstrate the same coupling characteristics; hence, the variations with frequency effectively cancel. Where a greater degree of leveling is needed in waveguide, a pair of 752 couplers are connected "back-to-back" as in Figure 4. In this configuration the insertion loss of the 3 dB coupler (752A) follows a curve directly opposite to the coupling curve of the mainline 752C or D coupler. The resulting power relationship between port 1 and port 2 is flat to better than ± 0.2 dB over full waveguide bands.

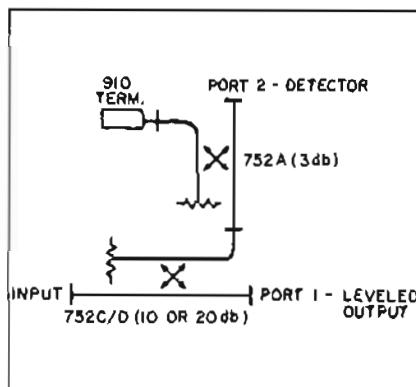

Figure 4. "Back-to-back" waveguide coupler arrangement for extremely flat output.

Swept-frequency systems

Reflectometer systems

Probably the major usage of sweep oscillators is in reflectometer systems for broadband measurement of reflection and transmission characteristics. Leveling the signal source brings new latitude of readout to the user, for measurement results can be read directly rather than on a ratio basis. Sophisticated instrumentation systems employing the principles of reflectometry such as the new HP 8540A Automatic Network Analyzer system described on page 259, rely upon the 8690A Series Swept Oscillators for frequency accuracy and operational simplicity.

Higher power systems

Typical backward-wave oscillators supply leveled power outputs in the milliwatt region. Applications such as RFI-susceptibility tests and high attenuation swept measurements often require 750 mW outputs. The E15-8690 system shown in the block diagram in Figure 5 will provide better than 750 mW from 1 to 12.4 GHz.

Special calibration systems

Leveled systems have also been designed to level on the net forward power applied to a device, permitting the examination, for example, of the efficiency and calibration factor of coaxial and waveguide devices. The E31-8690 Power Calibration System series which employs this principle is described on page 408.

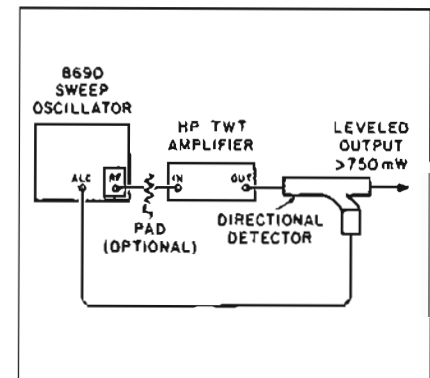

Figure 5. The E15-8690A system generates high-level (750 mW), flat output power. The pad between the sweep oscillator and the TWT amplifier is used to keep the signal level into the amplifier below that which would saturate the TWT.

Swept frequency display devices

Especially useful is the new HP 1416A plug-in for the 140A and 141A Oscilloscopes. Designed expressly for use in leveled reflectometer systems using square-law detectors, the 1416A provides an accurate 30 dB of dynamic range when used with HP 423A and 424A Series Crystal Detectors. It also provides excellent resolution; sensitivity of .5 dB/cm permits close examination of results. The 1416A is particularly effective with the 141A variable persistence oscilloscope as a readout device for the swept slotted line measurement system described on page 272.

Stabilized sweep oscillator systems

Applications such as microwave spectroscopy and high-Q swept frequency cavity measurements have brought about the need for phase-locked fixed or swept frequency operation of the 8690 Series sweep oscillators.

HP stabilized sweep oscillator systems are available for swept and CW operation or CW operation only in the coaxial (1 to 12.4 GHz) and waveguide bands (12.4 to 40 GHz). Figure 6 shows a swept and CW coaxial system.

In these systems an 8690A Sweep Oscillator with appropriate interchangeable RF unit is phase-locked to a 240-400 MHz reference oscillator. The reference oscillator stability is thereby transferred to the sweep oscillator. The reference oscillator is continuously tunable, so the sweep oscillators can be stabilized at any frequency in their respective ranges quickly and easily; there are no crystals to change.

Frequency indication is unambiguous and can be read directly from the sweeper dial. For more accurate frequency indication, a counter can be added.

The phase-lock IF is 20 MHz. This choice of frequency eliminates IF feed-through and leakage which arise in applications such as sensitive receiver testing when the receiver IF is the same as the phase-lock IF. A 21.5 MHz phase-lock IF is also available for applications in which 20 MHz is undesirable.

Phase-locking the system is simple. The desired frequency is set on the sweeper dial and the reference oscillator is then tuned for lock as indicated by a front panel light on the synchronizer. For systems that include a counter, the reference oscillator is tuned to obtain the desired sweeper frequency on the counter (although the counter indicates sweeper frequency, it counts the reference oscilla-

tor). The sweeper is then tuned to the appropriate lock point. The wide spacing of the lock points (240 to 400 MHz) makes picking the right lock point easy.

Economical, low frequency sweeper

The HP 3211A, with its Marker Plug-in unit and choice of six frequency plug-in units, is a low-cost, versatile, high-performance sweep oscillator ideally suited for use in the design, calibration, and alignment of FM tuners and receivers, and the general testing of IF sections of TV receivers, radar and communication systems, and other video to VHF circuits. Its high output (>.7 V rms) and accurate 59-dB attenuator make the instrument a valuable tool for the testing of both high and low-gain circuits under variable signal conditions.

The 100 kHz to 110 MHz frequency range of the 3211A is covered by five RF plug-in units with overlapping octave ranges, operating at the fundamental frequency, and a video range heterodyne plug-in unit. These plug-in units are designed for quick and easy changing.

The Marker Plug-in unit accepts up to eight different, crystal-controlled marker oscillator plug-in boards. These internal markers may be individually turned on or off by means of front panel switches, making identification easy on the oscilloscope display. The test signal display may be set up to provide positive or negative vertical markers, or intensity modulated markers. Intensity modulated (Z-axis) markers provide well-defined frequency identification, without distorting the display waveshape. The Marker Plug-in unit also has provision for connection of additional external markers from a CW or marker generator source.

A birdie by-pass marker system transforms the markers into video pulses and applies these pulses to the detected response of the test circuit, eliminating marker distortion, and preventing the response of the test circuit from being affected by the marker system. Front panel controls are provided for the adjustment of marker sensitivity and bandwidth.

Sweep width of the 3211A is continuously adjustable to 100% of all plug-in unit ranges. The sweep rate is continuously adjustable over the range of 10 to 100 Hz, with provisions for a single, variable, 1 to 10-second sweep compatible with X-Y recording requirements.

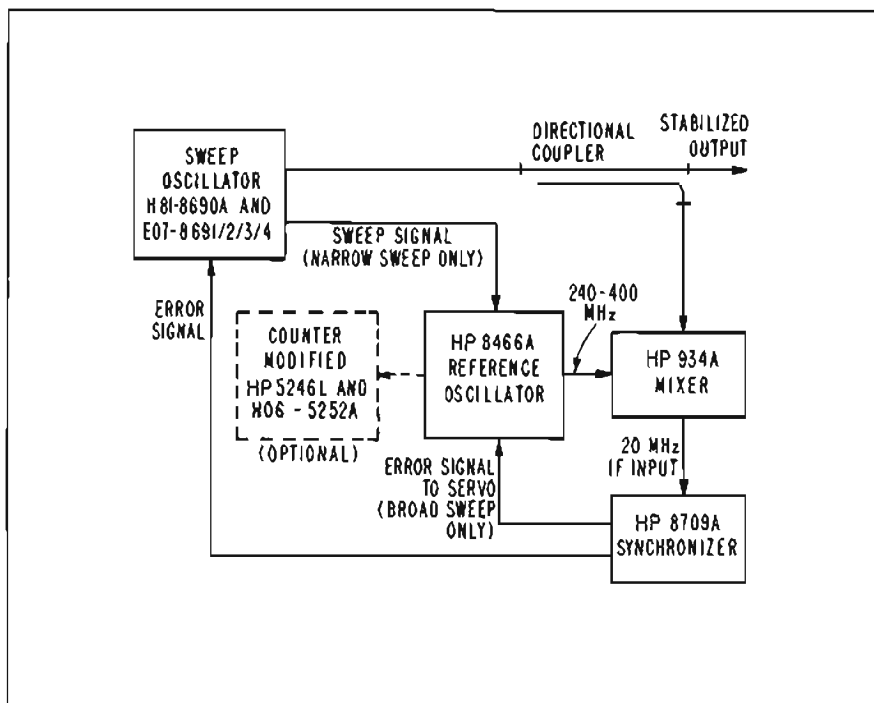

Figure 6. Coaxial systems (1 to 12.4 GHz) stabilized in swept or CW mode.

Table 1. Hewlett-Packard sweepers

HP model	Freq. range	Max output	Flatness	Residual FM	Sweep linearity	Sweep time	Sweep modes			Built-in markers	Page
							Auto	Single	Manual		
3300A (.01 Hz-100 kHz) Function Generator, 2 sweeper plug-ins											
3304A	0.1 Hz-100 kHz	5 V rms into 600Ω	±1% to ±3%		1% (linear)	0.01-100 s	Yes	No	No	No	340
3305A					logarithmic			Yes	Yes		382
675A (10 kHz-32 MHz) Sweeper, 1 range, no plug-ins											
675A	10 kHz-32 MHz	1 V rms into 50Ω	±0.15 dB 40 ±1 dB	70 Hz peak	±0.5% of sweepwidth	0.01-100 s	Yes	Yes	Yes	Opt	384
3211A (100 kHz-110 MHz) Sweep Oscillator, 6 plug-ins											
3212A	100 kHz-30 MHz	>0.7 V rms into 50Ω	±0.25 dB	< ±5 kHz	±10%	0.01-0.1 s continuous 1-10s (single)	Yes	Yes	No	Opt	385
3213A	8-16 MHz			< ±0.005% center freq	±1%-±10%						
3214A	12-28 MHz										
3215A	20-45 MHz										
3216A	30-70 MHz										
3217A	50-110 MHz										
8690A (0.1 MHz-40 GHz) Convertible Sweep Oscillator, 18 plug-ins											
8698A	0.1-11 MHz 1-110 MHz	2.24 V rms into 50Ω	±0.25 dB	<150 Hz- <500 Hz peak	±0.5% of sweepwidth	0.01-100 s	Yes	Yes	Yes	Yes	386
8691A	1-2 GHz	≥100 mW	±0.2 dB	<30 kHz peak	±1%						
8691B	1-2 GHz	≥70 mW	±0.1 dB		±10 MHz						
8692A	2-4 GHz		±0.2 dB		±1%						
8692B	2-4 GHz		≥40 mW		±0.1 dB						
H01-8692B	1.7-4.2 GHz	≥15 mW	±0.1 dB		±13 MHz						
8693A	4-8 GHz	≥30 mW	±0.2 dB		<50 kHz peak						
8693B	4-8 GHz	≥15 mW	±0.1 dB	±20 MHz							
H01-8693B	3.7-12.4 GHz	≥5 mW	±0.1 dB	±25 MHz							
8694A	8-12.4 GHz	≥50 mW	±0.2 dB	<60 kHz peak	±1%						
H01-8694A	7-12.4 GHz	≥25 mW									
H02-8694A	7-11 GHz	≥25 mW									
8694B	8-12.4 GHz	≥30 mW	±0.1 dB	<60 kHz peak	±30 MHz						
H01-8694B	7-12.4 GHz	≥15 mW			±40 MHz						
H02-8694B	7-11 GHz	≥15 mW			±30 MHz						
8695A	12.4-18 GHz	≥40 mW	±0.2 dB	<150 kHz	±1%						
8696A	18-26.5 GHz	≥10 mW		<200 kHz							
8697A	26.5-40 GHz	5 mW		<350 kHz							



SWEEP PLUG-IN FOR 3300A

Sweeps 4 decades logarithmically

Models 3300A, 3305A

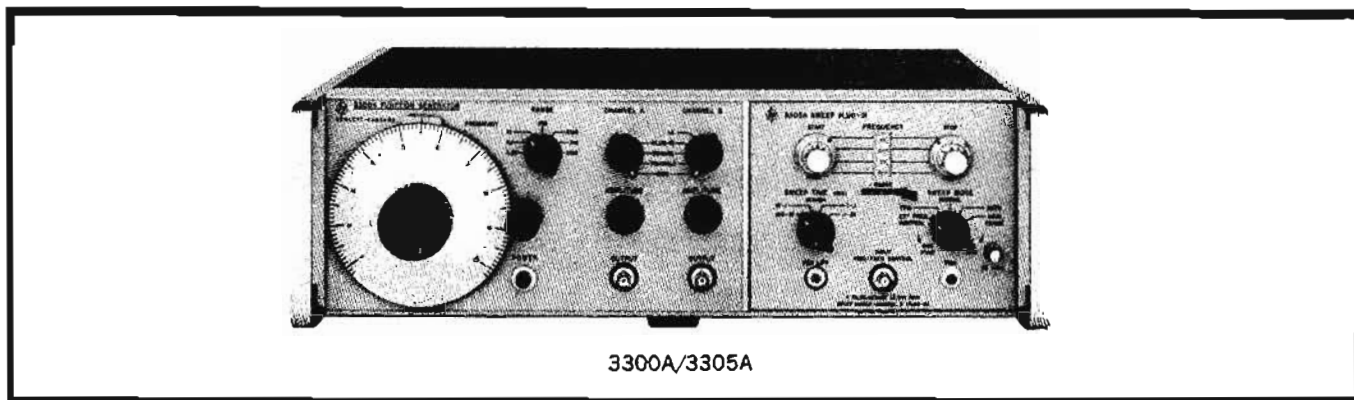

Description

The 3305A Sweep Plug-in combined with the 3300A Function Generator is an automatic, manually or externally triggered 4-decade sweeper and an external, 4-decade frequency-controlled signal source.

Four-decade logarithmic sweep

The 3300A/3305A will sweep logarithmically between any two frequencies in one of the three (4-decade) ranges—0.1 Hz to 1 kHz, 1 Hz to 10 kHz, and 10 Hz to 100 kHz. Calibrated independent start-stop controls greatly simplify setting desired sweep end points. Adjustable sweep time from 0.01 to 100 seconds provides sweep times slow enough for accurate response testing of low-frequency high-Q systems and fast enough for good visual displays of higher frequency responses. A frequency range greater than the audio band can be swept without any range switching or display equipment readjustment.

The manual sweep, vernier adjustment of frequency between the start-stop limits, allows close observation of a small portion of a response curve. This manual control also permits measurement of a critical frequency with counter accuracy and simpler set-ups for oscilloscopes or X-Y recorders.

Programming

For automated testing, the 3300A/3305A frequency can be analog-programmed over any one of the 4 decade ranges. Also, a single sweep can be externally triggered.

Sweep output

X-axis readjustment is eliminated since the sweep output amplitude is independent of start-stop, sweep time and sweep width settings.

Tentative specifications, 3305A*

Frequency range: 0.1 Hz to 100 kHz in 3 overlapping ranges.

Sweep width: limits adjustable 0 to 4 decades in any of three 4-decade bands—0.1 Hz to 1 kHz, 1 Hz to 10 kHz, 10 Hz to 100 kHz.

Start-stop dial accuracy: $\pm 5\%$ of setting, 0.1 Hz to 20 kHz;
 $\pm 7\%$ of setting, 20 kHz to 100 kHz.

Sweep modes

Automatic: repetitive logarithmic sweep between start and stop frequency settings.

Manual: vernier adjustment of frequency between start and stop frequency settings.

Trigger: sweep between start and stop frequency settings and retrace with application of external trigger voltage or by depressing front-panel trigger button.

Trigger requirements: ac coupled, positive-going, at least 1 V peak with > 2 V per ms rise rate.

Maximum input: ± 90 V peak.

Sweep time: 0.01 s to 100 s in 4 decade steps continuously adjustable vernier.

Retrace time: 0.001 s for 0.1 to 0.01 s sweep times, 0.01 s for 1 to 0.1 s sweep times, 2 s for 100 to 1 s sweep times.

Blanking: sine and triangle outputs, 0 V during retrace.

Pen lift: terminals shorted during sweep, open during retrace in auto and trigger modes for 100 to 1 s sweep times.

Sweep output: linear ramp at Channel B output (plug-in); amplitude adjustable independently of sweep width; max. output > 15 V p-p into open circuit, > 7 V p-p into 600 Ω .

External frequency control

Sensitivity: 6 V/decade (referenced to start setting), ± 24 V max.

V-to-F conversion accuracy: for each 6 V change in programming voltage, frequency changes 1 decade $\pm 5\%$ of final frequency.

Input Impedance: 400 k Ω .

Maximum rate: 100 Hz.

General

Dimensions: 6-1/16" wide, 4 3/4" high, 10 1/4" deep (153,9 x 120,7 x 260,4 mm).

Weight: net 4 lbs 6 oz (2 kg); shipping 6 lbs 6 oz (2,9 kg).

Price: HP 3305A, \$975.

* Refer to pages 339 and 340 for information on the 3300A and other plug-ins.

SWEEP SIGNAL GENERATOR

10 kHz to 32 MHz in one range; 0.15 dB flatness
Model 675A



SIGNAL SOURCES

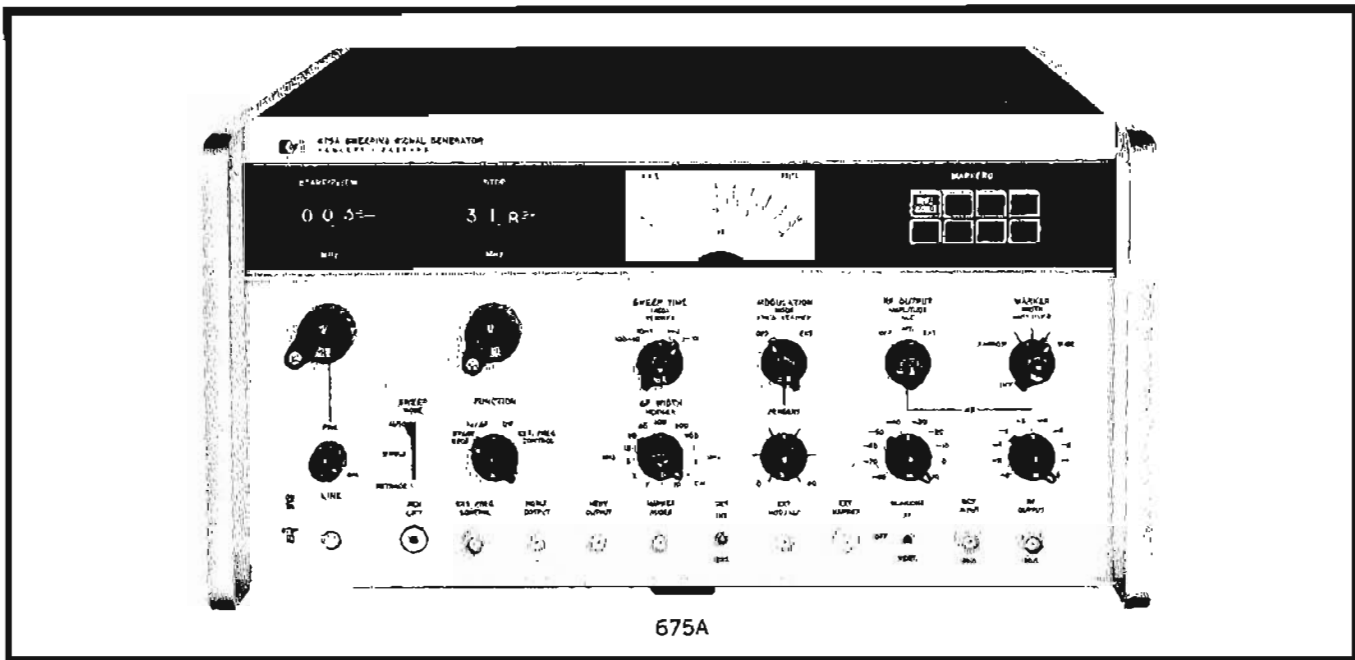

Features:

- 10 kHz to 32 MHz in one range
- 0.5% linearity
- 0.15 dB flatness
- Residual FM < 70 Hz peak
- CW dial accuracy 0.5% of full scale
- Programmability

Description

The Hewlett-Packard 675A Sweeping Signal Generator is a high quality, precision center-sweep or start-stop sweeper, a high accuracy signal generator with internal or external amplitude modulation and external frequency modulation capabilities, and an analog programmable signal source. Optional fixed frequency and harmonic comb markers can be provided when crystal accuracy in frequency identification is required. The versatile 675A is designed to fill almost every signal source requirement with such additional features as variable sweep time, built-in RF detector, vertical and RF blanking, pen lift, and external leveling.

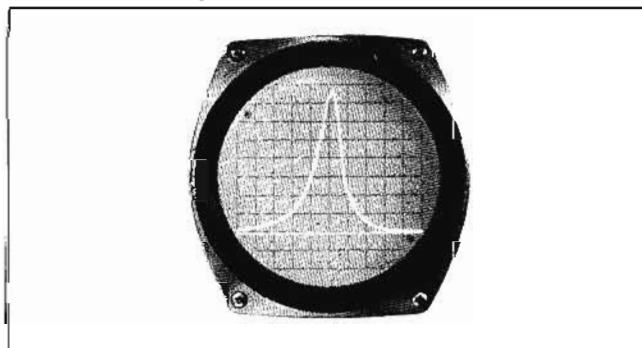

Tune High Q Filters

Start-stop and center sweep

The HP 675A will sweep frequencies between two preset limits or will sweep predetermined frequency increments about a center frequency. To obtain the full value of a swept measurement, the end points are accurate enough and the sweep linear enough to provide a frequency-calibrated display on an oscilloscope or X-Y recorder. Low residual and spurious FM permit accurate measurements of devices with steep responses. The sweep time is adjustable to insure display accuracy regardless of the bandwidth of the circuit under test.

Programming

The Model 675A is analog programmable in both amplitude and frequency, making it useful in automated test stations and systems. The frequency is programmable over the entire 10 kHz to 32 MHz range at a dc-to-4 kHz rate, and the amplitude can be programmed over a 10 dB range at a rate from dc to 600 kHz.

Refer to page 377 for additional information.

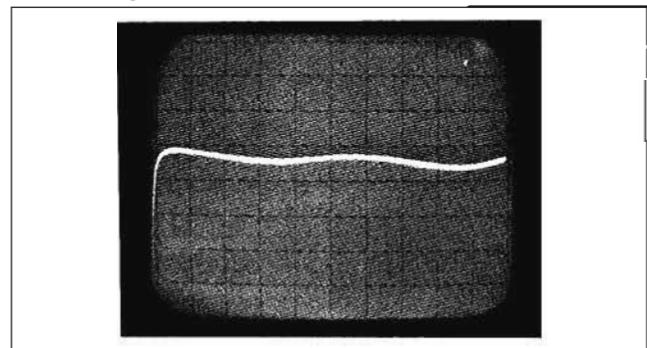

Measure Frequency Response of Broadband Amplifiers

SWEEP SIGNAL GENERATORS *continued*

10 kHz to 32 kHz in one range; 0.15 dB flatness
Model 675A

Tentative Specifications

Frequency range: 10 kHz to 32 MHz in one range.

Output: maximum, +13 dBm (1 V rms into 50 Ω , 2 V rms open circuit); continuously adjustable.

Impedance: 50 Ω .

RF Flatness	10 kHz	50 kHz	200 kHz	1 MHz	10 MHz	32 MHz
Unleveled:	± 1 dB					
Internally levelled:		± 1 dB		± 0.15 dB		
Externally levelled:	± 0.15 dB					

System Flatness

Using internal RF

Detector, internally levelled:	10 kHz	50 kHz	200 kHz	1 MHz	10 MHz	32 MHz
	± 1 dB	± 0.4 dB		± 0.25 dB		

Using External RF

Detector Externally levelled:	10 kHz	100 kHz	1 MHz	10 MHz	32 MHz
	± 0.25 dB				

Internal detector output (vertical): at least 1.2 V dc for 1 V rms.

Attenuator

Range: 99 dB in 10 and 1 dB steps.

Accuracy: ± 0.3 dB, +10 dB to -10 dB steps, 0 to -2 dB steps; ± 0.4 dB + 6 μ V, -20 dB to -80 dB steps, -3 to -9 dB steps.

Output monitor

Range: -3 to +3 dB (0.5 V to 1 V).

Accuracy: ± 0.3 dB, 200 kHz to 32 MHz.

Distortion

Harmonic: >30 dB down from fundamental.

Spurious: >50 dB down from fundamental.

Residual (line related) FM: <70 Hz peak.

Spurious FM: <60 Hz rms.

Frequency drift: <1 kHz/hr, <3 kHz/ $^{\circ}$ C.

Auxiliary output (rear panel): 100 MHz to 132 MHz unleveled.

Sweep functions

Linearity: $\pm 0.5\%$ of sweep width ± 100 Hz.

Start-stop: sweeps up or down from start to stop frequency settings.

Range: 10 kHz to 32 MHz.

End-point accuracy: $\pm 1\%$ of full scale, +20 $^{\circ}$ C to +30 $^{\circ}$ C; $\pm 2\%$ of full scale, 0 $^{\circ}$ to +20 $^{\circ}$ C and +30 $^{\circ}$ C to +50 $^{\circ}$ C.

F₀/ Δ F: Δ F sweeps up centered on F₀ setting.

F₀ range: 10 kHz to 32 MHz.

F₀ accuracy: $\pm 0.5\%$ of full scale.

Δ F range: 200 Hz to 10 MHz.

Δ F width: calibrated steps 1 kHz to 10 MHz in 1-2-5 sequence, continuously adjustable.

Δ F width accuracy: $\pm 5\%$ of calibrated steps ± 100 Hz.

Sweep modes

Auto: repetitive sweeps.

Single: beginning-to-end sweep.

Retrace: end-to-beginning retrace.

Sweep time: 0.01 s to 100 s in decade steps, continuously adjustable.

Retrace time: 0.01 s for 0.01 to 1 s sweep times, 1 s for 1 to 100 s sweep times.

Horizontal output: 0 to +5 V dc, proportional to frequency.

Blanking

RF: RF output off during retrace.

Vertical: vertical output shorted to ground during retrace.

Pen lift: terminal shorted during sweep, open during retrace.

Crystal markers: 100 kHz, 1 MHz harmonic comb and/or up to 5 fixed frequencies from 100 kHz to 32 MHz.

Accuracy: $\pm 0.005\%$ of frequency.

Width: adjustable 5 steps, 4 kHz to 100 kHz.

External marker: front-panel BNC input (50 Ω impedance), 50 to 500 mV rms.

Signal generator functions

CW dial accuracy: $\pm 0.5\%$ of full scale.

CW settability: 1 kHz.

CW resolution: 20 kHz.

Internal AM: 0 to 50% sinusoidal, 985 to 1015 Hz continuously adjustable.

External AM: 0 to 50%, dc to 1 kHz leveled; 0 to 50%, 50 Hz to 600 kHz unleveled.

External frequency control and external FM

Sensitivity: 1 MHz/V.

Input impedance: 1 M Ω .

Rate: dc to 4 kHz. Above 4 kHz the range and sensitivity decreases 20 dB/decade.

General

Temperature range: 0 $^{\circ}$ to +50 $^{\circ}$ C.

Power: 115 or 230 V $\pm 10\%$, 50 to 1000 Hz, 80 W max.

Dimensions: 16 $\frac{3}{4}$ " wide, 8 $\frac{3}{4}$ " high, 18 $\frac{3}{8}$ " deep (425 x 221 x 467 mm).

Weight: net 46 lbs (20.8 kg); shipping 51 lbs (23.2 kg).

Accessories furnished: HP 11048A 50 Ω Feed-Thru Termination.

Accessories available: HP 11300A Single-Frequency Marker (frequency must be specified), \$75; add \$25 for those factory installed.

HP Model 11097A External RF Detector, \$30.

Specifications (tentative)

Maximum input: 2 V rms.

Input impedance: 50 Ω .

DC output: +1.2 V for 1 V rms input.

Frequency range: 10 kHz to 32 MHz.

Flatness: ± 0.15 dB.

HP Model 11098A External Leveling Detector, \$30.

This external leveling detector allows the Model 675A Sweeping Signal Generator to be leveled at the input of the device under test, thus preventing insertion loss between the generator and the load. The 11098A levels the RF signal from the 675A to within ± 0.15 dB across the entire 10 kHz to 32 MHz frequency range.

Price: HP 675A, \$2250.

Option 01: 1 MHz harmonic comb marker, \$2325.

Option 02: 100 kHz harmonic marker, \$2325.

Option 03: 100 kHz and 1 MHz harmonic markers, \$2375.

SWEEP OSCILLATOR

Low-cost, solid-state, plug-in versatility
Model 3211A



SIGNAL SOURCES

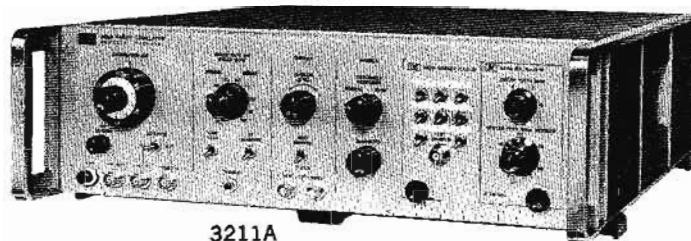

3211A

Advantages:

- RF and marker plug-ins
- Individual on-off marker switches
- Continuous or single sweep with variable rate
- Continuous sweep width adjustment
- Width and level controls to optimize marker display

The HP 3211A Sweep Oscillator, with its 3221A Marker Plug-in and choice of six frequency plug-ins, is a low-cost, versatile, high-performance sweep oscillator ideally suited for use in the design, calibration, and alignment of FM tuners and receivers, and the general testing of IF sections of TV receivers, radar and communication systems, and other video to VHF circuits. Its high output (>.7 V rms) and accurate 59-dB attenuator make the instrument a valuable tool for the testing of both high and low-gain circuits under variable signal conditions.

Specifications (Main Frame)

RF output

Level: greater than .7 V rms into 50-ohm load, greater than 1.4 V rms into open circuit.

Impedance: 50 ohms, 1.2 to 1 VSWR in 0 dB attenuator position; 1.1 to 1 for attenuator settings greater than 10 dB.

Attenuation: 0 to 59 dB in 1 and 10-dB steps. Electrical vernier provides level adjust between 1-dB steps.

Attenuator accuracy: $\pm .25$ dB for 1-dB steps; ± 0.5 dB on 10, 20, 30-dB steps; ± 1 dB on 40 and 50-dB steps.

Sweep characteristics

Rate: variable; repetitive sweep 10 to 100 Hz nominal; single sweep 1 to 10 seconds nominal. Line lock provided.

Blanking: switch selects RF blanking or unblanking during retrace; marker blanking on retrace at all times.

Vertical channel

Detector: half-wave peak detector; input VSWR less than 1.05 to 1; flatness $\pm .1$ dB; video bandwidth 20 kHz; freq. range: 0.5 to 110 MHz.

Output: internal 50-ohm detector, greater than .4 V dc for 1 V rms input; external detector, greater than .4 V dc for 1 V dc input.

Horizontal channel output: 0 to 15 V pk-pk triangular.

Marker characteristics

Type: birdie by-pass; beat note detected and used to generate high-level marker pulse.

Display: front panel control and switch permit either addition of marker pulse to the vertical channel output or Z axis modulation of oscilloscope with 0 to ± 20 V pulse.

Dimensions: 16 $\frac{3}{4}$ " wide, 5 $\frac{1}{2}$ " high, 18 $\frac{3}{8}$ " deep (426 x 140 x 552 mm).

Weight: net 30 lbs (13.5 kg); shipping 40 lbs (18.2 kg).

Power: 105 to 125 V or 210 to 250 V, 50 to 1000 Hz, 25 W.

Price: 3211A Sweep Oscillator, \$665; 3221A Marker Plug-in, \$85; 3212A RF Plug-in, \$225; 3213A-3217A RF Plug-ins, \$150 ea.; 13511A Marker Oscillators, \$40 ea. Complete instrument consists of 3211A Sweep Oscillator, 3221A Marker Plug-in, and one RF plug-in.

Marker Plug-in—Model 3221A

Internal markers: accepts up to 8 crystal-stabilized 13511A marker oscillators. Specify frequencies desired.

External markers: front panel BNC input from CW source or marker generator; input requirements, .1 to .3 V rms into 50 ohms.

Marker Oscillators—Model 13511A

Frequency: 1 to 110 MHz; accuracy: .005%; output level: 35 mV rms into 50 ohms.

RF Plug-ins

Specification	HP Model Number					
	3212A	3213A	3214A	3216A	3218A	3217A
RF range	100 kHz to 30 MHz	8 to 16 MHz	12 to 28 MHz	20 to 45 MHz	30 to 70 MHz	50 to 110 MHz
Flatness	$\pm .25$ dB across 50-ohm load over frequency range of plug-in					
Spurious output	50 dB down	None, 3213A-3217A operate at fundamental frequency				
Harmonic output	30 dB below output level					
Residual FM	$\leq \pm 5$ kHz	$\leq \pm .005\%$ of center frequency				
Sweep width	Continuously adjustable to 100% of frequency range					
Linearity	$\pm 10\%$ of absolute frequency at max sweep width	$\pm 1\%$ over any 25% of segment of range; $\pm 3\%$ over any 50% segment of range; $\pm 5\%$ over any 75% segment of range; $\pm 10\%$ over full range; measured as percent of absolute frequency				
Price	\$225	\$150	\$150	\$150	\$150	\$150



SWEEP OSCILLATOR

Superior performance, 100 kHz through 40 GHz
Series 8690

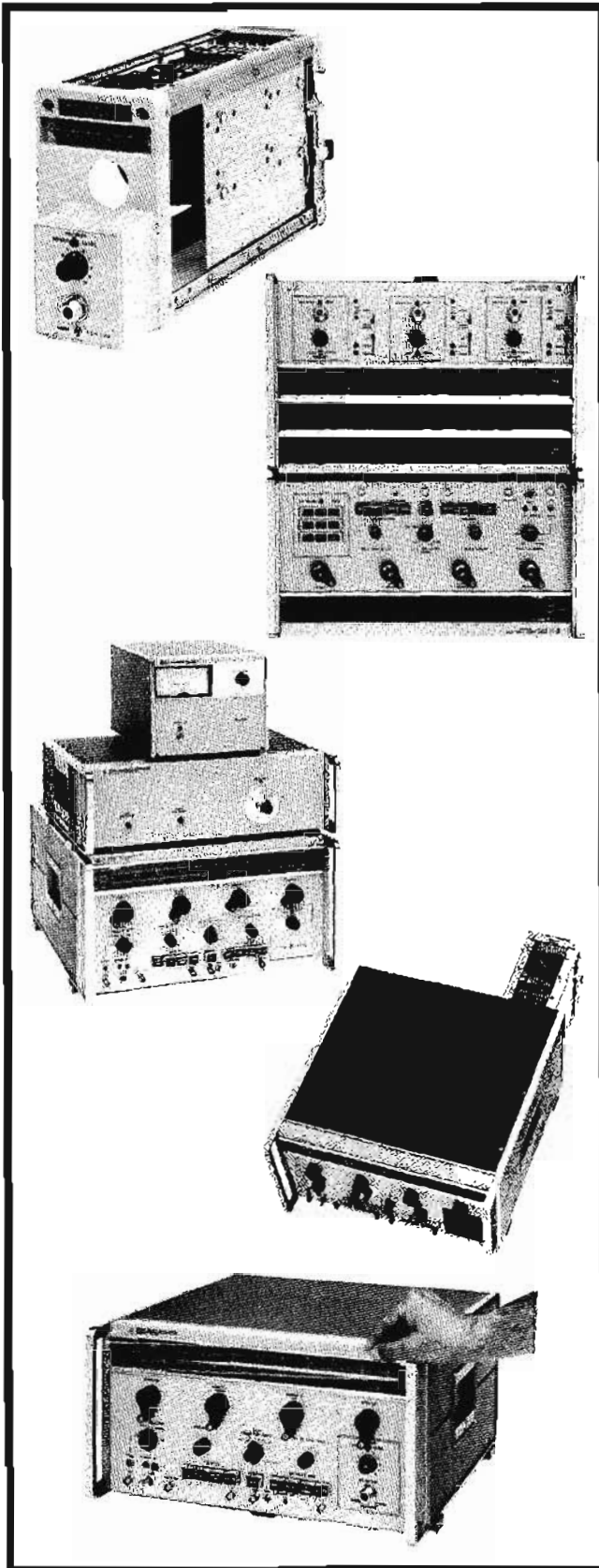

Interchangeable RF units offer multiband capability at low cost

Choose from a wide selection of RF units for the 8690A Sweep Oscillator. Units are available to cover the entire 100 kHz through 40 GHz range. The introduction of the Model 8691C/D RF units extends magnetic shielding capability to all seven microwave bands.

PIN diode modulation and leveling is available in "B" and "D" type RF units from 1 to 12.4 GHz. The 8691D and 8691-4B RF units offer exceptionally good frequency accuracy (between 0.25% and 1%) over a wide range of modulation conditions. Frequency pulling is practically nonexistent over a 10 dB dynamic range.

Multiband capability provides unprecedented versatility

Here is the first inexpensive solution to broadband swept operation over the complete RF and microwave spectrum: 100 kHz through 40 GHz.

The Model 8706A/8707A RF Unit Control Systems allow programmable selection of up to nine RF units by pushbutton or remote contact closure.

The system offers operational simplicity and maximizes BWO life. Multiband tests can be made quickly and easily.

Stabilized systems provide phase-locked signals for sophisticated applications

Phase-locked CW and swept frequency systems from 1 through 12.4 GHz are available to satisfy the exacting needs of such applications as microwave spectroscopy, high-Q swept frequency measurements, Doppler system sources, and narrow-band receiver or filter testing.

These systems are stabilized at any frequency in their operating range. Short term stability is that of the reference oscillator employed.

Rear loading uses minimum panel space, permits compact size with full width, high resolution dial

RF units that preserve integral sweeper performance can be changed in seconds without adjustment. One snap of the positive-locking rear handle and the RF unit is installed, ready to provide superior performance over the frequency range your application requires.

The 8690A Sweep Oscillator combines interchangeable RF units with high accuracy, versatility, and ease of operation to bring you all the advantages of single unit sweep oscillators plus economical ultrawide frequency coverage.

Dials are easy to change, keyed for accurate positioning

The snap-in scale that accompanies each RF unit illustrates the ease of obtaining ultrawide frequency coverage. The high resolution frequency scale is typical of many features that enhance user convenience and allow straightforward operation.

Among the outstanding features that make the 8690A Sweep Oscillator easy to use are pushbutton function selection, logical and easy-to-read frequency settings and operation modes, and independently adjustable sweep modes.

For versatile performance to meet all of your swept measurement needs, there are START/STOP, MARKER, and calibrated ΔF sweeps, all of which offer highest accuracy, linearity, and resolution.

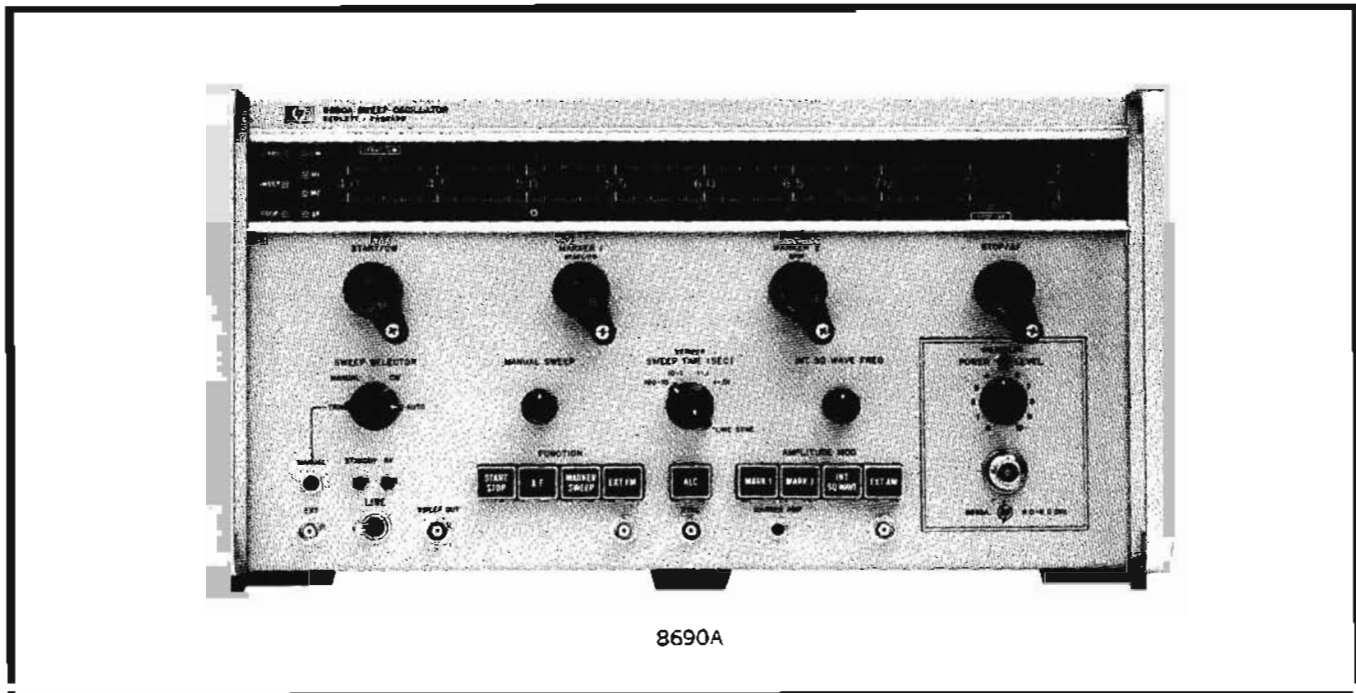

Series 8690 Sweep Oscillators

The Hewlett-Packard 8690A Sweep Oscillator and 8690A/B Series RF Units offer you all the advantages of single unit sweep oscillators plus economical multiband capability. The 8698A RF Unit sweeps the range of 100 kHz to 110 MHz with outstanding frequency accuracy and linearity. Complete coverage from 100 kHz to 40 GHz is available with RF units featuring a choice of PIN diode modulation ("B" and "D" models), grid modulated BWO units ("A" models), and optional internal leveling. RF units can be changed quickly and without adjustment.

Snap-in scales are keyed for easy changing and accurate positioning. The full-width maximum-resolution scale and a human-engineered layout of the front panel controls allow simple, uncomplicated operation. Ease of operation is enhanced by pushbutton function selection, lighted function indicators adjacent to the scale, presentation of all frequency information which may be read at a glance, and simplified X-Y recorder setup through the use of manual sweep control.

Highly accurate, calibrated frequency displays, broad and narrowband sweeps, external FM for frequency sweep programming, CW operation, automatic triggered or manual sweep control plus leveling in all modes of operation combine to give you unequalled performance and versatility in a space saving package design.

In addition, the Model 8706A Control Unit, which plugs into the sweep oscillator like an RF unit, permits immediate band switching between up to nine selected RF units contained in up to three Model 8707A RF Unit Holders.

Plug-in RF units

Five types of RF units are available, permitting selection to meet any application requirement: the Model 8698A low frequency signal generator; the Models 8691-4 featuring PIN modulation or grid modulated BWO's and covering the coaxial frequencies from 1 to 12.4 GHz; and the Model 8701A covering the Models 8695-7A for waveguide coverage of the P, K, and R bands 100 MHz to 4 GHz.

The Model 8698A RF unit covers two frequency ranges, selected by front panel switch: 100 kHz to 11 MHz and 1 to 110 MHz. The unit features a frequency discriminator feedback circuit to obtain extremely low residual FM, excellent frequency accuracy and linearity.

The Model 8691-4B and 8691D RF Units, covering 1 to 12.4 GHz feature PIN diode attenuators which permit all of the amplitude modulation functions, including leveling, to be performed independently of the backward wave oscillator tube. The result is a virtual elimination of frequency pulling, enabling excellent frequency accuracy and linearity, low incidental FM, permitting a wide variety of modulation conditions over a 10-dB dynamic range.

The "A" type model RF units use grid-modulated BWO's for AM and leveling functions. The grid-modulated BWO RF units are available in seven models. Models 8691-4A and 8691C have 50 ohm output with type N connectors; the Models 8695-7A have P, K, and R band waveguide flange outputs respectively.

All Model 8692-7A/B Units have shielded BWO's and meet the RFI measurement test standards specified in MIL-I-6181D. Model 8691C RF Units offer shielded BWO's in the 1- to 2-GHz range. See pages 388 through 391 for further descriptions of RF units.

SWEEP OSCILLATOR *continued*

Superior performance, 100 kHz through 40 GHz
Series 8690

Model 8698A: 100 kHz to 110 MHz

This RF unit is a low-frequency swept-signal generator that brings 8690A microwave sweeper sophistication, precision and operating features into the RF region. The unit features a calibrated 1% accuracy frequency display, 0.5% linearity, and 100 mW leveled output, calibrated from +10 dBm to -110 dBm.

Minimum residual FM and excellent stability enable low frequency accuracy and linearity of $\pm(20 \text{ MHz} \pm 1\%)$ to be satisfied. The highly accurate calibrated display establishes measurement confidence. Crystal calibrator marker pips are not required. One narrowband and two broadband continuously adjustable and calibrated sweeps with automatic, triggered or manual control are available. The unit offers complete modulation capabilities including internal square wave, and external AM and FM. See page 392.

Model 8701A: 100 MHz to 4 GHz

A new heterodyning RF unit provides coverage from 100 MHz to 4 GHz in two bands. Band 1, 100 MHz and 2 GHz, offers frequency accuracy and linearity of $\pm(20 \text{ MHz to } \pm 1\%)$ with power output of -15 dBm. Band 2, 2 to 4 GHz, specifications are the same as for the 8692A RF Unit. See page 391.

Models 8691-4A/B and 8691C/D: 1 to 12.4 GHz

Coaxial microwave frequencies from 1 to 12.4 GHz are covered by the 8691-4A/B RF Units. "B" and "D" models are PIN diode-attenuator modulated and maintain excellent frequency accuracy and stability to satisfy the most stringent amplitude modulation requirements. PIN diode-attenuator modulation eliminates frequency pulling during AM, which results in extremely high frequency accuracy, linearity and very low residual FM. The "A" and "C" models contain grid modulated BWO's. Option 01 internal leveling is available on all RF units covering 1 to 12.4 GHz except the 8691B/D and the 8692B. Models are available on special order to cover every frequency range for which there is a BWO. See page 390.

Models 8695-7A and 8691B/D: 12.4 to 40 GHz

The P, K, and R waveguide bands are covered by the Models 8694A, 8696A and 8697A respectively. The units contain grid modulated BWO's and have a frequency range and linearity of $\pm 1\%$ over a 6 dB power range. Output power variation with external leveling is $\pm 0.2 \text{ dB}$. See page 390.

Model 8706A Control Unit

The 8706A Control Unit, with the Model 8707A RF Unit Holder allows microwave and RF wideband testing to be performed without interchanging RF units. The 8706A Control Unit immediately switches between RF units contained in up to three Model 8707A RF Unit Holders.

Each RF unit holder is the same size as the 8690A Sweep Oscillator and accepts three RF units. Thus, up to nine RF units can be selected by simply pressing a button. Switching time is 1 second and no adjustments are required.

A normalized scale, reading from 0 to 100 is used for all RF unit frequency ranges. The complete microwave spectrum from 100 kHz to 40 GHz is at your fingertips. Preset start and stop

sweep frequencies for each RF unit can be set on the front panel of the Model 8707A RF Unit Holder. This creates a preset mode of operation in which the 8690A Sweep Oscillator can provide a preset CW, or third broad or narrowband sweep. See page 394.

Sweep oscillator features:**Sweep modes**

Automatic, triggered and manual sweeps are available, in addition to CW operation. Automatic and triggered sweep times are adjustable from 0.01 to 100 seconds, and the triggered sweeps can be synchronized from an external source or started manually from a front panel pushbutton.

To enhance the clarity of oscilloscope presentations, RF power is blanked during retrace to produce a zero base line; however RF is restored before the start of the next sweep to eliminate transients during the early part of the sweep. Oscilloscope photography at slow sweeps is simplified by a front panel sweep indicator that lights automatically during the sweep.

For X-Y recording, an automatic pen lift circuit is provided. The circuit drops the pen during the stabilizing period prior to the sweep and lifts the pen during the second stabilizing period which occurs at the end of the sweep just before retrace. Thus, transients and retrace lines are eliminated from X-Y plots. During manual sweep, a front panel control varies the RF frequency between the limits set on the selected sweep function. With the use of manual sweep, X-Y recorder setup time is just a few seconds.

Sweep functions and monitors

Two independent frequency markers can be set separately on the "start-stop" sweep whose end points can be set anywhere in the band. Independent controls set the start and stop frequencies on the scale. Thus, the set frequency range can be swept up or down, depending only on the setting of the start frequency with respect to the stop frequency.

Two independent frequency markers, set separately on the scale and direct reading in GHz, can be positioned anywhere in the band. The markers amplitude modulate the RF output, providing triangular markers sharp enough to give high resolution on narrow sweeps, yet broad enough to be quite visible on the widest sweeps. Marker amplitude can be adjusted from the front panel.

The markers can be used as end points for a second broadband sweep which starts at the Marker 1 frequency and stops at the Marker 2 frequency. The marker sweep is especially advantageous. Extensive Hewlett-Packard design experience using swept-frequency techniques has proven that valuable time can be saved by bracketing circuit discontinuities with the markers. By pressing the marker sweep button, expanded investigation of the frequency range of interest is immediately available. Thus, the two independently adjustable broadband sweeps can be set for study of either broad or narrowband frequency ranges.

Besides sweeping from a start frequency to a stop frequency, the 8690 provides a continuously calibrated narrow band sweep, the ΔF sweep, which is symmetrical about a center frequency. Calibrated directly in MHz, the ΔF sweep width is continuously adjustable from 0 to 10% of the band. Frequency markers can be applied to the ΔF as well as the start-stop sweep.

Leveling

Leveling minimizes the variations in RF output amplitude with frequency. The 8690's are designed for external, closed loop leveling. This is accomplished by driving the built-in leveling amplifier with a signal derived by sampling RF output power with a directional coupler and detector. The amplified signal is applied to the modulating circuits in the RF unit to maintain a constant power at the output of the directional coupler. External leveling eliminates the frequency dependent transmission characteristics of any components between the oscillator and sampling point and also virtually eliminates source mismatch. Thus, leveled power can be established at any point in the system even though it is remote from the source. The degree of leveling is primarily determined by the coupler and detector variation.

Internal leveling is available as Option 01 on all grid modulated BWO RF units below 12.4 GHz, Models 8691-4A, and 8691C, and on PIN diode attenuator modulated RF units above 4 GHz, Models 8693-4B. Internally leveled RF units are useful in less critical applications in which transmission variations between oscillator and test point are not significant or when a package free of external elements is desired.

Modulation

All modulation functions are selected by pushbutton, and can be used simultaneously. Included is internal square wave modulation, 950 to 1050 Hz, plus external AM and FM. External FM permits frequency programming, including externally controlled sweeps over all or any part of the band.

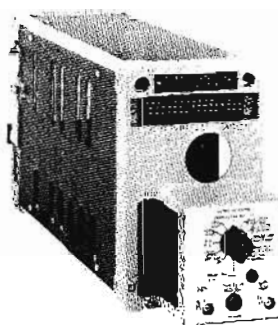

The Model K04-8690A Calibrator facilitates 8690A Sweep Oscillator calibration and troubleshooting. The unit plugs into the 8690A like an RF unit. Circuit points sampled during the calibration procedure are presented on front-panel BNC connectors. The unit switches in standard calibrating circuits, equivalent to those in the RF units, to ensure interchangeability of all RF units in the 8690A Sweep Oscillator.

Specifications, 8690A Sweep Oscillator (with RF Unit installed)

Frequency range: determined by RF unit.

Sweep functions

Start-stop sweep: sweeps from "start" to "stop" frequency setting.

Range: both settings continuously and independently adjustable over the entire frequency range; can be set to sweep either up or down in frequency.

End-point accuracy: same as RF unit frequency accuracy.

Marker sweep: sweeps from "Marker 1" to "Marker 2" frequency setting.

Range: both settings continuously and independently adjustable over the entire frequency range; can be set to sweep either up or down in frequency.

End-point accuracy: same as RF unit frequency accuracy.

ΔF sweep: sweeps upward in frequency, centered on CW setting.

Width: continuously adjustable from zero to 10% of the frequency band; calibrated directly in MHz.

Width accuracy*: ±10% of ΔF being swept ±1% of maximum ΔF (±20% ±2% respectively with 8691A/B RF Units).

Center-frequency accuracy: same as RF unit frequency accuracy.

Frequency markers: two frequency markers, independently adjustable over the entire frequency range, amplitude-modulate the RF output; amplitude is adjustable from the front panel; the markers are also available for external use.

Accuracy: same as RF unit frequency accuracy.

Resolution: better than 0.05% of RF unit bandwidth.

Marker output: triangular pulse, typically -5 V peak into 1000 ohm load.

CW operation: single-frequency RF output selected by START/CW or MARKER 1 control, depending on sweep function selected.

Accuracy: same as RF unit frequency accuracy.

Preset frequencies: start-stop sweep end points and marker frequencies can be used as four preset CW frequencies.

Sweep mode

Auto: sweep recurs automatically.

Manual: front-panel control provides continuous manual adjustment of frequency between end frequencies set in any of the above sweep functions.

Triggered: sweep is actuated by front-panel pushbutton or by externally applied signal <-25 V peak, >1 μs pulse width, and >0.1 V/μs rise.

Sweep time: continuously adjustable in four decade ranges, 0.01 to 100 seconds; can be synchronized with the power line frequency.

Sweep indicator: front-panel indicator lights during the sweep, providing indication of sweep duration on slower sweep times.

Sweep output: direct-coupled sawtooth, zero to approximately +15 V, concurrent with swept RF output; zero at start of sweep, approximately +15 V at end of sweep regardless of sweep width or direction; source impedance, 10,000 ohms.

Frequency linearity*†: same as RF unit frequency accuracy.

Blanking: RF automatically turned off during retrace, turned on after completion of retrace. On automatic sweeps, RF is on long enough before sweep starts to stabilize external circuits and equipment whose response is compatible with the selected sweep rate; blanking disable switch provided.

Blanking output: direct-coupled rectangular pulse approximately -4 V coincident with RF blanking; source impedance approximately 3000 ohms.

Pen lift: for use with X-Y graphic recorders; penlift terminals shorted during sweep, open during retrace.

Power leveling amplifier: internal dc-coupled leveling amplifier provided.

* Listed separately for 8698A; see page 393.

† Correlation between frequency and both the sweep and reference output.

SWEEP OSCILLATOR *continued***Superior performance, 100 kHz through 40 GHz
Series 8690**

Crystal input: approximate -20 to -350 mV for specified leveling at rated output; for use with negative-polarity detectors such as 780 Series Directional Detectors, 423A and 424 Series Crystal Detectors.

Modulation*

Internal AM: square wave modulation continuously adjustable from 950 to 1050 Hz on all sweep times; on/off ratio greater than 20 dB at rated output.

External AM

Frequency response: dc to 350 kHz unlevelled, dc to 50 kHz levelled.

Sensitivity: -10 V reduced RF level output at least 30 dB below rated CW output.

Input impedance: approximately 1000 ohms.

External FM

Frequency response: dc to 20 kHz.

Sensitivity: deviation from CW setting approximately 6% of the frequency band per volt.

Maximum range: full band for modulation frequencies up to 150 Hz (approximately 17 V pp input), decreases to about 1% of the band for 20 kHz modulation.

Input impedance: approximately 200,000 ohms.

General

Power: 115 or 230 volts $\pm 10\%$, 50 to 60 Hz; approximately 350 watts.

Dimensions: 16 $\frac{3}{4}$ " wide, 9" high, 18 $\frac{3}{8}$ " deep (426 x 229 x 467 mm); hardware furnished for rack mount, 19" wide, 8-23/32" high, 16 $\frac{3}{8}$ " deep behind panel (483 x 221 x 416 mm).

Weight (not including RF unit): net 53 lb (23.9 kg); shipping 62 lb (27.9).

Furnished: 7 $\frac{1}{2}$ foot (2290 mm) power cable with NEMA plug; rack mounting kit.

Available:

HP K04-8690A Calibrator (page 398), \$280.

HP 8706A Control Unit (pages 394, 395), \$375.

HP 8707A RF Unit Holder (pages 394, 395), \$850.

Price: HP 8690A, \$1,600.

External leveling accessories available

Directional detectors: 780 Series (pages 274, 275), 1 to 12.4 GHz, \$300 to \$350.

Directional couplers: coaxial: 790 Series (pages 274, 275), 1 to 8 GHz, \$200 to \$225; waveguide: 752 Series (page 276), 2.6 to 40 GHz, \$125 to \$600.

Crystal detectors: coaxial: 423A (page 273), 10 MHz to 12.4 GHz, \$125; waveguide: 424A Series (page 273), 2.6 to 18 GHz, \$135 to \$250 and 422A (page 273), 18 to 40 GHz, \$250.

* Listed separately for 8698A; see page 393.

† Correlation between frequency and both the sweep and reference output.

RF unit specifications, series 8690

HP Model	Frequency range	Frequency accuracy	Maximum leveled power	RF power control	Frequency stability				Power variation, external leveling*	Output impedance	Output connector	Price	Option 01, Internal leveling		
					With temperature	With 10% change in line voltage	With 50 dB power level change	Residual FM					Power variation	Equivalent isolation match	Price
8691A	1 to 2 GHz	$\pm 1\%$	≥ 100 mW	BWO grid	$\pm 0.01\%/^{\circ}\text{C}$	≈ 500 kHz	typically ≈ 20 MHz	< 30 kHz peak	≈ 0.2 dB	50 ohms	Type N	\$1875	≈ 0.4 dB	1.13:1	\$315
8691B	1 to 2 GHz	± 10 MHz	≥ 70 mW	PIN line	$\pm 0.01\%/^{\circ}\text{C}$	≈ 500 kHz	≈ 500 kHz	< 30 kHz peak	≈ 0.1 dB	50 ohms	Type N	\$2225	—	—	—
8691D**	1 to 2 GHz	± 10 MHz	≥ 70 mW	PIN line	$\pm 0.01\%/^{\circ}\text{C}$	≈ 500 kHz	≈ 500 kHz	< 30 kHz peak	≈ 0.1 dB	50 ohms	Type N	\$2325	—	—	—
8692A	2 to 4 GHz	$\pm 1\%$	≥ 70 mW	BWO grid	$\pm 0.01\%/^{\circ}\text{C}$	≈ 500 kHz	typically ≈ 40 MHz	< 30 kHz peak	≈ 0.2 dB	50 ohms	Type N	\$2275	≈ 0.4 dB	1.16:1	\$315
8692B	2 to 4 GHz	± 10 MHz	≥ 40 mW	PIN line	$\pm 0.01\%/^{\circ}\text{C}$	≈ 500 kHz	≈ 500 kHz	< 30 kHz peak	≈ 0.1 dB	50 ohms	Type N	\$2025	—	—	—
H01-8692B	1.7 to 4.2 GHz	± 13 MHz	≥ 15 mW	PIN line	$\pm 0.01\%/^{\circ}\text{C}$	≈ 500 MHz	≈ 500 kHz	< 30 kHz peak	≈ 0.1 dB	50 ohms	Type N	\$2325	—	—	—
8693A	4 to 8 GHz	$\pm 1\%$	≥ 50 mW	BWO grid	$\pm 0.01\%/^{\circ}\text{C}$	≈ 1 MHz	typically ≈ 80 MHz	< 50 kHz peak	≈ 0.2 dB	50 ohms	Type N	\$1575	≈ 0.5 dB	1.25:1	\$350
8693B	4 to 8 GHz	± 20 MHz	≥ 15 mW	PIN line	$\pm 0.01\%/^{\circ}\text{C}$	≈ 1 MHz	≈ 1 MHz	< 50 kHz peak	≈ 0.1 dB	50 ohms	Type N	\$1950	≈ 0.4 dB	1.25:1	\$350
H01-8693B	3.7 to 8.3 GHz	± 25 MHz	≥ 5 mW	PIN line	$\pm 0.01\%/^{\circ}\text{C}$	≈ 1 MHz	≈ 1 MHz	< 50 kHz peak	≈ 0.1 dB	50 ohms	Type N	\$2250	≈ 0.4 dB	1.25:1	\$350
8694A	8 to 12.4 GHz	$\pm 1\%$ †	≥ 50 mW	BWO grid	$\pm 0.01\%/^{\circ}\text{C}$	≈ 1 MHz	†	< 50 kHz peak	≈ 0.2 dB	50 ohms	Type N	\$1575	≈ 1.0 dB	2:1	\$375
H01-8694A	7 to 12.4 GHz	$\pm 1\%$ †	≥ 25 mW	BWO grid	$\pm 0.01\%/^{\circ}\text{C}$	≈ 1 MHz	†	< 50 kHz peak	≈ 0.2 dB	50 ohms	Type N	\$1850	≈ 1.0 dB	2:1	\$400
H02-8694A	7 to 11 GHz	$\pm 1\%$ †	≥ 25 mW	BWO grid	$\pm 0.01\%/^{\circ}\text{C}$	≈ 1 MHz	†	< 50 kHz peak	≈ 0.2 dB	50 ohms	Type N	\$1600	≈ 1.0 dB	2:1	\$375
8694B	8 to 12.4 GHz	± 30 MHz	≥ 30 mW	PIN line	$\pm 0.01\%/^{\circ}\text{C}$	≈ 1 MHz	≈ 1 MHz	< 50 kHz peak	≈ 0.1 dB	50 ohms	Type N	\$1975	≈ 0.75 dB	1.5:1	\$375
H01-8694B	7 to 12.4 GHz	± 40 MHz	≥ 15 mW	PIN line	$\pm 0.01\%/^{\circ}\text{C}$	≈ 1 MHz	≈ 1 MHz	< 50 kHz peak	≈ 0.1 dB	50 ohms	Type N	\$2250	≈ 0.75 dB	1.5:1	\$400
H02-8694B	7 to 11 GHz	± 30 MHz	≥ 15 mW	PIN line	$\pm 0.01\%/^{\circ}\text{C}$	≈ 1 MHz	≈ 1 MHz	< 50 kHz peak	≈ 0.1 dB	50 ohms	Type N	\$2000	≈ 0.75 dB	1.5:1	\$375

* Excluding coupler and detector variation.

† Frequency accuracy specified over ≥ 6 dB range.

** 8691D has shielded BWO.

HP Model	8695A	8696A	8697A
Frequency range	12.4 to 18 GHz	18 to 26.5 GHz	26.5 to 40 GHz
Frequency accuracy (over a 6 dB range)	$\pm 1\%$	$\pm 1\%$	$\pm 1\%$
Maximum leveled power	≥ 40 mW	≥ 10 mW	≥ 5 mW
Frequency stability with temperature	$\pm 0.01\%/^{\circ}\text{C}$	$\pm 0.01\%/^{\circ}\text{C}$	$\pm 0.01\%/^{\circ}\text{C}$
With 10% change in line voltage	≈ 10 MHz	≈ 15 MHz	≈ 20 MHz
Residual FM	< 150 kHz	< 200 kHz	< 350 kHz
Power variation, external leveling*	≈ 0.2 dB	≈ 0.2 dB	≈ 0.2 dB
Output connector	UG-419/U	UG-595/U	UG-599/U
Price	\$1700	\$2500	\$4300

* Excluding coupler and detector variation

For all 8691-8697 RF Units

Magnetic shielding: all RF units except 8691A/B have shielded BWO's.

Residual AM: at least 40 dB below CW output.

Spurious signals: harmonics, at least 20 dB below CW output; nonharmonics, at least 40 dB below CW output.

Reference output: direct-coupled voltage proportional to RF frequency, approximately 0 V at the low end of the band, increasing approx 40 V/octave; output impedance, 25,000 ohms.

Leveling indicator: front-panel indicator lights when power level set too high to permit leveling over entire selected sweep range or when operating in unlevelled mode.

Equivalent source match

Externally leveled: depends on coupler.

Unlevelled: less than 2.5:1.

Power variation, unlevelled: less than 10 dB over the entire band.

Weight

8691A, 8692A: net 17 lb (7,6 kg); shipping 25 lb (11,3 kg).

8691B, 8692B: net 20 lb (9 kg); shipping 28 lb (12,6 kg).

8693A-8697A: net 10 lb (4,5 kg); shipping 18 lb (8,1 kg).

8693B, 8694B: net 12 lb (5,4 kg); shipping 20 lb (9 kg).

8701A RF Unit, 100 MHz to 4 GHz

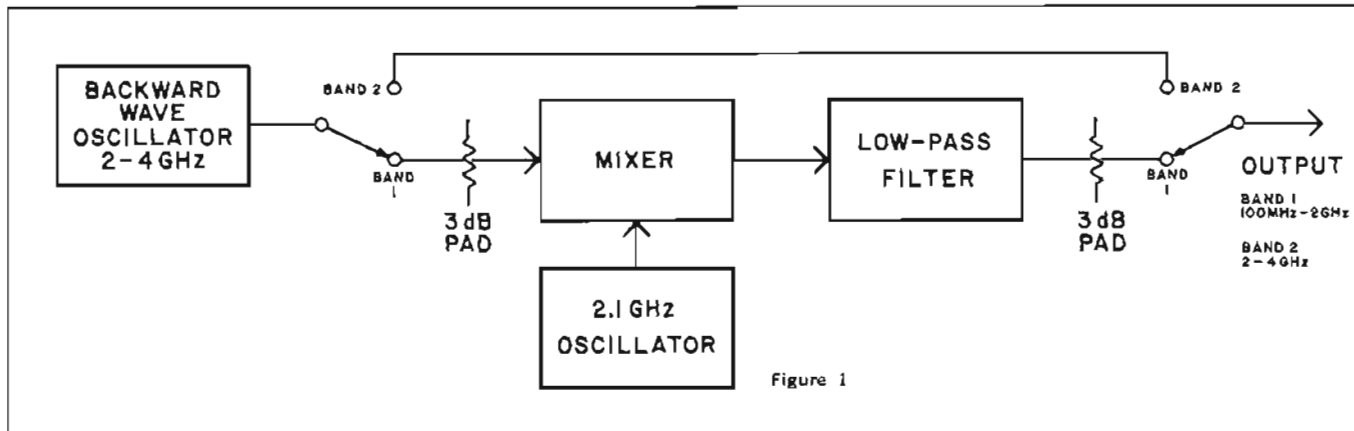

Model 8701A RF Unit Block Diagram

The Model 8701A RF Unit for the 8690A Sweep Oscillator provides CW and swept operation in the important 100 MHz to 4 GHz frequency range in two bands. Band 1 covers 100 MHz to 2 GHz and Band 2 covers 2 to 4 GHz.

The wide frequency coverage is accomplished by heterodyning the 2 to 4 GHz BWO output with a 2.1 GHz local oscillator and filtering the 100 MHz to 2 GHz difference frequency in Band 1. Band 2 output is the fundamental operating frequency of the BWO. Figure 1 shows a block diagram of the Model 8701A RF Unit.

Major specifications, 8701A RF Unit

Frequency range

Band 1: 100 MHz to 2 GHz.

Band 2: 2 GHz to 4 GHz.

Frequency accuracy and linearity

Band 1: $\pm(20 \text{ MHz} \pm 1\%)$.

Band 2: $\pm 1\%$.

Power output

Band 1: -15 dBm.

Band 2: 70 mW.

Power output variation: <6 dB across the band.

Spurious signals

Band 1: harmonics and spurious, >25 dB down.

Band 2: harmonics, >20 dB below CW output; non-harmonics, >40 dB below CW output.

Price: HP 8701A, \$3000.

H25-8690A Digital Frequency Controller

The H25-8690A is an 8690A Sweep Oscillator modified to accept a 10-line binary input to permit the programming of 1000 points across the band. Frequency accuracy of the 8690A Sweep Oscillator is maintained with open loop programming. Although designed to be compatible with the

2116A Instrumentation Computer, the H25-8690A can be easily interfaced with other equipment having programming levels of Logic 1 = contact closure to ground and Logic 0 = open circuit.

Price: HP H25-8690A, \$2100.



RF UNIT

8690A features in a 100 kHz-110 MHz sweeper
Model 8698A

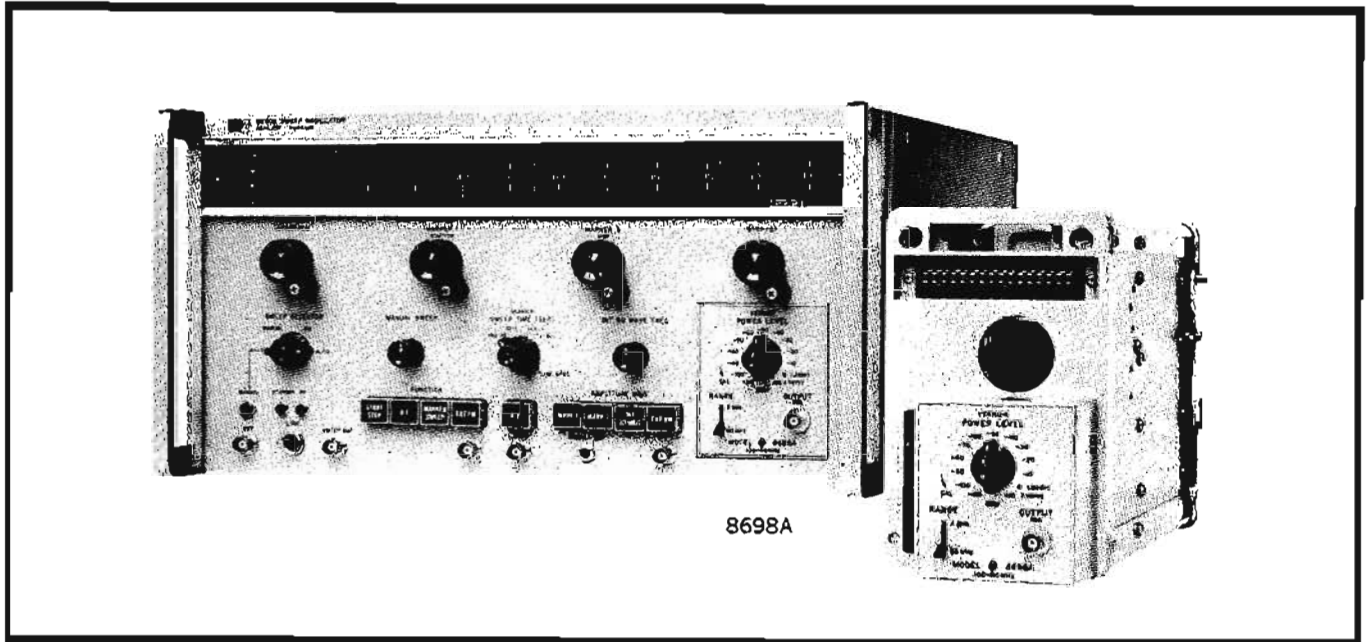

NOW! . . . SATISFY LOW FREQUENCY CW AND SWEEP SIGNAL GENERATOR DESIGN AND TEST REQUIREMENTS . . . IF STRIPS — RF COMPONENTS — VIDEO AND OPERATIONAL AMPLIFIERS — RADIO AND TELEVISION CIRCUITS — FILTER PARAMETERS

Description

The Model 8698A RF Unit for the Model 8690A Sweep Oscillator is a low frequency sweep signal generator. It covers the frequency range from 100 kHz to 110 MHz in two ranges on a calibrated $\pm 1\%$ accuracy frequency display. All of the performance features designed into the 8690A Sweep Oscillator for microwave use are retained with the 8698A RF Sweep Signal Generator.

The all solid-state Model 8698A RF Unit makes an outstanding low frequency contribution for several reasons:

- Sweep linearity is exceptionally good, departing less than $\pm 0.5\%$ from a straight-line function, and frequency accuracy is $\pm 1\%$. Residual FM is very low, less than 150 Hz (low range) and 500 Hz (high range). The user is thus able to define the roll-off characteristics of amplifiers and filters accurately.
- Output power is calibrated from +10 to -110 dBm with vernier adjustment between steps. Calibrated power makes it easier to define gain and loss in networks and amplifiers.
- Maximum output is +20 dBm into a 50 ohm load. Output power at this level enables noise-free measurements on networks with high attenuation.
- A built-in leveling circuit holds the output flat within ± 0.25 dB throughout the maximum sweep width (100

MHz) and flat within ± 0.1 dB over any 10 MHz portion of the band. This assures accuracy in measuring amplifier and network frequency response.

Operation

Besides the greater precision and higher accuracy that this RF unit brings into the radio frequency range, there are also operating features of special import. Start and stop sweep points are continuously adjustable and calibrated over the full range, and the instrument sweeps up or down in frequency. Two continuously adjustable markers identify the frequencies of any part of the sweep and can also serve as the end points of another sweep. This marker sweep can be used to expand a small portion of a broadband sweep enabling resolution of displayed discontinuities. A ΔF sweep function sweeps over a calibrated frequency range symmetrically on either side of a selected center frequency.

Design

The accuracy and linearity of the Model 8698A sweep has never before been approached by a sweep oscillator in this frequency range. To achieve this, a frequency comparator technique uses a pulse count discriminator in a frequency-controlling feedback loop. This discriminator generates a voltage proportional to the frequency output of the RF Unit. This voltage is compared to the linear tuning voltage ramp reference furnished by the 8698A Sweep Oscillator. The

voltage comparison results in tuning voltage compensation applied to a voltage-tuned-oscillator (VTO) to ensure an accurate and linear swept frequency output with time. This technique also substantially reduces residual FM. The output frequency will track an externally applied control voltage faithfully at any deviation rate up to 2 kHz and up to the full 110 MHz frequency deviation range.

The 8698A start-stop type sweep, frequency accuracy and linearity eliminate the need for crystal markers to identify

sweep width or points intermediate in the sweep. Frequency settability of $\pm 1\%$, low residual FM, and calibrated power output permit the 8698A to satisfy many RF signal generator CW applications.

Two auxiliary outputs, the auxiliary RF output and the VTO output, allow a frequency counter to supplement the $\pm 1\%$ frequency display and provide a second RF output for applications requiring external mixing techniques.

Specifications, 8698A installed in 8690A Sweep Oscillator*

Frequency range: 0.1 to 11 MHz or 1 to 110 MHz, selected by front-panel switch.

Power output: at least +20 dBm (2.24 V rms) max into 50 Ω ; calibrated power output adjustable from +10 to -110 dBm in 10 dB steps; 10 dB vernier permits continuous adjustment between steps; source impedance 50 Ω .

Output accuracy (vernier in calibrate position):†
+10 to -60 dBm: ± 2 dB.
-70 to -110 dBm: ± 3 dB.

Flatness (vernier in calibrate position):**
1 to 110 MHz: ± 0.25 dB (typically ± 0.5 dB with vernier in fully clockwise position).

Over any 10 MHz range: typically ± 0.1 dB.

Attenuator accuracy:

10 to 70 dB: ± 1 dB.
80 to 120 dB: ± 2 dB.

Frequency stability:

With temperature:
0.1 to 11 MHz: $\pm 0.06\%/^{\circ}\text{C}$ or ± 1.2 kHz/ $^{\circ}\text{C}$, whichever is greater.
1 to 110 MHz: $\pm 0.06\%/^{\circ}\text{C}$ or ± 12 kHz/ $^{\circ}\text{C}$, whichever is greater.

With 10% line voltage change:

0.1 to 11 MHz: ± 5 kHz.
1 to 110 MHz: ± 50 kHz.

Residual FM:††

0.1 to 11 MHz: <150 Hz peak.
1 to 110 MHz: <500 Hz peak.

Spurious signals:

Nonharmonics: at least 35 dB below CW output.

Harmonics (vernier in calibrate position): at least 30 dB below CW output from 1 to 110 MHz.

Noise: at least 45 dB below CW output.

Sweep functions

Start-stop sweep: sweeps from "start" to "stop" frequency setting.

Range: both settings continuously and independently adjustable over the entire frequency range; can be set to sweep either up or down in frequency.

End-point accuracy:
0.1 to 11 MHz: $\pm 1\%$ of full scale.
1 to 110 MHz: $\pm 1\%$ of full scale.

Marker sweep: sweeps from "Marker 1" to "Marker 2" frequency setting.

Range: both settings continuously and independently adjustable over the entire frequency range; can be set to sweep either up or down in frequency.

End-point accuracy:
0.1 to 11 MHz: $\pm 1\%$ of full scale.
1 to 110 MHz: $\pm 1\%$ of full scale.

ΔF sweep: sweeps upward in frequency, centered on CW setting.

Width: continuously adjustable from zero to 10% of the frequency band; calibrated directly in MHz.

Width accuracy:
0.1 to 11 MHz: $\pm 3\%$ of ΔF being swept or ± 20 kHz, whichever is greater.
1 to 110 MHz: $\pm 3\%$ of ΔF being swept or ± 200 kHz, whichever is greater.

Center-frequency accuracy:
0.1 to 11 MHz: $\pm 1\%$ or ± 100 kHz, whichever is greater.
1 to 110 MHz: $\pm 1\%$ or ± 500 kHz, whichever is greater.

* Specifications apply for typical lab environment of 15 to 55 $^{\circ}\text{C}$, unless otherwise noted.

† In typical lab environment (15 to 30 $^{\circ}\text{C}$).

** When measured with negative-peak detecting device having 50 Ω impedance.

†† Power line related components.

Linearity: $\pm 0.5\%$ of sweep width.

Frequency markers: two frequency markers, independently adjustable over the entire frequency range, amplitude modulate the RF output; amplitude is adjustable from the front panel; the markers are also available for external use.

Accuracy:
0.1 to 11 MHz: $\pm 1\%$ of full scale.
1 to 110 MHz: $\pm 1\%$ of full scale.

Resolution: better than 0.05% of RF unit bandwidth.

Marker output: triangular pulse, typically -5 V peak into 1000 ohm load.

CW operation: single-frequency RF output selected by START/CW or MARKER 1 control, depending upon sweep function selected.

Accuracy:
0.1 to 11 MHz: $\pm 1\%$ or ± 100 kHz, whichever is greater.
1 to 110 MHz: $\pm 1\%$ or ± 500 kHz, whichever is greater.

Preset frequencies: start-stop sweep end points and marker frequencies can be used as four preset CW frequencies.

Sweep mode

Auto: sweep recurs automatically.

Manual: front-panel control provides continuous manual adjustment of frequency between end frequencies set in any of the above sweep functions.

Triggered: sweep is actuated by front-panel pushbutton or by externally applied signal <-25 V peak, >1 μs pulse width, and >0.1 V/ μs rise.

Sweep time: continuously adjustable in four decade ranges, 0.01 to 100 seconds; can be synchronized with the power line frequency.

Sweep indicator: front-panel indicator lights during the sweep to provide indication of sweep duration on slower sweep times.

Auxiliary outputs:

Sweep output: direct-coupled sawtooth, zero to approx +15 V, concurrent with swept RF output; zero at start of sweep, approx +15 V at end of sweep regardless of sweep width or direction; source impedance, 10 k Ω .

Sweep reference:
0.1 to 11 MHz: approx 1 V/MHz.
1 to 110 MHz: approx 1 V/10 MHz.

Auxiliary RF output: CW signal corresponding to front-panel output; output level at least -15 dBm.

VTO output: 200 to 310 MHz CW; output level at least -15 dBm.

Blanking: RF automatically turned off during retrace, turned on after completion of retrace; on automatic sweeps, RF is on long enough before sweep starts to stabilize external circuits and equipment whose response is compatible with the selected sweep rate; blanking disable switch provided.

Blanking output: direct-coupled rectangular pulse approx -4 V coincident with RF blanking; source impedance approx 3000 ohms.

Pen lift: for use with X-Y graphic recorders; penlift terminals shorted during sweep, open during retrace.

Modulation:

Internal AM: squarewave modulation continuously adjustable from 950 to 1050 Hz on all sweep times.

External AM: bandwidth typically 5 kHz.

External FM:
Max p-p deviation: 110 MHz.
Max rate (any deviation): 2 kHz.
Linearity: $\pm 0.5\%$ of p-p deviation.

Power: 115 or 230 V $\pm 10\%$, 50 to 60 Hz; approx 350 W.

Weight:

8698A: net 11 lb (5 kg); shipping 20 lb (9 kg).

8690A: net 53 lb (23.9 kg); shipping 71 lb (32 kg).

Price: HP Model 8698A, \$950. HP Model 8690A, \$1,600.

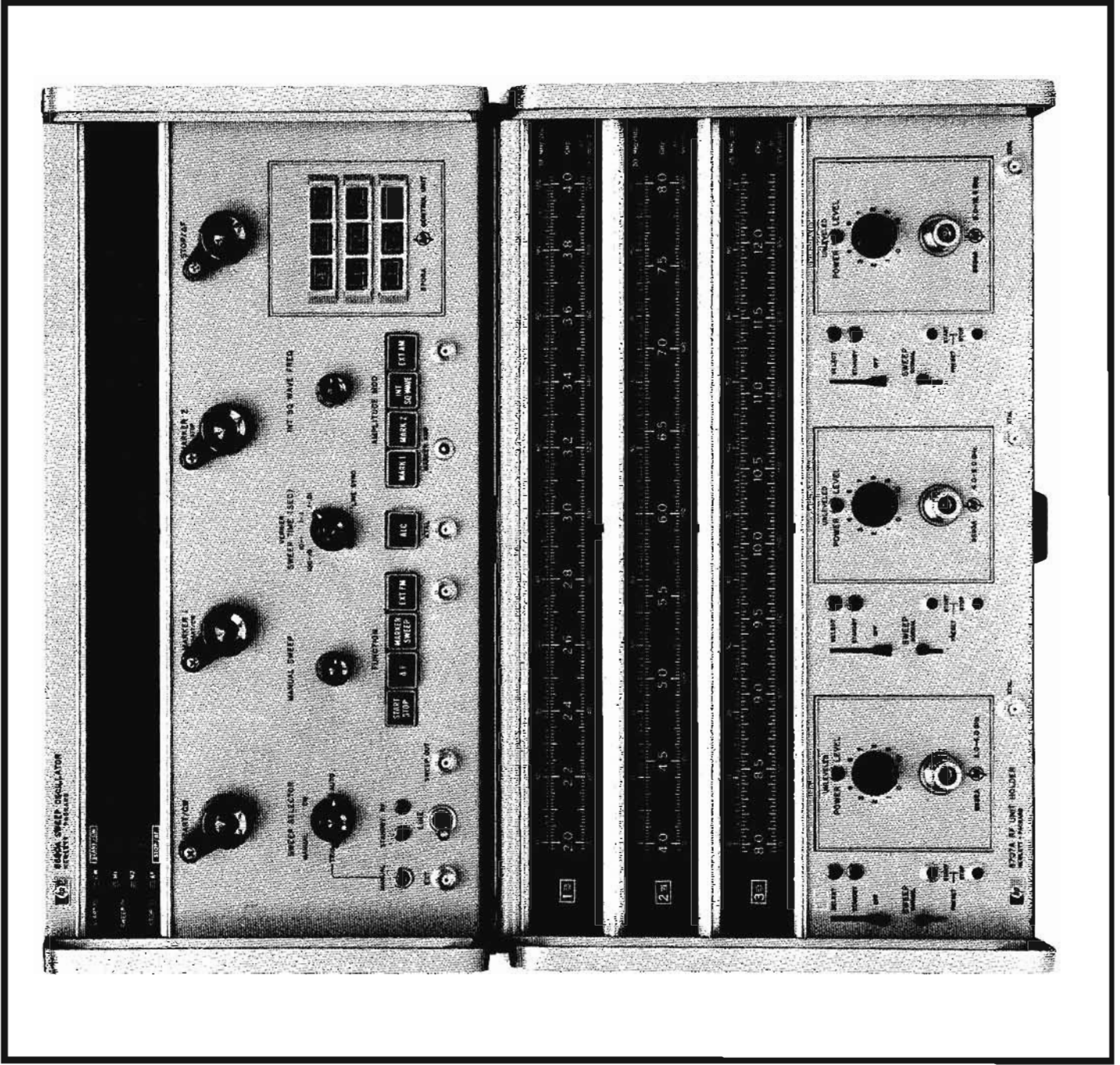

Inexpensive wideband coverage

The 8706A Control Unit and 8707A RF Unit Holder form the 8706A plus into the 8690A like an RF unit and is

RF units may be programmed in two ways: by 8706A front panel pushbutton selection, or by remote contact closure to ground. The 8706A also provides voltages for operation of external circuits such as a switching system to route the outputs of the RF units through a single system output connector.

Each RF unit in the system operates independently, with only one RF unit providing output power at any given time. Other RF units are either on "standby" or are turned off. During "standby" mode, the BWO filaments are on without high voltage applied to conserve tube life. "Standby" operation permits switching in one second between RF units. RF units not in use can be turned off to further extend tube life. For RF units that are turned off, turn-on time is approximately 90 seconds.

Operation

Models 8706A and 8707A allow uncomplicated operation

over extremely wide RF and microwave frequencies without the need to interchange RF units. The 8706A can switch between as many as nine RF units contained in three 8707A RF Unit Holders which accept three RF units each.

The 8706A/8707A system preserves all control features of the 8690A Sweep Oscillator, and in addition offers a preset sweep mode for each RF unit. If normal 8690A sweeps are selected for one or more of the RF units in the 8707A, the breadth of the sweep will correspond to the setting of the start/stop cursor on the 8690A Sweep Oscillator; 100% if 0 and 100 are selected, or any proportion as designated on the start/stop dial. The preset sweep mode is available for one or more RF units by presetting start/stop frequencies on potentiometers adjacent to each RF unit in the 8707A RF Unit Holders. Any of the RF units can be preset to sweep up or down in frequency, or for CW, without reference to the 8690A sweep frequency controls.

Specifications, 8706A

Compatibility: the 8706A controls up to three 8707A Head Holders; selection of RF unit is by front-panel pushbutton or remote contact closure (see Remote Control below).

Switching time between RF units: 1 second.

Remote control: single ten-pin connector on rear panel permits selection of RF units from remote location or control of remote circuits or switches from the 8706A; nine control pins (one corresponding to each front-panel pushbutton) and one common ground pin; mating connector (not supplied), Amphenol 57-30140 (also available from HP under part number 1251-0142).

RF unit selection: momentary grounding of appropriate control pin.

Control pin voltage: pins are at 0 V (ground) when RF unit is selected, otherwise at -5 V when RF unit is not in use (standby); these voltages can be used to program external devices such as coaxial switches.

Minimum external resistance (per control pin) for unselected RF units: 50Ω .

Maximum external resistance for positive selection of RF unit: 50Ω .

Maximum current per control pin: 100 mA.

Weight: net 25 lb (11,3 kg); shipping 31 lb (10,1 kg).

Price: HP Model 8706A, \$375.

Specifications, 8707A

Compatibility: accepts up to three 8691C/D, 8692-8698, 8701A RF units; no modification of the RF units is necessary.

Frequency range: 100 kHz to 40 GHz.

Frequency accuracy: $\pm 1\%$ for all RF units.

Maximum leveled power: same as 8691C/D, 8692-8698, 8701A RF units.

Leveling capability: same as 8691C/D, 8692-8698, 8701A RF units.

Output impedance and connector: same as RF units.

Sweep functions

Normal: permits any sweep function available from the 8690A.

Preset: provides start-stop sweep determined by preset adjustments on the 8708A; sweep endpoints can be set independently for each RF unit.

Dimensions: $16\frac{3}{4}$ " wide, 9" high, $18\frac{3}{8}$ " deep (426 x 229 x 467 mm); hardware furnished for rack mount, 19" wide, $8\text{-}23/32$ " high, $16\frac{3}{8}$ " deep behind panel (483 x 221 x 416 mm).

Power: approximately 385 W for system with one each 8690A, 8706A, 8707A, and three RF units; approx 25 W for each additional RF unit.

Weight: net 25 lb (11,3 kg); shipping 31 lb (14 kg).

Accessory available: K04-8690A Power Supply Tester, \$280.

Price: HP Model 8707A, \$1050.



STABILIZED OSCILLATOR SYSTEMS

Phase-locked signals, 1 through 40 GHz
Model 8709, E20 Series 8690A



Uses:

Narrowband receiver or filter test
Parametric amplifier pump
Doppler system source

Features:

Stabilized at any frequency
— 1 to 40 GHz
Stabilized CW or swept,
 $5 \times 10^{-1}/s$, $1 \times 10^{-6}/hr$
Positive frequency indication

E20 Series Stabilized Sweep Oscillator Systems

The E20 Series Stabilized Sweep Oscillator Systems satisfy the requirement for high stability in many microwave applications. These systems offer both CW and swept operation in the 1 to 40 GHz range. Phase-lock stabilization is provided by the 8709A Synchronizer.

The 8709A Synchronizer phase-locks the 8690 Series Sweep Oscillators by providing a voltage output that is proportional to the phase difference between the synchronizer input signal and a highly stable internal reference signal. The input signal is derived by mixing the sweep oscillator output with a highly stable external reference oscillator. The lock-points are spaced by the reference oscillator frequency instead of the IF frequency because the synchronizer rejects the lower of two possible lock-points for any given frequency. This feature enables you to read the phase-locked frequency directly from the sweep oscillator dial. Two internal reference oscillators are available: 20 MHz or 21.5 MHz, eliminating IF feedthrough which is often a problem in sensitive receiver testing applications.

The stabilized 8691-7A/B RF Units include the H15-8690A Shunt Tube BWO Coupler that permits control of the BWO helix voltage by the low voltage output of the 8709A Synchronizer.

Frequency calibration of the RF unit is maintained because the BWO is calibrated with the shunt tube in the circuit. Phase-

lock loop gain can be adjusted by changing one resistor so that phase detectors with lower error voltage outputs may be used. The H15-8691-7A/B is compatible with the DY2650A, DY2590A, and HP8709A, and most other commercially available synchronizers.

Major specifications, H15-8690 Series RF Units

Input voltage: $\leq \pm 20$ V dc, $40 \mu A$ dc max.

Modulation sensitivity:

1.0 to 4.0 GHz: 1 MHz/V
4.0 to 12.4 GHz: 2.5 MHz/V
12.4 to 40.0 GHz: 6 MHz/V

Frequency response: dc to 500 kHz.

Price: RF unit price plus \$175.

Several reference oscillators are available for HP phase-locked systems. Using the 8464A Reference Oscillator provides $5 \times 10^{-1}/s$ short term stability for CW operation. The 8466 Reference Oscillator provides 5×10^{-1} short term stability with the additional capability of phase-locking while sweeping. The 5105A Frequency Synthesizer may be used as the reference for more rigid stability requirements. A new digitally controlled, highly stable reference oscillator will be tentatively available in the summer of 1968.

Further information on these systems is available on the E20-8690A Data Sheet and from your local HP sales engineer.

Major specifications, E20 Series 8690A

CW systems:

E20-8690A: 1 to 12.4 GHz
E21-8690A: 12.4 to 40 GHz

CW and swept systems:

E22-8690A: 1 to 12.4 GHz
E23-8690A: 12.4 to 40 GHz

Stabilized frequency stability:

Short term: $\leq 5 \times 10^{-1}/s$
Long term: $\leq 1 \times 10^{-5}/hr$

Residual FM: $\leq 5 \times 10^{-1}$

EXTEND USEFULNESS, CAPABILITIES, OF OTHER EQUIPMENT



MIXERS, MODULATORS, ATTENUATORS

Attenuators

Attenuators are important tools in the design and testing of electronic components and equipment. They perform a wide variety of functions, particularly in the RF and microwave frequency ranges. For example, fixed attenuators are often used to improve the source match of signal sources and thereby reduce the level of the re-reflected signal. Reduction of this signal is important in measurements requiring high accuracy.

Variable or step attenuators can be used to extend the power range of signal sources as well as improve source match. The power range of the HP 8690A Sweep Oscillator (see Signal Sources) can be increased from 10 to 70 dB in this manner.

Extension of the range of power meters and prevention of overload and burn-out of sensitive detectors are additional attenuator applications. Another is the use of precision variable attenuators in the RF substitution method of measuring transmission and reflection characteristics. In this method the attenuator is used to keep the signal level at the detector the same for both the calibration of the system and the actual measurement. The uncertainty of the power response of the detector, generally four to five times the attenuator uncertainty, is thereby eliminated as a factor in measurement accuracy.

Hewlett-Packard manufactures a broad line of attenuators for use in both coaxial and waveguide systems. New to the line is a series of fixed coaxial pads, Models 8491A, 8492A, and 8493A,B. Based on the development of thin film technology at Hewlett-Packard, these pads operate over the extremely wide frequency range of dc to 12.4 GHz (8491A, 8493A) and dc to 18 GHz (8491B, 8492A, and 8493B). Attenuation accuracy is high over the entire frequency range as shown in Figure 1. (The data for this figure are based on a sample of 60 8491A 10-dB pads.) In addition to

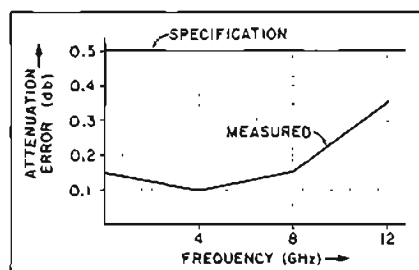

Figure 1. Typical attenuation accuracy of HP 8491A Option 10 10-dB pad.

outstanding performance, these attenuators are available with various rf input connectors. The 8491A,B have type N male; the 8492A, APC-7[®]; and the 8493A,B, OSM[®]-type male.

Model 354A, a coaxial turret attenuator, is another which makes use of thin films. Operating from dc to 12.4 GHz, the 354A provides up to 60 dB of attenuation in 10-dB steps. These and the other attenuators produced by Hewlett-Packard are described in detail on pages 402 through 405.

Modulators

Sinusoidal and complex modulation of microwave signals is possible with the HP 8730 Series PIN Modulators. The series covers the coaxial range from 0.8 to 12.4 GHz in four overlapping bands in addition to X-band in waveguide. Utilizing PIN diodes, the modulators present a good match and virtually eliminate frequency pulling.

Physically, the PIN modulator comprises a number of PIN diodes mounted as shunt elements across a transmission line. Since PIN diodes have appreciable storage time, they do not rectify at signal frequencies above 100 MHz. However, when a dc forward bias is applied, the diodes conduct, and their resistance goes down. Thus, the diodes act as low-reactance, variable resistors shunting the transmission line. Their resistance, and the degree of attenuation of an rf signal, are functions of the modulating current.

New modulation techniques are possible with the HP modulators, since they may be connected in series for compound modulation, such as amplitude modulation of rf pulses.

Two models of PIN modulators are available within each band: one which provides at least 35 dB of attenuation range, and one which provides at least 80 dB.

The 35 dB version is especially useful as the control element in a closed-loop system for microwave power leveling. Conventional amplitude modulation also can be accomplished. The 80 dB modulators provide high on/off ratios for critical pulse-modulation applications. The modulators are capable of achieving pulse rise and fall times of typically 30 nanoseconds. The HP Model 8403A Modulator provides complete control of the PIN modulators, supplying the appropriate modulation wave shapes and bias levels for fast rise times, rated on/off ratios and amplitude modulation.

Double balanced mixers
The Hewlett-Packard Double-Balanced

Mixers, Models 10514A,B, 10534A,B are versatile devices of broadband (200 kHz to 500 MHz and 50 kHz to 150 MHz) application that can serve as mixers, modulators, attenuators, or phase detectors. This exceptional versatility in units that measures 2.3 x 0.6 x 1.7 inches (printed circuit models also available) is made possible by circuitry that takes full advantage of specially developed transformers and specially selected hot carrier diodes produced by HP Associates. The 10514A,B has a 7 dB maximum noise figure to 50 MHz and a 9 dB maximum noise figure to 500 MHz. The 10534A,B has a 6.5 dB noise figure to 35 MHz and 8.0 dB noise figure to 150 MHz.

One of the ports of the mixers is coupled to dc, allowing efficient operation as a low-noise phase detector, as an amplitude or pulse modulator, and as a current-controlled attenuator. The mixers have a very good 1/f noise specification (very important when used as phase detectors) due to the specifically selected hpa Hot Carrier Diodes.

Figure 2 shows the mixers, with ports marked "L", "R", and "X".

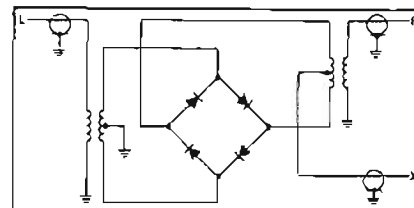

Figure 2. Ring Modulator

With rf input signals at L and R, the output at X contains the sum and difference frequencies. For phase detecting and doubling, L and R are at the same frequency; their sum is twice the input, their difference is dc; the desired output can be selected by a high-pass, low-pass or bandpass filter at X.

If the mixers are to serve as current-controlled attenuators, balanced modulators, or amplitude or pulse modulators, the control or modulating signal is connected at X and the output taken from R. With a dc current applied at X, output at R is attenuated in an amount inversely proportional to applied current. With an rf signal at L and a modulating signal at X, the output at R is the rf frequency plus and minus the modulating frequency; the carrier is suppressed as in a balanced modulator. Amplitude and pulse modulation are combinations of the effects already described.

* Amphenol RF Division, Danbury, Conn.
® Omni-Spectra, Inc., Southfield, Mich.

MIXERS, MODULATORS, ATTENUATORS



DOUBLE BALANCED MIXERS

High performance simplifies many design tasks
Models 10514A/B, 10534A/B

Advantages:

- Wide-band, low-noise performance that compares favorably with narrow-band mixers of limited usefulness
- Excellent balance of ports
- Flat response
- Low insertion loss
- Low intermodulation products
- Rugged, environmentally type-tested
- Models for printed circuit mounting

Uses:

- As a mixer for extracting the sum or difference of two frequencies as in a receiver tuned voltmeter or wave analyzer; high degree of carrier suppression greatly reduces filter requirements in single sideband systems
- As a frequency doubler for very flat-response, low-noise frequency doubling
- As a suppressed carrier modulator with 45 dB typical carrier rejection at HF
- As a pulse modulator or spectrum generator with precise turn-on and turn-off characteristics
- As a current-controlled attenuator where the level of a signal (at the mixer "L" port) is to be attenuated linearly with respect to a dc current (at the "X" port); insertion loss and harmonics are low; linear range is approximately 30 dB

As a phase detector with low-noise and dc coupling that permit phase or frequency stability measurement on the most stable, high-quality signal sources and quartz crystals

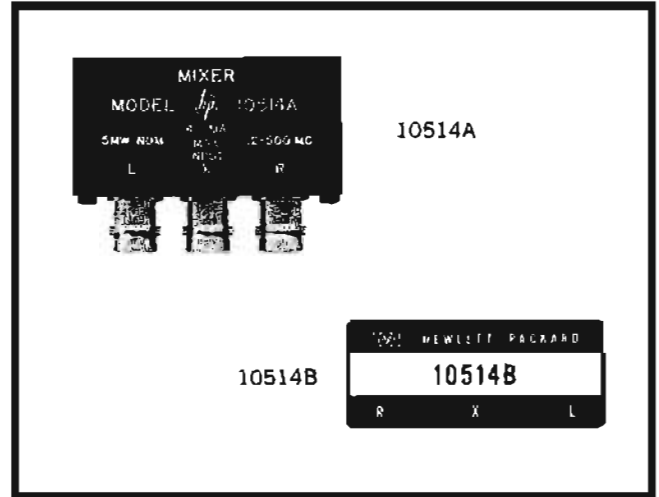

The addition of the models 10534A/B to the HP mixer line provides extremely economical mixers for users who only need a frequency range of 150 MHz. The identical specifications for the BNC and Printed Circuit models ensures that the mixer performance will stay the same when changed from the laboratory type with BNC connectors to production type use in printed circuits.

Specifications, 10514A/B, 10534A/B

	10514A	10514B	10534A	10534B
Input/output frequencies:	"L" and "R" ports: 200 kHz to 500 MHz; "X" port: dc to 500 MHz.		"L" and "R" ports: 50 kHz to 150 MHz; "X" port: dc to 150 MHz.	
Maximum input:	40 mA (damage level).		40 mA (damage level).	
Impedance:	Designed for and specified in 50 Ω system.		Designed for and specified in a 50 Ω system.	
Mixer conversion loss (single sideband):	7 dB max for f_L and f_R in the 500 kHz to 50 MHz range and f_X from dc to 50 MHz. 9 dB max for f_L and f_R in the 200 kHz to 500 MHz range and f_X from dc to 500 MHz.		6.5 dB max for f_L and f_R in the 200 kHz to 35 MHz range and f_X from dc to 35 MHz. 8.0 dB max for f_L and f_R in the 50 kHz to 150 MHz range and f_X from dc to 150 MHz.	
Noise performance (single sideband):	7 dB max noise figure for f_L and f_R in the 500 kHz to 50 MHz range and f_X in the 50 kHz to 50 MHz range. 9 dB max noise figure for f_L and f_R in the 200 kHz to 500 MHz range and f_X in the 50 kHz to 500 MHz range. Less than 100 nV per root cycle max at output for f_X at 10 Hz.		6.5 dB max noise figure for f_L and f_R in the 200 kHz to 35 MHz range and f_X in the 50 kHz to 35 MHz range. 8.0 dB max noise figure for f_L and f_R in the 100 kHz to 150 MHz range and f_X in the 50 kHz to 150 MHz range. Less than 100 nV per root cycle max at output for f_X at 10 Hz.	
Typical conversion compression:	By f_R alone: 0.3 dB for 1 mW level. By f_{R2} signal presence interfering with f_{R1} signal: 1 dB for f_{R2} level of 1 mW; 10 dB for f_{R2} level of 10 mW.		By f_R alone: 0.3 dB for 1 mW level. By f_{R2} signal presence interfering with f_{R1} signal: 1 dB for f_{R2} level of 1 mW, 10 dB for f_{R2} level of 10 mW (f_L level at 5 mW).	

	10514A	10514B	10534A	10534B																																																								
Inter-modulation:	Typical intermodulation product production with f_L level of 5 mW and f_R at 70 mV. <table border="1"> <thead> <tr> <th>Product</th> <th>Level*</th> <th>Product</th> <th>Level*</th> </tr> </thead> <tbody> <tr> <td>$2f_L - f_R$</td> <td>30 dB</td> <td>$2f_R - f_L$</td> <td>65 dB</td> </tr> <tr> <td>$3f_L - 2f_R$</td> <td>70 dB</td> <td>$3f_R - 2f_L$</td> <td>65 dB</td> </tr> <tr> <td>$4f_L - 3f_R$</td> <td>70 dB</td> <td>$4f_R - 3f_L$</td> <td>85 dB</td> </tr> <tr> <td>$5f_L - 4f_R$</td> <td>90 dB</td> <td>$5f_R - 4f_L$</td> <td>90 dB</td> </tr> <tr> <td>$6f_L - 5f_R$</td> <td>95 dB</td> <td>$6f_R - 5f_L$</td> <td>100 dB</td> </tr> <tr> <td>$7f_L - 6f_R$</td> <td>100 dB</td> <td>$7f_R - 6f_L$</td> <td>100 dB</td> </tr> </tbody> </table> *Referred to f_X level.		Product	Level*	Product	Level*	$2f_L - f_R$	30 dB	$2f_R - f_L$	65 dB	$3f_L - 2f_R$	70 dB	$3f_R - 2f_L$	65 dB	$4f_L - 3f_R$	70 dB	$4f_R - 3f_L$	85 dB	$5f_L - 4f_R$	90 dB	$5f_R - 4f_L$	90 dB	$6f_L - 5f_R$	95 dB	$6f_R - 5f_L$	100 dB	$7f_L - 6f_R$	100 dB	$7f_R - 6f_L$	100 dB	Typical intermodulation product production with f_L level of 5 mW and f_R at 70 mV. $f_R = 21$ MHz and $f_L = 20$ MHz. <table border="1"> <thead> <tr> <th>Product</th> <th>Level*</th> <th>Product</th> <th>Level*</th> </tr> </thead> <tbody> <tr> <td>$2f_L - f_R$</td> <td>40 dB</td> <td>$2f_R - f_L$</td> <td>65 dB</td> </tr> <tr> <td>$3f_L - 2f_R$</td> <td>65 dB</td> <td>$3f_R - 2f_L$</td> <td>65 dB</td> </tr> <tr> <td>$4f_L - 3f_R$</td> <td>65 dB</td> <td>$4f_R - 3f_L$</td> <td>90 dB</td> </tr> <tr> <td>$5f_L - 4f_R$</td> <td>85 dB</td> <td>$5f_R - 4f_L$</td> <td>90 dB</td> </tr> <tr> <td>$6f_L - 5f_R$</td> <td>90 dB</td> <td>$6f_R - 5f_L$</td> <td>95 dB</td> </tr> <tr> <td>$7f_L - 6f_R$</td> <td>95 dB</td> <td>$7f_R - 6f_L$</td> <td>95 dB</td> </tr> </tbody> </table> *Referred to f_X level.		Product	Level*	Product	Level*	$2f_L - f_R$	40 dB	$2f_R - f_L$	65 dB	$3f_L - 2f_R$	65 dB	$3f_R - 2f_L$	65 dB	$4f_L - 3f_R$	65 dB	$4f_R - 3f_L$	90 dB	$5f_L - 4f_R$	85 dB	$5f_R - 4f_L$	90 dB	$6f_L - 5f_R$	90 dB	$6f_R - 5f_L$	95 dB	$7f_L - 6f_R$	95 dB	$7f_R - 6f_L$	95 dB
Product	Level*	Product	Level*																																																									
$2f_L - f_R$	30 dB	$2f_R - f_L$	65 dB																																																									
$3f_L - 2f_R$	70 dB	$3f_R - 2f_L$	65 dB																																																									
$4f_L - 3f_R$	70 dB	$4f_R - 3f_L$	85 dB																																																									
$5f_L - 4f_R$	90 dB	$5f_R - 4f_L$	90 dB																																																									
$6f_L - 5f_R$	95 dB	$6f_R - 5f_L$	100 dB																																																									
$7f_L - 6f_R$	100 dB	$7f_R - 6f_L$	100 dB																																																									
Product	Level*	Product	Level*																																																									
$2f_L - f_R$	40 dB	$2f_R - f_L$	65 dB																																																									
$3f_L - 2f_R$	65 dB	$3f_R - 2f_L$	65 dB																																																									
$4f_L - 3f_R$	65 dB	$4f_R - 3f_L$	90 dB																																																									
$5f_L - 4f_R$	85 dB	$5f_R - 4f_L$	90 dB																																																									
$6f_L - 5f_R$	90 dB	$6f_R - 5f_L$	95 dB																																																									
$7f_L - 6f_R$	95 dB	$7f_R - 6f_L$	95 dB																																																									
Typical pulse modulator performance (pulse input "X" port, output at "R"):	Rise or fall times: 1 nanosecond. Pulse width: no restriction. On-off ratio: 35 dB. Saturation pulse amplitude: 10 mA with $f_L = 5$ mW. Maximum input: 40 mA (damage level). Modulation source: either + or - polarity turns switch on; amplitude between pulses, within 2 mV of 0 V. Linearity: output is linear over a 30 dB range at 500 MHz; better at lower frequencies.		Rise or fall times: 1 nanosecond. Pulse width: no restriction. On-off ratio: 35 dB. Saturation pulse amplitude: 10 mA with $f_L = 5$ mW. Maximum input: 40 mA (damage level). Modulation source: either + or - polarity turns switch on; amplitude between pulses, within 2 mV of 0 V. Linearity: output is linear over a 30 dB input current range at 150 MHz; better at lower frequencies.																																																									
Mixer balance:	(1) For f_L and f_R in the 500 kHz to 50 MHz range and f_X from dc to 50 MHz. (2) For f_L and f_R in the 200 kHz to 500 MHz range and f_X from dc to 500 MHz. (1) (2) 40 dB 30 dB f_L at R with f_L ref 40 dB 20 dB f_L at X with f_L ref 45 dB 30 dB f_R at L with f_R ref 25 dB 15 dB f_R at X with f_R ref 35 dB 15 dB f_X at L with f_X ref 25 dB 15 dB f_X at R with f_X ref	(1) For f_L and f_R in the 500 kHz to 50 MHz range and f_X from dc to 50 MHz. (2) For f_L and f_R in the 200 kHz to 500 MHz range and f_X from dc to 500 MHz. (1) (2) (2) 40 dB 25 dB f_L at R with f_L ref 40 dB 15 dB f_L at X with f_L ref 45 dB 25 dB f_R at L with f_R ref 25 dB 15 dB f_R at X with f_R ref 35 dB 15 dB f_X at L with f_X ref 25 dB 15 dB f_X at R with f_X ref	(1) For f_L and f_R in the 50 kHz to 35 MHz range and f_X from dc to 35 MHz. (2) For f_L and f_R in the 35 kHz to 150 MHz range and f_X from dc to 150 MHz. (1) (2) 40 dB 30 dB f_L at R with f_L ref 35 dB 20 dB f_L at X with f_L ref 40 dB 30 dB f_R at L with f_R ref 20 dB 15 dB f_R at X with f_R ref 35 dB 20 dB f_X at L with f_X ref 20 dB 12 dB f_X at R with f_X ref	(1) For f_L and f_R in the 50 kHz to 35 MHz range and f_X from dc to 35 MHz. (2) For f_L and f_R in the 35 kHz to 150 MHz range and f_X from dc to 150 MHz. (1) (2) 40 dB 30 dB f_L at R with f_L ref 35 dB 20 dB f_L at X with f_L ref 40 dB 30 dB f_R at L with f_R ref 20 dB 15 dB f_R at X with f_R ref 35 dB 20 dB f_X at L with f_X ref 20 dB 12 dB f_X at R with f_X ref																																																								
Connectors:	Female BNC.	0.040-inch pins for printed circuit board mounting.	Female BNC.	0.040-inch pins for printed circuit board mounting.																																																								
Environmental:	Mixer has been type tested to meet its specifications over -20°C to $+65^\circ\text{C}$ and through five cycles of 40°C and 95% humidity. Compliance with the rigid MIL-I-6181D RFI specification has been demonstrated. Non-operating tests include -40°C to $+75^\circ\text{C}$ exposure, 0.060 inch peak-to-peak vibration at 55 Hz, 4-inch bench drop, and altitude to 25,000 feet.	Type tested to meet environmental specifications of MIL-E-16400F Class 1; MIL-T-21200 Class 1; and MIL-5400D Class 2. Conditions include: non-operating temp -54°C to $+75^\circ\text{C}$; humidity 95% at $+60^\circ\text{C}$; vibration to 500 Hz ≈ 10 g's; shock simulated hammer test 1500 g's; operating altitude 50,000 feet. The 10514B is not designed to meet RFI requirements since it is intended for use in other equipment.	Mixer has been type tested to meet its specifications over -20°C to $+65^\circ\text{C}$ and through five cycles of 40°C and 95% humidity. Compliance with the rigid MIL-I-6181D RFI specification has been demonstrated. Non-operating tests include -40°C to $+75^\circ\text{C}$ exposure, 0.060 inch peak-to-peak vibration to 55 Hz, 4-inch bench drop, and altitude to 25,000 feet.	Type tested to meet environmental specifications of MIL-E-16400F Class 1; MIL-T-21200 Class 1; and MIL-5400D Class 2. Conditions include: nonoperating temp -62°C to $+85^\circ\text{C}$; operating temp -54°C to $+75^\circ\text{C}$; humidity 95% at 65°C ; vibration to 500 Hz to 10 g's; shock simulated hammer test 1500 g's; operating altitude 50,000 feet. The 10534B is not designed to meet RFI requirements since its intended use is in other equipment.																																																								
Lead temperature (during soldering):	Does not apply.	265°C (509°F) max at distances greater than 1/32 inch from seating surface for 10 seconds max.	Does not apply.	265°C (509°F) max at distances greater than 1/32 inch from seating surface for 10 seconds max.																																																								
Dimensions:	2.3 in x 0.6 in x 1.7 in (59 x 15 x 43 mm).	1.63 in L x 0.70 in W x 0.43 in H seated (0.63 in H with pins).	2.3 in x 0.6 in x 1.7 in (59 x 15 x 43 mm).	1.63 in L x 0.70 in W x 0.43 in H seated (0.63 in H with pins).																																																								
Weight:	2.1 oz (59 grams).	0.5 oz (14 grams).	2.1 oz (59 grams).	0.5 oz (14 grams).																																																								
Price: *1 - 4 5 - 9 10 - 24	\$95 85 78	\$85 75 68	\$70 63 58	\$60 53 48																																																								

*Contact Hewlett-Packard for prices of larger quantities.

MIXERS, MODULATORS, ATTENUATORS



PIN MODULATORS, MODULATORS

Versatile modulation
8730 Series, 8403A

8730 PIN Modulators

The Hewlett-Packard 8730 Series PIN Modulators increase the flexibility and performance of signal generators and sources by providing increased modulation capability. With PIN modulators, signal sources, including klystrons, can be pulse modulated, leveled or amplitude modulated with sinusoidal and complex waveforms. Incidental FM is virtually eliminated, because modulation is accomplished by absorption of rf power, independent of the signal source, with a nearly constant match presented to both the source and load. Thus, the source can operate continuously at its optimum output level. Extremely fast rise times, typically 30 ns, also result from the absorption type of modulation, which sidesteps the bandwidth limitations imposed by the high-Q rf output circuits.

The 8730 PIN Modulators cover the coaxial range from 0.8 to 12.4 GHz in four overlapping bands, in addition to X-band in waveguide. Two models are available within each band: an "A" model, which provides at least 35 dB of attenuation range, and a "B" model, which provides at least 80 dB.

Physically, the PIN modulator comprises a number of PIN diodes mounted as shunt elements across a transmission line. Since PIN diodes have appreciable storage time, they do not rectify at signal frequencies above 100 MHz. However, when a dc forward bias is applied, the diodes conduct, and their resistance goes down. Thus, the diodes act as low-reactance, variable resistors shunting the transmission line. Their resistance and the degree of attenuation of an rf signal are functions of the modulating current. However, due to the storage time of the diodes, specially shaped modulation signals must be applied to realize the fast rf rise and decay times of which the PIN modulators are capable. The HP Model 8403A Modulator is specifically designed to supply these modulation signals.

8403A Modulator

The Model 8403A provides complete control of the PIN modulators, supplying the appropriate modulation wave shapes and bias levels for fast rise times, rated on/off ratios and amplitude modulation. An internal square-wave and pulse modulator, which can be synchronized with external signals, has a free-running prf from 50 Hz to 50 kHz. In the pulse-modulation mode both pulse width and pulse delay are adjustable from 0.1 to 100 μ s, and jitter with respect to the sync pulse and pulse width is less than 1 ns. An external AM input permits remote control of attenuation or sinusoidal modulation from dc to 10 MHz.

The Model 8403A also provides square wave and pulses for general pulse applications. Repetition rate, delay and jitter are the same as above. The output signal has an amplitude of 25 to 30 volts.

For situations requiring an absorption-type modulator complete with controls in a single unit, a PIN modulator can be installed in the Model 8403A. This combination is fully portable and convenient for bench use.

Specifications, 8403A

Output characteristics

AM and pulse output for driving 8730 PIN Modulators: pulse output specially shaped for optimum rf rise and decay times.

Pulse output for general pulse applications: positive dc-coupled pulse 25 to 30 volts in amplitude, approximately symmetrical about 0 volt; no AM signal.

Output signals available concurrently from separate front-panel connectors.

Internal modulation

Square wave

Frequency: continuously variable from 50 Hz to 50 kHz, 3 decade ranges.

Symmetry: better than 45/55%.

Pulse

Repetition rate: continuously variable from 50 Hz to 50 kHz, 3 decade ranges.

Delay: continuously variable from 0.1 μ s to 100 μ s, in 3 decade ranges, between sync out pulse and rf output pulse.

Width: continuously variable from 0.1 μ s to 100 μ s in 3 decade ranges.

Maximum duty cycle: see graph.

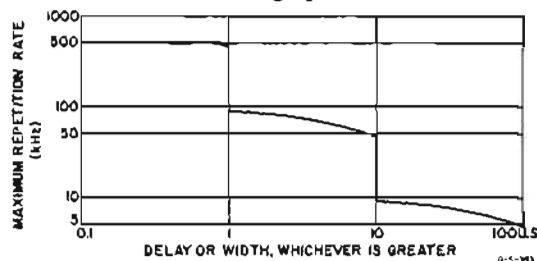

External sync

Amplitude: 5 volts to 20 volts peak.

Waveform: pulse or sine wave.

Polarity: either positive or negative.

Input impedance: approx. 2000 ohms, dc-coupled.

Rate: subject to internal recovery time considerations; see graph.

Trigger out

Sync out: 0.1 to 100 μ s in advance of rf pulse, as set by Delay control (internal pulse mode); simultaneous with rf pulse (internal square wave and external pulse mode).

Delayed sync out: simultaneous with output pulse (internal pulse mode only).

Amplitude: approximately -2 volts.

Source impedance: approximately 330 ohms.

External modulation

Pulse input

Amplitude and polarity: 5 volts to 20 volts peak, either positive or negative.

Repetition rate: maximum average prf, 500 kHz.

Input impedance: approx. 2000 ohms, dc-coupled.

Minimum width: 0.1 μ s.

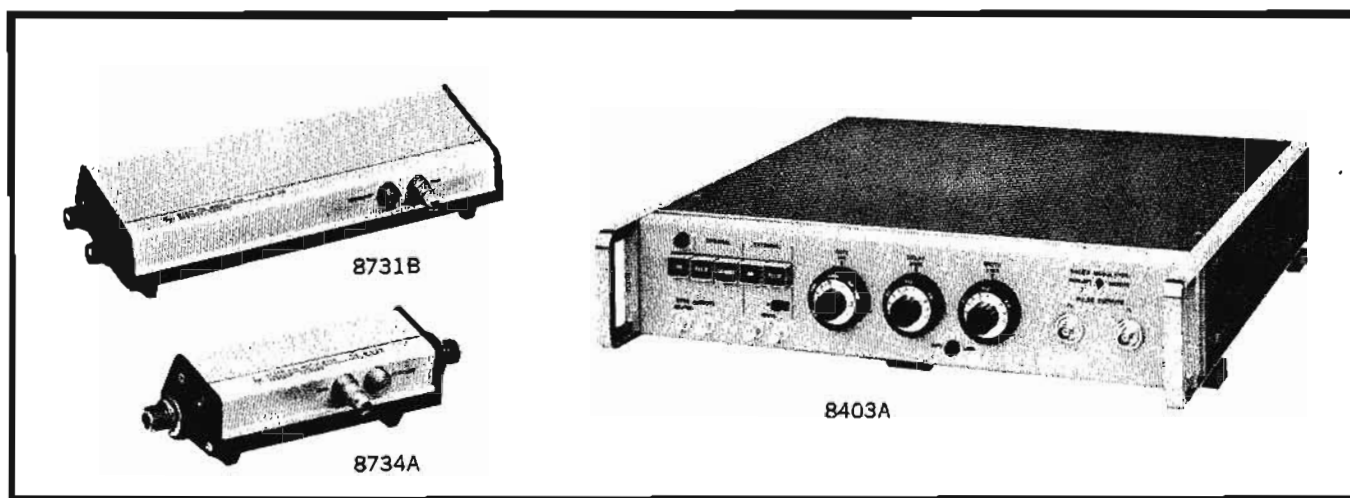

Maximum width: $\frac{1}{\text{prf}} - 0.4 \mu\text{s}$.

Continuous amplitude modulation (with 8730 Series)

Frequency response: dc to approximately 10 MHz (3 dB).

Sensitivity: approximately 10 dB/volt with HP 8730A Series, approximately 20 dB/volt with HP 8730B Series.

Input impedance: approximately 1000 ohms.

Level control: AM input is dc-coupled, permitting control by bias of AM input; rear-panel control for use with ac-coupled modulation.

General

Power: 115 or 230 volts $\pm 10\%$, 50 to 400 Hz, approximately 10 watts.

Dimensions: 16 $\frac{3}{4}$ " wide, 3 $\frac{3}{4}$ " high, 18 $\frac{3}{8}$ " deep (425 x

96 x 467 mm); hardware furnished for conversion to rack mount 19" wide, 3-15/32" high, 16 $\frac{3}{8}$ " deep behind panel (483 x 88 x 416 mm).

Weight: net 16 $\frac{1}{2}$ lbs (7.4 kg); shipping 21 lbs (9.5 kg).
Price: HP 8403A, \$800.

Options

01. HP 8731A PIN Modulator installed, add \$350.
02. HP 8731B PIN Modulator installed, add \$575.
03. HP 8732A PIN Modulator installed, add \$350.
04. HP 8732B PIN Modulator installed, add \$575.
05. HP 8733A PIN Modulator installed, add \$375.
06. HP 8733B PIN Modulator installed, add \$600.
07. HP 8734A PIN Modulator installed, add \$400.
08. HP 8734B PIN Modulator installed, add \$625.
09. Sync output and external modulation input connectors on rear panel in parallel with front-panel connectors; pulse output (or rf input and output) connectors on rear panel only, add \$25.

Specifications, 8730 Series

HP Model	8731A	8731B	8732A	8732B	8733A	8733B	8734A	8734B	8735A	8735B	H01-8731B ⁶
Frequency range (GHz)	0.8-2.4	0.8-2.4	1.8-4.5	1.8-4.5	3.7-8.3	3.7-8.3	7.0-12.4	7.0-12.4	8.2-12.4	8.2-12.4	0.4-0.9
Dynamic range (dB)	35	80	35	80	35	80	35	80	35	80	35
Max. residual atten. (dB) ¹	<1.5	<2.0	<2.0	<3.5 ²	<2.0	<3.0	<4.0	<5.0	<4.0	<5.0	<2.0
Typical rise time (nsec) ³	40	30	40	30	30	30	30	30	30	30	40
Typical decay time (nsec) ³	30	20	30	20	20	20	20	20	20	20	30
SWR, min. attenuation	1.5	1.6	1.5	1.6 ⁴	1.8	2.0	1.8	2.0	1.7	2.0	1.25 ⁷
SWR, max. attenuation	1.8	2.0	1.8	2.0	2.0	2.2	2.0	2.2	2.0	2.2	1.57
Forward bias input resistance (ohms)	300	100	300	100	300	100	300	100	300	100	300
RF connector type	N	N	N	N	N	N	N	N	W/G ⁵	W/G ⁵	N
Weight, net (lbs)	3	5 $\frac{1}{2}$	3	5 $\frac{1}{2}$	2 $\frac{1}{2}$	3 $\frac{1}{2}$	2 $\frac{1}{2}$	3 $\frac{1}{2}$	2 $\frac{1}{2}$	3 $\frac{1}{2}$	5 $\frac{1}{2}$
(kg)	1.4	2.5	1.4	2.5	1.1	1.6	1.1	1.6	1.1	1.6	2.5
shipping (lbs)	5	8	5	8	4	5	4	5	4	5	8
(kg)	2.2	3.6	2.2	3.6	1.8	2.3	1.8	2.3	1.8	2.3	3.6
Dimensions											
Length (in)	11 $\frac{1}{8}$	11 $\frac{1}{8}$	11 $\frac{1}{8}$	11 $\frac{1}{8}$	8 $\frac{3}{8}$	12 $\frac{1}{4}$	8 $\frac{3}{8}$	12 $\frac{1}{4}$	3 $\frac{1}{4}$	10 $\frac{1}{2}$	11 $\frac{1}{8}$
(mm)	283	289	283	289	213	311	213	311	171	267	289
Width (in)	3 $\frac{1}{4}$	4 $\frac{1}{8}$	3 $\frac{1}{4}$	4 $\frac{1}{8}$	3 $\frac{1}{4}$	3 $\frac{1}{4}$	3 $\frac{1}{4}$	3 $\frac{1}{4}$	3 $\frac{1}{4}$	3 $\frac{1}{4}$	4 $\frac{1}{8}$
(mm)	83	124	83	124	83	83	83	83	83	83	124
Height (in)	2 $\frac{1}{4}$	2 $\frac{1}{4}$	2 $\frac{1}{4}$	2 $\frac{1}{4}$	2 $\frac{1}{4}$	2 $\frac{1}{4}$	2 $\frac{1}{4}$	2 $\frac{1}{4}$	2 $\frac{1}{4}$	2 $\frac{1}{4}$	2 $\frac{1}{4}$
(mm)	57	57	57	57	57	57	57	57	57	57	57
Price	\$300	\$525	\$300	\$525	\$325	\$550	\$350	\$575	\$350	\$575	\$525

Maximum ratings: maximum input power, peak or cw: 1W; bias limits: +20 V, -10 V.

Bias polarity: negative voltage increases attenuation.

RFI: radiated leakage limits are below those specified in MIL-I-6181D at input levels less than 1 mW; at all input levels radiated interference is sufficiently low to obtain rated attenuation.

¹With -5 V bias.

²4 dB, 4 to 4.5 GHz.

³Driven by HP 8403A Modulator.

⁴2.0 swr, 4 to 4.5 GHz.

⁵Fits 1 x 1/2 in. (WR90) waveguide.

⁶External high-pass filters required.

⁷Excluding high-pass filters.

MIXERS, MODULATORS, ATTENUATORS



VARIABLE COAXIAL ATTENUATOR

Versatile application to 2 GHz

Models 355C,D, 393A, 394A

355C,D VHF Attenuators

Unique design provides accurate attenuation from dc to 1 GHz with the HP 355C (0 to 12 dB in 1 dB steps) and HP 355D (0 to 120 dB in 10 dB steps). Attenuator sections are inserted and removed by cam-driven microswitches. These sections are adjusted by a time-domain reflectometry system to minimize reflections and assure high accuracy. Insertion loss is low, and using both instruments provides attenuation in 1 dB steps to 132 dB. The units can be connected with either terminal as input or output, and their small size and mounting versatility permit several installation schemes—even within other equipment.

393A, 394A Coaxial Attenuators

Each of these coaxial variable attenuators uses the principle of a directional coupler (see Figure 1) to achieve a wide range of attenuation over a full octave. The HP 393A covers 5 to 120 dB from 500 to 1000 MHz; HP 394A covers 6 to 120 dB from 1 to 2 GHz. With special high-power terminations, they will handle up to 200 watts average.

Since these instruments are variable directional couplers, they are particularly useful for mixing signals while maintaining isolation.

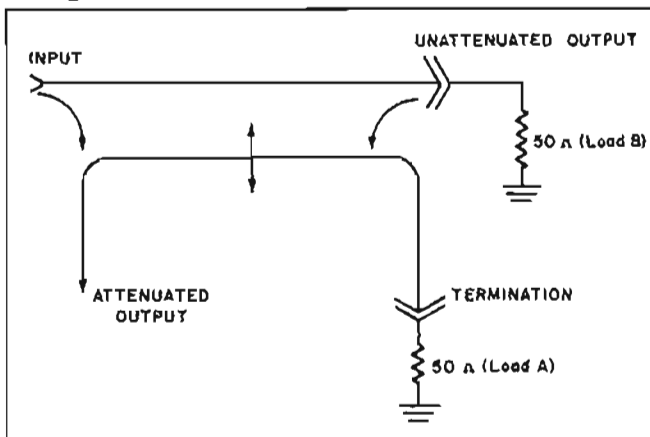
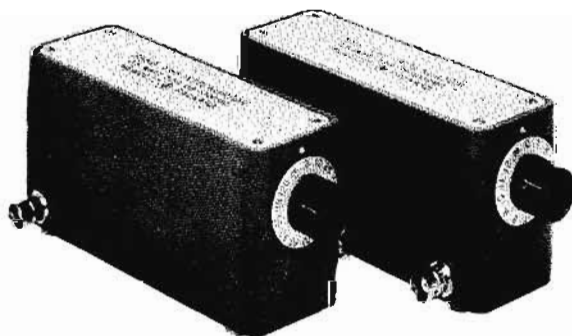

Figure 1. With loads A and B in place the instrument is an attenuator. With load A only, the instrument is a variable directional coupler.

Specifications	355C	355D
Attenuation:	12 dB in 1 dB steps	120 dB in 10 dB steps
Frequency range:	dc to 1 GHz	
Overall accuracy:	± 0.1 dB at 1000 Hz; ± 0.25 dB dc to 500 MHz; ± 0.35 dB dc to 1 GHz	± 0.3 dB to 120 dB at 1000 Hz; ± 1.5 dB to 90 dB below 1 GHz; ± 3 dB to 120 dB below 1 GHz
Impedance:	50 ohms nominal	
Power dissipation:	0.5 watt average, 350 volts peak	
Maximum swr (input and output):	1.2 below 250 MHz; 1.3 below 500 MHz; 1.5 below 1 GHz	
Maximum insertion loss:	0.25 dB at 100 MHz; 0.75 dB to 500 MHz; 1.5 dB to 1 GHz	
Dimensions:	6" long, 2 1/4" wide, 2 5/8" high (152 x 70 x 67 mm)	
Weight:	net 1 1/2 lbs (0.7 kg); shipping 3 lbs (1.4 kg)	
Price:	HP 355C, \$150	HP 355D, \$150

Specifications	393A	394A
Frequency range:	500 MHz to 1 GHz	1 to 2 GHz
Attenuation or coupling:	5 to 120 dB, variable	6 to 120 dB, variable
Directivity (with loads less than 1.05 swr):	typically 10 dB, 10 to 40 dB attenuation	
Absolute accuracy (between matched generator and load):	± 1.25 dB or $\pm 1.75\%$ of dial reading, whichever is greater	± 1.25 dB or $\pm 2.5\%$ of dial reading, whichever is greater
SWR input:	< 2.5, 5 to 15 dB attenuation < 1.5, 15 to 30 dB attenuation < 1.2, 30 to 120 dB attenuation	< 2.5, 6 to 10 dB attenuation < 1.8, 10 to 15 dB attenuation < 1.6, 15 to 120 dB attenuation
SWR output:	< 2.5, 5 to 15 dB attenuation < 1.5, 15 to 30 dB attenuation < 1.4, 30 to 120 dB attenuation	< 2.5, 6 to 10 dB attenuation < 1.8, 10 to 15 dB attenuation < 1.6, 15 to 120 dB attenuation
Impedance:	50 ohms nominal	
Maximum voltage:	500 volts peak	
Average power:	approx. 200 watts maximum; power rating of terminations must be observed (908A, 0.5 watt terminations furnished)	
Dimensions:	5 1/2" wide, 12" long, 2 1/4" deep (140 x 305 x 70 mm)	
Weight:	net 6 lbs (2.7 kg); shipping 13 lbs (5.8 kg)	
Price:	HP 393A, \$525	HP 394A, \$550
Option 01:	supplied without 908A coaxial terminations, less \$70	



355C,D

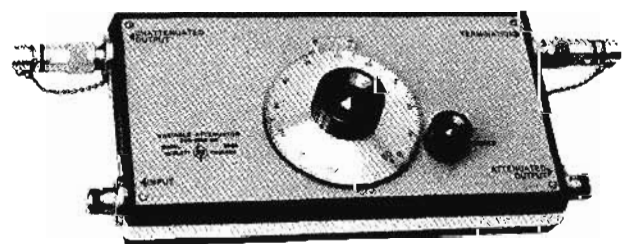

393A

COAXIAL ATTENUATOR SETS

Models 11581A, 11582A, 11583A



**MIXERS, MODULATORS,
ATTENUATORS**



11581A

Attenuator Set

A set of four HP attenuators, 3, 6, 10, and 20 dB, are furnished in a handsome walnut accessory case. In addition to protecting the units when not being used, the case is also a convenient storage place for the attenuator calibration reports provided with the set of four attenuators. These calibration reports include the accuracy of the measurement and are certified traceable to the National Bureau of Standards.

Attenuation calibrations are stamped on the attenuators at dc, 4, 8, and 12 GHz for the 8491A and at dc, 4, 8, 12, and 18 GHz for the 8491B and 8492A. In addition, the calibration report includes both the attenuation and the reflection coefficient at each port of the attenuator at these frequencies. Calibrations at other frequencies are available on request.

Specifications

Accuracy of insertion loss measurements: (S_{21} , S_{12})

DC	± 0.01 dB
0-20 dB	
4 - 12 GHz	± 0.062 dB
18 GHz	± 0.097 dB
Above 20 dB	$\pm 1\%$ of Attenuation

Accuracy of reflection coefficient measurements: (S_{11} , S_{22})

4 - 12 GHz	$\Delta\Gamma_L \leq \pm(0.036 + 0.03\Gamma_L + 0.045\Gamma_L^2)$
12 - 18 GHz	$\Delta\Gamma_L \leq \pm(0.046 + 0.03\Gamma_L + 0.055\Gamma_L^2)$

Prices

Attenuator set:

- 11581A (for 8491B) includes 3, 6, 10, 20 dB values, \$225.
- 11582A (for 8491B) includes 3, 6, 10, 20 dB values, \$285.
- 11583A (for 8492A) includes 3, 6, 10, 20 dB values, \$525.

COAXIAL STEP ATTENUATOR

DC to 12.4 GHz
Model 354A

Specifications

- Frequency range: dc to 12.4 GHz.
- Incremental attenuation: 0 to 60 dB in 10-dB steps.
- Accuracy (Including frequency response): ± 2 dB.
- Residual attenuation: less than 1.5 dB.
- Impedance: 50Ω .
- Reflection coefficient
 - 0 to 8 GHz: less than 0.2 (1.5 swr, 14 dB return loss).
 - 8 to 12.4 GHz: less than 0.273 (1.75 swr, 11.3 dB return loss).
- Maximum power: 2 W average, 300 W peak.
- Connectors: Type N female, stainless steel.
- Dimensions (maximum envelope): 4 in. wide, $3\frac{1}{8}$ in. high, $4\frac{1}{2}$ in. deep (102 x 79 x 114 mm); panel mount, $3\frac{1}{16}$ in. wide, $2\frac{5}{16}$ in. high, $3\frac{3}{4}$ in. deep behind panel (78 x 59 x 95 mm).
- Weight (with base): net $2\frac{3}{4}$ lb (1,2 kg); shipping 4 lbs (1,8 kg).
- Price: Model 354A, \$350.

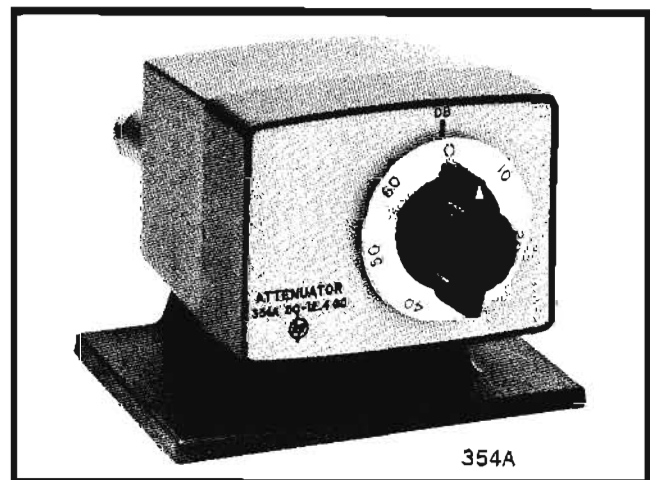

354A

Attenuation 0 to 60 dB
in 10-dB steps

Flat response dc
to 12.4 GHz

Low residual attenuation

Simple knob rotation

**MIXERS, MODULATORS,
ATTENUATORS**



COAXIAL ATTENUATORS

Performance at low cost

Models 8491A,B, 8492A, 8493A,B

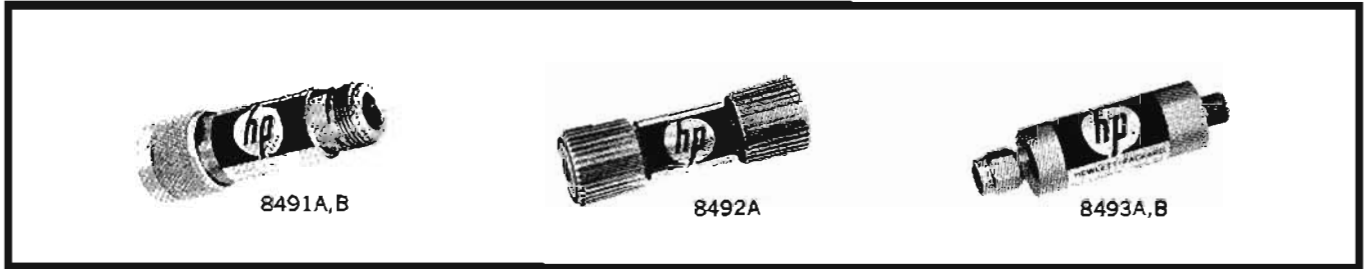

Hewlett-Packard fixed coaxial and step attenuators provide precision attenuation, flat frequency response, and low VSWR attenuators over a frequency range of dc to 18 GHz at low prices. Attenuators are furnished in 3, 6, 10, and 20 dB nominal attenuations by the appropriate option number (e.g., 8492A, Op. 10, is a 10-dB attenuator). Other attenuation values of 30, 40, 50, and 60 dB up to 12.4 GHz are available on request.

In addition to being used for accurate RF substitution measurements of attenuation or return loss, their low prices make these units useful in many other applications. Attenuators are used as isolators to reduce VSWR in order to improve attenuation measurement accuracy, to extend the range of sensitive power meters for higher power measurements, and to reduce power level to sensitive components and instrumentation systems.

Swept frequency tested

Each HP attenuator is swept frequency tested. Swept frequency VSWR testing with an 18 GHz slotted line assures that the attenuator meets specifications at all frequencies in the specified range. Spot frequency testing can easily overlook narrow "resonances" in the band.

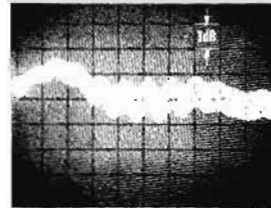

Swept SWR of 8491A. Vertical Scale = 1 dB/cm maximum swr < 1.16 over X-band.

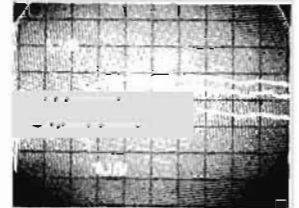

Swept Attenuation of 8491A. Vertical Scale = 0.5 dB/cm response within ±0.1 dB over X-band.

Specifications

Frequency range: 8491A and 8493A, DC to 12.4 GHz; 8491B, 8492A, and 8493B, DC to 18 GHz.

Maximum Input power: 2 W average, 300 W peak.

Calibration frequencies: 8491B, 8492A, and 8493B, 4, 8, 12, 18 GHz; 8491A and 8493A, 4, 8, 12 GHz.

Connectors (50 Ω): 8491A, B, Type N*; 8492A, APC-7**;
8493A, B, OSM®.

Dimensions: 8491A, B, 2-7/16" x 13/16" dia (62 x 21 mm); 8492A, 2 3/4" x 13/16" dia (70 x 21 mm); 8493A, B, 2 1/8" x 9/16" dia (54 x 14 mm).

Weight: 8491A, B, 8492A, 3 1/2 oz (98 g) net; 8493A, B, 1 oz (28 g) net; Shipping weight, 8 oz (220 g) all models.

Attenuation Accuracy	DC-7		7-12.4		DC-12		12-18			
	=0.3 dB		=0.3 dB		=0.3 dB		=0.3 dB			
3 dB	=0.3 dB		=0.4 dB		=0.3 dB		=0.4 dB			
6 dB	=0.5 dB		=0.5 dB		=0.5 dB		=0.5 dB			
10 dB	=0.5 dB		=1 dB		=0.5 dB		=1 dB			
20 dB	DC-7		7-12.4		DC-7		7-12		12-18	
3 dB	1.25		1.35		1.25		1.35		1.5	
6 dB	1.2		1.3		1.2		1.3		1.5	
10 dB	1.2		1.3		1.2		1.3		1.5	
20 dB	1.2		1.3		1.2		1.3		1.5	
Price	8491A : \$50.00		8493A : \$60.00		8491B : \$65.00		8493B : \$75.00		8492A : \$125.00	

VARIABLE ATTENUATORS

Frequency coverage to 40 GHz

Models 382A, B, C and 375A



**MIXERS, MODULATORS,
ATTENUATORS**

Precision Variable Attenuators

Operation of these direct-reading, precision attenuators depends on a mathematical law, rather than on the resistivity of the attenuating material. Accurate attenuation from 0 to 50 dB (0 to 60 dB for S382B,C) is assured regardless of temperature and humidity. The

instruments can handle considerable power and feature large, easily read dials. In addition, the S382B,C achieve both long electrical length and short physical dimensions through dielectric loading. The result is an S-band attenuator which is only 25¼ in. long and yet is more accurate than previously available units.

HP Model	S382B,C	G382A	J382A	H382A	X382A	P382A	K382A*	R382A*
Frequency range (GHz):	2.6-3.95	3.95 - 5.85	5.3 - 8.2	7.05 - 10.0	8.2 - 12.4	12.4 - 18.0	18.0 - 26.5	26.5 - 40.0
Waveguide size (in): (EIA):	3 x 1½ WR284	2 x 1 WR187	1½ x ¾ WR137	1¼ x ¾ WR112	1 x ½ WR90	.702 x .391 WR62	½ x ¼ WR42	.360 x .220 WR28
Power handling capacity, watts, average continuous duty:	10	15	10	10	10	5	2	1
Size length, in. (mm): height, in. (mm): depth, in. (mm):	25¼ (641) 6 (152) 8 (203)	31½ (803) 9⅞ (245) 7¼ (197)	25¼ (638) 7-15/16 (202) 6½ (165)	20 (508) 7-15/16 (202) 6½ (165)	15½ (397) 7⅞ (194) 4-11/16 (119)	12½ (318) 7¼ (197) 4¾ (121)	7¼ (194) 5½ (140) 3¾ (92)	6-7/16 (164) 5½ (140) 3¾ (92)
Weight net, lb (kg): shipping, lb (kg):	18 (8,1) 28 (12,6)	25 (11,3) 32 (14,4)	13 (5,9) 24 (10,8)	10 (4,5) 22 (9,9)	5 (2,3) 8 (3,6)	6 (2,7) 8 (3,6)	4 (1,8) 9 (4,1)	4 (1,8) 9 (4,1)
Price:	\$725 (S382B) \$800 (S382C)	\$500	\$375	\$350	\$275	\$300	\$475	\$500

For all 382A Models

Calibrated attenuation range: 0 to 50 dB (above residual attenuation).

Residual attenuation: less than 1 dB.

Reflection coefficient: less than 0.07 (1.15 swr, 23.1 dB return loss).

Accuracy: ±2% of reading in dB, or 0.1 dB, whichever is greater. Includes calibration and frequency error.

For S382B, C Models

Calibrated attenuation range: 0 to 60 dB (above residual attenuation).

Residual attenuation: less than 1 dB.

Accuracy: ±1% of reading in dB, or 0.1 dB, whichever is greater, from 0 to 50 dB; ±2% of reading above 50 dB; includes calibration and frequency error.

Reflection coefficient: less than 0.091 (1.2 swr, 20.8 dB return loss), 2.6 to 3 GHz; less than 0.07 (1.15 swr, 23.1 dB return loss), 3 to 3.95 GHz.

Degree dial: 0 to 90°; S382B calibrated in 0.1° increments; S382C calibrated in 0.01° increments.

*Circular flange adapters: K-band (UG-425/U) 11515A, \$35 each; R-band (UG-381/U) 11516A, \$40 each.

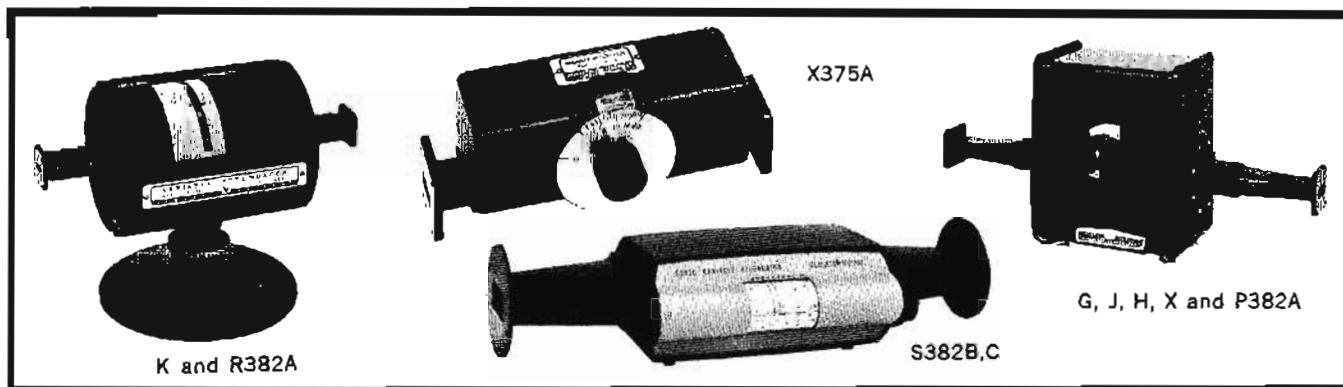

General Purpose Attenuators

Variable flap attenuators provide a simple, convenient means of adjusting waveguide power level or isolating source and load. They consist of a slotted section in which a matched resistive strip is inserted. The degree of strip penetration determines attenuation. A dial shows average reading over the frequency band, and a shielded dust cover reduces external radiation and eliminates hand capacity effects. Attenuation is variable from 0 to 20 dB. Dial calibration is accurate within ±1 dB from 0 to 10 dB, ±2 dB from 10 to 20 dB. Maximum reflection coefficient is 0.07 (1.15 swr, 23.1 dB return loss).

Specifications, 375A

HP Model	Frequency (GHz)	Power dissipation (watts)	Length		Fits waveguide size (in.)	Price
			(in.)	(mm)		
S375A	2.6 - 3.95	2.0	14½	359	3 x 1½	\$250
G375A	3.95 - 5.85	2.0	13	330	2 x 1	\$200
J375A	5.3 - 8.2	2.0	13	330	1½ x ¾	\$175
H375A	7.05 - 10.0	2.0	8¼	210	1¼ x ¾	\$150
X375A	8.2 - 12.4	2.0	7-3/16	183	1 x ½	\$110
P375A	12.4 - 18.0	1.0	7¼	184	.702 x .391	\$135
K375A*	18.0 - 26.5	0.5	4½	114	½ x ¼	\$200
R375A*	26.5 - 40.0	0.5	4¾	111	.360 x .220	\$225

*Circular flange adapters: K-band (UG-425/U) 11515A, \$35 each; R-band (UG-381/U) 11516A, \$40 each.

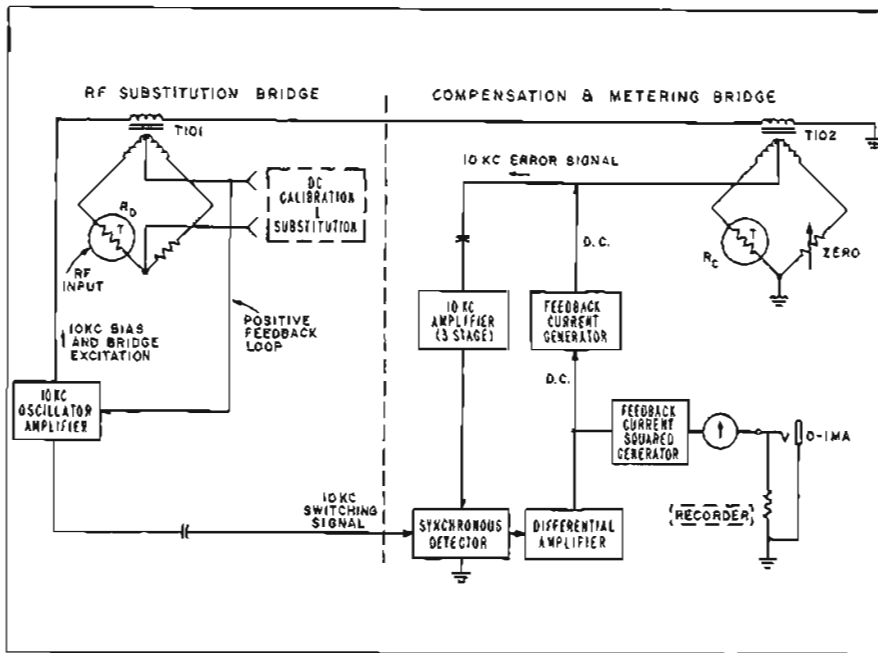

Figure 1. Block diagram of HP 431C Power Meter. Dual bridge provides proper bias to thermistor mount to correct for temperature variation and reduce zero drift.

Power is a basic measurement made at microwave frequencies. Unlike voltage and current levels along a transmission line, microwave power remains constant with position of measurement in a lossless line and can easily be related to circuit performance. (Newly developed instrumentation for convenient measurement of phase, gain, and impedance at microwave frequencies is also available. See page 245.)

Bolometric power meters

Below 10 milliwatts, power is usually measured with bolometers (temperature-sensitive resistive elements) in conjunction with a balanced bridge. There are two general types of bolometers: thermistors, whose resistance decreases with temperature (negative temperature coefficient), and barretters which have a positive temperature coefficient. Thermistors are mostly commonly used because they are more rugged, both physically and electrically, than barretters. These bolometer elements are mounted in devices that present an impedance match to microwave transmission lines, either coaxial or waveguide. Such devices are appropriately termed bolometer mounts and allow a "bias" connection to the bolometer element, as well as a proper entry point for rf. The bolometer is connected as one leg of a Wheatstone bridge (or modification thereof) through the

bias connection, and bridge excitation is applied. The dc or ac bridge excitation biases the bolometer element to balance the bridge. When the unknown microwave power is applied to the bolometer, the resulting temperature rise causes the element's resistance to change, unbalancing the bridge. Withdrawing a like amount of bias power from the element rebalances the bridge. The amount of bias removed can be displayed on a meter.

Automatic bolometer bridges

There are a number of bolometer bridge designs which provide various degrees of accuracy, speed, and convenience.

The Hewlett-Packard Model 431C Power Meter is a temperature-compensated, automatically balanced thermistor bridge of versatile design. Operating with any of the HP temperature-compensated thermistor mounts, the 431C automatically maintains bridge balance and reads substituted bias power to a basic accuracy of $\pm 1\%$ of full scale. The 431C power ranges of 10 microwatts to 10 milliwatts (full scale) encompass virtually all levels involved in small signal microwave power measurement.

Since all bolometer elements are temperature-sensing devices, they are unable to distinguish between applied power level changes and environmental tem-

perature changes. As bolometer bridge sensitivity is increased, even minute temperature variations can unbalance the bridge. The result, if uncompensated, is "zero drift" of the power meter and erroneous power measurements.

A dual bridge arrangement, as shown in Figure 1, is used in the 431C to compensate for variations in temperature at the thermistor mount. The thermistor mounts used with the 431C have two thermistor elements. The two are in close thermal proximity and are affected equally by changes in ambient temperature. Thus R_D responds to both ambient temperature and applied RF power; R_C , isolated from the RF power, responds only to ambient temperature. Each element is connected to its own bridge circuit in the power meter, which automatically controls bias power. This arrangement compensates for temperature changes, thus reducing zero drift in the 431C by a factor of 100 over uncompensated meters. Another advantage of the 431C design is that when zeroed on the most sensitive range, the meter may be switched to any other power range without re-zeroing (zero-carryover is within 1% on all ranges). A dc output proportional to the meter deflection is available for recording purposes or control of external circuits such as power meter leveling of microwave sweep oscillators and signal generators.

Thermistor mounts designed specifically for the 431C include the 478A and 8478B Coaxial Mounts and 486A Waveguide Series. The coaxial unit operates from 10 MHz to 10 GHz; the waveguide units collectively cover waveguide bands from 2.6 to 40 GHz. All mounts present low swr over their frequency ranges without tuning.

Non-temperature-compensated bridges

The HP Model 430C Power Meter operates with a number of non-temperature-compensated barretter or thermistor mounts such as the HP 477B Coaxial and 487 Waveguide Series. The 478A, 8478B, and 486A Thermistor Mounts also can be operated in a non-temperature-compensated mode with the 430C using the 11528A Adapter. This permits utilization of the 430C Power Meter in waveguide bands not covered by the 487 series of mounts. Accuracy of the 430C in measuring substituted power is $\pm 5\%$ of full scale.

Calorimetric power meters

Bolometer elements cannot be used for direct power measurement at levels above 10 to 50 milliwatts because of their physical size. Calibrated directional couplers or attenuators are sometimes used to reduce the power level to the bolometer's range; however, this also reduces overall accuracy because of the additional tolerances on coupling factor or attenuator calibration. Where better accuracy is desired, calorimetric techniques provide a more useful result.

Calorimetric power meters dissipate the unknown power in a resistive termination that is matched to the transmission line or source impedance. The temperature rise caused by the power dissipation is then measured by a temperature sensor which is calibrated against known amounts of dc power. Calorimetric power meters fall into two categories—dry and fluid. Dry calorimeters depend upon a static thermal path between the dissipative load and the temperature sensor. This arrangement often requires several minutes for the termination and sensor to reach equilibrium, making measurements time-consuming and too sluggish for tuning circuit parameters for optimum output.

Fluid calorimeters such as the HP 434A utilize a moving stream of oil to transfer heat quickly to the sensing element. An amplifier-feedback arrangement, in conjunction with the series oil flow system as shown in Figure 2, reduces measurement time in the 434A to less than 5 seconds for full-scale response. The physical size of the termination and the flow rate of liquid passing over the termination are primary factors which determine the maximum power that may be dissipated by a fluid calorimeter. The HP 434A covers the important range of 10 mW to 10 watts.

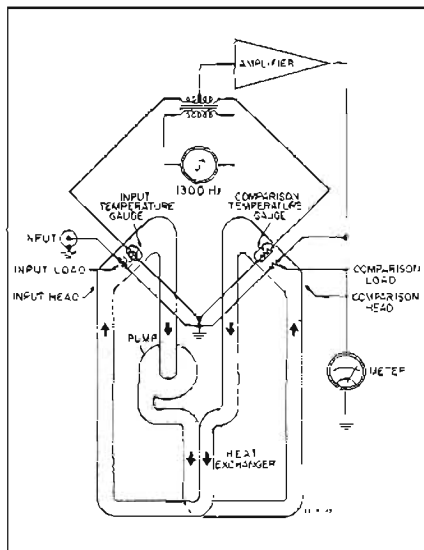

Figure 2. Simplified diagram of HP 434A Calorimetric Power Meter, showing oil flow path.

Peak power measurement

A frequent requirement in microwave work is the measurement of peak power in a periodic pulse. This may be done by various indirect techniques using bolometers or calorimeters. Hewlett-Packard produces a versatile instrument that conveniently measures peak power directly in the 50 MHz to 2 GHz region. This instrument (the 8900B) utilizes a video comparator technique to bring a known dc voltage, supplied by the 8900B, in a known impedance to a level which is equal to the pulse being measured. This allows simple measurements of peak pulse power with a basic accuracy of 1.5 dB even when the waveform is not rectangular. A custom calibration chart increases accuracy to 0.6 dB for critical applications.

Application Note 64

Complete information on the theory and operation of bolometers and bridges, along with other types of power meters, is included in a comprehensive application note available from Hewlett-Packard. Application Note 64 contains up-to-date information on virtually all aspects of microwave power measurement, including detailed descriptions and illustrations of instruments, techniques, error analysis and applications. Sources of measurement error and systematic methods for error-reduction allow selection of the best procedure for a specific application. Application Note 64, entitled "Microwave Power Measurement", is available on request through your HP sales office.

Steps toward better accuracy

The fundamental standards of microwave power lie in dc or low-frequency ac voltage and resistance standards which may be accurately measured and used for comparison or substitution. Other factors, such as impedance matching and efficiency of the sensing device, play an important role in the overall measurement accuracy.

The basic accuracy of HP power measuring equipment satisfies the requirements of most applications without complicated set-ups requiring extensive manual operations and calculation. Should greater accuracy be required, the versatility and stability of HP equipment allows easy enhancement of its basic accuracy in a step-by-step manner until the degree of accuracy needed is achieved.

Tuners: Certainly one of the most important steps for higher accuracy is the elimination of mismatch loss with a tuner. Hewlett-Packard bolometer mounts and calorimeter input systems are designed and tested for good broadband impedance match (low swr) to common microwave transmission lines. However, source swr must also be considered in any power measurement, and

the combination of source and load swr can produce serious mismatch errors. To eliminate mismatch error, HP 870A Waveguide Series or 872A Coaxial Slide-screw Tuners may be used ahead of the bolometer or calorimeter input.

Effective Efficiency and Calibration Factor: A bolometric power meter can only measure power that is absorbed by the bolometer element, not that which is dissipated elsewhere in the mount or reflected by the mount (swr). Furthermore, the spatial distribution of current and resistance within the element is slightly different for microwave frequencies and the dc (or low-frequency ac) which is actually measured by the meter. The effects of these sources of error are measured at certain frequencies during the manufacture of the Models 478A and 486A mounts and presented on their nameplates as Calibration Factor and Effective Efficiency. Calibration Factor is the ratio of substituted bias power in the power meter to the microwave power incident on the mount. Effective Efficiency is the ratio of substituted bias power in the power meter to the microwave power absorbed by the mount. Although direct traceability to NBS (National Bureau of Standards) is not yet available in certain bands, the extensive tests and cross-checks conducted by HP on literally thousands of mounts assure a uniformly high level of efficiency in all mounts. (The HP E51-8690 Series of power calibration systems provides these data in either coax or waveguide—see page 410). In addition, the mounts are swept-frequency tested, so the effects of even sharp resonances on efficiency are revealed and eliminated.

Instrumentation: HP 431C power meters provide a basic accuracy of $\pm 1\%$ in substituted power to the thermistor. A dc input on the rear panel allows external dc substitution for increased accuracy when required. The HP 8402B Power Meter Calibrator may be connected to the dc substitution jack on the 431C to reduce instrumentation error to $\pm 0.16\%$. The DVM output of the HP 431C allows connection of a digital voltmeter (such as the HP 3440A, pages 228-229) for high precision readout of power.

The 434A Calorimetric Power Meter basic accuracy is $\pm 5\%$ of full scale, which includes both instrumentation error and efficiency. The built-in calibration source provides a 0.1 watt dc check point accurate to 1% for convenient verification of the 434A calibration. Instrumentation uncertainty can be substantially reduced by calibrating the 434A on the range to be used with an external dc test set. The HP K02-434A dc Test Set provides calibration power levels in convenient steps from 2 mW to 10 W, accurate to $\pm 0.5\%$ of output.



METER; THERMISTOR MOUNTS

Accurate power measurements, 10 MHz to 40 GHz
Models 431C, 478A, 486A, 8478B

The Model 431C Power Meter, together with its companion 478A, 8478B, and 486A Thermistor Mounts, enables you to make even routine microwave power measurements with standards-lab accuracy. You have complete confidence in the accuracy of your measurements because all sources of error are taken into consideration. Thermistor mount efficiency, stated as both Effective Efficiency and Calibration Factor,* is furnished with each Thermistor Mount, and the 431C itself affords high instrumentation accuracy (better than 1% of full scale on most ranges)—thus the characteristics of the measurement system are known from thermistor mount input to power meter readout.

Thermistor mount efficiency plays a very significant role in determining overall measurement accuracy, and the 431C provides real convenience for utilization of the efficiency data imprinted on each mount. The 431C contains a front panel Calibration Factor control, calibrated in 1% steps from 100% to 88%, which normalizes the meter reading to account for the efficiency correction factor of the mount. Simply set the control and read the meter; no calculations are required.

The 431C provides full scale readings from 10 microwatts to 10 milliwatts in seven ranges; range switching is in 5-dB steps. The meter movement is calibrated in milliwatts and dBm. The accuracy of the 431C is maintained even in the presence of high intensity fields, for the instrument exhibits very low rf susceptibility. In fact, the 431C surpasses all the requirements of MIL-I-6181D.

Two self-balancing bridges (of which the thermistor mount forms a part) are used in the power measuring system of the 431C. One bridge senses the rf power; the other corrects the meter reading for ambient temperature changes. The result is very high stability, eliminating the need to continually check and reset the zero adjustment. In addition, a single zero adjustment holds for all ranges, simplifying measurements where it is inconvenient to turn off the power source during range changes.

Provision is also incorporated in the 431C for further refinement of instrument accuracy and resolution. A Voltmeter Output allows use of appropriate digital or differential dc voltmeter for increased resolution of the meter indication. In addition, a dc calibration input jack permits precise dc calibration of the instrument and thermistor mount (see HP 8402B, page 410).

Specifications, 431C

Instrument type: automatic, self-balancing power meter for use with temperature-compensated thermistor mounts.

Power range: 7 ranges with full-scale readings of 10, 30, 100, and 300 μ W, 1, 3, and 10 mW; also calibrated in dBm from -20 dBm to +10 dBm full scale in 5-dB steps.

Accuracy: +20°C to +35°C: $\pm 1\%$ of full scale (100 μ W range and above); $\pm 1.5\%$ of full scale (30 μ W range); $\pm 2\%$ of full scale (10 μ W range).
0°C to +55°C: $\pm 3\%$ of full scale on all ranges.

*Calibration Factor and Effective Efficiency: "Figures of merit" that express the ratio of the substituted audio signal measured by the power meter to the microwave power incident on and absorbed by the mount, respectively.

Calibration factor control: 13 position switch normalizes meter reading to account for thermistor mount Calibration Factor (or Effective Efficiency). Range: 100% to 88% in 1% steps.

Thermistor mount: external temperature-compensated thermistor mounts required for operation.

Meter movement: taut-band suspension, individually calibrated mirror-backed scales; milliwatt scale greater than 4¼ in. (108 mm) long.

Zero carryover: less than 1% of full scale when zeroed on most sensitive range.

Zero balance: continuous control about zero point; range below zero is equivalent to at least 2% of full scale.

DVM output: 1.000 V into open circuit corresponds to full-scale meter deflection (1.0 on 0-1 scale) $\pm 0.5\%$; 1 k Ω output impedance, BNC female connector; effect of loading impedance less than 10 M Ω must be accounted for.

Recorder/leveler output: with load impedance of 600 Ω or more, output is approximately 1 V dc at full scale meter deflection; BNC female connector.

Calibration input: binding posts for calibration of bridge with HP 8402B Power Meter Calibrator or precise dc standards.

Power: 115 or 230 V $\pm 10\%$, 50 to 400 Hz, 2½ W; optional rechargeable battery provides up to 24 hours continuous operation.

RFI: meets all conditions specified in MIL-I-6181D.

Dimensions: 7¼ in. wide, 6½ in. high, 11 in. deep from panel (197 x 165 x 279).

Weight: net, 9 lbs (4.1 kg), 12 lbs (5.4 kg) with battery; shipping, 11 lbs (5 kg), 14 lbs (6.3 kg) with battery.

Furnished: 5-ft (1520 mm) cable for HP temperature compensated thermistor mounts; 7½ ft. (2290 mm) power cable, NEMA plug.

Available: 00415-606 Rechargeable Battery Pack for field installation, \$100.

Price: Model 431C, \$475.

Options:

01. Rechargeable battery installed, provides up to 24 hours continuous operation, add \$100.
02. Rear input connector wired in parallel with front panel input connector, add \$15.
09. With 10-foot (3050 mm) cable for 100 Ω or 200 Ω mount, add \$25.
10. With 20-foot (6100 mm) cable for 100 Ω or 200 Ω mount, add \$50.
11. With 50-foot (15240 mm) cable for 100 Ω mount, add \$100.
12. With 100-foot (30480 mm) cable for 100 Ω mount, add \$150.
13. With 200-foot (60960 mm) cable for 100 Ω mount, add \$250.
21. With 50-foot (15240 mm) cable for 200 Ω mount, add \$100.
22. With 100-foot (30480 mm) cable for 200 Ω mount, add \$150.
23. With 200-foot (60960 mm) cable for 478A and K, R486A mounts, add \$250.
24. With 200-foot (60960 mm) cable for 8478B mount, add \$250.

478A, 8478B, and 486A Thermistor Mounts

These thermistor mounts are designed for use with HP 431C Power Meter. Each is supplied with Calibration Factor and Effective Efficiency Data, permitting power measurements to be made with absolute accuracy. The data, provided at several points across each band, are traceable to the National Bureau of Standards to the extent allowed by the Bureau's facilities. Thus, mount losses and reflections (that part of the incident power which does not reach the power-sensing thermistor) can be accounted for under all measurement conditions.

The calibration data at points not yet on the NBS schedule are based on interim standards established at Hewlett-Packard after years of designing, manufacturing, and testing thermistor mounts. Literally thousands of tests and measurements have gone into the development of these standards, including cross-checks against NBS-calibrated mounts wherever possible. Thus efficiency data are provided at many points in addition to those on the NBS schedule to facilitate interpolation and help you to make more accurate power measurements more easily. For easy access, these data are affixed directly to each mount.

Both Calibration Factor and Effective Efficiency Data are furnished to provide complete measurement flexibility. Calibration Factor is used as the correction factor for general applications when a tuner is not used; Effective Efficiency is used whenever a tuner is part of the measurement system.

These mounts are temperature compensated for low drift, permitting measurement of microwave power as low as one microwatt. In addition, the 8478B features a balanced thermistor circuit when operated with the 431C. Thus, the 431C can be zeroed with the mount disconnected from the rf system if the rf power cannot be turned off; and the 10-kHz thermistor bias signal is reduced to less than 0.5 mV into 50 ohms, permitting measurements in extremely sensitive systems.

Models 478A, and 8478B are designed for 50-ohm coaxial systems. They operate over frequencies from 10 MHz to 10

and 18 GHz respectively. Each presents a good 50-ohm match over its frequency range, and no tuning is required. The 478A is furnished with a type N rf connector; the 8478B, with type N or, as option 11, with APC-7.

Model 486A mounts are designed for 2.6 to 40 GHz waveguide systems. Each mount provides a good match over its waveguide range; no tuning is required.

The subject of power measurements is covered in detail in Hewlett-Packard Application Note 64., "Microwave Power Measurement." This comprehensive Note discusses principles of operation, techniques of measurement, interpretation of results, and accuracy considerations. Application Note 64 is available upon request from any Hewlett-Packard Field Office.

Specifications

HP Model ¹	Frequency range, GHz	Maximum swr	Operating resistance (ohms)	Price
478A	10 MHz to 10 GHz	1.75, 10 to 25 MHz 1.3, 25 MHz to 7 GHz 1.5, 10 to 10 GHz	200	\$155
8478B ²	10 MHz to 18 GHz	1.75, 10 to 30 MHz 1.35, 30 to 100 MHz 1.1, 0.1 to 1 GHz 1.35, 1 to 12.4 GHz 1.6, 12.4 to 18 GHz	200	\$275 ⁴
S486A	2.60 to 3.95	1.35	100	\$195
G486A	3.95 to 5.85	1.5	100	\$180
J486A	5.30 to 8.20	1.5	100	\$170
H486A	7.05 to 10.0	1.5	100	\$165
X486A	8.20 to 12.4	1.5	100	\$145
M486A	10.0 to 15.0	1.5	100	\$225
P486A	12.4 to 18.0	1.5	100	\$195
K486A ³	18.0 to 26.5	2.0	200	\$300
R486A ³	26.5 to 40.0	2.0	200	\$375

¹ 11528A Adapter adapts mounts to 430 Series Power Meter (thermistor circuit unbalanced, no temperature compensation), \$10.

² 11527A Adapter adapts 8478B to 431A/B Power Meters (thermistor circuit unbalanced), \$25.

³ Circular flange adapters: K-band (UG-425/U) HP 11515A, \$35 each; R-band UG-381/U) HP 11516A, \$40 each.

⁴ Option 11, furnished with APC-7 rf connector, add \$25.

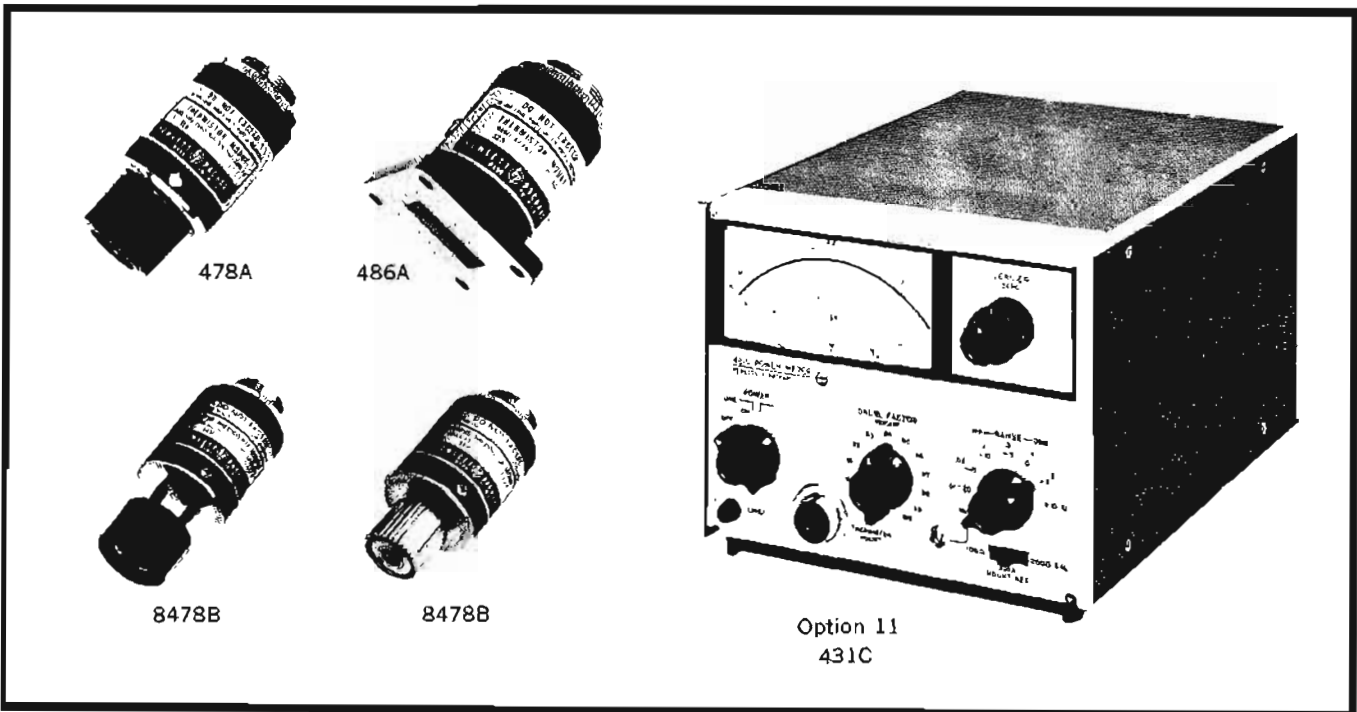

POWER

METER, MOUNT CALIBRATORS

Increase power measurement accuracy

Model 8402B; E31-8690A systems

8402B Power Meter Calibrator

Full-scale calibration and meter tracking of HP 431 Power Meters can be verified with the 8402B. In addition, the Power Meter Calibrator can be used to determine operating resistance of the thermistors in the thermistor mount used with a particular 431 and to improve on the basic accuracy of the 431 Power Meter with the dc substitution technique.

Specifications, 8402B

Calibration function

Calibration points: output currents corresponding to 0.01, 0.03, 0.1, 0.3, 1.0, 3.0, 10.0, 30.0, 60.0, 4.0, and 2.0 mW.

Calibration current uncertainty: $\pm 0.05\%$, +20 to +30°C; $\pm 0.2\%$, 0 to +55°C.

Power meter calibration uncertainty: 2 x current uncertainty + thermistor operating resistance uncertainty ($\pm 0.16\%$, +20 to +30°C; $\pm 0.46\%$, 0 to +55°C).

Thermistor operating resistance function

Resistance center values: 100 and 200 ohms.

Range: $\pm 0.5\%$ about center values in 0.1% steps.

Uncertainty: $\pm 0.06\%$.

DC substitution function

Range: 1 μ W to 10 mW (precision differential or digital voltmeter required—voltmeter input resistance ≥ 10 megohms required for negligible loading effect).

Uncertainty: $\pm [(0.06\%) + (\text{thermistor operating resistance uncertainty}) + (2 \times \text{voltmeter uncertainty})]$, 0 to +55°C.

General

RFI: meets all conditions specified in MIL-I-6181D.

Power: 115 or 230 V $\pm 10\%$, 50 to 400 Hz, approximately 3 W.

Dimensions: 7 $\frac{3}{4}$ " wide, 6 $\frac{1}{2}$ " high, 11" deep from panel (197 x 165 x 279 mm).

Weight: net 6 $\frac{1}{2}$ lbs (2.9 kg); shipping 9 lbs (4.1 kg).

Price: HP 8402B, \$475.

Thermistor mount calibration systems

For accurate power measurements, thermistor mount elements used with power meter bridges must be calibrated for either Effective Efficiency or Calibration Factor. Hewlett-Packard offers a series of systems which make such measurements possible on a swept or stepped frequency basis with high transfer accuracy. The system is furnished with one or more thermistor mounts which are calibrated by the HP Standards Laboratory at six frequencies across the band of interest. Traceability to NBS is furnished wherever currently available. Calibration is achieved by normalizing the readout device to the reference mount so that the readout is directly in percentage Calibration Factor or Effective Efficiency. Two types of readout are available: a digital voltmeter which is programed to display values at the six calibrated frequencies, and an X-Y recorder which gives a continuous presentation across the band. Mounts thus calibrated can then be used to advantage with the HP 431C which has a front-panel control to normalize the meter reading to account for the correction factor of the mount.

The Power Calibration System consists of two subsystems. One is the frequency-independent E31-8690A. The other is one or more of the E30-8691B through E31-8697A frequency-dependent subsystem. A total of twelve frequency-dependent subsystems are available which collectively cover the range from 1 to 40 GHz. For further information, contact the nearest Hewlett-Packard Sales Office.

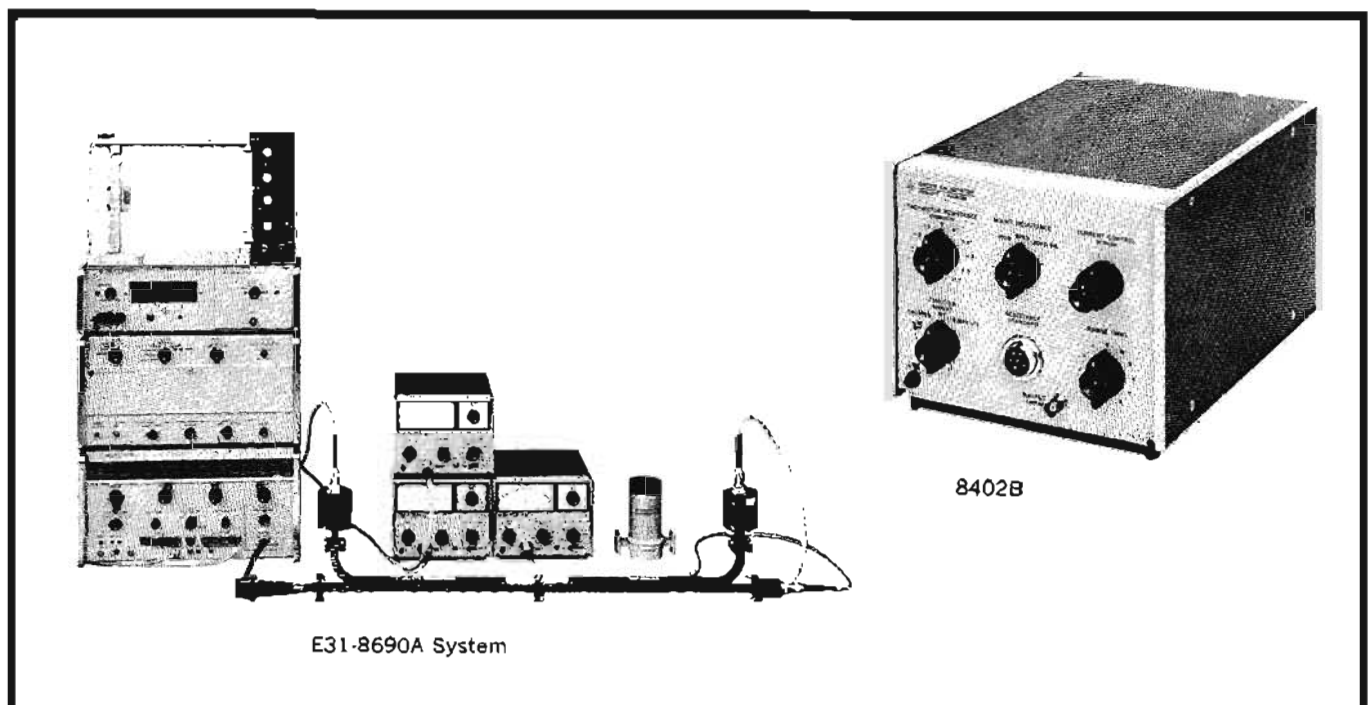

E31-8690A System

8402B

MICROWAVE POWER METER

Reads directly in mW and dBm, 0.01 to 10mW
Models 430C; 477B, 487 Thermistor Mounts



POWER

The HP 430C reads rf power directly in dBm or mW—and completely eliminates tedious computation and troublesome adjustments during operation. The instrument may be used at any frequency for which there are bolometer mounts—and measurements are entirely automatic.

In measuring power, HP 430C uses a bolometer at either 100- or 200-ohm levels. Power is read directly in milliwatts, 0.01 to 10 mW, or in dBm from -20 to +10. Higher powers may be measured by adding attenuators to the system. Directional couplers also may be used to sample energy.

When used in an appropriate bolometer mount, instrument fuses are generally satisfactory for measuring power at frequencies up to 4 GHz. Barretters and thermistors can be used for measurements at much higher frequencies, up to 12.4 GHz for barretters (in HP mounts) and up to 40 GHz for certain thermistors.

Hewlett-Packard waveguide bolometer mounts for the 430C are available covering, collectively, the frequency spectrum from 2.6 to 40 GHz. In addition, Model 477B Thermistor Mount covers the frequency spectrum from 10 MHz to 10 GHz.

Specifications, 430C

Power range: 5 ranges, front-panel selector; full-scale readings of 0.1, 0.3, 1, 3, and 10 mW; also continuous readings from -20 to +10 dBm.

External bolometer: frequency range depends on bolometer mount; bolometers can operate at resistance levels of 100 or 200 ohms and can have positive or negative temperature coefficients; any dc bias current up to 16 mA is available for biasing bolometers; dc bias current is continuously adjustable and independent of bolometer resistance and power level range.

Accuracy: $\pm 5\%$ of full scale.

Power: 115 or 235 V $\pm 10\%$, 50 to 400 Hz, 90 W.

Dimensions: cabinet: 7 $\frac{1}{2}$ " wide, 11 $\frac{1}{2}$ " high, 14 $\frac{1}{4}$ " deep (191 x 292 x 362 mm); rack mount: 19" wide, 7" high, 13 $\frac{1}{8}$ " deep behind panel (483 x 178 x 333 mm).

Weight: net 14 lbs (6.3 kg), shipping 16 lbs (7.2 kg) (cabinet); net 18 lbs (8.1 kg); shipping 27 lbs (12.2 kg) (rack mount).

Accessory Available: 11528A Adapter, adapts HP 478A, 486A, 8478B Thermistor Mounts for use with 430C, \$10.

Price: HP 430C, \$295 (cabinet); HP 430CR, \$300 (rack mount).

477B Thermistor Mount

This coaxial thermistor mount, designed for use in 50-ohm systems with the HP 430C, covers 10 MHz to 10 GHz with an swr of less than 1.5. It requires no tuning and employs long-time-constant elements that assure measurement accuracy—even for low duty cycle pulses. In addition, it is not susceptible to burnout even at 1 watt peak.

Specifications, 477B

Frequency range: 10 MHz to 10 GHz.

Reflection Coefficient: full range, < 0.2 (1.5 swr, 14 dB return loss); 50 MHz to 7 GHz, < 0.13 (1.3 swr, 17.7 dB return loss).

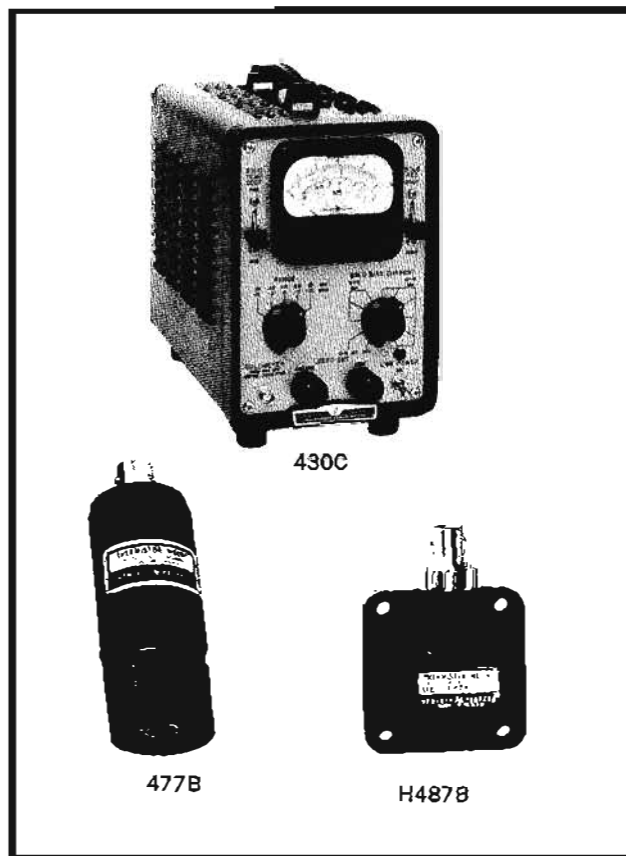

Power range: 0.01 to 10 mW (with HP 430C).

Element: 200-ohm, negative temperature coefficient thermistor included; approx. 13 mA bias required.

RF connector: Type N male.

Price: HP 477B, \$75.

HP Model	Maximum swr	Frequency range* GHz	Price
J487B	1.5	5.3 - 8.2	\$ 90
H487B	1.5	7.05 - 10.0	\$ 80
X487B	1.5	8.2 - 12.4	\$ 75
P487B	1.5	12.4 - 18.0	\$110

*HP 486A Waveguide Thermistor Mounts are available in S- through R-band (2.6 to 40 GHz); 11528A Adapter required.



PEAK POWER CALIBRATOR

Power measurements, 50 to 2000 MHz, to ± 0.6 dB
Model 8900B

Features

- Measures true peak power ± 0.6 dB absolute
- Measurement completely independent of repetition rate and pulse width ($> 0.25 \mu\text{sec}$)
- Readily standardized against external bolometer or calorimeter
- Incorporates wide-band (7 MHz) detector output for pulse monitoring

The HP 8900B Peak Power Calibrator provides a convenient means for measuring the peak RF power of pulses in the range from 50 to 2000 MHz. The power level is read out directly on the panel meter and is completely independent of repetition rate and pulse width ($> 0.25 \mu\text{sec}$). The instrument consists basically of a precision terminated input circuit, diode detector, dc reference supply, meter and a chopped video output system.

In operation, the RF signal is applied to the input circuit, which, through a power splitter, feeds the diode detector. The demodulated diode output and the output of the dc reference supply are simultaneously fed to the video output through a mechanical chopper. In making a measurement, a suitable external oscilloscope is connected to the video output, and the dc reference voltage is adjusted so that it is exactly equal to the peak value of the demodulated pulse.

Panel meter readout

The level of the required dc reference voltage is then indicated on the panel meter, calibrated to read peak RF power. The diode is operated in a biased condition for

maximum stability of calibration. Provision is made, however, for readily standardizing the instrument against an external bolometer or calorimeter by simply connecting to a rear-panel output in place of a standard termination.

Specifications

Radio frequency measurement characteristics

RF range: 50 to 2000 MHz.

RF power range: 200 mW peak full scale (may be readily increased through use of external attenuators or directional couplers).

RF power accuracy: ± 1.5 dB (± 0.6 dB with custom calibration curve).

RF power precision: 0.1 dB.

RF pulse width: $> 0.25 \mu\text{s}$.

RF repetition rate: 1.5 MHz maximum.

RF impedance: 50 ohms.

RF vswr: < 1.25 .

Monitor output

Level: > 0.2 volt for 20 mW input (nominal).

Impedance: 150 ohms nominal.

Bandwidth: > 7 MHz.

Physical characteristics

Dimensions: $7\frac{3}{4}$ " wide, $6\frac{1}{8}$ " high, 11" deep (197 x 156 x 279 mm).

Weight: net 10 lbs (4.5 kg); shipping 13 lbs (5.9 kg).

Power: 105 to 125 or 210 to 250 volts, 50 to 60 Hz.

Price: HP 8900B, \$625.

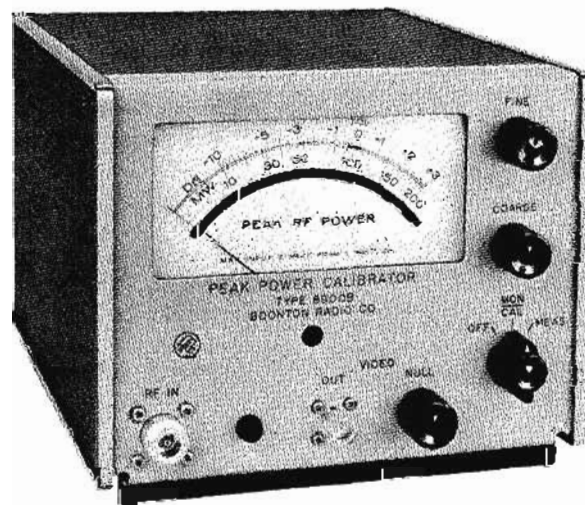

8900B

CALORIMETRIC POWER METER

Just connect, read power 10 mW to 10 watts
Model 434A



POWER

With the 434A, measurement is literally as simple as connecting to a 50-ohm Type N front-panel terminal and reading power directly. The instrument has only two simple front-panel controls and is ideal for use by non-technical personnel.

Model 434A fills the important range between bolometer-type microwave power meters such as HP 431C and conventional calorimeters whose lower range is approximately 10 watts. But, unlike previous cumbersome and costly equipment suggested for its range, the HP 434A is completely self-contained and requires no external detectors. In addition, the wider frequency response permits the unit to be conveniently calibrated by the application of a known dc power.

Rapid response time

Model 434A employs a self-balancing bridge and a high-efficiency heat transfer system to and from an oil stream to provide a full-scale response time of 5 seconds or less. This fast reaction, a fraction of the response time needed by ordinary calorimeters, means the 434A quickly follows small power changes, such as may be encountered in tuning.

Basically, the Model 434A consists of a self-balancing bridge which has identical temperature-sensitive resistors (gauges) in

two legs, an indicating meter and two load resistors, one for the unknown input power and one for the comparison power. The input load resistor and one gauge are in close thermal proximity so that heat generated in the input load resistor heats the gauge and unbalances the bridge. The unbalance signal is amplified and applied to the comparison load resistor which is in close thermal proximity to the other gauge so that the heat generated in the comparison load resistor is transferred to its gauge and nearly rebalances the bridge.

The meter measures the power supplied to the comparison load to rebalance the bridge. The characteristics of the gauges are the same, and the heat transfer characteristics from each load are the same, so the power dissipated in each load is the same, and the meter may be calibrated directly in input power.

The power measurement is accurate because the flow rates through the two heads are the same and the oil enters the heads at nearly the same temperature. To insure constant temperature and to bring the streams to nearly the same temperature, they are passed through a parallel-flow heat exchanger just prior to entering the heads. Identical flow rates are obtained by placing all elements of the oil system in series.

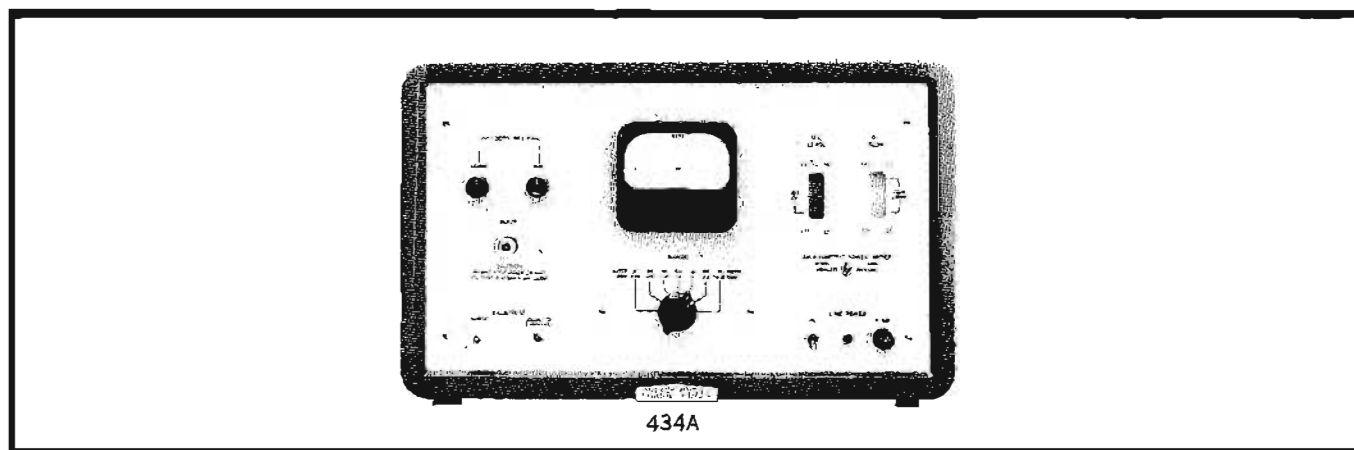

Specifications

Input power range: seven meter ranges; full-scale readings of 0.01, 0.03, 0.1, 0.3, 1, 3 and 10 watts; meter scale also calibrated from -10 to 0 dBW, providing continuous readings from -30 to $+10$ dBW; power range can be extended upward with attenuators or directional couplers.

Maximum input power: 1 kW peak; 10 watts average.

Frequency range: dc to 12.4 GHz.

Accuracy: within $\pm 5\%$ of full scale; includes dc calibration and rf termination efficiency but not mismatch loss; greater accuracy can be achieved through appropriate techniques.

Estimated attainable accuracy

	Upper ranges	Two lowest ranges
DC	0.5%	2%
0 to 1 GHz	1%	3%
1 to 4 GHz	2%	4%
4 to 10 GHz	3%	5%
10 to 12.4 GHz	4%	5%

DC input resistance: 50 ± 5 ohms at Type N input jack.

Reflection Coefficient: dc to 5 GHz, < 0.13 (1.3 swr, 17.7 dB return loss); 5 to 11 GHz, < 0.2 (1.5 swr, 14 dB return loss); 11 to 12.4 GHz, < 0.26 (1.7 swr, 11.7 dB return loss).

Meter response time: less than 5 seconds for full-scale deflection.

Internal calibrator: 100 mW dc $\pm 1\%$ into 45 to 55 ohms.

Power: 115 or 230 volts $\pm 10\%$, 50 to 60 Hz approximately 180 watts with no input, 200 watts with 10 watts input.

Dimensions: cabinet: $20\frac{3}{4}$ " wide, $12\frac{3}{4}$ " high, 14" deep (527 x 324 x 356 mm); rack mount: 19" wide, 10-15/32" high, $13\frac{1}{2}$ " deep behind panel (483 x 266 x 343 mm).

Weight: net 49 lbs (22,1 kg), shipping 59 lbs (26,6 kg) (cabinet); net 43 lbs (19,4 kg), shipping 56 lbs (25,2 kg) (rack mount).

Accessories available: 281A,B Waveguide-to-Coax Adapters; K02-434A DC Test Set (for more accurate power measurements), \$1000.

Price: HP 434A, \$1600 (cabinet); HP 434AR, \$1585 (rack mount).

NOISE FIGURE



NOISE FIGURE METERS; SOURCES

Automatic noise figure measurements to 18 GHz
Models 340B, 342A; 343A, 345B, 347A, 349A

In microwave communications, radar, etc., the weakest signal that can be detected is usually determined by the amount of noise added by the receiving system. Thus, any decrease in the amount of noise generated in the receiving system will produce an increase in the output signal-to-noise ratio equivalent to a corresponding increase in received signal. From a performance standpoint, an increase in the signal-to-noise ratio by reducing the amount of noise in the receiver is more economical than increasing the power of the transmitter.

The quality of a receiver or amplifier is expressed in a figure of merit, or noise figure. Noise figure is the ratio, expressed in dB, of the actual output noise power of the device to the noise power which would be available if the device were perfect and merely amplified the thermal noise of the input termination

rather than contributing any noise of its own.

The Hewlett-Packard system of automatic noise figure measurement depends upon the periodic insertion of a known excess noise power at the input of the device under test. Subsequent detection of noise power results in a pulse train

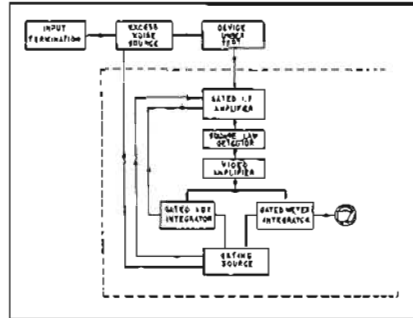

Figure 1. Automatic noise figure measurement system.

of two power levels. The power ratio of these two levels contains the desired noise figure information. Hewlett-Packard noise figure meters automatically measure and present this ratio directly in dB of noise figure.

Noise figure is discussed in detail in Hewlett-Packard Application Note 57, which is available from your local Hewlett-Packard field office upon request. Application Note 57, "Noise Figure Primer," derives noise figure formulas, describes general noise figure measurements and discusses accuracy considerations. One of the measurement systems discussed in Application Note 57 is shown in Figure 1. The portion of the diagram within the dashed box is a simplified block diagram of the HP 340B and 342A Noise Figure Meters, and the excess noise source could be any of the noise sources described on these pages.

Advantages:

- Reads noise figure directly in dB
- Completely automatic measurement
- Easily used by non-technical personnel
- No periodic recalibration needed
- Fast response; ideal for recorder operation

Uses:

- Measure noise figure in microwave or radar receivers, rf and IF amplifiers
- Compare unknown noise sources against known noise levels
- Adjust parametric amplifiers for optimum noise figure

Receiver and component alignment jobs which once took skilled engineers a full hour are now done in 5 minutes by a semi-skilled worker. Receiver noise figure often can be improved over the best adjustment previously possible. For instance, a 3 dB improvement in receiver noise figure is equivalent to doubling transmitter output. Since accurate alignment is easy, equipment is better maintained and peak performance enjoyed regularly.

These are some of the time-saving, cost-cutting advantages of Hewlett-Packard noise figure measuring equipment, Models 340B and 342A, when used with coaxial and waveguide noise sources.

Model 340B Noise Figure Meter, when used with an HP noise source, automatically measures and continuously dis-

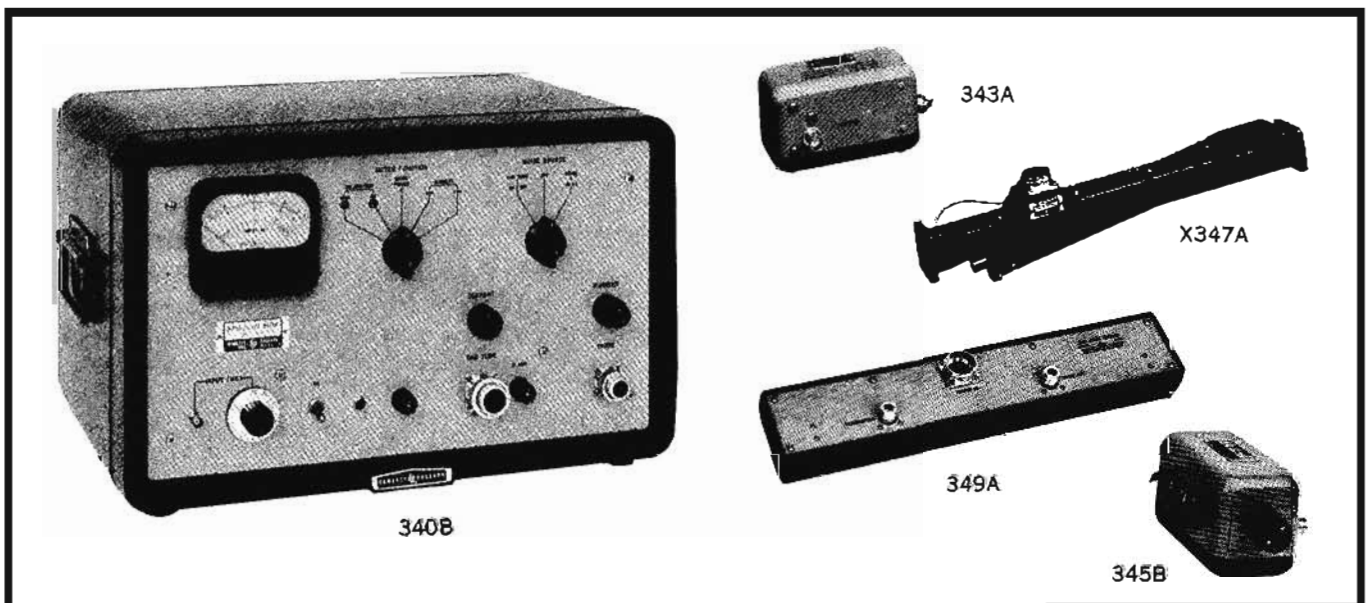

plays the noise figure of IF or rf amplifiers tuned to 30 or 60 MHz and of radar or microwave receivers with intermediate frequencies of 30 and 60 MHz. Collectively, HP noise sources cover frequencies from 10 MHz to 18 GHz.

Five-frequency operation

Model 342A Noise Figure Meter is similar to HP 340B, except that it operates on five frequencies between 30 and 200 MHz. Four of these frequencies are normally 60, 70, 105 and 200 MHz; the fifth is the basic 342A tuned amplifier frequency of 30 MHz.

In operation, a noise source, either a gas discharge tube or a diode, is connected to the input of a device under test. The IF amplifier output of the device is connected to the 340B or 342A. The noise figure meter gates the noise source on and off. When the source is on, the noise level is that of the device, plus the noise source. When the source is off, the noise level is that of the device and its termination. The noise figure meter automatically compares these two conditions and presents noise figure directly on a front-panel meter. Rate of response is such that changes in noise figure are constantly indicated on the meter.

Noise sources

Hewlett-Packard 343A VHF Noise Source: Specifically for IF and rf amplifier noise measurement, a temperature-limited diode source with broadband noise output from 10 to 600 MHz with 50-ohm source impedance and low swr.

Hewlett-Packard 345B IF Noise Source: Operates at either 30 or 60 MHz, as selected by a switch; another selector permits matching 50-, 100-, 200-, and 400-ohm impedances.

Hewlett-Packard 347A Waveguide Noise Sources: Argon gas discharge tubes mounted in waveguide sections; for waveguide bands 2.6 through 18 GHz, they provide uniform noise throughout the range; maximum swr is 1.2.

Hewlett-Packard 349A UHF Noise Source: Argon gas discharge tubes in Type N coaxial configuration for automatic noise figure readings, 400 to 4000 MHz.

Specifications, 340B and 342A

Noise figure range: 5.2 dB noise source, 0 to 15 dB, indication to infinity; 15.2 dB noise source, 3 to 30 dB, indication to infinity.

Accuracy (excluding source accuracy): noise diode scale: ± 0.5 dB, 0 to 15 dB; gas tube scale: ± 0.5 dB, 10 to 25 dB; ± 1 dB, 3 to 10 dB and 25 to 30 dB; (for stated accuracy with 343A S-, H-, X- and P347A and 349A Noise Sources, correction factor equal to the difference between specified excess noise and 15.2 dB must be applied to meter reading).

Input frequency: 340B; 30 or 60 MHz, selected by switch; 342A: 30, 60, 70, 105, and 200 MHz, selected by switch; other frequencies available.

Bandwidth: 1 MHz minimum.

Input requirements: -60 to -10 dBm (noise source on); corresponds to gain between noise source and input of approximately 50 to 100 dB for 5.2 dB noise source and 40 to 90 dB for 15.2 dB noise source.

Input impedance: 50 ohms nominal.

AGC output: nominally 0 to -6 V from rear binding posts.

Recorder output: 1 mA maximum into 2000 ohms maximum.

Power input: 115 or 230 volts $\pm 10\%$, 50 to 60 Hz, 185 to 435 watts, depending on noise source and line voltage.

Power output: sufficient to operate 343A, 345B, 347A or 349A Noise Sources.

Dimensions: cabinet: 20 $\frac{3}{4}$ " wide, 12 $\frac{3}{4}$ " high, 14 $\frac{1}{2}$ " deep (527 x 324 x 368 mm); rack mount: 19" wide, 10-15/32" high, 13 $\frac{7}{8}$ " deep behind panel (483 x 266 x 353 mm).

Weight: net 43 lbs (19,4 kg), shipping 54 lbs (24,3 kg) cabinet); net 37 lbs (16,7 kg), shipping 50 lbs (22,5 kg) (rack mount).

Accessories furnished: one 340A-16A Cable Assembly, connects noise figure meter to 347A or 349A Noise Source.

Price: HP 340B, \$715 (cabinet); HP 340BR, \$700 (rack mount); HP 342A, \$815 (cabinet); HP 342AR, \$800 (rack mount); not available in all countries.

Specifications, 343A

Frequency range: 10 to 600 MHz.

Excess noise: 10 to 30 MHz, 5.20 dB ± 0.20 dB; 100 MHz, 5.50 dB ± 0.25 dB; 200 MHz, 5.80 dB ± 0.30 dB; 300 MHz, 6.05 dB ± 0.30 dB; 400 MHz, 6.30 dB ± 0.50 dB; 500 MHz, 6.50 dB ± 0.50 dB; 600 MHz, 6.60 dB ± 0.50 dB.

Source Impedance: 50 ohms; swr less than 1.2, 10 to 400 MHz, and less than 1.3, 400 to 600 MHz.

Dimensions: 2 $\frac{3}{4}$ " wide, 2 $\frac{1}{2}$ " high, 5" deep (70 x 63 x 127 mm).

Weight: net $\frac{3}{4}$ lb (0,34 kg); shipping 2 lbs (0,9 kg).

Price: HP 343A, \$100.

Option 01: spare noise diode(s) calibrated and supplied with instrument, add \$40 each.

Specifications, 345B

(same weight and dimensions as 343A)

Spectrum center: 30 or 60 MHz, selected by switch.

Excess noise: 5.2 dB into conjugate load.

Source Impedance: 50, 100, 200 or 400 ohms, $\pm 4\%$, as selected by switch; less than 1 pF shunt capacitance.

Price: HP 345B, \$125 (operation at any two frequencies between 10 and 60 MHz in lieu of 30 and 60 MHz available on special order).

Specifications, 347A

HP Model	Range (GHz)	Excess noise (dB)	Approx. length		Price
			(in.)	(mm)	
G347A	3.95—5.85	15.2 ± 0.5	19	483	\$310
J347A	5.30—8.20	15.2 ± 0.5	19	483	\$300
H347A	7.05—10.0	15.7 ± 0.5	16	406	\$275
X347A	8.20—12.4	15.7 ± 0.4	14 $\frac{1}{4}$	375	\$225
P347A	12.4—18.0	16.0 ± 0.5	14 $\frac{1}{4}$	375	\$275

SWR for all models, fired or unfired, 1.2 maximum.

Specifications, 349A

Frequency range: 400 to 4000 MHz, wider with correction.

Excess noise: 15.6 dB ± 0.6 dB, 400 to 1000 MHz; 15.7 dB ± 0.5 dB, 1000 to 4000 MHz.

SWR: < 1.35 (fired), < 1.5 (unfired) up to 2600 MHz; < 1.5 (fired or unfired), 2600 to 3000 MHz; < 2.0 (fired), < 3.0 (unfired) 3000 to 4000 MHz.

Dimensions: 3" wide, 2" high, 15" long (76 x 51 x 381 mm).

Weight: net 3 $\frac{1}{4}$ lbs (1,4 kg); shipping 6 lbs (2,7 kg).

Price: HP 349A, \$325.



The subjective sensation of loudness is exceedingly nonlinear with respect to most of the readily measured parameters of sound. Yet effective noise abatement, or any other endeavor which seeks to relate man to the sound environment in which he lives, calls for instruments which can reliably and repeatably measure loudness.

Early sound level meters, by measuring the level of a frequency weighted sound pressure, gave good results for continuous, narrowband sound but could be in error by as much as 20 dB, however, for wideband or impulse sounds.

Research on human hearing, extending over more than 40 years past, recently has resulted in good mathematical expressions for the complex relations between the subjective sensation of loudness and the physical properties of sound. The physical properties—sound pressure levels—can be measured quite accurately. Now, the complex computations which relate physical reality to sensation can be built into an instrument, and a meaningful display or other readout of the information can be produced.

Internationally accepted, in Recommendation 532 of the ISO (International Organization for Standardization), is the loudness measuring method of Zwicker. The Hewlett-Packard Model 8051A is the first commercial instrument to incorporate the method.

Zwicker's method takes into account four weighting factors which have to be applied to sound pressure to convert pressure to subjective loudness. They are: 1) weighting according to the frequency response of the human ear (in accord with Fletcher-Munson normal equal loudness contours), 2) correction for diffused or plane sound fields, 3) division of the audio spectrum into critical bands, and 4) weighting to account for the masking effect in the human ear when more than one frequency is present. The results of a Zwicker analysis of a sound are in the form of a curve drawn on a Zwicker diagram. The contribution of each frequency band to total loudness is clearly indicated and the area under this curve is the total loudness of the sound.

Equal loudness contours, first published in 1933 by Fletcher and Munson, demonstrate the wide variation in absolute sound pressure which human subjects judge equal in loudness. Based upon pure tones, these well established data show clearly that human hearing re-

sponse peaks in a frequency range between 2000 and 5000 Hz and declines increasingly at higher frequencies. Human hearing response also declines at lower frequencies but, for low intensity, low frequency sounds, the loudness does not increase with the logarithm of the sound pressure. Small changes in the intensity of low frequency pure tones produce disproportionately *large* changes in subjective loudness. Clearly, dynamically linear networks cannot simulate hearing response.

Complicating the matter further, diffused sound fields are characteristic of indoor locations, whereas the equal-loudness-contour data were gathered using plane-front sound fields.

The differences that are necessary in sound pressure level to give the same sensation of loudness in a diffused field as in a plane field have been standardized in ISO Recommendation 454. Using these standards, curves of equal loudness level for the diffused sound field can be calculated from those for the plane field.

Sounds of broad frequency bandwidth, like those produced by jet aircraft, are much louder than pure tones or narrowband noise which have the same sound pressure level. At a center frequency of 1 kHz, for example, noise with a bandwidth of 2 kHz is 2.5 times louder than noise of the same sound pressure level but of 160 Hz bandwidth. On the other hand, noise having a bandwidth of *less* than 160 Hz has the *same* loudness as the noise of 160 Hz bandwidth, provided that the sound pressure levels are the same. At 1 kHz, therefore, a bandwidth of 160 Hz is a *critical bandwidth*.

Other center frequencies have different critical bandwidths. To account for this, a loudness measuring instrument must divide the sound spectrum into critical frequency bands. Filter resolution must be sharp enough that the spectral distribution of the sound does not influence the loudness measurement. Placing such bands side by side, the audio range is covered by 24 bands of equal subjective pitch interval, i.e., each band is one critical bandwidth wide at the corresponding center frequency. The unit of subjective pitch is called the Bark, named after Barkhausen. One Bark corresponds to one critical bandwidth.

The Zwicker method of measuring loudness is only slightly compromised in its ISO-recommended form, the number of critical bands being reduced to 20,

each of approximately 1.2 Bark, spanning the range 45 Hz to 14.4 kHz.

The human ear is not very selective. Even pure tones or narrowband noise excite nerves in the ear corresponding to a wide range of frequencies. Two sounds at different frequencies may, therefore, excite the same nerves. When this happens, the sensation of loudness for the two sounds together is not the same as the sum of the loudnesses of the two sounds taken separately. This is the *masking effect*. It is most pronounced when a high level sound is close in frequency to a low level higher frequency sound; the higher frequency sound may not be heard at all. Zwicker has developed curves which approximate the masking effect of the ear.

Now that practical instrumentation has been devised, to apply the Zwicker method, it becomes possible to make realistic evaluation of wideband, continuous sounds such as those produced by jet aircraft. Meaningful, repeatable loudness measurements of transient sounds may also be made. In a practical way, we may find, for any sound, the critical band in which occurs the most important loudness contribution.

The HP Model 8051A traces a new Zwicker diagram on its crt display every 25 ms. It adheres faithfully to the standard procedures set down by ISO Recommendation 532, Method B. On command, it can "remember," and continuously display any such 25 ms interval. Thus it can produce Zwicker diagrams for transient sounds. Analysis requires no complications such as recording and repeated replay.

Using the instrument, one may quickly see that the most obvious sound producing element in a mechanism under observation may be contributing only slightly to loudness, but that some minor and easily altered element is a powerful offender. A resonant panel, easily damped, often turns out to be the worst offender, and much improvement in noise performance then can be achieved inexpensively. Sometimes, when the intensity of an offending sound cannot be reduced economically, its frequency can be moved to a less audible band.

With electronic storage capability, either the instantaneous or the maximum loudness spectrum of a single transient can be stored, or the loudness spectrum of a continuous sound can be "frozen." Recordings can then be made with a camera, or plotted on an X-Y recorder.

LOUDNESS ANALYZER

Instantaneous display of loudness spectrum

Model 8051A



ANALYZERS

The HP 8051A Loudness Analyzer provides a continuous 1/3 octave analysis of acoustic noise, and computes loudness in sones, as set forth by Zwicker.

A meter indicates total loudness 1 sone₀ to 400 sones₀ in four scale ranges 12, 40, 120, and 400 sones₀. Simultaneously, a loudness spectrum is displayed on a cathode ray tube.

A complete spectrum analysis is repeated every 25 ms, facilitating not only loudness measurements of steady noises but those of impulsive noises as well. An electronic storage capability allows the storage of instantaneous or the maximum loudness spectrum of a single transient. Recordings can be made with a camera or plotted on an X-Y recorder immediately.

Specifications

Loudness range: 1 sone₀ - 400 sones₀ (corresponding to 40 phons₀ - 127 phons₀) in 4 ranges; full scale meter deflections: 12, 40, 120, and 400 sones₀ corresponding to sensitivity range of loudness density display: 0.12, 0.4, 1.2, and 4 (sones₀/Bark) division.

Accuracy: deviation of less than $\pm 5\%$ of full scale.

Noise: less than 0.3 sone₀ in the most sensitive range for source resistance of 600 Ω or less.

Sound pressure level ranges: representative values of SPL for loudness and loudness density readings at 1 kHz (frontal field):

Range sones ₀	SPL - dB	Loudness density divisions	Loudness sones ₀
400	110	5.5 \pm 0.3	128 \pm 20
120	90	5.7 \pm 0.3	32 \pm 6
40	70	5.35 \pm 0.3	8 \pm 2
12	50	5.25 \pm 0.3	2 \pm 0.6

The maximum SPL at 1 kHz is 114 dB. 0 dB = 2.10⁻⁴ μ Bar.

Channel	Relative bandwidth	Center frequency
1	octave	63 Hz
2	octave	125 Hz
3	two-third octave	224 Hz
4 ... 20	one-third octave	315 Hz ... 12.5 kHz

The 1/3 octave filters have an attenuation of about 20 dB in the center of the next passband and about 60 dB at twice and half the center frequency. Rolloff of the octave filters is approx 40 dB/octave.

Diffuse field network: response as per ISO Recommendation 454.

Accuracy: 45 Hz - 4 kHz: ± 0.5 dB.
5 kHz - 12.5 kHz: ± 1 dB.

Outputs

Meter: positive 4 V for full scale deflection of the meter. Load resistance 1 k Ω or more.

Y-axis: positive 7 V for full vertical deflection of the sampling point on the crt; load resistance 1 k Ω or more.

X-axis: positive 10 V for full horizontal deflection of the sampling point on the crt; load resistance 1 k Ω or more.

CRT vertical: output waveform of vertical amplifier to drive external oscilloscopes or fast recorders. Positive 1 V/div of the vertical deflection on the crt; load resistance 1 k Ω or more.

CRT sync: positive pulse to trigger external equipment coincident with the start of the internal sweep, about +6 V.



Auxiliary output: output of preamplifier; the gain of the preamplifier depends on the range setting for direct input and frontal sound field:

Range — sones	Amplifier — gain
400	-20 dB \pm 0.5 dB
120	0 dB \pm 0.5 dB
40	+20 dB \pm 0.5 dB
12	+40 dB \pm 0.5 dB

Display

Instant: display of the instantaneous loudness spectrum on the crt and indication of the total loudness on the meter.

Peak: display of the max total loudness on the meter with the crt displaying the corresponding spectrum; remote operation by contact closure.

Hold: storage of display on the crt and loudness reading on the meter; less than 0.3 div change of the crt display for up to 2 minutes storage; remote operation by contact closure.

Check: internal noise generator checks overall operation of the instrument.

Scanning: manual or automatic; scanning time for the whole spectrum in the automatic mode is 90 s \pm 30 s.

Overload: overload lamp glows if the crest factor of the signal in any channel exceeds 7 at full scale, or if any of the circuits are overdriven.

Power requirements: line voltage 115/230 V switch, $\pm 10\%$ - 50 Hz - 400 Hz; power consumption approx 80 W.

Dimensions: 16 $\frac{3}{4}$ " wide (425 mm), 12" high (306 mm) (without feet), 24 $\frac{3}{8}$ " deep overall (708 mm).

Weight: 64 lbs (29 kg).

Accessories supplied: detachable power cord; 200 sheets of loudness analysis diagram (ISO Recommendation 552), 25 each for each range in the frontal and diffuse sound field.

Price: HP Model 8051A, \$5,500.

Accessories available

Model 15109A Microphone Assembly

Sensitivity: (at preamplifier output): 5 mV/ μ Bar.

Dynamic Range (from equivalent A-weighted noise level to 3% harmonic distortion): 28 dB - 140 dB, 0 dB = 2.10⁻⁴ μ Bar.

Dimensions: outside diameter: 0.936 in (23.77 mm). Length 5.5/16 in (135 mm).

Price: HP Model 15109A, \$270.

Manufactured in West Germany by Hewlett-Packard GmbH.



Distortion in amplifiers, created by nonlinear circuits, consists of components present in the output that are not contained in the input signal. Distortion in a sine-wave signal source consists of frequency components that exist in the output in addition to the fundamental frequency. An ac signal that appears to be a pure sine wave as viewed on an oscilloscope (Figure 1) may have some harmonic distortion. The total of these frequency components present in the signal in addition to the fundamental frequency can be measured quickly and easily with a distortion analyzer.

One type of distortion analyzer contains a narrow-band rejection filter which, when properly tuned, removes the fundamental frequency so that the amplitude of the remaining components can be measured simultaneously. The distortion analyzer is used for fast quantitative measurements of total harmonic distortion and noise.

HP distortion analyzers

The Hewlett-Packard distortion analyzers (Models 331A, 332A, 333A and 334A) measure total distortion which can easily be determined in either a percentage or dB below the reference signal. The procedure is simple. The signal to be analyzed is connected to the input of the instrument. A reference level is established by adjusting the sensitivity control to the desired reference (such as 100% or 0 dB) with the function and meter range controls in the set level position. The function switch is then turned to distortion; the frequency and balance controls are adjusted for a null on the meter while increasing the meter sensitivity. The total distortion is read directly in either percent of the total signal or in dB below the total signal.

The HP distortion analyzers have two modes of operation—the distortion mode and the voltmeter mode. The tuning range in the distortion mode is 5 Hz to 600 kHz. Signals with distortion components to 3 MHz can be measured. The voltmeter mode provides a full-scale sensitivity from 300 μ V to 300 V for frequencies from 5 Hz to 3 MHz (20 Hz to 500 kHz on the 300 μ V range, and 5 Hz to 500 kHz on the 100 V and 300 V ranges).

The basic design of Hewlett-Packard distortion analyzers essentially follows ac voltmeter practice, in that there is a low-noise impedance converter at the input

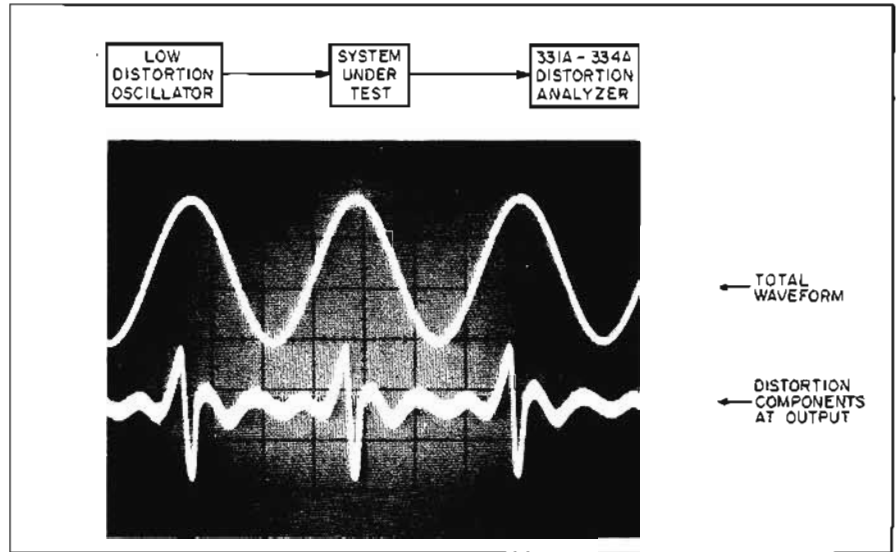

Figure 1. The lower trace is the output signal of a nonlinear system with the fundamental filtered out. The residual output shows that a seemingly pure sine wave does, in fact, contain harmonics.

followed by an attenuator, a broadband amplifier, an ac to dc converter, and a meter as shown in the block diagram of Figure 2. The tunable rejection amplifier is switched in or out as required.

The impedance converter uses a field-effect transistor (FET) to obtain exceptionally high input impedance and a noise level that is less than 25 μ V referred to the input (600-ohm source impedance).

The meter responds to the average value of the waveform, but is calibrated to read the rms value of a sine wave. Ordinarily, any difference between the average-responding meter indication and the true rms value is of little concern.

However, if the true rms value of the residual waveform is desired, it is readily found by connecting an rms-responding meter to the output terminals of the analyzer.

The output terminals supply a voltage that is proportional to the current supplied to the meter rectifiers. The output is taken from the calibration network in the feedback circuit of the meter amplifier and thus, at frequencies up to 600 kHz, the output waveform is not subject to the diode crossover distortion that has been characteristic of earlier average-responding circuits. Maximum output corresponding to full-scale meter deflection is 0.1 V rms.

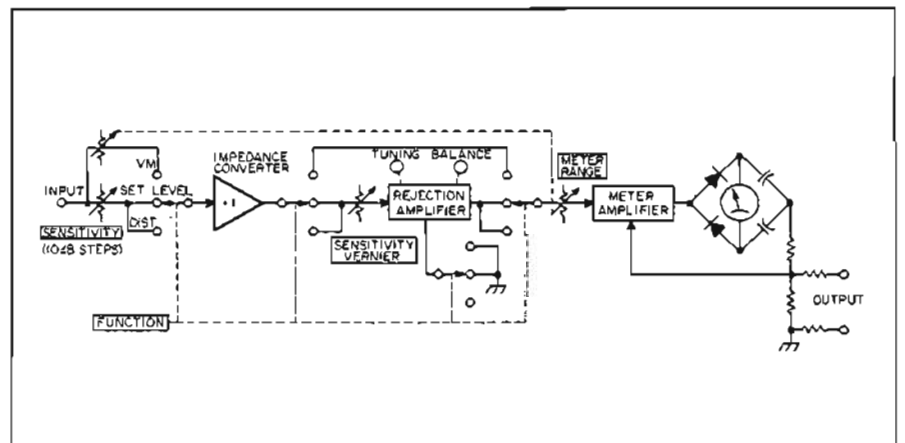
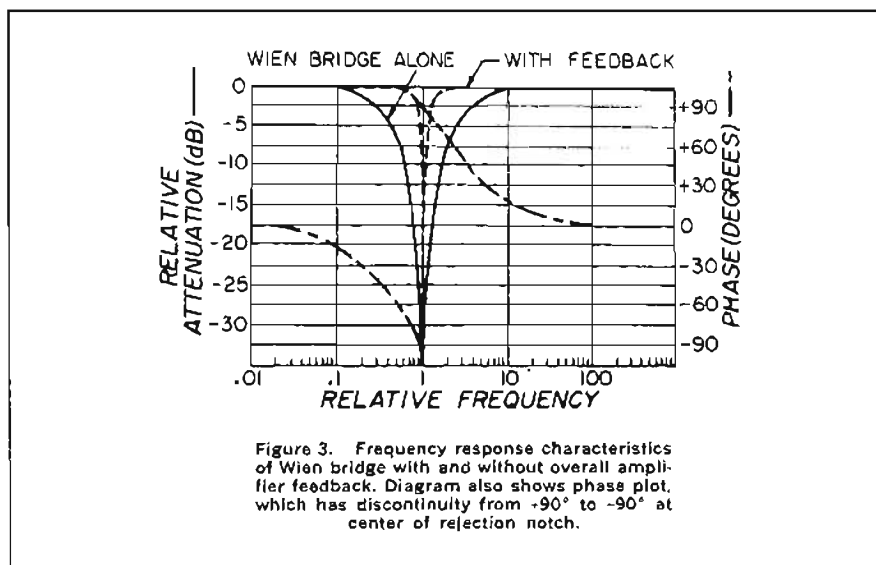

Figure 2. The distortion analyzer functions as a broadband calibrated ac voltmeter in "voltmeter" mode and as a signal level indicator in "set level" mode. In "distortion" mode, rejection amplifier can be tuned to suppress fundamental frequency of input signal, permitting comparison of distortion component's level to total signal level.

Rejection amplifier

During a distortion measurement, the fundamental component of the signal is rejected by the tunable Wien bridge in the interstage coupling network of the rejection amplifier. To prevent attenuation of harmonics, the distortion analyzer uses heavy feedback around the rejection amplifier to flatten the overall response, except in the deepest part of the notch where the Wien bridge attenuation is greater than available amplifier gain. With feedback, sharpness of the null is increased, as shown by the dotted line in Figure 3. The notch width is only 0.007% of the center frequency at the -70 dB points and the second harmonic is attenuated typically less than 0.2 dB within a fundamental range of 20 Hz to 20 kHz, while the fundamental is attenuated more than 80 dB.



Since the distortion analyzer has a full-scale sensitivity of 0.1% and internal noise of less than 25 μV rms, distortion levels of 0.03% can easily be resolved.

To reduce interference from power-line hum or other low-frequency signals, the Models 333A and 334A Distortion Analyzers have a switchable high-pass filter for use with input signals higher than 1 kHz. The filter attenuates 60 Hz power-line interference by more than 40 dB. All models have rear-panel terminals to permit operation from batteries should it be desired to eliminate ground loops arising from power-line interconnections.

The overall performance of the HP analyzers has been evaluated by using a wave analyzer to measure the distortion that a typical distortion analyzer introduces into a signal. For these tests, a signal with distortion products at least 100 dB below the fundamental was applied to the distortion analyzer input. When the test signal was set to 5 kHz,

0.3 V rms (100% set level), the wave analyzer showed the distortion analyzer output to have a second harmonic (10 kHz) level 84 dB below the fundamental. The third harmonic (15 kHz) was -100 dB. By contrast, any indication of total distortion lower than -76 dB is off the scale of the distortion analyzer and within the noise level. Hence, distortion introduced by the distortion analyzer in the audio range is so low as to be not distinguishable from the noise level.

RF detector

Amplitude modulation distortion can be measured by use of the broadband RF detector in the Models 332A and 334A Analyzers. The detector is untuned and accepts RF signals greater than 1 V within a range of 550 kHz to 65 MHz.

cially if the test signal tends to drift.

The automatic nulling system is based on the phase characteristics of the Wien bridge, plotted as the dashed line in Figure 3.

As shown, the phase of the residual signal across the bridge lags the driving signal by 90° if the bridge is tuned slightly below the signal frequency; it leads by 90° if the bridge is tuned above. A phase-sensitive detector therefore is able to sense any mistuning and is able to indicate the direction that a correction should take.

Automatic readjustment is provided by photoconductors which vary the resis-

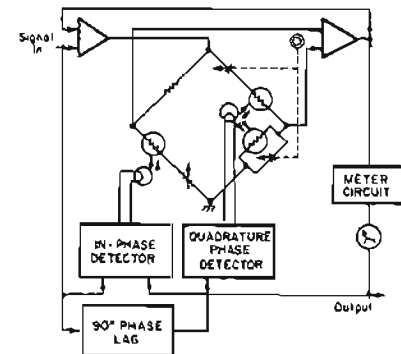

Figure 4. Rejection amplifier with automatic nulling circuitry. Phase detectors sense bridge unbalance and control intensity of lamps to change resistance of photoconductors, thus adjusting bridge to reject fundamental frequency of input signal.

tance in the arms of the bridge, as shown in the diagram in Figure 4. The photoconductors in the reactive arm are illuminated by lamps controlled by the quadrature phase-sensitive detector. The photoconductor in the resistive arm is illuminated by a lamp controlled by the in-phase detector. The outputs of the phase detectors thus adjust the resistance of the photoconductors by means of the lamps to bring the bridge into balance.

The null-seeking circuits are able to track frequency deviations of at least 1%. If the frequency should vary, typical instrument response time is on the order of 5 seconds for a 1% step in frequency, assuring minimum delay in the measurement.

Selecting an analyzer

For applications where lower initial cost is more important than speed and convenience of automatic nulling, Models 331A and 332A have precision mechanical drives for accurate manual tuning. These models do not have the high-pass filter; however, the Model 332A includes the RF detector.

Model 333A is identical to the Model 334A Automatic Nulling Distortion Analyzer except that the RF detector is omitted.

In the broadcast band (550 to 1600 kHz), the detector introduces less than 0.3% distortion on 3 to 8 V rms carriers modulated 30%.

Automatic null

Models 333A and 334A Distortion Analyzers contain circuits that automatically tune the rejection filter to suppress the fundamental of the input signal while the remaining components are measured. The operator needs only to tune approximately to the null and switch to the automatic mode, whereupon the instrument seeks the true null and retains it. Distortion measurements formerly requiring patience and considerable time and skill because of the sharpness of the rejection filter may now be performed without requiring extensive operator training. Besides simplifying distortion measurements, automatic nulling also assures accuracy and repeatability, espe-



DISTORTION ANALYZERS

Accurate distortion readings, 5 Hz to 600 kHz
Models 331A, 332A, 333A, 334A

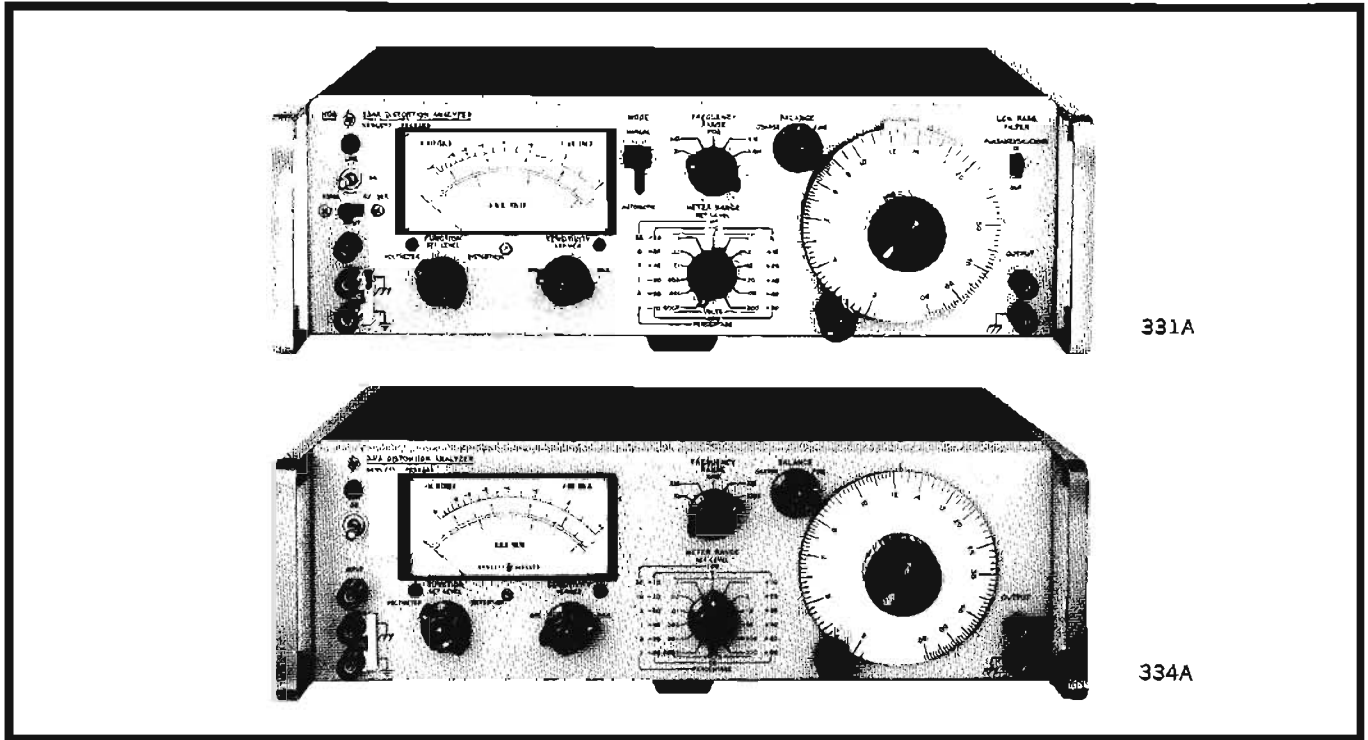

Description

Distortion Analyzers have gone solid-state, offering extended tuning range, greater set-level sensitivity, improved selectivity and greater overall accuracy. The Model 331A, 332A, 333A, 334A Distortion Analyzers measure total distortion down to 0.1% full scale at any frequency between 5 Hz to 600 kHz; harmonics are indicated up to 3 MHz. These instruments measure noise as low as 50 microvolts, and measure voltages over a wide range of level and frequency. All four models may be used as sensitive wide-range transistorized voltmeters for general-purpose voltage and gain measurements.

Automatic fundamental nulling

Automatic fundamental nulling (available in HP Models 333A and 334A) speeds up the normally time-consuming portion of the measurement. This is done by manually nulling with the coarse tuning and balance controls to less than 10% of the Set-Level Reference. The automatic mode is used to complete rejection of the fundamental on more sensitive ranges without any further manual tuning.

Amplitude modulation detector

The HP Models 332A and 334A Analyzers are provided with an amplitude modulation detector having a frequency range from 550 kHz to greater than 65 MHz.

The high-impedance dc restoring peak detector which utilizes a semiconductor diode measures distortion at carrier

levels as low as 1 V. The input to the detector is located on the rear of the instrument. The Model 334A is similar to Model 332A, but is provided with Automatic Fundamental Nulling and a High-Pass Filter.

High-pass filter

In order to reduce the effect of hum components, a high-pass filter is provided which attenuates frequencies below 400 Hz. The filter may be activated by a front-panel switch when measuring distortion of signals greater than 1 kHz in frequency.

High-impedance voltmeter

The transistorized ac voltmeter, part of the HP 331A through 334A, provides 13 ranges from 300 μ V to 300 V rms full scale.

Models And Available Features

Model No.	Automatic Fundamental Nulling	Hi-Pass Filter	AM Detector	Gear Reduction Tuning	VU Meter
331A				X	Option: 01
332A			X	X	Option: 01
333A	X	X			Option: 01
334A	X	X	X		Option: 01

Specifications

Model 331A

Distortion measurement range: any fundamental frequency, 5 Hz to 600 kHz. Distortion levels of 0.1%-100% are measured full scale in 7 ranges.

Distortion measurement accuracy:

Harmonic measurement accuracy:

Fundamental Input Less Than 30 V

Range	±3%	±6%	±12%
100%-0.3%	10 Hz-1 MHz	10 Hz-3 MHz	
0.1%	30 Hz-300 kHz	20 Hz-500 kHz	10 Hz-1.2 MHz

Fundamental Input Greater Than 30 V

Range	±3%	±6%	±12%
100%-0.3%	10 Hz-300 kHz	10 Hz-500 kHz	10 Hz-3 MHz
0.1%	30 Hz-300 kHz	20 Hz-500 kHz	10 Hz-1.2 MHz

Elimination characteristics:

Fundamental rejection >80 dB.

Second harmonic accuracy for a fundamental of:

5 to 20 Hz: better than +1 dB.

20 Hz to 20 kHz: better than ±0.6 dB.

20 kHz to 100 kHz: better than -1 dB.

100 kHz to 300 kHz: better than -2 dB.

300 kHz to 600 kHz: better than -3 dB.

Distortion introduced by instrument: <0.03% from 5 Hz to 200 kHz; <0.06% from 200 kHz to 600 kHz.

Meter indication is proportional to the average value of a sine wave.

Frequency calibration accuracy:

Better than ±2% from 10 Hz to 200 kHz.

Better than -3% from 5 to 10 Hz.

Better than +8% from 200 to 600 kHz.

Input Impedance: distortion mode: 1 megohm shunted by less than 60 (*80) pF (10 megohms shunted by <10 pF with HP 10001A 10:1 Divider Probe).

Voltmeter mode: 1 megohm shunted by 30 (*50) pF 1 to 300 V rms; 1 megohm shunted by 60 (*80) pF, 300 μV to 0.3 V rms.

Input level for distortion measurements: 0.3 V rms for 100% set level or 0.245 V for 0 dB set level. (Up to 300 V may be attenuated to set-level reference.)

DC Isolation: signal ground may be ±400 V dc from external chassis.

Voltmeter range: 300 μV to 300 V rms full scale (13 ranges) 10 dB per range.

Voltmeter accuracy: (Using front panel input terminals.)

Range	±2%	±5%
300 μV	30 Hz-300 kHz	20 Hz-500 kHz
1 mV-30 V	10 Hz-1 MHz	5 Hz-3 MHz
100 V-300 V	10 Hz-300 kHz	5 Hz-500 kHz

Noise measurements: voltmeter residual noise on the 300 μV range: <25 μV rms, when terminated in 600 ohms, <30 μV rms terminated with a shielded 100 k ohm resistor.

*With rear input modifications.

Output: approximately 0.1 V rms output for full scale meter deflection.

Output Impedance: 2 kilohms.

Power supply: 115 or 230 volts ±10%, 50 to 1000 Hz, approximately 4 watts. Terminals are provided for external battery supply. Positive and negative voltages between 30 V and 50 V are required. Current drain from each supply is 40 mA.

Model 332A

Same as Model 331A except as indicated below:

AM detector: high impedance dc restoring peak detector with semiconductor diode operates from 550 kHz to greater than 65 MHz. Broadband input, no tuning is required.

Maximum Input: 40 V p-p ac or 40 V peak transient.

Distortion introduced by detector: carrier frequency: 550 kHz-1.6 MHz: <0.3% for 3-8 V rms carriers modulated 30%. 1.6 MHz-65 MHz: <1% for 3-8 V rms carriers modulated 30%.

NOTE: distortion introduced at carrier levels as low as 1 V is normally <1% 550 kHz to 65 MHz for carriers modulated 30%.

Model 333A

Same as Model 331A except as indicated below:

Automatic nulling mode:

Set level: at least 0.2 V rms.

Frequency ranges: X1, manual null tuned to less than 3% of set level; total frequency hold-in ±0.5% about true manual null. X10 through X10 k, manual null tuned to less than 10% of set level; total frequency hold-in ±1% about true manual null.

Automatic null accuracy:

5 Hz to 100 Hz; meter reading within 0 to +3 dB of manual null. 100 Hz to 600 kHz; meter reading within 0 to +1.5 dB of manual null.

High-pass filter: 3 dB point at 400 Hz with 18 dB per octave roll off. 60 Hz rejection >40 dB. Normally used only with fundamental frequencies greater than 1 kHz.

Frequency calibration accuracy:

Better than ±3% from 5 Hz to 200 kHz.

Better than +8% from 200 kHz to 600 kHz.

Power supply: same as Model 331A except current drain from each supply is 80 mA.

Model 334A

Same as Model 333A except includes AM Detector described under Model 332A.

General

Weight: net 17¾ lbs (7.98 kg); shipping 26 lbs (11.79 kg).

Dimensions: 16¾" wide, 5-7/32" high, 13¼" deep (425.6 x 132.6 x 336.6 mm).

Price: HP 331A, \$625; HP 332A, \$655; HP 333A, \$825; HP 334A, \$855.

Option 01, indicating meter has VU characteristics conforming to FCC requirements for AM/FM and TV broadcasting; add \$15.



Wave Analyzers





The wave analyzer is a highly selective voltmeter containing a narrow bandpass filter. It is used to analyze the amplitude of individual components of a distorted or a complex waveform.

A wave analyzer may be used to measure the total harmonic distortion found in the output of a nonlinear system by measuring the amplitude of the individual harmonics and applying them to the following formula:

Percentage distortion is defined as 100 times the ratio of the root-mean-square sum of the harmonics to the fundamental.

$$\% \text{ distortion} = \frac{(A_2^2 + A_3^2 + A_4^2 \dots)^{1/2} \times 100}{A_1}$$

where A_1 is the rms amplitude of the fundamental and $A_2, A_3, A_4 \dots$ are the rms amplitudes of the individual harmonics.

In operation the instrument is tuned to the frequency of the signal component to be measured. The amplitude of this component is read directly on the front panel meter. Analysis of a complex waveform with a wave analyzer permits measurement of intermodulation (IM) distortion, harmonic content, and any spurious components, such as hum, which may appear in the input signal. Such information is useful, for instance, in the design and testing of amplifiers, mixers, and oscillators. In analysis of waveforms obtained from vibration systems, system resonance can be pinpointed by the presence of larger than normal harmonic components.

Hewlett-Packard wave analyzers are heterodyning tuned voltmeters, which means simply that the input signal is heterodyned to a higher intermediate (IF) frequency by an internal local oscillator. Tuning the local oscillator shifts the various signal frequency components into the passband of the IF amplifiers. The output of the IF amplifiers is rectified and supplied to the metering circuit.

Two attenuators ensure that low level harmonic content can be read with accuracy. The input attenuator is set according to the amplitude of the input signal, allowing maximum input amplitude without overloading the linear amplifier and modulator. The second attenuator, just before the IF amplifier and metering circuit, permits the amplitudes of harmonic components to be read with accuracy over a dynamic range of better than 72 dB, depending on the model of the wave analyzer.

Hewlett-Packard wave analyzers cover a broad frequency range from below 20 Hz up to 22 MHz. Model 302A covers the important audio frequency range, 20 Hz to 50 kHz. The 310A provides coverage in the video range 1 kHz to 1.5 MHz. The Model 312A extends the coverage to 18 MHz in 18 overlapping bands (22 MHz with the H01-312A). This analyzer is useful for testing multiplex communications systems, IF and video amplifiers, filters, etc.

An important use of wave analyzers is plotting amplitude vs frequency; that is, frequency response characteristics of amplifiers,* filters, attenuators, etc. A tracking oscillator automatically tuned to the same frequency as the wave analyzer greatly simplifies such measurements. The information concerning specific Hewlett-Packard wave analyzers gives advantages of each concerning tracking oscillators, sweep outputs, recorder outputs, and types of frequency indication.

Model 302A

The 302A Wave Analyzer is a tunable voltmeter covering the frequency range of 20 Hz to 50 kHz. The frequency scale is linear throughout the band with a constant resolution of a division per 10 Hz. It can be used as a tuned voltmeter which will read absolute or relative levels. The 7 Hz bandwidth permits the separation of closely spaced signals.

The automatic frequency control used in all Hewlett-Packard wave analyzers greatly facilitates wave analysis. With the 7 Hz passband of the 302A, a slightly unstable input signal could easily drift out of the passband during measurement. The automatic frequency control locks the analyzer's tuning to the frequency of the signal component so that measurements are not affected by drift in the source signal.

Semiautomatic plots of amplitude vs frequency can be made with the 302A or 310A in the BFO operation by using the 297A Sweep Drive unit and an X-Y recorder.

Model 310A

The 310A Wave Analyzer is a tunable voltmeter covering the frequency range of 1 kHz to 1.5 MHz. This wave analyzer offers a front panel selection of three bandwidths: 200 Hz for maximum resolution; 1000 Hz to simplify calculations of noise power/Hz measurements; and

3000 Hz for operation of the wave analyzer as a receiver. In this mode, IF bandwidth is sufficient to recover voice modulation from either standard AM or single sideband systems (a carrier reinsertion oscillator is provided to permit detection of either normal or inverted single sideband transmissions).

The 310A Wave Analyzer features a wide dynamic range (-75 dB) over the entire frequency band, automatic frequency control, high sensitivity and a restored frequency output.

Models 312A/313A

The 312A Wave Analyzer is a tuned voltmeter with selectable bandwidths of 200 Hz, 1000 Hz and 3000 Hz. The operating frequency range is 10 kHz to 18 MHz in 18 overlapping bands (to 22 MHz with the H01-312A). Using the narrowest bandwidth, the instrument will function down to 1 kHz. With these bandwidths and frequencies, the 312A can be used for communication system measurements including long haul coaxial cable carriers. The 312A can be used for measurements of harmonics, intermodulation distortion, and crosstalk. It is a sensitive detector for bridge measurements, and with the use of the 313A Tracking Oscillator it will measure frequency vs amplitude for response curves of IF amplifiers, attenuators, and crystal-filter circuits.

In addition the operation of the 312A is simple and is enhanced by logical panel layout. The digital readout indicates the frequency of the center of the passband with 10 Hz resolution.

For maximum flexibility, the 312A input may be operated either balanced or unbalanced. In the terminated mode, the input signal is terminated in a selectable impedance of 50, 60, 75, 124, 135, 150, or 600 ohms. The meter indicates power in dBm absorbed by the selected impedance. In the bridged mode, the input impedance is 20 k Ω balanced and 10 k Ω unbalanced. In the bridging mode, the meter can indicate dBm according to the impedance selected, or it can indicate voltage by selecting the volts calibrated position of the impedance selector switch.

The high impedance 11530A Probe also can be used for bridging measurements to eliminate the loading effects.

The input signal enters the instrument through either the bridged-terminated connector or the probe connector. The probe contains a unity-gain isolation amplifier at the end of a cable. The BAL/

*See Hewlett-Packard Application Note 59, "Loop Gain Measurements with HP Wave Analyzers," for a more complete discussion.

UNBAL switch grounds one end of the input terminal in the unbalanced position.

In the heterodyning process of the 312A, the local oscillator uses a synthesis technique stabilized by a 1 MHz crystal timebase oscillator (Figure 1). The output of this local oscillator is mixed with the input frequency to form a 30 MHz intermediate frequency for uniform amplification. The signal is then divided into two channels, shifted in phase and mixed with a 30 MHz crystal oscillator input, resulting in information centered on a zero frequency. Both of these quadrature channels contain three cascaded lowpass filter-amplifiers which produce a flat response within the passband with symmetrical slopes of 72 dB per octave beyond cutoff. These two channels are mixed with two 250 kHz carriers and phased so that the difference frequency is obtained. The resultant is amplified and detected to drive the meter. The AFC circuit keeps the input frequency centered in the passband, and a decade counter is designed to read the center frequency of the passband.

The single sideband detector circuit consists of an upper sideband carrier reinsertion crystal oscillator which operates at 248.2 kHz and a lower sideband oscillator which operates at 251.8 kHz. A product detector and appropriate switching provide for the demodulation of upper and lower sidebands when using the 3 kHz bandwidth for both aural and recorder purposes. The analyzer also detects AM signals.

The 313A Tracking Oscillator complements the 312A Wave Analyzer in making distortion checks, loop gain measurements and analyzing frequency response characteristics. The 313A has two modes of operation, a track 312A mode and a

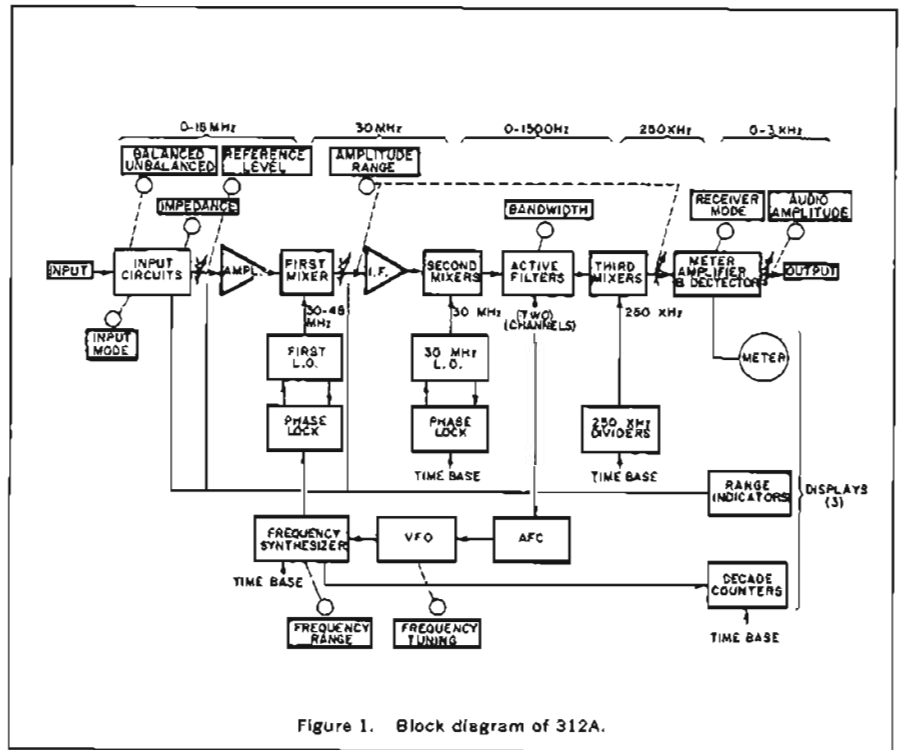

Figure 1. Block diagram of 312A.

free-running internal mode. In the track 312A mode of operation, the 313A utilizes the 30 MHz crystal oscillator and the local oscillator from the 312A to obtain a beat frequency at the tuned frequency of the 312A. In the internal mode of operation, the 313A uses its own internal local oscillator and 30 MHz crystal oscillator for adjustable frequencies from 10 kHz to 22 MHz in one single band. Any 313A Tracking Oscillator can be used with any 312A Analyzer. Output levels from +10 dBm to -99.9 dBm are available adjustable in 10, 1 and 0.1 dB steps.

An important feature of the 313A

Tracking Oscillator is its meter expand function. Any 2 dB range of the 312A meter indication from -7 to +3 dB can be expanded for full-scale coverage. This is accomplished by using the 312A recorder output and placing the 313A meter mode switch to 312A expand position.

The standard 312A and 313A have a high frequency of 18 MHz while the H01-312A and 313A have a high frequency of 22 MHz. Specifications for special instruments, page 428, give differences in connectors and impedance. Table 1 summarizes the basic specifications of HP wave analyzers.

Table 1. HP wave analyzers.

HP wave analyzers	Frequency range	Selective bandpasses	Dynamic range Absolute	Relative	Freq readouts	Type of Inputs	Type of outputs	Modes of operation
302A	20 Hz to 50 kHz	7 Hz 50 Hz 140 Hz	30 μ V-300 V full scale	> 75 dB	dial	banana jacks	rec: 1 mA dc into 1500 Ω full scale BFO: 2 V open circuit, meter at full scale	AFC, normal, BFO
310A	1 kHz to 1.5 MHz 5 kHz to 1.5 MHz 10 kHz to 1.5 MHz	200 Hz 1000 Hz 3000 Hz	10 μ V-100 V full scale	> 75 dB	dial	banana jacks	rec: 1 mA dc into 1500 Ω full scale BFO: 0.5 V open circuit, meter at full scale output impedance 135 Ω	AFC, normal BFO, USB, LSB, AM
312A/ 313A*	10 kHz to 18 MHz 18 ranges	200 Hz 1000 Hz 3000 Hz	3 μ V-3 V full scale or -97 to +23 dBm -107 to +13 dBm (600 Ω only)	> 72 dB	7-place decade counter	probe 11530A bridged/ terminated balanced or unbalanced	rec: 1 V dc full scale 1 k Ω source aux: 1 MHz (1 V p-p) 30 MHz (40-60 mV) rms L.O. (30-48 MHz) 60 to 80 mV rms audio: -5 V into 10 k Ω 313A: track or tuned 75 Ω unbalanced, -99.9 to +10 dBm	AFC, AM, beat, LSB, USB
H01-312A/ 313A*	10 kHz to 22 MHz 22 ranges	200 Hz 1000 Hz 3000 Hz	3 μ V-3 V full scale or -97 to +23 dB -107 to +13 dBm (600 Ω only)	> 72 dB	7-place decade counter	bridged/ terminated, unbalanced WE-477B	rec: 1 V dc full scale, 1 k Ω source aux: 1 MHz (1 V p-p) 30 MHz (40-60 mV) rms L.O. (30-48 MHz) into 75 Ω , 60-80 mV rms 313A, Option 01: track or tuned 50 Ω unbalanced, -99.9 to 10 dBm	AFC, AM, beat, LSB, USB
H05-312A/ 313A	Same as H01-312A except 50 Ω unbalanced input with BNC connector							

*313A Option 01, 50 Ω unbalance output

WAVE ANALYZER, SWEEP DRIVE

Measures wave components directly to 50 kHz
Models 302A, 297A



ANALYZERS

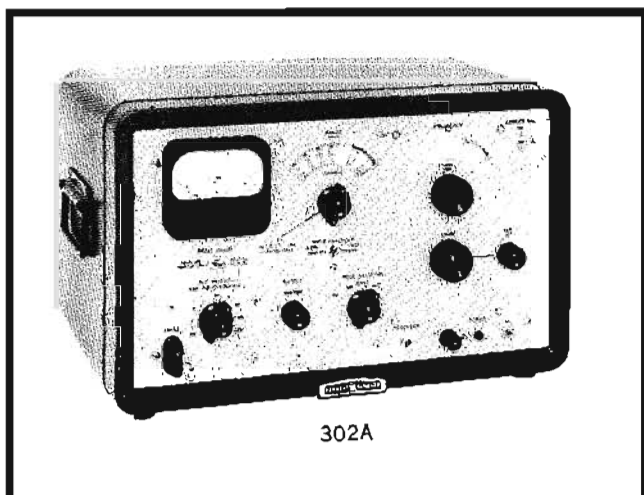

302A



297A mounted on 302A

Description

The HP Model 302A Wave Analyzer is a tunable voltmeter of high selectivity and high sensitivity covering the frequency range of 20 Hz to 50 kHz. The frequency scale is linear throughout the band with a constant resolution of 1 division per 10 Hz.

The instrument separates an input signal into its individual frequency components so that fundamental harmonic and intermodulation products may be separately measured and evaluated. It may also be used as a narrow-band tuned voltmeter which will read absolute or relative levels.

An automatic frequency control (AFC) circuit locks the measuring system to the frequency of the incoming signal, eliminating any need for frequency tracking while making a measurement.

Besides its primary function as a waveform analyzer, the 302A can be operated as an oscillator-tuned voltmeter combination. In BFO operation, an oscillator and the tuned voltmeter track together over the entire frequency range (20 Hz to 50 kHz) of the Model 302A. One control tunes both the oscillator and the voltmeter simultaneously, making filter and amplifier response measurements easy.

Specifications, 302A

Frequency range: 20 Hz to 50 kHz.

Frequency calibration: linear graduation 1 division per 10 Hz.

Dial accuracy: $\pm(1\% + 5 \text{ Hz})$.

Voltage range: 30 μV to 300 V full scale, 15 ranges in a 30, 100, 300 sequence; ranges provided by input attenuator and a meter range switch in steps of 1:3 or 10 dB; meter range is indicated by a dial mechanically linked with the input attenuator; an absolute-relative switch, in conjunction with a variable 10 dB control, is provided for adjustment for intermediate values.

Warmup time: none.

Voltage accuracy: $\pm 5\%$ of full-scale value.

Residual modulation products and hum voltage: $> 75 \text{ dB}$ down.
Intermediate frequency rejection: intermediate frequency present in input signal rejected by at least 75 dB.

Selectivity: $\pm 1 \text{ Hz}$ bandwidth, less than 1% down; $\pm 3.5 \text{ Hz}$ bandwidth, at least 3 dB down; $\pm 25 \text{ Hz}$ bandwidth, at least 50 dB down; $\pm 70 \text{ Hz}$ bandwidth, at least 80 dB down; beyond $\pm 70 \text{ Hz}$ bandwidth, at least 80 dB down.

Input impedance: determined by setting of input attenuator. 100 k Ω ($< 100 \text{ pF}$ shunt) on 4 most sensitive ranges; 1 M Ω ($< 20 \text{ pF}$ shunt) on remaining ranges.

Restored frequency output: 1 V across 600 Ω at output terminals for full-scale meter deflection; output voltage proportional to meter reading; output level control provided; frequency response $\pm 2\%$, 20 Hz to 50 kHz; output impedance approximately 600 Ω .

Oscillator output: 1 V across 600 Ω at output terminals (mode selector in BFO); output level control provided; frequency response $\pm 2\%$, 20 Hz to 50 kHz; output impedance approximately 600 Ω .

Recorder output: 1 mA dc into 1500 Ω or less at full-scale meter indication for grounded or ungrounded recorders.

Automatic frequency control: range of frequency hold-in is $\pm 100 \text{ Hz}$ minimum.

Power: 115 or 230 V $\pm 10\%$, 50 to 400 Hz, approx. 3 W; terminals are provided for powering instrument from external battery source; battery supply range, 28 V to 18 V.

Dimensions: cabinet 12 $\frac{1}{2}$ " high, 20 $\frac{3}{4}$ " wide, 14 $\frac{1}{2}$ " deep behind panel ($318 \times 527 \times 368 \text{ mm}$).

Weight: cabinet net 43 lbs (19,5 kg), shipping 53 lbs (23,9 kg); rack mount net 35 lbs (16 kg), shipping 49 lbs (22,1 kg).

Price: HP 302A, \$1800 (cabinet); HP 302AR, \$1785 (rack mount).

297A Sweep Drive

The 297A is a motor-drive unit designed to enhance the usefulness of the HP 302A, 310A or 312A Wave Analyzers. With the 297A you may sweep through all or any part of the 302A range. Because the 297A produces an X-axis output, you may easily make semiautomatic plots of harmonics, intermodulation products and response characteristics with an X-Y recorder such as Model 7035A.

The 297A may also be used to drive other tunable devices through their ranges. A stand (HP 11505A) allows the shaft height to be adjusted from 4 to 12 inches (102 to 305 mm).

Specifications, 297A

Sweep limits: any interval from 64 revolutions to 10 degrees.

Sweep speed with 302A: 170 and 17 Hz/s.

Shaft speed: 10 rpm, 1 rpm, and neutral; other shaft speeds available on special order; neutral permits manual operation.

Sweep voltage output: at least 12 V maximum; full output is obtained with either 2.1 or 50 revolutions of the shaft.

Torque: 9 in/oz at 10 rpm (approx. 22 in/oz max. at 1 rpm).

Power: 115 V $\pm 10\%$, 60 Hz, 12 W running or stalled.

Weight: net 4 $\frac{1}{4}$ lbs (1,9 kg); shipping 7 lbs (3,2 kg).

Price: HP 297A, \$350.

HP H03-297A (230 V, 50 Hz), \$375.



WAVE ANALYZER

Measure harmonics, intermodulation products
Model 310A

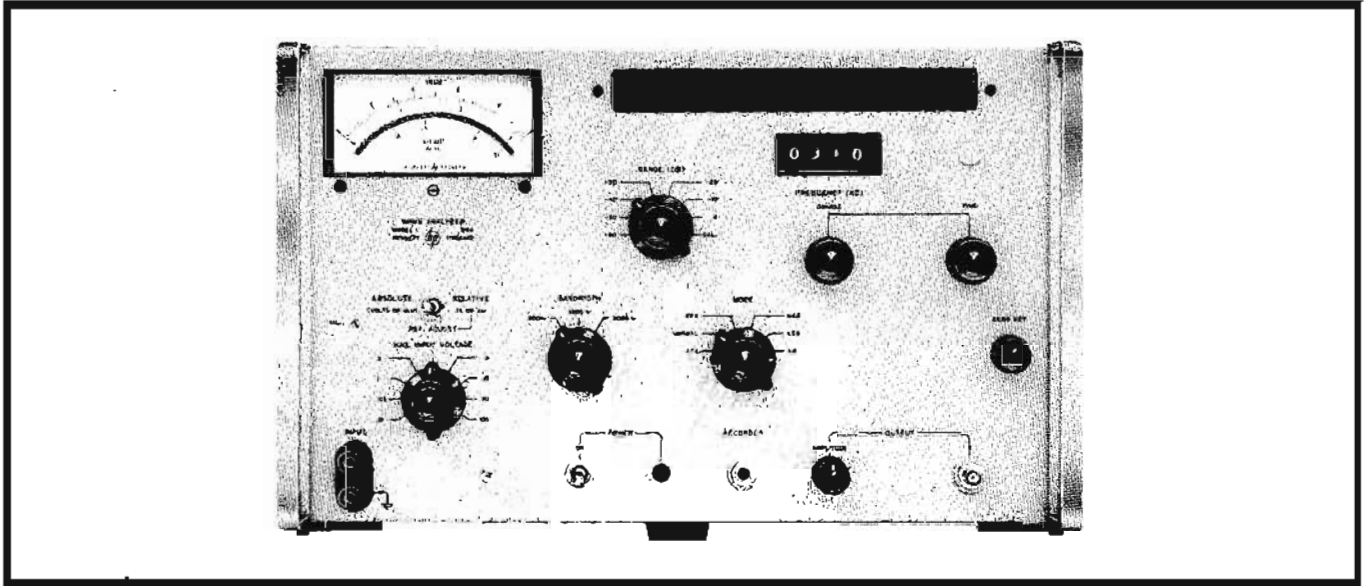

Description

The HP 310A High-Frequency Wave Analyzer is a sensitive, tunable, highly selective voltmeter. Selectivity allows analysis of closely spaced fundamental signals, harmonics, and intermodulation products. Signal components between 1 kHz and 1.5 MHz may be measured in both relative and absolute terms. Absolute readouts in volts and dBm, and relative readings in percent and dB are easily made. BFO operation allows use of the 310A as a signal generator and response meter suitable for measuring both amplifier and passive element characteristics. Also, provisions have been made for detecting and monitoring single side-band and AM signals.

Specifications

Frequency range: 1 kHz to 1.5 MHz (200 Hz bandwidth); 5 kHz to 1.5 MHz (1000 Hz bandwidth); 10 kHz to 1.5 MHz (3000 Hz bandwidth).

Frequency accuracy: $\pm(1\% + 300 \text{ Hz})$.

Frequency calibration: linear graduation, 1 div per 200 Hz.

Selectivity: 3 IF bandwidths, 200 Hz, 1000 Hz and 3000 Hz; mid-point of the passband (f_0) is readily distinguished by a rejection region 1 Hz wide between the 3 dB points.

	200 Hz bandwidth	1000 Hz bandwidth	3000 Hz bandwidth
Rejection*	frequency (Hz)	frequency (Hz)	frequency (Hz)
$\geq 3 \text{ dB}$	$f_0 \approx 108$	$f_0 \approx 540$	$f_0 \approx 1550$
$\geq 50 \text{ dB}$	$f_0 \approx 500$	$f_0 \approx 2400$	$f_0 \approx 7000$
$\geq 75 \text{ dB}$	$f_0 \approx 1000$	$f_0 \approx 5000$	$f_0 \approx 17000$

*Rejection increases smoothly beyond the -75 dB points.

Voltage range: 10 μV to 100 V full scale, ranges provided by input attenuator and meter range switch in steps of 1:3 or 10 dB.

Voltage accuracy: $\pm 6\%$ of full scale.

Internal calibrator stability: $\pm 1\%$ of full scale.

Dynamic range: $> 75 \text{ dB}$.

Noise and spurious response: at least 75 dB below a full-scale reference set on the 0 dB position of Range switch.

Input resistance: determined by input attenuator; 10 k Ω on most sensitive range, 30 k Ω on next range, 100 k Ω on other ranges; shunt capacitance $< 100 \text{ pF}$ on three most sensitive ranges. $< 50 \text{ pF}$ on other ranges.

Automatic frequency control: dynamic hold-in range is $\pm 3 \text{ kHz}$ minimum at 100 kHz; tracking speed is approximately 100 Hz/s; locks on signal as low as 70 dB below a full-scale reference set on the 0 dB position of the Range switch.

Restored-frequency output: restored signal frequency maximum output is at least 0.25 V (meter at full scale) across 135 Ω , with approximately 30 dB of level control provided; output impedance approximately 135 Ω .

BFO output: 0.5 V across 135 Ω with approx. 30 dB of level control provided; output impedance approx. 135 Ω .

Recorder output: 1 V dc into an open circuit from 1000 Ω source impedance for single-ended recorders; output of 1 mA dc into 1500 Ω or less available on special order.

Receiver function (Aural or Recording provision): internal carrier reinsertion oscillator is provided for demodulation of either normal or inverted single sideband signals; AM signal also can be detected.

RFI: conducted and radiated leakage limits are below those specified in MIL-1-6181D.

Power: 115 or 230 V $\pm 10\%$, 50 to 400 Hz; approx. 16 W.

Dimensions: 16 $\frac{3}{4}$ " wide, 10 $\frac{3}{4}$ " high, 18 $\frac{3}{8}$ " deep (426 x 274 x 467 mm); hardware furnished for conversion to rack mount 19" wide, 10-15/32" high, 16 $\frac{3}{8}$ " deep behind panel (483 x 266 x 416 mm).

Weight: net 45 lbs (20,3 kg); shipping 53 lbs (23,9 kg).

Accessories available: 11001A Cable Assembly, \$6; 10503A Cable Assembly, \$7; 10111A Adapter, \$7; 297A Sweep Drive, \$350; 11505A Bench Stand for 297A, \$25; K02-310A Bracket for mounting the 297A when the 310A is rack-mounted, \$35.

Price: HP 310A, \$2350.

Options

- 01: internal frequency calibrator providing check points every 100 kHz; interpolation accuracy (between check points): $\pm 2 \text{ kHz}$ up to 1.4 MHz, $\pm 3 \text{ kHz}$ between 1.4 and 1.5 MHz; add \$105.
kHz up to 1.4 MHz, $\pm 3 \text{ kHz}$ between 1.4 and 1.5 MHz; add \$25.

WAVE ANALYZER; OSCILLATOR

Signal analysis to 18 MHz; tracking oscillator
Models 312A; 313A



ANALYZERS

312A Waveform analyzer

Model 312A permits analysis of complex wave forms whose spectra extend to 18 MHz. The Wave Analyzer utilizes the tuned-voltmeter technique to separate the various components of an input signal so that the fundamental, harmonics, and intermodulation products can be located and measured. The instrument is particularly well suited for measurement in communications systems accommodating basebands to 18 MHz. The high selectivity, wide dynamic range, and high sensitivity of the 312A greatly simplify measurements such as distortion, attenuation, cross talk, frequency response, etc. Versatility is enhanced by three selectable bandwidths: 200 Hz for maximum resolution, 1,000 Hz for simple calculations of noise power per Hz, and 3,000 Hz for easy location of signals or operation as a receiver.

For maximum flexibility, the 312A input may be operated either balanced or unbalanced. In the Terminated mode, the input signal is terminated in a selectable impedance of 50, 60, 75, 124, 135, 150, or 600 ohms. The meter indicates power in dBm absorbed by the selected impedance; in the 50 ohms position, the meter also indicates voltage. In the Bridged mode, the input impedance is 20 kilohms balanced and 10 kilohms unbalanced. When bridging an externally terminated transmission line of the same impedance selected on the 312A, the meter indicates dBm. In this mode the 312A can also indicate voltage by selecting the Volts Calibrated position of the Impedance Selector. The high impedance 11530A Probe can also be used for bridging measurements to eliminate the loading effect of the input cable on the circuit under test.

The 312A has two signal attenuators. One, at the input, prevents the applied signal from overdriving the input amplifier. The second attenuator provides up to 60 dB attenuation in the IF channel and permits measurement of signals which are at least 65 dB below a full-scale reference set on the 0-dB position. Thus, low level distortion products may be readily measured.

Tuning is accomplished in 18 overlapping bands. The frequency to which the analyzer is tuned is indicated by an in-line digital readout with 10-Hz resolution.

For use with equipment requiring only 75-ohm unbalanced measurements, the HP H01-312A provides wave analysis capability to 22 MHz.

313A Tracking oscillator

HP 313A Tracking Oscillator provides a tracking output to complement the 312A Wave Analyzer. The frequency of this output signal automatically tracks the center of the 312A passband, so the 312A and 313A are excellent for analyzing the frequency response characteristics of amplifiers, filters, etc.

The output of the 313A is extremely flat over the entire frequency range and is calibrated in dBm. A precision 100-dB attenuator, calibrated in 0.1 dB steps, adds to the versatility. Together with the wide dynamic range of the 312A, the output flexibility of the 313A permits high values of gain and attenuation to be checked easily and accurately.



The 313A can also be used to provide increased amplitude resolution by expanding selectable 2-dB ranges of the 312A meter to full scale on the 313A meter. Any 2-dB range between -7 and $+3$ dB on the 312A meter may be selected for display. Amplitude variations as small as 0.01 dB can be resolved. Thus, minute variations in filter passbands or long-term gain variations in a communications channel can be analyzed easily.

The 313A can be operated as a signal source independent of the 312A Wave Analyzer. As such, the 313A has a frequency range from 10 kHz to 22 MHz in a single band. The output is extremely flat over the entire range and is adjustable from $+10$ to -99.9 dBm.

Specifications, 312A

Tuning characteristics

Frequency range: 10 kHz to 18 MHz in 18 overlapping bands. 200 kHz overlap between bands. Usable to 1 kHz with 200 Hz bandwidth.

Frequency accuracy: ± 10 Hz \pm time-base accuracy. Frequency indicated on in-line digital readout with ± 10 Hz resolution.

Time-base stability

Aging rate: less than ± 2 ppm per week.

As a function of ambient temperature: $+15^\circ$ to $+35^\circ\text{C}$, less than ± 20 ppm; 0° to $+55^\circ\text{C}$, less than ± 100 ppm.

As a function of line voltage: less than ± 0.1 ppm for changes of $\pm 10\%$.

Selectivity

Rejection	200 Hz bandwidth	1000 Hz bandwidth	3000 Hz bandwidth
3 dB	200 Hz \approx 10%	1 kHz \approx 10%	3 kHz \approx 10%
60 dB	<470 Hz	<2350 Hz	<6680 Hz

(Midpoint of the band is marked by rejection notch 3Hz wide.)

Automatic frequency control

Dynamic hold-in range: ± 3 kHz.

Tracking speed: 100 Hz/s; locks on to signals as low as 60 dB below zero reference with Amplitude Range switch set at 0 dB.

Amplitude characteristics

Amplitude range: 50 to 150 Ω , -97 dBm to +23 dBm full scale; 600 Ω , -107 to +13 dBm.

Voltage: 3 μ V to 3 V (50 Ω reference).

Amplitude accuracy

Amplitude range: ± 0.1 dB (1% of full scale).

Reference level (bridging input with external termination of 50 Ω $\pm 1\%$): 10 kHz to 10 MHz, ± 0.2 dB (2% of full scale); 10 MHz to 18 MHz, ± 0.5 dB (5% of full scale).

Meter tracking: ± 0.1 dB to -10 dBm indication (1% of full scale).

Internal calibrator output

Frequency: 1 MHz (derived from time base).

Amplitude: -40 dBm into 75 Ω termination.

Amplitude stability: ± 0.1 dB.

Output connector: BNC female.

Matching impedance: 50, 60, 75, 124, 135, 150 or 600 Ω , balanced or unbalanced.

Bridging impedance: 20 k Ω shunted by <18 pF (balanced); 10 k Ω shunted by <35 pF (unbalanced).

Common-mode rejection (balanced input): 10 kHz to 5 MHz, >40 dB; 5 MHz to 18 MHz, >30 dB.

Input connector: BNC female (2).

Harmonic distortion: 10 kHz to 1 MHz, 55 dB below zero reference with Amplitude Range switch set at 0 dB; 1 MHz to 18 MHz, 65 dB below zero reference with Amplitude Range switch set at 0 dB.

Residual responses: 72 dB below zero reference with Amplitude Range switch set at 0 dB.

Noise level, referred to input: 50 to 150 Ω , -120 dBm (200 Hz bandwidth); 600 Ω , -130 dBm (200 Hz bandwidth).

Receiver characteristics**Receiver mode outputs:**

AM and AM/AF: diode-demodulated audio.

Beat: beat frequency audio center at f_0 .

LSB: product-demodulated audio, carrier reinserted at $f_0 + 1.8$ kHz.

USB: product-demodulated audio, carrier reinserted at $f_0 - 1.8$ kHz.

Output connector: BNC female.

Audio output level (into at least 10 k Ω): 0.5 V with full-scale meter deflection.

General

Recorder output level: 1 V with full-scale meter deflection across open circuit. Output connector, BNC female. Tracking accuracy, better than ± 0.1 dB to 20 dB below full-scale reference on 0 dB position of Amplitude Range switch; better than ± 0.2 dB to 30 dB below full-scale reference. Output resistance, 1 k Ω .

Auxiliary outputs

1 MHz: approx 1 V p-p into 1 k Ω ; output connector, BNC female.

30 MHz: approx 40 to 70 mV rms into 50 Ω ; output connector, BNC female.

Local oscillator (30 to 48 MHz): approx 60 to 90 mV rms into 50 Ω ; output connector, BNC female.

Power: 115 or 230 V $\pm 10\%$, 50 to 400 Hz, 90 W.

Dimensions: 16 $\frac{3}{4}$ " wide, 10 $\frac{3}{4}$ " high, 18 $\frac{3}{8}$ " deep (426 x 274 x 467 mm); hardware furnished for conversion to rack mount 19" wide, 10 15/32" high, 16 $\frac{3}{8}$ " deep behind panel (483 x 266 x 416 mm).

Weight: net 46 lbs (20.7 kg); shipping 59 lbs (26.6 kg).

Accessory available: 11530A Probe provides amplitude accuracy (probe and divider only) of ± 0.5 dB; \$200.

Probe input impedance (at 1 MHz)

Probe divider	Input impedance	
	Unbalanced	Balanced
1:1 (0 dB)	20 k Ω shunted by <20 pF	40 k Ω shunted by <10 pF
10:1 (20 dB)	20 k Ω shunted by <12 pF	40 k Ω shunted by <6 pF
100:1 (40 dB)	20 k Ω shunted by <7 pF	40 k Ω shunted by <4 pF

5060-0216 Joining Bracket Kit for joining two full-module instruments, \$25.

Price: HP 312A, \$3900.

HP C01-312A, furnished with WE-465C coaxial input connector and WE-477B coaxial connector for the internal calibrator output, \$3975.

Specifications, H01-312A

(Same as 312A with following exceptions)

Frequency range: 10 kHz to 22 MHz in 22 overlapping bands.

Amplitude accuracy: reference level (matched 75 Ω input); ± 0.2 dB (+15 $^\circ$ to +40 $^\circ$ C), ± 0.3 dB (0 to +55 $^\circ$ C).

Meter calibration: dBm only (75 Ω reference).

Input impedance: 75 Ω or bridging (10 k Ω) shunted by <35 pF, unbalanced, selectable at front panel. Input connector equivalent to WE-477B.

Receiver output connector (H01-312A): accepts WE-289B twin plug or single two-conductor telephone plug.

Internal calibrator output connector (H01-312A): equivalent to WE-477B.

Price: HP H01-312A, \$3850; HP H10-312A, \$3800.

Specifications, 313A**Frequency range**

As tracking oscillator: same as 312A (18 MHz) or H01-312A and H05-312A (22 MHz).

As signal source: 10 kHz to 22 MHz in one band, continuous tuning.

Frequency accuracy

As tracking oscillator: 35 Hz ± 4 Hz above 312A tuning.

As signal source: $\pm 1\%$ of maximum dial setting from 10 kHz to 2 MHz; $\pm 3\%$ of maximum dial setting from 2 to 8 MHz; $\pm 5\%$ of maximum dial setting from 8 to 22 MHz.

Frequency stability

As tracking oscillator: same as 312A time base ± 100 Hz/ $^\circ$ C.

As signal source: short term (5 min) drift <1 kHz in stable environment after warmup.

Frequency response: ± 0.1 dB, 10 kHz to 22 MHz.

Amplitude stability: ± 0.1 dB for 90 days (0 to +55 $^\circ$ C).

Meter mode

312A Expand: meter expands any 2 dB range of 312A meter indication from -7 to +3 dB using 312A recorder output. Meter range, -1 to +1 dB; tracking error, ± 0.05 dB over full 2 dB range (operates with any 1V, 1 k Ω recorder output).

Output monitor: meter indicates voltage level at the input of the attenuator and can be calibrated from the front panel.

Maximum output: 0 or +10 dBm ± 0.1 dB, selectable at front panel.

Output attenuator: 3-section attenuator provides 0 to 99.9 dB attenuation in 0.1 dB steps.

Attenuator accuracy: 0.9 dB section (0.1 dB steps), ± 0.02 dB; 9 dB section (1 dB steps), ± 0.1 dB; 90 dB section (10 dB steps), ± 0.1 dB to 50 dB, ± 0.2 dB to 90 dB.

Output impedance: 75 Ω unbalanced (50 Ω optional, see Option 01 below).

Output connector: BNC female (also see C01-313A below).

Harmonic distortion: more than 34 dB below fundamental.

Non-harmonic distortion

As tracking oscillator: more than 40 dB below fundamental.

As signal source: more than 50 dB below fundamental.

Recorder output: +0.3 V for full-scale deflection. Output impedance 1 k Ω , BNC female connector.

Power: 115 or 230 V $\pm 10\%$, 50 to 1000 Hz, 30 W maximum.

Dimensions: 16 $\frac{3}{4}$ " wide, 5 $\frac{1}{2}$ " high, 18 $\frac{3}{8}$ " deep (426 x 141 x 467 mm).

Weight: net 25 lbs (11.3 kg); shipping 29 lbs (13.1 kg).

Accessories furnished: 11086A interconnecting cables for use with HP 312A, each cable 2 ft (610 mm) long with BNC male connectors (3).

Price: HP 313A, \$1250.

C01-313A, furnished with output connector equivalent to WE-477B; add \$40.

Option 01: output impedance 50 Ω unbalanced; no additional charge.



Spectrum Analyzers





Spectrum analysis is the study of energy distribution across the frequency spectrum generated by a given electrical signal. Evaluation of the relative amplitudes and frequencies of the discrete components of rf signals yields information on bandwidths, modulation characteristics, spurious signal generation and other valuable data impossible or impractical to obtain by any other means.

Microwave spectrum analysis has assumed added importance since the introduction of the HP 851B/8551B and its versatile accessories. With its fully calibrated controls and displays, plus wide spectrum coverage, this analyzer brings welcome practicality to frequency-domain measurements and opens up new areas of application.

The basic frequency range of the HP Spectrum Analyzer is 10 MHz to 12 GHz. The addition of external waveguide mixers provides coverage from 8.2 GHz to 40 GHz. Low-frequency coverage of the Spectrum Analyzer can be extended to 10 kHz with the K15-8551B with improved sensitivity (-107 dBm).

Broadband applications

Radio Frequency Interference (RFI) testing, spectrum surveillance and gathering of spectrum signatures—these are important fields being revolutionized by the HP spectrum analyzer. The far-ranging sidebands of radar transmitters, intermodulation products of multiple transmissions and spurious signals generated by electronic and electrical devices can be quickly detected and measured with the analyzer. Wide dynamic range and broad spectrum coverage in the HP spectrum analyzer permit measurements of signals widely separated in frequency and amplitude.

The HP 8441A Preselector is a valuable tool to aid RFI and spectrum surveillance measurements. The 8441A is a voltage-tuneable bandpass filter using an yttrium-iron-garnet (YIG) current-tuneable filter

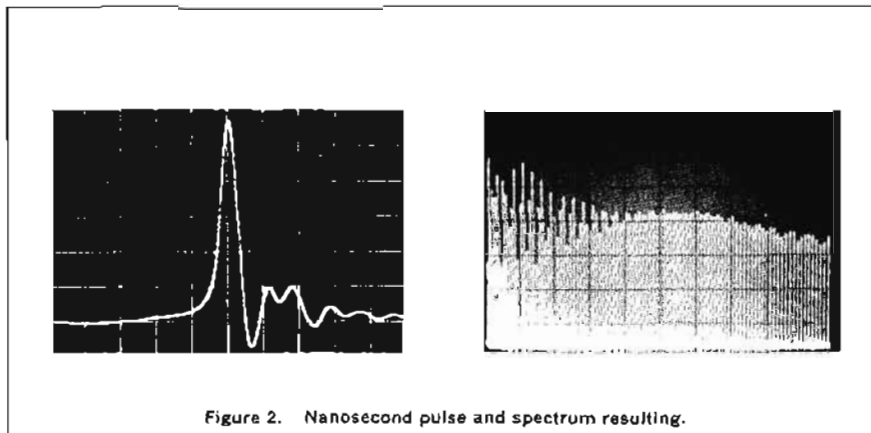

Figure 2. Nanosecond pulse and spectrum resulting.

to pass a desired signal and reject others. By automatically tracking the desired spectrum analyzer tuning response, it virtually eliminates multiple image and spurious responses in the 1.8 to 12.4 GHz range. This greatly simplifies the display, making it easier to interpret. The Preselector can extend the dynamic range of the analyzer for distortion measurements as much as an additional 35 dB, permitting distortion measurements as low as 0.01%.

Transients and random interference can be recorded by a time-exposed photo of the analyzer's crt display taken with an oscilloscope camera or by the use of the long-persistence feature of the oscilloscope in the Model 852A Display Section. Displays of repetitive signals may be plotted on an x-y recorder, using the vertical and horizontal output signals from the analyzer. Figure 1 shows the radiation present throughout the entire vhf spectrum in a large metropolitan area as viewed on the HP spectrum analyzer. Note the cluster of FM broadcast stations on the left and the television audio and video carriers appearing at center-right of the display. This display represents only 15% of the analyzer's maximum spectrum width capability. Power density measurements are another

important application of the spectrum analyzer, made possible by calibrated IF bandwidths. The HP Model 8442A 20 MHz Crystal Filter is a bandpass filter to improve the skirt characteristics of the 1 kHz IF of the 851B/8551B Spectrum Analyzer. This provides greater resolution of closely spaced signals having large differences in amplitude. By knowing the effective noise bandwidth of the IF amplifier, a calibrated output in terms of noise power per megacycle is possible using an rf indicator such as the HP 411A RF Millivoltmeter (page 197) to measure the analyzer's 20 MHz IF output. Calibration is achieved by feeding a known signal level into the analyzer rf input from a signal generator and noting the output level on the rf millivoltmeter. This level then becomes a reference to which all power density measurements may be referred.

New broadband applications

The recently introduced Model 852A Spectrum Analyzer Display Section expands the capabilities of the 8551B Spectrum Analyzer System by providing a brighter, steadier display on a variable persistence CRT. Oscilloscope display of transients which previously could be seen only on photographic plates is now possible.

Solid-state applications

Conventional methods of tuning varactor multiplier strings and parametric amplifier circuits can be tedious and time consuming. Also there is a good chance that spurious signals may be present in the output of such devices, even when everything seems "peaked up" correctly. With the HP Spectrum Analyzer all output frequencies can be observed simultaneously for easy adjustment of such devices for optimum output free of spurious signals.

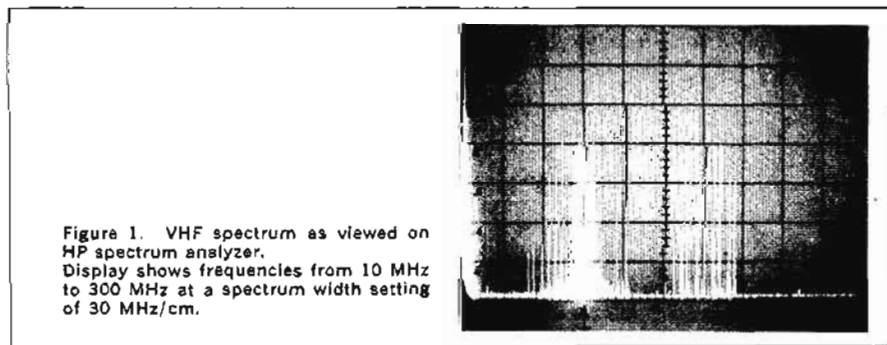

Figure 1. VHF spectrum as viewed on HP spectrum analyzer. Display shows frequencies from 10 MHz to 300 MHz at a spectrum width setting of 30 MHz/cm.

Fast rising, short duration pulse waveforms in the nanosecond region can be generated by semiconductor diodes driving a shorted transmission line. Often, it is desirable to obtain a uniform output across large segments of the spectrum with such devices (Figure 2). With the broad frequency display and flat amplitude response of the 851B/8551B, it is a simple task to measure narrow, fast rising pulse spectra and make adjustments for discontinuities in the generating system.

Narrowband measurements

In addition to the broad spectrum capability of the analyzer, calibrated spectrum widths down to 10 kHz/cm allow detailed analysis of very narrow segments of the band. Spectrum width can be reduced to zero with a vernier for operation of the Spectrum Analyzer as a fixed-frequency receiver. A unique phase-lock stabilization system reduces local oscillator residual FM in the analyzer to less than 1 kHz peak-to-peak deviation when viewing narrower spectrum widths. This system permits stable displays of narrow spectra, plus the convenience of remaining stabilized while tuning across the band. Narrow spectrum widths are useful for applications such as FM deviation measurements and residual FM checks on signal sources. The 60 dB dynamic range and display makes FM measurements by the "carrier-zero" method extremely accurate since the modulation frequency may be adjusted to the precise point where all the signal energy is contained in the sidebands. The modulation frequency is measured on an electronic counter and noted. Then, using a table of Bessel functions, carrier deviation is a simple calculation:

$$f_c = m f_n,$$

where f_c = carrier deviation
 m = modulation index (from Bessel table)
 f_n = modulation frequency

Series 63 application notes

Well illustrated application notes containing detailed information concerning spectrum analysis are available through any HP Sales Office.

Application Note 63 contains an introduction to spectrum analysis which explains the basic principles of this branch of microwave measurement. Illustrations of spectral displays and examples of their interpretation form a considerable portion of the text. An appendix provides a rigorous treatment of Fourier analysis as applied to spectrum analyzer displays.

AN 63A details new measurement techniques made possible by the HP Spectrum Analyzer. A sampling of the topics covered includes:

Achievement of high sensitivity through proper use of low noise preamplifiers

Klystron linearity and FM deviation measurements

Spectrum analysis of semiconductor phenomena at microwave frequencies

Improvement of X-Y recording of RF pulse spectra.

AN 63B discusses use of the 8441A Preselector in limiting responses to the band of interest. An explanation of the Analyzer's multiple responses and use of the 8441 to reduce harmonics in the output of a sweep oscillator is discussed. Use of the 8441 as a simple TRF spectrum analyzer is described.

AN63C describes application of the spectrum analyzer in the measurement of white noise power density.

AN63D describes accurate frequency calibration of the spectrum analyzer by use of the HP 8406A Frequency Comb Generator; frequency accuracy attainable is 0.01% through 5 GHz and slightly less through 40 GHz. Theory, setup, and examples are included.

AN63E describes RFI/EMI measurements to satisfy requirements of MIL-STD-826A, including details of test setups and procedure. A slide rule for simplifying calibration calculations is enclosed within each application note.

Your copies of these application notes are available on request through HP Sales Offices in your area.

Spectrum analyzer requirements

The basic functions of a spectrum analyzer are to translate electrical functions into their various frequency components and present their amplitudes on a visual display. To be versatile and do an effective job, the spectrum analyzer should have: 1) the ability to locate and identify signals over a wide frequency spectrum, 2) the ability to magnify portions of the spectrum for detailed analysis with stable calibrated sweeps and resolution, 3) minimum display clutter from spurious re-

sponses in the analyzer, and 4) wide dynamic range and flat frequency response.

A simplified block diagram of the HP 851B/8551B Spectrum Analyzer is shown in Figure 3. The rf section contains the local oscillators, mixers and two of the three IF amplifiers, comprising a triple conversion superheterodyne receiver. The first local oscillator is a backward wave oscillator which is capable of being swept or tuned from 2 to 4 GHz. Input signals of 12 MHz to 10 GHz pass through the 0-60 dB rf attenuator to a crystal harmonic mixer and are converted to the 2 GHz IF. After amplification, the 2 GHz IF is converted to 200 MHz, amplified, and converted again to 20 MHz. The use of a 2 GHz first IF keeps images 4 GHz apart, preventing a confusing double response for a single input frequency. The first mixer is carefully designed for minimum spurious generation and flat frequency response.

The display section contains the 20 MHz IF attenuator, bandpass filters, amplifiers, and video detector, plus the crt, sweep generator and display shapers.

Except for the crt, this section is designed with solid-state components throughout. The input consists of an accurate 0-80 dB attenuator calibrated in 1 dB steps. Bandpass filters controlling the analyzer's resolution follow the attenuator. These have accurately controlled bandwidths of 1, 3, 10, 100 kHz and 1 MHz. The switching logic of the Sweep Time and Spectrum Width selectors automatically select the optimum filter for best resolution without sacrifice in gain. Manual selection of the filters also is provided. A current controlled attenuator and feedback network comprise a display shaper which allows calibrated readout on the crt in terms of relative input power (square law), dB (logarithmic) or relative voltage (linear). A full discussion of spectrum analyzer design considerations is included in Application Note 63.

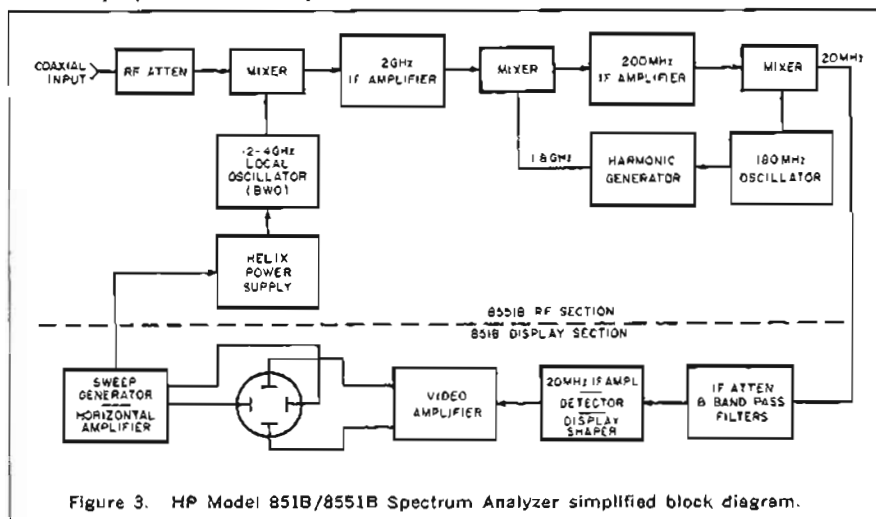
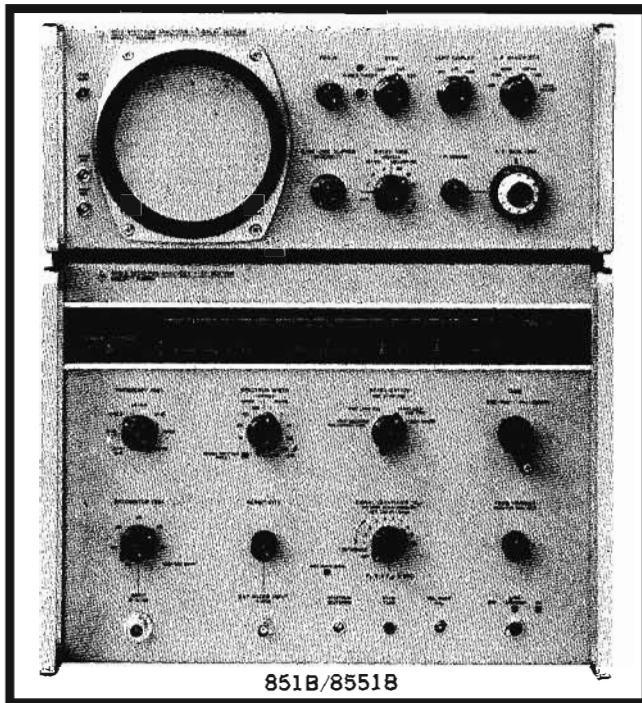

Figure 3. HP Model 851B/8551B Spectrum Analyzer simplified block diagram.



SPECTRUM ANALYZER

Fully calibrated, 2 GHz spectrum width
Model 851B/8551B



Description

The Hewlett-Packard 851B Spectrum Analyzer System is a fully calibrated, highly versatile analyzer which covers the range from 10.1 MHz to 40 GHz. The accuracy and flexibility of the instrument make it suitable for many applications beyond the capability of other spectrum analyzers. These include wideband yet rapid RFI measurements, spectrum surveillance and spectrum signature work, and semiconductor evaluations embracing such tests as fast pulsing viewed in the frequency domain.

The analyzer consists of two units, the 8551B RF Section and either the 851B or the 852B Display Section, comprising a triple-conversion superheterodyne receiver with swept first local oscillator and oscilloscope readout. The RF Section includes the mixers, local oscillators, and two of the three IF amplifiers. The Display Section includes the final IF amplifier, IF attenuator and bandpass filters, and video detector plus the cathode ray tube, sweep generator, and display controls.

Maximum RF input flexibility

The extremely wideband coaxial input system will accept signals from 10.1 MHz to 12 GHz. Use of the broadband, untuned first mixer permits simultaneous observation of widely spaced signals; testing of parametric amplifiers is an application in which this feature is useful, for you can observe the signal, pump, and idler frequencies on a single display and immediately note the effects of adjustments. When it becomes desirable or necessary to limit the input frequency range, this can be done easily by adding appropriate preselectors (such as filters, isolators, tuned amplifiers, etc.). The user has complete latitude in the choice of preselectors, for the analyzer imposes no arbitrary frequency band limitations.

Additional input system flexibility and convenience are afforded by the inclusion of a high performance RF attenuator for use with the coaxial inputs when higher level signals are to be examined. Signal levels as high as 1 watt can be viewed without jeopardizing the input mixer. The attenuator has 60-dB range in 10-dB steps, and because its residual attenuation is very small (less than 2 dB at 10 GHz), it can remain an integral part of the input system, thereby eliminating any need for cable patching. In addition, the attenuator provides a well matched input for the analyzer. The match on the straight-through or 0-dB position of the attenuator is also good with a maximum of reflection coefficient of 0.5 (swr of 3).

Flat response, high sensitivity

The HP-developed input mixer provides the analyzer with extremely flat frequency response. Over full 2-GHz spectrum widths, response is ± 1 dB on fundamental mixing, ± 2 to ± 3.5 dB on harmonic mixing to 10 GHz. Over spectrum widths of 100 MHz, frequency response is correspondingly better. Response over the 4 to 6-GHz range is shown in Figure 1. Such flat frequency response permits reliable quantitative measurements where amplitude comparisons of signals at different frequencies can be made (such as in measuring the harmonic content of signals). Very low-level harmonic and intermodulation products are generated within the mixer. For example, with a -30 dBm input level to the mixer, harmonic and intermodulation products are typically 50 dB below the signal level when fundamental mixing is employed. An additional feature of the input mixer is that the diode is a standard, readily available item easily replaceable from the front panel.

The 851B/8551B has high sensitivity as well as flat frequency response. Sensitivity (10 kHz BW) ranges from -100 dBm in the lower coaxial ranges (where fundamental mixing is employed) to -65 dBm in the highest waveguide band (using harmonic mixing). This sensitivity plus the 60 dB range of the input attenuator enables the analyzer to handle an extremely broad range of signal levels.

The discussion above deals primarily with the coaxial input system of the analyzer. Analysis of signals at higher frequencies where waveguide systems are employed can also be performed. External waveguide mixers covering 8.2 to 40 GHz are used, with a simple coaxial cable serving as the interconnecting link between the mixer and the 8551B. The single cable delivers local oscillator power to the mixer and returns the mixing products to the analyzer. Thus there is no need to use cumbersome flexguide or resort to awkward handling merely to observe signals in waveguide systems. External waveguide attenuators, such as the HP 382 series, can be used to control the input signal level.

2 GHz spectrum width with clutter-free display

A fresh approach to spectrum analyzer design has resulted in an 8551B offering up to 2 GHz of calibrated spectrum width with display that is free from the spurious responses and images which historically have made interpretation of spectral displays very difficult. This is achieved through use of the 2-4 GHz backward wave oscillator acting as the first

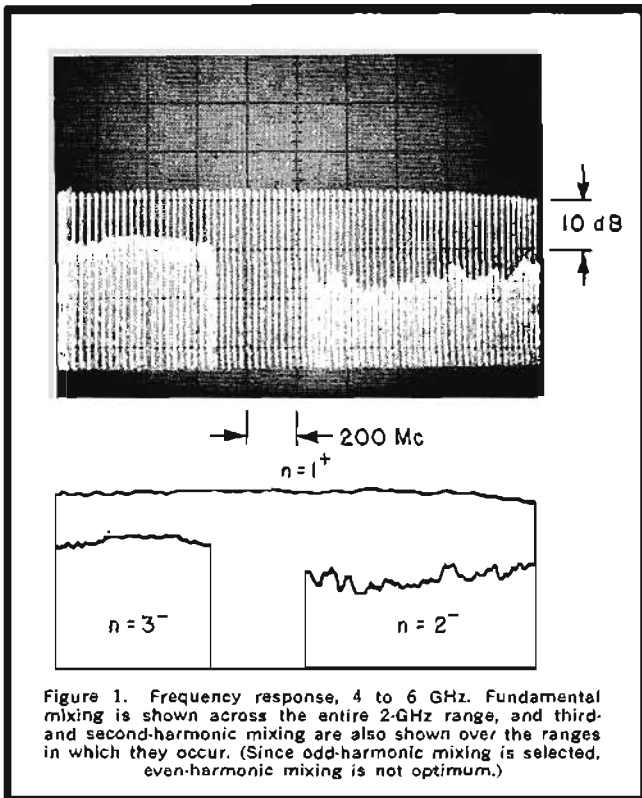

Figure 1. Frequency response, 4 to 6 GHz. Fundamental mixing is shown across the entire 2-GHz range, and third- and second-harmonic mixing are also shown over the ranges in which they occur. (Since odd-harmonic mixing is selected, even-harmonic mixing is not optimum.)

swept local oscillator (LO) followed by a 2 GHz first IF amplifier. Sweeping the first local oscillator allows use of fixed tuned, narrow-band IF amplifiers throughout the analyzer, which eliminates the sources of spurious signals found in other spectrum analyzers. The high frequency first IF spaces images 4 GHz apart and therefore image signals do not clutter the display. The combination of a 2-4 GHz swept LO and a 2 GHz first IF provides low frequency coverage down to 10.1 MHz. When the LO is set to 2 GHz, the LO feeds directly through the IF and can serve as a signal source to perform self-checks on the analyzer's performance and calibration. Figure 2 illustrates the use of the 2-GHz spectrum width in the evaluation of a frequency doubler.

When viewing signals very close to 2 GHz in frequency, a separate first IF of 200 MHz can be switch selected. The 200 MHz first IF mode can be used to observe signals from 1.8 to 4.2 GHz; sensitivity exceeds -100 dBm and images are 400 MHz apart. Flatness of response and freedom from internally generated spurious signals are also characteristic of this mode.

In addition to its wide sweep capability, the 851B/8551B Spectrum Analyzer also excels in the presentation of narrow frequency sweeps. Spectrum widths as narrow as 100 kHz can be selected for detailed examination of individual signals, distortion products, etc. Figure 3 is the spectrum of an amplitude-modulated signal in the VHF region. The narrow sweep capability of the analyzer is made possible by a self-contained phase-lock system which reduces residual FM in the first local oscillator to less than 1 kHz. Stabilization of the local oscillator by means of phase-lock is possible for spectrum widths up to $N(10\text{MHz})$ (where N is the harmonic number of the LO); this is well beyond the point where residual FM of the unstabilized LO could be detected on the display. For operator convenience, a front panel warning light indicates spectrum width too great for use of phase-lock stabilization.

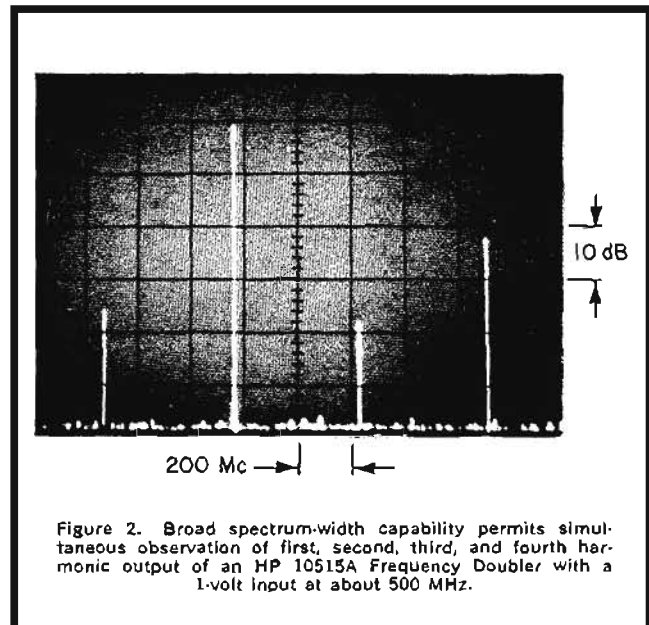

Figure 2. Broad spectrum-width capability permits simultaneous observation of first, second, third, and fourth harmonic output of an HP 10515A Frequency Doubler with a 1-volt input at about 500 MHz.

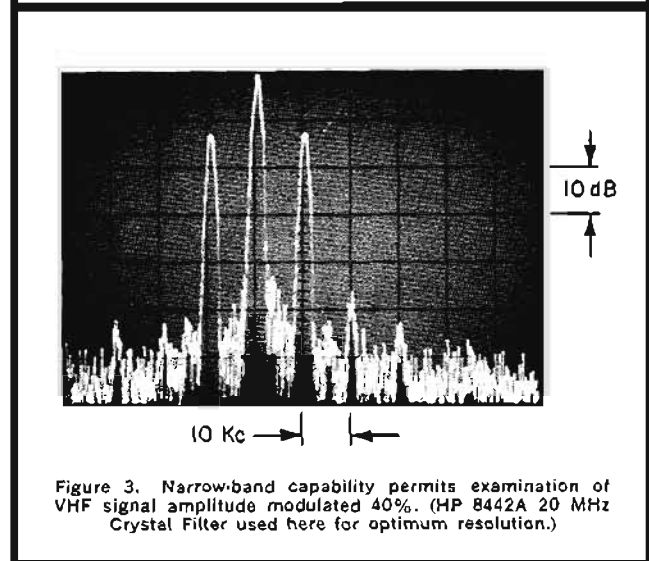

Figure 3. Narrow-band capability permits examination of VHF signal amplitude modulated 40%. (HP 8442A 20 MHz Crystal Filter used here for optimum resolution.)

The 8551B provides simplicity of tuning, particularly when the unit is operated with the LO stabilized. The phase-lock system itself tracks with tuning so the LO remains stabilized while it is sweeping and also when its center frequency is changed. Thus, there is no need to re-establish phase-lock with every change of frequency, so the operator can continue to tune the analyzer with a single-knob.

Two tuning speeds are available. The shift between coarse and fine tuning is accomplished by a pull-push selector on the tuning control. An ultra-fine vernier is also available during stabilized operation for precise positioning of the display.

Positive signal identification

Measurements with the 8551B are simplified by the fact that all displayed signals are easily and positively identifiable. Factors contributing to the ease of signal identification are the 4-GHz image separation and almost total absence of spurious signals which otherwise clutter the display and mask real signals. Actual identification is straightforward. A front-panel control permits rapid determination of the LO mixing harmonic and identification of the signal as an upper or lower mixing product.

SPECTRUM ANALYZER *continued***8551B RF section****Specifications**

(When connected to display section)

Coaxial Input characteristics**Frequency range:** 10.1 MHz to 12 GHz. Input connector, Type N female.**Sensitivity**
$$\frac{(\text{signal power} + \text{noise power})}{\text{noise power}} = 2; 10 \text{ kHz IF bandwidth):}$$

10.1 MHz to 100 MHz, -98 dBm, fundamental mixing

100 MHz to 1.8 GHz, -100 dBm, fundamental mixing

1.8 to 4.2 GHz, -100 dBm, fundamental mixing (using 200 MHz 1st IF)

2.4 to 4.1 GHz, -90 dBm, second harmonic mixing

4.1 to 6 GHz, -100 dBm, fundamental mixing

6 to 8 GHz, -88 dBm, third harmonic mixing

8 to 10 GHz, -91 dBm, second harmonic mixing

10 to 12.0 GHz, -85 dBm, third harmonic mixing

With source stability better than 1 kHz, greater sensitivity can be achieved using narrower IF bandwidth.

Image separation: 4GHz, (2 GHz First IF: 400 MHz separation when using 200 MHz IF).**Maximum input power (for 1 dB signal compression)**

Input Atten Setting	Typical Max Input (peak or average)
0 dB	-10 dBm
10 dB	0 dBm
20 dB	+10 dBm
30 dB	+20 dBm
40 - 60 dB	+30 dBm

Mixer diode: standard 1N4603 replaceable from the front panel.**Residual responses (no input signal):** less than -90 dBm referred to signal input on fundamental mixing (-85 dBm when LO is within 60 MHz of 2 or 4 GHz).**RF input attenuator:** 0 to 60 dB in 10-dB steps (attenuator residual loss and flatness characteristics included in sensitivity and frequency response specifications). Input ac coupled; maximum dc voltage: 50 V on 0 - dB setting, 7 V on all others.**Waveguide input characteristics****Frequency range:** 8.2 to 40 GHz (accessory mixers and adapters required).**Sensitivity**
$$\frac{(\text{signal power} + \text{noise power})}{\text{noise power}} = 2; 10 \text{ kHz IF bandwidth):}$$

8.2 to 18 GHz, -80 dBm

18 to 26.5 GHz, -75 dBm

26.5 to 40 GHz, -65 dBm

Maximum input power (for 1 dB signal compression):

8.2 to 12.4 GHz (using 11521A Mixer) typically -15 dBm peak or average.

12.4 to 40 GHz (using 11517A Mixer) typically -15 dBm peak or average.

External mixer input connector: BNC female; LO power to mixer and 2 GHz IF signal from mixer use this connector.**RF sweep, first local oscillator (LO), and RF tuning characteristics****Spectrum width:** 10 calibrated spectrum widths from 100 kHz to 2 GHz in a 1, 3, 10 sequence to 1 GHz. Vernier allows continuous adjustment between calibrated ranges and can be used to reduce width to 0. Displayed over 10-cm horizontal span on display section CRT.**Swept frequency linearity:** spectrum widths 200 MHz/cm to 3 MHz/cm: Frequency error between two points on the display is less than $\pm 10\%$ ± 3 MHz of the indicated frequency separation between the two points.Spectrum widths 1 MHz/cm to 10 kHz/cm (stabilized tuning mode): Frequency error between two points on the display is less than $\pm 5\%$ of the indicated frequency separation between the two points.**First local oscillator:** 2 to 4 GHz backward wave oscillator.**Tuning accuracy:** $\pm 1\%$ of first LO fundamental or harmonic.**Tuning modes:** selectable continuous coarse, fine, and stabilized (phase-locked) tuning determines center frequency about which first Local Oscillator (LO) is swept. Tuning accomplished with single front panel TUNE control (with FREQUENCY VERNIER control for increased settability when in stabilized tuning mode; vernier tuning range 100 kHz).

Frequency change of LO fundamental is 200 MHz per revolution of TUNE control for COARSE, 10 MHz per revolution for FINE.

LO stabilization range: first LO can be phase-locked to internal voltage-tuned reference oscillator. LO sweep tracks reference oscillator sweep for spectrum widths up to $N \times 10$ MHz ($N =$ harmonic number).**Stabilized tuning:** internal reference oscillator automatically tracks with TUNE control over full LO range to retain stabilization at any LO frequency. Frequency change of LO fundamental is 10 MHz per revolution of the TUNE control. FREQUENCY VERNIER control (100 kHz tuning range) permits precise settability.**LO characteristics****Residual FM:** less than 1 kHz (p-p) when first LO stabilized; typically less than 40 kHz (p-p) when LO not stabilized.**Noise sidebands:** more than 60 dB below CW signal level 90 kHz or more away from signal, using fundamental mixing.**Auxiliary RF output:** approximately 20 mW available at rear panel Type N female connector for use with other equipment (e.g. frequency counter, wavemeter). Requires nominal 50-ohm load impedance; HP 908A termination furnished.**Frequency response, Coaxial input**(includes mixer and RF attenuator response with attenuator setting ≥ 10 dB):

Frequency range	n*	Mixing mode IF (GHz)	Relative gain** (dB)	Flatness, full range (dB)	Flatness, 100 (dB)
10.1 to 100 MHz	1-	2	0	± 2.0	± 2.0
100 MHz to 1.8 GHz	1-	2	0	± 1.5	± 1.0
1.8 to 4.2 GHz	1±	0.2	0	± 3.5	± 2.0
2.4 to 4.1 GHz	2-	2	-7	± 2.5	± 2.0
4.1 to 6 GHz	1+	2	0	± 1.5	± 1.0
6 to 8 GHz	3-	2	-11	± 2.0	± 1.5
8 to 10 GHz	2+	2	-7	± 2.0	± 1.5
10 to 12.0 GHz	3+	2	-12	± 3.5	± 2.0

* n = LO harmonic. Normal operating range specified; full range approximately same performance.

** The approximate relative displayed amplitudes of equal-amplitude input signals for the various harmonic mixing modes.

Signal identification and self-check characteristics

Signal identifier: front panel switch introduces precise frequency offsets to permit exact determination of LO harmonic number used for mixing. Direction of display shift indicates whether signal frequency is higher or lower than LO harmonic. Concentric push button switch permits reestablishment of reference position to facilitate identification of drifting signals.

Self-check: first IF of 2 GHz permits use of swept LO (tuned to 2 GHz) for calibration, alignment, and general performance checks. Stabilized LO provides swept RF signal with very high linearity over 10-MHz range for IF bandwidth calibrations.

General

IF output center frequency: 20 MHz (at rear panel BNC female connector for use with 851B or 852A Display Section).

RFI: conducted and radiated leakage are below requirements of MIL-I-16910C when the RF and display sections are fastened together with the bracket kit supplied.

Power: 115 or 230 V $\pm 10\%$, 50 to 60 cps, less than 275 W (less than 330 W, total, when display section power supplied through 8551B rear panel switched line output).

Weight: net 88 lbs (39,6 kg); shipping 134 lbs (60,3 kg).

Dimensions: 16 $\frac{3}{4}$ " wide, 12-7/32" high, 18 $\frac{3}{8}$ " deep (425 x 310 x 467 mm).

Accessory items furnished: 7 $\frac{1}{2}$ ft (2290 mm) power cable; rack mounting kit; cables to connect 8551B RF section to display section; 908A Termination for rear panel auxiliary LO output.

Price: Model 8551B, \$7550.

851B display section

Display characteristics

Vertical display (7 cm full scale deflection):

Cathode ray tube: 7.5 kV post-accelerator tube with P2 medium persistence phosphor (other optional) and internal graticule; light blue filter supplied; light-proof CRT bezel provides firm mount for oscilloscope camera.

CRT internal graticule: parallax-free 7 x 10 cm, marked in centimeter squares with 2 mm subdivisions on major horizontal and vertical axes.

CRT base line clipper: front panel control permits blanking of CRT trace baseline to allow more detailed analysis of low repetition rate signals.

Weight: net 34 lbs (15,2 kg); shipping 38 $\frac{1}{4}$ lbs (17,1 kg).

Price: Model 851B, \$2400.

Options: 07; P7 phosphor in lieu of P2 (amber filter supplied)n/c 31; P31 phosphor in lieu of P2 (green filter supplied)n/c

852A display section

Display characteristics

Cathode-ray tube:

Type: Post-accelerator storage tube, 7300-volt accelerating potential; aluminized P31 phosphor; etched safety glass face plate reduces glare.

Graticule: 7 x 10 divisions (approximately 8.5 x 5.9 cm) parallax-free internal graticule; 5 subdivisions per major division on major horizontal and vertical axes.

Warranty: CRT specifications (persistence, brightness, storage time) warranted for one year.

Persistence:

Normal: Natural persistence of P31 phosphor (approximately 0.1 second).

Variable:

Normal writing rate mode: continuously variable from less than 1 min (typically to 2 or 3 minutes).

Max. writing rate mode: typically variable from 0.2 to 15 s.

Erase: manual; erasure takes approximately 0.5 s; CRT ready to record immediately after erasure.

Brightness: Greater than 100 foot-lamberts in NORMAL or VIEW; typically 5 foot-lamberts in STORE.

SPECTRUM ANALYZER *continued*

851B, 852A display section

Storage time:

	NORMAL Writing Rate mode	MAX Writing Rate mode
STORE mode (dim display)	longer than 1 hour	typically 15 minutes
VIEW mode (bright display)	longer than 1 minute (typically 2 or 3 minutes)	typically 15 seconds

CRT base line clipper: front panel control permits blanking of CRT trace baseline to allow more detailed analysis of low repetition rate signals.

Power: 115 or 230 volts $\pm 10\%$, 50 to 400 cps, 75 W.

Weight: Net 36 lbs (16,1 kg). Shipping 40 $\frac{1}{4}$ lbs (18 kg).

Price: Model 852A, \$3,400.00.

851A, 852A display section

IF characteristics

IF input center frequency: 20 MHz (accepts 20 MHz output from 8551B RF Section).

IF bandwidth: manual: bandwidths of 1, 3, 10, 100 kHz, and 1 MHz can be selected; AUTO SELECT: one of the above bandwidths automatically selected for best resolution of a CW signal for each combination of Spectrum Width and Sweep Time; bandwidth accuracy: individual bandwidths are calibrated within $\pm 20\%$, bandwidth repeatability and stability typically better than $\pm 3\%$.

IF gain set: 2-section attenuator provides 0 to 80 dB attenuation in 1-dB steps; one section provides 0 to 70 dB attenuation in 10-dB steps; the other 0 to 10 dB in 1-dB steps; IF Vernier provides continuous adjustment between 1-dB steps.

IF gain set accuracy: 70-dB section, ± 0.5 dB; 10-dB section, ± 0.1 dB.

Sweep characteristics

Sweep time: six calibrated rates from 3 msec/cm to 1 sec/cm in a 1, 3, 10 sequence; Vernier provides continuous adjustment between calibrated rates and extends slowest rate to at least 3 sec/cm.

Sweep time accuracy: $\pm 3\%$.

Sweep synchronization: INTERNAL: sweep free runs; LINE: sweep synchronized with power-line frequency; EXTERNAL: sweep synchronized with externally applied signal of +3 to +15 volts peak amplitude; BNC female input connector on rear panel; SINGLE SWEEP: sweep actuated by front panel pushbutton; panel light signifies duration of single sweep.

External sweep: input: 0 to +15 volt external signal (from 10 k ohm source impedance) results in full horizontal trace; BNC female connector on rear panel, direct-coupled; blanking: -5 volt external blanking signal required to blank retrace; BNC female connector on rear panel.

General

Output signals: vertical and horizontal signals applied to CRT are available for external applications; rear panel BNC female connectors; vertical: 0 to approximately -4 volts, open circuit, 4700 ohms source impedance; horizontal: 10 volts p-p ± 0.3 volt, open circuit, sweep approximately symmetrical about 0 volts, source impedance 4700 ohms, IF test point (20 MHz) also provided, rear panel BNC female connector.

Power: 115 or 230 V $\pm 10\%$, 50 to 400 Hz, < 55 W.

Dimensions: 16 $\frac{3}{4}$ " high, 16 $\frac{3}{8}$ " deep behind panel (483 x 177 x 416 mm).

Weight: net 41 lbs (18,5 kg); shipping 48 lbs (21,6 kg).

Accessory items available: 8442A 20 Mc Crystal Filter for increased resolution on 1 KHz IF bandwidth \$225.00. 197A Oscilloscope Camera, \$540.00.

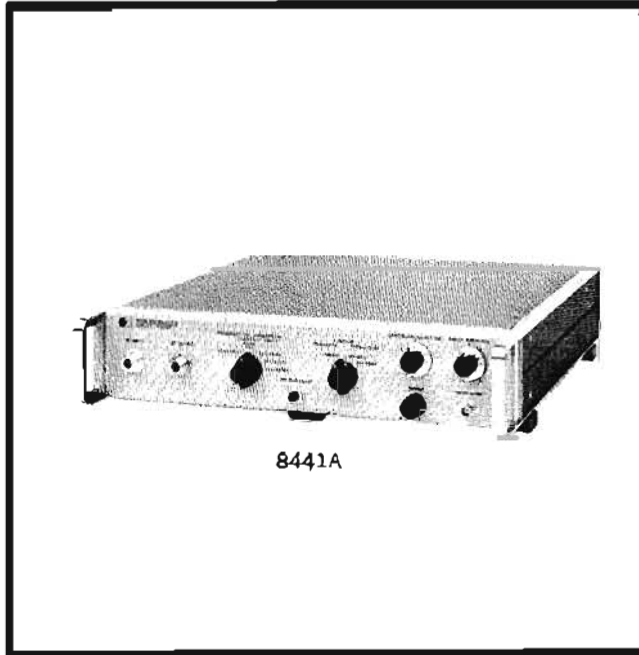
SPECTRUM ANALYZER *continued***Accessories**

The HP 8441A Preselector is a voltage-tunable bandpass filter designed primarily as an accessory instrument for the HP 8551B Spectrum Analyzer. The 8441A uses an yttrium-iron-garnet (YIG) filter as the tunable element. The YIG sphere is tuned by a current-controlled magnetic field. Passband of the filter is about 30 MHz; frequency range is from 1.8 to 12.4 GHz. When used with the 8551B, the preselector tracks the RF input frequency of the analyzer to reject all signals other than those desired. By automatically tracking the analyzer front end, the 8441A Preselector virtually eliminates multiple responses, image responses and spurious responses. The display on the CRT is greatly simplified as only the band of frequencies desired is present on the display. Center frequency of display may be read directly on the 8551B tuning dial, eliminating the necessity for a signal identifier.

The 8441A can be used as a manually tuned narrow-band microwave filter anywhere in the 1.8 to 12.4 GHz frequency range. Continuous tuning is controlled by one dial on the front panel. Also, the filter may be tuned across its range by an internal sweep oscillator. Center frequency and sweep limits are front panel selected. When internally swept, the 8441A plus a broadband crystal detector and a sensitive oscilloscope form a simple spectrum analyzer.

Specifications, as preselector for 8551B

Frequency range: 1.8 to 12.4 GHz. Input connector, Type N female.

Insertion loss: insertion loss in the passband is less than 5 dB; minimum VSWR in the passband is less than 2:1. The filter reflects applied signals at frequencies other than the passband, so the VSWR is very high outside the passband.

Undesired response reduction: (reduction of responses of the 8551 to harmonic mixing modes other than the one preselected). At least 35 dB.

Contribution to 8551B frequency response

Preselector Harmonic Mixing Mode	Addition to 8551B Variation
1±; 200 MHz IF	±2.5 dB over 2 GHz range
1+; 2 GHz IF	±2.5 dB over 2 GHz range
2±; 2 GHz IF	±3.5 dB over 2 GHz range
3±; 2 GHz IF	±4.5 dB over 2 GHz range

Limiting level: (maximum input level for <2 dB signal compression).

−20 dBm, 1.8 GHz to 2 GHz.

+10 dBm, 2 GHz to 12.4 GHz.

Absolute maximum input level: +30 dBm; 8551 Input Attenuator must be set to keep power to analyzer input mixer below 0 dBm to prevent damage to the mixer.

Reduction in 8551 Local Oscillator Emission: (LO emission is 2 GHz to 4 GHz; level is typically 0 dBm).

2 GHz IF input: 50 dB (except when preselecting 2-harmonic mixing mode from 2 GHz to 4 GHz).

200 MHz IF Input: 33 dB (1-harmonic mixing mode).

40 dB (1-harmonic mixing mode).

Dimensions: 16¾" wide, 13¼" high, 19" deep (425 x 337 x 483 mm).

Maximum 851 or 852 sweep rate: 10 milliseconds/div.

Connections to 851B/8551B; 852A/8551B

851B/852A horizontal output, BNC female.

8551B preselector drive output, BNC female.

8551B RF input, Type N female.

RFI: conducted and radiated leakage are below those specified in MIL-I-6181D and MIL-I-16910C.

Power: 115 or 230 volts ±10%, 50 to 400 Hz.

Weight: net 18¾ lbs (8.6 kg); shipping 22¾ lbs (10.5 kg).

Accessory items furnished: 7½ foot power cable, rack mounting kit; cables to connect preselector to 8551B.

Price: Model 8441A, \$2,950.

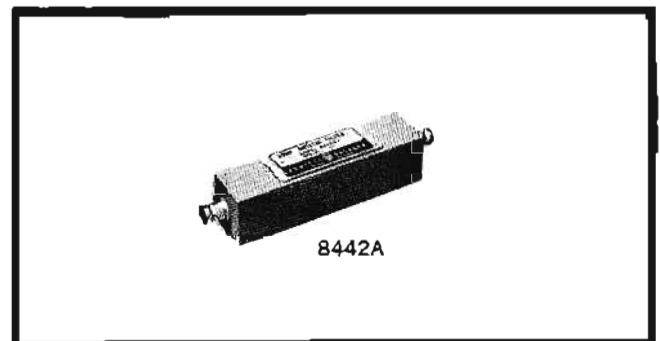

The HP 8442A 20 MHz Crystal Filter is a bandpass filter with a 20 MHz center frequency for use with the HP 8551B Spectrum Analyzer. The filter, which has a 2 kHz passband, improves the skirt characteristics of the 851/852 display section of the analyzer for greater resolution of closely spaced signals. Filter bandwidth at the 60 dB points is less than 10 kHz. Small in size, the filter is easily connected in the 20 MHz line between the 8551B and the display sections of the analyzer.

Price: HP 8442A, \$225.

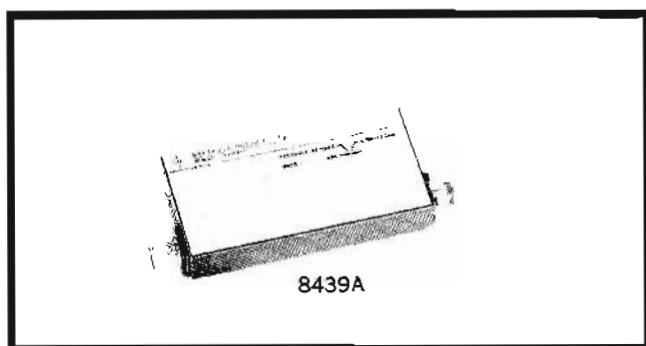

8439A 2 GHz notch filter

Model 8439A has an extremely narrow rejection notch (2 MHz at 60 dB down) at 2 GHz, thereby permitting observation of broadband signals without interference from signals at the 2-GHz IF (evidenced by the raising of the entire baseline on the CRT). Price: HP 8439A, \$240.

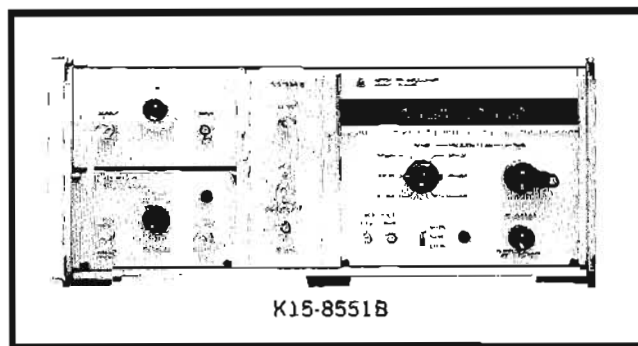

K15-8551B up-converter

The K15-8551B extends the lower-frequency limit of the 8551B spectrum Analyzer from 10 MHz to 10 kHz. With a sensitivity of about -107 dBm ($1 \mu\text{V}$) throughout this range, the Up-converter/Spectrum Analyzer combination is equally well suited to the laboratory and the field. For example, the combination can be used in the design of low-level transistor oscillators; it can also serve as a spectrum-surveillance monitor for control of interference in radio communication. For maximum flexibility, the Up-converter includes an input attenuator which provides up to 120 dB of attenuation in 10-dB steps plus an amplifier with 20 or 40 dB of gain. Price: HP K15-8551B, \$1555.

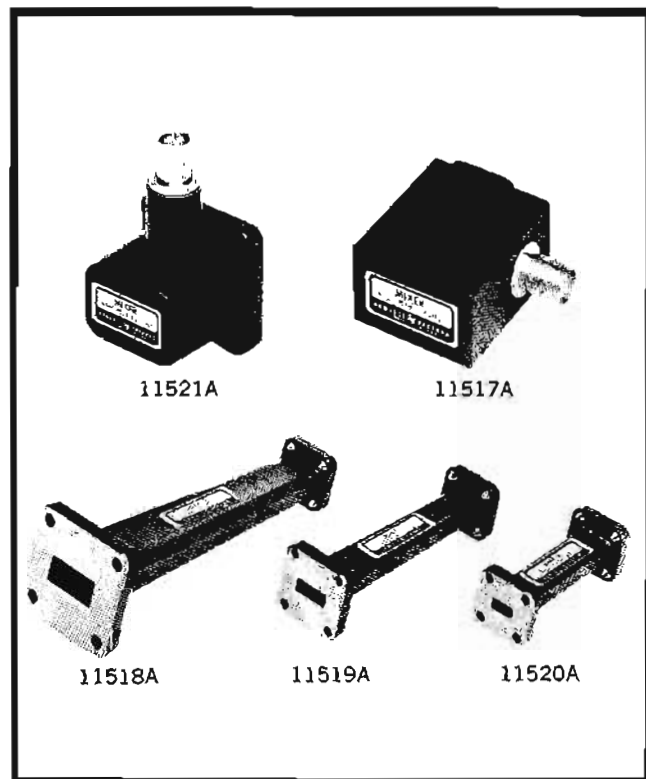

External waveguide mixers, adapters

External waveguide mixers 11517A and 11521A permit direct observation of signals in waveguide systems. The 11517A covers 12.4 to 40 GHz and requires adapters 11518A, 11519A, 11520A as transitions to P-, K-, R-band waveguide respectively. The 11521A Mixer covers X-band (8.2 to 12.4 GHz). Price: HP 11517A Mixer (12.4-40 GHz), \$160, 11518A Adapter (12.4-18 GHz), \$65; HP 11519A Adapter (18-26.5 GHz), \$65; HP 11520A Adapter (26.5-40 GHz), \$65; HP 11521A Mixer (8.2-12.4 GHz), \$75.

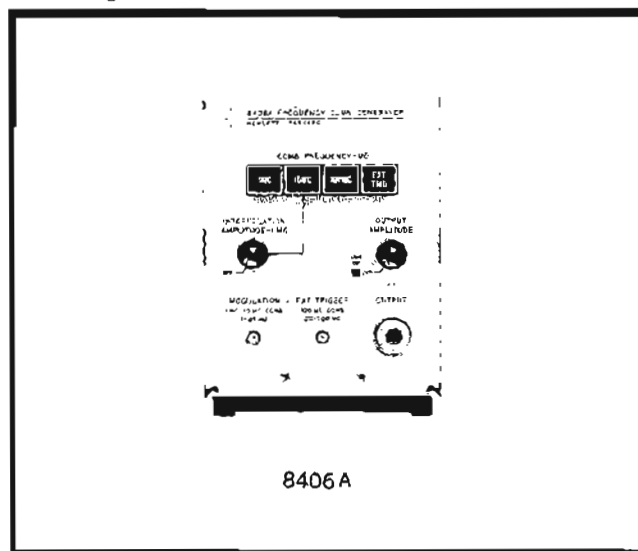

8406A frequency comb generator

Model 8406A provides frequency markers spaced 1, 10, and 100 MHz for frequency calibration of the spectrum analyzer. Because the markers are harmonics derived from 0.01% crystal oscillators, accurate determination of absolute as well as relative frequencies is possible. An external oscillator can be used to produce a comb with different spacing; or each of the output combs can be phase modulated with external oscillators to produce sidebands about each tooth of the comb, thereby facilitating interpolation measurements. The combs are useable from the fundamental to beyond 5 GHz. Price: HP 8406A, \$500.



Amplifiers

Amplifiers have two basic functions in instrumentation: 1) to amplify signals that are too low in level for intended applications, and 2) to isolate circuits from other circuits.

General-purpose amplifiers

A typical general-purpose ac amplifier is the HP 465A. Designed to amplify low-level signals, it has a noise level of 25 μ V and a bandwidth of 1 MHz.

This solid-state amplifier is ideal for increasing the power output of transistorized oscillators or amplifiers. Output power of HP oscillators can be increased 14 times into a 600 Ω load with the 465A, or by a factor of 180 into a 50 Ω load.

The HP 467A Power Amplifier has an average ac power capability of 5 watts over a frequency range from dc to beyond 1 MHz, and 10-watt peak-power output. It has an output impedance that is virtually zero (<0.005 Ω in series with 1 μ H).

If signals >40 volts p-p are needed, two power amplifiers, driven from a differential source such as the HP 200CD Oscillator, may be connected in a push-pull arrangement. This combination will develop 80 volts p-p at 1 ampere.

When the 465A Amplifier is cascaded with the 467A Power Amplifier, Figure 1, the combination achieves 10-watt peak-power output, an overall stable gain of 60 dB and a 1 MHz frequency response.

The 467A also serves as a power supply with an adjustable control that can

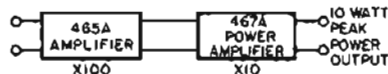

Figure 1. Cascading the HP 467A Power Amplifier with the HP 465A Amplifier results in a stable 60 dB amplifier with 10 M Ω input impedance and 10 W peak-power output.

provide maximum-negative to maximum-positive output voltage. The output voltage polarity may thus be changed without switching or lead changing, a useful feature in semi-conductor diode testing, where both reverse and forward bias are required.

Precision ac amplifier

Recently introduced, the HP 463A is a precision, all solid-state amplifier delivering 100 volts rms at 5 watts. Augmenting these features is the ultra-low distortion specification and three fixed-gain ranges (10, 100 and 1000) with a continuously-adjustable gain capability from 0 to 1000.

The 463A is valuable not only in precision measurements and calibration set-ups, but as a general-purpose amplifier. It is ideal for amplifying the output of the most stable solid-state oscillators, or to isolate thermocouple transfer measurements. It is entirely suitable as a pre-amplifier for precision ac voltmeters, whether digital (HP 3440A/3445A) or other (e.g., 741B Differential Voltmeter).

High-frequency ac amplifiers

The HP Models 461A and 462A Amplifiers have wide bandwidths plus input and output emitter-followers to match 50 Ω coaxial lines. The 461A frequency response extends to 150 MHz. The 462A is rolled off along a Gaussian curve to preserve the wave-shapes of complex waveforms.

Sources of radio frequency interference generated by high-frequency or fast-pulse circuits can be located and identified by combining the HP Model 140A/1410A/1425A Sampling Oscilloscope with a 461A/462A Amplifier. An exploring loop of two or three turns of wire attached to the amplifier input cable serves as a convenient probe. The amplifier provides sufficient gain to drive the sync input of the scope input channels through a probe tee on the amplifier output cable, as shown in Figure 2.

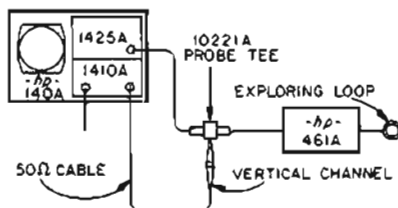

Figure 2. Block diagram shows use of amplifier with search exploring loop and oscilloscope to probe for RF radiation sources.

DC amplifiers

A widely-used technique for circumventing the drift problems of direct-coupled amplifiers is to convert the dc to an equivalent ac (modulation). The ac is amplified in a gain-stable ac amplifier and reconverted to dc (demodulation). During amplification, the signal is represented by the difference between the maximum and minimum excursions of the ac waveform and is not affected by drift in the absolute voltage levels within the amplifier.

One method of converting the dc to ac is to switch the amplifier input alternately to both sides of a transformer, as shown in Figure 3. This periodically inverts the

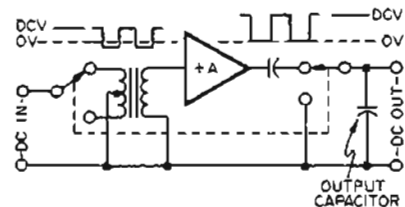

Figure 3. Modulated amplifier.

polarity of the signal applied to the amplifier. The switches illustrated may be mechanical, transistor or photoconductive. Another pair of contacts at the output establishes the ground level for a storage capacitor in series with the output. The output storage capacitor becomes charged to a level corresponding to the amplitude of the output square wave. Synchronous detection preserves the polarity of the input voltage and recovers both positive and negative voltages with the correct polarity.

The dc amplifiers just described offer drift-free amplification of low-level signals in the microvolt region. Another modulation technique uses two photoconductors—one in series with, and one parallel to the amplifier input, shown in Figure 4.

Photoconductors' resistance is proportional to their illumination. By illuminating the photoconductors alternately, the amplifier input is connected to the signal

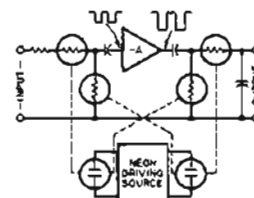

Figure 4. Amplifier with photoconductive modulator.

and to ground. Photoconductors perform well as modulators at microvolt levels. They can be isolated from the driving signal and designed with very low offset voltages.

Differential amplifiers

Differential data amplifiers have two identical input channels that function in push-pull fashion. The output generally is single-ended and represents the amplified difference between the two input channels. This arrangement cancels hum or other interference picked up on the signal leads which appear in phase to the amplifier inputs (referred to as common-mode signals). Examples are the HP Models 2470A and 8875A.

Since a differential amplifier is sensitive only to the difference between the two input signals, the transducer or other signal source need not be grounded. Therefore, differential amplifiers allow a bridge-type transducer to be used with a grounded power supply.

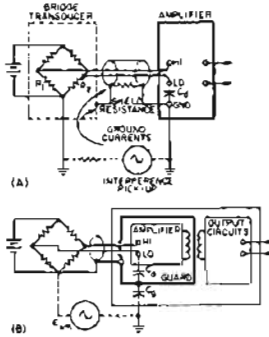

Figure 5. Guard reduces capacitance between signal leads and ground.

The differential amplifier configuration also allows injection of a fixed dc voltage into either channel to permit establishment of a new voltage-reference level at the output (zero suppression).

When the input is floating, cable shielding may be connected to chassis ground rather than to signal ground. However, both ac and dc potentials can exist between two widely-separated earth grounds, and common-mode currents may circulate. The signal leads and the internal capacitances are shown lumped as C_A in Figure 5. Consequently, a ground loop may inject interference into the signal path. A guard shield (Figure 5) providing an electrostatic shield around the input circuitry breaks the stray capacitance into two series capacitances, C_A and C_B . A much higher impedance is then presented to the flow of common-mode signals. This type is termed a floated and guarded amplifier.

DC amplifiers using choppers are able to couple the signal information out of the guard shield by means of transformers. No dc connection between the output and input grounds is necessary; and no ground loops are formed between the input circuits and equipment connected to the output.

Amplifiers designed for use with guarded digital voltmeters or other guarded equipment (Models 2411A and 860-4300) continue the guard shield through the output.

Microwave amplifiers

There often are applications requiring high-quality microwave signals, such as those obtained from precision signal generators where the magnitude of signal power needed is greater than that available directly from the signal generator. Amplification of the signal generator output will fill this requirement. At frequen-

cies from 1 to 12.4 GHz this is accomplished by HP microwave amplifiers. Four broadband amplifiers are available, each using a traveling-wave tube that delivers at least one watt output with one milliwatt or less input. Excellent stability is achieved through the use of highly regulated power supplies for all elements of the TWT, including the filament. The amplifiers have provision for amplitude modulation and since the internal modulation amplifier is dc-coupled, remote programming and power leveling are possible. Sensitivity is high for large output power changes from relatively small modulation signals, obviating the need for an external modulation amplifier.

Selecting an amplifier

Stability, noise and input-output impedances, as well as cost, are basic considerations. If an amplifier is to be used for general-purpose applications, low

distortion and preservation of magnitude relations are essential. When selecting an amplifier for pulse applications, low rise times and low sag are of prime importance. The differential amplifier is the most logical choice when interference from other connecting equipment is likely. To preserve guarding features of voltmeters or other connecting equipment, or to suppress common-mode noise, a floated and guarded amplifier is essential.

All the Hewlett-Packard amplifiers described have been designed to maximize performance over a specific group of applications while minimizing cost. A Hewlett-Packard amplifier is available to meet your specific requirements. Refer to tables for relative functions and features. The extensive amplifier line of Hewlett-Packard Sanborn Division, comprising a wide variety of general-purpose and specialized types, is described on pages 440 and 441.

General-purpose amplifiers

Model	Frequency response	Gain	Input Z	Noise (max)	Output (max)	See page
450A	± 0.5 dB, 10 Hz - 1 MHz ± 1 dB, 5 - 10 Hz and 1 - 2 MHz ± 0.5 dB, 5 Hz - 1 MHz ± 1 dB, 2 - 5 Hz and 1 - 1.2 MHz	40 dB 20 dB	1 M Ω /15 pF	250 μ V (referred to input)	10 V into 3000 Ω	443
461A/462A	± 1 dB, 1 kHz - 150 MHz into 50 Ω load	40 dB 20 dB	50 Ω	< 40 μ V at 40 dB	0.5 V into 50 Ω load	445
465A	± 0.1 dB, 100 Hz - 50 kHz < 2 dB, at 5 Hz and 1 MHz	40 dB 20 dB	10 M Ω /20 pF	25 μ V referred to input	5 V rms into 50 Ω 10 V open circuit	444
466A	± 0.5 dB, 10 Hz - 1 MHz < 3 dB at 5 Hz and 2 MHz	40 dB 20 dB	1 M Ω /25 pF	75 μ V rms	1.5 V rms into 1500 Ω	443
467A	$\pm 1\%$, dc - 100 kHz $\pm 10\%$, 100 kHz - 1 MHz	X1, X2, X5, X10	50 K Ω / 100 pF	< 5 mV p-p	± 20 V peak at 0.5 A peak	444
463A	$\leq 0.01\%$, 10 Hz - 10 kHz $\leq 0.1\%$, 10 kHz - 100 kHz $\leq 0.1\%$, 10 Hz - 20 kHz $\leq 1\%$, 20 kHz - 100 kHz $\leq 0.3\%$, 10 Hz - 20 kHz $\leq 3\%$, 20 kHz - 100 kHz	X10 X100 X1000	1 M Ω / 35 pF (fixed gain) 50 k Ω / < 200 pF (Adj. gain)	(rms referred to input) 1.5 mV 150 μ V 50 μ V	100 V rms (5 W continuous)	446

Power and voltage amplifiers

Model	Instrument	Frequency response	Gain	Output	See Page
467A	Power amplifier is also ± 1 V to ± 20 V $\frac{1}{2}$ amp power supply, input Z 50 k Ω /100 pF, noise < 5 mV p-p.	dc - 100 kHz ($\pm 1\%$) 100 kHz - 1 MHz ($\pm 10\%$)	X1, X2, X5, X10	20 V peak-0.5 A peak	444
230A	Tunable Power Amplifier, source of high-level rf power when used with signal generators.	10-500 MHz	30, 27, 24 dB, depending on frequency	0-15 V into 50 Ω	447
489A	Microwave power amplifiers; TWT devices; amplitude modulation capability with internal 20 dB, 500 kHz modulation amplifier.	1-2 GHz	30 dB	1 W	448
491C		2-4 GHz	30 dB	1 W	448
493A		4-8 GHz	30 dB	1 W	448
495A		7-12.4 GHz	30 dB	1 W	448

Data amplifiers

Model	Instrument	Frequency response	Gain	Noise (max)	Output	See Page
2470A	Differential data amplifier (with internal power supply)	dc-50 kHz	10, 30, 100, 300, 1000	5 μ V rms rti	± 10 V	442
8875A	Differential data amplifier (with internal power supply)	dc-75 kHz	1-1000	5 μ V rms rti	± 10 V	440
860-4300	Narrowband differential amplifier	dc-100 Hz	1000	3 μ V p-p	± 5 V	441

Specialized guarded amplifiers, for use with guarded digital voltmeters, are discussed on pages 236 and 242.



DIFFERENTIAL AMPLIFIER

Wideband amplifier for data acquisition systems
Model 8875A

The 8875A is a differential dc amplifier for use with modern data acquisition systems, to provide high gain (up to 3,000) and a wide bandwidth. It features a low drift for improved long-term measurements, as well as a common-mode rejection of at least 120 dB at 60 Hz, and a common-mode tolerance of ± 20 volts. Intermodulation distortion is avoided by use of a no-chopper input circuit. Dual isolated outputs having 10 mA and 100 mA output capabilities are available by option. The 8875A is available as a single unit, or in banks of up to 10 channels for mounting in a single relay rack.

The 8875A is ideal for use with thermocouples, dc excited strain gages, and other low-level sources, with read-out to devices such as digital voltmeters, data recorders, analog-digital converters, and similar units. Possible duties include space vehicle checkout, monitoring of physical variables, wind tunnel tests, and other data acquisition applications.

Specifications, 8875A

- Bandwidth:** dc to 75 Hz within 3 dB. Can be narrowed to as low as dc to 2 Hz by adding capacitor.
- Gain:** fixed steps of 1, 3, 10, 30, 100, 300, 1000, plus OFF; variable gain (switch-selected) provides uncalibrated gain up to 3X gain switch setting. Gain accuracy $\pm 0.1\%$; gain vernier allows setting any one fixed gain to 0.01% accuracy.
- Input circuit:** floating; will accept floating input without ground return; may be used single-ended.
- Input impedance:** differential, 20 M Ω with $< 0.001 \mu\text{F}$ shunt; common-mode (guarded), 2,000 M Ω with $< 2 \text{ pF}$ shunt.
- Common-mode rejection:** at least 120 dB from dc to 60 Hz for up to 500 ohms source impedance either side of input at gain of 1,000; 66 dB min at gain of 1.
- Common-mode tolerance:** ± 20 volts.
- Input overload tolerance:** ± 30 volts differential; ± 70 volts common-mode will not damage the amplifier.
- Output circuit:** ± 10 volts across 100 ohms (100 mA), output impedance (dc) 0.2 ohms max. Short circuit proof; current limited to approx 150 mA. Will not oscillate with any value of capacity load.
- Zero drift:** $\pm 3 \mu\text{V}$ referred to input, $\pm 0.2 \text{ mV}$ referred to output, at constant ambient temp for 30 days. $\pm 1 \mu\text{V}/^\circ\text{C}$ referred to input, $\pm 0.2 \text{ mV}/^\circ\text{C}$ referred to output. $\pm 2 \text{ mV}$ referred to output for $\pm 10\%$ change in line voltage.
- Gain stability:** $\pm 0.01\%$ at constant ambient temperature for 30 days, $\pm 0.005\%/^\circ\text{C}$ (fixed-gain steps only). $\pm 0.01\%$ for $\pm 10\%$ change in line voltage.
- Non-linearity:** less than 0.01% of full-scale 10-volt output (zero-based terminal linearity).
- Current feed to source:** 10^{-9}A max at constant ambient temperature, $\pm 10^{-9}\text{A}/^\circ\text{C}$.
- Settling time:** 100 μs to 99.9% of final value for a step input.
- Overload recovery time:** from differential overload signal of $\pm 10 \text{ V}$, at gains of 300 to 1,000, recovery in 10 ms to within 10 μV referred to input plus 10 mV referred to output; for gains of 1 to 100, recovery in 1 ms. For a 10X

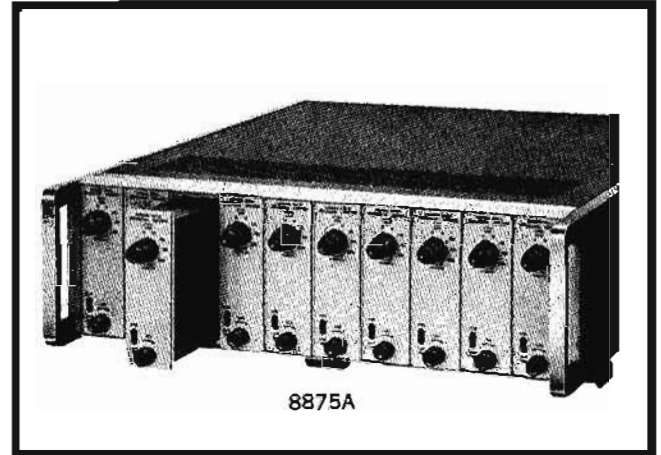

full scale overload of any duration, recovery in 2 ms for gains of 300 to 1,000, and 100 μs for gains of 1 to 100.

Noise: measured at gain of 1,000, with respect to input, 1,000 ohms source impedance:

Bandwidth	Noise	Bandwidth	Noise
dc-10 Hz	1 μV p-p	dc-10 kHz	3 μV rms
dc-100 Hz	3 μV p-p	dc-50 kHz	4 μV rms
dc-1 kHz	6 μV p-p	dc-250 kHz	5 μV rms

Slewing: output circuit, 10^8 V/s for 10 mV shift in dc output with resistive load of 100 ohms or greater. Input circuit, gain = 1, $2.5 \times 10^8 \text{ V/s}$ for 10 mV shift in dc output, gain = 3, $0.83 \times 10^8 \text{ V/s}$ for 10 mV shift in dc output. Output circuit determines slewing rates for gains greater than 3.

Input-output isolation: 2,000 M Ω shunted by 2 pF.

Temperature range: 0°C to 55°C .

General Specifications

Power: 115/230 V $\pm 10\%$, 50-400 Hz, 6 W.

Dimensions: 4 $\frac{3}{4}$ " high, 1-9/16" wide, 15" deep (121 x 40 x 381 mm).

Weight: 3.5 lbs (1.6 kg).

Prices: 8875A Differential Amplifier, \$495.

Option 01: dual outputs, 10 mA and 100 mA capability, short on one output has negligible effect on other, add \$75.

Option 02: switch-selected filters, single-pole low-pass corner frequencies of 2, 200, 2,000, and 20,000 Hz, add \$75.

Option 03: gain ranges 10, 20, 50, 100, 200, 500, and 1,000, add \$25.

Option 04: 14010A Cord Set for bench-top use, required for single-channel operation, add \$25.

Option 05: combines Options 01 and 02 (filters on 10 mA output), add \$150.

Note: must also order 1069-01A Case for multi-channel banks of 10 or less, \$365. Order blank panels 01069-61060 as needed, \$10.

DIFFERENTIAL AMPLIFIERS

High-gain amplification of low-level signals

Model 860-4300



AMPLIFIERS

860-4300 Narrow-Band Differential DC Amplifier

Model 860-4300 is designed to amplify low-level signals from thermocouples, strain gages and other resistance bridge transducers. This completely solid-state, low noise amplifier successfully combines a floating input which allows measurement of low-level signals even though complicated by ground loops, high gain and zero stability; and a floating output (isolated from input) which eliminates ground loop problems with terminal equipment. Typical outputs for these data amplifiers include digital voltmeters, tape recorders, oscillographs, oscilloscopes and other read-out devices.

These amplifiers also are offered in convenient 2- and 8-unit modules for rack mounting, and as an individual amplifier in a portable case. Power supplies are required.

Specifications,* 860-4300

- Gain:** 1000, 500, 200, 100, 50, 20, 10 and off; accuracy: $\pm 0.5\%$ at dc; stability: $\pm 0.05\%$ at dc with constant ambient temperature for 40 hours; $\pm 0.005\%$ change/ $^{\circ}\text{C}$; trim: any gain setting can be trimmed to within $\pm 0.02\%$, covers $\pm 3\%$ range.
- Input:** isolated from ground and from output; impedance: 1 megohm minimum, independent of gain.
- Common mode rejection:** (for 1000 ohms in either input lead) 130 dB at 60 Hz; 160 dB at dc.
- Common mode tolerance:** 220 V rms.
- Bandwidth:** dc to $\pm 1\%$ at 30 Hz; dc to 3 dB down at 100 Hz.
- Rise time:** 20 ms to 0.1% of final value for a step input.
- Output:** isolated from input and from ground; impedance: 75 ohms.
- Output capability:** ± 5 volts at 2.5 mA. Amplifier is internally loaded with 2 k in parallel with 25 ufd. Any part, or all, or this load may be removed and connected externally.
- Linearity:** $\pm 0.05\%$; ($\pm 0.03\%$ for 0 to +5 V or 0 to -5 V).
- Drift:** $\pm 2 \mu\text{V}$ at constant ambient temperature for 40 hours; $\pm 0.2 \mu\text{V}/^{\circ}\text{C}$ referred to input. $\pm 0.1 \text{ mV}$ at constant ambient for 40 hours; $\pm 0.05 \text{ mV}/^{\circ}\text{C}$ referred to output.
- Zero trim:** $\pm 2 \text{ mV}$ for zero input (app).
- Overload recovery:** 200 msec from $\pm 10 \text{ V}$ overload; differential input voltages of $\pm 60 \text{ V}$ peak will not damage input circuitry or chopper. Protection to higher voltages possible.
- Noise:** 3 μV p-p referred to output for zero signal input, gain of 1000 (wideband).
- Ripple:** (peak, due to signal) 0.04% of signal.

General specifications, all models

- Power:** 115 V $\pm 10\%$, 50 to 400 Hz; approx. 5 watts.
- Dimensions:** 7" high, 2" wide, 14.9" deep (178 x 51 x 379 mm); 8800-03A Opt 01 (8-channel rack mounts and power supplies) 7" high, 19" wide, 20-55/64" deep (178 x 483 x

*Specifications are for source impedances of 1000 ohms and ambient temperatures from 15 $^{\circ}\text{C}$ to 45 $^{\circ}\text{C}$. Rate of ambient temperature variation not to exceed 10 $^{\circ}\text{C}/\text{hour}$. Amplifier will operate with higher source impedances. Performance degradation will be in gain accuracy, noise specification and temperature coefficient of gain. Amplifier will operate in ambients to 60 $^{\circ}\text{C}$. In range above 45 $^{\circ}\text{C}$, temperature coefficient of gain will increase to $\pm 0.01\%/^{\circ}\text{C}$ when used with source impedance from 0 to 1000 ohms.

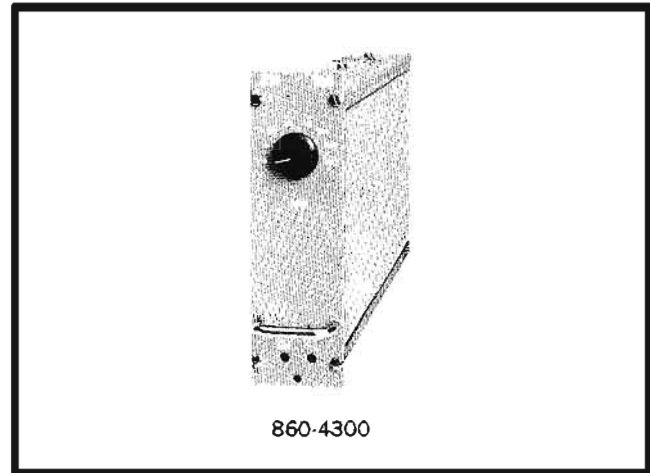

860-4300

530 mm); 860-200A (2-channel extended-front module): 3 $\frac{1}{2}$ " high, 19" wide, 19 $\frac{1}{8}$ " deep (89 x 484 x 486 mm); 860-1400 (1-channel portable case): 8 $\frac{3}{4}$ " high, 3 $\frac{1}{4}$ " wide, 21 $\frac{7}{8}$ " long (222 x 83 x 556 mm). 8849A Opt 01 (1-channel power supply): 7 $\frac{1}{4}$ " high, 3 $\frac{1}{4}$ " wide, 5 $\frac{1}{4}$ " deep (181 x 81 x 131 mm).

Weight: 860-4300: net 5 lbs (2,3 kg), shipping 12 lbs (5,4 kg); 8800-03A Opt 01 (power supplies): net 26 lbs (11,8 kg), shipping, 35 lbs (15,8 kg); 860-200A (2-channel modules): net 10 lbs (4,6 kg), shipping 25 lbs (11,5 kg); 860-1400 (1-channel portable case): net 25 lbs (11,5 kg); shipping 35 lbs (15,9 kg). 8849A Opt 01 (1-channel power supply): net 6 lbs (2,8 kg), shipping 10 lbs (4,6 kg).

Price: 860-4300 Differential Amplifier, requires separate power supply, \$450.

Option 01: horizontal lettering on panel for use with 860-200A, no extra charge.

Accessory prices: 860-200A Two Channel Module (for 860-4300 Opt 01), \$115. 860-1400 case, \$100. 8849A Opt 01 Power Supply, single-channel, \$225. 8800-03A Opt 01 Power Supply, 8-channel, \$1100; 8800-03A may add Opt 04, 10-ft power cord, no extra charge; Opt 05, less standard 3-ft power cord and slide kit, no extra charge.

Other versions of 860-4300

Narrower bandwidths, lower output impedance, higher output, lower drift and other added capabilities listed below are readily available in other versions of Model 860-4300. Contact your Hewlett-Packard sales office for complete information.

Output impedance: < 0.5 ohms. When used with 8800-03A Opt 01 power supply, the low output side of all channels are connected together but not to ground; output connection does not ordinarily introduce objectionable noise; when used with commutators, as in multi-channel data acquisition systems, the output noise introduced will be negligible.

Output capabilities: $\pm 5 \text{ V}$ at $\pm 5 \text{ mA}$ to $\pm 10 \text{ V}$ at $\pm 100 \text{ mA}$.

Dual-output provisions: two 5 mA, or one 5 mA and one 100 mA.

Frequency response: plug-in filters with 12 dB/octave roll-off provide cutoff frequencies to 4 Hz (smooths out noisy signals).

Linearity: $\pm 0.03\%$ of 5 V output (terminal).

Drift: $\pm 1 \mu\text{V}$ at constant ambient temperature for 40 hours.



DATA AMPLIFIER

Solid-state, wideband differential amplifier
Model 2470A

The HP 2470A Amplifier is a flexible wideband differential amplifier exhibiting low drift and noise, achieved without the use of a chopper. The instrument will supply up to 1 watt output to a resistive or reactive load. Exceptionally high reliability and accuracy are achieved by the use of silicon semiconductors.

Applications include amplification of strain gage bridge, thermocouple and other low-impedance sensors. Amplifier provides an output suitable for data acquisition devices, in-

cluding recording galvanometers and oscillographs, analog recorders, servo control systems. Low instrument cost keeps per-channel price to the minimum. The 2470A also applies directly to many general-purpose laboratory uses, both differential and single-ended.

The amplifier with its power supply is packaged in a unique molded dielectric case, so compact that ten instruments fit side-by-side in 5 1/4" of standard 19" rack space.



Specifications

(Specifications hold after 30 min. warm-up in combining case at 25°C ambient, 1 K ohm source resistance, any unbalance. Warm-up period in free air is 1 1/2 hours.)

DC gain: fixed steps: X0 (output shorted), X10, X30, X100, X300, X1000; optionally X0, X1, X10, X100, X1000, or other steps between 1 and 1000 available, up to 6 positions.

Gain accuracy (no load): at 25°C, $\pm 0.02\%$ initially $\pm 0.005\%$ per month stability; $\pm 0.001\%$ per °C maximum temperature coefficient.

Vernier adjustment (optional): $\pm 1\%$ trimpot, $\pm 0.01\%$ resolution; or X1 to X3.5 multiplier with dial calibrated to $\pm 3\%$ accuracy, 0.5% resolution.

DC linearity: 0.002% at gain of 1000, 0 to ± 10 V output.

Input impedance: 10^9 ohms in shunt with 0.001 μ F max.

Zero stability (at constant 25°C): ± 5 μ V per day referred to input; ± 200 μ V per day referred to output; ± 1 μ V/°C, ± 0.5 nA per °C rti; ± 40 μ V/°C rto.

Noise: 0. to 100 Hz: 3 μ V p-p referred to input; +30 μ V p-p referred to output; to 50 kHz: 5 μ V rms, rti; +500 μ V rms rto.

Common mode rejection: 120 dB to 60 Hz.

Maximum input signal: ± 11 V, differential + common mode.

Output: ± 10 V, 0 to 100 mA; self-limits.

Output impedance: 0.1 ohm in series with +10 μ H max.

Load capability: 100 ohms or 0.01 μ F for full output; amplifier undamaged by short or capacitive load.

Reliability: predicted MTBF (90% confidence) 10,000 hours at 25°C ambient.

Slowing: 10^7 V/s referred to output, or 10^9 V/s referred to input.

Bandwidth: ± 1 dB, 0 to 15 kHz, any gain step; ± 3 dB 0 to 50 kHz any gain step; other fixed 3 dB bandwidths between 0 to 50 kHz and 0 to 10 Hz optionally available.

Settling time: 100 μ s to within 0.01% of final value.

Overload recovery: settling time +100 μ s for inputs (signal plus common mode) up to 10 times full scale; less than 5 ms for inputs up to 20 V.

Overload signal (optional): output is -17.5 to -19.5 V without overload; 0 to -1 V with overload, 5 mA drive capability; also, front-panel indication.

Operating conditions: 0 to 55°C ambient temperature range; up to 95% relative humidity at 40°C.

Power: 115 or 230 V $\pm 10\%$, 50 to 400 Hz, 10 W max.

Dimensions: 1-9/16" wide, 4 7/8" high, 15" deep (39.7 x 123.9 x 381 mm).

Weight: net 4 lbs (1.8 kg); shipping 6 lbs (2.9 kg).

Accessories available: mating rear connector with power cord, input/output cables; combining case: contains up to 10 instruments in 5 1/4" of standard 19" rack space (mating connectors furnished with amplifier); bench stand: holds one amplifier upright and includes input/output connectors, power switch, pilot light, power cord.

Optional modifications: 3.5 to 1 gain vernier; overload indicator with output signal; special gain steps; additional buffered output; special bandwidth.

Price: HP 2470A Data Amplifier, \$585.

AMPLIFIERS

Offer 20 or 40 dB gain
Models 450A, 466A



AMPLIFIERS

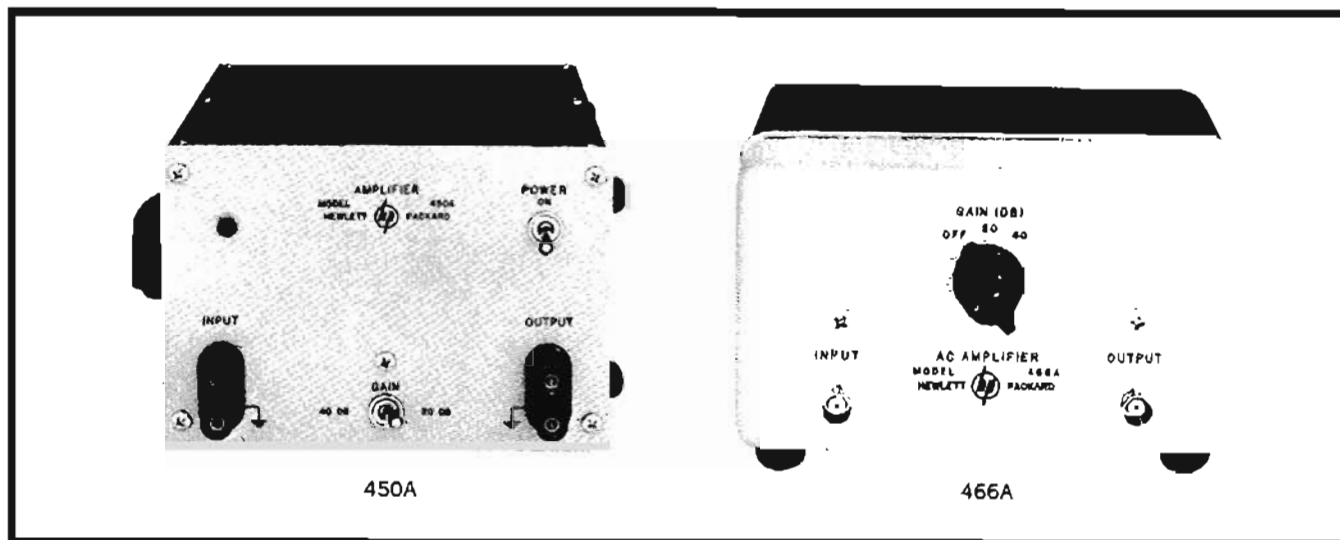

450A Stabilized Amplifier

The HP Model 450A is ideal as a general-purpose instrument wherever wide-frequency range and stable gain are essential. The instrument has an extremely stable 20 dB or 40 dB gain over a continuous frequency range of 10 Hz to 1 MHz. Either gain may be selected quickly with a toggle switch on the front panel.

The amplifier is resistance-coupled and does not use peaking or compensating networks. Optimum performance is obtained entirely from a straightforward amplifier design in combination with inverse feedback. Phase shift is negligible and there are no spurious oscillations or resonances.

Specifications, 450A

- Gain:** 20 dB (X10) or 40 dB (X100) ± 0.125 at 1000 Hz.
- Frequency response:** 40 dB gain: ± 0.5 dB, 10 Hz to 1 MHz; ± 1 dB, 5 Hz to 2 MHz; 20 dB gain: ± 0.5 dB, 5 Hz to 1 MHz; ± 1 dB, 2 Hz to 1.2 MHz.
- Stability:** $\pm 2\%$, includes line voltage variation 115 or 230 V $\pm 10\%$.
- Impedance:** input, 1 megohm, 15 pF shunt; internal, less than 150 ohms.
- Distortion:** less than 1%, 2 Hz to 100 kHz at maximum output; approximately 2% above 100 kHz.
- Output:** 10 V maximum into 3000-ohm or greater load.
- Noise referred to input:** 40 dB gain, 40 μ V; 20 dB gain, 250 μ V.
- Power:** 115 or 230 V $\pm 10\%$, 50 to 1000 Hz, 50 watts.
- Dimensions:** cabinet: 8 $\frac{3}{8}$ " wide, 5 $\frac{1}{2}$ " high, 10 $\frac{3}{4}$ " deep (219 x 140 x 273 mm); rack mount: 19" wide, 5 $\frac{1}{4}$ " high, 10 $\frac{3}{8}$ " deep behind panel (483 x 133 x 270 mm).
- Weight:** net 10 lbs (4.5 kg), shipping 15 lbs (6.8 kg) (cabinet); net 11 lbs (5 kg), shipping 23 lbs (10.4 kg) (rack mount).
- Price:** HP 450A, \$220 (cabinet); HP 450AR, \$225 (rack mount).

466A AC Amplifier

The HP Model 466A AC Amplifier is ideal wherever low distortion, stability, wide-frequency range, and portability are desirable; and it may be used to increase the sensitivity of voltmeters and oscilloscopes, since its gain is accurate and stable.

Model 466A is normally furnished with a plug-in supply for ac operation. For portable operation or for isolation from power lines, the supply may be quickly removed and replaced with batteries. If desired, specify batteries in lieu of the plug-in supply (Option 01).

Specifications, 466A

- Gain:** 20 dB (X10) or 40 dB (X100) ± 0.2 dB at 1000 Hz.
- Frequency response:** ± 0.5 dB, 10 Hz to 1 MHz down 3 dB, or less at 5 Hz and 2 MHz.
- Output voltage:** 1.5 V rms across 1500 ohms.
- Output current:** 1 mA rms maximum.
- Noise:** 75 μ V rms referred to input, 100,000-ohm source.
- Impedance:** input, 1 megohm, 25 pF shunt; output, 50 ohms in series with 100 μ F.
- Distortion:** less than 1%, 10 Hz to 100 kHz; less than 5% to 1 MHz.
- Power:** 115 or 230 V $\pm 10\%$, 50 to 1000 Hz, approximately 1 watt (supply normally furnished); battery operation optional: radio-type mercury batteries, TR234-316649 or equivalent, 3 required (HP \neq 1420-0006); battery life, 150 hours.
- Dimensions:** 6 $\frac{1}{4}$ " wide, 4" high, 6 $\frac{1}{4}$ " deep (159 x 102 x 159 mm).
- Weight:** net 2 $\frac{1}{2}$ lbs (1.13 kg); shipping 3 $\frac{1}{2}$ lbs (1.58 kg).
- Price:** HP 466A, \$180, ac operation.
- HP 466A Option 01:** batteries in lieu of ac supply, \$150.

AMPLIFIERS



SOLID-STATE AMPLIFIERS

Precision general-purpose amplifiers

Models 465A, 467A

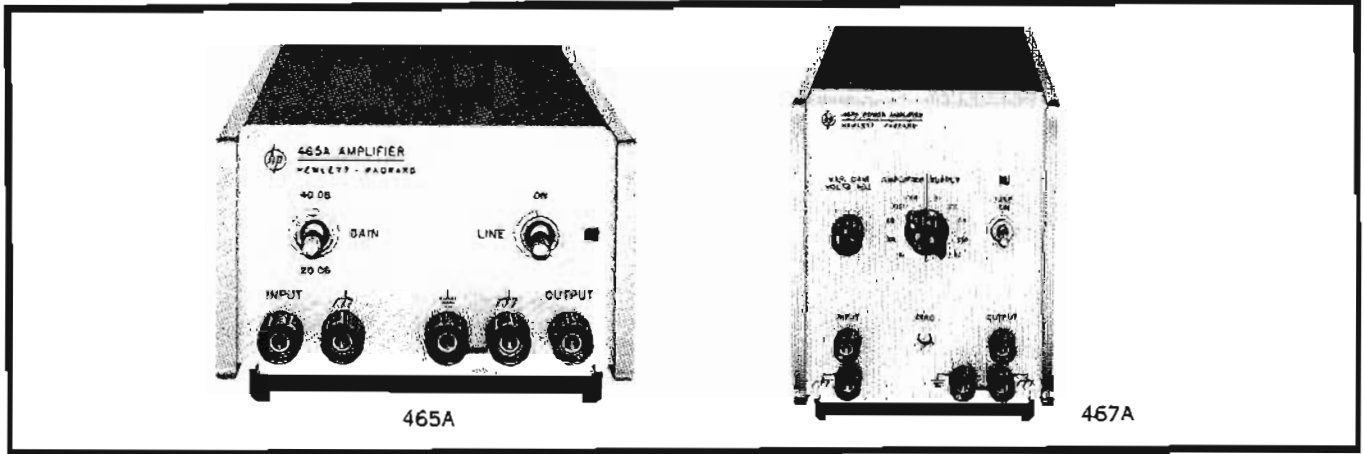

The HP Model 465A is a general-purpose amplifier and an excellent impedance converter (10 megohms to 50 ohms). This amplifier has extremely stable 20 dB or 40 dB gain over a continuous frequency range of 5 Hz to 1 MHz. Either gain may be selected rapidly with a switch on the front panel.

This solid-state amplifier is ideal for increasing the power output of solid-state oscillators or amplifiers. The output stage provides low-output impedance and wide dynamic range. The HP 465A is a three-terminal device isolated from chassis and may be floated up to 500 volts dc above chassis ground.

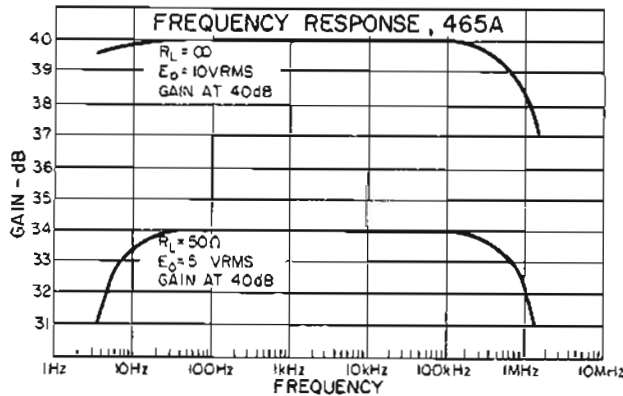

The solid-state HP 467A Power Amplifier/Supply is a 10-watt peak power amplifier and -20 to $+20$ volt dc power supply. The power amplifier has a wide bandwidth and low dc drift, suitable for many applications wherever a power source is required. Unique features are low distortion ($<0.01\%$), low drift and high-gain accuracy.

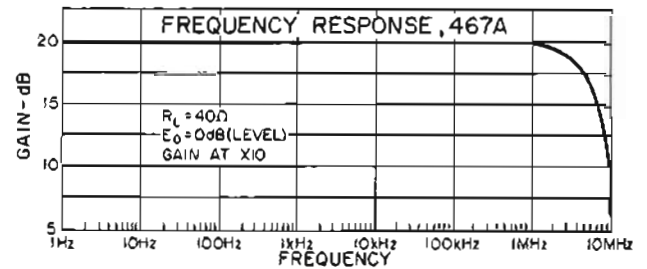

An output greater than ± 20 volts peak and 0.5 amp peak is available from dc up to 1 MHz. At full output the distortion of the 467A is less than 3% up to 1 MHz. The amplifier is a three-terminal device isolated from chassis and may be floated up to 200 volts dc above chassis ground. A front panel switch converts the amplifier to a power supply that delivers ± 20 volts dc at currents up to 0.5 amp.

	Specifications, 465A	Specifications, 467A
Voltage gain	20 dB (X10) or 40 dB (X100), open circuit	fixed steps: X1, X2, X5, X10; variable: 0 to 10, resolution better than 0.1% of full output
Gain accuracy	± 0.1 dB ($\pm 1\%$) at 1000 Hz	$\pm 0.3\%$, dc to 10 kHz with load of >40 ohms
Frequency response	± 0.1 dB, 100 Hz to 50 kHz; <2 dB down, 5 Hz to 1 MHz	$\pm 1\%$, dc to 100 kHz, $\pm 10\%$, 100 kHz to 1 MHz; (fixed steps)
Output	>10 V rms open circuit; >5 V rms into 50 ohms ($\frac{1}{2}$ watt)	± 20 V peak at 0.5 A peak
Distortion	$<1\%$, 10 Hz to 100 kHz; $<2\%$, 5 Hz to 10 Hz and 100 kHz to 1 MHz	$<0.01\%$ at 1 kHz; $<1\%$ at 100 kHz; $<3\%$ at 1 MHz
Input impedance	10 megohms shunted by <20 pF	50 k ohms shunted by 100 pF
Output impedance	50 ohms	5 milliohms in series with 1 μ H (front-panel connector only)
Noise	<25 μ V rms referred to input (with 1 megohm source resistance)	<5 mV peak-to-peak
DC power supply		voltage range: $> \pm 20$ V, ± 10 V, ± 4 V, ± 2 V, ± 1 V with continuously variable vernier between ranges; resolution: better than 0.1% output; current: ± 0.5 amp; line and load regulation: <10 mV change for $\pm 10\%$ line voltage change and 0 to 0.5 A load change; current limit: <800 mA; capacitor load: 0.01 μ F or less does not cause instability; ripple: <5 mV p-p
Temperature range	0 to $+50^\circ\text{C}$	0 to $+50^\circ\text{C}$ temperature coefficient: $< \pm 0.05\%/^\circ\text{C}$ or 2 mV/ $^\circ\text{C}$, whichever is greater
Power	115 or 230 V $\pm 10\%$, 50 to 1000 Hz, 10 W at full load	115 or 230 V, $\pm 10\%$, 50 to 1000 Hz, 35 W at full load
Dimensions	5 $\frac{1}{2}$ " wide, 3-7/16" high, 11" deep (130 x 87 x 279 mm) (1/3 module)	5 $\frac{1}{2}$ " wide, 6 $\frac{1}{2}$ " high, 11" deep (130 x 165 x 279 mm) (1/3 module)
Weight	net 4 lbs (1.8 kg); shipping 6 lbs (2.7 kg)	net 10 lbs (4.5 kg); shipping 14 lbs (6.3 kg)
Price	\$210	\$575

SOLID STATE AMPLIFIERS

Wide band, 40 dB solid-state amplifiers
Models 461A, 462A



AMPLIFIERS

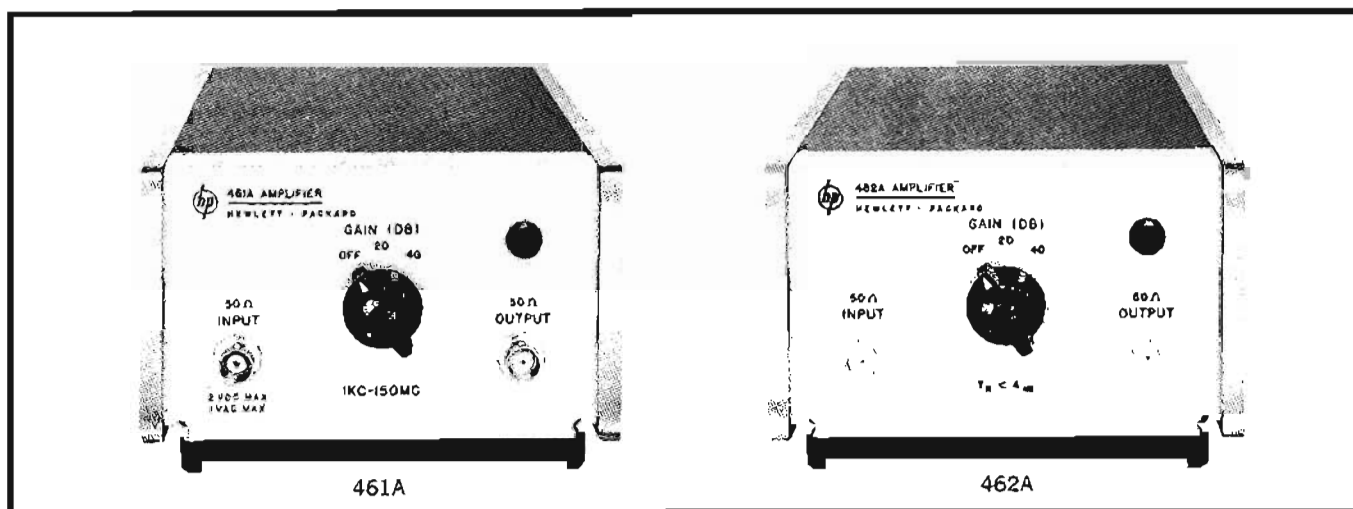

The solid-state HP 461A and 462A Amplifiers are excellent wherever wide-frequency range, low distortion and portability are desired.

The 461A Amplifier is a general-purpose instrument designed to deliver stable gain over a wide-frequency range. Either 20 dB or 40 dB gain may be selected with a front-panel switch. Figure 1 illustrates the typical frequency response of the 461A. Both input and output impedances are matched to 50 ohms. Maximum output is $\frac{1}{2}$ volt rms.

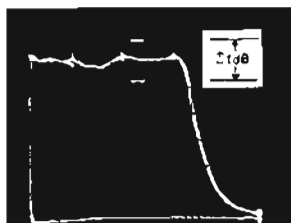

Figure 1. Frequency response curve of HP 461A. Markers shown from left to right are: 50, 100, 150 and 200 MHz. Gain control is set in 20 or 40 dB position.

The ability of the 462A to amplify very fast pulses can be seen in Figure 2. The upper trace (A) shows a 20 ns pulse applied to the input of the 462A Amplifier. The lower trace shows the same pulse amplified at 40 dB, as viewed on the HP 185B Sampling Oscilloscope.



Figure 2. (A) Input Pulse to HP 462A (5 mV peak to peak). (B) Output Pulse of HP 462A (500 mV peak to peak). Gain control is set in 40 dB position. Sweep speed is 5 ns/cm.

This amplifier gives maximum usefulness for fast-pulse applications, television, and vhf work.

Specifications, 461A

- Frequency range:** 1 kHz to 150 MHz.
- Frequency response:** ± 1 dB, 1 kHz to 150 MHz, when operating into a 50-ohm resistive load (500 kHz reference).
- Gain at 500 kHz:** 40 dB ± 0.5 dB; or 20 dB ± 1.0 dB, selected by front-panel switch (inverting).
- Input impedance:** nominal 50 ohms.
- Maximum input:** 1 volt rms or 2 volts p-p pulse.
- Maximum dc input:** ± 2 volts.*
- Output:** 0.5 volt rms into 50-ohm resistive load.
- Equivalent wideband input noise level:** less than 40 μ V in 40 dB position.
- Distortion:** $< 5\%$ at maximum output and rated load.
- Overload recovery:** < 1 μ s for 10 times overload.

Specifications, 462A

- Pulse response:** leading edge and trailing edge: rise time, less than 4 nanoseconds; overshoot, less than 5%.
- Pulse overload recovery:** less than 1 μ s for 10 times overload.
- Pulse duration for 10% droop:** 30 μ s.
- Equivalent input noise level:** less than 40 μ V in 40 dB position.
- Input impedance:** nominal 50 ohms.
- Maximum input:** 1 volt rms or 2 volts p-p pulse.
- Maximum dc input:** ± 2 volts.*
- Gain:** 20 or 40 dB selected by front-panel switch (inverting).
- Output:** 1 volt peak-to-peak into 50-ohm resistive load.
- Delay:** nominally 12 to 14 nanoseconds.

General Specifications

- Dimensions:** 3 $\frac{1}{2}$ " high, 5 $\frac{1}{8}$ " wide, 11" deep (87 x 130 x 279 mm).
- Weight:** net 3 $\frac{1}{4}$ lbs (1.5 kg); shipping 5 lbs (2.3 kg).
- Power:** 115 or 230 volts $\pm 10\%$, 50 to 1000 Hz, 5 watts.
- Connectors:** BNC female.
- Accessories available:** 11038A 50- to 200-Ohm Transformer, \$50.00; 11048B 50-Ohm Feed-thru Termination, \$10; Combining Cases: 1051A, \$110, or 1052A \$120, (each holds six HP 461A Amplifiers).

Price: HP 461A, \$325; HP 462A, \$325.

*For the protection of the input circuitry.

AMPLIFIERS



PRECISION AC AMPLIFIER

Low level measurements; precision applications

Model 463A

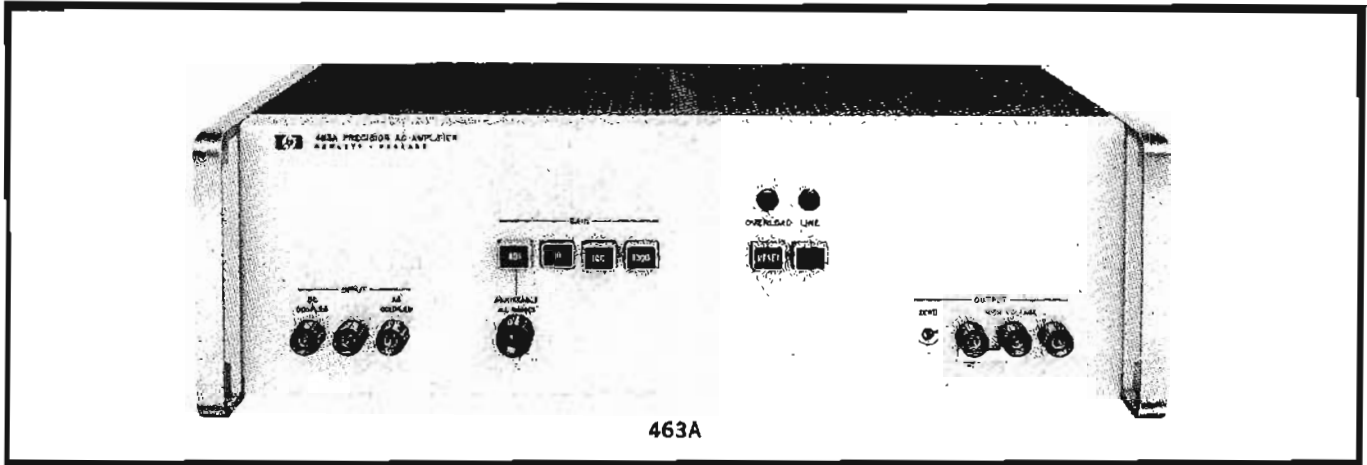

Description

A precision ac amplifier, the solid-state HP 463A has gain accuracy better than 0.01% with long-term stability of 100 ppm/yr., distortion below 0.01%, and output capability up to 100 volts rms at 5 watts continuous. The 463A has a bandwidth from dc to 100 kHz offering use in many applications. Unusual precision in the performance of the 463A Amplifier suggests its usefulness in ac calibration procedures; for example, in calibrating precision attenuators. The 100-volt output capability makes it practical to measure as much as 110 dB of attenuation. It is ideal to amplify the output of the most stable solid-state oscillators, or to use as an isolator for thermocouple transfer measurements. The Hewlett-Packard Model 463A Precision Amplifier was designed to meet the most critical requirements for wide-range, low-distortion applications.

Specifications*

Fixed Gain (DC Coupled)

X10 Range

Accuracy: Dc to 10 Hz, $< \pm 0.3\%$; 10 Hz to 10 kHz, $< \pm 0.01\%^{**}$; 10 kHz to 100 kHz, $< \pm 0.1\%^{**}$.

Distortion (100 V output, full load): 10 Hz to 10 kHz, $< 0.01\%$; 10 kHz to 100 kHz, $< 0.1\%$.

X100 Range

Accuracy: Dc to 10 Hz, $< \pm 3\%$; 10 Hz to 20 kHz, $< \pm 0.1\%^{**}$; 20 kHz to 100 kHz, $< \pm 1.0\%^{**}$.

Distortion (100 V output, full load): 10 Hz to 10 kHz, $< 0.03\%$; 10 kHz to 100 kHz, $< 0.1\%$.

X1000 Range

Accuracy: Dc to 10 Hz, $< \pm 30\%$; 10 Hz to 20 kHz, $< \pm 0.3\%^{**}$; 20 kHz to 100 kHz, $< \pm 3.0\%^{**}$.

Distortion (100 V output, full load): 10 Hz to 10 kHz, $< 0.1\%$; 10 kHz to 100 kHz, $< 0.5\%$.

Fixed gain (AC Coupled): Identical to dc coupled except coupling capacitor causes 0.01% error at 25 Hz to 3 dB error at 0.35 Hz.

Adjustable gain (AC or DC Coupled): Gain may be adjusted from 0 to 100% of the fixed gain range.

*For complete data refer to Technical Data Sheet.

**Dc to 10 Hz accuracy includes TC and short-term stability. The other accuracy specifications include neither.

Distortion: same as fixed gain range.

Long term stability (Fixed Gain):

Frequency	X10	Gain, X100	X1000
10 Hz to 10 kHz	0.003%/mo or 0.01%/yr	0.03%/mo or 0.1%/yr	0.3%/mo or 1%/yr
10 kHz to 100 kHz	0.03%/mo	0.3%/mo	3%/mo

Temperature coefficient: X10 (10 Hz to 10 kHz) 10 ppm/°C (10 kHz to 100 kHz) 50 ppm/°C; X100 (10 Hz to 10 kHz) 50 ppm/°C (10 kHz to 100 kHz) 250 ppm/°C; X1000 (10 Hz to 10 kHz) 100 ppm/°C (10 kHz to 100 kHz) 500 ppm/°C.

DC Zero Stability:

Short term: (23°C ± 1°C)	Gain range	V/hr. (output)
	X10	0.05
	X100	0.5
	X1000	5.0

Input characteristics: fixed gain; 1 MΩ ($\pm 5\%$), < 35 pF; Adjustable gain; 50 kΩ, < 200 pF.

Maximum input voltage: protected to ± 150 volts. Ac coupling capacitor ± 500 volts peak.

Noise (rms referred to input):

Gain range	< 1 kΩ source	> 1 kΩ source†
X10	1.5 mV	1.5 mV
X100	150 μV	300 μV
X1000	50 μV	200 μV

†with input shielded

Output characteristics:

Voltage: dc: 100 V, 20 mA; ac: 100 V rms, 50 mA.

Power: 5 W continuous.

Impedance: X10 range: 0.05 Ω dc to 10 kHz, 0.5 Ω 10 kHz to 100 kHz. X100 range: 0.2 Ω dc to 10 kHz, 2 Ω 10 kHz to 100 kHz. X1000 range: 2 Ω dc to 10 kHz, 20 Ω 10 kHz to 100 kHz.

General:

Temperature range: 0 to +50°C.

Power: 115 or 230 V, $\pm 10\%$, 50 to 1 kHz, 50 W full load.

Dimensions: 5-7/32" high, 16 3/4" wide, 13 1/4" deep (132,6 x 425,6 x 336,6 mm).

Weight: net 19 lbs. (8,6 kg); shipping 25 lbs (11,3 kg).

Price: HP 463A, \$690.

POWER AMPLIFIER

Provides more than 4.5 watts, 10 to 500 MHz
Model 230A



AMPLIFIERS

The HP 230A Signal Generator Power Amplifier is the ideal solution to high RF power requirements, including receiver testing, wattmeter calibration, antenna testing, filter and component testing and attenuation measurements.

The amplifier may be conveniently driven with any conventional signal generator and is designed to reproduce

AM, FM and pulse modulation characteristics of the driving generator with minimum distortion.

The 230A employs three tuned, cascaded stages of grounded-grid amplification fed from a regulated power supply. An RF output voltmeter is also included and the unit is designed for either standard 19" rack or cabinet use.

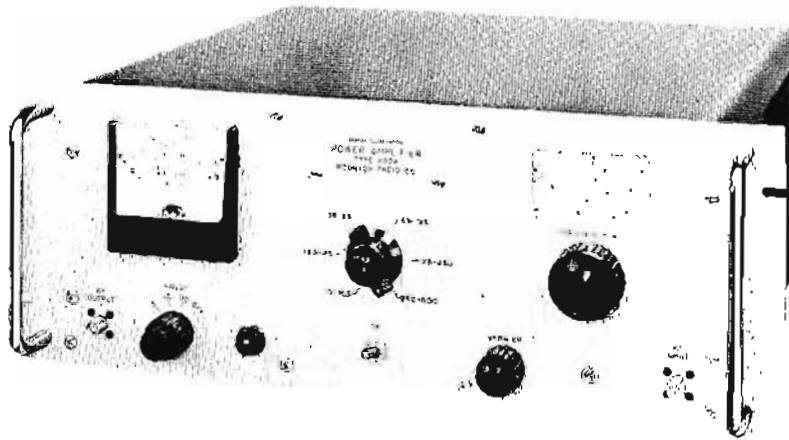

230A

Specifications

Radio frequency characteristics

RF range: total range: 10 to 500 MHz; number bands: 6; band ranges: 10 to 18.5 MHz, 18.5 to 35 MHz, 35 to 65 MHz, 65 to 125 MHz, 125 to 250 MHz, 250 to 500 MHz.

RF calibration: increments of approximately 10%, accurate to $\pm 10\%$.

RF output: range: up to 15 volts (across external 50-ohm load); calibration: 0.2 to 3 volts f.s., increments of approx. 5%; 1 to 10 volts f.s., increments of approx. 5%; 2 to 30 volts f.s., increments of approx. 5%; accuracy: ± 1 dB of f.s. (10 to 250 MHz), ± 1.5 dB of f.s. (250 to 500 MHz); leakage: effective shielding is greater than 40 dB.

RF bandwidth:* > 700 kHz (10 to 150 MHz); > 1.4 MHz (150 to 500 MHz).

RF input: level** : ≤ 0.316 volts, 30 dB gain, (10 to 125 MHz); ≤ 0.446 volts, 27 dB gain, (125 to 250 MHz); ≤ 0.63 volts, 24 dB gain, (250 to 500 MHz).

*Frequency interval between points 3 dB down from max. response.
**For 10 volts output into 50 ohms.

Amplitude modulation characteristics

AM range: reproduces modulation of driving signal generator 0 to 100%†.

AM distortion: $< 10\%$ added to distortion of driving signal generator†.

Frequency modulation characteristics

FM range: reproduces modulation of driving signal generator except as limited by the RF bandwidth.

Incidental AM: $< 10\%$ added to modulation of driving signal generator (at 150 kHz deviation).

FM distortion: negligible distortion added to distortion of driving signal generator for < 150 kHz deviations and modulation frequencies.

Physical characteristics

Dimensions: 16 $\frac{3}{4}$ " wide, 7- $\frac{3}{16}$ " high, 18- $\frac{1}{16}$ " deep (425 x 183 x 459 mm).

Weight: net 37 lbs (16,7 kg); shipping 57 lbs (25,7 kg).

Power: 105 to 125 or 210 to 250 V, 50 to 60 Hz, 150 W.

Price: HP 230A, \$1350.

†Up to 5 volt max. carrier output for up to 100% AM.

AMPLIFIERS



MICROWAVE AMPLIFIERS

Broadband, high-gain, high-power amplification
Models 489A-495A

Advantages:

- DC-coupled modulation circuitry allows power leveling and remote programming
- PPM focusing means fewer alignment problems

Uses:

- Antenna efficiency and pattern measurements
- Extends attenuation measuring systems capability by at least 30 dB.

Description

Amplification of frequencies from 1 to 12.4 GHz is accomplished in four ranges by the Hewlett-Packard microwave amplifiers. Each delivers at least 1 watt with an input of 1 mW or less, a gain of at least 30 dB.

Amplitude modulation circuitry has been designed for wide bandwidth (down to dc) and with internal amplification, so that small modulation signals cause a large output power change. This unique modulation circuitry also per-

mits power leveling with external elements, plus remote programming. Spurious phase modulation of 0.1° or less and residual AM at least 45 dB below carrier are assured by regulation of the filament, anode and helix power supplies. TWT cathode current is monitored by a front-panel meter and can be controlled by the Gain adjustment for rated power output, or for reducing tube current to extend tube life when full output power is not required. Helix, collector and anode current can be measured at an easily accessible test point board.

Periodic permanent magnet focusing reduces weight, size and power consumption and at the same time alleviates alignment problems. Protective features incorporated to prevent TWT failure include an overload relay on the helix power supply, a three-minute time delay on the beam supply and a fail-safe circuit that disconnects ac power whenever the regulated filament supply voltage exceeds a predetermined level.

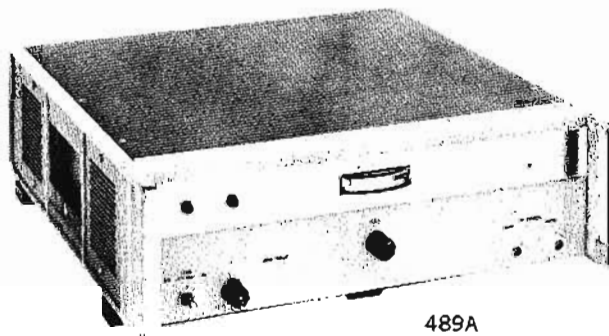

489A

Specifications

	489A	491C	493A	495A
Frequency range (GHz)	1-2	2-4	4-8	7-12.4
Power output (with 1 mW or less input)	1 W	1 W	1 W	1 W
Gain at rated output	30 dB	30 dB	30 dB	30 dB
Gain variation with freq. at rated output small signal	≤ 6 dB	≤ 6 dB	≤ 6 dB	≤ 6 dB
across any 10% of band	≤ 5 dB	≤ 5 dB	≤ 5 dB	≤ 5 dB
across full band	≤ 10 dB	≤ 10 dB	≤ 12 dB	≤ 10 dB
Gain variation with = 10% variation from rated line voltage	≤ 1 dB	≤ 1 dB	≤ 1 dB	≤ 1 dB
Noise max. noise figure	30 dB	30 dB	30 dB	30 dB
typ. noise power out	-10 dBm	-10 dBm	0 dBm	0 dBm
Price	\$2250	\$2250	\$2600	\$2600

For all models

Maximum rf Input: 100 mW.

Input/output characteristics: impedance, 50Ω; reflection coefficient (cold), ≤ 0.43 (2.5 swr, 7.3 dB return loss); connectors, type N female.

Amplitude modulation

Sensitivity: a signal —20 volts peak at the modulation input reduces rf output by more than 20 dB.

Frequency response: dc to 500 kHz (3 dB).

Input impedance: 100 kΩ shunted by approx. 50 pF.

Pulse response: < 1 μs rise and fall times.

Residual AM: at least 45 dB below carrier.

Dimensions: 16³/₄" wide, 5¹/₂" high, 18³/₈" deep (426 x 141 x 467 mm); hardware furnished for conversion to rack mount 19" wide, 5-7/32" high, 16³/₈" deep behind panel (483 x 133 x 416 mm).

Weight: net 38 lbs (17,1 kg); shipping 43 lbs (19,4 kg).

Power: 115 or 230 volts ±10%, 50 to 60 Hz, approx. 225 watts.

Accessories available: 11500A Cable Assembly, \$15; 11501A Cable Assembly, \$15.

GENERAL INFORMATION



OSCILLOSCOPES

The oscilloscope is an extremely fast X-Y plotter which displays one input signal versus another signal, or versus time. The variations are displayed on the face of the cathode-ray tube. The "stylus" is a luminous spot which moves over the CRT in response to input voltages. In the usual scope application the X axis represents time. To do this a linear ramp of voltage is generated internally which moves the spot uniformly from left to right across the face of the CRT. The voltage being examined is applied to the Y axis input, moving the spot up or down in accordance with its instantaneous value. The spot then traces a curve which shows how the input voltage varies as a function of time.

Because the oscilloscope can display time varying voltages, it has become a universal tool in all kinds of electronic investigations. In addition, the oscilloscope can present a visual display of a variety of dynamic phenomena by the use of transducers which convert current, strain, acceleration, pressure, sound and other physical quantities into voltages.

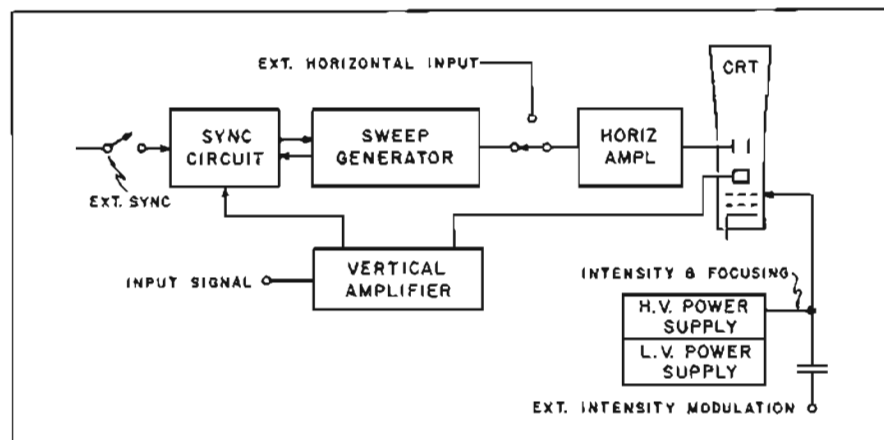

Figure 1. Oscilloscope block diagram.

The primary sub-systems of an oscilloscope are the vertical deflection system, horizontal deflection system, power supplies, and the cathode-ray tube. The vertical deflection system processes the Y axis input signal to control the up and down movement of the CRT spot. The horizontal deflection system either generates the sweep to move the spot across the CRT or processes an external signal to control the horizontal movement of the spot. The low voltage power supply provides power for the scope circuitry and the high voltage power supply provides power for the cathode-ray tube.

The CRT is the readout device that displays the plot of Y versus X or Y versus time.

Cathode-ray Tube

The cathode-ray tube is the heart of

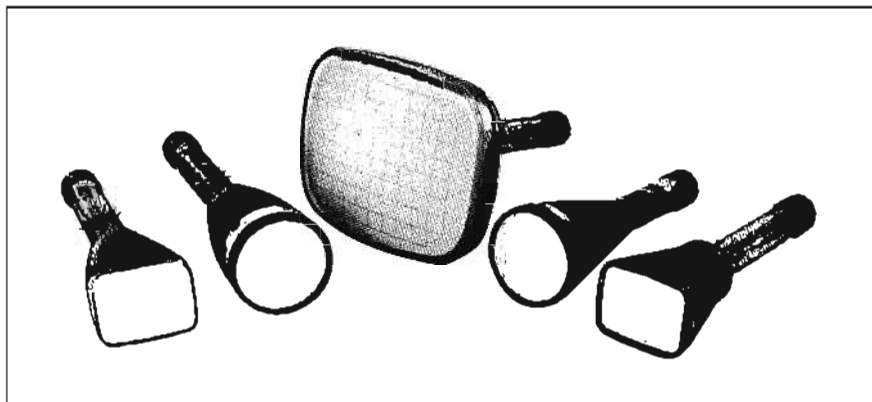

Figure 2. Some of the CRT's made in Hewlett-Packard's cathode-ray tube facility.

the oscilloscope, with the rest of the instrument consisting of circuitry for operating the CRT. As is commonly known, the tube has an electron gun at one end and a phosphor display screen at the other

the other pair move it from side to side. The electrodes that move the beam up and down are the vertical deflection plates and the pair that moves the spot sideways are called the horizontal deflec-

tion plates. These movements are independent of each other so that the spot may be positioned anywhere on the phosphor screen by the appropriate input voltages.

The accuracy with which the viewed waveform corresponds to the deflection voltages depends to a large measure on the performance of the cathode-ray tube. Careful design of the electron gun structure and precision manufacturing techniques of the Hewlett-Packard cathode-ray tube facility insure that the beam moves linearly with respect to the deflection voltages. Precision CRT's make it possible to measure accurately the input voltage amplitude at any point on the waveform by measuring the amount of deflection of the fluorescent spot.

In order to make measurements of the spot deflection a rectangular grid (called a graticule) is scribed on transparent material and attached to the face plate of the CRT. All HP CRT's however, incorporate an internal graticule. This type of graticule consists of lines placed in the same plane as the phosphor. The internal graticule avoids errors caused by parallax which exists when the graticule is external to the tube, separated from the phosphor by the thickness of the glass face plate.

Vertical deflection system

The vertical deflection system is made up of an input attenuator and an amplifier chain. Since the CRT is limited as to the range of voltage that can be applied to deflection plates, considerations must be made to handle signals outside

end. The electron gun is made up of a thermionic cathode, various accelerating electrodes for directing emitted electrons toward the display screen, and controls necessary for focus and intensity. The resulting narrow beams of electrons from the gun strike the phosphor in a small spot with enough energy to cause fluorescence.

On leaving the gun, the electron stream passes between each of two pairs of deflection electrodes. Voltages applied to these electrodes bend the beam. Voltages on one pair of electrodes move the beam up and down and voltages on

this range. For signal amplitudes below this range the amplifier chain is used to increase the amplitude. If the signal is too large the attenuator reduces the signal so that it can be displayed. By calibrating the attenuator and amplifiers the deflection factor is known for each setting of the attenuator. That is, the graticule is calibrated in so many volts/cm depending on the attenuator setting.

The amplifiers in Hewlett-Packard oscilloscopes are stable enough to permit voltage measurements with confidence to at least $\pm 3\%$ accuracy. To verify amplifier accuracy, all HP scopes have built-in calibrators which supply precisely controlled signals for use as calibrating test signals.

High amplifier gain with minimum drift and noise, is obtained in HP scopes by careful circuit design. This allows scopes to be built with high sensitivity. Large amounts of negative feedback, aided by the use of regulated power supplies, achieve gain stability for measurement accuracy.

DC coupling preserves the waveform of slowly varying signals and also permits a dc reference line to be established on the display, facilitating precise amplitude measurements. DC coupling is not desirable though when a small ac component on a relatively large dc voltage is examined. All HP scopes have provision for switching decoupling capacitors into the signal line when dc coupling is not desired.

Horizontal deflection system

The horizontal deflection system supplies drive voltages for moving the electron beam horizontally. Since so many measurements are concerned with plotting voltages versus time, the horizontal deflection system also includes sawtooth waveform generators for sweeping the beam horizontally at a uniform rate. Since the rate of sweep is uniform the scope can be calibrated for so many s/cm of horizontal display. To accept signals that vary over a wide range of frequencies, a switch is used to vary the sweep rate. Each position of the switch is calibrated so that the time scale can be varied from s/cm to ms/cm to μ s/cm.

Also necessary are synchronizing circuits for starting the horizontal sweep at a specific instant with respect to the measured waveform. Starting the sweep (triggering) is quick and easy with HP scopes through the use of automatic triggering. Preset adjustments produce synchronized sweeps with little or no ad-

justment of the front-panel controls. An automatic baseline, present on many HP scopes, facilitates setting up the display in the absence of an input signal. The sweep magnifier feature is valuable for close examination of trace segments which occur too late in time after the start of the trace to be examined with faster sweeps.

The horizontal amplifiers of most Hewlett-Packard scopes may be used separately from the sweep generating circuits for deflecting the horizontal beam in response to external waveforms, a useful technique for making X-Y plots. Phase shift measurements can also be made in this mode of operation by selecting a scope that has horizontal and vertical amplifiers with identical characteristics.

Power supplies

The low voltage power supply provides regulated voltages to the various circuits of the scope. The high voltage supply provides the voltage necessary to operate the CRT cathode.

Probes

A probe is used to transfer the signal from the circuit under test to the vertical amplifier of the oscilloscope. The characteristics of a probe should be such that

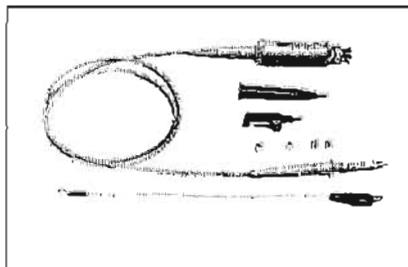

Figure 3. One type of probe used to transfer the signal from the test circuit to the scope.

it does not disturb in any way the circuit that is being tested or the performance of the oscilloscope. To accomplish this the probe has a very high impedance, say 10 M Ω , and a variable capacitor to adjust for high frequency components of the signal. Most probes are of the vol-

tage divider type which reduce the signal amplitude. The typical division ratio is 10:1. There are types of probes other than voltage divider, such as active probes, current probes and sampling probes. Each of these types of probes performs the same basic function that is to get the signal from the circuit under test, to the input of the oscilloscope with little or no distortion.

State of the art

There is quite a bit more to an oscilloscope than was covered in the previous general discussion. Also the technology in this area is advancing at a rapid rate. Some of the areas where HP is advancing the technology are: sampling oscilloscopes, storage and variable persistence, large screen displays, all solid state units using FET's, and strip delay lines to name a few.

Storage and variable persistence

The Hewlett-Packard Models 141A/181A oscilloscopes are effectively three scopes in one. They are first of all, a normal oscilloscope; secondly a storage scope capable of storing traces for periods of up to an hour; and thirdly a variable persistence oscilloscope. By persistence we mean the time it takes for the trace to fade to 10% of its original brightness. The persistence of these scopes is continuously variable from .2 seconds to more than a minute. These versatile oscilloscopes were made possible by uniquely designed CRT's and persistence control circuitry.

Sampling oscilloscopes

Conventional or "real time" oscilloscopes are limited in bandwidth to frequencies in the mega Hertz region. Sampling scopes, however, have bandwidths to 12.4 GHz, (12.4×10^9 Hertz). This type of oscilloscope uses a stroboscopic approach to reconstruct the input waveform from samples taken during many recurrences of the waveform. This technique is illustrated by the waveforms of Figure 4. In reconstructing a waveform,

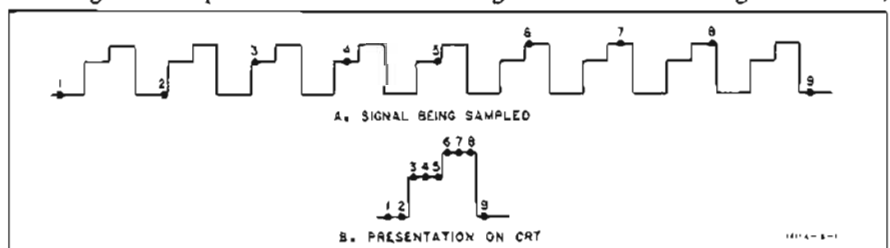

Figure 4. The sampling oscilloscope reconstructs the test signal by taking up to 1000 samples.

the sampling pulse "turns on" the sampling circuit for an extremely short interval and the waveform voltage at that instant is measured. The CRT spot is positioned vertically to correspond to this voltage amplitude.

The next sample is taken during a subsequent cycle at a slightly later point on the input waveform. The CRT spot moves horizontally a short distance and is repositioned vertically to the new voltage. In this way, the scope plots the waveform point by point, as many as 1000 samples being used to reconstruct the waveform.

A bright trace is obtained regardless of sampling rate, sweep speed, or waveform duty cycle, since each CRT spot remains "ON" during the full interval between samples.

The unique sampling circuit developed by HP, minimizes circuit loading with its high input impedance. During a sampling interval, sampling pulses momentarily bias the diodes of the balanced sampling gate in the forward direction, briefly connecting input capacitance to the test point. The balanced bridge minimizes coupling of the sampling pulses back into the test circuit. The capacitance is charged slightly toward the new voltage level. This charge is then amplified to the original value present in the test circuit and fed back to the input. In effect, the circuit detects the "error" signal between the previous and new samples and nulls out the difference. High sensitivity and gain stability are thus achieved. All HP wideband sampling scopes feature feedthrough inputs for monitoring signals without terminating, or otherwise disturbing them.

Large screen displays

Another area in which HP is advancing the technology is that of Cathode-Ray Tube design. The ideal oscilloscope would have a very large viewing area in a very short tube. However, since the CRT beam is deflected at the gun structure and then rises as it moves toward the screen, the height of the vertical deflection depends on the distance from the gun to the screen. In order to get a large display in a short tube the electron beam must be made to rise faster. This was first done in the Model 140A CRT by placing a wire mesh after the electron gun. A voltage applied to the mesh creates an electrostatic field which causes the beam to bend farther. The next step in this expansion-mesh technology was to change the shape of the mesh to get greater magnification. This resulted in the 180A CRT which has 30% more

viewing area in a tube that is four inches shorter than previous high frequency tubes. One of the most recent developments is the 8 inch by 10 inch CRT in the 1300A. This is the first time that a tube with this size display area has been designed into an 18" long tube with a deflection factor of only 14 volts for 1 inch of display.

Selecting an oscilloscope

Choice of an oscilloscope is based largely on considerations of both performance capabilities and versatility. However the complexity of the plug-in scope necessitates higher costs. Non-plug-in scopes that are designed to meet specific needs can be produced at lower costs.

Bandwidth and deflection factor of the vertical amplifiers are the primary characteristics which describe an oscilloscope's performance capabilities. Wide bandwidth is obtained at the expense of more complicated circuitry and more expensive cathode-ray tubes. A low deflection factor (high sensitivity) requires more amplifier stages and added refinements for minimizing dc drift and noise. In addition to these two primary considerations and the question of plug-in's or not, there are special requirements and features that can dictate which scope is selected.

Non-plug-in oscilloscopes

Hewlett-Packard's non-plug-in oscilloscopes make accurate voltage and time measurements on a wide variety of waveforms in the subsonic, audio, ultrasonic

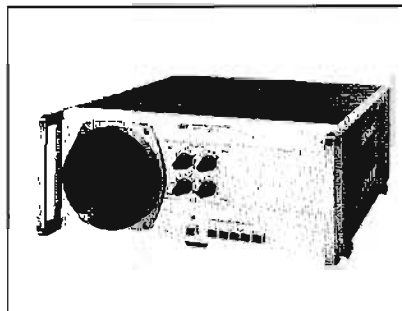

Figure 5. The 780-6A Monitor scope is a non-plug-in scope used by doctors and nurses to monitor heartbeats and other patient signals.

and low rf frequency ranges. These scopes are intended for analysis of waveforms in which little importance is attached to frequency components beyond 500 kHz. The dc amplifiers and long sweep rates are suitable for medical and mechanical observations, as well as for low-frequency electrical work. At the same time, faster sweep speeds are provided in these instruments for detailed

studies of transient phenomena, vibration effects, audio analysis and other medium frequency events.

Since these instruments have relatively simple circuitry and construction they are the most economical type of oscilloscope. In applications such as systems, where the scope performs a limited number of functions and the added expense of plug-in flexibility is not needed, the non-plug-in oscilloscope provides maximum economy.

Plug-in oscilloscopes

Hewlett-Packard plug-in oscilloscopes enable the user to make a very wide va-

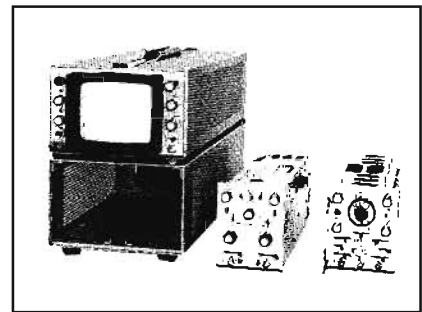

Figure 6. The Model 180A plug-in oscilloscope features aircraft type frame construction for maximum ruggedness with minimum weight.

riety of measurements with just one oscilloscope. The instrument characteristics can be altered by simply changing the vertical and horizontal plug-ins. Bandwidth, sensitivity, number of channels, and time base can all be tailored to exact needs. Other features such as sampling or TDR can be added at will. Plug-in capability also enables a scope's performance to be updated as new plug-ins become available.

In determining which scope to buy, the considerations are: Will the needs change in the future—if so a plug-in scope would be the best buy; is cost a major consideration—if so then a non-plug-in scope might fill the bill; or is there a special function that is desired—this then dictates the type of scope. A general rule for selection would be to determine the basic requirements of the oscilloscope based on the intended application and then use the Selection charts to determine the one best suited for the task.

If there is any question as to which oscilloscope to choose, it is recommended that the customer consult with the local HP field engineer. HP field engineers are trained in the use and applications of all HP instruments and can assist in solving the particular applications problem in the most economical way.

OSCILLOSCOPES



SELECTION CHART

Choose the oscilloscope for the application

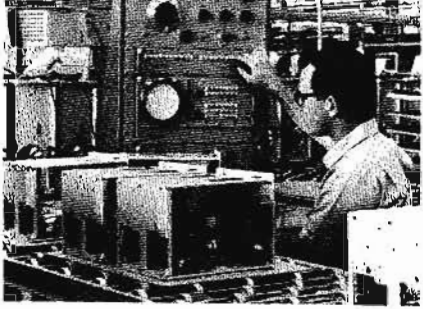

155A



141A



132A

Type	Non plug-in						Plug-in		
	120B	122A	130C	132A	155A	1300A	175A	140A 141A	180A 181A
Model No.	120B	122A	130C	132A	155A	1300A	175A	140A 141A	180A 181A
Bandwidth	450 kHz	200 kHz	500 kHz	500 kHz	25 MHz	20 MHz	50 MHz	12.4 GHz	50 MHz
Min. deflection factor	10 MV/cm	10 MV/cm	200 μ V/cm	100 μ V/cm	5 MV/cm	0.1 V/in.	5 MV/cm	10 μ V/cm	1 MV/cm
Sampling								•	
Storage								•	•
Variable persistence								•	•
Differential input	•	•	•	•			•	•	•
Programmability					•				
Large screen monitor						•			
Two channel		•		•			•	•	•
Four channel							•		•
TDR								•	
DC offset								•	•
Swept frequency								•	
Delayed sweep								•	•
Price	\$495	\$695	\$695	\$1395	\$3050	\$1900	\$1575 and up	\$1070 and up	\$1950 and up
Page	454	455	456	458	484	486	488	460	491

Glossary of oscilloscope terminology

Accelerating Voltage—The cathode-to-viewing-screen voltage applied to a cathode ray tube for the purpose of accelerating the electron beam.

Alternate Mode—A means of displaying output signals of two or more channels by switching the channels, in sequence, after each sweep.

Automatic Triggering—A mode of triggering in which one or more of the triggering circuit controls are preset to conditions suitable for automatically displaying repetitive waveforms. The automatic mode may also provide a recurrent trigger or recurrent sweep in the absence of triggering signals.

Bandwidth—A statement of the frequencies defining the upper and lower limits of a frequency spectrum where the amplitude response of an amplifier to a sinusoidal waveform becomes .707 (−3db) of the amplitude of a reference frequency. When only one number appears, it is taken as the upper limit.

Chopped Mode—A time sharing method of displaying output signals of two or more channels with a single cathode ray tube gun, in sequence, at a rate not referenced to the sweep.

Common Mode Rejection Ratio (CMRR)—Ratio of the deflection factor for a common-mode signal to the deflection factor for a differential signal.

Common-Mode Signal—The instantaneous algebraic average of two signals applied to a balanced circuit, all signals referred to a common reference.

Common-Mode Signal Maximum—The largest common-mode signal at which the specified common-mode rejection ratio is valid.

DC Balance—An adjustment of circuitry to avoid a change in dc level when changing gain.

DC Drift (Stability)—Property of retaining defined electrical characteristics for a prescribed period.

DC Shift—An error in transient response with a time constant approaching several seconds.

Deflection Axis—The major coordinates passing through the center of the viewing area.

Deflection Factor (Sensitivity)—The ratio of the input signal amplitude to the resultant displacement of the indicating spot (e.g., volts/division).

Delayed Sweep—A sweep that has been delayed either by a predetermined period or by a period determined by an additional independent variable.

Differential Amplifier—An amplifier whose output signal is proportional to the algebraic difference between two input signals.

Dual-Beam Oscilloscope—An oscilloscope in which the cathode ray tube produces two separate electron beams that may be individually or jointly controlled.

Dual Trace—A mode of operation in which a single beam in a cathode ray tube is shared by two signal channels. See Alternate Mode and Chopped Mode.

Free-Running Sweep—A sweep that runs without being triggered and is not synchronized by any applied signal.

Guarded Input—Means of connecting an input signal so as to prevent any common mode signal from causing current to flow in the input, thus differences of source impedance do not cause conversion of the common mode signal into a differential signal.

Input RC Characteristics—The dc resistance and capacitance to ground present at the input of an oscilloscope.

Internal Graticule—A scale for measurement of quantities displayed on the crt whose rulings are a permanent part of the inner surface of the cathode ray tube faceplate.

Jitter—An aberration of a repetitive display indicating instability of the signal or of the oscilloscope. May be random or periodic, and is usually associated with the time axis.

Magnified Sweep—A sweep whose time per division has been decreased by amplification of the sweep waveform rather than by changing the time constants used to generate it.

Mixed Sweep—In a system having both a delaying sweep and a delayed sweep, a means of displaying the delaying sweep to the delaying pickoff and the delayed sweep beyond that point.

Risetime—The interval between the instants at which the pulse amplitude first reaches specified lower and upper limits. Unless otherwise stated, these limits shall be 10% and 90% of the pulse's amplitude.

Single Sweep—Operating mode for a triggered-sweep oscilloscope in which the sweep must be reset for each operation, thus preventing unwanted multiple displays.

Sweep—An independent variable of a display; unless otherwise specified, this variable is a linear function of time, but may be any quantity that varies in a definable manner.

Sweep Holdoff—The interval between sweeps during which the sweep and/or trigger circuits are inhibited.

Time Base—The sweep generator in an oscilloscope that generates the time function, which is usually linear and expressed in sec/cm.

Time Base Accuracy—Accuracy of the time base usually expressed in terms of average rate error as a percent of full scale.

Trigger—A pulse used to initiate some function.

Triggering Level—The instantaneous level of a triggering signal at which a trigger is to be generated.

Triggering Slope—The positive going (+ slope) or negative slope (− slope) portion of a triggering signal from which a trigger is to be derived.

Cathode ray tube phosphor characteristics

Phosphor	Trace Color		Persistence	Relative Burn Resistance	Relative Brightness
	Under Excitation	After-Glow			
P2	yellowish-green	yellowish-green	medium short	6	6.5
P7	white	yellowish-green	long	3	8
P11	blue	blue	medium short	3	5.4
P31	green	green	medium short	10	10
Description of Persistence			Time to Decay to 10% of Initial Brightness		
medium short			10 microsec to 1 millisecc		
medium			1 millisecc to 100 millisecc		
long			100 millisecc to 1 sec		
Phosphor	Application		Information		
P2	Observing either low- or medium-speed non-recurring phenomena.		After-glow may have useful persistence for over a minute under conditions of adequate excitation and low-ambient illumination.		
P7	Observing either extremely low-speed recurrent phenomena or medium-speed non-recurrent phenomena.		During excitation the trace is white. After excitation the trace is yellowish-green for several minutes.		
P11	For use in all photographic applications.		Trace is high intensity actinic blue.		
P31	Observing either low- or medium-speed non-recurring phenomena.		Highest visual brightness.		

OSCILLOSCOPES



450 kHz OSCILLOSCOPE

Easy-to-use, general-purpose 10 mV/cm scope
Model 120B

The HP Model 120B Oscilloscope is an easy-to-use, general-purpose oscilloscope for both laboratory and industrial applications. It combines accurately calibrated horizontal sweep times and vertical deflection sensitivities with an internal graticule CRT that eliminates parallax error. In addition, the front panel controls are logically grouped by function to simplify operation. The automatic triggering feature synchronizes the sweep circuitry with the displayed

waveform, eliminating time-consuming trigger adjustments. The Hewlett-Packard modular enclosure is equally well suited for bench use or for rack mounting with the hardware provided with each instrument. Moreover, the removable top and bottom covers of the modular enclosure permit access to all components and adjustments within the instrument for easy routine maintenance.

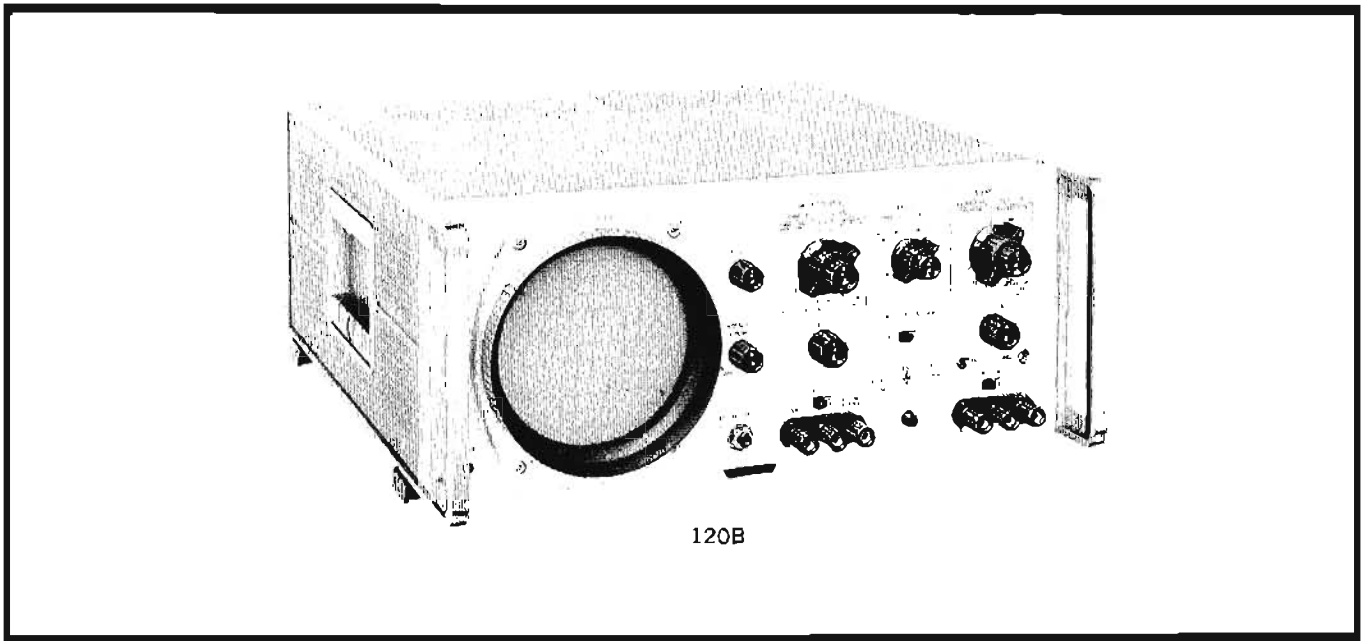

Specifications

Time base

Range: 5 μ s/cm to 200 ms/cm, 13 ranges in a 1, 2, 5, sequence; accuracy $\pm 5\%$; vernier provides continuous adjustment between steps and extends the 200 ms/cm step to at least 0.5 s/cm.

Magnifier: X5 sweep expansion may be used on all ranges and expands the fastest sweep to 1 μ s/cm; expanded sweep accuracy is $\pm 10\%$.

Automatic triggering (baseline displayed in the absence of an input signal):

Internal: 50 Hz to 450 kHz for signals causing 0.5 cm or more vertical deflection; also from line voltage.

External: 50 Hz to 450 kHz for signals at least 1.5 volts peak-to-peak.

Trigger slope: positive or negative slope of vertical deflection signal; or negative slope of external sync signal.

Amplitude selection triggering:

Internal: 10 Hz to 450 kHz for signals causing 0.5 cm or more vertical deflection.

External: 10 Hz to 450 kHz for signals at least 1.5 volts, peak-to-peak.

Trigger point and slope: from any point on the vertical waveform presented on CRT; or continuously variable from -7 to $+7$ volts on the negative slope of external sync signal.

Vertical amplifier

Bandwidth: dc coupled, dc to 450 kHz; ac coupled, 2 Hz to 450 kHz.

Deflection factor (sensitivity): 10 mV/cm to 10 volts/cm in 4 calibrated steps; accuracy $\pm 3\%$; vernier provides continuous adjustment between steps and extends 10 V/cm step to at least 100 V/cm.

Maximum input: 500 V peak (dc + ac).

Internal calibrator: calibrating signal automatically connected to vertical amplifier for setting amplifier gain, accuracy $\pm 2\%$.

Input RC: 1 megohm shunted by approximately 50 pF.

Balanced input: on 10 mV/cm range; input RC, 2 megohms shunted by approximately 25 pF; common mode rejection at least 40 dB; common mode signal must not exceed ± 3 volts peak.

Phase shift: vertical and horizontal amplifiers have same phase characteristics within $\pm 2^\circ$ to 100 kHz (with verniers in Cal).

Horizontal amplifier

Bandwidth: dc coupled, dc to 300 kHz; ac coupled, 2 Hz to 300 kHz.

Deflection factor (sensitivity): 0.1 volt/cm to 10 volts/cm in 3 calibrated

steps, accuracy $\pm 5\%$; vernier provides continuous adjustment between steps and extends 10 V/cm step to at least 100 V/cm.

Input RC: 1 megohm, nominal, shunted by approximately 100 pF.

General

Cathode ray tube: mono-accelerator, 2700-volt accelerating potential; aluminized P31 phosphor (other phosphors available, see modifications); etched safety glass face plate reduces glare.

Graticule: 10 cm x 10 cm parallax-free internal graticule marked in cm squares; major horizontal and vertical axes have 2 mm sub-divisions.

Beam finder: pressing beam finder control brings trace on CRT screen, regardless of settings of horizontal, vertical, or intensity controls.

Intensity modulation: +20 volt pulse will blank trace of normal intensity; input terminals on front panel.

Dimensions: 16 $\frac{3}{4}$ " wide, 7 $\frac{1}{2}$ " high, 18 $\frac{3}{4}$ " deep overall (426 x 191 x 466 mm); hardware furnished for quick conversion to 7" x 19" (178 x 483 mm) rack mount.

Weight: net 29 lbs (13 kg); shipping 35 lbs (15.8 kg).

Power: 115 or 230 volts $\pm 10\%$; 50 to 1000 Hz; approximately 95 W.

Price: HP Model 120B, \$495.

Modifications: CRT phosphors (specify by phosphor number): P31 standard; P2, P7 with amber filter. P11 available, no charge.

Special order: chassis slides and adapter kit; fixed slides, order HP Part No. 1490-0714, \$32.50; pivot slides, order HP Part No. 1490-0718, \$40; slide adapter kit for mounting slides on scope, order HP Part No. 1490-0721, \$20.

Options: (specify by option number)

05: external graticule CRT with P31 phosphor (P2, P7, P11 available, please specify) in lieu of standard internal graticule, add \$24; includes edge-lighting of external graticule.

06: rear terminals in parallel with front panel terminals; two 3-pin AN connectors for horizontal, vertical, and trigger inputs, add \$30; mating AN connectors supplied.

10: provision for single-sweep operation, as well as conventional triggered sweep, add \$35.

13: plain 3/16" x 7" x 19" front panel for rack mounting only; suitable for installing special handles to match existing equipment in system or console, add \$20.

DUAL-TRACE OSCILLOSCOPE

Economical versatility—200 kHz 10 mV/cm
Models 122A, 122AR



OSCILLOSCOPES

The Model 122A/AR is a dual trace, 200 kHz bandwidth oscilloscope which simplifies observation and measurement of electrical and mechanical equipment performance. It can be used as an ordinary scope with a single trace, or, when a comparison of two quantities is required it can provide two separate traces which in many ways is like having two scopes.

Personnel quickly learn the operation of this instrument and can use it with confidence since it has guaranteed calibration on both its sweep (time base) and voltage amplitude measurements.

Signals may be compared simultaneously and directly due to the twin vertical amplifiers which may be used separately or automatically switched. Input and output signals of amplifiers, filters, and other networks may be viewed simultaneously and transmission or rejection characteristics seen immediately. Since dc coupling is available, very low frequency square-waves may be used for testing, or the scope may be ac coupled to eliminate and unwanted dc signal.

Specifications

Time base

Range: 5 μ s/cm to 200 ms/cm. 15 ranges in a 1, 2, 5 sequence; accuracy $\pm 5\%$; vernier provides continuous adjustment between steps, and extends the 200 ms/cm step to at least 0.5 s/cm.

Magnifier: X5 sweep expansion may be used on all ranges and expands the fastest sweep to 1 μ s/cm; expanded sweep accuracy is $\pm 10\%$.

Automatic triggering (baseline displayed in the absence of an input signal):

Internal: 50 Hz to 250 kHz for signals causing 0.5 cm or more vertical deflection; also from line voltage.

External: 50 Hz to 250 kHz for signals at least 2.5 volts peak-to-peak.

Trigger slope: positive or negative slope of vertical deflection signals; or negative slope of external sync signals.

Amplitude selection triggering:

Internal: 10 Hz to 250 kHz for signals causing 0.5 cm or more vertical deflection.

External: 10 Hz to 250 kHz for signals at least 2.5 volts peak-to-peak.

Trigger point and slope: from any point on the vertical waveform presented on crt; or continuously variable from -10 to $+10$ volts on negative slope of external sync signal.

Vertical amplifiers

Bandwidth: dc coupled, dc to 200 kHz; ac coupled, 2 Hz to 200 kHz.

Deflection factor (sensitivity): 10 mV/cm to 10 volts/cm in 4 calibrated steps; accuracy $\pm 3\%$; vernier provides continuous adjustment between steps and extends 10 V/cm step to at least 100 V/cm.

Maximum input: 500 V peak (dc + ac).

Internal calibrator: calibrating signal automatically connected to vertical amplifier for setting amplifier gain, accuracy $\pm 2\%$.

Input RC: 1 megohm shunted by approximately 50 pF.

Balanced input: on 10 mV/cm range; input RC, 2 megohms shunted by approximately 25 pF; common mode rejection at least 40 dB; common mode signal must not exceed ± 3 volts peak.

Phase shift: vertical and horizontal amplifiers have same phase characteristics within $\pm 2^\circ$ to 100 kHz (with verniers in Cal).

Isolation: greater than 80 dB between Channels A and B from dc to 200 kHz.

Difference input: both input signals may be switched to one channel to give differential input on all sensitivity ranges; the sensitivity controls may be set separately to allow mixing signals of different levels; common mode rejection is at least 40 dB with both controls in most sensitive range, 30 dB on other ranges.

Vertical presentation: control selects; A only, B only, B-A. Alternate, or Chopped.

Horizontal amplifier

Bandwidth: dc coupled, dc to 200 kHz; ac coupled, 2 Hz to 200 kHz.

Deflection factor (sensitivity): 0.1 volt/cm to 10 volts/cm in 3 calibrated steps; accuracy $\pm 5\%$; vernier provides continuous adjustment between steps and extends 10 V/cm step to at least 100 V/cm.

Input RC: 1 megohm, nominal, shunted by approximately 100 pF.

General

Cathode ray tube: mono-accelerator, 3000-volt accelerating potential; aluminized P31 phosphor (other phosphors available, see modifications); etched safety glass face plate reduces glare.

Graticule: 10 cm x 10 cm parallax-free internal graticule marked in cm squares; major horizontal and vertical axes have 2 mm sub-divisions.

CRT plates: direct connection to crt deflection plates via terminals on rear panel; sensitivity approximately 20 V/cm.

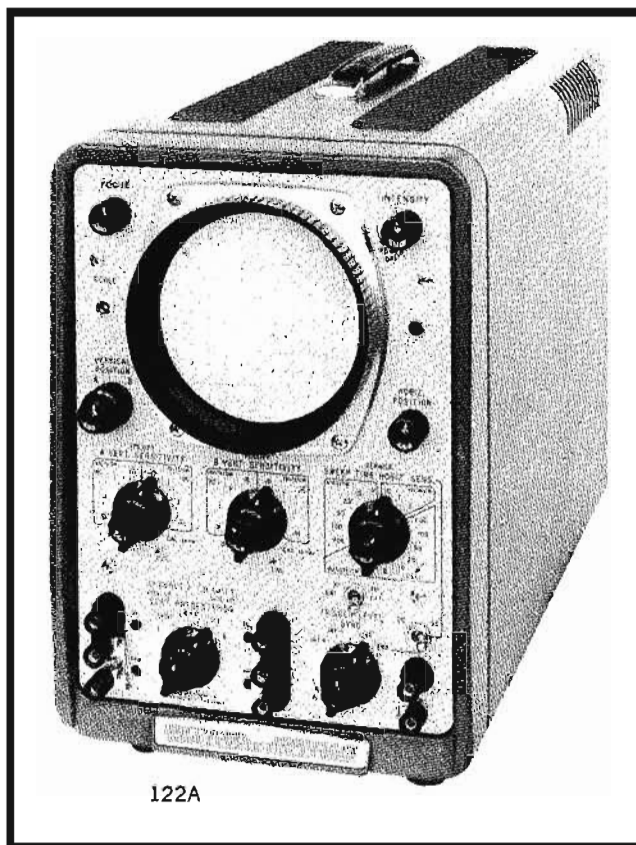

122A

Intensity modulation: +20 volt pulse will blank trace of normal intensity; input terminals on rear panel.

Dimensions: cabinet: 9 $\frac{3}{4}$ " wide, 15" high, 21 $\frac{1}{4}$ " deep overall (248 x 310 x 540 mm); rack mount: 19" wide, 7" high, 19 $\frac{1}{2}$ " deep behind panel (483 x 178 x 495 mm).

Weight: cabinet: net, 35 lbs (15.8 kg); shipping, 45 lbs (20.3 kg); rack mount: net, 34 lbs (11.3 kg); shipping, 49 lbs (22 kg).

Power: 115 or 230 volts $\pm 10\%$; 50 to 1000 Hz; approximately 150 W.

Price: HP Model 122A (cabinet), \$695; HP Model 122AR (rack mount), \$695; for single sweep operation specify H15-122A or H15-122AR, \$765.

Modifications

CRT phosphors (specify by phosphor number): P31 standard; P2, P7 with amber filter, P11 available, no charge.

Options: (specify by option number)

05 External graticule CRT with P31 phosphor (P2, P7, P11 available, please specify) in lieu of standard internal graticule, add \$25; includes edge-lighting of external graticule.

06 Rear terminals in parallel with front panel terminals; three 3-pin AN connectors for horizontal, vertical, and trigger inputs, add \$40; mating AN connectors supplied.

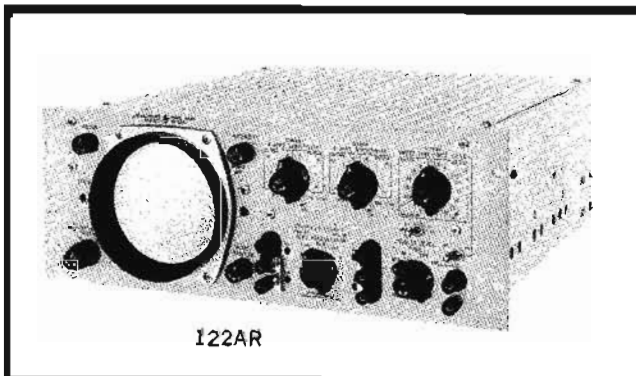

122AR

OSCILLOSCOPES



200 $\mu\text{V}/\text{CM}$ OSCILLOSCOPE

Features identical amplifiers for x-y plots
Model 130C

The HP Model 130C Oscilloscope is a versatile all-purpose instrument for laboratory, production line, industrial process measurements and medical applications. The outputs of rf detectors, strain gauges, transducers and other low-level devices may be viewed directly without preamplification. Calibrated sweeps allow accurate time measurements, and the identical horizontal and vertical amplifiers permit simple and precise measurement of phase.

The Model 130C is easy to operate even by inexperienced personnel. Controls are color coded to front-panel markings and are logically arranged by function. An internal-graticule crt provides a bright, clear, non-glare display without parallax. Automatic triggering minimizes adjustments. Positive pushbutton beam finder immediately locates an off-screen trace.

Identical amplifiers

Identical horizontal and vertical amplifiers provide a high sensitivity of 200 $\mu\text{V}/\text{cm}$ from dc to 500 kHz and balanced inputs on all ranges. Balanced output signals from low-level transducers, such as those used in industrial and medical fields, can be measured directly without external amplification. The amplifiers also may be used single-ended with ac or dc coupling. Regulated power supplies, high-stability components and extensive feedback insure excellent gain stability and low noise even on the most sensitive ranges. A front-panel switch (Amplifier AC-DC) provides ac coupling between amplifier stages and virtually eliminates all drift—even on the most sensitive range. Phase shift between amplifiers is held to less than $\pm 1^\circ$ up to 100 kHz for accurate phase measurements.

Probes may be used with both the horizontal and vertical amplifiers, and since the input impedance is constant, the probes will not require recompensation between sensitivity ranges.

Automatic triggering

Trigger adjustments are minimized with the Model 130C by the automatic triggering feature, which provides a base line in the absence of an input signal. For fast expanded sweep times where the automatic base line would be too dim for observation, a free run mode establishes a bright base line. A trigger level control is located on the front panel so that automatic triggering may be easily locked out if desired, and a preset trigger level established.

Versatile sweeps

For accurate time measurements, 21 linear direct-reading sweep times from 1 $\mu\text{s}/\text{cm}$ to 5 s/cm are available, accurate within $\pm 3\%$. A calibrated X2 to X50 magnifier expands the sweep up to 0.2 $\mu\text{s}/\text{cm}$, accurate within $\pm 5\%$. A vernier control permits continuous adjustment between calibrated ranges and extends the slowest sweep speed to at least 12.5 s/cm. In addition, a front-panel switch for either normal or single sweep permits observation of single-shot phenomena or random events. Switching to single sweep will disable the sweep circuit after a single sweep so that it can not be retriggered until manually rearmed. A front-panel sweep "armed" light indicates when the sweep is armed and ready to be triggered.

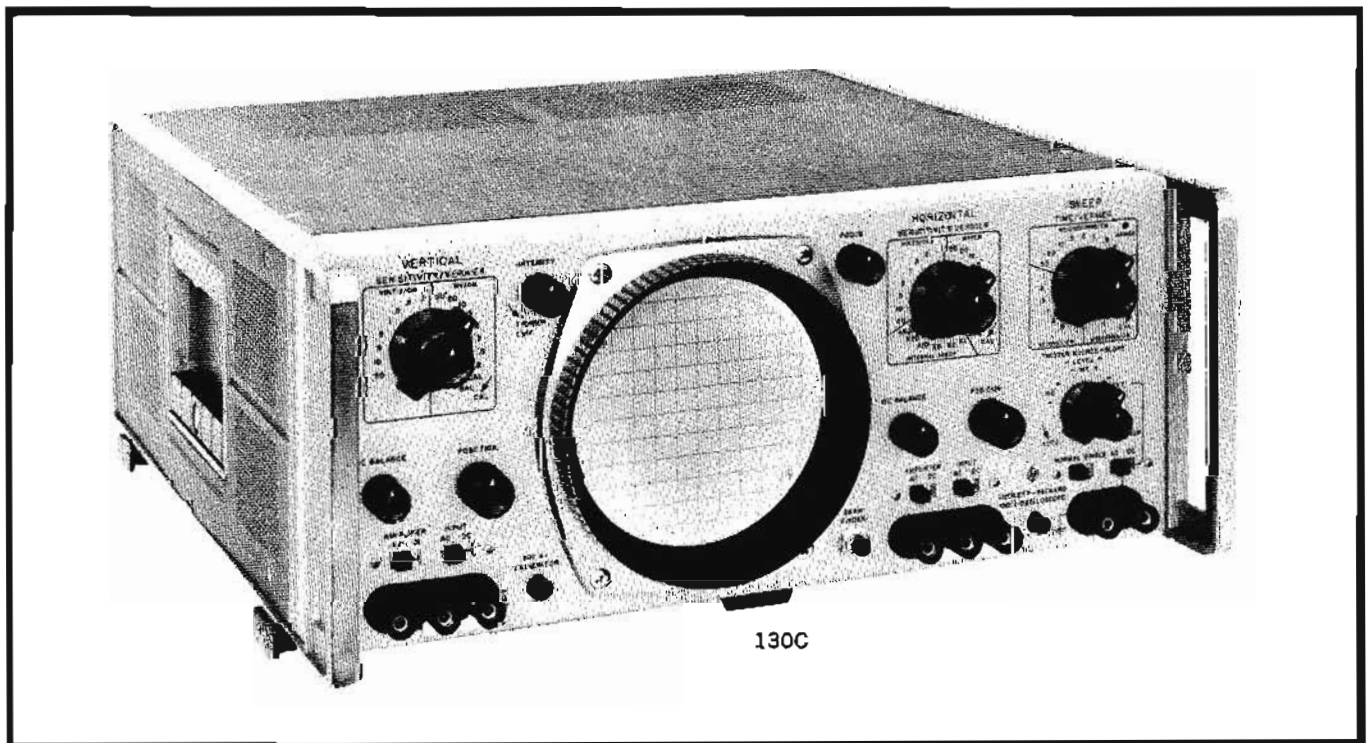

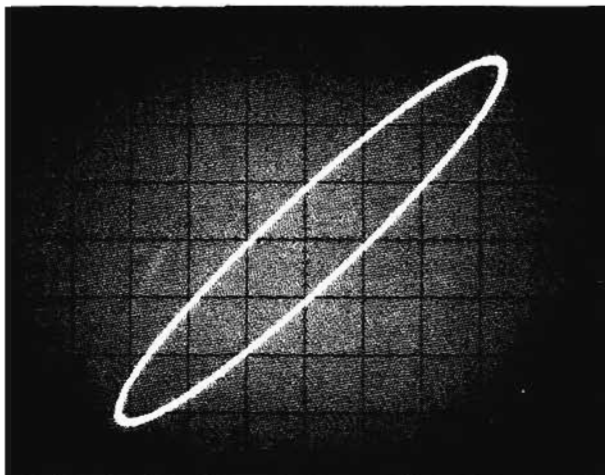

Phase shift measurements are easily made, as a result of the identical horizontal and vertical amplifiers in the Model 130C.

Specifications

Time base

Range: 1 $\mu\text{s}/\text{cm}$ to 5 s/cm, 21 ranges in a 1, 2, 5 sequence; accuracy $\pm 3\%$; vernier provides continuous adjustment between steps and extends the 5 s/cm step to at least 12.5 s/cm.

Magnifier: X2, X5, X10, X20, X50; overall sweep accuracy within $\pm 5\%$ for sweep rates which do not exceed a maximum rate of 0.2 $\mu\text{s}/\text{cm}$.

Automatic triggering (baseline displayed in the absence of an input signal):

Internal: 50 Hz to 500 kHz for signals causing 0.5 cm or more vertical deflection; also from line voltage.

External: 50 Hz to 500 kHz for signals at least 0.5 volt peak-to-peak.

Trigger slope: positive or negative slope of external sync signal or internal vertical deflection signal.

Amplitude selection triggering:

Internal: 10 Hz to 500 kHz for signals causing 0.5 cm or more vertical deflection.

External: for signals at least 0.5 volt peak-to-peak; dc coupled, dc to 500 kHz; ac coupled, 20 Hz to 500 kHz.

Trigger point and slope: from any point on the vertical waveform presented on CRT; or continuously variable from -10 to $+10$ volts on either positive or negative slope of external sync signal.

Single sweep: front panel switch permits single sweep operation.

Vertical and horizontal amplifiers

Bandwidth: dc coupled, dc to 500 kHz; ac coupled (input), 2 Hz to 500 kHz; ac coupled (amplifier), 25 Hz to 500 kHz at 0.2 mV/cm deflection factor; lower cut-off frequency (f_{co}) is reduced as deflection factor is increased; at 20 mV/cm, f_{co} is 0.25 Hz; on less sensitive ranges, response extends to dc.

Deflection factor (sensitivity): 0.2 mV/cm to 20 volts/cm, 16 ranges in a 1, 2, 5 sequence; accuracy $\pm 3\%$; vernier provides continuous adjustment between steps and extends 20 V/cm step to at least 50 V/cm.

Maximum input: 500 V peak (dc + ac).

Internal calibrator: calibrating signal (approximately 350 Hz square wave, 5 mV $\pm 3\%$) for setting amplifier gain, is automatically connected to amplifier when sensitivity vernier is set to Cal.

Input RC: 1 megohm shunted by approximately 45 pF; constant on all ranges.

Balanced inputs: on all sensitivity ranges.

Common mode rejection (dc to 50 kHz): at least 40 dB from 0.2 mV/cm to 0.1 V/cm sensitivities, common mode signal not to exceed 4 volts pk-pk; at least 30 dB from 0.2 V/cm to 20 V/cm sensitivities, common mode signal not to exceed 4 volts pk-pk on the 0.2 V/cm range, 40 volts pk-pk on the 0.5 V/cm to 2 V/cm ranges, or 400 volts pk-pk on the 5 V/cm to 20 V/cm ranges.

Phase shift: amplifiers have same phase characteristics within $\pm 1^\circ$ to 100 kHz (with verniers in Cal, and equal input sensitivities).

General

Calibrator: approximately 350 Hz, 500 mV $\pm 2\%$ provided through jack on front panel.

Cathode ray tube: mono-accelerator, 3000-volt accelerating potential; aluminized P31 phosphor (other phosphors available, see modifications); etched safety glass face plate reduces glare.

Graticule: 10 cm x 10 cm parallax-free internal graticule marked in cm squares; major horizontal and vertical axes have 2 mm sub-divisions.

Beam finder: pressing beam finder control brings trace on CRT screen, regardless of setting of horizontal, vertical, or intensity controls.

Intensity modulation: +20 volt pulse will blank trace of normal intensity; input terminals on rear panel.

Dimensions: 16 $\frac{3}{4}$ " wide, 7 $\frac{1}{2}$ " high, 18 $\frac{3}{8}$ " deep overall (426 x 191 x 466 mm); hardware furnished for quick conversion to 7" x 19" (178 x 483 mm) rack mount.

Weight: net, 31 lbs (14 kg); shipping, 38 lbs (17.1 kg).

Power: 115 or 230 volts $\pm 10\%$; 50 to 1000 Hz; approximately 90 W.

Price: HP Model 130C, \$695.

Modifications: CRT phosphors (specify by phosphor number); P31 standard; P2, P7 with amber filter, P11 available, no charge.

Special order: chassis slides and adapter kit; fixed slides, order HP Part No. 1490-0714, \$32.50; pivot slides, order HP Part No. 1490-0718, \$40; slide adapter kit for mounting slides on scope, order HP Part No. 1490-0721, \$20.

Options (specify by Option number):

05 External graticule CRT with P31 phosphor (P2, P7, P11 available, please specify) in lieu of standard internal graticule, add \$25; includes edge-lighting of external graticule.

60 Rear terminals in parallel with front panel terminals; two 3-pin AN connectors for horizontal and vertical signal inputs, BNC for trigger input, add \$45; mating AN connectors supplied.

13 Plain 3/16" x 7" x 19" panel for rack mounting only; suitable for installing special handles to match existing equipment in system or console, add \$20.

OSCILLOSCOPES



DUAL-BEAM OSCILLOSCOPE

Two completely independent beams

Model 132A

The HP Model 132A Dual-Beam Oscilloscope is designed to perform many electronic, scientific, bio-medical and mechanical measurements. Its 100 $\mu\text{V}/\text{cm}$ sensitivity, 500 kHz bandwidth, two completely independent beams, and low microphonics and drift assure ease and accuracy in a wide variety of applications.

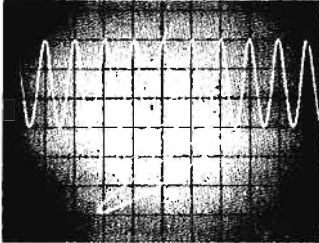

Figure 1. Simultaneous x-y and time plots are possible with Model 132A, since it has two completely independent CRT beams.

Unusual versatility is available with the Model 132A through its many different display capabilities. Functions such as pressure vs. volume, the outputs of vector cardiographs, or phase shift may be shown in x-y form on one channel, while related rate functions are displayed vs. time on the other. Also, slow and fast signals may be viewed simultaneously on different sweep speeds, or the same signal may be studied at two different sweep rates.

The Model 132A is ideal for use in areas of vibration or noise, since the amplifiers have very low microphonics and dc drift. Each input stage has nuvistor tubes contained in a shock-mounted block of aluminum. Besides isolating the nuvistors from vibration, the block also serves to keep the temperature of the tubes identical, thus providing excellent dc stability.

Differential operation is provided on all ranges for the elimination of common mode pickup such as 60-Hz hum. Rejection ratios as high as 20,000 to 1 (86 dB) assure completely clean waveforms even in the presence of high common mode interference.

Waveforms look the same from range to range with the

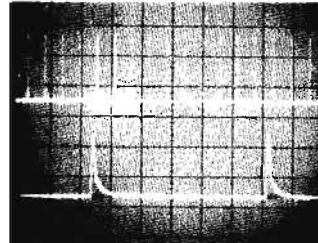
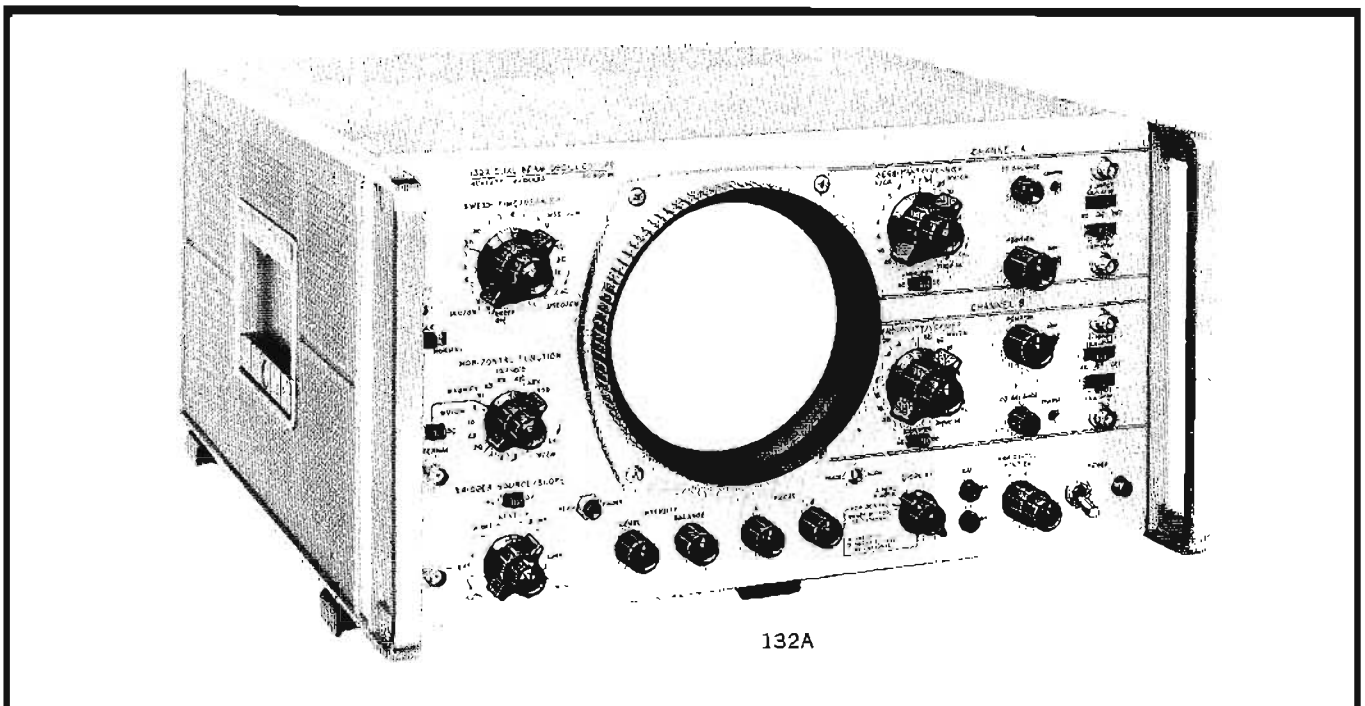

Figure 2. The same signal may be shown at two different sweep speeds with the slower sweep intensified to show location of fast sweep.

Model 132A, since the full 500 kHz bandwidth is retained at sensitivities from 1 mV/cm through 20 V/cm. At the most sensitive range, 100 $\mu\text{V}/\text{cm}$, bandwidth becomes 150 kHz.

Each vertical amplifier has an output at the rear panel of the Model 132A, allowing the user to monitor displays with an rms voltmeter, or drive a tape recorder.

The 3.5 kV aluminized CRT provides displays that are brighter than those previously available, making the Model 132A an excellent instrument for observing single-shot phenomena. A beam finder facilitates locating an off-screen trace by simply depressing a front-panel control. The internal graticule of the CRT eliminates parallax error, thus increasing measurement accuracy.



132A

Specifications

Time base

Range: may be selected for both beams, or one beam only with the other driven externally; 1 $\mu\text{s}/\text{cm}$ to 5 s/cm, 21 ranges in a 1, 2, 5 sequence; vernier provides continuous adjustment between steps, and extends 5 s/cm step to at least 12.5 s/cm.

Magnifier: X2, X5, X10, X20, X50; may be selected for both channels together, or Channel B only; vernier provides continuous adjustment between steps; with same vertical input applied to both channels, any portion of the display may be magnified on Channel B and the magnified portion will be intensified on Channel A display.

Automatic triggering (baseline displayed in the absence of an input signal):

Internal: 50 Hz to 500 kHz for signals causing 0.5 cm or more vertical deflection; selected from either channel input, or from line voltage.

External: 50 Hz to 500 kHz, for signals at least 0.5 volt peak-to-peak.

Trigger slope: positive or negative slope of external sync signal or internal vertical deflection signals.

Amplitude selection triggering

Internal: for signals causing 0.5 volt or more vertical deflection; dc coupled, dc to 500 kHz; ac coupled, 20 Hz to 500 kHz; selected from either channel signal, or from line voltage.

External: for signals at least 0.5 volt peak-to-peak; dc coupled, dc to 500 kHz; ac coupled, 20 Hz to 500 kHz.

Trigger point and slope: from any point on vertical waveform presented on CRT or continuously variable from -10 to $+10$ volts on either positive or negative slope of external signal.

External trigger input RC: ac coupled, 0.01 μF in series with 1 megohm; dc coupled, 1 megohm.

Sweep delay time: a pretrigger of approximately 1 μs will allow the leading edge of non-recurrent waveform to be visible.

Single sweep: front panel switch and pushbutton permit single sweep operation.

Identical vertical amplifiers

Deflection factor (sensitivity): 100 $\mu\text{V}/\text{cm}$ to 20 V/cm; 17 ranges in a 1, 2, 5 sequence; accuracy $\pm 3\%$; verniers provide continuous adjustment between steps, and extend 20 V/cm steps to at least 50 V/cm.

Bandwidth: dc to greater than 500 kHz (10% to 90% rise time less than 0.7 μs) on ranges 20 V/cm through 1 mV/cm, decreasing to greater than 150 kHz at 100 $\mu\text{V}/\text{cm}$, input may be ac coupled with 2 Hz lower cutoff; amplifier may be ac coupled (to eliminate drift) with 2.5 Hz lower cutoff at 100 $\mu\text{V}/\text{cm}$, decreasing to 0.1 Hz at 20 mV/cm.

Differential input: differential input may be selected on all attenuator ranges; the following common mode signals will not override the amplifier:

Deflection factor	Input: DC	Input: AC
0.1 mV/cm to 0.2 V/cm	≈ 2 V	4 V peak-to-peak
0.5 V/cm to 2.0 V/cm	≈ 20 V	40 V peak-to-peak
5.0 V/cm to 20 V/cm	≈ 200 V	400 V peak-to-peak

When a sine wave not exceeding the above limits is simultaneously applied from a low-impedance source to the dc coupled amplifier inputs, the vertical amplifiers have the following rejection ratios:

Deflection factor	60 Hz	1 kHz	50 kHz
0.1 mV/cm	86	80	74
1 mV/cm	66	66	66
0.2 V/cm	40	40	40
0.5 V/cm to 20 V/cm	30	30	30

With input ac coupled, maximum CMR at 60 Hz is 60 dB.

Inputs: two BNC connectors for + and - polarities; AC, DC, or Off may be selected for each input; input RC in 1 megohm shunted by 50 pF, constant on all ranges; max. input voltage is ± 500 V peak (dc + ac).

Amplifier outputs: a single-ended, dc-coupled output for each amplifier is provided on the rear panel; voltage output is approx. 2 V/cm from a 2 k ohm source impedance; bandwidth is approx. 500 kHz with a non-capacitive load.

External horizontal amplifier

Functions: may be used on both beams simultaneously, or on one beam only while the other is sweeping unmagnified.

Deflection factor (sensitivity): 5 mV/cm to 2 V/cm; 9 ranges in a 1, 2, 5 sequence; accuracy $\pm 3\%$; vernier provides continuous adjustment between steps and extends 2 V/cm step to at least 5 V/cm.

Bandwidth: dc to greater than 300 kHz (with vernier in Cal); ac coupled, lower limit is 2 Hz.

Input: BNC connector; input RC, 1 megohm shunted by 50 pF, constant on all ranges; max. input voltage, ± 500 volts peak (dc + ac).

X-Y operation

Single beam: x-y curve tracing; one of the vertical amplifiers can be switched to the horizontal deflection plates of the other beam, allowing x-y operation of the two identical amplifiers; the unused beam is positioned off screen; relative phase shift between + inputs is within $\pm 2^\circ$ for frequencies up to 50 kHz with verniers in Cal and equal input sensitivities.

Dual-beam: x-y plots can be made between the external horizontal amplifier and the B vertical amplifier while the other beam is operating normally with the sweep and A vertical amplifier, or, dual plots can be made using the external horizontal amplifier driving both beams; relative phase shift is normally within $\pm 2^\circ$ for frequencies up to 10 kHz with vernier in Cal and equal input sensitivities.

General

Calibrator: approximately 350 Hz square wave, 0.5 V and 0.5 mV, provided through jacks on front panel; accuracy $\pm 2\%$.

Cathode ray tube: mono-accelerator, 3500-volt accelerating potential; aluminumized P2 phosphor (other phosphors available, see modifications); dual gun and two independent sets of vertical and horizontal deflection plates; etched safety glass face plate reduces glare.

Graticule: 10 cm x 10 cm parallax-free internal graticule marked in cm squares; display area for each beam is 8 cm x 10 cm, with 6 cm vertical overlap in center; vertical and horizontal axes for each beam have 2 mm subdivisions.

Beam finder: pressing beam finder control brings both traces on CRT screen, regardless of vertical, horizontal, or intensity control settings.

Intensity modulation: +20 volt pulse will blank traces of normal intensity; input terminals on rear panel; input time constant is approximately 125 μsec (9400 pF and 13.5 k ohms).

Dimensions: 16 $\frac{3}{4}$ " wide, 9" high, 18 $\frac{3}{8}$ " deep overall (426 x 229 x 466 mm); hardware furnished for quick conversion to 19" x 8 $\frac{3}{4}$ " x 16 $\frac{3}{8}$ " behind panel (483 x 222 x 416 mm) rack mount.

Weight: net 43 lbs (19.4 kg); shipping 55 lbs (24.8 kg).

Power: 115 or 230 volts $\pm 10\%$; 50 to 1000 Hz; approximately 130 W.

Price: HP Model 132A, \$1395.

Modifications: CRT phosphors (specify by phosphor number); P7, P11, P31 available; no charge.

Special order: chassis slides and adapter kit; fixed slides, order HP Part No. 1490-0714, \$32.50; pivot slides, order HP Part No. 1490-0718, \$40; slide adapter kit for mounting slides on scope, order HP Part No. 1490-0721, \$20.

Options: (specify by option number)

05 External graticule CRT with P2 phosphor (P7, P11, P31 available, please specify) in lieu of standard internal graticule, includes edge-lighting of external graticule, add \$25.

06 Rear terminal in parallel with front panel terminals; 3-pin AN connectors for vertical signal inputs; BNC for horizontal and trigger signal inputs, mating AN connectors supplied, add \$45.



PLUG-IN OSCILLOSCOPE

One scope to do nearly any measurement task
Model 140A System

The HP 140A Scope System, which consists of either the 140A mainframe or the 141A mainframe and the 1400-series plug-ins, provides the versatility you need to get step-ahead measurements over the entire oscilloscope spectrum. With 17 high-performance vertical and horizontal plug-ins to choose from, you can head in any measurement direction: Wide-band, sampling, high-sensitivity or measurements such as Time Domain Reflectometry and Swept Frequency... all with optional variable persistence and storage if you like.

HP's 140A system offers these capabilities: An oscilloscope system that gives you sampling bandwidth to 12.4 GHz... sampling delayed sweep time base... 50 $\mu\text{V}/\text{cm}$ sensitivity with no dc drift... versatile single or double-size plug-in capability... plus plug-ins for direct readout TDR and Swept Frequency. In addition, it is the only oscilloscope system to offer either standard CRT persistence in the 140A mainframe—or optional variable persistence and storage in

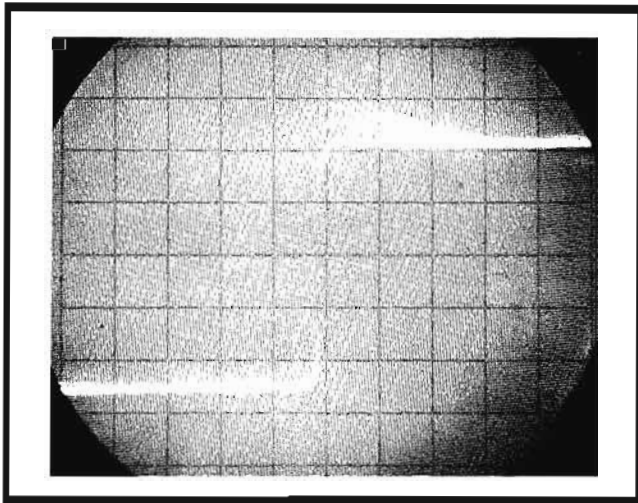

See signal trends while making circuit adjustments by simply making persistence long enough so that several traces appear on screen simultaneously.

the 141A mainframe. Select from these unique measurement capabilities, or choose from the general purpose plug-ins available.

12.4 GHz Sampling with Delayed Sweep

Exceedingly fast HP switching diodes have opened a true breakthrough in sampling scope capabilities.

For the first time, you can see through X band, observe CW signals to 12.4 GHz and beyond, and see fast pulses with a 28 ps rise time capability. You can also use TDR measurements to resolve discontinuities down to less than 1 cm in the design of cables, coaxial components, connectors and strip lines. In addition, you can utilize delayed sweep through the full bandwidth to get displays of pulse segments that leave conventional sampling scopes blurred. You also get less than 20 ps jitter to ensure steady, clear displays.

Two vertical amplifiers are available. Model 1411A provides dc to 12.4 GHz at 1 mV/cm, dual-channel perfor-

mance with remote samplers featuring feed-through inputs for minimum signal disturbance. The other sampling vertical amplifier, Model 1410A, gives performance to 1 GHz, with both high-Z probes and 50 ohm inputs—and internal triggering. Model 1425A Sampling Time Base plug-in provides delayed sweep, automatic triggering and a movable intensified dot that makes it easy to set up the point of magnification.

50 $\mu\text{V}/\text{CM}$ Zero Drift

The versatile HP 140A Scope System gives you five high-sensitivity plug-ins specifically designed for measurement of low-level signals. For example, the 1406A vertical plug-in offers high 50 $\mu\text{V}/\text{cm}$ sensitivity with no dc drift—plus precision calibrated dc offset for extreme magnification.

With the HP calibrated offset feature, the 1406A gives you the advantages of a dc and ac voltmeter—four-digit readout, auto decimal placement, better than 0.5% measurement accuracy. As a dc voltmeter, the 1406A offers you the additional advantages of no drift in the measurement instrument, and the ability to observe and measure any ac riding on the dc voltage. With these capabilities you can make measurements never before possible. For example, you can simultaneously display a 10 V dc signal at 50 $\mu\text{V}/\text{cm}$ (giving a magnification of 200,000), measure dc level accurately to four digits, see short term dc drift with microvolt resolution, and view and measure all ac ripple—an impossible measurement with a meter. The HP 1406A plug-in also operates as a dc coupled, no drift differential amplifier with 80 dB common mode rejection.

Simplify Design of Microwave & Pulse Circuits with 150 ps TDR.

You can use a 1415A Time Domain Reflectometer plug-in to quickly determine the magnitude and nature of each resistive or reactive discontinuity in strip lines or coaxial components such as attenuators, cables, connectors and delay lines. This 150 ps system enables you to resolve discontinuities an inch apart.

The 1415A is a completely self-contained system consisting of a fast-rise pulse generator, single channel sampler, and time base. No additional vertical or horizontal amplifiers are required, thus eliminating introduction of additional chances of error. The vertical channel is calibrated in reflection coefficient for direct readout, with a maximum sensitivity of .005 p/cm for measurement of extremely small discontinuities. Full 10 cm x 10 cm display area gives maximum resolution. Distances can be read directly on the horizontal axis. The compact control panel contains only those controls necessary for TDR measurements, thus making the 1415A much simpler to operate than comparable systems costing twice as much.

Accessories for direct readout in special applications: Rise Time Converters which eliminate reflections beyond the bandwidth of interest, 75 ohm adapters, and a Susceptance Standard which gives direct readings of reactive discontinuities.

Get 20 MHz Bandwidth and Delayed Sweep Readability

If you need wideband performance, for example, you can use the dual-trace 1402A vertical amplifier and get dc to 20 MHz at 5 mV/cm, algebraic addition, built-in delay line for viewing the leading edge of fast-rise pulses, full 6 cm deflection and a wide dynamic range. An internal sync amplifier triggers on Channel A in dual trace mode of operation—gives stable traces and accurate time measurements without external triggering.

For easy readability of complex waveforms and accurate time interval measurements, Model 1421A Time Base & Delay Generator provides extreme magnification—calibrated time delays from 10 seconds to 0.5 μ s, calibrated sweep speeds from 1 s/cm to 20 ns/cm. The 1421A also offers the additional advantage of exclusive HP mixed sweep. This feature combines display of the first portion of a trace at normal sweep speeds, and simultaneously expands the trailing portion of the trace at faster delayed sweep speeds to allow step-by-step magnified examination.

Choose from Two HP High-Performance Mainframes:

The advanced HP 140A and 141A mainframes give you a choice between conventional (fixed) CRT persistence—and variable persistence and storage. As a result, the 140A/141A system gives you not only an extensive plug-in capability, but also, the CRT versatility you need to meet the requirements of any measurement problem today—six months from now—or at any future time.

These HP 140A and 141A mainframes are specifically designed to give you both high-frequency and high-sensitivity performance. Both consist of the essential functional blocks for low and high frequency applications—plus sampling. Included is a post-accelerator CRT, associated control circuitry, power supplies, and the dc supplies required to power the HP 1400 Series plug-ins which contain CRT drive circuitry.

This true building-block arrangement assures that you can use existing and future plug-ins without modification to the mainframe. You pay only for the circuitry you actually need to make your particular measurements.

Because all deflection circuitry is contained in the plug-ins, you get exclusive capabilities in mixing plug-ins. You can not only select the amplifier you need for the vertical axis, but also, you can select the particular time base generator needed for the horizontal axis.

Further, since the 140A and 141A CRT's have identical horizontal and vertical deflection sensitivities, you can use two vertical amplifiers for an X-Y display . . . or one single-channel amplifier and one dual-channel amplifier to plot two variables against a third . . . or two identical dual-channel amplifiers for a pair of simultaneous X-Y displays.

Or, you can remove the shield which separates upper and lower plug-in compartments and use double-size plug-ins such as the HP Model 1415A Time Domain Reflectometer, or Model 1416A Swept Frequency Indicator.

Both 140A and 141A mainframes are equipped with a convenient beam finder which quickly locates a trace and puts it on screen for fast trouble-free set-up.

The 141A mainframe gives you all the advantages of the 140A mainframe—plus the exclusive benefits of HP variable persistence and storage.

The HP 141A has a 7.3 kV, post accelerator CRT—with unique mesh storage. At the twist of a knob, you can adjust the 141A's memory span (trace persistence) from 0.2 seconds to a minute . . . to hours . . . to days. This exclusive HP variable persistence allows you to adjust the CRT persistence to match the changing characteristics of a signal—any necessary number of traces can be held for trend comparisons, or

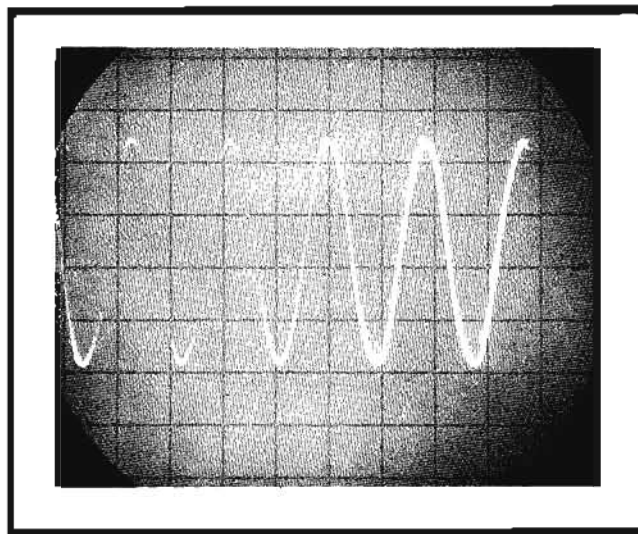

Exclusive HP variable persistence enables you to match the persistence of your CRT screen to any signal—eliminating annoying flicker on slow signals such as swept frequency and sampling waveforms, transducer signals and low-frequency displays.

for flicker free displays. With a bi-stable storage tube, all information is stored, often creating jumbled displays—or you have flickering "full" erase and no retained information.

The HP mesh storage tube offers many advantages. With the 141A CRT, the stored trace has the same high contrast as a conventional CRT. Intermediate trace values stand out clearly, you can easily distinguish between four or five separate trace intensities—as opposed to the limiting black-and-white-only displays of ordinary bi-stable storage. Intensity of the 141A CRT can be varied by a front panel control, or modulated externally for X-Y-Z presentations. Maximum viewing intensity in storeview mode is 200 foot lamberts—25 times brighter than bi-stable tubes. With the HP storage mesh CRT, trace brightness and writing speed are maintained over the entire life of the tube—specified performance is warranted for one year.

In addition to conventional storage, the 141A CRT is also capable of storage after power has been turned off. This feature permits a graphic display of some critical parameter prior to (a) system failure, (b) activation of a safety device, or (c) excursions beyond some predetermined limit. As much as a full minute of information can be stored in this manner for days.

Utilize the HP 141A scope for variable persistence, conventional persistence, and storage—it's like having three scopes in one! Also, you have the advantage of choosing from any of the HP high-performance 1400 Series plug-ins.

OSCILLOSCOPES 140A SYSTEM *continued*

Accepts all 1400-Series Plug-ins
Mainframe Model 140A

The Model 140A is a main-frame which contains the basic functional circuitry for both low and high frequency applications, as well as those for sampling. It contains a post-accelerator CRT with its associated power supplies and control

circuitry, and the dc supplies required to power the Model 1400-series plug-ins. The plug-ins contain all of the circuitry necessary to produce beam deflection, and work directly into the CRT of the Model 140A mainframe.

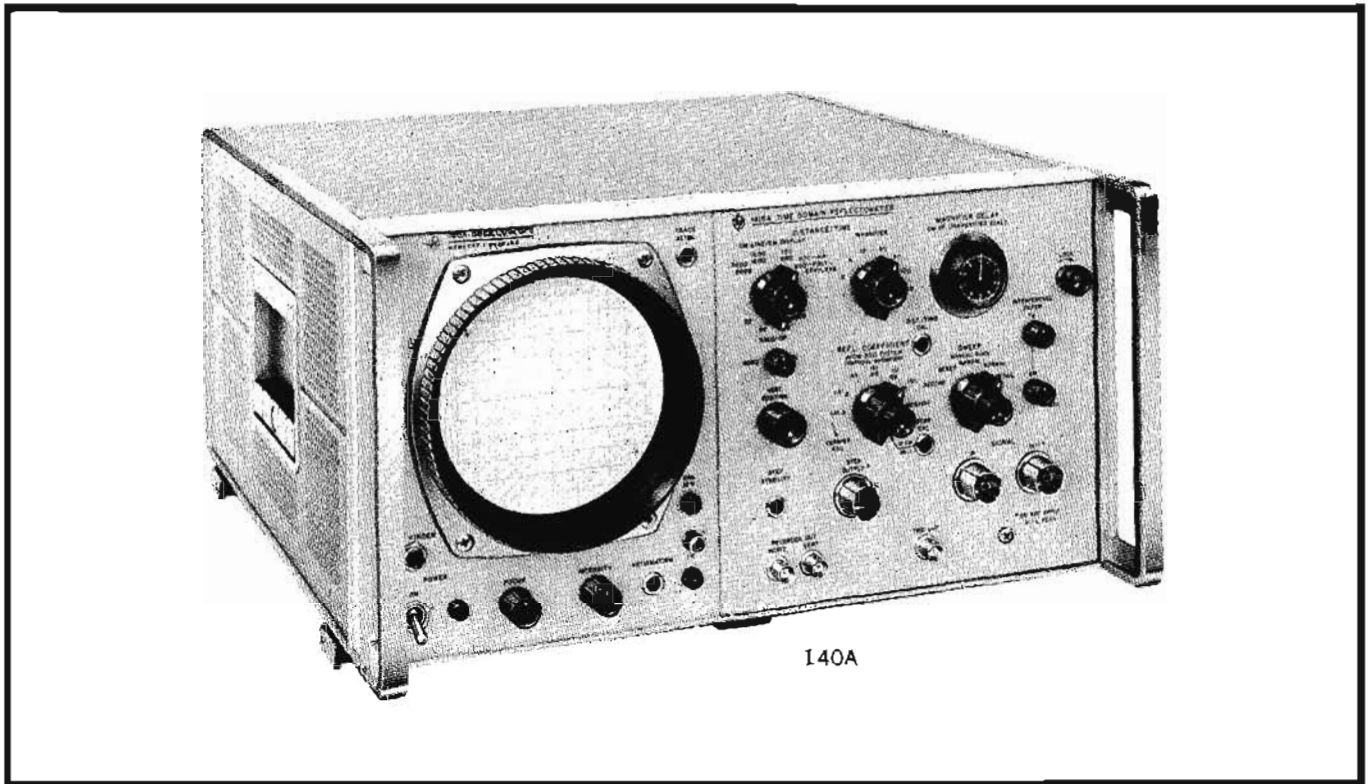

Specifications

Plug-ins: accepts Model 1400-series plug-ins; upper compartment for horizontal axis and lower compartment for vertical axis; center shield may be removed to accommodate a single dual-axis Model 1400-series unit.

Cathode-ray tube:

Type: post-accelerator, 7300-volt accelerating potential; aluminized P31 phosphor (other phosphors available, see modifications); etched safety glass face plate reduces glare.

Graticule: 10 cm x 10 cm parallax-free internal graticule marked in cm squares; major horizontal and vertical axes, and second and tenth horizontal graticule lines have 2 mm subdivisions.

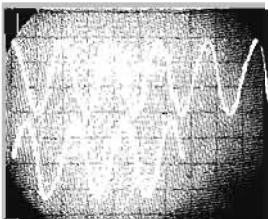

In the HP 140A CRT, you get high 7.3 kV electron beam acceleration for bright, easy-to-see traces . . . internal graticule eliminates parallax . . . carefully shaped post accelerator field gives full 10 cm x 10 cm display area without distortion.

Intensity modulation: ac coupled, +20 volt pulse will blank trace of normal intensity; input terminals on rear panel.

Warranty: CRT warranted for one year.

Writing rate: (using HP Model 197A Camera with $f/1.9$ lens and Polaroid® 3000 speed film).

P31 Phosphor: 300 cm/ μ sec.

P11 Phosphor: 430 cm/ μ sec.

Calibrator:

Type: line-frequency rectangular signal, approximately 0.5 μ sec rise time.

Voltage: two outputs: 1 volt and 10 volts peak-to-peak. $\pm 1\%$ from 15°C to 35°C, $\pm 3\%$ from 0°C to 55°C.

Beam finder: pressing beam finder control brings trace on CRT screen regardless of settings of horizontal, vertical or intensity controls.

Power requirements: 115 or 230 volts $\pm 10\%$, 50 to 60 Hz, normally less than 285 watts (varies with plug-in units used).

Price: HP Model 140A (without plug-ins), \$595.00.

"Polaroid"® by Polaroid Corporation

OSCILLOSCOPES 140A SYSTEM *continued***Variable Persistence and Storage
Mainframe Model 141A**

The 141A gives you storage for side-by-side comparison of waveforms. In this mode, traces can be held intact for more than an hour (days, in fact, with the scope turned off). Fast 1 cm/ μ sec storage writing rate enables you to capture single-shot transients.

The Model 141A mainframe contains the same basic circuitry for low-frequency, high frequency and sampling applications as the 140A mainframe. It also accepts all of the 1400-series plug-ins. In addition the 141A mainframe contains the Cathode-Ray-Tube and associated circuitry for the unique variable persistence and storage capabilities.

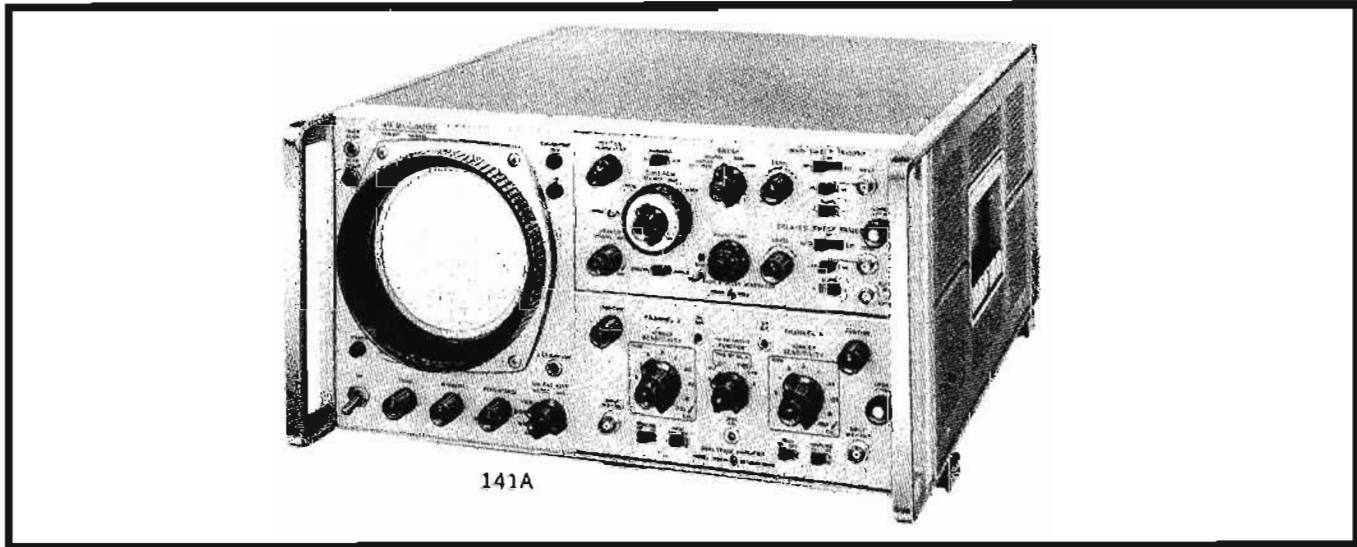
**Specifications**

Plug-ins: same as Model 140A.

Cathode-ray tube:

Type: post-accelerator storage tube, 7300-volt accelerating potential; aluminized P31 phosphor; etched safety glass face plate reduces glare.

Graticule: 10 x 10 divisions (approximately 9.4 x 9.4 cm) parallax-free internal graticule; 5 subdivisions per major division on major horizontal and vertical axes, and on second and tenth horizontal graticule lines.

Intensity modulation: ac coupled, +20 volt pulse will blank trace of normal intensity; input terminals on rear panel.

Warranty: CRT specifications (persistence, writing rate, brightness, storage time) warranted for one year.

Persistence:

Normal: natural persistence of P31 phosphor (approximately 0.1 second).

Variable:

Normal writing rate mode: continuously variable from less than 0.2 second to more than one minute (typically to two or three minutes).

Max writing rate mode: typically variable from 0.2 second to 15 seconds.

Erase: manual; erasure takes approximately 0.5 sec; scope ready to record immediately after erasure (see options for remote erase).

Writing rate (conventional operation): (using HP Model 197A Camera with f/1.9 lens and Polaroid® 3000 speed film): 100 cm/ μ sec.

Writing rate (storage):

Normal mode: greater than 20 cm/msec.

Max. mode: greater than 1 cm/ μ sec.

Calibrator:**Beam finder:****Power requirements:****Dimensions:**

Weight: net, 40 lbs (18 kg); shipping, 51 lbs (23 kg).

Price: HP Model 141A (without plug-ins), \$1395.00.

Options: (specify by option number).

09: Remote erase. BNC input on rear panel; shorting to ground for at least 200 ms erases screen; input draws 20 mA from ground through a 600-ohm impedance to a -12 volt supply. Add \$25.

Special order: chassis slides and adapter kit; fixed slides, order HP Part No. 1490-0714, \$32.50; pivot slides, order HP Part No. 1490-0718, \$40; slide adapter kit for mounting slides on scope, order HP Part No. 1490-0721, \$20. New-fast writing rate CRT option for HP 141A, 5 cm/ μ sec. Order Model C05-141A. Price \$1495.

OSCILLOSCOPES 140A SYSTEM *continued*Selection chart
1400 Series plug-ins

Capabilities	Vertical plug-ins									
	1400A	1401A	1402A	1403A	1405A	1406A	1407A	1410A	1411A	1430A
1. Wide band			•		•					
2. Sampling								•	•	•
3. High gain differential	•			•		•	•			
4. Dual trace		•	•		•			•	•	
5. X-Y	•	•	•	•	•	•	•	•	•	
6. Delayed sweep			1421A for real time			1425A for sampling				
7. No drift						•	•			
8. High common mode rejection				•		•	•			
9. Algebraic addition		•	•		•			•	•	
10. Time domain reflectometry										
11. Wide band TDR									•	•
12. Swept frequency										

**1400A**

- 100 μ V/cm
- dc to 400 kHz
- Differential on all ranges

Price: \$250.

Page 465

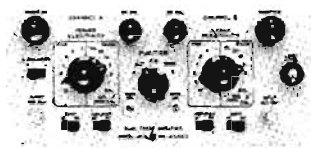
**1401A**

- 1 mV/cm-dual trace
- dc to 450 kHz
- Convenient dual trace triggering

Price: \$425.

Page 465

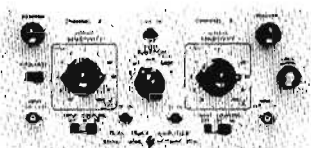
**1402A**

- 5 mV/cm
- dc to 20 MHz-dual trace
- Signal delay for fast rise viewing

Price: \$575.

Page 466

**1403A**

- 10 μ V/cm.
- 0.1 Hz to 400 kHz
- 106 dB common mode rejection

Price: \$475.

Page 470

**1405A**

- 5 mV/cm-dual trace
- dc to 5 MHz
- Algebraic addition

Price: \$325.

Page 467

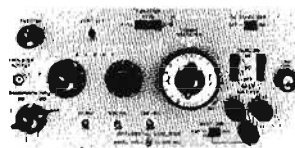
**1406A**

- 50 μ V/cm-dc to 400 kHz
- No drift
- Calibrated offset for accurate ac and dc measurements

Price: \$850.

Page 470

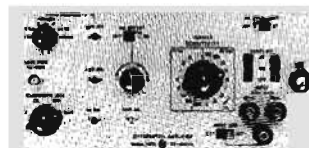
**1407A**

- 50 μ V/cm
- No drift
- 80 dB common mode rejection

Price: \$625.

Page 470

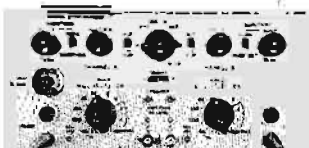
**1410A**

- 1 mV/cm at 1 GHz-dual trace
- Internal triggering
- High impedance probes and 50 Ω inputs

Price: \$1600.

Page 473

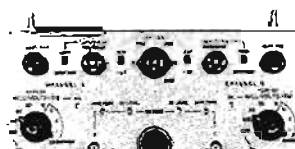
**1411A**

- 1 mV/cm-dual trace
- Bandwidths to 12.4 GHz
- Remote samplers

Price: \$700.

Page 475

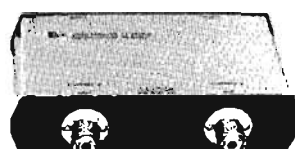
**1430A**

- 28 ps rise time—

Price: \$3000.

Page 476

Capabilities	Vertical plug-ins		Compatible time bases						Double size plug-ins	
	1431A	1432A	1420A	1421A	1422A	1423A	1424A	1426A	1415A	1418A
1. Wide band			•	•		•				
2. Sampling	•	•					•	•		
3. High gain differential			•	•	•	•				
4. Dual trace			•	•	•	•	•	•		
5. X-Y			Use 2 vertical or ext. horizontal							
6. Delayed sweep				•				•		
7. No drift			•	•	•	•				
8. High common mode rejection			•	•	•	•				
9. Algebraic addition			•	•	•	•	•	•		
10. Time domain reflectometry									•	
11. Wide band TDR							•	•		
12. Swept frequency										•

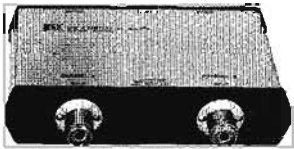

Price: \$3000.

1431A
 • 12.4 GHz bandwidth
 Page 476

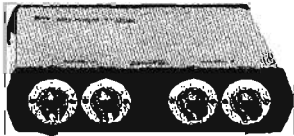

Price: \$1000.

1432A
 • 90 ps rise time—
 Page 475

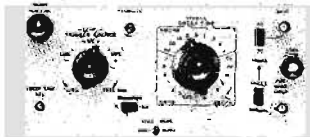

Price: \$325.

1420A
 • 10 MHz triggering
 • Sweeps to 50 ns/cm
 • Auto triggering
 Page 471

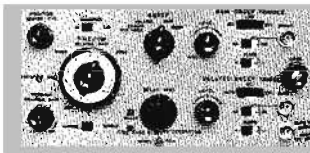

Price: \$625.

1421A
 • 20 MHz triggering
 • Delayed sweep
 • Sweeps to 20 ns/cm
 Page 472

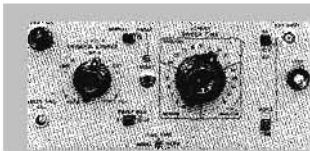

Price: \$225.

1422A
 • 500 kHz triggering
 • Sweeps to 200 ns/cm
 • Auto triggering
 Page 471

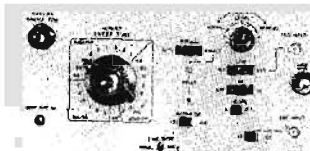

Price: \$450.

1423A
 • 20 MHz triggering
 • Sweeps to 20 ns/cm
 • Trigger hold-off
 Page 471

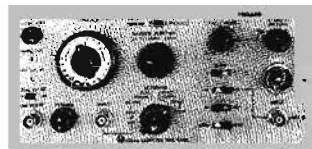

Price: \$1200.

1424A
 • Triggering to 5 GHz
 • Sweeps to 10 ps/cm
 • Direct readout on all sweeps
 Page 477

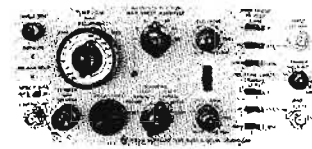

Price: \$1600.

1425A
 • Delayed sweep
 • Sweeps to 10 ps/cm
 • Triggering to 1 GHz
 Page 478

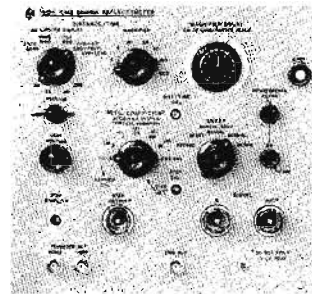

Price: \$1050.

1415A
 • Complete TDR system for testing cables, connectors, striplines
 • Determines location, meaning, and nature of each discontinuity
 • Resolves discontinuities—an inch apart
 • Easy to operate
 Page 481

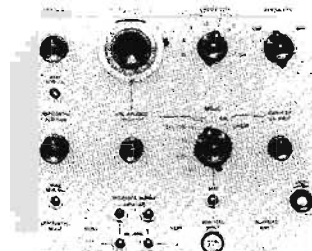

Price: \$675.

1416A
 • Speeds and simplifies swept frequency measurements
 • High resolution readout directly in dB
 Page 480

OSCILLOSCOPES 140A SYSTEM *continued*

20 MHz With Signal Delay
Dual Trace Amplifier Model 1402A

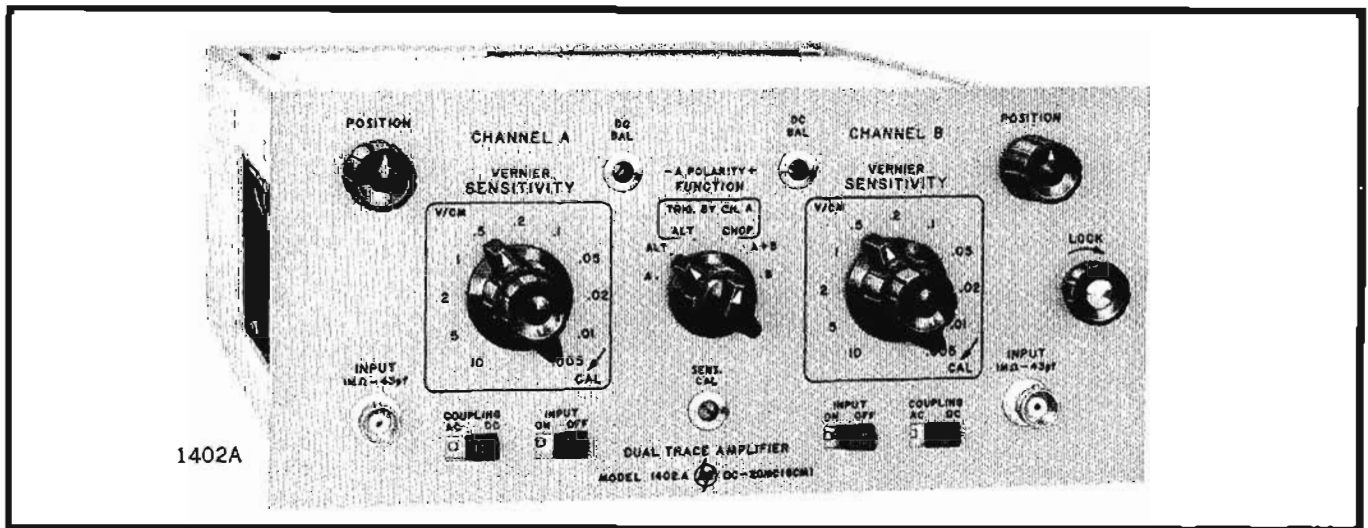

The 1402A Dual Trace Amplifier provides greater than 20 MHz bandwidth plus 5 mV/cm sensitivity on each channel for accurate analysis of high frequency low level signals. Rise times of signals can be easily measured because the 1402A has a built-in delay line in the vertical amplifier following the trigger take-off.

Two signals can be displayed with the 1402A in each of two modes. Slow signals can be viewed in the chopped mode, since the input to the CRT is switched between Channel A and Channel B at a high rate during each sweep. Fast signals can be viewed in the alternate mode since the input to the CRT is switched at the end of each sweep, with Channel A displayed during one sweep and Channel B on the following sweep.

Accurate time difference measurements are possible because the sync amplifier in the 1402A can be switched to Channel A alone. This feature is useful when dual traces are displayed on alternate sweeps; switching the sync to Channel A preserves the time relationship between the two signals, because the sweep always triggers on the same point on Channel A. Also, syncing to Channel A when in the chopped dual trace mode assures triggering on the displayed waveform rather than the chopper. Two unrelated signals can be displayed by triggering on the composite waveform. This feature

avoids resorting to external triggering for either of these dual trace presentations.

Single-channel displays are also possible for either input A or B. The two channels may also be displayed algebraically added, and a polarity reversal switch on Channel A allows the differential signal, $B - A$, to be displayed.

Although maximum bandwidth is obtained from the 1402A with 6 cm or less deflection, larger amplitude signals can be displayed without distortion and with only a small sacrifice in bandwidth. For example, the bandwidth when using a full 10-cm deflection is greater than 15 MHz.

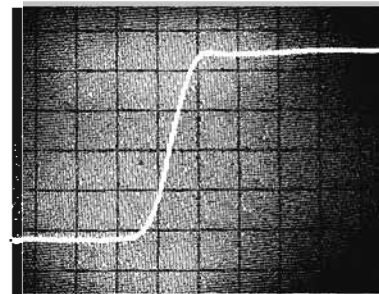

Above photo demonstrates bandwidth and excellent transient response of 1402A Dual Trace Amplifier. Sweep time is 20 ns/cm; sensitivity is 5 mV/cm.

Specifications

Mode of operation: (1) Channel A alone, (2) Channel B alone, (3) Channel A and Channel B displayed on alternate sweeps, (4) Channel A and Channel B displayed by switching at approx. 100 kHz, with trace blanking during switching, (5) Channel A and Channel B added algebraically, polarity of Channel A may be inverted to obtain differential operation.

Bandwidth: (6 cm reference signal) dc coupled, dc to 20 MHz; ac coupled, 2 Hz to 20 MHz.

Risetime: less than 20 ns with 6 cm step input.

Deflection factor (sensitivity): each channel; 5 mV/cm to 10 V/cm, 11 ranges in a 1, 2, 5 sequence; accuracy $\pm 3\%$;

vernier provides continuous adjustment between steps and extends 10 V/cm step to at least 25 V/cm.

Signal delay: signal is delayed so that leading edge of fast-rise signals is visible at start of sweep.

Common mode rejection: (in B-A mode) at least 40 dB on 5, 10 and 20 mV/cm ranges, at least 30 dB on 50 mV/cm to 10 V/cm ranges; common mode signal not to exceed 150 cm (e.g., 150 volts on 1 V/cm range or a frequency of 500 kHz).

Input RC: 1 megohm shunted by 43 pF.

Maximum input: 600 volts peak (dc + ac).

Weight: net, 6 lbs (2,7 kg); shipping, 8 lbs (3,6 kg).

Price: HP Model 1402A, \$575.

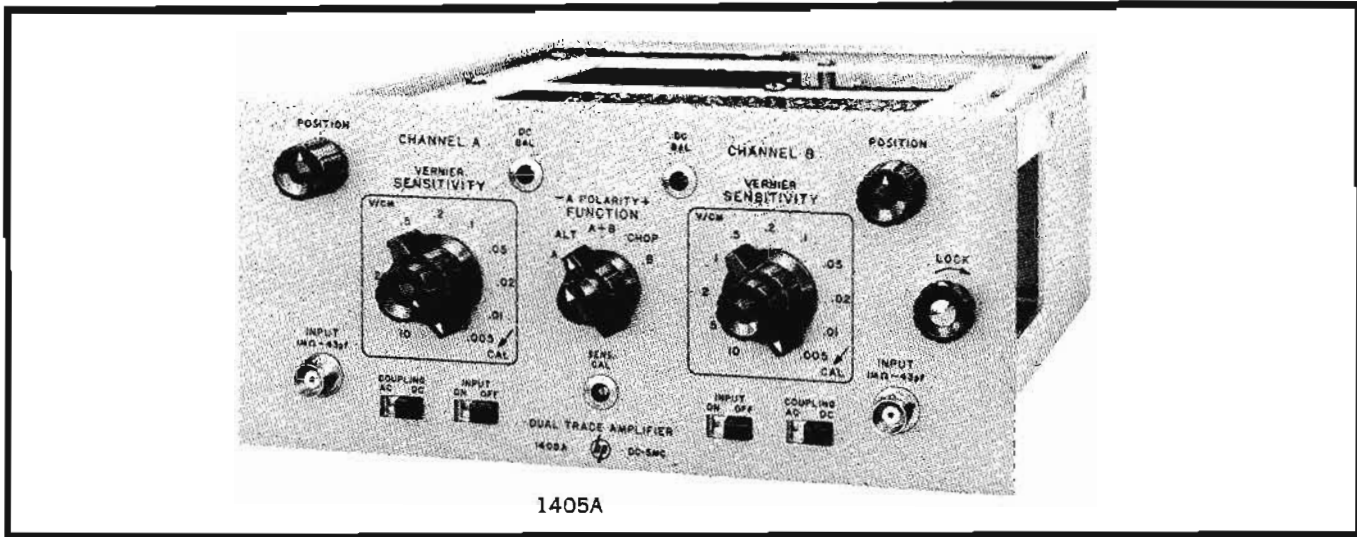
OSCILLOSCOPES 140A SYSTEM *continued*
5 MHz with 5 mV/cm Sensitivity
Dual Trace Amplifier Model 1405A

The 1405A Dual Trace Amplifier provides 5 MHz bandwidth at 5 mV/cm sensitivity. Dual trace presentations can be displayed on alternate sweeps or by chopping between the two input signals on the same sweep at a 100 kHz rate. In addition to single-trace presentations of Channel A or B, the two channels may be algebraically added or, by a reversal of the Channel A polarity switch, the differential signal may be viewed. The full 5 MHz frequency response is achieved in every operating mode, and when operating in any sensitivity position.

In all operating modes each channel has independent positioning and sensitivity controls, permitting the comparison of signals with widely differing amplitudes. When used as a differential amplifier, a common-mode rejection of better than 40 dB in the higher sensitivity positions permits the display of low-level signals while attenuating undesirable components such as hum.

The wide dynamic range of the 1405A permits a 50 cm peak-to-peak signal to be displayed without significant distortion. Using A + B mode and a variable dc voltage source such as the 723A power supply applied to the second channel, any 10-cm segment of the 50-cm trace can be positioned

on screen and analyzed. The 1405A is an ideal tool for video waveforms when used with the 1421A Time Base and Delay Generator, since any single line of a television frame may be isolated and displayed. The 5 mV/cm sensitivity permits the display of signals in low-level stages, or permits the use of attenuator probes to prevent circuit loading. For X-Y measurements, such as phase shift or Lissajous patterns, the 1405A may be used with any other 1400 series plug-in (including another 1405A) for either vertical or horizontal deflection.

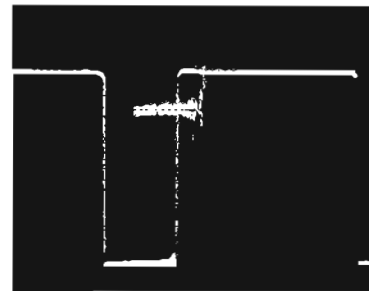

Double exposure showing 5-cm pulse on upper waveform, and the same pulse expanded. 10 X to view small perturbation on the top.

Specifications

Mode of operation: (1) Channel A alone, (2) Channel B alone, (3) Channel A and Channel B displayed in alternate sweeps (4) Channel A and Channel B displayed by switching at approx. 100 kHz, with trace blanking during switching, (5) Channel A and Channel B added algebraically, polarity of Channel A may be inverted to obtain differential operation.

Bandwidth: dc coupled, dc to 5 MHz (70 nsec rise time; ac coupled, 2 Hz to 5 MHz (the lower limit is extended to approx. 0.2 Hz with a X10 probe).

Deflection factor (sensitivity): each channel; 5 mV/cm to 10 V/cm, 11 ranges in a 1, 2, 5 sequence; accuracy $\pm 3\%$;

vernier provides continuous adjustment between steps and extends 10 V/cm step to at least 25 V/cm.

Common mode rejection: at least 40 dB on 5, 10, and 20 mV/cm ranges, at least 30 dB on 50 mV/cm to 10 V/cm ranges; common mode signal not to exceed 50 cm (e.g., 0.5 volt on 10 mV/cm range) or a frequency of 50 kHz.

Input RC: 1 megohm shunted by 43 pF.

Maximum input: 600 volts peak (dc + ac).

Weight: net, 4 lbs (1,8 kg); shipping, 7 lbs (3,2 kg).

Price: HP Model 1405A, \$325.

Special order: double-size, single-channel, X-Y only version of Model 1405A; order H20-1405A; price, \$ 450.

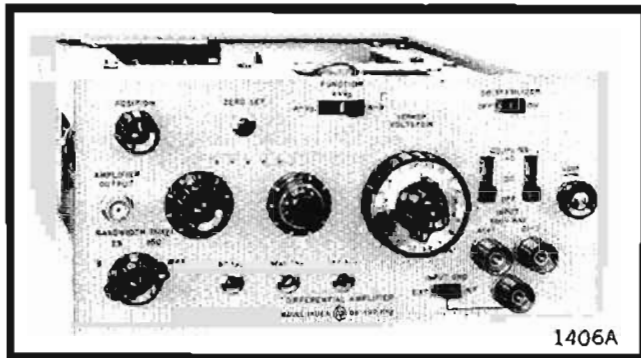
OSCILLOSCOPES 140A SYSTEM *continued***Differential amplifier with calibrated offset**
Precision amplifiers Model 1406A

In addition to 50 $\mu\text{V}/\text{cm}$ sensitivity, no drift dc stabilization, and wide dynamic range, the 1406A offers a calibrated dc offset for better than 0.5% accurate ac and dc voltage measurements.

Accurate measurements are accomplished by inserting the test signal into one side of a high common mode rejection differential amplifier and a very accurate (0.15%) dc level

Specifications

Sensitivity: 50 $\mu\text{V}/\text{cm}$ to 20 V/cm in a 1, 2, 5 sequence; vernier provides continuous adjustment between ranges and extends minimum sensitivity to at least 50 V/cm; attenuator accuracy is $\pm 3\%$.

Amplifier output: approx 1 V/cm, dc coupled, single ended, dc level approx 0 volts, output impedance less than 100 ohms, dynamic range $\pm 5\text{ V}$.

Bandwidth**Upper limit:**

20 V/cm to 100 $\mu\text{V}/\text{cm}$ - 400 kHz (0.9 μs rise time);
or 50 $\mu\text{V}/\text{cm}$ - 300 kHz.

Upper limits of max, 100, 25, and 5 kHz selectable with front panel switch on all sensitivities.

Lower limit: dc with input dc coupled, 2 Hz with input ac coupled.

Drift

Long-term drift: less than $\pm 0.2\text{ cm}$ or less than $\pm 20\ \mu\text{V}$ per 200 hrs, whichever is greater.

Temperature drift: less than $\pm 0.2\text{ cm}$ or less than $\pm 50\ \mu\text{V}$, whichever is greater over a temperature range of 0°C to 55°C.

Drift correction occurs at 3 Hz for 50 ms/cm sweeps and faster, and 1.5 Hz on 0.1 s/cm sweeps and slower.

Range to range shift: dc stabilization maintains a fixed baseline reference within $\pm 1\text{ cm}$ on crt over entire range of sensitivity after a 3-minute warmup.

Positioning: baseline can be positioned $\pm 10\text{ cm}$ by continuous position.

DC offset: offset is applied to the B (-) input.

Readout: 4-digit resolution, with lighted decimal indicators.

Ranges: $\pm 0.1\text{ V}$, $\pm 1\text{ V}$, $\pm 10\text{ V}$, $\pm 100\text{ V}$, $\pm 1000\text{ V}$.
Up to $\pm 10\text{ V}$ offset can be used on all sensitivity ranges; an equivalent $\pm 100\text{ V}$ range can be used from 0.5 mV/cm through 20 V/cm, and an equivalent $\pm 1000\text{ V}$ range from 5 mV/cm through 20 V/cm.

into the other side. The top of the waveform is then positioned to center screen with the offset controls and the offset reading noted. This is then repeated for the bottom of the waveform. The difference between the two offset readings is the ac amplitude.

The same technique is used when measuring a dc level except only one reading is required; zero volts is already established because the stabilizer eliminates drift.

The range switching is interlocked with the sensitivity switching so that the direct reading offset does not change when changing the sensitivity. There are ten offset ranges providing $\pm 0.1\text{ V}$ to $\pm 1000\text{ V}$ in decade steps.

The 1406A can also be used as a differential amplifier. The high common mode rejection and no drift features provide for accurate differential measurements. An external ground is also provided to eliminate ground loops.

The adjustable bandwidth control of the 1406A allows the user to reduce bandwidth from the maximum of 400 kHz down to 100, 25, 5 kHz, eliminating noise present in the unused part of the bandwidth. The front panel amplifier output permits driving external equipment such as X-Y Recorders or tape recorders.

Accuracy: $\pm 0.15\%$ of indicated value plus 0.05% of full scale offset range, on $\pm 0.1\text{ V}$, $\pm 1\text{ V}$, and $\pm 10\text{ V}$ ranges.
 $\pm 0.4\%$ of indicated value plus 0.05% of full scale offset range, on $\pm 100\text{ V}$ and $\pm 1000\text{ V}$ ranges.

Differential input: may be selected on all sensitivity ranges. Single-ended operation is used when employing offset.

Common mode rejection: $\pm 5\text{ V}$ (dc + pk ac) or $\pm 10\text{ V}$ dc, dc coupled, 50 $\mu\text{V}/\text{cm}$ to 20 mV/cm; dc to 60 Hz, 80 dB; 60 Hz to 10 kHz, 60 dB.

Maximum input without overload

50 $\mu\text{V}/\text{cm}$ to 20 mV/cm — $\pm 10\text{ V}$ pk-pk.

50 mV/cm to 2 V/cm — $\pm 100\text{ V}$ pk-pk.

5 V/cm to 20 V/cm — $\pm 600\text{ V}$ pk-pk.

Dynamic range: dynamic signals of at least $\pm 50\text{ cm}$ of deflection can be displayed without distortion.

Input impedance: 1 megohm shunted by 100 pF, constant on all attenuator ranges.

Max input

V_0 range: 0.1 to 10.

15 V (dc + peak ac), 0.05 mV/cm to 20 mV/cm;
150, 50 mV/cm to 0.2 V/cm; 600 V, 0.5 V/cm to 20 V/cm.

V_0 range: 100.

150 V (dc + peak ac).

V_0 range: 1000.

600 V (dc + peak ac).

X-Y operation: two 1406A's or 1406A and a 1407A can be used to give X-Y presentation.

Time base compatibility: the 1406A and 1407A can be used directly with the 1422A and 1423A; 1420's below serial 441-01326 and 1421A's below serial 545-00651 must be modified. (Order kits 01420-69502 for the 1420A, 01421-69501 for the 1421A.)

Weight: net 5 lbs (1,8 kg); shipping 7 lbs (3,2 kg).

Price: HP Model 1406A, \$850.

OSCILLOSCOPES 140A SYSTEM *continued*

Measure microvolt signals
High sensitivity amplifiers Models 1400A, 1401A

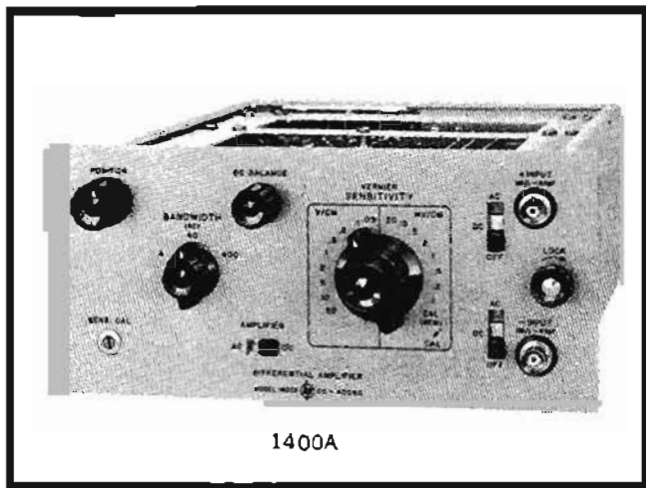

1400A

Get 100 $\mu\text{V}/\text{cm}$ sensitivity and selectable bandwidth from dc to 400 kHz with low drift differential amplifiers in the 1400A.

Specifications, 1400A**Bandwidth**

Upper limit: 400 (0.9 μs rise time), 40 or 4 kHz.

Lower limit: input and amplifier coupling set to dc: dc; input set to dc and amplifier set to ac: dc from 20 V/cm to 50 mV/cm, approx 0.1 Hz on 20 mV/cm increasing with deflection factor to approx 20 Hz at 0.1 mV/cm; input set to ac and amplifier set to dc: 2 Hz.

Deflection factor (sensitivity): 100 $\mu\text{V}/\text{cm}$ to 20 V/cm, 17 ranges in a 1, 2, 5 sequence; accuracy $\pm 3\%$; vernier provides continuous adjustment between steps and extends 20 V/cm step to at least 50 V/cm.

Phase shift: when used with another Model 1400A, less than 2° relative phase shift up to 50 kHz with X and Y deflection factors the same, and verniers in Cal.

Common mode rejection: differential input may be selected on all ranges; cmr at least 40 dB on 0.1 mV/cm to 0.2 V/cm ranges, signal not to exceed 4 V pk-pk; at least 30 dB on 0.5 V/cm to 20 V/cm ranges, signal not to exceed 40 V pk-pk on 0.5, 1, and 2 V/cm ranges or 400 V pk-pk on 5, 10, and 20 V/cm ranges, measured with 1 kHz sine wave.

Input RC: 1 megohm shunted by 45 pF.

Maximum input: 600 volts peak (dc + ac).

Internal calibrator: line frequency square wave, 6 cm pk-pk; displayed when vernier is set to Cal; accuracy $\pm 3\%$.

Weight: net 4 lbs (1,8 kg); shipping 7 lbs (3,2 kg).

Price: HP Model 1400A, \$250.

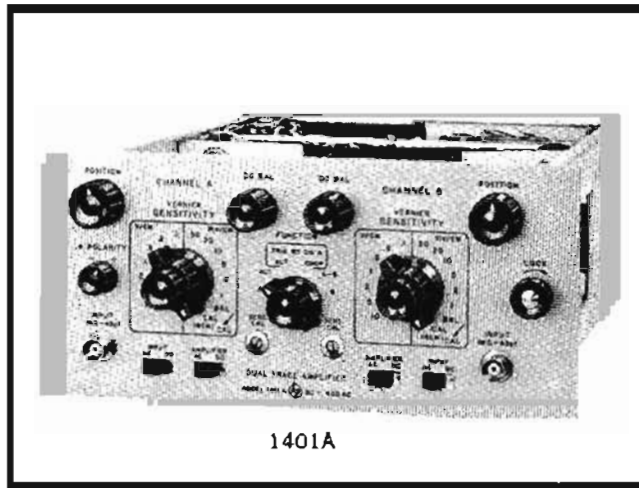

1401A

The 1401A is a dual trace amplifier with 1 mV/cm sensitivity and a 450 kHz bandwidth.

Specifications, 1401A

Bandwidth: input and amplifier coupling set to dc, dc to 450 kHz (0.8 μs rise time); input set to dc and amplifier set to ac, dc to 450 kHz for deflection factors from 50 mV/cm to 10 V/cm; from 1 mV/cm to 20 V/cm, lower cutoff depends on the deflection factor: approx 0.5 Hz (to 450 kHz) at 20 mV/cm and 10 Hz (to 450 kHz) at 1 mV/cm; input set to ac and amplifier set to dc, 2 Hz to 450 kHz.

Deflection factor (sensitivity): each channel; 1 mV/cm to 10 V/cm, 14 ranges in a 1, 2, 5 sequence; accuracy $\pm 3\%$; vernier provides continuous adjustment between steps and extends 10 V/cm step to at least 25 V/cm.

Phase shift: when used with another Model 1401A, less than 2° relative phase shift up to 50 kHz with X and Y deflection factors the same, and verniers in Cal.

Common mode rejection: both inputs may be switched to one channel to give differential input; cmr at least 40 dB on 1 mV/cm to 0.1 V/cm ranges, signal not to exceed 4 V pk-pk; at least 30 dB on 0.2 V/cm to 10 V/cm ranges, signal not to exceed 40 V pk-pk on 0.2, 0.5, and 1 V/cm ranges or 400 V pk-pk on 2, 5 and 10 V/cm ranges; measured with 1 kHz sine wave.

Input RC: 1 megohm shunted by 45 pF.

Maximum input: 60 volts peak (dc + ac).

Internal calibrator: line frequency square wave, 6 cm pk-pk; displayed when vernier is set to Cal; accuracy $\pm 3\%$.

Mode of operation: (1) channel A alone, (2) channel B alone, (3) channel A and channel B displayed on alternate sweeps, (4) channel A and channel B displayed by switching at approx 100 kHz, with trace blanking during switching, (5) channel A minus channel B.

Display polarity: + up or - up, selectable, 7 lbs (3,2 kg).

Weight: net 5 lbs (2,3 kg); shipping 7 lbs (3,2 kg).

Price: HP Model 1401A, \$425.

OSCILLOSCOPES 140A SYSTEM *continued***High common mode rejection**

High sensitivity amplifiers Models 1403A, 1407A

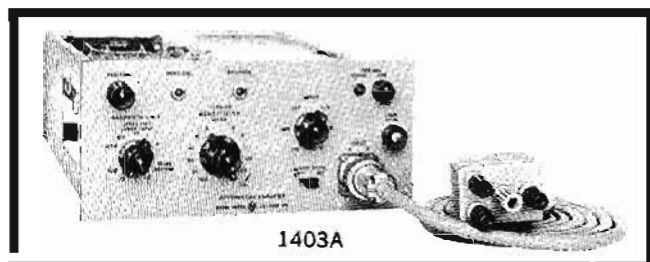

1403A

The Model 1403A Amplifier features 106 dB of common mode rejection with guarded input and 10 $\mu\text{V}/\text{cm}$ sensitivity.

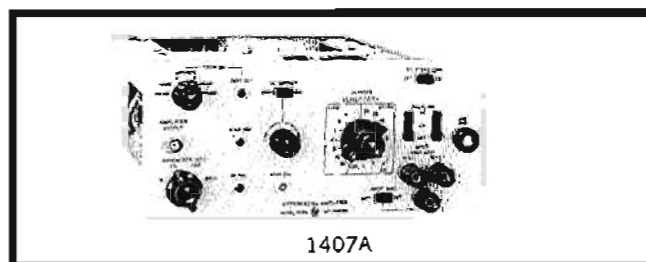

1407A

The Model 1407A has 50 $\mu\text{V}/\text{cm}$ sensitivity, 80 dB of common mode rejection, and no dc drift.

Specifications, 1407A**Bandwidth**

Upper limit: selectable; 5, 25, 100 kHz, and max (400 kHz for 20 V/cm to 100 $\mu\text{V}/\text{cm}$ ranges, 0.9 μs rise time; or 300 kHz for 50 $\mu\text{V}/\text{cm}$ range).

Lower limit: dc coupled input, dc; ac coupled input, 2 Hz.

Deflection factor (sensitivity): 50 $\mu\text{V}/\text{cm}$ to 20 V/cm, 17 ranges in a 1, 2, 5 sequence; accuracy $\pm 3\%$; vernier provides continuous adjustment between steps and extends 20 V/cm step to at least 50 V/cm.

Amplifier output: approx 1 V/cm, dc coupled, single-ended, dc level approx 0 V, output impedance less than 100 ohms, dynamic range ± 5 V.

Drift: drift correction occurs at 3 Hz for 50 ms/cm speeds and faster, 1.5 Hz on 0.1 s/cm speeds and slower.

Long term drift: less than ± 0.2 cm or less than ± 20 $\mu\text{V}/200$ hours, whichever is greater.

Temperature drift: less than ± 0.2 cm or less than ± 50 μV , whichever is greater, over a temperature range of 0°C to 55°C.

Range to range shift: dc stabilization maintains a fixed baseline reference within ± 1 cm on crt over entire deflection factor range, after a 3-minute warmup.

Positioning: baseline can be positioned continuously or in calibrated steps of 0, ± 5 cm, and ± 10 cm; accuracy $\pm 3\%$.

DC offset: uncalibrated dc offset is provided in both single-ended and differential operation; the max amount of offset obtainable, referenced to the input, varies with deflection factor approx as follows: 0.2 V at 50 $\mu\text{V}/\text{cm}$, increasing to 0.5 V at 10 mV/cm, 5 V at 100 mV/cm, 50 V at 1 V/cm, and 600 V at 20 V/cm; offset dc drift is less than 20 $\mu\text{V}/\text{hr}$ at constant ambient temperature, or less than ± 100 μV for ambient temperature change of 0°C to 50°C.

Differential input: may be selected on all ranges; offset capability is maintained in differential operation.

Common mode rejection: ± 5 V (dc - pk ac) or ± 10 V dc, dc coupled, 50 $\mu\text{V}/\text{cm}$ to 20 mV/cm; dc to 60 Hz, 80 dB; 60 Hz to 10 kHz, 60 dB; max input without overload: 50 $\mu\text{V}/\text{cm}$ to 20 mV/cm, ± 10 V pk-pk; 50 mV/cm to 2 V/cm, ± 100 V pk-pk; 5 V/cm to 20 V/cm, ± 600 V pk-pk.

Dynamic range: dynamic signals of less than ± 50 cm of deflection can be displayed without distortion.

Input RC: 1 megohm shunted by 90 pF.

Maximum input: 100 volts peak (dc + ac) for 0.05 mV/cm to 20 mV/cm ranges, 600 volts peak (dc + ac) for 50 mV/cm to 20 V/cm ranges.

X-Y operation: two 1407A's or 1407A and a 1406A can be used to provide X-Y presentations.

Time base compatibility: the Model 1407A may be used directly with Models 1422A and 1423A; Model 1420A's below serial 441-01326, and Model 1421A's below serial 545-00651 must be modified for use with the Model 1407A (order kits 01420-69502 for the Model 1420A, \$12.50; or 01421-69501 for the Model 1421A, \$20).

Weight: net 5 lbs (1.8 kg); shipping 7 lbs (3.2 kg).

Price: HP Model 1407A, \$625.

Deflection factor (mV/cm)	Common mode rejection (dB)
0.01 to 0.2	106
0.5, 1, 2	86
5, 10, 20	66
50, 100	46

Typical CMR with an unbalanced source impedance when using Guard Drive Ext on most sensitive ranges:

Unbalance	60 Hz	120 Hz	1 kHz	10 kHz
100 ohms	100 dB	100 dB	100 dB	90 dB
1 k ohms	100 dB	100 dB	90 dB	70 dB
10 k ohms	80 dB	80 dB	70 dB	50 dB

Input RC: 10 megohms by approx. 60 pF.

Maximum input: 600 volts peak (dc + ac) on A and B inputs, 10 volts on Guard input.

Noise: 20 μV pk-pk at 100 kHz, noise is reduced as bandwidth is reduced.

Internal calibrator: line frequency square wave, 100 mV pk-pk, displayed when input selector is set to Cal; accuracy $\pm 3\%$.

Weight: net 4 lbs (1.8 kg); shipping 7 lbs (3.2 kg).

Accessories furnished: 6-ft double-shielded extension cable, and a 4-terminal binding post adapter.

Price: HP Model 1403A, \$475.

OSCILLOSCOPES 140A SYSTEM *continued***Sweeps to 20 ns/cm**

Time bases Models 1420A, 1422A, 1423A

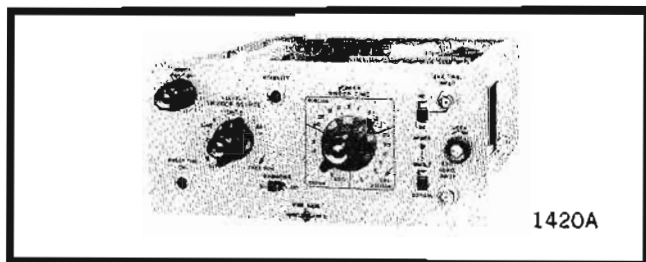

10 MHz triggering with sweeps to 50 ns/cm and automatic triggering.

Specifications, 1420A

Range: 0.5 μ s/cm to 5 s/cm, 22 ranges in a 1, 2, 5 sequence; accuracy $\pm 3\%$; vernier provides continuous adjustment between steps and extends the 5 s/cm step to at least 12.5 s/cm.

Magnifier: X10, overall accuracy $\pm 5\%$; expands 0.5 μ s/cm speed to 50 ns/cm.

Automatic triggering: (baseline displayed in the absence of an input signal).

Internal: 40 Hz to 500 kHz for signals causing 0.5 cm or more vertical deflection; also from line signal.

External: 40 Hz to 500 kHz for signals at least 0.5 V pk-pk.

Trigger slope: positive or negative slope of external sync signal or internal vertical deflection signal.

Amplitude selection triggering

Internal: 10 Hz to 5 MHz for signals causing 0.5 cm or more vertical deflection.

External: for signals at least 0.5 V pk-pk; dc coupled, dc to 5 MHz; ac coupled, 10 Hz to 5 MHz; max input, 600 V pk (dc + ac).

Trigger point and slope: from any point on the vertical waveform presented on crt; or continuously variable from -7 to +7 volts on external sync signal; positive or negative slope.

Single sweep: front panel switch permits single sweep operation.

Horizontal input

Bandwidth: dc to better than 1.5 MHz (typically).

Deflection factor (sensitivity): vernier permits continuous adjustment from approx 50 mV/cm to 5 V/cm.

Input RC: 1 megohm shunted by approximately 50 pF.

Weight: net 5 lbs (2.3 kg); shipping 7 lbs (3.2 kg).

Price: HP Model 1420A, \$325.

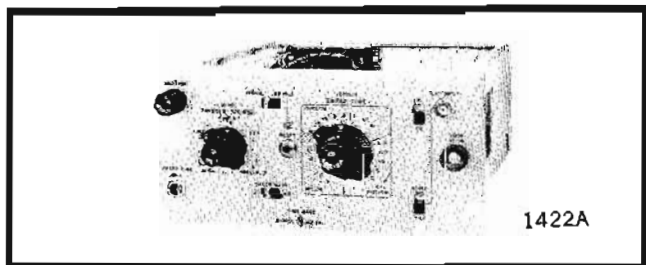

500 kHz triggering with sweeps to 200 ns/cm and automatic triggering.

Specifications, 1422A

Range: 1 μ s/cm to 5 s/cm, 21 ranges in a 1, 2, 5 sequence; accuracy $\pm 3\%$; vernier provides continuous adjustment between steps and extends the 5 s/cm step to at least 12.5 s/cm.

Magnifier: X5, overall accuracy $\pm 5\%$; expands 1 μ s/cm speed to 200 ns/cm.

Automatic triggering: (baseline displayed in the absence of an input signal).

Internal: 50 Hz to 500 kHz for signals causing 0.5 cm or more vertical deflection; also from line signal.

External: 50 Hz to 500 kHz for signals at least 0.5 V pk-pk.

Trigger slope: positive or negative slope of external sync signal or internal vertical deflection signal.

Amplitude selection triggering

Internal: dc or 10 Hz to 500 kHz (depending on vertical system) for signals causing 0.5 cm or more vertical deflection.

External: for signals at least 0.5 V pk-pk; dc coupled, dc to 500 kHz; ac coupled, 10 Hz to 500 kHz; max input, 600 V pk (dc + ac).

Trigger point and slope: from any point on the vertical waveform presented on crt; or continuously variable from -10 to +10 volts on external sync signal; positive or negative slope.

Single sweep: front panel switch permits single sweep operation.

Horizontal input

Bandwidth: dc coupled, dc to 400 kHz; ac coupled, 20 Hz to 400 kHz.

Deflection factor (sensitivity): vernier permits continuous adjustment from approx 0.8 V/cm to 2.5 V/cm.

Input RC: 1 megohm shunted by approx 150 pF.

Weight: net 5 lbs (2.3 kg); shipping 7 lbs (3.2 kg).

Price: HP Model 1422A, \$225.

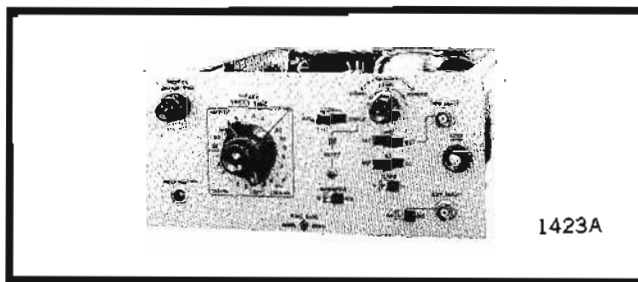

20 MHz triggering with sweeps to 20 ns/cm and trigger hold-off.

Specifications, 1423A

Range: 0.2 μ s/cm to 5 s/cm, 23 ranges in a 1, 2, 5 sequence; accuracy $\pm 3\%$; vernier provides continuous adjustment between steps and extends the 5 s/cm step to at least 12.5 s/cm.

Magnifier: X10, overall accuracy $\pm 5\%$; expands 0.2 μ s/cm speed to 20 ns/cm.

Automatic triggering: (baseline displayed in the absence of an input signal) same as normal, except lower limit is 40 Hz for both ac and dc coupling.

Normal triggering

Internal: dc coupled: dc (with Models 1406A/1407A) to 15 MHz for signals causing 0.5 cm or more vertical deflection, to 20 MHz for 1 cm signals; ac coupled: 10 Hz to 15 MHz for 0.5 cm signals, to 20 MHz for 1 cm signals; ACF, approx 2 kHz to 15 MHz for 0.5 cm signals, to 20 MHz for 1 cm signals.

External: for signals at least 0.5 V pk-pk; dc coupled, dc to 20 MHz; ac coupled, 10 Hz to 20 MHz; ACF, approx 2 kHz to 20 MHz; max input, 600 V pk (dc + ac).

Line: triggering from line frequency also selectable.

Trigger point and slope: selectable in both normal and automatic; from any point on the vertical waveform presented on crt; or continuously variable from -5 to +5 volts on external sync signal; positive or negative slope.

Trigger hold-off: time continuously variable, exceeding one full sweep at 50 ns/cm and faster, prevents multiple triggering on signals that have desired triggering level and slope appearing more than once per cycle.

Trigger Input RC: dc and ac, approx 1 megohm shunted by 50 pF; acf, approx 120 k ohms shunted by 50 pF.

Single sweep: front panel switch permits single sweep operation.

Horizontal input

Bandwidth: dc to 500 kHz.

Deflection factor (sensitivity): vernier and X10 magnifier permit continuous adjustment from approx 300 mV/cm to 30 V/cm.

Input RC: 1 megohm shunted by approx 50 pF.

Weight: net 5 lbs (2.3 kg); shipping 7 lbs (3.2 kg).

Price: HP Model 1423A, \$450.

OSCILLOSCOPES 140A SYSTEM *continued*

Delayed sweep to 20 MHz
Time base Model 1421A

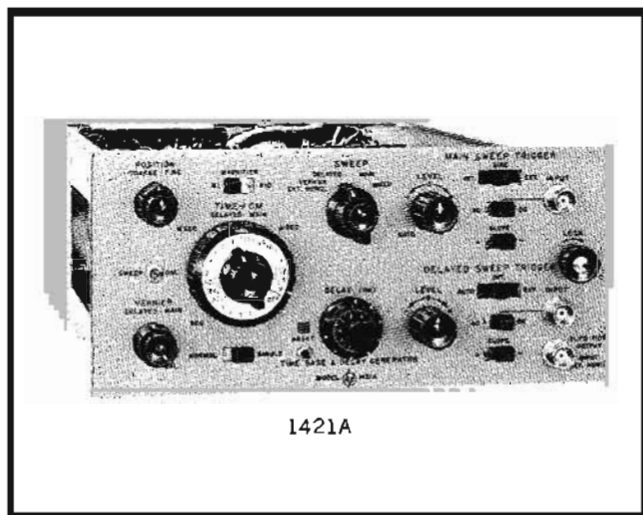

The 1421A Time Base and Delay Generator provides sweep speeds to 20 ns/cm with stable triggering to 20 MHz and beyond.

The delayed sweep feature of the 1421A permits detailed examination of any portion of a complex signal or pulse train by generating an accurately controlled delay time, at the end of which, a second sweep in the 1421A provides the deflection signal to the crt. The 1421A has provision to trigger the deflection sweep at the end of the delay interval either automatically, on the vertical deflection signal (internal), or on an external signal. In the automatic mode, the delayed sweep is immediately triggered at the end of the delay interval, thereby permitting accurate measurements of the time jitter in the input waveform. In the internal and external modes, the delayed sweep is armed at the end of the delay interval and the signal triggers the delayed sweep. Thus the rise time and amplitude can be accurately measured without jitter.

Specifications

Main sweep: for displaying signals vs time where sweep delay is not required; employs the main time base only.

Range: 0.2 μ s/cm to 1 s/cm, 21 ranges in a 1, 2, 5 sequence; accuracy $\pm 3\%$; vernier provides continuous adjustment between steps and extends 1 s/cm step to at least 2.5 s/cm.

Triggering: (when used with Model 1402A).

Amplitude selection:

Internal: approx 10 Hz to 15 MHz for signals causing 0.5 cm or more vertical deflection, to 20 MHz for 1 cm signals; also from line signal.

External: for signals at least 0.5 V pk-pk; dc coupled, dc to 20 MHz; ac coupled, approx 5 Hz to 20 MHz.

Trigger point and slope: controls allow selection of level and positive or negative slope; trigger level of external sync signal is continuously variable from -5 to $+5$ volts.

Automatic: baseline displayed in the absence of an input signal; internally down to 40 Hz on signals causing 1 cm or more vertical deflection, also on line signal; externally down to 40 Hz on signals at least 1 V pk-pk; trigger slope, positive or negative.

Trace intensification: used for setting up delayed or mixed sweep modes by increasing brightness of portion of main sweep which will be expanded to full screen in delayed sweep, or magnified portion of display in mixed sweep; rotating delayed sweep time switch out of off position activates intensified mode.

Delayed sweep: delayed time base sweeps after a time delay set by main sweep and delay controls.

Range: 0.2 μ s/cm to 50 ms/cm, 17 ranges in a 1, 2, 5 sequence; accuracy $\pm 3\%$; vernier provides continuous adjustment between steps and extends 50 ms/cm step to at least 125 ms/cm.

Delay (before start of delayed sweep):

Time: continuously variable from 0.5 μ s to 10 s.

Accuracy: $\pm 1\%$; linearity, $\pm 0.2\%$; time jitter less than 0.005% of max delay of each range (1 part in 20,000).

Trigger output: (at end of delay time) approx +4 V with less than 150 ns risetime, from 1 k ohms output impedance.

Triggering: (applies to intensified main, delayed, and mixed sweep modes).

Automatic: delayed sweep starts precisely at end of delay period.

Internal: delayed sweep triggered by vertical waveform presented on crt after end of delay period; approx 10 Hz to 15 MHz for signals causing 0.5 cm or more vertical deflection, or to 20 MHz for 1 cm signals.

External: delayed sweep triggered by external signal after end of delay period; for signals at least 0.5 V pk-pk; dc coupled, dc to 20 MHz; ac coupled, approx 5 Hz to 20 MHz.

Trigger point and slope: (internal and external) same as main sweep.

Mixed sweep: dual sweep-speed display in which main sweep drives first portion of display, and delayed sweep completes the display at sweep speeds up to 100 times faster; changeover point determined approx by delay setting.

Triggering: same as for delayed sweep.

Magnifier: X10, any display; overall accuracy $\pm 5\%$; expands 0.2 μ s/cm speed to 20 ns/cm.

Single sweep: any display can be operated in single sweep.

Horizontal Input

Bandwidth: dc to typically better than 500 kHz.

Deflection factor (sensitivity): vernier and X10 magnifier permit continuous adjustment from approx 0.3 V/cm to 30 V/cm.

Input RC: 1 megohm shunted by less than 20 pF.

Weight: net 5 lbs (2.3 kg); shipping 7 lbs (3.2 kg).

Price: HP Model 1421A, \$625.

OSCILLOSCOPES 140A SYSTEM *continued*

1 GHz sampling Sampling vertical amplifier Model 1410A

The versatile 1410A Sampling Vertical Amplifier provides 1 mV/cm sensitivity at 1 GHz. Optimum compromise among rise time, overshoot, and noise can be easily and quickly made with the front-panel risetime and smoothing controls.

Front-panel recorder outputs with both d-c level and amplitude adjustments simplify your X-Y or strip chart recorder setup and enable permanent recording of crt traces.

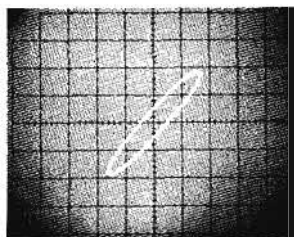

The A vs B mode of the 1410A permits X-Y measurements to 1 GHz and above.

Specifications

Mode of operation

1. channel A only.
2. channel B only.
3. channel A and channel B.
4. channel A and channel B added algebraically.
5. channel A vs channel B.

Polarity: either channel may be displayed either positive or negative up in any mode.

Risetime: less than 350 ps.

Bandwidth: dc to 1 GHz.

Overshoot: less than 5%.

Sensitivity: calibrated ranges from 1 mV/cm to 200 mV/cm in a 1, 2, 5 sequence; vernier control provides continuous adjustment between ranges and increases maximum sensitivity to greater than 0.4 mV/cm.

Attenuator accuracy: $\pm 3\%$.

Isolation between channels: greater than 40 dB to 1 GHz.

Input impedance

Probes: 100 K ohms shunted by 2 pF nominal.

GR type 874 inputs: 50 ohms $\pm 2\%$ with 57 ns internal delay lines for viewing leading edge of fast rise signals. Reflection from input connector is approx 10%, using a 150 ps TDR system.

Noise: (with sampling efficiency set to 100%, record amplitude set for 100 mV/cm, input terminated in 50 Ω , and sweep set to 10 μ s/cm; less than 8 mV from Y record output as measured on a true rms meter, from 5 mV/cm to 200 mV/cm (corresponds to approximately 1 mV observed noise on crt excluding 10% of random dots); noise decreases on automatically smoothed ranges and 2 and 1 mV/cm; smoothed position of smoothing switch reduces

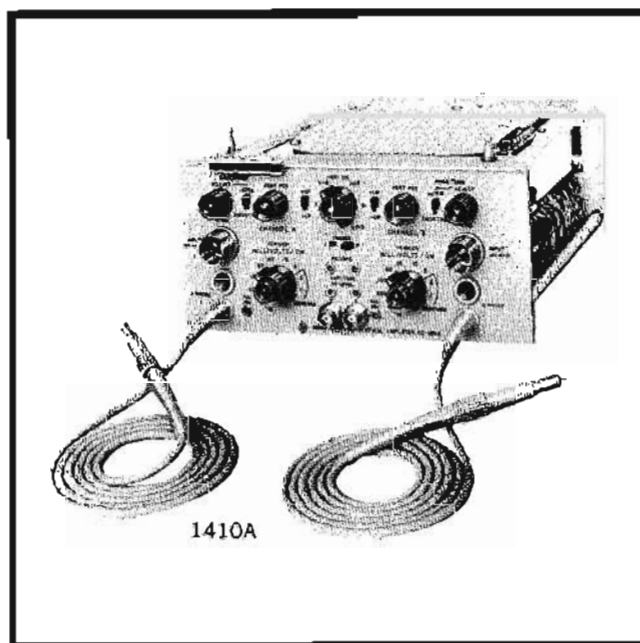

noise and jitter approximately 4:1; vernier control provides continuous adjustment between the normal and smoother modes.

Dynamic range: ± 2 volts.

Drift: less than 3 mV/hr after warmup.

Maximum safe input

Probes: ± 50 volts.

50 Ω inputs: ± 5 volts.

Triggering: internal or external when using 50 Ω inputs; internal triggering selectable from channels A or B; external triggering necessary when using probes.

Time difference between channels (for probes or 50 Ω inputs): less than 100 ps.

Recorder outputs: front panel outputs provide 0.1 V/cm from a 500 Ω source; gain adjustable from approximately 0.05 V/cm to 0.2 V/cm; dc level adjustable from approx -1.5 V to $+0.5$ V.

Accessories provided

HP Model	Quantity	Description
10214A	2	10:1 divider
10216A	2	isolator
10217A	2	0.001 μ F blocking capacitor
10218A	2	BNC adapter
10219A	1	GR adapter
10220A	2	Microdot adapter
10221A	1	50-ohm T-connector
10213-62102	6	Ground clip
5020-0457	6	Probe tip
—	1	Accessory box

Weight: net 10 lbs (4.5 kg); shipping 15 lbs (6.8 kg).

Price: HP Model 1410A, \$1600.

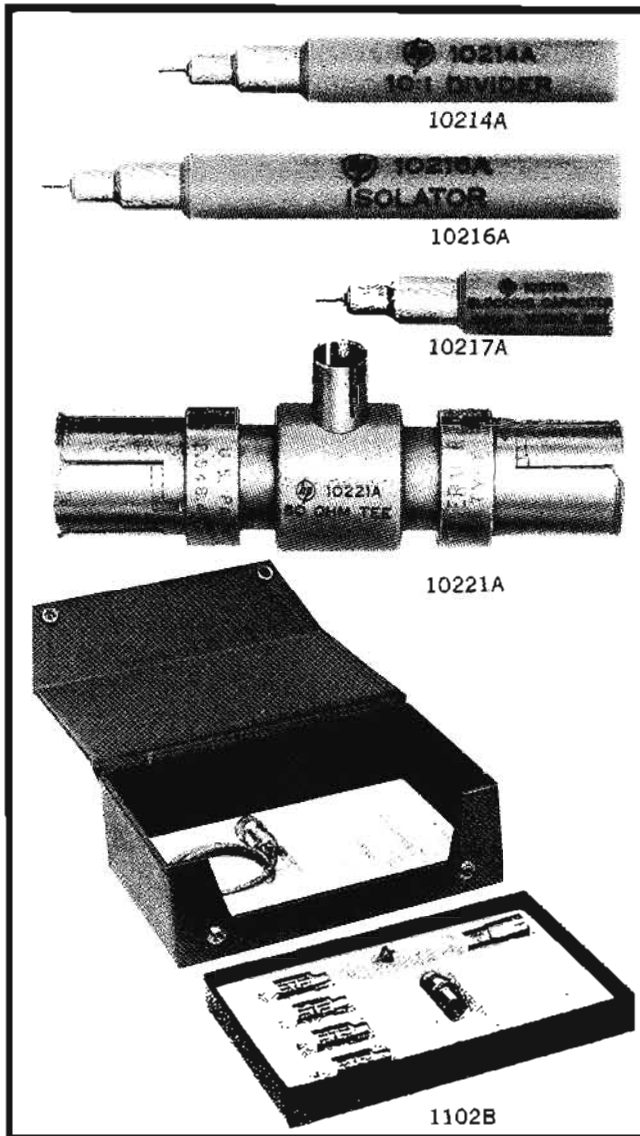
OSCILLOSCOPES 140A SYSTEM *continued***Accessories for 1 GHz Sampling
Sampling Accessories for 1410A****Specifications****1410 ACCESSORIES (Separately Available)**

10214A 10:1 divider: permits accurate measurement of signals as large as 20 volts peak-to-peak and increases the impedance of the probe to 1 megohm shunted by 2.5 pF. **Price, \$30.**

10216A isolator: increases convenience and accuracy when probing by reducing base line shift and transient response changes caused by changes in the circuit source impedance. 1410A rise time is increased to approximately 0.6 nsec and probe input capacitance is increased by less than 3 pF. **Price, \$25.**

10217A blocking capacitor: this blocking capacitor (0.001 μ F) permits measurements of signals that are ± 50 volts from ground (to ± 200 V when used with 10214A 10:1 Divider). The blocking capacitor contributes only 1% sag when used with the 10:1 divider. No more than 2.5 pF shunt capacitance is added to the input by the blocking capacitor. **Price, \$20.**

10218A BNC adapter: converts probe tip into a male BNC connector. **Price, \$6.**

10219A GR adapter: converts probe tip into a GR type 874 connector. **Price, \$15.**

10220A microdot screw-on adapter and 10223A microdot slide-on adapter: allows easy connection to coaxial connectors and also provides a solid ground reference. 10220A adapts to connectors similar to Microdot series 31-50. 10223A adapts to connectors similar to Microdot series SOS-50. **Price: 10222A, \$4; 10223A, \$5.**

10221A 50-ohm T connector: permits monitoring of signals in 50 ohm transmission lines with the 1410A without terminating the line or disturbing the signal. Mismatch is low; the reflection from a step input is no greater than 20% of the input step height. **Price, \$40.**

ADDITIONAL ACCESSORIES

(Not supplied with 1410A)

10203A 100:1 divider: this 100:1 divider may be used to reduce levels as high as 200 V to the ± 2 V dynamic range of the 1410A. The 10203A offers less than 1 pF shunt capacity and 10 megohms shunt resistance to the circuit under test. (The K01-10203A Divider Adapter must be used to adapt the 10203A to the 1401A probe). **Price, \$60.**

K01-10230A divider adapter: adapts the 10203A 100:1 divider to the 1410 probe. **Price, \$30.**

1102B ACCESSORY KIT

The Model 1102B Accessory Kit permits convenient circuit probing and reduced circuit loading with oscilloscopes that have 50-ohm input impedances. Thus it allows probing with the 1410A where the 50 ohm inputs are used in order to get internal triggering. The kit is also ideal for the 1432A where a high input impedance is needed to prevent loading of the test circuit.

10201A to D resistive divider probes and 10122A cable: the dividers should always be terminated with 50 ohms to provide the correct voltage division. They should not be attached directly to the 1410A probe.

Model	Input Resistance (ohms) [†]	Division Ratio	Division Ratio with 10206A Sync Take-off	Max Input (V rms) [†]	μ s for 1% Sag with 10209A
10201A	250	5:1	10:1	10	0.25
10201B	500	10:1	20:1	15	0.5
10201C	2500	50:1	100:1	35	2.5
10201D	5000	100:1	200:1	50	5.0

Input capacitance: 0:4 pF.

Price, as sold separately, \$40.00 each.

10208A blocking capacitor: this blocking capacitor (0.001 μ F) permits measurements of signals that are ± 600 volts from ground. No more than 0.5 pF shunt capacitance is added to the input by the blocking capacitor. **Price, as sold separately, \$5.**

10209A blocking capacitor: this blocking capacitor (0.1 μ F) may be used to observe relatively long pulses or signals ± 200 volts from ground. Signals which have rise times slower than 1 nsec may be displayed without distortion. No more than 3.5 pF shunt capacitance is added to the input. **Price, as sold separately, \$35.** The kit also includes: 1 ea HP Model 10122A, Cable, Coaxial, Type N to BNC Female; 1 ea GR Type 874, Type N Female to GR Adapter; 2 ea HP Part Number 5060-0415, Ground Clip; and 1 ea Accessory Box.

Weight: net, 3 lbs (1.4 kg); shipping: 4 lbs (1.8 kg).

Price: Model 1102B Accessory Kit, \$160.

[†]When terminated in 50 ohms.

^{††}Limited by the power dissipation of the resistive element.

OSCILLOSCOPES 140A SYSTEM *continued*

Bandwidth to 12.4 GHz at 1 mV/cm
 Amplifier and sampler Models 1411A, 1432A

1411A Sampling Amplifier, 12.4 GHz

The 1411A Sampling Vertical Amplifier is a basic vertical plug-in that accepts a series of wide band samplers. All three samplers have 1 mV/cm sensitivity. Feedthrough inputs are also featured, for monitoring signals without terminating them and for precise Time Domain Reflectometry measurements.

The remote samplers, connected to the oscilloscope by a five-foot cable, can be placed right at the signal source, eliminating lossy lines.

Risetime is set with a front panel knob, allowing convenient adjustment of risetime and bandwidth to the ultimate when needed, at the sacrifice of increased noise. Front panel recorder outputs and an X-Y mode for wideband phase measurements add to the 1411A's measurement capability.

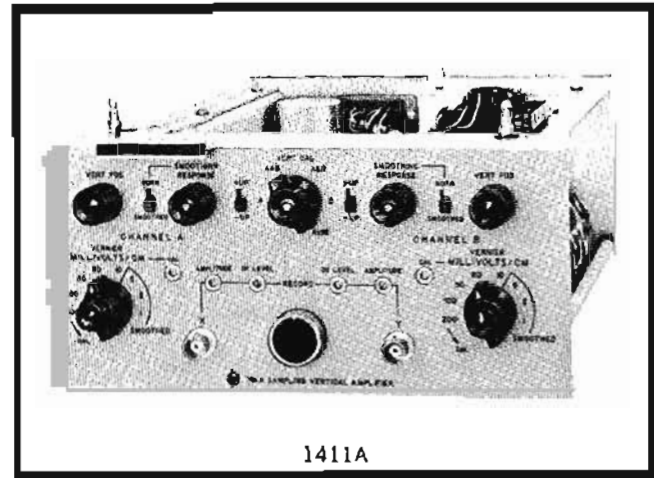

Specifications, 1411A
 (When used with 1430A, 1431A, or 1432A)

Mode of operation

1. channel A only.
2. channel B only.
3. channel A and channel B.
4. channel A and channel B added algebraically.
5. channel A vs channel B.

Polarity: either channel may be displayed either positive or negative up in any mode.

Sensitivity: calibrated ranges from 1 mV/cm to 200 mV/cm in a 1, 2, 5 sequence; vernier control provides continuous

adjustment between ranges and increases maximum sensitivity to greater than 0.4 mV/cm.

Attenuator accuracy: $\pm 3\%$.

Isolation between channels: greater than 40 dB over bandwidth of sampler.

Recorder outputs: front panel outputs provide 0.1 V/cm from a 500 ohm source; gain adjustable from approximately 0.05 V/cm to 0.2 V/cm; dc level adjustable from approximately -1.5 V to +0.5 V.

Weight: net 10 lbs (4,5 kg); shipping 15 lbs (6,8 kg).

Price: HP Model 1411A, \$700.

1432A Sampler, 90 ps

The 1432A is a lower-priced version of the 1430A and 1431A. Its 90 ps rise time (dc to 4 GHz bandwidth), 1 mV/cm sensitivity, and feedthrough inputs permit many accurate measurements involving cw, fast pulses, and TDR.

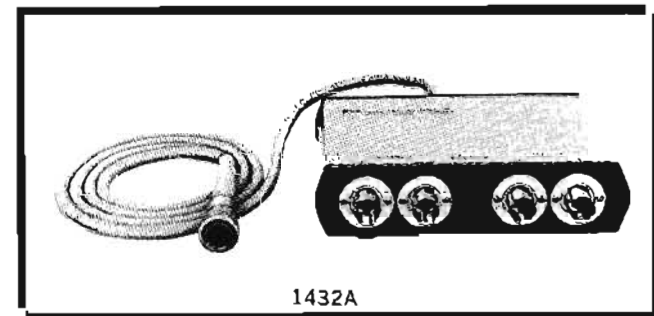

Specifications, 1432A
 (When used with 1411A)

Risetime: less than 90 ps.

Bandwidth: dc to 4 GHz.

Overshoot: less than $\pm 5\%$.

Noise: same as 1430A, except less than 10 mV from Y record output, corresponding to approx 3 mV observed noise.

Dynamic range: ± 1 volt.

Low frequency distortion: less than $\pm 3\%$.

Maximum safe input: ± 5 volts.

Input characteristics

Mechanical: GR type 874 connectors used on input and output.

Electrical: 50 ohm feedthrough, dc coupled; reflection from sampler is approximately 15% using a 90 ps TDR system; pulses emitted from sampler input are approx 50 mV in amplitude and 10 ns wide.

Time difference between channels: less than 25 ps.

Connecting cable length: 5 ft (for longer cable, see special order below).

Weight: net 4 lbs (1,8 kg); shipping 9 lbs (4,1 kg).

Accessories provided: two GR Model 874-W50 50 ohm loads.

Price: HP Model 1432A, \$1000.

Special order: 10-ft connecting cable (5-ft is standard), order CO1-1432A. Price, \$1035.

OSCILLOSCOPES 140A SYSTEM *continued*

Sampler with 28 psec risetime
12.4 GHz samplers Models 1430A, 1431A

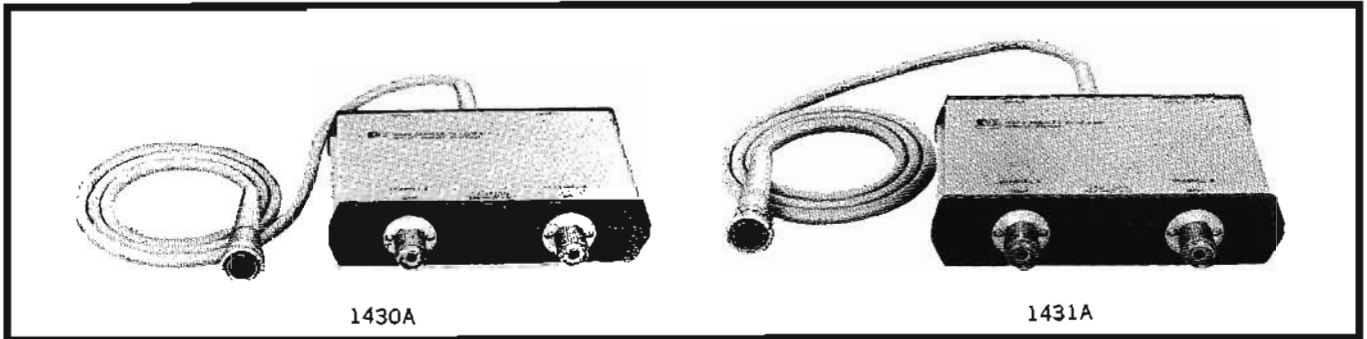

Model 1430A provides 28 ps risetime with minimal overshoot for accurate measurements on fast-rise pulses. Used with the 1105A/1106A 20 ps pulse generator, its response and feedthrough inputs make it ideal for TDR measurements.

Specifications, 1430A
(When used with 1411A)

- Risetime:** approx. 28 ps (less than 35 ps observed with 1105A/1106A pulser and 909A 50-ohm load).
- Bandwidth:** dc to approx 12.4 GHz.
- Overshoot:** less than $\pm 5\%$.
- Noise:** (Same conditions as 1410A noise spec.) Less than 30 mV from Y record output as measured on a true rms meter, from 10 mV/cm to 200 mV/cm. (Corresponds to approximately 8 mV observed noise on crt excluding 10% of random dots.) Noise decreases on automatically smoothed ranges 5, 2, and 1 mV/cm. Smoothed position of smoothing switch reduces noise and jitter approximately 4:1. Vernier control provides continuous adjustment between the normal and smoothed modes.
- Dynamic range:** ± 1 volt.
- Low frequency distortion:** less than $\pm 3\%$.
- Maximum safe input:** ± 3 volts.
- Input characteristics**
 - Mechanical:** Amphenol APC-7 precision 7 mm connectors on input and output.
 - Electrical:** 50 ohm feedthrough, dc coupled. Reflection from sampler is approx 10%, using a 40 ps TDR system. Pulses emitted from sampler input are approximately 10 mV in amplitude and 5 ns in duration. Vswr less than 3:1 at 12.4 GHz.
- Time difference between channels:** less than 5 ps.
- Connecting cable length:** 5 ft.
- Weight:** net 4 lbs (1.8 kg); shipping 9 lbs (4.1 kg).
- Accessories provided:** two Amphenol APC-7 to female Type N adapters (HP 10224A); two 50-ohm loads (HP 909A).
- Price:** HP 1430A, \$3000.

The 1431A allows viewing of CW signals from dc to beyond 12.4 GHz at 1 mV/cm sensitivity. It differs slightly from the 1430A, having a very flat bandwidth and low vswr at the sacrifice of increased overshoot.

Specifications, 1431A
(When used with 1411A)

- Bandwidth:** dc to greater than 12.4 GHz (less than 3 dB down from a 10 cm dc reference).
- Risetime:** approx 28 ps.
- Vswr:** dc to 8 GHz, 1.4:1
8 to 10 GHz, 1.6:1
10 to 12.4 GHz, 2.0:1
- Noise:** same as 1430A.
- Dynamic range:** ± 1 volt.
- Low frequency distortion:** less than $\pm 3\%$.
- Maximum safe input:** ± 3 volts.
- Input characteristics**
 - Mechanical:** Amphenol APC-7 precision 7 mm connector used on input and output.
 - Electrical:** 50-ohm feedthrough, dc coupled. Reflection from sampler is approx 5%, using a 40 ps TDR system. Pulses emitted from sampler input are approx 10 mV in amplitude and 5 ns in duration.
- Phase shift between channels:** less than 10° at 5 GHz, typically less than 2° at 1 GHz.
- Connecting cable length:** 5 ft.
- Weight:** net 4 lbs (1.8 kg); shipping 9 lbs (4.1 kg).
- Accessories provided:** two Amphenol APC-7 to female Type N adapters (HP 10224A); two 50-ohm loads (HP 909A).
- Price:** HP 1431A, \$3000.
- Special order:** 10-ft connecting cable (5-ft is standard), order CO1-1431A. **Price,** \$3035.

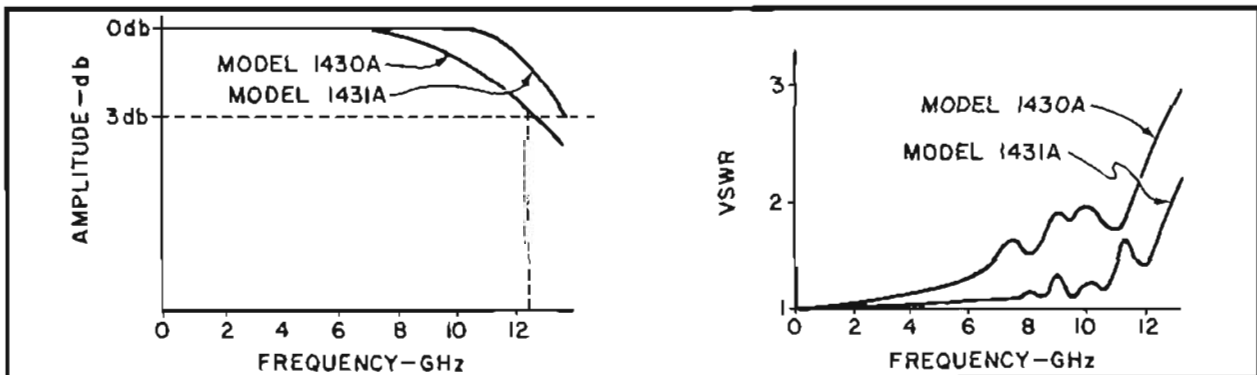

OSCILLOSCOPES 140A SYSTEM *continued*

Solid triggering to 5 GHz
Sampling time base Model 1424A

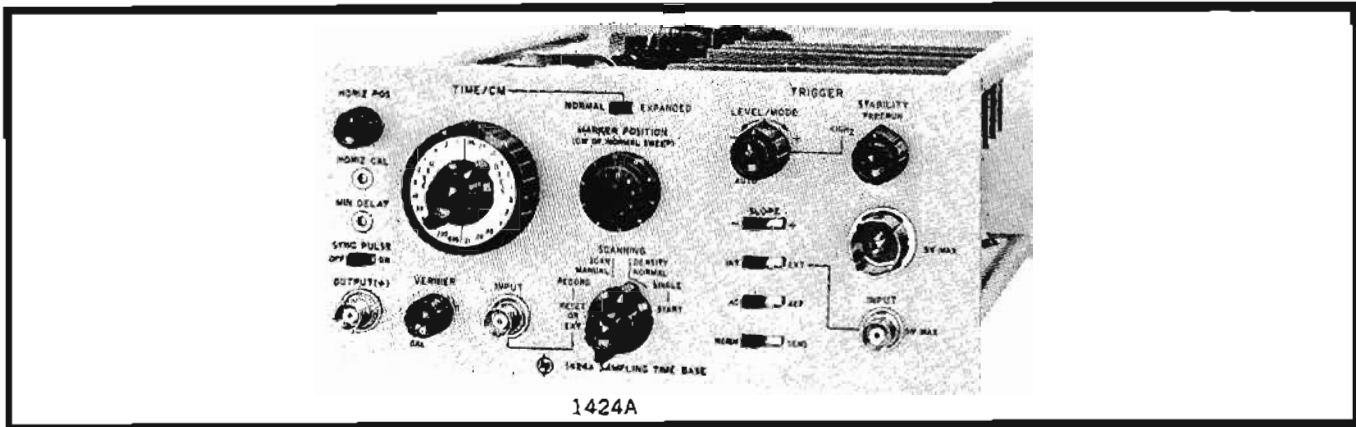

Model 1424A is an easy-to-operate time base for use with the 1410A and 1411A plug-ins. Convenient and more meaningful measurements are made possible through features such as: Direct sweep readout, calibrated marker position control (which positions an intensified marker), and automatic triggering (which locks in on a wide range of signals). A single scan feature helps provide clearer photos and stored traces of drifting or changing signals.

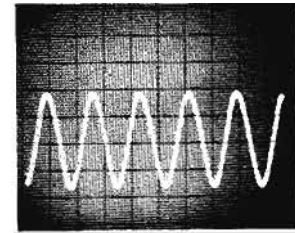

Solid triggering to 5 GHz without external count down box.

Specifications, 1424A

Sweep range: 24 ranges, 10 ps/cm to 500 μ s/cm in a 1, 2, 5 sequence. Sweeps from 1 ns/cm to 500 μ s/cm may be expanded up to 100 times and read out directly. Sweeps from 10 ps/cm to 500 ps/cm are obtained by expansion and also read out directly. Accuracy $\pm 3\%$ except for time represented by approx first $\frac{1}{4}$ cm of unexpanded sweep. Vernier provides continuous adjustment between ranges and increases max sweep speed to faster than 4 ps/cm.

Marker position: intensified marker indicates point about which sweep ranges and increases max sweep speed to faster than 4 ps/cm.

Minimum delay: less than 55 ns.

Triggering: (less than 1 GHz)

Internal (with 1410A)

Automatic: baseline displayed in the absence of an input signal.

Pulses: at least 50 mV amplitude required of pulses 2 ns or wider for jitter less than 30 ps.

Sine waves: signals from 200 Hz to 150 MHz require 25 mV amplitude for jitter less than 10% of input signal period (usable to 1 GHz with increased jitter)

Level selects

Pulses: at least 50 mV amplitude required for pulses 2 ns or wider for jitter less than 20 ps.

Sine waves: signals require from 200 Hz to 150 MHz 25 mV amplitude (increasing to 400 mV at 1 GHz) for jitter less than 1.5% of input signal period ± 10 ps.

External

Automatic: baseline displayed in the absence of an input signal.

Pulses: at least 100 mV amplitude required of fast rise pulses 2 ns or wider for jitter less than 20 ps.

Sine waves: signals from 200 Hz to 500 MHz require 50 mV for jitter less than 10% of input signal period (usable to 1 GHz with increased jitter).

Level select

Pulses: at least 50 mV amplitude required of fast rise pulses 2 ns or wider for jitter less than 20 ps.

Sine waves: signals from 200 Hz to 1 GHz require 50 mV for jitter less than 1.5% of input signal period ± 10 ps; jitter is less than 50 ps for signals of 10 mV at 1 GHz.

Slope: positive or negative.

Sensitivity: jitter specifications above given for sensitive mode; normal mode reduces sensitivity by approx 10:1.

Dynamic range: 100 mV in sensitive 1.0 V in normal (external).

External trigger input: 50 ohm, ac or ac fast; signal output, < 10 mV in sensitive and < 5 mV in normal.

Maximum safe input: sensitive, 5 V rms or peak transient; normal, 5 V rms (50 V peak transient); internal, 5 V rms or peak transient.

Jitter: less than 10 ps on 1 ns/cm range, and less than 20 ps (or 0.005% of unexpanded sweep speed, whichever is larger) at 2 ns/cm and slower, with signals having rise times of 1 ns or faster.

Triggering: (greater than 1 GHz) jitter less than 30 ps for 25 mV input, 1 GHz to 4 GHz, and 50 mV input, 4 to 5 GHz.

Scanning

Internal: X axis driven from internal source; scan density continuously variable.

Manual: X axis driven by manual scan control knob.

Record: X axis driven by internal slow ramp; approx 60 seconds for one scan.

External: 0 to +15 V required for scan; input impedance, 10 k ohms.

Single scan: one scan per actuation; scan density continuously variable.

Sync pulse output

Amplitude: greater than 1.5 V into 50 ohm.

Risetime: approx 1 ns.

Overshoot: less than 5%.

Width: approx 1 μ s.

Relative jitter: less than 10 ps.

Repetition rate: one pulse per sample.

Weight: net 5 lbs (2.3 kg); shipping 9 lbs (4.1 kg)

Price: HP 1424A, \$1200.

OSCILLOSCOPES 140A SYSTEM *continued*

Triggering to 1 GHz with delayed sweep
Sampling time base Model 1425A

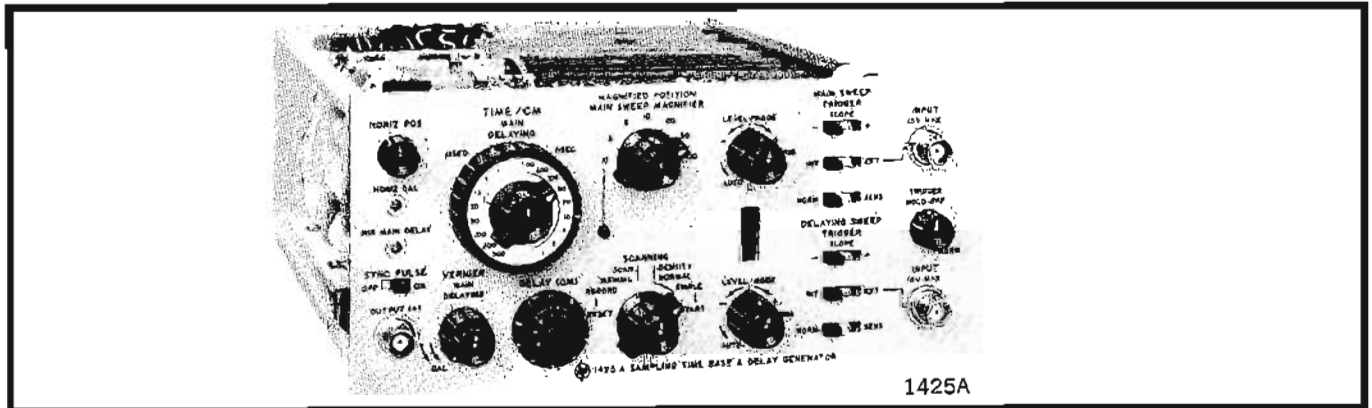

Model 1425's delayed sweep feature allows detailed examination (magnification as great as 10,000:1) of any portion of complex signals and pulse trains for the first time in the GHz region. And accurate time jitter measurements in the input waveform can be measured when in the automatic triggering mode. This same automatic triggering mode provides a baseline in the absence of an input signal aiding in getting a trace displayed sooner.

When you want to set up a magnified trace, an intensified market dot locates the expansion point for you. You also get pushbutton return to X1 magnification for fast reference or relocation of the expansion point.

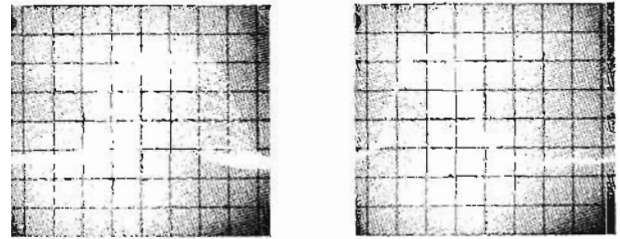

Jitter on delayed pulse in left photo eliminated at right by retriggering the delayed sweep. Sweep speed, 1 ns/cm; delay, 5 μ s.

Specifications, 1425A

Main Sweep

Range: 1 ns/cm to 10 μ s/cm, 13 ranges in a 1, 2, 5 sequence; accuracy $\pm 3\%$, except for time represented by approx first $\frac{1}{4}$ cm of unexpanded sweep. Vernier provides continuous adjustment between steps and extends max magnified speed to at least 4 ps/cm.

Magnifier: X1 to X100 in 7 calibrated steps; increase 1 ns/cm sweep to 10 ps/cm; pushbutton returns magnifier to X1.

Marker position: intensified marker indicates point about which sweep is expanded; 10-turn control.

Minimum delay: main sweep, less than 55 ns; main delayed sweep, less than 105 ns.

Triggering: (for both main and delaying sweep)

Internal

Automatic: baseline displayed in the absence of an input signal.

Pulses: at least 75 mV amplitude required of pulses 2 ns or wider for jitter less than 30 ps.

Sine waves: signals from 200 Hz to 150 MHz require 50 mV amplitude for jitter less than 10% of input signal period (usable to 1 GHz with increased jitter).

Level select

Pulses: at least 100 mV amplitude required for fast rise pulses 2 ns or wider for jitter less than 20 ps.

Sine waves: signals from 200 Hz to 500 MHz require 50 mV amplitude (increasing to 400 mV at 1 GHz) for jitter less than 1.5% of input signal period ± 10 ps.

External

Automatic: baseline displayed in the absence of an input signal.

Pulses: at least 100 mV amplitude required of fast-rise pulses 2 ns or wider for jitter less than 20 ps.

Sine waves: signals from 200 Hz to 500 MHz require 50 mV amplitude for jitter less than 10% of input signal period (usable to 1 GHz with increased jitter).

Level select

Pulses: at least 50 mV amplitude required for fast-rise

pulses 2 ns or wider for jitter less than 20 ps.

Sine waves: signals from 200 Hz to 1 GHz require 50 mV for jitter less than 1.5% of input signal period ± 10 ps; jitter is less than 50 ps for signals of 10 mV amplitude at 1 GHz.

External trigger input: 50 ohms, ac-coupled (2.2 μ F); signal output, less than 10 mV in sensitive and less than 5 mV in normal.

Slope: positive or negative.

Sensitivity: jitter specifications given above are for sensitive mode; normal mode reduces sensitivity by approx 10:1.

Dynamic range: 100 mV in sensitive, 1.0 V in normal (external).

Maximum input: sensitive, 5 V rms or peak transient; normal 5 V rms (50 V pk transient); internal, 5 V rms or peak transient.

Jitter: less than 10 ps on 1 ns/cm range and less than 20 ps (or 0.005% of unexpanded sweep, whichever is larger) at 2 ns/cm and slower, with large amplitude signals having rise times of 1 ns or faster.

Delaying sweep

Range: 10 ns/cm to 500 μ s/cm, 13 ranges in a 1, 2, 5 sequence; accuracy $\pm 3\%$, except for slight nonlinearity at start of sweep, $\pm 5\%$, on 200 μ s/cm and 500 μ s/cm ranges, vernier provides continuous adjustment between steps and increases 10 ns/cm step to at least 4 ns/cm.

Delay time: continuously variable from 50 ns to 5 ms.

Accuracy: $\pm 3\%$; linearity 0.5%; jitter time is less than 1 part in 20,000 or 20 ps, whichever is greater.

Sweep functions: main, delaying, and main delayed.

Scanning: same as 1424A except no external scan input.

Sync pulse output: same as 1424A. Pulse always synchronized to main sweep trigger circuit; pulse delay and rate are variable.

Weight: net 7 lbs (3.2 kg); shipping 11 lbs (5 kg).

Price: HP 1425A, \$1600.

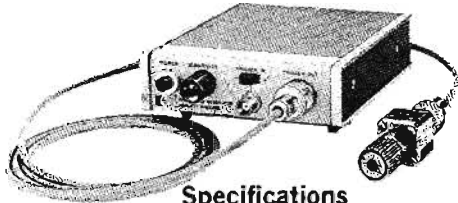
1105A/1106A 20 psec pulse generator**Specifications****Output**

Rise time: approximately 20 ps. Less than 35 ps observed with HP Model 1411A/1430A 28 ps Sampler and HP Model 909A 50 ohm termination.

Overshoot: less than $\pm 5\%$ as observed on 1411A/1430A with 909A.

Droop: less than 3% in first 100 ns.

Width: approximately 3 μ s.

Amplitude: greater than +200 mV into 50 ohms.

Output characteristics (1106A):

Mechanical: Amphenol APC-7 connector.

Electrical: dc resistance -50 ohm $\pm 2\%$. Source reflection—less than 10%, using a 40 ps TDR system. DC offset voltage—approximately 0.1 V.

Triggering

Amplitude: at least ± 0.5 V peak required.

Rise time: less than 20 ns required. Jitter less than 15 ps when triggered by 1 ns rise time sync pulse from 1424A or 1425A Sampling Time Base.

Width: greater than 2 ns.

Maximum safe input: 10 volts.

Input impedance: 200 ohms, ac coupled through 20 pF.

Repetition rate: 0 to 100 kHz; free runs at 100 kHz.

Accessories provided (with Model 1105A): one 6-ft 50 ohm cable with Type N connectors, HP Model No. 10132A.

Weight

1105A: net 3 lbs (1.4 kg); shipping 8 lbs (3.6 kg).

1106A: net 1 lb (0.5 kg); shipping 3 lbs (1.4 kg).

Price: 1105A, \$200. 1106A, \$550.

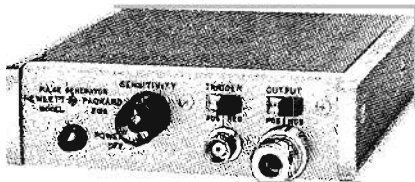
213B pulse generator

Combines fast rise time (100 ps) with low jitter and 100 kc repetition rate. The pulse has minimum overshoot and is flat for 100 ns after the fast rise. It contains useful harmonics from 10 MHz to 3.5 GHz. Price, \$250.

Coaxial attenuators**8492A fixed coaxial attenuator**

Nominal attenuation: Options 03, 3 dB; 06, 6 dB; 10, 10 dB; 20, 20 dB. APC-7 connectors. Range dc to 18 GHz.

Price: \$125.

849A Fixed Coaxial Attenuator

Nominal attenuation: Options 03, 3 dB; 06, 6 dB; 10, 10 dB; 20, 20 dB. Type N connectors, 1 male, 1 female. Range dc to 12.4 GHz.

Price: \$50.

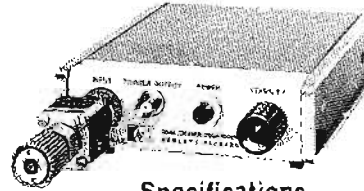
1104A/1106A 18 GHz trigger countdown**Specifications****Input**

Frequency range: 1 GHz to 18 GHz.

Sensitivity: signals 100 mV or larger, and up to 12.4 GHz, produce less than 20 ps of jitter (200 mV required to 18 GHz).

Maximum safe input: ± 1 V.

Input impedance (1106A): 50-ohm Amphenol APC-7 input connector. Reflection from input connector is less than 10%, using a 40 ps TDR system.

Signal appearing at input connector: approximately 250 mV.

Output

Center frequency: approximately 100 MHz.

Amplitude: typically 150 mV.

Weight

1104A: net 2 lbs (0.9 kg); shipping 4 lbs (1.8 kg).

1106A: net 1 lb (0.5 kg); shipping 3 lbs (1.4 kg).

Price: 1104A, \$200. 1106A, \$550.

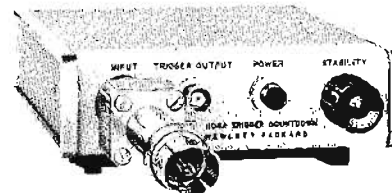
**1104A/1108A
10 GHz trigger countdown**

The Model 1104A/1108A is similar to the Model 1104A/1106A except: frequency range is from 1 GHz to 10 GHz with sensitivity of 50 mV or greater for less than 20 ps of jitter. Maximum safe input is 1 V peak through the GR-874A connector. Price: Model 1108A, \$250.

50-ohm loads

The HP 908A and 909A are 50-ohm terminating coaxial loads with frequency ranges of dc—4 GHz and dc—18 GHz respectively. The 908A has a Type N male connector and the 909A has an APC-7 with Type N option. Price: 908A, \$35; 909A, \$75.

10200B sync probe

The 10200B, for use with Model 1424A and 1425A Sampling Time Bases, increases trigger input impedance to more than 750 ohms, ac coupled. It reduces sensitivity by about 4:1 at 10 MHz and higher, and by about 20:1 at low frequencies. Price, \$51.

50-ohm adapter

The Model 10224A type N to APC-7 Adapter has a frequency range of 18 GHz. This adapter uses HP's new stainless steel precision type N female connector. Price, \$75.

Air line extensions

Price: 11566A 10 cm/11567A 20 cm air line extensions, \$100.

OSCILLOSCOPES 140A SYSTEM *continued*

Make microwave swept frequency measurements
Swept frequency indicator Model 1416A

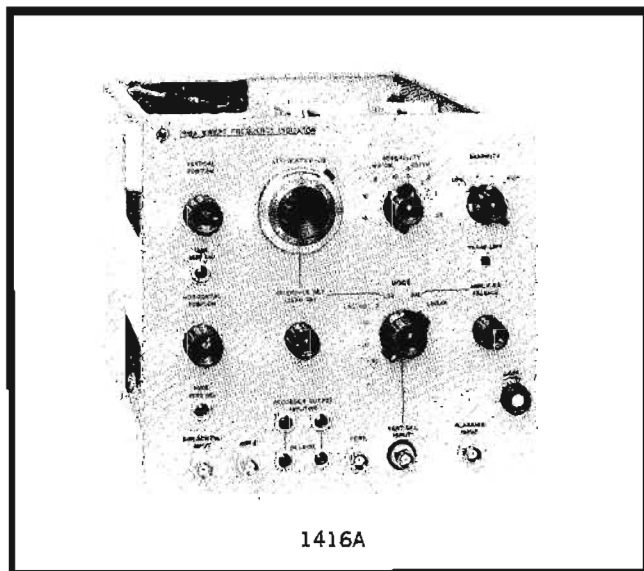

Model 1416A Swept Frequency Indicator transforms Model 140A/141A into an X-Y oscilloscope which speeds and simplifies microwave swept frequency measurements. Insertion loss vs frequency measurements on attenuators, filters, ferrite isolators, and return loss measurements on all types of loads can be made with ease and accuracy.

Model 1416A incorporates a number of features which

provide convenience and accuracy not available with the usually used conventional X-Y scope. Readouts directly in dB are provided by Model 1416A's logarithmic amplifier. The attenuation-dB control allows a calibrated dB offset to be applied to an offscreen trace, allowing it to be centered on screen and for high resolution readings. A linear mode of operation is also provided. A chopper stabilized input amplifier minimizes drift, and a front-panel adjustable bandwidth switch allows the operator to select a bandwidth just wide enough to present the signal with a minimum amount of noise. An internal dB calibrator, accurate to 3%, allows a quick check of amplifier accuracy. Also provided on the front panel are outputs for driving an X-Y recorder. Thus, you can now achieve speed, convenience, and accuracy with all types of swept frequency measurements by using the Model 140A-141A/1416A combination and appropriate auxiliary equipment. Sweep oscillators and associated instruments are available for testing both coaxial and waveguide microwave components from 1 to 40 GHz. Such items as adapters, impedance transformers, tuners, loads, filters, detectors, couplers, and attenuators can be measured or adjusted. Swept frequency techniques are also useful for overall system analysis.

Swept frequency techniques are not only helpful design aids, but can be used as maintenance tools as well. They provide fast routine maintenance checks on laboratory instruments. Hours and sometimes days of tedious precise measurements can often be completed within minutes.

Specifications, 1416A

Mode of operation: linear or logarithmic.

Bandwidth

Linear: variable from approx. 1 kHz to 30 kHz in four steps.

Logarithmic: varies with input level.

Deflection factor (sensitivity):

Linear: 50 $\mu\text{V}/\text{cm}$ to 10 mV/cm , 8 ranges in a 1, 2, 5 sequence; accuracy $\pm 3\%$.

Logarithmic: 0.5 dB/cm to 10 dB/cm (referred to rF input into crystal detector) in 5 ranges; accuracy (after 30-min warmup), ± 0.02 dB/dB (0 to -25 dB) and ± 0.03 dB/dB (-25 to -30 dB).

Noise: typical observed values on crt:

Mode	Noise at low bandwidth	Noise at high bandwidth
Linear	40 μV pk-pk	200 μV pk-pk
Logarithmic: input signal level		
0 dB	0.05 dB	0.1 dB
-10 dB	0.05 dB	0.2 dB
-20 dB	0.3 dB	0.4 dB
-25 dB	1 dB	1 dB
-30 dB	4 dB	4 dB

Maximum measured noise at recorder output: (measured with a true rms voltmeter, and recorder output deflection factor set to 200 mV/cm).

Linear: less than 120 mV ; Model 1416A deflection factor set to 0.05 mV/cm and input shortened.

Logarithmic: less than 50 mV/cm ; Model 1416A deflection factor set to 5 dB/cm and input signal of -30 μV (-30 dB).

Internal calibrator: four positions: 0, 10, 20, and 30 dB below approx. 50 mV ; accuracy ± 0.01 dB/dB.

Sweep and blanking: supplied by Model 690 Series Sweep Oscillator.

Recorder outputs:

Vertical: gain adjustable from 0 to approx. 200 mV/cm ; dc level adjustable over approx. ± 1.5 volts.

Horizontal: gain adjustable from 0 to approx. 100 mV/cm ; dc level adjustable over approx. ± 1 volt.

Inputs

Vertical: input impedance, 75 k ohms; dynamic range: logarithmic, -50 μV to -100 mV ; linear 0 to -100 mV ; BNC connector receives output from Models 423A or 424A Crystal Detectors, or Models 786D or 787D Directional Detectors (all Option 02).

Horizontal: ramp required; amplitude between 7.5 and 20 volts; some part of ramp must be at 0 volts.

Blanking: 0 to -5 V gate (supplied by Model 690 Series Sweep Oscillator; early models require slight modification).

Power: supplied by oscilloscope.

Weight: net 7 lbs (3,2 kg); shipping 14 lbs (6,3 kg).

Price: HP 1416A, \$675.

OSCILLOSCOPES 140A SYSTEM *continued***Complete cable testing system**

Time domain reflectometer Model 1415A

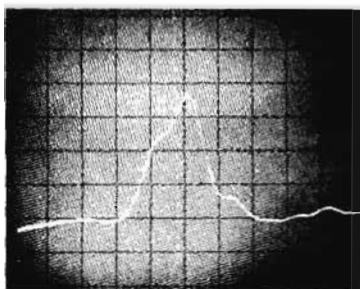

Magnified display of a BNC connector joining two 50-ohm cables. The horizontal axis is set at 2 cm/cm. Multiplying the 3.5 cm deflection by the reflection coefficient sensitivity of 0.01/cm, one can determine the connector has a ρ of 0.035.

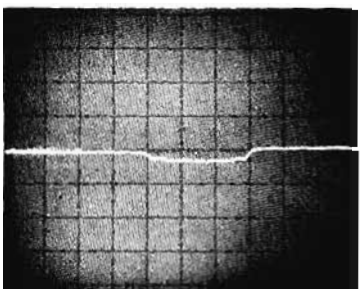

TDR display of a section of unknown cable spliced into a length of 50-ohm cable. Noting the distance setting of 40 cm/cm, and reflection coefficient sensitivity of 0.2/cm, one can determine the unknown cable is 120 cm long and has a Z_0 of 44 ohms.



The Model 1415A Time Domain Reflectometer/140A or 141A Oscilloscope represents a completely integrated broadband system for testing cables, transmission lines, strip lines, connectors, and many other types of devices used in your high frequency systems.

You can, for example, quickly determine the magnitude and nature of each resistive or reactive discontinuity in coaxial components such as attenuators, cables, connectors and delay lines used in microwave and pulse circuit design. Or you can locate and identify cable faults such as shorts, opens, loose connectors, defective tap offs, splices, and mismatches if you are using cables for signal transmission. Whatever your application the 1415A can save you time and money by minimizing guesswork and indecision.

Specifications, 1415A**System (in reflectometer configuration)****Risetime:** less than 150 ps.**Overshoot:** 5% or less overshoot and ringing (down to 1/2 in 2ns).**Internal reflections:** less than 10% (does not limit resolution).**Reflectometer sensitivity:** reflection coefficients as small as 0.001 can be observed.**Rep. rate:** 150 kc nominal.**Signal channel****Risetime:** approximately 110 ps.**Reflection coefficient:** 0.5/cm to 0.005/cm in 1, 2, 5 sequence.**Input:** 50 ohms, feedthrough type.**Noise and internal pickup, peak:** less than 0.2 cm on 0.005/cm range, with step disconnected and input terminated in 50 ohms.**Dynamic range:** ± 0.5 volt.**External signal level:** up to 1 V p-p may be safely applied to the signal out connector.**Attenuator accuracy:** $\pm 3\%$.**Step generator****Amplitude:** approximately 0.25 V into 50 ohms (0.5 V into open circuit).**Risetime:** approximately 50 ps.**Output impedance:** 50 ohms ± 1 ohm.**Droop:** less than 1%.**Distance/time scale****Distance scale (cm line/cm display) accuracy:** 5%.**Polyethylene line ($\epsilon=2.25$):** 200 to 2000 cm/cm.**Air line ($\epsilon=1$):** 300 to 3000 cm/cm (0.19 mi.).**Time scale:** 20 to 200 ns/cm, $\pm 5\%$ accuracy.**Magnification:** X1 to X200 in 1, 2, 5 sequence; accuracy of the basic sweep is maintained at all magnifier settings with the exception of time represented by the first 0.1 cm of the unmagnified step.**Delay control:** 0 to 10 cm of unmagnified sweep, calibrated.**Jitter:** less than 20 ps.**Power:** supplied by oscilloscope.**Weight:** net 7 lbs (3.2 kg); shipping 11 lbs (5 kg).**Accessories furnished:** 2 GR elbows (HP Part No. 1250-0239).

1 GR to Type N adapter (1250-0240), and 1 Type N to BNC adapter (1250-0067).

Price: HP 1415A, \$1050.**Option 14:** long-line TDR for cables up to 1500 meters (0.62 mile); P7 phosphor recommended for Model 140A, no extra charge; specifications same as for 1415A except as follows:**System risetime:** less than 200 ps.**Rep rate:** 30 kHz, nominal.**Noise and internal pickup:** 0.25% of step.**Droop:** 2%.**Time scale:** 20 ns/cm to 1 μ s/cm.**Air line:** 300 cm/cm to 150 m/cm.**Polyethylene:** 200 cm/cm to 100 m/cm.**Price:** HP 1415A Option 14, \$1150.

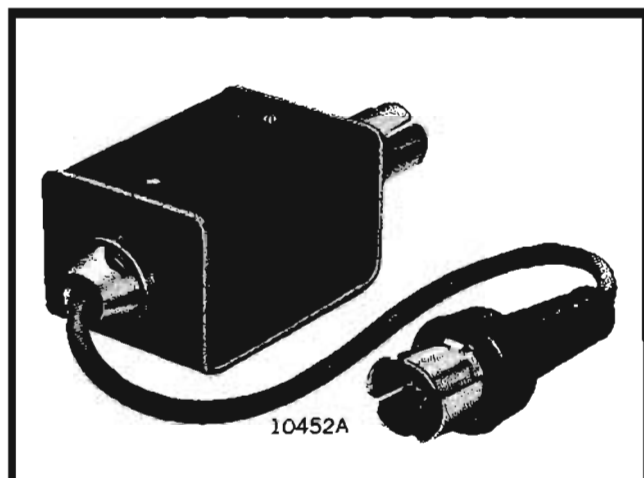
OSCILLOSCOPES 140A SYSTEM *continued***TDR Accessories**

10452A

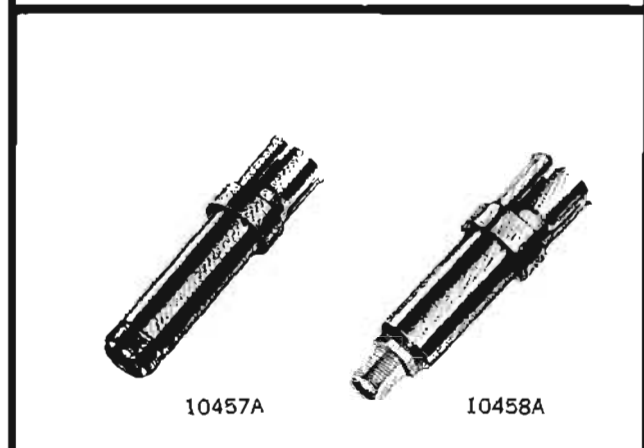

10457A

10458A

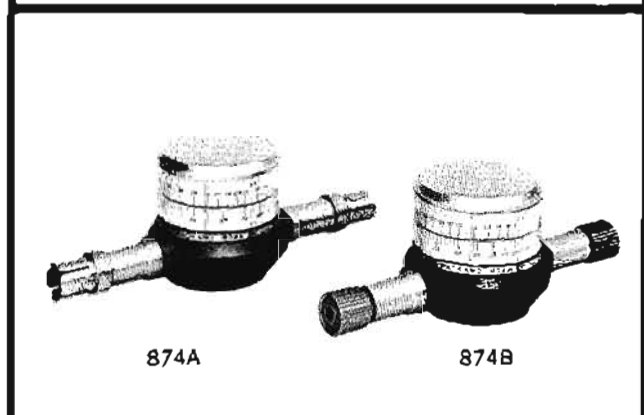

874A

874B

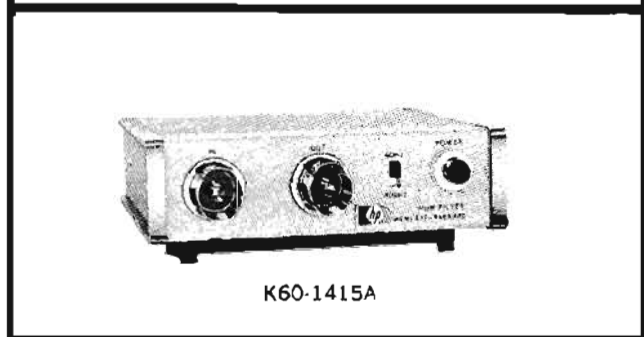

K60-1415A

Models 10452A-10456A

Model 10452A through 10456A Rise Time Converters slow down the step from the 1415A in order to eliminate reflections caused by frequencies beyond the bandwidth of interest.

Specifications

Rise times: (10-90% points as measured in 150 ps rise time system.)

10452A: 0.5 ns. 10453A: 1 ns. 10454A: 2 ns. 10455A: 5 ns. 10456A: 10 ns.

Rise time accuracy: better than $\pm 5\%$.

Overshoot: less than $\pm 3\%$.

Output Impedance (dc): 50 ohms (accuracy determined by output impedance of generator).

Output mismatch: less than $\pm 5\%$ reflection to output rise time.

Allowable Input voltage: up to 50 volts, open circuit (from a 50-ohm source).

Connectors: GR Type 874.

Price: \$75 each.

Models 10457A-10458A

Adapters convert 1415A 50 ohm output to 75 ohm systems. Model 10457A: converts 50 ohm GR to 75 ohm Type N. Price: \$35.

Model 10458A: converts 50 ohm GR to 75 ohm Type F (CATV).

Price: \$25.

Models 874A/B

The 874A/B are calibrated TDR comparison devices for simple, rapid, direct-reading evaluation of reactive discontinuities.

Specifications

Characteristic Impedance: 50 ohms ± 0.1 ohm.

Capacitance range: 0 to 1 pF.

Inductance range: 0 to 2 nH.

Accuracy: capacitance: ± 0.005 pF or $\pm 5\%$, whichever is greater, from 0 to 0.5 pF. Inductance: ± 0.013 nH or $\pm 5\%$, whichever is greater, from 0 to 1.3 nH.

Line length: 17.4 cm.

Connectors: 874A, GR type 874; 874B, Amphenol APC-7.

Price: 874A, \$250; 874B, \$325.

Model K60-1415A

Power line interference can be reduced with the K60-1415A Hum Filter when used with Time Domain Reflectometers such as the HP Model 1415A. A front panel switch allows you to select either 60 Hz or 400 Hz filtering.

Specifications**Hum rejection**

In a 50 ohm hum source

50-120 Hz, 40 dB; 400 Hz, 35 dB.

Introduced reflection: less than 5%.

Step distortion (droop): less than 3%.

Power

115-230 volts ac; 50-400 Hz; 1 watt.

Price: \$175.

ACCESSORIES—PROBES

Versatile Line of Probes For All Applications



OSCILLOSCOPES

Current probe and amplifier

With the HP Model 1110A and Model 1111A Current Probe and Amplifier you can observe fast-rise, ac current waveforms on any wideband oscilloscope. The Model 1110A Probe may be used by itself, giving a sensitivity of 1 mV/mA. The Model 1111A Amplifier increases the 1110A Probe's sensitivity and extends low frequency response. When used with a 50 mV/cm sensitivity oscilloscope, the Model 1111A's attenuator indicates directly in milliamperes per centimeter on the CRT thus eliminating cumbersome conversion factors.

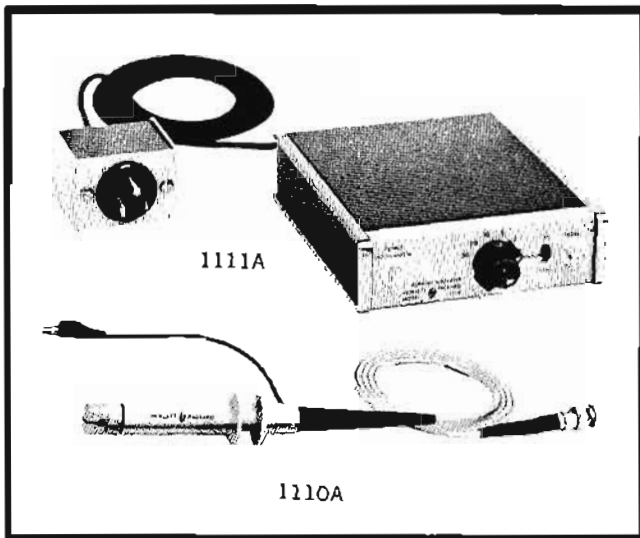

Specifications, Model 1110A

Sensitivity: 1 mV/mA.

Accuracy: $\pm 3\%$.

Bandwidth: lower limit: 1700 Hz (850 Hz with Model 10100B 100-ohm termination); upper limit: inversely proportional to capacitance of load: 4 pF load, 45 MHz, 7 ns rise time (e.g., Model 140A/1410A/1424A Sampling Oscilloscope); 30 pF load: 35 MHz, 9 ns rise time (e.g., Model 180A/1801A/1820A Oscilloscope).

Maximum dc current: 0.5 ampere.

Maximum ac current: 15 amperes pk-pk above 4 kHz; decreasing below 4 kHz at the rate of 3.8 A/kHz (30 A pk-pk max. with Model 10100B 100-ohm, termination).

Insertion Impedance: approximately 0.01 ohm, shunted by 1 μ H; capacitance to ground is less than 3 pF.

Accessory available: Model 10100B 100-ohm feed-through termination; decreases sensitivity to 0.5 mV/mA, lower cut-off to 850 Hz; increases maximum ac current to 30 A pk-pk above 4 kHz; price, \$18.

Model 1110A with Model 1111A

Sensitivity: 1 mA/cm to 50 mA/cm in X1, and 100 mA/cm to 5 A/cm in X100 (1, 2, 5, sequence when used with an oscilloscope at 50 mV/cm sensitivity).

Accuracy: $\pm 3\%$ on 50 mA/cm sensitivity and below; $\pm 4\%$ on 100 mA/cm sensitivity and above, (when Models 1110A and 1111A are calibrated together).

Bandwidth: 50 Hz to 20 MHz (18 ns rise time).

Noise: less than 100 μ A pk-pk, referred to input.

Maximum ac current: 50 A pk-pk above 700 Hz decreasing below 700 Hz at the rate of 1.4 A/20 Hz.

Output impedance: 50 ohms.

General

Dimensions: amplifier: 1½" high, 5½" wide, 6" deep (38 x 130 x 150 mm); probe: aperture, 5/32" (4 mm) diameter; 5 ft. cable (1520 mm).

Weight: Model 1110A: net ½ lb (0,23 kg); shipping 1 lb (0,45 kg); Model 1111A: net 2 lbs (0,9 kg); shipping 3 lbs (1,4 kg).

Power: 115 or 230 V $\pm 10\%$, 50 to 1000 Hz, approximately 1.5 W.

Price: HP Model 1110A, \$100; HP Model 1111A, \$160.

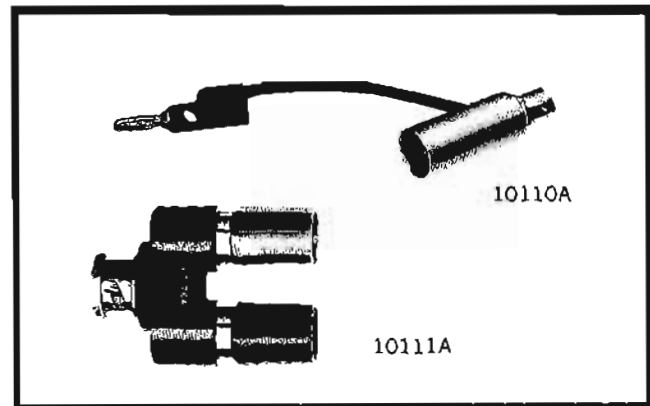

The Model 10110A Adapter (BNC male to dual-banana-post) quickly converts standard BNC input terminals on oscilloscopes to dual banana posts; price, \$5.

The Model 10111A Adapter (shielded banana-post to female-BNC) converts banana post inputs on oscilloscopes to shielded BNC inputs for low-level signal work; price, \$7.

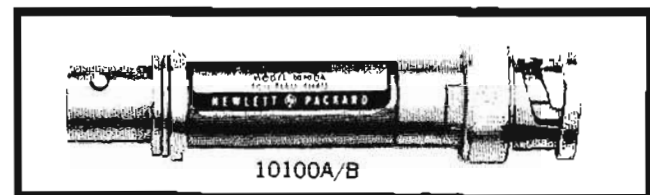

The Model 10100A is a 50-ohm (± 1 ohm) feed-through termination which can be used to terminate 50-ohm systems at scope inputs; price, \$15.

The Model 10100B is a 100-ohm (± 2 ohms) feed-through termination which can be used to increase the maximum ac current capability of the Model 1110A Current Probe; price, \$18.

OSCILLOSCOPES



PROGRAMMABLE OSCILLOSCOPE Production Line Speed; Laboratory Performance Model 155A/1550A



155A/1550A

The HP Model 155A Programmable Oscilloscope and Model 1550A Programmer combination is especially useful in all testing applications where repetitive measurements must be made. Electronic components and circuit assemblies, as well as end items, can be rapidly tested with a programmed Model 155A. Production test procedures are greatly simplified and testing time can be significantly reduced since the oscilloscope is preset and the operator need only push one program button and immediately observe the desired waveform. Repeated adjustments of sensitivity, sweep, etc. are eliminated. Because the procedure is so simple, operator errors and training time are minimized. Because testing can be done faster, fewer test stations and test technicians are required. Not only is the cost per test reduced, but also, oscilloscope control switch maintenance and down-time are significantly decreased. Because of driftless operation and calibrated positioning, the Model 155A can be used as an accurate dc voltmeter, thereby offering the possibility of reducing capital equipment expenditures. DC measurement accuracy is typically within $\pm 2\%$ of reading and always within $\pm 4\%$. The illuminated position, sensitivity and sweep indicators provide quick, easy-to-read verification of the oscilloscope operating modes. To provide testing flexibility, all controls can be operated manually, even when the oscilloscope is programmed. Programmed functions are automatically overridden. Programming is re-established by simply pressing the desired program button.

The speed of complex, automatic checkout systems is no longer limited by the time required to adjust an oscilloscope. Because the Model 155A will not normally have to

be adjusted during the test, the operator simply presses one button to obtain the required test waveform. Bright trace display with no parallax and illuminated function controls permit oscilloscope readings at considerable distances, thereby allowing the system operator to remain at his control console, monitoring the progress of the entire test.

A wide variety of programmers, such as punched or magnetic tape, cards, etc., can also be used to directly program the oscilloscope. If conventional programmers are used alone to directly control the scope, nine contact closures are required to fully activate a program. The Model 1550A, however, uses only one contact closure to select a complete program. The reduction in contact closures is accomplished by the use of a diode programming board.

155A Specifications

Time base

Range: 0.1 $\mu\text{s}/\text{cm}$ to 50 ms/cm in a 1, 2, 5 sequence; accuracy $\pm 3\%$, vernier provides continuous adjustment between steps and extends 50 ms/cm step to at least 0.125 s/cm .

Magnifier: X 5 sweep expansion expands fastest sweep to 20 ns/cm ; accuracy $\pm 5\%$.

Slow sweeps: slows all decade steps to 0.1, 0.2, 0.5 s/cm respectively; accuracy $\pm 5\%$.

Automatic triggering: (baseline displayed in the absence of an input signal).

Internal: 40 Hz to greater than 25 MHz for signals causing 0.5 cm or more vertical deflection on 50 mV/cm to 20 mV/cm steps, and for signals causing 2.0 cm or more vertical deflection on 5 mV/cm to 20 mV/cm steps; also from line voltage.

External: 40 Hz to greater than 25 MHz for signals from 0.5 to 10 volts peak-to-peak; input RC, 100 k ohms shunted by approximately 20 pF.

Trigger slope: positive or negative slope of external sync signal or internal vertical deflection signal.

Amplitude selection triggering:

Internal: same as automatic internal, except lower cutoff frequency extends to 10 Hz.

External: same as automatic external, except lower cutoff frequency extends to 10 Hz.

Trigger point and slope: from any point on the vertical waveform presented on CRT or continuously variable from -5 to $+5$ volts on either positive or negative slope of external sync signal.

Single sweep: front panel switch and pushbutton-indicator permit single sweep operation.

Sweep output: approximately 30 V sawtooth (-2 to $+28$ V); minimum load RC, 20 k ohms shunted by 150 pF.

Vertical amplifier

Bandwidth: (8 cm reference signal at 1 MHz from a 25 ohm source) dc coupled, dc to greater than 25 MHz at 3 dB down; ac coupled, 2 Hz to greater than 25 MHz at 3 dB down.

Deflection factor (sensitivity): 5 mV/cm to 20 V/cm in a 1, 2, 5 sequence; accuracy $\pm 2\%$; vernier provides continuous adjustment between steps and extends 20 V/cm step to at least 50 V/cm .

Maximum input: 400 V peak (dc + ac).

Input RC: 1 megohm shunted by approximately 50 pF, constant on all ranges.

Rise time: (with a 25-ohm source) less than 15 ns at 8 cm reference signal; less than 20 ns at 25 cm reference signal.

Position: baseline may be offset ± 25 cm from center screen in 1 cm steps from 0 to 5 cm, and 5 cm steps from 5 to 25 cm; accuracy of steps is $\pm 2\%$ when amplifier gain is calibrated; vernier provides ± 2 cm adjustment about setting of step offset.

DC stability: zero setting dc stabilization maintains a zero offset baseline within ± 0.1 cm of center screen over entire deflection factor range (after approximately 3 minute warmup); zero setting occurs approximately 3 times per second.

Signal delay: signal is delayed so that leading edge of fast rise signals is visible at start of sweep.

Rear input: rear panel BNC connector is selected by front panel switch; input RC, 1 megohm shunted by approximately 80 pF; bandwidth, greater than 20 MHz; rise time, 1 s than 18 ns at 8 cm reference signal.

Rear output: rear panel BNC connector provides low impedance, dc-coupled vertical signal output for an on-screen display; signal is dc stabilized and contains 5 ms switching transients at approximately 3 Hz, with stabilizer operating; with output terminated into 50 ohms: dc level is approximately -1.7 V at center screen; output amplitude is approximately 170 mV/cm; bandwidth is approximately 25 MHz.

Stabilizer timing output: 6-volt pulse (-6 V to 0 V) 5 ms wide, occurs during stabilization; minimum load resistance is 20 k ohms.

Remote programming

Programming is by contact closure to ground; control lines are at -12 volts and closure current is approximately 20 mA; programmable functions are as follows:

Vertical:

Deflection factor (sensitivity): 5 mV/cm to 20 V/cm, in a 1, 2, 5 sequence; seven control lines, two used per range.

Input coupling: ac or dc; one control line.

Vertical positioning: ± 1 to 5, ± 10 , ± 15 , ± 20 , ± 25 cm and zero; 12 control lines, two used per range.

Time base:

Range: 0.1 μ s/cm to 50 ms/cm, in a 1, 2, 5 sequence; nine control lines, two used per range.

Trigger source: internal, external, or line frequency; three control lines.

Trigger slope: positive or negative; two control lines.

Program inputs: control lines available at rear panel connector with power for programmer (Model 1550A).

General

Calibrator: line frequency square wave, 1 volt peak-to-peak; accuracy is $\pm 1\%$ ($+15$ to 35°C), and $\pm 3\%$ (0 to 55°C); rise time, 0.5 μ s or less.

Cathode ray tube: post-accelerator, 7500-volt accelerating potential; aluminized P2 phosphor; etched safety glass face plate reduces glare.

Graticule: 8 cm x 10 cm parallax-free internal graticule marked in cm squares; major horizontal and vertical axes have 2 mm subdivisions.

Intensity modulation: approximately +20 volt pulse will blank trace of normal intensity; input terminals on rear panel; dc coupled; input resistance approximately 22 k ohms; rise time less than 60 ns.

Dimensions: 16 $\frac{3}{4}$ " wide, 9" high, 18 $\frac{3}{8}$ " deep overall (426 x 229 x 466 mm); hardware furnished for quick conversion to 8 $\frac{3}{4}$ " x 19" (222 x 483 mm) rack mount.

Weight: net 45 lbs (20 kg); shipping 55 lbs (24.8 kg).

Power: 115 or 230 volts $\pm 10\%$, 50 to 60 Hz; approximately 200 W.

Price: HP Model 155A, \$2450.

Modifications: CRT phosphor numbers: P2 standard; P7, P11, P31 available, no charge.

Special order: chassis slides and adapter kit; fixed slides, order HP part No. 1490-0714, \$32.50; pivot slides, order HP part No. 1490-0719, \$37.50; slide adapter kit for mounting slides on scope, order HP part No. 1490-0721, \$20.

Options: (specify by option number).

01. Without programming capability, \$2150.

09. With horizontal input in place of sweep output; deflection factor, 200 mV/cm to 2 V/cm; bandwidth, approximately 500 kHz; add \$150.

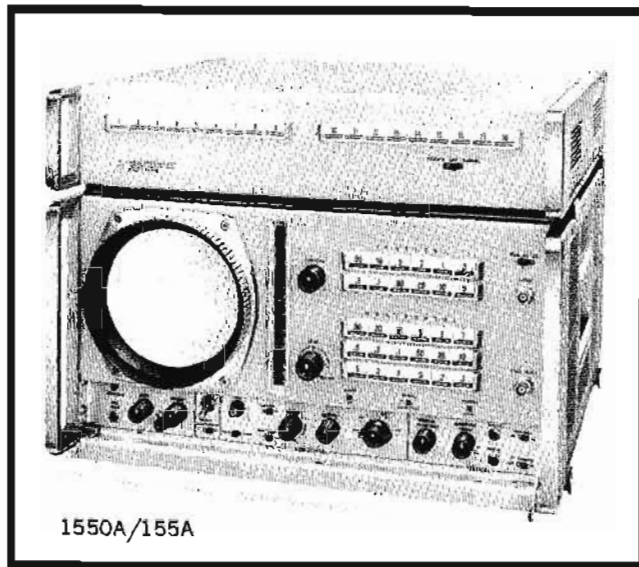

1550A Specifications

Programmer provides the means for programming vertical sensitivity, vertical positioning, vertical input coupling, sweep time, trigger source, and trigger slope in the Model 155A Programmable Oscilloscope, plus an auxiliary single line function.

Program storage: up to 18 different programs may be stored; an additional output connector for the control lines is provided on the rear panel to permit the cascading of programmers if additional program storage is desired.

Manual programming: preset programs are selected in any order by illuminated pushbuttons on the programmer front panel.

Remote programming: programs may be selected externally by making a single contact closure to ground; program control lines are available at a connector on the rear panel; externally selected programs are identified by the illuminated readout on the front panel; external switching must provide break-before-make contact closures; external contacts must switch a maximum of 300 mA.

Off: the programmer can be disabled when manual-only operation of the oscilloscope is desired regardless of programmer switching.

Programming pins: programs are preselected by inserting diode pins in a 15" x 10" program board; extra diode pins are included for one auxiliary function per program.

Power requirements: power required by the Model 1550A is supplied by the Model 155A Oscilloscope.

Dimensions: 16 $\frac{3}{4}$ " wide, 3-15/32" high, 18 $\frac{3}{8}$ " deep overall 426 x 88 x 467 mm); hardware furnished for quick conversion to 3 $\frac{3}{8}$ " x 19" (86 x 483 mm) rack mount.

Weight: net 6 lbs (2.7 kg); shipping 12 lbs (5.4 kg).

Accessories furnished: Model 10129A Interconnecting Cable to Model 155A Oscilloscope, 3 ft. long; mating connector for remote programming connector.

Price: HP Model 1550A, \$600.

Accessories available: Model 10130A Interconnecting Cable to Model 155A Oscilloscope, 10 ft. long, \$80; special length interconnecting cables are available upon request.

Special order: chassis slides and adapter kit; fixed slides, order part No. 1490-0714, \$32.50; pivot slides, order HP part No. 1490-0719, \$37.50; slide adapter kit for mounting slides on scope, order HP part No. 1490-0722, \$15.

OSCILLOSCOPES



X-Y DISPLAY

20 MHz Monitor with 8 inch by 10 inch screen
Model 1300A

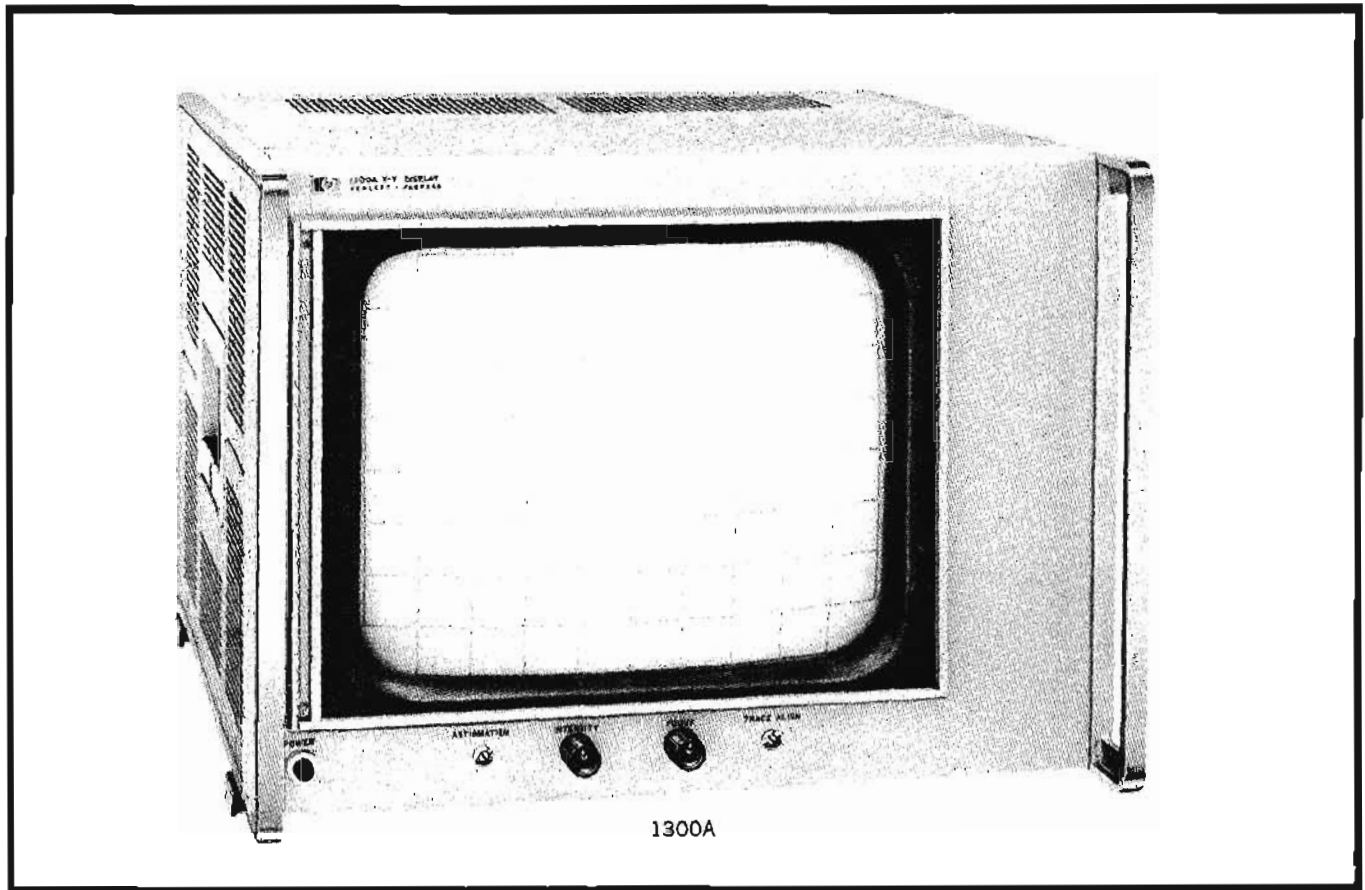

The extremely wide dc-20 MHz bandwidth of the Model 1300A Monitor provides capabilities not found in any other large screen display. The fast 20 nanoseconds rise time and 200 nanoseconds settling time allow rapid switching between several input waveforms without flicker. The 1300A CRT writes at better than 20 inches/ μ s for bright displays of low rep rate signals. The 8 inch x 10 inch viewing area provides the high resolution readout needed for many measurements. Some of these include swept frequency, spectrum analysis and time domain reflectometry. The 1300A's 20 kV display is easy to see even from long distances making it especially suited for system applications as well as production testing or classroom demonstrations. When used in conjunction with the H96-140A, the Model 1300A has the full versatility of the Model 140A plug-in oscilloscope plus remote display capability. The H96-140A provides 50-ohm amplifier outputs to drive the 1300A remotely. Control and amplifier options are available for increased versatility. Contact your local HP field engineer for your special requirements.

Applications

Swept frequency measurements are especially suited for a large screen readout. The H09-1300A is a special model of the 1300A X-Y Display that has been modified to be directly compatible with the Model 675A Sweeping Signal Generator. These two instruments when used together, pro-

vide an easy to read, easy to use, high resolution display of swept frequency measurements. Extended vertical dynamic range in the H09-1300A allows high sensitivity measurements at any point on the 1.5 volt output of the Model 675A Sweeping Signal Generator. The H09-1300A vertical position control provides the dc offset required to look at any point on the incoming signal while at sensitivities as high as 10 mV/in.

Another important application for the 1300A is analog computer readout. The 1300A provides a significant increase in useful resolution over the conventional 5 inch oscilloscope, without sacrificing useful bandwidth for displays such as analog computers, bar graphs, and the like. Increased resolution coupled with 1% linearity provides an accurate display of even high frequency phenomena and stable dc amplifiers provide excellent repeatability. The all solid state circuits of the Model 1300A provide a very reliable instrument that will be free from maintenance and service requirements.

Specifications

X-Y amplifiers

Deflection factor (sensitivity): at least 0.1 V/inch; vernier provides 2.5:1 reduction.

Drift: <0.1 inch/hr after 1/2-hr warmup; <0.2 inch/8 hr.



Model 1300A displaying a computer readout. X-Y-Z information provides an easy to read three dimensional display.

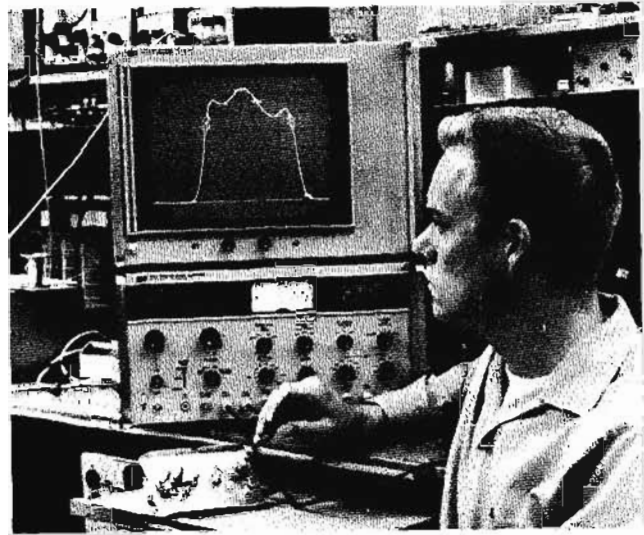

Model 1300A displaying filter response in conjunction with Model 675A Sweeping Signal Generator.

Bandwidth: dc coupled, dc to 20 MHz; ac coupled 2 Hz to 20 MHz (8-inch reference at 50 kHz).

Rise time: < 20 ns (10% to 90% points).

Settling time: < 200 ns to within a trace width of final value.

Repeatability: less than 0.15% error for re-addressing a point from any direction; source impedance < 4 k Ω .

Input RC: 1 megohm shunted by approximately 20 pF.

Input: single ended; BNC connector, maximum input ± 500 V (dc + peak ac).

Linearity: over 8 x 10-inch screen $\pm 1\%$ of full screen; any inch with respect to any other inch, within 10%.

Phase shift: 0.1° to 50 kHz, up to 100-inch signal; 1° to 1 MHz, up to 10-inch signal.

Z amplifier

Analog input: dc to 20 MHz bandwidth over the 0 to +1 V range; +1 V gives full blanking, -1 V gives full intensity; vernier gives 2.5:1 reduction, balance allows intensity adjustment of ± 1 V, maximum input ± 500 V (dc + peak ac).

Rise time: < 20 ns (10% to 90% points).

Sweep blank input: digital dc blanking with < 1 K Ω and -0.7 V to +5 V; unblanking with > 20 K Ω and 0 V to -5 V. Repetition rates to 1 MHz.

Chop blank input: ac coupled blanking, +50 V blanks CRT. Input grounded when not in use.

Calibrator

0.5 V $\pm 2\%$, line frequency square wave.

CRT

Accelerating potential: 20 kV.

Writing rate: > 20 inches/ μ s.

Spot size: less than 30 mils throughout 8 x 10-inch screen at 100 ft. lamberts light output; nominally 20 mils at center screen (shrinking raster).

Phosphor and graticule: aluminized P31 phosphor with 1-inch grid and 0.2-inch subdivisions on major axis. P2, P4, P7, P11 and other phosphors available; other graticules available on special order. Amber face plate

filter supplied with P7 phosphor instead of standard blue-green.

Controls: X-Y-Z inputs, ac-dc input switches, calibrator, X-Y gain verniers and position, Z axis vernier and balance on rear panel. Intensity, astigmatism, trace align, and focus on front panel.

General

Size: 12 $\frac{1}{4}$ " high, 16 $\frac{3}{4}$ " wide, 19 $\frac{7}{8}$ " deep, 18 $\frac{1}{2}$ " behind front panel (310 x 425 x 470 mm). Rack mount hardware supplied.

Weight: net 47 lbs (21,4 kg); shipping 64 lbs (29,1 kg).

Power: 175 W at 110-220 V; 50-1000 Hz.

Price: Model 1300A, \$1900.

Special order: a number of special modifications are available. They include: front panel X and Y inputs and controls, X10 pre-amplifier for 10 mV/in X and Y sensitivity, Z axis to provide eight gray scales, attenuators for X and Y amplifiers. Contact your local HP Field Engineer for details on these and other special requirements.

Model H09-1300A: specially modified 1300A to be directly compatible with Model 675A Sweeping Signal Generator. Includes 10 mV/inch vertical sensitivity and attenuator. All X and Y inputs and controls on front panel. Price, \$2100.

Option 14: no graticule in lieu of standard internal graticule. No additional charge.

Accessories available

Anti-reflection filter: nylon mesh attached to contrast filter to reduce reflections; Model 10181A blue-green filter for standard phosphors. Model 10182A amber filter for P7 phosphor. Price, Model 10181A, \$25; Model 10182A, \$25.

Chassis slides and adapters; fixed slides, order HP Part No. 1490-0714, \$32.50; pivot slides, order HP Part No. 1490-0718, \$40; slide adapter kit for mounting slides, order HP Part No. 1490-0721, \$20. Note: One adapter kit required for mounting one pair of chassis slides.

OSCILLOSCOPES



50 MHz OSCILLOSCOPE

High-performance scope with versatile plug-ins
Model 175A

Features

The HP Model 175A Oscilloscope is an accurate general-purpose test instrument that provides at least 50 MHz of bandwidth for a wide variety of measurements. It has both horizontal and vertical plug-in capability, allowing the user to choose the exact features he desires. Circuitry has been simplified, making it easier to adjust and maintain. In addition, extra features such as the improved triggering, variable hold-off triggering, logically arranged controls and convenient beam finder make the oscilloscope easier to use.

Horizontal and Vertical Plug-ins

The Model 175A accepts not only a wide line of vertical plug-ins, but also a series of horizontal time axis plug-ins which greatly extend its versatility. Such features as sweep delay, 0.5% time measurements, x-y recorder driving, or pushbutton recordings may be added when needed, allowing one instrument to be used for several widely differing measurements. Four vertical and four horizontal plug-ins are available. In different combinations they adapt the Model 175A to almost any test application.

Specifications

Time base

Range: 0.1 μ s/cm to 5 s/cm, 24 ranges in a 1, 2, 5 sequence; accuracy $\pm 3\%$; vernier provides continuous adjustment between steps and extends the 5 s/cm step to at least 12.5 s/cm.

Magnifier: X1 and X10; overall sweep accuracy within $\pm 5\%$ in X10.

Triggering: internal, ac coupled; power line; external, ac or dc coupled.

Triggering sensitivity

Internal: approximately 2 mm vertical deflection at 1 MHz, 2 cm at 50 MHz.

External: approximately 0.25 V peak to peak at 1 MHz, 0.5 V peak to peak at 50 MHz.

Triggering point: controls allow selection of slope and level; external level adjustable from -5 V to $+5$ V.

Horizontal amplifier

Bandwidth: dc coupled, dc to 500 kHz; ac coupled, approximately 2 Hz to 500 kHz.

Deflection factor (sensitivity): 0.1 V/cm and 1V/cm; accuracy $\pm 5\%$; vernier provides continuous adjustment between steps and extends 1 V/cm step to at least 10 V/cm.

Input RC: 1 megohm shunted by approximately 30 pF.

Vertical amplifier

Rise time: less than 7 ns.

General

Calibrator: 1 kHz square wave, approximately 3 μ s rise time; 1 V and 10 V peak to peak; accuracy $\pm 1\%$ at 15°C to 35°C.

Cathode ray tube: post accelerator, 12 kV accelerating potential; P31 aluminum phosphor (others available, see modifications); etched safety glass face plate reduces glare.

Graticule: 6 x 10 cm parallax-free internal graticule marked in cm squares; major horizontal and vertical axes have 2 mm subdivisions.

Beam finder: pressing beam finder control brings trace on crt screen, regardless of setting of horizontal and vertical position controls or intensity controls.

Intensity modulation: +20 V pulse will blank trace of normal intensity; BNC connector on rear panel.

Dimensions: 16 $\frac{3}{4}$ " wide, 12 $\frac{1}{2}$ " high, 24 $\frac{3}{8}$ " deep overall (425 x 311 x 593 mm); hardware furnished for quick conversion to 12 $\frac{1}{2}$ " x 19" rack mount, 22" deep behind panel (311 x 483 x 559 mm).

Weight: net, 64 lbs (29 kg); shipping, 88 lbs (39.5 kg).

Power: 115 or 230 V $\pm 10\%$, 50 to 60 Hz, approximately 425 W (depends on plug-ins).

Accessories furnished: two 10:1 voltage divider probes; detachable power cord.

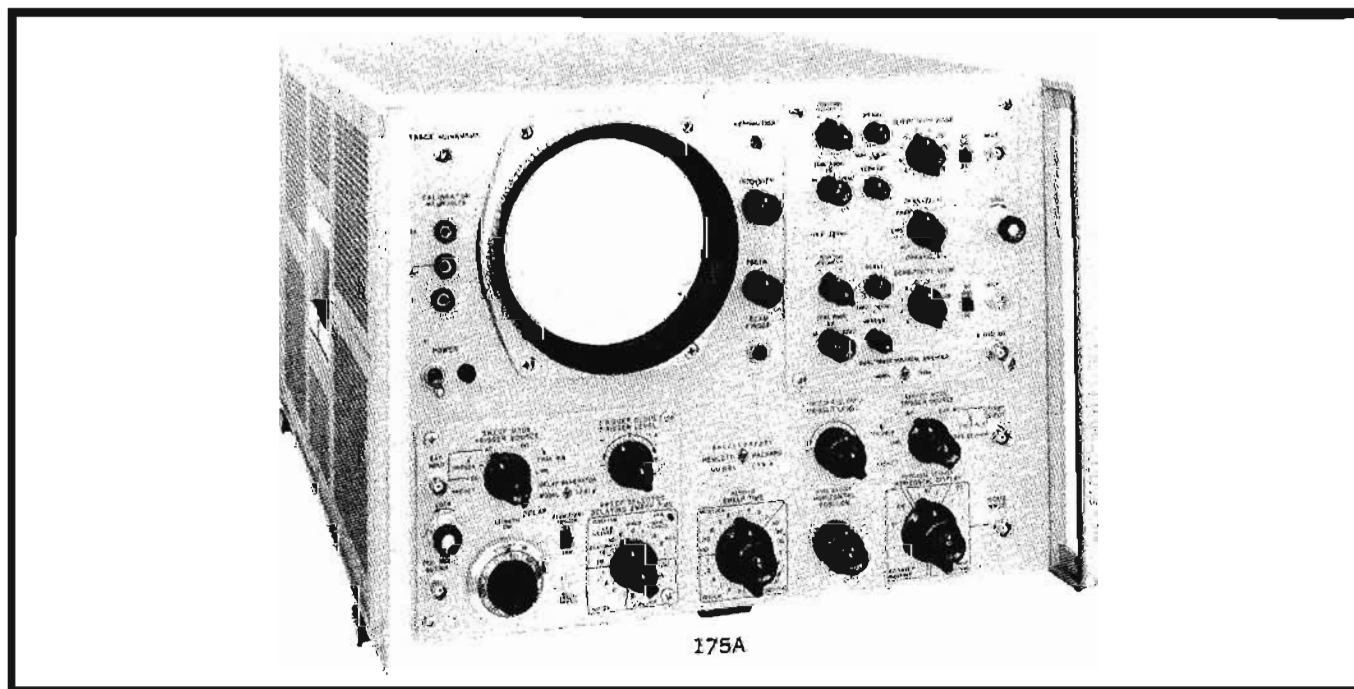

Price: HP Model 175A, \$1325 (without plug-ins, 2 required).

Modifications: CRT phosphors (specify by phosphor number): P31 standard, P2, P7 with amber filter, P11 available. no charge.

Special order:

Chassis slides and adapter kit; fixed slides, order HP Part No. 1490-0714, \$32.50; pivot slides, order HP Part No. 1490-0720, \$37.50; slide adapter kit for mounting slides on scope, order HP Part No. 1490-0721, \$20.

50 to 440 Hz frequency, 115 V or 230 V $\pm 10\%$ line power, order H12-175A; price, \$1375; line filter and modification to meet RFI spec MIL-I-16910A; order H20-175A; price, \$1400.

Options: (specify by option number).

05. External graticule CRT with P31 phosphor (P2, P7, P11 available, please specify) in lieu of standard internal graticule, add \$25; includes edge-lighting of external graticule.

08. Gate and sawtooth outputs, add \$25

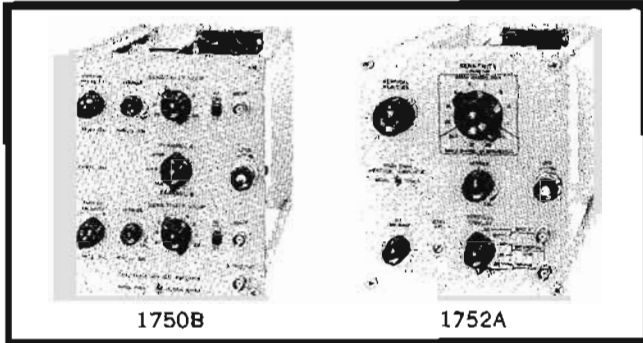

Specifications, 1750B

Modes of operation

Single channel: channel A or B.

Dual channel: channels A and B displayed on alternate sweeps; channels A and B displayed by switching at 200 kHz rate, trace blanked during switching.

A + B: channels A and B added algebraically (single display).

Vertical amplifier (each channel)

Bandwidth: dc to at least 50 MHz; ac coupled, approximately 2 Hz to 50 MHz.

Deflection factor (sensitivity): 0.05 V/cm to 20 V/cm, 9 ranges in a 1, 2, 5 sequence; accuracy $\pm 3\%$; vernier provides continuous adjustment between steps and extends 20 V/cm step to at least 50 V/cm.

Maximum input: 600 V dc (ac-coupled input).

Input RC: 1 megohm shunted by 23 pF.

Rise time: less than 7 ns.

Polarity presentation: + or - up, selectable.

Differential input: bandwidth and sensitivity unchanged; common mode rejection at least 30 dB at 0.05 V/cm.

B trigger output: B channel signal, amplified, 5 Hz and 2.5 MHz bandwidth, available on front panel.

General

Weight: net 4 lbs (1.8 kg); shipping 8 lbs (3.6 kg).

Accessories furnished: one Model 10121A coaxial cable.

Price: HP Model 1750B, \$325.

Specifications, 1752A

Vertical amplifier

Bandwidth: dc coupled, 50 mV/cm and above, dc to 22 MHz; 20 mV/cm to 5 mV/cm, dc to 18 MHz; ac coupled same as dc coupled except down 3 dB at 2 Hz.

Deflection factor (sensitivity): 5 mV/cm to 20 V/cm, 12 ranges in a 1, 2, 5 sequence; accuracy $\pm 3\%$; vernier provides continuous adjustment between steps and extends 20 V/cm step to at least 50 V/cm.

Input connection: separate BNC connectors, selectable ac or dc coupling for each; at least 80 dB isolation between inputs; differential input on 5 mV/cm ranges with common mode rejection of at least 40 dB; maximum common mode signal 4 V peak to peak.

Maximum Input: 600 V dc (ac-coupled input).

Input RC: 1 megohm shunted by 35 pF.

General

Weight: net 4 lbs (1.8 kg); shipping 8 lbs (3.6 kg).

Price: HP Model 1752A, \$225.

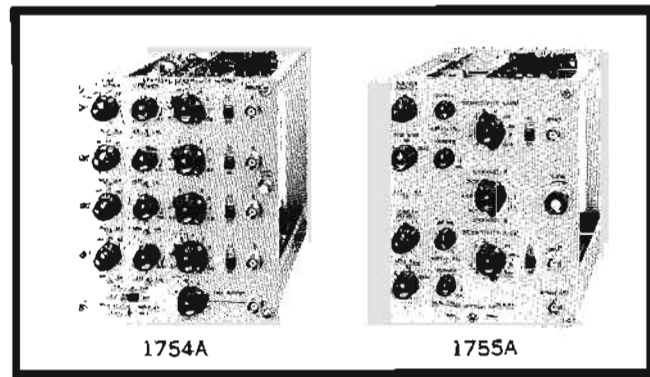

Specifications, 1754A

Modes of operation

Single channel: any channel (A, B, C, or D) separately.

Multi-channel: any combination of channels (2, 3, or 4 displays) on alternate sweeps, or chopped at 1 MHz rate, trace blanked during switching.

Vertical amplifier (each channel)

Bandwidth: dc-coupled, dc to 40 MHz; ac-coupled 2 Hz to 40 MHz.

Deflection factor (sensitivity): 0.005 V/cm to 20 V/cm, 9 ranges in a 1, 2, 5 sequence; accuracy $\pm 3\%$; vernier provides continuous adjustment between steps and extends 20 V/cm step to at least 50 V/cm.

Input connection: separate BNC connectors, selectable ac or dc coupling for each.

Maximum input: 600 V dc (ac-coupled input).

Input RC: 1 megohm shunted by 22 pF.

Rise time: less than 9 ns.

Polarity presentation: + or - up, selectable.

Trigger output: single output connector selectable for A, B, C, or D channel input signal, amplifier bandwidth 10 Hz to 8 MHz in alternate mode.

General

Weight: net 5 lbs (2.3 kg); shipping 9 lbs (4.1 kg).

Accessories furnished: one Model 10121A Coaxial Cable.

Price: HP Model 1754A, \$595.

Specifications, 1755A

Modes of operation

Single channel: channel A or B.

Dual channel: channels A and B displayed on alternate sweeps; channels A and B displayed by switching at 200 kHz rate, blanked during switching.

A + B: channels A and B added algebraically (single display).

Vertical amplifier (each channel)

Bandwidth and rise time:

Vertical amplifier: (each channel).

Bandwidth and rise time:

Sensitivity	Bandwidth
10 mV/cm to 5 V/cm (sens mode X1)	dc to 50 MHz (8.5 ns)
5 mV/cm (sens mode X1)	dc to 40 MHz (9 ns)
1 mV/cm (sens mode X5)	dc to 20 MHz (17 ns)

Bandwidth, lower limit: ac coupled, X1 and X5, 2 Hz; X5 ac 4 Hz.

Deflection factor (sensitivity):

X1 mode: 0.005 V/cm to 5 V/cm, 10 ranges in a 1, 2, 5 sequence; accuracy $\pm 3\%$; vernier provides continuous adjustment between steps and extends 5 V/cm step to at least 12.5 V/cm.

X5 mode: increases maximum sensitivity to 1 mV/cm; accuracy $\pm 5\%$.

X5 ac mode: provides internal ac coupling to eliminate drift; sensitivity and accuracy same as X5 mode.

Maximum Input: 600 V dc (ac-coupled input).

Input RC: 1 megohm shunted by 22 pF.

Polarity presentation: + or - up, selectable.

Differential input: common mode rejection at least 20:1, dc to 50 kHz with verniers in Cal; common mode rejection may be increased to greater than 100:1 by adjusting verniers; maxi-

OSCILLOSCOPES MODEL 175A *continued***1700 Series plug-ins**

imum common mode signal 10 cm display on all sensitivity ranges.

B trigger output: B channel signal amplified, 5 Hz to 5 MHz bandwidth, available on front panel.

General

Weight: net 5 lbs (2,3 kg); shipping 9 lbs (4,1 kg).

Accessories furnished: one Model 10121A Coaxial Cable.

Price: HP Model 1755A, \$575.

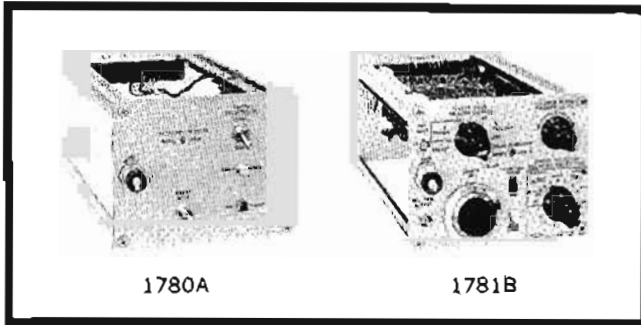

1780A

1781B

Specifications, 1780A

Sweep occurrence: normal or single.

Sweep arming: internal or by external pulse, 1 to 200 μ s, ± 15 to 25 V peak.

Input connector: BNC.

Weight: net 2 lbs (0,9 kg); shipping 5 lbs (2,3 kg).

Price: HP Model 1780A, \$25.

Specifications, 1781B**Delay**

Time: 0,5 μ s to 10 s delay; delay time is product of delay sweep setting in s/cm and delay length setting in cm.

Sweep: 2 μ s/cm to 1 s/cm; 18 ranges in a 1, 2, 5 sequence.

Length: 0 to 10 cm (the physical location, in cm from the beginning of the trace, to the point where the main sweep is triggered).

Accuracy: $\pm 1\%$, 2 μ s to 0,1 s/cm ranges: $\pm 3\%$, 0,2, 0,5, 1 s ranges; $\pm 0,2\%$ linearity.

Function: trigger main sweep; arm main sweep.

Jitter: $\pm 0,002\%$ maximum delay on each range (1 part in 50,000).

Triggering

Internal: ac coupled (2 mm or more vertical display); power line.

External: ac or dc coupled (0,5 V peak-to-peak minimum).

Point: level and slope selectable; external sync level adjustable -5 to $+5$ volts.

Sweep selection

Main: main sweep only.

Delaying: brightened segment of trace indicates time relationship between delaying sweep display and main sweep display.

Main delayed: main sweep delayed as indicated.

Mixed: main and delayed sweeps.

Single: single sweep of main.

Trigger output

Delayed trigger: approximately $+10$ volts.

General

Weight: net 4 lbs (2,1 kg); shipping 7 lbs (3,2 kg).

Price: HP Model 1781B, \$325.

Specifications, 1782A

Vertical output: approximately 200 mV/cm; gain and dc level are independently adjustable.

Horizontal output: output level, adjustable to zero volts; output amplitude, adjustable from 0 to $+15$ volts.

Bandwidth: at least 30 MHz when installed with a 40 MHz vertical plug-in amplifier.

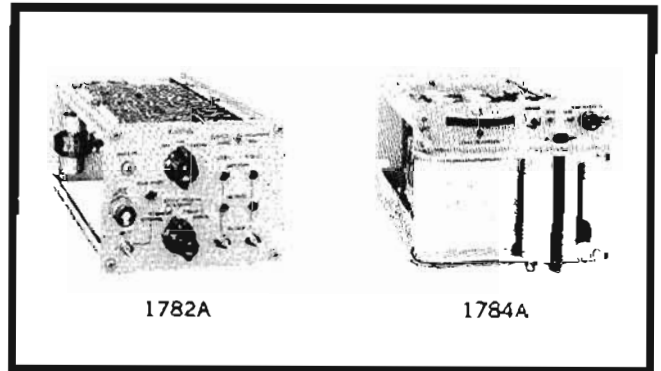

1782A

1784A

Scanning: manual, internal (with pen speed either stabilized or linear) or external, requires 0 to 15 V for full scan, maximum external scan rate, 1 kHz.

Scanning time: internal, linear: approximately 1,5 minutes; internal, with pen speed stabilized: approximately 20 seconds when displaying time base only.

Oscilloscope sweep speed: from fastest sweep to 5 ms/cm; signal repetition rate greater than 20 Hz.

Remote pen lift: lifts pen when switching from Record to Arm Recorder.

Weight: net 4 lbs (1,8 kg); shipping 6 lbs (2,7 kg)

Price: HP Model 1782A, \$425.

Specifications, 1784A

Amplitude recording accuracy: duplicates CRT display within $3\% \pm 1$ mm, excluding bandwidth limitation. Bandwidth is dc to greater than 30 MHz when used with a vertical plug-in having 40 MHz or greater bandwidth.

Writing rate: waveforms with slopes of at least 50:1 can be recorded with a continuous line.

Line width: approximately 0,25 mm at normal line intensity.

Time recording accuracy: thumbwheel may be adjusted to provide time correlation between CRT and recording with ± 1 mm. Linearity of recording within 3%.

Repetition rate: signal rep rates of 60 Hz or greater and sweep speeds of 1 ms/cm and faster are required. (Usable below these limits, but with progressively greater distortion in the form of small steps on the plot.)

Recording cycle time: approximately 30 seconds.

Recording paper: HP Recording Permapaper®; actual recording size 5 x 8½ cm divided into 6 x 10 major divisions, corresponding to the Model 175A graticule markings; one 75-foot roll provides approximately 125 recordings; for single rolls, order HP Part No. 9281-0083; price, \$2.

For pack of six rolls, order HP Part No. 9281-0099; price, \$10. For single roll or blue grid paper suitable for photographing, order HP Part No. 9281-0380; price, \$3.

For single rolls of translucent paper suitable for making Ozalid reproductions, order HP Part No. 9281-0304; price, \$4,50.

Weight: net 9 lbs (4,1 kg); shipping 16 lbs (7,2 kg).

Accessories furnished: six rolls of HP Recording Permapaper.

Price: HP Model 1784A, \$875.

175A Service Accessories**Vertical Test Adapter**

The Model 10404A Vertical Test Adapter provides a convenient means of applying a known voltage to the main vertical amplifier of the Model 175A for setting the gain; price, \$15.

Vertical Response Tester

The Model 10405A Vertical Response Tester provides a fast step function for use in establishing and adjusting the "step" response of the main vertical amplifier in the Model 175A. This plug-in generates a positive or negative 2 V adjustable pulse with a rise time less than 1 ns, 240 pulse rep rate; price, \$125.

Plug-In Extenders

The Model 10400B, 30-inch extension cable for Model 175A vertical plug-ins; price, \$25. The Model 10402A, 24-inch extension cable for Model 175A time axis plug-ins; price, \$35.

Alignment Attenuator

The Model 10403A Alignment Attenuator may be used to check and adjust the input capacity of the Vertical Amplifiers. It is factory set for approximately 22 pF input impedance (Models 1754A and 1755A); adjustable for other vertical amplifiers; price, \$35.

SOLID STATE OSCILLOSCOPES

Large display, lower power, light weight

Models 180A, 181A



OSCILLOSCOPES

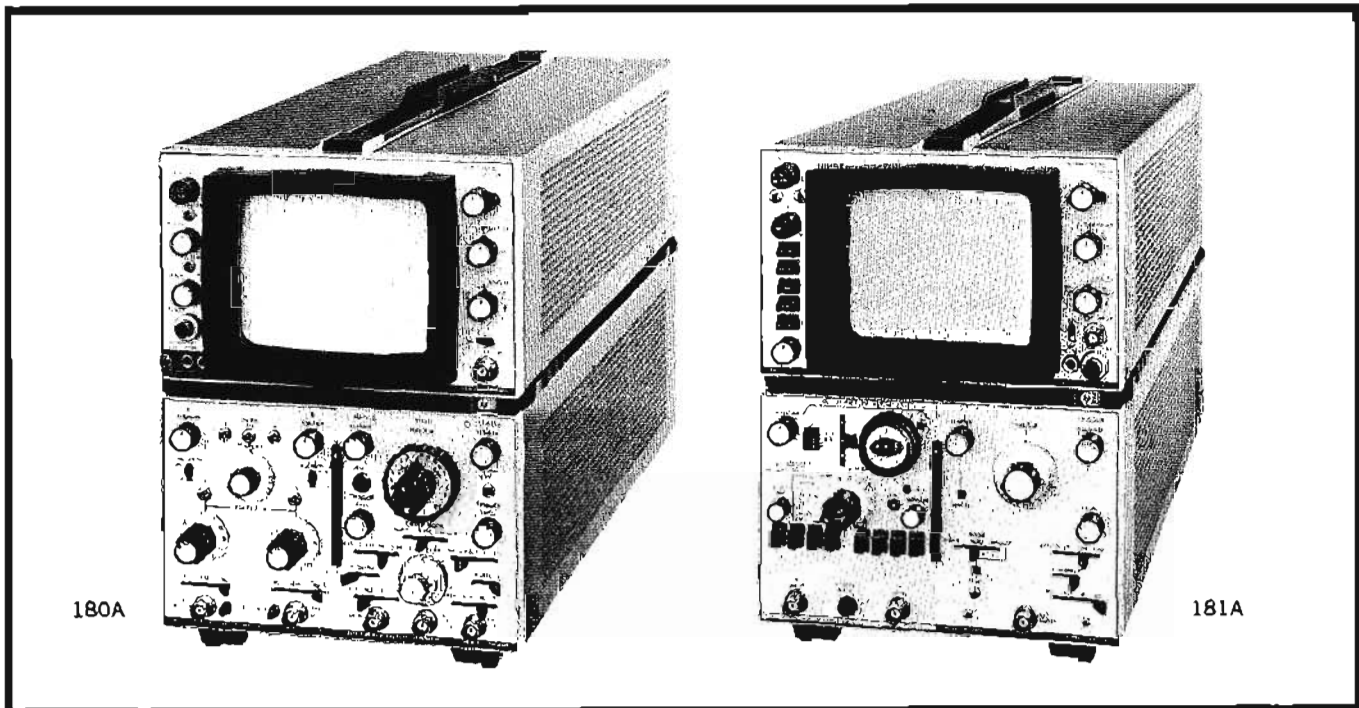

Features

- Standard or variable persistence and storage.
- Cabinet or modular/rack models, takes only 5¼ inches of rack space.
- Vertical and horizontal plug-ins for versatility.
- Aircraft-type frame construction—maximum ruggedness with minimum weight.
- Large area, 8 x 10 division CRT.
- Operate in any position, no forced-air cooling needed.
- Main frames and plug-ins are fully solid-state.

Description

The 180A and 181A provide a new standard in high performance, general purpose oscilloscope design. Small and light weight, these all-solid-state scopes take little bench space, and may easily be carried about. Both are ruggedly constructed for field and lab use and tested to operate in a

large range of environments (if unusually severe environmental conditions are to be encountered, see data on the 180E on page 499).

Though small, the 180A and 181A have large-screen displays, offering 30% to 100% greater viewing area than any other high-frequency scope. The 12kv CRT on the 180A produces clear, bright traces even at the fastest sweep speeds, while the 181A's variable persistence feature permits "developing" or integrating traces which are nearly invisible on an ordinary oscilloscope.

Power supplies on both main frames are designed for solid-state devices, and all five plug-ins presently available are fully solid-state. Vertical deflection plug-ins drive the cathode ray tube directly, so that the driving amplifiers may be designed to suit the requirements of the plug-in, and also provide for extended bandwidth capabilities in future plug-ins. See your HP field engineer for information on plug-ins which may have been introduced since publication of this catalog.

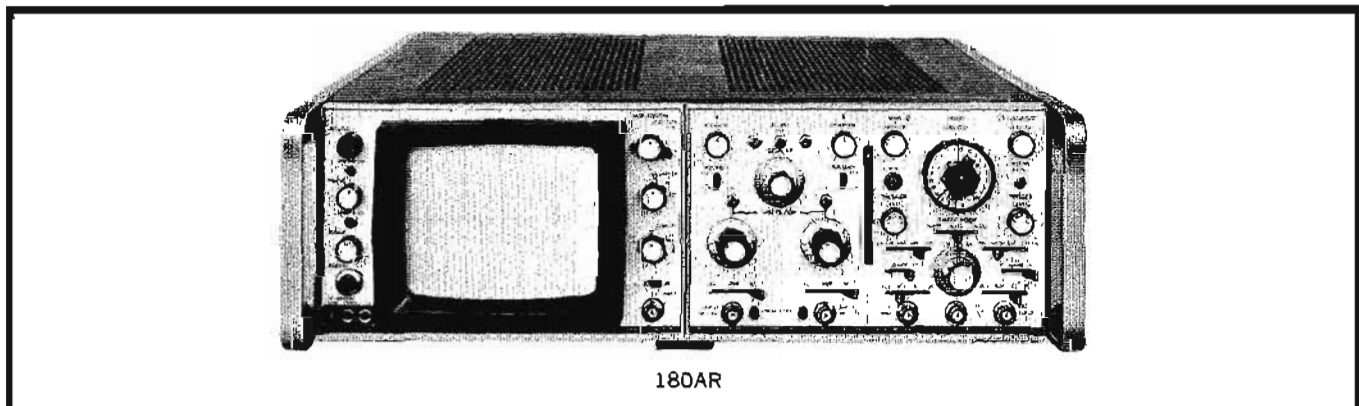

180AR

OSCILLOSCOPES 180A SYSTEM *continued*

8 x 10 cm display, solid-state, 30 pounds

Models 180A, 180AR Mainframes

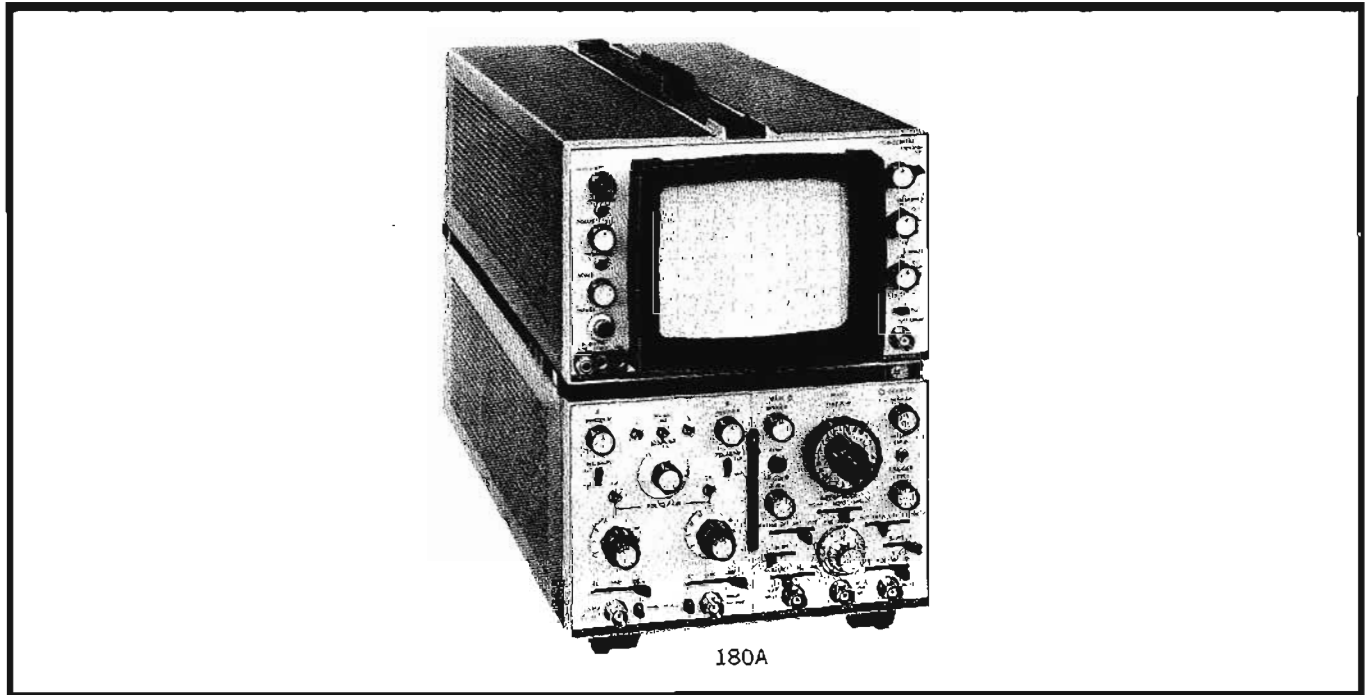

180A

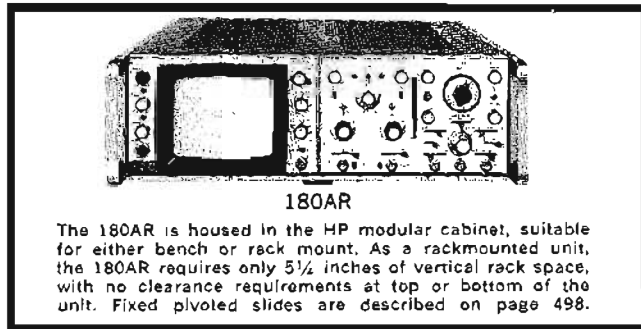

180AR

The 180AR is housed in the HP modular cabinet, suitable for either bench or rack mount. As a rack-mounted unit, the 180AR requires only 5¼ inches of vertical rack space, with no clearance requirements at top or bottom of the unit. Fixed pivoted slides are described on page 498.

Specifications 180A/180AR Mainframe**Horizontal amplifier:****External input:**

Bandwidth: dc coupled, dc to 5 MHz; ac coupled, 5 Hz to 5 MHz.

Deflection factor (sensitivity): 1 V/cm, X1; 0.2 V/cm, X5; 0.1 V/cm, X10; vernier provides continuous adjustment between ranges; dynamic range ± 5 V.

Maximum input: 600 V dc (ac-coupled input).

Input RC: 1 megohm shunted by approximately 30 pF.

Sweep magnifier: X1, X5, X10; magnified sweep accuracy $\pm 5\%$.

Calibrator:

Type: approx 1 kHz square wave, 3 μ s rise time.

Voltage: 2 outputs, 250 mV and 10 V p-p, $\pm 1\%$.

General:

Cathode ray tube: post-accelerator, 12 kV accelerating potential; aluminized P31 phosphor (other phosphors available; see modifications) with etched safety glass face plate to reduce glare.

Graticule: 8 x 10 cm parallax-free internal graticule marked in cm squares, 2 mm subdivisions on major axes;

front panel recessed Trace Align aligns trace with graticule; internal Y-align aligns Y-trace with X-trace; Scale control illuminates CRT phosphor for viewing with hood or taking photographs.

Beam finder: pressing beam finder control brings trace on CRT screen regardless of setting of horizontal, vertical or intensity controls.

Intensity modulation: approx +2 V, dc to 15 MHz, will blank trace of normal intensity; input R, 5.1 k ohms; input connector on rear panel.

Active components: all solid-state (except CRT).

Environmental: Model 180A scope operates within specs over the following ranges: temperature, -28 to 65°C ; humidity, to 95% relative humidity to 40°C ; altitude, to 15,000 ft.; vibration, vibrated in three planes for 15 min each with 0.010" excursion from 10 to 55 Hz.

Power: 115 or 230 V, $\pm 10\%$, 50 to 1000 Hz, 100 watts at normal line, convection cooled.

Dimensions: cabinet: 8" wide, 11" high, 22½" deep overall (204 x 280 x 572 cm); rack unit: 19" wide, 5¼" high, 19½" deep behind front panel, 21½" deep overall.

Weight: (without plug-ins) Model 180A: net 22 lbs (9,9 kg); shipping, 30 lbs (13,5 kg); Model 180AR: net, 25 lbs (11,3 kg); shipping, 33 lbs (14,9 kg).

Outputs: four emitter follower outputs for main and delayed gates, main and delayed sweeps; maximum current available, ± 3 mA; outputs will drive impedances down to 1 k Ω without distortion.

Accessories furnished: mesh contrast filter, detachable power cord, rack mounting hardware (180AR only).

Price: (without plug-ins) HP Model 180A, \$825; HP Model 180AR, \$900.

Modifications: CRT phosphor (specify by phosphor number): P31 standard; P2, P7, P11 available, no extra charge.

OSCILLOSCOPES 180A SYSTEM *continued*

Variable Persistence, All Solid-State
Models 181A, 181AR Mainframes

Features:

- Vary persistence to view slow signals
- "Develop" fast, low repetition rate pulses
- Bright, high-contrast storage up to 1 hour
- Rugged construction for field use
- Scope with plug-ins weighs only 32 pounds
- Push-button erase and mode controls

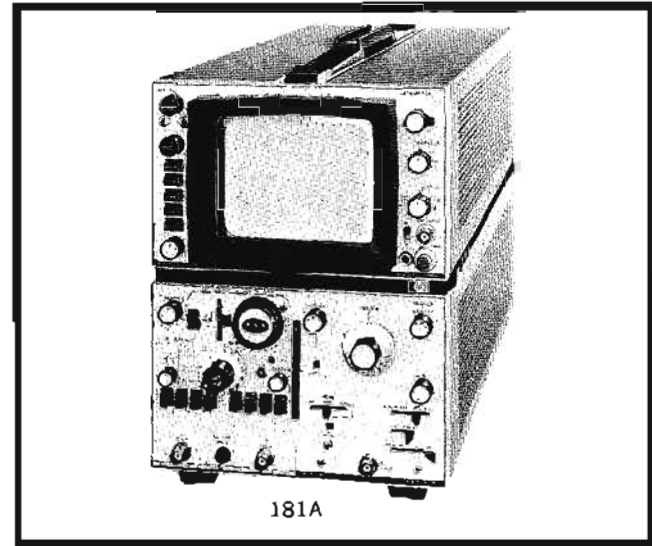
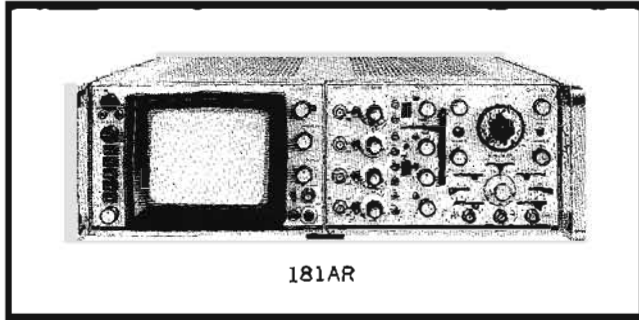
**Specifications****Horizontal amplifier****Ext. Input**

Bandwidth: dc coupled, dc to 5 MHz; ac coupled, 5 Hz to 5 MHz.

Deflection factor (sensitivity): 1 v/cm, X1; .2 v/cm, X5; .1 v/cm, X10; vernier provides continuous adjustment between ranges. Dynamic ranges ± 5 v.

Input R_c: 1 megohm shunted by approximately 30pf.

Sweep Magnifier: X1, X5, X10; magnified sweep accuracy, $\pm 5\%$.

Calibrator

Type: approximately 1 kHz square wave, 3 μ s rise time.

Voltage: 10 volt peak-to-peak, $\pm 1\%$.

Cathode ray tube and controls
Type: post accelerator storage tube; 8.5 kv accelerating potential; aluminized P31 phosphor.

Graticule: 8 x 10 div parallax-free internal graticule marked in 0.95 cm squares. Sub-divisions of .2 div on major axes. Front panel recessed TRACE ALIGN aligns trace with graticule. Y axis may be aligned to be perpendicular with X axis with internal control, for accurate rise time measurements.

Beam finder: pressing Find Beam control brings trace

on CRT screen regardless of setting of horizontal, vertical, or intensity controls.

Intensity modulation: approximately +2 volts, dc to 15 MHz, will blank trace at normal intensity. Input R, 5.1k ohms.

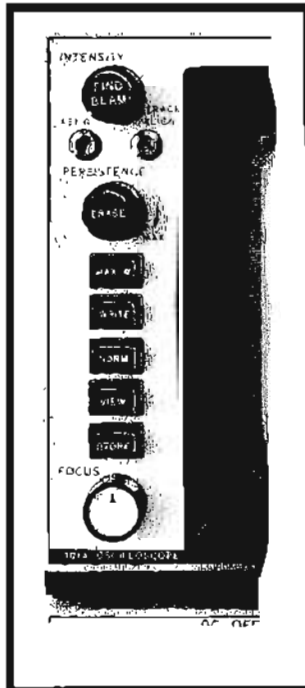

Persistence: normal, natural persistence of P31 phosphor (about 0.1 second). Variable, continuously variable from less than 0.2 seconds to more than 1 minute.

Writing rate: (with variable persistence)

Write mode; greater than 20 cm/ms

Max. Write mode; greater than 1 cm/ μ s

Brightness: measured with entire screen faded positive; greater than 200 foot lamberts.

Storage time: store mode, traces can be stored for more than one hour at reduced intensity. View mode, stored traces can be viewed at normal intensity for accumulative time of more than one minute.

Erase: manual, push-button erasure takes approximately 260ms.

Outputs

Four emitter follower outputs for main and delayed gates, main and delayed sweeps. Maximum current available, ± 3 ma. Outputs will drive impedances down to 1k ohm without distortion.

General

Active components: all solid-state, no vacuum tubes (except CRT).

Environment: 181A scope operates within specs over the following ranges:

Temperature: -28°C to $+65^{\circ}\text{C}$.

Humidity: to 95% relative humidity to 40°C .

Altitude: to 15,000 ft.

Vibration: vibrated in three planes for 15 min. each with 0.010" excursion 10 to 55 Hz.

Power: 115 or 230 volts, $\pm 10\%$, 50-400 Hz, 100 watts at normal line, convection cooled.

Dimensions: same as 180A.

Weight: (without plug-ins) Model 181A; net, 25 lbs (9.9 kg); shipping, 32 lbs (13.5 kg). Model 181AR net, 26 lbs (11.3 kg); shipping, 35 lbs (14.9 kg).

Accessories furnished: mesh contrast filter, detachable power cord, rack mounting hardware (181AR only).

Price: HP Model 181A (cabinet), \$1850; HP Model 181AR (modular rack), \$1925.

OSCILLOSCOPES 180A SYSTEM *continued***50 MHz solid-state vertical amplifier**

Model 1801A

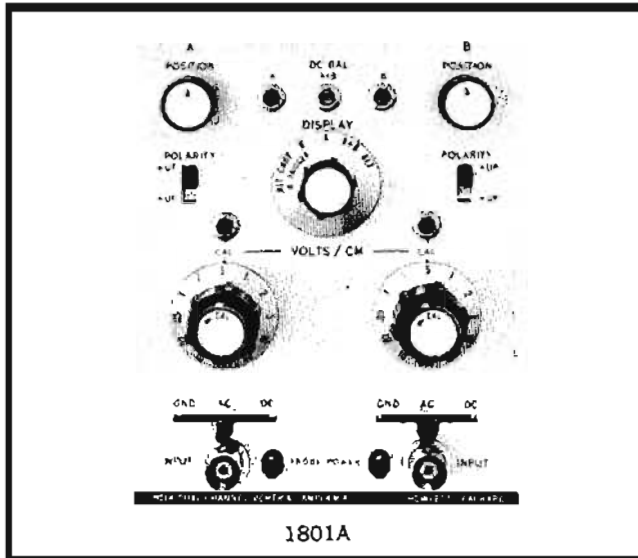

This dual channel amplifier is ideal for general-purpose use in the 180A or 181A. Its high sensitivity of 5 mV/cm provides the extra gain needed when divider probes are used. The 1801A has FET inputs for low drift and instant warm-up, plus a virtual absence of microphonics. All attenuation, which sets deflection factor, occurs prior to any active component—eliminating trace shift with range changes and also assuring constant bandwidth in excess of 50 MHz on all ranges. Internal triggering on the B channel signal assures time correlation between traces in either chopped or alternate operation.

Specifications

Modes of operation: Channel A alone; Channel B alone; Channels A and B displayed on alternate time bases; Channels A and B displayed by switching at approximately a 400 kHz rate, with blanking during switching; Channel A plus Channel B (algebraic addition).

Each channel:

Bandwidth: (direct or with probes 3 dB down from 8 cm 50 kHz reference signal) dc coupled, dc to 50 MHz; ac coupled, 2 Hz to 50 MHz.

Rise time: (direct or with probes) less than 7 ns with 8 cm input step.

Deflection factor (sensitivity): 0.005 V/cm to 20 V/cm in 12 ranges in a 1, 2, 5 sequence; accuracy $\pm 3\%$; vernier extends minimum sensitivity to 50 V/cm; a sensitivity calibration adjustment for each channel is provided on the front panel.

Input RC: 1 megohm shunted by approximately 25 pF.

Maximum input: 600 V peak ac coupled; dc coupled, 150 V at 5 mV/cm increasing to 350 V at 20 V/cm.

Polarity presentation: + or - up, selectable.

A + B Input:

Amplifier: bandwidth and deflection factor remain unchanged; either Channel A or B may be inverted to

give A-B operation.

Differential Input (A-B): common mode rejection at least 40 dB at 5 mV/cm, 20 dB on other ranges for frequencies up to 1 MHz; common mode signal should not exceed an amplitude equivalent to 50 cm.

Triggering:

Mode: Channel A, B or A + B on the signal displayed. Chopped mode on the B channel. Alternate mode on either the B channel or the composite waveform.

Frequency: provides sufficient signal to the time base for triggering over the range of dc to 50 MHz with 0.5 cm pk-pk signal or more displayed on the CRT in all modes except CHOP; 100 kHz in CHOP.

Environmental:

Same as 180A/181A Oscilloscope main frame.

General:

Weight: net, 4 lbs (1,8 kg); shipping, 6½ lbs (3 kg).

Price: HP Model 1801A, \$650.

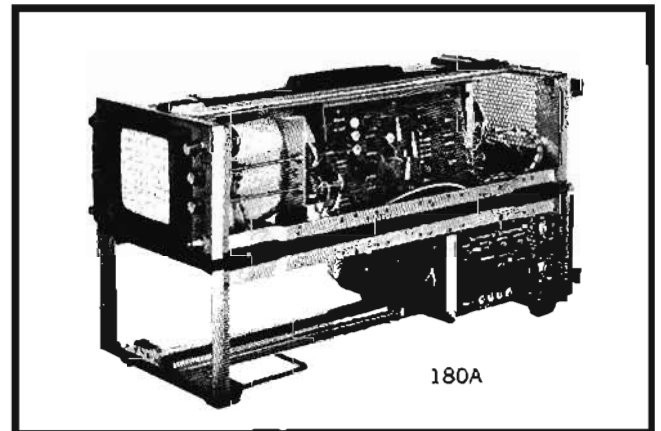

Aircraft frame construction of the 180A provides rugged support for the CRT, plug-ins and electrical components. Yet the scope with plug-ins weighs only 30 pounds.

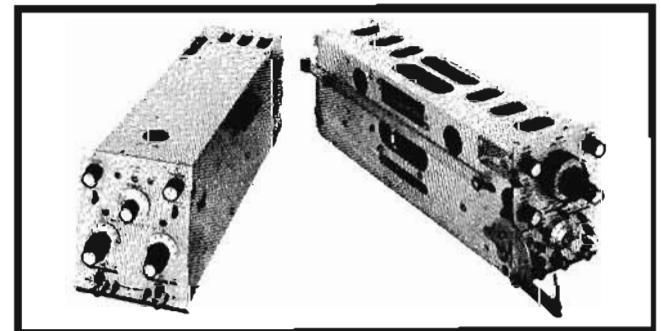

Unique plug-ins lock together for optimum performance

Vertical (left) and time base (right) are locked together and installed in the Model 180A/AR as a single unit. A level type lock used to secure the plug-ins in the mainframe also serves as a handle for removing and carrying the plug-ins. Mating the plug-ins together and using a single mainframe jack reduces lead length and improves overall performance.

OSCILLOSCOPES 180A SYSTEM *continued*

Differential comparator, 4-channel amplifier
Models 1803A, 1804A

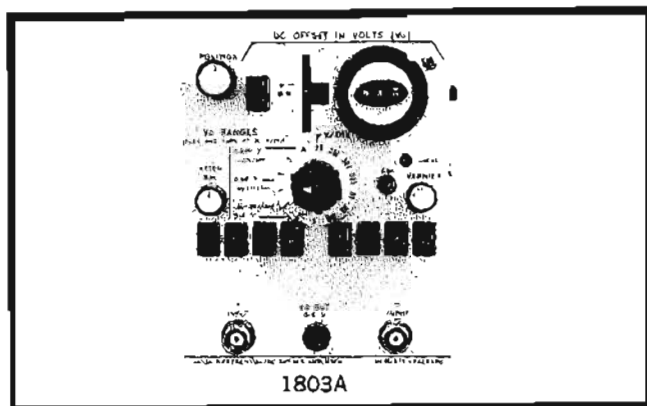

The Model 1803A Differential/DC Offset Amplifier uses the slide-back technique to achieve greater measurement accuracy. The plug-in generates a very stable, precise dc voltage which may be read to four-digit resolution. This voltage is then compared to the input signal. If the input signal is expanded to many screen diameters the dc offset permits any part of the input signal to be displayed on screen and measured accurately. Fool-proof, interlocked controls prevent unwanted offset changes as sensitivity is changed.

Used as a differential amplifier, the 1803A has high common-mode rejection and will withstand a 10 V common-mode signal on the most sensitive range of 1 mV/div. Even higher common-mode signals may be applied on the less sensitive ranges. Rugged construction and conservative design insures that full accuracy is maintained over the specified environmental extremes.

Specifications

Differential amplifier

Deflection factor: .001 V/div to 20 V/div, 14 ranges in a 1, 2, 5 sequence; accuracy $\pm 3\%$; vernier provides continuous adjustment between ranges and extends maximum deflection factor to approximately 50 V/cm.

Bandwidth: (direct or with probes, 3 dB down from an 8 div 50 kHz reference signal) dc to 40 MHz from .005 V/div to 20 V/div; dc to 30 MHz at .001 V/div and .002 V/div.

Rise time: (direct or with probes) less than 9 ns from .005 V/div to 20 V/div; less than 12 ns at .001 V/div and .002 V/div.

Input RC: 1 megohm $\pm 1\%$ shunted by approximately 27 pF.

Input coupling: dc; ac, limits low frequency 3 dB point to 2 Hz; gnd, disconnects input signal to provide zero volt reference trace; V_o , disconnects input signal and substitutes internal dc offset voltage.

Common mode rejection: greater than 86 dB from dc to 100 kHz, deflection factor .001 V/div for common mode signals up to 10 V peak-to-peak. Common mode rejection decreases with increasing frequency or deflection factor.

Recovery time: less than 1.0 μ s to return from overload condition to within ± 2 mV of final signal value for overload voltage up to 6 volts, .001 V/div to .02 V/div (± 20 mV from 60 volts, .05 to .2 V/div; ± 2 V from 600 volts, .5 to 20 V/div).

Maximum input: 600 V peak ac coupled; dc coupled, 600 V peak 0.1 V/div to 20 V/div, decreasing to 10 V peak at 1 mV/div.

Triggering: provides sufficient signal to the time base for triggering over the range of dc to 40 MHz with 0.5 div peak-to-peak signal or more displayed on the CRT.

V_o output: dc offset voltage is available at front panel, continuously variable from 0 to ± 0.006 V, ± 0.06 V, $\pm .6$ V, or ± 6 V. Accuracy of the ± 6 V range is $\pm 0.15\%$ of reading ± 8 mV, when loaded with 10 megohms or higher.

Environmental: same as 180A/181A oscilloscope.

DC offset amplifier

Offset range	Deflection factor	Comparison accuracy
0 to ± 6 V	.001 V/div to .02 V/div .05 V/div to .2 V/div .5 V/div to 2 V/div 5 V/div to 20 V/div	$\pm (0.15\% + 8 \text{ mV})$ $\pm (0.75\% + 8 \text{ mV})$ $\pm (1\%)$ $\pm (3\%)$
0 to ± 60 V	.01 V/div to 2 V/div .5 V/div to 2 V/div 5 V/div to 20 V/div	$\pm (0.4\% + 80 \text{ mV})$ $\pm (0.75\% + 80 \text{ mV})$ $\pm (3\%)$
0 to ± 600 V	.1 V/div to 2 V/div 5 V/div to 20 V/div	$\pm (0.65\% + 8 \text{ V})$ $\pm (3\%)$

Weight: net 4 lbs (1.8 kg); shipping 6½ lbs (3 kg)

Price: HP Model 1803A, \$950.

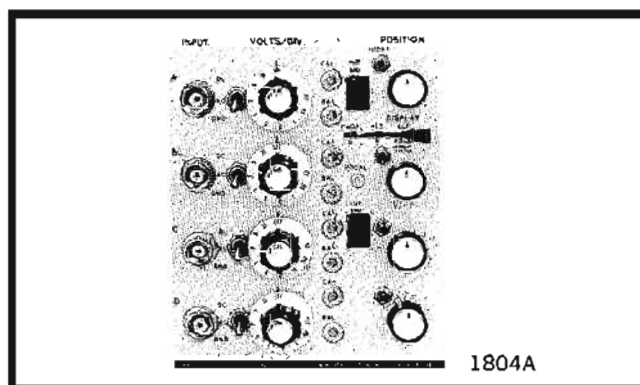

The 1804A Four Channel Amplifier permits the direct comparison of four signals simultaneously. Each of the four channels features 50 MHz bandwidth, 20 mV/div sensitivity. Ideal for logic circuit testing, the 1804A may be operated to trigger on each channel individually for asynchronous signals or for direct comparison of input/output pulses in spite of time delays. Or, the triggering may be set for one channel only for time correlation measurements. Unused channels may be turned off for uncluttered displays of three channels or less, and identifier buttons are provided for each channel.

Specifications

Mode of operation: any channel or combination of channels may be displayed. Channels may be displayed on alternate sweeps or by switching at approximately 500 kHz rate with blanking during switching.

Each channel

Bandwidth: (direct or with probes 3 dB down from an 8 cm, 50 kHz reference signal) dc coupled, dc to 50 MHz; ac coupled, 10 Hz to 50 MHz.

Rise time: (direct or with probes) less than 7 ns with an 8 cm input step.

Deflection factor: .02 V/div to 10 V/div; 9 ranges in a 1, 2, 5 sequence; attenuator accuracy $\pm 3\%$; vernier provides continuous adjustment between ranges and extends maximum deflection factor to approximately 25 volts/div.

Input RC: 1 megohm shunted by approximately 25 pF.

Maximum input: 400 V peak ac coupled; dc coupled, 150 V at 20 mV/div increasing to 350 V at 10 V/div.

Trace identification: button for each channel moves respective trace approximately ½ cm.

Polarity presentation: Channels A and C have + or - up, selectable.

Triggering: in chopped mode by Channel D. In alternate mode either by Channel D or by the composite signal. Any channel turned OFF will be skipped by sequential triggering.

Environmental: operating temperature, 0° to 55°C; other specifications same as 180A/181A oscilloscope.

Weight: net 4¾ lbs (2.1 kg); shipping 7¾ lbs (3.2 kg).

Price: HP Model 1804A, \$975.

OSCILLOSCOPES 180A SYSTEM *continued***Triggering to 100 MHz with variable hold-off**
Models 1820A, 1821A**Time base plug-ins**

The Model 1820A Time Base provides sweep speeds from 2 s/cm to 50 ns/cm, 5 ns/cm when using Model 180A/181A X10 horizontal amplifier magnifier. Positive triggering is assured to 100 MHz and a front panel trigger holdoff control locks in complex waveforms. Automatic triggering provides a bright baseline in the absence of an input signal, and syncs on the input waveform when a vertical input signal is applied.

Model 1821A Time Base and Delay Generator provides from 1 s/cm to 100 ns/cm, 10 ns/cm when using Model 180A/181A magnifier. It also features easy-to-use delayed sweeps. Exclusive Hewlett-Packard mixed sweep combines display of first portion of trace at normal sweep speeds, and simultaneously expands trailing portion of trace at faster delayed sweep speeds to allow magnified examination. Functional groupings of all controls simplifies operation. The internally generated delay trigger is available for external syncing.

Specifications, Model 1820A

Time base: 24 ranges, 0.05 μ sec/cm to 2 sec/cm in a 1, 2, 5 sequence; accuracy, $\pm 3\%$; vernier provides continuous adjustment between steps and extends slowest step to at least 5 sec/cm; horizontal magnifier expands fastest step to 5 nsec/cm.

Triggering:

Internal: see vertical amplifier plug-in.

External: dc to 50 MHz from signals 0.5 V pk-pk or more increasing to 1 V at 100 MHz.

Automatic: bright base line displayed in absence of input signal; internal, from 40 Hz, see vertical amplifier specification; external from 40 Hz on signals 0.5 V pk-pk or more to greater than 50 MHz, increasing to 1 V at 100 MHz.

Trigger point and slope: controls allow selection of level and positive or negative slope; trigger level on external sync signal adjustable over range of ± 3 V, ± 30 V in $\div 10$ position.

Coupling: ac, dc, acf, acs; ac attenuates signals below approx. 20 Hz; acf attenuates signals below approx. 15 kHz; acs attenuates signals above approx. 30 kHz.

Single sweep: front panel switch provides single sweep operation.

Variable trigger holdoff: permits variation of time between sweeps to allow triggering on asymmetrical pulse trains.

Weight: net, 2 $\frac{3}{4}$ lbs (1,3 kg); shipping, 5 $\frac{1}{4}$ lbs (2,4 kg).

Price: HP Model 1820A, \$475.

Specifications, Model 1821A**Main time base:**

Range: 22 ranges, 0.1 μ s/cm to 1 s/cm in 1, 2, 5 sequence; accuracy, $\pm 3\%$; vernier provides continuous adjustment between steps and extends slowest step to at least 2.5 s/cm; horizontal magnifier expands fastest step to 10 ns/cm.

Triggering:

Internal: see vertical amplifier plug-in.

External: dc to 50 MHz from signals 0.5 V pk-pk or more increasing to 1 V at 100 MHz.

Automatic: bright base line displayed in absence of an input signal; internal, from 40 Hz, see vertical amplifier specification; external, from 40 Hz on signals 0.5 V pk-pk or more to greater than 50 MHz increasing to 1 V at 100 MHz; and from line voltage.

Trigger point and slope: controls allow selection of level and positive and negative slope; trigger level on external sync signal adjustable over range of ± 3 volts, ± 30 V in $\div 10$ position.

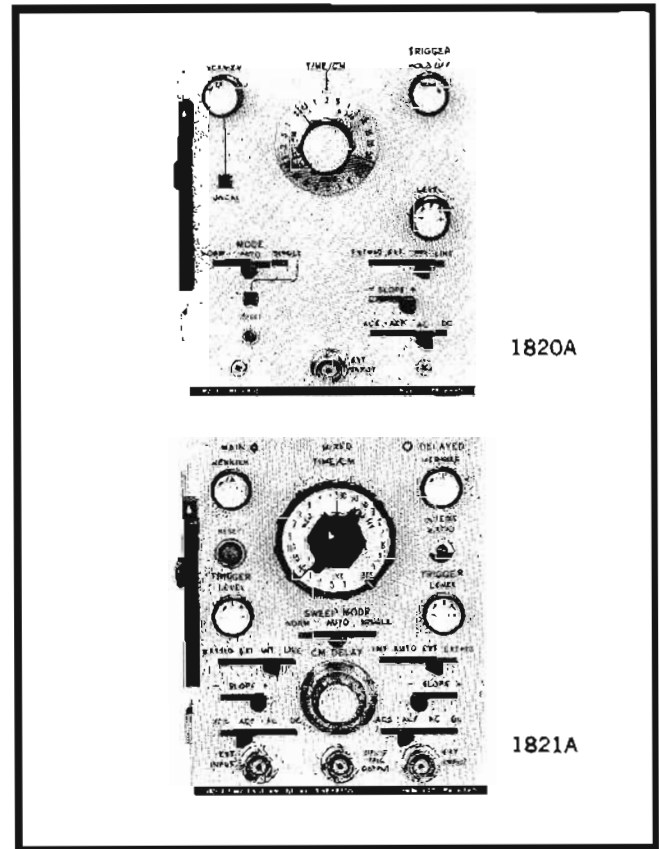

Coupling: ac, dc, acf, acs; ac attenuates signals below approx. 20 Hz; acf attenuates signals below approx. 15 kHz; acs attenuates signals above approx. 30 kHz.

Trace Intensification: used for setting up delayed or mixed time base; increases in brightness that part of main time base to be expanded full screen in delayed time base; rotating delayed time base switch from Off position activates intensified mode. Intensity ratio adjustment sets relative brightness of intensified segment.

Delayed time base: delayed time base sweeps after a time delay set by main time base and delay controls.

Range: 18 ranges, 0.1 μ s/cm to 50 ms/cm in 1, 2, 5 sequence; accuracy, $\pm 3\%$; vernier provides continuous adjustment between steps and extends slowest step to at least 125 ms/cm.

Triggering: applied to intensified Main, Delayed, and Mixed Time Base Modes.

Automatic: delayed time base starts at end of delayed period.

Internal, external, slope, level, and coupling: same as main time base triggering.

Delay (before start of delayed time base):

Time: continuously variable from 0.1 μ s to 10 s.

Accuracy: $\pm 1\%$; linearity, $\pm 0.2\%$; time jitter is less than 0.005% of maximum delay of each step (1 part in 20,000).

Trigger output: (at end of delay time) approximately 1.5 V with less than 50 ns rise time from 1 k ohm impedance.

Mixed time base: dual time base display in which main time base drives first portion of display and delayed sweep completes display at speeds up to 1000 times faster.

Single sweep: any display may be operated in single sweep.

Weight: net, 3 $\frac{3}{4}$ lbs (1,7 kg); shipping, 6 $\frac{1}{4}$ lbs (2,8 kg).

Price: HP Model 1821A, \$800.

OSCILLOSCOPES 180A SYSTEM *continued*

Accessories for convenient storage and transportation
Model 180A/181A accessories

Model 1118A testmobile

The HP Model 1118A Testmobile for the Cabinet Model 180A provides adjustable height from 32 to 42 inches, 360° rotation, and instrument tilt from +45° to -45°. The Model 1118A with its large 3-inch locking wheels adds to the "go anywhere" feature of the Model 180A. **Price: \$95.**

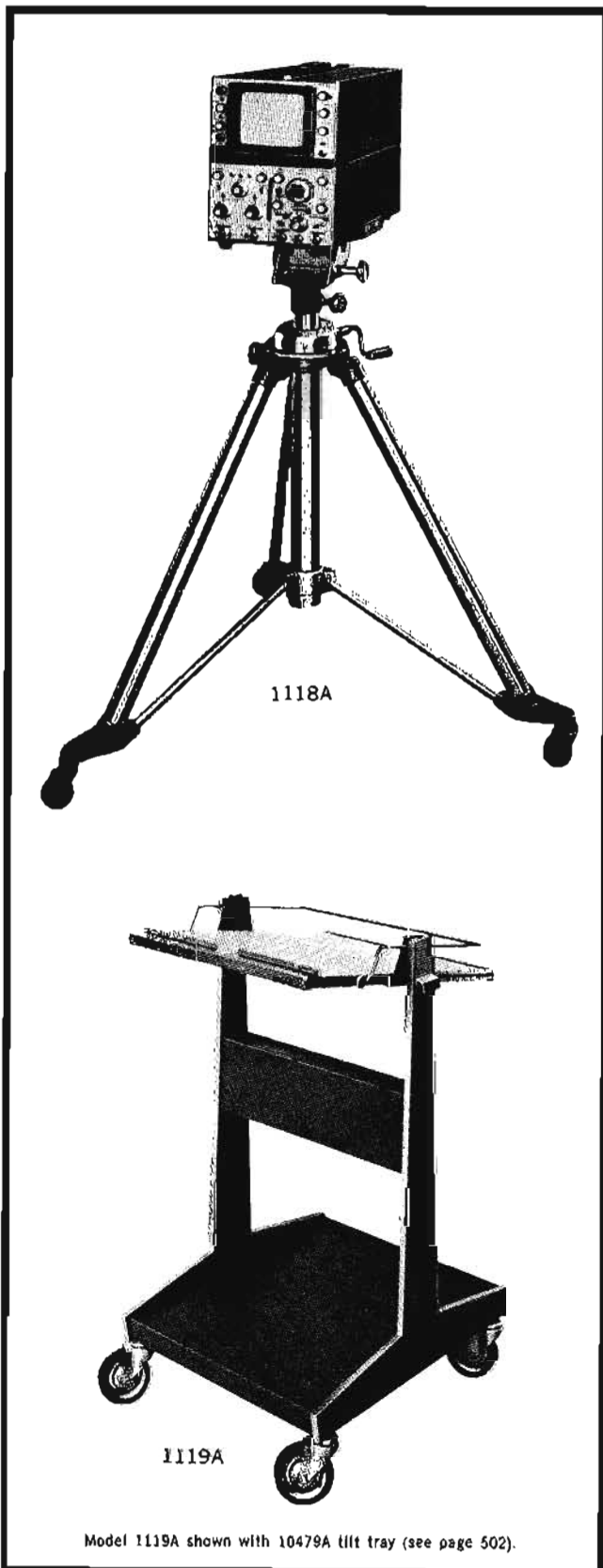

1118A



1119A

Model 1119A shown with 10479A tilt tray (see page 502).



10166A

Model 10166A panel cover

The HP Model 10166A Panel Cover, made of fiberglass material, provides protection to the front panel controls of the Model 180A. **Price: \$25.**

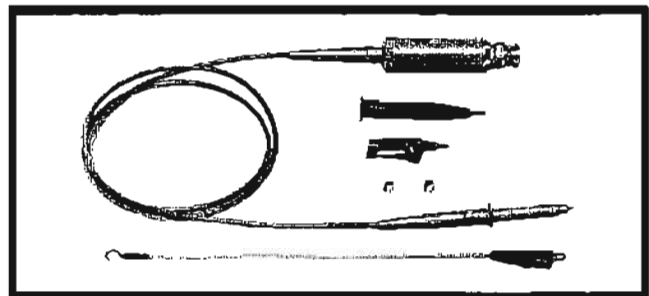
**Miniature probes**

The high impedance input of these probes reduces loading on the circuit under test, and provides attenuation for large signals. When used with a 180 system, full system bandwidth of 50 MHz is maintained with or without any of these probes. All probes have a division ratio to 10:1, ± 2 per cent. Impedance at the probe tip when used with a 180 system is 10 megohms paralleled by approximately 10 pF.

Price: 10004A Probe with 3½' cable \$35
10006A Probe with 6' cable \$40
10005A Probe with 10' cable \$45

OSCILLOSCOPES 180A SYSTEM *continued*

Accessories for convenient storage and transportation
Model 180A/181A accessories

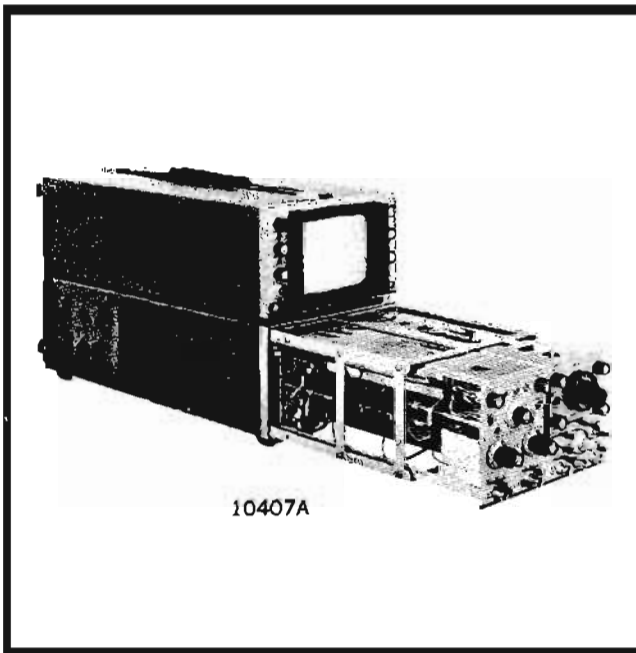

Model 10407A plug-in extender

The all solid-state plug-in concept of the 180A/181A system allows easy and convenient calibration and maintenance. The plug-ins can be removed from the mainframe thereby exposing all components and adjustments. The side covers all easily removed for access to the mainframe components.

The plug-in extender, HP Part No. 10407A, is available to allow calibration and maintenance of the plug-ins while the unit is operating. Price: 10407A, \$65.

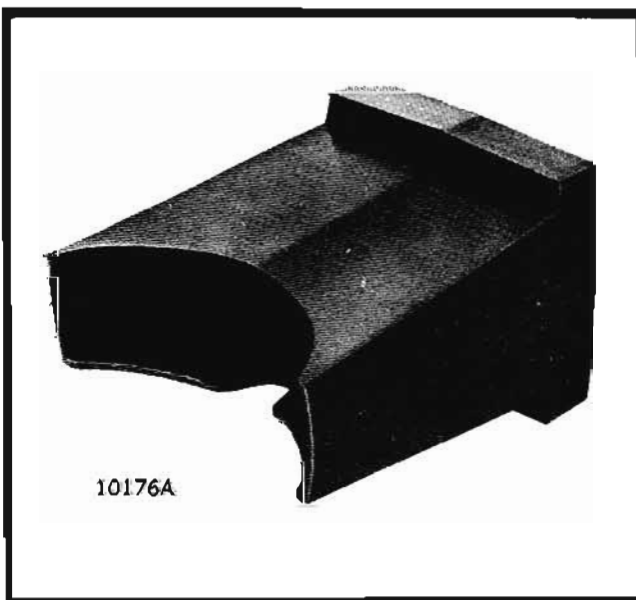

10176A viewing hood

The 10176A Viewing Hood is a face-fitting, vinyl mask to aid in viewing fast transients. Price: \$7.

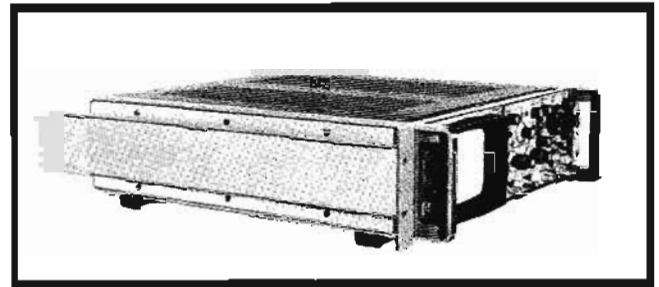

Slide adapter

Both fixed and pivoted 22-inch slides are available for slide mounting the 180AR/181AR. Price: 1490-0768 Slide Adapter (required for either slide), \$22.50; 1490-0714 Fixed Slides, \$32.50; 1490-0719 Pivoted Slides, \$37.50.

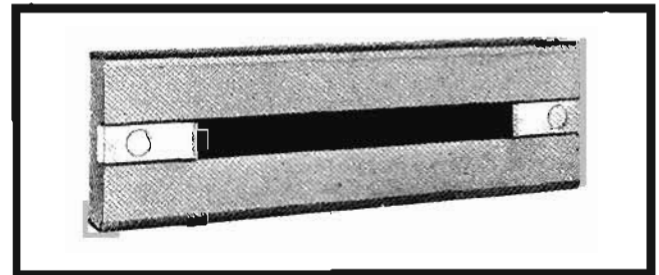

Cover

Cover for 180AR or 181AR protects panel from dust and accidental damage. May be used on the instrument whether rack mounted or when carried is a portable instrument. Price: 5060-0437, \$25.

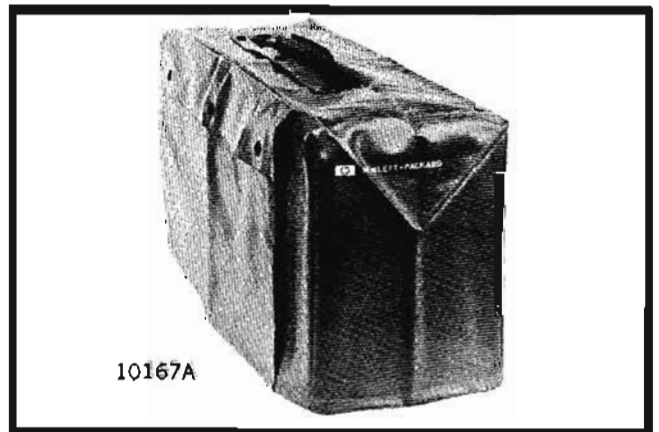

Model 10167A carrying cover

The HP Model 10167A Carrying Cover, made of flexible vinyl material, fits over the Cabinet Model 180A. The top of the cover is slotted for access to the carrying handle. Price: \$20.

Camera accessories

The HP Model 197A Camera fits the rectangular bezel of the Model 180A directly. See page 505 for accessories which adapt the HP Model 196A/B and the Tektronics C12 and C27 Oscilloscope Cameras to the Model 180A.

RUGGEDIZED OSCILLOSCOPE

Designed to meet military requirements
Model AN/USM-281 (180E)



OSCILLOSCOPES

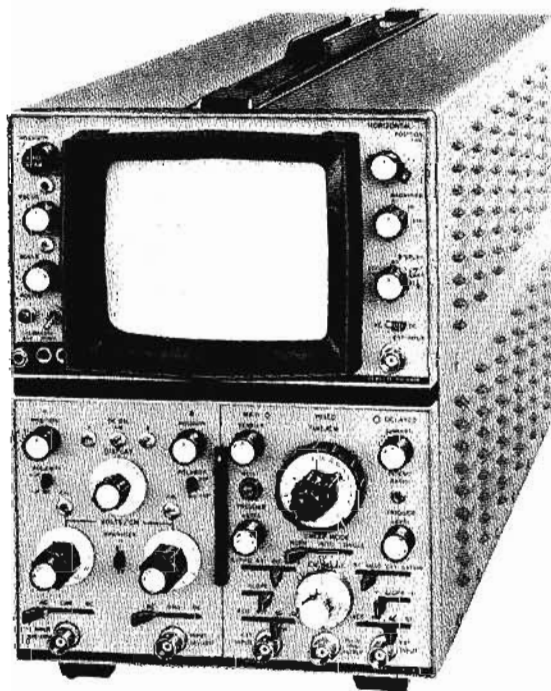

AN/USM-281 (180E)

Now the new HP 180E offers you the solution to an age-old problem; to provide a highly accurate, versatile, light-weight general-purpose oscilloscope which will meet the rigid requirements of military operations. The answer is on these pages—the 180E is fully specified for electrical performance as well as environmental performance.

In the past, the industrial or military user has had to sacrifice electrical performance in order to have an instrument rugged enough for field operation. No such sacrifice has been made in the 180E. Here are some of the features never before available in a militarized, high-frequency oscilloscope:

50 MHz bandwidth

No compromise. This specification is met under all environmental conditions, at any sensitivity range from 5 mV/cm to 20 V/cm, with or without the probe. For difficult measurements of low-level signals, a X5 magnifier is provided to achieve a sensitivity of 1 mV/cm with a bandwidth of 20 MHz.

Large screen display

The 8 x 10 cm screen offers double the viewing area previously available. The graticule is on the inside of the Cathode-ray Tube, in the same plane as the phosphor, which eliminates the inaccuracy caused by visual parallax. An accelerating potential of 12 kV provides an exceptionally bright trace for easy viewing of fast, random pulses without the need for a viewing hood. Phosphor burning has been virtually eliminated extending the usable life of the CRT.

All solid state

Accurate measurements can be made within 15 seconds after turn-on. Power consumption is less than 110 watts, permitting use

on heavily loaded power lines. There is no fan. No brushes or bearings to wear out or clog in sand and dust. The 180E will operate on power line frequencies from 50 to 1000 Hz without adapters or converters. It makes no noise, so can be operated near microphones or listening devices.

Lightweight, small size

The 35-pound package can be carried anywhere by one man. The small size of the 180E means it can be operated on the bench or next to the device under test. No need for clumsy carts or long cables. (But if a cart is desired even the cart can be carried around—the 1118A Testmobile weighs only 11 pounds.) The 180ER occupies only 5¼ inches of valuable rack space allowing smaller, lighter consoles.

Foolproof operation

The 180E is designed to cut test time and minimize errors. At turn-on, if all knobs are pointed up and all switches centered, a trace will be on screen. An HP-developed Beam Finder button brings the beam on screen regardless of the setting position, intensity, sweep or trigger controls. A unique delayed sweep interlock prohibits unusable sweep settings, and makes delayed sweep measurements easier than using a magnifier, yet with far greater accuracy. Whether for commercial or military use, the 180E is unexcelled in performance. Both the vertical and horizontal amplifiers are plug-in, and fully interchangeable with plug-ins for the HP 180A Oscilloscope.

RUGGEDIZED OSCILLOSCOPE *continued*

Designed to meet military requirements
Model AN/USM-281 (180E)

The complete system, including 180E main frame, 1801E vertical amplifier plug-in, 1821E time base plug-in, and the 10164A front panel cover, may be ordered through a government contract only as the AN/USM 281. Price, \$3,100. The system is also available under Federal Stock Number 6625-053-3112. Alternatively, the individual items may be ordered by HP Model Number. Use the cross reference below.

Description	MIL designation	HP Model No	Price
Portable system with PL-1186, PL-1187, CW-946	AN/USM-281	—	\$3,100
Rack-mount system with PL-1186, PL-1187	AN/USM-296	—	2,925
Portable oscilloscope	OS-189 (P)/USM-281	180E	1,215
Rack-mount oscilloscope	OS-194 (P)/USM-296	180ER	1,205
Dual channel vertical amplifier	PL-1186	1801E	800
Time base and delay generator	PL-1187	1821E	920
Time base	PL-1213	1820E	570
Panel covers with probes and accessories	CW-946/USM-281	10164A	165*

*If other probes than those normally supplied are desired, order 10164A Option 01 and subtract \$65. Then select appropriate probes as separate items.

Environmental specifications

(Refer to 180A for electrical specifications.)

Temperature operating -28°C to $+65^{\circ}\text{C}$

The instrument shall be operated at the maximum temperature for at least 16 hours. A complete performance test shall be made at the end of this heat run.

The instrument shall be allowed to stabilize at least 1 hour at the minimum temperature with the power off. It shall then be turned on and a complete performance test performed after a 30-minute warm-up.

Temperature nonoperating -62°C to $+85^{\circ}\text{C}$

The instrument, nonoperating, is placed in the test chamber. The chamber is reduced to the minimum temperature and held for at least 72 hours. It is then raised to room ambient and a complete performance test performed after a 30-minute warm-up. The procedure is repeated with the test chamber held at the maximum temperature for at least 48 hours.

Humidity/temperature -28°C to $+65^{\circ}\text{C}$ at humidities to 95%

In order to comply with a greater number of military specifications, two different temperature/humidity tests were conducted. In test No. 1, instrument was operating throughout test, and performance tests made at various temperatures from -28°C to $+65^{\circ}\text{C}$ with the humidity constant at 95% (except uncontrolled at temperatures below -5°C) for cycle 1 and repeated for 4 additional 33 hour cycles at humidities of 90%, 75%, 50% and 25%. In test No. 2 instrument nonoperating except during test period at end of each of ten 24 hour cycles (no dry out period) consisting of subjecting the instrument to temperatures from -20°C to $+65^{\circ}\text{C}$ at a constant humidity of 95%.

Altitude operating 25,000 feet

The instrument operating shall be subjected to a pressure of 11.1 inches of mercury (temperature and humidity uncontrolled) for at least 1 hour. A performance test shall be conducted at this pressure. The pressure, with the instrument still operating, shall be increased

to normal ground. At the completion of this test the instrument shall pass a complete performance test.

Altitude nonoperating 50,000 feet

The instrument, nonoperating, shall be subjected to a pressure of 3.4 inches of mercury (temperature and humidity uncontrolled) for at least 1 hour.

The pressure shall then be increased to normal ground and the instrument shall pass a complete performance test.

Vibration 5 to 55 Hz

Instrument shall be subjected to vibration as follows, for at least 5 minutes at each frequency. If a resonant frequency is found, the instrument shall be vibrated at that frequency for at least 2 hours.

Frequency	Amplitude
5-14 Hz	0.060 D.A.
15-25 Hz	0.040 D.A.
26-55 Hz	0.020 D.A.

Repeat in all three planes, and at the conclusion of the test conduct a complete performance test.

Shock

AN/USM 281 (180E)

Passed MIL-S-901C Grade A; No. 400 hammer at 1-, 3-, and 5-foot drops in 3 planes.

180ER (rack version)

10 Gs for 11 ± 1 milliseconds to each of the 6 sides method as per MIL-E-4970A Procedure II (sandbox).

Both models

Each edge raised 15° or $4''$, whichever is greater, from solid table top and dropped. Four drops per edge.

At the conclusion of the shock test the instrument shall pass a complete performance test.

EMC MIL-1-16910C and MIL-1-6181D

Tests were conducted according to two military specifications MIL-1-16910C class 1 and MIL-1-6181D. Both specifications were met completely. In keeping with the requirements of these specifications the following conditions apply. No input signal applied, oscilloscope in CHOP mode, intensity bright and RFI filter on face of CRT.

Reliability (MTBF) 5000 hrs (MIL HDBK 217)

5 oscilloscopes were randomly selected from finished stock and given a complete evaluation. All instruments were then cycled 6 hrs. on, 2 hrs. off. Every 24 hrs. four of the oscilloscopes were given a performance check and the fifth one a complete evaluation (instrument receiving complete evaluation was rotated each day). When each instrument had accumulated 1000 hrs. of operating time the test was terminated, with each instrument receiving a complete evaluation. One random failure was noted during the test. The 100-volt regulator in one oscilloscope failed to fire when turned on at low line. Normal line operation was satisfactory. No recalibration was allowed during any part of the test. Using this information (5000 total hrs. and 1 failure) and referring to MIL HDBK 217, the MTBR is 5000 hrs.

Line voltage and frequency variation

115 V/230 V $\pm 10\%$ at 50-1000 Hz.

Power consumption—less than 110 watts with plug-ins.

Package drop

20 Gs (22 milliseconds duration) on each of eight corners.

38 Gs (22 ms duration) on bottom.

OSCILLOSCOPES



TESTMOBILES

Store, transport test equipment conveniently

Models 1116A, 1119A, 1117B

Hewlett-Packard Testmobiles provide easy, convenient portability of test equipment to multiple test locations. These testmobiles can also be equipped to provide extra storage space for equipment and accessories which will increase test-bench working area.

Model 1116A Testmobile

The Model 1116A is the basic, inexpensive testmobile. Its instrument rack can be tilted from horizontal to 30° above horizontal in four steps. The standard-equipment open wire basket can be used to hold bulky accessory equipment. This testmobile can also be folded for easy transportation to the test site or for more convenient storage.

Dimensions: 40" high, 20" wide, 24" deep (1016 x 508 x 610 mm).

Weight: net, 34 lbs (15,3 kg); shipping, 42 lbs (18,9 kg).

Price: Model 1116A Testmobile, \$95.

Model 1119A Testmobile

The Model 1119A Testmobile, for standard Hewlett-Packard modular instruments, has a unique trunnion mounting that allows the instrument to be rotated a full 360°. The dented tilt positions are located at 10° intervals. Instruments larger than ten inches from pivot point to corner can be tilted ±40° from the horizon.

When working with non-modular equipment, a Model 10479A Tilt Tray can be mounted on the testmobile.

For more storage space, the Model 10480A cabinet can be quickly mounted in place of the lateral brace. This cabinet has adequate space for plug-ins and small instruments. The cabinet also is equipped with a 1 5/8" drawer for cables and accessories.

Dimensions: 38" high, 19 1/4" wide, 23 1/2" deep (965 x 489 x 597 mm).

Weight: net, 42 lbs (19,1 kg); shipping, 50 lbs (22,5 kg).

Price: Model 1119A Testmobile, \$110.

Model 10480A Storage Cabinet

Dimensions: 11 1/4" high, 18 1/4" wide, 15" deep (286 x 464 x 381 mm).

Weight: net, 19 1/2 lbs (8,9 kg); shipping, 22 1/2 lbs (10 kg).

Price: Model 10480A Storage Cabinet, \$35.

Model 10479A Tilt Tray

For use with instruments other than standard Hewlett-Packard modular size.

Dimensions: 17 1/4" wide, 23" deep.

Weight: net, 12 lbs (5,5 kg); shipping, 15 lbs (6,8 kg).

Price: Model 10479A Tilt Tray, \$35.

Model 1117B Testmobile

The Model 1117B Testmobile can be equipped as a complete, portable test center. The top instrument tray can be tilted from 15° below to 30° above the horizontal in 7 1/2° steps. The front or rear frame can accommodate standard 19 inch RETMA rack panels so that any necessary equipment can be carried with the testmobile. In addition, HP Combining Cases or Rack Adapter Frames may be mounted on the testmobile to accommodate any sub-modular components.

Central power distribution to the instruments is provided by four standard NEMA plugs on the back panel.

Two storage drawers are also separately available—a three inch drawer for small accessories; and an eight inch drawer for bulky items such as plug-ins. Both drawers can be removed or repositioned at the option of the user.

Dimensions: 39" high, 20" wide, 24" deep (991 x 508 x 610 mm).

Weight: net, 85 lbs (38,3 kg); shipping, 117 lbs (52,7 kg).

Price: Model 1117B Testmobile (without drawers), \$185.

Model 10475A 3-inch Drawer

Weight: net, 9 lbs (4,1 kg); shipping, 13 lbs (5,9 kg).

Price: Model 10475A, \$30.

Model 10476A 8-inch Drawer

Weight: net, 11 lbs (5 kg); shipping, 25 lbs (11,3 kg).

Price: Model 10476A, \$35.

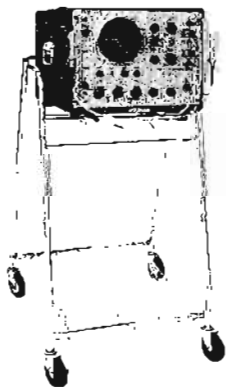

1116A



1119A



1117B

ACCESSORIES



OSCILLOSCOPES

Voltage divider probes

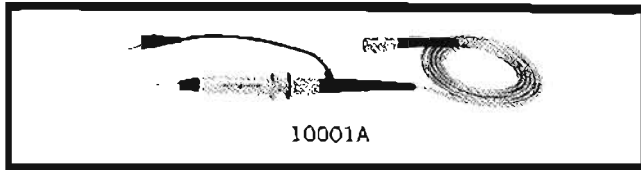

10001A

HP Probe	Atten.	Bandwidth (0.5 dB) MHz	Resist- ance (meg- ohms)	Capaci- tance	Div. accu- racy	Peak input volts	Approx. overall length ft. (cm)	Approx. rise time
10001A or C*	10:1	dc to 30	10	10 pF	2%	600	5 (152)	5 nsec
10001B or D*	10:1	dc to 30	10	20 pF	2%	600	10 (305)	5 nsec
10002A or C*	50:1	dc to 30	9	2.5 pF	3%	1000	5 (152)	5 nsec
10002B or D*	50:1	dc to 30	9	5 pF	3%	1000	10 (305)	5 nsec
10003A or B*	10:1	dc to 40	10	10 pF	2%	600	4 (122)	3 nsec

*These probes have black identification boots; the others have red boots.

The high impedance input of these probes reduces loading of oscilloscopes on the circuit under test, and the probes provide attenuation for large signals. The probes may be quickly and accurately compensated for optimum step response.

Price:

Models 10001A, C and 10003A, \$30.

Models 10001B, D and 10003B, \$35.

Models 10002A, B, C, and D, \$40.

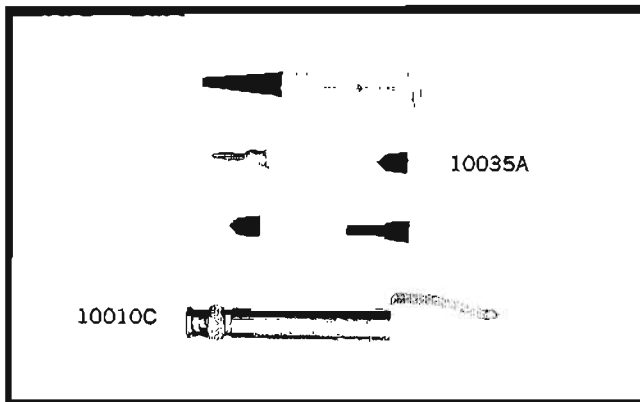

10010C

10035A

The Model 10035A Probe Kit and the Model 10010C BNC Tip provide maximum versatility when used with the voltage divider probe. The kit contains a pincer jaw, banana tip, pin tip, hook tip and spring tip; price: Probe Kit, \$5; BNC Tip, \$10.

Straight-through voltage probe

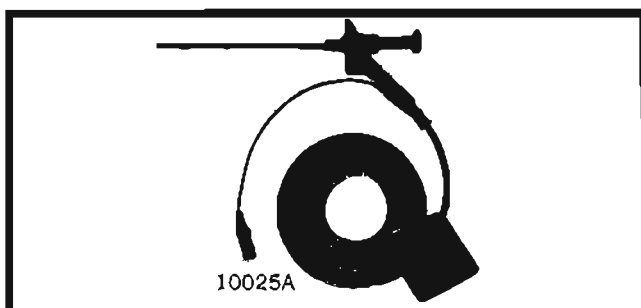

10025A

The HP Model 10025A is a thin, flexible probe with small, pushbutton pincer jaws which provides a straight-through connection to voltmeters, ohmmeters and oscilloscopes. Maximum input voltage is 600 volts peak, and the shunt capacity is approximately 150 picofarads. The cable is terminated in a shielded dual banana plug; price, \$15.

High quality cables

Specifically designed for high-frequency pulse applications, the HP Model 10120 - Series 50-ohm coaxial cables insure faithful transmission of fast rise signals. Mismatch loss is reduced to a minimum by using close tolerance (1%) 50-ohm cable and high quality connectors. Long life and good flexibility are assured by enclosing the low-density polyethylene dielectric in a single-braided shield with a tough vinyl jacket.

Cable specifications

HP Model	Length	Description	Price
10120A	3' (91 cm)	male BNC-to-male BNC	\$10
10121A	8" (203 mm)	male BNC-to-male BNC	\$10
10122A	3' (91 mm)	male BNC-to-male Type N	\$10
10123A	6' (183 cm)	male BNC-to-male BNC	\$11
10124A	9' (274 cm)	male BNC-to-male BNC	\$12
10126A	18' (549 cm)	male BNC-to-male BNC	\$13
10127A	1' (305 mm)	GR-to-male BNC	\$16
10128A	1' (305 mm)	GR-to-female BNC	\$16

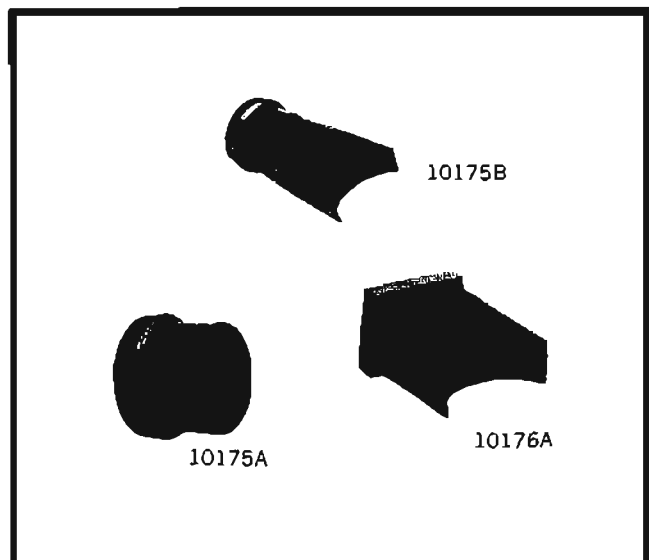

10175B

10175A

10176A

The Model 10175A polarized hood increases contrast and reduces glare for viewing dim traces under all ambient light conditions; price, \$15.

The Model 10175B hood with removable vinyl face mask is ideal for viewing fast transients; price, \$15.

The Model 10176A flexible viewing hood is designed for use on the HP rectangular bezels; price, \$7.



OSCILLOSCOPE CAMERA

Permanent records of oscilloscope traces
Model 197A

The Model 197A Oscilloscope Camera provides an accurate, convenient way of recording oscilloscope displays. It is a precision instrument, meant for long, hard use.

The Model 197A employs a new electronic shutter which provides accurate exposure times from 1/30 to 4 s. The shutter may be tripped electrically from a remote source, and a sync output provides a contact closure when the shutter is opened, allowing synchronizing of other equipment with the camera. Circuitry is all solid-state.

The new $f/1.9$ lens, designed for Hewlett-Packard by Wollensak, is mounted in a direct line with the film and transmits a maximum amount of light for photography of dim traces.

An ultra-violet light is included in the Model 197A for illuminating the internal graticule used on HP oscilloscopes. The "black" light, adjustable in intensity to suit conditions, excites the phosphor on the tube face and causes it to photograph an intermediate gray. The gray background clearly distinguishes the thin black graticule lines by contrast. Trace intensity is not degraded by this induced fluorescence, and the resulting photographs are actually easier to read, since the black graticule lines also contrast clearly with the trace, and their exact crossings can be accurately located. This black light has the additional advantage of presensitizing the film at the same time that the photograph is taken. The uniform glow of the CRT face lowers the apparent threshold sensitivity of the film, enabling it to record dimmer traces and making possible clear, sharp photographs of both repetitive and single sweep phenomena (see Figure 1). In addition to continuously adjustable ultraviolet intensity, the Model 197A also provides a "flash" feature which automatically turns the UV on and off. The "flash" permits recording of slow single-shot events and complete graticule information in a single exposure. In other cameras a double exposure is usually required.

All Model 197A controls are located outside the camera. Shutter speed, f -stop, and UV light brightness are color coded to provide an optimum starting point for the inexperienced photographer. The lightweight Model 197A is

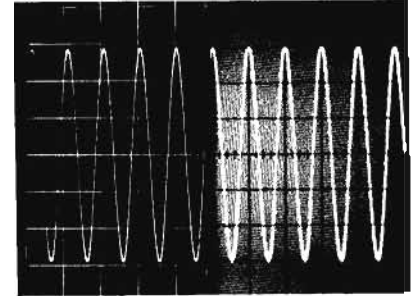
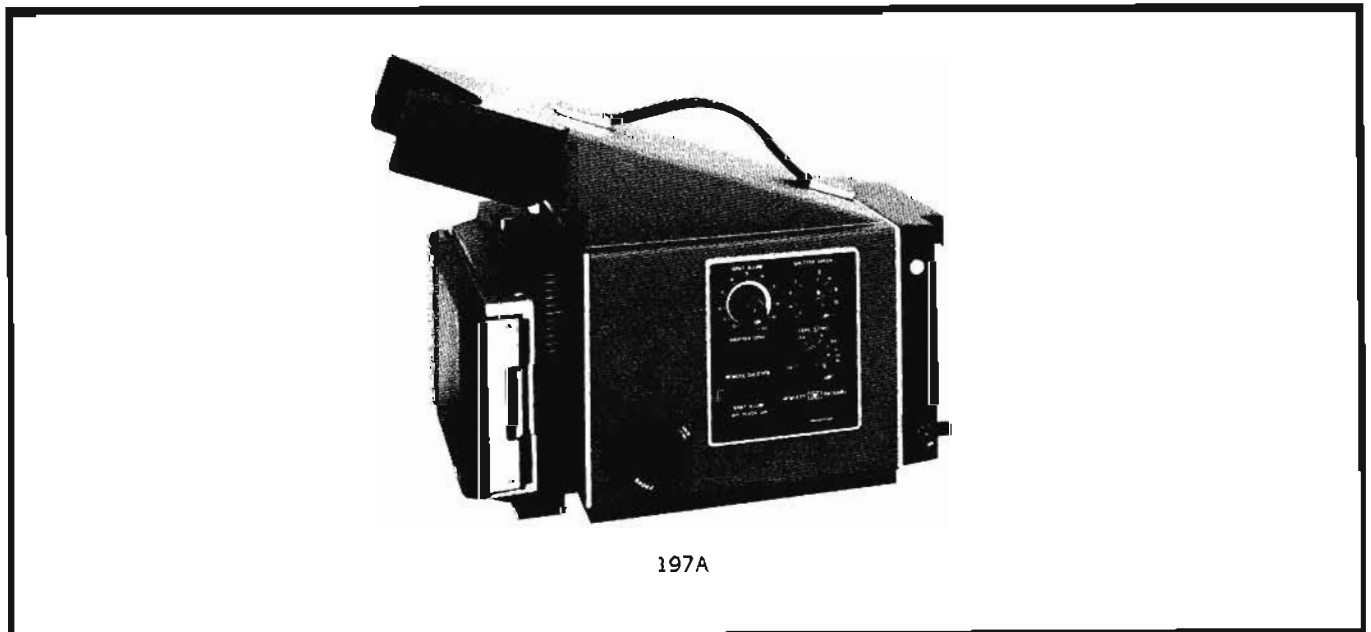

Figure 1. "Half-and-half" photo made with special cathode ray tube compares photographic qualities of conventional external graticule (left) and UV-illuminated internal graticule.

quickly and easily mounted on any oscilloscope, and swings away from the CRT face when not needed. The face-fitting, flexible hood has a low viewing angle for accurate alignment of the trace with an external graticule. The hood may be removed and replaced with a flat panel, allowing a series of cameras to be mounted on stacked oscilloscopes with heights as low as 7 inches.

The Model 197A back may be rotated from the normal horizontal position to a vertical position, allowing two smaller pictures to be taken on one photograph. The back also can be moved through 11 detented positions for multiple exposures (see Figure 2) or it can be removed and replaced with a 4 x 5 inch Graflok® back. The entire film area of the back may be utilized through the use of the Model 197A's easily adjustable continuous reduction ratio feature. The camera may then be quickly refocused with a simple knob adjustment, using the furnished split image focusing plate stored in the camera.



197A

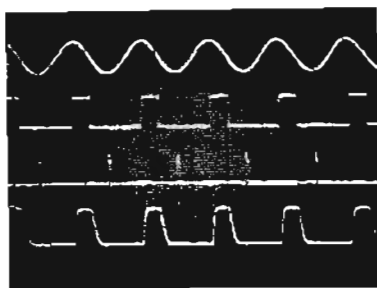

Figure 2. Multiple exposure photographs are easily made with the Model 197A Camera.

Specifications

Reduction ratio: continuously adjustable from 1:1 to 1:0.7; reference scale provided on focus plate.

Lens: 75 mm, $f/1.9$ high transmission lens, manufactured exclusively for HP by Wollensak; aperture ranges $f/1.9$ to $f/16$; optional 88 mm $f/1.4$ OscilloRaptar lens available.

Shutter: electronically operated and timed shutter, with all solid-state circuitry; shutter speeds are 1/30, 1/15, 1/8, 1/4, 1/2, 1, 2, 4 s, Time and Bulb; shutter has a sync contact closure output for triggering external equipment and input jack for remote operation.

Camera back: Polaroid® Land Camera using pack film Type 107 supplied; Graflok® back available (see Options); backs

may be interchanged without refocusing and may be rotated in 90-degree increments.

Mounting: quick lift on-off mounting with positive lock; swing away to left.

Viewing: low-angle, direct viewing flexible face mask; hood may be removed and replaced with panel to allow stacking on 7-inch high oscilloscopes (see Accessories Available).

Multiple exposure: back moves vertically through 11 detented positions at 1/2 cm per detent at 1:0.9 object-to-image ratio. **Focus:** adjustable focusing with lock; split image focusing plate provided.

Dimensions: 14" long, 10 1/2" high, 7 3/8" wide (356 x 267 x 194 mm) with hood; 12" long, 6 1/2" high, 7 3/8" wide (305 x 165 x 194 mm) without hood.

Weight: net 10 lbs (4,5 kg); shipping 19 lbs (8,6 kg).

Power: 115 V \pm 10%, 50 to 1000 Hz, 6 W.

Accessories furnished: combination split image focusing plate and reduction ratio scale.

Price: HP Model 197A, \$540.

Option 01: without ultraviolet light, deduct \$50.

Option 02: $f/1.4$ lens, add \$270.

Option 03: Graflok back in place of Polaroid back; no charge.

Option 12: modified for 230 V operation; no charge.

"Polaroid"® by Polaroid Corp.

"Graflok"® by Graflex, Inc.

Camera Backs



10352A



10353A

The Model 197A is supplied with a Polaroid® Pack Film back as standard or a 4 x 5 Graflok® back as Option 03. These backs can also be ordered separately. Polaroid back Model 10353A, \$85; Graflok back Model 10352A, \$85.

Accessories available

Carrying Case



10358A

The Model 10358A carrying case is a sturdy fiber-glass and aluminum construction with foam padding to provide maximum protection for the Model 197A in transit or storage, \$65.

Oscilloscope Bezel Adapters



10355A



10356A



10357A



10360A



10361A



10362A

The Model 197A fits all HP oscilloscopes and can easily be fitted to other types by means of bezel adapters. Model 10355A adapts to Tektronix and Fairchild 5-inch round bezels, \$15. Model 10356A adapts to Tektronix 560 Series rectangular bezels, \$15. Model 10357A adapts to Tektronix 640 Series rectangular bezels, \$15. The Model 10360A adapts the Model 196A/B camera to the HP rectangular bezel, \$15. The Model 10361A adapts the Tektronix C12 camera to the HP rectangular bezel, \$15. The Model 10362A adapts the Tektronix C27 camera to the HP rectangular bezel, \$15.

Other accessories

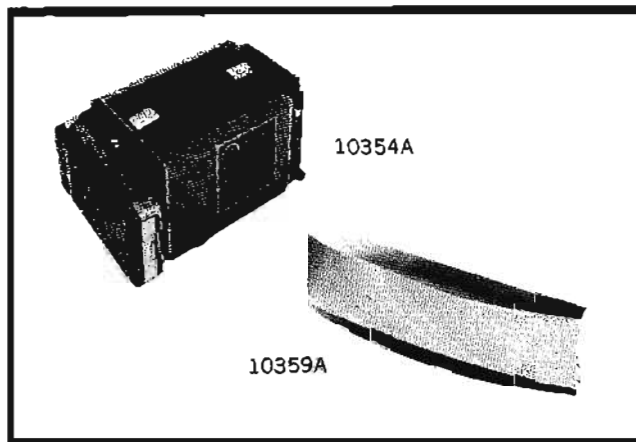

10354A

10359A

Model 10354A Viewing Hood Replacement Plate is used in place of the Model 197A viewing hood and permits camera mounting on stacked oscilloscopes with heights as low as 7 inches, \$7.

The Model 10359A Viewing Lens is a ground plastic lens which fits inside the viewing hood for easy trace viewing by those with farsighted vision, \$25.



OSCILLOSCOPE CAMERA

Convenient pictures of oscilloscope traces

Model 196A/B

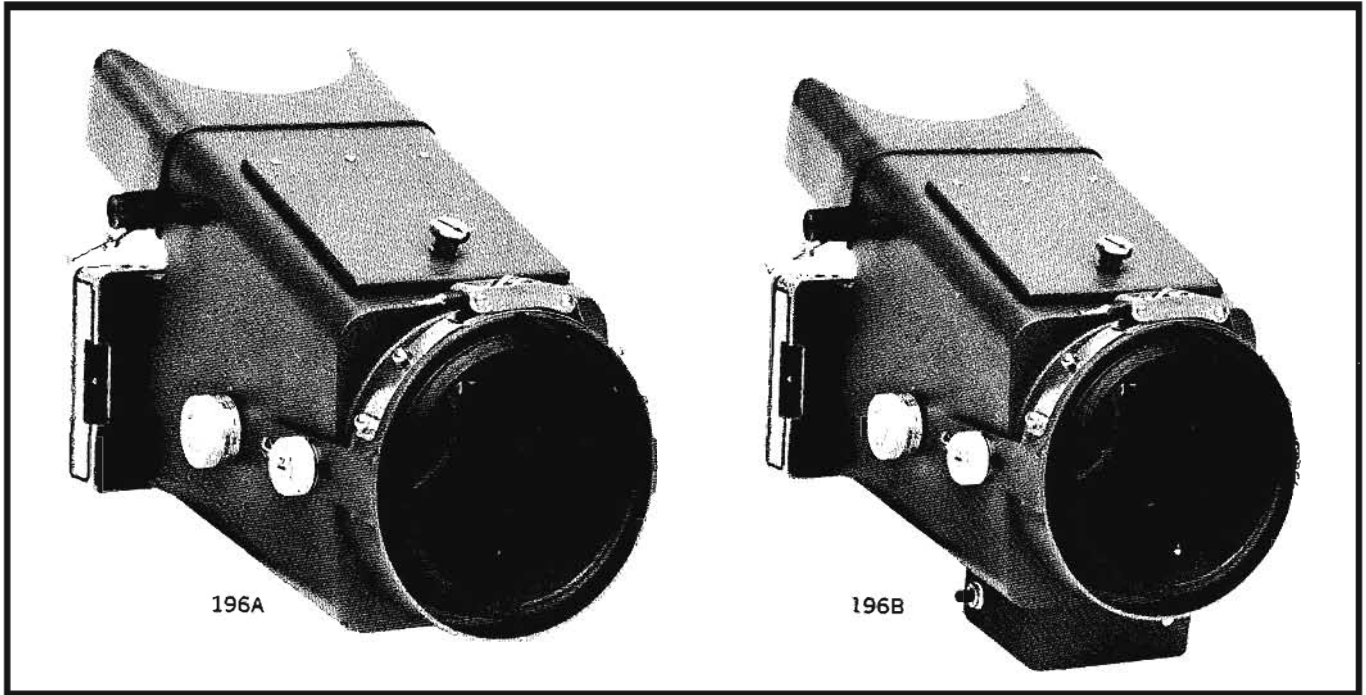

Description

The 196A/B provides a quick, convenient way for recording oscilloscope displays. The only difference between the 196A and 196B is that the 196B has an ultraviolet light source for illuminating internal graticules and the 196A doesn't. The 196A, therefore, doesn't require line power for operation.

A forward access port allows adjustment of shutter speed and diaphragm with the camera mounted on the oscilloscope. The lens may be adjusted vertically through 11 detented positions using an external knob, allowing multiple photos to be easily made. A quick-connect clamp offers speedy, reliable mounting to the oscilloscope.

Object to image ratio is preadjusted at the factory to 1:0.9 for optimum photos for most applications. The $f/1.9$ lens which is specifically designed for oscilloscope photography has extremely low distortion, which means accurate measurements can be made from the photographs.

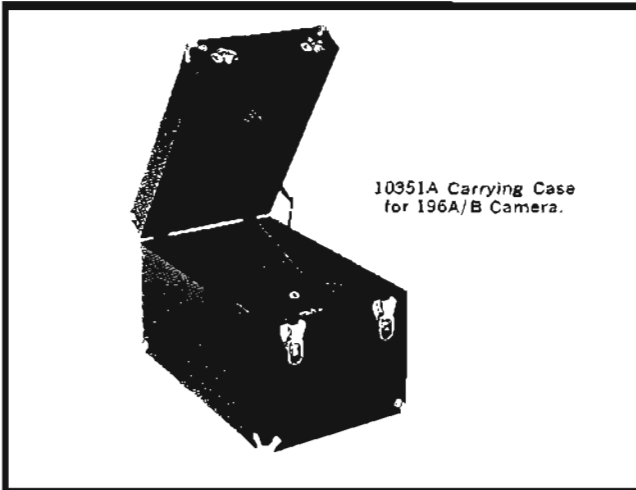

10351A Carrying Case
for 196A/B Camera.

Specifications, Model 196A/B

Object-to-image-ratio: 1 to 0.9; 1 to 1 optional.

Lens: 75 mm, $f/1.9$ high-resolution lens.

Focus: adjustable; factory-set for optimum resolution of both trace and graticule.

Lens opening: $f/1.9$ to $f/16$.

Shutter: speed and f -stop settings are completely visible and adjustable from access port; shutter speeds are: 1/50, 1/25, 1/10, 1/5, 1/2, 1 sec., Time, Bulb (solenoid operation on special order).

Print size: $3\frac{1}{4}'' \times 4\frac{1}{4}''$ (83 x 108 mm).

Image size: $2\frac{7}{8}'' \times 3\text{-}13/16''$ (73 x 96 mm).

Film: Polaroid® Land Film Packs, Type 107, 3000 speed.

Dimensions: 10" wide, $13\frac{1}{2}''$ long, $10\frac{1}{4}''$ high, (254 x 343 x 262 mm).

Weight: net, 9 lbs (4,1 kg); shipping, 18 lbs (8,1 kg); 32 lbs (14,9 kg) with carrying case.

Power: Model 196B, 115 V $\pm 10\%$, 60 Hz, 10 W.

Accessories available: Model 10351A Carrying Case, \$40; Model 10355A Tektronix Adapter, \$15.

Price: HP Model 196B, \$475; HP Model 196A (identical with Model 196B, but without black light source), \$425.

Special order: 1:1 object-to-image-ratio, add \$25; and order C01-196A for Model 196A, C06-196B for Model 196B.

Conversion kits: 196A-95C, converts "A" to "B"; price, \$50; 196A-95D, same as above but with Option 12; price, \$65.

Option 12: Model 196B for 115 or 230 V $\pm 10\%$, 50 to 60 Hz operation, add \$15.

PRODUCT CATEGORY INDEX



DC POWER SUPPLIES

Bench supplies

Bench Series small laboratory supplies	output	0-25 V, 0-400 mA	0-25 V, 0-400 mA	0-50 V, 0-200 mA	0-50 V, 0-200 mA							518, 519	
	model	6215A	6216A	6217A	6218A								
LAB Series laboratory supplies	output	0-7.5 V 0-3 A	0-20 V, 0-0.6 A 0-40 V, 0-0.3 A	0-20 V, 0-0.6 A 0-40 V, 0-0.3 A	0-20 V, 0-1.5 A	0-20 V, 0-1.5 A	0-30 V, 0-1 A 0-60 V, 0-0.5 A	0-40 V, 0-0.75 A	0-160 V, 0-0.2 A	0-320 V, 0-0.1 A			520, 521
	model	6203B	6204B	(dual)6205B	6201B	6200B	6206B	6202B	6207B	6209B			
HVB Series high voltage	output	0-1600 V 0-5 mA	0-3000 V 0-6 mA										522
	model	6515A	6516A										
MPM Series medium power modular	output	0-24 V, 0-3 A	0-25 V, 0-1.5 A 0-50 V, 0-75 A	0-50 V 0-1.5 A									523
	model	6224B	6220B	6226B									
MPB-3, MPB-6 Series medium power	output	0-7.5 V 0-5 A	0-10 V, 0-10 A	0-20 V, 0-3 A	0-20 V, 0-5 A	0-20 V, 0-10 A	0-40 V, 0-1.5 A	0-40 V, 0-3 A	0-40 V, 0-5 A	0-60 V, 0-1 A	0-60 V, 0-3 A	0-100 V, 0-750 mA	524, 525
	model	6281A	6282A	6284A	6285A	6286A	6290A	6291A	6294A	6296A	6299A		
STB Series high stability laboratory supplies	output	0-20 V, 0-1 A	0-40 V, 0-0.5 A	0-100 V, 0-200 mA	0-3000 V, 0-5 mA	0-10 V, 0-2 A							526, 527
	model	6101A, 6111A	6102A, 6112A	6106A, 6116A	6110A	6113A							
CCB Series constant current	output	0-50 V 0-750 mA	0-100 V 0-300 mA	0-300 V 0-100 mA									528, 529
	model	6177A	6181A	6186A									
Medium voltage multiple output	output	0-500 V, 0-0.1 A and 12.6/6.3 V ac		0-500 V, 0-0.2 A; -300 V, 0.05 A; 0 to -150 V, .005 A; 12.6/6.3 V ac									542
	model	711A		712B									

Rack supplies

DRP Series dual power	output	0-20 V, 0-3 A	0-40 V, 0-1.5 A										524, 255
	model	6253A	6255A										
LVA Series low voltage	output	0-10 V, 0-100 A	0-18 V, 0-10 A	0-18 V, 0-20 A	0-36 V, 0-3 A	0-36 V, 0-5 A	0-36 V, 0-10 A	0-40 V, 0-30 A	0-40 V, 0-50 A	0-60 V, 0-3 A	0-60 V, 0-15 A	532, 533	
	model	6260A	6263A	6264A	6265A	6266A	6267A	6268A	6269A	6271B	6274A		
MVA Series medium voltage	output	0-320 V 0-800 mA	0-320 V 0-1.5 A										534
	model	890A	895A										
HVA Series high voltage	output	0-1000 V 0-200 mA	0-2000 V 0-100 mA	0-4000 V 0-50 mA									534
	model	6521A	6522A	6525A									
SCR-1P Series	output	0-20 V, 0-15 A	0-20 V, 0-45 A	0-36 V, 0-10 A	0-40 V, 0-25 A	0-60 V, 0-5 A	0-60 V, 0-15 A	0-120 V, 0-2.5 A	0-600 V, 0-1.5 A				535
	model	6427B	6428B	6433B	6434B	6438B	6439B	6443B	6448B				
SCR-3 Series	output	0-15 V, 0-200 A	0-36 V, 0-100 A	0-64 V, 0-50 A									536
	model	6453A	6456B	6459A									
SCR-10 Series	output	0-4 V, 0-200 A	0-8 V, 0-1000 A	0-16 V, 0-600 A 0-18 V, 0-500 A	0-36 V, 0-300 A	0-64 V, 0-150 A	0-110 V, 0-100 A	0-220 V, 0-50 A	0-300 V, 0-35 A	0-440 V, 0-25 A 0-500 V, 0-20 A 0-600 V, 0-15 A			537
	model	6463A	6464A	6466A	6469A	6472A	6475A	6477A	6479A	6483B			

Special products

Digital voltage source	output	0-±15 V, ±1 A										514, 515	
	model	6130A											
PS/A Series dc power supply and amplifier	output	power supply	-20 V to +20 V, 0-0.5 A				-50 V to +50 V, 0-1 A						517
	model	amplifier	40 V p-p, 0-0.5 A				100 V p-p, 0-1 A						
ICB Series low voltage rack, for integrated circuits	output	4-5.5 V, 0-8 A	0-7.5 V, 0-15 A	0-7.5 V, 0-30 A	0-7.5 V, 0-60 A	0-7.5 V, 0-120 A						530, 531	
	model	6384A	6385A	6386A	6387A	6388A							
*MOD Series modular plug-in power supplies	output	0-18 V, 0-300 mA	0-18 V, 0-1 A	0-36 V, 0-150 mA	0-36 V, 0-500 mA	0-160 V, 0-400 mA	0-320 V, 0-200 mA						538, 539
	model	6343A	6344A	6346A	6347A	6354A	6357A						
SLOT Series fixed output modules	output	6 V, 0-3.5 A	12 V, 0-1 A	12 V, 0-2.2 A	±15 V, ±10%, 0-0.75 A	24 V, 0-1 A	28 V, 0-1.5 A						540, 541
	model	60065A	60123A	60125A	60155C	60244A	60285A						
Strain gage supply	output	0-25 V, 0-0.2 A										542	
	model	801C											
Klystron power supplies	output	0 to -900 V, -250 to -400 V, 6.0 V ac				0 to -800 V, -250 to -800 V, 6.3 V dc						543	
	model	715A				716B							

*These supplies can also be rack mounted. Refer to pages indicated for details.

DC POWER SUPPLIES



SELECTION GUIDE

The following is a step-by-step procedure which, when used with the Condensed Listing on the following pages and the Definitions on pages 512 and 513 will be helpful in choosing the right power supply.

(1) Determine dc output voltage rating

A dc voltage requirement is often expressed as a nominal rating, but power supplies are rated in terms of maximum output under worst operating conditions. For example, if the dc voltage required is nominally 32 volts, adjustable $\pm 10\%$, a 36 volt supply (not 32 volts) should be obtained, provided operation is actually desired at 110% of nominal (39.2 volts). This can be important if "marginal checking" of a system or a load circuit is to be accomplished by varying the dc power supply feeding it.

(2) Determine dc output current rating

The output current rating of a power supply must be selected on the basis of the peak current requirement, not the average current requirement; this results from the fact that the current limiting protection circuitry internal to the supply is extremely fast in order to protect the series power transistors. The current limit circuit is normally adjustable to between 105 and 110% of the nominal current rating of the power supply. If inverse current loading is involved, the power supply must have a current rating equal to or greater than the sum of peak current delivered and peak current absorbed.

(3) Consult condensed listing

Enter the Condensed Listing at the voltage rating found from (1). Supplies above this point are eliminated from consideration because of insufficient output voltage. Many supplies below this point are also eliminated because of a current rating too small compared with (2). If the desired output voltage-current combination does not appear in the Condensed Listing, consider series and parallel combinations of power supplies; Hewlett-Packard's Auto-Series and Auto-Parallel feature permits one knob control and equal voltage and current sharing.

(4) Constant voltage and/or constant current output

Most applications require constant voltage power supplies. However, some load devices require a constant current source of dc power. Still other applications (e.g. battery charging and electrolytic capacitor forming) call for supplies which have automatic crossover between constant voltage and constant current operation.

If the requirement involves constant current performance, then the Condensed Listing should be used to determine which supplies remaining from (3) are capable of

constant current operation. Remember that all Remote Programming constant voltage supplies can also be converted to constant current use with one external resistor.

(5) Specifications for load regulation, line regulation, ripple and transient response

Generally speaking, a Hewlett-Packard power supply employs one of two basic circuit techniques — (1) a transistor regulator, or (2) an SCR regulator. (In the case of high power output rating, the transistor regulator is preceded by an SCR preregulator.) All low output power supplies use circuit technique (1), since this results in both lower cost and better performance. Either circuit technique (1) or (2) may be utilized in a supply of moderate output power capability. Power supplies of very high output power employ circuit technique (2).

These two circuit techniques result in distinctly different performance characteristics — particularly with regard to regulation, ripple and transient response.

Specification	Transistor Regulated
Load Regulation	0.001% to 0.05%
Line Regulation	0.001% to 0.05%
Ripple and Noise	50 μ v to 1 mv
Transient Response	Less than 50 μ sec.

Specification	SCR Regulated
Load Regulation	0.1% to 1%
Line Regulation	0.1% to 1%
Ripple and Noise	0.1% to 1%
Transient Response	Less than 50-200 msec.

(6) Is remote programming required?

If it is desired to control the output of the power supply remotely using switched or variable values of resistance, or if the supply is to be controlled by means of a voltage input, then look on the Condensed Listing for those power supplies with a check under "Remote Programming."

(7) Physical configuration

Power supplies are available in three basic packages — rack mounting (standard 19" RETMA), bench, and modular. For high output ratings, rack mounting is the only practical configuration. All supplies which are not normally rack mounting are easily adapted to rack applications using standard hardware available from Hewlett-Packard. Reference to the appropriate catalog pages will indicate the nature and cost of this rack mounting adapting hardware.

(8) Miscellaneous requirements

Depending on the particular application, check also for remote error sensing, permissible values of input line voltage and frequency, front and/or rear output terminals, meters, etc. Many of these miscellaneous requirements can be checked directly on the Condensed Listing. In other cases it will be necessary to refer to the more de-

tailed information on the catalog pages referenced by the Condensed Listing.

A spec sheet can be obtained from any Hewlett-Packard sales office.

Power supply Series designations

Series designations identify groupings of Hewlett-Packard power supplies that have similar circuit techniques and operating characteristics.

The model numbers assigned to each Series can be determined from the Product Category Index on page 507.

Note that each multiple letter Series designation (1) suggests the general type of power supply in a given category and (2) indicates (in the third letter) the nature of the power supply case and its "normal" mode of installation. A final "B" indicates Bench supplies and a final "R" applies to units which are Rack mounted. Absence of a "B" or an "R" as the final letter means that the supplies have not been designed primarily for either Bench or Rack use, or that the series includes both full rack width and half rack width instruments.

Notice that these designations are not part of the model number. They do not appear on the instrument and should not be used when ordering.

Series	Description
BENCH	Small Laboratory Bench
CCB	Constant-Current, Bench
DPR	Dual Power Rack
HVB	High Voltage Bench
HVR	High Voltage Rack
ICS	Low Voltage for Integrated Circuits
LAB	Laboratory Bench
LVR	Low Voltage Rack
MOD	Plug-In Modular
MPB-3	3½"-High Medium Power Bench
MPB-5	5½"-High Medium Power Bench
MPM	Medium Power Modular
MVR	Medium Voltage Rack
PS/A	Power Supply/Amplifier
SCR-1P	Primary SCR Regulated, Output Ratings — 300 and 900 Watts
SCR-3	SCR Regulated, Output Ratings up to 3 KW
SCR-10	SCR Regulated, Output Ratings up to 10 KW
SLOT	Fixed Output Modules
STB	High Stability Supply/Calibrator

Further information on power supplies can be found in Application Note 90, Power Supply Handbook, available from your local Hewlett-Packard Sales Office.

CONDENSED LISTING



DC POWER SUPPLIES

Output (volts)	Output (amperes)	Model	Series	Catalog page	Load regulation (mV)	Line regulation (mV)	RMS ripple & noise (mV)	Input line voltage (Vac)	Input line frequency	Remote programming	Bench or Rack*	CV/CC**	Price
0-4	0-2000	6463A	SCR-10	537	50 mV combined		280	3 ϕ 208/220/460 \pm 10%	57-63	\checkmark	R	\checkmark	\$3500
4-5.5	0-8	6384A	ICS	530, 531	1 mV	1 mV	1 mV	115 \pm 10%	48-63		B		220
6 \pm 10%	0-3	60065A	SLOT	540, 541	0.05%	0.05%	1 mV	115 \pm 10%	48-440		R		See pg 540
0-7.5	0-3	6203B	LAB	520, 521	5 mV	3 mV	0.2	115 \pm 10%	50-400	\checkmark	B	\checkmark	169
0-7.5	0-5	6281A	MPB-3	524, 525	5 mV	2 mV +0.01%	0.2	115 \pm 10%	50-400	\checkmark	B	\checkmark	210
0-7.5	0-15	6385A	ICS	530, 531	1 mV	1 mV	1 mV	115 \pm 10%	48-63	\checkmark	R	\checkmark	500
0-7.5	0-30	6386A	ICS	530, 531	1 mV	1 mV	1 mV	115 \pm 10%	48-63	\checkmark	R	\checkmark	700
0-7.5	0-60	6387A	ICS	530, 531	1 mV	1 mV	1 mV	115 \pm 10%	48-63	\checkmark	R	\checkmark	900
0-7.5	0-120	6388A	ICS	530, 531	1 mV	1 mV	1 mV	230 \pm 10%	48-63	\checkmark	R	\checkmark	1125
0-8	0-1000	6464A	SCR-10	537	25 mV combined		80	3 ϕ 208/230/460 \pm 10%	57-63	\checkmark	R	\checkmark	3300
0-10	0-2	6113A	STB	526, 527	0.001% +1.1 mV	0.001%	0.04	115 \pm 10%	48-63	\checkmark	B		375
0-10	0-10	6282A	MPB-5	524, 525	1 mV +0.01%	1 mV +0.01%	0.5	105-125	50-60	\checkmark	B	\checkmark	350
0-10	0-100	6260A	LVR	532, 533	200 μ V +0.01%	200 μ V +0.01%	1.0	230 \pm 10%	48-63	\checkmark	R	\checkmark	775
12 \pm 10%	0-1	60123A	SLOT	540, 541	0.05%	0.05%	1 mV	115 \pm 10%	48-440		R		See pg 540
12 \pm 10%	0-2.2	60125A	SLOT	540, 541	0.05%	0.05%	1 mV	115 \pm 10%	48-440		R		See pg 540
\pm 15 \pm 10%	0-0.75	60155C	SLOT	540, 541	0.03%	0.01%	0.3	115 \pm 10%	48-440		R		See pg 541
0-15	0-200	6453A	SCR-3	536	10 mV +0.2% combined		150	3 ϕ 208/230/460 \pm 10%	57-63	\checkmark	R	\checkmark	1375
0-16 or 0-18	0-600 or 0-500	6466A	SCR-10	537	10 mV +0.2% combined		160 or 180	3 ϕ 208/230/460 \pm 10%	57-63	\checkmark	R	\checkmark	2600
0-18	0-0.3	6343A	MOD	538, 539	3 mV or 0.03%	3 mV or 0.03%	1.0	115 \pm 10%	48-440	\checkmark	R		120
0-18	0-1	6344A	MOD	538, 539	3 mV or 0.03%	3 mV or 0.03%	1.0	115 \pm 10%	48-63	\checkmark	R		165
0-18	0-10	6263A	LVR	532, 533	200 μ V +0.01%	200 μ V +0.01%	0.5	115 Vac \pm 10%	48-63	\checkmark	R	\checkmark	435
0-18	0-20	6264A	LVR	532, 533	200 μ V +0.01%	200 μ V +0.01%	0.5	115 Vac \pm 10%	48-63	\checkmark	R	\checkmark	525
-20 to +20	0-0.5	6823A	PS/A	517	5 mV +0.02%	5 mV +0.02%	2	115 \pm 10%	50-440	\checkmark	B	\checkmark	194
0-20	0-0.6	6204B	LAB	520, 521	4 mV +0.01%	4 mV +0.01%	0.2	115 \pm 10%	50-400	\checkmark	B		144
0-20 and 0-40	0-0.6 and 0-0.3	6205B	LAB	520, 521	4 mV +0.01%	4 mV +0.01%	0.2	115 \pm 10%	50-440	\checkmark	B	\checkmark	235
0-20	0-1	6101A	STB	526, 527	600 μ V +0.001%	0.001%	0.04	115 \pm 10%	48-63	\checkmark	B		265
0-20	0-1	6111A	STB	526, 527	600 μ V +0.001%	0.001%	0.04	115 \pm 10%	48-63	\checkmark	B		375
0-20	0-1.5	6200B	LAB	520, 521	4 mV +0.01%	4 mV +0.01%	0.2	115 \pm 10%	50-400	\checkmark	B	\checkmark	189
0-20	0-1.5	6201B	LAB	520, 521	4 mV +0.01%	4 mV +0.01%	0.2	115 \pm 10%	50-400	\checkmark	B	\checkmark	169
0-20 Dual	0-3	6253A	DPR	524, 525	4 mV +0.01%	2 mV +0.01%	0.2	115 \pm 10%	50-400	\checkmark	R	\checkmark	445
0-20	0-3	6284A	MPB-3	524, 525	4 mV +0.01%	2 mV +0.01%	0.2	115 \pm 10%	50-400	\checkmark	B	\checkmark	210
0-20	0-5	6285A	MPB-5	524, 525	1 mV +0.01%	1 mV +0.01%	0.5	105-125	50-60	\checkmark	B	\checkmark	350
0-20	0-10	6286A	MPB-5	524, 525	1 mV +0.01%	1 mV +0.01%	0.5	105-125	50-60	\checkmark	B	\checkmark	395
0-20	0-15	6427B	SCR-1P	535	20 mV	10 mV	40	105-125	57-63	\checkmark	R	\checkmark	380

*"B" indicates bench type and "R" indicates full rack width type supplies. All bench supplies (except Models 721A, 711A, 712B and 715A) can be rack mounted using accessory rack mounting hardware.

**Automatic crossover between constant voltage (cv) and constant current (cc) operation.

additional listings on next page

CONDENSED LISTING *continued*

Output (volts)	Output (amperes)	Model	Series	Catalog page	Load regulation (mV)	Line regulation (mV)	RMS ripple & noise (mV)	Input line voltage (Vac)	Input line frequency	Remote programming	Bench or Rank*	CY/CC**	Price
0-20	0-45	6428B	SCR-1P	535	40 mV	20 mV	40	115 ± 10%	57-63	✓	R	✓	\$ 550
24 ± 10%	0-1	60244A	SLOT	540, 541	0.05%	0.05%	1 mV	115 ± 10%	48-440		R		See pg 540
0-24	0-3	6224B	MPM	523	.01% + 4 mV	.01% + 2 mV	0.2	115 ± 10%	50-60	✓	B	✓	325
0-25	0-0.2	801C	—	542	2 mV	2 mV	0.1	105 - 125	55-65		R		149
0-25	0-0.4	6215A	BENCH	518, 519	.01% + 1 mV	.01% + 4 mV	0.2	115 ± 10%	50-400		B		90
0-25	0-0.4	6216A	BENCH	518, 519	.01% + 1 mV	.01% + 4 mV	0.2	115 ± 10%	50-400		B	✓	115
0-25	0-1	6220B	MPM	523	.01% + 2 mV	.01% + 2 mV	0.2	115 ± 10%	50-400	✓	B	✓	250
28 ± 10%	0-1.5	60285A	SLOT	540, 541	0.05%	0.05%	1 mV	115 ± 10%	48-400		R		See pg 540
0-30	0-0.15	721A	—	—	30 mV	± 15 mV	0.15	115/230 ± 10%	50-60		B		145
0-30	0-1	6206B	LAB	520, 521	4 mV + 0.01%	4 mV + 0.01%	0.2	115 ± 10%	50-400	✓	B		169
0-36	0-0.15	6346A	MOD	538, 539	3 mV or 0.02%	3 mV or 0.02%	1.0	115 ± 10%	48-440	✓	R		120
0-36	0-0.5	6347A	MOD	538, 539	3 mV or 0.02%	3 mV or 0.02%	1.0	115 ± 10%	48-63	✓	R		165
0-36	0-3	6265A	LVR	532, 533	200 μV + 0.01%	200 μV + 0.01%	0.5	115 Vac ± 10%	48-63	✓	R	✓	350
0-36	0-5	6266A	LVR	532, 533	200 μV + 0.01%	200 μV + 0.01%	0.5	115 Vac ± 10%	48-63	✓	R	✓	435
0-36	0-10	6433B	SCR-1P	535	36 mV	18 mV	36	115 ± 10%	57-63	✓	R	✓	370
0-36	0-10	6267A	LVR	532, 533	200 μV + 0.01%	200 μV + 0.01%	0.5	115 Vac ± 10%	48-63	✓	R	✓	525
0-36	0-100	6456B	SCR-3	536	10 mV + 0.2% combined		160	3 ^φ 208/230/460 ± 10%	57-63	✓	R	✓	1276
0-36	0-300	6469A	SCR-10	537	10 mV + 0.2% combined		180	3 ^φ 208/230/460 ± 10%	57-63	✓	R	✓	2300
0-40	0-0.3	6204B	LAB	520, 521	4 mV + 0.01%	4 mV + 0.01%	0.2	115 ± 10%	50-400	✓	B		144
0-40 and 0-20	0-0.3 and 0-0.6	6205B	LAB	520, 521	4 mV + 0.01%	4 mV + 0.01%	0.2	115 ± 10%	50-440	✓	B	✓	235
0-40	0-0.5	6102A	STB	526, 527	350 μV + 0.001%	0.001%	0.04	115 ± 10%	48-63	✓	B		265
0-40	0-0.5	6112A	STB	526, 527	350 μV + 0.001%	0.001%	0.04	115 ± 10%	48-63	✓	B		375
0-40	0-0.75	6200B	LAB	520, 521	4 mV + 0.01%	4 mV + 0.01%	0.2	115 ± 10%	50-400	✓	B	✓	189
0-40	0-0.75	6202B	LAB	520, 521	4 mV + 0.01%	4 mV + 0.01%	0.2	115 ± 10%	50-400	✓	B	✓	169
0-40	Dual 0-1.5	6255A	DPR	524, 525	2 mV + 0.01%	2 mV + 0.01%	0.2	115 ± 10%	50-400	✓	R	✓	445
0-40	0-1.5	6289A	MPB-3	524, 525	2 mV + 0.01%	2 mV + 0.01%	0.2	115 ± 10%	50-400	✓	B	✓	210
0-40	0-3	6290A	MPB-5	524, 525	1 mV + 0.01%	1 mV + 0.01%	0.5	105 - 125	50-60	✓	B	✓	350
0-40	0-5	6291A	MPB-5	524, 525	1 mV + 0.01%	1 mV + 0.01%	0.5	115 ± 10%	50-60	✓	B	✓	395
0-40	0-25	6434B	SCR-1P	535	40 mV	18 mV	40	115 ± 10%	57-63	✓	R	✓	550
0-40	0-30	6268A	LVR	532, 533	200 μV + 0.01%	200 μV + 0.01%	1	230 ± 10%	48-63	✓	R	✓	695
0-40	0-50	6269A	LVR	532, 533	200 μV + 0.01%	200 μV + 0.01%	0.5	230 ± 10%	48-63	✓	R	✓	875
-50 to +50	0-1	6824A	PS/A	517	5 mV + 0.02%	5 mV + 0.02%	10	115 ± 10%	50-60	✓	B	✓	350
0 = 50	± 1	6130A	DVS	514, 515	.01%	.01%	1 mV	115 ± 10%	60	✓	B		1500
0-50	0-0.2	6217A	BENCH	518, 519	.01% + 1 mV	.01% + 4 mV	0.2	115 ± 10%	50-400		B		90
0-50	0-0.2	6218A	BENCH	518, 519	.01% + 1 mV	.01% + 4 mV	0.2	115 ± 10%	50-400		B	✓	115
0-50	0-0.75	6177A	CCB	528, 529	0.0015%	0.001%	0.075 mA	115 ± 10%	48-63	✓	B		425
0-50	0-0.75	6220B	MPM	523	4 mV + .01%	4 mV + .01%	0.2	115 ± 10%	50-400	✓	B	✓	259
0-50	0-1.5	6226B	MPM	523	2 mV + .01%	2 mV + .01%	0.2	115 ± 10%	50-60	✓	B	✓	325
0-60	0-0.5	6206B	LAB	520, 521	4 mV + 0.01%	4 mV + 0.01%	0.2	115 ± 10%	50-400	✓	B		169

additional listings on next page

Output (volts)	Output (amperes)	Model	Series	Catalog page	Load regulation (mV)	Line regulation (mV)	RMS ripple & noise (mV)	Input line voltage (Vac)	Input line frequency	Remote programming	Bench or Rack*	CY/CC**	Price
0-60	0-1	6294A	MPB-3	524, 525	2 mV + 0.01%	2 mV + 0.01%	0.2	115 ± 10%	50-400	✓	B	✓	\$210
0-60	0-3	6296A	MPB-5	524, 525	1 mV + 0.01%	1 mV + 0.01%	0.5	105-125	50-60	✓	B	✓	395
0-60	0-3	6271A	LVR	532, 533	200 μV + 0.01%	200 μV + 0.01%	0.5	115 V ac ± 10%	48-63	✓	R	✓	435
0-60	0-5	6438B	SCR-1P	535	60 mV	30 mV	120	105-125	57-63	✓	R	✓	360
0-60	0-15	6439B	SCR-1P	535	120 mV	60 mV	60	105-125	57-63	✓	R	✓	550
0-60	0-15	6274A	LVR	532, 533	0.2 mV + 0.01%	0.2 mV + 0.01%	0.5	100-130	48-63	✓	R	✓	695
0-64	0-50	6459A	SCR-3	536	10 mV + 0.2% combined		160	3φ 208/230/460 ± 10%	57-63	✓	R	✓	1275
0-64	0-150	6472A	SCR-10	537	100 mV + 0.2% combined		160	3φ 208/230/460 ± 10%	57-63	✓	R	✓	2600
0-100	0-0.2	6106A	STB	526, 527	200 μV + 0.001%	0.001%	0.04	115 ± 10%	48-63	✓	B		265
0-100	0-0.2	6116A	STB	526, 527	200 μV + 0.001%	0.001%	0.04	115 ± 10%	48-63	✓	B		375
0-100	0-0.3	6181A	CCB	528, 529	0.0015%	0.001%	0.03 mA	115 V ac ± 10%	48-63	✓	B		425
0-100	0-0.75	6299A	MPB-3	524, 525	2 mV + 0.01%	2 mV + 0.01%	0.2	115 ± 10%	50-400	✓	B	✓	225
0-110	0-100	6475A	SCR-10	537	100 mV + 0.2% combined		220	3φ 208/230/460 ± 10%	57-63	✓	R	✓	2600
0-120	0-2.5	6443B	SCR-1P	535	120 mV	60 mV	240	115 ± 10%	57-63	✓	R	✓	360
0-160	0-0.2	6207B	LAB	520, 521	2 mV + 0.02%	2 mV + 0.02%	0.5	115 ± 10%	48-63	✓	B	✓	194
0-160	0-0.4	6354A	MOD	538, 539	2 mV + 0.005%	1 mV + 0.005%	1.0	115 ± 10%	48-63	✓	R	✓	259
0-220	0-50	6477A	SCR-10	537	100 mV + 0.2% combined		330	3φ 208/230/460 ± 10%	57-63	✓	R	✓	2600
0-300	0-0.1	6186A	CCB	528, 529	0.0015%	0.001%	0.01 mA	115 V ac ± 10%	48-63	✓	B		425
0-300	0-35	6479A	SCR-10	537	100 mV + 0.2% combined		300	3φ 208/230/460 ± 10%	57-63	✓	R	✓	2600
0-320	0-0.1	6209B	LAB	520, 521	2 mV + 0.02%	2 mV + 0.02%	1.0	115 ± 10%	48-63	✓	B	✓	194
0-320	0-0.2	6357A	MOD	538, 539	2 mV + 0.005%	1 mV + 0.005%	1.0	115 ± 10%	48-63	✓	R	✓	259
0-320	0-0.6	890A	MVR	534	10 mV or 0.007%	10 mV or 0.007%	1.0	115 ± 10%	57-63	✓	R		445
0-320	0-1.5	895A	MVR	534	10 mV or 0.007%	10 mV or 0.007%	1.0	115 ± 10%	57-63	✓	R		625
-250 to -400 0 to -900	.03-.05 0-10 μA	715A†	—	543	1% 1%	1% 1%	7 10	115/230 ± 10%	50-60		B		365
0-500	0-0.1	711A†	—	542	1000 or 0.5%	1000 or 0.5%	1	115/230 ± 10%	50-1000		B		275
0 to +500 -300 0 to -150	0-0.2 0-0.05 0-0.005	712B†	—	542	50 50 —	± 100 ± 100 ± 100	0.5 0.5 0.5	115 ± 10%	50-60		B		490
0-440 or 0-500 or 0-600	0-25 or 0-20 or 0-15	6483B	SCR-10	537	100 mV + 0.2% combined		500	3φ 208/230/460 ± 10%	57-63	✓	R	✓	2600
1-600	0-1.5	6448B	SCR-1P	535	600 mV	600 mV	600 mV	115 V ac ± 10%	57-63	✓	R	✓	550
-250 to -800 0 to -800 6.3 V (ADJ)	0-2.0	716B†	—	543	0.05% — —	0.05% 0.05% 1%	1 0.5 2	115/230 ± 10%	50-60		B		875
0-1000	0-0.2	6521A	HVR	534	20 mV or 0.005%	20 mV or 0.005%	1.0	115 ± 10%	50-70		R		750
0-1600	0-0.005	6515A	HVB	522	16 mV or 0.01%	16 mV or 0.01%	2.0	115 ± 10%	60		B		235
0-2000	0-0.1	6522A	HVR	534	20 mV or 0.002%	20 mV or 0.005%	1.0	115 ± 10%	50-70		R		750
0-3000	0-0.006	6110A	STB	526, 527	100 μV + 0.001%	0.001%	0.4	115 ± 10%	57-63		B		495
0-3000	0-0.006	6516A	HVB	522	16 mV or 0.01%	16 mV or 0.01%	4	115 ± 10%	57-63		B		295
0-4000	0-0.05	6525A	HVR	534	20 mV or 0.001%	20 mV or 0.005%	1.0	115 ± 10%	50-70		R		750

All Supplies: 50°C maximum ambient temperature rating. Floating output (ground either side), continuously variable output, low output impedance at all frequencies, 3-wire input, computer-quality electrolytics, 1 year warranty. No turn-on, turn-off overshoot; short-circuit-proof, all semiconductor except as noted by †.

Transistor Supplies: Glass-epoxy printed circuit board construction, fully automatic overload protection — short-circuit-proof.



Refer to "Power Supply Handbook," Application Note 90 for further information on definitions, theory, operation, and applications. AN-90 is available free of charge from your local Hewlett-Packard Field Sales Office.

Ambient temperature. The room temperature, or effective temperature of the environment in which the power supply is operating.

Auto-parallel or automatic parallel operation. A master-slave parallel connection of the outputs of two or more Hewlett-Packard supplies used for obtaining a current output greater than that obtainable from one supply. Auto-Parallel operation is characterized by one-knob control, equal current sharing, and no internal wiring changes. Normally only supplies having the same model number may be connected in Auto-Parallel; in certain cases, however, supplies of the same Series are capable of mixed Auto-Parallel operation.

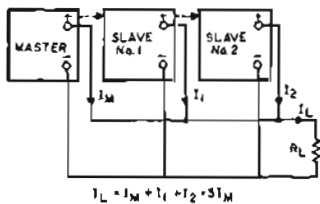

Auto-parallel power supply system

Auto-series or automatic series operation. A master-slave series connection of the outputs of two or more Hewlett-Packard power supplies used for obtaining a voltage greater than that obtainable from one supply. Auto-Series operation, which is permissible up to 300 volts off ground, is characterized by one-knob control, equal or proportional voltage sharing, and no internal wiring changes. Supplies of mixed model numbers may be connected in Auto-Series without restriction, provided that each slave is listed as being capable of Auto-Series operation.

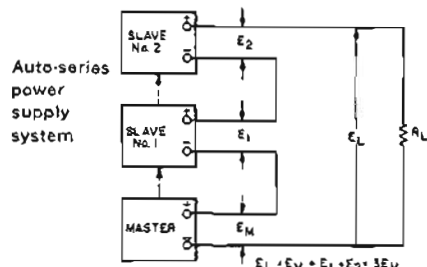

Auto-tracking or automatic tracking operation. A master-slave connection of two or more Hewlett-Packard power supplies each of which has *one* of its out-

put terminals in common with *one* of the output terminals of *all* of the other power supplies, such a connection pattern being characterized by one-knob control, proportional output voltage from all supplies, and no internal wiring changes. Useful where simultaneous turn-up, turn-down or proportional control of all power supplies in a system is required.

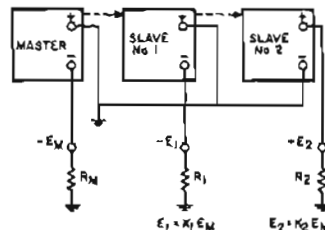

Auto-tracking power supply system

Constant current power supply. A regulated power supply which acts to keep its output current constant in spite of changes in load, line, or temperature. Thus, for a change in load resistance, the output current remains constant to a first approximation, while the output voltage changes by whatever amount necessary to accomplish this.

Constant voltage power supply. A regulated power supply which acts to keep its output voltage constant in spite of changes in load, line, or temperature. Thus, for a change in load resistance, the output voltage of this type of supply remains constant to a first approximation, while the output current changes by whatever amount necessary to accomplish this, the most common type of regulated dc power supply.

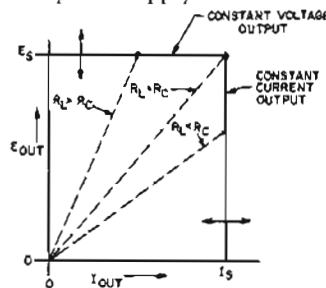

Constant voltage/constant current (CV/CC) output characteristic

Constant voltage/constant current (CV/CC) with automatic crossover. A power supply which acts as a constant voltage source for comparatively large values of load resistance and as a constant current source for comparatively small values of load resistance. The automatic crossover or transition between these two modes of operation occurs at a "critical" or "crossover" value of load resistance $R_C = E_S /$

I_S where E_S is the front panel voltage control setting and I_S is the front panel current control setting.

Constant voltage/current limiting (CV/CL) with automatic crossover. The same as CV/CC operation except for a slightly poorer regulation characteristic for low values of load resistance, i.e., in the "constant current" region of operation.

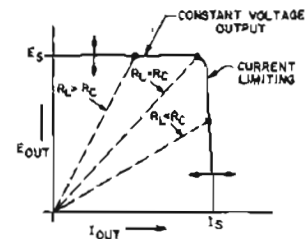

Constant voltage/current limiting (CV/CL) output characteristic

"Crowbar" voltage protector. A separate circuit which monitors the output of a power supply and instantaneously throws a short circuit (or "crowbar") across the output terminals of the power supply whenever a preset voltage limit is exceeded. An SCR is usually used as the "crowbar" device.

Drift. A term loosely used to describe the slow variations in the output of a regulated power supply due to STABILITY and/or TEMPERATURE COEFFICIENT.

Line regulation of a constant current power supply. The change in the static value of the dc output current resulting from a change in ac input voltage from low line (usually 105 volts) to high line (usually 125 volts) or from high line to low line.

Line regulation of a constant voltage power supply. The change in the static value of dc output voltage resulting from a change in ac input voltage from low line (usually 105 volts) to high line (usually 125 volts) or from high line to low line.

Load regulation of a constant current power supply. The change in the static value of dc output current resulting from a change in load resistance from short circuit to a value which gives maximum rated output voltage.

Load regulation of a constant voltage power supply. The change in the static value of dc output voltage resulting from a change in load resistance from open circuit to a value which yields maximum rated output current.

Output impedance of a power supply. At any given frequency of load change, $\Delta E_{out}/\Delta I_{out}$. Strictly speaking the definition applies only for a sinusoidal load disturbance, unless, of course, the measurement is made at zero frequency (dc). The output impedance of an ideal constant voltage power supply would be zero at all frequencies, while the output impedance for an ideal constant-current power supply would be infinite at all frequencies.

Recovery time. See Transient Recovery Time.

Remote error sensing or Remote sensing. A feature found on most HP power supplies, which, by means of two extra wires between the supply and the load, permits the power supply to achieve its optimum regulation at the load terminals rather than at the power supply output terminals, thus compensating for the IR drop present in the current carrying leads connecting the load to its power supply. The current through the sensing leads is so small that in spite of the resistance of these leads, their voltage drop is negligible.

Remote programming. A feature of most HP power supplies which makes possible control of the regulated output by means of a remotely varied resistance. This feature also permits control of the output of a power supply by means of a voltage input rather than by means of a control resistance.

Ripple. The residual ac component which is superimposed on the dc component of the output of a regulated power supply. Ripple is usually specified in terms of its RMS value.

Stability. Obviously a misnomer, this term refers to the instability in power supply output which occurs in the presence of constant load, constant line and constant ambient temperature for a stated period of time (usually 8 hours) following warm-up. This small output variation, which is related in part to the internal temperature rise of the power supply, is the zero frequency component of noise which must be present in any dc amplifier or regulator, even though all input, output, environmental, and control parameters are held constant.

Temperature coefficient. For a power supply operated at constant load and under conditions of constant input ac line voltage, the change in output voltage (for a constant voltage supply) or output current (for a constant current supply) for each degree change in the ambient temperature.

Transient recovery time. Sometimes referred to as recovery time, transient response time, or response time — loosely speaking the time required for the output voltage of a power supply to come back to within a level approximating the nor-

mal dc output following a sudden change in load current. More exactly, Transient Recovery Time is the time "X" required for output voltage recovery to within "Y" millivolts of the nominal output voltage following a "Z" amp step change in load current — where:

"Y" is specified separately for each model but is generally of the same order as the load regulation specification, the nominal output voltage is defined as the dc level half way between the static output voltage before and after the imposed load change, and "Z" is the specified load current change, normally equal to the full load current rating of the supply.

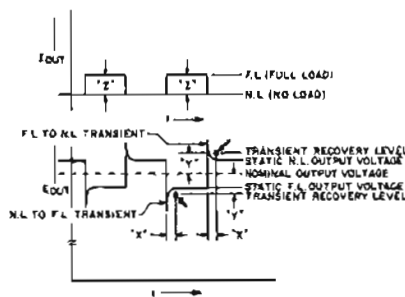

Options

Options are mechanical and/or electrical modifications to standard instruments performed at the factory. Below is a list of all the options available on HP DC Power Supplies. To determine which options are available for a particular supply, refer to the appropriate product (pages 514-543).

No.	Description
01	208 $\pm 10\%$ V ac, 3-phase Input, 57-63 Hz. Input is factory wired for 208 V ac.
02	230 $\pm 10\%$ V ac, 3-phase Input, 57-63 Hz. Input is factory wired for 230 V ac.
03	460 $\pm 10\%$ V ac, 3-phase Input, 57-63 Hz. Input is factory wired for 460 V ac.
04	Casters. Factory mounts 4 casters on base of standard instrument.
05	50 Hz AC Input Regulation Re-alignment. Standard instrument will operate satisfactorily at both 60 and 50 Hz without adjustment. However, Option 05 factory re-alignment results in more efficient operation at 50 Hz, and is recommended for all applications which involve continuous operation from a 50 Hz ac input.
06	Overvoltage "Crowbar" Protector. Protects delicate loads against power supply failure or operator error. Compact, inexpensive, can be factory installed (only) at rear of power supply. Virtual short circuit (SCR crowbar) is placed
07	Ten-Turn Output Voltage Control. Replaces concentric coarse and fine voltage control.
08	Ten-Turn Output Current Control. Replaces concentric coarse and fine current control.
09	Ten-Turn Output Voltage And Current Controls. Same as Options 07 and 08 on same instrument.
10	Chassis Slides: Enables convenient access to power supply interior for maintenance. Chassis slides are attached to supply at the factory.
13	Three Digit Graduated Decadial Voltage Control: Includes 10-turn control replacing coarse and fine voltage control.
14	Three Digit Graduated Decadial Current Control: Includes 10-turn control replacing coarse and fine current control.
15	No 5 V and 0.075 A Meter Ranges: Model 6205B is available without the lower meter ranges, resulting in a \$40 price reduction from the standard model.
16	115 V ac $\pm 10\%$, Single Phase Input: Factory modification includes the installation of a 115-volt input power transformer to replace the standard 230-volt transformer.
17	208 V ac $\pm 10\%$, Single Phase Input: Factory modification includes the installation of a 208-volt input power transformer to replace the standard 115 or 230-volt transformer.
18	230 V ac $\pm 10\%$, Single Phase Input: Factory modification includes the installation of a 230-volt input power transformer to replace the standard 115-volt transformer.
26	115 V ac $\pm 10\%$, Single Phase Input: Factory modification consists of reconnecting the multi-tap input power transformer for 115-volt operation.
27	208 V ac $\pm 10\%$, Single Phase Input: Factory modification consists of reconnecting the multi-tap input power transformer for 208-volt operation.
28	230 V ac $\pm 10\%$, Single Phase Input: Factory modification consists of reconnecting the multi-tap input power transformer for 230-volt operation.
31	380 V ac $\pm 10\%$, 57-63 Hz, 3-phase input.
32	400 V ac $\pm 10\%$, 57-63 Hz, 3-phase input.

across load within 10 microseconds after trip voltage is exceeded. For complete specifications, refer to appropriate data sheet.



DIGITAL VOLTAGE SOURCE

High-speed, digitally-programmed, bipolar output
Model 6130A

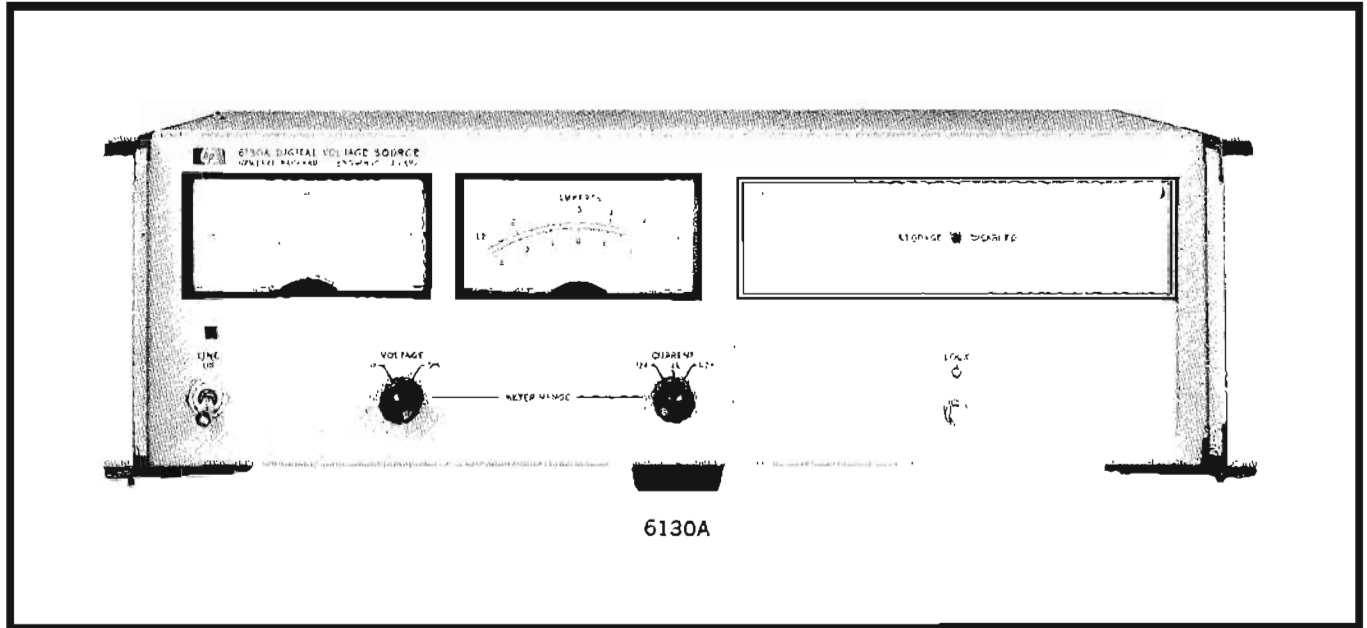

Advantages:

- High-speed digital programming through zero
- All electronic logic
- No overshoot of programmed output voltage. With a resistive load, overshoot for any change in programmed output voltage is: less than 0.1% ± 1 mV in 0-10 volt range; less than 0.1% ± 10 mV in 0-50 volt range
- Isolation and storage: all data inputs are isolated from the dc output. Voltage polarity and magnitude data are stored
- Output current sinking capability of 500 mA
- Current limit protection
- No turn-on, turn-off, or power removal overshoot

Description

Digital Voltage Source, Model 6130A, is a digitally-programmed bipolar regulated dc power supply. The functions that can be controlled by a digital computer or programmer and the output capability of Model 6130A are illustrated.

Model 6130A is intended primarily for use with a digital programmer using an 8421 BCD format and interfaces conveniently with HP Instrumentation Computer Model 2116A. The plug-in board design enables rapid inexpensive modifications to suit the coding and logic levels of most computers as shown on the data sheet.

Model 6130A consists of three main sections; output voltage data processor, current limit data processor, and high-speed power amplifier. All data processing is performed by electronic circuits (no relays) with the exception of the

output voltage range, and manual/automatic selection. Thus, the output voltage can be programmed from -50 V to $+50$ V in less than 100 μ s.

Output voltage range data can be provided automatically by a programmer or manually by means of switches on the 6130A. It programs the power amplifier for X1 or X10 (0-10 V or 0-50 V output). Voltage polarity and magnitude data are determined by the program; Model 6130A isolates, stores, and converts the data to the selected output voltage.

Current limit magnitude data can be provided automatically by the programmer or manually by switches on the 6130A. It is decoded and compared to a sample of the load current. If the output current exceeds the programmed current limit, the power amplifier opens the output and the programmer is notified of the current overload.

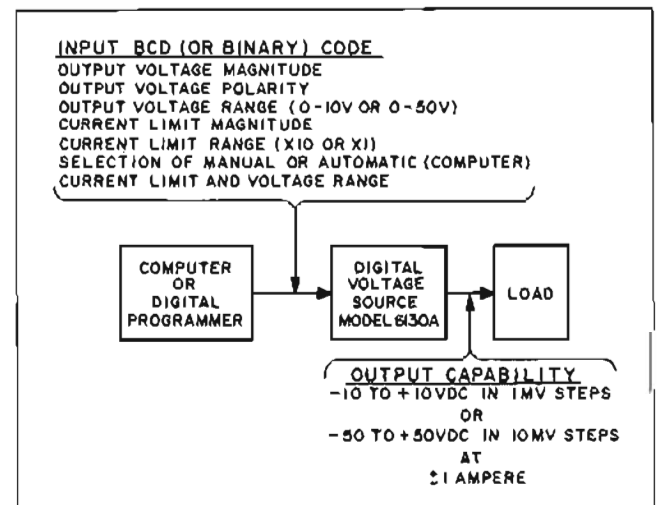

Specifications

Dual range dc output: -10 to $+10$ V dc (1 mV increments) at 0 - 1 A (up to 500 mA sinking). -50 to $+50$ V dc (10 mV increments) at 0 - 1 A (up to 500 mA sinking).

Current limit: 20, 50, 70, 100, 200, 500, 700, or 1000 mA with an accuracy of 5%.

Current limit operates in both the source and sink modes. The reaction time for the adjustable current limit circuitry to open-circuit the output may be varied from 5 μ s to 2 ms by adding an external capacitor at the rear terminals. A separate fixed current limit circuit limits peak output current to 1.1 A at all times.

AC power input: 115 V ac $\pm 10\%$, 50 - 400 Hz.

Load regulation: for a load current change equal to the current rating of the supply.

10-volt range: 0.2 mV.

50-volt range: 1 mV.

Line regulation: for a 10% change in the nominal line voltage.

10-volt range: 0.2 mV.

50-volt range: 1 mV.

Ripple and noise: less than 1 mV p-p at any line voltage and load condition within rating.

Transient recovery time: less than 30 μ s is required for output voltage recovery to within 0.1% of the range setting following a change in output current equal to the current rating of the supply.

Temperature coefficient: output change per degree centigrade change in ambient following 30 minutes warm-up.

10-volt range: less than 100 μ V/ $^{\circ}$ C.

50-volt range: less than 500 μ V/ $^{\circ}$ C.

Accuracy and resolution: at 25° C $\pm 10^{\circ}$ C.

10-volt range: 1 mV.

50-volt range: 10 mV.

Programming speed: time required to attain 99.9% of programmed value.

Voltage: -50 V to $+50$ V or $+50$ V to -50 V in less than 100 μ s.

Voltage data transfer rate: greater than 10 kHz.

Current limit: less than 2 ms.

Voltage range: less than 2 ms.

Input/Output Coding: desirable

Input Description	Lines	Typical Levels and Coding	
		High	Low
Voltage magnitude (#421 BCD form)	16	Logical 0	Logical 1
Voltage Polarity	1	+	-
Voltage Range (0-10 V or 0-50 V)	1	10 V	50 V
Current Limit Magnitude (00=20 mA; 01=50 mA; 10=70 mA; 11=100 mA)	2	Logical 0	Logical 1
Current Limit Range (X1 or X10)	1	X10	X1
Manual/Auto Current Limit and Voltage Range Control	1	Manual	Auto
Gate 1—Starts processing of voltage magnitude and polarity data.	1	Hold	Read
Gate 2—Signals the start of current or voltage range change.	1	Hold	Process
Total Input Lines	24		

Input/Output Coding: (Continued)

Outputs	Lines	Typical Levels and Coding	
		High	Low
Current Overload Indicator—Notifies programmer that the output current has exceeded the preset current limit value.	1	Normal	Overload
Current Overload Latch—Notifies programmer that Model 6130A has opened the output terminals in response to a current overload.	1	Normal	Latch
Flag 1—Notifies programmer that voltage magnitude and polarity data processing is complete.	1	Processing	Complete
Flag 2—Notifies programmer that current or voltage change is complete.	1	Processing	Complete
Total Output Lines	4		

Temperature ranges:

Operating: 0 to 55° C.

Storage: -40 to $+75^{\circ}$ C.

Controls: Line switch (on-off), Voltage Meter Range Switch (10 V, 60 V), Current Meter Range Switch (0.12 A, 0.3 A, 1.2 A).

Rear output terminals: terminals for Output, Output Sensing, Common, Common Sensing, Ground, and Current Latch Delay are included on a rear barrier strip. The *common* output terminal may be connected to ground through a separate ground terminal, or the output can float up to 300 volts off ground. Inputs enter the rear through a 50 contact ribbon connector.

Cooling: convection cooling is employed. The supply has no moving parts.

Meters: the front panel includes a voltmeter and ammeter with the following ranges:

Volts: -60 to $+60$ V

-10 to $+10$ V

Amperes: -1.2 to $+1.2$ A

-0.3 to $+0.3$ A

-0.12 to $+0.12$ A

Dimensions: $16\frac{3}{4}$ " W \times $5\text{-}7/32$ " H \times $15\frac{5}{8}$ " D (42.5 cm W \times 13.3 cm H \times 39.6 cm D).

Weight: 30 lbs (13.6 kg) net.

Price: HP Model 6130A, \$1500.

Accessories furnished:

50 Contact Rear Plug, HP Part No. 1251-0086 (Cinch 57-30500-375).

Rack Mounting Kit, HP Part No. 5060-0775.

Option 28: 230 V ac $\pm 10\%$, single phase input. Factory modification consists of reconnecting the multi-tap input power transformer for 230 volt operation. \$10.



DIGITAL-TO-ANALOG CONVERTER

High-speed, bipolar output

Model 6933A

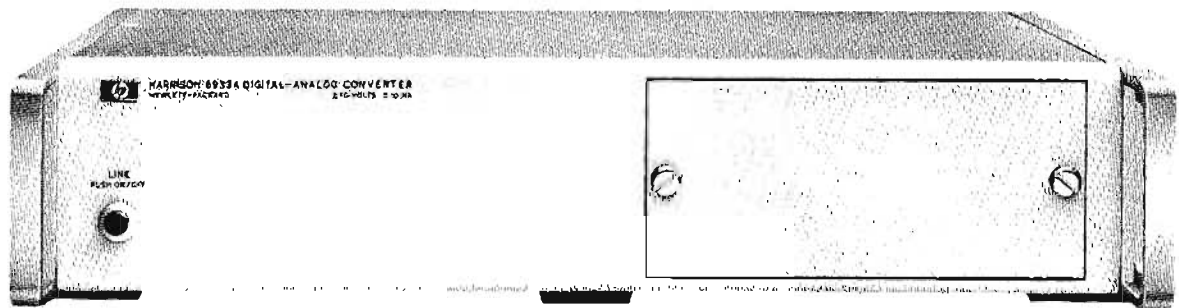

6933A

Advantages:

- High-speed digital programming through zero
- All electronic logic
- No overshoot of programmed output voltage: with a resistive load, overshoot for any change in programmed output voltage is less than $0.1\% \pm 1$ mV
- Isolation and storage: all data inputs are isolated from the dc output and internally stored
- Output current sinking capability of 10 mA
- No turn-on, turn-off, or power removal overshoot
- Short circuit proof

Description

Digital-to-Analog Converter, Model 6933A is an all-electronic high-speed device with a bipolar output. It stores and isolates the data from the dc output.

Model 6933A is intended primarily for use with a digital programmer using an 8-4-2-1 BCD format and interfaces conveniently with HP Instrumentation Computer Model 2116A. The plug-in board design enables rapid inexpensive modifications to suit the coding and logic levels of most computers as shown on the data sheet.

All HP power supplies that feature external voltage programming can be programmed by the D-A converter with little or no modifications.

Specifications

- Dual range dc output:** -10 to $+10$ V dc (1 mV increments) at 0-10 mA (10 mA sinking).
- AC power input:** 115 V ac $\pm 10\%$, 50-400 Hz.
- Load regulation:** less than 0.2 mV for a load current change of 10 mA.
- Line regulation:** less than 0.2 mV for a 10% change in the nominal line voltage.
- Ripple and noise:** less than 1 mV p-p at any line voltage and load condition within rating.
- Transient recovery time:** less than 30 μ s is required for output voltage recovery to within 0.1% of the range setting following a change in output current equal to the current rating of the supply.

Temperature coefficient: less than 100 μ V output change per degree centigrade change in ambient following 30 minutes warm-up.

Accuracy and resolution: 1 mV at $25^\circ\text{C} \pm 10^\circ\text{C}$.

Programming speed: time required to attain 99.9% of programmed value.

Output voltage: -10 to $+10$ V or $+10$ to -10 V in less than 10 μ s.

Voltage data transfer rate: greater than 100 kHz.

Input/output coding: other codes and levels available.

Input Description	Lines	Typical Levels and Coding	
		High	Low
Voltage magnitude (8421 BCD form)	16	Logical 0	Logical 1
Voltage polarity	1	+	-
Gate: starts processing of voltage magnitude and polarity data	1	Hold	Read
Total input lines	18		
Output Description			
Flag: notifies programmer that voltage magnitude and polarity data processing are complete	1	Processing	Complete

Temperature ranges:

Operating: 0 to 55°C .

Storage: -40 to $+75^\circ\text{C}$.

Controls: line switch (on-off)

Rear output terminals: terminals for output, common, and ground. The *common* output terminal may be connected to ground through a separate ground terminal, or the output can float up to 300 volts off ground. Inputs enter the rear through a 50-contact ribbon connector.

Dimensions: $16\frac{3}{4}$ " W x $3\frac{3}{8}$ " H x $13\frac{1}{4}$ " D (42.5 cm W x 8.6 cm H x 33.7 cm D).

Price: HP Model 6933A, \$1200.

Option 28: 230 V ac $\pm 10\%$, single phase input. Factory modification consists of reconnecting the multi-tap input power transformer for 230 volt operation; price, \$10.

PS/A SERIES

DC power supply/amplifier

Models 6823A, 6824A



DC POWER SUPPLIES

Specifications

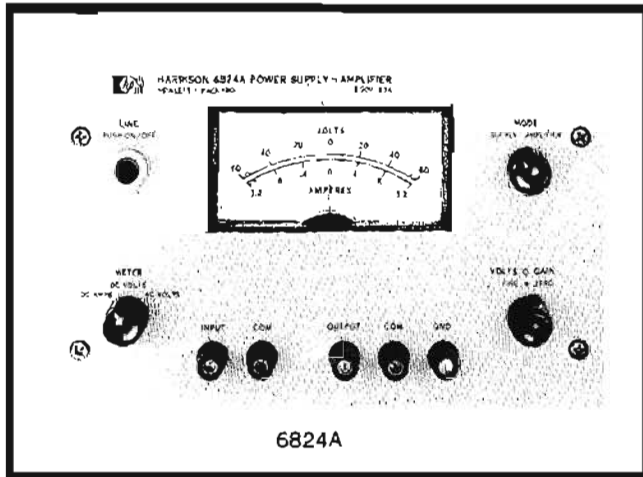

Models 6823A and 6824A are dual-purpose dc regulated power supplies and direct-coupled amplifiers. Two or more of these units can be connected in Auto-Series to obtain greater voltage capability. High speed constant current operation can be obtained by simply adding an external resistor in series with the load and making minor changes in the rear barrier strapping.

Two temperature-compensated zener diodes are employed as reference elements in a series regulator feedback circuit which monitors and controls the output voltage. The resulting low ripple and low output impedance permit these instruments to be used in critical power supply applications. Low internal dissipation assures reliability.

As a power amplifier, both instruments offer a signal-to-noise ratio of 80 dB at full output with low distortion and 20 dB gain from dc-20 kHz (kc); making them useful in a wide variety of applications. The output is inverted. Rack mounting hardware is available for mounting singly or in pairs in 3½" or 5¼" of rack height.

Advantages:

Power supply

- Output adjustable through zero
- High-speed programming
- Short-circuit-proof
- Low ripple and noise
- Fast transient recovery
- No overshoot for turn-on, turn-off, or power removal

Power amplifier

- Variable gain
- High signal-to-noise ratio
- Low distortion
- Frequency response — dc to 20 kHz

Applications

As a dc Power Supply, Models 6823A or 6824A can be controlled from the front panel, or remotely programmed with resistance or voltage. The low output drift and noise combined with high speed programming adapt this supply to a wide variety of laboratory and production testing applications.

As a dc coupled Power Amplifier, the unusually low output impedance, distortion, ripple and noise make the 6823A or 6824A useful in servo systems, as a pulse or oscillator amplifier, and for motor control. Constant Current output is readily achieved by connecting a current monitoring resistor to the rear terminal barrier strip—makes an ideal driver-amplifier for deflection coils!

For more information, refer to Application Note 82, Power Supply/Amplifier Concepts and Modes of Operation, available free of charge from your local Hewlett-Packard field sales office.

MODEL 6823A	
High speed programming dc power supply	10 watt peak output dc power amplifier
Output: —20 to +20 V dc @ 0-0.5 A	Output: 40 volts p-p @ 0-0.5 A
Load regulation: 0.02% +5 mV	Voltage gain: Variable 0-10 (20 dB) output inverted.
Line regulation: 0.02% +5 mV	Frequency response: at full output, ≈ 3 dB from dc to 20 kHz.
Ripple & noise: 2 mV rms	Max. phase shift: dc —180° 100 Hz —181° 1 kHz —183° 10 kHz —205° 20 kHz —225°
Transient recovery time: less than 100 μs to within 5 mV +0.02% of the nominal output.	Distortion: <0.02% at 1 kHz and full output.
Remote programming: 500 ohms/V. Also voltage programming.	Input impedance: 2k ohms approx.
Programming speed: less than 50 μs are required for programming between —20 V and +20 V. Typically the programming time between 0 and 90% of the maximum voltage span is 20 μs.	Input terminals: front and rear.
AC Input: 115 V ac ±10%, single phase, 50-440 Hz; 0.33 amp, 24 watts max. Meter: Dual purpose with selector switch; —24 to +24 volts, —0.6 to +0.6 amps. Size: 3½" H x 8¼" W x 13" D (8.9 cm H x 21.8 cm W x 33 cm D). Weight: 16 pounds (7.26 kg) net, 20 pounds (9.07 kg) shipping. Price: \$194. Rack mounting kits: refer to HVB Series (P522) for details. 14513A: mounts one 3½" high unit—add \$20.00 14523A: mounts two 3½" high units—add \$10.00	

MODEL 6824A	
High speed programming dc power supply	60 watt peak output dc power amplifier
Output: —50 to +50 V DC @ 0-1.0 A	Output: 100 volts p-p @ 0-1.0 A
Load regulation: 0.02% +5 mV	Voltage gain: variable, 0-10 (20 dB), output inverted.
Line regulation: 0.02% +5 mV	Frequency response: At full output, ≈ 3 dB from dc to 20 kHz.
Ripple & noise: 10 mV rms.	Max. phase shift: dc —180° 100 Hz —180.7°, 1 kHz —182.9° 10 kHz —205°, 20 kHz —225°
Transient recovery time: less than 100 μs to within 5 mV +0.02% of the nominal output.	Distortion: <0.02% at 1 kHz and full output.
Remote programming: 500 ohms/V. Also voltage programming.	Input impedance: 2k ohms approx.
Programming speed: less than 50 μs are required for programming between —50 V and +50 V. Typically, the programming time between 0 and 90% of the maximum voltage span is 20 μs.	Input terminals: front and rear.
AC Input: 115 V ac ±10%, single phase, 50-60 Hz, 1.3 amps, 96 watts max. Meter: triple purpose with selector switch; —60 to +60 volts, —1.2 to +1.2 amps, 0 to 60 V rms Size: 5½" H x 8¼" W x 13" D (14 cm H x 21.8 cm W x 33 cm D). Weight: 17 pounds (7.7 kg) net, 21 pounds (9.55 kg) shipping. Price: \$350 Rack mounting kits: refer to HVB Series (P522) for details. 14515A: mounts one 5½" high unit—add \$23.00 14525A: mounts two 5½" high units—add \$13.00	

Other specifications for both models

Temperature ratings: operating: 0 to 50°C. Storage +20 to 85°C.

Temperature coefficient: 0.015% +1 mV per °C.

Stability: 0.075% +5 mV for 8 hrs. (after ½ hr. warm-up); ambient temperature variation held to 3°C.

Overload protection: the unit is completely protected for all overload conditions including a short circuit applied directly across the output terminals.

Output terminals: both front and rear terminals are provided.

Option 28: 230 V ac ±10%, single phase input. Factory modification consists of reconnecting the multi-tap input power transformer for 230-volt operation.

DC POWER SUPPLIES
BENCH SERIES
 Small laboratory supplies
 Model 6215A - 6218A

6215A, 6217A
 Constant Voltage
 Current Limiting

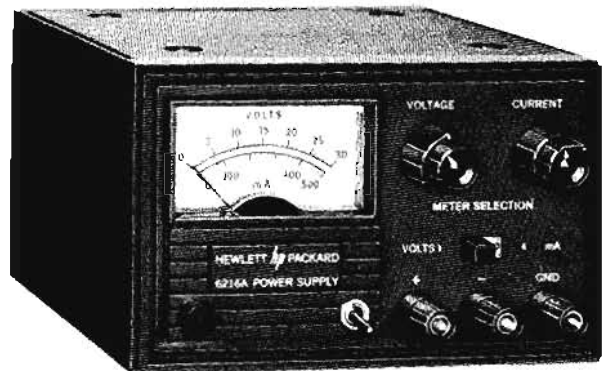

6216A, 6218A
 Constant Voltage
 Constant Current

Advantages:

- All silicon semiconductor circuitry
- Short circuit-proof—current limit circuit protects the supply against any overload, including a direct short circuit across the output terminals, for any time interval without damage
- Compact—impact-resistant case
- Floating output—supply can be operated as a positive or negative source
- Silicon differential amplifiers compare the output voltage with a stable reference voltage; provide improved stability
- No turn-on, turn-off, or power removal overshoot
- Coarse and fine voltage controls
- Low output ripple and drift
- Rack mounting hardware available
- Fully serviceable
- Quality components and construction

Description

Four extremely compact well-regulated dc power supplies, designed especially for bench use, have just been added to the Hewlett-Packard power supply line. New fabrication

techniques have been employed for these supplies to minimize manufacturing costs while retaining component and circuit quality. Reliable, yet low cost, these "hand-size" battery substitutes have overall performance features ideal for circuit development, component evaluation, and other laboratory applications.

The all-silicon circuit uses an input differential amplifier to compare the output voltage with reference voltage derived from a temperature-compensated zener diode. These stable input and reference circuits are combined with a high gain feedback amplifier to achieve low-noise drift-free performance. Output voltage is fully adjustable to zero. Special design precautions prevent output overshoot during turn-on or turn-off, or when ac power is suddenly removed.

The front panel meter can be switched to monitor output voltage or current. Constant Voltage/Constant Current or Constant Voltage/Current Limiting insures short circuit-proof operation, and permits series and parallel connection of two or more supplies when greater voltage or current is desired.

The molded, impact-resistant case includes an interlocking feature for stacking several units vertically, thus minimizing bench space required for multiple supplies. Alternatively, up to three units can be mounted side by side in a 19" rack using a special Rack Mounting Kit.

Specifications

		Constant voltage/current limiting		Constant voltage/constant current	
Model		6215A	6217A	6218A	6218A
Output	DC voltage	0 - 25 V	0 - 50 V	0 - 25 V	0 - 50 V
	DC current	0 - 400 mA	0 - 200 mA	0 - 400 mA	0 - 200 mA
Input: 115 V ac \pm 10%, 50 - 400 cps		0.25 A, 25 W	0.25 A, 25 W	0.25 A, 26 W	0.25 A, 26 W
Load regulation: the constant voltage load regulation is given for a load current change equal to the current rating of the supply; the Constant Current load regulation is given for a load voltage change equal to the voltage rating of the supply.	C V	0.01% + 1 mV			
	C C	—	—	0.05% + 250 μ A	0.05% + 200 μ A
Line regulation: for a 10% change in the nominal line voltage at any output voltage and current within rating.	C V	0.01% + 4 mV			
	C C	—	—	0.05% + 250 μ A	0.05% + 250 μ A
Ripple and noise: at any line voltage and under any load condition within rating.	C V	200 μ V rms/1 mV p-p (dc to 20 MHz)			
	C C	—	—	200 μ A rms	200 μ A rms
Temperature coefficient: output change per degree centigrade change in ambient following 30 minutes warmup.	C V	0.02% + 1 mV/°C			
	C C	—	—	0.02% + 1 mA/°C	0.02% + 0.5 mA/°C
Stability: under constant ambient conditions, total drift for 8 hours following 30 minutes warmup.	C V	0.1% + 5 mV			
	C C	—	—	0.1% + 5 mA	0.1% + 2.5 mA
Resolution:	C V	<5 mV	<10 mV	<5 mV	<10 mV
	C C	—	—	<20 μ A	<10 μ A
Controls:	On-off switch and separate pilot light; one-turn coarse and fine voltage controls; meter switch selects volts or mA			On-off switch and separate pilot light; concentric coarse and fine voltage control; concentric coarse and fine current control; meter range switch	
Meter ranges: accuracy is 3% of full scale.		0 - 30 V, 0 - 500 mA	0 - 60 V, 0 - 250 mA	0 - 30 V, 0 - 500 mA	0 - 60 V, 0 - 250 mA
Weight: (net/shipping)	lbs	4.5/6.5	4.5/6.5	4.75/6.75	4.75/6.75
	kg	2.0/2.9	2.0/2.9	2.2/3.1	2.2/3.1
Price		\$90	\$90	\$115	\$115

Transient recovery time: less than 50 μ seconds is required for output voltage recovery in constant voltage operation to within 15 millivolts of the nominal output voltage following a change in output current equal to the current rating of the supply; the nominal output voltage is defined as the mean between the no load and full load voltages.

Output impedance:

Less than 0.03 ohm from DC to 1 kHz.
Less than 0.5 ohm from 1 kHz to 100 kHz.
Less than 3 ohms from 100 kHz to 1 MHz.

Temperature ratings:

Operating: 0 to 55°C (consult factory for derating information for operation over 55°C).
Storage: -40°C to +75°C.

Size: — 3¼" H x 5¼" W x 7" D.
— 8,26 cm H x 13,34 cm W x 17,78 cm D.

Output terminals: either positive or negative output terminal may be connected to ground through a separate terminal provided for that purpose, or the supply may be operated floating at up to 300 volts off ground.

Cooling: convection cooling is employed — no moving parts.

Power cord: a 3-wire, 5-foot (1,52 m) power cord is provided with each unit.

Construction: impact-resistant case with simulated vinyl-clad finish.

Option 28 — 230 vac \pm 10%, single phase Input: factory modification consists of reconnecting the multitap input power transformer for 230-volt operation; Price \$10.

Accessories

14521A, 3½" high rack kit for three BENCH supplies: accommodates up to three "BENCH" supplies in an area 3½" high x 19" wide, and is easily attached to a standard 19" EIA rack.

Price: \$25.



14521A Rack Kit (3½") shown with three supplies.

DC POWER SUPPLIES



LAB SERIES

Laboratory bench dc power supplies

Models 6200B-6209B

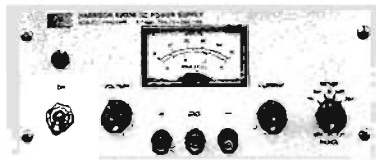

6200B, 6201B, 6202B
6203B, 6207B, 6209B

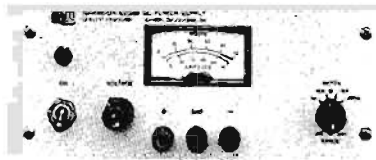

6204B, 6206B

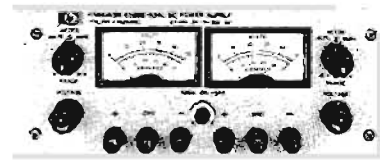

6205B

LAB Series supplies, already regarded as the industry standard for comparison because of their reliability, versatility, and performance specifications, have now been updated. The glass epoxy printed wiring board now mounts all circuit components via plated-through holes; a new package design achieves greater rack-mounting rigidity and ease in assembly. New production techniques result in improved reliability and lowered costs permitting Hewlett-Packard to manufacture these instruments at a competitive price.

All "B" version LAB Series supplies employ all-silicon circuitry. In addition, on models 6200B, 6201B, 6202B, and 6203B, special circuitry has been included to increase the down-programming speed, thus making it commensurate with the up-programming capability.

To further increase bench utility, multiple range meters have been included as standard on all models. Switching the meter range switch to the "wrong" position will result in no damage to the meter or degradation of power supply performance.

Model		6200B†	6201B‡	6202B‡	6203B
CONSTANT VOLTAGE/CONSTANT CURRENT					
Output	DC Voltage	0-20 V	0-20 V	0-40 V	0-7.5 V
	DC Current	0-1.5 A	0-1.5 A	0-0.75 A	0-3 A
Input		115 V ac = 10%, 50-400 Hz, 0.9 A, 70 W	115 V ac = 10%, 50-400 Hz, 0.8 A, 66 W	115 V ac = 10%, 50-400 Hz, 0.8 A, 66 W	115 V ac = 10%, 50-400 Hz, 0.9 A, 70 W
		0.01% plus 4 mV	0.01% plus 4 mV	0.01% plus 4 mV	5 mV
Load regulation	Constant Voltage	0.01% plus 4 mV	0.01% plus 4 mV	0.01% plus 4 mV	3 mV
	Constant Current	0.03% plus 250 μ A	0.03% plus 250 μ A	0.03% plus 250 μ A	0.03% plus 250 μ A
Line regulation	Constant Voltage	0.01% plus 4 mV	0.01% plus 4 mV	0.01% plus 4 mV	0.01% plus 250 μ A
	Constant Current	0.01% plus 250 μ A	0.01% plus 250 μ A	0.01% plus 250 μ A	0.01% plus 250 μ A
Ripple and noise	Constant Voltage	200 μ V rms	200 μ V rms	200 μ V rms	200 μ V rms
	Constant Current	500 μ A rms	500 μ A rms	500 μ A rms	500 μ A rms
Remote programming	Constant Voltage*	200 ohms per volt	200 ohms per volt	200 ohms per volt	200 ohms per volt
	Constant Current†	500 ohms per amp 1000 ohms per amp	1000 ohms per amp	1000 ohms per amp	500 ohms per amp
Overload protection		Constant voltage/constant current circuit provides complete protection for the power supply for any overload condition. In addition, continuously adjustable current limiting in constant voltage operation and continuously adjustable voltage limiting in constant current operation provides optimum protection for the load device.			
Controls		Off-On Switch, Pilot Light, Concentric Coarse and Fine Voltage Control, Concentric Coarse and Fine Current Control, Concentric Meter Range and Output Range Switch.	Off-On Switch, Pilot Light, Concentric Coarse and Fine Voltage Control, Concentric Coarse and Fine Current Control, Meter Range Switch.	Off-On Switch, Pilot Light, Concentric Coarse and Fine Voltage Control, Concentric Coarse and Fine Current Control, Meter Range Switch.	Off-On Switch, Pilot Light, Concentric Coarse and Fine Voltage Control, Concentric Coarse and Fine Current Control, Meter Range Switch.
Meter ranges		0-5 V, 0-50 V, 0-.18 A, 0-1.8 A	0-2.4 V, 0-24 V, 0-.18 A, 0-1.8 A	0-5 V, 0-50 V, 0-.09 A, 0-9 A	0-9 V, 0-9 V, 0-.4 A, 0-4 A
Weight (Net/Shipping)		14/19 lbs. (6.34/8.60 kg)	14/19 lbs. (6.34/8.60 kg)	14/19 lbs. (6.34/8.60 kg)	14/19 lbs. (6.34/8.60 kg)
Price		\$189	\$169	\$169	\$169
Options Refer to page 513 for descriptions		06-\$95 07-\$25	08-\$25 09-\$45	13-\$60 14-\$60	28-\$10 07-\$25 08-\$25 09-\$45 13-\$60 14-\$60 28-\$10

Advantages

- All-silicon design
- Multiple range meter
- Remote programming and sensing
- High-speed programming
- Auto-series, auto-parallel, auto-tracking
- Overtoltage protection "crowbar" option
- Short circuit proof
- Front and rear output terminals
- Floating output
- RFI conformance to MIL-I-6181D

LAB Specifications

Transient Recovery Time—Less than 50 μ s for output recovery to within 10 mv following a full load current change in output.
Internal Impedance— Less than 0.02 ohm from DC to 1 kc. Less than 0.5 ohm from 1 kc to 100 kc. Less than 3.0 ohms from 100 kc to 1 mc.
Cooling— Convection cooling is employed. No moving parts.
Power Cord— 3-wire, 5-foot power cord.
Size— 3½" (8,9 cm) H x 12⅝" (32 cm) D x 8½" (21,6 cm) W —Half rack width.
Finish— Light gray panel with dark gray case.

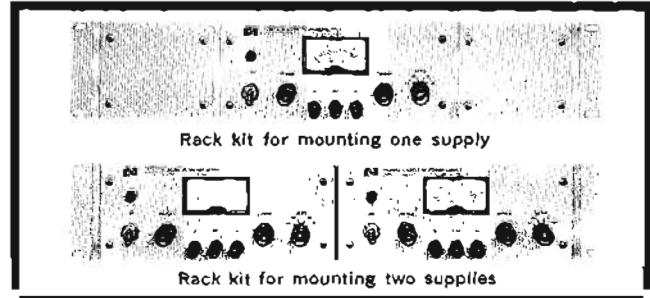

Accessories:

Part Number	Description	Price
C05	8" black handle attached to side of 3½" H supply	\$15.00
14513A	Rack Kit for mounting one 3½" H supply	\$20.00
14523A	Rack Kit for mounting two 3½" H supplies	\$10.00

High-Speed Programming — Models 6200B, 6201B, 6202B, 6203B; 30v/ms when programming in either direction between 1v and maximum rated output; less than 2 ms between 0 and 1v.
Maximum Ambient Operating Temperature — +50°C.

6204B†		6205B		6206B		6207B		6209B	
0-20 V	DUAL RANGE	0-40	0-20 V TWO DUAL RANGE	0-40 V	0-30 V	DUAL RANGE	0-60 V	0-160 V	0-320 V
0-0.6 A		0-0.3 A	0-0.6 A	OUTPUTS 0-0.3 A	0-1 A		0-0.5 A	0-0.2 A	0-0.1 A
115 V ac \pm 10%, 50-400 Hz, 0.4 A, 24 W		115 V ac \pm 10%, 50-440 Hz, 0.5 A, 50 W		115 V ac \pm 10%, 50-400 Hz, 1.0 A, 66 W		115 V ac \pm 10%, 48-63 Hz, 1.0 A, 60 W		115 V ac \pm 10%, 48-63 Hz, 1.0 A, 60 W	
0.01% plus 4 mV		0.01% plus 4 mV		0.01% plus 4 mV		0.02% plus 2 mV		0.02% plus 2 mV	
0.01% plus 4 mV		0.01% plus 4 mV		0.01% plus 4 mV		200 μ A		200 μ A	
200 μ V rms		200 μ V rms		200 μ V rms		500 μ V rms		1 mV rms	
200 ohms per volt		200 ohms per volt		300 ohms per volt		200 μ A rms		200 μ A rms	
200 ohms per volt		200 ohms per volt		300 ohms per volt		300 ohms per volt		300 ohms per volt	
75 K ohms per amp		150 K ohms per amp		75 K ohms per amp		150 K ohms per amp		Same as 6200B	
Fixed current limit provides complete protection for any overload condition. This limit is set at approximately 700 mA for the 20 volt range and 350 mA for the 40 volt range.		Fixed current limit provides complete protection for any overload condition. This limit is set at approximately 700 mA for the 20 volt range and 350 mA for the 40 volt range.		Fixed current limit provides complete protection for any overload condition. This limit is set for approximately 1.2 A for the 30 volt range and 600 mA for the 60 volt range.		Off-On Switch, Pilot Light, 10-turn Voltage Control, Concentric Coarse and Fine Current Control, Meter Range Switch.		Off-On Switch, Pilot Light, 10-turn Voltage Control, Concentric Coarse and Fine Current Control, Meter Range Switch.	
Off-On Switch, Pilot Light, Concentric Coarse and Fine Voltage Control, Concentric Meter Range and Output Range Switch.		Combined Pilot Light and On-Off Button, Two Concentric Coarse and Fine Voltage Controls, Two Concentric Meter Range and Output Range Switches.		Off-On Switch, Pilot Light, Concentric Coarse and Fine Voltage Control, Concentric Meter Range and Output Range Switch.		Off-On Switch, Pilot Light, 10-turn Voltage Control, Concentric Coarse and Fine Current Control, Meter Range Switch.		Off-On Switch, Pilot Light, 10-turn Voltage Control, Concentric Coarse and Fine Current Control, Meter Range Switch.	
0-5 V, 0-50 V, 0-.075 A, 0-.75 A		0-5 V, 0-50 V, 0-.075A, 0-.75A		0-7 V, 0-70 V, 0-.12 A, 0-1.2 A		0-20 V, 0-200 V, 0-24 mA, 0-240 mA		0-40 V, 0-400 V, 0-12 mA, 0-120 mA	
10/13 lbs. (4,53/5,89 kg)		10/13 lbs. (4,53/5,89 kg)		12/17 lbs. (5,43/7,70 kg)		13/18 lbs. (5,89/8,15 kg)		13/18 lbs. (5,89/8,15 kg)	
		\$235		\$169		\$194		\$194	
06—\$95 13—\$60 07—\$25 28—\$10		06—\$95 13—\$140 07—\$50 28—\$10 15—Deduct \$40		06—\$95 13—\$60 07—\$25 28—\$10		08—\$25 13—\$35		14—\$60 28—\$10	

†Current programming coefficient accuracy 6% of current rating; \pm 10% of output current setting.

DC POWER SUPPLIES



HVB SERIES

High voltage bench supplies
Models 6515A, 6516A

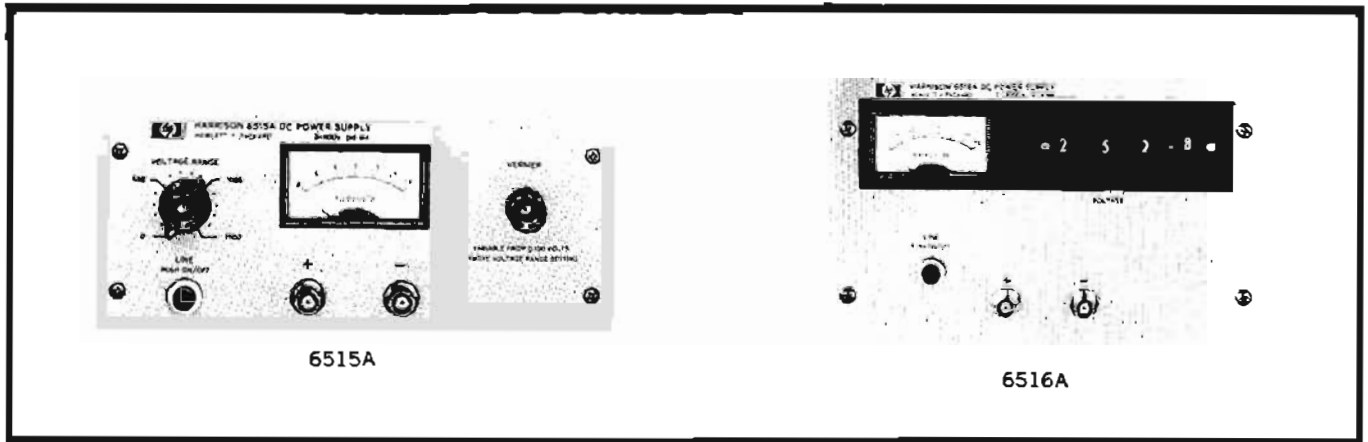

Advantages

- All-silicon semiconductor circuitry—no tubes
- Short-circuit-proof—current limit circuit
- Low output impedance at all frequencies
- 100 μ s load transient recovery
- No overshoot for turn-on, turn-off, or power removal
- Floating output—can be used as positive or negative source—up to 1000 volts
- Adjustable to zero volts for curve plotting and gradual turn-on of delicate loads

Accessories

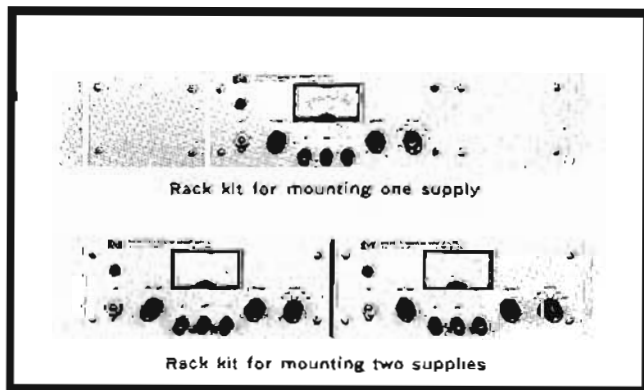

PART NO.	DESCRIPTION	PRICE
C05	8" black handle attached to side of 3½" H supply. Standard on 5¼" H supplies	\$15.00
14513A	Rack kit for mounting one 3½" H supply	\$20.00
14515A	Rack kit for mounting one 5¼" H supply	\$23.00
14523A	Rack kit for mounting two 3½" H supplies	\$10.00
14525A	Rack kit for mounting two 5¼" H supplies	\$12.00

Specifications

- Output:** 6515A—0-1600 V dc, 0.5 milliamps. 6516A—0-3000 V dc, 0-6 milliamps.
- Input:** 6515A—115 Vac \pm 10%, single phase, 60 \pm 0.3 Hz (cps), 162 mA, 19 watts max. 6516A—115 Vac \pm 10%, single phase, 57-63 Hz, 1.0 amp, 40 watts max.
- Load regulation:** Less than 0.01% or 16 millivolts (whichever is greater).
- Line regulation:** Less than 0.01% or 16 millivolts (whichever is greater).
- Ripple and noise:** Less than 2 mV rms. Less than 5 mV peak-to-peak.
- Temperature coefficient:** Less than 0.02% plus 2 millivolts/ $^{\circ}$ C.
- Stability:** The total drift for 8 hours (after 30 minutes warmup) at a constant ambient is less than 0.05% plus 5 millivolts.
- Temperature rating:** Operating 0 to 55 $^{\circ}$ C. Storage -40 to 70 $^{\circ}$ C.
- Output impedance:**
Less than 32 ohms from dc to 30 Hz.
Less than 8 ohms from 30 Hz to 100 kHz.
Less than 2 ohms from 100 kHz to 1 MHz.
- Controls:** 6515A—Sixteen position rotary switch adjusts the output voltage in 100-volt steps; a 10-turn vernier permits continuous adjustment with a 100 mV resolution over any 100-volt span. 6516A—Four-digit front panel voltage programmer with 1-volt resolution.
- Meters:** A 0-1800 Volt voltmeter is included on the front panel of the 6515A. The 6516A has a 0-3500 Volt voltmeter.
- Size:** 6515A—8½" (21,6 cm) W x 3½" (8,9 cm) H x 11-13/16" (3 cm) D. 6516A—8½" (21,6 cm) W x 5¼" (12,8 cm) H x 14" (35,6 cm) D.
- Weight:** 6515A—12 pounds (5,44 kg) net, 15 pounds (6,8 kg) shipping.
6516A—17 pounds (7,71 kg) net, 20 pounds (9,07 kg) shipping.
- Finish:** Light gray front panel with dark gray case.
- Power cord:** A 3-wire 5-foot (1,52 m) power cord is provided with each unit.
- Price:** 6515A—\$235.00, 6516A—\$295.00.

Options:

05. 50 Hz ac input: Supply as normally shipped is wired for 60 Hz operation; Option 05 includes internal rewiring and retesting. Available on Model 6516A only. Add: \$50.
13. Calibrated Decadal. This calibrated 10-turn potentiometer replaces the front panel 10-turn vernier to provide resetability within 0.1%. Add \$35.00. Available in Model 6515A only.
18. 230 Vac \pm 10% Single Phase Input: Factory modification includes the installation of a 230-volt power transformer to replace the standard 115-volt transformer. Available on Model 6516A only, add \$50.

MPM SERIES

Medium power modular dc supplies
Models 6220B-6226B



DC POWER SUPPLIES

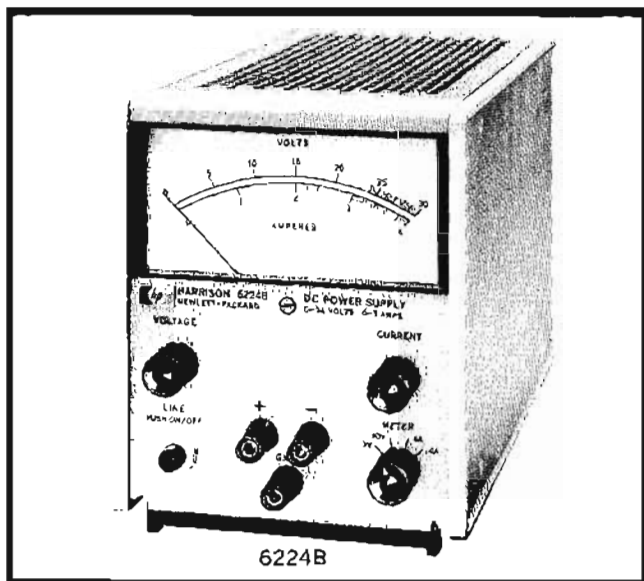

The MPM Series consists of compact Constant Voltage/Constant Current dc power supplies suitable for either bench or rack operation. They are packaged in one-third rack width modules for use in the modular enclosure system, described on pages 631 and 632. MPM supplies are designed to satisfy the need for a general purpose and reliable source of power for engineers experimenting with transistor circuit design.

Models 6224B and 6226B possess all of the advantages of the preceding "A" versions of these models plus the following improvements:

- Increased output voltage.
- Ten-turn voltage and current controls for better output settable.
- Multiple range meter for increased bench utility.
- Special circuitry for faster programming.
- All silicon semiconductors for greater reliability.

In addition a dual range supply, Model 6220B has been added to the series. This supply can be used as a 0-25 volt source at 0-1 A or a 0-50 volt source at 0-0.5 A.

Specifications

Model		6220B	6224B	6226B
Output	DC voltage	0-25 V	Dual range 0-50 V	0-24 V
	DC current	0-1 A	0-0.5 A	0-3 A
Input: 115 V ac $\pm 10\%$		50-400 Hz 0.5A, 44W	50-60 Hz 1.8 A, 164 W	50-60 Hz 1.8 A, 164 W
Load regulation: the constant voltage load regulation is given for a load current change equal to the current rating of the supply. The constant current load regulation is given for a load voltage change equal to the voltage rating of the supply.	CV	0.01% plus 2 mV	0.01% plus 4 mV	0.01% plus 2 mV
	CC	0.01% plus 250 μ A	0.01% plus 250 μ A	0.01% plus 250 μ A
Line regulation: for a $\pm 10\%$ change in the nominal line voltage at any output voltage and current within rating.	CV	0.01% plus 2 mV	0.01% plus 2 mV	0.01% plus 2 mV
	CC	0.01% plus 250 μ A	0.01% plus 250 μ A	0.01% plus 250 μ A
Ripple and noise: at any line voltage and under any load condition within rating.	CV	200 μ V rms/1 mV p-p (dc to 20 MHz)		
	CC	200 μ A rms/1 mA p-p (dc to 20 MHz)		
Temperature coefficient: output change per degree centigrade change in ambient following 30 minutes warm-up.	CV	0.02% plus 1 mV	0.02% plus 500 μ V	0.02% plus 500 μ V
	CC	0.02% plus 1 mA	0.02% plus 1.5 mA	0.02% plus 0.8 mA
Stability: under constant ambient conditions, total drift for 8 hours following 30 minutes warm-up.	CV	0.1% plus 5 mV	0.1% plus 2.5 mV	0.1% plus 2.5 mV
	CC	0.1% plus 5 mA	0.1% plus 7.5 mA	0.1% plus 4 mA
Remote programming: all programming terminals are located on rear barrier strips.	CV	200 ohms per volt	200 ohms per volt	200 ohms per volt
	CC	500 ohms per amp	500 ohms per amp	500 ohms per amp
Meter ranges:		0-6 V, 0-60 V, 0-0.12 A, 0-1.2 A	0-3 V, 0-30 V, 0-0.4 A, 0-4 A	0-6 V, 0-60 V, 0-0.18 A, 0-1.8 A
Weight: (net/shipping)	lbs. kg	16/20 7.25/9.1	16/20 7.25/8.6	16/20 7.25/8.6
Price:		\$250	\$325	\$325
Options: refer to page 513 for description			13—\$35 14—\$35 28—\$10	

CV = Constant Voltage CC = Constant Current

Output Impedance

DC to 100 Hz—less than 0.001 ohm, 100 Hz to 1 kHz—less than 0.01 ohm, 1 kHz to 100 kHz—less than 0.2 ohm, 100 kHz to 1 MHz—less than 2 ohms.

Transient recovery time: less than 50 μ seconds is required for output voltage recovery in constant voltage operation to within 10 millivolts of the nominal output voltage following a change in output current equal to the current rating of the supply. The nominal output voltage is defined as the mean between the no load and full load voltages.

Temperature ratings: operating: 0-50°C (consult factory for derating information for operation between 50°C and 71°C); storage: -20°C to +85°C.

Controls: ten-turn output voltage and current controls permit continuous adjustment over entire output span. Switch selects front panel meter voltage or current scale.

Finish: light gray panel with dark gray case.

Size: 6 $\frac{1}{4}$ " H x 5 $\frac{1}{8}$ " W x 11" D (15.9 cm H x 13 cm W x 28 cm D).

DC POWER SUPPLIES



MPB-3 & MPB-5; DPR SERIES

Medium power bench; dual power rack supplies
Models 6281A-6299A; 6253A, 6255A

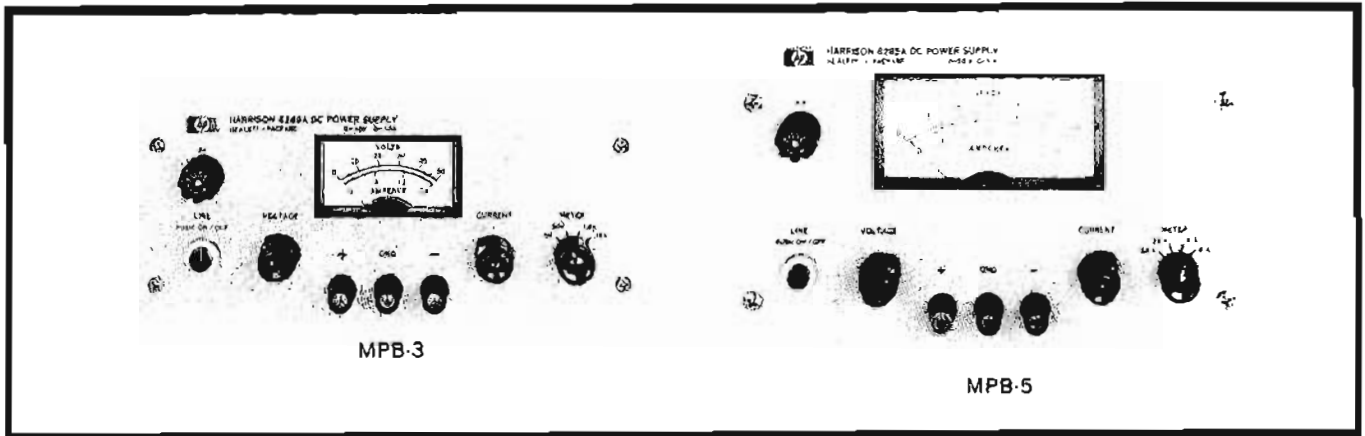

The MPB-3 and MPB-5 Series of dc power supplies are highly regulated, medium power, Constant Voltage/Constant Current bench models. All include multiple range meters and provision for Remote Sensing, Remote Programming, Auto-Series, Auto-Parallel, and Auto-Tracking operation.

The DPR models contain two identical MPB-3 supplies mounted in a full rack-width chassis. All DPR features and specifications are identical to the MPB-3 with the exceptions listed on the following page.

Advantages:

- Short circuit proof
- Constant voltage/constant current operation with automatic crossover
- Multiple range meters
- Floating output
- All silicon circuitry
- Front and rear output terminals
- No overshoot on turn-on, turn-off, or power removal
- Easily rack mounted
- Oversvoltage protection "crowbar" option
- Auto-series, auto-parallel, auto-tracking

MPB-5 Specifications

Model		6282A	6285A	6288A	6290A	6291A	6296A
Output	DC Voltage	0-10V	0-20V	0-20V	0-40V	0-40V	0-60V
	DC Current	0-10A	0-5A	0-10A	0-3A	0-5A	0-3A
Input: 115 V ac $\pm 10\%$, 50-60 Hz		3.5A, 200W	3.5A, 160W	5.5A, 320W	3.5A, 170W	5.5A, 280W	4.5A, 250W
*Load regulation: The Constant Voltage Load Regulation specification is given for a load current change equal to the current rating of the supply. The Constant Current Load Regulation specification is given for a load voltage change equal to the voltage rating of the supply.	C V	0.01% plus 1 mV	0.01% plus 1 mV	0.01% plus 1 mV	0.01% plus 1 mV	0.01% plus 1 mV	0.01% plus 1 mV
	C C	0.05% plus 1 mA	0.05% plus 1 mA	0.05% plus 1 mA	0.05% plus 1 mA	0.05% plus 1 mA	0.05% plus 1 mA
Line regulation: For a 10% change in the nominal voltage line at any output voltage and current within rating.	C V	0.01% plus 1 mV	0.01% plus 1 mV	0.01% plus 1 mV	0.01% plus 1 mV	0.01% plus 1 mV	0.01% plus 1 mV
	C C	0.05% plus 1 mA	0.05% plus 1 mA	0.05% plus 1 mA	0.05% plus 1 mA	0.05% plus 1 mA	0.05% plus 1 mA
Ripple and noise: At any line voltage and under any load condition within rating.	C V	500 μ V RMS	500 μ V RMS	500 μ V RMS	500 μ V RMS	500 μ V RMS	500 μ V RMS
	C C	5 mA RMS	3 mA RMS	5 mA RMS	3 mA RMS	3 mA RMS	3 mA RMS
Remote programming: All Programming terminals are located on rear barrier strips.	C V	200 ohms per volt	200 ohms per volt	200 ohms per volt	200 ohms per volt	200 ohms per volt	300 ohms per volt
	C C	100 ohms per amp	200 ohms per amp	100 ohms per amp	500 ohms per amp	200 ohms per amp	500 ohms per amp
Meter ranges:		0-1.2 V, 0-12 V, 0-1.2 A, 0-12 A	0-2.4 V, 0-24 V, 0-6 A, 0-6 A	0-2.4 V, 0-24 V, 0-1.2 A, 0-12 A	0-5 V, 0-50 V, 0-4 A, 0-4 A	0-5 V, 0-50 V, 0-6 A, 0-6 A	0-7 V, 0-70 V, 0-4 A, 0-4 A
Weight: (Net/Shipping)	lbs	25/32	25/32	30/40	26/33	30/40	29/38
	kg	11.3/14.5	11.3/14.5	13.6/14.1	11.8/15.0	13.6/14.1	13.1/12.7
Price		\$350	\$350	\$395	\$350	\$395	\$395
Options:		06-\$125	06-\$95	06-\$125	06-\$95	06-\$95	06-\$95
Refer to page 513 for description		05-\$10 09-\$45	No charge if ordered with Option 28 13-\$60		07-\$25 28-\$50	08-\$25	

*CV load regulation given for rear terminals only. At front terminals CV load regulation is 0.5 mv per amp greater due to front terminal resistance.

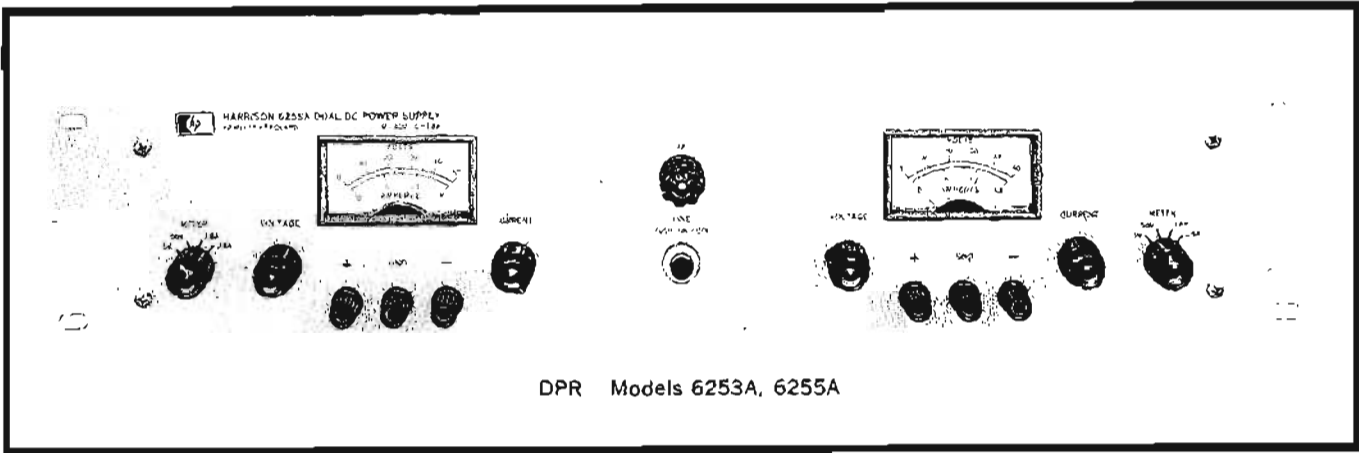

Output impedance:

- DC to 1 kHz-less than 0.02 ohm
- 1 kHz to 10 kHz-less than 0.03 ohm
- 10 kHz to 100 kHz-less than 0.3 ohm
- 100 kHz to 1 MHz-less than 3 ohms

Controls: Concentric coarse and fine output voltage and current controls permit continuous adjustment over entire output span. Model 6299A incorporates a 10-turn front panel voltage control in lieu of the concentric coarse and fine voltage controls. Switch selects front panel meter voltage or current scale

Finish: Light gray panel with dark gray case.

Accessories: Same as HVB Series. Refer to page 522.

Transient recovery time: Less than μ s is required for output voltage recovery in constant voltage operation to within

15 millivolts of the nominal output voltage following a change in output current equal to the current rating of the supply or 5 amperes, whichever is smaller. The nominal output voltage is defined as the mean between the no load and full load voltages.

Temperature ratings:

- Operating: 0-50°C (consult factory for derating information for operation between 50°C and 71°C)
- Storage -20°C to +85°C

Size:

- MPB-3 — 3½" H x 8½" W x 14½" D
— 8,9 cm H x 21,8 cm W x 36,8 cm D
- MPB-5 — 5¼" H x 8½" W x 16" D
— 13,3 cm H x 21,8 cm W x 40,7 cm D
- DPR — 3½" H x 14½" D x 19" W
— 8,9 cm H x 36,8 cm D x 48,3 cm W

Model		MPB-3 6281A	MPB-3 6284A	DPR 6253A	MPB-3 6289A	DPR 6255A	MPB-3 6294A	MPB-3 6299A
Output	DC Voltage	0-7.5V	0-20V		0-40V		0-60V	0-100V
	DC Current	0-5A	0-3A		0-1.5A		0-1A	0-750 mA
Input: 115 V ac ±10%, 50-400 Hz		1.3 A 118 W	1.5 A 128 W	3 A 256 W	1.3 A 110 W	2.6 A 220 W	1.3 A 114 W	1.5 A 135 W
*Load regulation: The Constant Voltage Load Regulation is given for a load current change equal to the current rating of the supply. The Constant Current Load regulation is given for a load voltage change equal to the voltage rating of the supply.	C V	5 mV	0.01% plus 4 mV		0.01% plus 2 mV		0.01% plus 2 mV	0.01% plus 2 mV
	C C	0.01% plus 250 μ A	0.01% plus 250 μ A		0.01% plus 250 μ A		0.01% plus 250 μ A	0.01% plus 250 μ A
Line regulation: For a 10% change in the nominal line voltage at any output voltage and current within rating.	C V	0.01% plus 2 mV	0.01% plus 2 mV		0.01% plus 2 mV		0.01% plus 2 mV	0.01% plus 2 mV
	C C	0.01% plus 250 μ A	0.01% plus 250 μ A		0.01% plus 250 μ A		0.01% plus 250 μ A	0.01% plus 250 μ A
Ripple and noise: At any line voltage and under any load condition within rating.	C V	200 μ V RMS/1 mV p-p						
	C C	4 mA RMS	2 mA RMS		500 μ A RMS		500 μ A RMS	500 μ A RMS
Remote programming: All Programming terminals are located on rear barrier strips.	C V	200 ohms per volt	200 ohms per volt		200 ohms per volt		300 ohms per volt	300 ohms per volt
	C C	200 ohms per amp	500 ohms per amp		500 ohms per amp		1000 ohms per amp	1000 ohms per amp
Meter ranges		0-9 V, 0-9 V, 0-6 A, 0-6 A	0-2.4 V, 0-24 V, 0-4 A, 0-4 A		0-5 V, 0-50 V, 0-18 A, 0-1.8 A		0-7 V, 0-70 V, 0-12 A, 0-1.2 A	0-12 V, 0-120 V, 0-1 A, 0-1 A
Weight: (Net/Shipping)	lbs.	14/19	14/19	28/35	14/19	28/35	14/19	15/20
	kg	6,4/8,6	6,4/8,6	12,7/15,8	6,4/8,6	12,7/15,8	6,4/8,6	6,8/9,1
Price		\$210	\$210	\$445	\$210	\$445	\$210	\$225
Options:		06	\$95	\$190	\$95	\$190	\$95	\$95
Refer to page 513 for details		MPB-3	07-\$25	08-\$25	09-\$45	13-\$60	14-\$60	28-\$10
		DPR	07-\$50	08-\$50	09-\$90	10-\$125	13-\$120	14-\$120
								28-\$10

CC Indicates constant current.

CV Indicates constant voltage.

DC POWER SUPPLIES



STB SERIES

High stability dc power supply/calibrator
Models 6101A - 6116A

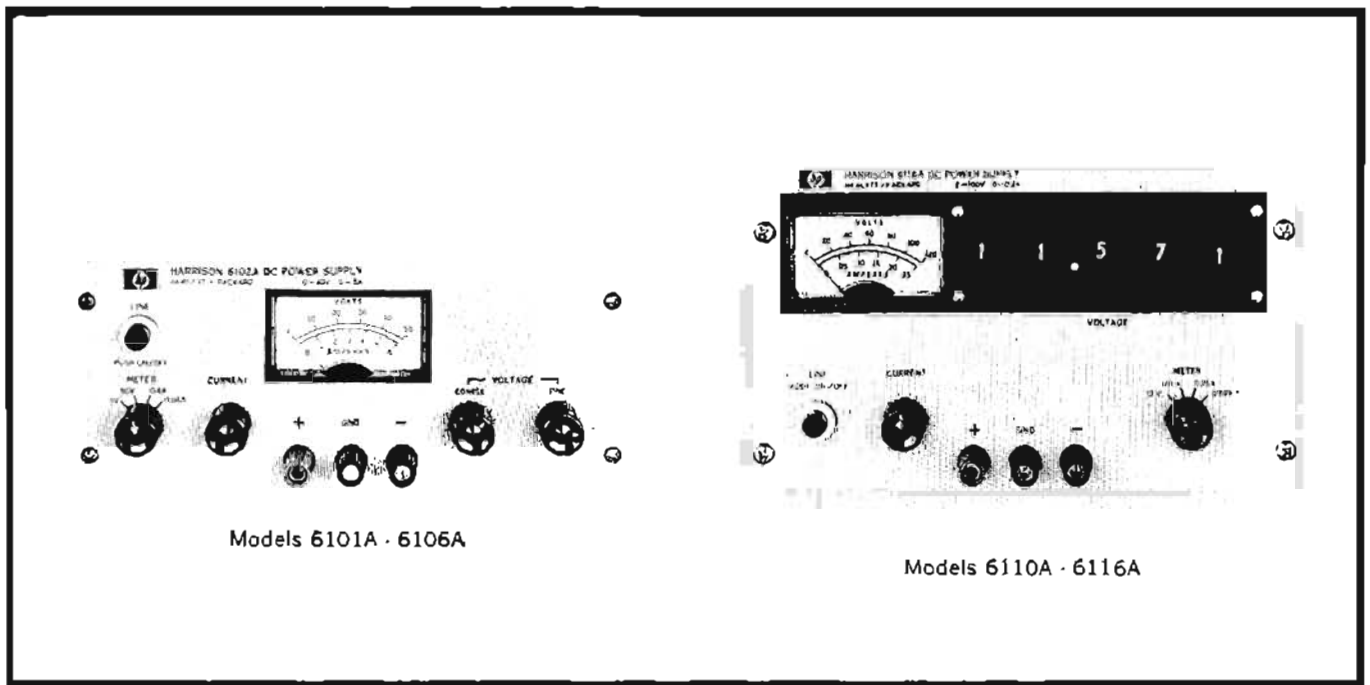

Models 6101A - 6106A

Models 6110A - 6116A

Model	6101A	6102A	6106A	6110A	6111A	6112A	6113A	6116A
DC output	0-20V 0-1A	0-40V 0-500mA	0-100V 0-200mA	0-3000V 0-6mA	0-20V 0-1A	0-40V 0-500mA	0-10V 0-2A	0-100V 0-200mA
Load regulation: For full rated output current change	Front terminals 0.001% (10ppm) plus 600 μ V Rear terminals 0.001% (10ppm) + 100 μ V	0.001% (10ppm) plus 350 μ V	0.001% (10ppm) plus 200 μ V	0.001% (10ppm) plus 100 μ V	0.001% (10ppm) plus 600 μ V	0.001% (10ppm) plus 350 μ V	0.001% (10ppm) plus 1.1 mV	0.001% (10ppm) plus 200 μ V
Line regulation: For a 10% change in the nominal line voltage	0.001% (10ppm)		0.001% (10ppm)			0.001% (10ppm)		
Ripple and noise	40 μ V RMS 100 μ V P-P		40 μ V RMS 100 μ V P-P	400 μ V RMS 1 mV P-P	40 μ V RMS 100 μ V P-P			
Temperature coefficient: Output voltage change per $^{\circ}$ C after 30 minute warm-up.	Front panel control 0.005% (50ppm) plus 30 μ V Remote programming 0.001% (10ppm) plus 10 μ V	0.005% (50ppm) plus 50 μ V	0.005% (50ppm) plus 100 μ V	0.001% (10ppm) plus 50 μ V	0.001% (10ppm) + 10 μ V			
Stability: Total drift after 30 minute warm-up and with 3 $^{\circ}$ C ambient variation.	Front panel control For 8 hrs. 0.01% + 300 μ V Remote programming For 8 hrs. — 0.01% + 100 μ V For 1 month — 0.012% + 120 μ V	For 8 hrs. 0.01% + 500 μ V	For 8 hrs. 0.01% + 1 mV	For 8 hrs. 0.01% + 500 μ V For 1 month 0.012% + 600 μ V	For 8 hours: 0.01% + 100 μ V For 1 month: 0.012% + 120 μ V Controlled Environment **for 8 hours: 0.005% + 10 μ V			
Output Impedance	DC — 100 Hz: <0.002 Ω 100 Hz — 1 kHz: <0.02 Ω 1 kHz — 100 kHz: <0.5 Ω 100 kHz — 1 MHz: <3 Ω			At 3000 V DC — 1000 Hz: <50 Ω At 3 V DC — 100 Hz: <0.05 Ω	DC — 100 Hz: <0.002 Ω 100 Hz — 1 kHz: <0.02 Ω 1 kHz — 100 kHz: <0.5 Ω 100 kHz — 1 MHz: <3 Ω			
Remote programming: All programming terminals are located on rear barrier strip	Coefficient — 1000 ohms per volt Accuracy — 0.1% plus 1 mV Resistability — 0.01% + 200 μ V			Coefficient — 1000 ohms per volt Accuracy — 0.1% plus 1 mV Resistability — 0.01% + 200 μ V				
Meters ranges Single meter with switch to select scale	0-2.5V/0-25V 0-120mA/0-1.2A	0-5V/0-50V 0-60mA/0-600mA	0-12V/0-120V 0-25mA/0-250mA	0-3500V 0-7mA	0-2.5V/0-25V 0-120mA/0-1.2A	0-5V/0-50V 0-60mA/0-600mA	0-12V/0-12V 0-25mA/0-2.5A	0-12V/0-120V 0-25mA/0-250mA
Size	Inches	8 1/4 W \times 3 1/4 H \times 12 1/2 D			8 1/2 W \times 5 1/4 H \times 16 D	8 3/4 W \times 5 1/4 H \times 12 1/2 D		
	Centimeters	21.6 W \times 8.9 H \times 32 D			21.6 W \times 14 H \times 40.6 D	21.6 W \times 14 H \times 32 D		
Weight: Net/Shipping (lb.)	Pounds	10/13	10/13	10/13	19.23	11/15	11/15	11/15
	Kilograms	4.5/5.9	4.5/5.9	4.5/5.9	7.7/10.4	5.0/6.8	5.0/6.8	5.0/6.8
Price		\$265	\$265	\$265	\$495	\$375	\$375	\$375
Options: Refer to p. 513 for description.		06 — \$95 28 — \$10	06 — \$95 28 — \$10	06 — \$95 28 — \$10	*05 — \$50 18 — \$50	06 — \$95 28 — \$10	06 — \$95 28 — \$10	06 — \$95 28 — \$10

*No charge if ordered with option 18

**Constant load current, line voltage, and ambient temperature

Advantages

- Low output drift and temperature coefficient.
- Low output ripple
- Low output impedance
- High accuracy remote programming (except 6110A)
- Remote error sensing (except 6110A)
- No overshoot on turn-on, turn-off, or power removal
- Output continuously adjustable to zero volts
- High output voltage resolution — ten-turn coarse and one-turn fine control (6101A, 6102A and 6106A)
- In-line 5-digit thumb-wheel voltage programmer (6110A, 6111A, 6112A, 6113A, 6116A)
- All silicon design
- Positive or negative output
- Short circuit proof
- Continuously variable current limit control
- Output voltage and current metering
- Easily rack mounted for systems applications
- Auto-series and auto-tracking operation
- Multiple range meter
- Resettability — 0.01% + 200 μ V

Description

The STB Series of high stability dc bench supplies has been designed for those applications requiring performance an order of magnitude better than well-regulated laboratory supplies. The performance advantages of the STB Series exist with regard to virtually every important aspect of power supply performance — ripple, stability, temperature coefficient, output resolution, programming accuracy, load and line regulation.

The all-silicon circuit uses as its reference element a temperature-compensated zener diode having a temperature coefficient of 20 ppm/ $^{\circ}$ C. A high gain feedback amplifier employing a "diff-amp" (matched silicon differential amplifier package) monitors and controls the output voltage. Critical components, including the zener reference diode and low level portions of the feedback amplifier, are enclosed in an oven which is temperature-controlled entirely with solid-state components — no moving parts to wear out.

Models 6111A, 6112A, 6113A, and 6116A are similar to models 6101A, 6102A and 6106A except for the built-in 5-digit thumb-wheel voltage programmer.

Model 6110A is a high-voltage high-stability supply that is all silicon (no tubes) and also can provide a positive or negative output. The 6110A is ideally suited for high-voltage photomultipliers requiring an exceptionally stable power source. It can also be used as a 0-3000 volt calibrator.

Specifications

AC input: Model 6110A—115 Vac \pm 10%, 57-63 Hz, 1A, 50 W. Other Models—115 Vac \pm 10%, 48-63 Hz, 0.5A, 52 W.

Temperature ranges: operating: 0 to 50 $^{\circ}$ C.
storage: -20 $^{\circ}$ C to +85 $^{\circ}$ C.

Transient recovery time: less than 50 μ s is required for output voltage to recover to within 10 millivolts of the nominal output voltage following a full load change in output current.

Less than 100 μ s is required for output voltage recovery to within the load regulation specification.

The nominal output voltage is defined as the means between the no load and full load voltage.

Controls: 6101A, 6102A & 6106A—A 10 turn pot permits continuous adjustment of the output voltage over its entire range. A single-turn pot allows fine trimming of the output voltage; resolution is 100 μ V +0.002% of the output voltage. A single-turn front-panel pot permits the current limit setting to be varied continuously from zero to a value slightly in excess of the full current rating. 6110A, 6111A, 6112A, 6113A & 6116A—An in-line 5-digit (thumb-wheel) voltage programmer permits control of the output voltage with an accuracy of 0.1% +1 mV (6110A is 0.1% +100 mV and 6113A is 0.1% + 10 μ V) of the output voltage. Resolution is 100 μ V (except 6110A, which is 10 mV). The 6111A, 6112A, 6113A & 6116A have a single-turn front panel pot that permits the current limit setting to be varied continuously from zero to a value slightly in excess of the full current rating. The 6110A has a fixed current limit built-in to the supply.

Overload protection: an all electronic, continuously acting current limit protects the power supply for all overloads regardless of how long imposed, including a direct short circuit across the output terminals.

Output terminals: The dc output of the supply is floating; thus, the supply can be used as either a positive or negative source. Terminals for +OUT, -OUT, and GND are provided on both the front and back of the supply (except 6110A which has front terminals only). In addition, the rear barrier strip includes terminals for remote programming, remote sensing, Auto-Series, and Auto-Tracking operation (except 6110A).

Cooling: convection cooling is employed. The supply has no moving parts.

Finish: light gray front panel with dark gray case.

Power cord: a 3-wire 5-foot power cord is provided with each unit.

Accessories: same as HVB Series. Refer to page 522.

DC POWER SUPPLIES



CCB SERIES

Constant current bench supplies
Models 6177A—6186A

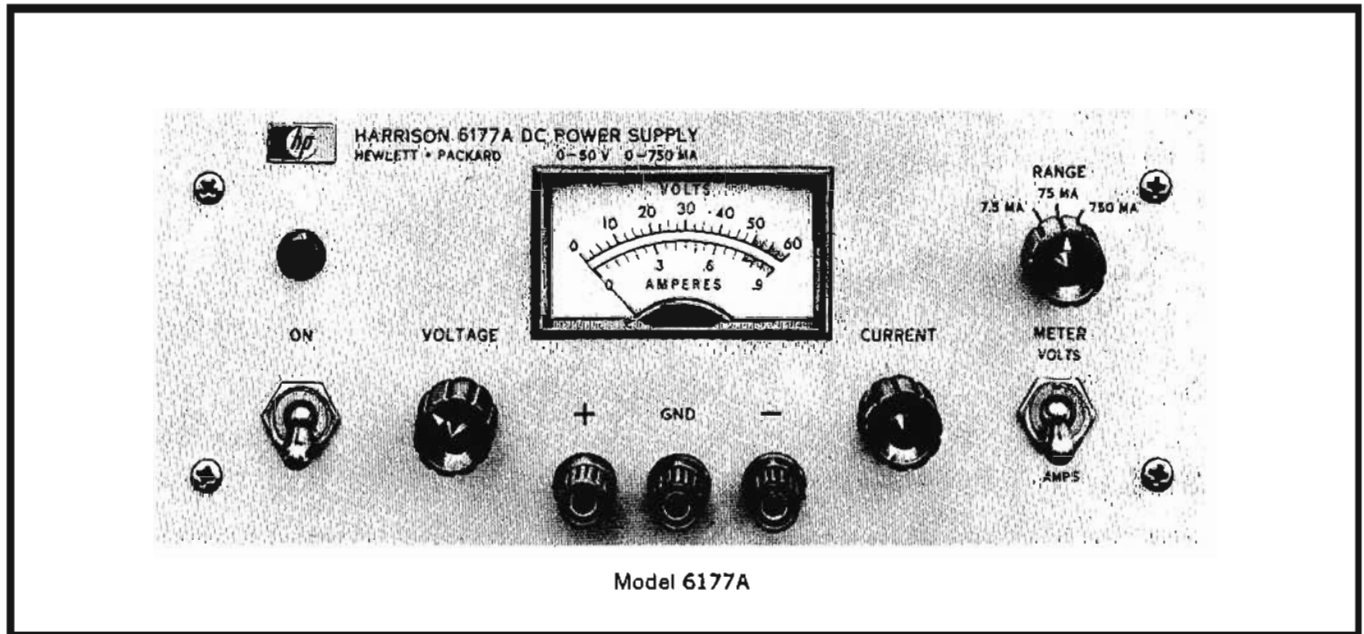

Model 6177A

Description

With the CCB Series, Hewlett-Packard has achieved a new concept in moderately priced, precision regulated constant current DC power supplies. These instruments, which employ all-silicon semiconductor circuitry, are much smaller and lighter than any constant current supplies of similar output rating now on the market. Their ripple, regulation, and drift characteristics are orders of magnitude better than comparably priced constant current supplies.

Placing a voltmeter across the output terminals of a standard constant current power supply degrades the load regulation and diminishes the load current. The CCB Series eliminates this error by using an operational amplifier to feed the front panel voltmeter. This "replica" of the output voltage is also presented on rear terminals for possible connection to a more accurate differential or digital voltmeter, thus increasing the utility of these constant current supplies for component testing and sorting systems.

The use of a three-position output range switch and 10-turn output control result in resolution down to $0.2 \mu\text{a}$; special attention has been given to circuit details so that well regulated performance is maintained down to these low output currents.

A considerable number of design precautions contribute to the dc isolation and ac shielding properties which are necessary for a high performance constant current supply. A double box shield technique insures a completely shielded ac power transformer primary; an additional shield is added around the outside of the transformer. Internal guarding techniques prevent switches and other components within the power supply from contributing to leakage and coupling paths which would degrade output performance.

Applications

Precision performance, low price, and small size and weight, combine to make CCB Series supplies useful as general purpose laboratory constant current sources for semiconductor circuit development and component evaluation.

In addition, the stability and rapid remote programming characteristics lend these same instruments to diverse applications; such as component testing and sorting zener diodes, diodes, transistors, SCR's, resistors, relays, meters; and precision electroplating, precision electromagnets, etc. The capability of superimposing output ac modulation or of applying a varying dc voltage input permit CCB supplies to be used for measurement of such characteristics as dynamic impedance, voltage breakdown, and leakage resistance.

Advantages

- Precision constant current regulation
- Rapid programming
- Output useful to microampere region
- All-silicon circuitry—no tubes
- Compact mechanical design—small size, light-weight
- High speed, full range voltage compliance
- High output impedance over wide frequency band
- Ammeter scales ganged to output range switch
- Remote programming using resistance or voltage control
- Can be modulated from external ac source
- Continuously variable voltage limit
- Auto parallel operation
- Front and rear output terminals
- Floating output can be used as positive or negative source
- No overshoot for turn-on, turn-off, or power removal
- Rack mounting hardware available
- Rear terminals for monitoring output voltage

Specifications

MODEL		6177A	6181A	6188A
Output Current		0-750 mA	0-300 mA	0-100 mA
Voltage Compliance		0-50V	0-100V	0-300V
Output Ranges		A.	0-7.5 mA	0-3 mA
		B.	0-75 mA	0-30 mA
		C.	0-750 mA	0-300 mA
Output Current Remote Programming	Voltage Control	Range A.	100 mV/mA	1V/mA
		Range B.	10 mV/mA	100 mV/mA
		Range C.	1 mV/mA	10 mV/mA
	Resistance Control	Range A.	1 k Ω /mA	10 k Ω /mA
		Range B.	100 Ω /mA	1 k Ω /mA
		Range C.	10 Ω /mA	100 Ω /mA
Voltage Limit Remote Programming		200 ohms/V	200 ohms/V	250 ohms/V
Meter Ranges		9, 90, 900 mA, 60V	3.6, 36, 360 mA, 120V	1.2, 12, 120 mA, 360V
Price		\$425	\$425	\$425

AC input: 115 V ac $\pm 10\%$, 48-63 Hz, 0.7 A, 60 W.

Load regulation: Less than 10 ppm of output + 5 ppm of range switch setting for a load change resulting in an output voltage change from zero to maximum rated output.

Line regulation: Less than 10 ppm for a 10% change in the nominal line voltage.

Rms ripple & noise: Less than 100 ppm of output + 20 ppm of range switch setting.

Transient recovery time: Less than 200 μ s for output current recovery to within 1% of the nominal output current following a full load change in output voltage.

Current programming speed: Less than 500 μ sec from zero to 0.99 of maximum output current with an accuracy of 1%.

Temperature coefficient: Less than 70 ppm of output + 5 ppm of range switch setting per degree C.

Stability: Less than 100 ppm of output + 25 ppm of range switch setting. Stability is measured for eight hours after 30 minutes warm-up under conditions of constant line, load, and temperature.

Resolution: 0.02% of range switch setting.

Temperature rating: Operating: 0 to 55°C.
Storage: -40 to +85°C.

Load protection: The continuously variable voltage limit circuit protects both the supply and the load for all conditions including an open circuit load.

Controls: Three-position output current and meter range switch, 10-turn output current control, voltage limit control, meter switch, power switch, and pilot light.

Output terminals: A positive and negative output terminal are included on the front panel, as well as a ground terminal. The supply may be operated floating or either side may be grounded. A rear panel barrier strip includes output terminals and other terminals necessary for remote programming, ac modulation, and other control functions. Two rear terminals provide a "replica" of the output voltage for connection of a differential or digital voltmeter—1 mA maximum current, accuracy settable to within 5 mV of the output voltage.

TYPICAL OUTPUT IMPEDANCE (OHMS)

MODEL	6177A			6181A			6188A		
	750	75	7.5	300	30	3	100	10	1
Dc to 100 Hz	$\geq 5M$	$\geq 50M$	$\geq 500M$	$\geq 20M$	$\geq 200M$	$\geq 2G$	$\geq 200M$	$\geq 2G$	$\geq 20G$
100 Hz to 1 kHz	$\geq 1 M\Omega$			1 kHz to 10 kHz			$\geq 100 k\Omega$		
10 kHz to 100 kHz	$\geq 10 k\Omega$			100 kHz to 1 MHz			$\geq 100 \Omega$		

Size: 3 $\frac{1}{2}$ " (89 mm) H x 8 $\frac{1}{2}$ " (216 mm) W x 12 $\frac{5}{8}$ " (321 mm) D. Package size is half rack width and is easily rack mounted using accessories listed below.

Weight: 10 lbs (4.53 kg) net, 13 lbs (5.9 kg) shipping.

Finish: Light gray front panel with dark gray case.

Power cord: A three-wire, 5 ft. (1.52 m) power cord is provided with each unit.

Option 14: Three digit graduated decadal current control. This calibrated 10-turn potentiometer replaces the front-panel 10-turn vernier to provide resettability within 0.1% Add \$35.00.

Option 28: 230Vac $\pm 10\%$, Single Phase Input. Factory modification consists of reconnecting the multi-tap input power transformer for 230-volt operation.

Add \$10.

Accessories: Same as HVB Series. Refer to page 522.

DC POWER SUPPLIES



ICS SERIES
Integrated circuit supplies
Models 6384A—6388A

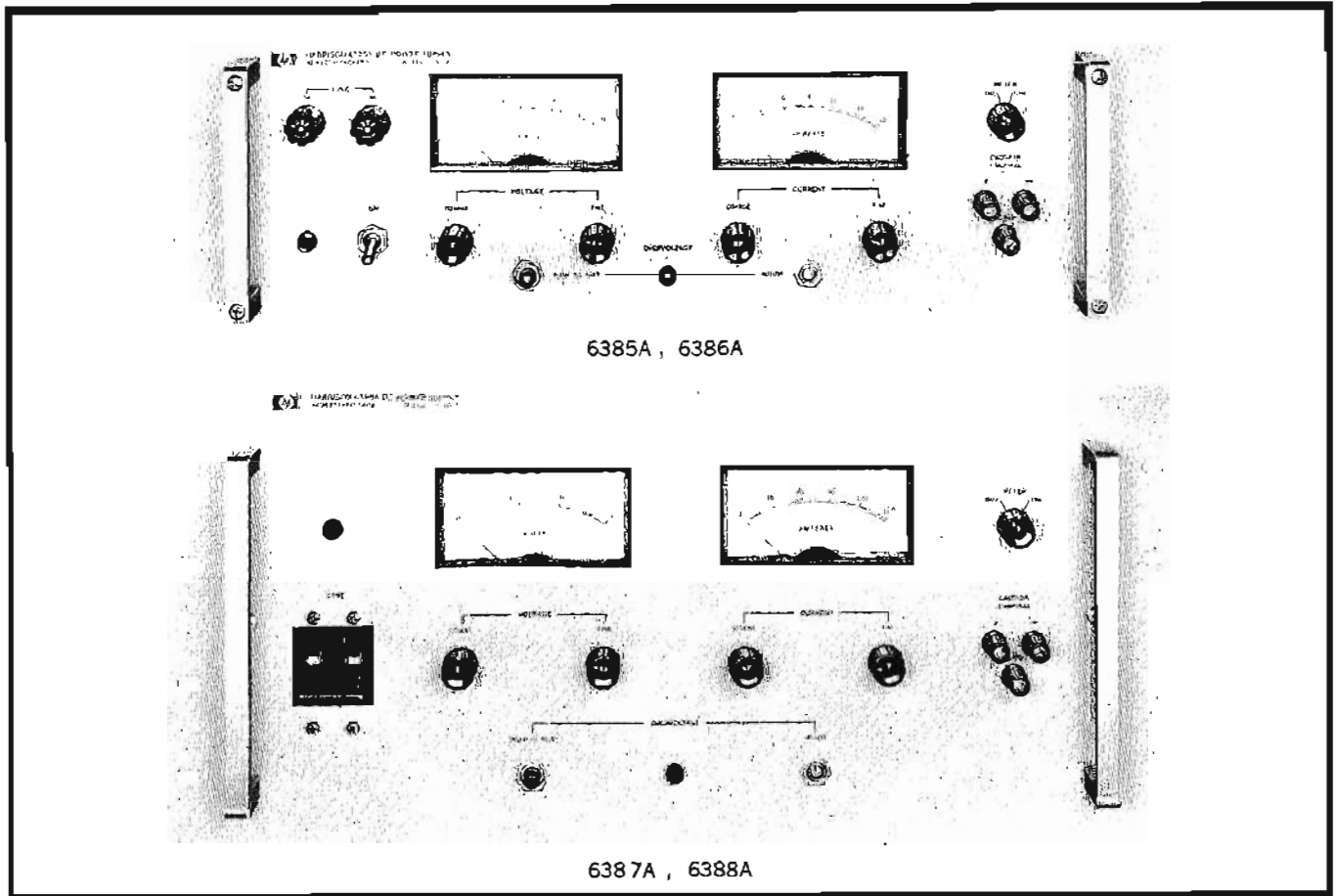

The ICS Series of well regulated dc constant voltage/constant current power supplies are specifically designed for use with integrated circuits, micromodular circuits, and other low voltage semiconductor circuitry. Included in these rack-width instruments is an overvoltage "crowbar" protection circuit. If for any reason an incipient overvoltage condition occurs, this completely independent circuit shorts the output terminals with an SCR crowbar within 10 μ s.

A temperature compensated zener diode is employed as the reference element in all-silicon series regulator feedback circuit which monitors and controls the output voltage. The resulting low ripple and low output impedance permit these supplies to be used in critical applications where less well regulated supplies are not suited.

Advantages

- All silicon semiconductor circuitry
- Low output drift
- High degree of output resolution
- Low peak to peak ripple and noise
- Low output impedance at all frequencies
- 200 μ s load transient recovery
- No overshoot for turn-on, turn-off, or power removal
- Floating output—can be used as positive or negative source
- Fully rated for any overload condition

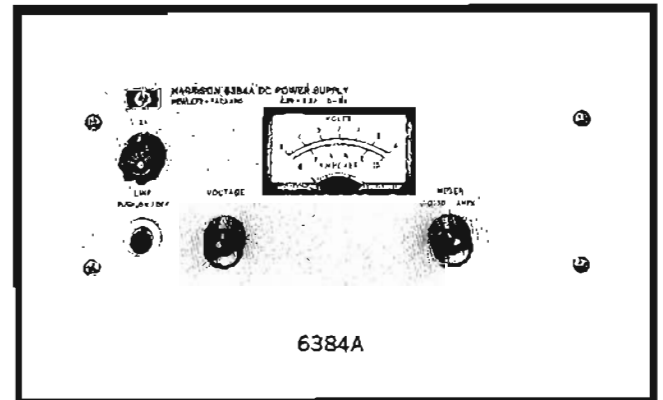

Additional Advantages, Models 6385A—6388A

- Remote programming
- Remote error sensing
- Continuously variable output voltage and current
- Auto-series, auto-parallel and auto-tracking operation
- Constant voltage/constant current operation with automatic crossover; Model 6384A — constant voltage/current limiting
- Both voltage comparison amplifier and current comparison amplifier employ "diffamps"

Specifications

MODEL		6384A*	6385A	6386A	6387A	6388A
Output	DC Voltage	4–5.5 V	0–7.5 V	0–7.5 V	0–7.5 V	0–7.5 V
	DC Current	0–8 A	0–15 A	0–30 A	0–60 A	0–120 A
Input 48–63 Hz		115 V ac \pm 10% 1.35 A, 120 W @ 115 V ac	115 V ac \pm 10%	115 V ac \pm 10%	230 V ac \pm 10%	230 V ac \pm 10%
Remote programming All Programming terminals are located on rear barrier strips.	CV	—	200 Ω /V	200 Ω /V	200 Ω /V	200 Ω /V
	CC	—	8 Ω /A	4 Ω /A	2 Ω /A	1 Ω /A
Meter ranges		0–6 V 0–10 A	0–9 V 0–1.8 A, 0–18 A	0–9 V 0–4 A, 0–40 A	0–9 V 0–7 A, 0–70 A	0–9 V 0–15 A, 0–150 A
Size	Inches	8½ W x 3½ H x 12½ D	19 W x 5½ H x 17½ D	19 W x 5¼ H x 17½ D	19 W x 8¼ H x 17½ D	19 W x 8¼ H x 17½ D
	Centimeters	21.6 W x 8.9 H x 32.1 D	48.3 W x 14 H x 44.4 D	48.3 W x 14 H x 44.4 D	48.3 W x 22.2 H x 44.4 D	48.3 W x 22.2 H x 44.4 D
Weight	lbs	12/15	—	—	89/111	120/146
Net/Shipping	kg	5.44/6.8	—	—	40.3/50.2	54.5/66.3
Price		\$220	\$500	\$700	\$900	\$1125
Options Refer to page 513 for description.		28–\$10	05–\$10, 10–\$125 27–\$10, 28–\$10	05–\$10, 10–\$125 27–\$10, 28–\$10	05–\$10, 10–\$125 26–\$10, 27–\$10	05–\$10, \$10–\$125 27–\$10

No charge for option 05 if ordered with option 26, 27, or 28

CV indicates constant voltage. CC indicates constant current. *Model 6384A is a constant voltage/current limit supply.

Load regulation:

CV—Less than 1 mV from no load to full load.

CC—Less than 0.03% + 2 mA of output from no load to full load.

Line regulation:

CV—Less than 1 mV for a 10% change in the nominal line voltage.

CC—Less than 0.03% + 2 mA for a 10% change in the nominal line voltage.

Transient recovery time: Less than 200 μ s (50 μ s for 6384A) is required for output voltage recovery in constant voltage operation to within 50 millivolts (10 mV for 6384A) of the nominal output voltage following a 20% change in output current. The nominal output voltage is defined as the mean between the no load and full load voltages.

Temperature coefficient: Output change per degree centigrade change in ambient following 30 minutes warm-up

CV—0.01% + 200 μ V

CC—0.01% + 10 mA

Stability: Under constant ambient conditions, total drift for 8 hrs. following 30 minutes warm-up

CV—0.03% + 1 mV, except 10 mV for 6384A

CC—0.03% + 30 mA

Output terminals: A rear barrier strip includes GND, +out, –out, +sensing, and –sensing terminals.

Either side of the supply may be grounded or the output may be operated floating at potentials of up to 300 V off ground.

Models 6385A, 6388A include monitoring output terminals mounted on the front panel (3 amps maximum).

Finish: Light gray front panel with dark gray case.

Power cord: A three wire 5 ft. (1.52 m) power cord is provided on all models except 6387A and 6388A which have a rear barrier strip.

Accessories, Model 6384A: Same as HVB Series. Refer to page 522.

Ripple and noise: At any line voltage and any load condition

within rating

CV—5mV p-p, 1mV rms

CC—50mA rms

Temperature rating: Operating: 0 to 55°C

Storage: –40 to +71°C

Output impedance:

Less than 0.001 ohm from dc to 100 Hz

Less than 0.01 ohm from 100 Hz to 1 kHz

Less than 0.05 ohm from 1 kHz to 10 kHz

Less than 0.2 ohm from 10 kHz to 100 kHz

Less than 2 ohms from 100 kHz to 1 MHz

Protection:

Short circuit protection: The output is current limited and is fully rated for operation under any overload condition including a direct short circuit, regardless of how long maintained. Supply will automatically restore to normal operation upon overload removal.

Overvoltage protection: An independent built-in overvoltage crowbar circuit prevents the output voltage from exceeding a preset voltage under any failure condition. This crowbar circuit shorts the output within 10 μ s following the onset of the over-voltage condition. Model 6384A: The crowbar threshold voltage is variable between 4.5 and 6.0 volts by monitoring rear terminals while substituting a selected resistor.

Models 6385A, 6388A: The crowbar threshold voltage is variable between 1.5 and 10 volts by adjusting a front-panel control.

Controls:

Model 6384A: Single-turn output voltage control, combined off-on switch and pilot light, and switch that selects voltage or current meter.

Models 6385A-6388A: Ten-turn coarse and single-turn fine voltage and current controls, off-on circuit breaker, pilot light, switch that selects current meter scale, over-voltage crowbar controls that set the threshold voltage.

DC POWER SUPPLIES



LVR SERIES

Low voltage rack supplies
Models 6260A-6274A



Models 6263A, 6265A, 6266A, 6271A

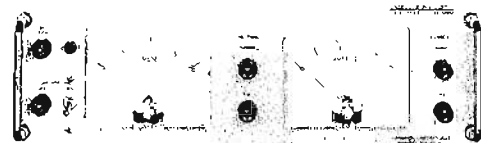

Models 6264A, 6267A

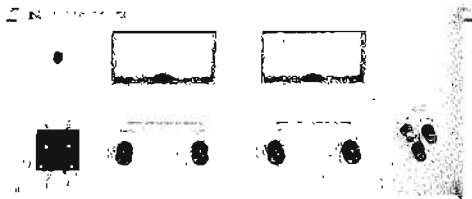

Models 6260A, 6268A, 6269A



Model 6274A

Model		6260A*	6263A	6264A	6265A
DC output		0-10 volts @ 0-100 amps	0-18 volts @ 0-10 amps	0-18 volts @ 0-20 amps	0-36 volts @ 0-3 amps
AC input		230 = 10% V ac 48-63 Hz 11 A, 1700 W	115 V ac = 10% 48-63 Hz, 4.3 A, 265 W @ 115 V	115 V ac = 10% 48-63 Hz, 7 A, 500 W @ 115 V	115 V ac = 10% 48-63 Hz, 2 A, 160 W @ 115 V
Load regulation: the constant voltage load regulation specification is given for a load current change equal to the current rating of the supply. The constant current load regulation specification is given for the load voltage change equal to the voltage rating of the supply.	cv	0.01% plus 200 μ V	0.01% plus 200 μ V	0.01% plus 200 μ V	0.01% plus 200 μ V
	cc	0.03% plus 2 mA	0.02% plus 500 μ A	0.02% plus 500 μ A	0.02% plus 500 μ A
Line regulation: for a change in line voltage from 100 to 130 or 200 to 260 at any output voltage and current within rating.	cv	0.01% plus 200 μ V	0.01% plus 200 μ V	0.01% plus 200 μ V	0.01% plus 200 μ V
	cc	0.03% plus 2 mA	0.02% plus 500 μ A	0.02% plus 500 μ A	0.02% plus 500 μ A
Ripple and noise: at any line voltage and under any load condition within rating.	cv	1 mV rms/50 mV p-p	500 microvolts rms	500 microvolts rms	500 microvolts rms
	cc	50 mA rms	3 mA rms	5 mA rms	3 mA rms
Temperature coefficient: output change per degree centigrade change in ambient following 30 minutes warmup.	cv	0.01% plus 200 μ V	0.01% plus 200 μ V	0.01% plus 200 μ V	0.01% plus 200 μ V
	cc	0.01% plus 8 mA	0.01% plus 2 mA	0.01% plus 2 mA	0.01% plus 1 mA
Remote programming: all programming terminals are located on rear barrier strips.	cv	200 ohms/volt	200 ohms/volt	200 ohms/volt	200 ohms/volt
	cc	2 ohms/amp	100 ohms/amp	10 ohms/amp	300 ohms/amp
Meters		0-12 V and 0-120 A	0-20 V and 0-12 A	0-20 V and 0-25 A	0-40 V and 0-3 A
Input power connections		Barrier Strip	3-Wire, 5-Foot Cord	3-Wire, 5-Foot Cord	3-Wire, 5-Foot Cord
Size: height x depth x width	inches	7 H x 17½ D x 19 W	3½ H x 17½ D x 19 W	5¼ H x 17½ x D x 19 W	3½ H x 17½ D x 19 W
	centimeters	17,8 H x 44,4 D x 48,3 W	8,9 H x 44,4 D x 48,3 W	14 H x 44,4 D x 48,3 W	8,9 H x 44,4 D x 48,3 W
Weight: (lbs) (net/shipping)		90 (44,8 kg)/115 (52,2 kg)	36 (16,3 kg)/50 (22,8 kg)	57 (25,9 kg)/72 (32,7 kg)	28 (12,7 kg)/41 (18,6 kg)
Price		\$775	\$435	\$525	\$350
Options: refer to page 513 for descriptions.		06-\$275, 16-\$50, 27-\$15	06-\$125, 28-\$10	06-\$175, 28-\$10	06-\$95, 28-\$10
		05-\$10 No charge if ordered with Option 26, 27, or 28. 10-\$125, 13-\$35, 14-\$35			

Advantages

Internally adjustable preregulator voltage limit
 Continuously variable output voltage and current—no range switching
 Auto-series, auto-parallel and auto-tracking operation
 Remote programming—voltage and current can be controlled by external resistance or control voltage
 Remote error sensing
 Low output impedance

Automatic restoration of normal operation following removal of overload
 Constant voltage constant current operation with automatic crossover
 Front panel coarse and fine voltage and current controls
 Fully rated for any overload condition including continuous short circuit operation
 Front panel voltmeter and ammeter
 RFI conformance to MIL-I-6181D

Specifications

Radio frequency Interference: Models 6260A, 6268A, 6269A, and 6274A are free from conducted and radiated RFI to the extent that they meet all the requirements of MIL-I-6181D.

Maximum operating temperature: 0 to 55°C. Storage: -20 to +71°C.

Internal impedance as a constant voltage source:

Less than .001 ohms from dc to 100 Hz.
 Less than .01 ohms from 100 Hz to 1 kHz.
 Less than .2 ohms from 1 kHz to 100 kHz.
 Less than 2 ohms from 100 kHz to 1 MHz.

Transient recovery time: less than 50 microseconds is required for output voltage recovery (in constant voltage operation) to within 10 millivolts of the nominal output voltage following a 5 amp change in output current.

Output terminals: an output terminal strip is located on the rear of the chassis. All power supply terminals are isolated from the chassis and either the positive or negative terminal may be connected to the chassis through a separate ground terminal located adjacent to the output terminals. Models 6260A, 6268A, 6269A and 6274A include front panel output terminals. They are banana jack type and limited to 3 amps maximum current output.

Finish: light gray front panel with dark gray case.

6266A	6267A	6268A*	6269A*	6271A	6274A*
0-36 volts @ 0-5 amps	0-36 volts @ 0-10 amps	0-40 volts @ 0-30 amps	0-40 volts @ 0-50 amps	0-60 volts @ 0-3 amps	0-60 volts @ 0-15 amps
115 V ac, ±10% 48-63 Hz, 4.3 A, 265 W @ 115 V	115 V ac, ±10% 48-63 Hz, 7 A, 500 W @ 115 V	230 ±10% V ac 48-63 Hz, 11 A, 1600 W	230 ±10% V ac 48-63 Hz, 18 A, 2600 W	115 V ac, ±10% 48-63 Hz, 4.3 A, 265 W @ 115 V	115 Vac, ±10% 48-63 Hz, 16 A, 1700 W
0.01% plus 200 μV	0.01% plus 200 μV	0.01% plus 200 μV	0.01% plus 200 μV	0.01% plus 200 μV	0.01% plus 200 μV
0.02% plus 500 μA	0.02% plus 500 μA	0.02% plus 3 mA	0.02% plus 3 mA	0.02% plus 500 μA	0.02% plus 2 mA
0.01% plus 200 μV	0.01% plus 200 μV	0.01% plus 200 μV	0.01% plus 200 μV	0.01% plus 200 μV	0.01% plus 200 μV
0.02% plus 500 μA	0.02% plus 500 μV	0.02% plus 3 mA	0.02% plus 3 mA	0.02% plus 500 μA	0.02% plus 2 mA
500 microvolts rms 3 mA rms	500 μV rms/20 mV p-p 3 mA rms	1 mV rms 20 mA rms	1 mV rms/20 mV p-p 30 mA rms	500 microvolts rms 3 mA rms	500 microvolts rms 10 mA rms
0.01% plus 200 μV	0.01% plus 200 μV	0.01% plus 500 μV	0.01% plus 200 μV	0.01% plus 200 μV	0.01% plus 200 μV
0.01% plus 2 mA	0.01% plus 2 mA	0.01% plus 2 mA	0.01% plus 4 mA	0.01% plus 1 mA	0.01% plus 2 mA
200 ohms/volt 200 ohms/amp	200 ohms/volt 100 ohms/amp	200 ohms/volt 6 ohms/amp	200 ohms/volt 4 ohms/amp	300 ohms/volt 300 ohms/amp	300 ohms/volt 50 ohms/amp
0-40 V and 0-6 A	0-40 V and 0-10 A	0-50 V and 0-40 A	0-50 V and 0-60 A	0-60 V and 0-3 A	0-70 V and 0-18 A
3-Wire, 5-Foot Cord	3-Wire, 5-Foot Cord	Barrier Strip	Barrier Strip	3-Wire, 5-Foot Cord	Barrier Strip
3½ H x 17½ D x 19 W	5¼ H x 17½ D x 19 W	7 H x 16¼ D x 19 W	7 H x 17½ D x 19 W	3½ H x 17½ D x 19 W	5¼ H x 17½ D x 19 W
8,9 H x 44,4 D x 48,3 W	14 H x 44,4 D x 48,3 W	17,8 H x 42,7 D x 48,3 W	17,8 H x 44,4 D x 48,3 W	8,9 H x 44,4 D x 48,3 W	14 H x 44,4 D x 48,3 W
33 (15 kg)/48 (21,8 kg)	52 (23,6 kg)/67 (30,4 kg)	93 (42,2 kg)/120 (54,5 kg)	93 (42,4 kg)/120 (54,5 kg)	33 (15 kg)/45 (20,4 kg)	75 (34 kg)/95 (43,1 kg)
\$435	\$525	\$695	\$875	\$435	\$695
06-\$95, 28-\$10	06-\$125, 28-\$10	06-\$175, 26-\$10, 27-\$15	06-\$200, 27-\$15	06-\$95, 28-\$10	06-\$175, 17-\$50, 18-\$50
05-\$10 No charge if ordered with Option 26, 27, or 28		10-\$125	13-\$35	14-\$35	

*All silicon

DC POWER SUPPLIES



MVR and HVR SERIES

Medium and high voltage rack supplies
Models 890A, 895A and 6521A—6525A

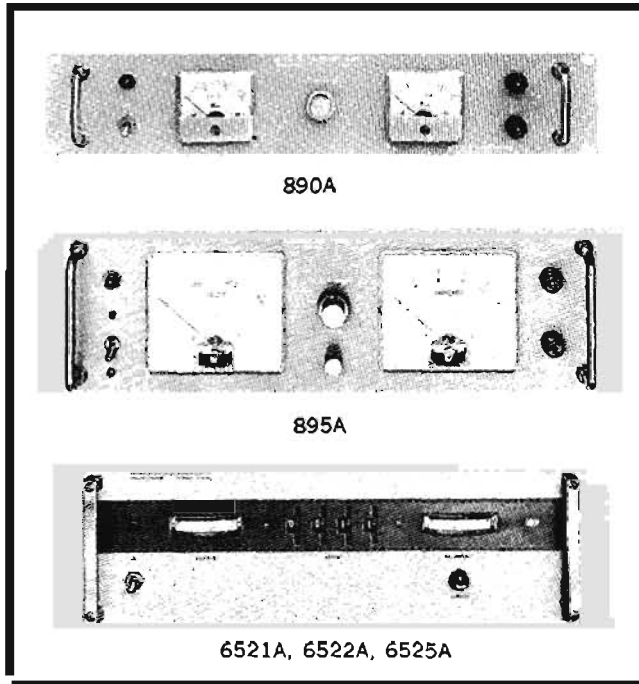

Advantages, MVR Series:

- All solid-state
- Short-circuit proof
- Remote programming, remote error sensing

Advantages, HVR Series:

- All solid-state, compact rack mounting
- 200 watt output
- Short circuit proof
- ± output—grounded or floating up to 2 kV off ground
- Decade voltage switching with 0.002% resolution
- Transient recovery time: less than 50 microseconds to within 0.005% or 20 mV, whichever is greater
- 1% calibration accuracy

The MVR Series features a unique "Piggy-Back" circuit; low voltage series power transistors, which are required to dissipate only a fraction of their power rating, provide high regulation—yet the supply can withstand a direct short circuit across the output terminals.

The HVR Series consists of three high-voltage supplies utilizing all silicon semiconductor circuitry—no tubes. All three supplies are tightly regulated and provide sufficient output current for many devices not capable of being powered from conventional low-current, high-voltage supplies. These supplies feature constant voltage/constant current operation with automatic crossover. Elimination of large series dissipating tube elements allows these supplies to have efficiencies approaching 80%.

MVR Series

Model		890A	895A
DC output	voltage	0 to 320	0 to 320
	amps	0 to 0.6	0 to 1.5
Line or load regulation		0.007% or 10 mV	
Ripple and noise (rms maximum)		1 mV	
Meters		320 V and 0.8 A	320 V and 1.5 A
Dimensions		3½" H x 16¼" D x 19" W (88 x 425 x 483 mm)	5¼" H x 16¼" D x 19" W (133 x 425 x 483 mm)
Weight (net/shipping)		35/43 lbs (15.8/19.4 kg)	50/66 lbs (22.5/29.7 kg)
Price		\$445	\$625

Short circuit proof: All-electronic, continuously acting current limit circuit protects the supply for all overloads, including a direct short placed across the output terminals; in addition, a fuse will blow when severe overload conditions occur.

Maximum operating temperature: 50°C.

Stability: better than 0.1% plus 5 mV.

Transient recovery time: less than 100 microseconds.

Output terminals: output terminal strip is located on the rear of the chassis.

Input ac: 115 V ac ±10%, 57 to 63 Hz.

HVR Series

Model		8521A	8522A	6525A
DC output	voltage	0 to 1000 V	0 to 2000 V	0 to 4000 V
	current	0 to 200 mA	0 to 100 mA	0 to 50 mA
AC input		115 V ac ±10%, 50 to 500 Hz		
Load regulation	constant voltage	0.005% or 20 mV		
	constant current	2% or 1 mA		
Line regulation	constant voltage	0.005% or 20 mV		
	constant current	1 mA		
Ripple and noise (rms maximum)	constant voltage	1 mV		
	constant current	2 mA	1 mA	500 µA
Temp. coefficient (output change per °C change in ambient following 30 min warm-up)	constant voltage	0.012% plus 1 mV		
	constant current	0.2% plus 0.2 mA	0.2% plus 0.1 mA	0.2% plus 0.05 mA
Stability (under constant ambient conditions, total drift for 8 hours following 80 min warm-up)	constant voltage	0.036% plus 3 mV		
	constant current	0.25% plus 0.5 mA	0.25% plus 0.25 mA	0.25% plus 0.12 mA
Meters		0 to 1 kV and 0 to 200 mA	0 to 2 kV and 0 to 100 mA	0 to 4 kV and 0 to 50 mA
Controls		voltage control—3 decade thumbwheel switches, plus thumbwheel vernier with 0.002% resolution, current control—single-turn potentiometer		
Dimensions		5¼" H x 18" D x 19" W (133 x 457 x 483 mm)		
Weight (net/shipping)		50/60 lbs (22.5/27 kg)		
Price		\$750	\$750	\$750

SCR-1P SERIES

Compact SCR regulated supplies
Models 6427B-6448B



DC POWER SUPPLIES

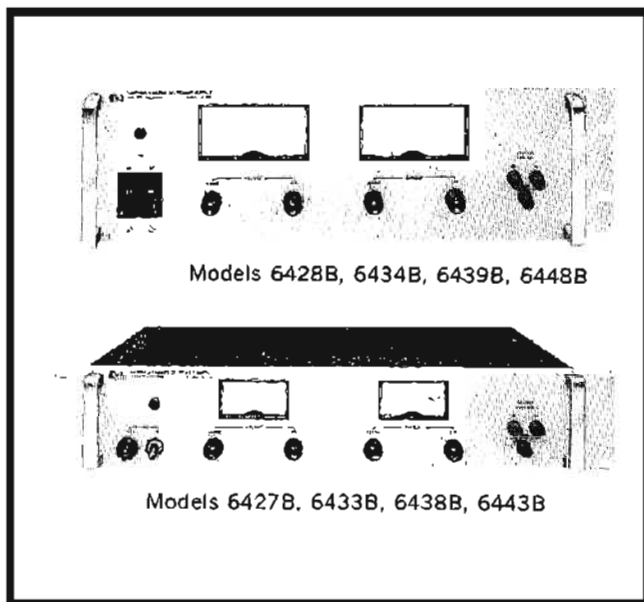

The SCR-1P Series consists of eight regulated dc power supplies utilizing all-silicon circuitry. Silicon-controlled rectifiers in series with the transformer primary, and controlled by the output voltage and current settings, accomplish the desired regulation using Harrison's unique "Ramp-Lock" phase control circuit. This circuit technique permits a reduction in the overall size and weight of the power supply and results in up to 75% efficiency at full output. Four models with output ratings of approximately 300 watts are packaged in a 3½" high rack mounting cabinet, while the four models with approximately 900 watt output power capability are 5¼" high. All supplies may also be used on the bench (attachable rubber feet for bench use available on request). These second generation SCR regulated power supplies also feature lower output ripple, tighter load and line regulation, and Constant Voltage/Constant Current operation with automatic crossover.

Advantages:

- Output continuously variable to zero in either voltage or current mode
- All-silicon circuitry
- Efficiency up to 75% at full output
- Excellent line transient immunity

Specifications

Model		6427B	6428B	6439B	6434B	6438B	6439B	6443B	6448B
DC output	volts	0-20	0-20	0-36	0-40	0-60	0-60	0-120	1-600
	amps	0-15	0-45	0-10	0-25	0-5	0-15	0-2.5	0-1.5
AC power in	volts	115 V ac ± 10%, 57-63 Hz							
	amps	6.5	17	7	19	6.5	17	6.5	16
	watts	450	1200	450	1300	400	1200	400	1200
Line regulation: For a 10% change in the nominal ac line voltage.	constant voltage	10 mV	20 mV	18 mV	18 mV	30 mV	60 mV	60 mV	600 mV
	constant current	150 mA	450 mA	100 mA	200 mA	50 mA	150 mA	25 mA	15 mA
Constant voltage load regulation: for a change in output current from no load to full load or full load to no load.		20 mV	40 mV	36 mV	40 mV	60 mV	120 mV	120 mV	600 mV
Constant current load regulation: for a change in output voltage from no load to full load or full load to no load.		150 mA	450 mA	100 mA	200 mA	50 mA	150 mA	25 mA	15 mA
Full scale meter readings: meters have 2% accuracy; all units have meter calibrating potentiometers.		24 V & 18 A	24 V & 50 A	40 V & 12 A	50 V & 30 A	70 V & 6 A	70 V & 18 A	150 V & 3 A	700 V & 1.8 A
*Transient recovery time: <200 ms for output recovery to within "A" mV; transient amplitude less than "B" volts/amp for any load change between 20% and 100% of rated output current.		A = 200 B = 0.35	A = 200 B = 0.15	A = 200 B = 0.5	A = 200 B = 0.3	A = 300 B = 1.0	A = 600 B = 0.4	A = 600 B = 4.0	A = 3000 B = 20
*Ripple and noise: rms maximum		40 mV	40 mV	36 mV	40 mV	120 mV	60 mV	240 mV	600 mV
Remote programming	constant voltage	200 ohms/volt	200 ohms/volt	200 ohms/volt	200 ohms/volt	300 ohms/volt	300 ohms/volt	300 ohms/volt	300 ohms/volt
	constant current	15 ohms/amp	5 ohms/amp	25 ohms/amp	10 ohms/amp	50 ohms/amp	15 ohms/amp	100 ohms/amp	170 ohms/amp
Size: W x H x D	Inches	19 x 3½ x 17	19 x 5¼ x 16¾	19 x 3½ x 17½	19 x 5¼ x 16¾	19 x 3½ x 17½	19 x 5¼ x 16¾	19 x 3½ x 17½	19 x 5¼ x 16¾
	centimeters	48,3 x 8,9 x 44	48,3 x 14 x 43,7	48,3 x 8,9 x 44,4	48,3 x 14 x 43,7	48,3 x 8,9 x 44,4	48,3 x 14 x 43,7	48,3 x 8,9 x 44,4	48,3 x 14 x 43,7
Weight (net/shipping)	pounds	36/51	67/76	33/48	67/76	31/46	61/70	31/46	61/70
	kilograms	16,3/23,1	30,4/34,4	14,9/21,7	30,4/34,4	14/20,8	27,6/31,7	14/20,8	27,6/31,7
Price		\$380	\$550	\$370	\$550	\$360	\$550	\$360	\$550
Options: refer to page 513 for descriptions.		05-\$10 10-\$125							

*Use of supply at 50 Hz input (possible only with option 05) results in a 50% increase in transient recovery time and ripple.

DC POWER SUPPLIES



SCR-3 SERIES

3 KW SCR regulated supplies
Models 6453A-6459A

The SCR-3 Series of regulated supplies are suitable for high-power applications which require up to 200 amps output current and up to 3.6 kilowatts output power. These supplies can be connected in Auto-Series and Auto-Parallel for higher power applications. In this series of supplies, silicon-controlled rectifiers perform simultaneously the rectifying and regulating functions with resulting voltage regulation of less than 0.3%.

Advantages:

- Constant voltage/constant current
- Minimum size, reduced weight
- Continuously variable to zero volts
- Excellent line transient immunity
- 50 millisecond recovery for load current changes
- Short-circuit-proof
- Remote programming
- Remote error sensing
- Auto-series and auto-parallel operation
- 75% efficiency at full load

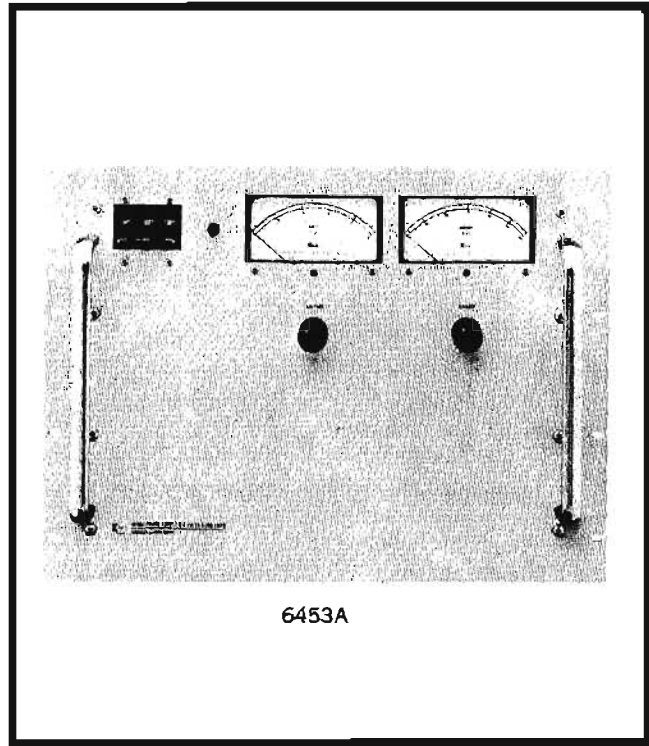

Model	6453A	6456B	6459A
DC volts out	0 to 15 V	0 to 36 V	0 to 64 V
DC amps out	0 to 200 A	0 to 100 A	0 to 50 A
AC power in	208/230/460 \pm 10%, 3 phase, 57 to 63 Hz; 14 amps per phase		
Combined load and line regulation	cv	0.2% + 10 mV	0.2% + 10 mV
	cc	1% or 2 A	1% or 1 A
†Ripple and noise (rms max., specified as percent of max. output voltage)	1%	0.5%	0.25%
Remote programming (all programming terminals located on rear barrier strips)	cv	200 ohms/volt	200 ohms/volt
	cc	1 ohm/amp	2 ohms/amp
†Transient recovery time (less than 50 ms required for output voltage recovery to within A mV of nominal output voltage following a load change from full load to half load or half load to full load)	A = 150	A = 300	A = 600
Meters	20 V and 200 A	40 V and 100 A	80 V and 50 A
Input terminals	4-terminal twist lock connector		
Output terminals	tapped rectangular bus bars		
Cooling	internal fan		
Dimensions	19" W, 14" H, 18 1/4" D (48,3 x 35,6 x 46,4 cm)		
Weight (net/shipping)	238/275 lbs (107/124 kg)	238/275 lbs (107/124 kg)	238/275 lbs (107/124 kg)
Price: Option 01, 02, or 03 must be specified when ordering	\$1375	\$1275	\$1275
Options: Refer to page 513 for description	06-\$350	06-\$300	06-\$300
	01-208 V ac input—no charge, 02-230 V ac input—no charge, 03-460 V ac input—no charge.		
	05-\$25, 10-\$195, 31-\$40, 32-\$40		

cc = constant current, cv = constant voltage

†Use of supply at 50 Hz input (possible only with option 05) results in a 20% increase in transient recovery time and ripple.

SCR-10 SERIES

10 KW SCR regulated supplies

Model 6463A—6483B



DC POWER SUPPLIES

The SCR-10 Series of all silicon, 10 kilowatt regulated supplies are intended for high power applications which require a fixed or variable dc source with a moderate degree of regulation. Silicon-controlled rectifiers in series with the transformer primary, and controlled by the output voltage and current settings, accomplish the desired regulation using Harrison's "Ramp-Lock" phase control circuit. This circuit technique permits a reduction in the overall size and weight of the power supply and results in up to 75% efficiency at full output. All features of the SCR-10 Series are the same as given for the SCR-3 Series on the previous page.

Specifications

- Controls:** a single control allows continuous adjustment of output voltage over the entire output range. A single control allows continuous adjustment of output current over the entire output range. Models 6475A, 6477A, 6479A, and 6483B have 10-turn voltage controls.
- Input terminals:** a 4-pin jack and mating connector are supplied.
- Output terminals:** tapped rectangular bus bars.
- Cooling:** internal fan.
- Size:** standard 19 inch (483 mm) relay rack mounting, 26 1/4 inches (669 mm) and 22 1/2 inches (572 mm) deep.
- Weight:** 420 lbs (191 kg) net, 500 lbs (227 kg) shipping weight.
- Finish:** light gray front panel with dark gray case.

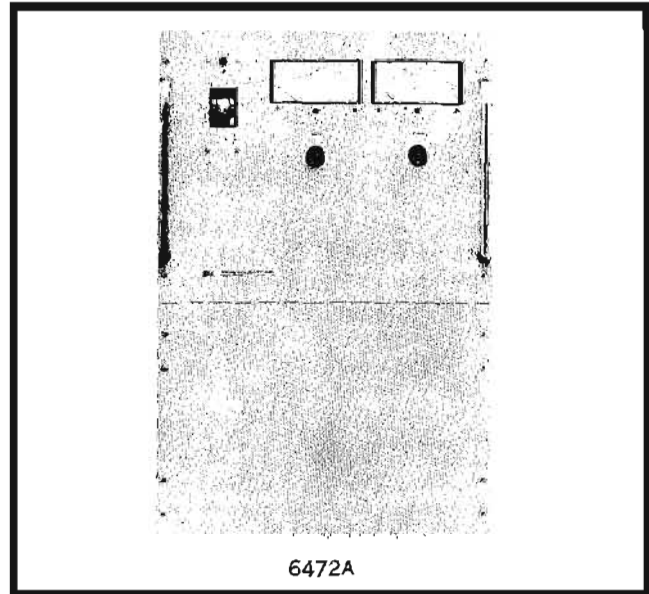

6472A

Model	6463A	6464A	6468A	6469A	6472A	6475A	6477A	6479A	6483B	
DC output	volts	0-4	0-8	0-16 or 0-18	0-36	0-64	0-110	0-220	0-300	0-440 or 0-500 or 0-600
	amps	0-2000	0-1000	0-600 or 0-500	0-300	0-150	0-100	0-50	0-35	0-15 or 0-20 or 0-25
AC input	208/230/460 ±10%, 3 Phase, 57-63 Hz, Specify by option number, see below									
	amps less than 50 amps per phase at 230 V ac									
Combined line and regulation constant voltage: for a change in output current from no load to full load or full load to no load combined with a ±10% change in line voltage.	50 mV	75 mV	0.2% plus 10 mV	0.2% plus 10 mV	0.2% plus 100 mV	0.2% plus 100 mV	0.2% plus 100 mV	0.2% plus 100 mV	0.2% plus 100 mV	0.2% plus 100 mV
Combined line and load regulation constant current: for a change in output voltage from no load to full load or full load to no load combined with a ±10% change in line voltage.	1% or 20 A	1% or 10 A	1% or 6 A	1% or 3 A	1% or 1.5 A	1% or 1 A	1% or 0.5 A	1% or 0.3 A	1% or 0.2 A	
Full scale meter readings: meters have 2% accuracy; all units have meter calibrating potentiometers.	5 V & 2400 A	10 V & 1200 A	18 V & 700 A	40 V & 350 A	80 V & 180 A	125 V & 120 A	250 V & 60 A	350 V & 40 A	600 V & 25 A	
†Transient recovery time: less than 50 milliseconds is required for output voltage recovery to within A millivolts of the nominal output voltage following a load change from full load to half load or half load to full load, or a change of 100 amperes, whichever is less.	—	A = 150	A = 150	A = 500	A = 600	A = 1 V	A = 2 V	A = 3 V	A = 5 V	
‡Ripple and noise: rms maximum, specified as percent of maximum output voltage.	7%	1%	1%	0.5%	0.25%	0.2%	0.15%	0.1%	0.1%	
Temperature coefficient: output change per degree centigrade change in ambient following 30 minutes warmup.	0.05% plus 2 mV									
	cv	12 A	6.0 A	3.6 A	1.8 A	0.9 A	0.6 A	0.3 A	0.2 A	0.1 A
Stability: under constant ambient conditions, total drift for 8 hours following 30 minutes warmup.	0.25% plus 10 mV									
	cc	60 A	30 A	18 A	9 A	4.5 A	3 A	1.5 A	1 A	0.6 A
Remote programming	cv	200Ω/V	200Ω/V	200Ω/V	200Ω/V	300Ω/V	300Ω/V	300Ω/V	300Ω/V	300Ω/V
	cc	0.1Ω/A	1/5Ω/A	1/3Ω/A	1/2Ω/A	1.5Ω/A	2Ω/A	4Ω/A	6Ω/A	10Ω/A
Price: Option 01, 02, or 03 must be specified when ordering.	\$3500	\$3300	\$2600	\$2300	\$2600	\$2600	\$2600	\$2600	\$2600	
Options: refer to page 513 for descriptions.	05	—	—	\$500	\$450	\$400	\$400	\$300	\$300	

01-208 V ac input-no charge, 02-230 V ac input-no charge, 03-460 V ac input- \$200, 04-\$85, 05-\$25, 10-\$225
31-\$275, 32-\$275

cv = constant voltage cc = constant current

†Use of supply at 50 Hz input (possible only with option 05) results in a 20% increase in transient recovery time and ripple

DC POWER SUPPLIES



MOD SERIES

Modular plug-in supplies
Models 6343A-6357A

The MOD Series of plug-in modular power supplies has been designed to meet the need for well regulated, inexpensive chassis-mounting supplies and the need for a line of dc supplies of low power rating capable of being efficiently grouped on rack panels. All input, output and control connections are accomplished via the 11-pin plug mounted at one end of the supply. Since the output voltage is determined by the value of a resistor connected between two of these terminals, these supplies can be made to be continuously variable over their entire output voltage range, or variable over some limited range, or fixed at some predetermined value — depending upon the manner in which the external rheostats and/or resistors are connected to the programming terminals.

A current limiting overload protection circuit is used in all MOD Series supplies. The current limit can be set at any value from zero to some value slightly greater than the current rating of the supply. This current setting is accomplished by means of a screwdriver adjustment slot accessible through a small hole in the side of the supply, thus permitting readjustment of the current limit value without removing the power supply module's cover.

The supply is thus fully protected for any overload condition, including a direct short circuit across the output terminals, and the current limit control can be set to the exact value necessary for optimum protection of the load device. No fuses are contained in the MOD Series supplies.

Specifications, MOD Series

Model	Output rating	Load regulation	Line regulation	Input power	Size	Weight (net/shipping)	Price	Options*
6343A	0 to 18 V at 0 to 300 mA	3 mV or 0.03%	3 mV or 0.03%	115 V ac = 10% 48 to 440 Hz	A	3/5 lbs. (1,4/2,3 kg)	\$120	05—\$10 28—\$10
6344A	0 to 18 V at 0 to 1 A	3 mV or 0.03%	3 mV or 0.03%	115 V ac = 10% 48 to 63 Hz	B	7/10 lbs (3,2/4,5 kg)	\$165	05—\$10 28—\$10
6346A	0 to 36 V at 0 to 150 mA	3 mV or 0.02%	3 mV or 0.02%	115 V ac = 10% 48 to 440 Hz	A	3/5 lbs (1,4/2,3 kg)	\$120	28—\$10
6347A	0 to 36 V at 0 to 500 mA	3 mV or 0.02%	3 mV or 0.02%	115 V ac = 10% 48 to 63 Hz	B	7/10 lbs (3,2/4,5 kg)	\$165	05—\$10 28—\$10
6354A	0 to 160 V at 0 to 400 mA	0.005%+2 mV	0.005%+1 mV	115 V ac = 10% 48 to 63 Hz	C	13/19 lbs (5,9/8,6 kg)	\$259	05—\$10 28—\$10
6357A	0 to 320 V at 0 to 200 mA	0.005%+2 mV	0.005%+1 mV	115 V ac = 10% 48 to 63 Hz	C	13/19 lbs (5,9/8,6 kg)	\$259	05—\$10 28—\$10

*Refer to page 513 for descriptions.

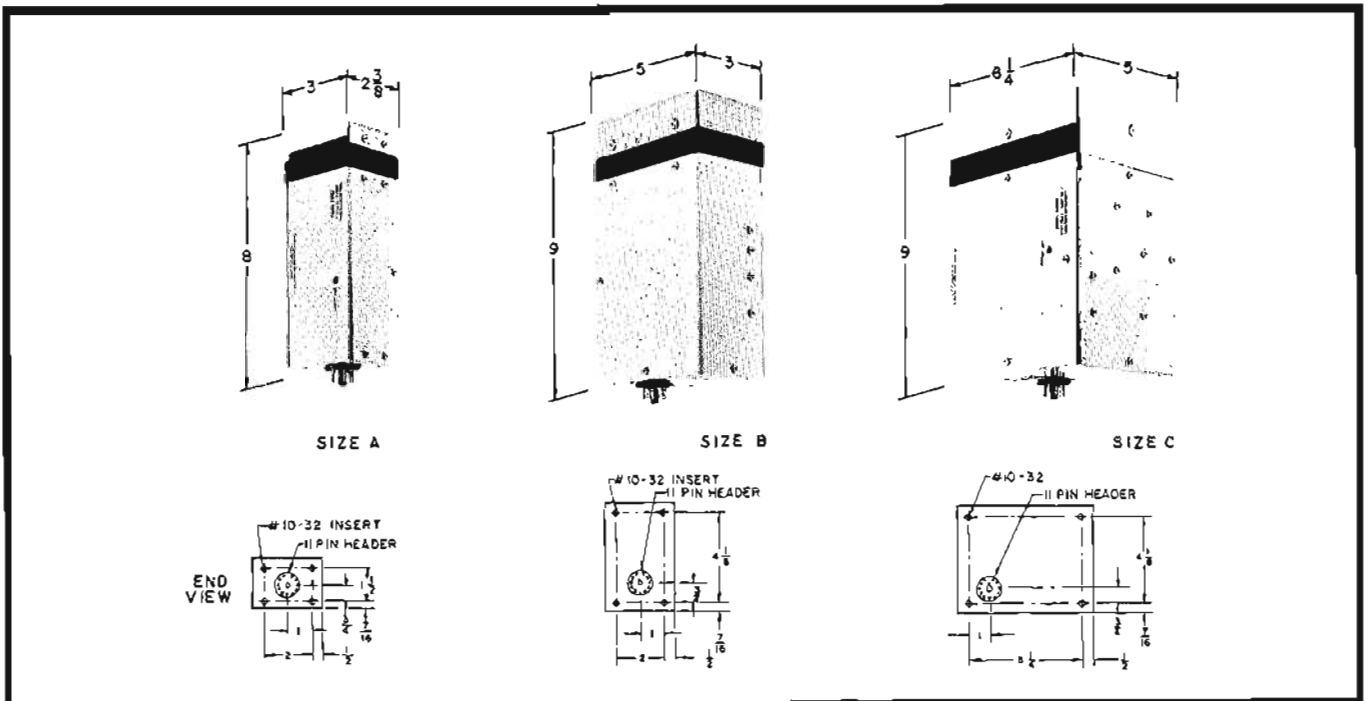

Specifications, all models

Ripple and noise: less than 1 mV rms for any combination of line voltage, output voltage and load current.

Operating temperature range: 0°C to 50°C (70°C for 6354A and 6357A).

Temperature coefficient: less than 0.033%, plus 2 mV/°C.

Stability: less than 0.1% plus 10 mV total drift for 8 hours (after 30 minutes' warm-up) at a constant ambient.

Transient response: less than 50 μ s is required for output voltage recovery to within 10 mV of the nominal output voltage following a full-load change in output current.

Remote error sensing and remote programming: sensing terminals are brought out through the header pins; for local sensing, these terminals are strapped to the output terminals; for remote sensing, leads are connected from the sensing terminals to the remote load terminals; the output voltage is determined by the value of resistance connected between terminals 1 and 2, 1 V out for each 200 ohms connected between these terminals (300 ohms for 6354A and 6357A).

Programming accuracy: 5%.

Cooling: convection cooling is employed.

Finish: light gray.

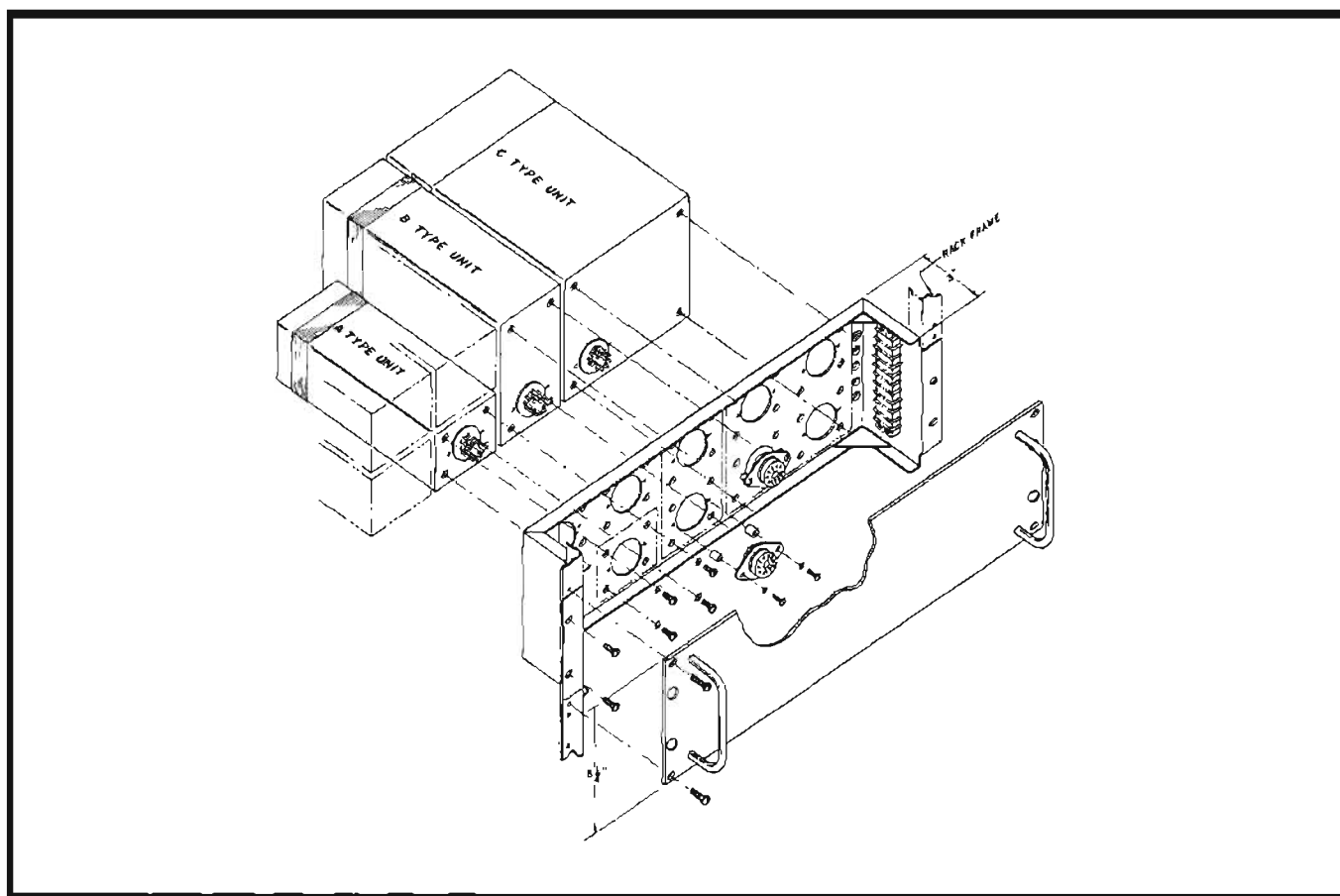

Efficient rack mounting

Dimensions and efficient mounting techniques are shown in the illustration for MOD Series plug-in supplies.

The drawing shows 14505A rack mounting assembly; 14503A is similar except for height— $3\frac{1}{2}$ " (88 mm) instead of $5\frac{1}{4}$ " (133 mm)—and the fact that it has holes for six 11-pin sockets. Whereas 14505A can accommodate "A", "B" or "C" size units as shown, the $3\frac{1}{2}$ " high rack mounting assembly can only accommodate "A" and "B" size units. On the $3\frac{1}{2}$ " panel these "A" and "B" size modules are rotated 90 degrees along the longest axis as compared with this drawing.

Part No. 14503A: $3\frac{1}{2}$ " high (88 mm) assembly capable of accommodating up to six "A" size modules or one "B" and four "A" modules, or two "B" and two "A" modules, or three "B" modules.

Price: 14503A, \$19.

Part No. 14505A: $5\frac{1}{4}$ " high (133 mm), 19" wide (483 mm) rack assembly for accommodating up to 10 "A" size modules or any combination of "A", "B" and "C" size modules having the same equivalent mounting area as 10 "A" modules.

Price: 14505A, \$29.

DC POWER SUPPLIES



SLOT SERIES

Fixed dc output — adjustable within $\pm 10\%$ band
Models 60065A — 60285A



Size 2

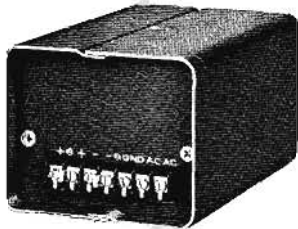

Size 3

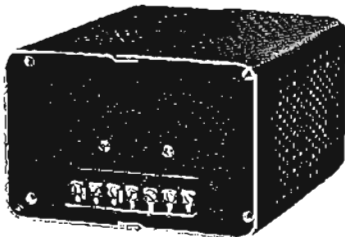

Size 4

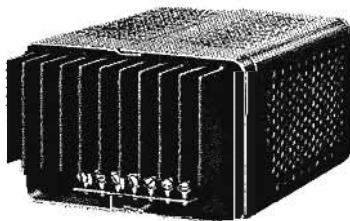

Size 5

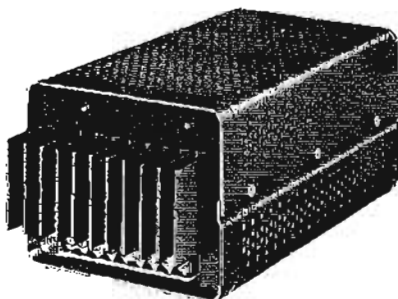

Size 6

The SLOT series of modular power supplies are intended for applications requiring a fixed constant voltage source of dc. Output voltage is adjustable to $\pm 10\%$ of the nominal.

The mechanical and electrical design have been accomplished with a view toward simplicity, without any compromise to component quality or manufacturing technique. The result is a low cost yet reliable power supply which can be bolted directly to standard rack panels (with only four screws) or included as a power module in a larger chassis. All supplies are fully rated to 50°C , and require no additional heat sinks.

A temperature compensated zener diode is employed as the reference element in an all-silicon series regulator feedback circuit which monitors and controls the output voltage. The resulting low ripple and low output impedance permit these supplies to be used in critical applications where less well regulated supplies are not suited.

All supplies are short circuit proof and will not be damaged by any overload regardless of how long imposed. The output is floating—thus any supply can be used as either a positive or negative source.

Output ratings available

Stock "off-the-shelf" models are available for immediate delivery. The output ratings and prices are given on the following page. If the desired model is not a stock item, choose from the adjacent output rating chart. The chart indicates the max current available at any output voltage, for any size module: the area below and to the left of each curve includes all available ratings for that size module.

Prices: in quantities of 20, the prices for typical ratings in each of the package sizes are: Size 2, \$68; Size 3, \$74; Size 4, \$83; Size 5, \$94; Size 6, \$169.

For any supply with an output voltage rating of 10 volts or less, add 10% to the above prices.

For an exact price and delivery quotation, contact your nearest HP field sales office, giving desired output voltage, current rating, and quantity.

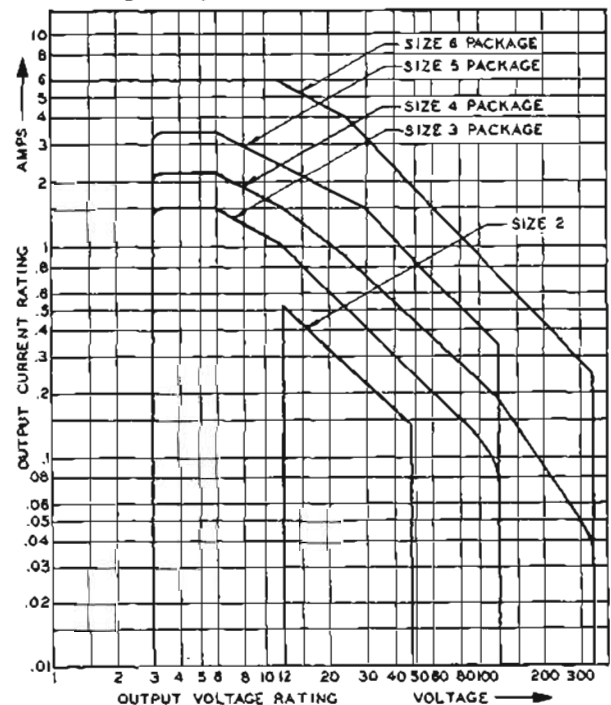

Specifications

Stock models:

Model	80085A	80123A	60125A	80244A	80285A	
Output	6 V ±10% 0 - 3 A	12 V ±10% 0 - 1 A	12 V ±10% 0 - 2.2 A	24 V ±10% 0 - 1 A	28 V ±10% 0 - 1.5 A	
Input	115 V ac ±10% 48 - 440 Hz	1.5 A	0.8 A	1.3 A	1 A	
Size	5	3	5	4	5	
Price	1 - 9	\$110	\$ 79	\$100	\$ 88	\$100
	10 - 19	\$107	\$ 77	\$ 97	\$ 85	\$ 97
	20 - 49	\$103	\$ 74	\$ 94	\$ 83	\$ 94

- Load regulation:** less than 0.05% from no load to full load.
- Line regulation:** less than 0.05% for 10% change in nominal line voltage.
- Ripple and noise:** less than 1 mV rms.
- Temperature coefficient:** output voltage change per °C is less than 0.025%.
- Stability:** the total drift for eight hours (after 30 minutes warmup) at a constant ambient is less than 0.1%.
- Temperature rating:** operating: 0 to 55°C; storage: -40 to +85°C.
- Output impedance:** less than 0.3 ohms to 100 kHz; less than 3 ohms to 1 MHz.
- Transient recovery time:** less than 25 μs for output voltage recovery to within 10 mV of the nominal output voltage following a full load or 5 amp load change, whichever is less.
- Overload protection:** the output is current limited (non-adjustable) and is fully rated for operation under any overload condition

including a direct short circuit, regardless of how long maintained. Supply will automatically restore to normal operation upon overload removal.

Terminals: a rear barrier strip includes AC, ACC, GND, + Out, - Out, + Sensing, and - Sensing terminals. Either side of the supply may be grounded or the output may be operated floating at potentials of up to 300 V off ground.

Output control: screwdriver adjust, accessible through hole in end plate.

Mounting: four 8-32 threaded nuts embedded in mounting end plate facilitate assembly of modules to rack panels, chassis, etc.

Overall dimensions:

	Mounting face	Module length
Size 2:	3 3/4" (8.6 cm) x 4 1/4" (10.5 cm)	4 1/4" (10.5 cm)
Size 3:	3 3/4" (8.6 cm) x 4 1/4" (10.5 cm)	6" (15.2 cm)
Size 4:	3 3/4" (8.6 cm) x 5 1/4" (13 cm)	6" (15.2 cm)
Size 5:	3 3/4" (8.6 cm) x 5 1/4" (13 cm)	7-5/16" (18.6 cm)
Size 6:	4 1/4" (10.8 cm) x 5 1/4" (13 cm)	11" (27.9 cm)

Weight:

	Net	Shipping
Size 2:	2.1 lbs (0.95 kg)	3.5 lbs (1.6 kg)
Size 3:	2.5 lbs (1.1 kg)	4.0 lbs (1.8 kg)
Size 4:	4.5 lbs (2 kg)	6.5 lbs (2.9 kg)
Size 5:	6.0 lbs (2.7 kg)	8.0 lbs (3.6 kg)
Size 6:	13 lbs (5.9 kg)	15 lbs (6.8 kg)

Options Available: 06, 17, 18. Refer to page 513 for description

60155C Dual SLOT Supply For Operational Amplifier

Model 60155C is a dual output SLOT supply ideal for powering operational amplifiers. This new supply provides a positive and negative 15 V dc output referenced to a common terminal and is internally connected for auto-tracking "rubber-band" operation. With the slave (-) supply tracking the master (+) supply, any change of the internal reference source (e.g. drift, ripple) will cause an equal percentage change in the outputs of both the master and slave supplies.

The degree by which the slave supply varies as a percentage from the master supply is defined as "tracking error." For Model 60155C, the tracking error is less than 30 mV for each 1 V change in the master. For example, if the master supply output voltage drifted more negative by 0.5 V, the slave supply output voltage would become more positive by 0.5 V ± 15 mV.

The features for Model 60155C are identical to the standard units in the SLOT Series as listed on the first page.

Specifications

Unless otherwise indicated, the specifications for Model 60155C are identical to the single output SLOT power supplies on the preceding pages.

Dual output: ±15 V dc, ±10%, 0 - 0.75 A.

Output current capability: as illustrated, the output voltage can be varied from 12 to 18 volts; but with output current limited to 0.5 A.

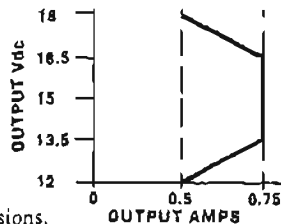

Size 5: refer to table above for dimensions.

Input: 115 V ac ±10%, 48 - 440 Hz.

Load regulation: less than 0.03% output voltage change for a load current change equal to the rating of the supply.

Line regulation: less than 0.01% output voltage change for a change in line voltage from 105 to 125 (or 125 to 105) volts at any output voltage and current within rating.

Ripple and noise: less than 300 μV rms, 2 mV p-p (dc to 20 MHz).

Temperature coefficient: output voltage change per degree centigrade after 30-minute warmup.

Master supply: less than 0.025%.

Slave supply: less than 0.015%.

Stability: total drift for 8 hours (after 30-minute warmup) at a constant ambient temperature.

Master supply: less than 0.1%.

Slave supply: less than 0.06%.

Slave tracking error: less than 30 mV for each 1V change in the master output voltage.

Terminals: a rear barrier strip includes AC, ACC, +, -, common, + sensing, - sensing, and common sensing terminals. Either side of the supply may be grounded or the output may be operated floating at potentials 300 V off ground.

Weight: net 5.25 lbs (2.4 kg); shipping 7.25 (3.2 kg).

Prices

1 to 9, \$133; 10 to 19, \$129; 20 to 49, \$125.

DC POWER SUPPLIES



STRAIN GAGE

Extreme isolation & versatile medium voltage

Models 801C and 711A, 712B

Designed to operate primarily as a power supply for strain gage applications, the 801C is a solid-state power supply whose design, construction and size permit extreme isolation from ground and the ac power line . . . greater than 10,000 megohms to ground or ac input and less than 1 pF capacity from output terminals to input power line.

Using many supplies to feed a large number of strain gages provides excellent isolation capabilities, and the shorting of a single strain gage will not disrupt the entire test setup.

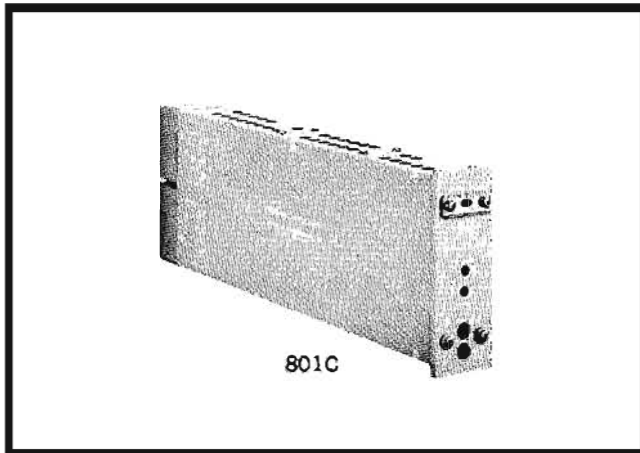

801C

Specifications

- Output:** 0 to 25 volts at 0 to 0.2 amp.
- Load regulation:** less than 2 mV change, no load to full load.
- Line regulation:** less than 2 mV change, for a change in line voltage from 105 to 125 volts.
- Ripple and noise:** less than 100 μ V rms.
- Maximum ambient operating temperature:** 50°C.
- Stability:** less than 0.1% \pm 5 mV total drift for 8 hours after 30-minute warmup.
- Overload protection:** current limiter protects supply from all overloads including direct shorts.
- Controls:** coarse and vernier for continuous voltage control.
- Remote error sensing:** at rear terminals.
- Power:** 105 to 125 V ac, 55-65 Hz.
- Dimensions:** 5" high, 14 $\frac{7}{8}$ " deep, 1 $\frac{1}{8}$ " wide.
- Weight:** net 4 lbs; shipping 8 lbs.
- Price:** 1 to 9, \$149 each; 10 to 49, \$145 each; 50 to 99, \$140 each; 100 and more, \$135 each.

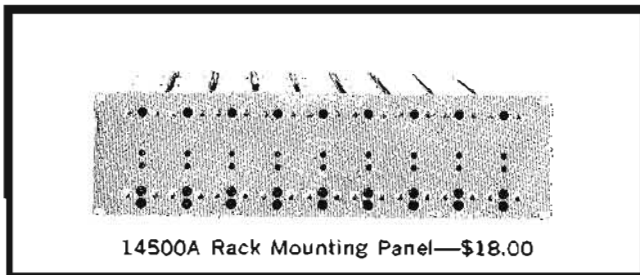

14500A Rack Mounting Panel—\$18.00

Rack mounting panel

This panel (5 $\frac{3}{4}$ " high x 19" wide) permits nine 801C modules to be rack-mounted side by side. All necessary hardware for mounting nine supplies is included. Provision is made on this panel for a label for each power supply. This label receives rear illumination from the pilot light when ac power is applied.

These easy-to-use general purpose, low-power medium-voltage laboratory supplies are particularly suitable for experimental setups and other medium-voltage bench applications. These instruments are designed for high regulation and low ripple. The 711A contains a 0-500-volt dc output at 100 mA along with an unregulated ac filament output, while the 712B contains four outputs—0-500 volts at 0-200 mA, 0 to -150 volts at 5 mA, -300 volts at 50 mA, and an unregulated ac filament source.

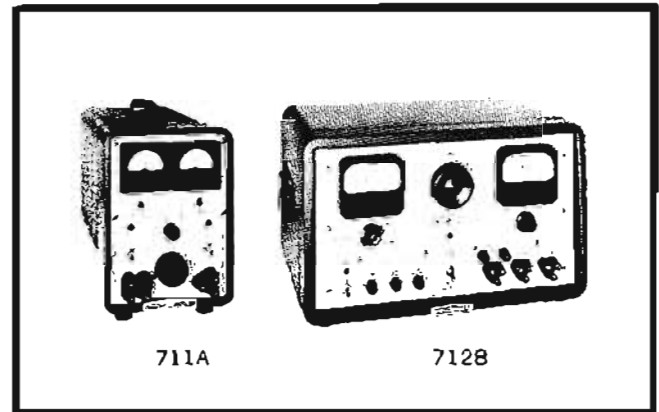

711A

712B

Specifications 711A supply

- Outputs:** 0 to 500 volts dc, 0 to 100 milliamps, 6.3 volts rms at 6 amps or 12.6 V rms CT at 3 amps unregulated.
- Load regulation:** less than 0.5% change or 1 volt change from no load to full load.
- Line regulation:** less than 0.5% change or 1 volt change for \pm 10% line voltage change.
- Ripple and noise:** less than 1 mV rms.
- Input:** 115 or 230 volts \pm 10%, 50 to 1000 cycles, approx. 145 watts.
- Dimensions:** 7 $\frac{3}{8}$ " (18.7 cm) wide x 11 $\frac{1}{2}$ " (31.5 cm) high x 14 $\frac{1}{4}$ " (38 cm) deep.
- Weight:** 20 lbs (9.2 kg) net; 26 lbs (11.8 kg) shipping.
- Price:** \$275.
- Option 28:** 230 V ac \pm 10%, single phase input: factory modification consists of reconnecting the multi-tap input power transformer for 230-volt operation. Price \$10.

Specifications 712B supply

- Outputs:**
 - DC regulated high voltage, 0 to +500 volts, 0 to 200 mA.
 - DC regulated fixed bias, -300 volts, 0-50 mA.
 - DC variable bias, 0 to -150 volts 0-5 mA.
 - AC unregulated voltage, 6.3 volts CT, 0-10 amps.
- Load regulation:**
 - DC regulated high voltage: less than 50 mV change, no load to full load.
 - DC regulated fixed bias: less than 50 mV change, no load to full load.
 - DC variable bias: tied to fixed bias. Hence, source regulation is same as fixed bias plus an internal impedance of 0-1000 ohms.
- Line regulation:** less than \pm 100 mV for a \pm 10% line voltage change.
- Ripple and noise:** less than 500 μ V.
- Input:** 115 volts \pm 10%, 50 to 60 cycles.
- Dimensions:** 20 $\frac{3}{4}$ " (56.9 cm) wide x 12 $\frac{3}{4}$ " (34.9 cm) high x 14 $\frac{3}{4}$ " (40.4 cm) deep.
- Weight:** 70 lbs (31.7 kg) net; 81 lbs (36.7 kg) shipping.
- Price:** \$490.

KLYSTRON POWER SUPPLIES

Versatile power sources for many klystrons
Models 715A, 716B



DC POWER SUPPLIES

The HP 716B Supply offers superior regulation, noise, ripple and hum characteristics, plus the broad capability of powering at least 250 types of klystrons. Beam and reflector voltages are closely regulated and continuously adjustable, using calibrated controls accurate to within $\pm 2\%$ on beam voltage and to within $0.5\% \pm 1$ volt on repeller voltage. In addition, a regulated dc filament supply minimizes residual FM and AM from the klystrons.

The reflector supply can be internally modulated with a sawtooth for FM or with a square wave for on-off operation. The positive excursion of the square wave is clamped to the reflector voltage, simplifying setup and minimizing double moding. Sawtooth and external modulation are ac-coupled to the reflector. A protective diode prevents the klystron reflector voltage from becoming positive with re-

spect to the cathode. Special circuitry eliminates turn-on transients that could be harmful to the klystron. Relays disconnect the beam supply to prevent klystron failure should the filament voltage drop below 1 volt or rise above 9 volts. The filament circuit in the 716B is protected against voltage surges up to 800 volts. These relays also disconnect the supplies whenever a klystron filament short circuits.

The HP 715A, designed to operate many types of low-power klystrons, offers a regulated 250-to-400 volt beam voltage, a 0-to-900 volt regulated reflector supply and a 6.3 volt ac filament supply. The reflector supply can also be square-wave modulated internally at the nominal frequency of 1000 Hz, externally modulated or sine-wave modulated at the power line frequency. Klystron protection is built in.

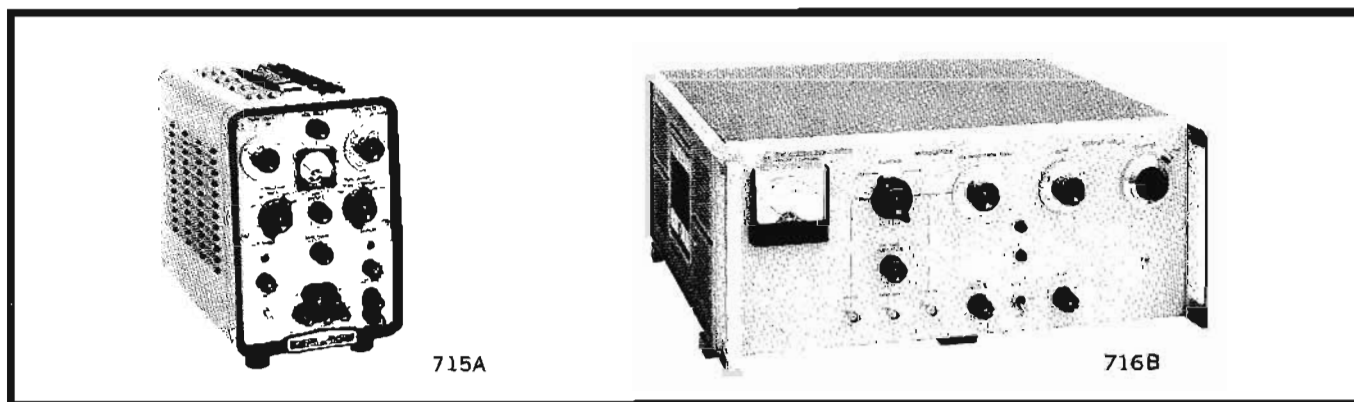

Reflector supply	0 to 900 V neg. with respect to beam supply, calibrated voltage controls; regulation within 1% $\pm 10\%$ line voltage variation; ripple < 10 mV; $10 \mu\text{A}$ max.	0 to 800 V neg. with respect to beam supply, accuracy $\pm 0.5\%$ of dial reading ± 1 V, line regulation better than 0.05%; ripple $< 500 \mu\text{V}$
Beam supply	250 to 400 V negative with respect to chassis ground, calibrated voltage controls; current 30 mA max. at 250 V, 50 mA max. at 400 V; regulation better than 1%, no load to full load or for $\pm 10\%$ normal line voltage variation; ripple less than 7 mV	250 to 800 V negative with respect to chassis ground, accuracy $\pm 2\%$ of dial reading; current 100 mA max.; line regulation better than 0.1%; load regulation better than 0.05%; ripple less than 1 mV
Filament supply	6.3 V ac, 1.5 amp maximum	6.3 V dc, adjustable nominally between 5 and 9 volts, isolated from ground; current 0 to 2 amps; 2 amps max. available to 6.5 V, decreasing to approx. 150 mA at 9 V, ripple < 2 mV; line regulation better than 1% with $\pm 10\%$ line change
Internal modulation	square wave: 1000 ± 100 Hz, adjustable; 0 to 110 V p-p, negative from reflector voltage; less than 10 μsec rise and decay times; sinusoidal power line frequency, 0 to 350 V p-p	square wave: 400 Hz to 2.5 kHz; 0.1% short-term stability; 10 to at least 150 V p-p, negative from reflector voltage; 5 μsec rise time; external sync of internal square wave 10 V peak, 500 k Ω nominal input impedance; sawtooth: 75 Hz nominal, 0 to at least 150 V nominal p-p, ac-coupled to reflector
External modulation	terminals provided; input impedance 100 k Ω	max. input 200 V p-p; input impedance 500 k Ω , 100 pF nominal
Oscilloscope output		with internal square-wave modulation: 1 V p-p min. for scope sync, 600 ohms output impedance; with internal sawtooth modulation: 10 V p-p min. for scope sweep, 50 k Ω output impedance
Meter	monitors beam current 0 to 50 mA	monitors beam current 0 to 100 mA
Power	115 V $\pm 10\%$, 50 to 60 Hz, 200 W	115/230 V switch $\pm 10\%$, 50 to 60 Hz, 200 to 350 W
Dimensions	7 $\frac{1}{2}$ " wide, 11 $\frac{1}{2}$ " high, 13 $\frac{1}{2}$ " deep (187 x 292 x 349 mm)	16 $\frac{1}{4}$ " wide, 6-25/32" high, 16 $\frac{1}{4}$ " deep (425 x 172 x 416 mm); hardware furnished for rack mounting
Weight	net 19 lbs (8,6 kg); shipping 24 lbs (10,8 kg)	net 46 lbs (20,7 kg); shipping 62 lbs (28,3 kg)
Accessories furnished	715A-16C shielded output cable, for connection to klystron	6' cable, terminated end mates with 716B (one furnished with instrument) HP Stock No. 00716-61601, \$25
Price	HP 715A, \$365; 50 to 60 Hz input	HP 716B, \$875



Frequency



FREQUENCY AND TIME MEASURING INSTRUMENTATION



FREQUENCY

Electronic counters have proven to be the most accurate, flexible, and convenient instruments available for making both frequency and time interval measurements. Since the introduction of the first high-speed counter (the 10 MHz HP Model 524A), more than 15 years ago, Hewlett-Packard has developed a broad range of both vacuum tube, solid-state and integrated circuit counters with a wide variety of features. Many vacuum tube models are still available, but they have generally been superseded by the solid state and integrated circuit line of counters. The counters and associated equipment can measure frequencies from dc to 40 GHz, and time intervals from 10 nanoseconds to more than 100 days.

An electronic counter is an instrument for comparing an unknown frequency or time interval to a known frequency or a known time interval. The counter's logic is designed to present this information in an easy-to-read, non-ambiguous, numerical display. The accuracy of this measurement depends primarily upon the stability of the known frequency, which is derived from the counter's internal oscillator. The oscillators in HP counters are designed and built by HP and have excellent stability (both long-term and short-term). All Hewlett-Packard counters are engineered for maximum reliability, accuracy and ease of operation.

The decision as to which electronic counter is best suited for a specific application depends upon the range and type of measurements to be made. See Electronic Counter Selection Guide (page 550). Hewlett-Packard has a broad line of counters with wide ranges of maximum frequency capability, accuracy, resolution and flexibility.

With this very complete line of electronic counters Hewlett-Packard also offers many input and output devices for these instruments. Included in the available accessory instruments are: digital recorders for automatic recording of counter measurements, digital clocks which control measurement intervals and supply information for simultaneous recording, digital-to-analog converters for obtaining analog records of digital measurements, and scanners for receiving the outputs from several electronic counters for display into a single recording device. Hewlett-Packard also manufactures magnetic and optical tachometers for rps measurement inputs to low-frequency electronic counters, fre-

quency meters and FM discriminators such as the HP 5210A/B.

Counter elements

The electronic counter has several basic functional sections which can be interconnected in a wide variety of ways for making different types of measurements. Of these, the most important functional sections are: (1) the decade counting assemblies (DCA's) with visual numerical readouts to totalize and display the count; (2) the main gate, which controls count start and stop with respect to time, and (3) the time base, which supplies the precise increment of time to control the gate for a frequency or pulse train measurement. Other sections include: signal shaping, display control, logic control and binary coded decimal (BCD) output. The logic control interconnects the proper circuits for the desired measurement, selects the appropriate measurement units for display and initiates the measurement cycle. The various modes of electronic counter operation are described in the following paragraphs, and accuracy is discussed on page 548.

Totalizing

Electronic counters can be operated in a totalizing mode with the main gate

flip-flop controlled by the manual start-stop switch as shown in Figure 1. With the switch in Start, the decimal counter assemblies totalize the input pulses until the main gate is closed by the switch being changed to Stop. The counter display then represents the input pulses received during the interval between manual Start and manual Stop.

Reversible counting

The unique feature of a Reversible Counter is each decade's ability to totalize in either a positive or negative direction. Signals on one input line are added, while signals on the other input line are subtracted; alternately, signals on the first input line may be added or subtracted, where information regarding the direction of count is supplied to the second input line. The HP 5280A can reverse its direction of count in 250 ns.

Frequency measurements

For direct frequency measurements, the input signal is first supplied to a signal shaper which converts the input signal (CW or pulses) to uniform pulses. The output of the shaper is then routed to decade counting assemblies (DCA's) through a gate controlled by the counter's time base as shown in Figure 2. The

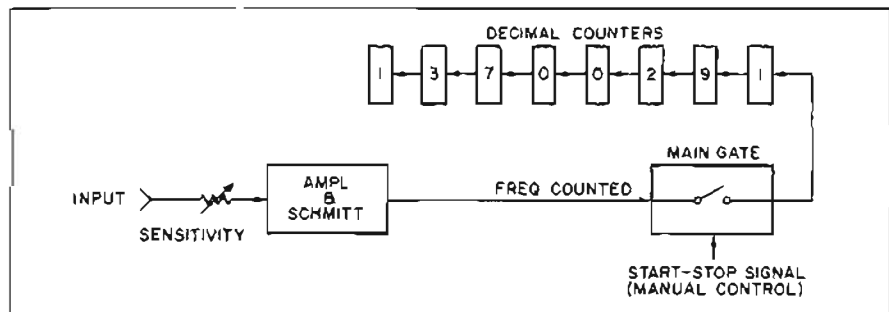

Figure 1. Function switch set to manual Start and Stop to determine interval for totalizing input signal.

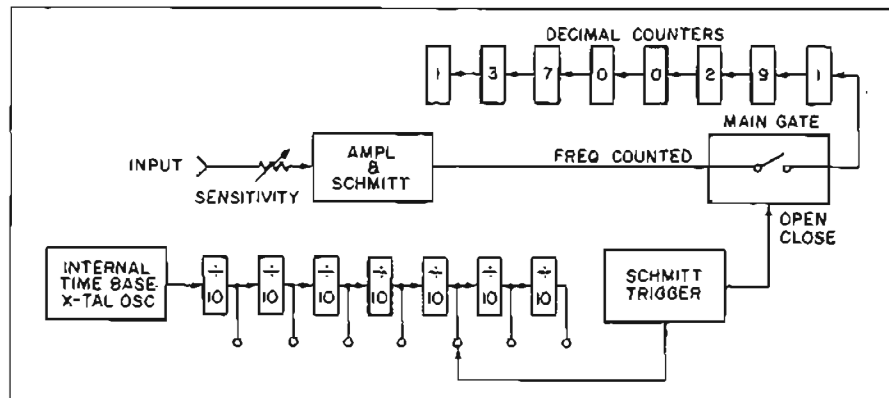

Figure 2. Function switch set to Frequency and gate time selected by time base switch.

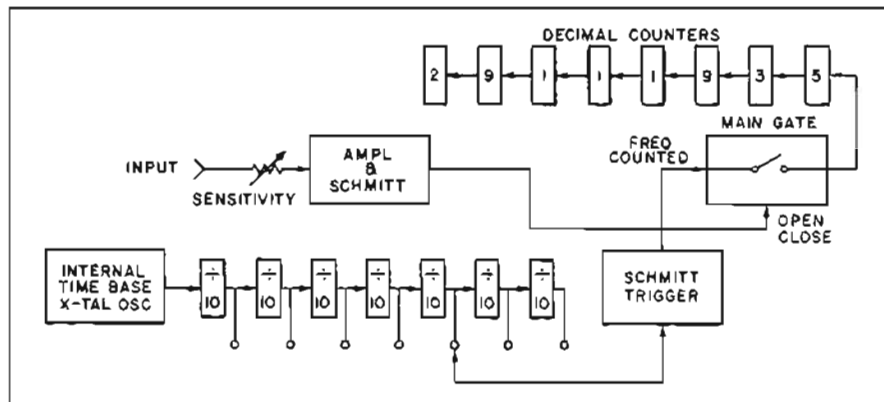

Figure 3. Function switch set to Period and counted frequency selected by time base switch.

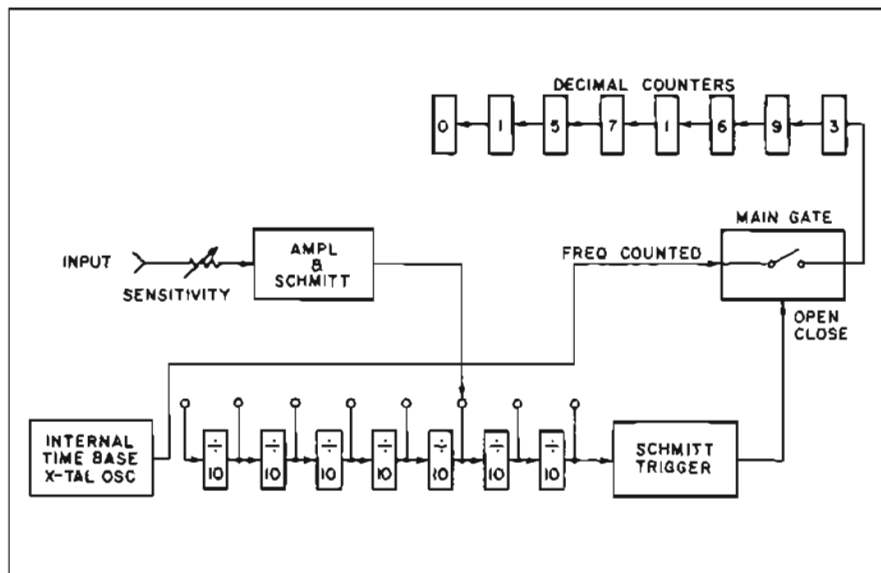

Figure 4. Function switch set to Period Average. Input signal controls gate for counting time base frequency.

number of pulses totalized in the DCA's for the selected period of time represents the frequency of the input signal. The frequency counted is displayed on a visual numerical readout, with a positioned decimal point, and is retained until a new sample is taken. The Sample Rate control determines the display time of the frequency measurement being made and initiates counter reset and the next measurement cycle.

The time base selector switch selects the gating interval, positions the decimal point and selects the appropriate measurement units.

In the event that frequency measurement of low level signals (down to 1 mV rms) is desired, HP manufactures a video amplifier plug-in (the model 5261A) for the 5245, 46 and 47 series counters. When using the 5261A on the most sensitive ranges, precaution should be taken to exclude the presence of stray radiation from the immediate measurement area because of the high sensitivity. A front panel meter indicates whether the input level is adequate for the measurement.

Period measurements

Period $P = 1/f$ where f is frequency;

therefore period measurements are made with the counter functions arranged as shown in Figure 3. The unknown input signal controls the main gate time, and the time base frequency is counted in the DCA's. The input shaping circuit selects the positive-going zero axis crossing of successive cycles as trigger points for opening and closing the gate.

Period measurements allow more accurate measurements of unknown low-frequency signals because of increased resolution. For example, a frequency measurement of 100 Hz on the 5245M,

with a 10-second gate time will be displayed as 0000.1000 kHz. A single period measurement of 100 Hz on an HP 5245M with 10 MHz as the counted frequency, would be displayed as 0010000.0 μ s. Thus, resolution is increased by a factor of 100. The accuracy here is also affected by the ± 1 count ambiguity \pm the time base accuracy \pm the trigger error. (Accuracy is discussed on Page 548.)

Multiple period averaging

The effect of the ± 1 count ambiguity and trigger error can each be reduced in decade steps by using multiple period averaging (Figure 4). In the HP 5245M, for example, the function selector switch is ganged to the decade divider assemblies (DDA's) so the input signal may be scaled in decade steps by factors up to 100,000 to reduce trigger error. The ± 1 count ambiguity is also reduced by a factor of 10 for each decade of scaling selected for the input signal. In the low-frequency measurement example above, the counter would display 10000.000 μ s for a 100 period average. (The function selector switch automatically shifts the decimal point in the display to show the correct reading for a single period.)

Ratio measurements

The ratio of two frequencies is determined by using the lower frequency signal for gate control while the higher frequency signal is counted, as shown in Figure 5. With proper transducers, ratio measurements may be applied to any phenomena which may be represented by pulses or sine waves. Gear ratios and clutch slippage, as well as frequency divider or multiplier operation, are some of the measurements which can be made using this technique.

Accuracy is ± 1 count \pm trigger error. The accuracy may be improved by using the multiple period averaging technique by counting the higher frequency for 10^N cycles of the lower frequency.

Rate measurements

With a preset counter or a counter with a preset plug-in, frequency meas-

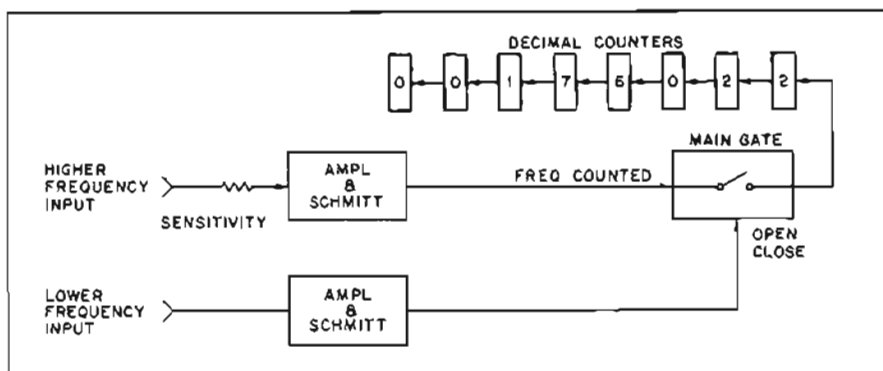

Figure 5. Function switch set to Period and time base switch to Ext. Lower frequency serves as gate control, while higher frequency replaces time base as counted frequency.

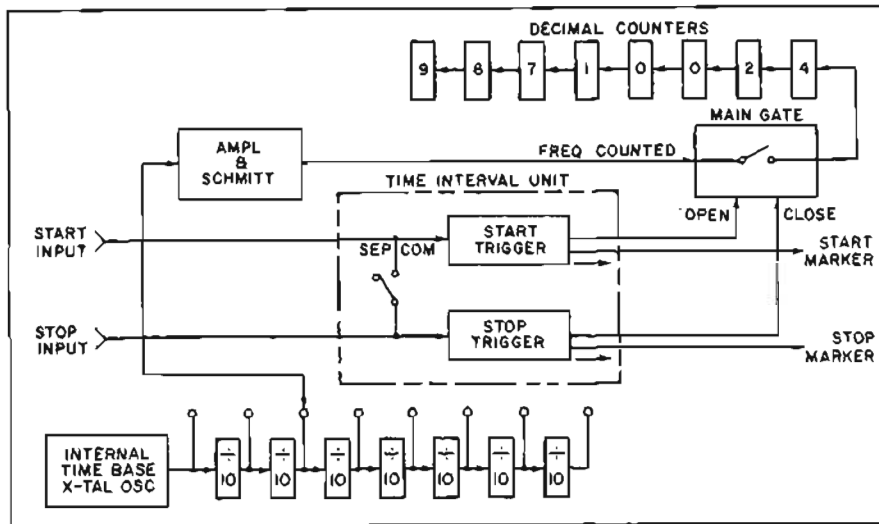

Figure 6. Start and stop signals derived from two sources or from different points of same waveform as selected by Com-Sep switch.

Measurements can be normalized automatically to rate measurements by appropriate selection of the gate time. The counter will then display a readout corresponding to the desired engineering units. For example: the HP 5214L Preset Counter or the HP 5245M Counter with HP 5264A Preset Plug-in can be set to a gate time of 600 milliseconds to cause an input from a 100-pulse-per-revolution tachometer to be displayed directly in revolutions per minute.

Scaling

The HP 5245M Solid-state Counter may be used for scaling (dividing down) an input by a factor of 10 to 10⁶. In this mode of operation, the input is routed through the units and tens decade di-

viders with the scaled output available from the rear of the counter.

Time interval measurements

Time interval measurements are similar to period measurements, except that the trigger points on the single waveform or waveforms are adjustable. As shown in Figure 6, separate signals may be used as start and stop signals or, by switching the Com-Sep switch to "Com," measurements may be made from one point on a waveform to another point on the same waveform. Triggering polarity, amplitude and slope are selected for each channel independently. The time interval is displayed in units of microseconds, milliseconds or seconds. Accuracy is affected by the same

factors which affect period measurements.

Extremely short time intervals (10 nanoseconds to 0.1 second) can be measured accurately with the 5275A Time Interval Counter. This instrument, using a 1 MHz external frequency standard, multiplies the 1 Hz to 100 MHz to obtain 10 nanosecond time increments as the "counted" frequency, for high resolution in time measurements.

Measurement of the time required for a number of random events to occur is possible with the 5214L Preset Counter. This instrument's decade dividers may be preset to close the gate on the Nth input pulse, where N is any number from 1 to 100,000.

High-frequency measurements

Accurate high-frequency measurements can be made with an electronic counter by using heterodyne converters, transfer oscillators or automatic dividers and for frequencies up to 350 MHz per scaling is available.

The unique capabilities of each will now be briefly described.

Heterodyne converters measure the average value of CW signals (even when FM'd to a certain extent) and have a resolution of 1 Hz in 1 second of counter gate time (HP 5255A and 5256A: 4 seconds). Hewlett-Packard manufactures a series of heterodyne converter plug-in units (see pages 558, 559) which convert the unknown high frequency to a related frequency which is within the counter's basic range. Measurements to 18 GHz are possible.

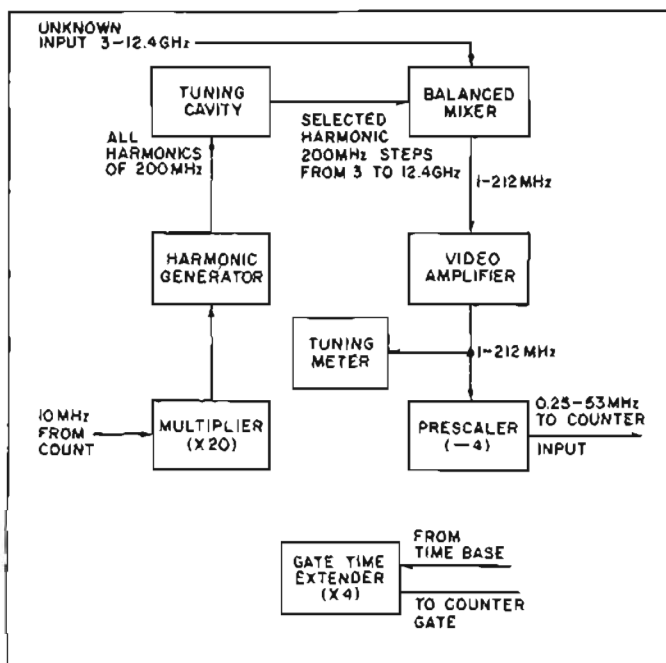

Figure 7. Heterodyne converter measurement (Block diagram of HP 5255A Frequency Converter). Counter measures difference frequency.

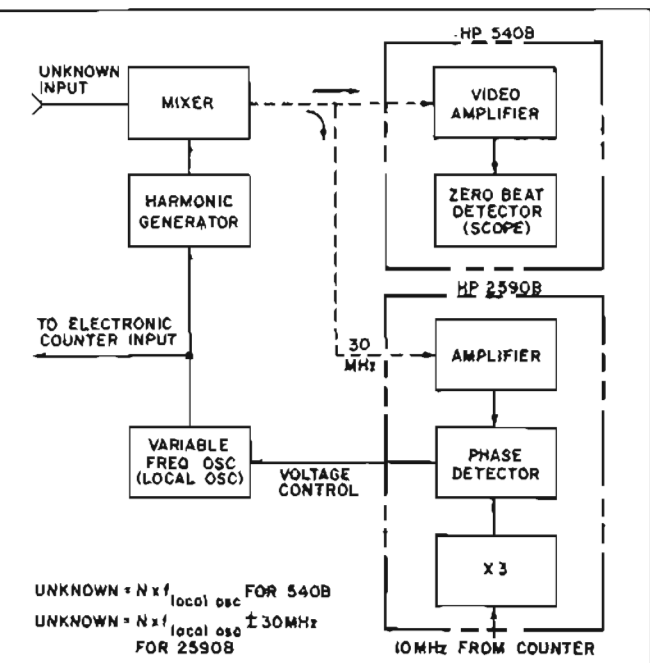

Figure 8. Transfer oscillator measurement. Counter measures oscillator frequency.

As an example we shall refer to the HP 5255A Plug-In Unit (see Fig. 7). The tuning control selects the 200 MHz harmonic that gives a beat frequency output which, after prescaling by a factor of four, is within the 50 MHz counting capability of the 5245M. At the same time the 5245M gate time is extended by a factor of 4 so that direct readout on the 5245M is achieved. The frequency reading on the counter is then added to the setting on the tuning dial to give the unknown frequency.

Transfer oscillators, on the other hand, are more versatile. They can measure FM or pulsed signals, as well as CW signals, over a very wide frequency range, can produce N Hz resolution in 1 second, counter gate time where N is the harmonic number, but require calculations (and perhaps two measurements) and thus need more operator skill and time. Note that accuracy may be less when measuring the carrier frequency of pulsed signals.

In operation, the transfer oscillator generates a variable frequency, which is adjusted so a harmonic of that frequency zero beats with the unknown CW signal (see Fig. 8). The transfer oscillator frequency is then measured on the counter and multiplied by the appropriate harmonic number to give the unknown frequency. In the HP 2590B, zero beat is obtained by an automatic phase lock loop after one of the nearest subharmonics has been manually tuned. Measurements to 15 GHz are possible with the HP 2590B, and to 40 GHz with the HP 540B with related instruments.

Automatic frequency dividers provide automatic measurement and direct readout of a wide range of CW frequencies, and furnish 1000 Hz resolution in 1 sec although little FM can be tolerated. Measurements from 0.3 GHz to 12.4 GHz can be achieved using the HP 5240A or HP 5260A with a suitable counter. The 5240A and 5260A zero beat with the input automatically and without offset and then provide an input frequency equal to exactly 1/100 or 1/1000 of the input frequency depending upon the division ratio switch setting.

Prescaling is accomplished by means of frequency division of the input signal. If the gate time is extended with the scale factor, the correct frequency will appear on the counter readout. The HP Model 5252A Prescaler plug-in unit has three selectable scale factors: $\div 8$, $\div 4$ and $\div 2$ and is dc-coupled which makes it very useful for counting of random pulses or events. Because the Prescaler is a wideband instrument it is more susceptible to noise than tuned instruments like the heterodyne converters. An adjustable trigger level control on the Prescaler can be used to discriminate against unwanted signals. The accuracy of the

Prescaler is the same as that of the counter although the measurement takes 2, 4 or 8 times as long time, depending on the scale factor.

For very low signal levels, HP manufactures a Sensitive Prescaler (Model 5258A) with a maximum sensitivity of 1 mV rms and a frequency range of 1 MHz-200 MHz. The scale factor is fixed at $\div 4$. For simplicity of operation, a meter indicates the input signal level.

Digital to analog conversion

In many measurement applications analog recordings can be of great value. In general it is not possible to make analog recordings directly from a counter. A good number of Hewlett-Packard's electronic counters will provide the measurement data in BCD form. Using this BCD output and the HP Models 580A or 581A Digital to Analog (D/A) Converters, an analog recorder output is then available from the D/A converters. A case where the D/A converters prove very useful is in the evaluation of the stability of quartz crystal oscillators. By using a counter, a D/A converter and a strip chart recorder it is possible to obtain a plot of fractional frequency deviation.*

In general, in cases where data have to be monitored continuously over a longer period of time, the use of D/A converters in connection with electronic counters becomes very useful. The HP 580 Series offers resolutions to 1 part in 10^7 .

Time-base oscillator accuracy

Definition of time base oscillator stability requires knowledge of long-term stability, short-term stability, and the effects of line-voltage, ambient temperature changes, and load changes.

Long-term stability (also called crystal aging rate or drift rate) refers to slow changes in average frequency with time due to secular changes in the resonator or other elements of the oscillator. This is usually expressed in fractional parts per unit time such as "parts in 10^6 per day." The aging rate of a crystal oscillator is predictable after an initial aging-in period and it generally assumes a linear characteristic. The slope of this line is the long-term aging rate of the oscillator. Aging is cumulative. Various methods exist for determining this aging rate and for calibrating the oscillator to a desired standard. Refer to Application Note 52, "Frequency and Time Standards", which is available from HP upon request. HP specifies maximum aging rates instead of using less conservative "typical" or statistical stability definitions.

Short-term stability is an additive factor in over-all accuracy and refers to changes in average frequency over a time sufficiently short such that the change in frequency due to long-term effects is negligible. Good short-term stability is necessary to permit close agreement from

*This and other stability measurements are described in greater detail in the HP Application Note AN-52, available without charge from the Hewlett-Packard Company.

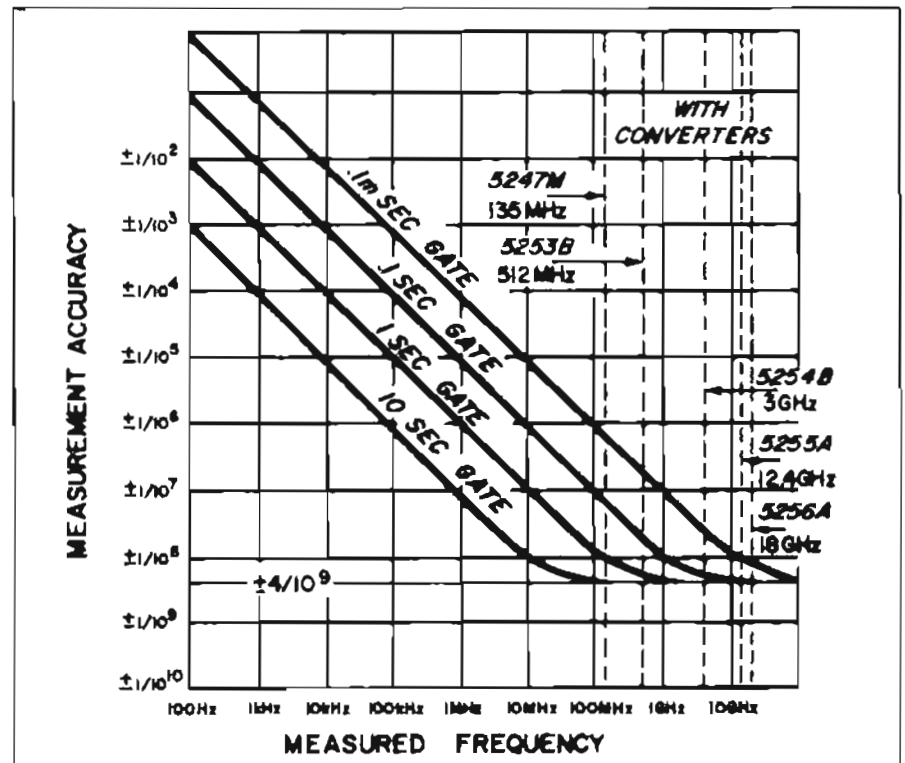

Figure 9. Attainable accuracy of 5245M Counter. Period measurement accuracy based on 10 MHz counted frequency. Time base accuracy was assumed to be 4 part in 10^9 overall for this example.

measurement to measurement. Short-term specifications on a counter's internal time base oscillator indicate the average effect of all noise on the counter's gate time accuracy over a certain averaging time. Thus, in the HP 5245M with 5 parts in 10^{11} rms for 1-second averaging, there is no short-term contribution to the gate error for a frequency measurement. This excellent performance is obtained using a crystal oven with proportional electronic control, instead of a less expensive but less stable on-off thermostat control. Averaging time should be expressed over a realistically short-time period since electronic counters seldom have gate times in excess of 10 seconds. Long averaging times can mask large short-term changes.

The attainable accuracy of any electronic counter is limited by the time base oscillator stability, since the time

base oscillator supplies the definitive time information for a measurement. The time base must be calibrated periodically, since the aging rate will cause a cumulative deviation in frequency which can result in a measurement error. Figure 8 graphically illustrates the attainable accuracy of the HP 5245M counter assuming an overall time base accuracy of 4×10^{-9} at time of use. Accuracy versus measured frequency is plotted and crossover points indicate areas below which determination of frequency is better performed by period measurement.

The ± 1 count ambiguity is inherent in measurements made with an electronic counter because the gating is not normally coherent with the input signal. It is possible for the gate to open or close while an input pulse is passing through so that this pulse may or may

not be included in the final count. The degree to which the ± 1 count ambiguity affects measurement accuracy is determined by the factor $1/\text{displayed count}$.

Period measurement accuracy is affected by trigger error (a function of the input signal-to-noise ratio and rise time), and by the time base stability, and is computed as follows: percentage error =

$$\pm \left(\frac{1}{f_{10}/f_x} + 0.003 + \text{L.T.} + \text{S.T.} \times \right)$$

100, where f_{10} = time base frequency counted, f_x = sine wave input with 40 dB signal-to-noise ratio, 0.003 = trigger error, L.T. = long-term stability of the time base oscillator, and S.T. = short-term stability of the time base oscillator. This total error is reduced by the number of periods averaged when multiple period average operation is selected.

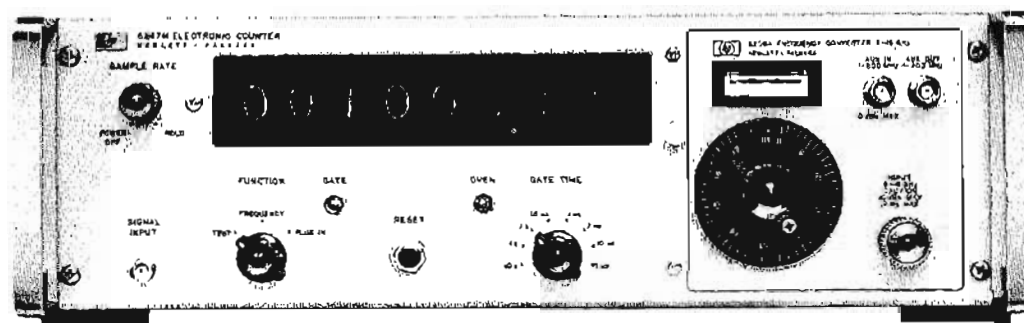

5247M/5256A



5216A



5221A

Solid-state and integrated circuit electronic counters

Instrument	Frequency range	Measures*	Readout	BCD output	Time base aging rate (gate times)	Model	Price	Page
‡Versatile, ultra stable fast warmup counter**	0 Hz to 50 MHz	F, P, MPA, R, MR†	8 digits in-line	Standard	$\approx 5/10^{10}/\text{day}$ (1 μs - 10 s)	5245M	\$2750	554 ***
‡Ultra stable, 135 MHz, fast warmup counter**	10 Hz to 135MHz	F†	8 digits in-line	Optional	$\approx 5/10^{10}/\text{day}$ (1 μs - 10 s)	5247M	\$2800	557
Versatile, accurate HP counter	0 Hz to 50 MHz	F, P, MPA, R, MR†	8 digits in-line	Standard	$\approx 3/10^9/\text{day}$ (1 μs - 10 s)	5245L	\$2450	552 ***
Economical counter with plug-in versatility	0 Hz to 50 MHz	F, R, MR†	6 digits in-line (7 to 8 optional)	Optional	$\approx 2/10^7/\text{month}$, $\approx 3/10^9/\text{day}$ optional (1 μs - 1 s)	5246L	\$1750	551
Economical 50 MHz counter	0 Hz to 50 MHz	F, P, MPA, R, MR	7 digits in-line	Standard	$\approx 2/10^7/\text{month}$ (1 μs - 10 s)	5244L	\$1850	563
‡12.4 GHz automatic digital frequency meter	0.3 to 12.4 GHz	F	8 digits in-line	Standard	$\approx 2/10^7/\text{month}$ (0.1 s, 1.0 s)	5240M	\$4750	567
	10 Hz to 12.5 MHz	F, R						
Economical universal counters; stable, wide range trigger controls	0 Hz to 2 MHz	F, P, MPA, R, MR, TI	6 digits in-line	Standard	$\approx 2/10^7/\text{month}$ (10 μs - 10 s)	5233L	\$1600	570
	0 Hz to 300 kHz	F, P, MPA, R, MR, TI	5 digits in-line	Standard	$\approx 2/10^6/\text{week}$ (10 μs - 10 s)	5223L	\$1275	570
‡Versatile, economical integrated circuit counter	3 Hz to 12.5 MHz	F, P, MPA, R, MR	7 digits in-line leading zeros blanked	Standard	$\approx 2/10^6/\text{month}$ (0.01 s - 10 s)	5216A	\$ 925	566
Versatility at moderate cost	2 Hz to 1.2 MHz	F, P, MPA, R, MR	6 digits in-line	Standard	$\approx 2/10^7/\text{month}$ (0.01 s - 10 s)	5532A	\$1350	568
			6 digits columnar			5232A	\$1250	
	2 Hz to 300 kHz	F, P, MPA, R, MR	5 digits in-line	Standard	$\approx 2/10^6/\text{week}$ (0.01 s - 10 s)	5512A	\$ 975	568
			5 digits columnar			5212A	\$ 875	
‡Economical 10 MHz integrated circuit counter	5 Hz to 10 MHz	F, R, MR	5 digits in-line (6 optional), leading zeros blanked	Standard	$\approx 1/10^6/\text{month}$ (0.01 s - 10 s)	5221B	\$ 700	564
‡Economical 10 MHz integrated circuit counter	5 Hz to 10 MHz	F	4 digits in-line (5 or 6 optional), leading zeros blanked	Not available	Power line (0.1 s, 1.0 s)	5221A	\$ 350	564
Low cost, low frequency counters	2 Hz to 300 kHz	F, R	4 digits in-line	Standard	Power line (0.01 s - 10 s)	H22-5211B	\$ 775	568
						5211B	\$ 675	
			4 digits columnar	Standard	Power line (0.1 s, 1.0 s)	5211A	\$ 575	568

Solid-state special purpose counters

Instrument	Frequency range	Measures*	Readout	BCD output	Time base	Model	Price	Page
Reversible counter, versatile high speed	0 Hz to 2 MHz	Count A, B, A + B, A - B, Af(B), A Quad B	6 digits in-line (7 or 8 optional)	Standard	External (in- ternal optional)	5280A (5285A)	\$1450 \$ 450	574
Present counter, normalizes count, versatile	2 Hz to 300 kHz	Normalized rate and ratio, ratio, time for N events	5 digits in-line	Standard	$\approx 2/10^6/\text{week}$	5214L	\$1300	572
Time interval counter	10 ns to 0.1 s	TI	7 digits columnar	Standard	External	5275A	\$2450	576

* F—Frequency, P—Period, MPA—Multiple Period Average, R—Ratio, TI—Time Interval, PD—Phase Delay.

† Accepts plug-ins for wide variety of other measurements.

** After 24 hours disconnected, ½ hour warm-up to reach 1 part/10⁷ of frequency at turn off; 1 hour warm-up to reach 5 parts/10⁹ of frequency at turn off.

‡ New counters.

*** See page 556 for a rugged version of this counter (meets Mil Std for RFI and drip proof).

ELECTRONIC COUNTER

Economical 50 MHz plug-in counter
Model 5246L



FREQUENCY

The 5246L offers the circuit advantages, basic 0 to 50 MHz range and plug-in accessory feature of the HP 5245L (p. 552), 5245M (p. 554) and 5247M (p. 557). Plug-ins purchased for those counters can be used with the 5246L (see p. 558 for performance with 5246L). The 5246L has display storage, a 6-digit readout (7 and 8-digits optional), and without any plug-ins will measure frequency and frequency ratio. BCD output and a higher stability (3×10^{-9} /day) crystal time base are optional. A dual field-effect transistor input amplifier offers almost constant 1 megohm/25 pF input impedance, and HP 10000 Series Probes can be used.

Frequency ratio (f_1/f_2) is measured by connecting signal f_2 (100 Hz to 1 MHz) in place of the counter's time base (BNC at rear), and connecting f_1 (up to 50 MHz) to the SIGNAL INPUT. Multiple ratios can be measured from 10 to 10⁶ in decade steps.

Specifications

Frequency measurements

Range: 0 to 50 MHz (dc coupled input). 25 Hz to 50 MHz (ac coupled input, maximum sensitivity).

Input: 100 mV rms sensitivity with 1 M Ω impedance.

Gate Time: 1 μ sec to 1.0 seconds in decade steps.

Accuracy: ± 1 count \pm time base accuracy.

Readout: kHz or MHz with positioned decimal point; units annunciator in line with digital display.

Time base

Crystal frequency (internal): 1 MHz.

Stability:

Aging rate: less than 2×10^{-7} /mo.

Temperature: less than ± 2 parts in 10⁹ ($+10^\circ$ to $+50^\circ\text{C}$)
 ± 2 parts in 10⁹ (0°C to 65°C).

Line voltage: less than ± 1 part in 10⁷ for 10% change.

Output Frequency: 1 MHz, > 3 V p-p into 1 k Ω .

External Input: Sensitivity: 1 volt rms into 500 ohms, sine wave. Range: 100 Hz to 1 MHz, sine wave.

General

Display: 6 digits in-line with rectangular Nixie tubes and display storage; 999,999 max. display.

Display Storage: Holds reading between samples; switch overrides storage.

Sample Rate: Time following a gate closing during which the gate may not be reopened is continuously variable from less than 0.2 s to 5 seconds in frequency mode, independent of gate time; display can be held indefinitely.

Signal Input

Maximum Sensitivity: 100 mV rms; coupling, AC or DC. AC coupling has 0.022 μ f 600 V DC capacitor (-3 dB at approximately 7 Hz).

Impedance: 1 M Ω shunted by 25 pF.

Overload: Diode clamps in series with 100 k Ω and 0.001 μ f protect input circuit for up to 120 V rms. Input resistance for overload condition (beyond approx. 1 V) is approximately 0.1 M Ω .

Self check: counts 10 MHz for the gate time chosen by the time base selector switch.

Operating temperature range: 0°C to $+65^\circ\text{C}$.

Power supply: 115 or 230 volts $\pm 10\%$, 50 to 60 Hz; 95 W (50 to 1000 Hz operation, inquire).

Weight: Net, 28 lbs (12.8 kg) with blank plug-in; shipping, 36 lbs (16.4 kg).

Accessories Furnished: HP 10503A Cable, 4 feet long, male BNC connectors. Detachable Power Cord, 7 $\frac{1}{2}$ ft. (2040 mm) long, NEMA plug. Circuit Board Extender.

Price: HP 5246L, \$1750.

Options

01: 7 digit readout, \$100.

02: 8 digit readout, \$200.

03: 4-2-2-1 "1" state positive 4-line BCD output.

"0" State Level: -8 V.

"1" State Level: $+18$ V.

Impedance: 100 K ohms, each line.

BCD Reference Levels:

Approximately $+17$ V, 350 Ω source.

Approximately -6.5 V, 1000 Ω source.

Print Command: $+13$ V to 0 V step, dc coupled.

Hold-off Requirement: $+15$ V min., $+25$ V max. from chassis ground (1000 Ω source).

Cable Connector: Amphenol 57-30500, 1 req'd \$75.

04: Similar to Option 03 except output is 1-2-4-8 "1" state negative 4 line BCD. \$85.

05: Similar to Option 03 except output is 1-2-4-8 "1" state positive 4 line BCD. \$85.

06: High Stability Time Base Oscillator: Specifications under "Stability", Model 5245L specification, page 501, apply. \$300.

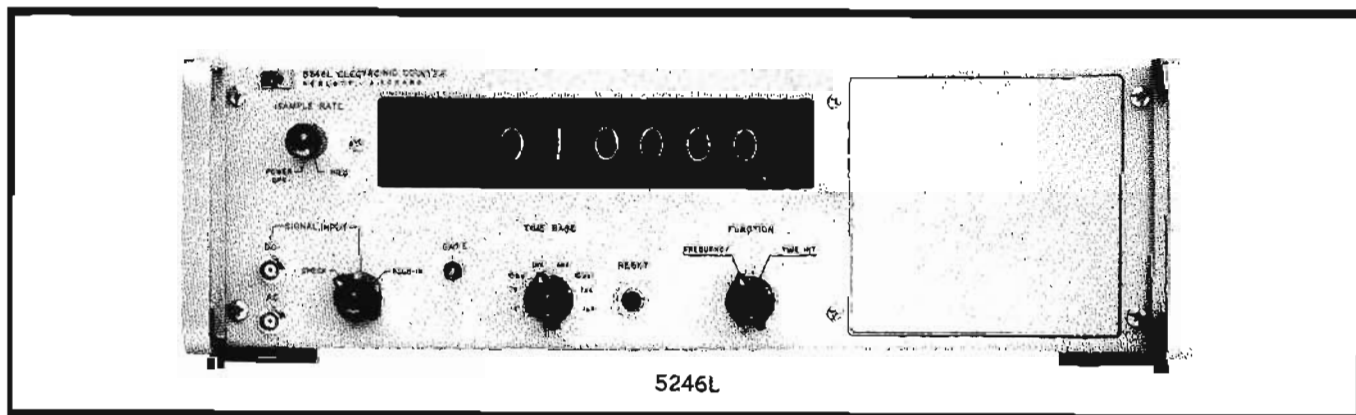



ELECTRONIC COUNTER

Accurate, versatile HP plug-in counter
Model 5245L

Advantages:

- Plug-ins for wide variety of measurements; frequencies to 18 GHz
- Excellent long and short-term stability
- High input impedance on all ranges
- Ac or dc coupling (dc usable to 50 MHz)
- Two-mode trigger level control
- Readout storage; BCD output

This solid-state electronic counter measures frequency, period, multiple period average, ratio and multiples of ratio and can be used to scale a signal by decades. Plug-ins, which go directly into the front panel, extend frequency measurements to 18 GHz, permit time interval measurements, and will perform a variety of other functions. The basic counter (without plug-ins) offers a counting rate of 50 MHz with 8-digit resolution. For plug-ins, see p. 558-562.

Excellent stability is attained with a proportionally controlled oven for the quartz crystal. Careful design consideration of the effects of temperature and line voltage contributes toward greater realizable measurement accuracy. The time base aging rate of better than 3 parts in 10^9 /day makes it useful as a frequency standard. Short-term stability exceeds 2×10^{-10} (1 sec. averaging time).

A dual FET input amplifier provides 1 meg/25 pF input impedance, independent of attenuator setting and frequency up to 50 MHz. Low VSWR is therefore attainable when properly terminated. High impedance probes (e.g., HP 10000 Series) may be used in the same manner as with high frequency oscilloscopes.

Basic Counter Operation

The 5245L (without plug-ins) measures frequencies and repetition rates of periodic or random pulses from 0 to 50

millions pps. Gate times from 1 μ sec to 10 seconds are selected with a front panel switch. Multiple period average to 10^5 periods is obtained without need for a separate plug-in. This capability, which also applies for ratio measurements since the decade divider assemblies are usable at any frequency, makes possible accurate measurements at low and intermediate frequencies. The increase in accuracy over that possible in single period or ratio is a direct result of division of the trigger error by the averaging factor, as well as the result of increased resolution. Ratios of frequencies that are almost identical can be accurately resolved.

The basic counter will also scale (divide) an input frequency as high as 50 MHz in decade steps by factors up to 10^9 . For example a 14 MHz signal can be divided to 0.014 Hz. A rear panel BNC connector and switch provide a choice of nine 5245L output frequencies.

Display storage and a Sample Rate control are provided.

Input Signal Triggering

Both preset and adjustable modes are provided. In PRESET, trigger level is optimum for signals which are symmetrical about ground; it is useful for most applications, and is automatically selected when plug-ins are used (without moving the TRIGGER control to PRESET). In ADJUSTABLE, the control can be rotated for counting + or - pulses, or for unusual signal conditions.

Electrical Readout and Remote Control

Four-line BCD code output is provided and is suitable for systems use or for output devices, such as Model 562A or 5050A Digital Recorder, and Model 580A or 581A Digital to Analog Converter. Other codes and remote control of front panel switches are optional.

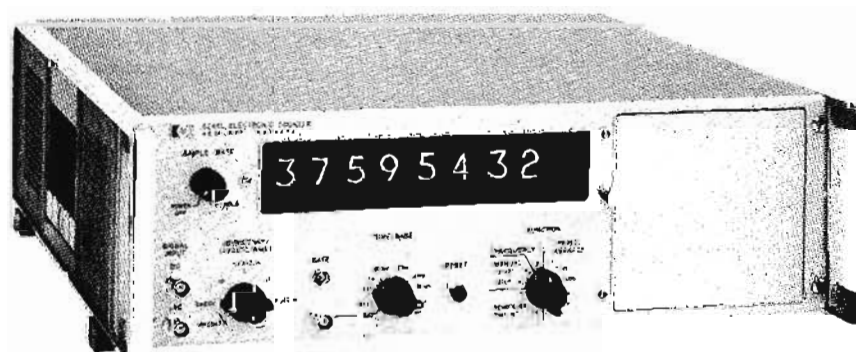

5245L

Specifications

Frequency measurements

Range: 0 to 50 MHz (dc input), typical response $< \pm 1$ dB, 25 Hz to 50 MHz (ac coupled).

Gate time: 1 μ s to 10 seconds in decade steps.

Accuracy: ± 1 count \pm time base accuracy.

Readout: kHz or MHz with positioned decimal point; units annunciator in line with digital display.

Self check: counts 10 MHz for the gate time chosen.

Scaling

Frequency range: 0 to 50 MHz.

Factor: by decades up to 10^6 , switch selected on rear panel. For $\div 2$, $\div 4$, $\div 8$, add HP 5252A Prescaler.

Input: front panel, signal input.

Output: in place of time base output frequencies.

Period average measurements

Range: SINGLE PERIOD 0 to 1 MHz.
MULTIPLE PERIOD 0 to 300 kHz.

Periods averaged: 1 period to 10^6 periods in decade steps.

Frequency counted:

1 AND 10 PERIOD 1 Hz to 10 MHz in decade steps.
100 PERIOD 10 Hz to 10 MHz.
1,000 PERIOD 100 Hz to 10 MHz.
10,000 PERIOD 1 kHz to 10 MHz.
100,000 PERIOD 10 kHz to 10 MHz.

Accuracy: ± 1 count \pm time base accuracy \pm trigger error.*

Readout: s, ms, μ s, with positioned decimal point; units annunciator in line with digital display.

Self check: gate time in 10 μ s to 1 s (periods averaged of 100 kHz); counts 100 kHz from the time base.

Ratio measurements

Displays: (f_1/f_2) times period multiplier; multiplier: 1- 10^5 .

Range: f_1 : 0 to 50 MHz, f_2 : 0 to 1 MHz in single period, 0 to 300 kHz in multiple period; periods averaged 1 to 10^5 in decade steps.

Sensitivity: 0.1 V rms, each input (max.).

Accuracy: ± 1 count of $f_1 \pm$ trigger error* of f_2 . f_1 is applied to the decimal counters (enters Time Base Ext. jack on front panel), f_2 is frequency applied to decade dividers (enters Signal Input jack).

Readout: dimensionless; positioned decimal point for number of periods averaged.

Self check: Period Average Self Check applies.

Time base

Crystal frequency (Internal): 1 MHz.

Stability: AGING RATE—less than 3 parts in 10^6 per 24 hours.† AS A FUNCTION OF TEMPERATURE—less than ± 2 parts in 10^6 per $^\circ$ C from -20° to $+55^\circ$ C. AS A FUNCTION OF LINE VOLTAGE—less than ± 5 parts in 10^6 for $\pm 10\%$ change in line voltage from 115 V or 230 V rms.

Short term:—less than 2 parts in 10^6 rms with measurement averaging time of one second under constant environmental and line voltage conditions.

Adjustment: Fine frequency adjustment (range approximately 4×10^{-5}) and medium frequency adjustment (range approximately 1×10^{-5}) are available from the front panel through the plug-in hole. Coarse frequency adjustment (range approximately 1×10^{-5}) is available at the rear of the instrument.

Output frequencies:

1. **Rear panel:** 0.1 Hz to 10 MHz in decade steps; switch selected on rear panel; all frequencies available in manual function without interruption at reset except 100 Hz, 10 Hz, 1 Hz, and 0.1 Hz which are interrupted by manual reset; 10 kHz to 10 MHz available continuously in all functions; 1 kHz available continuously for all functions except 100 k period average; stability same as internal time base; 5 volts p-p rectangular wave with 1000 ohm source impedance at 1 MHz and lower; 1 volt rms sine wave with 1000 ohm source impedance only at 10 MHz.

2. **Front panel:** 0.1 Hz to 1 MHz in decade steps; by Time Base switch; availability defined under Output Frequencies (1) above; stability same as internal time base; 1 V p-p.

External standard frequency: 1 MHz, 1 V rms into 1000 ohms required at rear panel BNC connector.

Time base external input (front panel):

Maximum sensitivity: 100 mV rms.

Impedance: 1 megohm, approx. 20 pF, dc coupled.

Overload: diodes protect input ckt. up to 120 V rms.

General

Display: 8 digits in-line with rectangular Nixie® tubes; 99,999,999 max. display; total width of display including units annunciator and auto-positioned decimal point indication does not exceed 7 inches.

Display storage: holds reading between samples; switch overrides storage.

Sample rate: time following a gate closing during which the gate may not be reopened is variable from less than 0.2 s to 5 seconds in frequency mode, independent of gate time; display can be held indefinitely.

Signal Input:

Maximum sensitivity: 100 mV rms.

Coupling: ac or dc, separate BNC connectors. AC coupling has 600 V dc, 0.022 μ F capacitor (-3 dB at approx 7 Hz).

Impedance: 1 meg. parallel with approx. 25 pF, all ranges.

Attenuation: step attenuator (SENSITIVITY switch) provides nominal sensitivities of 0.1, 1, and 10 V rms.

Trigger level adjustment (mln.): front panel control has ± 0.3 V trigger level range on 0.1 V position, ± 3 V range on 1 V position, ± 30 V range on 10 V position. A PRESET position automatically centers trigger level at 0 V.

Overload protection: diodes protect input circuit for up to 120 V rms on 0.1 V range, 250 V rms on 1 V range, 500 V rms on 10 V range. Input resistance for overload conditions (input amplitude $>$ ten times SENSITIVITY) is 100 k Ω on 0.1 V range, and is approximately 1 M Ω on other ranges.

Pulse measurements: front panel TRIGGER LEVEL adjustment allows counting positive or negative pulses.

Digital output: 4-line BCD 4-2-2-1, "1" state positive, 4-line BCD 8-4-2-1, available as Option 02 ("1" state positive and Option 03 ("1" state negative).
"0" STATE LEVEL: -8 V, "1" STATE LEVEL: $+18$ V.

Impedance: 100 k Ω , each line.

BCD reference levels: approximately $+17$ V, 350 Ω source; approximately -6.5 V, 1000 Ω source.

Print command: $+13$ V to 0 V sep. DC-coupled.

Cable connector: Amphenol 50-pin 57-30500, 1 req'd.

Hold-off requirement: $+15$ V min., $+25$ V max. from chassis ground (1000 Ω source).

Operating temperature range: -20° C to $+65^\circ$ C.

Power supply: 115 or 230 volts $\pm 10\%$, 50 to 60 Hz, 95 watts. (50 to 1000 Hz operation, price on request.)

Weight: net, 32 lbs (14.4 kg) with blank plug-in panel; shipping, 40 lbs (18.2 kg).

Connectors: BNC (exc. remote program and BCD out).

Accessories furnished: 10503A Cable, 4' long, male BNC connectors. Detachable Power Cord, 7 1/2' long, NEMA plug. Circuit Board Extender, rack mount conversion parts.

Dimensions: 5 1/4" high by 16 3/4" wide.

Price: Model 5245L, \$2,450.

Optional and special features:

Option 02. 4-line BCD 8-4-2-1, "1" state positive (for digits only) in lieu of 4-2-2-1 (identical in other respects to above output data), add \$10.

Option 03. 4-line BCD 8-4-2-1, "1" state negative (for digits only) in lieu of 4-2-2-1 (identical in other respects to above output data), add \$10.

J35-5245L: similar to 5245L with Option 02 except has 8-4-2-1 output "1" state positive for digits, measurement units, and decimal point, \$2,480. (Note: M47-562A/AR Printer is especially suitable for J35-5245L.)

J36-5245L: similar to 5245L with Option 03 except has 8-4-2-1 output "1" state negative for digits, measurement units, and decimal point, \$2,480. (Note: P64-562A/AR Printer is especially suitable for J36-5245L.)

Electromagnetic compatibility: Model H60-5245L meets the requirements of military specification MIL-I-6181D, price on request.

Remote operation: all functions which may be programmed from the front panel controls (in normal use) may be programmed from a remote location except for the "Sample Rate" (as defined above) and the sensitivity control setting; order H65-5245L, price on request.

*Trigger error is less than $\pm 0.3\%$ of one period + periods averaged for signals with 40 dB or better signal-to-noise ratio.

†After 72 hours of continuous operation.



ELECTRONIC COUNTER

Most accurate, versatile HP plug-in counter
Model 5245M

Advantages:

- New, quick warm-up time base
- Ultra-stable
- Plug-ins for wide variety of measurements; frequencies to 18 GHz
- High input impedance on all ranges
- Ac or dc coupling (dc usable to 50 MHz)
- Two-mode trigger level control
- Readout storage; BCD output

This solid-state electronic counter measures frequency, period, multiple period average, ratio and multiples of ratio and can be used to scale a signal by decades. Plug-ins, which go directly into the front panel, extend frequency measurements to 18 GHz, permit time interval measurements, and will perform a variety of other functions. The basic counter (without plug-ins) offers a counting rate of 50-MHz with 8-digit resolution. For plug-ins, see p. 558-562.

Excellent stability is attained with a proportionally controlled oven for the quartz crystal. Careful design consideration of the effects of temperature and line voltage contributes toward greater measurement accuracy. The time base aging rate of better than 5 parts in 10^{10} /day makes it useful as a frequency standard. Short-term stability exceeds 5×10^{11} (1 s averaging time).

A dual FET input amplifier provides 1 meg/25 pF input impedance, independent of attenuator setting and frequency up to 50 MHz. Low VSWR is therefore attainable when properly terminated. High impedance probes (e.g., HP 10000 Series) may be used in the same manner as with high frequency oscilloscopes.

Basic counter operation

The 5245M (without plug-ins) measures frequencies and repetition rates of periodic or random pulses from 0 to 50 million pps. Gate times from 1 μ s to 10 seconds are selected with a front panel switch. Multiple period average to 10^5 periods is obtained without need for a separate plug-in. This capability, which also applies for ratio measurements since the decade divider assemblies are usable at any frequency, makes possible accurate measurements at low and intermediate frequencies. The increase in accuracy over that possible in single period or ratio is a direct result of division of the trigger error and the ± 1 count ambiguity by the averaging factor, as well as the result of increased resolution. Ratios of frequencies that are almost identical can be accurately resolved.

The basic counter will also scale (divide) an input frequency as high as 50 MHz in decade steps by factors up to 10^6 . For example a 14 MHz signal can be divided to 0.014 Hz. A rear panel BNC connector and switch provide your choice of nine 5245M output frequencies.

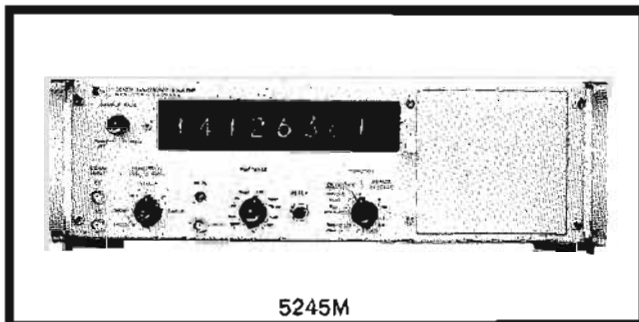

Display storage and a Sample Rate control are provided.

Input signal triggering

Both present and adjustable modes are provided. In PRESET, trigger level is optimum for signals which are symmetrical about ground; it is useful for most applications, and is automatically selected when plug-ins are used (without moving the TRIGGER control to PRESET). In ADJUSTABLE, the control can be rotated for counting + or - pulses, or for unusual signal conditions.

Electrical readout and remote control

Four-line BCD code output is provided and is suitable for systems use or for output devices, such as Model 562A or 5050A Digital Recorder, and Model 580A or 581A Digital to Analog Converter. Other codes and remote control of front panel switches are optional.

Specifications

Frequency measurements

Range: 0 to 50 MHz (dc input), typical response $< \pm 1$ dB, 25 Hz to 50 MHz (ac coupled).

Gate time: 1 μ s to 10 seconds in decade steps.

Accuracy: ± 1 count \pm time base accuracy.

Readout: kHz or MHz with positioned decimal point; units annunciator in line with digital display.

Self check: counts 10 MHz for the gate time chosen.

Scaling

Frequency range: 0 to 50 MHz.

Factor: by decades up to 10^6 , switch selected on rear panel.

For $\div 2$, $\div 4$, $\div 8$, add HP 5252A Prescaler.

Input: front panel, signal input.

Output: in place of time base output frequencies.

Period average measurements

Range: Single Period 0 to 1 MHz.

Multiple Period 0 to 300 MHz.

Periods averaged: 1 period to 10^5 periods in decade steps.

Accuracy: ± 1 count \pm time base accuracy \pm trigger error.*

Frequency counted:

1 and 10 Periods 1 Hz to 10 MHz in decade steps.

100 Period 10 Hz to 10 MHz.

1,000 Period 100 Hz to 10 MHz.

10,000 Period 1 kHz to 10 MHz.

100,000 Period 10 kHz to 10 MHz.

Read In: s, ms, μ s, with positioned decimal point; units annunciator in line with digital display.

Self check: gate time in 10 μ s to 1 s (periods averaged of 100 kHz); counts 100 kHz from the time base.

Ratio measurements

Displays: (f_1/f_2) times period multiplier.

Range: f_1 : 0 to 50 MHz. f_2 : 0 to 1 MHz in single period. 0 to 300 kHz in multiple period; periods averaged 1 to 10^5 in decade steps.

Sensitivity: 0.1V rms, each input (max.).

Accuracy: ± 1 count of $f_1 \pm$ trigger error* of f_2 . f_1 is applied to the decimal counters (enter Time Base Ext. jack on front panel), f_2 is frequency applied to decade dividers (enters Signal Input jack).

Readout: dimensionless; positioned decimal point for number of periods averaged.

Self check: Period Average Self Check applies.

Time base

Frequency (internal): 5 MHz.

Stability: Aging Rate: <5 parts in 10^{10} per 24 hours after warm-up.** As a Function of Temperature: <5 parts in 10^{11} /°C from 0° to 50°C (<2.5 parts in 10^9 within the entire span of 0° to 50°C). As a Function of Line Voltage: <± 5 parts in 10^{11} for 10% change in line voltage from 115V or 230V rms. As a Function of Load: typically <± 2 parts in 10^{11} for any of the following loads—open, short, 50Ω resistive, 50Ω inductive, 50Ω capacitive. Short Term Stability (RMS fractional frequency deviation) better than 5 parts in 10^{11} for 1 second averaging time.

Warm-up: for "off" periods up to approximately 24 hours: 1 hour typical to reach 5 parts in 10^9 of the frequency that existed when turned off. The time base operates whenever the power cord is connected.

Adjustment: fine frequency adjustment, range approx. 5×10^{-4} , 16-turn control accessible through plug-in accessory compartment in front panel. Coarse frequency adjustment, range approx. 1×10^{-9} , 20-turn control at rear panel.

Output frequencies:

1. Rear Panel: 5 MHz sine wave. 1V rms into 50Ω. Available at all times whenever power line cord is energized, whether front panel power switch is ON or OFF. Stability is defined above. Signal-to-Noise Ratio typically >87 dB below rated output. Harmonic Distortion typically >40 dB below rated output. Non-harmonic Components typically >80 dB below rated output.
2. Rear Panel: 0.1 Hz to 10 MHz in decade steps; switch selected on rear panel; all frequencies available in manual function without interruption at reset except 100 Hz, 10 Hz, 1 Hz, and 0.1 Hz which are interrupted by manual reset; 10 kHz to 10 MHz available continuously in all functions; 1 kHz available continuously for all functions except 100K period average; stability same as internal time base; 5V p-p rectangular wave with 1000Ω source impedance at 1 MHz and lower; 1V rms sine wave with 1000Ω source impedance only at 10 MHz.
3. Front Panel: 0.1 Hz to 1 MHz in decade steps; selected by Time Base switch; availability as defined under Output Frequencies (2) above; stability same as internal time base; 1V peak-to-peak.

External standard frequency: 5 or 10 MHz. 1V rms into 1000Ω required at rear panel BNC connector.

General

Registration: 8 digits in-line with rectangular Nixie® tubes; 99,999,999 max. display; total width of display including units annunciator and auto-positioned decimal point indication does not exceed 7 inches.

Display storage: holds reading between samples; switch over-rides storage.

Sample rate: time following a gate closing during which the gate may not be reopened is variable from less than 0.2 s to 5 seconds in frequency mode, independent of gate time; display can be held indefinitely.

Operating temperature range: -20°C to +65°C.

Connectors: BNC (exc. remote program and BCD out).

Signal Input:

Maximum sensitivity: 100 mV rms.

Attenuation: step attenuator (SENSITIVITY switch) provides nominal sensitivities of 0.1, 1, and 10V rms.

Trigger level adjustment (min.): front panel control has ±0.3V trigger level range on 0.1V position, ±3V range on 1V position, ±30V range on 10V position. A PRE-SET position automatically centers trigger level at 0V.

Impedance: 1MΩ parallel with approx. 25 pF, all ranges.

Coupling: ac or dc, separate BNC connectors. ac coupling has 600V dc .022 μF capacitor (-3 dB at approx. 7 Hz).

Overload protection: diodes protect input circuit for up to 120V rms on 0.1V range, 240V rms on 1V range, 500V

rms on 10V range. Input resistance for overload conditions (input amplitude > ten times SENSITIVITY) is 100 kΩ on 0.1V range, and is approximately 1MΩ on other ranges.

Pulse measurements: front panel TRIGGER LEVEL adjustment allows counting positive or negative pulses.

Time base external input (front panel):

Maximum sensitivity: 100 mV rms.

Impedance: 1 MΩ, approx. 20 pF, dc coupled.

Overload: diodes protect input ckt. up to 120V rms.

Digital output: 4-line BCD 4-2-2-1, "1" state positive. 4-line BCD 8-4-2-1, available as Option 02 ("1" state positive) and Option 03 ("1" state negative).

"0" STATE LEVEL: -8V. "1" STATE LEVEL: +18V.

Impedance: 100 kΩ, each line.

BCD reference levels: approximately +17V, 350Ω source; approximately -6.5V, 1000Ω source. Output is suitable for systems use or output devices such as Models 580A and 581A Digital to Analog Converters, and 562 and 5050A Printers, and includes decimal point and measurements unit. **Print command:** +13V to 0V step, dc-coupled.

Cable connector: HP Stock No. 1251-0086 (Amphenol or Cinch 50-pin, 57-30500-375). 1 required.

Weight: net, 32 lbs (14.4 kg) with blank plug-in panel; shipping, 40 lbs (18.2 kg).

Power supply: 115 or 230V ±10%, 50 to 60 Hz; 95 W, except is 150W, max., during approx. the first 2 minutes after power line is first energized. (50 to 1000 Hz operation, price on request.)

Accessories furnished: 10503A Cable, 4' long, male BNC connectors. Detachable Power Cord, 7½' long, NEMA plug. Circuit Board Extender, rack mount conversion parts.

Price: Model 5245M, \$2,750.00.

Dimensions: 5¼" high, 16¾" wide, 16¾" deep 133 x 425 x 416 mm.

Optional and special features

Option 02: 4-line BCD 8-4-2-1, "1" state positive (for digits only) in lieu of 4-2-2-1 (identical in other respects to above Output data), add \$10.00.

Option 03: 4-line BCD 8-4-2-1, "1" state negative (for digits only) in lieu of 4-2-2-1 (identical in other respects to above Output data), add \$10.00.

J35-5245M: similar to 5245M with Option 02 except has 8-4-2-1 output "1" state positive for digits, measurement units, and decimal point, \$2,780.00. (Note: M47-562A/AR and 5050A Option 01 Printers are especially suitable for J35-5245M.)

J36-5245M: similar to 5245M with Option 03 except has 8-4-2-1 output "1" state negative for digits, measurement units, and decimal point, \$2,780.00. (Note: P64-562A/AR and Option 02 Printers are especially suitable for J36-5245M.)

Electromagnetic compatibility: Model H60-5245M meets the stringent requirements of military specification MIL-I-6181D (model no. of plug-in accessories must also be prefixed H60-), prices on request.

Remote operation: all functions which may be programmed from the front panel controls (in normal use) may be programmed from a remote location except for the "Sample Rate" (as defined above) and the sensitivity control setting: order H65-5245M. Price: \$2,865.00.

M07-5245M: is a 5245M with "GHz" added to the readout and controlled from Model 5260A Automatic Frequency Divider having Option 02. Readout is inhibited when 5260A "searches." Has remote operation of H65-5245M (above). Price: \$2,885.00.

*Trigger error is less than ±0.3% of one period—periods averaged for signals with 40 dB or better signal-to-noise ratio.

**Up to 72 hours continuous operation may be required to reach this aging rate after transportation or lengthy "off" periods.



RUGGED ELECTRONIC COUNTERS

High performance, plug-in, dc to 50 MHz

Models M54-5245L, M54-5245M

Advantages

- New enclosure meets MIL specification for RFI and drip proofing
- Operationally identical to 5245L
- Meets MIL specification for temperature, humidity, vibration, shock, altitude
- Weight and dimensions almost identical to 5245L
- Easily carried and handled

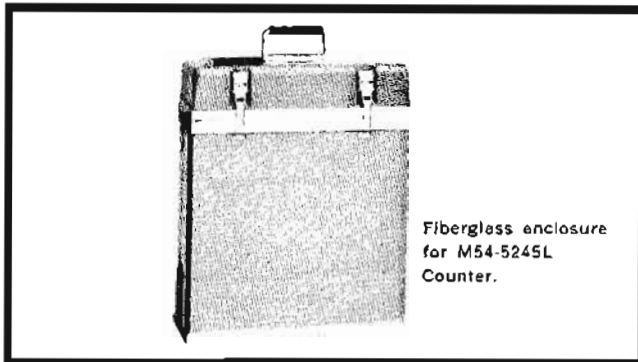

Fiberglass enclosure for M54-5245L Counter.

The environmental resistance of the rugged 5245L has been increased by encasing it in a tough, fiberglass enclosure. The main improvements are drip proofing and improved RFI specifications.

Environmental Specifications

- RFI:** (MIL-I-6181D) meets all four sections of the specification—limits on radiated and conducted interference generation and on susceptibility to radiated and conducted interference.
- Enclosure:** meets MIL-STD-108D section on drip proof enclosures.
- Operating temperature:** operating range of -20°C to $+55^{\circ}\text{C}$ meets and exceeds MIL-E-4158C for indoor equipment and MIL-E-16400, Class 4.
- Non-operating temperature:** meets all classes of MIL-E-16400F. -62°C to $+85^{\circ}\text{C}$.
- Humidity:** meets MIL-E-16400F for Class 3 and 4 equipment. 95% RH over operating temperature range.
- Vibration:** when operating in cabinet configuration, it meets MIL-T-21200 for Class 2 and 3 equipment.
 - 5-15 Hz at .06" DA
 - 15-25 Hz at .04" DA
 - 25-55 Hz at .02" DA

- Shock:** meets MIL-T-21200F for all classes of equipment. Three impact shocks of 30 G's applied to each of the six sides. Each shock has a duration of $11\text{ ms} \pm 1\text{ ms}$ and a half sine wave shape.
- Operating altitude:** operation at 15,000 ft. meets and exceeds MIL-E-4158C.
- Non-operating altitude:** exposure to 50,000 ft. altitude without ill effect; meets and exceeds MIL-E-4158C.

Operating Specifications

- Operation:** identical to 5245L (see page 554).
- Weight:** net 37 lbs (15,5 kg).
- Accessories furnished:** fiberglass front panel cover, detachable power cord, $7\frac{1}{2}$ feet (204 cm), NEMA plug, rack mounting kit.
- Dimensions:** $5\frac{7}{8}$ " (14,9 cm) high, $16\text{-}15\frac{1}{16}$ " (43 cm) wide, $16\frac{1}{2}$ " (42 cm) deep without front panel cover, $21\frac{1}{8}$ " (53,8 cm) deep with front panel cover.
- Price:** Model M54-5245L, \$2850.

Operation Identical to 5245L

The functional performance of the M54-5245L is identical to that of the 5245L. It is a dc to 50 MHz plug-in counter which can perform a wide range of functions with great accuracy. Refer to page 554 for the full operating specifications of the M54-5245L.

The frequency range of the H54-5245L can be extended to 18 GHz by the use of plug-in units. It accepts all of the plug-in units for the 5245L (see pp. 558-562). The plug-in units must have the H60 modification in order to meet the MIL RFI specification (MIL-I-6181D).

New Fiberglass Enclosure

The tough fiberglass enclosure for the M54-5245L includes a detachable front panel cover with a conveniently located carrying handle (as shown in the accompanying photograph). The Instrument can be mounted in a rack with the rack-mounting fixture which is standard equipment.

Ruggedized Version of Precision 5245M Plug-in Counter

The 5245M ultra-stable counter will also be offered in a ruggedized version which will meet most of the same MIL performance specification as the M54-5245L. However, since the 5245M is a very new product, the ruggedized version has not yet received official recognition for its MIL performance features.

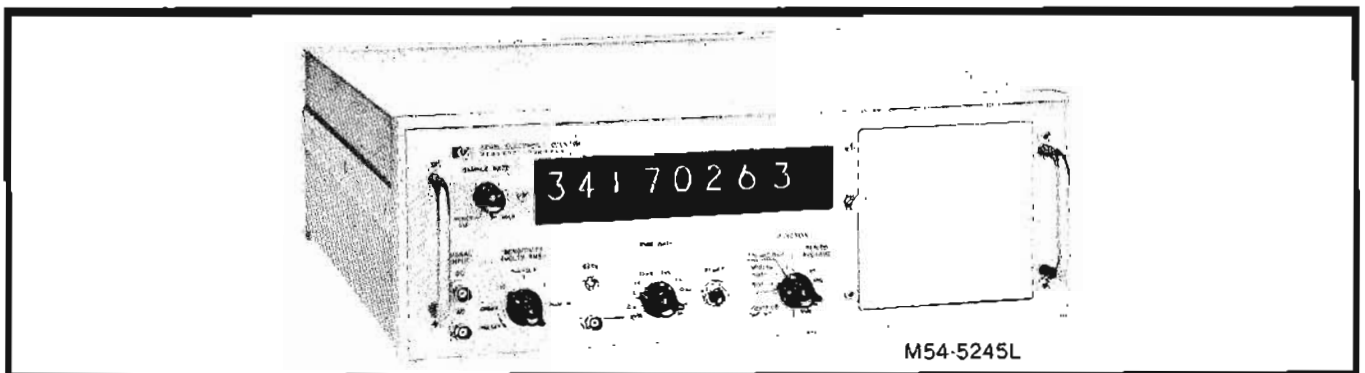

ELECTRONIC COUNTERS

Ultra-Stable Counting to 135 MHz

Model 5247M



FREQUENCY

Advantages:

- 10 Hz to 135 MHz basic range
- Ultra-stable, fast warm-up time base
- Plug-ins for measurements to 18 GHz
- Wide input voltage range without level adjustment
- 8 digit readout

The 5247M performs frequency measurements over a very wide frequency range with great accuracy and stability. It has a new, fast warm-up crystal time base which is extremely stable. The instrument's stability and the extreme spectral purity of its output also make it useful as a secondary frequency standard. (Signal to noise ratio is greater than 87 dB at rated output of 1 V into 50 Ω .)

Use of the Model 5247M is the most economical way to measure frequencies between 50 MHz and 135 MHz with the degree of accuracy possible with the 5247M. Equivalent accuracy can be obtained only at greater expense by using a Model 5245M with a plug-in unit to extend its frequency range.

The 5247M is a plug-in counter which accepts most of the 5245L/M plug-ins. Thus, with the use of plug-in units, the 5247M can make frequency measurements from 10 Hz to 18 GHz.

The 5247M has a unique input section which accepts any input voltage level between 100 mV and 10 V rms without adjustment. This feature and the fast warm-up feature make the instrument very convenient to use.

Specifications

Frequency measurement

- Range: 10 Hz to 135 MHz (ac coupled).
- Input: 100 mV to 10 V rms; 1 M Ω shunted by 25 pF.
- Gate time: 1 μ s to 10.0 seconds in decade steps.
- Accuracy: ± 1 count \pm time base accuracy.
- Readout: MHz, kHz or Hz with positioned decimal point; units annunciator in line with digital display.

Time base

Crystal frequency: 5 MHz.

Stability

- Aging rate: <5 parts in 10¹⁰ per 24 hours after warm-up (after 72 hours of continuous operation).
- Short term: <5 parts in 10¹¹ for 1 second average (rms fractional frequency deviation).
- Temperature: <5 parts in 10¹¹ per °C from 0° to 50°C; <2.5 parts in 10⁸ within the entire span of 0° to 50°C.
- Line voltage: < ± 1 part in 10¹⁰ for 10% change in line voltage from 115 V or 230 V rms.

Load stability: typically ± 1 part in 10⁹ for any of the following loads — open, short, 50 Ω resistive, 50 Ω inductive, 50 Ω capacitive.

Warm-up: for "off" periods up to approximately 24 hours: 1 hour typical to reach 5 parts in 10⁹ of the frequency that existed when turned off (30 min., typical, to 1 part in 10⁷). Time base operates whenever power cord is connected.

Output frequencies: rear panel: 5 MHz sine wave. 1 V rms into 50 Ω . Available at all times whenever power line cord is energized, whether front panel power switch is ON or OFF. Stability as defined above. Signal-to-Noise Ratio typically >87 dB at rated output. Harmonic Distortion typically >40 dB below rated output. Non-harmonic Components typically >80 dB below rated output.

General

Display: 8 digits in-line; rectangular display tubes and display storage.

Signal input

Sensitivity: 100 mV rms to 10 V rms (maximum) without level adjustment. Voltage exceeding ± 100 V dc may cause damage.

Impedance: 1 M Ω shunted by 25 pF.

Connectors: BNC type.

Operating temperature range: 0°C to +60°C.

Power requirements: 115 or 230 volts $\pm 10\%$, 50 to 60 Hz; 95 W, except is 150 W, max., during approx. the first 2 minutes after power line is first energized.

Weight: net, 34 lbs (15,4 kg) with blank plug-in; shipping 40 lbs (18,2 kg).

Accessories furnished: HP 10503A Cable. 4 feet long, male BNC connectors. Detachable power cord, 7½ ft. (200 cm) long, NEMA plug. Circuit Board Extender. Rack mount conversion parts.

Price: \$2,800 Model 5247M.

Dimensions: 16¾" (425 mm) wide, 5-7/32" (133 mm) high, 16¾" (416 mm) deep.

Chassis connectors: BNC type.

Options: digital output (Options 1 and 2):

Code: Option 2: 8-4-2-1 + ("0" level: -8 V; "1" level: 18 V; impedance: 100 K Ω). Option 1: 8-4-2-1 - ("0" level: 18 V; "1" level: -8 V; impedance: 100 K Ω).

Reference level: +17 V, 350 Ω ; -6.5 V, 1 k Ω .

Print command: +13 V to 0 V step, dc coupled.

Hold-off requirements: +15 V minimum, +25 V maximum from chassis ground (1000 Ω source).

Option 3: rear terminal input in addition to front panel input; specifications are the same as front panel input.

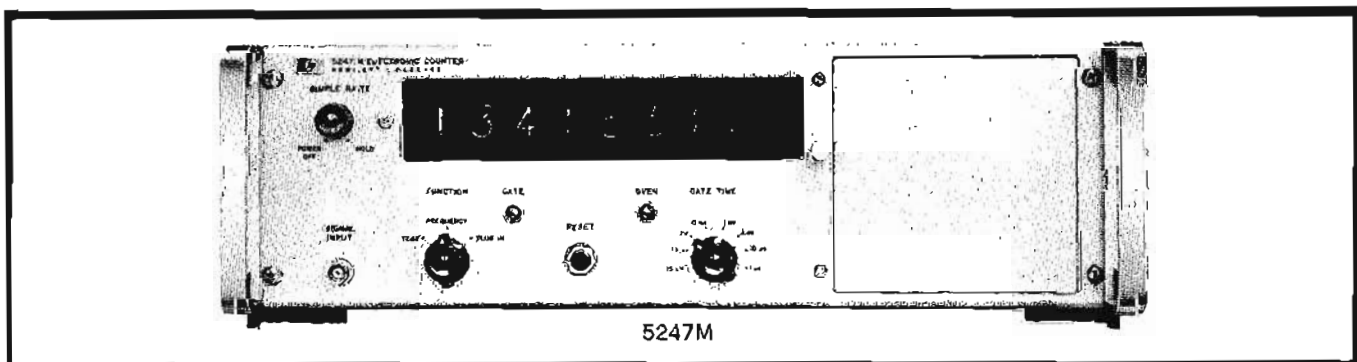



FREQUENCY CONVERTERS

Measure to 18 GHz with counter accuracy
Models 5251A, 5253B, 5254B, 5255A, 5256A

Advantages:

- Retains counter accuracy
- Up to 1 Hz resolution in 1 to 4 seconds measurement time
- Easy to operate—has smooth, backlash-free, spurious-free tuning and a level indicator
- Sensitivity is high and relatively constant
- AC coupled input in most models

Frequency converters can increase the range of your 5245L, 5245M, 5246L or 5247M Counter to 18,000 MHz for CW signals. The stability and accuracy of the basic counter are retained in these higher frequency measurements because the converters use a multiple of the 10 MHz signal from the electronic counter crystal oscillator to beat with the signal to be measured. Operation of the equipment is simple and convenient permitting non-technical personnel to make frequency measurements up to 18 GHz quickly and accurately.

The basic measurement ranges of the counter are retained with the converter installed. Measurements to 50 MHz are obtained simply by moving the counter Sensitivity control off the "plug-in" position and connecting the input signal directly to the counter input.

The AC coupled inputs of the 5251A, 5253B, and 5254B prevent DC voltages which may be present along with the signal from affecting the measurement sensitivity or damaging the mixer circuits in the converter. The higher frequency AC coupled converters (5253B and 5254B) are unique in that the AC coupling is integrated into the input circuit, so it behaves as a transmission line with good VSWR; this results in relatively constant impedance (and converter sensitivity) over the entire frequency range. Thus, performance of these higher frequency converters is better than if AC coupling were achieved by simply using a series capacitor. VSWRs of the 5255A and 5256A are also excellent.

Models 5253B, 5254B, 5255A, and 5256A are cavity-tuned. Since constant bandwidth cavities are used, tuning peaks and dial "feel" (tuning peak spread) are the same over the entire dial.

Operation

The converter subtracts multiples of 10, 50, or 200 MHz (depending upon converter model) from the CW frequency to be measured and provides the difference to be measured by the counter. For example, if a frequency of 279.25 MHz is to be measured with the 5253B, the operator tunes the converter dial upward until the converter Level Indicator shows an acceptable voltage level. This will occur at a dial reading (mixing frequency) of 270 MHz for a 279.25 MHz input. At this dial setting, the converter will subtract 270 MHz from the input signal and pass 9.25 MHz, which the counter will measure and display. The measured frequency is then the sum of the counter reading and the 5253B dial reading.

Readout resolution is 1 Hz with the counter gate time set to 1 second, 0.1 Hz at 10 seconds, 10 Hz at 0.1 second, etc. Counter gate time is automatically multiplied by 4 when the 5255A and 5256A are used.

Model 5255A and 5256A

The 5256A's high frequency measuring range is unique in the microwave converter field. Previously, only transfer oscillators could make high accuracy measurements up to 18 GHz. Now, the 5255A and 5256A enable frequency measurements through X-band with greater speed, accuracy, and simplicity at comparable price.

The 5255A or 5256A can be used as a prescaler to extend the counting and direct readout range of the counter to 200 MHz. This is because the converters have an internal prescaler which divides both the 0 to 200 MHz heterodyne difference frequency and the counter's time base by a factor of four to achieve direct readout in MHz on the 50 MHz counter. The prescaler input is available at the AUX IN port, and inputs as low as 5 mV between 1 and 200 MHz are prescaled by 4 and displayed directly in MHz on the counter. The 5255A is also useful as a down-converter; the heterodyne difference frequency is available at the AUX OUT port, so that 3 to 12.4 GHz inputs can be beat down to 200 MHz maximum, for oscilloscope observation, etc. Similarly, by adding a detector at AUX OUT, the unit serves as a receiver. The 5256A can be used similarly.

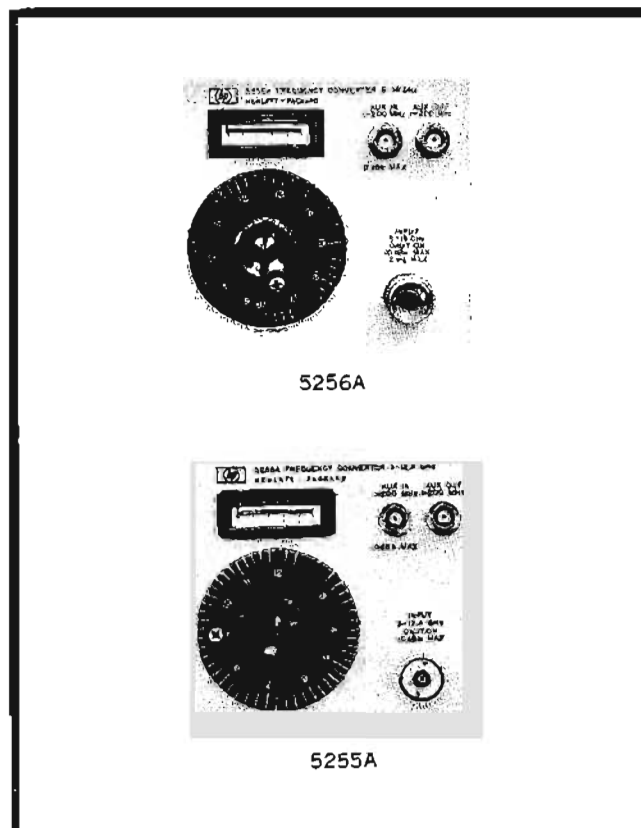

	5256A	5255A*	5254B*	5253B**	5251A†
RANGE	8 to 18 GHz; as a prescaler, 1 MHz to 200 MHz	3 to 12.4 GHz; as a prescaler, 1 MHz to 200 MHz	0.2 to 3 GHz	50 to 512 MHz	20 to 100 MHz
		2.8 to 12.4 GHz in 200 MHz steps	0.2 to 3 GHz in 50 MHz steps	50 to 500 MHz in 10 MHz steps	20 to 100 MHz in 10 MHz steps
INPUT VOLTAGE RANGE (min. to max., rms)	100 mV (-7 dBm) to 0.7 V (+10 dBm); as a prescaler, 5 mV (-33 dBm) to 0.22 V (0 dBm)	100 mV (-7 dBm) to 0.7 V (+10 dBm); as a prescaler, 5 mV (-33 dBm) to 0.22 V (0 dBm)	50 mV (-13 dBm) to 1 V (+13 dBm)	50 mV (-13 dBm) to 1 V (+13 dBm)	50 mV (-13 dBm) to 1 V (13 dBm); typical sensitivity, 20 mV
MAXIMUM INPUT OVERLOAD	0.7 V rms (+10 dBm) (as a converter or prescaler)	0.7 V rms (+10 dBm) (as a converter or prescaler)	2.2 V rms (+20 dBm); 125 V dc	2 V rms (+19 dBm), 250 V dc	2 V rms (+19 dBm), 100 V dc
NOMINAL INPUT IMPEDANCE	50 ohms nominal	50 ohms	50 ohms	50 ohms	50 ohms
INPUT COUPLING	dc	dc	ac	ac	ac
ACCURACY					
REGISTRATION	counter display in MHz is added to converter dial reading				
LEVEL INDICATOR	meter aids frequency selection and indicates usable signal level				
INSTALLATION	into front panel plug-in compartment of some HP Electronic Counters (see footnote)				
INPUT CONNECTOR	Precision Type APC-7 Connector	Precision Type N female (GPC-7, optional)	Type N female	BNC female	BNC female
WEIGHT net shipping	8¼ lbs. (3.8 kg) 12 lbs. (5.5 kg)	8¼ lbs. (3.8 kg) 12 lbs. (5.5 kg)	5 lbs. (2.3 kg) 9 lbs. (4.1 kg)	5 lbs. (2.3 kg) 9 lbs. (4.1 kg)	2 lbs. (0.9 kg) 6 lbs. (2.7 kg)
PRICE	\$1,750	\$1,650	\$825	\$500††	\$300††

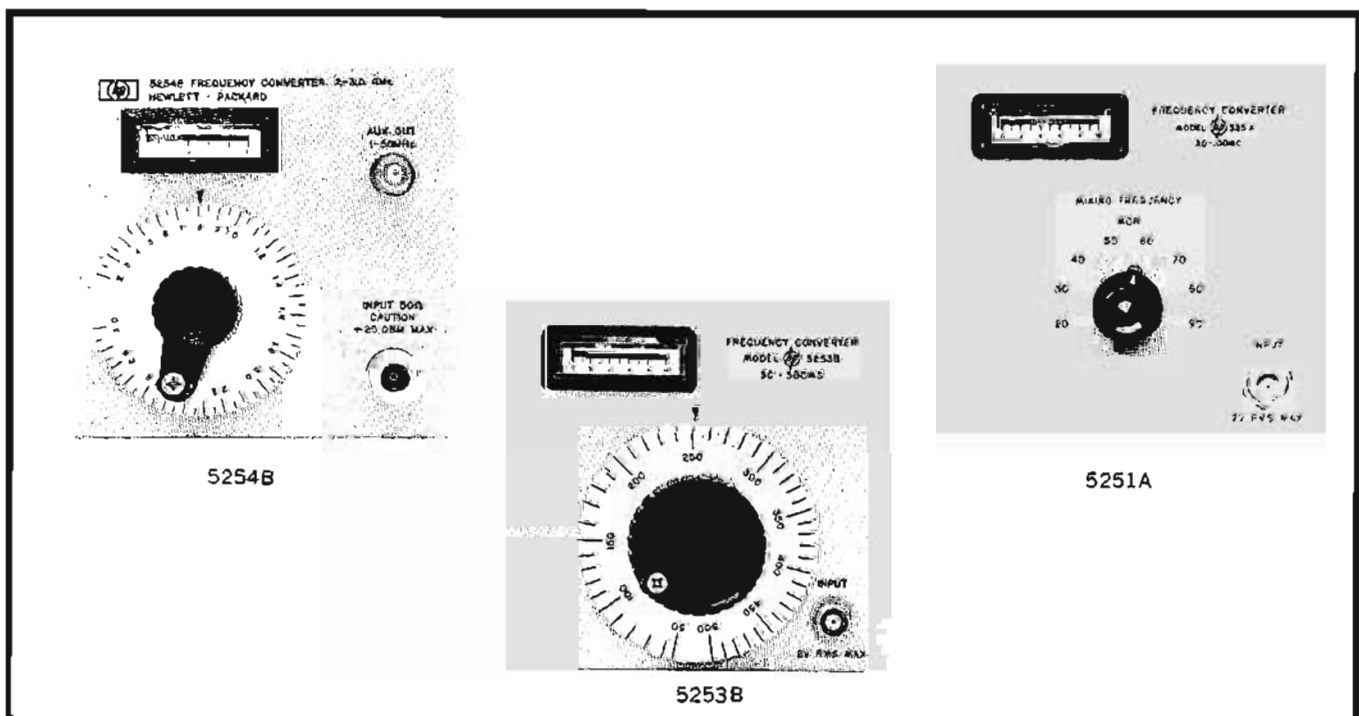

FREQUENCY



PRESET UNIT

Normalized readings; div. by N; count N events
Model 5264A

The HP Model 5264A Preset Unit extends the versatility of the time bases of the HP 5245 L/M and 5246L Electronic Counters, and the counters retain their basic functions and measurement range. Decade dividers in the preset unit control the counter gate; N may be any integer between 1 and 100,000. The 5264A makes possible the following:

N x frequency measurements: gate time is controlled by the preset decades (N) and the counter's Time Base switch. The gate is held open for N periods of the time base setting.

This selectable gate time makes possible normalized readings or conversion of frequencies into practical units. The long gate times that are available (5245 L/M — 10^6 s; 5246L — 10^5 s) permit accurate measurement of low frequencies.

N x period measurements (5245L/M only): measures the time for N events to occur in increments of 0.1 μ s to 10 seconds, depending on the setting of the counter's Time Base switch. Period and multiple period measurements are also easily made. Period average is determined by dividing the time reading by N.

Ratio, N x ratio measurements (5245L/M only): permits ratio measurements with a choice of normalizing factors from 1 to 100,000 in one-digit steps. The counter displays $Nf_1 \div f_2$, and f_1 is counted for N periods of f_2 .

Dividing by N: permits division by N of any input frequency up to 100 kHz. With the 5245L/M only, the counter's prescaling capability (up to 10^9 in decade steps) allows frequencies as high as 50 MHz to be divided by a five-digit number, provided that the frequency supplied the preset units (from the counter) does not exceed 100 kHz.

Preset Counting: N events are counted. The first event opens the gate; the Nth closes it. This feature is useful in batching, and the gate signal can be used to control external circuitry or relays.

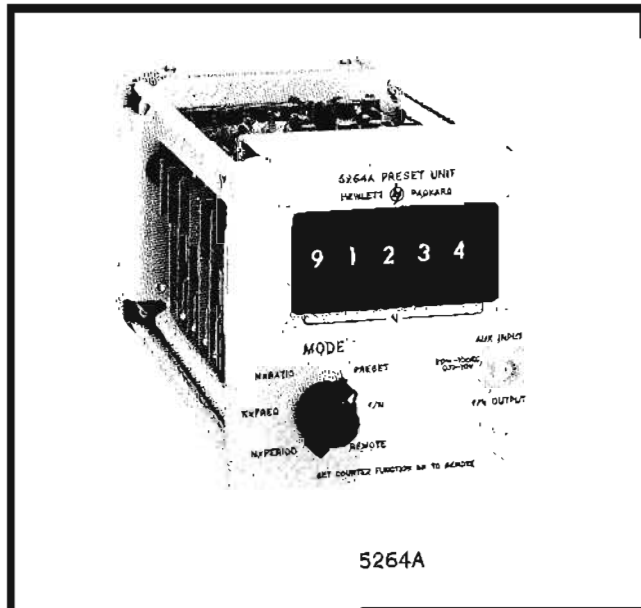

Specifications, 5264A*

N x frequency (counter signal input)

Range: 0 to 50 MHz.

Maximum sensitivity: 0.1 V rms.

Input impedance: 1 megohm shunted by 25 pF.

Gate time: (set by counter Time Base and "N" switches)

10 μ s to 1 s in 10 μ s steps

100 μ s to 10 s in 100 μ s steps

1 ms to 100 s in 1 ms steps

10 ms to 10^5 s in 10 ms steps

0.1 s to 10^4 s in 0.1 s steps

1 s to 10^3 s in 1 s steps

†10 s to 10^5 s in 10 s steps

Accuracy: ± 1 count \pm time base accuracy.

†N x period (counter signal input)

Input frequency range: 0 Hz to 100 kHz.

Maximum sensitivity: 0.1 V rms.

Input impedance: 1 megohm shunted by 25 pF.

Time units: 0.1 μ s to 10 s in decade steps.

Accuracy: ± 1 count \pm time base accuracy \pm trigger error.**

†N x ratio

f_1 (counter Ext. Time Base Input)

Frequency range: 0 to 50 MHz.

Sensitivity: 0.1 V rms.

Input impedance: 10 k Ω ; 40 pF shunt.

f_2 (counter signal input)

Frequency range: 0 Hz to 100 kHz.

Maximum sensitivity: 0.1 volt.

Input impedance: 1 megohm shunted by 25 pF.

Reads: $N \times f_1/f_2$.

Accuracy: ± 1 count of f_1 .

Divide by N (5264A Auxillary Input, f/N mode)

Frequency range: 20 Hz to 100 kHz (sinusoidal).

Sensitivity: 0.1 V rms.

Input impedance: 1 megohm, 50 pF shunt.

Overload: signals in excess of 10 V rms may damage the instrument.

†Prescaling: in decade steps to 10^9 of maximum rate of counter; (scaled output frequency \leq 100 kHz).

Output: 0.2 V peak to peak centered at 0 volts, into high-impedance load; rise time < 1 μ s, duration approximately 5 μ s.

Preset (5264A Auxillary input)

Input frequency range: 20 Hz to 100 kHz.

Maximum sensitivity: 0.1 V rms.

Input impedance: 1 megohm, 50 pF shunt.

Overload: signals in excess of 10 V rms may damage the instrument.

Preset range: 1 to 99,999 in steps of one.

Weight: net 3 lbs (1.4 kg); shipping 7 lbs (3.2 kg).

Accessory furnished: 10503A cable, 4 ft (1220 mm) long, male BNC connectors.

Price: HP 5264A, \$650.

*When used with HP 5245L/M or HP 5246L Electronic Counters.

**Trigger error (sine wave) $< 0.3\%$ of one period + N for ≥ 40 dB signal-to-noise ratio on input signal; trigger error decreases with increased signal amplitude and slope.

†HP 5245L or 5245M only.

VIDEO AMPLIFIER; T. I. UNIT

1 mV sensitivity; 0.1 μ sec resolution
Models 5261A, 5262A



FREQUENCY

5261A Video Amplifier

The HP 5261A plug-in increases the sensitivity of the HP 5245L/M and HP 5246L Electronic Counters to 1 mV rms over the range of 10 Hz to 50 MHz. The output level meter indicates when the signal level to the counter is acceptable for a stable count. The auxiliary 50-ohm output permits monitoring the unknown input signal to the counter with a scope. A 10 megohm 10:1 divider probe is available to facilitate frequency measurements in high-impedance circuits.

Specifications, 5261A*

Bandwidth: 10 Hz to 50 MHz.

Input sensitivity: 1 mV to 300 mV rms.

Max. Input: 100 V dc; 5 V rms (ranges: 1, 3, 10, 30, 100 mV).

Input impedance: approximately 1 megohm, 15 pF shunt.

Output level meter: shows acceptable signal level.

Accuracy: retains accuracy of electronic counter.

Auxiliary output: front-panel BNC for oscilloscope monitoring or driving external equipment; 50-ohm source impedance; on amplifier's most sensitive attenuator range, 1 mV rms at input results in at least 100 mV rms at auxiliary output into 50-ohm load; maximum undistorted output is 300 mV rms into a 50-ohm load.

Accessory furnished: 10507A Low Microphonic 50-ohm Cable, 4 feet (1220 mm) long, BNC connectors.

Accessories available: 10003A 10:1 Probe, 10 pF shunt, 600 V max., \$30; 10100A 50-ohm Feed-Thru Termination, \$15.

Weight: net 2 lbs (0,90 kg); shipping 6 lbs (2,7 kg).

Price: HP 5261A, \$325.

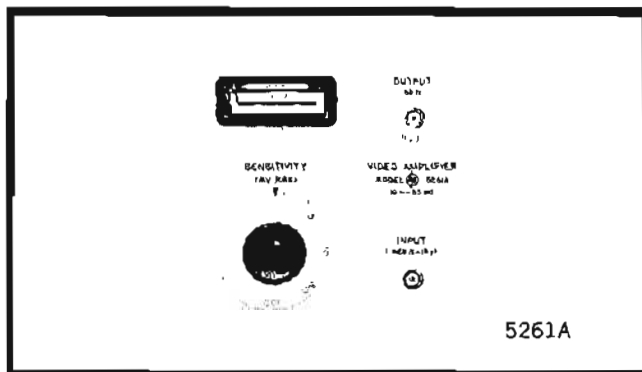

5262A Time Interval Unit

The HP 5262A greatly increases the versatility of a 5245L/M or 5246L by making possible accurate time interval measurements with 0.1 μ s resolution. Time is read directly from the counter display with units and decimal point also indicated. Counter time base accuracy is retained, since the counted signal is derived from the time base oscillator. The HP 5262A measures from 1 μ s to 10⁶ s with the 5245L/M or 8-digit 5246L; to 10⁸ s with the standard 5246L. It measures pulse length, pulse spacing and delays, and triggers from separate or common signals. The 5262A may be used as an amplitude discriminator for the 5245L or 5246L, which

permits counting only signals meeting requirements set by trigger level controls.

Specifications, 5262A*

Range: 1 μ s to 10⁸ s (5245L/M or 8-digit 5246L). 1 μ s to 10⁶ s (standard 5246L).

Standard frequency counted: 10⁷ to 1 Hz in decade steps from 5245L/M, 5246L or external frequency.

Accuracy (pulse): ± 1 period of standard frequency counted \pm time base accuracy.

Registration: on electronic counter.

Input voltage: 0.3 volt, p-p, minimum, direct-coupled input.

Input impedance and overload: input impedance (constant up to 40 volts times Multiplier setting).

Multiplier	Input Impedance		Max. Input
	Resistance	Capacitance	
X0.1 X0.2 X0.3	10 k 10 k 30 k	80 pF 80 pF 40 pF	50 V rms \approx 150 V peak
X1 X3	100 k 300 k	20 pF 20 pF	150 V rms \approx 250 V peak
X10 X30 X100	1 M 3 M 10 M	20 pF 20 pF 20 pF	\approx 250 V peak

Start-stop: separate or common channels.

Trigger slope: positive or negative on start and stop channels, independently selected.

Trigger amplitude: both channels adjustable, -250 to $+250$ V.

Frequency range: 0 to above 2 MHz when used as input signal discriminator.

Markers: (HP 5245L/M only) separate output voltage steps, 0.5 volt peak-to-peak from source impedance of approximately 7 k, 100 pF; available at rear panel of counter with negative step coincident with trigger points on input waveforms for positive slope and positive step coincident for negative slope.

Reads In: μ s, ms, s with measurements unit indicated and decimal point positioned.

Accessories furnished: 10503A Cable Assembly, male BNC to male BNC, 4 feet (1220 mm) long.

Weight: net 2.5 lbs (1,1 kg); shipping, 6 lbs (2,7 kg).

Price: HP 5263A, \$250.

*When used with HP 5245L, 5245M or HP 5246L Electronic Counters. 5261A can be used with 5247M up to 50 MHz.

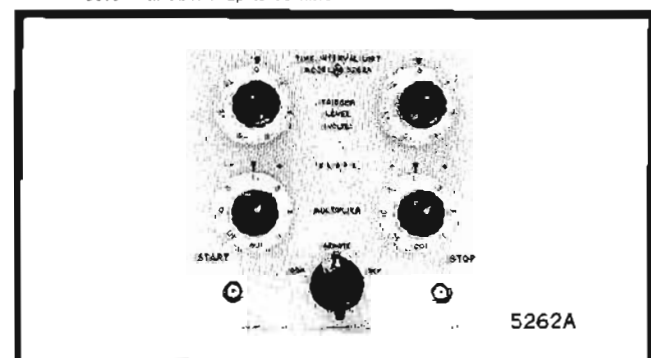



PRESCALER; DIGITAL VOLTMETER

Increase capability of 5245L/M and 5246L
Models 5252A, 5258A, 5265A

5252A Prescaler

The direct-counting frequency of the HP 5245L/M, 5246L and 5247M Electronic Counters is extended to 350 MHz using the Model 5252A Prescaler Plug-in. Prescaling is accomplished with transistor binary dividers which operate over the frequency range dc to 350 MHz. No tuning is required. A trigger level adjustment permits counting when unusual measurement conditions are encountered.

Prescalers divide the input frequency by a factor of 2, 4 or 8, and at the same time adjusting the counter's time base to provide a direct reading in frequency.

Specifications, 5252A**

Operating frequency range: dc to 350 MHz.
Accuracy: same as the basic counter.
Input sensitivity: 100mV rms.
Maximum input: 2 volts, +20 dBm, or 100 mW.
Input Impedance: 50 ohms (nominal).
Operating temperature range: -20°C to +55°C.
Scaled output: >100 mV rms into 50 ohms is available at the AUX A BNC connector of the basic counter.
Weight: net 2.2 lbs (1 kg); shipping 6¾ lbs (3,1 kg).
Price: HP 5252A, \$685.

5258A Sensitive Prescaler

5258A installation, use and operation are similar to the 5252A. It is also useful as a video amplifier.

Specifications, 5258A

Operating frequency range: 1 MHz to 200 MHz.
Accuracy: same as the basic counter.
Input sensitivity: 1 mV/10 mV/0.2 V rms as selected by front panel switch.
Resolution: 1 Hz in 4 s, 10 Hz in 0.4 s, etc.
Maximum input: 3 V, +22.5 dBm, or 180 mW.
Input impedance: 50Ω.
Operating temperature range: -20°C to +65°C.
Scaled output: 100 mV rms into 50Ω is available at the Aux A output BNC connector of the basic counter.

Weight: net 4.75 lbs (2,16 kg); shipping 9.25 lbs (4,2 kg).
Price: HP 5258A, \$825.

5265A Digital Voltmeter

The HP 5265A Digital Voltmeter Plug-in quickly converts your 5245L/M or 5246L Electronic Counter to an accurate dc digital voltmeter. Operation is straightforward—simply set range switch, connect the voltage to be measured and read.

A Local-Remote switch permits remote selection of the DVM mode or the regular electronic counter functions when used with an H65-5245L or H65-5245M Counter (remote control option).

Specifications, 5265A**

Voltage range: 6-digit presentation of 10.0000, 100.000, and 1000.00 V full scale with 5% overrange capability.
Registration: on 5245L or 5246L.
Reads In: dc volts with decimal point positioned by range switch; automatic polarity indicator.
Accuracy (0° to +50°C): ±0.1% of reading; ±0.01% of fs <1/10 fs (within 24 hrs and ±10°C temperature change since last front-panel calibration adjustment and within 6 mos. of calibration of internal zener reference).
Range selection: manual.
Sample rate: 5 per second. Has storage.
Input resistance: 10.2 megohms to dc on all ranges.
Input filter:
AC rejection: 30 dB at 60 Hz, increasing at 12 dB per octave.
Response time: less than 450 ms to a step function to within 0.05% of final value.
Accessory furnished: 5060-0630 22-pin extender board.
Weight: net 2½ lbs (1,1 kg); shipping 7 lbs (3,2 kg).
Price: HP 5265A, \$575.

*When used with HP 5245L/M, 5247M or 5246L (serial prefixed 402 and above) Electronic Counters.

**When used with HP 5245 L/M or 5246L Electronic Counter.

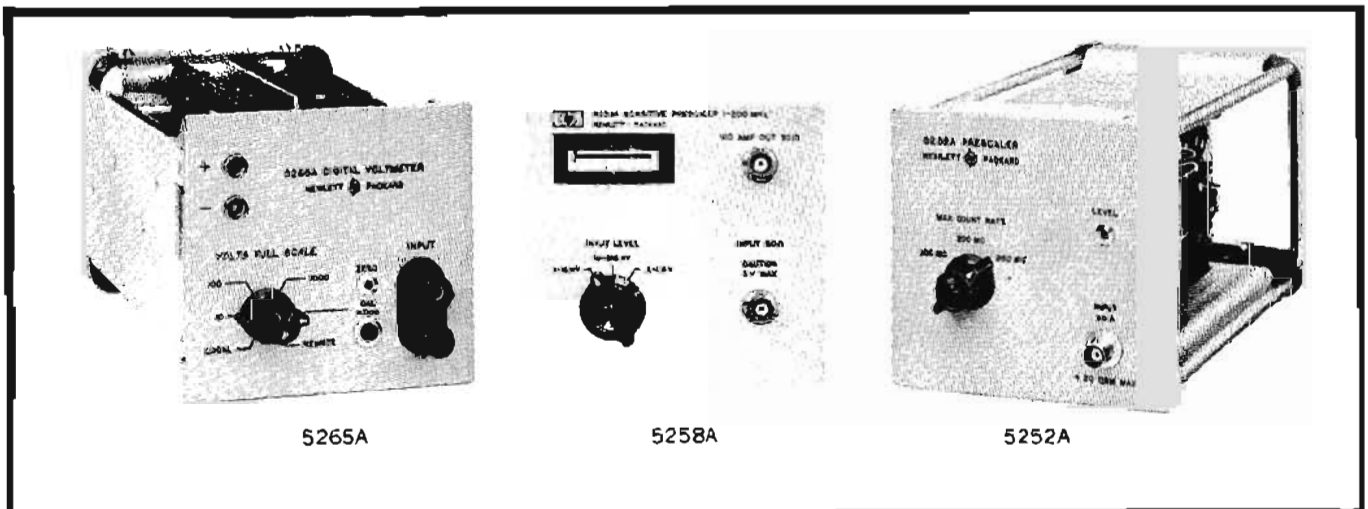

5265A

5258A

5252A

ELECTRONIC COUNTER

50 MHz counting rate with 0.1 V sensitivity

Model 5244L



FREQUENCY

The HP 5244L Electronic Counter measures frequency, period, multiple period average, ratio and multiples of ratio with a maximum counting rate of 50 MHz. Rear connectors provide digital output in BCD form. Maximum sensitivity is 0.1 volt rms. The counter time base is a quartz crystal oscillator with an aging rate of less than 2 parts in 10^7 per month. Display storage provides a continuous display of the most recent measurement. With the function switch in "Frequency," the "Sample Rate" control adjusts the time between gates from less than 0.2 second to at least 5 seconds.

Specifications

Frequency measurements

Range: 0 to 50 MHz, dc input; 50 Hz to 50 MHz, ac input.

Input: 100 mV sensitivity; 100 k Ω /v impedance.

Gate time: 1 μ s to 10 seconds in decade steps.

Accuracy: ± 1 count \pm time base accuracy.

Readout: kHz or MHz with positioned decimal point; units annunciator in-line with digital display.

Self check: counts 1 MHz for the gate time selected by time base switch.

Period average measurements

Range: single period, 0 to 1 MHz; multiple period, 0 to 300 kHz.

Input: 100 mV sensitivity; 100 k Ω /v impedance.

Periods averaged: 1 period to 10^3 periods in decade steps.

Accuracy: ± 1 count \pm time base accuracy \pm trigger error.*

Frequency counted: single period, 10^4 to 1 Hz in decade steps; multiple period, 10^9 , 10^6 or 10^4 Hz.

Readout: sec, ms, μ s with positioned decimal point; units annunciator in-line with digital display.

Self check: gate time is 10 μ s to 1 s; counts 100 kHz.

Ratio measurements

Displays: f_1/f_2 times Period Average setting—(Range of 1 to 10^6).

Range: f_1 : 50 Hz to maximum rate of counter, f_2 : 0 to 1 MHz in single period, 0 to 300 kHz in multiple period; periods averaged 1 to 10^6 in decade steps.

Sensitivity: f_1 : 1 V rms from 100 Hz to maximum rate of counter, 2 V rms from 50 to 100 Hz; 2500-ohm input impedance; f_2 : 0.1 V rms, 100 k Ω /V input impedance.

Accuracy: ± 1 count of f_1 \pm trigger error* of f_2 , where f_1 is frequency applied to counting binaries (at Time Base Ext. jack) and f_2 is applied to decade dividers (at signal input jack).

Readout: dimensionless units with positioned decimal.

Self check: gate time is 10 μ sec to 1 sec; counts 100 kHz.

Time base

Crystal frequency: 1 MHz.

Stability:**

Aging rate: less than ± 2 parts in 10^7 per month.

Temperature: less than ± 2 parts in 10^6 for a change from $+10^\circ$ to 50° C, ± 20 parts in 10^6 for a change from 0° to 65° C.

Line voltage: less than ± 1 part in 10^2 for $\pm 10\%$ line voltage change.

Output frequencies: 0.1 Hz to 1 MHz in decade steps selected by Time Base switch.

General

Display: 7 digits in-line with rectangular Nixie® tubes and display storage.

Sample rate: time following a gate closing during which the gate may not be reopened is continuously variable in the frequency function from less than 0.1 second to 5 seconds, independent of gate time; display can be held indefinitely.

Signal input

Maximum sensitivity: 100 mV rms.

Coupling: ac or dc.

Impedance: 100 k Ω /V (10 k Ω at 100 mV), approximately 40 pF on 0.1 V range, 15 pF on 1 and 10 V ranges.

Attenuation: step attenuator provides ranges of 0.1, 1 and 10 volts.

Overload: diodes protect input circuit up to 50 V rms on 0.1-volt range, 150 V rms on 1-volt range, 500 V rms on 10-volt range; 600 V dc tolerable.

Operating temperature range: -0° C to $+65^\circ$ C.

Connectors: BNC type except for BCD output.

Output: 4-line 1-2-2-4 BCD with "1" state positive; 1-2-4-8 optional; "0" state: -8 volts; "1" state: $+18$ volts; impedance: 100 k Ω ohms each line; reference levels: $+17$ volts (350-ohm source), -6.5 volts (1000-ohm source); print command: $+13$ volts to 0 volt step, dc coupled.

Hold-off requirement: $+15$ volts minimum, $+25$ volts maximum from chassis ground, 1000-ohm source.

Dimensions: 16 $\frac{3}{4}$ " wide, 5 $\frac{1}{2}$ " high, 16 $\frac{3}{8}$ " deep (425 x 140 x 416 mm).

Weight: net 23 lbs (10.4 kg); shipping 35 lbs (16 kg).

Power: 115 or 230 volts $\pm 10\%$, 50 to 60 Hz, approximately 80 watts (50 to 1000 Hz operation, price on request).

Accessories furnished: 10503A cable assembly, 4 ft (1220 mm), male BNC connectors; detachable power cord 7 $\frac{1}{2}$ ft (2270 mm) with NEMA plug; printed circuit board extender.

Price: HP 5244L, \$1850.

Options:

01. 8-digit registration, add \$100.

02. 1-2-4-8 BCD ("1" state positive) output (7-digit), add \$10.

03. 1-2-4-8 BCD ("1" state negative) output (7-digit), add \$10.

04. 8-digit registration and 1-2-4-8 BCD ("1" state positive) output, add \$110.

05. 8-digit registration and 1-2-4-8 BCD ("1" state negative) output, add \$110.

RFI: The counter, modified to meet electromagnetic compatibility specification MIL-I-6181D, may be obtained by specifying H60-5244L. Add \$350.

*Trigger error for sine wave input is $\leq 0.3\%$ of one period / periods averaged for signals with 40 dB or more signal-to-noise-ratio.

**The crystal time base (better than ± 3 parts in 10^6 per 24 hours and better than 2 parts in 10^{10} rms with 1 second averaging) which is used in the 5244L is available on special order. Specify H15-5244L (add \$325).

© Burroughs Corporation

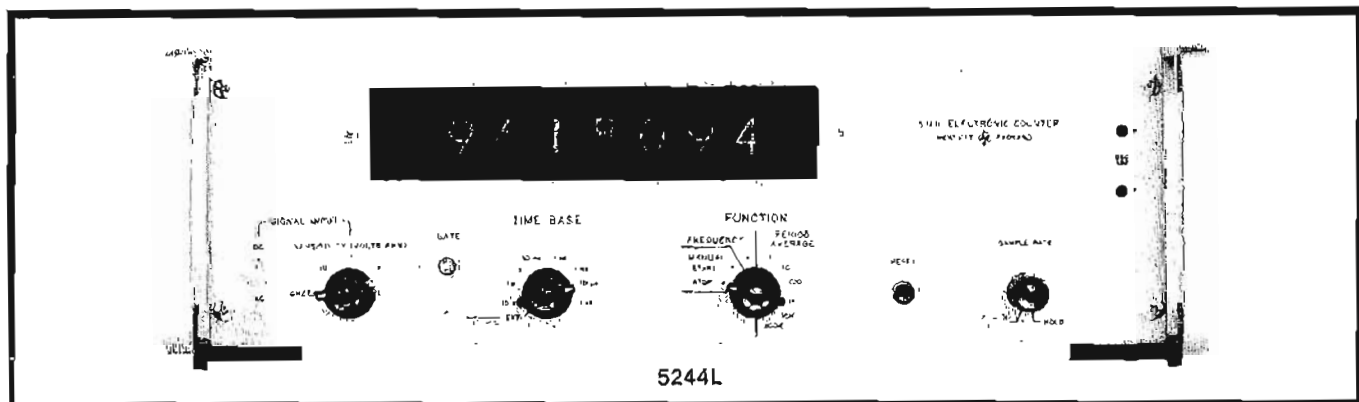



ELECTRONIC COUNTER

Low cost, IC, 10 MHz counter

Model 5221A

Advantages:

- High count rate at low price
- Compact, rugged, light weight
- Blanking of insignificant zeros

The versatile, new, 5221A Electronic Counter makes extensive use of integrated circuits manufactured in HP's own IC facilities. This accounts for a very light, compact, and rugged instrument with low power consumption and high reliability. It has a maximum count rate of 10 MHz with minimum pulse spacing of 100 nanoseconds, and minimum pulse width of 50 nanoseconds. (Six-digit readout option required for full) display of maximum count rate.) A long life 4-digit (5 and 6 available) NIXIE® tube display with storage is offered. A unique blanking feature suppresses the display of unwanted zeros, i.e., zeros left of the most significant digit.

Input sensitivity is 0.1 V rms from 5 Hz to 10 MHz with an input impedance of 1 M Ω shunted by 30 pF.

The 5221A is housed in a standard 1/3 module cabinet, very convenient for bench use and easily adaptable for rack mount in the HP 5060-0797 adapter frame.

Frequency Measurements

This counter measures frequency or repetition rate of periodic signals by totalizing the events during gate times of 0.1 or 1 second. The gate times (derived by dividing the power line frequency) are selected with a front panel switch. An internal control allows counting of either positive or negative input pulses.

Totalizing

Input pulses are totalized during the time the GATE SELECTOR switch is in the OPEN position.

Remote Gate Control

The 5221A features remote gate control operation. With the GATE CONTROL switch on OPEN, the gate can be closed by contact closure or saturated NPN transistor to ground of the rear panel BNC connector. This feature enables remote control of totalizing. If the frequency totalized

is known (as in CHECK position), the gate time can be determined.

Self-Check

Here the instrument counts the power line frequency time base to ensure that the decade counters, gates, amplifier, and time base are operating.

Specifications

Frequency measurement

Range: 5 Hz to 10 MHz.

Input: .1 V rms max. sensitivity; 1 M Ω /30 pF.

Gate time: 1 s and 0.1 s.

Accuracy: ± 1 count \pm power line frequency accuracy. (Line frequency accuracy is typically better than 0.1% for commercial power in the U.S.)

Maximum displayed frequency: standard model: 99.99 kHz; Option 01: 999.99 kHz; Option 02: 9.99999 MHz (decimal point and units are not shown in display).

Time base: the power line frequency is counted to derive the gate times.

Gate control: controlled by manual GATE SELECTOR switch on front panel or by contact closure or saturated NPN transistor ground on EXT BNC on rear panel with GATE SELECTOR switch in OPEN position.

General

Display: 4 digits (5 and 6 available) with display storage, and automatic blanking of leading zeros.

Sample rate: the period between samples is variable from 50 ms to approximately 5 s or can be extended indefinitely until manually reset.

Signal input

Sensitivity: .1 V rms maximum sensitivity from 5 Hz to 10 MHz.

Pulses: 300 mV peak voltage (internal control adjusts for positive or negative pulses); 50 ns minimum pulse width.

Impedance: approximately 1 M Ω shunted by 30 pF.

Attenuation: there is a 3/4 turn variable attenuator on the front panel.

Overload: at maximum sensitivity, input should not exceed 3.5 V rms to retain rated input impedance.

Damage level is 15 V rms. At minimum sensitivity damage level is 250 V rms.

Self check: counts power line frequency.

Operating temperature range: 0°C to 50°C.

Power requirements: 115 or 230 V $\pm 10\%$, 60 Hz, 12 W max.

Weight: net 5 lbs (2.3 kg); shipping 6 1/2 lbs (3.0 kg).

Accessories supplied: detachable power cord, 7 1/2 feet (231 cm) long, NEMA plug.

Price: HP Model 5221A, \$350.

Dimensions: 5 1/8" wide, 6-3/32" high, 11" deep (130 x 155 x 279 mm).

Options

01: 5-digit display, add \$75.

02: 6-digit display, add \$125.

10: 50 Hz operation, add \$25.



ELECTRONIC COUNTERS

IC, crystal controlled 10 MHz counter

Model 5221B



FREQUENCY

Advantages:

- Precision 10 MHz measurements at low price
- Crystal controlled gate
- BCD output is standard
- Blanking of insignificant zeros

The Model 5221B Frequency Counter measures frequencies to 10 MHz with high accuracy using a crystal controlled gate. Printer output and remote gate control are provided to enhance use of the 5221B where more expensive counters have previously been required. A stepped, high impedance input attenuator adds further to the counter's versatility. Sensitivity is 100 mV with an impedance of 1 M Ω shunted by 30 pF.

Extensive use of HP integrated circuits accounts for a very light, compact, and rugged instrument with low power consumption and high reliability. HP integrated circuits also enable unique features such as the blanking of leading zeros.

Frequency measurements

This counter measures frequency or repetition rate of periodic signals by totalizing the events during gate times of .01, .1, 1, or 10 seconds. The gate times are derived from a stable, 1 MHz crystal oscillator and are selected by a front panel switch. An internal control allows counting of either positive or negative input pulses.

Totalizing

Input pulses are totalized during the time the GATE SELECTOR switch is on OPEN.

Ratio

The ratio of two frequencies is measured by the use of one frequency (B) as the time base for the gate while the other frequency (A) is totalized (frequency A can be a pulse source). The setting of the GATE SELECTOR switch determines M, the number of time base cycles for which the gate is open. The display reads $M \times A \div B$, where M can be 10^1 , 10^2 , 10^3 , or 10^4 .

Time interval

With the GATE SELECTOR switch on OPEN, the gate can be closed by contact closure or saturated NPN transistor to ground of the rear panel BNC connector. This feature allows time interval measurements of up to .1s (up to 1s with 6 digit display) with the internal 1 MHz time base. The 1 MHz frequency is counted when the counter is in the CHECK mode. An external time base can be used to time longer intervals.

Display storage and blanking

Display storage provides a continuous storage of the most recent measurement. A unique blanking feature suppresses the display of leading zeros. These convenience features reduce training time and operator errors.

Specifications

Frequency measurement

- Range:** 5 Hz to 10 MHz.
- Input:** .1V rms sensitivity; 1 M Ω /30 pF.
- Gate time:** rotary switch; .01, .1, 1, 10 seconds.
- Accuracy:** ± 1 count \pm time base accuracy.
- Readout:** 5 digits: xxx.xx kHz; 6 digits (Option 01): xxxx.xx kHz. Decimal point and units not displayed.

Ratio measurement

- Displays:** multiplier $\times f_a/f_b$; Multiplier: $10^1 - 10^4$.
- Range:** f_a : 5 Hz to 10 MHz; f_b : 1 kHz to 1 MHz.
- Sensitivity:** f_a : 0.1 V rms/1 M Ω ; f_b : 1 V rms/1000 Ω .
- Accuracy:** ± 1 count of $f_a \pm$ trigger error of f_b .
- f_b applied to EXTERNAL TIME INPUT on rear panel.
- f_a is applied to INPUT on front panel.

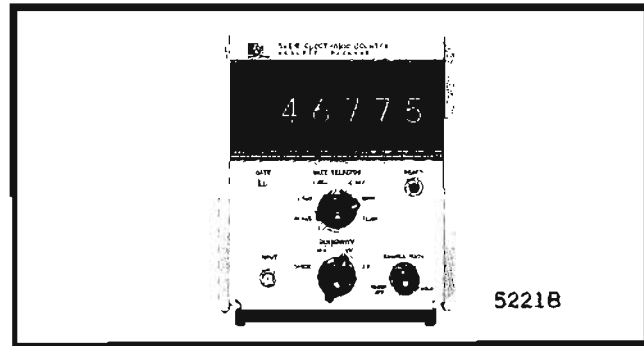

Time interval measurement

- Range:** 1 μ s to 0.1s (5 digits), 1 μ s to 1s (6 digits).
- Input:** with GATE SELECTOR switch in OPEN, grounding EXTERNAL GATE connector closes gate.
- Frequency counted:** 1 MHz.
- Accuracy:** ± 1 count \pm time base accuracy \pm trigger error.
- Readout:** time interval in μ s.
- Reset:** counter must be reset after each measurement.

Time base

- Crystal frequency:** 1 MHz.
- Stability:** aging rate: $< \pm 1$ part in 10^6 /month; Temperature ± 3 parts in 10^5 (0°C to 50°C) ± 2 parts in 10^5 (10°C to 40°C); Line Voltage: $< \pm 1$ part in 10^6 for $\pm 10\%$ variation in line voltage.
- Output frequencies:** 1 MHz, 3 V p-p open circuit, 100 Ω .
- External Input:** sensitivity: 1 V rms into 1 k Ω (10V rms max). Range: 1 kHz to 1 MHz.

General

- Display:** 5 digits (6 available); long life NIXIE[®] with display storage and blanking.
- Sample rate:** 25 ms to 5 s chosen by SAMPLE RATE switch.
- Signal Input:** sensitivity: ac: .1 V rms from 5 Hz to 10 MHz. Stepped attenuator on front panel (.1, 1, 10 V); Pulses: .3 V p-p voltage; internal adjustment for + or - pulses; 50 ns min. pulse width. Impedance: 1 M Ω shunted by 30 pF.
- Self-check:** counts 1 MHz for selected gate time.
- Digital output:** code: 8-4-2-1 "1" level positive; "0" Level: 0 V open circuit, 5.1 k Ω ; "1" Level: 5 V open circuit, 7.6 k Ω ; Reference Levels: Ground, +5 V. Print Command: Step from 5 V to 0 V, dc coupled; 5 k Ω at 5 V. Hold-Off Requirements: > 2 V dc inhibits gate opening; 56 k Ω .
- Chassis Connectors:** Accepts HP Cable 10513A with special connector for 5221B and 50 pin Amphenol or Cinch type 57-30500-375, HP Part Number 1251-0086, male connector, for HP 5050A Digital Recorder.
- Operating temperature range:** 0°C to 50°C .
- Power requirements:** 115 or 230 V $\pm 10\%$, 50 - 400 Hz, 17 W max.
- Weight:** net 5 lb (2.3 kg); shipping, 6.5 lb (3 kg).
- Accessories furnished:** detachable power cord 7 1/2 feet (231 cm) long, NEMA plug.
- Price:** Model 5221B, \$700.
- Dimensions:** 5 1/8" (130 mm) wide, 6-3/32" (155 mm), high, 11" (279 mm) deep.
- Option 01:** 6 digit display.



ELECTRONIC COUNTER

Versatile, IC, 12.4 MHz counter
Model 5216A

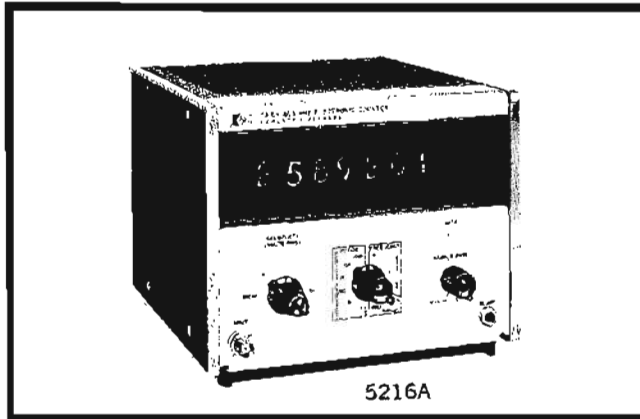

Advantages:

Precision measurements: frequency, period, multiple period average, ratio, multiple ratio, time interval
Crystal time base
10 mV sensitivity
Blanking of insignificant zeros
BCD output standard

This versatile, new general purpose counter from Hewlett-Packard uses HP-manufactured integrated circuits. For this reason, the instrument is light, compact, and rugged with low power consumption and high reliability. The 5216A will measure frequency, period, multiple period average, ratio and time interval and will also totalize.

The 5216A has a maximum counting rate of 12.5 MHz. The time base is controlled by a precision 10 MHz crystal oscillator. Normally, the counted frequency is 1 MHz although an adjustment allows the 10 MHz oscillator to be counted.

Data are displayed in a 7 digit display with storage. The 5216A has a unique blanking feature which suppresses the display of leading zeros. BCD output is standard.

The 5216A is housed in a standard 1/2 module cabinet, which is convenient for bench use and easily rack mounted using the HP 5060-0797 adapter frame.

Specifications

Frequency measurement

Range: 3 Hz to 12.5 MHz.
Input: 10 mV rms sensitivity; 1 M Ω /50 pF.
Gate times: 10, 1, 0.1, 0.01 s.
Accuracy: ± 1 count \pm time base accuracy.
Readout: MHz and kHz with positioned decimal point.

Time interval measurement

Range: 10 μ s to 10 s.
Input: contact closure or saturated NPN transistor to ground. Signal duration ≥ 1 μ s. Current ≥ 2 mA. START signal must end before STOP signal begins. Time from STOP to next START: ≥ 30 ms for external reset or ≥ 30 ms + sample time for internal reset. Two input BNC on rear panel.

Frequency counted: 1 MHz internal, or external standard.

Period measurement

Range: 3 Hz to 1 MHz single period; to 2 MHz in multiple periods averaged.

Periods averaged: 1, 10, 10², 10³, 10⁴, 10⁵.

Frequency counted: 1 MHz internal, or external standard.

Accuracy: ± 1 count \pm time base accuracy \pm trigger error.

Ratio measurement

Displays: (f_1/f_2) \times multiplier; multiplier: 1-10⁶.

Range, sensitivity: f_1 : 1 kHz to 10 MHz into external time base BNC connector, 1 V rms minimum into 1 K Ω . f_2 : 3 Hz to 1 MHz single period; to 2 MHz in multiple period ratio; 10 mV rms sensitivity except 100 mV rms below 1 kHz.

Accuracy: ± 1 count of f_2 \pm trigger error of f_1 .

Time base

Crystal frequency: 10 MHz.

Stability

Aging rate: $< \pm 2 \times 10^{-6}$ /month.

Temperature: $< \pm 1 \times 10^{-5}$ from +15°C to +35°C;
 $< \pm 3 \times 10^{-5}$ from 0°C to +50°C.

Line voltage: $< 1 \times 10^{-6}$ for $\pm 10\%$ change.

Output frequency: 1 MHz, 3 V p-p minimum open circuit; source impedance is 2 k Ω max.

External input: 1 kHz to 10 MHz sinewave, 1 V rms into 1 k Ω (10 V rms maximum).

General

Display: 7 digits, long-life Nixie® tubes.

Display storage, blanking: yes.

Reset: manual and remote.

Sample time: 50 ms to 5 s or hold until reset.

Signal input

Sensitivity: 10 mV rms max.; 100 mV rms max. for trigger below 1 kHz. 30 mV peak pulse, min. width 40 ns.

Impedance: approx. 1 M Ω shunted by 50 pF.

Attenuation: step attenuator, .01, 0.1, 1, 10 V.

Trigger level adjustment: continuously variable.

Overload: input voltage should be < 60 dB above attenuator setting 300 V rms may cause damage.

Self-check: works on all functions.

Digital output

Code: 8-4-2-1, "1" state positive; "0" level: 0 V nominal; "1" level: +5 V open circuit, nominal; source impedance: 7.5 k Ω maximum, each line.

Reference levels: ground; +5 V, low impedance.

Print command: step from 0 V to +5 V, dc coupled.

Hold-off requirements: voltage must be between -10 V and -15 V.

Chassis connector: accepts HP Cable 10513A with one special connector for the 5216A and one 50 pin amphenol or cinch type 57-30500-375, HP part number 1251-0086, male connector, for HP 5050A or 562A Digital Recorder.

Operating temperature range: 0°C to +50°C.

Power requirements: 115/230 V $\pm 10\%$, 50-400 Hz 20 W maximum.

Weight: net 7 lbs (3.1 kg); shipping 8 1/2 lbs (3.9 kg).

Accessories furnished: HP 10503A 4 feet, 50 Ω cable, BNC connectors. Detachable power cord 7 1/2 feet (231 cm) long, NEMA plug.

Dimensions: 7-25/32" (190 mm) wide, 6-3/32" (155) high, 11" (279) deep.

Price: HP Model 5216A, \$925.

DIGITAL FREQUENCY METER

Automatic measurement to 12.4 GHz

Model 5240A



FREQUENCY

Advantages:

Frequency ranges: 0.3-1.2 GHz, 1-12.4 GHz, 5 Hz — 12.4 MHz

Completely automatic measurement in each range

No readout unless phase lock is established

8 digit readout with decimal point and units

BCD output with decimal point and units

Description

Completely automatic measurement and direct readout of frequencies from 0.3 to 12.4 GHz and 5 Hz to 12.5 MHz can be achieved by using the new HP Model 5240A Digital Frequency Meter. The 5240A consists of an automatic frequency divider identical to the HP 5260A and a low frequency integrated circuit counter to make up a completely self-contained unit. Measurements are as rapid and simple as with an ordinary counter. There are two separate inputs, one covering 5 Hz to 12.5 MHz and one covering 0.3 to 12.4 GHz with a corresponding range selector. Except for selecting the proper range, ALL TUNING IS AUTOMATIC AND NO ADJUSTMENTS BY THE OPERATOR ARE REQUIRED TO OBTAIN THE CORRECT OUTPUT READOUT. An output frequency equal to exactly 1/100 or 1/1000 of the input frequency is available from a connector on the rear panel.

Specifications

Automatic frequency divider portion

Ranges: 0.3 to 1.2 GHz and 1 to 12.4 GHz.

Input sensitivity: 100 mV rms (−7 dBm).

Input impedance: 50Ω nominal.

Input VSWR (Type N or APC-7 connectors):

Freq.	Typical	Max.
0.3-8 GHz	1.2:1	1.4:1
8-10 GHz	1.4:1	1.6:1
10-12.4 GHz	1.8:1	2:1

Maximum input: +10 dBm.

Level indicator: front panel meter indicates approximate input level, −10 dBm to +10 dBm.

Division ratio: front panel switches selects —100 (for use up to 1.2 GHz) or —1000 (from 1 to 12.4 GHz) operation.

Input connector: precision Type N female (APC-7, optional).

Operation: completely automatic once the range switch is positioned.

Output frequency: 1/100 or 1/1000 of input (1 to 12.4 MHz).

Low frequency counter portion

Frequency measurements

Range: 5 Hz to 12.5 MHz.

Gate time: 0.1 1.0 s; 10 s on special order.

Self check: counts 1 MHz for gate time chosen.

Signal input

Sensitivity: 100 mV rms.

Maximum input: 2 V rms.

Impedance: 1 MΩ shunted by 25 pF.

Time base

Frequency: 1 MHz.

Stability: aging rate: <2 parts in 10⁷/month. As function of temperature: <±2 parts in 10⁶ (+10°C to +50°C), <±20 parts in 10⁶ (0°C to +65°C). As function of line voltage (±10%): 1 part in 10⁷.

External input: 1 V rms into 1 kΩ.

Output: 1 MHz, 2 V square wave into 6 kΩ.

Remote reset: by grounding center of BNC on back panel.

General

Accuracy: ±1 count ±time base accuracy.

Readout: MHz or GHz with positional decimal point.

Printer output: compatible with HP Models 562A and 5050A Digital Recorders with 8-4-2-1 BCD "1" state negative (add Option 14 for the 562A). Printers record decimal point and measurement units (562A only).

Chassis connector: Amphenol or Cinch type 57-40500-375, HP part no. 1251-0087, 50 pin, female. Mating connector Amphenol or Cinch type 57-30500-375, HP part no. 1251-0086, 50 pin, male.

"0" state level: +6 V.

"1" state level: 0 V.

Impedance: 20 kΩ, each line.

BCD reference levels: ground; +5 V, 1 kΩ source.

Print command: 0 V to 10 V step, dc coupled.

Hold-off requirements: +15 V max., +2.5 V min.

Power requirements: 115/230 V ±10%, 50 to 60 Hz, 90 W.

Weight: net, 37 lbs (16.8 kg.)

Dimensions: 5-7/32" (133) high, 16 3/4" (425) wide, 16 3/8" (416) deep.

Price: Model 5240A, \$4750.

Accessories supplied: detachable power cord 7 1/2 feet (231 cm) long, NEMA plug.

Options:

01. Amphenol APC-7 Input Connector on high frequency input. — add \$25.



5240A



ELECTRONIC COUNTERS

Versatile, low cost, 1.2 MHz and 300 kHz counters
Models 5211A,B, 5212A, 5512A, 5232A, 5532A

Advantages:

- Reliable, rugged and compact
- High input impedance, high sensitivity
- Low power consumption with solid-state components
- Display storage
- Accurate measurement of frequency, ratio, period, multiple period
- Higher sampling rates; sampling time independent of gate time

These six Hewlett-Packard electronic counters offer the advantages of solid-state construction, broad measurement capabilities, rugged and compact packaging and a wide selection of performance characteristics.

Maximum counting rate ranges from 300 kHz to 1.2 MHz. A variety of visual readouts contain from 4 to 6 digits, with both in-line digital tube and neon columnar displays. Features offered in common by all six counters include modular cabinets only 3½" high, low heat dissipation and power consumption with solid-state components, 0.1 V sensitivity, display storage for non-blinking readout, four-line BCD output for systems and recorders (optional for 5211A), flexible operation and reduced operator errors. When a counter is in the frequency mode, the time between counts is adjustable from less than 0.2 second to more than 5 seconds and is independent of gate time. Because time between counts is not dependent upon gate time, faster sampling rates are often possible.

The instruments are compact and reliable, have low power consumption and can operate with specified accuracy over a wide temperature range. Plug-in module construction increases instrument versatility and simplifies maintenance. Conservative design features such as the use of decade dividers in the gate generating circuits, provide operational stability and eliminate calibration problems. Input sensitivity is 0.1 V rms, input impedance, 1 megohm, 50 pF.

5211A,B Counters

Models 5211A and 5211B have a maximum counting rate of 300 kHz and make direct frequency and ratio measurements. They also measure speed in rpm and rps, when used with transducers, and count events occurring within a selected period of time. They offer four-digit resolution and neon columnar display. They are identical except for gate times and recorder

output. The 5211A has gate times of 0.1 and 1 second; the 5211B has a third gate time of 10 seconds.

Both offer manual control of the gate by a front-panel function switch, by external contact closure or by 3 volt peak positive pulses at least 10 μs wide at half-amplitude points. Time base is derived from the power line, and since power line frequency is usually held to better than 0.1%, the counters have an accuracy fully adequate for most industrial measurements. A special modification of the 5211B, the H22-5211B, offers an in-line readout.

5212A, 5512A, 5232A, 5532A Counters

With this group of solid-state instruments, two basic counters give maximum counting rates of 300 kHz and 1.2 MHz, with a choice of column or in-line readout. Each makes direct frequency, period, multiple period average and ratio measurements. Models 5212A and 5512A have a maximum counting rate of 300 kHz, 5-digit resolution and respective displays of neon columns and long-life digital display tubes. Models 5232A and 5532A have maximum counting rates of 1.2 MHz and 6-digit resolution with the same readout choice.

The front panel of each counter has input attenuation control, display control, reset button and function switch. In the rear are the storage-disable switch, external standard input jack (permits use of an external oscillator as the counter time base) and digital recorder output connector. Self-check is provided for both frequency and period measurement modes.

General specifications

Operating temperature range: -20°C to 50°C for 5211A, B; -20°C to +65°C for 5212A and 5512A; 0°C to +65°C for 5232A and 5532A*.

Power: 115 or 230 V ±10%, 50 to 60 Hz**, less than 40 W.

Weight: all models, net less than 15 lbs (6.8 kg), shipping less than 21 lbs (9.5 kg).

Accessories furnished: 10503A Cable, 4 feet long, BNC connectors; detachable power cord; circuit board extender.

Dimensions: 16¾" wide, 3½" high, 11¼" deep (425 x 89 x 286 mm); hardware furnished for converting to 19" wide by 3½" high rack mount.

*The 5232A and 5532A will operate from -20°C to +65°C on special order or with an external time base.

**HP 5211A,B require 50 or 60 Hz operation (specify Option 01 for 50 Hz operation); 5212A, 5512A, 5232A and 5532A operate between 50 and 60 Hz line frequency with limit imposed by fan.

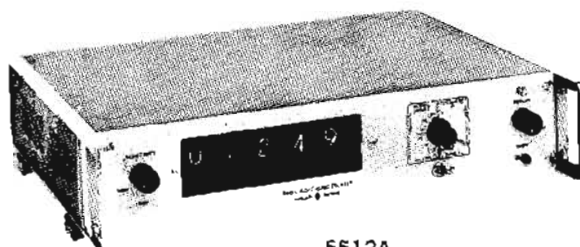

5512A

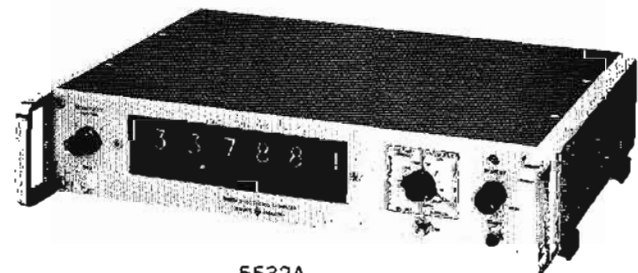

5532A

HP Counter		5211A,B	5212A	5512A	5232A	5532A
Max. counting rate		300 kHz	300 kHz	300 kHz	1.2 MHz	1.2 MHz
Registration		4 digits columnar	5 digits columnar	5 digital display indicators	6 digits columnar	6 digital display indicators
Time base		power line; accuracy typically $\pm 0.1\%$ or better	100 kHz crystal oscillator; aging rate, $\pm 2/10^6$ /week		1 MHz crystal oscillator; aging rate, $\pm 2/10^7$ /month	
Input		sensitivity, 0.1 V rms sine wave; input impedance approx. 1 meg/50 pf				
Period and multiple period average measurement	Range	—	2 Hz to 300 kHz		2 Hz to 1.2 MHz	
	Periods averaged	—	1, 10, 10 ² , 10 ³ , 10 ⁴ , 10 ⁵			
	Accuracy	—	\pm one count, \pm time base accuracy, \pm trigger error			
	Readout	—	msec or μ sec with positioned decimal			
Frequency measurement	Range	2 Hz to 300 kHz		2 Hz to 1.2 MHz		
	Gate time	1, 0.01 sec; 5211B, additional 10 sec	10, 1, 0.1, 0.01 sec			
	Accuracy	\pm 1 count, \pm time base accuracy				
	Readout	KHz, Hz with positioned decimal	KHz with positioned decimal			
Ratio measurement	Display	f_1/f_2	$f_1/f_2 \times$ multiplier; multiplier: 1-10 ⁵			
	Range, Sensitivity	f_1 : 2 Hz to 300 kHz (0.1 V rms); f_2 : 100 Hz to 300 kHz (1 V rms into 1000 ohms)	f_1 : 100 Hz to 300 kHz (1 V rms into 1000 ohms); f_2 : 2 Hz to 300 kHz		f_1 : 100 Hz to 1.2 MHz (1 V rms into 500 ohms above 1 kHz, 2 V rms into 500 ohms 100 Hz to 1 kHz); f_2 : 2 Hz to 300 kHz	
	Accuracy	\pm 1 count of f_1 , \pm trigger error of f_2				
Recorder output (optional at added cost in 5211A; standard in all other models)		4-line BCD (4-2-2-1); 4-line BCD (8-4-2-1) available as Option 02				
	Impedance	100 K each line				
	"0" state level	approximately — 28 volts				
	"1" state level	— 2 volts				
	Reference levels print command	approximately — 2.4 volts, 350-ohm source impedance; and approximately — 26.9 volts, 1000-ohm source impedance				
	Hold-off requirements	+28 V step, from 2700-ohm source in series with 1000 pf chassis ground to +12 volts maximum				
Price		HP 5211A, \$575 HP 5211B, \$675	HP 5212A, \$875	HP 5512A, \$975	HP 5232A, \$1250	HP 5532A, \$1350

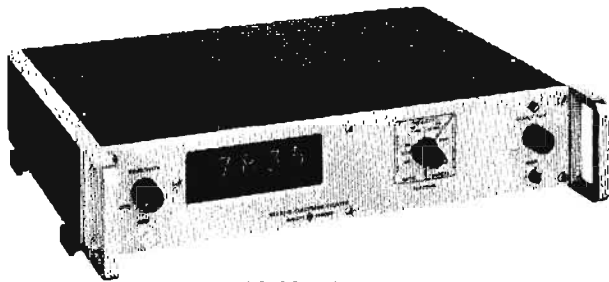

H22-5211B

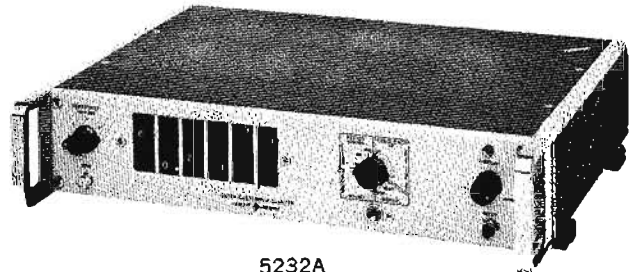

5232A



5212A



ELECTRONIC COUNTERS

Versatile universal counters to 2 MHz

Models 5223L, 5233L

Advantages:

- Superior trigger level controls usable in all functions
- Improved readability with rectangular digital tubes
- Minimum bench or rack space, 3½" panel height
- Reliable, rugged and completely solid state
- Versatile, yet easy to operate
- More accurate low-frequency measurements with multiple period averages
- Low-level measurements without accessories;
 - 0.1 Volt sensitivity
- Coupling ac or dc
- Display storage

Uses:

- Measure frequency
- Count periodic or random pulses
- Measure period, period average, time interval
- Determine ratio and multiples of ratio
- With transducers, measure speed, flow rate, other physical variables
- Scale inputs

Models 5223L and 5233L are universal electronic counters. They measure time interval, frequency, period, multiple period average, ratio and multiple ratio. The 5223L provides a maximum counting rate of more than 300 kHz and 5-digit resolution, and the 5233L provides a maximum counting rate of more than 2 MHz with 6-digit resolution. Both instrument readouts are in-line displays of rectangular digital tubes.

DC coupling

With the 5223L and 5233L, dc coupling allows accurate trigger point definition with low input amplifier noise and low trigger drift.

With the ac-coupled input, triggering responds to an average dc level. Therefore, the trigger point will change with wave shape and repetition rate. This situation is not of great significance in frequency measurements since

it is only desired to count the number of zero crossings. However, if a pulse of large amplitude and duration is followed by a pulse of small amplitude and duration, the trigger may miss the small pulse, if circuit time constants are such that the average dc level does not have time to recover. This would be a serious limitation in nuclear work, where counted pulses are random in amplitude and width. The variability of trigger point with repetition rate and wave shape (produced with ac coupling) is a serious source of error in time interval measurements—some doubt always exists as to where the actual trigger point is. It may be a point of low slope near the top of a pulse where noise can cause appreciable error.

Optimum trigger point definition

The 5223L and 5233L each provide two identical input channels for optimum trigger point definition. Separate or the same signals may be used to start and stop the count; the time interval measured may be selected between any desired points on either signal with a choice of ac or dc coupling. Input channel controls allow selection of the slope, amplitude and polarity of the trigger voltage for all other measurement functions, as well as time interval.

Any input amplifier drift or noise will add to the trigger ambiguity. The effect of this internal noise becomes increasingly apparent as the input signal-to-noise ratio increases. Consequently, for precise measurement capabilities, each input channel of the 5223L and 5233L has been designed to minimize amplifier drift and noise. In these instruments the amplifier noise referred to the input is typically less than 100 microvolts.

Particular design care was necessary to insure that these input amplifiers would possess an extremely wide dynamic range. This insures that the input signal peaks can exceed the highest level control adjustment for the next higher attenuator range without changing the dc level. For example, on the X1 attenuator position, peaks considerably beyond 10 Volts do not alter the zero crossover point.



5233L

5223L Electronic Counter		5233L Electronic Counter	
Input channels (A and B)	<p>Range: dc coupled: 0 to more than 300 kHz; ac coupled: 10 Hz to more than 300 kHz.</p> <p>Impedance: approx. 1 megohm, 80 pF shunt.</p> <p>Sensitivity: 0.1 V rms sine wave; 1 V pulse, 1 μs min. width.</p> <p>Trigger level: -100 to +100 V, adjustable, either positive or negative slope; independent controls on each channel.</p> <p>Channel inputs: Common, Separate, Check.</p> <p>Marker output: available at rear panel for oscilloscope intensity modulation to mark trigger points on input waveform; >1 μs duration and -15 V peak.</p>	<p>Range: dc coupled: 0 to more than 2 MHz; ac coupled: 10 Hz to more than 2 MHz.</p> <p>Impedance: approx. 1 megohm, 80 pF shunt.</p> <p>Sensitivity: 0.1 V rms sine wave; 1 V pulse, 0.2 μs min. width.</p> <p>Trigger level: -100 to +100 V, adjustable either positive or negative slope; independent controls on each channel.</p> <p>Channel inputs: Common, Separate, Check.</p> <p>Marker output: available at rear panel for oscilloscope intensity modulation to mark trigger points on input waveforms; 1 μs duration and -15 V peak.</p>	
Time interval	<p>Range: 10 μs to 10⁶ s.</p> <p>Input: Channels A and B.</p> <p>Accuracy: ±1 count = time base accuracy ± trigger error.*</p> <p>Reads in: ms or s with positioned decimal.</p> <p>Measurement: time from A to B.</p> <p>Self check: period self check below applies, when levels and slopes of both channels are identical.</p>	<p>Range: 10 μs to 10⁷ s.</p> <p>Input: Channels A and B.</p> <p>Standard frequency counted: 1 MHz to 0.1 Hz in decade steps or external frequency 100 Hz to 1 MHz.</p> <p>Accuracy: ±1 count = time base accuracy ± trigger error.*</p> <p>Reads in: ms or s with positioned decimal.</p> <p>Measurement: time from A to B.</p>	
Frequency	<p>Range: 0 to >300 kHz.</p> <p>Input: Channel A.</p> <p>Accuracy: ±1 count = time base accuracy.</p> <p>Reads in: kHz or MHz with positioned decimal.</p> <p>Gate time: 10 μs to 10 s in decades.</p> <p>Self check: counts 100 kHz for the gate time chosen by time base selector.</p>	<p>Range: 0 to >2 MHz.</p> <p>Input: Channel A.</p> <p>Accuracy: ±1 count = time base accuracy.</p> <p>Reads in: kHz or MHz with positioned decimal.</p> <p>Gate time: 1 μs to 10 s in decades.</p> <p>Self check: counts 1 MHz for the gate time chosen by time base selector.</p>	
Period	<p>Range: 0 to 100 kHz.</p> <p>Input: Channel A.</p> <p>Accuracy: ±1 count = time base accuracy ± trigger error.**</p> <p>Reads in: μs or ms with positioned decimal.</p> <p>Frequency counted: 100 kHz to 0.1 Hz in decade steps.</p> <p>Self check: gate time is 1 s; frequency counted is 0.1 Hz to 100 kHz as selected by time base switch.</p>	<p>Range: 0 to 100 kHz.</p> <p>Input: Channel A.</p> <p>Accuracy: ±1 count = time base accuracy ± trigger error.**</p> <p>Reads in: ms or s with positioned decimal.</p> <p>Frequency counted: 1 MHz to 0.1 Hz in decade steps.</p> <p>Self check: gate time is 1 s; frequency counted is 0.1 Hz to 1 MHz as selected by time base switch.</p>	
Period average	<p>Range: 0 to 300 kHz.</p> <p>Input: Channel A.</p> <p>Accuracy: ±1 count = time base accuracy ± trigger error.**</p> <p>Reads in: μs or ms with positioned decimal.</p> <p>Frequency counted: 100 kHz.</p> <p>Periods averaged: 10 to 10⁶ in decade steps.</p> <p>Self check: gate time is 10 μs to 10 s (1 to 10⁶ periods of 100 kHz); counts 100 kHz.</p>	<p>Range: 0 to 2 MHz (multiple period), 0 to 1 MHz (X10), 0 to 100 kHz (X1).</p> <p>Input: Channel A.</p> <p>Accuracy: ±1 count = time base accuracy ± trigger error.**</p> <p>Reads in: μs or ns with positioned decimal.</p> <p>Periods averaged: 10 to 10⁷ in decade steps.</p> <p>Frequency counted: 1 MHz.</p> <p>Self check: gate time is 10 μs to 10 s (10 to 10⁷ periods of 1 MHz); counts 1 MHz.</p>	
Ratio	<p>Range: Channel A (F_A): 0 to above 300 kHz; Channel B (F_B): 0 to 300 kHz (X10 to X10⁶), 0 to 100 kHz (X1).</p> <p>Input: Channels A and B.</p> <p>Measures: F_A (multiplier)</p> <p>Reads: $\frac{F_A}{F_B}$ or $\frac{1000F_A}{F_B}$, depending on multiplier setting.</p> <p>Accuracy: ±1 count of F_A = $\frac{\text{trigger error of } F_B}{\text{multiplier setting}}$</p> <p>Multiplier: 1 to 10⁶ in decade steps.</p> <p>Self check: counts 100 kHz for 10 μs to 10 s depending on multiplier setting.</p>	<p>Range: Channel A (F_A): 0 to more than 2 MHz; Channel B (F_B): 0 to 2 MHz (multiple period), 0 to 1 MHz (X10), 0 to 100 kHz (X1).</p> <p>Input: Channels A and B.</p> <p>Measures: F_A (multiplier)</p> <p>Reads: $\frac{F_A}{F_B}$ or $\frac{1000F_A}{F_B}$, depending on multiplier setting.</p> <p>Accuracy: ±1 count of F_A = $\frac{\text{trigger error of } F_B}{\text{multiplier setting}}$</p> <p>Multiplier: 1 to 10⁷ in decade steps.</p> <p>Self check: counts 1 MHz for 10 μs to 10 s, depending on multiplier setting.</p>	
Manual	<p>Input: Channel A.</p> <p>Multiplier: prescales input of Channel A in decades, 1 to 10⁶.</p> <p>Totalize: periodic events at rates to more than 3 × 10⁶/s; random events with pulse spacing of 3.3 μs or more.</p>	<p>Input: Channel A.</p> <p>Multiplier: prescales input of Channel A in decades, 1 to 10⁷.</p> <p>Totalize: periodic events at rates to more than 2 × 10⁶/s; random events with pulse spacing to 0.5 μs or less.</p>	
Time base	<p>Frequency (internal): 100 kHz.</p> <p>Stability: aging rate: <±2 parts in 10⁶/week; as a function of line voltage: <1 part in 10⁴ for 10% changes in line; as a function of ambient temperature: <±20 parts in 10⁶ (+15°C to +35°C), <100 parts in 10⁶ (-20°C to +65°C).</p> <p>External input: sensitivity: 1 V rms, sine wave into 1 K ohm; range: 100 Hz to 300 kHz, sine wave.</p> <p>Outputs, rear panel</p> <p>Oscillator: 100 kHz, 1 V peak to peak, open circuit; time base (separate BNC connector): 0.1 Hz to 100 kHz in decade steps, 5 V peak open circuit, 1 μs width; 1000-ohm source; available in Period, Time Interval, and Manual without reset interruptions.</p>	<p>Frequency (internal): 1 MHz.</p> <p>Stability: aging rate: <±2 parts in 10⁷ per month; as a function of line voltage: <±1 part in 10⁴ for changes of ±10%; as a function of ambient temperature: <±2 parts in 10⁶ (-10° to +50°C), ±20 parts in 10⁶ (0° to +65°C).</p> <p>External input: range: 100 Hz to 1 MHz, sine wave; sensitivity: 1 V rms above 1 kHz; 2 V rms, 100 Hz to 1 kHz.</p> <p>Outputs, rear panel</p> <p>Oscillator: 1 MHz, 3 V p-p; time base (separate BNC connector): 0.1 Hz to 1 MHz in decade steps, 5 V p-p, 600-ohm source; available in Period, Time Interval, and Manual without reset interruptions.</p>	
Scaling	<p>Range: 0 to 300 kHz.</p> <p>Function setting: Manual.</p> <p>Input: Channel A.</p> <p>Factor: by decades up to 10⁶.</p> <p>Output: rear panel in place of time base output frequencies.</p>	<p>Range: 0 to >2 MHz.</p> <p>Function setting: Manual.</p> <p>Input: Channel A.</p> <p>Factor: by decades up to 10⁷.</p> <p>Output: rear panel in place of time base output frequencies 5 V p-p from 600 ohms.</p>	
General	<p>Printer output</p> <p>Output: 4-line 4-2-2-1 BCD; 100 K each line; '0' state level: approx. -25 V; '1' state level: -2 V.</p> <p>Reference levels: approx. -2.4 V, 350-ohm source impedance, and -26.9 V, 1000-ohm source.</p> <p>Print command: +28 V step from 2700-ohm source in series with 1000 pF.</p> <p>Hold-off requirements: chassis ground to +12 V maximum.</p> <p>Registration: 5 long-life rectangular digital tubes with display storage.</p> <p>Sample rate: time following a gate closing during which the gate may not be reopened is continuously variable from less than 0.2 s to 5 s; independent of gate time; display can be held indefinitely.</p> <p>Self check: in all function and multiplier positions.</p> <p>Operating temperature range: -20°C to +65°C.</p> <p>Power: 115 or 230 V ±10%, 50 to 60 Hz***; 40 watts.</p> <p>Dimensions: 16 3/4" wide, 3-15/32" high, 11 1/4" deep (425 x 86 x 285 mm).</p> <p>Weight: net 19 lbs (8.5 kg); shipping 22 lbs (10 kg).</p> <p>Price: HP 5223L, \$1275.</p> <p>Option 02: 1-2-4-8 BCD output ('1' state positive), in lieu of 1-2-2-4 BCD output, add \$10.†</p>	<p>Printer output</p> <p>Output: 4-line 4-2-2-1 BCD; 100 K each line; '0' state level: approx. -8 V; '1' state level: approx. +18 V.</p> <p>Reference levels: approx. +13 V, 900-ohm source impedance, and approx. -5 V, 1200-ohm source impedance.</p> <p>Print command: -28 V step, 2700-ohm source impedance; 1000 pF in series.</p> <p>Hold-off requirements: from +2 V to -20 V.</p> <p>Registration: 6 long-life rectangular digital tubes with display storage.</p> <p>Measurements unit: unit readout for frequency, period, period average, and time interval with positioned decimal point.</p> <p>Sample rate: time following a gate closing during which the gate may not be reopened is continuously variable from less than 0.2 s to 5 s; independent of gate time; display can be held indefinitely.</p> <p>Self check: in all function and multiplier positions.</p> <p>Operating temperature range: 0°C to +65°C.</p> <p>Power: 115 or 230 V ±10%, 50 to 60 Hz,***; 50 watts.</p> <p>Dimensions: 16 3/4" wide, 3-15/32" high, 11 1/4" deep (425 x 86 x 385 mm).</p> <p>Weight: net 19 lbs (8.5 kg); shipping 22 lbs (10 kg).</p> <p>Price: HP 5233L, \$1600.</p> <p>Option 02: 1-2-4-8 BCD output in lieu of 1-2-2-4 BCD, add \$10.†</p>	
<p>* For any wave shape, trigger error is less than $\frac{0.0025}{\text{signal slope (V/}\mu\text{s)}}$ μs; below 0.1 Hz maximum error may increase up to 10-fold, depending on line voltage and environmental conditions.</p>		<p>** With trigger level set at zero, either slope, trigger error for sine wave input is less than $\frac{0.3\% \text{ of one period}}{\text{periods averaged}}$ at rated sensitivity for signals with 40 dB signal-to-noise ratio.</p>	
<p>*** Line frequency limit imposed by cooling fan.</p>		<p>† Option 03.—same as 02, except '1' state negative, add \$10.</p>	



PRESET COUNTER

Normalizes data; controls, counts and times

Model 5214L

Uses:

- Measures normalized rate
- Measures ratio
- Measures normalized ratio
- Measures time for N events to occur
- Counts N events, giving an output pulse at the start and the end of the count
- Allows N to be remotely preset
(N may be set to any integer from 1 to 100,000)

Model 5214L Preset Counter is one of the most versatile electronic counters ever produced. It not only measures frequency and period and totalizes, as do most universal electronic counters, but it also performs the additional measurement functions enumerated under "Uses". Such versatility is achieved by using two sets of decades; one set registers the signal being counted, the other, which may be preset to any integer from 1 to 100,000, controls the gate. Provision has been made so that the number N can be remotely programmed. Separate output signals also are available to operate external equipment whenever the gate opens or closes. Solid state circuits are used throughout.

Rate measurement

In rate measurements, which correspond to the frequency measurements of ordinary counters, gate time is controlled by the preset decades (N), the time base (100 kHz), and the multiplier (M). The gate is held open for N periods ($N = 1$ to $N = 100,000$) of the frequency furnished by the time base. If the internal 100 kHz time base is connected directly to the preset decades (M at X1), the gate time is set in 10 μ s steps. Setting the Multiplier to X10 or X100 divides the time base frequency by 10 or 100 respectively, so that time may be set in 100 μ s or 1 ms steps, as well. Setting gate time for 1 second permits frequency measurements directly in cycles per second.

Being able to select gate time allows you to normalize readings or to convert frequencies into practical units. For instance, if a tachometer generator, which produces 100 pulses per revolution, is connected to a rotating shaft, you can set the gate to 10.000 ms (0.01 s) and measure rps directly or you can set the gate for 600.00 ms (0.6 s) and measure rpm.

The long gate times that are available (up to 100 seconds) allow you to measure low frequencies or register the least significant digits of an input signal better to observe small variations of rate.

Ratio measurement

Model 5214L measures ratio over a wide range of frequencies and with a wide choice of normalizing factors. The signal connected to input B goes through the Multiplier switch and the preset decades, and controls the gate time; the signal connected to input A goes to the readout decades. Consequently, signal A is counted for a number of periods of signal B equal to the product of N and the Multiplier setting.

The number displayed by the readout decades is MNA/B ,

where A is the frequency of the signal connected to input A, and B is the frequency of the signal connected to input B. Gate length from 1 to 10^7 periods of signal B can be chosen in steps of 1, 10, or 100. Input B also can be used for extending gate time or for applications requiring an external time base.

Time measurement

In the Time function, which corresponds to period measurements in conventional counters, the hp 5214L measures the time in milliseconds for N events to occur. The measurement may be made in increments of 0.01, 0.1 or 1 ms by setting the Multiplier to X1, X10, or X100, respectively.

Period and multiple period measurements are also easily made with the function switch in the Time position, and period average is determined by dividing the time reading by N. The ability to choose the number of input cycles measured and to choose time increments of 0.01 ms, 0.1 ms, or 1 ms allows the operator to achieve the greatest accuracy possible, or to obtain a required accuracy in the shortest measurement time.

Preset counting

When the Function switch is set to Preset at N, the 5214L counts N events and provides an output pulse at the beginning and end of the preset count. This feature is useful in batching, as the gate signal can be used to control external equipment. Separate electrical output signals are available at the beginning and end of the count.

Display storage

All HP solid-state electronic counters have display storage which holds the most recent measurement even while the instrument is gated for a new count. If the new count differs from the stored count, the display will shift to the new reading directly. Where desirable, the storage feature may be disabled by a rear-panel switch.

Electrical readout

These counters provide a four-line BCD code output with assigned weights of 4-2-2-1 ("1" state positive with respect to "0" state). This output is suitable for systems use or for output devices such as HP 562A Digital Recorder, or the 580A, 581A Digital-to-Analog Converters (pages 113 to 117). 8-4-2-1 BCD code output is also available at extra cost.

Specifications

Functions

Totalize (Input A)

Range: 2 Hz to 300 kHz.

Sensitivity: *0.1 volt rms sine wave.

Gate time: manual control.

Input Impedance: 1 megohm, 50 pF shunt.

Capacity: 99,999 counts in units, tens or hundreds.

Rate (Input A)

Range: 2 Hz to 300 kHz.

Sensitivity: *0.1 volt rms sine wave.

Gate time: 10 μ s to 1 s in 10 μ s steps; 100 μ s to 10 s in

100 μ s steps; 1 ms to 100 s in 1 ms steps.

Accuracy: ± 1 count \pm time base accuracy.

Input Impedance: 1 megohm, 50 pF shunt.

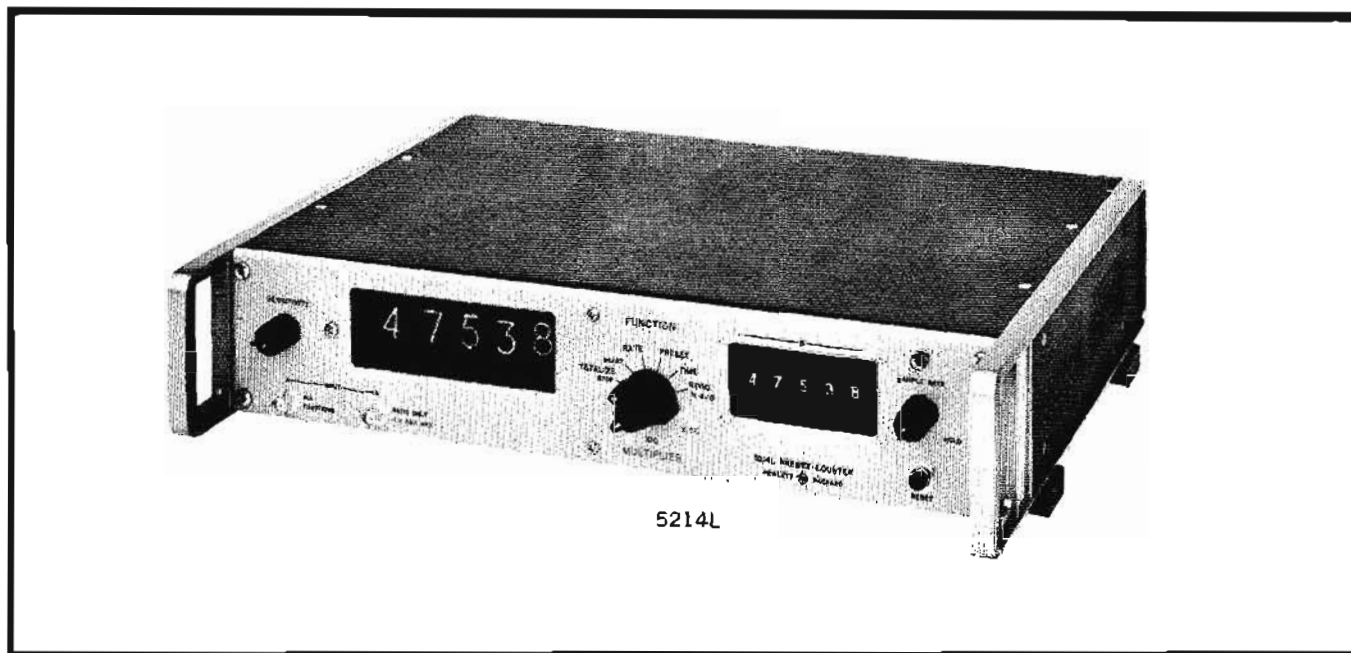
**Preset (Input A)**

Input frequency range: 2 Hz to 100 kHz.

Sensitivity*: 0.1 V rms sine wave.

Reads: time for N events in ms.

Time units: 10 μ s, 0.1 ms or 1 ms.

Input impedance: 1 megohm, 50 pf shunt.

Accuracy: ± 1 count \pm time base accuracy \pm trigger error.†

Ratio

Display: N x A/B x Multiplier; Multiplier x N: 1 to 10⁷.

Input A: frequency range 2 Hz to 300 kHz; sensitivity, *0.1 V rms sine wave; input impedance, 1 megohm, 50 pf shunt.

Input B: frequency range, 2 Hz to 100 kHz on X1 (2 Hz to 300 kHz on X10 and X100); sensitivity, 0.1 V to 10 V rms; input impedance, 1 megohm, 50 pf shunt.

Accuracy: ± 1 count.

Internal time base stability

Aging rate: $< \pm 2$ parts in 10⁶/ week.

Temperature: $< \pm 20$ parts in 10⁶ +15°C to +35°C;
 $< \pm 100$ parts in 10⁶ -20°C to +65°C.

Line voltage: < 1 part in 10⁶ for $\pm 10\%$ line.

General

Display: 5 long-life rectangular digital display tubes with display storage.

Sample rate: sample rate control determines length of time after gate closure before gate can be reopened; adjustable from 0.2 s min. to at least 5 s max. with counter in Rate, it is independent of gate time, and display can be held indefinitely.

Input connectors: BNC, on front and rear panels, wired in parallel.

Digital output

Output: 4-line 4-2-2-1 BCD; 8-4-2-1 BCD optional.

Impedance: 100 K each line; "0" state level: approx. -28 V; "1" state level: -2 V.

Reference levels: approx. -2.4 V, 350-ohm source impedance and -26.9 V, 1000-ohm source.

Print command: step from -29 V to -1 V from 2700-ohm source in series with 1000 pf.

Hold-off requirements: chassis ground to +12 V max.

Remote operation: number "N" can be remotely preset by appropriate contact closures.

Operating temperature: -20 to +65°C.

Power: 115 or 230 V $\pm 10\%$, 50 to 60 Hz, 35 W (line frequency limit imposed by fan motor).

Weight: net 15 lbs (6,75 kg); shipping 25 lbs (11 kg).

Accessories provided: two 10503A cables, 4 feet long, BNC connectors, circuit board extender, detachable power cord.

Outputs: positive pulse approx. 10 V high and 5 μ sec wide at gate opening and closing.

Dimensions: 16 $\frac{3}{4}$ " wide, 3-13/16" high, 13 $\frac{1}{4}$ " deep (426 x 97 x 337 mm); quickly converts to rack mount: 19" wide, 3 $\frac{1}{2}$ " high, 11 $\frac{1}{4}$ " deep behind mounting surface (483 x 89 x 286 mm).

Price: HP 5214L, \$1300.

Options

02. 8-4-2-1 BCD ("1" state positive) in lieu of 4-2-2-1, add \$10.

03. Same as Option 02. except "1" state negative, add \$10.

* Internal control allows trigger adjustment for negative or positive periodic pulses.

† Trigger error (sine wave) $< \frac{0.3\% \text{ of one period}}{N}$ for ≥ 40 dB signal-to-noise ratio on input signal; trigger error decreases with increased signal amplitude and slope.



REVERSIBLE COUNTER

Counts up, down at 2 MHz rate; very versatile
Model 5280A

The 5280A/5285A Reversible Counter/Plug-In combination has two input channels ("A" and "B") with an individual range of dc to more than 2 MHz. The superior trigger level controls for each channel allow the use of a wide range of inputs in all modes of operation. Drift of the differential dc amplifiers, used in the input circuitry, is unusually low to provide more accurate definition and retention of set trigger points.

Three basic types of measurement provide exceptional versatility.

Algebraic A, B

A: The A input is totalized, dc to more than 2 MHz, for the length of time the main gate is open.

A - B: The input A minus the input B is totalized, dc to 1 MHz each channel, for the gate open period. In this mode the 1 MHz rate is retained while reversing direction of count, and while passing through zero.

A + B: The input A plus the input B is totalized, dc to 1 MHz each channel, for the gate open period.

B: The B input is totalized, dc to more than 2 MHz, for the length of time the main gate is open.

A directional MODE switch can be used to reverse the measurements in the above 4 modes, i.e., $-A$, $-A+B$, $-A-B$, and $-B$. In the $A-B$ and $A+B$ modes, an anti-coincidence circuit is used to prevent the loss of any counts that arrive at the inputs in time coincidence.

Af(B)

In this mode of operation, A is counted forward when the B input is more positive than its trigger level setting, and A is counted in reverse when B is more negative than its trigger level. (Inverse operation is possible). A unique count direction gating system is used to prevent the inherent propagation delay down the readout decades from limiting the input frequency capability of A. The maximum input to channel A in this mode is 2 MHz even when the 7th and 8th digits have been added to the readout. The count direction can be reversed without count error with a minimum of 250 ns between the reverse step function command and the next input pulse.

A Quad B

This mode of operation is designed to operate with transducers having two outputs separated 90° in phase (in quadrature). The A output is totalized, up or down, depending upon its phase relationship with the B input. When B leads A, A is totalized in a positive direction; when B lags A, A is totalized in a negative direction. (Inverse operation is possible.) The direction of count may be reversed at a 1 MHz rate, which is also the maximum frequency allowable on A and B.

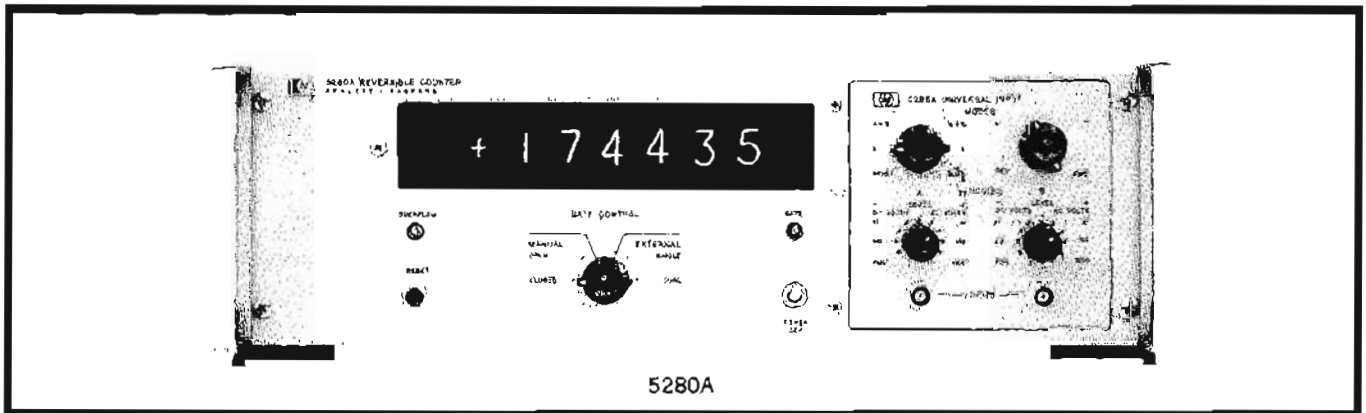

Readout

Registration is by a 6-digit in-line display of rectangular Nixie tubes with a 7th and 8th digit of display available on request. Overflow of the displayed readout is indicated by a front panel neon light. A long-life Nixie® displays + or - corresponding to the algebraic sign of the readout.

Four-line, BCD-coded output including polarity and overflow is provided as a standard feature with the assigned weights of 1-2-4-8 ("1" state positive with respect to the "0" state). This output is suitable for systems use, or for output devices such as the Hewlett-Packard Model 562A Digital Recorder, the HO3-580A and HO3-581A Digital-to-Analog Converters.

Gating

Three gating modes are available, selected by a front panel switch. Manual "OPEN" and manual "CLOSED" operate the main gate for all functional modes of the plug-in operation. External "SINGLE" requires a dc voltage applied to a rear panel "START" input for the desired gate open period. In the external "DUAL" position separate inputs to two wires at the rear "START" "STOP" connectors are required to open and close the main gate. Reset may be accomplished by a front panel push button or by applying an input to a rear panel connector.

5285A Universal Input Plug-In

The 5285A Plug-In operates in conjunction with the 5280A Reversible Counter. Both units must be ordered; neither one will operate independently of the other.

Typical Applications

With laser interferometer for precision metrology.

With flow meters to measure and control liquid flow rates or volume in a tank.

With rotary optical encoders to measure and control position and velocity, for example, of rolls of paper.

5280A Reversible Counter

General

Range: dc to 2 MHz Channel A or Channel B (see 5285A specifications for details concerning other input requirements).

Display: 6 long-life rectangular Nixie® tubes (7th and 8th digit of readout optional). + and - indication by long-life rectangular Nixie tube. Overflow indication by front panel neon light.

Reset: remote by contact closure or saturated NPN transistor to ground. Input via rear panel BNC. Manual by front panel pushbutton.

Reset time: less than 10 μ s.

Inhibit: start channel is inhibited during reset time with the function switch in the DUAL position only. Inhibit released at end of reset time.

Gate light: gate light indicates main gate open.

Gate control

Manual: controlled by front panel function switch for OPEN and CLOSED positions.

External dual

Input: separate BNC's on rear panel for START and STOP inputs.

Sensitivity: sine wave 1 volt rms; pulse 2 V p-p.

Impedance: approximately 100 k ohms, 25 pF in shunt.

Trigger level: +10 volts to -10 volts, adjustable at the rear panel. Independent controls on each input.

Polarity: + or - rear panel switch selects triggering slope.

External single

Input: START BNC on rear panel.

Sensitivity: sine wave 1 volt rms; pulse 2 V p-p.

Impedance: approximately 100 k ohms, 25 pF in shunt.

Trigger level: +10 volts to -10 volts, adjustable at rear panel.

Polarity: + or - rear panel switch selects gate open polarity.

Gate: (+) opens when input is positive with respect to the trigger level. Closes when input is negative with respect to the trigger level. (-) inverse of (+). Manually switched dc voltage is a satisfactory gating input.

Printer output

Code: 4-line 1-2-4-8 BCD.

"0" state level: approximately -14 volts.

"1" state level: approximately +10 volts.

Impedance: 100 k ohms each line.

Reference levels: 0 volts for "0" and "1" states.

Print command: positive 15-volt step from -15 volts to 0 volts.

Hold-off requirements: externally applied level change from 0 volts or more negative than 0 volts to +10 volts (effective with function switch in DUAL position only).

Overflow: single line output, 100 k ohms impedance. "OFF" level approximately +17 volts, "ON" level approximately -13 volts.

\pm Nixie sign (Indicates sign of count): single line output, 100 k ohms impedance, + level approximately -15 volts, - level approximately +13 volts.

Physical specifications

Rear panel connectors: BNC "START" and "STOP" gate inputs. BNC rear terminal in parallel (RTIP) inputs for "A" and "B" channels of the 5285A Universal Input plug-in. BNC input for external RESET. BNC MONITOR outputs for channel A and B triggers. 50 pin mating connector for BCD output. Amphenol #57-30500-375 (HP #1251-0086).

Rear panel controls: \pm polarity switch for single and dual gate control input. Trigger level adjustments for "START" "STOP" inputs, \pm 10 volts.

Power: 115 or 230 volts \pm 10%, 50 to 60 Hz, 110 W (with 5285A plug-in).

©Burroughs Corp.

For crystal frequency comparison in production testing.
With optical encoders or stepping motors to indicate position of numerically controlled machine tools.

With V to F converters to integrate dc voltages and thus obtain the average value of drift over a time period.

Request Application Note 85 for further discussion of applications.

Specifications

Operating temperature range (5280A/5285A): 0°C (32°F) to +65°C (+149°F).

Weight: Net, 29 lbs (13,2 kg). Shipping, 40 lbs (18,1 kg). (Weights include plug-in.)

Price: \$1450.

Dimensions: 5¼" high, 16¾" wide, 16⅞" deep (132 x 425 x 416 mm).

Option 01: 4 line BCD 4-2-2-1 "1" state positive in lieu of 8-4-2-1 "1" state positive. \$15 per decade.

H19-5280A: Addition of 100 kHz internal time base allows gate times of 0.1 s, 1 s, and 10 s. The time base is the same as in the 5223L counter. Add \$545.

H20-5280A: "Readout on the Fly": enables the count to be saved in an internal buffer storage register on command (within 10 μ s) without interrupting counting. Output in BCD code 8-4-2-1 "1" state negative, add \$1200.

H21-5280A: Same as H20-5280A except output in BCD code 4-2-2-1 "1" state positive, add \$1200.

5285A Universal Input Plug-In

(for operation in HP Model 5280A only)

Input channels (A and B)

Range: dc coupled: 0 to more than 2 MHz. ac coupled: 10 Hz to more than 2 MHz.

Impedance: approximately 1 megohm, 75 pF shunt.

Maximum input: ac coupled, \pm 600 volts peak; dc coupled, 25 volts rms (X1), 150 volts rms (X10), 350 volts rms (X100).

Sensitivity: 0.1 volt rms sine wave; 1 volt pulse, 0.2 μ s minimum width.

Trigger level: -100 to +100 volts, adjustable, independent controls on each channel.

Modes of operation

A Quad B: totalizes A as a function of B phase. Maximum rate 1 MHz (same frequency in both channels).

Totalizes A positively if B leads A.

Totalizes A negatively if B lags A.

(Above for directional MODE switch in FWD position. Count direction reversed with switch in REV position.)

Af(B): totalizes A as a function of B from dc to more than 2 MHz. If B is positive, A is totalized positively. If B is negative, A is totalized negatively. Count direction reversed within 250 nsec of B step function command. (Direction of A counted as a function of B is reversed with directional MODE switch in REV position.)

Algebraic A, B: totalizes both A and B according to MODE selector setting.

A: A only to greater than 2 MHz.

A-B: input A minus input B; to 1 MHz per channel. Anti-coincidence circuit prevents count loss when pulses arrive in time coincidence.

A+B: input A plus input B; 1 MHz per channel. Anti-coincidence circuit prevents count loss when pulses arrive in time coincidence.

B: B only to >2 MHz.

Direction of counting is reversed with the directional MODE switch in - position, i.e., modes would be -A, -A+B, -A-B, -B.

Physical specifications

Weight: Net, 3 lbs (1,4 kg). Shipped in 5280A.

Dimensions: 4-25/64" high, 4-37/64" wide, 8½" deep (112 x 116 x 216 mm).

Price: \$450.

FREQUENCY



TIME INTERVAL COUNTER

Measure intervals from 10 nanosec to 0.1 sec.
Model 5275A

Model 5275A is ideally suited for precise digital measurements of short time intervals between events that can be represented by suitable electrical pulses. Resolution to 10 nanoseconds is achieved in automatic measurements over the full 10 nsec to 0.1 sec range of the instrument.

Counted frequency is 100 MHz, obtained from an external 1 MHz standard by a multiplying circuit within the counter. Applications for this instrument include the measurement of explosive burning rates, speed and acceleration timing of test vehicles in the free-flight wind tunnels, and nuclear measurements of various kinds.

Rugged, modular construction and solid-state components

contribute to the quality and reliability of this instrument. Standard features of remote reset, rear-mounted trigger terminals and 4-line BCD output make the 5275A suitable for many applications that would otherwise require equipment of special design. The time interval counter is housed in the HP cabinet configuration which allows easy convertibility from bench use to rack mount.

For system installation, the HP 101A 1 MHz Oscillator (see page 594) is capable of supplying the time base for as many as twenty 5275A Time Interval Counters. Using one frequency standard conserves valuable rack space and reduces system cost where several time interval counters are required.

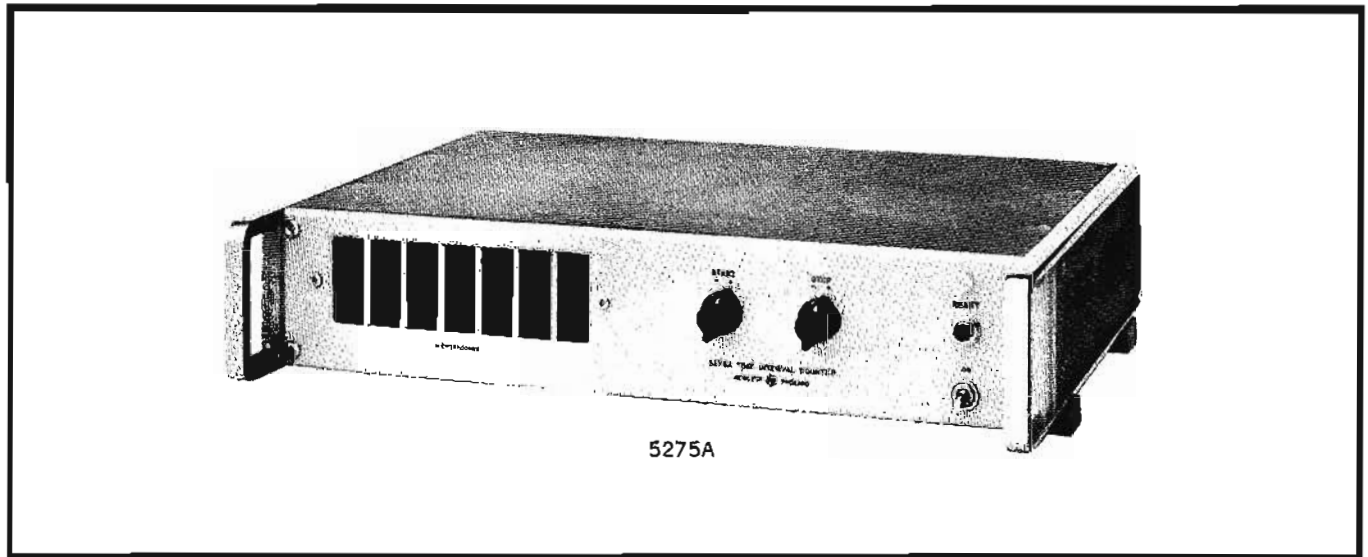

Specifications

Time interval measurement

Range: 10 nanoseconds to 0.1 seconds.
Resolution: 10 nanoseconds.
Input: start, stop trigger by separate channels.
Frequency counted: 100 MHz.
Accuracy: ± 10 nanoseconds \pm time base accuracy.
Readout: in microseconds, with decimal point.

Time base input: (HP 101A Oscillator recommended)

Frequency: 1 MHz.
Stability: compatible with measurement needs.
Amplitude: 1 V rms into 1000 Ω .
Signal to noise ratio: 60 dB.
Phase and amplitude modulation: less than 0.1%.

General

Display: 7 places, digital, in neon columns.
Reset: automatic, manual, or remote, using rear terminals (30 μ s minimum connection to ground).
Input trigger pulse
Sensitivity: 3 V peak, 0.5 V/ns rise time, 5 ns width.
Impedance: 50 Ω
Polarity: selectable, positive or negative.
Digital output
Code: 4-2-2-1; "0" level: -8 V, "1" level: 18 V, impedance: 100 k Ω , each line.

Reference level: + level 17.6 V; 350 Ω ; - level -6.9 V; 1000 Ω .

Print command: step from -6 to 13 V, dc coupled, 2000 Ω source.

Hold-off requirements: 0 V enables the reset; +13 V disables reset; 10 k Ω impedance.

Chassis connector: BNC connector; mates with Amphenol 57-30500.

Operating temperature range: -20°C to +65°C.

Power requirements: 115 or 230 V $\pm 10\%$, 50 to 60 cps, 50 W.

Weight: net 15 lbs (7 kg); shipping 18 lbs (8.2 kg).

Accessories furnished: two 10503A cables, 4 ft. long, male BNC connectors.

Price: HP 5275A, \$2450.

Dimensions: 16 $\frac{3}{4}$ " wide, 3-15/32" high, 19" deep (425 x 88 x 483 mm).

Option 02: 4 line BCD output, 8-4-2-1, "1" level positive in lieu of 4-2-2-1 (identical in all other respects), add \$10.

Option 03: same as Option 02, except "1" level negative, add \$10.

PLUG-IN UNITS FOR 524 COUNTER

Frequency converters; time interval
Models 525A, 525C, 526B



FREQUENCY

525A Frequency Converter Unit

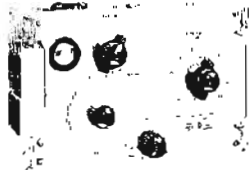

525A—extends frequency measurement range from 10 MHz to 100 MHz.

525C Frequency Converter Unit



525C—enables counter to measure frequency between 100 MHz and 510 MHz.

526B Time Interval Unit

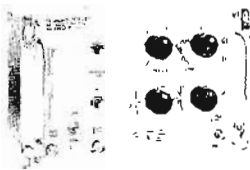

526B—provides time interval measurement capabilities—1 μ sec to 100 days.

For use with the 524C or 524D vacuum tube counters.

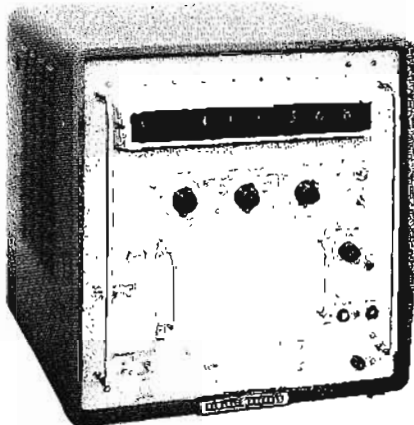

524C Electronic Counter

The performance of 524C and 524D Vacuum Tube Counters can be increased by the use of the following plug-in units.

525A Frequency Converter Unit

(plugged into 524 Electronic Counter)

Range: as amplifier, 10 Hz to 10.1 MHz; as converter, 10.1 MHz to 100 MHz.

Accuracy: retains accuracy of counter.

Resolution: 0.1 cycle to 1000 cycles, depending on gate time.

Input voltage: 0.1 V to 10 V rms, 10 Hz to 10 MHz; 10 mV to 1 V rms, 10 MHz to 100 MHz.

Input impedance: approximately 1 M Ω shunted by 40 pF, 10 Hz to 10 MHz; approximately 50 ohms, 10 MHz to 100 MHz.

Tuning indicator: tuning eye aids frequency selection, indicates correct voltage level adjustment.

Weight: net 5 lbs (2 kg); shipping 9 lbs (4 kg).

Price: HP 525A, \$350.

525C Frequency Converter Unit

(plugged into 524 Electronic Counter)

Range: as converter for counter, 100 MHz to 510 MHz; as amplifier for counter, 50 kHz to 10.1 MHz; direct connection for 0 to 10.1 MHz.

Accuracy: retains accuracy of counter.

Resolution: 0.1 cycle to 1000 cycles, depending on gate time.

Input voltage: 20 mV rms minimum, 50 kHz to 10.1 MHz; 100 mV rms minimum 100 to 510 MHz.

Maximum input: 2 V rms from 50 kHz to 10.1 MHz and 100 to 510 MHz.

Input impedance: approximately 700 ohms, 50 kHz to 10.1 MHz; approximately 50 ohms, 100 MHz to 510 MHz.

Level indicator: meter aids frequency selection, indicates usable voltage level.

Weight: net 7 lbs (3 kg); shipping 10 lbs (5 kg).

Price: HP 525C, \$475.

526B Time Interval Unit

(plugged into 524 Electronic Counter)

Range: 1 μ s to 10⁷ seconds.

Accuracy: ± 1 period of standard frequency counted, \pm time base accuracy.

Registration: on 524 Counter.

Input voltage: 1 V peak minimum, direct-coupled input.

Input impedance: approximately 1 M Ω , 40 pF shunt

Start-stop: independent or common channels.

Trigger slope: positive or negative on START and/or STOP channels.

Trigger amplitude: both channels continuously adjustable from -192 to +192 Volts.

Standard frequency counted: 10 Hz, 1 or 100 kHz, 10 MHz from 524 counter; or externally applied frequency.

Reads in: s, ms or μ s; decimal point automatically positioned.

Accessory furnished: 10503A Cable Assembly, 48" RG-58C/U cable terminated with UG-88/U BNC connectors.

Weight: net 5 lbs (2 kg); shipping 7 lbs (3 kg).

Price: HP 526B, \$275.



COMPLEMENTARY EQUIPMENT

Increases versatility of basic instruments

The versatility of Hewlett-Packard counters is greatly enhanced by complementary Hewlett-Packard equipment.

The HP 2590B Microwave Frequency Converter extends the frequency measuring capability of a 5245L/M (or 5246L) 50 MHz Counter, 5253B 500 MHz Frequency Converter Plug-In combination to 15 GHz. The HP 5260A Automatic Frequency Divider with a suitable Counter makes possible automatic frequency measurements up to 12.4 GHz.

The HP 2539A Digital Comparator and HP 2515A Digital Scanner increase the number of systems applications by providing data handling for making Go/No-Go decisions on counter measurements, and by scanning the BCD outputs of up to six counters.

Various solid state output couplers increase the forms in which the BCD output of counters may be recorded and stored for additional data handling or processing by digital machines.

HP 562A and HP 5050A are solid state digital recorders that provide permanent printed records of counter measurements in digital form. X-Y and strip-chart recorders, in conjunction with HP 580A/581A Digital-to-Analog Converters, provide the user with a selection of equipment for analog recording of digital data.

The HP 2212A voltage-to-frequency converter transforms analog information (i.e., voltages) into signals suitable for feeding directly into electronic counters.

Figure 1 demonstrates the capability of the HP-2539A Digital Comparator to compare readings made with the HP 5246M Counter with a predetermined level (or predetermined upper and lower levels). The result of the comparison is available and may be printed by the HP 562A Digital Printer or fed back to the system being monitored by the counter, thus completing a feedback control system. Front-panel indication of the comparison is also available. The data from the counter used by the digital comparator in the actual comparison is available from the comparator in BCD form. It may be printed with the Go/No-Go in-

dications by the 562A or converted to analog form by the HP 580A, 581A Digital-to-Analog Converters and plotted on an HP 680 Strip-Chart Recorder, providing a permanent, visual record of the comparison.

The system in Figure 2 demonstrates the use of the HP 2515A Digital Scanner to scan up to six 5245M 50 MHz Counters with 5253B 500 MHz Frequency Converter Plug-ins, using the HP 2590A Microwave Frequency Converter or HP 5260A Automatic Frequency Divider to measure microwave frequencies. Frequency measurements made by the counters are sequentially or randomly (depending on the mode of operation) scanned by the HP 2515A, and the data, in BCD form, is made directly available to one of four different types of output equipment. The scanner couples directly to the HP 562A, AR Digital Recorders and modified versions of the HP 2545 Tape Punch Coupler, HP 2546 Magnetic Tape Recorder Coupler and HP 2526 Card Punch Coupler. Both the magnetic tape records and the punched cards are IBM-compatible.

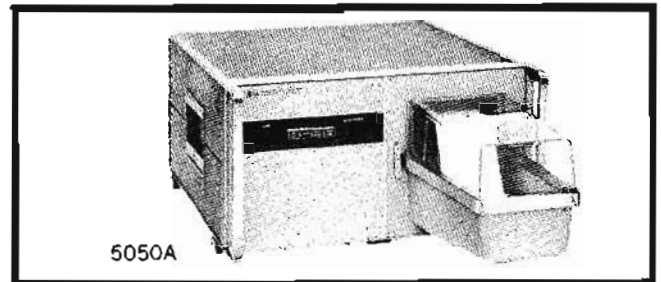

5050A

The 5050A Digital Recorder can print up to 18 columns at 20 lines per second. Numbers and a limited set of symbols can be printed. The code base is easily changed by changing an inexpensive code disc. Mixed codes can be used. Price: 5050A, \$1750 plus \$70 per column board (one board needed for every two columns used), \$35 per input cable (10 columns of input per cable), pages 113-114.

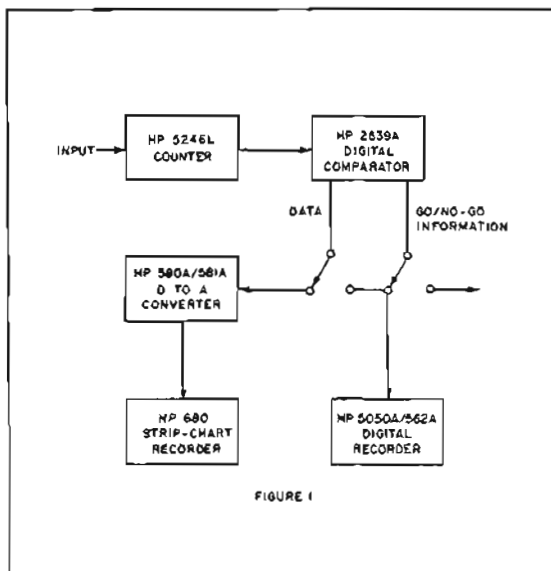

FIGURE 1

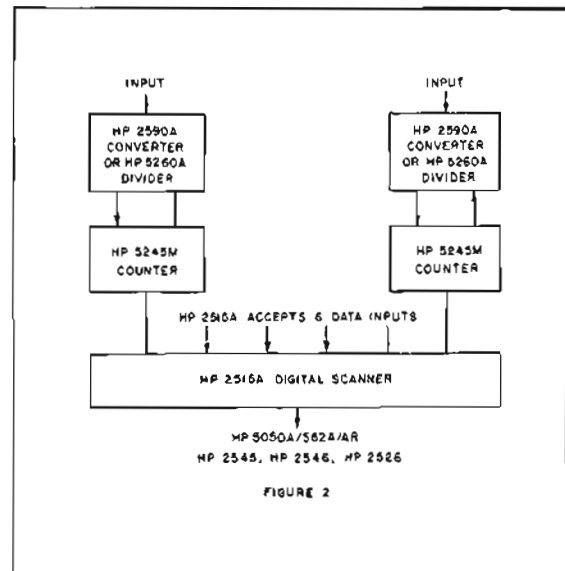
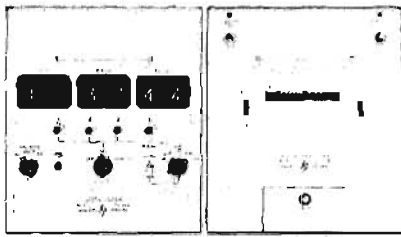
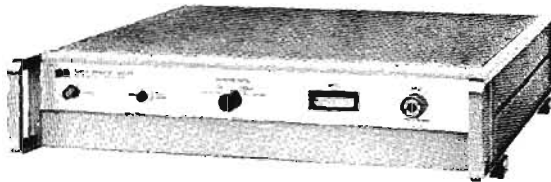

FIGURE 2



562A

The HP 562A Digital Recorder (shown with HP H03-571B Digital Clock) is one of the most useful of a line of recorders featuring parallel entry that provides a permanent printed record of counter measurements. Low inertia moving parts allow printing rates as high as 5 lines/sec. A data storage feature allows transference of data in 2 msec. \$1600 approximately; page 115.



5260A

The HP 5260A Automatic Frequency Divider zero beats with input frequencies between 0.3 and 12.4 GHz automatically and without offset, and then provides an output frequency exactly equal to 1/100 or 1/1000 of the input frequency. Thus no tuning or harmonic computation are required, and the input frequency is displayed immediately and directly on an electronic counter. \$3450; page 582.

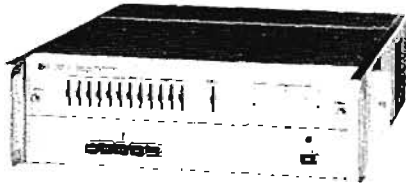

2515A

The HP 2515A Digital Scanner transmits digital data from up to six counters to one digital recording instrument. The scanner is compatible with the BCD outputs from all HP solid-state counters, data acquisition systems. The 2515A can operate in either sequential or random scanning modes with continuous scan, single scan or manual steps. \$4200 (3 sources, 12 digits per source); page 92.

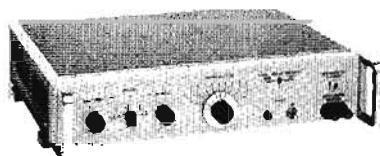

580A

The HP 580A, 581A Digital-to-Analog Converters accept 4 line BCD output for all HP solid-state counters. The analog output is available for galvanometer or potentiometer recorders. \$525; page 117.



2590B

The HP 2590B Microwave Frequency Converter is an all solid-state instrument with its chassis cast in one piece to completely eliminate troublesome R.F.I. The 2590B measures frequency to 15 GHz by phase-locking an internal transfer oscillator to the signal source. Measurement accuracy is equal to that of the counter time base. A search oscillator is provided to simplify phase locking. \$2150; page 580 (see also HP 540B, \$1050; page 581).

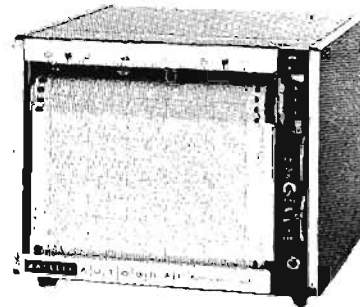

680A

The HP 680A strip chart recorder is a solid-state device with eight chart speeds, continuous zero set and a zener reference. The recorder may be used with a digital-to-analog converter to obtain permanent, visual records of counter measurements versus time. \$750; page 131.



2539A

The HP 2539A Digital Comparator compares BCD information against single or dual preset limits providing Go/No-Go lamp indications and electrical output. Comparisons take less than 2 msec. The 2539A provides all possible comparison conditions—combinations of relative sign and magnitude—encountered in measurement situations with counters. \$2600 for 6 digit and sign comparison; page 94.

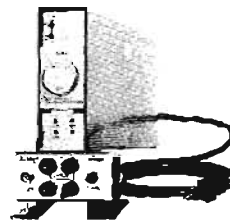

2212A

The HP 2212A Voltage-to-Frequency Converter transforms a dc input voltage to a proportional pulse rate output. The counter reads the average value of the signal over the sample period, thereby minimizing effects of noise and ripple. May be used to integrate analog signals over extended periods. \$995; page 243.



FREQUENCY CONVERTER

Measure frequency to 15 GHz at counter accuracy
Model 2590B

Model 2590B, in a single compact all-solid-state instrument, performs the functions of a transfer oscillator and a transfer oscillator synchronizer.

By phase-locking an internal transfer oscillator to the signal frequency, Model 2590B makes CW frequency measurements inherently equal to the accuracy of the external time base used, even on rapidly drifting signals. With the HP 5253B and 5245L or 5246L complete coverage is provided from dc to 15 GHz with attainable accuracy as high as 2 parts in 10^{10} . Permanently phase-locked, the signal frequency's drift may be tracked continuously over long periods.

The 2590B automatic phase-lock is augmented by an automatic search oscillator, to simplify synchronization at system set-up. An automatic gain control eliminates input level adjustments. The instrument incorporates a precision FM discriminator and an envelope detector, for observation and accurate measurement of FM deviation, deviation rate and signal amplitude modulation.

FM and other short-term frequency disturbances can be observed on an oscilloscope while phase-locked to the signal. For signals with carrier frequency sufficiently stable not to require phase-locking, accurate measurements of FM deviation and deviation rate may be made with the precision built-in discriminator. A separate output from the envelope detector provides for oscilloscope observation and measurement of signal AM, in either FM or phase-locked operating modes.

The carrier frequency of pulsed signals can be determined to well within ± 4 parts in 10^6 using the 2590B with an auxiliary oscilloscope. FM on the pulse also can be observed.

The 2590B is available as an individual instrument to be coupled by the user with a counter, or as part of a complete frequency measuring and recording system.

Specifications

Frequency range: 0.5 to 15 GHz. Optionally 12 to 18 GHz.

Signal input: minimum level, typically -30 dBm at 0.5 GHz, -40 dBm at 5 GHz, and -15 dBm at 15 GHz. With Option, -15 dBm from 12.4 to 18.0 GHz, typical.

Lock-on range: $\pm 0.15\%$ minimum of signal frequency over entire transfer oscillator range. Track mode increases lock-range to $\pm 0.35\%$ of signal frequency at 240 MHz end of transfer oscillator range, decreasing to $\pm 0.1\%$ at 390 MHz end.

Accuracy: \pm stability \pm resolution of measurement of transfer oscillator fundamental; stability, same as 10 MHz reference supplied; resolution, ± 1 count at transfer oscillator frequency, equivalent to 4.2 to 2.5 parts in 10^9 with 1 sec counter gate or 4.2 to 2.5 parts in 10^{10} with 10 sec gate over 240 to 390 MHz range.

External reference: 10 MHz, 0.1 V min. into 90 ohms.

FM measurements: discriminator characteristics when in FM mode: linearity (max. deviation from straight line through origin), better than $\pm 1\%$ over bandwidth of ± 500 kHz, better than $\pm 5\%$ over bandwidth of ± 2 MHz; video frequency response; 30 Hz to 1 MHz (3 dB points); center frequency, 30 MHz (nominal); sensitivity, 5 V/MHz ($\pm 5\%$); output impedance, 1.2 k ohm.

AM measurement: sensitivity, 200 mV p-p (nominal) for 100% modulation at 1 kHz; frequency response, 30 Hz to 1 MHz, load impedance, 10^6 ohms shunted by 12 pF max.

APC monitor: FM on signal may be monitored when in APC operating mode; sensitivity, ± 2 V minimum for frequency deviation of $\pm 0.25\%$; deviation limits, APC mode can follow frequency deviations to full lock-on range at rates up to 100 Hz; above 100 Hz, deviation decreases at 6 dB/octave; impedance, measuring device should have min. input impedance of 10^6 ohms, shunt capacitance not greater than 150 pF.

Transfer oscillator: fundamental frequency range, 240 to 390 MHz; drift, less than $5/10^4$ per hour immediately after turn-on, less than $1/10^5$ per hour after 3 hours' operation (oscillator automatically corrected for drift in APC mode); residual FM less than 10 Hz rms; dial, $2\frac{1}{4}$ " dia. calibrated in 5 MHz increments.

Power: 115/230 V $\pm 10\%$, 50 to 1000 Hz, approx. 35 W.

Operating conditions: ambient temperatures 0 to 55°C, relative humidities to 95% at 40°C.

Dimensions: $16\frac{3}{4}$ " wide, $3\frac{1}{2}$ " high, $16\text{-}5/16$ " deep behind panel (426 x 86 x 414 mm); instrument is fully enclosed for use on bench; may be mounted in 19" rack with side extensions to panel (furnished).

Weight: net 23 lbs (10.4 kg); shipping 30 lbs (13.6 kg).

Price: Model 2590B, \$2150.

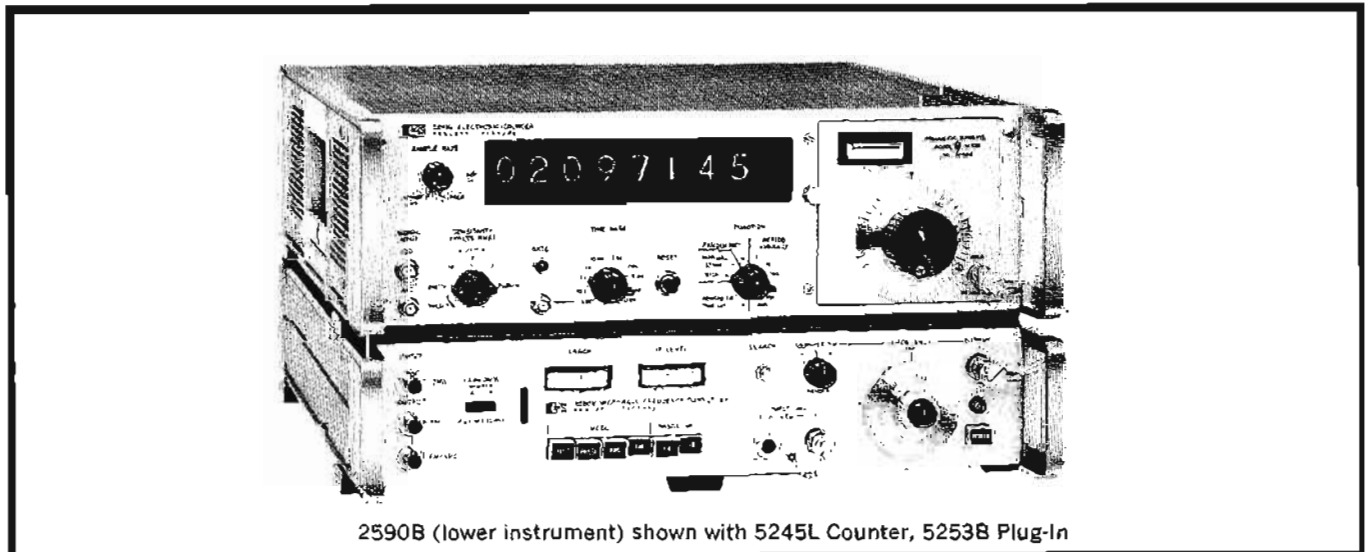

2590B (lower instrument) shown with 5245L Counter, 5253B Plug-In

TRANSFER OSCILLATOR

Measure to 18 GHz with counter accuracy
Model 540B



FREQUENCY

USES:

- Measure frequency to 12.4 GHz with the 540B Transfer Oscillator plus an electronic counter.
- Add a P932A Harmonic Mixer and measure frequency to 18 GHz.
- Measure frequency of FM signals.
- Determine FM deviation.
- Measure signal frequency of pulsed signals.

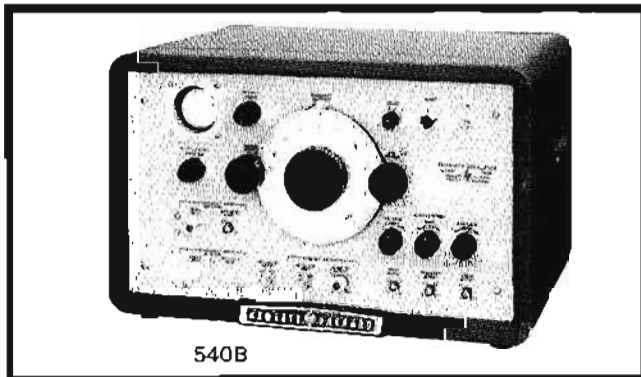

540B

The HP Model 540B Transfer Oscillator provides a straightforward means of extending the frequency measurement range of many Hewlett-Packard Electronic Counters. It makes possible a completely flexible frequency measuring system for laboratory or industrial use. Adding the HP P932A Harmonic Mixer to the system further extends the frequency measuring range to 18 GHz.

The P932A mounts directly in the waveguide system and operates with the counter, mixing generated harmonics with the unknown microwave frequency. The mixer's beat frequency output is applied to the 540B. The measuring procedure is the same as the procedure using the 540B's internal mixer.

The system's accuracy approaches that of the electronic counter on clean cw signals. On pulsed signals, accuracy is governed by carrier frequency and pulse length. On noisy or intense AM signals, the transfer oscillator system with the 540B often provides the only means of accurate measurement. Overall system accuracy is greater than 10 times that of the best microwave wavemeters.

A direct-coupled reactance control circuit in the 540B allows the oscillator to be locked at a sub-multiple of the measured frequency when it is desirable to measure automatically or record drift characteristics of microwave signal sources.

Model 540B may be used with the following:

- HP 5245L, 5245M, or 5247M Electronic Counters with either a 5253A Frequency Converter or 5252A Prescaler;
- HP 524 Series Electronic Counter with either 525B or 525C Frequency Converter; 5246L Electronic Counter.

Specifications

- Frequency range:** 10 MHz to 12.4 GHz.
- Input signal:** cw, FM, AM or pulse.
- Input signal level:** varies with frequency and individual crystals. (See chart, upper right.)
- Accuracy:** cw; approximately 1 part in 10^7 or better.

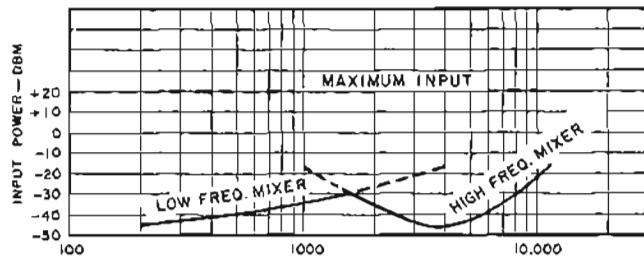

INPUT FREQUENCY — MHz; 0 REF = 1 mW Into 50 ohms.

Oscillator

Fundamental frequency range: 100 MHz to 220 MHz.

Harmonic frequency range: above 12.4 GHz.

Stability: <0.002% change per minute after 30-minute warm-up.

Dial: six-inch diameter, calibrated in 1 MHz increments; accuracy, $\pm 0.5\%$.

Output: approximately 2 V into 50 ohms.

Amplifier

Gain: adjustable, 40 dB max.

Bandwidth: variable; high frequency: 3 dB point adjustable approximately 1 kHz to 2 MHz; low frequency: 3 dB point switched from 100 Hz to below 10 kHz, then continuously adjustable to above 400 kHz.

Output: 1 V rms maximum into 1000 ohms.

Internal oscilloscope

Frequency range: 100 Hz to 200 kHz.

Vertical deflection sensitivity: 5 mV rms per inch.

Horizontal sweep: internal, power supply frequency with phase control, or external (connection at rear) with 1 V per inch, 20 Hz to 5 kHz.

General

Size: cabinet: 20 $\frac{3}{4}$ " wide, 12 $\frac{1}{2}$ " high, 15 $\frac{1}{4}$ " deep (527 x 318 x 387 mm); rack mount: 19" wide, 10 $\frac{1}{2}$ " high, 14 $\frac{1}{4}$ " deep behind panel (483 x 267 x 362 mm).

Weight: net 42 lbs (19 kg), shipping 51 lbs (23 kg) (cabinet); net 35 lbs (15.9 kg), shipping 48 lbs (21.7 kg) (rack mount).

Power: 115 or 230 V $\pm 10\%$, 50 to 1000 Hz, approx. 110 W.

Accessories furnished: 10503A Cable Assembly, 4' (1219 mm) long, BNC-to-BNC; a 6" jumper cable (BNC-to-BNC) is included for use between jacks on front panel.

Price: HP 540B, \$1050 (cabinet); HP 540BR, \$1050 (rack mount).

Auxiliary equipment

5245L, 5245M, 5247M, 5246L Electronic Counters (pages 551 through 557).

5252A Prescaler (page 562).

5253B Frequency Converter (page 558).

130C Oscilloscope (page 456) or other suitable Oscilloscope.

P932A Mixer, 12.4 to 18 GHz. \$250.



AUTO FREQUENCY DIVIDER

Extends automatic counting range to 12.4 GHz
Model 5260A

Advantages

- Automatic measurement, 0.3 GHz to 12.4 GHz
- Direct readout, no calculations or offset
- Maintains counter accuracy
- Essentially constant 100 mV sensitivity

Automatic measurement and direct readout of an unusually wide range of CW microwave frequencies can now be achieved using the HP Model 5260A with a suitable electronic counter. The 5260A divides input signals in the 300 MHz to 12.4 GHz frequency range by 100 or 1000 to provide an output signal in the 1 MHz to 12.4 MHz frequency range. Measurements are rapid and simple, with accuracy the same as for basic counter measurements, the frequency being displayed directly on the electronic counter. There is no ambiguity or offset, and no calculations are needed. Except for selecting the proper division ratio, ALL TUNING IS AUTOMATIC AND NO ADJUSTMENTS BY THE OPERATOR ARE REQUIRED TO OBTAIN THE CORRECT OUTPUT READOUT.

Suitable Electronic Counters (No plug-ins required)

- HP 5245L, 5245M (see page 552, 554)
- HP M07-5245L or M07-5245M (see Option 02)
- HP 5246L (see page 551)
- HP 5244L (see page 563)
- HP 5247M (see page 557)

Measuring dc to 12.4 GHz

A system for rapid, automatic, direct readout of frequencies from dc to 12.4 GHz can be assembled by combining an HP 5245L, 5245M, 5247M or 5246L Electronic Counter (dc to 50 MHz), 5252A Prescaler Plug-in (dc to 350 MHz), and 5260A Automatic Frequency Divider (300 MHz to 12.4 GHz). It is only necessary to select the frequency range desired and read the electronic counter readout; no tuning or calculations are required. Note, however, that the 5252A Prescaler is NOT required for operating the counters from the 5260A. The 5252A Prescaler is only necessary for measurements within the frequency range 50 MHz (135 MHz in 5247M) to 300 MHz.

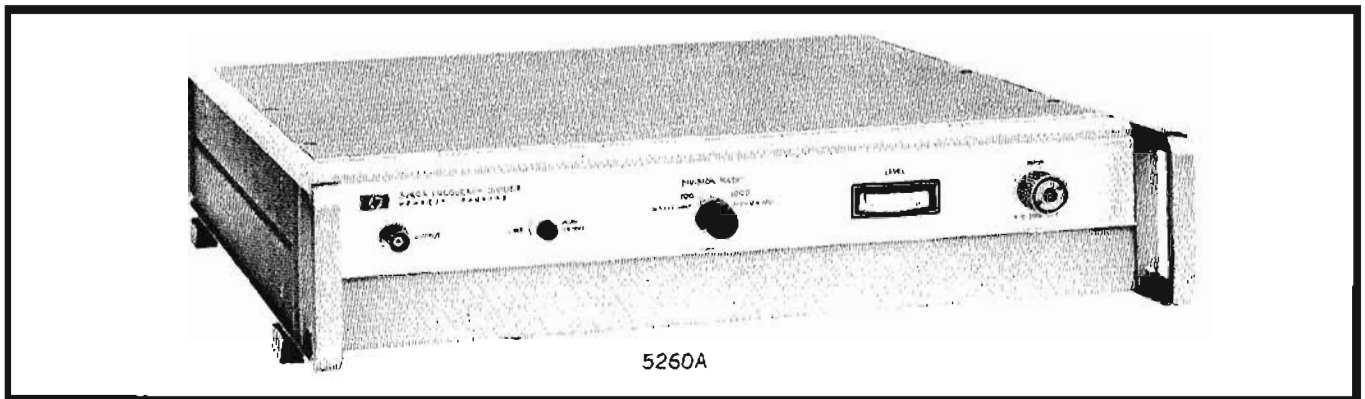

Specifications

Range: 0.3 to 12.4 GHz.

Accuracy: retains accuracy of electronic counter.

Input sensitivity: 100 mV rms (-7 dBm).

Input impedance: 50 ohms nominal.

Freq.	Input VSWR	
	Typical	Max.
0.3-8 GHz	1.2:1	1.4:1
8-10 GHz	1.4:1	1.6:1
10-12.4 GHz	1.8:1	2:1

Maximum input: +10 dBm.

Level indicator: front panel meter indicates approximate input level, -10 dBm to +10 dBm.

Division ratio: front panel switch selects $\div 100$ (for use up to 1.2 GHz) or $\div 1000$ (from 1 to 12.4 GHz) operation.

Input connector: precision Type N female.

Operation: completely automatic once the DIVISION RATIO switch is positioned.

Output frequency: 1/100 or 1/1000 of input (1 to 12.4 MHz).

Output impedance: designed for 50 ohm (or higher impedance) load.

Output level: 0 dBm, nominal AGC.

Registration: input frequencies from 0.3 to 12.4 GHz are measured by measuring the 5260A output with an electronic counter such as the HP 5245L, 5245M, 5247M, 5246L or 5244L, and suitably positioning the decimal point. Readout is direct with no offset, ambiguity, or arithmetic processing. See also Option 02, below.

Measurement time: set by electronic counter gate time.

Power supply: 115 or 230 V $\pm 10\%$, 50 to 60 Hz, 47 watts (52 watts with Option 2). Other frequencies on special order.

Weight: net 29 lbs (13.2 kg); shipping 33 lbs (15 kg).

Dimensions: 16 $\frac{3}{4}$ " wide, 3-15/32" high, 16 $\frac{3}{8}$ " deep (425 x 88 x 416 mm).

Price: Model 5260A Automatic Frequency Divider, \$3,450.

Options:

01. Amphenol APC-7 Input Connector, add \$25.
02. Provides 5260A with circuitry such that, when used with the HP Model M07-5245L or M07-5245M Electronic Counter, the decimal point will be automatically positioned for readout in GHz, and the symbol "GHz" will appear in the counter's readout. Readout is inhibited and displays all zeros unless an adequate input signal is present. Add \$175.

FREQUENCY METER

Wideband, highly linear FM Discriminator
Model 5210 A/B



FREQUENCY

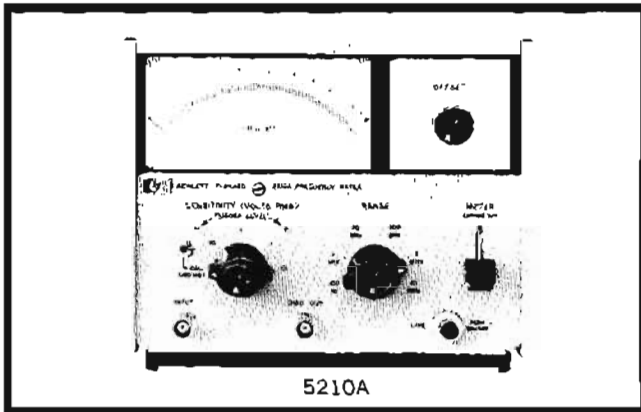

The Model 5210A Frequency Meter/FM Discriminator directly measures frequency or repetition rate of signals from 3 Hz to 10 MHz, independent of input voltage waveform. A sensitivity control allows for measurement of noisy signals. The special log linear scale offers an accuracy of 1% of reading from 10% of full scale up. With calibrated offset (Option 01) the effective accuracy is up to 0.2% of full scale range.

The 5201A is also a wideband highly linear FM Discriminator with a 3 dB output bandwidth of better than 1 MHz for precise measurements on FM and PM signals. With output filters (HP 10531A) frequency deviation, modulation index, frequency response, distortion, incidental FM, and FM noise can be determined as well as "flutter" and "wow" to better than 100 dB below carrier frequency.

The 5210B is particularly well suited for tachometry work with calibration directly in rpm.

Specifications, 5210A

Frequency range: 3 Hz to 10 MHz in six decade ranges from 100 Hz full scale to 10 MHz full scale.

Expanded scale: with a continuously adjustable OFF-SET control, meter and recorder output display any 10% of full scale expanded to full scale.

Sensitivity: maximum sensitivity of 10 mV rms from 20 Hz to 10 MHz increasing to 200 mV at 3 Hz with four attenuator ranges of 0.01, 0.1, 1.0 and 10 V.

Input impedance: 1 M Ω shunted by 30 pF; used with HP 10003A 10:1 divider probe 10 M Ω shunted by 10 pF.

Accuracy:

Discriminator output current: 0.2% of reading below 1 MHz, 0.3% of reading on 10 MHz range.

Meter: 1% of reading from 10% of full scale to full scale.

Expanded scale: 0.1% of full scale for differential frequency readings.

Calibration: crystal calibration oscillator at 100 kHz accurate to $\pm 0.01\%$.

Line voltage and frequency: changes in line voltage of $\pm 10\%$ and frequency of 50-1000 Hz cause less than 0.05% change in output.

Temperature: frequency reading changes less than 0.02%/°C 100 Hz to 1 MHz ranges, 0.04%/°C 10 MHz range from 0 to +55°C.

Recorder output:

Level: potentiometer outputs of 10 mV and 100 mV, adjustable from 9 mV to 11 mV and 90 mV to 110 mV for full scale; galvanometer output 1 mA into 2 k Ω max for full scale. Adjustable $\pm 10\%$ for 1 k Ω to 2 k Ω loads.

Linearity: 0.025% of full scale 100 Hz to 100 kHz ranges;

0.05% of full scale 1 MHz range; 0.1% of full scale to 10 MHz range.

Accuracy: same as discriminator output current above.

Time constant: approximately 100 ms.

Discriminator output:

Level: adjustable 0.8 to 1.2 V for full scale.

Linearity: 0.025% of full scale 100 Hz to 100 kHz ranges, 0.05% of full scale 1 MHz range, 0.1% of full scale 10 MHz range.

Bandwidth: 3 dB down at greater than 1 MHz.

Residual FM noise: rms line frequency components below 300 Hz are 100 dB below the 1 V full scale output. At other frequencies the rms noise deviations are at least 120 dB below the carrier frequency when the noise is measured in a 6 Hz bandwidth.

Power requirements: 115 or 230 V ac $\pm 10\%$ 50-1000 Hz at less than 10 W.

Dimensions: 7-25/32" wide, 6-3/32" high and 11" deep; (190 x 155 x 279 mm).

Weight: net, 8 $\frac{3}{4}$ lbs (4 kg); shipping, 10 $\frac{1}{2}$ lbs (4.8 kg).

Price: HP 5210A \$575; Option 01 add \$125; HP 1053A \$175.

Option 01, Calibrated Offset

General: the calibrated offset provides for display of any of the 10 major divisions on a separate full meter scale (the EXPAND scale). This allows frequency measurements to be made with higher accuracy than is possible using the meter in the NORMAL mode.

Discriminator output: same as above except bandwidth is 3 dB down at greater than 750 kHz.

Accuracy: 0.2% of full scale (range switch setting) for 100 Hz to 1 MHz ranges; 0.3% of full scale (range switch setting) for the 10 MHz range.

Temperature: the accuracy specification is increased by 0.01%/°C of reading on the 100 Hz to 1 MHz ranges and 0.03%/°C of reading on the 10 MHz range from 0°C to 55°C for deviations from 25°C when zero and self-calibration adjustments are made at the ambient temperature.

Price: add \$125 to price of 5210A/B.

HP 10531A, Filter Kit

General: the HP 10531A Accessory Filter Kit provides a series of three plug-in low pass filters which can be adjusted to cover frequencies from 100 Hz to 1 MHz. These filters provide rejection of carrier and carrier harmonics while passing modulation components. Thus it is possible to measure demodulated signal components up to 20% of the carrier frequency using the HP 302A or 310A Wave Analyzers or similar narrow band voltmeters on their most sensitive ranges. By lowering filter cut-off frequency or in case of wide deviation signals measurements may be made using less selective voltmeters or other instruments.

Frequency range: the upper cut-off frequency can be adjusted from 100 Hz to 1 MHz. The lower cut-off frequency will vary up to 10 Hz, depending on load resistance used with the filter.

Carrier rejection: with the output filter the carrier and its harmonics are less than 30 mV rms total when the filter cut-off is less than 15% of the carrier frequency and drops to 1.0 mV maximum for filter cut-off frequencies less than 5% of the carrier frequency.

Output impedance: nominal 600 Ω . However, matched loads are not required.

Output impedance: nominal 600 Ω . However, matched loads are at discriminator output.

Price: HP 10531A \$175.

Specifications, 5210B

Model 5210B frequency meter is identical in construction and circuitry to 5210A but is calibrated in rpm for greater convenience in tachometry applications.

Speed range: 6000; 60,000; 600,000; 6,000,000 (CAL position) rpm.

Maximum resolution: 6 rpm.

Price: HP 5210B, \$570.

FREQUENCY



METERS; TRANSDUCERS

Measure frequency, 3 Hz to 100 kHz

Models 500B,C; 506A; 508A,B,C,D

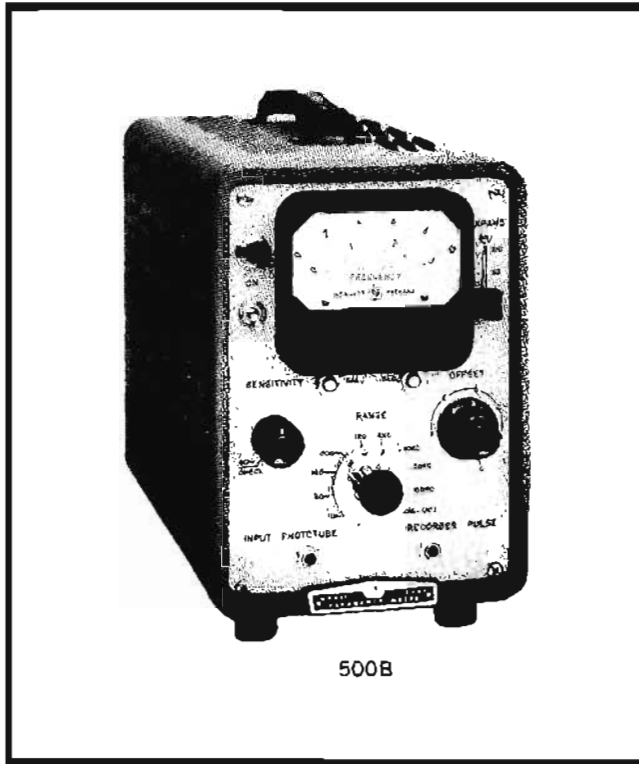

500B

The HP Model 500B directly measures the frequency of an alternating voltage from 3 Hz to 100 kHz. Suitable for laboratory and production measurements of audio and ultrasonic frequencies, it also is useful for direct tachometry measurements with a transducer such as HP 506A or 508A,B,C,D.

Readings on the 500B and 500C are not affected by variations of input signal level or power line voltage. The meter will count sine waves, square waves or pulses and will indicate the average frequency of random events. Provision is made for checking the calibration against power line frequency and to operate a recorder for a continuous frequency record or x-y plot.

Specifications, 500B

Frequency range: 3 Hz to 100 kHz, 9 ranges in 10, 30, 100 sequence.

Expanded scale: allows any 10% or 30% portion of a selected range to be expanded to full meter scale (except 10 Hz range).

Input voltage: sensitivity: 0.2 V rms minimum for sine waves, +1 V peak minimum for pulses; maximum, 250 V peak; sensitivity control reduces threshold sensitivity.

Input impedance: approx. 1 M Ω shunted by 40 pF BNC connector for input.

Accuracy: better than $\pm 2\%$ of full scale (unexpanded); reading affected less than 0.5% by $\pm 10\%$ variation from nominal line voltage; expanded scale $\pm 0.75\%$ of range switch setting.

Output linearity: (relation of input frequency to output current at the external meter jack): on 100 kHz range, within approx. $\pm 0.25\%$ of full-scale value; other ranges, $\pm 0.1\%$ of full-scale value.

Recorder output: 1 mA for full-scale deflection into 1400 $\pm 100\Omega$.

Pulse output: to trigger stroboscope, etc., in synchronism with input signal; to measure FM.

Photocell input: phone jack on panel provides bias for Type 1P41

Phototube; allows direct connection of 506A Tachometer Head.

Power: 115 or 230 V $\pm 10\%$, 50 to 1000 Hz, 110 W.

Dimensions: cabinet: 7 $\frac{1}{2}$ " wide, 11 $\frac{1}{2}$ " high, 14 $\frac{1}{2}$ " deep (191 x 292 x 368 mm); rack mount: 19" wide, 7" high, 13" deep (483 x 178 x 330 mm).

Weight: net 17 lbs (8 kg), shipping 19 lbs (9 kg) (cabinet); net 20 lbs (9 kg), shipping 30 lbs (14 kg) (rack mount).

Accessory furnished: 10501A Cable.

Accessories available: 506A Optical Tachometer, \$195; 508A, B,C,D Tachometer Generators, \$125 each; 500B-95A Accessory Meter for remote indication (operates from recorder jack), \$55.

Price: HP 500B, \$335 (cabinet); HP 500 BR, \$335 (rack mount).

Specifications, 500C

Model 500C Frequency Meter is identical in construction and circuitry to 500B but is calibrated in rpm for greater convenience in tachometry applications.

Speed range: 180 rpm (15 rpm with multiplying transducer) to 6,000,000 rpm, 9 ranges.

Accessory available: 500C-95A Accessory Meter, \$55

Price: HP 500C, \$345 (cabinet); HP 500CR, \$345 (rack mount).

506A Optical Tachometer

Model 506A is a light source and photocell for use as a transducer with instruments such as HP 521 Series Electronic Counters, HP 500B Electronic Frequency Meter and HP 500C Electronic Tachometer Indicator.

Specifications, 506A

Range for direct reading: 1 to 5000 rps with 521 Series; 3 to 5000 rps with 500B; 180 to 300,000 rpm with 500C; lower speed may be measured by using a multisegment reflector.

Output voltage: at least 1 V rms, 300 to 100,000 rpm (into 1 M Ω or more impedance) with reflecting and absorbing surfaces $\frac{3}{4}$ " square.

Light source: 21 candlepower, 6 V automotive bulb.

Phototube: Type 1P41.

Phototube bias: +70 to +90 V dc (supplied by 500B,C 521).

Power: 115 or 230 V $\pm 10\%$, 50 to 1000 Hz, 25 W.

Dimensions: 22" high, 11" wide maximum (559 x 279 mm).

Weight: net 10 lbs (5 kg); shipping 17 lbs (8 kg).

Accessories available: 56A-16B Adapter Cable (connects 506A to 522B Counter), \$40.

Price: HP 506A, \$195.

508 Tachometer Generators

Models 508A,B,C,D Tachometer Generators are rotational speed transducers for use with electronic counters or frequency meters in making fast, accurate rpm measurements, 15 to 40,000 rpm. They are specifically designed to operate with Hewlett-Packard electronic counters and frequency meters.

Specifications, 508 Series

Shaft speed range: 508A, 15 to 40,000 rpm; 508B, 30 to 30,000 rpm; 508C, 40 to 25,000 rpm; 508D, 50 to 5000 rpm.

Output frequency: 508A, 60 cycles/rev.; 508B, 100 cycles/rev.; 508C, 120 cycles/rev.; 508D, 360 cycles/rev.

Drive shaft: $\frac{1}{4}$ " diameter, projects 19/32".

Running torque: approx. 0.15 in-oz; 0.5 in-oz at 1500 rpm.

Peak starting torque: approximately 4 in-oz.

Dimensions: 2-7/16" high, 3 $\frac{1}{2}$ " wide, 3 $\frac{3}{4}$ " deep (62 x 89 x 95 mm).

Weight: net 2 lbs (1 kg); shipping 3 lbs (1 kg).

Price: HP 508A,B,C,D, \$125 each.

FREQUENCY METERS

For general-purpose or lab use
Models 532A/B, 536A, 537A



FREQUENCY

Advantages

- High resolution, easy-to-read dial
- Direct reading
- Broadband
- Accuracy specified over 20°C and 0 to 100% relative humidity

These direct-reading frequency meters allow you to measure frequencies from 3.95 to 40 GHz in waveguide and from 960 MHz to 12.4 GHz in coax quickly and accurately. Their long scale length and numerous calibration marks provide a high resolution which is particularly useful when measuring frequency differences or small frequency changes. Frequency is read directly in GHz so no interpolation or charts are required.

The instruments comprise a special transmission section with a high-Q resonant cavity which is tuned by a choke plunger. A 1 dB or greater dip in output indicates resonance; virtually full power is transmitted off resonance. Tuning is by a precision lead screw, spring-loaded to eliminate backlash. Resolution is enhanced by a long, spiral scale calibrated in small frequency increments. For example, Model X532B has an effective scale length of 77 inches (1956 mm) and is calibrated in 5-MHz increments. Resettability is extremely good, and all frequency calibrations are visible so you can tell at a glance the specific portion of the band you are measuring. Except for the J532A, there are no spurious modes or resonances. (See note 4 below.)

Specifications, 532A,B, 536A and 537A

HP Model	Frequency range (GHz)	Dial accuracy (%)	Overall accuracy ¹ (%)	Calibration Increment (MHz)	Price
536A	0.96-4.20	0.10 ²	0.17 ³	2	\$550
537A	3.7-12.4	0.10	0.17	10	\$550
G532A	3.95-5.85	0.033	0.065	1	\$400
J532A	5.30-8.20 ⁴	0.033	0.065	2	\$375
H532A	7.05-10.0	0.040	0.075	2	\$325
X532B	8.20-12.4	0.050	0.08	5	\$200
M532A	10.0-15.0	0.053	0.085	5	\$350
P532A	12.4-18.0	0.068	0.10	5	\$275
K532A ⁵	18.0-26.5	0.077	0.11	10	\$350
R532A ⁵	26.5-40.0	0.083	0.12	10	\$400

¹ Includes allowance for 0 to 100% relative humidity, temperature variation from 13 to 33°C, and backlash.

² 0.15, 0.96 to 1 GHz.

³ 0.22, 0.96 to 1 GHz.

⁴ Because of the wide frequency range of the J532A, frequencies from 7.6 to 8.2 GHz can excite the TE₁₁₂ mode when the dial is set between 5.3 and 5.6 GHz.

⁵ Circular flange adapters: K-band (UG-425/U) 11515A, \$35 each; R-band (UG-381/U) 11516A, \$40 each.

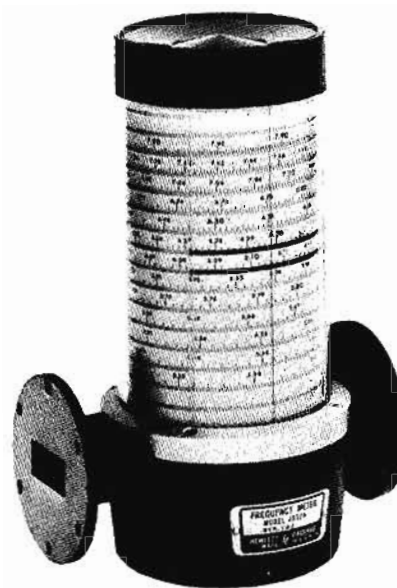

G532A

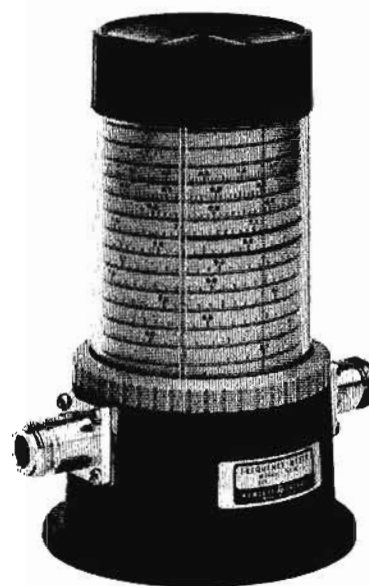

537A



Hewlett-Packard offers Frequency & Time Standards systems which provide accurate frequencies, time intervals and time-keeping capabilities. Further, Hewlett-Packard systems provide means for comparing these quantities against national standards such as the National Bureau of Standards (NBS). Units of frequency or time cannot be kept in vault for ready reference. They must be generated for each use, hence must be regularly compared against recognized primary standards.

Frequency and Time Standard systems manufactured by Hewlett-Packard are used for control and calibration at observatories, national centers for measurement standards, physical research laboratories, missile and satellite tracking stations, manufacturing plants and radio monitoring and transmitting stations. System applications include the following:

Distributed standard frequencies in factories or research facilities ("house standards"), controls of standard frequency, time standard broadcasts, synchronization of electronic systems for navigation, investigation of radio propagation phenomena, frequency synthesis, control, and adjustment of single side-band communication equipment.

Four performance characteristics are of vital interest to users of frequency and time measurement equipment and standards: accuracy, precision, stability and reliability. Hewlett-Packard systems offer these four in ample measure, plus operational simplicity. Hewlett-Packard has devoted the efforts of an entire division to the continual improvement and innovation necessary to keep in the forefront of frequency and time measurements and standards.

Types of frequency standards

At the present time, four types of frequency standards are in common use. These are:

1. The atomic hydrogen maser.
2. The cesium atomic beam controlled oscillator.
3. The rubidium gas cell controlled oscillator, and
4. The quartz crystal oscillator.

Of these four standards, the first two are referred to as primary frequency standards and the last two as secondary frequency standards. The distinction between a primary standard and a secondary standard is that the primary standard does not require any other refer-

ence for calibration; whereas the secondary standard requires calibrations both during manufacturing and during use as well as at certain intervals depending upon the stability desired. At the present time Hewlett-Packard is manufacturing three of these four types of frequency standards. The models are for the hydrogen maser, the HP Model H-10, for the cesium beam frequency standard, the HP Model 5061A, and for the quartz crystal oscillators, the HP Models 105A and B, 106A and B, and 107AR and BR. Table 1 gives a summary of the advantages and limitations for these four types of frequency standards. In the following paragraphs we shall give more detailed description of the hydrogen maser, the cesium beam frequency standard and quartz crystal oscillators.

being reflected upon each encounter with the walls. During this interaction process within the bulb, the atoms tend to relax and give the energy up to the microwave field within the tuned cavity. This field also tends to stimulate more atoms to radiate, thus building in intensity until steady state maser operation is achieved. However, some atoms relax unproductively due to collisions with the wall, magnetic inhomogeneity or other hydrogen atoms. Some atoms also escape through the bulb opening. Although the atoms undergo many collisions while in the bulb, their effective interaction time has been lengthened to more than 1 second. Perfecting these techniques, the extremely sharp resonance frequency has led to a Q approaching 10^9 . The low power level of approximately 10^{-12} watts

TABLE 1
Sources of Advantages and Limitations for Frequency Standards

Standard	Principal construction feature	Principal advantage	Principal limitation
Atomic Hydrogen Maser	Active maser with coated wall storage cell having longest atomic interaction time	Greatest intrinsic reproducibility, long and short-term stability. Primary standard capability	Size and weight
Cesium Atomic Beam Resonator Controlled Oscillator	Atomic beam interaction with fields—minimum disturbance of resonating atoms due to collisions and extraneous influences	High intrinsic reproducibility and long-term stability. Designated as primary standard for definition of time interval	Short-term stability
Rubidium Gas Cell Resonator Controlled Oscillator	Gas buffered resonance cell with optically pumped state selection	Very compact and light weight. Very high degree of short-term stability	Requires calibration against primary standard
Quartz Crystal Oscillator	Piezoelectrically active quartz crystal with electronic stabilization	Very compact, light and rugged. Inexpensive	Long term stability. Requires calibration against primary standard

Atomic hydrogen maser

Figure 1 gives a schematic diagram of an atomic hydrogen maser. A beam of atomic hydrogen is directed through a highly inhomogeneous magnetic field which acts to select atoms in states of higher energy from those in states of lower energy and allows them to proceed into the quartz bulb. The quartz bulb is enclosed in a tuned microwave cavity set to the transition frequency of the hydrogen atom between the $F=1, m_F=0$ and $F=0, m_F=0$ energy levels. The quartz bulb has teflon coated walls to reduce perturbation of the important energy states.

Inside the coated storage bulb, the hydrogen atom makes random transits.

require that considerable amplification be used to obtain a useful standard frequency.

Figure 2 shows a block diagram of a complete hydrogen maser. It illustrates how a slave oscillator is phase locked to the maser. The Hewlett-Packard Model H-10 Hydrogen Maser does not supply this phase lock system. It only supplies the maser frequency of 1.4204 MHz at a very low output level, namely $5\mu\text{V}$ across 50Ω . It is left up to the user to arrange for the phase lock system externally to the hydrogen maser. By doing this, the output provided is essentially independent of any quartz oscillator and its inherent instabilities. Maximum long term fractional frequency excursion in-

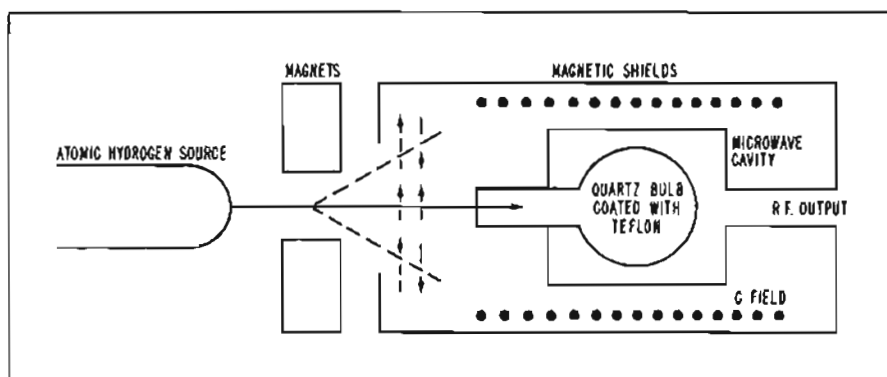

Figure 1. Atomic hydrogen maser diagram

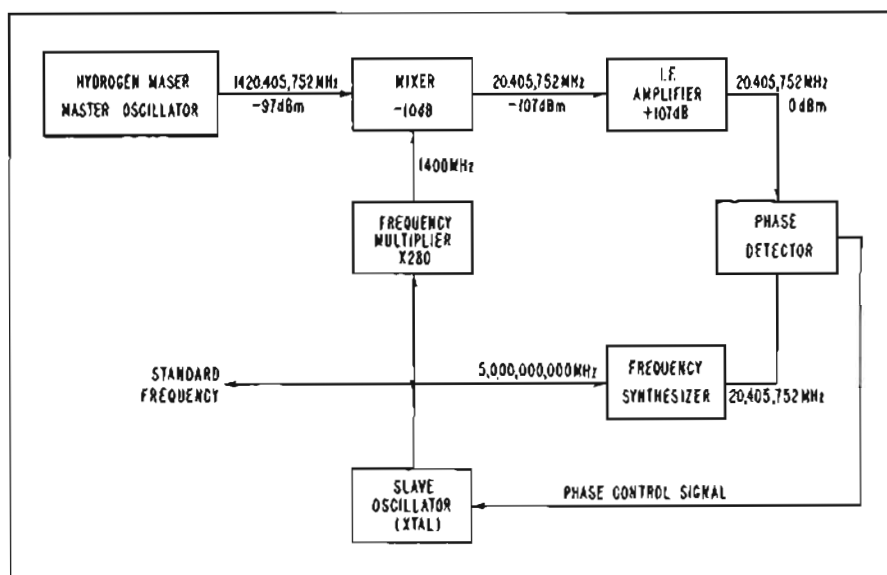

Figure 2. Hydrogen maser block diagram

ard H-10 Hydrogen Maser is 2×10^{-12} . During observations of two hydrogen masers extending over a period of one year no long term drift of one with respect to the other has been detected. Measurement resolution during this period was better than 1 part in 10^{12} . The short term stabilities for averaging intervals of 10 seconds is better than 1 part in 10^{11} rms.

Cesium beam frequency standard

Cesium beam standards are in use wherever the goal is very high accuracy primary frequency standard. In fact, the NBS frequency standard itself is of the cesium beam type. The cesium beam standard is an atomic resonance device which provides access to one of nature's invariant frequencies in accordance with the relationship of quantum mechanics. The cesium standard is a true primary standard and requires no other reference for calibration.

Atomic frequency standards are based on the frequency, ν , corresponding to a

transition between two atomic states separating the energy by ΔE :

$$\Delta E = h\nu,$$

where h is Planck's constant. Common to atomic standards are means for 1) selecting atoms in a certain energy state, 2) enabling long lifetimes in that state, 3) exposing these atoms to (microwave) energy, and 4) detecting the results.

For the cesium beam standard, the quantum effects of interest arise in the

nuclear magnetic hyperfine splitting of the ground state of the atoms. The transition described as $(F=4, m_F=0) \leftrightarrow (F=3, m_F=0)$ is observed.

The HP Model 5061A is a portable cesium beam standard proved capable of realizing the cesium transition frequency to the same levels of accuracy and long-term stability usually achieved by large-scale laboratory models.

The 5061A operates to keep an ultra stable quartz oscillator precisely "on frequency" via servo-control that refers, ultimately, to the center of the atomic resonance. The output signal is derived from the quartz oscillator, the cesium beam tube serves as its reference—and the two are linked by circuitry that includes means to adjust the frequency of the quartz oscillator to automatically compensate for its aging or drift.

A simplified sketch of the beam tube is shown in Figure 3.

It is possible to accelerate cesium atoms by a force dependent on the applied magnetic field gradient together with the atom's magnetic dipole moment. Thus cesium atoms can be sorted and focused by passing a beam of them through a magnetic field having a high gradient ("A" magnet). Atoms in the quantum state of interest are directed down the beam tube and others are deflected away. These selected atoms then drift through a space where the field ("C" field) is kept low (typically, about 50 milligauss) and uniform and are subjected to microwave radiation corresponding to just the frequency which separates the two energy levels. The atoms flop from one energy state to the other; and those which have made the transition in the desired direction are selected and directed by a second field ("B" magnet) onto a detector.

Now, the maximum signal means that the maximum number of transitions are occurring, which indicates that the injected microwave energy is of precisely the transition frequency. The oscillator which is the source of this energy is therefore known to be operating at a frequency directly related to the transition

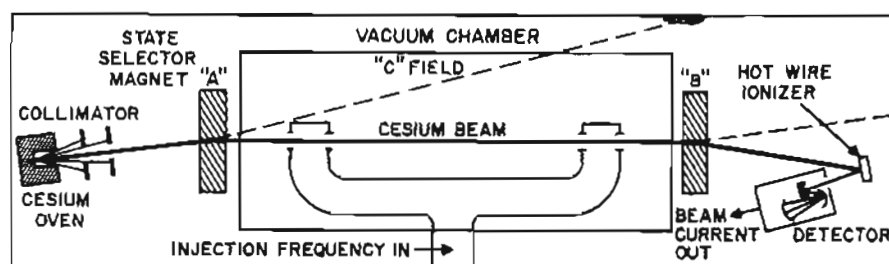

Figure 3. Schematic of cesium beam resonator

frequency. A constant of the atom has been made the frequency reference.

Quartz crystal oscillators

The modern era of precision frequency control was initiated in the 1920's when the quartz crystal resonator was first applied in the construction of frequency oscillators. Its use in instruments for the generation and measurement of precision frequencies is now universal in national and industrial laboratories of the world. Today, the most exacting uses demand atomic resonance control. Nonetheless, quartz crystal oscillators remain the workhorses of virtually every frequency control application.

When used to control an oscillator, a quartz resonator is mounted between conducting electrodes, usually thin metallic (gold) coatings deposited directly on the crystal by evaporation. Mechanical support is provided at places on the crystal chosen to avoid any inhibition of the desired vibration and if possible such that unwanted vibration modes are suppressed. Advantage is taken of the piezoelectric effect that links mechanical vibrations and electrical effects in certain crystals. An alternating voltage at a selected natural frequency applied across a properly cut quartz crystal causes it to vibrate. This crystal resonator behaves as though it were an electrical network and can be made to impose its own frequency upon an oscillator circuit.

An inherent characteristic of crystal oscillators is that their resonant frequency changes slightly as they age. This "aging rate" or "drift" of a well-behaved oscillator is almost constant. After the initial aging period (a few days to a month) the rate can be taken to be constant with but slight error. Once the rate is measured, it is usually easy to correct data to remove its effect. Over a long period, the accumulated error drift could amount to a serious error. Thus, periodic frequency checks are needed to maintain a quartz crystal frequency standard. (The cesium beam standard, on the other hand, has no known drift.)

Hewlett-Packard offers the Models 105A/B Quartz Oscillators rated at 5 parts in 10^{10} per day long term stability, the HP Models 106A/B rated at 5 parts in 10^{11} per day long-term stability, and the ruggedized HP Models 107AR/BR, rated at 5×10^{10} per day. Such exceptional stability (and, substantially better performance is attained under normal operating conditions) results from careful attention to all controllable factors such as selection of the highest quality crystals, their operation in precision temperature controlled ovens, and their incorporation into inherently stable circuits designed for low power dissipation within the crystal.

Spectral purity

A frequency standard must provide a stable, spectrally pure signal if it is to yield a narrow spectrum after multiplication to the microwave region. Even a crude oscillator will have a reasonably good spectrum at the frequency of oscillation. The spectrum rapidly degrades with frequency multiplication, however.

Hewlett-Packard quartz oscillators are designed to produce exceptional spectral purity. They give spectra only slightly degraded even after high multiplication.

Figure 4 shows a noise spectrum plot for the HP 106A/B Quartz Oscillator (see HP Application Note 52, "Frequency and Time Standards", page 5-3 for details of this noise measurement).

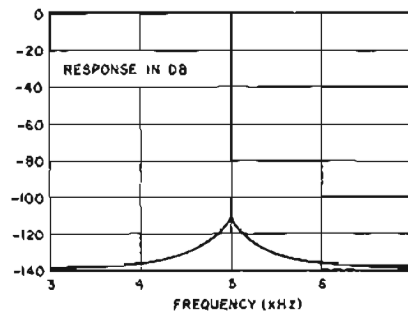

Figure 4. Spectrum of a 5 kHz beat note at 9.2 GHz; comparison of two HP 106A,B Oscillators.

Frequency standards and clocks

Time standards and frequency standards have no fundamental differences—they are based upon dual aspects of the same phenomenon. The reciprocal of time interval is frequency. Frequency measurements are measurements of the number of cycles—counted one by one—per time interval (second). For precision oscillators, a complete statement of frequency must include the time scale in use, so that the exact length of the time interval is specified.

As a practical matter, to maintain a time standard places stringent additional requirements upon a frequency standard. A clock is a device for counting cycles. The time it keeps is a function of its driving frequency: in effect, a clock integrates frequency. Even a small frequency error can cause large time errors to accumulate, for a clock must measure off nearly 100,000 seconds in just one day.

The basis for a modern time standard clock is an ultra-stable oscillator, often a quartz crystal oscillator. The low frequency convenient for clock operation must be derived from the high quartz frequency (typically, 0.1 MHz to 5 MHz) in a way that does not degrade its ac-

curacy. This is accomplished by fail-safe regenerative dividers. A local time standard, then, comprises 1) a stable, precision oscillator and 2) a frequency divider and clock.

A cesium beam standard is an excellent frequency standard to drive a clock because of its extremely good long-term stability. If a quartz oscillator or other secondary standard is used, it must be evaluated for rate of drift and be kept carefully corrected.

The Hewlett-Packard Model 5061A Cesium Beam Frequency Standard offers an Option 01 Time Standard.

The Option 01 provides the 5061A with a 1 pulse per second clock output available at both front and rear panel BNC connectors. The clock is driven by 1 MHz, internally connected. The clock pulse is adjustable with respect to a reference by 6 thumbwheel switches in decade steps from 1 μ s to 1 s. An internal screwdriver adjustment allows fine continuous adjustment over any 1 μ s range. The thumbwheel switches are located under the access door in the top cover.

The time standard option includes a Patek Philippe 24 hour clock movement indicating time in hours, minutes and seconds. Advance/Stop pushbuttons on clock module allow clock to be set to the nearest second. Pressing an internal sync button automatically synchronizes the 1 pps clock pulse to an external sync pulse.

Frequency comparison by VLF broadcast

One excellent way to keep a local system's frequency—hence, time interval—referenced against master time interval is by use of a low frequency standard broadcast such as the National Bureau of Standards WWVB, 60 kHz. Prime means for doing this with ease and convenience is the HP 117A Comparator. This unit is a complete system in itself. The strip chart produced by the 117A records minute by minute the results of a precision phase comparison (resolution, 1 μ sec) of the local signal against the received signal to show frequency offset or error of the local standard.

Reliable, fail-safe operation

Hewlett-Packard frequency and time standards have many features that ensure ease of operation and maintenance. This allows house frequency standards and timekeeping systems to be operated at the highest possible accuracies. Hewlett-Packard standards have built-in dependability. For example, regenerative dividers of the non-self-starting type are used in

the 115BR/CR frequency divider and clock; the very presence of an output signal is a positive indication that divider output has not lost time relative to the driving signal. The dividers stop and remain stopped upon any interruption of signal or of supply power.

The HP 105A/B, 106A/B and 107AR/BR quartz oscillators have a digital indicator, calibrated in parts in 10^{11} (10^{10} for 105A/B, 107AR/BR), which greatly facilitates making fine corrections to bring the oscillator back to reference frequency, as determined by offset measurements made against NBS via the 117A Comparator.

Standby power supplies

Minimum down-time, important for any system, is vital to a time standard. Its worth depends directly on continuity of operation. Non-interrupted operation is also important to ultra-precise quartz oscillators. If a crystal is allowed to cool from its operating temperature, upon renewed operation it may assume a frequency offset and even an altered aging rate for a short period of time.

Hewlett-Packard standby power supplies ensure continued operation despite line interruptions, and operate over a range of ac line voltage to supply regulated dc to operate frequency standards and frequency dividers and clocks. The batteries in the supplies assume the full load immediately when ac power fails.

Alarm systems include local indication of operating conditions and provisions for remote alarms.

Variable frequency source

There are applications in many areas such as microwave spectroscopy and production testing of frequency sensitive devices for an instrument having the basic stability and spectral purity of a precision quartz oscillator, yet offering not just a few but many thousands of discrete frequencies. This capability is offered by the line of frequency synthesizers produced by Hewlett-Packard. The Model 5100B/5110B covers the frequency range of 0.01 Hz to 50 MHz in 0.01 Hz steps. The Model 5105A/5110B covers the frequency range of .1 MHz to 500 MHz in .1 Hz steps. Other models cover various other ranges.

Atomic and UT2 time scales

The time interval of the atomic time scale is the International Second, defined

in October 1964 by the Twelfth General Conference of Weights and Measures:

"The standard to be employed is the transition between two hyperfine levels $F=4$, $m_F=0$ and $F=3$, $m_F=0$ of the fundamental state $^3S_1/2$ of the atom of cesium-133 undisturbed by external fields and the value of 9 192 631 770 hertz is assigned."

The Universal Time Scale, UT2 is related to the earth's rotation and has been proceeding at a rate slightly slower than that of the atomic scale. Its time interval—second—is slightly longer.

U. S. Standard Time, kept by the U. S. Naval Observatory's master clock, differs from nominal UT2 by an integral number of hours. The time interval broadcast by NBS stations WWV, WWVH and WWVL is that of a stepped approximation to UT2. WWVB (60 kHz) broadcasts the atomic second, without offset.

A time scale which approximates UT2 can be produced by oscillations offset from the atomic frequency in an amount proportional to the difference in the intervals employed. By international agreement, the amount of this frequency offset is fixed each year by the Bureau International de l'Heure, in Paris: for 1967 it is -300×10^{-16} .

Operational complications which arise owing to the need for changed offsets from year to year are eased considerably by design provisions Hewlett-Packard makes. The HP 5061A can be easily referenced to either of the two time scales, Atomic, A.1, or UTC. The UTC time scale is the stepped approximation of the UT2 time scale. These changes are accomplished by simply changing the setting on a set of 4 thumbwheel switches located inside the unit under the top cover. The HP 117A Comparator is adjustable simply by a gear ratio change in the translator kit.

Hewlett-Packard systems anticipate future needs as well, and can easily be set up to new offset UTC offset scales as required.

Timekeeping to microsecond accuracy

Studies and systems requiring synchronized measurements at points widely separated in distance increasingly demand time standards capable of microsecond accuracy. Examples are studies of the propagation of electromagnetic waves, advanced systems for navigation, and aircraft collision avoidance.

In the 1966 Flying Clock Experiment* Hewlett-Packard demonstrated a system

of three cesium beam time standards, one stationary and two transported by commercial airlines and automobiles on a 50,000 mile journey, that maintained time over an entire month to a mutual agreement within one microsecond.

This is believed to be the first time that clocks operated independently of each other for a month—no frequency adjustments or time resets were made during the trip—have maintained time to such a close agreement.

Older methods relying on high frequency radio signals cannot correlate widely separated clocks to much better than a millisecond. The use of a portable time standard that travels among all the clocks of a system to correlate them with a master clock has proved to be ideal means of establishing time to microsecond accuracies.

Hewlett-Packard offers a portable time standard, the E20-5061A, which has proved itself capable of microsecond accuracy and which is easily transported by commercial airlines and automobiles.

Hewlett-Packard time and frequency standard

The HP House Standard has as its basic reference the HP 5060A Cesium Beam Standard. The output is continually compared in phase with the U. S. Frequency Standard (USFS) at Boulder, Colorado by reception of NBS standards stations WWVB and WWVL via HP 117A Comparators. The standard is also compared to two of the U. S. Navy's VLF stations. Time is correlated on each occasion when the HP Flying Clocks visit U. S. national timekeeping centers. Frequency is maintained in agreement with USFS with an accuracy of parts in 10^{12} . Studies have shown this standard to rank among the world's most accurate.

The output of the house working frequency standard, an HP 107AR Quartz Oscillator, is distributed throughout the Hewlett-Packard plant in Palo Alto wherever precision frequency or time instrumentation is being built and tested.

A precision time comparison is made by the use of the HP 5245L Electronic Counter with a time interval plug-in.

The measurement is one of totalizing pulses during the interval separating the one-second ticks generated by the flying clock and those generated by the reference clock.

Hewlett-Packard Application Note 52, "Frequency and Time Standards", discusses practical aspects of equipment, operation, and time scales (100 pages).

* Hewlett-Packard Journal 17, 12 August 1966.

CESIUM BEAM FREQUENCY STANDARD

 Compact primary standard, $\pm 1 \times 10^{-11}$ accuracy

Models 5061A, E20-5061A

Advantages:

- Accuracy of ± 1 part in 10^{11}
- Circuit-check meters and lights monitor operation
- Clock and Digital Divider built-in (optional)
- Standby battery supply built-in (optional)
- All solid-state circuits, low power consumption
- Compact— $8\frac{3}{4}$ inches high, 60 pounds

The Hewlett-Packard Model 5061A is a compact, self-contained primary standard of the atomic beam type, utilizing Cesium 133. A cesium beam tube resonator stabilizes the output frequency of a high quality quartz oscillator. Solid-state modular design is used throughout, and the closed-loop, self-checking control circuit yields exceptional accuracy of $\pm 1 \times 10^{-11}$. The 5061A has provision for an optional internal clock and digital divider and for battery with 1 hour (typical) standby power capacity.

The cesium beam tubes exhibit frequency perturbations so small that independently constructed tubes compare within a few parts in 10^{12} . Outstandingly reliable, these tubes have a guaranteed life of 10,000 hours. The 5061A can easily be referred to either of the two time scales in widespread scientific use: UTC or Atomic. The change is accomplished by changing a set of 4 thumbwheel switches and a slide switch, located under the top cover.

The quartz crystal oscillator used in the 5061A has superior characteristics even without control by the atomic resonator. The quartz oscillator portion of this cesium beam standard is identical to the HP 105A.

The 5061A is compact and portable, no complex permanent installation is required.

Operation

In the atomic resonator a beam of state selected Cesium 133 atoms passes through a microwave cavity. When the frequency of the microwave magnetic field is near the hyperfine transition frequency of Cesium 133, it induces transitions from one energy level to another. Those atoms which have undergone such a transition are then detected by a hot wire ionizer and electron multiplier. The microwave field, derived

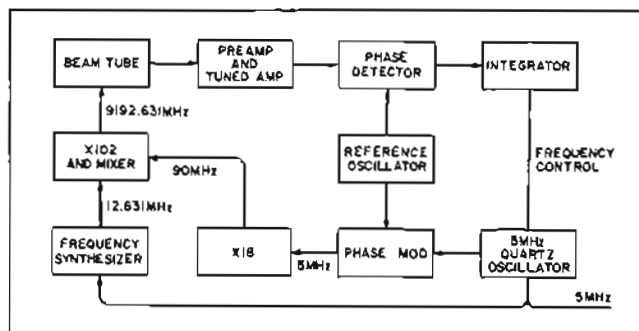

Figure 1

from a precision quartz oscillator by frequency multiplication and synthesis, is phase modulated at a low audio rate. When the microwave frequency deviates from the center of the atomic resonance, the current from the electron multiplier contains a component alternating at the modulation rate and proportional to the frequency deviation. This component is then filtered, amplified, and synchronously detected to provide a dc voltage proportional to the frequency deviation. The integral of this dc voltage is then used to automatically tune the quartz oscillator to zero frequency error.

The control circuit provides continuous monitoring of the output signal. Automatic logic circuitry is arranged to present an indication of correct operation. Figure 1 shows a simplified block diagram of the 5061A operation.

E20-5061A

The E20-5061A consists of a 5061A Cesium Beam Standard and a 5086A Power Supply both enclosed in a cabinet with carrying handles. The power supply, which can be operated from 6 or 12 V dc, 24 to 30 V dc, or 115/230 V $\pm 10\%$, 50-400 Hz, will provide approximately 8 hours standby power (from batteries) for the 5061A. Thus the E20-5061A is a truly portable, primary frequency standard, and with option 01 on the 5061A, a complete flying clock of considerably smaller dimensions than the E20-5060A.*

*See Hewlett-Packard Journal 17, No. 12, August 1966.

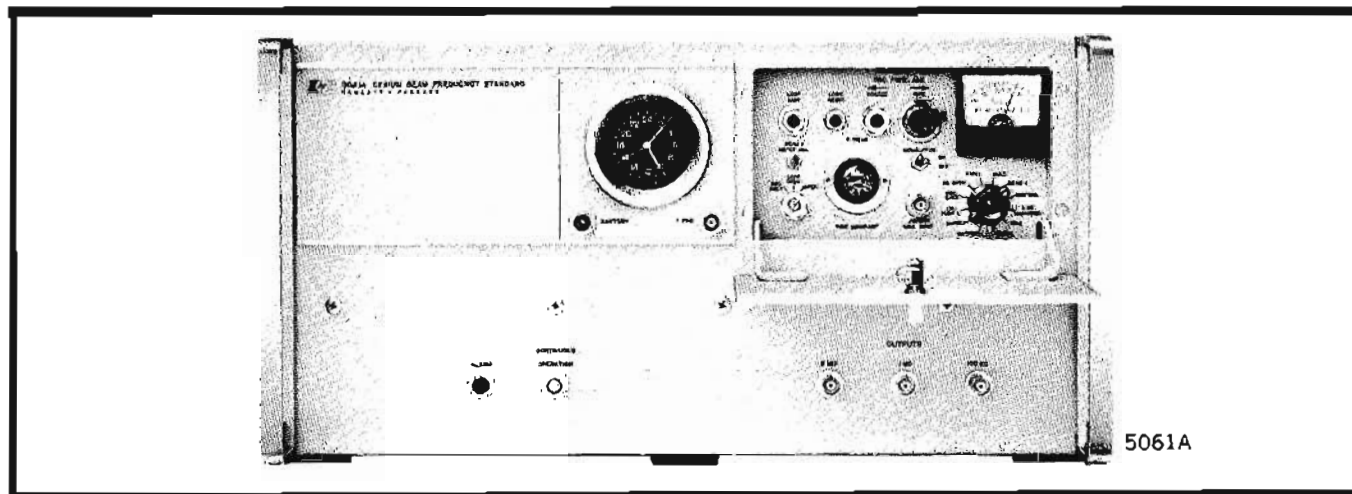

Specifications

5061A Cesium Beam Standard

Accuracy:^o $\pm 1 \times 10^{-11}$.

Reproducibility:^o $\pm 5 \times 10^{-12}$.

Long term stability:^o $\pm 1 \times 10^{-11}$ (for life of tube).

Short term stability: rear panel switch selects 1 s or 60 s loop time constant (see figure below).

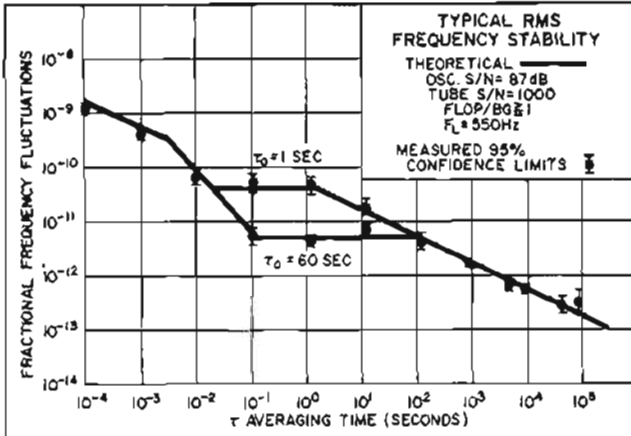

Warm-up time: $\frac{3}{4}$ hour to fully operational from 25°C ambient temperature.

Harmonic distortion: (5 MHz, 1 MHz, and 100 kHz) down more than 40 dB from rated output.

Non-harmonically related output: (5 MHz, 1 MHz, and 100 kHz) down more than 80 dB from rated output.

Output frequencies: 5 MHz, 100 kHz sinusoidal, 100 kHz clock drive (1 MHz clock drive optional).

Output voltages: 1 V rms into 50Ω; clock drive suitable for Hewlett-Packard Frequency Divider and Clocks.

Output terminals: 5 MHz, 1 MHz, 100 kHz, front and rear BNC connector, 100 kHz clock drive, rear BNC connector.

Time scale: adjustable with 4 thumbwheel switches and a slide switch from 0 to -700×10^{-10} , 12.63 . . . MHz test frequency available on rear panel.

Cesium Beam Tube

Tube life: 10,000 hours guaranteed (operating) within 2 years of receipt of tube.

Length: $16 \pm 1/16$ in.

Diameter: approximately $5\frac{3}{8}$ in.

Weight: 16 lbs.

Line width: 550 Hz ($\pm 20\%$).

S/N Ratio (Voltage): typical, 1000 ($\frac{1}{4}$ Hz noise bandwidth).

RF power (9192 + MHz): 30 μW.

Power input, 25°C, typical: 6.5 W.

Quartz Oscillator

Aging rate: <15 parts in 10^{10} per 24 hours.

Signal-to-noise ratio: for 1 and 5 MHz, > 87 dB at rated output (in a 30 kHz noise bandwidth, 5 MHz output filter bandwidth is approx. 100 Hz) F or 100 kHz, > 60 dB in 30 kHz noise bandwidth.

Frequency adjustments:

Fine adjustment: 5 parts in 10^8 range, with dial reading parts in 10^{10} .

Coarse adjustment: 1 part in 10^6 , screwdriver adjustment at front panel.

Stability: as a Function of Ambient Temperature: $< 2.5 \times 10^{-9}$ total from 0° to +50°C.

As a Function of Load: $< \pm 2 \times 10^{-11}$ for open circuit to short, and 50Ω R,L,C load change.

As a Function of Supply Voltage: $< \pm 5 \times 10^{-11}$ for 22 to 30 V dc, or for 115/230 V ac, $\pm 10\%$.

General

Environmental: typical stability with respect to temperature is $< \pm 5 \times 10^{-12}$, 0 to 50°C. Humidity, 0 to 95%. Typical stability with respect to magnetic fields is $< \pm 1 \times 10^{-11}$, 2 gauss field, any orientation. Production 5061A's have passed the stringent shake and vibration test MIL-STD-167, and have exceeded the electromagnetic compatibility specification, MIL-I-6181D (EMC, also known as RFI).

Power: 115 or 230 V ac $\pm 10\%$, 50 to 1000 Hz or 22 or 30 V dc. Approximately 30 W operating from dc without options. Approximately 50 W operating from ac without options.

Dimensions: $16\frac{3}{4}$ " wide x $16\frac{3}{8}$ " deep x $8\frac{3}{4}$ " high (425 x 416 x 221 mm).

Weight: net, 60 lbs, no options. Option 01 add 2 lbs. Option 02 add 5 lbs.

Accessories furnished: Rack Mounting Kit 5060-0777; 22 pin plug-in extender board 5060-7202; detachable 6 ft. ac power cord, connectors 1251-0038 (Cannon MS 3106A10SL-35C) and 1251-0037 (A.P.M. Corp.) UP1 131M (NUP 121M).

Accessories available: 103A-16A dc Cable (connects 5061A to 5085A dc output), \$21.50.

Price: HP Model 5061A, \$14,800.00.

Option 01 Time Standard

Clock pulse:

Rate: 1 pulse per second.

Amplitude: +10 V peak.

Width: 20 μs $\pm 10\%$.

Raise time: < 50 ns.

Fall time: 1 μs.

Jitter: < 20 ns.

All specs are with 50Ω load.

Synchronization: 10 μs (± 1 μs) delayed from reference input pulse. Reference pulse must be $> +5$ V, with a rise time > 50 ns.

Price: Option 01, add \$1,500.00.

Option 02 Standby Power Supply

Capacity: 30 minutes minimum (1 hour typical at 25°C) at full charge.

Charge control: automatic when ac power is connected.

Indicator: a front panel light flashes when ac power is interrupted and battery is being used.

Price: Option 02, add \$600.00.

*Definition of Terms

Accuracy: The degree to which oscillator frequency is the same as that of an accepted primary standard for (example, the U.S. Frequency Standard), or the degree to which oscillator frequency corresponds to the accepted definition, presently that of the 12th General Conference of Weights and Measures.

Reproducibility: The degree to which an oscillator will produce the same frequency from unit to unit and from one occasion of operation to another. Included within this definition is the degree to which the frequency of an oscillator can be set by a calibration procedure.

Intrinsic Reproducibility: The degree to which an oscillator will reproduce a given frequency without the need for calibrating adjustments either during manufacture or afterwards. This quality is a characteristic of an apparatus design, not of a resonance.

Long Term Stability: Total fractional frequency drift for the life of the cesium beam tube.

CESIUM BEAM TUBE

$\pm 1 \times 10^{-11}$ long term stability
Model 5082A

Applications

Ultra Precise Frequency Standards for the calibration of lesser standards and the study of oscillator performance.

Time Keeping during long continuous intervals in which the highest degree of uniformity and reliability is required.

Communications for the fine resolution of frequencies up through the microwave spectrum.

Spectroscopy for the resolution of the finest details of physical spectra.

The HP Model 5082A Cesium Beam Tube (formerly BLR-2) is an ultra stable resonator or frequency reference component based upon the quantum mechanical properties of Cs^{133} . A unique motion within the cesium atom is coupled to an electromagnetic circuit to provide a resonance signal for the accurate control of frequency in electronic oscillators.

Through the use of the Cesium Beam Tube, it is possible to construct electronic oscillators with an extremely high degree of reproducibility and stability. Long term drifts and aging effects which are unavoidable in the best quartz crystal oscillators are absent in cesium beam stabilized oscillators. The Cesium Beam Tube is applied as the reference component in a feedback control system. All radio frequencies may be derived from the cesium controlled frequency without loss of precision by the use of well established synthesizing techniques.

Features

High Intrinsic Reproducibility—The HP Cesium Beam Tube characteristics are reproducible from unit to unit with no requirement for calibration against a primary standard during manufacture or during use.

Uniform Magnetic Field—To realize the highest degree of intrinsic reproducibility, the tube has been designed with special attention to the uniformity of the magnetic field in the atomic interaction space. Particular care has been exercised with respect to shielding factors and with respect to end effects.

High Q Resonance—Resonance Q of 3.5×10^7 permits high accuracy from associated oscillator circuits.

Reliability, Long Life—The 5082A provides the highest degree of reliability and long trouble-free operation. Tube life exceeds commonly accepted standards for microwave tubes.

Mass Spectrometer Detector—The high performance potential of the cesium beam technique is fully realized by the use of an efficient mass spectrometer detector which eliminates spurious impurity signals. Reliability and stability would otherwise be compromised by impurity signal pulses occurring, for example, as infrequently as once per week.

Construction—The tube is designed to ensure maximum accuracy in the alignment of the beam deflecting components. Every advantage is taken of the most advanced microwave tube technology to attain reliable, rugged construction. The vacuum envelope protects all critical parts from environmental effects. There are no external adjustments.

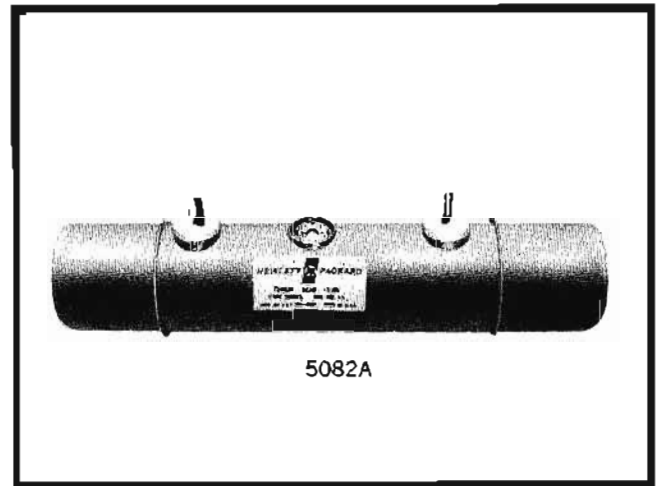

5082A

Specifications

Electrical

Frequency: 9,192,631, 770 ± 0.2 Hz.

Long term stability: ± 1 part in 10^{11} .

Reproducibility: ± 1 part in 10^{11} . (Reproducibility refers to the degree to which resonance frequency is the same from one unit to any other.)

Output voltage: (signal/noise) 750 min. for 1 second time constant.

Output signal: 5×10^{-6} A at resonance peak.

Operating life: 10,000 hour warranty (35°C max. storage temp.). For details request 5082A Data Sheet.

Orientation: Frequency change is less than 5×10^{-12} for any position in the earth's field.

Mechanical

Dimensions: 25 1/4" long; diameter approximately 5 5/8".

Weight: 23 lbs (11.5 kg) net; 34 lbs (15 kg) shipping.

Power requirements

R-F power: 30 μW maximum.

C-Field supply: nominal +20 mA dc regulated into 1 Ω .

Hot wire ionizer: 1.5 V, 3.0 A ac or dc.

Mass spectrometer: nominal +14 V dc regulated to 0.5%.

Cesium oven: steady state, nominal 5 V at 0.8 A ac or dc. Thermistor included for proportional control.

Electron multiplier: -1800 to -2500 V dc $\pm 0.1\%$ at 50 μA maximum.

Ion pump (internal): initial, 1 mA dc at +3500 V. Steady state, nominal 1 μA dc at +3500 volts $\pm 15\%$.

Price: Model 5082A, \$5500.

STANDBY POWER SUPPLIES

For Frequency and Time Standards

Models 5085A, 5086A



FREQUENCY, TIME STANDARDS

Advantages:

- 2 amperes at 24 volts
- Up to 21 ampere-hours of standby
- Solid state, modular

Uses:

- Continued operation of primary standards when ac line power is interrupted

The HP Model 5085A 24 volt 2 ampere power supply keeps primary frequency or time standard systems in operation when ac line power is interrupted. Specifically designed to deliver standby power to the HP Cesium Beam Standards and peripheral equipment, the 5085A will also serve HP Quartz Oscillator Frequency Standards and the 115BR/CR Frequency Divider and Clock. The only requirement is that the total current drawn from the supply not exceed 2 A for any extended period of time.

The frequency and time standard system is not affected during changeover since no switching is used in transferring power from line to battery operation and back again.

Vented nickel-cadmium batteries with an 18 ampere-hour guaranteed capacity (derated from 25) are used in the 5085A. They provide about 12 hours of standby power for the 5061A Cesium Standard (at average ambient temperature of 25°C).

Front panel lights indicate mode of operation, report fuse failure, ac interrupt.

Specifications, 5085A

- Output voltage:** 24 \pm 2 V dc at rated current.
- Maximum rated current** (total external load): 2 amperes.*
- Standby capacity:** (At 25°C**) 18 ampere hours after 48 hours with manually operated CHARGE switch set to CHARGE.
- Alarm indicators:** Panel lamps indicate: (1) FUSE FAILURE, (2) AC POWER, (3) AC INTERRUPT, (4) CHARGE.
- Remote alarm provisions:** SPDT relay contacts provided at rear terminals for operating remote alarm from separate power system. Contacts rated at 3 A (resistive) 115 V ac or 28 V dc.
- Panel meters:** Voltmeter and ammeter indicate battery voltage and battery charge/discharge current.
- Power requirements:** 115 or 230 \pm 10% Vac; 50 to 1,000 Hz (2.0 A max. at 115 V line).
- Output connectors:** MS type female connectors at rear mate with 106AR, 107AR, 115CR, 5060A power cables (Cannon Part No. 71468-MS3102R14S-5P, HP No. 1251-0111).
- Battery (supplied):** Vented nickel-cadmium 25 ampere-hour rated capacity. Periodic maintenance required.
- Additional (external) battery provision:** MS3102R14S-2S female connector, with cap, at rear.
- Dimensions:** 16 $\frac{3}{4}$ " wide, 6-31/32" high, 16 $\frac{3}{8}$ " deep (425 x 177,2 x 467 mm).
- Weight:** net, 75 lbs (34,1 kg); shipping, 101 lbs (45,9 kg) including battery. Option 01 (no batteries) is 50 lbs (22,8 kg) less.
- Accessories furnished:**
 - AC Power Line Power Cable, 6 feet long.
 - Instrument Extension Slides (for std. 24" deep rack).
- Price:** Model 5085A (complete with batteries), \$1,250.
- Options:** Specify Option 01 if batteries are to be excluded. Model 5085A with Option 01 is \$820.

* 2.5 A for 30 minutes.

** Derate capacity to 75% at high temperature (50°C) and low temperature (0°C).

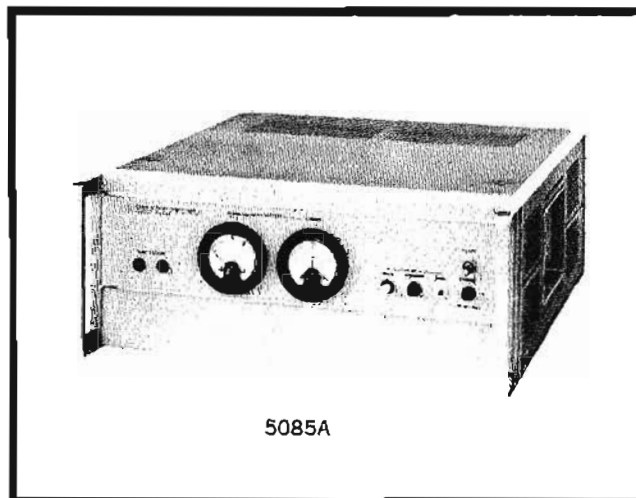

5085A

The 5086A was specifically made as a standby power supply for the 5061A in the E20-5061A "Flying Clock" and incorporates a number of features not found in the 5085A. The 5086A has a special inverter which will allow it to operate from 6 or 12 V dc or 24 to 30 V dc besides 115/230 V. The nickel-cadmium batteries are of the sealed type and thus spill-proof. The charging of the batteries is controlled from a special automatic recharging circuit.

Specifications, 5086A

- Output voltages:** 115 V ac, 50 to 400 Hz, 26 \pm 4 volts dc.
- Output current:**
 - ac, 0.5 A.
 - dc, 2 A.
- Standby capacity:** 15 ampere-hours at 25°C, 8 hours standby when used in E20-5061A.
- Recharging:** automatic 14 hours for full charge.
- Alarm indicator:** External Power and Fast Charge.
- Panel meters:** Voltmeter, Ammeter indicating voltage and current of 3 internal batteries and 5061A.
- Power requirements:** 6 or 12 V dc -10% $+20\%$; or 24 to 30 V dc; or 115/230 \pm 10% V ac, 50 to 400 Hz. Can be connected simultaneously with ac or other dc power inputs for extra standby reserve.
- Output connectors:**
 - ac: CA-3102R-10SL-3S.
 - dc: MS-3102R-14S-5S.
- Input connectors:**
 - 6 and 12 V dc: MS-3102R-16-11P.
 - 24 to 30 V dc: MS-3102R-14S-7P.
 - ac: MS-3102R-10SL-3P.
- Battery:** three paralleled, 22 series Ni-Cd cell, 7 ampere-hour, rechargeable batteries that can be individually removed from the circuit without interfering with power supply operation.
- Dimensions:** 16 $\frac{3}{4}$ " wide, 6-31/32" high, 18 $\frac{3}{8}$ " deep (425 x 177 x 467 mm).
- Weight:** net, 65 lbs.
- Accessories furnished:** ac Power line cable, 6 feet long.
- Price:** Model 5086A, \$2750.

FREQUENCY, TIME STANDARDS



QUARTZ OSCILLATORS

State-of-the-art frequency stability
Models 105A,B, 106A,B, 107AR,BR, 101A

Advantages:

- High spectral purity
- Well-buffered outputs
- Solid-state reliability

Uses:

- In-house frequency and time standards
- Microwave spectroscopy
- Comparisons with atomic standards
- Advanced navigation, communication systems

Models 105A,B, 106A,B and 107AR,BR Quartz Oscillators provide state-of-the-art application in precision frequency and time standard systems because of their excellent long and short term stability characteristics, spectrally pure outputs, unexcelled reliability, and ability to operate under a wide range of environmental conditions.

The Models 107AR and 107BR are rugged, hermetically sealed, precision quartz oscillators for frequency and time standards. Model 107AR operates from 26 ± 4 V dc; Model 107BR operates from the ac line and includes a 2-hour stand-by battery mounted within the oscillator. Both instruments provide sinusoidal signals of 5 MHz, 1 MHz, and 100 kHz with excellent short term stability and long term drift rate. They operate over a wide range of environmental conditions.

Models 107AR and 107BR have been prototype tested to conform to the shock and vibration requirements of MIL-E-16400E. MIL-E-16400E subjects the instrument to vibration at 5 to 33 Hz rates with excursions from 0.03 to 0.01 inch in each of three mutually perpendicular planes. Under the shock test the instrument receives nine blows from a 400-pound hammer. Blows are from one foot, three, and five feet in each of three planes.

Particular care was taken to provide a spectrally pure 5 MHz output which, when multiplied high into the microwave region, provides signals with spectra only a few cycles wide. Spectra less than 1 Hz wide can be obtained in X-band (8.2 to 12.4 GHz). The stability and purity of the 5 MHz output make it suitable for doppler measurements, microwave spectroscopy, and similar applications where the reference frequency must be multiplied by a large factor.

Provision also has been made in the 107AR and 107BR Quartz Oscillators so that they can be voltage controlled; therefore these oscillators can be used in phase locked systems. The sensitivity of this automatic frequency control is such that a change from +5 to -5 volts will change the output by approximately 2 parts in 10^6 .

The models 106A,B have the highest long term stability

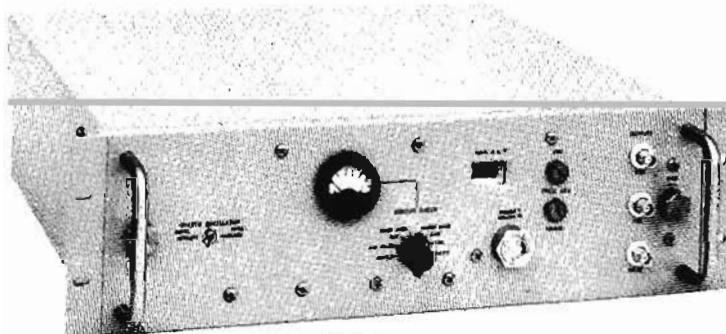

107AR



106B

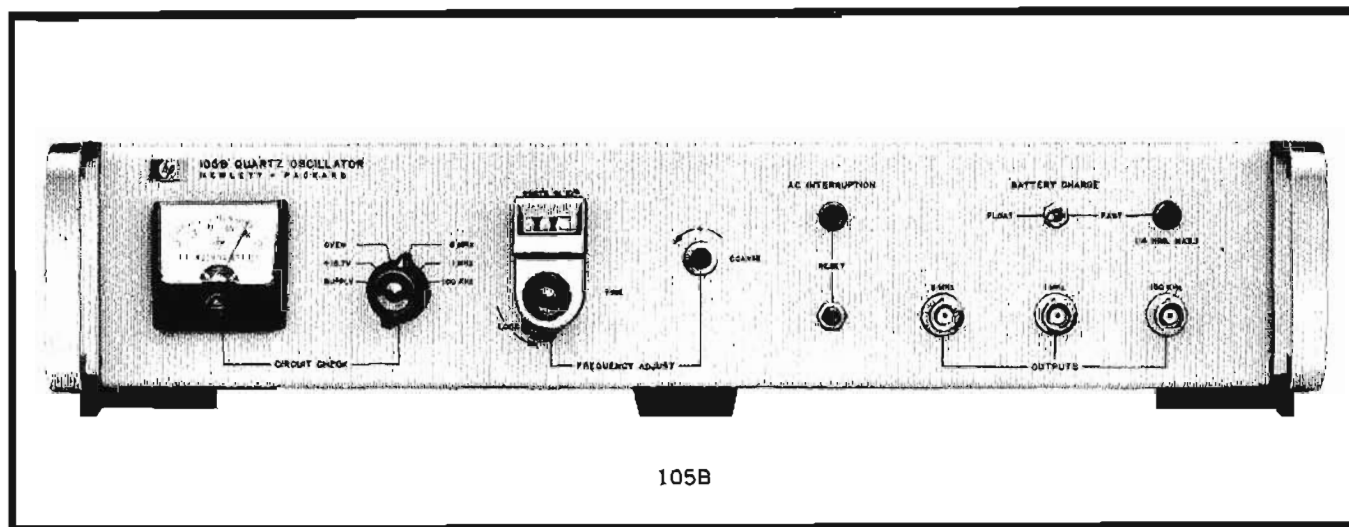

of the HP quartz oscillators. In addition to high stability these oscillators have very high spectral purity and Hewlett-Packard's unexcelled reliability.

The heart of these oscillators is an extremely stable 2.5 MHz quartz crystal mounted with other critical components in a proportionally controlled double oven. The crystal and this type of control results in an oscillator with extremely good long term stability—better than ± 5 parts in 10^{11} per day. Short term stability is also excellent, being ± 1.5 parts in 10^{11} for sample periods as short as 0.1 second.

The 5 MHz output provided by these oscillators has the stability and high spectral purity of the 2.5 MHz crystal. Spectra only a few cycles wide may be obtained in the GHz region by multiplication of the 5 MHz output.

Models 106A and B are identical in every respect except for their power requirements. The 106B operates from 115 or 230 volts ac line or from an external dc power supply (HP 5085A or 5086A recommended) and contains an emergency standby power supply capable of sustaining operation for 8 hours. The 106A requires an external supply voltage of 22 to 30 V dc, such as the HP 5085A or 5086A.

The models 105A,B are the latest addition to the HP quartz oscillator line. They fill a need for a smaller and more economical and yet highly stable precision quartz oscillator for frequency and time standards. Both models can be operated from the ac line; the 105B has a built-in 8-hour standby battery supply for uninterrupted operation should line power fail. Both models have 5 MHz, 1 MHz, and 100 kHz sinusoidal outputs with excellent short term stability (1 part in 10^{11} rms for 1 s averaging time) and aging rate (< 5 parts in 10^{10} per day). In addition, the 105A/B features rapid warm-up. Typically, the oscillator will be within 1 part in 10^5 of the previous frequency in 45 minutes after an "off" period of approximately 24 hours under lab conditions.

The basis of these oscillators is an extremely stable 5 MHz, 5th overtone quartz crystal developed by Hewlett-Packard. New technologies in the crystal mounting and packaging

have resulted in a cleaner crystal which in turn has a lower aging time. The crystal, oscillator and AGC circuit are all enclosed in a proportional oven which reduces the temperature effects on these components and circuits.

Each frequency output of the 105A/B is buffered to provide an output stable to within ± 2 parts in 10^{11} regardless of load changes occurring in any other output. Buffering between the outputs, in addition to the excellent stability of the 5 MHz crystal, makes the 105A and 105B ideal for application in frequency standard systems requiring use of multiple outputs. The 105A and 105B may be used in complex systems with complete assurance that loading changes, such as accidental shorts or disconnections in other outputs, will not affect frequency of the output of primary concern.

Provision has been made in Models 105A/B to control the output frequency over a small range, using externally applied voltage. A 12 V change in applied voltage across varactor will change the 5 MHz output frequency to approximately 5 parts in 10^6 .

101A

Hewlett-Packard Model 101A 1 MHz Oscillator is a high-stability crystal controlled oscillator suitable for many field and laboratory applications. Although designed specifically to be the time base for Model 5275A Electronic Time Interval Counter, the high precision capabilities and low cost of Model 101A make it an ideal instrument for many other applications as well.

Long term stability of 5 parts in 10^9 per week is achieved by careful oscillator design and by housing the high quality crystal and associated critical components in a well-regulated oven. Ambient temperature may vary from -5°C to $+55^\circ\text{C}$ without degrading the performance of this instrument.

Short term stability, including all effects of line, load, and ambient temperature variation over specified ranges, is better than 3 parts in 10^6 . A front panel adjustment permits frequency adjustment over a range of approximately ± 1 part in 10^6 .

QUARTZ OSCILLATORS *continued*

State-of-the-art frequency stability

Models 105A, B, 106AB, 107AR, BR, 101A

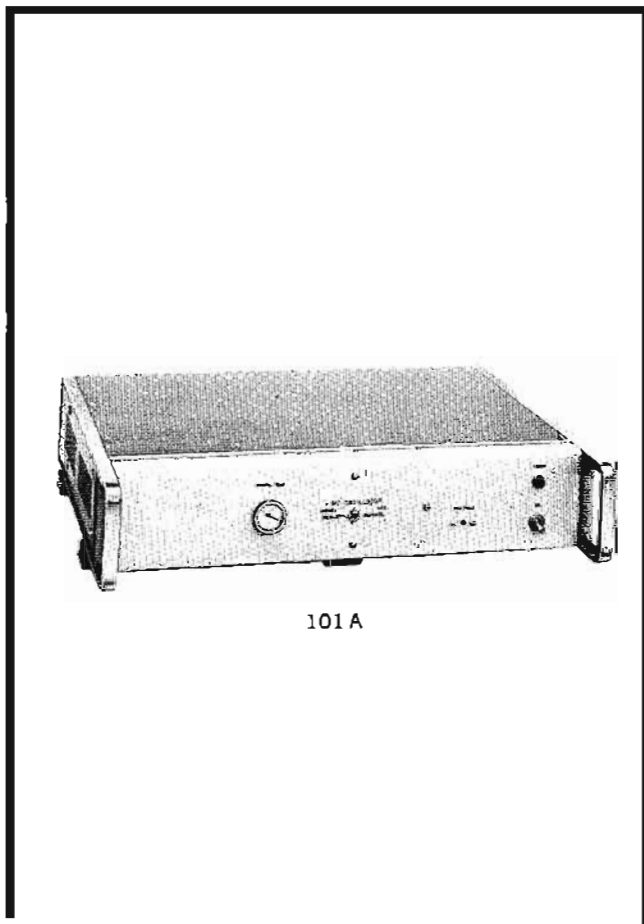

101A

Specifications, Model 101A**Stability**Short term: 3 parts in 10^5 .Long term: 5 parts in 10^6 per week.**Output frequencies:** 1 MHz and 100 kHz (sinusoidal), rear BNC connectors.**Output voltage:** 1 V rms min into 50-ohm load.**Distortion:** less than 4% into rated load.**Oven temperature indicator:** front panel dial thermometer.**Frequency adjustment:** front panel screwdriver adjust with range of approximately ± 1 part in 10^6 for calibration from primary standard.**Power:** 115 or 230 V $\pm 10\%$, 50 to 1000 Hz, 2 to 15 W depending on oven cycle.**Dimensions:** 16 $\frac{3}{4}$ " wide, 3 $\frac{1}{2}$ " high, 11 $\frac{1}{2}$ " deep (426 x 89 x 292 mm).**Weight:** net approximately 10 lbs (4.5 kg); shipping 13 lbs (5.9 kg).**Accessories furnished:** 10503A, 4-foot (122 cm) cable assembly, each end terminated by BNC male connector.**Price:** Model 101A, \$600.

Models	107AR, BR		
Output frequencies	5 MHz, 1 MHz, 100 kHz sinusoidal; 100 kHz clock drive		
Output voltages	5 MHz, 1 MHz, and 100 kHz, 1 V rms into 50 ohms; 100 kHz for driving HP frequency divider and clocks, 0.5 V rms into 1000 ohms		
Stability (long term)	$\leq 5 \times 10^{-10}$ per 24 hrs		
As a function of ambient temperature	$\leq 1 \times 10^{-10}$ from 0° to +50°C		
As a function of humidity	instruments are hermetically sealed		
As a function of load	$\leq 2 \times 10^{-11}$ for any resistive load change		
voltage			
As a function of line voltage	(107BR) $\leq 1 \times 10^{-11}$ for 10% change from 115 or 230 V ac		
RMS deviation of 5 MHz (short-term stability)	averaging time	max. rms fractional-frequency deviation ($\Delta f/f$)	max. rms phase deviation (milliradians)
	1 ms	8×10^{-10}	0.03
	10 ms	1.5×10^{-10}	0.04
	0.1 s	1.5×10^{-11}	0.04
	1 s	1.5×10^{-11}	0.4
Noise-to-signal ratio (5 MHz)	at least 87 dB below rated 5 MHz output; output filter bandwidth is approximately 125 Hz		
Harmonic distortion (5 MHz, 1 MHz, and 100 kHz)	down more than 40 dB from rated output		
Non-harmonically related output (5 MHz, 1 MHz, and 100 kHz)	down more than 80 dB from rated output		
Output terminals	5 MHz, 1 MHz, 100 kHz, front and rear BNC connectors; 100 kHz clock drive, rear BNC connector		
Frequency adjustments			
Fine adjustment	5 parts in 10^6 total; 1 part in 10^9 per rev; 1 part in 10^{10} per division at 10 divisions per revolution		
Coarse adjustment	1 part in 10^6 ($\approx 0.5 \times 10^{-6}$)		
Environmental			
Storage temperature	-65°C to +85°C (mfr. specifies -40°C to +50°C limit for 107BR battery storage)		
Operating temperature	0°C to +50°C		
Humidity	instrument is hermetically sealed, will operate under water without degradation of performance		
Vibration and shock	complete passes vibration and shock requirements of MIL-E-16400E		
Weight	107AR: net 20 lbs (9 kg), shipping 38 lbs (17 kg); 107BR: net 35 lbs (16 kg), shipping 53 lbs (24 kg)		
	5-7/32" (133 mm) 19" (483 mm) 16 $\frac{1}{2}$ " (416 mm)		
Power	107AR: 22 to 30 V dc, approx. 12 W operating, 15 W during warm-up; 107BR: 115 or 230 V ac $\approx 10\%$, 50 to 1000 Hz, approx. 25 W operating with battery on trickle charge (30 W on fast charge), 33 W during warm-up (38 W on fast charge)		
Price	HP 107AR, \$2400 HP 107BR, \$2750		

Specifications

Models	106A,B	106A,B																																				
Output frequencies	5 MHz, 1 MHz, 100 kHz sinusoidal; 100 kHz clock drive	5 MHz, 1 MHz, 100 kHz sinusoidal; 1 MHz or 100 kHz clock drive																																				
Output voltages	5 MHz, 1 MHz, and 100 kHz, 1 V rms into 50 ohms; 100 kHz for driving HP frequency divider and clocks, 0.5 V rms into 1000 ohms																																					
Stability (long term)	$< \approx 5 \times 10^{-11}$ per 24 hrs	$< (5) \times 10^{-10}$ per 24 hours																																				
As a function of ambient temperature	$< \approx 1 \times 10^{-10}$ from 0° to +40°C	2.5×10^{-9} total from 0°C to +50°C																																				
As a function of humidity	basic oscillator is sealed	basic oscillator is sealed																																				
As a function of load	$< \approx 2 \times 10^{-11}$ for any resistive load change	$< \approx 2 \times 10^{-11}$ for open, short, 50 Ω resistive, inductive and capacitive																																				
As a function of supply voltage	(106A) $< \approx 3 \times 10^{-11}$ for 22 to 30 V dc	$< \approx 5 \times 10^{-11}$ for 22-30 V dc																																				
As a function of line voltage	(106B) $< \approx 1 \times 10^{-11}$ for $\approx 10\%$ change from 115 or 130 V ac	$< \approx 5 \times 10^{-11}$ for 115/230 V ac $\approx 10\%$																																				
RMS deviation of 5 MHz (short-term stability)	<table border="1"> <thead> <tr> <th>averaging time</th> <th>max. rms fractional-frequency deviation ($\Delta f/f$)</th> <th>max. rms phase deviation (milliradians)</th> </tr> </thead> <tbody> <tr> <td>1 ms</td> <td>8×10^{-10}</td> <td>0.03</td> </tr> <tr> <td>10 ms</td> <td>1.5×10^{-10}</td> <td>0.04</td> </tr> <tr> <td>0.1 s</td> <td>1.5×10^{-11}</td> <td>0.4</td> </tr> <tr> <td>1 s</td> <td>1.5×10^{-11}</td> <td>4</td> </tr> <tr> <td>10 s</td> <td>1.5×10^{-11}</td> <td>4</td> </tr> </tbody> </table>	averaging time	max. rms fractional-frequency deviation ($\Delta f/f$)	max. rms phase deviation (milliradians)	1 ms	8×10^{-10}	0.03	10 ms	1.5×10^{-10}	0.04	0.1 s	1.5×10^{-11}	0.4	1 s	1.5×10^{-11}	4	10 s	1.5×10^{-11}	4	<table border="1"> <thead> <tr> <th>averaging time</th> <th>max. rms fractional-frequency deviation ($\Delta f/f$)</th> <th>max. rms phase deviation (milliradians)</th> </tr> </thead> <tbody> <tr> <td>1 ms</td> <td>5×10^{-10}</td> <td>0.016</td> </tr> <tr> <td>10 ms</td> <td>1×10^{-10}</td> <td>0.031</td> </tr> <tr> <td>0.1 s</td> <td>1×10^{-11}</td> <td>0.31</td> </tr> <tr> <td>1 s</td> <td>1×10^{-11}</td> <td>3.1</td> </tr> <tr> <td>10 s</td> <td>1×10^{-11}</td> <td>3.1</td> </tr> </tbody> </table>	averaging time	max. rms fractional-frequency deviation ($\Delta f/f$)	max. rms phase deviation (milliradians)	1 ms	5×10^{-10}	0.016	10 ms	1×10^{-10}	0.031	0.1 s	1×10^{-11}	0.31	1 s	1×10^{-11}	3.1	10 s	1×10^{-11}	3.1
averaging time	max. rms fractional-frequency deviation ($\Delta f/f$)	max. rms phase deviation (milliradians)																																				
1 ms	8×10^{-10}	0.03																																				
10 ms	1.5×10^{-10}	0.04																																				
0.1 s	1.5×10^{-11}	0.4																																				
1 s	1.5×10^{-11}	4																																				
10 s	1.5×10^{-11}	4																																				
averaging time	max. rms fractional-frequency deviation ($\Delta f/f$)	max. rms phase deviation (milliradians)																																				
1 ms	5×10^{-10}	0.016																																				
10 ms	1×10^{-10}	0.031																																				
0.1 s	1×10^{-11}	0.31																																				
1 s	1×10^{-11}	3.1																																				
10 s	1×10^{-11}	3.1																																				
Noise-to-signal ratio (5 MHz)	at least 87 dB below rated 5 MHz output; output filter bandwidth is approximately 125 Hz	> 90 dB below rated output; output filter bandwidth (3 dB) ≈ 100 Hz																																				
Harmonic distortion (5 MHz, 1 MHz, and 100 kHz)	down more than 40 dB from rated output																																					
Non-harmonically related output (5 MHz, 1 MHz, and 100 kHz)	down more than 80 dB from rated output																																					
Output terminals	5 MHz, 1 MHz, 100 kHz, front and rear BNC connectors; 100 kHz clock drive, rear BNC connector	5 MHz, 1 MHz, 100 kHz, front and rear BNC connectors; clock drive and electrical frequency control, rear BNC connectors																																				
Frequency adjustments	<p>Fine adjustment 2 parts in 10^4 total; 1 part in 10^{10} per rev; 1 part in 10^{11} per division at 10 divisions per revolution</p> <p>Coarse adjustment 5 parts in 10^7 ($\approx 2.5 \times 10^{-7}$)</p>	<p>5×10^{-6} total, with digital dial reading parts in 10^{10}</p> <p>1×10^{-5} (screwdriver adjustment)</p>																																				
Environmental	<p>Storage temperature -40°C to +75°C (mfr. specifies -40°C to +50°C limit for 106B battery storage)</p> <p>Operating temperature 0°C to +40°C</p> <p>Humidity</p> <p>Vibration and shock</p>	<p>-40°C to 75°C (mfr. specifies -40°C to +50°C limit for 105B battery storage)</p> <p>0°C to +50°C</p>																																				
Weight	106A: net 25 lbs (11,3 kg), shipping 33 lbs (15 kg); 106B: net 39 lbs (17,6 kg), shipping 47 lbs (21,3 kg)	105A: net 16 lbs (7,3 kg), shipping 23 lbs (10,4 kg). 105B: net 24 lbs. (10,9 kg), shipping, 31 lbs (14,1 kg)																																				
Dimensions	<p>Height 6-31/32" (177 mm)</p> <p>Width 16 3/8" (425 mm)</p> <p>Depth 16 3/8" (416 mm)</p>	<p>3-15/32" (88 mm)</p> <p>16 3/8" (425 mm)</p> <p>11 1/4" (286 mm)</p>																																				
Power	106A: 22 to 30 V dc, negative ground, approx. 8W operating, 13W during warm-up; 106B: 115 or 230 V ac $\approx 10\%$, 50 to 1000 Hz, negative ground approx. 17 W operating with battery on trickle charge (27 W on fast charge), 33 W during warm-up (43 W on fast charge)	105A: 115/230 V $\approx 10\%$, 50-400 Hz, at 17 W (21 W warm-up) 105B: 115/230 V $\approx 10\%$, 50-400 Hz, at 18 W (24 W warm-up), at float charge. Add 12 W for fast charge Both: 22-30 V dc at 6.4 W (10.3 W warm-up)																																				
Price	HP 106A, \$3450 HP 106B, \$3900	HP 105A, \$1500 HP 105B, \$1800																																				

FREQUENCY TIME STANDARDS



VLF COMPARATOR

Compares frequency against NBS standard
Model 117A

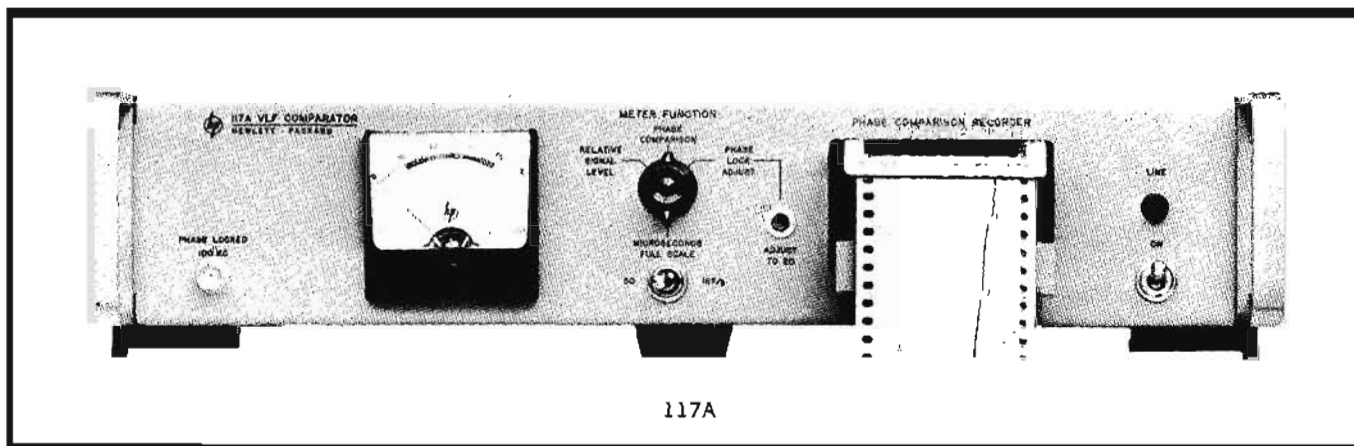

Advantages:

- Plots minute-by-minute phase record
- Provides all equipment needed for frequency comparison
- Offers one microsecond resolution
- Makes available 100 kHz phase-locked output

Uses:

- Offset and drift determinations for crystal oscillators
- Quick and easy checks of counter time-base accuracy
- Monitors atomic standards against USFS

The HP 117A VLF Comparator measures the frequency offset of a local standard frequency source against a radio signal based on the U.S. Frequency Standard to an accuracy that can reach a few parts in 10^{11} in a 24-hour period. The HP 117A thus provides a link between house frequency standards and the Boulder, Colorado laboratories of the National Bureau of Standards (NBS) via station WWVB, which broadcasts at 60 kHz on a continuous basis.

The strip chart produced by the HP 117A records minute by minute the results of a precision phase comparison of the local signal against the received signal to show frequency offset or error of the local standard, and over a few hours to a day or more, its drift rate.

Local precision frequency sources such as quartz crystal oscillators that drive clocks or synthesizers or that serve as counter time bases can be quickly compared in frequency for purposes of calibration or can be monitored over as long a time as desired to determine their behavior and to measure long-term drift rate.

Method of Operation

The VLF Comparator is a complete system (exclusive of local standard) which consists in one package of a receiver, an electronic servo-controlled oscillator which functions as a narrow band tracking filter, a linear phase comparator, and a strip chart recorder. The servo loop and phase-locked oscillator provide a continuous output signal despite noise and interfering signals. A front panel meter can be switched to show relative signal level, phase lock with WWVB, or phase comparison. Output terminals on the rear provide for the connection of external galvanometer and potentiometer recordings if desired. A loop antenna with built-in preamplifier and 30 meters of lead-in cable is included.

The recorded trace is easily evaluated directly in terms of

frequency offset with a transparent template supplied with the instrument. Chart speed is 1 inch per hour and full-scale chart width may be set for either 50 μsec or 16-2/3 μsec by operation of a front panel switch. The readability of the trace and the overall stability of the comparator easily provide a resolution of better than 1 μsec under normally encountered laboratory conditions.

NBS Standard Broadcast WWVB

The WWVB 60 kHz signal reaches a primary service area that includes the entire continental United States. NBS controls the broadcast frequency to within $\pm 2 \times 10^{-11}$ of its intended value. NBS publishes monthly, in *Proceedings of the IEEE*, frequency correction data relative to WWVB and also to the other standard broadcasts, which are WWV and WWVH (high frequency) and WWVL (20 kHz).

WWVB is referenced to the U.S. Frequency Standard and its frequency is *not* offset. WWVB seconds pulses are those of the time scale NBS-A, for which time interval is the international (atomic) second. (Frequency of the other NBS services is offset by an amount coordinated through the Bureau International de l'Heure: for 1967, offset is -300×10^{-10} . Purpose of the offset is to make the second of time interval correspond closely to that of UT-2, the time scale in ordinary use.)

Accuracy of the HP 117A approaches that of the broadcast signal itself. The HP 117A takes advantage of the phase-stable nature of the lower frequencies to make possible quick comparisons to accuracies far exceeding those achieved by use of the older high frequency services. In the continental U.S., frequency standard comparisons to an accuracy of a part in 10^{10} can be approached in an 8-hr. period. A 24-hr. period may give 2 parts in 10^{11} , and a 30-day period may give accuracies of parts in 10^{12} . The local standard being calibrated must, of course, be of a quality commensurate with the realization of such high accuracies.

Template

A transparent template, overlaid on the HP 117A's strip chart recording, enables the operator to read at a glance the frequency offset of his local standard. The template curve most nearly matching the chart's trace is selected, then offset is read directly, together with its sign. The sign indicates whether local frequency lies above or below reference frequency.

Atomic and UT-2 Time Scales

Many users prefer to maintain their local frequency standard referenced to the interval of UT-2, the time scale in ordinary use, rather than to NBS-A (these two scales are explained at the beginning of the "Frequency and Time Standards" section). Use of a translator kit adapts the 117A for UT-2 service. Hewlett-Packard offers two translators:

The 00117-91027 Translator Kit installs in the 117A. A power-line-driven synchronous motor and gear train rotate a phase shifter to continuously retard the phase of the WWVB signal, thereby decrease the frequency. Power-line frequency changes of 0.1% cause translation errors of only about 1.5×10^{-11} . Most lines average much less than 0.1% frequency deviation over extended periods.

The K10-117A Translator is a separate instrument for use external to the 117A. It also uses a motor-driven phase shifter. It shifts the frequency of, and derives its time base from, the external 100 kHz (1 MHz, optional) source being compared with WWVB, and is unaffected by line frequency. The direction of translation can be changed.

In both translators, the correct gear ratio is supplied for coordinated frequency offset in effect at time of purchase. Different gear ratios will be available at a nominal charge to change the translation ratio when the offset is changed. The 117A is available with the 00117-91027 translator installed (see Specifications).

Antenna

The loop antenna supplied with the 117A contains a preamplifier which allows at least 300 meters of cable (30.5 meters supplied) between antenna and receiver. The cable's center conductor carries power to the preamplifier.

Antenna location and orientation are important. For best signal pick-up it should be mounted on the roof (it is sealed against the weather) and oriented with the plane of the loop aligned with signal direction.

Additional Information

A complete discussion of the use of lower frequency broadcasts in frequency standardization is included in Hewlett-Packard Application Note 52, "Frequency and Time Standards."

Phase Comparison Record

The slope of the trace plotted by the 117A's strip chart recorder is, at a given instant, frequency offset between the local standard and the received signal. This slope may be read at a glance with the transparent template supplied with the instrument. Two offset readings separated by a span of time usually chosen to be one day give all data needed to allow a determination of the drift rate of the local standard (drift rate is given by the difference in offset over a specified elapsed time).

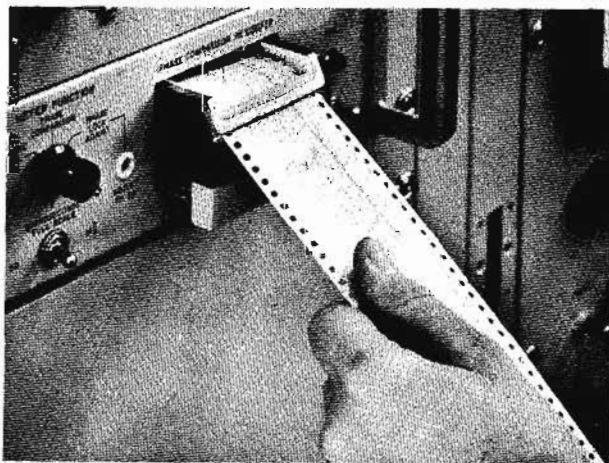

Greatest accuracy results when the user selects the times he makes observations to fall in a period when propagation conditions are stable, as revealed by the nature of the trace. VLF signals are normally highly stable when the entire propagation path is in sunlight. Near sunrise and sunset, the diurnal shift makes an apparent change in the offset.

Any VLF Comparator is but one element of the system which the user must consider: (1) transmitted signal, (2) transmission path, (3) VLF comparator, and (4) local standard. Since the first two elements are not under the user's control, he must make his observations in accordance with reception conditions. While VLF signals are noted for their stability, variations in propagation conditions do exist and must be taken into account.

European Service from MSF Rugby

The 60 kHz broadcast from MSF Rugby, which was extended to provide 24 hour service in the summer of 1966, has been successfully monitored with a standard 117A unit at Geneva. MSF is operated by England's National Physical Laboratory.

Received signal strength was entirely satisfactory and indicates a good possibility that the MSF service can be received throughout Western Europe.

Specifications, 117A

- Received standard frequency:** 60 kHz, NBS station WWVB.
- Sensitivity:** 1 μ V into 50 Ω
- Local standard input:** 100 kHz, 1 V rms into 1000 Ω (divider to accept 1 MHz at extra cost).
- 100 kHz phase-locked output:** 5 V rectangular positive pulses into 5000 Ω
- 60 kHz test output:** self-checks the 117A.
- Recorder outputs:** phase comparison and relative signal strength: 0-1 mA dc into 1400 Ω and 0.100 mV dc from 2000 Ω .
- Overall phase stability:** ± 1 μ sec 0-50 $^{\circ}$ C.
- Chart speed:** 1 in/hr (6 or 12 in/hr available).
- Chart width:** 50 μ s or 16 $\frac{2}{3}$ μ s (selected by front panel switch).
- Meter readings:** three switch positions: (1) relative signal level; (2) phase comparison calibrated scale 0-50 μ s 0-16 $\frac{2}{3}$ μ s full scale; (3) phase-lock range indicated insures negligible phase error.
- Adjustments:** a front panel control adjusts free-running frequency of voltage-controlled oscillator; three rear panel adjustments provide calibration of phase comparison, full-scale adjustment for internal recorder, internal meter, and external galvanometer recorder.
- Storage temperature:** -50 $^{\circ}$ to +75 $^{\circ}$ C.
- Operating temperature:** 0 to 50 $^{\circ}$ C.
- Dimensions:** 16 $\frac{3}{4}$ " wide, 3-15/32" high, 13 $\frac{1}{4}$ " deep (425 x 88 x 337 mm).
- Weight:** 117A: net 20 lbs (9,1 kg), shipping 22 lbs (10 kg); antenna: net 12.5 lbs (5,7 kg), shipping 21 lbs (9,5 kg).
- Power:** 115 or 230 V $\pm 10\%$ 60 cycles, 40 watts.

Accessories (included)

- 10509A loop antenna:** antenna has electrical height of 1.6 mm, is 43 in. (109 cm) diameter and mounts on 1-in. pipe thread. Operating temperature: -60 $^{\circ}$ to +80 $^{\circ}$ C. Also available separately (for use only with HP 117A), \$280.
- 10512A Coaxial lead-in cable:** 50 Ω BNC-BNC connectors 100 feet (30.5 m) long. Also available separately, \$30.
- Accessories (not included with 117A):**
- Time Scale Translators:**
- 00117-91027 translator kit, \$300.
- K10-117A translator, \$1,100.
- 9281-0081 recorder chart paper:** box of six 30-ft rolls, \$12.50.
- Prices:** 117A including 10509A antenna/pre-amp and 10512A lead-in cable, \$1,300.
- H21-117A: is model 117A with 0117-91027 translator installed, \$1,575.

FREQUENCY, TIME STANDARDS



FREQUENCY DIVIDER, CLOCKS

Time comparison capability to $\pm 10 \mu\text{s}$

Models 115BR, 115CR

Advantages:

- Generates precise time signals
- In-line digital readout
- Compatible with atomic or quartz frequency standards
- Suitable for mobile applications

Uses:

- Frequency and time standard systems
- Time comparisons against broadcast time signals

The HP 115BR and 115CR Frequency Divider and Clocks generate precise time signals, offer the convenience of digital readout, and provide features which make possible highly accurate comparisons against national time standards. Detailed records of oscillator drift rates and of time and frequency differences can be obtained.

Time readout is an in-line digital display of hours, minutes and seconds. An additional drum allows an operator to resolve time visually to 0.1 sec or by stroboscopic methods to 0.01 sec.

Overall time comparison accuracy is $\pm 10 \mu\text{s}$ and the divided outputs are virtually free from jitter. The time reference control is a precision resolver and the unique optical gate system cannot contribute jitter.

Hewlett-Packard Application Note 52 explains in detail how a time comparison system, set up to use precise time signals from WWV or another standard broadcast, can yield timekeeping accuracy to within a millisecond and enable studies of oscillator frequency drift rate and error. For microsecond accuracy a portable master clock is an ideal means for establishing this reference.

Success of time comparisons, typically made over periods of weeks or months, depends upon continuous operation. Premium electrical and mechanical components used in the 115BR/CR insure maximum reliability. The non-self-starting regenerative dividers avoid noise and spurious signal problems.

Driving standard

The 115BR/CR input frequency is 100 kHz. Recommended driving standards include the HP 105A/B, 106A/B, 107AR/BR Quartz Oscillators and HP 5061A Cesium Beam Standard. The HP 5061A option 01 contains a Frequency Divider and Clock which has considerably less jitter and rise and fall times than the 115BR/CR.

BCD time signals

By the addition of a Time Encoder, the 115BR/CR provides BCD time-of-day signals in addition to the standard output frequencies and visual time display.

Specifications, 115BR,CR

Input frequency: 100 kHz for ordinary time, input bandwidth $\pm 300 \text{ Hz}$; 100.3 kHz for sidereal time, on special order.

Input voltage: 0.5 to 5 V rms.

Pulse outputs: (see chart).

Accuracy: same as input frequency.

Input impedance: 300 Ω nominal.

Auxiliary output: (115BR only): amplitude, 0.25 V rms minimum; source impedance, approx. 1200 Ω ; frequency, 100, 10 and 1 kHz (60 Hz on special order).

Time reference: continuously adjustable, calibrated in 10 μsec

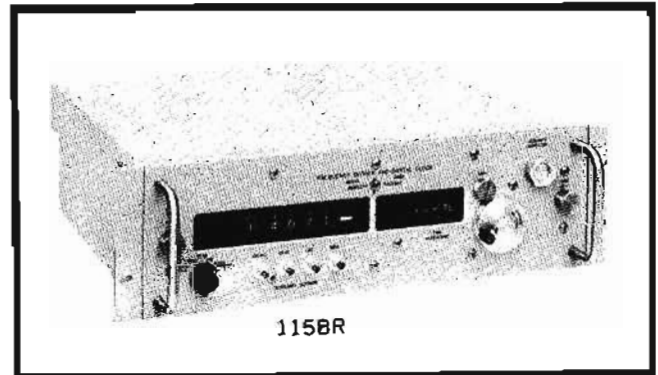

increments: numerical display from 999.9 ms to 000.0 ms in-line vernier in 10 μs increments.

Effect of transients: will not gain or lose time because of: (1) $\pm 300 \text{ V}$ step function on 100 kHz input; (2) 0 to 50 V pulses, 0 to 500 pps, 1 to 10 μs duration on 100 kHz input; (3) $\pm 4 \text{ V}$ step in 26 V dc input.

Characteristic	Positive t10k	Negative t10k	Auxiliary pulse*	Positive** 1 kHz p1ps
Pulse rate amplitude	1 pps $+10 \text{ V}^{***}$ min.	1 pps -10 V^{***} min.	1 pps $+4 \text{ V}$ min. open ckt, $+2 \text{ V}$ min. into 50 Ω	1000 pps $+4 \text{ V}$ min.
Rise time	2 μs max.	2 μs max.	1 μs max.	2 μs max.
Duration	20 μs min.	20 μs min.	200 μs	20 μs min.
Jitter	1 μs max.	1 μs max.	1 μs max.	1 μs max.
Recommended load impedance	4700 Ω min. shunted by 200 pF max.	1 M Ω min. shunted by 100 pF max.	50 Ω min. shunted by 5000 pF max.	1000 Ω min. shunted by 1000 pF max.

*Standard for 115BR, available for 115CR.

**Negative pulses available on special order.

***For any load impedance higher than minimum recommended.

Monitor meter: (115BR only), checks supply voltage, divider operation (100 kHz, 10 kHz, 1 kHz) and total clock current.

Power: 22 to 30 V dc, negative ground for operating with 106A/B or 107AR/BR, (may be selected by a switch), approximately 2.5 W, recommended supply, 724BR or 725AR (positive ground).

Environmental tests:*

115BR only: The 115BR Frequency Divider and Clock has been prototype-tested to pass the following military environmental specifications.

- Temperature:** MIL-E-16400C, Class 4, Paragraph 4.6.7. (Nonoperating test limits: -40°C to -60°C .)
- Humidity:** MIL-E-16400C, Paragraph 4.6.8.
- Vibration:** MIL-E-16400C, Paragraph 4.6.14.
- Inclination:** MIL-E-16400C, Paragraph 4.6.14.
- Shock:** MIL-E-16400C, Paragraph 4.6.14.

The 115BR is an airtight and watertight instrument.

Dimensions: 115BR: 19" wide, 5 1/4" high, 12" deep behind panel (483 x 133 x 356 mm); 115CR: 19" wide, 3 1/2" high, 12" deep behind panel (483 x 89 x 305 mm).

Weight: 115BR: net 35 lbs (15.8 kg), shipping 51 lbs (23.0 kg); 115CR: net 15 lbs (6.8 kg), shipping 25 lbs (11.0 kg).

Accessories furnished: 113A-16E Cable, 6 feet long (1830 mm), connects 115BR or 115CR to 724BR, 725AR, or 5085A standby power supply.

Price: HP 115BR, \$2750; HP 115CR, \$1500.

*These environmental specifications apply to the 115BR without the optional time encoders. For complete information regarding the ability of the 115BR (and time encoders) to pass military specifications, write Hewlett-Packard.

FREQUENCY SYNTHESIZERS



FREQUENCY, TIME STANDARDS

Hewlett-Packard frequency synthesizers translate the stable frequency of a precision frequency standard to any selected one of thousands, even billions of frequencies over a broad spectrum that extends from dc to 500 MHz. The selected frequency is known to quartz crystal oscillator accuracy; resolution is as fine as 0.01 Hz; and a new frequency can be switched upon electronic command in 20 μ s or from a keyboard as fast as the operator can push buttons. One synthesizer can do the work of a whole battery of oscillators and special-purpose signal generators and can do it better.

Synthesizers find application in many areas where the stability of a high-quality standard is required, including advanced communications, radio sounding, testing of frequency sensitive devices, and spectrum analysis.

The range of synthesized frequencies available is greatly extended with the Hewlett-Packard Synthesizer, Model 5105A/5110B, which covers 0.1 MHz to 500 MHz. Model 5105A is the newest addition to the Hewlett-Packard synthesizer group:

Hewlett-Packard Synthesizers

Model No.	Range	Minimum Step
5100B/5110B	0.01 Hz to 50 MHz	0.01 Hz
5102A	0.1 Hz to 1 MHz 0.01 Hz to 100 kHz	0.1 Hz 0.01 Hz
5103A	1 Hz to 10 MHz 0.1 Hz to 1 MHz	1 Hz 0.1 Hz
5105A/5110B	0.1 MHz to 500 MHz	0.1 Hz

All of the Hewlett-Packard Synthesizers offer digital selection from a pushbutton keyboard or by remote switch closure, and in addition, a search oscillator for continuously variable frequency selection. All derive their output frequency by the direct synthesis technique, one capable of translating the stability and spectral purity of the source to the selected output. All have a self-contained 1 MHz source, a precision quartz oscillator of excellent stability, and all can use in its place an external 1 MHz or 5 MHz standard.

Direct vs. indirect synthesis

Two basic approaches to frequency synthesis are "direct" and "indirect". Direct synthesis simply performs a series of arithmetic operations on the signal from the frequency standard to achieve the desired output frequency. In indirect synthesis, a master oscillator is phase

locked to signals derived from the standard.

The direct synthesis approach has the pronounced advantages of permitting fine resolution, fast switching, and a spectrally pure output signal. Also, direct synthesis is fail-safe. A system using indirect synthesis will provide an erroneous signal when a failure not suspected by the operator causes the variable frequency oscillator to become unlocked or to lock to the wrong frequency.

The synthesis operation

The 5100B/5110B and the 5105A/5110B synthesizers are made up of two completely solid-state units: the synthesizer proper, and the driver.

The driver contains a frequency source, a spectrum generator, and appropriate selective networks. The source is a high quality crystal oscillator housed in an oven. It is well protected from line voltage variations, and has an aging rate of less than 3 parts in 10^6 per day. A crystal filter at the oscillator output limits the noise bandwidth to about 150 Hz.

The spectrum generator is a step-recovery diode. Active filtering, synchronously tuned transistor stages and frequency dividers provide a series of fixed frequencies between 3 and 39 MHz which are fed to the synthesizer unit.

The synthesizer unit contains harmonic generators and suitable mixers, dividers, and amplifiers to derive the desired output frequency as a function of the fixed frequencies. The front-panel pushbuttons actuate a diode switching matrix. All frequencies appearing at the inputs to this matrix are always present. This is one of the key advantages of the direct synthesis method. The limitations on switching speed are just the time constants on the filtering circuits in the supply line to the switch and circuit bandwidths.

High-speed switching

The oscillogram of Figure 1 shows the speed which is typical of Hewlett-

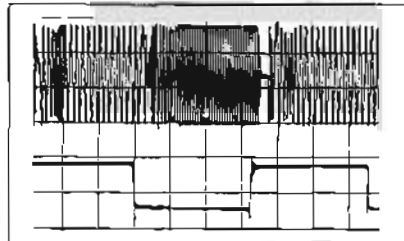

Figure 1. Switching speed, Model 5103A: 1.2 MHz to 2.7 MHz, 30 kHz switching rate. 5 μ s/cm, 10 MHz Range.

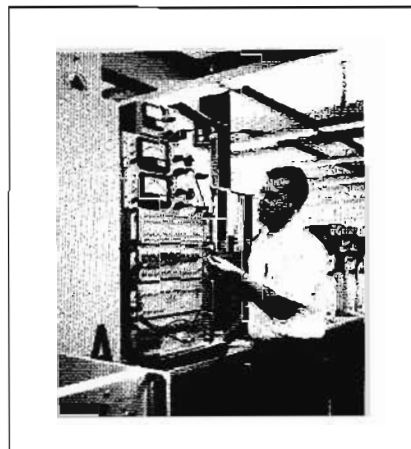

Figure 2. Stability monitoring equipment.

Packard synthesizers when they change output frequency under electronic command. The upper waveform is synthesizer output; the lower is the externally applied switching voltage. Note the virtual absence of dead time and switching transients.

Signal purity

Two of the central design objectives for the Hewlett-Packard synthesizers were (1) virtual elimination of non-harmonically related spurious signals and (2) the reduction of noise to as low a level as possible. Noise appears as a small, random phase modulation which adversely affects the short-term stability of a signal.

Performance of the Model 5100B/5110B is typical of Hewlett-Packard synthesizers and attests to the attainment of these objectives: non-harmonically related signals are at least 90 dB below the selected frequency, and signal to phase noise ratio is greater than 54 dB (in a 30 kHz noise bandwidth centered on the signal, with a 1 Hz central band excluded).

At Hewlett-Packard, a considerable number of engineering years have been spent on problems of frequency stability and its measurement. Routine production line tests are made of frequency stability with the use of specially designed equipment of a sophistication not often found even in frequency measurement research laboratories. Figure 2 shows a multi-channel short-term frequency stability monitor used to check each Hewlett-Packard synthesizer driver. This equipment monitors both rms and peak phase noise of all the driver outputs at the same time and shows an alarm light if any one of the set limits is exceeded.

FREQUENCY, TIME STANDARDS



FREQUENCY SYNTHESIZER

0.1 to 500 MHz in 0.1 Hz increments
Model: 5105A - 5110B

Advantages:

- Frequencies from 0.1 MHz to 500 MHz
- Push-button selection in 0.1 Hz increments, plus Search oscillator
- Remote programming
- Switching speed typically 20 μ s
- Spurious 70 dB down
- All solid-state, modular construction

Uses:

- Offers new levels of spectral purity and stability for such applications as:
 - Accurate doppler measurements
 - Microwave spectroscopy
 - Narrow-band telemetry
 - Automatic testing of frequency-sensitive devices
 - Communications systems

The Model 5105A Frequency Synthesizer, a new member of the Hewlett-Packard group of synthesizers, extends frequency synthesis capability to 500 MHz. The 5105A provides push-button or remote selection of any frequency from 0.1 MHz to 500 MHz in steps as small as 0.1 Hz. The 5105A shares with the other Hewlett-Packard synthesizers the utilization of direct synthesis. This technique translates the stability and spectral purity of the source to the selected output, and in addition, provides a fail-safe output. The 5110B Synthesizer Driver described on page 548 supplies the 22 fixed frequencies required as input to the 5105A. The 5110B is capable of driving up to four 5105A Synthesizers. Source for the frequencies is a precision 1 MHz quartz oscillator of excellent stability. If desired for special applications, an external 1 MHz or 5 MHz frequency standard can be used instead. These features, plus others such as phase modulation input and variable output level, establish the 5105A-5110B as a precision variable frequency standard which brings a new capability to the frequency range 0.1 to 500 MHz.

Continuous Tuning, Sweep, FM

A search oscillator provides continuously variable frequency selection over the range of any one column except the tens and hundreds of megahertz columns (the left-hand two). Operation of a front-panel control manually tunes the search oscillator over the complete frequency range of the selected digit, that is, over incremental ranges from 1.0 Hz through 10 MHz. One of the advantages afforded by continuous control is the easy identification of an unknown frequency by beating it against the synthesizer output.

The search oscillator also may be controlled by application of a dc voltage (-1 to -11 volts, linearity $\pm 5\%$) which enables remote operation and gives sweep capability.

The search oscillator can be frequency modulated from an external source (sinewave) at a maximum rate of 1 kHz while retaining the voltage control calibration.

Remote operation

The 5105A-5110B offers control flexibility never before possible in a precision frequency source of its range. Any frequency or search oscillator position available from the keyboard can be remotely selected and can be rapidly switched: in 20 μ s, typically.

Rear panel connectors on the 5105A provide pins corresponding to each front panel pushbutton, a ground connection, and a -12.6 volt line for use in remote programming. A combination of remote and local programming may be used, if so desired.

No actual contact closure, such as a relay, is required. The -12.6 volts dc may be applied to the selected pin by electronic means.

The remarkably fast switching speed, valuable for such tasks as automatic digital frequency tracking, is one of the significant advantages of the direct synthesis method. There are no phase-locked loops which must settle to a final value when output frequency is changed.

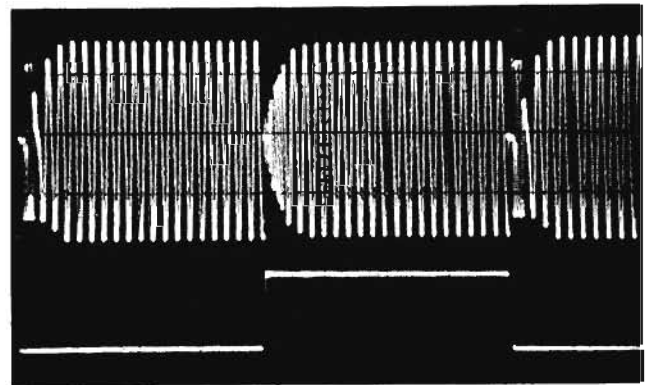

Figure 1. Synthesizer switching speed (25 μ s/cm).

Fast switching

Figure 1 shows (upper trace) the 5105A-5110B output frequency switched between 399.8 MHz and 400.2 MHz with 400 MHz subtracted to display switching in greater detail. The sweep is 25 μ s/cm. The lower trace is that of the switching waveform applied to the synthesizer.

Low noise performance

To achieve the excellent low-noise output specified for the 5105A-5110B Synthesizer over the full range requires the utmost care in design to identify and minimize noise sources followed by extensive testing at each stage of manufacture.

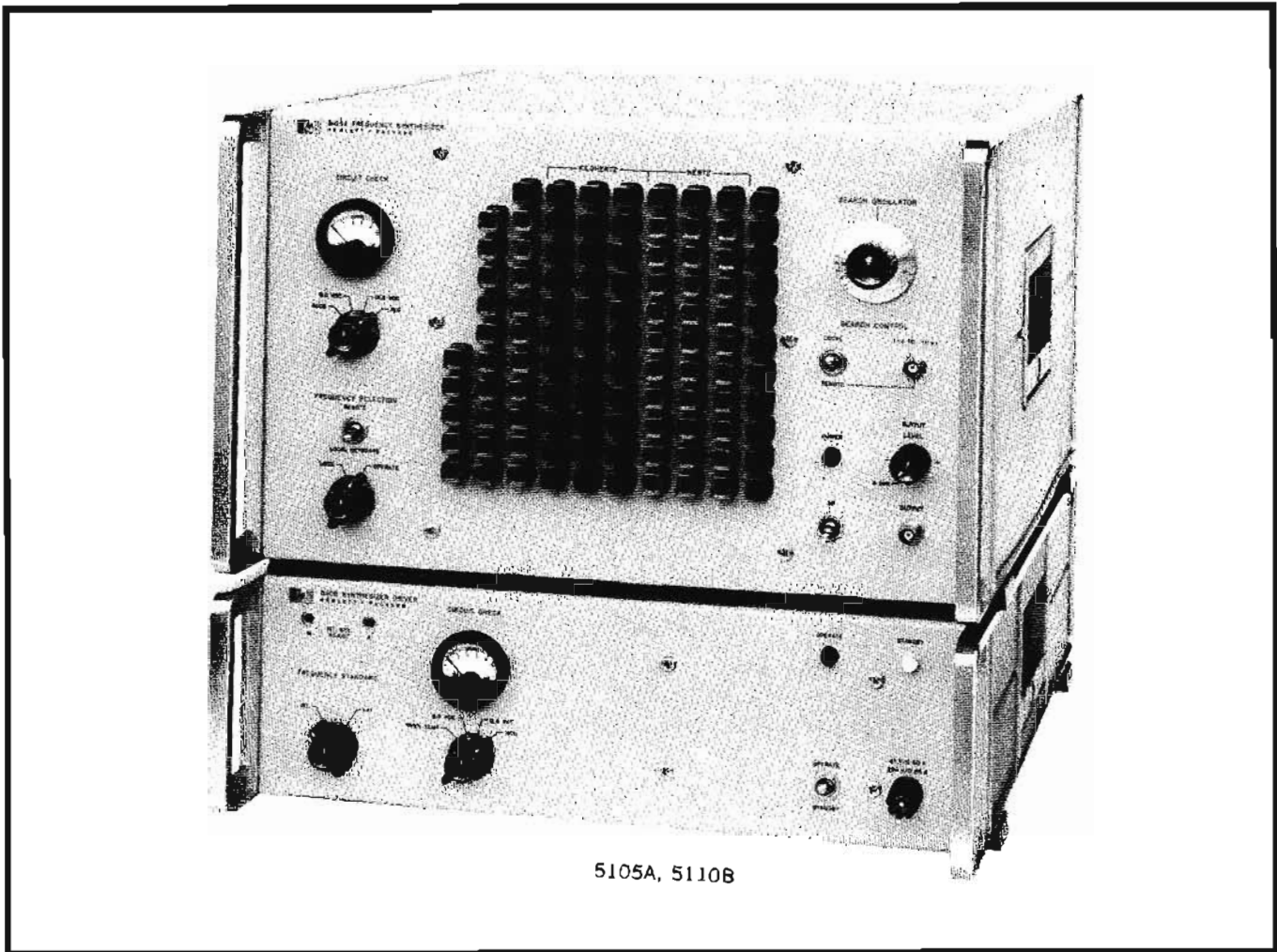

5105A, 5110B

Figure 2 shows phase noise distribution at 500 MHz. The ratio of output signal to single-sideband phase noise (in a 1-Hz bandwidth) is plotted against frequency of offset from the signal.

The noise performance reflected in this plot is remarkable for an instrument as complex and versatile as the 5105A-5110B, and demonstrates its suitability for applications where spectrum requirements are critical. One such application would be as a local oscillator in a single-sideband communications system, both for transmitters and for receivers.

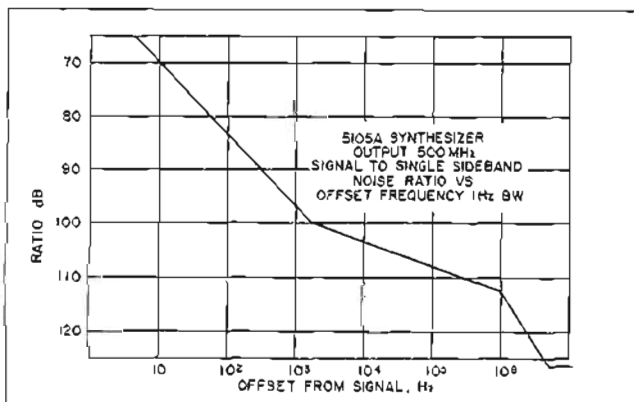

Figure 2. Log plot of phase noise.

Spectral purity and stability

Spurious signals are at least 70 dB below the selected output. This reflects the extremely high level of spectral purity and stability achieved for the 5105A-5110B by advanced design.

Many applications require that a signal be multiplied. If the frequency multiplying device is broadband, the ratio of total sideband power to signal power increases as the square of the multiplying factor; since total power is constant, the increased sideband power must come from the carrier. The spectrum begins to spread, owing to intermodulation.

To achieve a signal having a good spectrum after high multiplication requires that the original signal have the highest possible signal-to-phase noise ratio. The 5105A has a signal-to-phase noise ratio (measured in a 30 kHz band centered on the signal, excluding the 1 Hz central band) which is excellent:

- At 1 MHz, 48 dB
- At 100 MHz, 48 dB
- At 500 MHz, 40 dB

Specifications

Specifications for the 5105A Synthesizer are presented on page 605. Specifications for the 5110B Synthesizer Driver are presented on page 606.

FREQUENCY, TIME STANDARDS



FREQUENCY SYNTHESIZER

DC to 50 MHz, 5 billion discrete frequencies
Model 5100B/5110B

Advantages:

- Digitally frequency selection
- 0.01 Hz frequency increments
- Spurious 90 dB down
- Remote programming
- Switching speed typically 20 μ s

The Hewlett-Packard Model 5100B/5110B Frequency Synthesizer provides any output frequency from 0.01 Hz to 50 MHz, selectable in steps as small as 0.01 Hz. The output frequency is derived from a precision single frequency source through direct synthesis, a technique which translates the stability and spectral purity of the source to the selected output. A precision 1 MHz quartz oscillator is provided, or an external 1 MHz or 5 MHz standard may be used.

Spectral purity

Particular care has been exercised in the design of the Model 5100B/5110B to insure that a very clean output signal is provided over the entire frequency range. A high order of spectral purity is essential for accurate doppler measurements, microwave spectroscopy, narrow band telemetry or communications, and similar applications. The design and construction of the 5100B/5110B make it possible to obtain output signals with a spurious content at least 90 dB below the selected output.

The 5110B Synthesizer Driver generates 22 spectrally pure signals from the standard signal. 21 of these frequencies are then fed to the 5100B Frequency Synthesizer by means of rear panel BNC connectors and are continuously available. The variable output signal is synthesized from these fixed frequencies by a series of arithmetic operations.

Fast switching

Since no phase-locked loops are involved, switching from one output frequency to another can be accomplished very rapidly, either from the front panel pushbuttons or remotely. Typically, 20 μ s are required to change output frequency.

Remote control

Any frequency or search oscillator position that can be selected by front panel pushbuttons can also be remotely selected. Connectors located on the 5100B rear panel provide pins corresponding to each front panel pushbutton position, a ground connection, and a -12.6 volt line for use in remote programming. The -12.6 volts is available in two arrangements — continuous and switched. This lends additional versatility since it enables the use of a combination of remote and local programming.

An actual contact closure such as a relay is not required for remote control of the Synthesizer. The required -12.6 volts dc may be applied to the selected pin electronically.

Modular construction

Modular construction has been used throughout the 5100B/5110B. The modular concept enables the system to

meet stringent demands regarding spurious signals since the isolation that it affords minimizes spurious coupling. It also enhances serviceability. Careful design and quality control insure that all modules are interchangeable from one instrument to another.

Search oscillator

The search oscillator can be selected either locally or remotely and swept either locally or remotely. Besides facilitating searching for an unknown frequency, the search feature permits frequency modulation of the output at a maximum sinewave rate of 1000 Hz, phase locking the synthesizer into another system, or sweep operation with a sweep range as small as 0.1 Hz. The incremental range of the search oscillator is between 0.1 Hz and 1 MHz, depending upon the column selected for search. Any one of the right-hand eight columns may be searched.

Simple operation

Operation of the 5100B/5110B is straightforward. The output frequency is selected simply by depressing one pushbutton in each of the 10 columns of pushbuttons. Any frequency that can be selected by the pushbuttons can be programmed remotely. The Lock-Operate switch prevents accidental operation of the pushbuttons. The Circuit Check switch and meter on both the 5100B and 5110B provide quick and easy checks of internal circuits. The Frequency Standard switch selects either the 1 MHz internal quartz oscillator or an external frequency standard, if desired.

Specifications

The table on the facing page lists specifications for the 5100B Synthesizer. The 5110B Synthesizer Driver is presented on page 606.

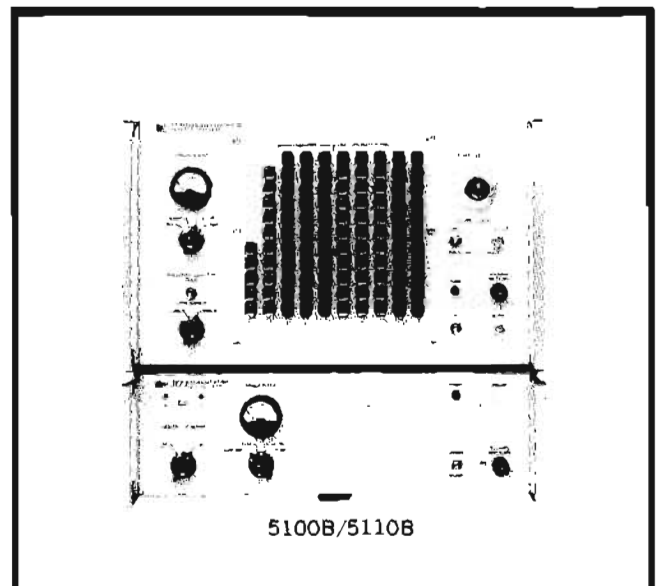

Specifications
5105A, 5100B Synthesizers

Specifications	5105A*	5100B*																																									
Output frequency	0.1 MHz to 500 MHz	dc to 50 MHz																																									
Digital frequency selection	0.1 Hz through 100 MHz per step. Selection by front panel pushbutton or by remote switch closure. Any change in frequency may be accomplished in 20 μ s typically.	0.01 Hz through 10 MHz per step. Selection by front panel pushbutton or by remote switch closure. Any change in frequency may be accomplished in 20 μ s typically.																																									
Output voltage	Fixed: 0 dBm \pm 1 dBm into a 50 ohm resistive load. Variable: -6 dBm to \geq 6 dBm into a 50 ohm resistive load.	1 volt rms \pm 1 dB from 100 kHz to 50 MHz. 1 volt rms +2 dB, -4 dB from 50 Hz to 100 kHz, into a 50 ohm resistive load. Nominal source impedance is 50 ohms. 15 mV rms minimum open circuit from 100 kHz down to dc, at separate rear output connector, source impedance of 10,000 ohms with shunt capacitance approximately 70 pF.																																									
Search oscillator	Provides continuous variable frequency selection with an incremental range of 1.0 Hz through 10 MHz. Manual or external voltage (-1 to -11 volts) control with linearity of \pm 5%.	Provides continuously variable frequency selection with an incremental range of 0.1 Hz through 1 MHz. Manual or external voltage (-1 to -11 volts) control with linearity of \pm 5%.																																									
Phase modulation	(rear panel input) \pm 3 radians maximum deviation; dc -1 MHz rate.																																										
Signal-to-phase noise ratio	Measured in a 30 kHz band centered on the signal (excluding a 1 Hz band centered on the signal) is greater than: <table border="1" style="margin-left: auto; margin-right: auto;"> <tr> <td>Output frequency—MHz</td> <td>1</td> <td>50</td> <td>100</td> <td>500</td> </tr> <tr> <td>Ratio—dB</td> <td>48</td> <td>48</td> <td>48</td> <td>40</td> </tr> </table>	Output frequency—MHz	1	50	100	500	Ratio—dB	48	48	48	40	Greater than 54 dB in a 30 kHz band centered on the signal (excluding a 1 Hz band centered on the signal).																															
Output frequency—MHz	1	50	100	500																																							
Ratio—dB	48	48	48	40																																							
Signal-to-AM noise ratio	(Above 100 kHz): Greater than 74 dB in a 30 kHz band.																																										
RMS fractional frequency deviation (with a 30 kHz noise bandwidth)**	<table border="1" style="width: 100%; text-align: center;"> <thead> <tr> <th rowspan="2">Averaging time</th> <th colspan="8">Output frequency</th> </tr> <tr> <th>1 MHz</th> <th>50 MHz</th> <th>100 MHz</th> <th>500 MHz</th> <th>1 MHz</th> <th>5 MHz</th> <th>10 MHz</th> <th>50 MHz</th> </tr> </thead> <tbody> <tr> <td>10 ms</td> <td>1×10^{-7}</td> <td>2×10^{-9}</td> <td>1×10^{-9}</td> <td>6×10^{-10}</td> <td>3×10^{-8}</td> <td>6×10^{-9}</td> <td>3×10^{-9}</td> <td>6×10^{-10}</td> </tr> <tr> <td>1 s</td> <td>2×10^{-9}</td> <td>4×10^{-11}</td> <td>2×10^{-11}</td> <td>1×10^{-11}</td> <td>3×10^{-10}</td> <td>6×10^{-11}</td> <td>3×10^{-11}</td> <td>1×10^{-11}</td> </tr> </tbody> </table>								Averaging time	Output frequency								1 MHz	50 MHz	100 MHz	500 MHz	1 MHz	5 MHz	10 MHz	50 MHz	10 ms	1×10^{-7}	2×10^{-9}	1×10^{-9}	6×10^{-10}	3×10^{-8}	6×10^{-9}	3×10^{-9}	6×10^{-10}	1 s	2×10^{-9}	4×10^{-11}	2×10^{-11}	1×10^{-11}	3×10^{-10}	6×10^{-11}	3×10^{-11}	1×10^{-11}
Averaging time	Output frequency																																										
	1 MHz	50 MHz	100 MHz	500 MHz	1 MHz	5 MHz	10 MHz	50 MHz																																			
10 ms	1×10^{-7}	2×10^{-9}	1×10^{-9}	6×10^{-10}	3×10^{-8}	6×10^{-9}	3×10^{-9}	6×10^{-10}																																			
1 s	2×10^{-9}	4×10^{-11}	2×10^{-11}	1×10^{-11}	3×10^{-10}	6×10^{-11}	3×10^{-11}	1×10^{-11}																																			
Spurious signals	Non-harmonically related signals are at least 70 dB below the selected frequency.	Non-harmonically related signals are at least 90 dB below the selected frequency.																																									
Harmonic signals	25 dB below the selected frequency, (applicable to fixed output when terminated in 50 ohms).	30 dB below the selected frequency (when terminated in 50 ohms).																																									
Dimensions	16 $\frac{3}{4}$ " wide, 16 $\frac{3}{8}$ " deep, 10-15/32" high (425 x 416 x 266 mm).																																										
Weight	net, 75 lbs (34 kg); shipping, 133 lbs (61 kg).																																										
Equipment furnished	Decade test cable: 05105-6054/55. Cable Assembly (connects 5105A Synthesizer to 5110B Driver) permits up to approx. 2.5 feet vertical separation.	05100-6180 Decade Test Cable, 05100-6066 Output Cable, 05100-6212/13 Cable Assembly connects 5100B Synthesizer to 5110B Driver. Permits rack mounting a 5100B up to approx. 2.5 ft. above or below the 5110B Driver. A special-length-cable assembly will be required for other mounting arrangements.																																									
Special cable	Special cable available. Specify configuration and length (50 ft. max.). Cable is supplied in five-foot increments. Price: \$40 per five-foot increment.	If a special-length cable assembly is required, order spec C05-5110B. Specify configuration and length (max. separation 50 feet). Cable is supplied in five-foot increment only. Price: \$40 per five-foot increment.																																									
Price	\$9,150. (Requires 5110B)	\$8,150. (Requires 5110B)																																									

*Requires 5110B Driver.

**Note: When the 5110B Driver utilizes an external frequency standard, this will affect the stability and spectral purity of the output. Performance data stated above are based on internal frequency standard or indicate synthesizer contribution to over-all performance with external standard.

FREQUENCY, TIME STANDARDS



SYNTHESIZER DRIVER

For the 5100B and 5105A Synthesizers
Model 5110B

The HP 5110B Synthesizer Driver supplies the HP 5100B and 5105A Synthesizers with 22 fixed, spectrally pure signals derived from a 1 MHz precision quartz oscillator.

The frequency synthesizer system comprising the 5105A Synthesizer and the 5110B Driver provides output frequencies from 0.1 to 500 MHz in increments as small as 0.1 Hz. The 5100B - 5110B system provides output frequencies from dc to 50 MHz in increments as small as 0.01 Hz. These synthesizers are described on pages 602-605.

The 1 MHz quartz oscillator which is the source for all output frequencies of the synthesizer driver is stable to ± 3 parts in 10^9 per 24 hours. To help maintain this excellent crystal stability, oven circuits are energized any time the instrument is connected to the power line. A circuit check meter allows verification of correct oven operation.

Where special requirements make it necessary that synthesized frequencies be derived from an external frequency standard, a rear panel connector on the 5110B and the 5110B accepts a 1 MHz or 5 MHz signal. Substitution of an external standard results in having the characteristics of the synthesized frequencies made partially dependent upon the characteristics of the external standard.

These synthesizer drivers are each capable of driving up to four synthesizers. Drivers equipped in accordance with Options 02 through 04, for driving from two to four synthesizers, must have additional outputs not in use terminated in 50 ohms in order that full specified spurious performance be met.

Specifications Synthesizer Driver 5110B For the 5100B and 5105A Synthesizers

Output frequencies: Provides 22 fixed frequencies for Frequency Synthesizer operation: 3.0 through 3.9 MHz in 0.1 MHz steps (50 mV ± 1 , -3 dB) 30 through 39 MHz in 1 MHz steps, 24 MHz, and 20 MHz (100 mV ± 1.5 dB), 50 Ω system. Note: 20 MHz is not used with the 5100B Synthesizer.

1 MHz buffered output (1 V ± 1.5 dB into a 50 Ω resistive load) available at rear panel connector.

Internal frequency standard:

Type: 1 MHz Quartz Oscillator.

Aging rate: Less than ± 3 parts in 10^9 per 24 hours.

Stability: As a function of ambient temperature: $\pm 2 \times 10^{-10}$ per $^{\circ}\text{C}$ from 0°C to $+55^{\circ}\text{C}$. As a function of line voltage $\pm 5 \times 10^{-11}$ for a $\pm 10\%$ change in line voltage (rated at 115 or 230 volts rms line voltage).

Short term (with internal crystal filter): Adequate to provide the 5100B and 5105A performances noted on page 605.

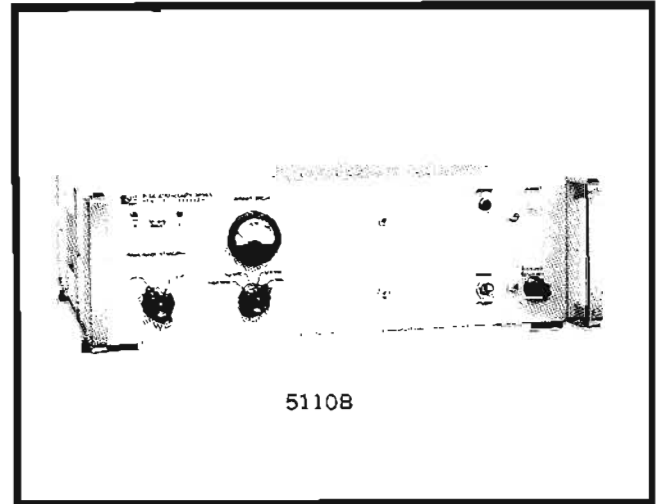

Phase-locking capability: A voltage control feature allows 5 parts in 10^8 frequency control for -5 to $+5$ volts applied externally.

External frequency standard input requirements: 1 MHz or 5 MHz, 0.2 V rms minimum, 5 V maximum across 500 ohms. Stability and spectral purity of Frequency Synthesizer will be partially determined by the characteristics of the external standard if used.

Dimensions: 16 $\frac{3}{4}$ " wide, 5-7/32" high, 16 $\frac{3}{8}$ " deep (425 x 133 x 416 mm).

Weight: Net, 54 lbs (25 kg). Shipping, 67 lbs (30 kg).

Operating temperature range: 0 to $+55^{\circ}\text{C}$.

Interference: Complies with MIL-I-26600, Class 1 and 3, MIL-I-6181D.*

Susceptibility: Complies with MIL-I-26600, Class 1 and 3, MIL-I-6181D.

Power: 115 or 230 V $\pm 10\%$, 50 to 400 cycles, 35 W.

Optional features: The Synthesizer Drivers are capable of driving up to four Frequency Synthesizers:

Option 02, outputs for driving two synthesizers, \$125; Option 03, for three, \$235; Option 04, for four, \$345.

Accessories available: 10510A BNC termination, 50 Ω . If Option 02-04 has been selected, outputs not connected to a Synthesizer must be terminated in 50 Ω if full specified spurious performance is required. For each set of outputs not connected to a Synthesizer, 22 of these 50 Ω terminations are required; thus, if Option 04 Driver is connected to only one Synthesizer, 66 would be required. Price, \$5 each.

Special interconnecting cable sets are described on page 605.
Note: Small phase jumps may be experienced in additional synthesizer when first is switched in frequency.

Price: Model 5110B, \$4350.

*Interference compliance requires that the 5100B/5105A and 5110B are connected by a low inductance path such as adjacent rack mounting.

FREQUENCY SYNTHESIZERS

Broad frequency coverage, dual-range
Models 5102A, 5103A



FREQUENCY, TIME
STANDARDS

The HP Models 5102A and 5103A Frequency Synthesizers increase synthesizer capability, providing instruments with dual-output frequency ranges of 100 kHz and 1 MHz (5102A), and 1 MHz and 10 MHz (5103A).

The 5102A provides output frequencies from 0.01 Hz to 100 kHz and from 0.1 Hz to 1 MHz in increments of 0.01 Hz and 0.1 Hz respectively. Output frequencies from 0.1 Hz to 1 MHz in increments of 0.1 Hz, and from 1 Hz to 10 MHz in 1 Hz increments are provided by the 5103A. Both instruments synthesize the output frequency from a single frequency source, translating the stability of the source to the output frequency via a direct synthesis technique. A very stable quartz oscillator, provided with each synthesizer, or an external 1 MHz (or 5 MHz) frequency standard may be used as the frequency source.

A Level control on the front panel allows continuous adjustment from 300 mV to 1 volt rms, of frequencies (greater than 50 Hz available at the front-panel BNC. For frequencies below 50 Hz, the signal is taken from a rear-panel Low Level output BNC. Frequencies available at the rear-panel BNC have a signal strength of approximately 80 mV for the 5102A and 20 mV for the 5103A.

Dual-range feature

The two distinct (dual) frequency ranges of the 5102A and 5103A provide the user with extended capability at minimum cost and without sacrifice of a convenient module size. The upper range extends the frequency capability of each model, at the same time retaining high levels of stability and spectral purity. The higher frequency capability has frequency increments that are the same percentage of the range maximum as in the lower frequency range.

The choice of frequency range is dependent on the maximum frequency required and is selected by the Range switch located on the front panel. The Range switch also positions a moveable label bar, conveniently indicating the decimal value of each column of pushbuttons. For both ranges the output frequency is selected three ways.

With the Frequency Select switch in the Local position, the output frequency is selected by seven columns of pushbuttons, arranged for rapid frequency selection. A locking switch is provided to prevent accidental operation of the pushbuttons once they are set. In addition, the full range of each column may be continuously varied either manually or externally by a search oscillator. Any frequency or search oscillator position locally controlled may be remotely selected via rear-panel connectors to each of the front-panel pushbuttons. The Frequency Select switch is positioned in Remote for remote control. Combined local-remote operation also is possible with the switch in the Local position. Any column not locally selected may be remotely controlled. Less than 20 μ s are required to switch between frequencies in the local mode of selection and also in the remote mode if proper impedance levels are selected for the remote controller. The switching speed is very rapid and accurate, due to the direct synthesis technique used, which eliminates slower, hard to synchronize phase-locked loops.

The search oscillator provides continuous tuning in any selected column plus an external sweep capability. This is an L-C oscillator which allows the operator to continuously "search" any significant column from 1 MHz to 0.1 Hz either manually by a front-panel control or remotely by application of a suitable voltage. The typical voltage vs frequency characteristic is shown in Figure 1. The approximate slope is

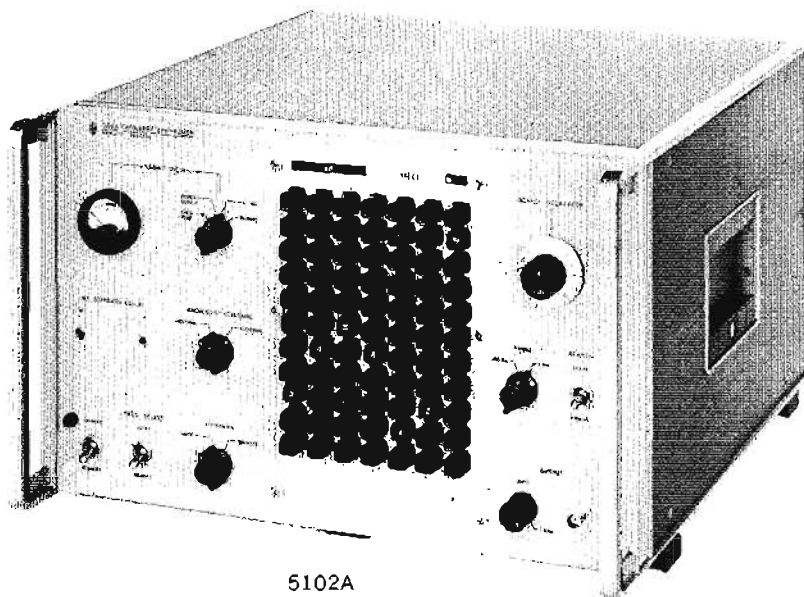

5102A

10% of the selected column's range per V. The search oscillator may be frequency modulated from an external source at a maximum sine wave rate of 1 kHz while retaining the voltage control calibration.

If the search oscillator is used, the stability of the synthesizer output is determined by either that of the standard instrument or that of the search oscillator—depending on the column which is "searched."

Outputs from the 5102A and 5103A are very clean over the full frequency ranges. Careful design and solid-state modular construction yield the high order of spectral purity essential for applications requiring clean and stable frequencies.

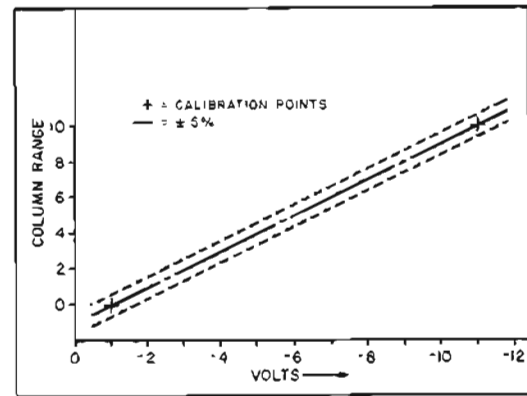

Figure 1.

Specifications

HP Model	5102A	5103A							
Output frequency:	100 kHz range: 50 Hz to 100 kHz; 1 MHz range: 50 Hz to 1 MHz	1 MHz range: 50 Hz to 1 MHz; 10 MHz range: 50 Hz to 10 MHz							
Output voltages:	Maximum output 1 V rms \pm 1 dB into 50 Ω resistive load. Level control (front panel output BNC) provides a minimum of 10 dB continuously variable attenuation.								
Auxiliary outputs:	(1) Low level: dc to value of range, both ranges (rear-panel BNC); (2) $f_0 + 30$ MHz (f_0 is selected frequency, dc to 1 MHz, both ranges) rear-panel BNC; (3) 1 MHz frequency standard (rear-panel BNC)								
Auxiliary output voltage:	(1) Low level 80 mV rms (minimum) open circuit (2) $f_0 + 30$ MHz: 1 volt rms, \pm 2 dB into a 50 Ω resistive load (3) 1 MHz: 1 volt rms, \pm 1.5 dB into a 50 Ω resistive load 20 mV rms (minimum) open circuit								
Digital frequency selection:	100 kHz range: 0.01 Hz to 10 kHz steps; 1 MHz range: 0.1 Hz to 100 kHz steps Selection by front-panel pushbutton or by remote contact closure; any change in frequency may be accomplished in $< 20 \mu$ s provided appropriate rear-panel connection is used	1 MHz range: 0.1 Hz to 100 kHz steps; 10 MHz range: 1 Hz to 1 MHz steps							
Switching time:	$< 20 \mu$ s for any change in frequency								
Search oscillator:	Provides continuously variable frequency selection in any desired column over complete range of that column; manual by a front-panel control or by an external voltage (-1 to -11 volts)								
Signal-to-phase noise ratio (output)*:	(Output): 100 kHz range, > 74 dB 1 MHz range, > 64 dB ($f_0 + 30$ MHz): > 60 dB	(Output): 1 MHz range, > 64 dB 10 MHz range, > 54 dB ($f_0 + 30$ MHz): > 60 dB							
Signal-to-AM noise ratio*:	(Output): 100 kHz range, > 80 dB for frequencies above 30 kHz; 1 MHz range, > 74 dB for frequencies above 100 kHz ($f_0 + 30$ MHz): > 80 dB	(Output): 1 MHz range, > 74 dB for frequencies above 100 kHz; 10 MHz range, > 74 dB for frequencies above 500 kHz ($f_0 + 30$ MHz): > 80 dB							
RMS fractional frequency deviation:	(Output):								
	100 kHz range	1 MHz range	1 MHz range	10 MHz range					
	Ave. Time	100 kHz Output Frequency	Ave. Time	100 kHz Output Frequency	1 MHz Output Frequency	Ave. Time	1 MHz Output Frequency	Ave. Time	10 MHz Output Frequency
	10 ms	3×10^{-8}	10 ms	1×10^{-7}	1×10^{-8}	10 ms	1×10^{-8}	10 ms	3×10^{-9}
	1 s	3×10^{-10}	1 s	1×10^{-9}	1×10^{-10}	1 s	1×10^{-10}	1 s	3×10^{-11}
(Output):		(Output):							
Ave. Time	Output Frequency	Ave. Time	Output Frequency						
10 ms	6×10^{-10}	10 ms	6×10^{-10}						
1 s	1×10^{-11}	1 s	1×10^{-11}						
Spurious signals:	100 kHz range: > 90 dB; 1 MHz range: > 70 dB (below selected output for non-harmonically related signals)	1 MHz range: > 70 dB; 10 MHz range: > 50 dB							
Harmonic signals:	> 35 dB on all ranges, all outputs (with proper termination)								
Internal frequency standard:	1 MHz quartz oscillator								
Internal frequency standard aging rate:	less than ± 3 parts in 10^9 per 24 hours								
Stability of internal frequency standard (as function of ambient temp.): (as function of line voltage):	$\pm 2 \times 10^{-10}$ per $^\circ\text{C}$ from 0°C to $+55^\circ\text{C}$ $\pm 5 \times 10^{-11}$ for a $\pm 10\%$ change in line voltage (115 or 230 V)								
External frequency standard:	1 MHz or 5 MHz, 0.2 V to 5 V rms across 500 Ω								
Standard input requirements:	stability and spectral purity of synthesizer will be partially determined by the characteristics of external standard if used								
Operating temperature range:	0 to $+55^\circ\text{C}$								
Dimensions:	16 $\frac{1}{4}$ " wide, 10-15/32" high, 16 $\frac{3}{8}$ " deep (425 x 266 x 416 mm)								
Weight/power:	net 75 lbs (34 kg); shipping 127 lbs (58 kg)/115 or 230 V \pm 10%, 50-400 Hz, 50W								
Price:	\$6,500	\$7,100							

*In a 30 kHz band centered on the carrier, excluding a 1 Hz band centered on the carrier.

FREQUENCY SYNTHESIZER APPLICATIONS



FREQUENCY, TIME STANDARDS

Hewlett-Packard Frequency Synthesizers are signal sources (essentially multiple frequency standards) whose output frequency can be selected from a keyboard or by electronic command to a very high resolution. Such an instrument with its extremely high spectral purity and stability constitutes a powerful tool in a wide range of systems and scientific applications.

Communications

The high spectral purity of synthesizer output signals makes them ideal as local oscillators in receiver applications where frequency agility and/or narrow I.F. bandwidths are required of the receiver.

Their very stable output frequencies make these synthesizers suitable for use in homodyne receiver circuitry. The advantages of using a synthesizer in this application are simplicity and freedom from image problems, both of which plague many receiver designs.

Data handling systems in all areas of industry and military applications use magnetic tape as a storage medium, linking the receiver to the data processing and analysis equipment. However, magnetic tape is not without fault, introducing certain distortions to the data. A synthesizer may be used to eliminate the degrading effects wow and flutter have on information that is received and stored on magnetic tape. This use is facilitated by the ability of the user to bypass the internal crystal filter in the synthesizer driver section. The input reference frequency may be offset by as much as 0.25%, with the same percentage offset translated to any output frequency. Thus, a recorded reference channel on the tape can be used as the reference frequency of the synthesizer, and wow and flutter can be removed by comparing the data channel with a convenient synthesizer output frequency derived from the reference channel.

A surveillance receiver system which monitors multiple data channels by rapidly switching between channels is an ideal area of application for one of the Hewlett-Packard frequency synthesizers. With its rapid, highly repeatable switching capability, a synthesizer will serve as the local oscillator in this type of receiver, providing the proper local oscillator frequency for each channel under surveillance. A similar application arises in radio sounding applications, used to de-

termine the maximum usable frequency allowed by ionospheric conditions. Since these conditions are always in a state of change, the ability of a synthesizer to generate test transmissions rapidly over the entire hf spectrum makes it an important tool for radio sounding.

The high spectral purity which characterizes the Hewlett-Packard synthesizers allows signal multiplication to microwave frequencies. HP synthesizers are ideal for use as the local oscillator in microwave communications systems.

A laboratory-type receiver capable of flat response over a broad range can easily be arranged with use of one of the synthesizers as the local oscillator, together with a broadband mixer and a narrow-band amplifier. For example, a combination of the HP 5105A/5110B Synthesizer, the HP 10514A Mixer, and the HP 415D SWR Meter exhibits an exceedingly flat response over the range 100 kHz to 500 MHz and a sensitivity greater than 10^{-16} watt.

Radar

The 5100B/5110B is capable of switching between output frequencies in 0.01 Hz increments at a very fast rate; thus it is capable of making very good approximations of frequency versus time functions. This performance feature finds application in high performance "chirp" radar installations, which require an ultra linear sweep.

In doppler radar applications the Hewlett-Packard frequency synthesizer easily supplies all the necessary requirements for precise velocity measurements. The excellent stability of the synthesizer makes it ideal as the basic signal source in the transmitter, which requires stability capable of staying within a receiver bandwidth only a few cycles wide in the microwave region. A 5100B/5110B or another of the synthesizers also is well suited for use as the local oscillator in the doppler receiver, where the local oscillator must be capable of rapid change in order to keep the returning signal within the narrow receiver bandwidth.

NMR applications

Nuclear magnetic resonance spectroscopy methods are used to determine the qualitative and quantitative structure of molecules. In NMR, the strength of an applied dc magnetic field and the frequency of simultaneously applied rf field

uniquely determine the spin-interaction of nuclei. In this application the broad frequency range and precise 0.01 Hz increments of frequency are very valuable.

Short-term stability measurements

Hewlett-Packard synthesizers are ideal for use in systems to evaluate short-term frequency stability. Often denoted as phase noise, short-term stability can be characterized by three measures: a phase noise vs. frequency of offset plot, a total measurement of instability over a frequency band, and statistical parameters. Their own excellent stability makes HP synthesizers ideal for use in systems to make these measurements on signal sources (such as oscillators) and on a variety of circuits: amplifiers, limiters, and filters. Systems for phase noise measurement utilizing the synthesizer offer a practical solution to problems of production testing. A synthesizer can serve as the frequency reference and also as the source of excitation for the circuit to be evaluated.

Synthesizer specials

Since their introduction in 1963, Hewlett-Packard synthesizers have found many unusual applications. Users have been quick to take advantage of synthesizer versatility and have shown great ingenuity in applying synthesizers to many research, manufacturing, and field instrumentation needs that otherwise could have been met only by costly laboratory-designed equipment.

Where none of the standard synthesizers can serve the need, however, Hewlett-Packard engineers in the synthesizer design group stand ready to apply their special knowledge to select, adapt or modify synthesizers to meet a customer's special requirements. It often proves to be the case that needs can be met with instruments built on the production line to narrowed environmental specifications, or with faster switching speed, or with changed output frequency ranges. Whenever possible, the synthesizer group specifies simple modifications that can be made at relatively low cost to the customer, thereby avoiding the far greater expense of special engineering design. Where necessary and warranted, though, this group will devise and build special synthesizers. Discuss your requirements with your Hewlett-Packard field engineer.



Hewlett-Packard offers research grade instruments for measurement of nuclear radiations. Important characteristics of nuclear radiations are their energy, angular distribution, and time relationships. Electronic pulse techniques are used for assessing and recording these characteristics.

Pulse spectrometers start with a radiation detector capable of producing an electrical pulse with amplitude related to the energy of the incident radiation. These detector signals are further amplified and are shaped suitably for analysis. Finally, the shaped pulses are sorted according to size or to time of arrival and are counted. A spectrum showing numbers of pulses versus energy constitutes the output information. HP Nuclear offers instruments capable of serving in each one of these areas: detectors, amplifiers, scaler-timers, and recorders.

The area of greatest interest for Hewlett-Packard's instruments lies with research physicists and chemists, with teachers, and with specialists in nuclear medicine. The Hewlett-Packard packaging format utilizing modular design and a unique systems approach brings real benefits for those customers who often need complex systems adaptable to a variety of measurements.

HP scintillation detectors find application for measuring gamma or X-radiation from solids or liquids. The appropriate model can be selected for sample size and for either planchet or test tube counting. All models offer a NaI(Tl) crystal-photomultiplier tube assembly and a preamp-amplifier with three levels of gain and pulse shaping. These components are housed in a sturdy stainless steel case for RFI and noise shielding, and for convenient decontamination and clean-up.

The Hewlett-Packard nuclear scalars accept pulses from a wide variety of nuclear detectors to accumulate, display and record nuclear events.

The Hewlett-Packard Multichannel Analyzer is the fastest, most accurate, more versatile system available for spectrum analysis.

In the AEC-NBS standard configuration, Hewlett-Packard offers the NIM Series of nuclear instrument modules: a power supply and combining case, a linear amplifier, and a single channel analyzer. Soon these will be joined by other modules presently under development.

Hewlett-Packard offers a unique capability among nuclear instrumentation manufacturers: witness to this is the cata-

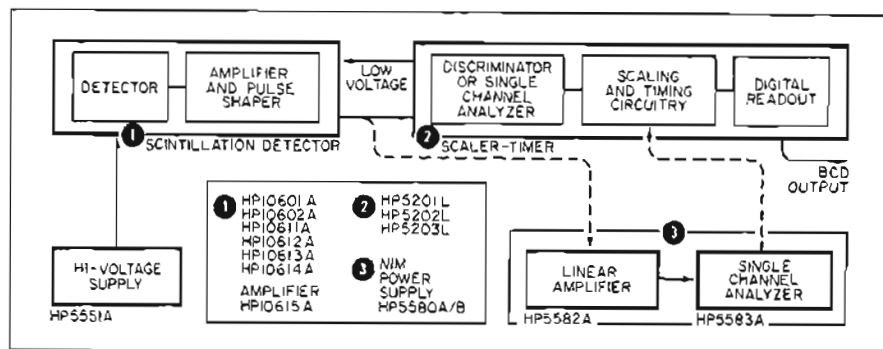

Figure 1. Nuclear system block diagram

log you are now reading, filled with data acquisition and recording instruments and systems of every type. This in-house capability brings the customer an important benefit. His instrumentation interface problems are for the most part eliminated entirely, and those that remain can be completely solved on an engineer-to-engineer basis within Hewlett-Packard where technical details can be exchanged in full.

Spectrometer systems—single channel analyzer

The basic nuclear instrumentation system Hewlett-Packard offers for counting nuclear events with use of a single channel analyzer is shown in Figure 1. It is a complete system for detecting, counting, and displaying gamma radiation. All systems for counting nuclear events contain these basic instruments, although they may be packaged differently. The Hewlett-Packard packaging format, utilizing modular cabinets, provides for the widest possible range of applications. Instruments are grouped so that they may be used to count almost any type of nuclear event if the proper detector is used.

There are many types of detectors available, each with an application for which it is best suited. For example, crystals of sodium iodide activated with thallium, NaI(Tl), are well suited for detection of gamma radiation. Hewlett-Packard uses this crystal in the integral assemblies of the 10600A series Scintillation Detectors.

With the 5201L Scaler-Timer operated in pulse height analysis mode, that is in the "narrow window— ΔE mode", the system may be used for counting all pulses with heights falling within a window having a width calibrated between 0 and 0.5 volt. With this narrow window,

the user is able to easily analyze the photo peaks of radiation samples.

If the window of the single channel analyzer in the 5201L is swept across the full energy spectrum of the sample, providing total energy spectrum information, the system is a scanning gamma spectrometer. Addition to the system of the HP 5552A Spectrum Scanner gives the user an automatic system.

NIM Series

Hewlett-Packard now has in production three instruments in the AEC-NBS standard configuration: the HP 5580A/B NIM Power Supply (a combining case and supply), the HP 5582A Linear Amplifier, and the HP 5583A Single Channel Analyzer.

The AEC-NBS standard configuration is a concept aimed at reducing the experimenter's interface difficulties. A typical physics experiment requires a rather large array of equipment; interface problems often result. An AEC-NBS committee took these problems in hand and has formulated a set of standards (TID-20893) for compatibility in size and voltage requirements among instruments.

The 5580A/B NIM Power Supply promotes trouble-free operation of the modular instruments it houses and powers by providing hefty power capability, blower cooling, and protection circuits. In addition to the standard voltage outputs, ± 24 V and ± 12 V, the 5580A/B also supplies ± 6 V. Many modular instruments will utilize integrated circuits, and many of these require ± 6 V. An efficient blower forces air through each module and also through the supply itself, with the air drawn first through the modules. The excellent heat removal provided can mean the difference between stable operation and drift, or even premature failure. The 5580A/B has an overvoltage protection

circuit that imposes limits on lower voltage circuits should they accidentally be shorted to higher voltage circuits, and prevents positive supplies from going negative and vice versa.

The 5582A Linear Amplifier provides maximum flexibility for nuclear pulse counting with all types of detectors and with a wide range of counting rates. RC shaping time constants, selectable by front panel switches, allow the experimenter to choose the optimum pulse shape for the detector and preamplifier he is using. In addition to RC shaping, there are two plug-in delay lines for shaping. The 5582A provides single or double differentiation and also integration, and gain is variable from 2 to 1280.

The 5583A Single Channel Analyzer has two basic modes of operation: single channel for pulse height analysis and dual integral where the discriminators operate as completely independent integral discriminators. The 5583A offers 200 nanosecond multiple pulse resolution, and strobed and/or gated operation.

Before the end of the year, Hewlett-Packard will offer in the NIM Series a set of timing modules that will enable the experimenter to make precise time as well as pulse height information the basis for his nuclear studies.

Hewlett-Packard digital systems

The choice between digital or analog treatment for data from a nuclear detector is a choice that must be made in many types of nuclear measurements. Hewlett-Packard offers digital systems that have significantly improved accuracy for most measurements. One digital system is an HP 5201L Scaler-Timer, an HP 581A Digital-to-Analog Converter, and an HP 680 Strip Chart Recorder. For comparison, an analog system is a ratemeter with a recorder of the same general type. A ratemeter does not have the six-digit resolution of a scaler and is not capable of its theoretical accuracy. It is a useful supplement where highest accuracy is not required.

Even where an analog trace is to be the primary data record, digital collection has many advantages. Comparisons of the reliability of analog and digital methods show that digital data recording offers markedly greater sensitivity and accuracy¹. In addition, digital recording lends itself to computer processing.

Applications in nuclear medicine

Hewlett-Packard offers the means to acquire and analyze a mass of measurement data—and to give the nuclear medi-

cal specialist results in a form that is directly useful.

To nuclear medicine, Hewlett-Packard brings 27 years of electronics experience. With a Hewlett-Packard system made up of components that are field proven and reliable, and put together by a team of experts, the nuclear specialist need not worry about such matters as time constants, frequency response, linearity, impedance matching, systems and line noise, cabling and grounding, overload recovery, count rate shift—all problems that Hewlett-Packard's nuclear instrumentation engineers can solve for him.

Multichannel analyzer

The Hewlett-Packard 5400A Multichannel Analyzer rapidly records a complete energy spectrum by simultaneously registering data into 1024 memory channels. The resulting spectrum, in the form of a histogram plot with the number of events as a function of energy (pulse height, voltage, time), can be displayed "live" during accumulation, or after.

Multichannel analyzers, first developed for nuclear physics research and today widely used also for analyzing mixtures of radionuclides, have a host of potential applications in many other areas.

The HP analyzer, described on the next two pages, is an extremely versatile instrument with three modes of operation: pulse height analysis, sampled voltage analysis, and multi-channel scaling.

In Pulse Height Analysis mode, the MCA accumulates a pulse height distribution. In Sample Voltage Analysis mode, the 5400A continually monitors an input waveform, samples it on command, and processes waveform amplitude at that instant as though it were a pulse. Result is a plot of the probability density function of the signal. In Multichannel Scaling mode, the 5400A sequentially addresses each channel and it may be incremented by an input pulse string; thus, each one serves as a scaler. This is useful for Mössbauer applications and time-rate studies.

Figures 2 and 3 are oscillograms taken directly from the 5400A. Figure 2 shows a spectrum of selenium-75 taken with a lithium-drifted silicon detector. Figure 3 shows the probability density function for a sine wave. The 5400A's CRT is far superior to any offered as standard equipment on a multichannel analyzer. The HP H51-180A Oscilloscope is the mainframe for the 5431A Display plug-in; all that is needed to have a 50 MHz dual channel oscilloscope is a set of two plug-ins: the HP 1801A Vertical Amplifier and the HP 1820A Time Base (see pages 494, 496).

Modular design and use of plug-ins make the 5400A easy to modify and to expand. The user has the assurance that

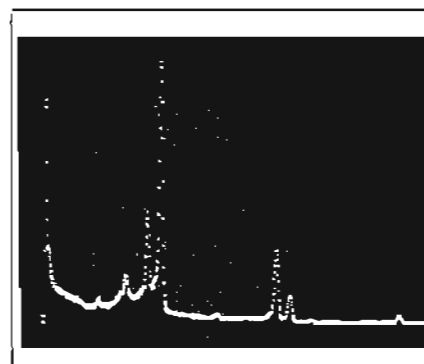

Figure 2. Spectrum of selenium-75

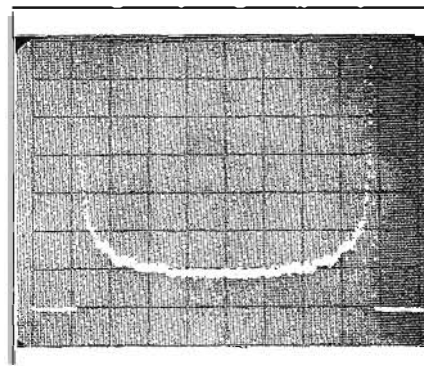

Figure 3. Probability density function for a sine wave

tomorrow's capabilities can be added at minimum cost.

Complete input-output flexibility is achieved by provision of an interface card cage. Simply by installing new circuit cards, the experimenter can record his data on perforated paper tape, magnetic tape, typewritten pages, or on a digital recorder print-out. He can even interface to the HP 2116A Instrumentation Computer.

Ease of use is built into the 5400A. Controls are grouped logically and annunciator lights indicate pertinent controls for each mode of operation. System calibration is simple and quick with use of a built-in pulse generator that supplies visual markers.

Specifications place the 5400A in a class by itself. First, speed: a 100 MHz clock rate ADC and an extremely short dead time make possible high counting rates and short resolving times. Second, linearity: integral linearity is within $\pm 0.1\%$ and differential linearity is within $\pm 1\%$ over 100% of the range. Third, stability: ADC base line and gain are automatically checked and adjusted at the rate of 20 times per second to give outstanding stability; gain $\pm 0.2\%/^{\circ}\text{C}$, zero drift $\pm 0.1\%/^{\circ}\text{C}$.

The 5400A was designed from the bench top up by the Nuclear Design Group at Hewlett-Packard. Extensive use of integrated circuits has made it possible to pack many useful features into a compact instrument. The Model 5400A will be available late in 1967.

¹Application Note 79, "Statistical Comparison of a Digital System and a Ratemeter for Nuclear Measurements."

NUCLEAR

MULTICHANNEL ANALYZER

100 MHz clock rate ADC; complete I/O flexibility
Model 5400A

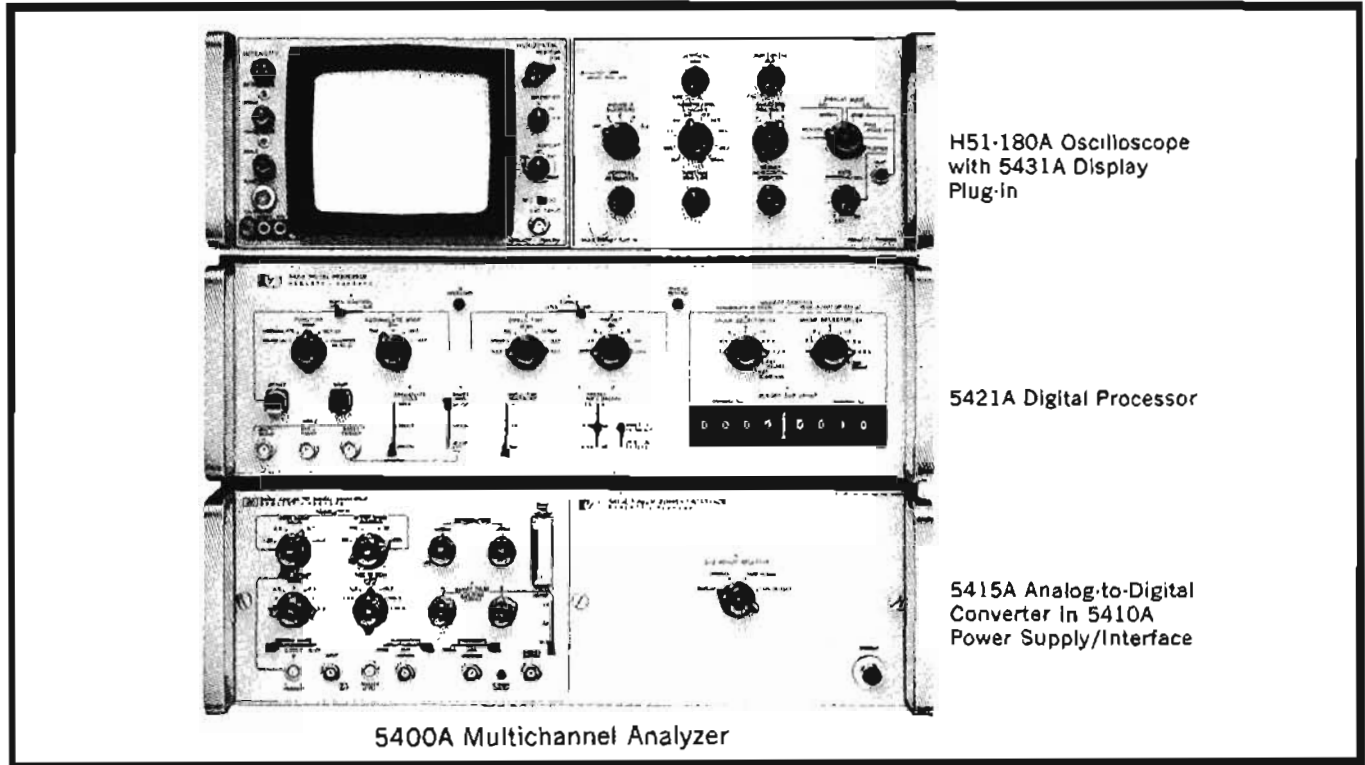

H51-180A Oscilloscope
with 5431A Display
Plug-in

5421A Digital Processor

5415A Analog-to-Digital
Converter in 5410A
Power Supply/Interface

5400A Multichannel Analyzer

Advantages:

- 1024 channels (Option 010, 512)
- Linearity $< 0.1\%$ integral and $< 1\%$ differential.
- 100 ns multiple pulse resolution (MCS mode).

The Hewlett-Packard 5400A Multichannel Analyzer is a fast, accurate, versatile tool for spectrum analysis work. It has a pulse height analyzer (PHA) mode of operation, a sampled voltage analysis (SVA) mode of operation (for probability function analysis) and a multichannel scaling (MCS) mode of operation.

Built in modular form, it consists of an analog-to-digital converter plug-in, which is housed in a power supply/interface mainframe, a digital processor, and a 50 MHz oscilloscope mainframe and display plug-in. This modular "three box" approach allows complete separation of the three main functions—digitizing the input, manipulation, and control of the digital data and visual display. This separation, the logical grouping of function controls and an annunciator function keying system make operation of front panel controls self-explanatory.

The Hewlett-Packard Multichannel Analyzer has also been designed with an input/output interface "card cage" to allow quick and easy adaptations of a wide variety of I/O devices at a modest cost. These I/O interface printed circuit cards are optional and may be added to the 5400A initially or any time after receipt of the instrument.

Specifications

ACCUMULATION MODES

PULSE HEIGHT ANALYSIS (PHA)

In this mode, the analyzer accumulates a pulse height distribution. Automatic termination of data accumulation may be employed. Coarse pulse amplitude discrimination is provided. Coincidence with an externally applied signal may also be a criterion for acceptance of a pulse.

Input pulse requirements:

- Amplitude range: 1.25 V; 2.5 V; 5 V; 10 V; positive.
- Pulse shape: > 100 ns to peak above the baseline.
- Input impedance: $1\text{ k}\Omega$, < 60 pF shunt; dc coupled.
- Trigger level: 10 mV to 1 V adjustable (establishes timing).
- Time to peak: 0.4 μ s to 12.8 μ s in binary steps.

ADC clock rate: 100 MHz.

Output Range: 128; 256; 512; 1024 channels.

Conversion gain (channels out/volt in):

- Range: 1024 channels/1.25 volts to 128 channels/10 volts.
- Gain change accuracy: 2:1, $\pm 0.1\%$ /step.
- Temperature stability: $< \pm 0.005\%$ / $^{\circ}\text{C}$.
- Time drift: $< \pm 0.01\%$ /24 hours.

Baseline (Input offset):

- Voltage: adjustable 0 to $+10$ V in 7 steps of 1.25 V/step + vernier.
- Vernier: 0 to ± 1.25 V; 0 to ± 25 mV; OFF.
- Step accuracy: ± 10 mV.
- Count rate shift: < 1 channel to 90% dead time.
- Temperature stability: $< \pm 0.1$ mV/ $^{\circ}\text{C}$.
- Time drift: $< \pm 1$ mV/24 hours at fixed temperature.

Integral linearity: $< \pm 0.1\%$ over 100% of range.

Differential linearity: $< \pm 1\%$ over 100% of range.

Pulse analysis time:

Up to 128 channels and up to 3.2 μ s coincidence strobe time—3.4 μ s.

Up to 512 channels and up to 6.4 μ s coincidence strobe time—6.6 μ s.

For 1024 channels or for greater than 6.4 μ s coincidence strobe time—13 μ s.

System dead time: analysis time plus time to peak.

System noise: less than 1 mV rms referred to the ADC input.

Coincidence inputs (normal and strobed):

Amplitude: 4-12 V positive.

Pulse shape: dc level or with specified timing. For Timing-Normal, input must be high for >100 ns after pulse crosses trigger level and prior to the coincidence strobe. For Timing-strobed, input must be high for a >300 ns interval which includes the coincidence strobe. Coincidence Strobe is a 200 ns pulse, generated at a time presettable in 400 ns intervals over the range 0-12.8 μ s after the input peak time, or after the sample pulse in the SVA mode. Output monitor jack provided. Timing jitter-strobe: \pm 50 ns from average.

Discriminators (upper and lower level) range: 0 to +10 V.

Dead time meter:

Accuracy: \pm 5%.

Live timer accuracy: \pm 0.5%.

Data control: add or subtract, switched.

Timing: count up to Preset, or down to Zero.

Present time range: live or Clock time, switch selectable; 0.01 min to 5000 min (decade steps x multiplier in 1, 2, 5, steps).

Memory grouping: any quarter, any half or whole memory.

Pulses exceeding selected memory range are rejected. No pulses are stored in 1st channel of group selected.

External routing: external control of memory grouping.

Pulse requirements: positive 4-12 V for 100 ns.

Channel capacity: to 10^6 counts.

Memory size: 1024 channels (standard), 512 channels (optional).

MULTICHANNEL SCALING (MCS)

In this mode, the analyzer sequentially addresses each channel of the selected portion of memory and the contents of each address may be incremented by an input pulse string. There is provision for vertical display. The address information is converted to an analog voltage available for such applications as driving a Mössbauer apparatus.

Input pulse requirements: (AEC standard compatible)

Amplitude: 4-12 V positive.

Input impedance: 1 k Ω , 50 pF shunt (dc coupled).

Minimum pulse width: 25 ns; separation 65 ns.

Pulse pair resolution: 100 ns.

Dwell time per channel: 10 μ s to 5 s (decade steps x multiplier in 1, 2, 5, steps), or ext.

Present sweeping: 1 sweep to 500,000 sweeps (decade steps x multiplier in 1, 2, 5, steps).

Sweep modes

Single: internal or external triggering.

Continuous sweeping: internal or external triggering with saw-tooth sweep drive; increasing channel number. Also, internal triggering with triangle waveform drive; increasing then decreasing channel number. (Output is available to drive Mössbauer apparatus for three sweep modes.)

Dead time between channels: 2.2 μ s.

SAMPLED VOLTAGE ANALYSIS (SVA)

(Probability density functions.) Operation in this mode is identical to pulse height and analysis except that the ADC continuously monitors a slowly changing voltage, samples it upon receipt of a pulse, and processes the sampled voltage as though it were a pulse.

Input signal requirements:

Amplitude range: 1.25 V; 2.5 V; 5 V; 10 V.

Polarity: positive.

Bandwidth: 1024 Channel Range, dc to 30 kHz; 128 Channel Range, dc to 240 kHz.

Input impedance: 1 k Ω , <60 pF shunt, dc coupled.

ADC clock rate: 100 MHz.

System dead time: analysis Time plus 400 ns.

Elapsed time or sweeps: first channel of selected memory group records elapsed time in 0.01 min increments (PHA and SVA modes) or number of sweeps (MCS and Test).

Analog set-up marker generation

In this mode, 2 variable amplitude pulse generators in the ADC provide pulse pairs—first one amplitude, then the other—at a jack on the ADC panel. These pulses are routed through the linear signal processing electronics to be set up, then into the ADC. Vertical stripes are generated on the CRT. Their horizontal position is an indication of pulse amplitude. The stripes may be used as references for adjusting system gain and baseline.

Digital processor operations

Transfer memory quarters: the contents of any quarter or either half of the memory may be transferred to any other quarter or the other half respectively. The data is retained in the sending memory group. Data previously stored in the receiving group is erased.

Erase memory contents: the data in any quarter or half of the memory, or the contents of the entire memory, may be erased.

READ-IN/READ-OUT MODES

CRT display (linear) modes, live and static: in Live, the channels are addressed and their contents displayed as they are being incremented. In Static, channels in a selected group are sequentially addressed and displayed.

Display time per point: 10 μ s minimum.

Channel identification:

Decades: intense dot for channels numbered 10^n .

Sub group: $\frac{1}{2}$ cm tail on data point.

Horizontal gain: x1 to x20 continuous. Expand about center screen.

Horizontal quarters full screen: 1, 2, 4; selectable.

Quarter overlap: halves or quarters may be overlapped, 2nd, 3rd, 4th quarters and 2nd half are movable vertically, to fully off screen, up or down.

Vertical gain: x1 through x3, continuous.

Vertical counts per centimeter: (5 cm full scale) 200, 500, 1k to 200k in 1, 2, 5 sequence. Selectable.

Analog plotter output

Amplitude: +5 V full scale into open circuit.

Impedance: 100 Ω .

Resolution: \pm 0.1% of full scale.

Integral linearity: \pm 0.2% of full scale.

Zero drift: \pm 0.1%/°C, \pm 0.1%/day at fixed temp.

Gain drift: \pm 0.05%/°C, \pm 0.1%/day at fixed temp.

Output rate: external timing, 600 channels per sec max; internal, 1-20 channels per sec, variable.

Analog output (for driving remote oscilloscope)

Digital output, parallel and serial

Logic levels: A state 0 V to 1 V, sink 20 mA. B state 2.4 k Ω to +12 V. "1" state, A or B. Negative voltages optional.

Control signals: transfer command output/ready command input; \pm dc level or pulse.

Output code: parallel, \pm 1-2-4-8 BCD; serial, ASCII.

Format: parallel, data + address, 10 digits per transfer. Serial, address plus 10 channels of data per line, includes leading zero suppression. Each line: carriage return; line feed; 4-digit address; spaced data.

Rate: 60,000 transfers/second maximum, parallel or serial.

Digital input: serial ASCII code with above format.

Logic levels: A state, -2 V to +1.5 V. B state, +4 V to 12 V. "1" state A or B; negative voltages optional; input impedance, 1 k Ω .

Rate: 60,000 characters per second.

Price: HP 5400A (1024 word memory), \$9500.

Option 010 (512 word memory), \$8750. (See data sheet for prices of input/output options.)

NUCLEAR



Nuclear Instrument Modules

AEC compatible series

Models 5582A, 5583A, 5580A/B

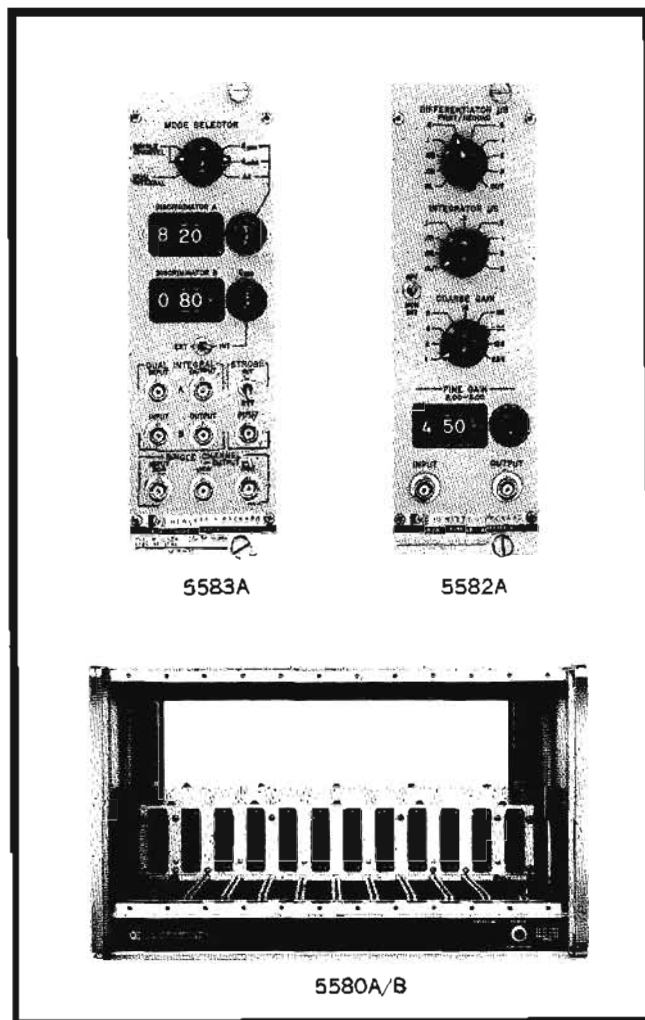

Advantages:

- TID-20893 compatible
- Easy to operate
- Versatile, research grade instruments

Model 5583A

The Hewlett-Packard Model 5583A Single Channel Analyzer is the most versatile instrument of its type ever offered. The 5583A has two basic modes of operation: single channel for pulse height analysis and dual integral where the discriminators operate as completely independent integral discriminators.

In the single channel mode, discriminator A may operate as ΔE (narrow window) to determine the window width up to 1.00 V wide. The window is tied to discriminator B (E_{min}) which determines the window's position relative to zero volts. Discriminator A may also operate as E_{max} ; the two discriminators may then be varied independently over their range.

In the single channel mode there are outputs triggered from both the leading edge and trailing edge of the input signal. The trailing edge outputs, fast negative and slow positive, are generated for input signals with amplitudes within the window limits. For single channel analysis work, this instrument may be strobed, either internally or externally.

A gate input allows the application of a +3 V signal to inhibit the output of the single channel analyzer.

The discriminators have a highly readable and in-line display of voltage 0.05-10.05 V, set by 10-turn pots.

Model 5582A

The Hewlett-Packard Model 5582A Linear Amplifier is an original HP design which provides maximum flexibility for nuclear pulse counting with all types of detectors and with a wide range of counting rates.

Front panel switches give the user his choice of pulse shaping for optimum response: integration and single or double RC differentiation, or single or double delay line shaping. Eight RC time constants from 20 ns to 5 μ s are provided.

The delay lines are plug-ins, making a change easy if different time constants are needed. Shaping times from 1 μ s to 100 ns are available. The standard 5582A is supplied with 1 μ s delay lines and these are temperature compensated for stability.

The fine gain control is variable from 2.00 to 5.00 by means of a 3-turn pot with horizontal in-line gain markings which eliminate ambiguity in reading.

Model 5580A/B

The Hewlett-Packard 5580A/B NIM Power Supply provides output voltages required by AEC-NBS standards (TID-20893), houses any combination of modular instruments (NIM) in a sturdy bin, and promotes trouble-free operation by oversized power capability, blower cooling, and special protection circuits.

Total power output capability is 120 watts and current ratings allow heavy drain without overload: ± 24 V at 2A, ± 12 V at 4A, and ± 6 V at 5A. In addition to the standard voltage outputs, the 5580A/B also supplies ± 6 V needed for modular instruments that utilize integrated circuits.

The 5580A/B incorporates a number of features that protect the nuclear instrument modules to which it is supplying power. A warning light advises the operator when operation could be marginal and protection circuits act automatically to prevent costly damage due to shorts and overloads.

The 5580A and the 5580B are electrically identical. Both are rack mount or bench top convertible, all hardware included. The 5580A provides space for 11 single widths in the NIM configuration and is packaged to be compatible with the standard Hewlett-Packard modular enclosure system. The 5580B has space for 12 single widths and because of this has its side frames $\frac{1}{2}$ in. wider than the standard HP enclosure.

Specifications

5582A Linear Amplifier

Input

Polarity: positive or negative.
Impedance: 1.5 k Ω , dc coupled.
Maximum voltage: 15 V peak, 15 V dc.

Gain

Range: 2 to 1280.
Resetability: one minor division (0.2% of full range at constant temperature).
Control: coarse, switch from 1 to 256 in binary steps. Fine, continuously variable from 2.00 to 5.00.

Pulse shaping

RC mode: integration, first and second differentiation: Time constants for each, 0.25-5 μ s in 1, 2, 5 sequence.
Delay line mode: single or double; 1 μ s delay lines (plug-ins) are standard; others are available.

Amplifier

Rise time: < 40 ns, typically 25 ns.
Bandpass: 2 kHz to 6 MHz, typical.
Stability: gain shift < 0.05%/°C, typically 0.02%/°C.

Output

Amplitude: ± 10 V except ± 5 V at 0.02 and 0.05 μ s differentiation time constants.
Impedance: < 5 Ω ; minimum load 90 Ω .
Polarity: positive and negative.
Delay: 65 ns, relative to input, typical.
Linearity: integral, < 0.3%; differential, < 1%, 0.3% below 8 volts (typical).
Noise: < 15 μ V RMS referred to input at maximum gain.
Crossover walk: < ± 0.5 ns.
Count rate shift: < 0.05% with inputs to 10⁸ cps, typical.
Overload recovery: from a 200x overload to 2% of baseline in less than 3 non-overload pulse widths.
Gain control input: for external fine gain control; BNC.
Power required: +24 V, 260 mA; -24 V, 325 mA.
Preamp power out: +24 V (TNC connector).
Price: \$550.

Option 01: 5582A without delay lines, \$500. With special delay lines installed, add \$75. Plug-in delay line kits (each has two delay lines), \$75.

Time Constant, ns	Delay Line Kits	5582A with Special Delay Lines Installed
100	K01-5582A	H01-5582A
200	K02-5582A	H02-5582A
300	K03-5582A	H03-5582A
400	K04-5582A	H04-5582A
500	K05-5582A	H05-5582A
600	K06-5582A	H06-5582A
700	K07-5582A	H07-5582A
800	K08-5582A	H08-5582A
900	K09-5582A	H09-5582A

5583A Single Channel Analyzer

Modes of operation

Single channel— ΔE : pulses between E_{min} and $E_{max} + \Delta E$.
Single channel— E_{max} : pulses between E_{min} and E_{max} .
Dual integral: pulses greater than E_{min} , two channels.

Multiple pulse resolution: 200 ns.

Input circuit: ac coupled, 1 ms time constant. Impedance is 500 Ω , single channel; 1 k Ω , dual integral.

Input signal: 50 mV to 10 V. Unipolar positive or bipolar with positive portion leading (negative on special order). Discriminator sensitivity to a 30 ns wide pulse drops to 90% of nominal. Nominal is defined as NaI-shaped pulse with rise time constant 0.25 μ s and decay time constant 1 μ s.

Discriminator Ranges

E_{min} and E_{max} : adjustable from 0.05 V to 10.05 V.
 ΔE : adjustable from 0.005 V to 1.005 V.

E_{min} bias input: allows external control of lower level discriminator, 5 V to scan complete range.

Integral linearity: $\pm 0.25\%$ of full scale.

Temperature stability: < 0.01%/°C, E_{max} and E_{min} ; < 0.1%/°C,

ΔE ; change over 0-55°C with dc voltage tolerance per TID-20893.

Spurious output pulses ("leak through"): none for input pulses outside window (as measured with Co-57).

Strobe input: 0.6 V negative and 15 ns wide, ac coupled.

Gate Input: > +3 V inhibits single channel outputs (dc coupled).

Outputs: available in all three modes; dc coupled, conform to AEC preferred practice logic.

Output	Pulse		Triggered From
	Amplitude	Width	
Dual Integral A and B	+5 V into 100 Ω	100 ns	Leading edge of input pulse.
Single Channel Positive	+6 V open circuit		Trailing edge of input pulse or from strobe input.
Negative	-0.8 V into 50 Ω	20 ns (5 ns rise time)	

Power required: +24 V, 225 mA; -24 V, 190 mA; +12 V, 10 mA.

Price: 5583A, \$550.

5580A/B NIM Power Supply

Outputs, dc: ± 24 V at 0 to 2A; ± 12 V at 0 to 4A; ± 6 V at 0 to 5A. Maximum output power, 120 W.

Outputs, ac: 115 V at line frequency.

Regulation: line, less than 0.05% for a 10% change. Load, output impedance < 0.040 Ω dc; < 0.3 Ω at 100 kHz.

Temperature coefficient: 0.02%/°C.

Ambient operating temperature: 0 to 55°C.

Noise and ripple: peak to peak 3 mV.

Recovery time: returns to within 0.1% of specified output within 50 μ s for a 1A load current change.

Input line voltage: 105 to 125 V or 210 to 250 V, 50 to 60 Hz.

Price: 5580A (11 modular widths), \$775. 5580B (12 widths), \$825.

Options: for applications not requiring the full set of output voltages.

Option	Power Supplies Included	5580A	5580B
01	± 24 V, ± 12 V	\$725	\$775
02	± 6 V, ± 24 V	\$725	\$775
03	± 6 V, ± 12 V	\$725	\$775
04	± 6 V	\$675	\$725
05	± 12 V	\$675	\$725
06	± 24 V	\$675	\$725

Options 01-06 can later be expanded to full capability by the addition of plug-in regulator board(s): the circuit is tuned to produce ± 24 , ± 12 or ± 6 volts. Model 05580-6004, \$75.

Common Specifications

Operating temperature: 0 to 55°C.

Connector block, power: AMP 202515-5.

Connectors, signal, inputs and outputs: BNC.

Dimensions: standard double-width module (5582A and 5583A) 2.703 in. wide by 8.714 in. high by 10.487 in. deep (68.6 x 203.0 x 266.0 mm).

NIM power supply 5580A/B: mechanical tolerances provide for use of the 5580A/B with standard AEC modular instrumentation (TID-20893). 5580A (holds 11 modular widths): 10-15/32 in. high by 16 $\frac{3}{4}$ in. wide by 19 $\frac{3}{8}$ in. deep (266 x 425 x 472 mm). 5580B (holds 12 modular widths): 10-15/32 in. high by 17 $\frac{1}{4}$ in. wide by 19 $\frac{3}{8}$ in. deep (266 x 438 x 472 mm).

Weight: double width module (5582A, 5583A) net 3.6 lbs (1.6 kg); shipping 5 lbs (2.3 kg). 5580A/B, net 35 lbs (15.9 kg); shipping 40 lbs (18.2 kg).

Cables, terminations, and accessories: HP 10519A 50-ohm 6 ft. long, BNC connectors, \$6.50. HP 10517A cable 6 ft. long, TNC connectors, \$7.50. NIM Power Supply Extender Cable 10521A for ease of servicing modules, \$35. HP 10510A 50-ohm BNC termination, \$5. HP 10100A 50-ohm feedthrough termination, \$15. HP 10100B 100-ohm feedthrough termination, \$17.50.

NUCLEAR

SCALER-TIMERS

Gross counting and pulse height analysis

Models 5201L, 5202L, 5203L

Advantages:

- Preset time and count
- Output for HP printers
- 6-digit in-line readout
- 200 ns pulse resolution
- Output for ratemeter
- Highly stable

The Hewlett-Packard scaler-timers allow wide flexibility in nuclear counting applications. The HP 5201L Scaler-Timer has a single-channel pulse height analyzer that allows manual or automatic spectrometry. In manual operation, the two integral discriminators have a digital (voltage) readout, and the discriminator levels are stable to 0.01% per °C full scale. In automatic operation, the lower level discriminator may be scanned by application of an external voltage.

The HP 5201L and 5202L differ in that the pulse height analyzer in the 5201L is replaced by a simple integral discriminator in the 5202L. Both may be used to totalize counts, count for a preset time or register time for a preset number of counts to occur. They have selectable preset count times in integral multiples of 0.1 second or 0.1 minute and utilize the power line frequency as the time base. Sampling mode may be either automatic or manual. The HP 5203L Scaler may be either manually operated or externally gated. It may be slaved to a 5201L or a 5202L.

All of the scalers and the scaler-timers have the same input counting capability with multiple pulse resolution of 200 ns. A binary-coded-decimal (BCD) output for driving HP digital recorders or other devices is provided in these instruments as a standard feature.

The compact modular cabinet design gives high portability, maximum utilization of space, plus the ability to convert quickly from bench to 19 in. rack mounting configuration (all conversion hardware included at no extra cost).

Specifications, 5201L

General

Resolving time: preset time mode, 200 ns, preset count mode 10 μ s.

Maximum periodic count rate: preset time mode, 5×10^6 counts/s; preset count mode, 1×10^5 counts/s.

Preset count times: 0.1 s to 9,999.9 s in 0.1 s steps; 0.1 min to 9,999.9 min in 0.1 min steps.

Sampling modes: "AUTO" position allows repeat of count at sampling rate. Sample time is 200 ms plus count time. "MANUAL" position requires that "START" button be depressed to start sample.

Accuracy: ± 1 count \pm time base accuracy.

Time base: power line frequency (typically $\pm 0.1\%$ or better). 100 kHz crystal time base optional).

Gate In: gate opens with external dc level $> +5$ V and $< +20$ V. Gate closes with dc level $< +2$ V.

Gate out: $> +15$ V when gate open, $< +2$ V when gate closed.

Reset: front panel pushbutton.

Power: 115 V or 230 V $\pm 10\%$, 60 Hz, 60 W (50 Hz version optional).

Temperature range: -0°C to $+55^\circ\text{C}$.

+20 V power supply: output through rear TNC.

Pulse height analyzer

Modes of operation: (a) integral; (b) differential with narrow window; and (c) differential with wide window.

Input circuit: ac coupled. Impedance 500 ohms. Maximum input pulse rise time is determined by 1 ms input time constant.

Polarity: positive or negative (selectable).

Output: nominal 0.5 V pulse into 50 ohms for ratemeter input.

NaI (Tl) scintillation counting performance

Discriminator ranges: E_{min} and E_{max} are adjustable from 0.05 V to 5.0 V.*

ΔE range: adjustable up to 0.5 V.*

Discriminator stability: $\pm 0.01\%/^\circ\text{C}$ full scale (± 0.5 mV/ $^\circ\text{C}$) change in E_{min} and E_{max} ; and less than $\pm 0.1\%/^\circ\text{C}$ of full scale (± 0.5 mV/ $^\circ\text{C}$) change in ΔE over 0 to $+55^\circ\text{C}$ and with $\pm 10\%$ line voltage variations.

Integral linearity: $\pm 0.25\%$ of full scale.

5 MHz scaler performance (Integral mode only)

Multiple pulse resolution: 200 ns.

Minimum pulse requirements: 40 ns minimum pulse width, 0.1 V peak.

Functions

Preset time: displays number of counts during preset time interval of 0.1 s or 0.1 min, \times preset number N.

Preset count: displays number of 0.1 sec or 0.1 min intervals required for N counts to occur.

Preset range: "N" number selectable 1 to 99,999 on thumb-wheel switches.

Manual: counts from discriminator are totalized for (a) time between pushbutton START-STOP; or for (b) time duration of a dc level applied at rear connector. (See Gate In, above.)

Specifications, 5202L

(same as 5201L except as follows)

Discriminator

Input pulse range: 0.1 to 5.0 V (max peak pulse amplitude).

Level adjustment: variable over small range around 80 mV (factory setting).

Input circuit: ac coupled. Impedance 1000 ohms. Maximum input pulse rise time is determined by 1 ms input time constant.

Minimum pulse requirements: 40 ns minimum pulse width.

Multiple pulse resolution: 200 ns.

Specifications, 5203L

General

Resolving time: 200 ns.

Maximum periodic count rate: 5×10^6 counts/s.

Gate In: gate opens with external dc level $> +5$ V and $< +20$ V. Gate closes with dc level $< +2$ V.

Gate out: > 15 V when gate is open, $< +2$ when gate is closed.

Reset: (a) front-panel pushbutton or (b) automatic internal reset.

* ΔE is differential between E_{min} and E_{max} .
 E_{min} is level set by Lower Level Discriminator (LLD)
 E_{max} is level set by Upper Level Discriminator (ULD)

Power: 115 or 230 volts $\pm 10\%$, 50 to 60 Hz, 45 W.

+20 V power supply: output at rear TNC.

Discriminators: same as 5202L.

Functions

Check: totalize internal source of approx. 80 kHz when START button is depressed.

Specifications, all models

Printer output

Output: 4-line BCD (1-2-4-8) code, "1" state negative standard; (1-2-4-8 code, "1" state positive or 1-2-2-4 code, "1" state positive optional).

Impedance: 100 k ohms each line.

Positive state level: +18 V.

Negative state level: -8 V.

Reference levels: +17.6 V, 350-ohms source impedance.

-6.9 V, 1000-ohm source impedance.

Print command: +28 V step, from 2700 ohms in series with 470 pF.

Hold-off requirements: externally applied +5 V to -6 V.

Printer output connector: 50-pin Amphenol 57-30500, rear.

Physical

Registration: 6 long-life rectangular digital display tubes with display storage.

Dimensions: 16 $\frac{3}{4}$ " wide, 3-15/32" high, 11 $\frac{1}{4}$ " deep (426 x 88,2 x 286 mm).

Weight: 18 lbs (8,2 kg) net; 23 lbs (10,4 kg) shipping.

Accessories furnished (5201L, 5202L and 5203L): two HP 10519A Cables, 6' long, BNC connectors; circuit board extenders; detachable power cord.

Prices: 5201L, \$1950; 5202L, \$1400; 5203L, \$950.

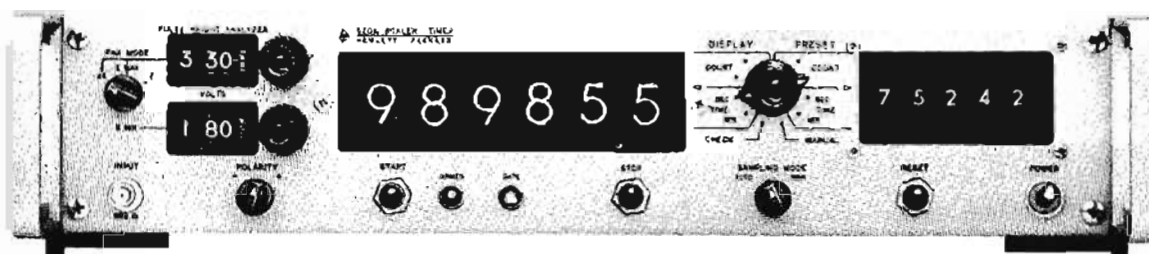

5201L



5202L



5203L

NUCLEAR



SPECTRUM SCANNER

For versatile automatic spectrum scanning
Model 5552A

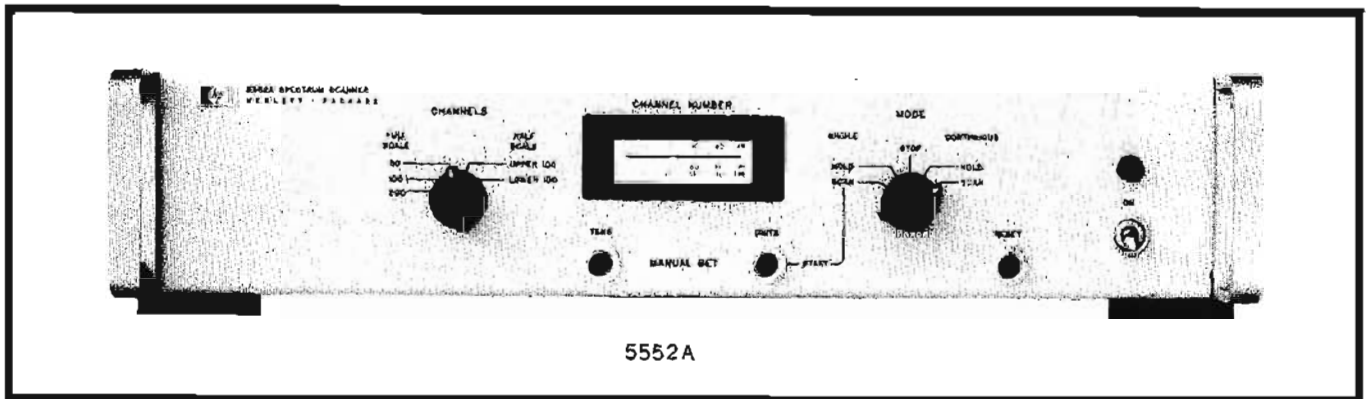

The HP 5552A Spectrum Scanner is designed for externally programming a single channel pulse height analyzer scaler-timer (such as the 5201L, page 616) for automatic recordings of gamma and x-ray energy spectra. The all-electronic method incorporated by the 5552A produces spectra such as that shown below (which is a plot of counts versus energy level) and provides data in a format analogous to that obtained from a multichannel analyzer.

The 5552A Spectrum Scanner is normally used in systems such as

that shown below. The 5552A supplies the voltage for the X-axis, and the HO3-580A Digital to Analog Converter converts the data from the 5201L Scaler-Timer for the deflection voltage for the Y-axis. The scaler-timer gates the scanner at the conclusion of a counting interval to allow the generation of the next voltage step.

The 5552A has control circuitry for scanning either a single spectrum or for continuous automatic rescanning. The 5552A enables the operator to stop the scan at any point for repeated counting in any particular channel and provides very versatile program control.

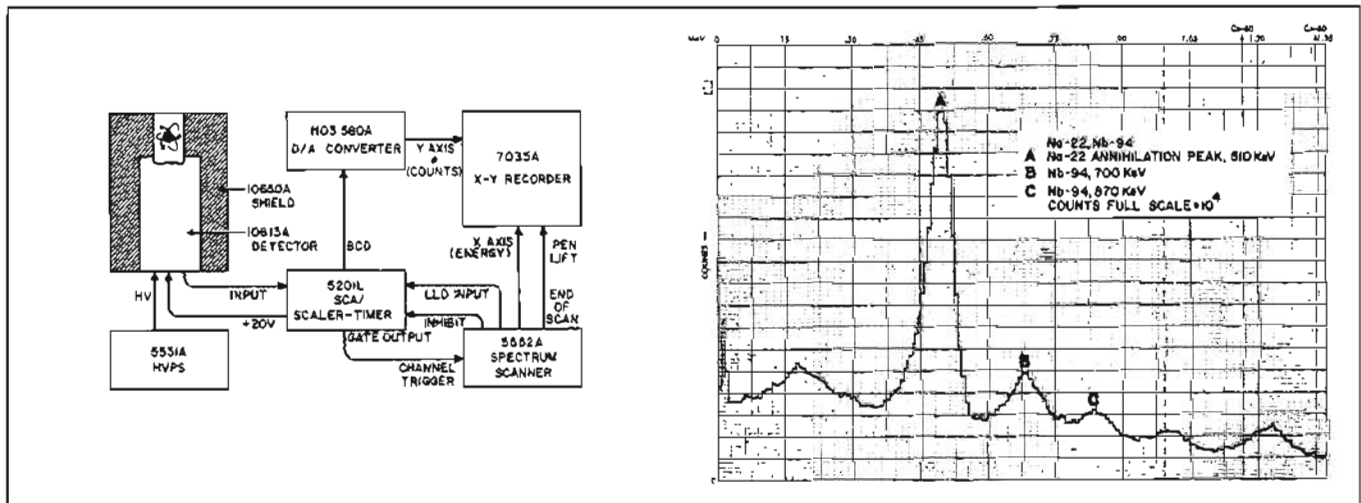

Spectrum scanning system and the spectrum of a mixture of Na-22 and Nb-94.

Specifications

E_{min} Output: (decreasing staircase) ± 4.980 V to -0.020 V.

Full Scale: 50 channels, 100 mV increments; 100, 50 mV; 200, 25 mV; or upper 100 or lower 100 channels.

Output Impedance: less than 10 Ω .

Output Current: maximum: 5 mA

X-Y Recorder Output: 0 to 100 mV at 1 k Ω .

Integral Linearity: 0.25% (0°C to 55°C).

Digital Recorder Output: (channel number)

Output: 4 line 1-2-4-8 BCD code, "1" state negative.

Impedance: 100 k Ω .

Positive State Level: approximately 0 V.

Negative State Level: approximately -20 V.

Reference Levels: -5 V, 1.2 k ohms source impedance; -10 V, 2.8 k ohm source impedance.

Print Command: not available from 5552A.

Power: 115 V or 230 V ac, 50 Hz to 1000 Hz, 11 W.

Weight: 12 lbs (5.5 kg) net, 17 lbs (7.7 kg) shipping.

Dimensions: 16 $\frac{3}{4}$ " wide, 3 $\frac{5}{32}$ " high, 11 $\frac{1}{4}$ " deep (426 x 89 x 286 mm).

Accessories Furnished: detachable power cord; rack mounting accessory kit; circuit board extender; two HP 10519A cables, 6 ft. long BNC connectors. HP 10530A cable.

Price: 5552A Spectrum Scanner, \$675.

POWER SUPPLY; LEAD SHIELD

Highly stable, convenient HV power supply
Models 5551A, 10650A



NUCLEAR

5551A Power Supply

The Hewlett-Packard Model 5551A High-Voltage Power Supply is designed to supply the high voltage (170 V to 1615 V) requirements of the photomultiplier in a gamma scintillation detector assembly. High stability and broad voltage range (voltage ranges are overlapped with an accurate vernier adjustment) make this instrument valuable in numerous other experimental and laboratory applications.

The 5551A utilizes standard components operating well within their design range. This, coupled with conservative overall design means long, trouble-free operation, plus ease of maintenance. Safety design features minimize the possibility of inadvertent contact with high voltages.

Model 5551A is an ideal instrument for applications where high stability with low current and high voltage is required.

This instrument is packaged in Hewlett-Packard's modular cabinet, allowing quick and easy conversion from bench to 19 in. rack configuration.

Specifications, 5551A

Electrical

Output voltage: 170 V to 1615 V.

Polarity: positive or negative (selectable).

Output current: 1 mA max.

Output impedance: < 20 k Ω .

Line regulation: $\pm 0.01\%$ for $\pm 10\%$ line change.

Ripple: < 0.005% rms or 15 mV (whichever is larger).

Power: 115 or 230 volts $\pm 10\%$, 60 Hz, 50 watts (50 Hz version available upon request, no charge).

Physical

Weight: net 20 lbs (9,1 kg); shipping 25 lbs (11,3 kg).

Dimensions: 16 $\frac{3}{4}$ " wide, 3-3/16" high, 11 $\frac{1}{4}$ " deep (426 x 97 x 286 mm).

Connectors: high voltage BNC connector, rear. Stabilizer input telephone jack, rear (mating connector, 2-conductor, 1251-0067; Switchcraft, Inc. 280). Can accept voltage from an external stabilization system (normally in the range 0 \pm 100 volts).

Accessories furnished: one HP 10516A high-voltage cable, 6 ft. long, high-voltage BNC connectors; detachable power cable.

Price: \$350.

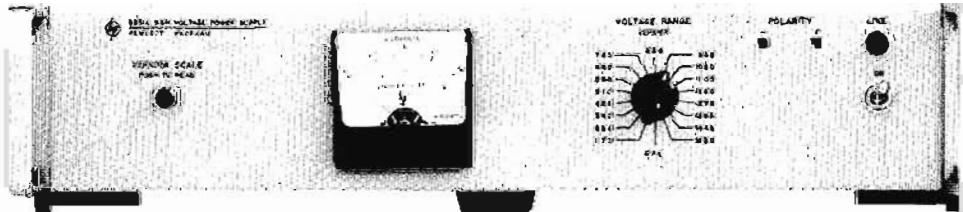

5551A HV power supply



10650A

10650A lead shield

The HP Model 10650A provides the equivalent of 2-inch lead shielding in all directions to lower background count with the 10611A and 10613A well-type (2 in. by 2 in. Crystal) scintillation detectors. Low porosity virgin lead; brass outer case and stainless steel inner liner. The counter-balanced lid has hole sizes of $\frac{5}{8}$ in. (16 mm) and $\frac{1}{8}$ in. (28 mm) for introducing test tube or solid samples. A lever permits raising the detector during removal. Maximum weight is 375 lbs. The shield is in two sections for easy handling. Dimensions: 7 $\frac{1}{2}$ in. (190 mm) diameter, 18 $\frac{3}{4}$ in. (475 mm) long. Price, \$455.

NUCLEAR



SCINTILLATION DETECTORS

Premium resolution, stability with low drift
10600A Series

Advantages:

- Low drift characteristics
- Premium resolution and stability

Hewlett-Packard scintillation detectors utilize selected sodium iodide (thallium activated) crystals and photomultiplier tubes as integral assemblies. These assemblies combine efficient scintillators for gamma ray detection with photomultipliers having the best light collection characteristics. A preamp-amplifier with three levels of gain completes the scintillation detector and is capable of driving the Hewlett-Packard single channel analyzers directly. The LTC (long-time constant) position on the gain switch gives a low gain output for use into an external amplifier such as the HP 5582A Linear Amplifier.

The HP scintillation detectors are available in both solid and well configurations, with 2 x 2 and 3 x 3 NaI (TI) crystals. A magnetic shield utilized in all detectors maximizes protection from external ac and dc magnetic fields. The entire assembly is sealed against moisture in a stainless steel case. A TNC connector is used for the low-voltage power supply input, a high-voltage BNC connector is used for the high-voltage power supply input, and a BNC connector for the signal output. A focus control and three-position selector switch (for selecting: long time constant; short time constant, X1 gain; short time constant, X10 gain) are accessible on the detector assembly for optimizing measurements.

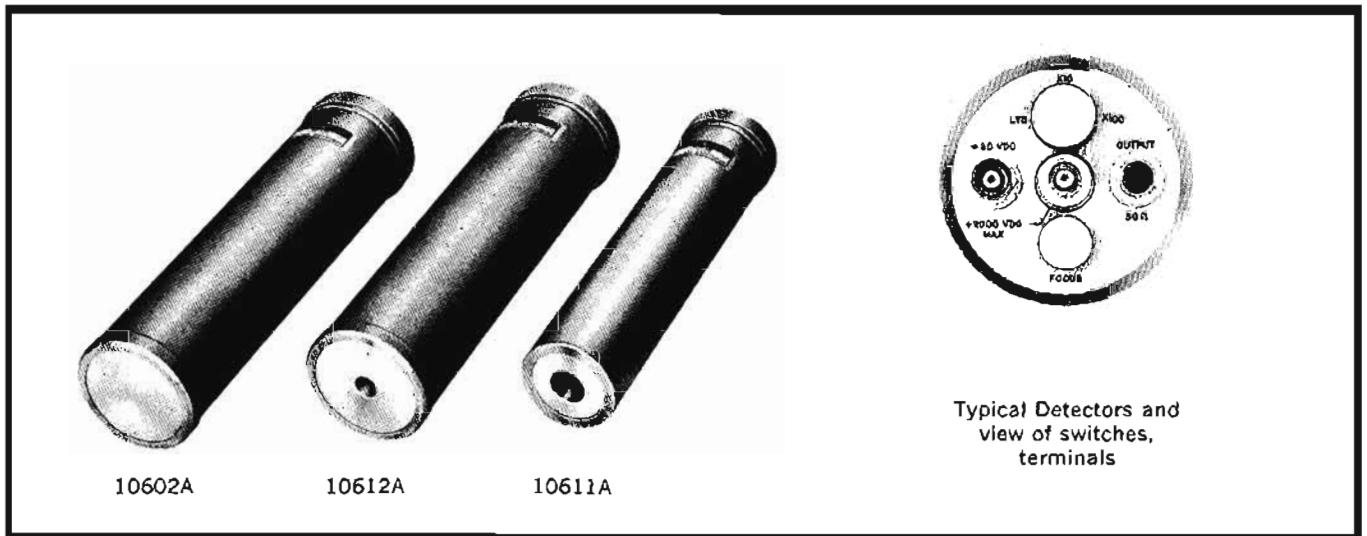

10602A

10612A

10611A

Typical Detectors and
view of switches,
terminals

Specifications

All Models

Crystal: NaI (TI).

Typical output:

- Long Time Constant (LTC) 0.30 V/MeV.
- Short Time Constant, Gain 10: 1.8 V/MeV.
- Short Time Constant, Gain 100: 18 V/MeV.
- (Detector at 25°C, High Voltage 1000 V.)

Magnetic field effects:

- AC:**
 - < ±0.5% change in pulse height (2 gauss rms).
 - < ±0.1% change in resolution (2 gauss rms) 60 Hz.
- DC:**
 - < ±0.5% change in pulse height (±2 gauss field).

Amplifier

- High voltage input:** 2000 V (max.), 7.35 MΩ (approx.).
- Low voltage input:** +20 V at 21 mA (+25 V max. input).

Typical output pulse shape @ 25°C:

- LTC:** 0.25 μs rise time-constant, 12.5 μs fall time-constant, 30 μs fall time, peak to 0 volts.
- Gain: X10** 0.25 μs rise time-constant, 1 μs fall time-constant, 3 μs fall time, peak to 0 volts.
- Gain: X100** 0.25 μs rise time-constant, 1 μs fall time-constant, 3 μs fall time, peak to 0 volts.

Maximum no load output:

- LTC +4 V
- X10 +10 V
- X100 +10 V

Output Impedance: 50Ω nominal.

Physical

Focus control: to adjust photomultiplier tube for optimum gain and resolution.

Connectors:

- Low voltage:** TNC connector (female).
- High voltage:** high voltage BNC connector (female).
- Signal output:** BNC connector (female).

Gain switch: 3-Position Slide Switch:

- LTC: Long Time Constant.
- X10: Short Time Constant, Gain 10.
- X100: Short Time Constant, Gain 100.

Magnetic shield: internal between integral assembly and case.

Case: stainless steel, moisture proof.

Accessories furnished: one HP 10517A cable 6' long, TNC connectors.

Specifications Individual

Model Type	10601A	10602A	10611A	10612A	10613A	10614A
Crystal Type	Solid		Well Type			
Crystal Dimensions	2" dia x 2" long	3" dia x 3" long	2" dia x 2" long	3" dia x 3" long	2" dia x 2" long	3" dia x 3" long
Well Dimensions			1" dia x 1-35/64" deep (25,4 x 39,3 mm)	21/32" dia x 2" deep (16,7 x 50,8 mm)	21/32" dia x 1-35/64" deep (16,7 x 39,3 mm)	1.024" dia x 2-3/64" deep (26 x 51 mm)
Resolution	< 8% FWHM*		< 10% FWHM*			
Drift	< ± 2%**	< ± 1%**	< ± 2%**	< ± 1%**	< ± 2%**	< ± 1%**
Stability	< ± 2%***	< ± 1%***	< ± 2%***	< ± 1%***	< ± 2%***	< ± 1%***
Overall Dimensions	2 3/4" dia x 12 1/4" long (70 x 312 mm)	3 1/2" dia x 13 3/4" long (82 x 350 mm)	2 3/4" dia x 12 3/4" long (70 x 324 mm)	3 1/2" dia x 13 3/4" long (82 x 350 mm)	2 3/4" dia x 12 3/4" long (70 x 324 mm)	3 1/2" dia x 13 3/4" long (82 x 350 mm)
Crystal Window	0.015" Aluminum	0.019" Aluminum	0.010" Aluminum			
Weight: Net Shipping	5 lbs (2,3 kg) 12 lbs (5,4 kg)	8 lbs (3,6 kg) 15 lbs (6,8 kg)	5 lbs (2,3 kg) 12 lbs (5,4 kg)	8 lbs (3,6 kg) 15 lbs (6,8 kg)	5 lbs (2,3 kg) 12 lbs (5,4 kg)	8 lbs (3,6 kg) 15 lbs (6,8 kg)
Price	\$835	\$1475	\$885	\$1565	\$885	\$1565

*FWHM = Full width at half maximum of Cs-137 photo peak.

**Pulse Height change at 25°C over 24 hours at 1000 cps.

***Rate shift change from 1000 cps to 10,000 cps (integral count rate Cs-137).

PREAMP-AMPLIFIER

Three levels of gain, pulse shaping Model 10615A

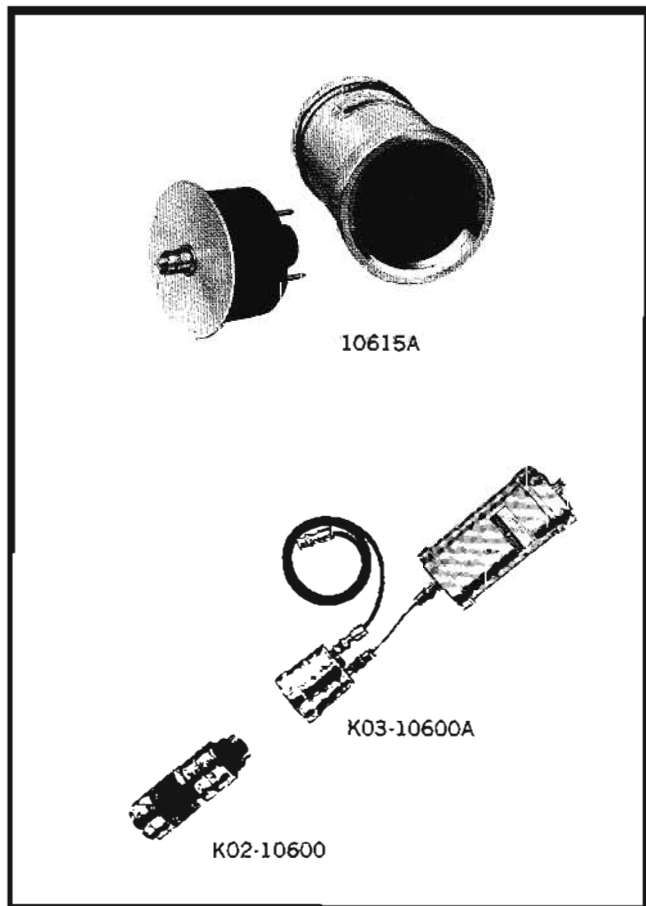

The Hewlett-Packard Model 10615A Preamp-Amplifier accepts input from a scintillation detector or other nuclear detector and provides output pulses suitable for driving a scaler or other follow-on instrumentation. The 10615A is the same excellent preamp-amplifier used in the HP Scintillation Detectors, Series 10600A. With the 10615A, special-purpose, high-performance detector assemblies can be quickly and easily made. A standard 10-stage photomultiplier tube plugs directly into the 10615A's recessed socket; a BNC adapter (included) provides for easy connection of units that cannot be plugged in directly. The 10615A is housed in a stainless steel case that provides excellent RFI and noise shielding. This case also permits convenient decontamination, should that become necessary.

The unit is compatible with HP Scalers and High Voltage Supplies. Dimensions: 2.95 in. (75 mm) diameter, 6.25 in. (158 mm) long. Price, \$295.

X-Ray Detector

A low-noise, low-background x-ray detection system is easily arranged with use of the 10615A, as shown. The 10615A connects to an x-ray detector assembly comprising a voltage divider adapter and a NaI(Tl) crystal. The adapter has two BNC connectors, one for the signal and the other for the high voltage. (Note that no high voltage connection need be made to the 10615A's high voltage terminal when an adapter is used.)

K02-10600 X-ray detector, NaI(Tl) crystal.

Price, \$286.00

K03-10600A Plug-in voltage divider.

Price, \$67.50

TEMPERATURE— PHYSICAL MEASUREMENTS



PHYSICAL MEASUREMENT Introduction

Quantitative measurement of physical factors, such as temperature, pressure, force, torque, strain, and displacement provides much of the basic knowledge required for industrial progress. Physical measurements are required first during fundamental research, next during product development, then for process control, finally for sampling tests used to assure continuance of product quality. The following elements are usually involved in physical measurements.

Measurand, a fluid or solid structure that is the source of the physical factor being measured.

Transducer, a device that converts the physical factor to an electrical signal, with or without the aid of a signal conditioner.

Signal Conditioner, a unit that provides the power and auxiliary controls needed to obtain a voltage output that is a known function of the physical factor sensed by the transducer.

Application of the data

The transducer signal becomes useful only when it has been reduced to a form suitable for evaluation. The present, and currently-expanding volume of physical measurement data being handled usually necessitates processing by a digital computer, which requires digitizing of transducer signals and recording in computer-compatible format with or without preliminary processing. The 2010, and 2012 Data Acquisition Systems (pages 96-98) digitize and format transducer inputs, recording on punched cards, punched paper tape, or computer-compatible magnetic tape. In addition to basic data system capabilities, the 2018 Data Acquisition Systems (page 100) provide computational capability for preliminary processing. Typical computations include: units conversion, such as thermocouple voltages to degrees of temperature; correction for transducer non-linearity; measurement comparison against high and low limits; conversion of strain gage rosette readings to principal strains or stresses; calculating mass flow from pressure readings; averaging or deriving rms value of one or several signals; calibrating transducers by the least squares fitting 'method', determining horsepower and efficiency in engine test stand applications.

Temperature sensors

The traditional and most commonly used temperature sensors are thermo-

couples, resistance thermometers, and thermistors.

The thermocouple, a junction of two dissimilar conductors, is thermoelectric. It is a low-cost, wide range sensor that produces a small thermally generated output voltage as a function of temperature.

The resistance thermometer and the thermistor are both thermoresistive sensors. The resistance thermometer is a resistive element made of a pure metal, usually nickel, platinum, or copper. It has a positive resistance temperature coefficient. Resistance thermometers are more costly than thermocouples, but are also far more accurate and operate over wider temperature ranges. The thermistor is basically a narrow-range sensor with a high negative resistance temperature coefficient, and poor linearity.

Thermo-resistive transducers requires dc signal conditioning (discussed later) to convert resistance changes to a dc voltage that can be digitized.

Quartz thermometry

Quartz thermometry is an entirely novel temperature measurement technique. The transducer, a small quartz disc that operates within a protective probe housing as a piezoelectric resonator for a sensor oscillator. The resonant frequency of the quartz crystal varies with heating or cooling of the probe such that the frequency of the sensor oscillator output signal is a linear function of temperature. The sensor oscillator is incorporated into a complete measurement system that includes a reference oscillator and a mixer. The reference frequency is mixed with the sensor oscillator frequency to cancel frequency offset. The mixer output is summed by counters that display the sensed temperature as a direct digital readout in °C or °F. The counters also provide a bcd output for recording temperature readings in computer compatible format.

Over the range of -80 to $+250^{\circ}\text{C}$ (-112 to $+482^{\circ}\text{F}$) the quartz thermometry technique pioneered by Hewlett-Packard offers simple operation combined with measurement resolution to 0.0001° . A variety of temperature sensing probes are available, including a special oceanographic probe capable of withstanding 10,000 psi. The standard probes may be connected to the sensor oscillator through up to 1000 feet of coaxial cable,

and may be operated up to one mile away with the addition of accessory amplifiers.

Strain gage transducers

The strain gage is a resistance element, usually metallic, that changes resistance when it is strained, or deformed as a result of being stressed. The basic application of the strain gage is stress measurement, in which strain gages are bonded to a specimen that is to be stress-tested. The strains that develop in the specimen during stress testing are transmitted to the strain gages, causing them to change resistance.

Just as important as stress measurement are other applications of the strain gage technique. In these applications, strain gages coupled to carefully designed and calibrated response elements are used to measure pressure, force, torque, and other physical factors that are convertible to strain. Strain gage resistance changes can be converted to output voltage by using dc signal conditioning.

DC signal conditioning

The most basic signal conditioning requirement of thermoresistive and strain gage transducers is excitation power, to convert resistance changes to voltage output. The excitation is usually connected across a bridge circuit, in which the transducer forms one, two or four active arms. Bridge completion resistors must be provided when a transducer forms only one or two active arms of the bridge.

Other signal conditioning requirements are bridge balance adjustment and provision for calibration, in which resistors shunted across one or opposite arms of the bridge simulate the resistance change that would be caused by a specific magnitude of full scale response by the transducer. With the calibration circuits activated, the excitation level is set to calibrate the output signal level to be produced by sensing of the actual effect.

The 2480 Series Signal Conditioning Equipment described on page 624 not only meets all basic signal conditioning requirements, but sets performance standards and offers convenience features that are completely unique. Now data system users can get signal conditioning equipment from Hewlett-Packard. The advantages are obvious: single source procurement, superior performance throughout the physical measurement system, and high-quality dependable equipment backed world-wide by Hewlett-Packard service facilities.

QUARTZ THERMOMETER

0.0001°C or °F resolution, direct measurement
Model 2801A



TEMPERATURE

The method of temperature sensing employed in the 2801A Quartz Thermometers is based on the sensitivity of the resonant frequency of a quartz crystal to temperature change.

Temperature range of the 2801A Quartz Thermometer is -80 to $+250^{\circ}\text{C}$ (-112 to $+482^{\circ}\text{F}$). The quartz thermometer is considerably more linear than a platinum resistance thermometer: $\pm .05\%$ of span from -40 to $+250^{\circ}\text{C}$ compared with a typical figure of $\pm .55\%$ for the same range for platinum thermometers. Linearity of the quartz thermometer is superior to that of thermocouples and thermistors, which have an exponential characteristic. The excellent sensing characteristics of the quartz thermometer are supplemented by the advantages of direct digital readout (no bridge balancing, or reference to resistance or voltage-temperature tables or curves), immunity to noise and cable resistance effects, no reference junction, and good interchangeability between sensing probes.

The 2801A is equipped with two sensing probes for measuring temperature at either probe or the difference between the two. A 6-digit visual readout and recording output with a choice of push-button-controlled sample times provides resolution of 0.01, 0.001 or 0.0001°C or F. Signal polarity indication is provided. The 2801A includes the capability for operation as a 300 kHz electronic counter.

Temperature sensing probes

Various standard probe configurations are available for the 2801A Quartz Thermometer. Probes from the 2850 series are furnished with the quartz thermometer. Outline drawings for all models appear at right. The optional 2833A probe contains an integral sensor oscillator, and is designed for remote operation in hostile environments.

Remote operation of probes

Each temperature sensing probe has a quartz-crystal which is resonant at a frequency dependent upon temperature, and is driven by a 2830A Sensor Oscillator. The oscillators are transistorized devices enclosed in small die-cast aluminum housings. They are normally installed in the 2801A flush-mounted in a front panel recess. 12-foot cable connects each probe to its associated sensor probe; this cable forms part of the tuned circuit and cannot be altered in length. However, the sensor oscillators may be unplugged from the instrument and connected to it by standard 75-ohm coaxial cable up to 1000 feet in length, with no loss in measurement accuracy.

Specifications 2801A

Temperature range: -80 to $+250^{\circ}\text{C}$ (-112 to $+482^{\circ}\text{F}$ with Option M1).

Calibration accuracy: thermometer-probe combination calibrated at factory to within $.02^{\circ}\text{C}$ ($.04^{\circ}\text{F}$) absolute, traceable to NBS.

Linearity: -40 to $+250^{\circ}\text{C}$. Better than $.15^{\circ}\text{C}$ ($.27^{\circ}\text{F}$) referred to best fit straight line through 0°C ; -80 to -40°C . Better than 0.7°C (1.26°F) referred to same line as above; 0 to $+100^{\circ}\text{C}$. Better than $.05^{\circ}\text{C}$ ($.09^{\circ}\text{F}$) referred to best fit straight line through 0°C .

Stability:

Short term: better than $\pm .0001^{\circ}$.

Long term: zero drift less than $\pm .01^{\circ}\text{C}$ ($.018^{\circ}\text{F}$) at constant probe temperature for 30 days.

Ambient temperature effect: less than $.002^{\circ}\text{C}$ per $^{\circ}\text{C}$ change.

Display: 2801A: 6-digit in-line readout in $^{\circ}\text{C}$, or $^{\circ}\text{F}$. Decimal point, $^{\circ}\text{C}$ ($^{\circ}\text{F}$), and polarity indication included. Readout and units indication in kc in counter mode of operation. Storage feature holds display between readings.

Digital recorder output: BCD, 4-2-2-1, positive-true, for each digit, decimal point (exponent), polarity, and operating mode. 8-4-2-1 positive true optionally available.

External programming: selected by contact closures or transistor circuit closures to ground. Measurement initiation, probe selection (T1, T2, or T1-T2), and resolution ($.01$, $.001$, or $.0001^{\circ}$) programmable.

Counter operation: Frequency Range: 2 Hz to 300 kHz; Resolution: 10, 1, and 0.1 Hz; Sensitivity: 0.5 to 10 V rms; Input Impedance: 1M, 50 pF shunt; Gate Time: 0.1, 1 and 10 sec.

Power required: 115/230 V $\pm 10\%$, 50 to 60 Hz, 85 W.

Instrument environment: ambient temperatures from 0 to $+55^{\circ}\text{C}$ ($+32$ to $+130^{\circ}\text{F}$), at relative humidity to 95% at 40°C .

Weight: net 22.5 lb (10.1 kg), shipping 35 lb (15.9 kg).

Dimensions: 3-15/32" x 16-5/16" x 16-3/4" (88 x 414 x 425 mm).

Price: 2801A Quartz Thermometer, including two 2830A Sensor Oscillators and two (matched) 2850 series Temperature Sensors, \$3,250.

Specifications 2833A temperature sensor

Temperature range: -40 to $+125^{\circ}\text{C}$ (-112 to $+257^{\circ}\text{F}$).

Response time: response to abrupt change in temperature of water flowing past sensor at 2 fps: 63.2% of final value in 3 s; 99.0% in 16 s; 99.9% in 24 s.

Output frequency: 28.2 MHz at 0°C , 0.25 V rms.

Power: $+12$ to $+15$ V dc, at 10 mA approx. provided by 2801A.

Pressure case rating: 10,000 psi (ocean depth of 22,500 feet).

Weight: net wt 8 oz (227 gm); ship wt 2 lb (0.9 kg).

Price: Model 2833A Temperature Sensor Assembly, \$750.00.

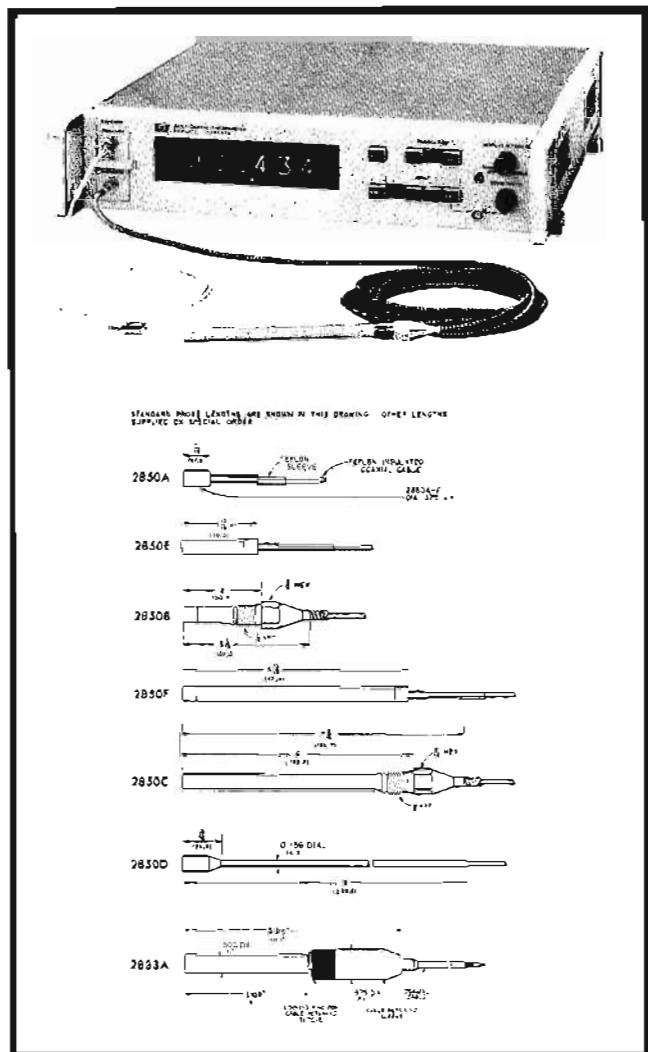



SIGNAL CONDITIONING UNITS

Compact conditioners for resistive transducers
2480 Series

Advantages

- Stable dc excitation source with switch selectable constant voltage and constant current operating modes
- Novel switch selectable 'linear' mode provides high linearity for single active arm bridges
- Floated and guarded power supply
- Exceptional excitation source stability
- Remote error voltage sensing
- Excitation polarity reversible by front panel switch
- Excitation, remote sense, remote calibrate, and data leads may be shorted indefinitely without damage to instrument; normal operation resumes upon removal of short

Description

The 2480 Series Signal Conditioning Modules provide dc excitation and signal conditioning (operating, balancing, and calibrating components) for strain gage transducers, resistance temperature devices and other resistive transducers. The following units are available:

2480A DC Excitation Source. An adjustable 30 V, 200 mA supply which may be operated in constant voltage or constant current mode, as selected by an internal switch. Output stability with changes in load, power line, and ambient temperature is exceptional, avoiding need for frequent checks and calibration adjustments, and saving man-hours in system involving many transducer channels.

In addition to these operating modes, a 'linear mode' is provided for single active arm bridge configurations. In this mode the voltage across the sensing arm resistance is kept constant, therefore constant current is maintained through the variable arm. This eliminates the high nonlinearity of single active arm conditioners operating in conventional excitation modes.

2481A Resistance Bridge. Accepts the necessary bridge completion and calibration resistors and provides switching circuitry

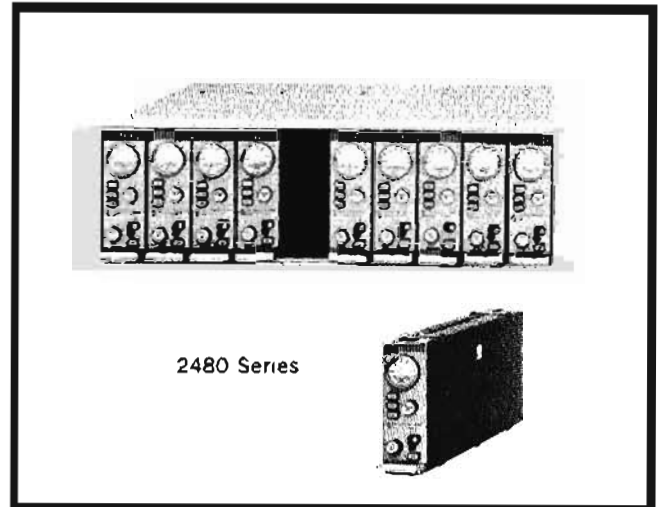
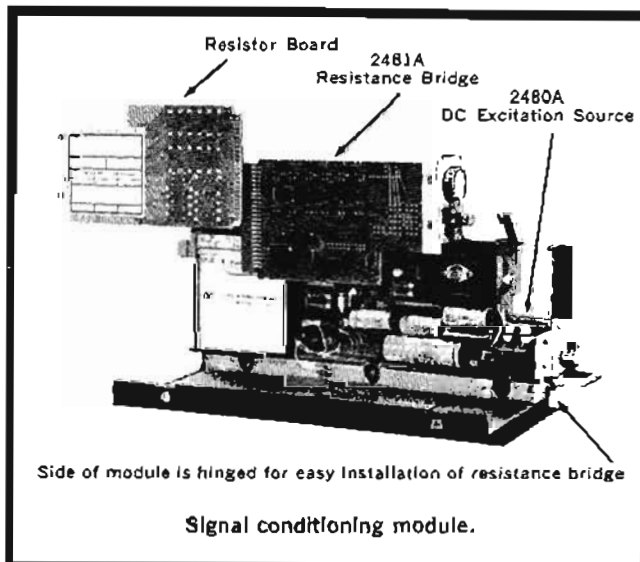

for strain gage transducers operating in 1, 2, and 4 active arm configurations.

The 2481A is contained on two circuit boards which plug together, end-to-end. All resistor values which depend on a specific transducer are mounted on the rear 'resistor board'. This makes it economical to keep additional loaded boards on hand to match different transducers.

2482N Monitor Function Selector. Enables the user to select excitation voltage, excitation current, or transducer signal voltage for monitoring by an external voltmeter. A front panel switch is provided for function selection.

2480C and 2480K Excitation Couplers. With the 2480K, control of the excitation is provided by an external power supply and the excitation level is necessarily the same for all transducer channels served. The 2480C Excitation Coupler combines local control of excitation for each channel plus all capabilities of the 2480K Coupler. Excitation is set with a ten turn 'excit adj' potentiometer. The excitation regulator in the 2480C can be set for constant voltage or constant current operation by an internal switch. The linear mode is not available in the 2480C or 2480K.

12521A Combining Case. HP 2480 Series Signal Conditioning Modules are designed to operate in the 12521A Combining Case, which holds ten modules in a 19-inch rack. The case occupies only 5¼ inches (133 mm) of panel space.

Each conditioning module plugs into a printed circuit board which extends the full width of the rear of the combining case. This board is fully wired to handle any combination of modules installed in the case. Time consuming intermodule wiring by the user is eliminated. Separate connectors for transducer and system interconnections are provided for each module.

12530B Portable Case. Accepts two 2480 Signal Conditioning modules, (also accepts 2470A Data Amplifiers, page 442, 2212A Voltage-to-Frequency Converters, page 243, or any combination of 2480, 2470, 2212A making up 2 units). It provides a convenient means of connecting power (including power switch) and signal to the signal conditioner or amplifier; its size and shape is designed for bench or field use. A rack adapter frame is available to mount two portable cases side-by-side in a standard 19" rack. An integral fan maximizes stability of instrument operation.

Specifications, 2480 Series

Performance figures hold for all combinations of permissible deviations in line voltage, load, and environmental conditions when unit is operated in a combining case or otherwise supplied forced air ventilation from the rear at 1 cfm, minimum, per channel.

2480A DC Excitation Source

Constant voltage mode

Output: 0.1 to 30 V dc, continuously adjustable (0 to 200 mA).

Noise output: total noise output due to ripple and thermal noise is 295 μ V max, 205 μ V min.

Regulation: load regulation: change in output voltage for load current change of 200 mA is $<600 \mu$ V at 30 V output; line regulation: change in output voltage for $\pm 10\%$ line voltage change is $<600 \mu$ V at 30 V output for 10 ohm loads.

Constant current mode

Output: 1 to 200 mA (compliance is 0 to 24 V).

Noise output: total noise output due to ripple and thermal noise is 5 μ A max and 3.2 μ A min.

Linear mode: (this mode of operation suitable for bridge configuration with 3 arms fixed and 1 arm variable).

Output: voltage across bridge, 0.1 to 30 V.

Noise output: the total rms noise due to ripple, injected current, and thermal noise is 5 μ A max, 3.2 μ A min.

Regulation: load regulation: change in current through bridge sensing arms as variable arm is changed through permissible range is $<10 \mu$ A at 200 mA; line regulation: change in current through bridge sensing arm for $\pm 10\%$ line voltage change is $<10 \mu$ A at 200 mA.

Environmental conditions: ambient temperature 0 to $+55^{\circ}$ C; relative humidity 95%, $+25$ to $+40^{\circ}$ C.

Power required: 115/230 V $\pm 10\%$, 50 to 400 Hz; approx 8.5 W at full load.

DC Isolation: 10^{10} ohms min for sense leads, excitation leads, or signal leads to ground or ac line.

Weight: combined excitation source, resistance bridge, and resistor board in module case, 4 lbs 5 oz (1.9 kg).

Price: HP 2480A (including module case), \$245.

2481A Resistance Bridge

Price: HP 2481A (including one resistor board), \$65 (plugs into 2480A, cork module case).

2482N Monitor Function Selector

Weight: 1 lb 6 oz (630 g).

Price: HP 2482N (supplied in module case), \$125.

2480K Excitation Coupler

Weight: 1 lb 2 oz (510 g).

Price: HP 2480K (supplied in module case), \$35.

2480C Excitation Coupler

Constant voltage mode

Output: 1-12 V, continuously adjustable (0-40 mA).

Noise: 450 mV rms max thermal noise measured in 40 kHz bandwidth across excitation leads.

Load regulation: <30 mV $+0.08\%$ of output voltage for 40 mA load current change; line regulation: <50 mV for 1 V change of input from 28 V dc master power supply.

Constant current mode

Output: 5 to 40 mA (compliance, 0 to 6 V).

Noise: 3 μ A rms max thermal noise measured in 40 kHz bandwidth across excitation leads.

Load regulation: $<150 \mu$ A for resistive load change of 10% at 40 mA load current; line regulation: 300 μ A for 1 V change of input from 28 V dc master power supply.

Environmental conditions: ambient temperature 0 to $+55^{\circ}$ C; relative humidity 95%, $+25$ to $+40^{\circ}$ C.

Power requirements: 28 V dc $\pm 5\%$, 30 mA + delivered current to transducer (from 2480A or external power supply).

Weight: 1 lb 2 oz (510 g).

Price: HP 2480C (including signal conditioning module case), \$110.

12521A Combining Case

Power required (for fans): 115/230 V, 50 to 60 Hz; 115/230 V switch and fuse included (400 Hz operation on special order).

Dimensions: 19" wide, 21-5/16" deep, 5-7/32" high (483 x 541 x 133 mm).

Weight: net 18 lbs (8.2 kg); shipping 39 lbs (17.7 kg).

Price: HP 12521A (includes transducer mating connectors, signal output mating connectors, power cable), \$500.

12530B Portable Case

Power required (for fan): 115 V $\pm 10\%$, 50 to 60 Hz.

Dimensions: 7 $\frac{3}{4}$ " wide, 6 $\frac{1}{2}$ " high, 17 $\frac{1}{2}$ " deep (198 x 165 x 444 mm).

Weight: net 8 lbs (3.63 kg); shipping 12 lbs (5.45 kg).

Price: HP Model 12530B, available on request.

Price of excitation source and resistance bridge installed in combining case, \$150 to \$360 per channel depending on configuration.

LEAK, FRICTION DETECTORS



ULTRASONIC SPEEDS MAINTENANCE, MINIMIZES DOWN TIME

HP Ultrasonic Translator Detectors are the first lightweight, low cost devices to provide instantaneous translation of ultrasonic energy to the audible range. Since their introduction in early 1961, their applications have spread from their initial use of maintaining pressure systems to utilization on vacuum systems, locating high-voltage breakdown and electrical corona, trouble-shooting operating fluid power systems, pinpointing engine defects, making possible preventive maintenance analyses of engines and motors, and other industrial uses.

In the HP Ultrasonic Translator Detector, a transducer pickup in the probe responds primarily to a 36 to 44 kHz bandwidth—the bandwidth of pronounced intensity in all mechanical and electrical phenomena tested to date. Since we are not interested in sounds in the audio frequency range, the output of the transducer is filtered to convert only the ultrasonic noises of 36 kHz to 44 kHz to the audible range; we heterodyne this band of frequencies with an oscillator having a frequency of 40 kHz. By proper sideband selection and filtering, our study band becomes a new group of frequencies between 300 Hz and 4 kHz within our peak hearing range. The tonal components of sounds are preserved so that it is possible to analyze the amplitude and characteristics of the translated ultrasonic signals.

Unlike other ultrasonic test equipment, these portable devices are passive; they are responsive to ultrasonic energy produced by external forces. The flow of air molecules escaping from a leak in a pressure system releases ultrasonic energy as the higher velocity molecules collide with those in the atmosphere. Bearings emit ultrasonic energy in proportion to their wear. Fluid power systems at work emit ultrasonic energy.

The HP principle of ultrasonic detection and translation employs two interchangeable transducers—the 22 degree directional probe for ultrasonic energy transmitted through the atmosphere, and the contact probe for ultrasonic energy conducted through solids. The diagrams on this page indicate the versatility of both industrial and scientific applications.

Pressure and vacuum leak detection

The sonic energy produced by the turbulence that occurs in the transition from laminar to turbulent flow of a gas provides a detectable and measurable quan-

tity that makes practical the use of this fundamental property of gases for leak detection and location. Figure 1 illustrates these conditions in a simple way. The ultrasonic method of leak detection depends upon these conditions being fulfilled at least in part. As with other natural phenomena, sharp lines of de-

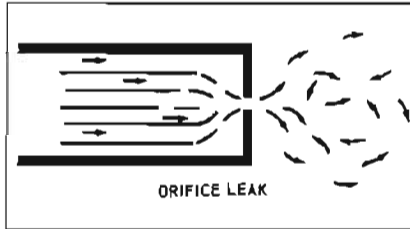
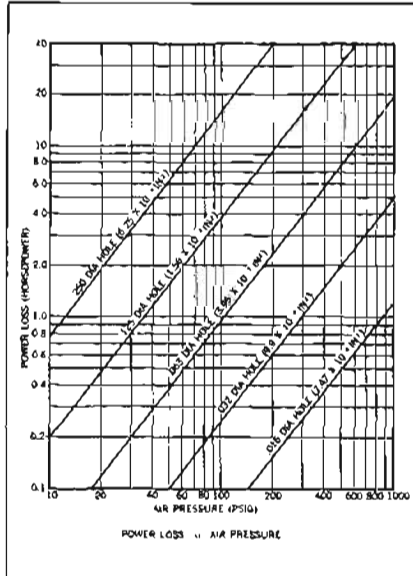

Figure 1.

marcation are difficult to establish; however, experience has shown that orifice-type leaks are easily detected at distances up to and beyond 100 feet. Diffused or labyrinth-type leaks do not generate the required turbulence conditions and consequently are not readily detected ultrasonically: Figure 2 shows what is meant by a labyrinth-type leak. Leaks in back-filled pipelines are similarly undetectable.

Locating high pressure leaks

There are compelling monetary reasons for maintaining the integrity of pressure



Air loss is very expensive as indicated by the above graph. In order to maintain a pressure system of 60 lbs which is leaking air through a .125 in diameter hole, a two-horsepower compressor would be required full time. This cost alone is justification to find one leak in a system, especially where the gas required is expensive.

distribution systems. Of course, leakage in poisonous, noxious or explosive gas systems is motivation itself for immediate location and repair.

Ultrasonic leak detection units have been employed with considerable success for several years in the maintenance of wide variety of gas pressure systems.

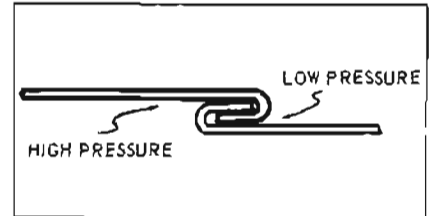
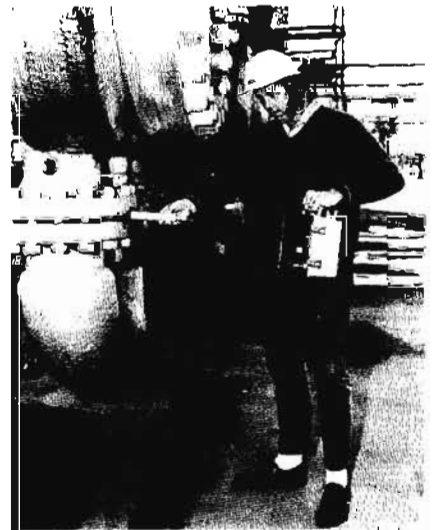
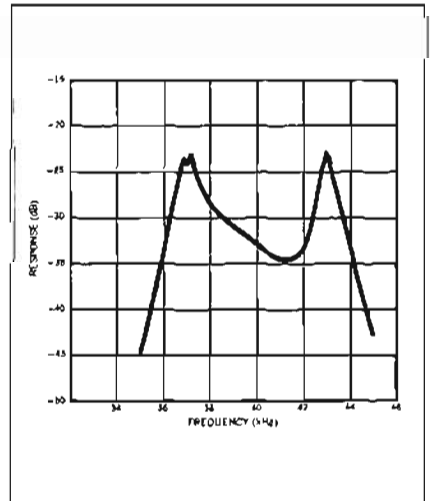

Figure 2. Labyrinth leaks do not produce enough ultrasonic energy to be readily detected by ultrasonic translators.



Leak testing with ultrasonic detector.



Typical frequency response of barium titanate transducer used in ultrasonic translator probes.

THE CONTACT PROBE AND HOW IT WORKS



LEAK-FRICTION DETECTORS

Previous field usage with the airborne probe had indicated the feasibility of detecting ultrasonic energy occurring within metallic structures. However, the airborne probe is unable to detect this energy unless the metallic surface is light enough to be oscillated mechanically by the acoustic energy. Thin-wall tubing or sheet metal structures are typical examples. Heavier metallic structures such as cast fluid power components and generally all engine structures such as heads

and bearing housings readily conduct ultrasonic acoustic energy. However, the mass of the structure prohibits its reverberating sufficiently to rebroadcast the acoustic energy through the atmosphere.

The ability to hear a distant train by putting your ear to the railroad track provides a good analogy of the conductance of metallic mass. In this case, your ear is acting as a "contact probe." This very phenomenon proves valuable in the practice of ultrasonic detection. Since the

contact probe does not respond to acoustic energy of any level transmitted through the atmosphere, its detection is limited strictly to ultrasonic energy released within the metal structure. For the maintenance engineer, this means his inspection is immediately pinpointed to his precise area of interest. Furthermore, this knowledge of the precise inspection point allows repetitive comparative inspections. (See Figure 1.) Figure 2 portrays a typical example of the utilization of the contact probe.

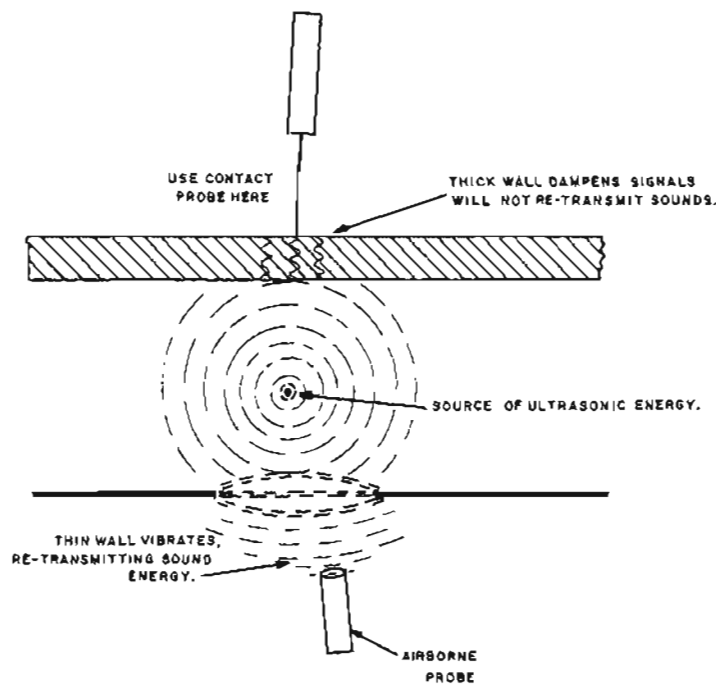

Figure 1.

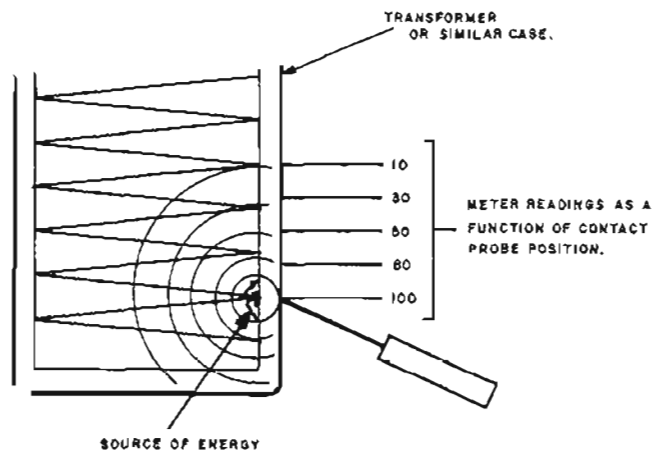

Figure 2.

How the contact probe works

The 11-centimeter length of the stainless steel stylus of the contact probe was selected after extensive research by Delcon engineers and government research organizations. This precise length was selected both to provide access to hydraulic system components and also as a function of the wavelength of a 40 kHz acoustic signal.

The contact probe stylus responds to the mechanical vibration conducted from the ultrasonic source through the structure. This mechanical energy is in turn transmitted through the stylus to a crystal within the probe housing. The crystal transducer converts the mechanical energy into an electrical signal. Solid-state circuitry within the probe amplifies the signal for introduction to the ultrasonic translation electronics within the basic instrument.

Currently ultrasonic detection using the contact probe is typically used in the fields of:

- 1) Fluid power systems
 - a) troubleshooting techniques
- 2) Engine maintenance
 - a) troubleshooting techniques
 - b) predictable maintenance programs with the use of auxiliary research equipment
- 3) Locating high voltage breakdown not visually observed
- 4) Preventive maintenance and on the spot analysis of bearings and other components of rotating machinery
- 5) Friction analysis, strength of materials testing and other advanced applications

LEAK-FRICTION DETECTORS



ULTRASONIC TRANSLATOR

Locates leaks or friction in seconds

Models 4917A, 4905A

Ultrasonic translator detector Model 4917A

The Model 4917A is Underwriters' Laboratories, Inc. listed, for use in Hazardous Locations Class I, Group D. This lightweight, portable instrument is designed for ultrasonic detection in laboratories, chemical plants, petroleum refineries, military installations, and industrial facilities where intrinsically safe equipment is required or desirable.

Carried by a neck strap, the miniaturized 4917A is ideal for field use and in close quarters where maximum portability is desired.

Ultrasonic translator detector Model 4905A

This lightweight, portable device is designed expressly for use in applications requiring a high degree of mobility. Offering operators hands-free efficiency, the 4905A has a built-in speaker making it ideal for hard-hat requirements. The reference meter is positioned on top of the instrument for easy viewing. The design of the 4905A is simple and functional. An untrained operator can use it efficiently after reading the detailed instructions on the cabinet. In addition, companies keep the 4905A performing faithfully, year after year, despite very rough handling.

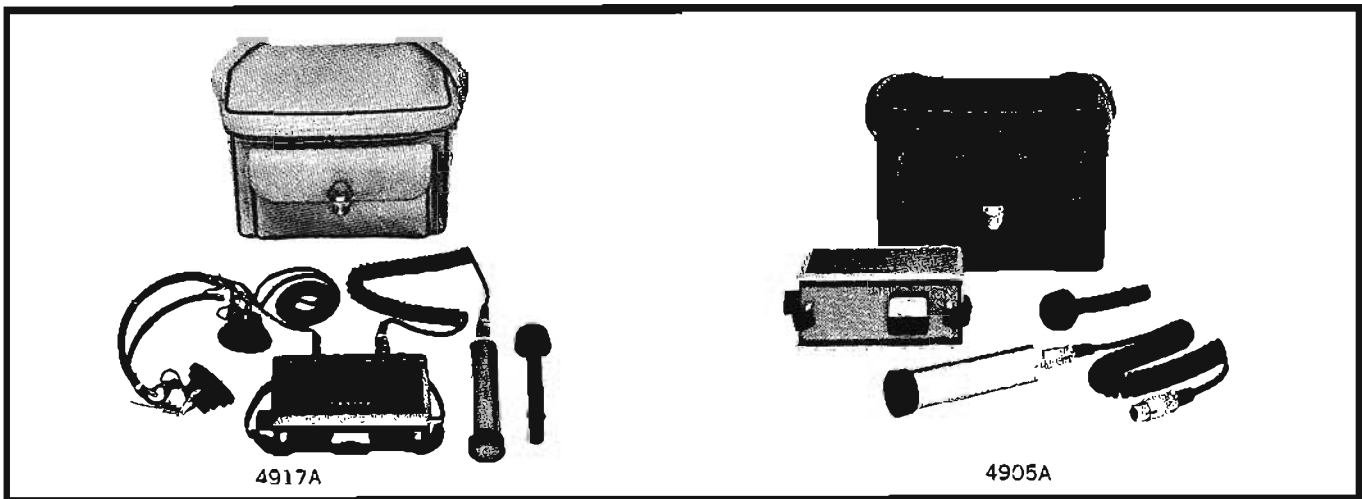

Specifications

Construction: rugged aluminum chassis and case; stainless steel hardware used throughout; Mil-Specification printed circuit board; quick-access battery compartment; detachable cabinet sideplates for servicing.

Circuitry: broad-range 4.5 volt transistorized circuit. Circuit gain controlled by single knob. Separate ON-OFF switch.

Frequency response: translates frequencies between 36 and 44 kHz into audible sounds; other sounds within audio range are screened out.

Probe and coil cord: hand-held, shielded against RF interference; output impedance 180 ohms; transistorized pre-amplifier; conical response ± 11 degrees at 3 dB points. Supplied with a six-foot coil cord employing latch-lock connectors. Less than 1 dB loss when used with a 100-foot connecting cable.

Probe size: $1\frac{3}{8}$ " diameter x $6\frac{1}{4}$ " long, including protective monel-screened cap. Power to probe supplied through cord from main unit.

Meter: ultrasonic sound intensity indicated by output meter; sealed and gasketed to lock out dirt and contaminants; scale length 1.75 inches; calibration (0-100) on upper scale for logging relative measurements; lower scale reads from 0-30 dB.

Temperature range: oscillator stability ± 15 Hz, and signal to noise ratio with ± 1 dB from 0-55 degrees C.

Headset: 1 milliwatt into 600 ohm matched headset. One volt RMS.

System weight: 6 lbs (2,72 kg); shipping weight: 9 lbs (4,1 kg).

Battery information: three cells, mercury type, Eveready E-12 or equivalent.

Battery life: 360-500 hours.

Price: Model 4917A, \$575.

18021A Contact Probe available as optional accessory at \$150 additional.

Construction: rugged aluminum chassis and case; stainless steel hardware throughout; Mil-Specification printed circuit board; quick-access battery compartment; detachable cabinet sideplate for servicing.

Circuitry: broad-range 4.5V transistorized circuitry with RF filter; circuit gain controlled by a single knob.

Frequency response: translates frequencies between 36 and 44 kHz into audible sounds; other sounds within audio range are screened out.

Probe and coil cord: hand-held; shielded against RF interference; output impedance 180 ohms; transistorized preamplifier; conical response ± 11 degrees at 3 dB points. Supplied with a six-foot coil cord employing latch-lock connectors. Less than 1 dB loss when used with a 100-foot connecting cable.

Probe size: $1\frac{3}{8}$ " diameter x $6\frac{1}{4}$ " long, including protective monel-screened cap. Power to probe supplied through cord from instrument.

Meter: ultrasonic sound intensity indicated by output meter; sealed and gasketed to lock out dirt and contaminants; scale length 1.75 inches; calibration (0-100) on upper scale for logging relative measurements; lower scale reads from 0-30 dB.

Speaker: incorporates 2.5 inch speaker; sealed against moisture; nominal power to speak 25 mW.

Temperature range: oscillator stability ± 15 Hz, and signal to noise ratio within ± 1 dB from 0-55 degrees C.

Headset jack: auxiliary 600 ohm output headset jack.

System weight: 6 lbs (2,7 kg); shipping weight: 8 lbs (3,6 kg).

Battery information: three cells, mercury type, Eveready E-12 or equivalent.

Battery life: 360-500 hours.

Price: 4905A, \$595.

18021A Contact Probe is available as optional accessory, \$150.

ULTRASONIC TRANSLATOR

Rugged, battery-powered leak, friction detector
Model 4918A, accessories



LEAK-FRICTION DETECTORS

Ultrasonic translator detector Model 4918A

The 4918A is Underwriters' Laboratories, Inc. Listed for use in Hazardous Locations Class I, Group D. This lightweight, portable instrument is designed for ultrasonic detection in laboratories, chemical plants, petroleum refineries, military in-

stallations and industrial facilities where intrinsically safe equipment is required or desirable.

The instrument's laboratory performance and rugged construction coupled with convenient features such as the built-in loud-speaker and sound level meter makes the 4918A ideally suited for research and shop use applications.

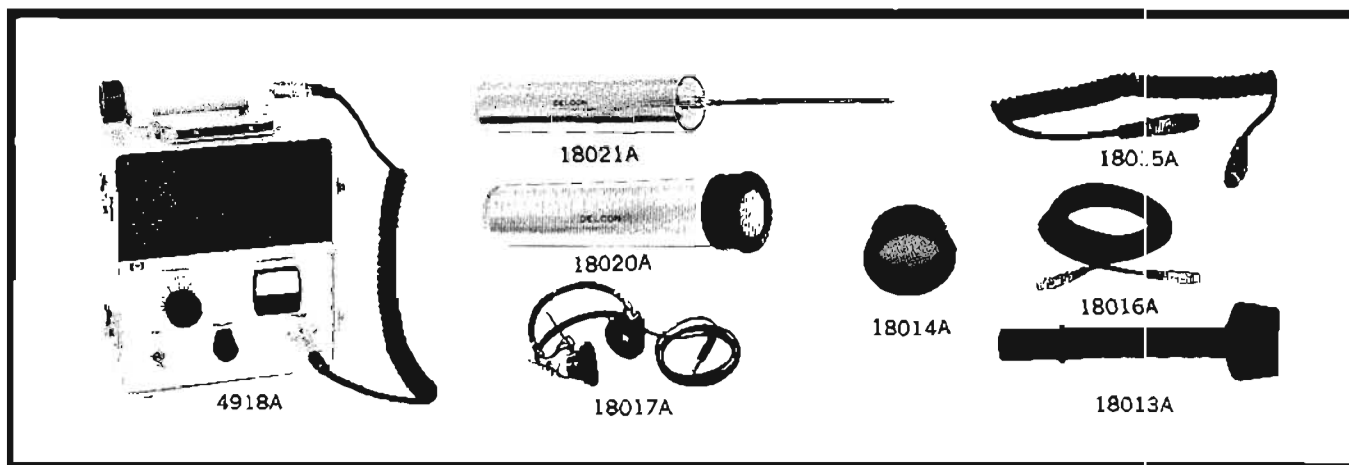

Specifications

Construction: rugged aluminum chassis and cabinet with detachable front cover with operating instructions and accessory storage. MIL-specification printed circuit boards; outside quick-access battery compartment.

Circuitry: broad-range 4.5 volt transistorized circuitry with RF filter. Hermetically-sealed power switch.

Frequency response: translates frequencies between 36 and 44 kHz into audible sounds; other sounds within audio range are screened out.

Probe and coil cord: hand-held probe shielded against RF interference; output impedance 180 ohms; transistorized pre-amplifier; conical response ± 11 degrees at 3 dB points. Supplied with a six-foot coil cord employing latch-lock connectors. Less than $1\frac{1}{8}$ " diameter x $6\frac{1}{4}$ " long, including protective monel-screened cap. Power to probe supplied through cord from instrument.

Meter: ultrasonic sound intensity indicated by output meter; sealed and gasketed to lock out dirt and contaminants; scale length 1.75 inches; calibration (0-100) on upper scale for logging relative measurements; lower scale calibrated from 0-30 dB.

Speaker: incorporates 4 x 6 inch speaker; power to speaker 400 mW.

Temperature: oscillator stability ± 15 Hz, and signal to noise ratio within ± 1 dB from 0-55 degrees C.

Headset jack: auxiliary 600-ohm headset jack. Headset furnished as standard.

System weight: net 11 lbs (5 kg); shipping 14 lbs (6.4 kg).

Battery Information: three cells, mercury type, Eveready E-42 or equivalent.

Battery life: 500-700 hours.

Price: 4918A, \$850.; Model 18021A Contact Probe available as optional accessory at \$150 additional.

Note: D.C. output jack is available as a special option.

Accessories

Model 18021A contact probe

Recommended uses:

- Locating internal hydraulic leakage.
- Locating internal gas leakage within valves.
- Detection of corona and arcing within transformers and sealed electrical components.
- Inspection of bearings and mechanical devices.

Circuitry: incorporates pre-amplifier circuit; output impedance 180 ohms.

Construction: non-ferrous construction; MIL-Specification printed circuit board.

System weight: net 11 oz (0.33 kg); shipping 2 lbs (0.91 kg).

Price: HP 18020A, \$150.

Other accessories:

18017A headset, 600-ohm.

System weight: 1 lb (0.45 kg); shipping 2 lbs (0.91 kg).

Price: \$27.00.

18015A cord, probe interconnecting, 6-foot coil cord.

System weight: 1 lb (0.45 kg); shipping: 2 lbs (0.91 kg).

Price: \$12.00.

18016A cord, probe interconnecting, 25-foot straight cord.

System weight: 1 lb (0.45 kg); shipping: 2 lbs (0.91 kg).

Price: \$13.00.

18013A focusing extension for 18020A probe.

System weight: 8 oz net (0.23 kg); shipping: 1 lb (0.45 kg).

Price: \$3.00.

18014A screened cap for 18020A Probe.

Shipping weight: 1 lb (0.45 kg).

Price: \$3.00.

18006A should strap (installed at factory or shipped as kit) for Model 4918A.

Shipping weight: 1 lb (0.45 kg).

Price: \$10.00.

LEAK-FRICTION DETECTORS



ULTRASONIC TRANSLATOR

Present alarm and trigger circuit; ac powered
Model 4950A

Ultrasonic detection recently has entered the laboratory, the production line, and the fixed station type of application in the form of the ac-powered Model 4950A, which is actually a variety of configurations for incorporation in numerous industrial systems.

The following information details how the special configurations now serve specific functions.

With up to five remote probes, programmed for sequential scanning (of five durations from 0.1 to 3.0 seconds) at separate locations each up to 500 feet or more from a central control station, 4950A's serve in continual leakage monitoring of critical pressure on vacuum systems, such as at atomic power stations.

The adjustable gate and alarm lengths can be preset for high speed production tests such as aerosol packages or pressure valves.

With built-in signal attenuator features, the instruments have the flexibility to perform a variety of quality assurance tests. The signal required to trigger the alarm can be set to any level to a 105 dB range above inherent noise with fine attenuation continuously adjustable over a 20 dB range.

Detecting leaks to 0.0001 cc/s. Attributable both to refined circuitry and to the fact that generally it is used in controlled environments, the Model 4950A can detect leaks of a size approaching those previously detectable only by mass spectrometers. Detergent vapors are introduced to the test chamber to serve as an acoustic amplifier, with a positive sensitivity of leaks smaller than 0.001 cc/s and with marginal sensitivity below 0.0001 inch.

With external oscillator jack, the 4950A users can select an oscillator frequency to eliminate the introduction of spurious signals or interference for testing high voltage transformers, etc.

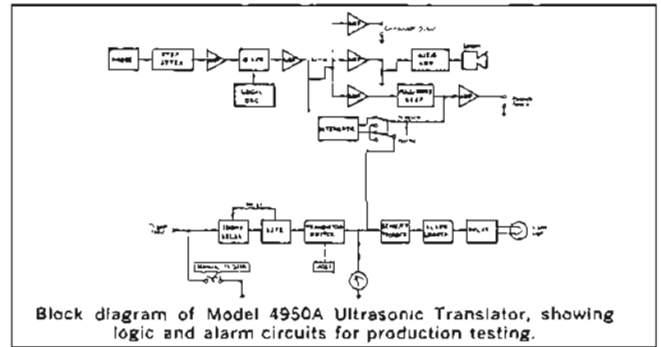

Translator operation can be either continuous or triggered. In continuous operation, the translated electrical signals corresponding to the ultrasonic input energy go directly and continuously to the audio meter, and alarm circuits. In triggered operation, the meter and alarm circuits are inactivated until a trigger—a momentary contact closure to ground—is applied to the trigger input. Then the gate is opened and the translator meter and alarm circuits are activated for a length of time determined by an adjustable monostable multivibrator. This mode could be used in production test systems which make loud ultrasonic noises while moving each new product into the test position. The activating trigger would be applied to the translator after each move is complete, the conveyor ultrasonically quiet, and the device ready to test.

All trigger and alarm controls are on the back panel. This allows the instrument to be preset by a line supervisor or quality assurance man but discourages tampering by the test position operator.

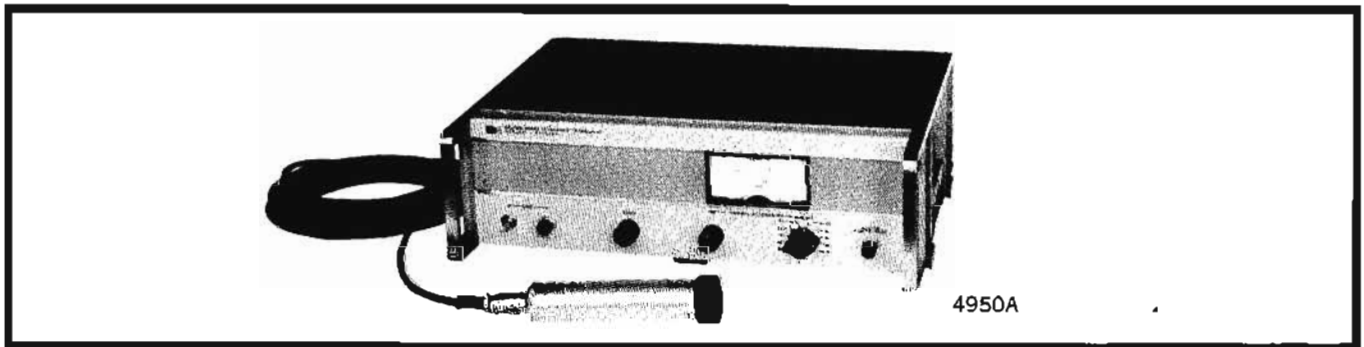

Specifications

Input: the 4950A Translator includes either the 18020A Ultrasonic Probe or 18021A Contact Probe as requested by the customer; these probes respond to ultrasonic energy in the 36 to 44 kHz band; Multiple input (5 limit) Option available.

Signal attenuator: step/dB - 10 dB/step attenuator over 90 dB range; Fine, continuously adjustable over 30 dB range.

Operation modes: continuous or triggered.

Continuous: continuous monitoring.

Triggered: adjustable gate length of 0.1, 0.3, 1.0, or 3.0 seconds; manual pushbutton or external contact closure to ground.

Meter response: normal or integrated for either operation mode.

Alarm system: activates at meter midscale.

Alarm length: 0.1, 0.3, 1.0, 3.0 s or latch.

Relay: SPDT terminals available at back panel; contacts 3.0 A at 30 V dc or 3.0 A at 115 V ac resistive.

Audio: has 2-watt audio amplifier with built-in loudspeaker.

Auxiliary outputs: oscilloscope, recorder, headphones.

Oscilloscope: 1.0 V rms output for full-scale meter deflection, 10 k ohms source impedance.

Recorder: 1.0 V dc output for full-scale meter deflection, 500-ohm potentiometer source impedance.

Headphones: requires 2,000-ohm dynamic headphones or similar; internal speaker is automatically disconnected.

Temperature: operating temperature range 0 to 50°C (+32 to +122°F).

Physical characteristics: dimensions 16¾" wide, 5½" high, 11¼" deep; system weight: net 18 lbs (8,26 kg), shipping weight 24 lbs (10,4 kg).

Power: 105 to 125 or 210 to 250 V, 50 to 60 Hz, 15 W.

Price: 4950A with 25' cable and 18020A General Purpose Probe, \$1,475.

18021A Contact Probe in lieu of 18020A available at no extra cost

MODULAR ENCLOSURE SYSTEM

Versatile instrument packaging



CABINETS & HARDWARE



Figure 1. Full rack width cabinets stack one atop the other.



Figure 2. Standard configurations include cabinets one-third and one-half full rack width. Accessory handle 11057A is shown on half-width instrument.

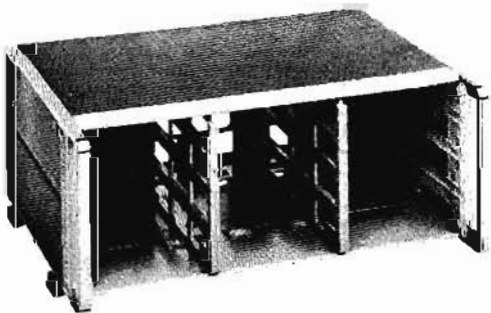

Figure 3. HP 1051A Combining Case.

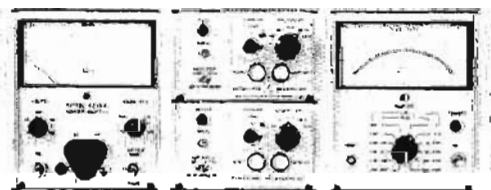

Figure 4. Here four HP instruments are mounted in one HP rack adapter frame.

The Hewlett-Packard modular enclosure system provides a complete solution to instrument packaging and mounting problems. The system is in accord with EIA standard rack and panel dimensions, yet each enclosure is equally well suited to bench or field use.

The matching enclosures offer an enviable combination of economy, strength and appearance. They are rugged enough to meet many of the stringent military requirements and present a rich, professional appearance which enhances the value of the instrument.

Two types of instruments

Basically, instruments enclosed in the modular system fall into two classes:

1. Those units which require the full EIA rack width. This class of instruments mounts directly in racks with the two brackets and filler-strip included with the instrument. Feet and tilt stand also are provided with full-module instruments for bench use, and the instruments can be stacked conveniently for maximum utilization of available space. For semi-permanent stacking, joining brackets are available which effectively combine two instruments into a single physical unit. Control panel covers are also available for these instruments to protect them when they are transported.
2. Those units which do not need the full rack width. These instruments are standardized at one-half or one-third the width of the full module. Because of their size, they are easily portable and can be used readily in the field, as well as on the bench. Accessory handles 11056A (one-third module) and 11057A (one-half module) are attached easily to these instruments for added handling convenience. In addition, adapter frames are available to mount these units in the standard EIA racks. The HP 1051A, 1052A Combining Cases also can be used for a multi-instrument package that is both portable and easily rack mounted with the hardware provided. Both combining cases and rack adapter frames use blank panels to fill areas not used by instruments and accept one-third width drawers for convenient storage of leads, probes, etc. Model 1052A Combining Cases also accept cooling kits to maintain proper ambient temperature.

Characteristic of both classes of modular instruments is ease of maintenance. Top and bottom covers, as well as side panels, are removable to provide access to all adjustments and test points within the instruments.

Carrying case (1/3 module)

A rugged, high impact plastic carrying case for HP 1/3 module instruments is now available. Instruments can be operated, stored or carried in the splash-proof case. A dual purpose tilt stand also serves as a carrying handle. At the rear of the case is an accessible compartment for the power cord; in the front lid is a storage space for cables, etc.

MODULAR ENCLOSURE SYSTEM *continued*

Versatile Instrument packaging

Specifications**1051A Combining Case (see Figure 3)**

Accepts third- or half-module instruments up to 11 $\frac{1}{4}$ " (286 mm) deep.

Dimensions: 16 $\frac{3}{4}$ " wide, 7 $\frac{1}{4}$ " high, 13 $\frac{1}{4}$ " deep (425 x 185 x 337 mm); hardware furnished for conversion to rack mount 19" wide, 6-31/32" high, 11 $\frac{1}{4}$ " deep behind panel (483 x 177 x 286 mm).

Weight: net 10 lbs (4,5 kg); shipping 14 lbs (6,3 kg).

Price: HP 1051A, \$110.

1052A Combining Case (not shown)

Accepts third- or half-module instruments up to 16 $\frac{3}{8}$ " (416 mm) deep.

Dimensions: 16 $\frac{3}{4}$ " wide, 7 $\frac{1}{4}$ " high, 18 $\frac{3}{8}$ " deep (425 x 185 x 467 mm); hardware furnished for conversion to rack mount 19" wide, 6-31/32" high, 16 $\frac{3}{8}$ " deep behind panel (483 x 177 x 416 mm).

Weight: net 12 lbs (5,4 kg); shipping 17 lbs (7,7 kg).

Price: HP 1052A, \$120.

Rack adapter frame (see Figure 4)

5060-0797 adapter to rack mount third- and/or half-module instruments up to 6-3/32" high (155 mm), \$25.

5060-0808 adapter to rack mount third- and/or half-module instruments up to 3" high (75 mm), \$25.

Modular enclosure accessories (see Figure 5)

Part Number	Control panel covers		Price
	EIA panel height (in.)	(mm)	
5060-0826	3-15/32	88	\$22.50
5060-0827	5-7/32	133	\$25.00
5060-0828*	6-31/32	177	\$27.50
5060-0829	8-23/32	222	\$28.50
5060-0830	10-15/32	266	\$30.00
5060-0831	12-7/32	310	\$32.50

* Also fits HP 1051A and 1052A.

Joining brackets (see Figure 7)

5060-0215 Joining Bracket Kit for semi-permanently joining any two full-module instruments 11 $\frac{1}{4}$ " (286 mm) deep behind the front panel, \$20.

5060-0216 Joining Bracket Kit for semi-permanently joining any two full-module instruments 16 $\frac{3}{8}$ " (416 mm) deep behind the front panel, \$25.

Accessory handles (see Figure 2)

11056A Handle for any one-third module instrument, \$5.

11057A Handle for any one-half module instrument, \$5.

11075A Carrying Case (see Figure 8)

Dimensions: will accept $\frac{1}{3}$ module instrument 6 $\frac{1}{2}$ " high, 8" deep.

Weight: net 2 $\frac{1}{4}$ lbs (1 kg); shipping 3 lbs (1,4 kg).

Price: HP 11075A, \$45.

11076A Carrying Case (see Figure 8)

Dimensions: will accept $\frac{1}{3}$ module instrument 6 $\frac{1}{2}$ " high, 11" deep.

Weight: net 2 $\frac{3}{4}$ lbs (1,2 kg); shipping 3 $\frac{1}{2}$ lbs (1,6 kg).

Price: HP 11076A, \$45.



Figure 5 Instrument covers quickly convert full-width cabinets to easily carried portable units.

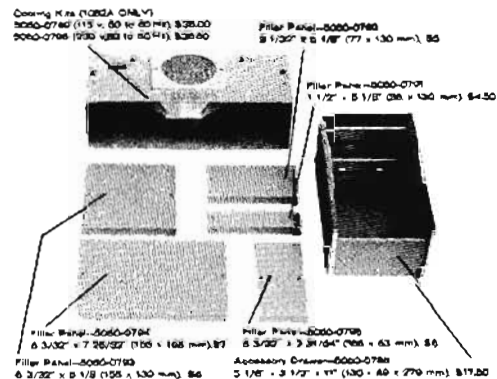

Figure 6. Combining case accessories.



Figure 7. Joining brackets effectively weld instruments into a single physical unit.

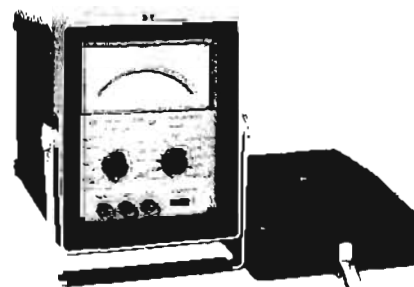

Figure 8. Rugged carrying case and tilt stand.



Indexes

Functional Index	634-642
Model Number Index	643-649

FUNCTIONAL INDEX



A

AC Calibrator	186, 187
AC Current Probe	220
AC Micro-voltmeter	201
AC Power Supply	170
AC Probe	221
AC Voltmeters	190, 201-213, 232
AC/DC Range Unit	232
AC/DC Remote Unit	232
AC, DC Voltmeter Calibrator	194
AC to DC Converters	236, 244
AC-DC VM, DC Standard	190, 191
AC/ohms to DC Converter	236
Accessories	
Analytical Instrumentation	50-52
Cable	222, 503
Carrying Cases	631
Current Shunt	221
Medical Instrumentation	61, 75
Microwave	277
Modular Enclosure	631
Oscilloscopes	479, 483, 497, 503
Oscilloscope Cameras	505, 506
Oscillator	351
Probe	253
Probe AC Current	220, 483
Probe, High Frequency	221, 498
Probe, Voltage Divider	221, 498, 503
Sampling Voltmeter	213
Spectrum Analyzer	437
Testmobiles	502
Voltmeter	220, 221
Adapters	221
BNC to Binding Posts	351
CATV 50 to 75 ohm	482
Coaxial	263
Oscilloscope Cameras	505
Rack for Small Modular Instruments	631
Sweep, Slotted Line	272-274
Waveguide, Square-to-Round Flange	285
Waveguide-to-Coaxial	277
Waveguide-to-Waveguide	277
Adjustable Short, Waveguide	292
Aircraft Electronic Test Equipment	374, 375
Alarm Display, Patient	71
Alarm Indicator, Remote	72
Ammeters	210, 215-217, 219, 231
Amplifiers	
AC Solid State	442-446
Battery-operated	443
DC	444, 517
DC Preamplifier	236
Data	442
ECG	63
Fast Pulse	445
General Purpose Stabilized	443-445
Heart Sound (Medical)	62

Isolation	443-446
Linear	614
Magnetic Tape Recording	167-169
Microwave	448
Multi-channel	156, 157
Nuclear	614
Power	444, 447, 517
Technical Information	136, 137, 438, 439
Wideband	444
Analog Magnetic Tape Recorders	86, 87, 163-170
Analog Measuring Equipment	
Tech. Info.	182-185, 196-200
Analog Voltmeter	188-192, 201-217
Analytical Instrumentation Introduction	24-26
Analyzers	
Analytical	39-42
Distortion	420-421
Microwave Link	308-309
Multichannel	612
Network	255-260
Spectrum	430-437
Waveforms	425-428
Apex Cardiogram	80
ATC Transponder Test Set	374
Attenuators	
Coaxial Pad	278, 404
Coaxial, Variable	278, 402
Current-Controlled	400-401
Decade	278, 302, 303, 351, 402
Precision, Variable Waveguide	280, 405
Set	351
Step	278, 402-403
Telephone Patch Panels	302, 303
Waveguide, Variable	280, 405
Audio Frequency Analyzers Distortion	420, 421
Audio Frequency Oscillators	337-350
Audio Frequency Signal Generators	337-350
Auto Frequency Divider	582
Auto Voltmeter	214, 230, 232
Automatic Network Analyzer	259, 260
Automatic Tape Degausser	170

B

Ballistocardiogram	80
Bandpass Filters, Coaxial	286
Battery Operated Oscillators	344
Battery Operated Voltmeters	207
Bolometer Mounts	270, 409, 411
Bridge	
Resistance	624
RF	263
Broadband Sampling Voltmeter	212, 213
Broadband Voltmeters	202-213

C

Cabinets, Modular	631
Cables, Test Leads	222

Cable Testing	
Fault Locating	481
Technical Information	316
Time Domain Reflectometer	481
Calibrators	
AC	186
AC/DC Meter	194, 195
Meter	194, 195
Peak Power	412
Power Meter	410
Thermistor Mount	410
Voltmeter	186, 194, 195
Calorimetric Power Meter	413
Cameras, Oscilloscope	504-506
Cardiac Monitoring, Instruments	66-69, 71-77
Cardiac Output Computer Medical	88
Cardio-Tach	81
Carriages, Universal Probe	272-274
Carrying Cases	631
Central Station Monitors, Medical	66, 71-74
Cesium Beam Standards	590, 591
Cesium Beam Tubes	592
Clamps, Waveguide	277
Clock, Digital	94, 113, 117, 600
Coagulation Analyzer	55
Coaxial	
Adapters-to-Waveguide	277
Attenuators	402-404
Bandpass Filters	286
Detector	287
Detector Mounts	272-274
Directional Couplers	288-290
Directional Detectors	288-290
Frequency Meters	585
Instrumentation	278, 279
Low-Pass Filters	286
Pads	404
PIN Modulators	400, 401
Slide-Screw Tuner	291
Slotted Sections	272-274
Terminations	292
Thermistor Mount	409-415
Coaxial Adapter	435
Coax Adapter Kit	263
Coaxial Instrumentation	278
Comb Generator	437
Combining Case	631-632
Combining Case, 12530B	625
Communications Test Equipment	293-323
Cable Fault Locating, Technical Information	296
Cable Fault Locators	297, 481
Open Pair Locators	298
Technical Information	299, 300
Telephone Test Meter, Oscillator	304-305
TV Monitoring	310-316
Ultrasonic Translators	294
Comparator, Digital	94

Compliance (lung)	80
Computer	
Cardiac Output	88
Digital	95, 102
Magnetic Tape Units	109-111
Microwave System	259-260
Computing System	100
Contact Crystal Microphone, Medical	78
Converters	
AC-DC	150-155, 236, 244, 507-542
AC/ohms to DC	236-242
Digital-to-Analog	514-516
Frequency	373
Microwave Frequency	580
Voltage to Frequency	243
Counters, Electronic	550-582
Ruggedized	556
Technical Information	545
Coupler	
DC Excitation	624
Directional	288-290
Output	95
Coupling Transformer	265
Crystal Detectors	287
Crystal Filters	437
Current Probe	221, 483
Current Shunt	221

D

D/A Converter	117, 514-516
Data Acquisition Systems	96, 98, 100, 259, 260
Data Amplifiers	440-442
Data Linearizer	94
DC Ammeters	210, 215-217, 219, 231
DC Amplifier	444, 517
DC Defibrillator	70
DC Digital Voltmeter	227-235, 238-242
DC Excitation Source	624
DC Microammeter	216-217
DC Milliammeter	216, 217
DC Multifunction	
Meter	188-192, 209-211, 214-217, 231-232
DC Multifunction Unit	231
DC Nanoammeter	217
DC Null Meter	214, 215
DC Null Voltmeter	214, 215
DC Null Voltmeter/Ammeter	215
DC Power Supplies	507-542
DC Preamplifier	236
DC Standard AC-DC Δ VM, AC-DC VM	190, 191
DC Standard/Differential Voltmeter	188, 189
DC Transfer Standard	193
DC Voltmeters	
.....	188-192, 209-211, 214-217, 227-235, 238-242
Defibrillator Electrodes	75
Degausser, Magnetic Tape	170

FUNCTIONAL INDEX



- Detectors
 Coaxial 272-274
 Couplers 288-289
 Crystal 278, 280, 287
 Directional 288, 289
 Nuclear 620
 Waveguide 270
 X-ray 621
 Diagnostic Sounder 56
 Digital Clock 94, 113, 117, 600
 Digital Comparator 94
 Digital Computer 95, 102
 Differential Amplifiers 440, 441
 Differential Voltmeter/DC Standard 188, 191
 Digital
 Ammeter Plug-in 231
 Clock 113, 117, 600
 Delay Generator 325
 Frequency Meter 567
 Magnetic Tape Units 109-111
 Ohmmeter Plug-in 231
 Oscillator 345
 Printer Mechanism 113
 Recorder 113-116
 Scanner 93
 Systems 96, 98, 100
 System Elements 92
 To-Analog Converter 514-516, 612
 Voltage Source 514-515
 Voltmeter 93, 227-235, 238-242
 Voltmeter Plug-ins 228-232, 562
 Voltmeter Technical Info. 223-226
 Wave Analyzer 426-428
 Digitally Programmed Power Supply 514-515
 Diodes
 Hot Carrier 174-175
 High Conductance 178
 Microwave Mixing 174
 Photo 180-181
 PIN 178
 Step Recovery 173
 Switching 175
 Directional Couplers 288-290
 Directional Detectors 288-289
 Displacement Transducers, Medical 79
 Distortion Analyzers 420-421
 FCC Approved 306
 Technical Information 418, 419
 DME/ATC Test Set 374
 Doubler Sets, Frequency 370
 Dual-Directional Coupler 288-290
 Dye Curve 80
- E**
- Earpiece Photo-Plethysmograph 75
 ECG 80
 ECG Amplifier 63
 ECG-EEG Preamplifier 69
 Electrocardiographs 60
 Electromyogram 80
 Electromyograph 58
 Electroretinogram 80
 Enclosures, Modular 631
 Excitation Coupler 624
 Excitation Source, DC 624
- F**
- FM Signal Generator 372
 FM Discriminators, Frequency Meters 583
 Feed-Thru
 50-ohm 351
 75-ohm 351
 600-ohm 351
 Fetal ECG 80
 Filters
 Bandpass 285, 286
 Bandpass, Waveguide 285, 286
 Crystal, 20MHz 437
 Flexible, Waveguide 283, 284
 Low-Pass 278, 286
 Notch 2GHz 437
 Flow, Air 80
 Flow, Blood 80
 Fluid Pressure Transducer, Medical 75, 78
 Force Transducers, Medical 79
 Frequency
 Comb Generator 437
 Converters 373, 558
 Counters 545-582
 Dividers, Clocks 600
 Doubler 370
 Doubler Probe 360
 Doubler Sets 370, 376
 Meters 585
 Meters, FM Discriminators 567, 583-585
 Microwave Converters 558, 580-582
 Plug-in for 524 Counter 577
 Synthesizers 602-605, 607, 608
 Frequency Synthesizer
 Applications 609
 Technical Information 601
 Frequency and Time Measuring Instrumentation 545-549
 Frequency, Time Standards 598, 599, 607, 608
 Function Generator
 Instruments 337-341
 Technical Information 332-333
 Variable Phase 337
 Voltage Controlled 339
- G**
- G-Band Instrumentation 280
 Galvanic Skin Resistance 80
 Gamma Ray Spectrum Scanner 618
 Gas Analysis 80
 Gas Chromatography 27-38

Generators

Audio Signal	342-350
Digital Delay	325
Function, Low Frequency	337-341
Function, Variable Phase	337
High Frequency	354-355
Noise, Digital	331
Pulse	332-333
SHF	366-369
Signal, FM-AM	371
Signal, FM	372
Signal, Glide Slope	375
Signal, Low Frequency	337-341
Signal, Telemetry	372
Spectrum	376
Square Wave	321, 337-341
Sweep	341, 382
Technical Information	352-353
UHF	361-364
VHF	356-359
Go/No-Go Comparator	94, 233
Guarded Data Amplifier	93, 242

H

H-Band Instrumentation	282
H-Band Test Set	365
Heart Rate	80
Heart Sound Amplifier	62
Heart Sound	80
Heart Sound Timing	80
HF Signal Generators	354-355
High-Conductance Diodes	178
High Frequency Probe	221
High-Go Low Comparator	233
Hot Carrier Diodes	174-175

I

ILS Receiver Test Set	375
Impedance	
Bridge	262-263
Meters	251, 254-260
Technical Information	245-249
Indicators, Standing Wave	269-270
Inductance Meter	251, 254, 262, 264, 266
Inductors, Reference	265-266
Input Scanner	92
Instrument Cart, Mobile	75
Instrumentation Magnetic Tape	
Recording Systems	163-170
Integrating Digital Voltmeters	93, 234, 238, 240, 242
Integrating/Potentiometric	
Digital Voltmeter	234, 235, 238, 289

J

J-Band Instrumentation	281
------------------------	-----

K

K-Band Instrumentation	285
------------------------	-----

Kits

Accessories for 3406A	213
Accessories for 8405A	253
Probe, for 3406A	213
Probe, for 411A	213

L

Lead Shield, Nuclear	619
Leak Friction Detectors	626-630
Limit Tester	233
Line Matching Transformer	351
Linear Amplifier	614
Linearizer, Data	94
Loads, Moving	292
Logarithmic Converters	134
Logarithmic Voltmeters	202-206
Loop Adapter, Magnetic Tape	170
Low Frequency Function Generator	337-341
Low Frequency Generator	337-341
Low Frequency Voltmeters	207
Low-Pass, Bandpass Filters	286
Low-Pass Filters	286
Low Power Waveguide Terminations	292

M

Magnetic Tape Degausser, Automatic	170
Magnetic Tape Output Coupler	95
Magnetic Tape Units, Analog	86, 87, 163-170
Magnetic Tape Units, Digital	109-111
Mark-Sense Reader	112
Medical Instrumentation	52-88
Meters	
AC-DC Δ VM, AC-DC VM, DC Standard	190, 191
Ammeters	210, 215-217, 219, 231
Auto-Voltmeter	214, 230
DC VM, DC Δ VM, DC Standard	188, 189
Digital	227-235, 238-242
Kilovoltmeter	209-211, 214-216, 228-235, 238-239
Microammeter	210, 216, 217
Micro-voltmeter	201, 217
Milliammeters	210, 211, 215-217, 219
Milliammeters Clip-on DC	219
Milliohmeter	218
Millivoltmeter	188-192, 209-211, 214-217, 227-232, 234-237
Mount Calibrators	410
Multi-function	188-192, 209-211, 214-217, 227-232, 234, 237
Nanoammeter	215, 217
Noise Figure	414-415
Ohmmeter	209-211, 214, 216, 218
Peak Power	412
Power	406-413
Q	264, 266
Ratio	271
RF Vector Impedance	254
RX	263

FUNCTIONAL INDEX



SWR	269-270
Thermistor Mounts	408, 409
Vector Impedance	251, 252, 254
Vector Voltmeter	252, 253
Volt-ammeter	215, 217
Voltmeters	188-192, 201-217, 227-242
Volt-ohmmeter	209, 211, 214
Volt-ohm-ammeter	210, 216
Volt-ohm-ammeter Plug-in	231
Microphone, Contact, Medical	78
Microvolt-ammeter	217
Microwave	
Accessories	277
Amplifiers	439, 448
Frequency Converter	580
Link Analyzer	308, 309
Power Meter	408, 409, 411, 413
Spectrometer	39, 40
Spectrum Analyzer	432-436
Technical Information	406, 407
Microwave Devices	
Comb Generators	177
Hybrid Integrated	176-177
Limiters	176
Mixer/Detectors	177
PIN Absorptive Modulators	177
Switches	176
Switching Modules	176
Millivoltmeter, RF	212
Miscellaneous Equipment	277
Mixers	389, 399, 437
Mobile Instrument Cart	75
Modulators	397-399, 401
Modulators, PIN	401
Molecular Weight Determination	43-49
Monitor	
Scope (Medical)	72
TV Picture	314-315
Video	314-315
Motor Drive Amplifier (see 3680 AC Power Supply) ..	170
Mount	
Bolometer, Coaxial	270
Detector, Coaxial	278, 287
Detector, Waveguide	270, 280, 287
Thermistor, Coaxial	279, 408, 409, 411
Thermistor, Waveguide	280, 408, 409, 411
Moving Loads	292
Moving Short, Waveguide	292
Multichannel Analyzer	612
Multi-Hole Couplers	290

N

Network Analyzer	255-258
Network Analyzer, Automatic	259-260
NIM Power Supply	614

Noise Figure Measurements	
Technical Information	414
Noise Figure Meters	414, 415
Noise Sources	280, 284, 414, 415
Notch Filter 2GHz	437
Nuclear Analyzer	280, 284, 414
Nuclear Scanner	618
Null Meters DC	214, 215
Numerical Readout, Medical	88

O

Ohmmeter	209-211, 214, 216, 218, 231
Optoelectronic Devices	
GaAs Sources	181
GaAs Infrared Sources	180
Photon Coupled Isolators	180-181
PIN Photodiodes	180-181
Optical Mark Reader	112
Oscillators	
Audio and Ultrasonic	337-350
Battery-operated	305, 344
Crystall Controlled	337
Digital	345
Low Distortion	306, 337, 343
Portable	344
Pushbutton	346
Sinusoidal	337-350
Sweep	340, 341, 382, 385-396
Technical Information	334-336, 381
Test	348, 349
Telephone Test	305
Tracking	427, 428
Ultra-low Frequency	337-341
VHF	360
Oscilloscopes	
Accessories	474, 479, 483, 503
Cameras	504-506
Instruments	73, 74, 311-313, 454-501
Medical	73, 74
Selection Chart	452
Technical Information	449
T.V. Waveform	311-313
Testmobile	498, 502

P

P-Band Instrumentation	284
Pacemaker	67-79
Patch Panels	302, 303
Patient Alarm Display	71
Patient Monitor	67, 69
Blood Pressure	69
ECG	67
Heart Rate	67
Pulse	67
Respiration Rate	67
Temperature	67, 69
Venous Pressure	69

- Patient Selector 71
- p^{CO_2} 80
- Peak Power Calibrator 412
- pH 80
- Phase Lock Function Generator 339, 340
- Phase Measurements 245-249
- Phase Measurements Plug-in 255-258
- Phase Measurements, Technical Information 245-249
- Phase Meter 252, 253
- Phase Shifter 291
- Photomultiplier Power Supply 619
- Photoconductor Devices
- Photocells 179
 - Photochoppers 179
 - Photo Controlled Resistors 179
- Physical Measurements, Technical Information 622
- PIN Diodes 400, 401
- PIN Modulators 400, 401
- Plethysmogram 80
- Plethysmograph 75
- Plug-in
- For Electric Counters 558-562, 577
- Pneumogram 80
- p^{O_2} 80
- Portable Test Set 302-305
- Portable Voltmeters 207
- Power Amplifier 444, 447, 517
- Power and Voltage Amplifiers 446, 517
- Power Measurement 406, 407
- Power Meters
- Calorimetric 413
 - Microwave 408, 411, 413
 - Peak 412
- Power Supply
- High Voltage 619
 - Klystron 543
 - Nuclear Instrument Modules 614
 - Regulated DC 507-543
- Preamplifier
- Cardio-tach, Medical 81
 - Carrier 150-155
 - Carrier, Medical 80, 81
 - DC 236-237
 - DC, Medical 80
 - DC Coupler, Medical 81
 - ECG, Medical 81
 - ECG/General, Medical 81
 - EEG, Medical 81
 - Heart Sound, Medical 80
 - High Gain DC 150-155
 - High Gain, Medical 81
 - Integrating, Medical 81
 - Log-Level 150-155
 - Low-Gain DC 150-155
 - Low Level, Medical 80, 81
 - Medium Gain DC 150-155
 - Nuclear 621
 - pH, Medical 81
 - Phase Sensitive 150-155
 - Plug-in 150-155
 - Respiration Rate 81
 - Special Purpose DC 150-155
 - Technical Information 136, 137
- Precision AC Amplifier 446
- Precision AC Calibrator 186, 187
- Precision Analog Voltmeters 188-192
- Precision Analog Voltmeters & Sources
- Technical Information 182-185
- Precision DC Sources 188-191, 193
- Precision Digital Voltmeter 234-239
- Precision Ratiometer 192
- Prescaler Plug-in 262
- Preselector 437
- Preset Counter 573
- Preset Unit 560
- Pressure (Medical) 80
- Pressure Processor 81
- Pressure Transducer
- Applanation 78
 - Fluid, Medical 79
 - Medical 78
- Printers, Digital 113-116
- Probability Distribution Analyzer 612
- Probe Carriages, Universal 272-274
- Probes
- AC 221
 - Coaxial "N" Connector 221
 - Coaxial "T" Connector 221
 - Current 220, 483
 - Frequency Doubler 360
 - High Frequency 221, 497
 - Magnetometer 219, 306
 - Microwave 272-274
 - Oscilloscope 479, 497, 503
 - Voltage Divider 221, 503
 - Voltmeter 220, 221, 253
- Processor, Digital 612
- Production Line Time Saver 233
- Programmable AC Calibrator 186
- Programmable Function Generator 339-341
- Programmable Oscilloscope 484
- Programmable Power Supply 514-516
- Programmable Sweeping Signal Generator 383
- Programmers, System 94
- Pulse Generators
- Instruments 322-329
 - Selection Chart 319
 - Technical Information 318
- Pulse Height Analyzer 612, 614
- Pulse Height Analyzer, Single Channel 616
- Pulse Wave 80
- Punched Card Output Coupler 95
- Punched Tape Output Coupler 95
- Pushbutton Oscillator 346

FUNCTIONAL INDEX



Q

Q Measurements	261
Q Meter	264, 266
Q Standards	265
Quartz Oscillators	594-597

R

R-Band Instrumentation	285
Ratio Meters	192, 271
Reader, Optical Mark	112
Record Amplifiers, Magnetic Tape	163-170
Recorders (see also Strip Chart X-Y Recorders)	
Accessories	135
Accessories, Magnetic Tape Recording	170
Digital	135
Direct Writing, Fluid	146-148, 155
Direct Writing, Thermal	138-145, 152-154
Electric Writing	131-132
Magnetic Tape, Analog	86, 87, 163-170
Magnetic Tape, Digital	109-111
Optical, Ultra-violet	149
Technical Information	136, 137
Recording Systems	
Fluid	146-148, 155
Fluid, Medical	84
Magnetic Tape	86, 87, 163-170
Optical, Medical Monitor	84
Optical, Ultra-violet	149
Photographic, Medical	85
Technical Information	136, 137
Thermal	138-145, 152-154
Thermal, Medical	82, 83
Thermal, Medical Monitor	84
Ultra-violet, Medical	85
Reference Inductors	265, 266
Reflection Coefficient Measurement	
Technical Information	248-250, 267, 268
Regulated Power Supplies	507-542
Remote Alarm Indicator	72
Remote/Auxiliary Signal Switch	71
Remote Monitor	72
Reproduce Amplifiers, Magnetic Tape	163-170
Resistance Bridge	624
Resistance, Pulmonary	80
Respiration Rate	80
Reversible Counter	574
RF Millivoltmeter	213
RF Sampling Voltmeters	212
RF Test Set	365
RF Vector Impedance Meter	254
RF Voltmeters	252-253
RMS Voltmeter	208
RX Meter	263

S

S-Band Instrumentation	280
S-Parameters	249
S-Parameter Test Set	250

Sampled Voltage Analyzer	612
Sampling RF Voltmeter	212, 213, 252-253
Scaler-timers	616
Scanner	
Digital	93
Input	92
Spectrum	618
Scattering Parameters	250
Scintillation Detector	620
Scope Camera	64, 65
Selective Voltmeters	425-428
Sensor, Temperature	623
Servo, System, Magnetic Tape (see 3681 Tape Servo) ..	170
SHF Signal Generators	366-368
SHF Test Set	365
Shield, Lead	619
Shorting Switch, Waveguide	277
Shorts, Waveguide, Adjustable	292
Shunt Resistor	221
Single Channel Analyzer	614, 616
Single Conditioning Equipment	624
Signal Delay	68
Signal Generators	
Aircraft Test	374, 375
Audio Frequency	337-350
AM-FM	371
FM	372
HF	354, 355
Power Amplifier	447
SHF	366-369
Sources	362, 363
Sweeping	350, 383, 384
Synchronizer	358-359
Technical Information	352, 353
To 40GHz	352, 353
UHF	361, 364
VHF	356-360
Signal Sources	324-396
Signal Switch, Remote/Auxiliary	71
Slide-Screw Tuners	291
Slotted Line Measurements	272-274
Slotted Lines	273, 274, 280
Slotted Line Sweep Adapter	272
Technical Information	267, 268
Slotted Lines, Detectors	272-274
Sodium Iodide Crystal Detectors	620
S Parameters	250
S Parameter Test Set	250
Special Purpose Counters	
Specialized Analytical Analyzers	39-42
Spectrometer, Microwave	39, 40
Spectrum Analyzer	432-436
Spectrum Analyzer Preselector	437
Spectrum Generator	376, 437
Spectrum Scanner	618
Square Wave Generators	
Instruments	320, 321

Selection Chart	319
Technical Information	318
Stand, Waveguide	277
Standards	
AC	186, 187
DC	188-191, 193
Inductance, Q	265
Standby Power Supply	593
Standing Wave Indicator	269, 270
Strain Gage Conditioning Equipment	92, 624
Step Recovery Diodes	174-175
Strip Chart Recorders	
Plug-ins	133
5-inch	131
10-inch	132
Technical Information	129
Sweep Function Generator	339-341, 382
Sweep Oscillator	385-396
Sweeping Signal Generator	350, 383, 384
Swept-Frequency Measurements	
Instruments	386-396, 480
Technical Information	377-381
SWR Indicator; Mounts	270
SWR Meters	269
Instruments	269-271
Technical Information	267, 268
SWR, Reflection Coefficient Measurement	267, 268
Synchronizer, Signal Generators	358, 359
Synthesizer Driver	606
System Programmer	94
Systems	
Analytical	24-42
Data Acquisition	96-101
Digital Tape	108-111
DME/ATC Test Set	374
Frequency, Time Standards	586-609
Instrumentation Computer	102-107
Medical, Intensive Care	66-79
Medical, Research	80-88
Network Analysis, Automatic	259
Recording	130, 136-170

T

TV Picture Monitor	314, 315
Tape Servo, Magnetic	170
Tape Recorders, Analog	86, 87, 163-170
Tape Recorders, Digital	109-111
Telemetry Signal Generator	372
Telemetry Magnetic Tape Recorders	163-170
Telephone Test Meter	304
Telephone Test Oscillator	305
Telephone Test Set	302-305
Television, Waveform Monitoring	
Technical Information	310
Television, Waveform Monitors	311-313
Temperature	80
Temperature Probe	623

Terminations	
Coaxial	292
Waveguide	277, 292
Terminations & Shorts	292
Test Leads	222
Test Oscillators	348-349
Test Oscillator Telephone	305
Test Set	
ATC Transponder	374
Communications Systems	302-305
DME/ATC	374
ILS Receiver	375
RF	365
Telephone Systems	302-305
Transmission Line	302-305
VOR Receiver	375
Thermal Dilution	80
Thermistor Mounts	279, 408, 409, 411
Thermistor Mount Calibrator	410
Thermistor Mount Coaxial	408, 409, 411
Thermometer, Quartz	43, 623
Time Interval	
Counter	576
Plug-in for 524 Counter	577
Unit	561
Transducers	75, 78, 79, 158, 159
Amplifier-Indicator	159
Displacement, Medical	79
Fluid Pressure, Medical	75, 78, 79
Force, Medical	79
Linear Displacement	158
Linear Velocity	158
Linearsyn	158
Low Level Force	159
Pressure	159
Pressure, Medical	78
Signal Conditioners	624
Velocity, Medical	79
Transfer Oscillator	580, 581
Transfer DC Standards	193
Transformer, Coupling	265
Transformer, Line Matching	351
Transistor Test Jig	263
Triangular Generators	338
Tunable Voltmeter	201
Tuners, Coaxial	291
Tuners, Phase Shifters	291
Tuners, Waveguide	291

U

UHF Signal Generator	361, 364
Universal Coupler	95
Universal Probe Carriage	272-274
Univert	373
Untuned Probes	272-274
Ultrasonic Diagnosis	56
Up-Converter, Spectrum Analyzer	437

FUNCTIONAL INDEX



V

VCG, Scaler	80
VHF Signal Generators	356-359
Variable Attenuators	402, 405
Variable Coaxial Attenuator	402
Vectorcardiogram	80
Vectorcardiograph	64
Vector Impedance Meter	251, 253
Vector Programmer	64
Vector Voltmeter	252, 254
Velocity Transducers, Medical	79
VHF Oscillator	360
VHF Signal Generator	356-359
Video Amplifier	561
Video Monitor	314-315
Viso Monitor	68
Viso Scope	73, 74
Voice Channel, Magnetic Tape Recording	165, 170
Volume, Respiratory	80
Volt-ammeter	215, 217
Voltage Divider Probe	221
Voltage-to-Frequency Converter	243
Voltmeters	206, 207
AC	190, 201-213, 232
AC Calibrator	186-187
Broadband Sampling	212, 213
Calibration System	194
Calibrator	195
DC	188-192, 209-211, 214-217, 227-235, 238-242
Digital	93, 227-235, 238-242
Logarithmic Scale	202-206
Plug-In Unit for Counter	562
RMS	208
Selective	425-428
Technical Information	182-185, 196-200, 223-226
Tunable	201
Vector	252, 253

VOR Receiver Test Set	375
-----------------------	-----

W

Wall Mount Bracket	75
Wave Analyzers	425-428
Technical Information	423, 424
Waveguide	
Adapters	277
Adjustable Shorts	292
Attenuators	405
Broadband Probes	272-274
Clamps	277
Detector Mounts	272-274
Detectors	287
Directional Couplers	290
Flexible	283, 284
Frequency Meters	585
Instrumentation	280-285
Loads, Moving	292
Low-Pass Filters	286
Noise Sources	415
Phase Shifter	291
Probe Carriages	272-274
Shorting Switch	277
Stands	277
Terminations	277, 292
Thermistor Mounts	408, 409, 411
Tuners	291

X

X-Band Instrumentation	255-258, 283, 408
X-Band Test Set	365
X-ray Detector	621
X-Y Recorder	
Technical Information	119
8 1/2 x 11	120-123
11 x 17	124-128



MODEL NUMBER INDEX

APT Applanation Pressure Transducer 78
 F3B Line Follower 135
 FTA Force Transducers 179
 FTA Low Level Force Transducers 159
 LV syn Velocity Transducer 79, 158
 2FA X-Y Recorder 128
 3LV Linear Velocity Transducers 158
 6LV Linear Velocity Transducers 158
 7DCDT Displacement Transducer 79, 158
 7LV Linear Velocity Transducers 158
 GV-10/11 Gas Sampling Valves 51
 24DCDT Linear Displacement Transducers 158
 40D Keyboard 135
 50 Automatic Attenuator 52
 51-4 Solid Sample Injector 51
 53 Battery Converter 145
 80 Pyrolyzer 51

100

101A 1 MHz Oscillator 595, 596
 105A Quartz Oscillator 594, 595, 596, 597
 105B Quartz Oscillator 594, 595, 596, 597
 106A Quartz Oscillator 594, 595, 596, 597
 106B Quartz Oscillator 594, 595, 596, 597
 107AR Quartz Oscillator 594, 595, 596, 597
 107BR Quartz Oscillator 594, 595, 596, 597
 115BR Frequency Divider and Digital Clock 600
 115CR Frequency Divider and Digital Clock 600
 117A VLF Comparator 598, 599
 120B 450 KHz Oscilloscope 454
 H40-120B Monitor Scope 74
 H41-120B Monitor Scope 74
 H45-120B Monitor Scope 74
 122A Dual Trace Oscilloscope 455
 130 Cardiac Output Computer 88
 130C 200 μ V/cm Oscilloscope 456
 132A Dual Beam Oscilloscope 458
 135A X-Y Recorder 122
 136A X-Y Recorder 123
 140A Plug-in Oscilloscope Main Frame 460, 462
 141A Variable Persistence Oscilloscope
 Mainframe 460, 463
 155A Programmable Oscilloscope 484
 175A Plug-in Oscilloscope 488
 180A Plug-in Oscilloscope Main Frame 491, 492
 H51-180A Oscilloscope 612
 180E Ruggedized Plug-in Oscilloscope 499
 181A Variable Persistence Main Frame 491, 493
 185 CHN Analyzer 41, 42
 190A Q Meter 266
 191A T.V. Waveform Oscilloscope 312
 193A T.V. Waveform Oscilloscope 311
 196A Oscilloscope Camera 506
 196B Oscilloscope Camera 506
 197A Oscilloscope Camera 504
 C04-197A Scope Camera 64, 65

200

200AB Audio Oscillator 342, 343

200CD Wide-Range Oscillator 342, 343
 H20-200CD Low Distortion Wide-Range
 Oscillator 306, 342, 343
 201C Audio Oscillator 342, 343
 202A Low Frequency Function Generator 338
 202C Low Frequency Oscillator 343
 202H FM-AM Signal Generator 371
 203A Variable Phase Function Generator 337
 204B Portable Oscillator 344
 205AG Audio Signal Generator 347
 206A Audio Signal Generator 347
 207H Univerter 373
 208A Test Oscillator 344
 211A Square Wave Generator 320
 211A VOR, ILS Signal Generator 375
 211B Square Wave Generator 321
 213B Pulse Generator 324
 214A Pulse Generator 327
 215A Pulse Generator 328
 216A Pulse Generator 329
 217A Square Wave Generator 321
 218AR Digital Delay Generator 325
 219A Dual Trigger Unit 325
 219B Dual Pulse Unit 325
 219C Digital Pulse Duration Unit 325
 220A Square Wave Generator 320
 222A Pulse Generator 326
 230A Signal Generator Power Amplifier 447
 232A Glide Slope Signal Generator 375
 236A Telephone Test Oscillator 305
 241A Pushbutton Oscillator 346
 250B RX Meter 263
 260A Q Meter 264
 267 Pressure Transducer 78
 267AC Fluid Pressure Transducer 75, 78
 268 Pressure Transducers 78
 281A/B Waveguide-to-Coaxial Adapters ... 277, 280-284
 292A/B Waveguide Adapters 277
 297A Sweep Drive 425
 299 1-Channel Portable Rec. Sys., Thermal 143, 145

300

301 1-Channel Portable Rec. Sys., Thermal 143, 145
 302 Vapor Pressure Osmometer 44, 45
 302A Wave Analyzer 301, 425
 310A Wave Analyzer 301, 426
 311A Transducer Amp.-Indicator 159
 312A Wave Analyzer 301, 427, 428
 313A Tracking Oscillator 301, 427, 428
 320 2-Channel Portable Rec. Sys., Thermal ... 144, 145
 321 2-Channel Portable Rec. Sys., Thermal ... 144, 145
 322 2-Channel Portable Rec. Sys., Thermal ... 144, 145
 322A 2-Channel Portable Rec. Sys., Thermal ... 144, 145
 331A Distortion Analyzer 420, 421
 332A Distortion Analyzer 420, 421
 HO5-332A Distortion Analyzer 306
 333A Distortion Analyzer 420, 421

606B HF Signal Generators	354, 355
608C/D/E/F VHF Signal Generators	356, 357
612A UHF Signal Generator	361
614A UHF Signal Generators	364
616B UHF Signal Generators	364
618C SHF Signal Generators	366
620B SHF Signal Generators	367
623B SHF Test Set	365
624C X-Band Test Set	365
626A SHF Signal Generators	368
628A SHF Signal Generators	368, 369
651B Test Oscillator	348, 349
652A Test Oscillator	349
658-2000 8-Channel Galv. Driver Amplifier	157
658-2900 8-Channel Low Gain Amp.	157
658-3400 8-Channel Med. Gain Amplifier	157
675A Sweeping Signal Generator	350, 383, 384
680 Strip Chart Recorder	131

700

700 Series Laboratory Gas Chromatographs	33, 34
711A D.C. Power Supply	542
712B Power Supply	542
715A Klystron Power Supply	543
716 Klystron Power Supply	543
735A DC Transfer Standard	193
E02-735A Transfer Standard Reference	193
738BR Voltmeter Calibrator	194
E02-738BR Voltmeter Calibration System	194
740B DC Standard/Differential Voltmeter	188, 189
741B AC-DC Differential Voltmeter/ DC Standard	190, 191
745A AC Calibrator	186, 187
752A, C, D Directional Couplers	280, 290
760-3A Cardio-tach	81
760-1300 DC Coupler	81
760-1500 Low Level Preamp.	81
760-1600A ECG Preamp.	81
760-2200 Resp. Rate Preamp.	81
760-2700A EEG Preamp.	81
760-3000 Carrier Preamp.	81
760-3100 Pressure Processor	81
768S Monitor Scope	72
769A Monitor Scope	72
770 Series Dual Directional Couplers	279, 288, 289
775 Automatic Preparative Gas Chromatograph	35, 36
776 Manual Preparative Gas Chromatograph	37, 38
780 Series Directional Couplers	279, 288, 289
780B Viso Monitor	68
780-1 Mobile Instrument Cart	75
780-2C Defibrillating Electrodes	75
780-3 Monitor/Scope	67
780-5A Signal Delay	68
780-6A Viso-Scope	73
780-7 Patient Monitor	67
780-7A Patient Monitor	67
780-8 Patient Monitor	67
780-9 Patient Monitor	69

780-10 Mobile Instrument Cart	75
780-11 Patient Selector	71
780-12 Patient Alarm Display	71
780-13A Remote/Auxiliary Signal Switch	71
780-15 Wall Mount Bracket	75
780-16 Earpiece Photo-Plethysmograph	75
780-18 ECG-EEG Preamplifier	69
780-19 Patient Monitor	69
780-21 Remote Alarm Indicator	72
780-800B Remote Monitor	72
790 Series Directional Couplers	279, 288, 289

800

801C Strain Gage Supply	542
805C-817A Slotted Lines; Detectors	272
851B Spectrum Analyzer Display Section	435
852A Spectrum Analyzer Display Section, Variable Persistence	435
860-4300 Differential Amp.	441
870A Slide-Screw Tuners, Waveguide	291
885A Waveguide Phase Shifters	291
890A MVR Power Supplies	534
895A MVR Power Supplies	534

900

907A Sliding Load, Coaxial	279, 280, 292
908A Low-Reflection Termination, Coaxial	279, 292
909A Low-Reflection Termination, Coaxial	279, 292
910A/B Terminations, Coaxial	280, 292
X913A Termination Waveguide	277
914A/B Moving Loads, Waveguide	280, 292
920A/B Adjustable Shorts, Waveguide	280, 292
X923A Terminations & Shorts	292
X930A Shorting Switch, Waveguide	277
P932A Harmonic Mixer	277
934A Harmonic Mixer	277, 279
938A Frequency Doubler Sets	370
940A Frequency Doubler Sets	370

1000

1051A, 1052A Combining Cases	631
1102B Accessory Kit	474
1105A/1106A Pulse Generator	324
1105A/1108A Pulse Generator	324
1110A/1111A Current Probe and Amplifier	483
1116A Testmobile	502
1117B Testmobile	502
1118A Testmobile for 180A/181A	497
1119A Testmobile	502
1280 Fluid Pressure Transducers	79
1281 Pressure Transducers	159
1300 X-Y Display	486
1400A Differential Amplifier for 140A/141A	469
1401A Dual Trace Amplifier For 140A/141A	469
1402A Dual Trace Amplifier for 140A/141A	466
1403A Guarded Differential Amplifier for 140A/141A	470
1405A Dual Trace Amplifier for 140A/141A	467
1406 High Sensitivity Amplifier for 140A/141A	468

MODEL NUMBER INDEX



1407A High Sensitivity Amplifier for 140A/141A ..	470
1410A Sampling Vertical Amplifier for 140A/141A ..	473
1411A Sampling Vertical Amplifier for 140A/141A ..	475
1415A Time Domain Reflectometer for 140A/141A ..	481
1416A Swept Frequency Indicator for 140A/141A ..	480
1420A Time Base for 140A/141A ..	471
1421A Time Base/Delay Generator for 140A/141A ..	472
1422A Time Base for 140A/141A ..	471
1423A Time Base for 140A/141A ..	471
1424A Sampling Time Base for 140A/141A ..	477
1425A Sampling Time Base for 140A/141A ..	478
1430A Sampler for 1411A ..	476
1431A Sampler for 1411A ..	475
1432A Sampler for 1411A ..	475
1500 Electrocardiograph ..	60
1501A Coagulation Analyzer ..	55
1506B Heart Sound Amplifier ..	62
1507A Vector Programmer ..	64
1508A ECG Amp., 3-Channel ..	63
1509A ECG Amp., 6-Channel ..	63
1510A Electromyograph ..	58
1511A Electrocardiograph, Mobile ..	60
1520A Vector System ..	64
1550A Programmable Oscilloscope ..	484
1750B-1784A Plug-ins for 175A Oscilloscope ..	489
1801A Vertical Amplifier for 180A/181A ..	494
1803A Differential Comparitor for 180A/181A ..	495
1804A Four Channel Plug-in for 180A/181A ..	495
1820A Time Bases for 180A/181A ..	496
1821A Time Bases for 180A/181A ..	496
2000	
2010 Series Data Acquisition System ..	96
2012 Series Data Acquisition System ..	98
2018 Data Acquisition System ..	100, 622
2020 Series Digital Magnetic Tape Units ..	109-111
2115A Computer ..	95, 102
2116A Computer ..	95, 100, 102
2150A Extender Module ..	102
2212A Voltage-to-Frequency Converter ..	243
2401C Integrating Digital Voltmeter ..	93, 224, 242
2402A Integrating Digital Voltmeter ..	93, 224, 240
2410B AC/ohms Converter ..	93, 242
2411A Guarded Data Amplifier ..	93, 242
2417A Data Linearizer ..	94
2470A Data Amplifier ..	438, 442
2480 Series Signal Conditioners ..	92, 622, 624
2480 DC Excitation Source ..	624
2480C Excitation Coupler ..	624
2480K Excitation Coupler ..	624
2481A Resistance Bridge ..	624
2482N Monitor Function Selector ..	624
2509A Digital Clock ..	94
2515A Digital Scanner ..	93
2526 Card Punch Coupler ..	95
2539A Digital Comparator ..	94
2545 Tape Punch Coupler ..	95
2546 Magnetic Tape Coupler ..	95
2547A Output Coupler ..	95, 98
2560AV Programmer System ..	94
2590B Frequency Converter ..	580
2760A Optical Mark Reader ..	112
2801A Quartz Thermometer ..	43, 622, 623
2830A Sensor Oscillator ..	623
2833A Temperature Sensor ..	623
2850 Series Temperature Sensors ..	623
2901A Input Scanner/Programmer ..	92
2911 Guarded Crossbar Scanner ..	92
2911C Programmer ..	94
3000	
3030 Series Digital Magnetic Tape Units ..	109-111
3200B VHF Oscillator ..	360
3205A FM Signal Generator ..	372
3211A Sweep Oscillator ..	385
3212A-3217A RF Plug-ins for 3211A ..	385
3221A Marker Plug-in for 3211A ..	385
3300A Function Generator ..	339
3302A Trigger/Phase Lock Plug-in for 3300A ..	340
3304A Sweep/Offset Plug-in for 3300A ..	340
3305A Sweep Plug-in Function Generator ..	341, 382
3400A RMS Voltmeter ..	208, 244
3406A Broadband Sampling Voltmeter ..	212, 213
3410A AC Microvoltmeter ..	201
3420A/B DC Differential Voltmeter/Ratiometer ..	192
3430A DC Digital Voltmeter ..	227
3434A High/Go/Low Comparator ..	233
3439A Plug-in Digital Voltmeter ..	228
3440A Plug-in Digital Voltmeter ..	229
3441A Range Selector for 3439A/3440A/3434A ..	230
3442A Automatic Range Selector for 3439A/3440A/3434A ..	230
3443A High-Gain/Auto Range Unit for 3439A/3440A/3434A ..	230
3444A Multi-Function Unit for 3439A/3440A/3434A ..	231
3445A AC/DC Range Unit for 3439A/3440A/3434A ..	232
3446A AC/DC Remote Unit for 3439A/3440A/3434A ..	232
3459A Digital Voltmeter ..	239
H04-3460A Digital Voltmeter ..	238, 239
3460B Digital Voltmeter ..	234-235
3461A AC/ohms Converter, DC Preamplifier ..	236, 237
3513A/3514A (Part of 3950 & 3955 Series) ..	166-169
3520A/3521A (Part of 3900 Series) ..	86, 87, 163-165
3520B/3521B (Part of 3955 Series) ..	163, 166-167
3524A/3525A (Part of 3955 Series) ..	163, 166-167
3526A/3527A (Part of 3950 Series) ..	163, 168-169
3528A Large Aperature Probe for 428B ..	219
3529A Magnetometer Probe for 428B ..	219
C11-3529A Magnetometer Probe ..	306
3534A Direct Record Amplifier (300 KHz) ..	167, 168
3535A FM Record Amplifier (dc-20 KHz) ..	167, 168, 169
3537A Direct Reproduce Amplifier (300 KHz) ..	167, 168
3538A FM Reproduce Amplifier (dc-20kHz) ..	167, 168, 169
3540A Direct Record Amplifier (1.5 MHz) ..	168, 169
3543A Direct Reproduce Amplifier (1.5 MHz) ..	168, 169
3550A Portable Test Set ..	302, 303
3555A Telephone Test Meter ..	304
3603A Automatic Tape Degausser ..	170

3604A Voice Channel	170
3605A FM Frequency Source	170
3680A AC Power Supply	170
3681A Tape Servo	170
3701A-3703A Microwave Link Analyzer	308, 309
3722A Noise Generator	331
3900-Series Magnetic Tape Recorders	86, 87, 163, 164
3907-06A Voice Channel Amplifier	165
3907-07A Input Signal Coupler	165
3907-11A Remote Control Unit	165, 170
3950-Series Instrumentation Magnetic Tape Recorders	163, 168
3955-Series Instrumentation Magnetic Tape Recorders	163, 166

4000

4204A Digital Oscillator	345
4260A Universal Impedance Bridge	262
4328A Milli-ohmmeter	218
4508B 8-Channel Osc. Rec. Sys., Ultra-Violet	149
4508BT Ultra-Violet Rec. Sys.	85
4524B 24-Channel Osc. Rec. Sys., Ultra-Violet	149
4561B Monitor Rec. Sys., Optical	84
4564B Photographic Rec. Sys.	85
4568B Photo. Rec. Sys.	85
4800A Vector Impedance Meter	251
4815A RF Vector Impedance Meter	254
4900A Cable Fault Locator	297
4901A Cable Fault Locator	297
4905A Ultrasonic Translator	294, 628
4910B Open Pair Fault Locator	298
4910C Open Pair Fault Locator	298
4916A Ultrasonic Translator	294
4917A Ultrasonic Translator	628
4918A Ultrasonic Translator	629
4950A Ultrasonic Translator	630

5000

5050A Digital Recorder	113, 114
5061 Cesium Beam Frequency Standard	590-591
E20-5061A Portable Cesium Beam Frequency Std.	590
5082-0112 Through 5082-0320 Step Recovery Diodes	173
5082-1001 Through 5082-1006 High Conductance Diodes	178
5082-2301 Through 5082-2997 Hot Carrier Diodes	174
5082-3001 Through 5082-3202 PIN Diodes	178
5082-4104 Through 5082-4320 Optoelectronic Devices	181
5082-4507 Through 5082-4610 Photoconductor Devices	179
5082A Cesium Beam Tube	592
5085A Stand-by Power Supply	593
5086 Stand-by Power Supply	593
5100B Frequency Synthesizer	604, 605
5102A Frequency Synthesizer	607-608
5103A Frequency Synthesizer	607-608
5110B Synthesizer Driver	606
5201L Scaler-Timer	616
5202L Scaler-Timer	616
5203L Scaler	616
5210A/B Frequency Meter	583
5211A Electronic Counter	550, 568
5211B Electronic Counter	550, 568
H22-5211B Electronic Counter	550
5212A Electronic Counter	550, 568

5214L Preset Counter	550, 573
5216A Electronic Counter	550, 566
5221A Electronic Counter	550, 564
5221B Electronic Counter	550, 565
5223L Electronic Counter	550, 570
5232A Electronic Counter	550, 568
5233L Electronic Counter	550, 570
5240A Digital Frequency Meter	550, 567
5244L Electronic Counter	550, 563
5245L Electronic Counter	550, 552, 580
M54-5245L/M Electronic Counter, Ruggedized	556
5245M Electronic Counter	550, 554
5246L Electronic Counter	551, 550
5247M Electronic Counter	550, 557
5251A Frequency Converter, Plug-in	558
5252A Prescaler Plug-in	562
5253B Frequency Converter Plug-in	558, 580
5254B Frequency Converter Plug-in	558
5255A Frequency Converter Plug-in	558
5256A Frequency Converter Plug-in	558
5258A Prescaler Plug-in	562
5260A Auto Frequency Divider	582
5261A Video Amplifier	561
5262A Time Interval Unit	561
5264A Preset Unit	560
5265A Digital Voltmeter Plug-in	562
5275A Time Interval Counter	550, 576
5280A Reversible Counter	550, 574
5400A Multichannel Analyzer	612
5410A Power Supply/Interface	612
5415A Analog-to-Digital Converter	612
5421A Digital Processor	612
5431A Display Plug-in	612
5512A Electronic Counter	568
5532A Electronic Counter	550, 568
5551A High Voltage Power Supply	619
5552A Spectrum Scanner	618
5580A/B NIM Power Supply	614
5582A Linear Amplifier	614
5583A Single Channel Analyzer	614
5601A Numerical Readout	88
5636 H-Band Test Set	365
5750-Series Research Gas Chromatographs	27, 28, 29, 30
5901B Auto-Viscometer	48, 49
5903A Printer-Programmer (For Auto Viscometer)	48, 49

6000

6110A-6116A STB Power Supplies	526-527
6130A Digital Voltage Source	514-515
6177A-6186A CCB Power Supplies	528-529
6200B-6209B LAB Power Supplies	520-521
6215A-6218A BENCH Power Supplies	518-519
6220B-6226B MPM Power Supplies	523
6253A DPR Power Supplies	524-525
6255A DPR Power Supplies	524-525
6260A-6274A LVR Power Supplies	532-533
6281A-6299A MPB-3, MPB-5, Power Supplies	524-525
6343A-6357A MOD Power Supplies	538-539
6384A-6388A ICS Power Supplies	530-531
6427B-6448B SCR-1P Power Supplies	535
6453A-6459A SCR-3 Power Supplies	536
6463A-6483A SCR-10 Power Supplies	537
6515A HVB Power Supplies	522

MODEL NUMBER INDEX



6516A HVB Power Supplies	522
6521A-6525A HVR Power Supplies	534
6823A PS/A Power Supplies	517
6824A PS/A Power Supplies	517
6920A AC/DC Meter Calibrator	195
6933A Digital-to-Analog Converter	514-515
6945A Video Monitors	314-315
6946A Video Monitors	314-315

7000

7000A X-Y Recorder	125
7001A X-Y Recorder	125
7004A X-Y Recorder	126
7005A X-Y Recorder	124
7030A X-Y Recorder	121
7035B X-Y Recorder	120
7100B Strip Chart Recorder	132
7101B Strip Chart Recorder	132
7127A Strip Chart Recorder	132
H10-7127A GC Strip Chart Recorder	50
71728A Strip Chart Recorder	132
H10-7128A GC Strip Chart Recorder (Dual Channel)	50
7214 Diagnostic Sounder	56
7560A Log Converter	134
7561A Log Converter	134
7562A Log Converter	134
7701B 1-Channel Osc. Rec. Sys., Thermal	138
7701BX 1-Channel Osc. Rec. Sys., Thermal	138
7702B 2-Channel Osc. Rec. Sys., Thermal	139
7704A 4-Channel Osc. Rec. Sys., Thermal	140
7706A 6-Channel Osc. Rec. Sys., Thermal	141, 142
7708A 8-Channel Osc. Rec. Sys., Thermal	141, 142
7712B 2-Channel Rec. Sys., Thermal	82
7714A 4-Channel Rec. Sys., Thermal	82
7716A 6-Channel Rec. Sys., Thermal	82
7717B 6-Channel Rec. Sys., Thermal	82
7718A 8-Channel Rec. Sys., Thermal	83
7719B 8-Channel Rec. Sys., Thermal	83
7720A 8-Channel Rec. Sys., Thermal	83
7727A 6-Channel Osc. Rec. Sys., Thermal	141, 142
7729A 8-Channel Osc. Rec. Sys., Thermal	141, 142
7734A Monitor Rec. Sys., Thermal	84
7802B DC Defibrillator	70
7804A Pacemaker	69
7858A 8-Channel Osc. Rec. Sys., Fluid	146-148
7868A 8-Channel Osc. Rec. Sys., Fluid	84, 146-148
7878A 8-Channel Osc. Rec. Sys., Fluid	146-148

8000

8000A Pulser	322
8001A Pulser	322
8003A Pulser	323
8051A Loudness Analyzer	417
8400B Microwave Spectrometer	39, 40
8402B Thermistor Mount Calibrator	410
8403A Modulator	400
8405A Vector Voltmeter	249, 250

8406A Frequency Comb Generator	437
8410A Network Analyzer System	253-260
8430A-8436A Bandpass Filters	278, 286
8439A 2 GHz Notch Filter, Coaxial	437
8441A Preselector, Voltage Tunable	436
8442A Crystal Filter for Spectrum Analyzer	437
8470A Crystal Detector, Coaxial	287
8471A Crystal Detector, Coaxial	287
8472A Crystal Detector, Coaxial	287
8478B Thermistor Mount	279, 408, 409
8491A/B Attenuator, Fixed Coaxial Pad	278, 404
8492A Attenuator, Fixed Coaxial Pad	278, 404
8439A/B Attenuator, Fixed Coaxial Pad	278, 404
8540A Automatic Network Analyzer	259-260
8551B Spectrum Analyzer RF Section	434-435
K15-8551B Spectrum Analyzer Up-Converter	437
8614A Signal Generators; Sources	362
8614B Signal Generators; Sources	362
8616A Signal Generators; Sources	362
8616B Signal Generators; Sources	362
8690A Sweep Oscillator, Signal Source	381
E31-8690A System Meter, Mount Calibrators	410
8691A/B-8698A RF Units for 8690A	381
8706A Control Unit	381
8707A RF Unit Holder	381
8708A Synchronizer	358, 359
8730-Series PIN Modulators	279, 400
8801A Low Gain DC Preamp.	150-155
8802A Med. Gain DC Preamp.	150-155
8803A High Gain DC Preamp.	150-155
8805A Carrier Preamplifier	150-155
8806B Phase Sen. Demod.	150-155
8807A AC-DC Converter	150-155
8808A Log Level Preamp.	150-155
8809A Spec. Purp. DC Preamp.	150-155
8820A 8-Channel Low Gain Amp.	156
8821A 8-Channel Med. Gain Amp.	156
8875A Differential Amplifier	440
8900B Peak Power Calibrator	412
8905A Wavemeter	374
8925A DME/ATC Test Set	374

00000-00610

00103A Inductor for 260A	265
00127A Set of Sixteen 00103A	265
00128A Set of Seventeen 00103A	265
00513A Q Standard for 260A	265
00515A Coax Adapter Kit for 250B	263
00518A Q Standard for 260A	265
00538A Set of five 00518A and one 00513A	265
00564A Coupling Transformer	265
00590A Inductors	266
00591A Set of six 00590A	266
00600A Probe Accessory Kit for 4815A	254
00601A Component Mounting Adapter for 4815A	254
00610A Terminal Shield for 4800A	251

10000

10003B Probes	503
10001A Probes	503
10005A Probe for 180A/181A	497
10006A Probe for 180A/181A	497
10025A Times one Probe	503
10035A Probe Tip Kit	503
10100A/B 50 ohm Terminations	483

10110A Adapter, BNC to binding posts	351, 483
10111A Adapter, BNC to binding post	351, 483
10166A Panel Cover for 180A/181A	497
10167A Carrying Cover for 180A/181A	497
10176A Viewing Hood	497
10203A 100:1 Divider Tip	474
10214A 10:1 Divider Tip	474
10216A Isolator	474
10217A Blocking Capacitor	474
10218A BNC Adapter	474
10220A Microdot Screw-on Adapter	474
10221A 50 ohm T Connector	474
10223A Microdot Slide-on Adapter	474
10452A Rise Time Converters	482
10457A 75 ohm Adapter	482
10458A 75 ohm Adapter	482

10500

10501A Cable Assembly	222
10502A Cable Assembly	222
10503A Cable Assembly	222
10511A Spectrum Generator	376
10514A Double Balanced Mixer	398, 399
10514B Double Balanced Mixer	398, 399
10515A Doubler	376
10534A Double Balanced Mixer	398, 399
10534B Double Balanced Mixer	398, 399
10601A Scintillation Detector	620
10602A Scintillation Detector	620
10611A Scintillation Detector	620
10612A Scintillation Detector	620
10613A Scintillation Detector	620
10614A Scintillation Detector	620
10615A Preamp-Amplifier	621
10650A Well Detector Shield	619

11000

11000A Cable Assembly	222
11001A Cable Assembly	222
11002A Test Leads	222
11003A Test Leads	222
11004A Line Matching Transformer	351
11005A Line Matching Transformer	351
11018A Adapter	221
11027A Probe Kit for 411A	213
11033A Shunt Resistor	221
11035A Cable Assembly	222
11036A AC Probe for 410C	221
11039A Capacitive Voltage Divider	220
11040A Capacitive Voltage Divider	220
11042A Probe Coaxial "T" Connector	221
11043A Probe Coaxial "N" Connector	221
11044A Capacitive Voltage Divider	220
11045A Capacitive Voltage Divider	220
11048B 50-ohm Feed-Thru	351
11049A-51A Thermal Converters	191
11064A Accessory Probe Kit for 3406A	213
11066A Current Shunt	221
11071A Accessory Probe Kit for 3406A	213
11074A Voltage Divider Probe	221
11075A 1/3 Module Carrying Case (8" deep)	631
11076A 1/3 Module Carrying Case (11" deep)	631
11086A Cable Assembly	222
11094A 75-ohm Feed-Thru	351

11095A 600-ohm Feed-Thru	351
11096A High Frequency Probe	221

11500

11500A Cable Assembly	222
11501A Cable Assembly	222
11503A Flexible Waveguide, P-Band	284
11504A Flexible Waveguide, X-Band	283
11507A Output Termination for 606A/B	355
11508 Output Cable, Terminated, for 608	357
11509 Fuseholder, Coaxial, for 608	357
11511A Short, Coaxial, Female	274
11512A, Short, Coaxial, Male	274
11515A and 16A Adapters, Square to Round Waveguide Flange	285, 287
11517A-11521A Spectrum Analyzer Waveguide Mixers and Adapters	437
11539A Reproduce Track Selector	170
11540A Waveguide Stand	277
11541A-11548A Waveguide Clamps	277

12000-13000

12530B Combining Case	625
13110A Continuous Loop Adapter	170
13111A Continuous Loop Adapter	170
13505A Isolator Monitor for 8925A	374
13510A Transistor Test Jig	263
13511A Marker Oscillator for 3211A	385
13515 Frequency Doubler Probe for 3200B	360
13525A Calibration Resistor for 4800A	251

17000

17005A Incremental Chart Advance	315
17006A Roll Chart Adapter	135
17009A/B Character Printer	135
17011A Point Plotter, Dual Head	135
17012A/B Point Plotter, Single Head	135
17170A Plug-in (7004A) DC Coupler	127
17171A Plug-in (7004A) DC Amplifier	127
17172A Plug-in (7004A) Time Base	127
17173A Plug-in (7004A) Null Detector	127
17174A Plug-in (7004A) DF Offset	127
17175A Plug-in (7004A) Input Filter	127
17500 Plug-in (7100B, 7101B, 7127A, 7128A) Multi Span Input Module	133
17501A Plug-in (7100B, 7101B, 7127A, 7128A) Multi-span (1 mv) Input Module	133
17502A Plug-in (7100B, 7101B, 7127A, 7128A) Temperature Input Module	133
17503A Plug-in (7100B, 7101B, 7127A, 7128A) 1 mV Input Module	133
17504A Plug-in (7100B, 7101B, 7127A, 7128A) Single Span Input Module	133

18000-60285

18002A Quick Search Wand	295
18003A Mobile Reflector	295
18526 Variable Temperature Controller	52
19030A Backflush Valve	51
19034A Effluent Splitter	52
19035A Injection Splitter	52
19046A Gas Purifier	52
19055A Total Collection System	52
33000A Thru 33803A Microwave Devices	176, 177
60065A-60285A SLOT Power Supplies	540-541