

# HP Archive

This vintage Hewlett Packard document was preserved  
and distributed by

**[www. hparchive.com](http://www.hparchive.com)**

Please visit us on the web !

On-line curator: Glenn Robb



*MEASUREMENT/COMPUTATION*

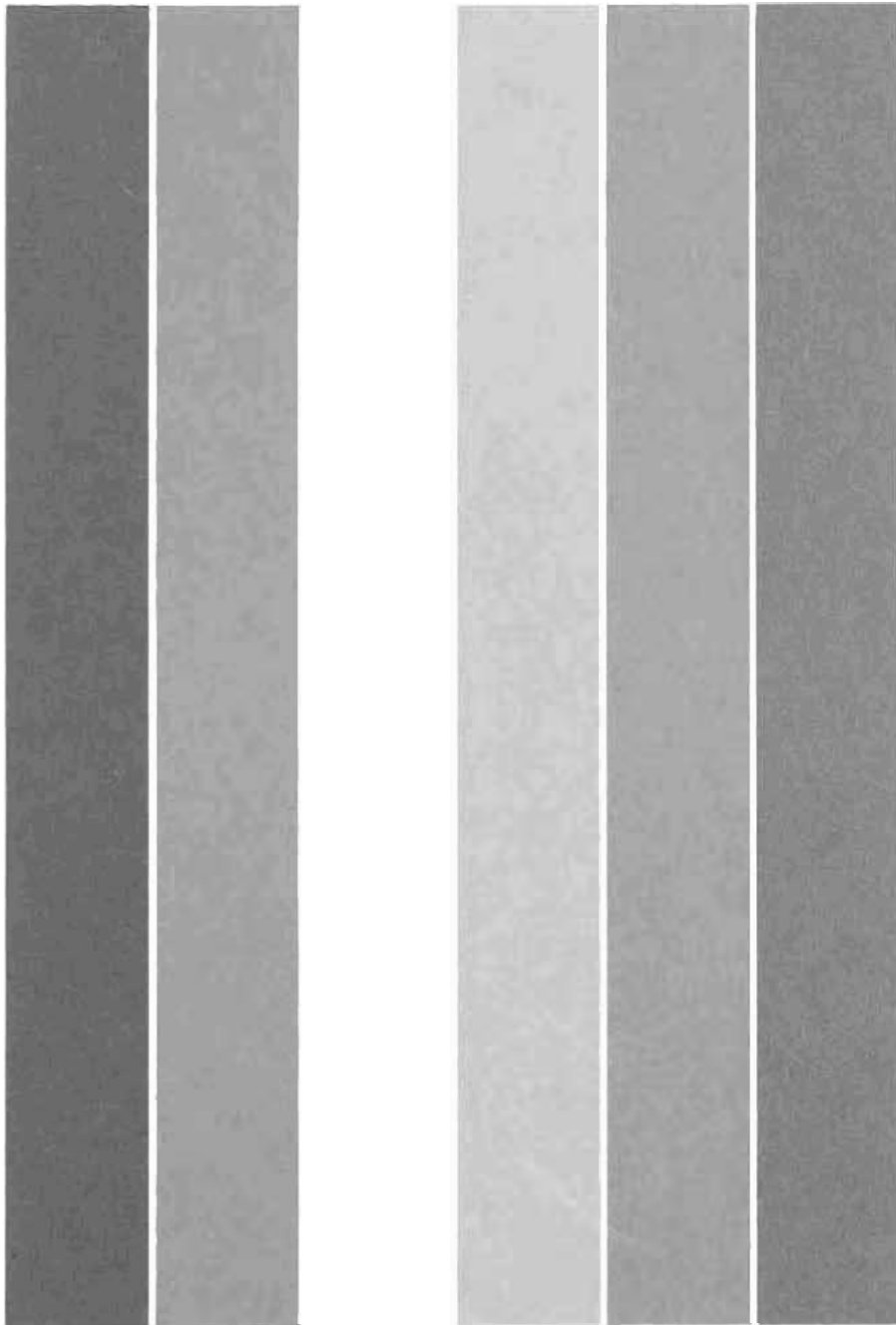

*1978*  
*ELECTRONIC  
INSTRUMENTS  
AND SYSTEMS*



## PRODUCT EXCELLENCE, LASTING VALUE

Assurance of lasting value accompanies every Hewlett-Packard product. Hewlett-Packard intends to continue the long-standing practice of offering excellent products, supported by a wide variety of useful services both before and after the sale.

### HP design technology

Hewlett-Packard's responsibility begins with product designs which apply advanced technologies, often pioneered at HP through extensive ongoing research. Many of today's commonly-accepted measurement standards and practices began with the design of innovative HP products.

Advanced technology is not the only design consideration, however. An HP product's "manufacturability" and (especially important after the purchase of a product) its "serviceability" also contribute to its lasting value.

### HP manufacturing

HP product designers understand the practical aspects of product manufacture. This emphasis on modern manufacturing technology, coupled with superior workmanship and high productivity, ultimately delivers high-value HP products at competitive prices. In addition, HP manufacturing facilities contribute to the ultimate serviceability of the products purchased by furnishing clear and well-written operating and service instructions.

Today, Hewlett-Packard has more than 30 manufacturing facilities located in California, Colorado, Idaho, New Jersey, Oregon, Pennsylvania and Massachusetts in the U.S.—as well as in Scotland, the German Federal Republic, France, Japan, Singapore, Malaysia and Brazil.

### HP product serviceability

Serviceability can mean many things. In the broadest sense, it means getting full utilization and value from a purchase, and this is one of HP's principal objectives in serving customers.

In other ways, it can mean having a product that is easy to understand and operate—as well as one that works under a variety of adverse conditions and can be depended upon to perform as expected for years to come. As a practical matter, it also means having a product backed by a reputable firm so that subsequent maintenance, repairs and parts are readily available. Hewlett-Packard's worldwide service organization helps provide full and continuing value from an HP product.

### HP SALES AND SERVICE: NEARBY . . . AND WORLDWIDE

Product excellence and value are only part of the total HP story. Equally important is the ready availability of local sales and service support.

To be responsive to customer needs, Hewlett-Packard has 172 sales/service offices in 65 countries. These offices are staffed by 3,100 HP sales and service engineers and electronics technicians, and by many highly-qualified specialists in HP's sales representative organizations. This means that a significantly large number of people are *specifically and directly available to HP customers, worldwide for pre- and post-sale technical support.*

To locate the HP Sales and Service Office nearest you, please see the listing inside the back cover of this catalog.



Identifies products having the Hewlett-Packard Interface Bus (HP-IB) capability. HP-IB is our implementation of the IEEE Standard 488 and the identical ANSI Standard MC1.1, "Digital interface for programmable instrumentation." For the complete story, see pages 20-29.



Identifies newly introduced products or capabilities. New products are also indicated by bold-face listings in the Model Number Index.

<b>ALPHABETICAL INDEX</b> .....	<b>1</b>
<b>MODEL NUMBER INDEX</b> .....	<b>10</b>

**PRODUCTS:**

Amplifiers .....	30	Medical Instrumentation .....	608
Analog Voltmeters .....	33	Microwave Test Equipment .....	410
Cabinets & Measurement Accessories .....	508	Network Analyzers .....	430
Calculators, Personal .....	566	Oscillators & Function Generators .....	333
Calibrators .....	352	Oscilloscopes .....	128
Chemical Analysis, Instruments for .....	610	Personal Calculators .....	566
Civil Engineering/Surveying .....	616	Physical & Optical Measurements .....	601
Component Test Equipment .....	75	Power & Noise Figure Meters .....	402
Computation: Computers, Systems/ Peripherals .....	572	Power Supplies .....	200
CRT Displays .....	182	Pulse & Word Generators .....	304
DC Power Supplies .....	200	Recorders & Printers .....	226
Digital Circuit Testers .....	100	Signal Analyzers .....	460
Digital Voltmeters .....	44	Signal Generators .....	356
Electronic Counters .....	259	Sweep Oscillators .....	381
Frequency Synthesizers .....	343	Solid State Components & Circuits .....	612
Frequency & Time Standards .....	292	Telecommunications Test Equipment .....	526
Hewlett-Packard Interface Bus (HP-IB) .....	20	Training/Video Tapes .....	617
Logic Analyzers .....	111	Transceiver Test Equipment .....	524
		X-Ray Systems, Scientific & Industrial .....	607

After-Sale Service .....	623
Application Notes—a selected listing .....	621
Information Request Card .....	back of catalog
Ordering Information .....	624
Sales/Service Offices .....	inside back cover
Warranty .....	624

**CATALOG CONTENT**

This catalog is designed primarily to serve the needs of engineers, scientists and technicians who are concerned or work with electrical/electronic phenomena. It deals with the broad area of *measurement* (plus generation and recording), as well as related *computation*.

Hewlett-Packard has many additional capabilities not detailed in this catalog, which are instead summarized on the last few pages. In the event your work is related to any of these other HP capabilities, we will be pleased to send you specific product information on request.

- A**
- AC**
- Calibrator ..... 354-355
  - Current Probe ..... 517
  - Digital Voltmeter ..... 44-70
  - Divider Probe ..... 516
  - Probes ..... 516
  - RF ..... 42
  - True RMS ..... 41, 52, 53, 58, 70
  - Voltmeters ..... 34-43, 46, 52, 58, 70
- Accessories**
- Cables/Connectors ..... 380, 514
  - Cameras ..... 177
  - Carrying Cases ..... 518
  - Connectors, Adapters ..... 380, 515
  - Modular Power Supplies ..... 223
  - Oscilloscope ..... 171
  - Signal Generators ..... 380
  - Spectrum Analyzer ..... 501-504
  - Voltmeter ..... 65, 516
- AC/DC Meter Calibrator** ..... 352, 517
- Active Probes** ..... 174, 449
- Adapters**
- 50 — 75Ω ..... 380, 445, 449, 501, 515
  - Cables/Connectors ..... 380, 514
  - Coaxial and Waveguide ..... 423
  - Four Channel ..... 330, 331
  - Slotted Line Sweep ..... 415
- Air Line Extensions** ..... 423
- Alphanumeric LED Displays** ..... 614
- Alphanumeric Printer** ..... 256
- AM/FM Signal Generators** ..... 358, 362, 365, 370
- Amplifiers**
- AC Calibrator/High Voltage ..... 354-355
  - AC Carrier Preamplifier ..... 247
  - Broadband Preamp ..... 31, 286
  - Digitally Programmable ..... 597
  - Frequency Standard Distribution ..... 302
  - General Purpose ..... 30
  - IF ..... 558
  - Logarithmic ..... 43
  - Plug-Ins for
    - Oscillographic Recorders ... 247-249, 251-253
  - Power ..... 32
  - Power Supply ..... 30, 219
  - RF/Microwave ..... 31, 32
- Analog-to-Digital Converter** ..... 28, 44, 600
- Analog Voltmeters General Information** ..... 33
- Analytical Instrumentation** ..... 610
- Automatic Calibration DMM** ..... 58
- Analyzers**
- Automatic Network ..... 435, 446, 458
  - Automatic Spectrum ..... 475, 483
  - Audio Spectrum ..... 476, 492, 504, 505
  - Bus System ..... 25
  - Correlation ..... 504, 505
  - Digital Signal ..... 504, 505
  - Distortion ..... 467-469, 504, 505
  - Fourier ..... 504, 505
  - Frequency Stability ..... 502, 504, 505
  - Gain-Phase ..... 438, 439, 504, 505
  - Logic ..... 111-127
  - Logic State, 16/32-bit Parallel ..... 124
  - Low Frequency Spectrum ..... 476, 492, 504, 505
  - Mechanical Impedance ..... 504, 505
  - Network ..... 430-459, 504, 505
  - Noise ..... 504, 505
  - Power Spectrum ..... 504, 505
  - Spectrum ..... 165, 473-506
  - Signature ..... 108
  - Telephone Line ..... 530, 534
  - Transfer Function ..... 504, 505
  - Vibration ..... 504, 505
  - Wave ..... 460, 472, 504, 505
- Application Terminals** ..... 592
- APC-7 Series Adapters** ..... 411, 515
- Atomic Clock/Frequency Standard** ..... 294-299
- Attenuators**
- 75 ohm General Purpose ..... 558
  - Coaxial ..... 411
  - Coaxial, Microwave, OEM ..... 414
  - Decade ..... 99
  - Resistive ..... 99
  - Coaxial Step ..... 412
  - Waveguide ..... 414
- Automatic Capacitance Bridge** ..... 75, 88-92
- Automated Measurement & Control Syst.** ..... 597
- Automatic Microwave Counters** ..... 288-291
- Automated Test Systems** 435, 446, 458, 475, 483, 597
- Automatic Data Acquisition System** ..... 73
- Automatic Data Logger** ..... 72
- Automatic Network Analyzer** ... 430, 435, 446, 458
- Automatic Synthesizer** ..... 350-351
- Automatic Spectrum Analyzer** ..... 475, 483
- Automatic Transceiver Test System** ..... 524
- Avionics Signal Generator** ..... 368
- B**
- Balanced 2/4-wire Audio Channel Selector ..... 565
  - Balancing Transformers ..... 517
  - Bandpass Filters ..... 380
  - Battery Operated
    - Counters ..... 278-276, 286
    - DVM ..... 47-51, 56, 68-70, 283
    - Hand-Held, Personal Calculators ..... 566-571
    - Microwave Power Meter ..... 405, 408
    - Multifunction Meter ..... 47-51, 58-71
    - Voltmeter ..... 47-51, 58-71
  - Bridge, Directional ..... 426, 444, 449
  - Broadband Detectors ..... 418

- Broadband Sampling Voltmeter ..... 42, 54
- C**
- Cables/Connectors ..... 514
- Cabinet X-Ray Systems ..... 607
- Cabinets ..... 508-523
- Cabinets, System II ..... 508-513
- Cable Assemblies ..... 514-516
- Calculators, Personal
- Arithmetic ..... 570
  - Business ..... 570
  - Financial ..... 570, 571
  - Printing ..... 568-571
  - Programmable ..... 567
  - Scientific ..... 567-570
- Calibrators
- AC ..... 352, 353, 354, 355
  - Power Meter Calibrator for
    - 432 Series Power Meters ..... 409
    - Range Calibrator for 435A Power Meter .... 405
    - Peak Power ..... 409
- Cameras
- Adapters ..... 178
  - Oscilloscope ..... 177
  - Oscilloscope Camera Adapter Table ..... 179
- Capacitance Bridges; Meters ..... 75-91
- Capacitive Voltage Divider ..... 516
- Capacitors, Decade ..... 99
- Card Readers ..... 331, 584, 593
- Card Reader for 1600A Logic State Analyzer .. 126
- Carriage, Slotted Section ..... 415
- Carrier Preamplifiers ..... 251
- Carrier Testing ..... 544
- Cases, Combining ..... 518
- Cavity Frequency Meters ..... 419
- Cesium Beam Frequency Standard ..... 294
- Chromatographic Data Systems ..... 610
- Civil Engineering Products ..... 616
- Clips, Logic ..... 104
- Clip, IC Test ..... 172
- Clip-on, DC Milliammeter ..... 36
- Clip-on, AC Current Probe ..... 517
- Clock, Atomic ..... 294
- Coaxial Instrumentation
- Accessories ..... 423, 514
  - Attenuators ..... 411-414
  - Crystal Detectors ..... 418, 419
  - Directional Bridge ..... 426, 444, 449
  - Directional Couplers ..... 416
  - Directional Detectors ..... 417, 557
  - Dual Directional Coupler ..... 416
  - Fixed Attenuators ..... 411
  - Frequency Meters ..... 419
  - Harmonic Mixer ..... 421
  - Low-Pass Filters ..... 421, 427
  - Pad, Attenuators ..... 411
  - Power Splitter ..... 426, 444, 450
  - Sliding Load ..... 420
  - Slotted Line ..... 415
  - Slotted Section ..... 415
  - Step Attenuators ..... 412
  - Swept Slotted Line Systems ..... 415
  - Switch ..... 422
  - Termination ..... 420
  - Thermistor Mount ..... 409
  - Thermocouple Mount ..... 406
  - Waveguide Adapters ..... 423
- Comb Generator ..... 501
- Combining Cases ..... 518
- Communication Test Equipment ..... 526-565
- Communications, Data ..... 526
- Communications Test Set ..... 534
- Comparator, Logic ..... 105
- Components, Microwave, OEM ..... 414, 418, 422
- Component Oscillators ..... 301
- Component Test ..... 75
- Auxiliary Capacitor ..... 99
  - Digital IC Tester ..... 94
  - Digital IC Test System ..... 96
  - Digital IC Tester Interface Kit ..... 97
  - General Information ..... 75
- Computers & Peripherals ..... 572-600
- Application Terminals ..... 592
  - Clock/Timer/Pacer Interface ..... 585
  - Desktop ..... 580-587
  - Disc Drivers ..... 595
  - Display Terminals, CRT ..... 588-591
  - External Tape Memory ..... 584
  - Plotter ..... 582
  - Serial Interface ..... 585
- Computer-based Network Analyzer .. 435, 446, 458
- Computer-based Spectrum Analyzer ..... 475, 483
- Computer (Desk Top)
- Controlled Instrument Systems ..... 597
- Computing Controller ..... 435
- Computing Controller ..... 475
- Computing Counter System ..... 267
- Connector Adapters ..... 423, 514
- Connectors, Microwave Precision ..... 423
- Constant Current Sources ..... 218
- Controller, Vibration ..... 504
- Controllers for HP-IB ..... 28
- Converters
- A-to-D ..... 28, 44-71, 600
  - D-to-A ..... 28, 212, 285, 600
  - DC to DC Converters ..... 222
  - HP-IB Programmable ..... 26, 28
  - Modular DC to DC Converters ..... 222
  - Series-to-Parallel Converters ..... 127
- Correlator ..... 504-506
- Counters, Electronic ..... 259-291
- Auto. Freq. Conv. ..... 262-265

Auto. Ranging .....	278-286	Voltmeters .....	33, 46
Computing .....	267	DC-to-DC Converters .....	222
Counter/Timer .....	262-265, 270, 282	DC Power Supplies .....	200
Counter/Tracking Generator .....	494	Amplifier/Power Supply .....	30, 219
Delay Generator .....	276	Condensed Listing .....	202
Digital Multimeter/Counter .....	276, 283	Constant Current Sources .....	218
DVM .....	270, 272	Digitally Controlled .....	212, 213, 224, 600
Heterodyne Converter Plug-Ins .....	265, 268-269	Dual Tracking .....	214
Low Cost .....	287	General Information .....	200
Microwave .....	266, 268, 288-290	General Purpose: 25 — 200 W Output .....	206
Plug-In Adapters .....	265	General Purpose: 100 — 2000 W Output .....	208
Portable, Battery Operated .....	278, 286	General Purpose: 300 — 11,000 W .....	202
Programmable .....	262, 270, 276-278, 285, 288-290	Output .....	210
Reciprocal .....	262, 267, 277, 284	General Purpose: 0 — 320 V .....	208
Time Interval .....	262, 267, 270, 277, 281, 284	High Voltage .....	215
Time Interval Probes .....	275	HP-IB Programmable .....	212, 213
Transfer Oscillator Plug-In .....	267	Low Cost Lab .....	204, 205
Universal .....	270, 277, 281, 284	Microprocessor .....	204, 222
Video Amplifier Plug-In .....	269	Modular, DC-to-DC Converters .....	222
Couplers, Directional (Coax and		Modular, Single Output, Series Regulated .....	222
Waveguide) .....	416, 417	Modular, Dual Output, Series Regulated .....	222
CRT Terminals .....	588	Modular, 200 — 600 W, Switching	
Crystal Detectors .....	418, 419	Regulated .....	222
Crystal Oscillators .....	300	Modular, 110 W Switching Regulated .....	222
Current		Modular, Triple-Output Switching .....	222
Divider .....	516	Options .....	220
Probe .....	517	Precision Voltage Sources .....	216, 224
Sources .....	218, 353	Programmable .....	212, 213, 224, 352
Current Tracer, Logic .....	103	Specifications Definitions .....	201
D		Decade Capacitors and Attenuators .....	99
D/A Converter .....	212, 285, 600	Delay Generator/Frequency Divider .....	276, 308
Data		Delay and Rate Plug-ins .....	322
Acquisition Systems .....	72, 73, 504	Desktop Computers and Peripherals .....	572
Communications .....	526, 527	8-bit Parallel Interface .....	585
Error Analyzer .....	528	16-bit Duplex Interface .....	585, 597
Generator .....	326, 332, 562	BCD Input Interface .....	585
Logger .....	72	Binary Synchronous ROM .....	585
Normalizer .....	443, 459	Card Reader .....	584, 593
Transmission Test Set .....	526-531, 528, 538	Data Communications Interface and ROM .....	585
Voice Channel Test Set .....	534-540	Character Impact Printer .....	587
Desktop Computers .....	580-583, 586	Desktop Computers .....	580-583
DC		Digitizer .....	584
Amplifier .....	30, 219	Flexible Disk Drive .....	587
Amplifier Plug-In Module .....	228	General Interface .....	585
Attenuator Plug-In Module .....	229	HP-IB Interface .....	212, 585, 597
Bridge Amplifier .....	247	High-Speed Tape Reader Subsystem .....	584
Coupler Plug-In Module .....	228	Hopper Card Reader .....	584
Differential Voltmeter .....	228	I/O Expander .....	584, 597
Digital Voltmeter .....	46-51, 54-70	Interactive ROM .....	585
Milliammeter .....	36	Line Printer Subsystem .....	585
Nullmeter .....	35	Mass Memory Subsystem .....	581
Offset Plug-In Module .....	229	Paper Tape Reader .....	584
Preamplifier Plug-In Module .....	229	Serial Interface .....	585
Standard .....	353	RS-232-C Serial Interface .....	585
Voltage Divider .....	516	Tape Cassette .....	584



# ALPHABETICAL INDEX

Tape Punch Subsystem .....	584
Thermal Printer .....	256, 585
X-Y Plotter .....	582, 585
<b>Detectors</b>	
Coaxial, Microwave, OEM .....	418
Crystal, Coaxial and Waveguide .....	418, 419
Directional .....	417, 557
Error .....	562
Slotted Line .....	415
<b>Digital</b>	
AC Voltmeters .....	37-42, 47-71
Analyzer, Signature .....	108
Capacitance Meter .....	75-93
Circuit Test .....	100, 597
Comparator, Logic .....	105
Current Tracer .....	103
DC Voltmeters .....	33-38, 47-71
IC Tester, Interface Kit .....	97
IC Tester .....	94
IC Test System .....	96
Interface (HP-IB, IEEE, ANSI) .....	20
I/O Sub-system .....	597
LCR Meter .....	84-86
Microprocessor, Troubleshooting .....	108
Multimeter .....	37, 38, 47-71, 283
Ohmmeter .....	37-38, 47-51, 58-71
Oscillator .....	336
Power Meters (RF/Microwave) .....	404
Pressure Gauge .....	604
Printer .....	254-256
Programmable Power Supplies .....	212, 213, 224
Magnetic Tape Units .....	596
Signal Analyzers .....	504, 505
Signature Analyzer .....	108
Spectrum Analyzers .....	504, 505
Storage Unit .....	443, 459
Tape Systems .....	596
Test Set, Digital Logic .....	106
Test Systems .....	577
Thermometer .....	605
Vibration Controller .....	504
Voltmeters .....	47-71
Digital-to-Analog Converters .....	47-71, 212, 600
Dimensional Measurement .....	602
Diodes .....	612
Disc Driver .....	595
Directional Bridge .....	426, 444, 449
<b>Directional Couplers</b>	
Coaxial .....	416, 417
Waveguide .....	417
Directional Detectors .....	417, 557
Cartridge Disc Sub-Systems .....	595
DISComputers .....	572
Display Terminal Interface .....	580
Displays, Cathode-Ray Tube .....	182-199
Small Screen .....	186-194
Large Screen .....	195-199
Distance Meter .....	616
Distortion Analyzers .....	467, 468, 473, 505
Distribution Amplifier .....	302
Divider Probe .....	516
Double Balanced Mixers .....	380
Down Converter, 0.5 to 550 kHz .....	369
Dual Tracking, Power Supply .....	214
<b>E</b>	
<b>EIA Registered Visible Light Emitting</b>	
Diodes .....	614
Electronic Counter .....	259-261
Electronic Total Station .....	616
Error Measuring Set (1 Kb/s × 50 Mb/s) .....	560
Error Rate Measurement .....	528, 560
Error Rate Measurement System .....	528, 560
Expander, I/O .....	584, 597
<b>F</b>	
Fast Fortran Processor .....	578
Faxitron™ X-Ray Systems .....	607
<b>Filters</b>	
Bandpass .....	380, 498
Coaxial and Waveguide .....	421, 427
High Pass .....	427
Low Pass .....	421, 427
Low Pass Plug-In Module .....	229
Four Channel Adapter .....	331
Four Channel TTL-CMOS Translator .....	331
Fourier Analyzer .....	504
FM Signal Generators .....	358, 362, 365, 370
<b>Frequency</b>	
Counters .....	257, 259-291, 600
Counter/Track Generator .....	494
Doubler Probe .....	378
Doublers .....	377, 380
Meters, Coaxial and Waveguide .....	419
Response Test Set .....	424, 505
Stability Analyzer .....	502
Synthesizer, Microwave .....	364
<b>Frequency Standards</b>	
Cesium .....	294
Distribution Amplifier .....	302
General Information .....	292
Quartz .....	300
Rubidium .....	297
Standby Power Supplies .....	303
Frequency Doubler .....	380
Frequency and Time Standards .....	292-303
<b>Frequency Selective Voltmeter and Tracking</b>	
Oscillator .....	532
Frequency Synthesizers .....	343-349
Function Generators .....	337-339
Fuseholder, RF .....	380



<b>G</b>	
Gas Chromatographs	610
General Purpose Interface Bus Controllers	20
<b>Generators</b>	
Data	326, 332, 520, 560, 562
Noise	403, 505, 507
Pattern	561
Pulse	304, 337
Signal	333, 342, 356-379
Spectrum	504
Square Wave	336
Sweep	338, 345-351, 381-401, 557
Tracking	484, 488, 492, 494, 496, 499, 550
Word	304
Graphic Plotters	226, 227, 236-239
Graphic Plotters Terminal	236, 237, 238
Graphics Translator	184
Group Delay (Network Analyzer)	440
Group Delay Network Computer	236, 237, 238
Guarded Digital Multimeter	59-62
<b>H</b>	
Harmonic Analyzer	504, 505
Harmonic Mixer (Coaxial and Waveguide)	421
<b>Hewlett-Packard Interface</b>	
Bus (HP-IB)	20-29, 212, 585, 597
High Gain Preamplifier	251, 286
High Resistance Meter	79
Hi-Rel Numeric Displays	614
HP-IB controlled Channel Selector	565
<b>I</b>	
IC Tester, Digital	94, 97
IC Test System, Digital	96
Impatt Diodes	612
Impedance Meter	84-92, 98
Impedance Meter, RF Vector	98
Impedance Probe	449
Impedance Transformers (50 — 75Ω)	445, 449, 501
Input/Output Computer Cards	600
Inspection Systems, X-Ray	607
Instrument Accessories	508-523
Insulation Resistance Meter	79
Insulation Test	79
Intelligent Terminals	588-591
Interface, Digital (HP-IB, IEEE, ANSI)	20-29
Interface Bus	20
Interface Cover for 1645A	528
Interface Kit, Digitally Controlled Power	
Supply	225
Interface Kit, Multiprogrammer	599
Integrating DVM	58-65, 272
Intermodulation Analyzer	473, 504, 505
<b>L</b>	
Laboratory, Strip Chart Recorders	226, 227, 240-246
Laboratory, X-Y Recorders	226, 227, 228-235
Laser Measurement	603
Laser Transducer	602
LCR Meter	84-88
Light Emitting Diodes	614
Limiter	501
Liquid Chromatographs	610
Loads/Termination, Coaxial and Waveguide	420
Logarithmic Preamplifier	252
Logarithmic Voltmeter	43
<b>Logic</b>	
Analyzer	111-127
Analyzer, Personality Modules	121
Clip	104
Current Tracer	103
Comparator	105
Lab	110
Probes	101
Pulser	102
State Analyzers	111-127
Tracer, Current	103
Troubleshooting Kits	106
Low Distortion Generator	345
<b>Low Frequency Spectrum</b>	
Analyzer	476, 492, 504, 505
Low Gain Preamplifier	251, 247, 248
Low Resistance Meter	78
<b>M</b>	
Machinery Analyzer	504, 505
Magnetic Tape Recorders, Analog	254
Magnetic Tape Subsystem, Digital	596
Magnetic Tape Units, Digital	596
Mark Reader, Optical	584, 593
Marker Generator	384
Mass Spectrometers	610
Mechanical Impedance Analyzer	504, 505
Medical Applications	608
Medium Gain Preamplifier	251, 247
Memory Systems	595, 596
<b>Meters</b>	
AC	36-43, 47-71
Capacitance	84-92
Digital Multimeter	43-71
Frequency	419
Gain Phase	438, 505
High Capacitance	89, 90
Impedance	82-87, 98
LCR	75-93
Logarithmic Voltmeters	43
Milliammeter, AC	68, 517
Milliammeter, DC	36, 68
Milliohmmeter	70, 78
Multifunction	37, 38, 47-51
Noise Figure	403
Ohmmeter	37-38, 47-51, 58-71
Power (RF/Microwave)	404, 405
Selective VM	553



# ALPHABETICAL INDEX

Standing-Wave-Ratio (SWR) .....	429
True RMS .....	41, 52, 58, 62, 70
Microcircuit Interface .....	597
Microprocessor Troubleshooting .....	100, 108
Microprocessor Power Supplies .....	204, 222
Microwave	
Catalog .....	410
Counters .....	288-291
Link Analyzers .....	554
Power Measuring Equipment .....	402-409
Radio Testing .....	553
Signal Generators .....	356-380
Synthesizer .....	362, 364
Test Equipment .....	408, 410-429
Milliohmmeter .....	58, 70, 78
Mixers, Coaxial and Waveguide .....	421, 501
Modal Analysis .....	504, 505
Modular Power Supplies .....	221
Modulators, PIN .....	378, 379
Motor Controller, Programmable .....	600
Multimeter .....	37, 38, 47-51
Multiple Span Plug-In Module .....	243
Multiplexer .....	74, 600
Multiprogrammer .....	597
<b>N</b>	
Network Analysis, General Information ..	430-434
Network Analyzers .....	430-459
Automatic .....	435
Computer-based .....	435, 446, 458
Noise	
Analyzer, Acoustic .....	504, 505
Figure Meter .....	403
Generator .....	403, 507
Source (1F) (UHF) (VHF) and Waveguide ..	403
Normalizer, (Data) .....	443, 459
Null Detector Plug-In Module .....	229
Null meter .....	35
Numeric LED Displays .....	614
<b>O</b>	
<b>OEM</b>	
Component Oscillators .....	301
Computers .....	572-600
Displays .....	182
Microwave Attenuators .....	411-414
Microwave Detectors .....	418, 419
Microwave Switches .....	422
Modular Power Supplies .....	221
Strip Chart Recorders .....	226, 227, 240-246
Switches, Coaxial, Microwave .....	422
X-Y Recorders .....	226, 227, 228-235
Ohmmeters .....	36, 38, 47-51, 58, 62, 68, 70
Optical Mark Readers .....	584, 593
Optoelectronics .....	614
Oscillators	
Audio .....	334-336
Function Generator .....	337-341
General Information .....	333
Low Frequency .....	334, 337-339
Quartz .....	300
Quartz Component .....	301
RF .....	378
Sweep .....	338, 344, 381-401, 557
Telephone Test .....	537
Test .....	342
Tracking .....	470-471
Wide Range .....	344
Oscillographic Recorders .....	226, 247-253
Oscilloscopes .....	128-181
Accessories .....	171
Cameras .....	177
Contrast Filters .....	176
100 MHz Third-Channel Trigger View .....	139
100 MHz Variable Persistence/Storage, Third-Channel Trigger View .....	139
100 MHz Crystal Delta Time, Third-Channel Trigger View .....	139
200 MHz Delta Time Measurements .....	136
275 MHz Delta Time Measurements .....	136
275 MHz Delta Time Measurements with Microprocessor .....	132
General Information .....	128-131
High Writing Speed Mainframe .....	152
Large Screen Mainframe .....	157
Light Shields .....	176
Low Frequency .....	166
Military .....	131
Plug-In, 180 series .....	153
Rack Mount Slides and Adapters .....	176
Sampling .....	160-163
Spectrum Analyzer Plug-In .....	165, 486, 488
Testmobiles .....	180
Variable Persistence/Storage .....	139, 149, 168
Viewing Hoods .....	176
Output Amplifiers (8080 System) .....	310
Output Plug-ins (1900 System) .....	322
Outside Plant Telecommunications	
Test Equipment .....	541
<b>P</b>	
Pad, Coaxial Attenuator .....	411
Pattern Generator/Error Detector .....	561
PCM Test Equipment .....	559, 564
Peak Power Calibrator .....	409
Peak Power Meter, Analog .....	409
Personality Modules .....	121
Phase Meters .....	440, 448, 450, 451, 505
Phase Modulation, Signal Generator .....	358, 361

Phase Sensitive Demodulator Preamplifiers	252	Precision Coaxial Connectors	420, 515
Physical & Optical Measurements	601	Precision Frequency Source	292
PIN Diodes	612	Precision Oscillator	300, 344
PIN Modulators, Microwave	378, 379	Precision Voltage Sources	216, 224
PIN Photodiodes	612	Preselector	498
Plotter, Graphic	238, 239, 582	Printers, Instrumentation	256-258
Plotter, X-Y	226, 227, 236-239, 582, 585	Printer, Line	594
Plug-In Counters	262-266, 270-275, 278	Probes	
Plug-In Oscilloscopes	146-164	Accessories	172, 176, 516
Plug-In Pulse Generator System	322	Active	174, 449
Point Plotter Plug-In Modules	229	Current	36, 103, 175, 517
Portable		Digital Multimeter	47-71
Calculators	566-571	Frequency Doubler	378
Counters	278-286	High Frequency	378, 516
Desktop Computers	580-583, 586	Impedance	449
Instrumentation Tape Recorders	254, 255	Logic	101
Signal Generators	370	Miniature	171
Strip Chart Recorders	226, 227, 240-246	Slotted Line	415
Test Set	540	Trigger (TTL)	127
Voltmeter	47-51, 68-71	Time Interval	275
X-Ray Systems	607	Voltage Divider	171, 173
Power Meters, RF & Microwave	404, 408	Process Control Interface	597
Power Sensors	406	Processors	578
Power Meter Calibrators	405, 409	Programmable	
Power Splitter	426, 444, 450	Counters	600
Power Supplies	200-225	Programmable Data Logger	72
Amplifier/Power Supplies	30, 219	Programmable Signal Source	340
Atomic Clock	303	Programming, 1900 System	322
Condensed Listing	202	Pulse and Word Generators	304
Constant Current Sources	218	Pulse Generators	276, 304
Digitally Controlled	212, 213, 224, 600	Pulse Modulator	378
Dual Tracking	214	Pulse Pattern Generator Plug-ins (1900 System)	322
Frequency Standards	303	Pulse/Word Generator System, 300 MHz/1 GHz	308
General Purpose: 25 — 200 W Output	206	Pulsers, Logic	102
General Purpose: 120 — 2000 W Output	208		
General Purpose: 300 — 11,000 W Output	210	<b>Q</b>	
General Purpose: 0 — 320 V	208	Q-Meter	93
High Voltage	215, 354	Quartz Component Oscillator	301
HP-IB Programmable	212, 213	Quartz Frequency Standard	300
Low Cost Lab	204, 205	Quartz Pressure Gauge	604
Microprocessor	204, 222	Quartz Thermometer	605
Modular, DC to DC Converters	222		
Modular, Single Output, Series Regulated	222	<b>R</b>	
Modular, Dual Output Series Regulated	222	Random Noise Generator	504, 505
Modular, 200 — 600 W, Switching	222	Range Calibrator (for 435A Power Meter)	405
Modular, 110 W, Switching	222	Ratio Meter	62
Modular, Triple-Output Switching	222	Readers, Card	331, 584, 593
Precision Voltage Sources	216, 224	Real Time Application Terminals	592
Programmable	212, 213, 224	Receiver Test System	524
Specifications Definitions	201	Reciprocal Counters	262, 267
Standby	303	Recorders	
Transistor Bias Supply	456	Oscillographic	226, 247-253
Power Supply/Amplifier	30, 219	Portable Instrumentation Tape	226, 254, 255
Preamplifiers	31, 251-253, 286		

- Strip Chart ..... 226, 240-246  
 X-Y ..... 226, 228-235  
 Reflection/Transmission Test  
   Sets ..... 426, 444, 449, 455-457  
 Reflectometer Bridge ..... 426  
 Relay Output Cards ..... 600  
 Relay Register ..... 600  
 Repetition Rate Generators (8080 System) ..... 308  
 Resistance Meter ..... 36, 37, 47-51, 58-71, 77-79  
 RMS Voltmeter ..... 35-41, 47-51  
 Rotary Air Line, Coaxial ..... 423  
 Rotary Joint, Coaxial ..... 423  
 Rotary Vane Attenuators, Waveguide ..... 414  
 Rotating Machinery Analysis ..... 504  
 Rubidium Frequency Standard ..... 294
- S**  
 S-Parameter Test Sets ..... 444, 455, 456  
 Sampling Oscilloscopes ..... 160-163  
 Sampling & TDR Accessories ..... 164  
 Scanner ..... 74, 600  
 Scanner Plug-In Module ..... 229, 600  
 Scientific & Industrial X-Ray Systems ..... 607  
 Selective Level Measuring Set ..... 546  
 Selective Level Voltmeters ..... 552  
 Selective Voltmeter ..... 552  
 Self-Test Digital Multimeter ..... 58, 62  
 Sensors, Microwave Power ..... 406  
 Serial Data Generator ..... 326  
 Serial-to-Parallel Converter ..... 127  
 Shorts, Coaxial and Waveguide ..... 420  
 Signal Analyzers ..... 165, 460-507  
   Computer-Based Spectrum Analyzer ... 475, 483  
   Digital ..... 504, 505  
   General Information ..... 460-466  
   Random Vibration Controller ..... 504  
   Shock Vibration Controller ..... 504  
   Sine Vibration Controller ..... 504  
   Spectrum Analyzers ..... 165, 473-506  
 Signal Conditioners ..... 251-253  
 Signal Coupler Preamplifier ..... 252  
 Signal Generators ..... 356  
   Accessories ..... 380  
   Down Converter, 0.5 to 500 kHz ..... 369  
   General Information ..... 356  
   HF, VHF, UHF ..... 370, 372-377  
   Microwave ..... 358-378  
   Pulse Modulator ..... 378  
   Synthesized ..... 343, 358, 362  
 Signal Sources ..... 343  
 Signal Source, Programmable ..... 340  
 Signature Analysis ..... 100, 476, 504, 505  
 Signature Analyzer, Digital ..... 108  
 Sinewave Generators ..... 333  
 Sinewave Oscillator ..... 333  
 Single Span Plug-In Module ..... 243  
 Sliding Load (Coaxial and Waveguide) ..... 420
- Slotted Lines (Coaxial & Waveguide) ..... 415  
 Solid State Displays/Lamps ..... 614  
 Spectrum Analyzers, General Information 460-466  
 Spectrum Analyzers ..... 165, 473-506  
 Spectrum Analyzer Preselector ..... 498  
 Spectrum Display ..... 506  
 Square Wave Generators ..... 337  
 Stability Analyzer, Frequency ..... 502, 504, 505  
 Standards: Frequency and Time ..... 292-303  
 Standing Wave Ratio (SWR) Meter ..... 429  
 Stepping Motor Control ..... 600  
 Step Attenuators, Coaxial ..... 412  
 Storage Normalizer ..... 443, 459  
 Strip Chart Recorder ..... 226, 227, 240-246  
 Structural Dynamics ..... 504, 505  
 Surveying Products ..... 616  
 Sweep Oscillators, General Information ... 381-383  
 Sweep Oscillators ..... 337, 344, 381-401, 557  
 Swept Slotted Line ..... 415  
 Switches ..... 600  
 Switches, Coaxial, Microwave OEM ..... 422  
 Swivel Adapter ..... 423  
 Synchronizer/Counter ..... 371  
 Synchronous Data Set Interface ..... 526  
 Synthesizer, Automatic ..... 350-351, 358, 362  
 Synthesizer, Frequency ..... 343, 358, 362, 364  
 Synthesized Signal Generators ..... 343, 358, 362  
 Synthesizers — General Information . 343-344, 356  
 Synthesizers, Spectrum ..... 504  
 System Digital Voltmeter ..... 54-64  
 Systems Accessories ..... 26
- T**  
 Tape Cassette, Punch, Reader Sub-systems ... 584  
 Tape Degausser ..... 254  
 Tape Memory, External ..... 584  
 Tape Recorders, Analog Magnetic ..... 254  
 Telecommunications Test Equipment ..... 526-565  
   Access Switch ..... 548  
   Amplifiers, Error Detector Input ..... 564  
   Amplifier — IF ..... 553, 558  
   Amplitude/Delay Distortion Analyzer ..... 530  
   Attenuator — 75 $\Omega$  General Purpose ..... 558  
   Audio Channel Selector: HP-1B Controlled .. 565  
   BB Sweeper ..... 558  
   Balanced 2/4-wire Audio Channel Selector .. 565  
   Carrier Testing ..... 544  
   Controller: Switch ..... 548  
   Converter, 75 $\Omega$  Unbal/110 $\Omega$  Bal ..... 564  
   Data Generator ..... 332, 560, 562  
   Detectors, Error ..... 560, 562  
   Down Converter ..... 556  
   Error Measuring Set (1 kb/s x 50 Mb/s) ..... 561  
   Error Rate Measurements ..... 560, 562  
   FDM Measurements ..... 544  
   FDM System Testing ..... 549  
   HP-1B Controlled Channel Selector ..... 565  
   Isolator, PCM Test Equipment ..... 564

- Microwave Link Analyzers ..... 554  
 Microwave Radio Testing ..... 553  
 Pattern Generator/Error Detector ..... 561  
 PCM Testing ..... 559  
 Selective Level/Meter ..... 550-551  
 Selective VM ..... 532, 533, 552  
 Selective Level Measuring Set ..... 546  
 Sweeper, RF ..... 557  
 Switch: Access ..... 548  
 Switch Controller ..... 548  
 Telephone Line Analyzer ..... 530, 534  
 Transmission Impairment Measuring Set ..... 538  
 Test Sets ..... 534-535  
 Upconverter Simulator for  
   Microwave Link Analyzer ..... 557  
   Voice Data Testing ..... 526, 527  
 Telephone Test Oscillators ..... 537  
 Temperature Plug-In Module ..... 243  
 Terminal, CRT ..... 588  
 Terminals, Application ..... 592  
 Terminations, Coaxial and Waveguide ..... 164, 420  
 Test Leads ..... 65, 514  
 Testmobiles, Oscilloscope ..... 180  
 Test Oscillators ..... 342  
 Test Set, Voice Band ..... 526  
 Test Sets, Digital Logic ..... 106  
 Test Sets, Transmission ..... 534, 536, 540  
 Thermal Printer ..... 256, 585  
 Thermistor Mounts, Coaxial and Waveguide ..... 409  
 Thermocouple Power Meter ..... 404  
 Thermocouple Power Sensors ..... 406  
 Thermometer ..... 606  
 Time Base External Module ..... 230  
 Time Domain Reflectometers ..... 162  
 Time Interval  
   Counters ..... 262, 267, 270, 277, 281, 284, 600  
 Time Standard ..... 294-299  
 TIMS ..... 538  
 Total Station ..... 616  
 Touch-Hold Probe ..... 103  
 Tracer, Current ..... 102  
 Tracking  
   Generators ..... 484, 488, 492, 494, 496, 499, 550  
 Training/Video Tapes ..... 617-620  
 Transceiver Test System ..... 524  
 Transfer Function Analyzer ..... 504, 505  
 Transistors, Siliconbipolar ..... 610  
 Translator, Four Channel TTL CMOS ..... 331, 330  
 Transmission Impairment Measuring Set ..... 538  
 Transmission Test Set ..... 534, 536, 540  
 Transistor Bias Supply ..... 456  
 Transistor Test Fixtures ..... 455-457  
 Transistors ..... 610  
 Triangle Wave Generator ..... 336, 337  
 Trigger Countdown ..... 164  
 True RMS Voltmeter ..... 41, 52, 53, 58, 70  
 Tuners, Microwave ..... 421  
 Tuning Varactors ..... 612  
 TTL-CMOS Translator, Four-Channel ... 331, 330  
 TWT Amplifiers ..... 32  
 Type N Short ..... 420  
  
**U**  
 Universal Bridge ..... 82-84  
 Universal Carriage (Slotted Section) ..... 415  
 Universal Counters ..... 262-274, 277-286  
 Upconverter Simulator  
   for Microwave Link Analyzer ..... 557  
  
**V**  
 Variable Phase Function Generator ..... 345  
 Vector Impedance Meter ..... 98  
 Vector Voltmeter ..... 450  
 VHF Oscillator ..... 378  
 Vibration Analyzer ..... 504  
 Vibration Controller ..... 504  
 Video Tapes ..... 617-620  
 Voice Data Testing ..... 526  
 Voltmeters ..... 33-74  
 Voltmeter, Vector ..... 450  
  
**W**  
 Wave Analyzer ..... 532  
 Wave Analyzer ..... 504, 505, 532  
 Wave and Distortion  
   Analyzers ..... 467, 468, 473, 504, 505  
 Waveform Analyzer, Fourier ..... 504, 505  
 Waveguide  
   Attenuators ..... 414  
   Coaxial Adapters ..... 423, 515  
   Crystal Detectors ..... 419  
   Directional Couplers ..... 416, 417  
   Frequency Meters ..... 419  
   Harmonic Mixer ..... 421  
   Holder ..... 423  
   Low-Pass Filters ..... 421  
   Movable Shorts ..... 420  
   Precision Attenuators ..... 414  
   Shorting Switch ..... 420  
   Slide Screw Tuners ..... 421  
   Sliding Loads ..... 420  
   Sliding Short ..... 420  
   Slotted Section ..... 415  
   Stand ..... 423  
   Terminations ..... 420  
   Thermistor Mounts ..... 409  
   Variable Attenuators ..... 414  
 Waveguide-Waveguide Adapters ..... 423  
 Word Generators ..... 304  
  
**X**  
 X-Ray Systems, Scientific & Industrial ..... 607  
 X-Y Displays ..... 182-199  
 X-Y Plotters/Recorders ..... 226-239, 585

# MODEL NUMBER INDEX

New product listings are printed in bold face type

HP-10 Hand-held Printing Calculator .....	570	350D Attenuator Set .....	99
<b>HP-19C Hand-held</b>		353A Patch Panel .....	540
<b>Programmable Printing Calculator</b> .....	<b>568</b>	355 series Coaxial Step Attenuators .....	412
HP-21 Scientific Pocket Calculator .....	567	360 series Coaxial Low-pass Filters .....	421
21 MX Computers .....	351, 578	362A series Waveguide Low-pass Filters .....	421
21 MX E-Series Computers 2109B, 2113B		375 series Waveguide Variable Attenuators .....	414
Processors .....	578	382 series Waveguide Precision Variable	
21 MX K-Series 2108K Processor Board .....	578	Attenuators .....	414
HP-22 Business Management Pocket		393A Coaxial Variable Attenuator .....	414
Calculator .....	570	394A Coaxial Variable Attenuator .....	414
HP-25/C Scientific Programmable Pocket			
Calculator .....	567	<b>400</b>	
HP-27 Scientific/Plus Pocket Calculator .....	570	400E & EL AC Voltmeters .....	40
<b>HP-29C Hand-held Programmable Calculator</b> .....	<b>568</b>	400F & FL AC Voltmeter .....	40
HP-67 Fully Programmable Pocket		400GL AC Voltmeter .....	40
Calculator .....	569	403B AC Voltmeter .....	39, 540
DTS-70 Digital Test Systems .....	577	410C Voltmeter .....	38
<b>HP-92 Business Printing Calculator</b> .....	<b>571</b>	415E SWR Meter .....	429
HP-97 Fully Programmable Printing		419A DC Null Voltmeter .....	35
Calculator .....	569	422A Series Waveguide Crystal Detectors .....	419
		423A/B Coaxial Crystal Detectors .....	418
<b>100</b>		424A Series Waveguide Crystal Detectors .....	419
101 HP-1B Data Output and Remote Control .....	88	427A Voltmeter .....	37
105A & B Quartz Frequency Standards .....	300	428B Clip-on DC Milliammeter .....	36
123A Oscilloscope Camera .....	177	432 Series Power Meters .....	408
140T Spectrum Analyzer Mainframe .....	491	435A Power Meter .....	405
141T system Spectrum Analyzers .....	490	436A Power Meter .....	404
141T Spectrum Analyzer Mainframe .....	491	440A Detector Mount .....	415
180 series Plug-in Oscilloscopes .....	146	442B Slotted Line RF Probe .....	415
180C, D & TR High Writing Speed		444A Slotted Line Detector .....	415
Oscilloscope Mainframes .....	152, 428, 486, 488	447B Slotted Line Detector .....	415
181A, AR, T & TR Variable Persistence/		448B Slotted Line Sweep Adapters .....	415
Storage Mainframes .....	149, 428, 486, 488	456A Current Probe for voltmeters .....	517
182C & T Large Screen Oscilloscope		461A Amplifier .....	30
Mainframe .....	151, 428, 486, 488	465A Amplifier .....	30
184A High Speed Oscilloscope		467A Power Amplifier .....	30
Mainframe .....	150	478A Coaxial Thermistor Mount .....	409
197A Oscilloscope Camera .....	177	486A Series Waveguide Thermistor Mounts .....	409
		489A TWT Amplifier .....	32
<b>200</b>		491C TWT Amplifier .....	32
200CD Wide Range Oscillator .....	333	493A TWT Amplifier .....	32
201C Audio Oscillator .....	333	495A TWT Amplifier .....	32
204C Oscillator .....	82, 333, 335, 540		
204D Oscillator .....	335	<b>500</b>	
209A Oscillator .....	333, 335	515A Coax Adapter Kit (For 250B) .....	98
214A Pulse Generator .....	320	532 Series Waveguide Frequency Meters .....	419
236A Telephone Test Oscillator .....	333, 536	536A Coaxial Frequency Meter .....	419
250B RX Meter .....	98	537A Coaxial Frequency Meter .....	419
281 series Coaxial-Waveguide Adapters .....	423	545A Logic Probe .....	101
292 series Waveguide-Waveguide & Adaptors .....	423	546A Logic Pulser .....	102
		547A Current Tracer .....	103
		548A Logic Clip .....	104
<b>300</b>			
312A & 313A Frequency Selective Voltmeter		<b>600</b>	
and Tracking Oscillator .....	470	606B Signal Generator .....	372
312D Selective Levelmeter & Generator .....	550	608E Signal Generator .....	373
331A Distortion Analyzer .....	468	612A Signal Generator .....	374
332A Distortion Analyzer .....	468	618C Signal Generator .....	376
333A Distortion Analyzer .....	468	620B Signal Generator .....	376
334A Distortion Analyzer .....	468	626A Signal Generator .....	377
339A Distortion Measuring Set .....	469	628A Signal Generator .....	377
340B Noise Figure Meter .....	403	651B Test Oscillator .....	333, 342
342A Noise Figure Meter .....	403	652A Test Oscillator .....	333, 342
343A VHF Noise Source .....	403	653A Test Oscillator .....	333
345B IF Noise Source .....	403	654A Test Oscillator .....	333, 342
347A series Noise Sources .....	403	680 Strip Chart Recorder .....	240
349A Noise Source .....	403		

700			
745A AC Calibrator	352, 354		
746A Hi Voltage Amplifier	354		
752 Series Waveguide Directional Couplers	417		
774D Coaxial Dual Directional Coupler	416		
775D Coaxial Dual Directional Coupler	416		
776D Coaxial Dual Directional Coupler	416		
777D Coaxial Dual Directional Coupler	416		
778D Coaxial Dual Directional Coupler	416		
779D Coaxial Dual Directional Coupler	416		
784B Coaxial Directional Detector	557		
786D Coaxial Directional Detector	417		
787D Coaxial Directional Detector	417		
788C Coaxial Directional Detector	417		
789C Coaxial Directional Detector	417		
796D Coaxial Directional Coupler	416		
797D Coaxial Directional Coupler	416		
798C Coaxial Directional Coupler	416		
800			
805C Coaxial Slotted Line	415		
809C Universal Carriage	415		
810B series Waveguide Slotted Sections	415		
816A Slotted Coaxial Section	415		
817A & B Coaxial Swept Slotted Line Systems	415		
870A series Waveguide Slide Screw Tuners	421		
895A DC Power Supply	208		
900			
905A Coaxial Sliding Load	420		
907A Coaxial Sliding Load	420		
908A Coaxial 50-Ohm Termination	164, 420		
909A Coaxial Termination	420		
909A Option 012 50-Ohm Termination	164		
910 series Waveguide Terminations	420		
911A/C Coaxial Sliding Load	420		
914 series Waveguide Sliding Loads	420		
920 series Waveguide Moving Shorts	420		
923A Waveguide Sliding Short	420		
930A Waveguide Shorting Switch	420		
932A Waveguide Harmonic Mixer	421		
934A Coaxial Harmonic Mixer	421		
938A Frequency Doubler Set	377		
940A Frequency Doubler Set	377		
970A Probe Digital Multimeter	46		
1000			
HP 1000 Systems	574		
1007A Testmobile	180		
1008A Testmobile	180		
1051A & 1052A Combining Cases	518		
1080 High Performance Liquid Chromatograph Systems	610		
1104A/1106B Opt 001 18 GHz Trigger Countdown	163		
1104A/1108A 10 GHz Trigger Countdown	163		
1105A/1106B 20 ps Pulse Generator	164		
1105A/1108A 60 ps Pulse Generator	164		
1109B High Pass Filter (type N)	164		
1110A Current Probe	175		
1111A AC Current Amplifier	175		
1114A Testmobile, Oscilloscope	180		
1117B Testmobile, Oscilloscope	180		
1120A 500 MHz Active Probe	174		
1121A AC Probe	449		
1122A Probe Power Supply	174		
1124A 100 MHz Active Probe	174		
1125A 250 MHz Impedance Converter Probe	175		
1200A & B Dual Channel Oscilloscopes, 100 $\mu$ V/div	166		
1201A & B Dual Channel Storage Oscilloscopes, 100 $\mu$ V/div	166, 474		
1205B Dual Channel Oscilloscopes, 5mV/div	166		
1220A Dual Channel Oscilloscope, 15 MHz	168		
1221A Single Channel Oscilloscope, 15 MHz	168		
1222A Dual Channel, Delay Line Oscilloscope, 15 MHz	168		
1223A Dual Channel, Variable Persistence/Storage Oscilloscope, 15 MHz	168		
1230A Logic Trigger	127		
1304A 32 cm. (13 in.) Display	195		
1310A 48.3 cm (19 in.) Display	195		
1311A 35.6 cm (14 in.) Display	195		
1317A 43.2 cm (17 in.) Display	195		
1321A 53.3 cm (21 in.) Display	195		
1332A Small Screen Display	188		
1333A Small Screen Display	188		
1335A Small Screen Display	188		
1336A, P Small Screen Display	192		
1340A Display Module	188		
1350A Graphics Translator	184		
1430C Sampling Head, 18 GHz for 1811A	160		
1600A 20 MHz, 16 Bit Logic State Analyzer	124, 526		
1600S 20 MHz, 32/16 Bit General Purpose Logic State Analyzer	124		
1602A Logic State Analyzer	188-120		
1607A 20 MHz, 16 Bit Logic State Analyzer	124		
1610A General Purpose Logic State Analyzer	115		
1611A Logic State Analyzer for Microprocessor Based Systems	121		
1645A Data Error Analyzer	526-528		
1645S Data Transmission Test Set	528		
1700 series Oscilloscopes	132		
1715A 200 MHz $\Delta$ Time Oscilloscope	136		
1722B 275 MHz Oscilloscope, Delta with Microprocessor	132		
1725A 275 MHz $\Delta$ Time Oscilloscope	136		
1740A 100 MHz Oscilloscope, Trigger View	139		
1741A 100 MHz Oscilloscope, Variable Persistence/Storage, Third-Channel Trigger View	139		
1743A 100 MHz $\Delta$ Time Oscilloscope, Thrd Channel Trigger View	139		
1801A Dual Channel Vertical Amplifier, 50 MHz	154		
1803A Differential DC Offset Amplifier	154		
1804 Four Channel Vertical Amplifier, 50 MHz	156		
1805A Dual Channel Vertical Amplifier, 100 MHz	153		
1806A 100 $\mu$ V Dual Channel Differential Amplifier	154		
1809A Four Channel Vertical Amplifier, 100 MHz	156		
1810A 1 GHz Dual Channel Sampler	160		
1811A 18 GHz Sampler	160		
1815B TDR/Sampler	162		
1817A Sampling Head 12.4 GHz	162		
1818A Time Domain Reflectometer, 170 ps rr	162		
1820C Time Base	158		
1821A Time Base/Delay Generator	158		

# MODEL NUMBER INDEX

New product listings are printed in bold face type

1825A Time Base and Delay Generator .....	159	3550B Communications Test Set .....	526, 534
1900A Pulse Generator Mainframe .....	322	3551A Transmission Test Set .....	527, 534
1905A Rate Generator Plug-in .....	323	3552A Transmission Test Set .....	527, 534
1915A Output Amplifier		3555B Transmission & Noise Measuring Set .....	536
Plug-in .....	323	3556A Psophometer .....	536
1917A Output Amplifier		3570A Tracking Receiver .....	435
Plug-in .....	323	3575A Gain/Phase Meter .....	433, 438
1920 Output Amplifier		3580A Spectrum Analyzer .....	465, 476
Plug-in .....	323	3581A Wave Analyzer .....	472
<b>2000</b>		3581C Selective Voltmeter .....	532
2026 System .....	573	3591A Selective Voltmeter .....	552
2240A Measurement & Control Processor .....	576	3594A Sweeping Local Oscillator Plug-in .....	552
2640B Interactive Display Terminal .....	589	3710A 1F Transmitter (70 MHz 1F) .....	554
2640C Cyrillic Display Terminal .....	590	3720A Spectrum Display .....	466, 506
2640N Danish/Norwegian Display Terminal .....	590	3721A Correlator .....	466, 526
2640S Swedish/Finnish Display Terminal .....	590	3722A Noise Generator .....	507
2641A APL Display Terminal .....	590	3730A Down Converter: RF to 1F .....	556
2645A Display Station .....	589	3743A 1F Amplifier .....	558
2645R Arabic Display Station .....	590	3744A BB Sweeper Accessory .....	558
2645S Swedish/Finnish Display Station .....	590		
2648A Graphics Terminal .....	588	3745A/B Selective Level Measuring Set .....	546
2649A Microprogrammable Terminal .....	589	3747A Selective Level Measuring Set .....	546
2802A Digital Thermometer .....	66, 606	3747B Selective Level Measuring Set .....	546
2804A Quartz Thermometer .....	605	3750A Attenuator: 75Ω .....	558
2811B Quartz Pressure Gauge .....	604	3754A Access Switch .....	548
		3755A Switch Controller .....	548
<b>3000</b>		3760A Data Generator .....	332, 560
HP 3000 Series II Systems .....	572, 573	3761A Error Detector .....	560
3040A Network Analyzer .....	433, 435-437	3762A Data Generator .....	562
3042A Network Analyzer .....	433, 435-437	3763A Error Detector .....	562
3044A Automatic Spectrum Analyzer .....	465, 473-475	3770A Amplitude/Delay	
3045A Automatic Spectrum Analyzer .....	465, 473-475	Distortion Analyzer .....	526, 530
3051A Programmable Data Logger .....	72	3770B Telephone Line Analyzer .....	526, 530
3052A Automatic Data		3777A HP-IB-controlled Channel Selector .....	565
Acquisition System .....	55, 59, 73	3780A Pattern Generator/Error Detector .....	561
3070A, 3071A Real Time		3790A 1F Transmitter (140 MHz 1F) .....	554
Applications Terminals .....	592	3805A Distance Meter .....	616
3200B VHF Oscillator .....	378	3810A Total Station .....	616
3310A Function Generator .....	333, 339	3820A Electronic Total Station .....	616
3310B Function Generator .....	333, 339	3964A Instrumentation Tape Recorder .....	254
3311A Function Generator .....	333, 337	3968A Instrumentation Tape Recorder .....	254
3312A Function Generator .....	333, 338	<b>4000</b>	
3320A Frequency Synthesizer .....	336, 348	4204A Oscillator .....	333, 336
3320B Frequency Synthesizer .....	336, 348	4260A Universal Bridge .....	75, 76, 82, 91
3320C Level Generator .....	335, 550	4261A Digital LCR Meter .....	75, 76, 84, 91
3330B Automatic Synthesizer .....	336, 350, 435	4262A Digital LCR Meter .....	80
3335A Frequency Synthesizer .....	345-347	4265B Universal Bridge .....	75, 76, 83, 91
3350A Laboratory Automation Systems .....	610	4270A Automatic	
3352A Laboratory Data System .....	610	Capacitance Bridge .....	75, 76, 88, 91
3380A Reporting Integrator .....	610	4271B Component Test 1 MHz	
3400A RMS Voltmeter .....	41	Digital LCR Meter .....	86
3403A True RMS Voltmeter .....	52	4272A 1 MHz Preset	
3406A Broadband Sampling Voltmeter .....	42	Capacitance Meter .....	75, 76, 89
3435A Digital Voltmeter .....	46, 50	4273A 1 kHz Preset C Meter .....	90
3437A System Digital Voltmeter .....	46, 54, 59, 73	4282A Digital High	
3438A S-Function DMM; HP-IB .....	56	Capacitance Meter .....	75, 76, 91, 92
3455A Digital Voltmeter .....	46, 58-61, 72, 76	4304B Ammeter .....	34
3465A Digital Multimeter .....	46, 68	4328A Milliohmmeter .....	75, 78
3465B Digital Voltmeter .....	46, 68	4329A High Resistance Meter .....	75, 79
3466A/B 4½ Digit Autoranging DMM .....	70	4332A LCR Meter .....	75-77
3470A Digital Multimeter .....	66	4333A Distortion Analyzer .....	467
3476A/B Digital Voltmeter .....	46, 48	4342A Q Meter .....	75, 93
3490A Multimeter .....	62-64	4436A Attenuator .....	99
3495A Scanner .....	55, 58, 72-74	4437A Attenuator .....	99
3529A Magnetometer Probe .....	36	4440B Decade Capacitor .....	99



4800A Vector Impedance Meter ..... 98  
 4815A Vector Impedance Meter ..... 98  
 4904A Cable Fault Locator ..... 543  
 4905A Ultrasonic Leak Detector ..... 543  
 4910G Open and Split Locator ..... 543  
 4930A Conductor Fault Locator ..... 541  
 4960A/4961A Automatic Pair Identifier ..... 542  
 4940A Transmission Impairment Measuring Set ..... 526, 538  
 4942A Transmission Impairment Measuring Set ..... 526, 538  
 4943A Transmission Impairment Measuring Set ..... 539  
 4944A Transmission Impairment Measuring Set ..... 539

**5000**

5004A Signature Analyzer ..... 108  
 5011T Logic Troubleshooting Kit ..... 107  
 5015T Logic Troubleshooting Kit ..... 107  
 5021A Logic Troubleshooting Kit ..... 106  
 5022A Logic Troubleshooting Kit ..... 106  
 5023A Logic Troubleshooting Kit ..... 106  
 5035A Basic Logic Lab ..... 110  
 5035I Logic Lab ..... 110  
 5045A Digital IC Tester ..... 94  
 5046A Digital IC Test System ..... 96  
 5050B Digital Recorder ..... 258  
 5055A Digital Recorder ..... 257  
 5060-Series Rack Frames and Adapters ..... 518  
 K02-5060A Standby Power Supply ..... 303  
 5061A Cesium Beam Frequency Standard ..... 294  
 5061A with Option 004 Tube ..... 295  
 E21-5061A Flying Clock (Cesium) ..... 295  
 5062C Cesium Beam Frequency Reference ..... 296  
 5065A Rubidium Frequency Standard ..... 297  
 E21-5065A Portable Rubidium Time Standard ..... 297  
 5085A Standby Power Supply ..... 303  
 5087A Distribution Amplifier ..... 302  
 5150A Thermal Printer ..... 256  
 5245L Electronic Counter ..... 266  
 5252A Plug-in for 5245L & 5345A ..... 268  
 5253B Frequency Converter Plug-in ..... 268  
 5254C Frequency Converter Plug-in ..... 268  
 5255A Frequency Converter Plug-in ..... 268  
 5256A Frequency Converter Plug-in ..... 268  
 5257A Transfer Oscillator Plug-in ..... 268  
 5261A Video Amplifier Plug-in ..... 269  
 5262A Time Interval Plug-in ..... 268  
 5267A Time Interval Plug-in ..... 269  
 5300A Counter Mainframe ..... 278  
 5300B Counter Mainframe ..... 278  
 5301A 10 MHz Counter Module ..... 281  
 5302A 50 MHz Universal Counter Module ..... 281  
 5303B 500 MHz Counter Module ..... 282  
 5304A Timer/Counter Module ..... 282  
 5305B 1300 MHz Counter Module ..... 283  
 5306A Digital Multimeter/Counter ..... 283  
 5307A Frequency Counter Module ..... 284  
 5308A Timer Counter Module ..... 284  
 5310A Battery Pack Module ..... 286  
 5311B Digital-to-Analog Converter ..... 285  
 5312A ASCII Converter ..... 285  
 5328A Universal Counter ..... 270-274  
 5340A Microwave Frequency Counter ..... 288-291  
 5341A Microwave Frequency Counter ..... 288-291

5342A Microwave Frequency Counter ..... 290  
 5345A Electronic Counter ..... 262-265, 463  
 5353A Channel C: Plug-in for 5345A ..... 265  
 5354A 4 GHz Frequency Converter ..... 265  
 5359A Time Synthesizer ..... 276  
 5360A Computing Counter ..... 267  
 5363A Time Interval Probes ..... 275  
 5370 Time Interval Counter ..... 277  
 5375A Computing Counter Keyboard ..... 267  
 5379A Time Interval Plug-in ..... 267  
 5381A Frequency Counter ..... 287  
 5382A Frequency Counter ..... 287  
 5383A Frequency Counter ..... 287  
 5390A Frequency Stability Analyzer ..... 502  
 5420A Digital Signal Analyzer ..... 505  
 5425A Digital Vibration Test Control System ..... 504  
 5427A Digital Vibration Control System ..... 504  
 5451B Fourier Analyzer ..... 504  
 5451B Option 350 Vibration Control System ..... 504  
 5501A Laser Transducer ..... 602  
 5526A Laser Interferometer ..... 603  
 5700A Laboratory Gas Chromatographs ..... 610  
 5840A Reporting Gas Chromatographs ..... 610  
 5985A GC/Mass Spectrometer ..... 610  
 5993A GC/Mass Spectrometers ..... 610

**6000**

6002A Extended Range DC Power Supply ..... 213  
 6110A-6116A Precision DC Power Supplies ..... 216  
 6129C-6131C Digitally Controlled Voltage Sources ..... 224  
 6140A Digital Current Source ..... 224  
 6177C Precision DC Current Source ..... 218  
 6181C Precision DC Current Source ..... 218  
 6186C Precision DC Current Source ..... 218  
 6200B-6209B DC Power Supplies ..... 205  
 6211A-6218A Dual Range DC Power Supplies ..... 204  
 6220B DC Power Supply ..... 206  
 6224B DC Power Supply ..... 206  
 6226B DC Power Supply ..... 206  
 6227B Dual Tracking DC Power Supply ..... 214  
 6228B Dual Tracking DC Power Supply ..... 214  
 6236B Triple Output DC Power Supply ..... 204  
 6237B Triple Output DC Power Supply ..... 204  
 6253A Dual Output DC Power Supply ..... 206  
 6255A Dual Output DC Power Supply ..... 206  
 6259B DC Power Supply ..... 208  
 6260B DC Power Supply ..... 208  
 6261B DC Power Supply ..... 208  
 6263B DC Power Supply ..... 208  
 6264B DC Power Supply ..... 208  
 6265B DC Power Supply ..... 208  
 6266B DC Power Supply ..... 208  
 6267B DC Power Supply ..... 208  
 6268B DC Power Supply ..... 208  
 6269B DC Power Supply ..... 208  
 6271B DC Power Supply ..... 208  
 6274B DC Power Supply ..... 208  
 6281A DC Power Supply ..... 206  
 6282A DC Power Supply ..... 206  
 6284A DC Power Supply ..... 206  
 6286A DC Power Supply ..... 206  
 6289A DC Power Supply ..... 206  
 6291A DC Power Supply ..... 206  
 6294A DC Power Supply ..... 206  
 6296A DC Power Supply ..... 206



# MODEL NUMBER INDEX

New product listings are printed in bold face type

6299A DC Power Supply	206
6384A DC Power Supply	205
6427B DC Power Supply	210
6428B DC Power Supply	210
6433B DC Power Supply	210
6434B DC Power Supply	210
6438B DC Power Supply	210
6439B DC Power Supply	210
6443B DC Power Supply	210
6448B DC Power Supply	210
6453A DC Power Supply	210
6456B DC Power Supply	210
6459A DC Power Supply	210
6464C DC Power Supply	210
6466C DC Power Supply	210
6469C DC Power Supply	210
6472C DC Power Supply	210
6475C DC Power Supply	210
6477C DC Power Supply	210
6479C DC Power Supply	210
6483C DC Power Supply	210
6515A High Voltage DC Power Supply	215
6516A High Voltage DC Power Supply	215
6521A High Voltage DC Power Supply	215
6522A High Voltage DC Power Supply	215
6525A High Voltage DC Power Supply	215
6824A DC Power Supply/Amplifier	219
6825A DC Power Supply/Amplifier	219
6826A DC Power Supply/Amplifier	219
6827A DC Power Supply/Amplifier	219
6920B AC/DC Meter Calibrator	353
6940B Multiprogrammer	597
6941B Multiprogrammer Extender	597
<b>7000</b>	
7004B X-Y Recorder	228
7010B X-Y Recorder	231
7015B X-Y Recorder	231
7034A X-Y Recorder	228
7035B X-Y Recorder	230, 533
7040A X-Y Recorder	232
7041A X-Y Recorder	232
7044A X-Y Recorder	234
7045A X-Y Recorder	234
7046A X-Y Recorder	233
7047A X-Y Recorder	234
7100B Strip Chart Recorder, 2 Pen	242
7101B Strip Chart Recorder, 1 Pen	242
7123A Strip Chart Recorder	241
7127A Strip Chart Recorder, 1 Pen	242
7128A Strip Chart Recorder, 2 Pen	242
7130A Strip Chart Recorder, 2 Pen	244
7131A Strip Chart Recorder, 1 Pen	244
7132A Strip Chart Recorder, 2 Pen	245
7133A Strip Chart Recorder, 1 Pen	245
7143A Strip Chart Recorder	241
7155B Portable Strip Chart Recorder	246
7202A Graphic Plotter	236
7203A Graphic Plotter	236
7210A Digital Plotter	237
7221A Digital Plotter	238
7260A Optical Mark Reader	593
7261A Optical Mark Reader	593
7402A 2-Channel Oscillographic Recorder	247
7404A 4-Channel Oscillographic Recorder	247
7414A 4-Channel Oscillographic Recorder	250
7418A 6 to 8 Channel Oscillographic Recorder	250
7562A Log Voltmeter/Converter	34, 43
7563A Log Voltmeter/Amplifier	34, 43
7702B 2-Channel Oscillographic Recorder	250
7906/7920 Disc Drives	595
7970 series Digital Magnetic Tape Subsystem	596
<b>8000</b>	
8005B Pulse Generator	321
8006A Pulse Generator	325
8007B Pulse Generator	319
8008A, see 8082A	
8010A Pulse Generator	321
8011A Pulse Generator	314
8012B Pulse Generator	315
8013B Pulse Generator	315
8015A Pulse Generator	316
8016A Pulse Generator	328
8018A 50 M bits/s Serial Data Generator	326
8080A Mainframe	309
8081A Repetition Rate Generator, 300 MHz	313
8082A Pulse Generator	318
8083A Output Amplifier, 300 MHz	310
8084A Word Generator, 300 MHz	311
8091A Repetition Rate Generator, 1 GHz	313
8092A Delay Generator/Freq. Divider	312
8093A Output Amplifier, 1 GHz	310
8165A Programmable Signal Source	340
8403A Modulator	379
8404A Leveling Amplifier	401
8405A Vector Voltmeter	450
8406A Comb Generator	501
8407A Network Analyzer	448
8409A Automatic Network Analyzer	458
8410B Network Analyzer Mainframe	454
8410S series Network Analyzers	451
8411A Harmonic Frequency Converter	454
8412A Phase-Magnitude Display	448, 454
8413A Phase Gain Indicator	454
8414A Polar Display	448, 454
8418A Auxiliary Power Supply	454
8443A Tracking Generator	494
8444A Tracking Generator	496, 499
8444A Option 058 Tracking Generator	484, 488
8445B Automatic Preselector	498
8447 series Amplifiers	31, 501
8470A Coaxial Crystal Detectors	418
8471A Coaxial Crystal Detector	418
8472A/B Coaxial Crystal Detector	418
8473B/C Coaxial Crystal Detectors	418
8477A Power Meter Calibrator	409
8478B Coaxial Thermistor Mount	409
8481A/H Power Sensor	406
8482A/H Power Sensor	406
8483A Power Sensor	406
8484A Power Sensor	406
8491A/B Coaxial Fixed Attenuators	411
8492A Coaxial Fixed Attenuator	411
8493A/B series Coaxial Fixed Attenuators	411
8494A/B/G/H series Coaxial Step Attenuators	412
8495A/B/D/G/H/K series Coaxial Step Attenuators	412
8495A/B/D/G/H/K series Coaxial Step Attenuators	412
8496A/B/G/H series Coaxial Step Attenuators	412
8501A Storage-Normalizer	443
8502A & B Reflection Transmission Bridges	444

8503A & B S-Parameter Test Sets ..... 444

8505A Network Analyzer ..... 440

8507A Automatic Network Analyzer ..... 446

8507B Automatic Network Analyzer ..... 446

8542C Automatic Network Analyzer ..... 577

8552A Spectrum Analyzer—IF Section ..... 491

8552B Spectrum Analyzer—IF Section ..... 491

8553B Spectrum Analyzer, Tuning Section ..... 494

8554B Spectrum Analyzer, Tuning Section ..... 496

8555A Spectrum Analyzer, Tuning Section ..... 498

8556A Spectrum Analyzer, Tuning Section ..... 492

8557A Spectrum Analyzer ..... 165, 486

8558B Spectrum Analyzer ..... 165, 488

8565A Spectrum Analyzer ..... 484

8568A Spectrum Analyzer ..... 478

8580C Automatic Spectrum Analyzer ..... 577

8581A Automatic Spectrum Analyzer ..... 483

8600A Digital Marker ..... 384, 449

8601A Generator/Sweeper ..... 384, 449

8614A Signal Generator ..... 375

8616A Signal Generator ..... 375

8620 system Sweep Oscillators ..... 385, 557

8620C Sweeper Mainframe ..... 386

8621B Multiband Sweeper Drawer ..... 396

8640A AM/FM Signal Generator ..... 365

8640B AM/FM Signal Generator ..... 365

8640C Option 004, Avionics Signal Generator ..... 368

8640M Signal Generator ..... 369

8654A Signal Generator ..... 370

8654B Signal Generator ..... 370

8655A Synchronizer/Counter ..... 371

8660A Synthesized Signal Generator ..... 358

8660C Synthesized Signal Generator ..... 358

8671A Microwave Frequency Synthesizer ..... 364

8672A Synthesized Signal Generator ..... 362

8690B Sweep Oscillator ..... 398

8691B-8695B RF Units (PIN leveled BWO)  
for 8690B ..... 399

8691A-8697A RF Units (Grid Leveled BWO)  
for 8690B ..... 399

8698B, 8699B Solid State RF Units for 8690B ..... 399

8705A Signal Multiplexer for 8690B ..... 401

8706A Control Unit for 8690B ..... 401

8707A RF Unit Holder for 8690B ..... 401

8709A Phase-lock Synchronizer ..... 401

8717B Transistor Bias Supply ..... 456

8721A Coaxial Directional Bridge ..... 449

8731-8735 series PIN Modulators ..... 379

8740A Transmission Test Unit ..... 456

8741A Reflection Test Unit ..... 456

8742A Reflection Test Unit ..... 456

8743A Reflection/Transmission Test Unit ..... 455

8745A S-Parameter Test Set ..... 455

8746B S-Parameter Test Set ..... 456

8747A Waveguide series  
Reflection/Transmission Test Units ..... 457

8750A Storage-  
Normalizer ..... 428, 448, 454, 459, 484, 486, 488, 501

8755B Frequency Response Test Set Plug-in ..... 428

8755S Frequency Response Test Sets ..... 424

8761A & B Coaxial Switches ..... 422

8801A Low Gain Preamplifier ..... 251

8802A Medium Gain Preamplifier ..... 251

8803A High Gain Preamplifier ..... 251

8805A Carrier Preamplifier ..... 251

8805B Carrier Preamplifier ..... 251

8806B Phase Sensitive Demodulator ..... 252

8807A AC/DC Converter ..... 252

8808A Logarithmic Preamplifier ..... 252

8809A Signal Coupler ..... 252

8820A DC Bank Amplifier ..... 253

8821A DC Bank Amplifier ..... 253

8900B Peak Power Calibrator ..... 409

8950B Automatic Transceiver Test System ..... 524

**9000**

9500 series Automatic Test Systems ..... 577

9815A Desktop Computer ..... 580

9825A Desktop Computer ..... 580

9830A Desktop Computer ..... 581

9830B Desktop Computer ..... 581

9831A Desktop Computer ..... 351, 582

9845A Desktop Computer ..... 583

9862A X-Y Plotter ..... 76, 585

9863A Tape Reader ..... 584

9864A Digitizer ..... 584

9865A Tape Cassette ..... 584

9866A Thermal Printer ..... 585

9866B Thermal Printer ..... 585

9868A I/O Expander ..... 584

9869A Hopper Card Reader ..... 584

9871A Character Impact Printer ..... 73, 587

9872A Four Color Plotter ..... 239, 582

9877A External Tape Memory ..... 584

9878A I/O Expander ..... 584

9880B Mass Memory Subsystem ..... 581

9881A Line Printer Subsystem ..... 585

9883A High Speed Tape Reader Subsystem ..... 584

9884A Tape Punch Subsystem ..... 584

9885M/S Flexible Disk Drive ..... 587

9896A Computation System ..... 586

**10000**

10001A 10:1 Divider Probe ..... 173

10001B 10:1 Divider Probe ..... 173

10002A 50:1 Divider Probe ..... 173

10002B 50:1 Divider Probe ..... 173

10003A 10:1 Divider Probe ..... 173

10004D 10:1 Divider Probe ..... 173

10005D 10:1 Divider Probe ..... 173

10006D 10:1 Divider Probe ..... 173

10007B 1:1 Probe ..... 65, 173, 516

10008B 1:1 Probe ..... 65, 173, 516

10011B BNC Adapter Tip ..... 176

10013A 10:1 Divider Probe ..... 173

10014A 10:1 Divider Probe ..... 173

10015A 10:1 Divider Probe ..... 173

10016B 10:1 Divider Probe ..... 173

10017A Miniature Divider Probe ..... 173

10018A Miniature Divider Probe ..... 171

10020A Resistance Divider ..... 173

10021A Miniature 1:1 Probe ..... 171

10022A Miniature 1:1 Probe ..... 171

10024A IC Test Clip ..... 172

10026A Miniature 1:1 Probe ..... 171

10027A Miniature 1:1 Probe ..... 171

10034A Probe Ground Lead Kit ..... 176

10035A Probe Tip Kit ..... 176

10036B Probe Tip Kit ..... 38, 176

10037A Probe Tip Kit ..... 176

10040A Miniature Divider Probe ..... 171



# MODEL NUMBER INDEX

New product listings are printed in bold face type

10041A Miniature Divider Probe .....	171	10544A/B/C Component Oscillator .....	301
10042A Miniature Divider Probe .....	171	10844A Programming Interface Kit (5045A) .....	97
10100B 100 ohm Feedthrough Termination .....	176	10851A, 10852A Rack Mount Kits .....	337
10100C 50 ohm Feedthrough Termination .....	176		
10106A Camera Bezel Adapter .....	179		
10110A BNC Male to Dual Banana Plug .....	515		
10111A Shielded Banana Plug to BNC Female .....	37, 515		
10113A Triple Banana Plug to Dual BNC Female .....	515		
10116A Light Shield (1220A, 1221A, 1222A) .....	176		
10117A Panel Cover (1220A, 1221A, 1222A) .....	170		
10119A Rack Mount Kit (1220A, 1221A, 1222A) .....	170		
10140A Viewing Hood (1704A, 1741A, 1734A) .....	176		
10173A RFI Filter and Contrast Screen (1740A, 1741A, 1743A) .....	176		
10176A Viewing Hood .....	176		
10178A Mesh Contrast/RFI Filter .....	176		
10233A Cable, 1645A to 5055A or 5150A .....	529		
10235A Interface Cover for 1645A .....	526, 529		
10250A TTL Trigger Probe .....	127		
10253A Card Reader for 1600A Logic State Analyzer .....	126		
10254A Serial-to-Parallel Converter .....	127, 527		
10257B Personality Module for 1611A .....	122		
10258B Personality Module for 1611A .....	122		
10259A Personality Module for 1611A .....	123		
10260A Personality Module for 1611A .....	123		
10352B Graflok Back .....	178		
10353A Pack Film Back .....	178		
10358B Camera Carrying Case .....	179		
10360A Camera Bezel Adapter .....	178		
10361A Camera Bezel Adapter .....	178		
10362A Camera Bezel Adapter .....	178		
10363A Camera Bezel Adapter .....	178		
10366B Camera Bezel Adapter .....	178		
10367A Camera Bezel Adapter .....	178		
10369A Camera Bezel Adapter .....	178		
10370A Camera Bezel Adapter .....	178		
10371A Camera Bezel Adapter .....	178		
10372A Camera Bezel Adapter .....	178		
10374A Camera Carrying Case .....	179		
10375A Camera Bezel Adapter .....	178		
10376A Camera Bezel Adapter .....	178		
10377A Camera Bezel Adapter .....	178		
10387A Interface, Type 303 Modems (1645A) .....	529		
10388A Interface, CCITT V.35 (1645A) .....	529		
10389A Interface, Breakout Box (RS-232C) (1645A) .....	529		
10407B Plug-in Extender (180 system) .....	176		
10475A 3 in. Drawer for 1117B .....	180		
10476A 8 in. Drawer for 1117B .....	180		
10491B Rack Mount Adapter, 1700 series, 1600A .....	176		
10511A Spectrum Generator .....	380		
10514A Double Balanced Mixer .....	380		
10525-60012 Tip Kits .....	101		
10525T, & 10525E Logic Probes .....	101		
10526T Logic Pulsar .....	102		
10528A Logic Clip .....	104		
10529A Logic Comparator .....	105		
10534A Double Balanced Mixer .....	380		
10541A Reference Boards .....	105		
K01-10541A Preprogrammed Reference Boards .....	105		
		11000	
		11000A Cable Assembly .....	514
		11001A Cable Assembly .....	514
		11002A Test Leads .....	514
		11003A Test Leads .....	514
		11004A Line Transformer .....	334, 336
		11005A Line Transformer .....	334, 336
		11021A Probe Accessories .....	516
		11028A Current Divider .....	516
		11035A Cable Assembly .....	514
		11036A AC Probe for 410C .....	38, 516
		11040A Probe Accessory .....	516
		11045A DC Voltage Divider for 410C .....	516
		11046A Carrying Case .....	518
		11047A Probe Accessory .....	516
		11067A Test Lead Kit .....	37, 51
		11068A Soft Carrying Case .....	65
		11070 A/B/C Cable Assembly .....	65
		11075A & 11076A Instrument Cases .....	37-41, 335, 518
		11096B High Frequency Probe .....	37, 51, 57, 65
		11143A BNC to Clip Leads Cable Assembly .....	88, 514
		11170A/B/C Cable Assembly .....	514
		11202A 8-bit Parallel I/O Interface Card .....	585
		11203A BCD Input Interface Card .....	585
		11205A Serial Interface Card .....	585
		11285A Data Communication Interface and ROM .....	585
		11297B Binary Synchronous ROM .....	505
		11298B Interactive ROM .....	585
		11500A/B Cable Assembly .....	514
		11501A Cable Assembly .....	514
		11507A Output Termination .....	380
		11508A Terminated Output Cable .....	380
		11509A Fuseholder .....	380
		11511A Type N Short .....	420
		11512A Type N Short .....	420
		11515A Waveguide Adapter .....	423
		11516A Waveguide Adapter .....	423
		11517A Mixer .....	485, 500, 501
		11518A-11520A Waveguide Taper Sections .....	501
		11524A APC-7 to N Adapter .....	423, 515
		11525A APC-7 to N Adapter .....	423, 515
		11530A Probe .....	471
		11531A Test Plug-in for 8690B .....	401
		11533A APC-7 to SMA Adapter .....	423, 515
		11534A APC-7 to SMA Adapter .....	423, 515
		11536A Probe Tee for 8405A .....	450
		11540A Waveguide Stand .....	423
		11542A-11548A Waveguide Clamps .....	423
		11549A Power Splitter for 8405A .....	450
		11565A APC-7 Short .....	420
		11566A Air Line Extension .....	423
		11567A Air Line Extension .....	423
		11570A Accessory Kit for 8405A .....	450
		11581A Attenuator Set .....	411
		11582A Attenuator Set .....	411
		11583A Attenuator Set .....	411

11587A Accessory Kit for 8410 series	457
11588A Swivel Adapter	423
11589A & 11590A Bias Networks	457
11599A Quick-Connect Adapter for 8745A	457
11600B Transistor Fixture	455
11602B Transistor Fixture	455
11604A Universal Extension for 8745A	455
11605A Flexible Arm for 8743A	455
11606A Rotary Air Line	423
11607A Small Signal Adapter for 8745A	457
11608A Transistor Fixture	456
11609A Cable Kit for 8410S	457
11650A Accessory Kit for 8410S	457
11652A Reflection/Transmission Kit for 8407A	449
11654A Passive Probe Kit for 8407A	449
11655A Impedance Probe for 8407A	449
11658A Matching Resistor for 8407A	449
11661A Frequency Extension Module	360
11664A Detector for 8755	428
11665B Modulator for 8755	426
11666A Reflectometer Bridge for 8755	426
11667A DC-18 GHz Power Splitter	426
11668A 50 MHz High Pass Filter for 8755	427
11675B Leveling Cable Assembly for 784B	577
11678A Low Pass Filter Kit	427
11679A/B Extension Cables for 8755	427
11683A Range Calibrator	405
11684/5/6/8/9A Low Pass Filters	427
11687A Adapter, 50 to 75 $\Omega$	380
11690A Frequency Doubler	380
11691D Coaxial Directional Coupler	416
11692D Coaxial Dual Directional Coupler	416
11693A Limiter	501
11694A Matching Transformer, 50-75 $\Omega$	501
11697A, B & C Bandpass Filters	380
11708A Attenuator (for Calibrating of 8484A)	403
11710B Down Converter	369
11720A Pulse Modulator	378
11850A & B Power Splitters	444
11851A RF Cable Kit for 8505A	445
11852A 50-75 $\Omega$ Minimum Loss Pad	445
11853A 50 $\Omega$ Type N Accessory Kit	445
11854A 50 $\Omega$ BNC Accessory Kit	445
11855A 75 $\Omega$ Type N Accessory Kit	445
11856A 75 $\Omega$ BNC Accessory Kit	445
11857A/B/C Test Port Extension Cables for 8503A & B	445
11858A Rigid Interconnect Adapter	445
<b>12000</b>	
12940A 20 Mbyte Disc Cartridge	595
12970A Magnetic Tape Subsystem	596
12971A Magnetic Tape Subsystem	596
12972A Magnetic Tape Subsystem	596
<b>13000</b>	
13394A 50 M byte Disc Pack	595
13515A Frequency Doubler Probe	378
<b>14000</b>	
14513A Rack Kit (for one unit, 3½"H)	220
14515A Rack Kit (for one unit, 5¼"H)	220
14521A Rack Kit, (for Bench Series)	220
14523A Rack Kit (for two units, 3½"H)	220
14525A Rack Kit (for two units, 5¼"H)	220
14533B Pocket Programmer	599
14534A Pocket Programmer Cable	599

14535A Interface Kit, DCPS-to-21 MX Computer	225
14536A DCPS Chaining Cable	225
14539A Cable Assembly, DCPS to 21 MX Computers	225
14540 Cable Assembly, Multiprogrammer-to 21 MX Computer	599
14541A Chaining Cable, 6940B or 6941B to 6941B	599
14545A Casters	220
14550A Interface Kit, Multiprogrammer-to-21 MX Computer	599
14551A Multiprogrammer Service Kit	599
14555A Multiprogrammer Card Connector	599
<b>15000</b>	
15263A Card Reader	330
15450A Four-Channel Adapter	330
15451A Four-Channel TTL-CMOS Translator	330
15507A Isolator	564
15508A Impedance Converter	564
15509A Amplifier	564
<b>16000</b>	
16005A Probes	78
16006A Probe	78
16007A Test Leads	78
16008A Resistivity Cell	79
16011A BNC Connector Test Fixtures	88
16012A, 16013A Test Fixtures	88
16014A Series Loss Test Adapter	93
16019A Test Fixture	77
16021A Calibration Connector	87, 89
16022A Test Fixture	89
16023A DC Bias Controller	87
16029A Test Fixture	83
16032A Test Leads (BNC)	87, 89
16033A Test Leads	89
16034A Test Fixtures	87, 89
16035A Test Leads	92
16036A Test Leads	92
16037A Test Fixture	92
16038A Test Fixture	89
16039A Test Fixture	87
16045A Test Leads	90
16061A Test Fixture	81, 85
16062A Test Lead	81, 85
16063A Test Lead	81, 85
16117A Test Lead	79
16138A Test Leads	77
16143A Probe Cable	78
16252A Matching Transformer	336
16411A HP-1B Interface Kit	88
16413A HP-1B Interface Kit	93
16462A Auxillary Capacitor	93
16470A Reference Inductors	93
<b>17000</b>	
17005A Chart Advance for 7004B Recorder	229
17012B Point Plotter	229
17012C Point Plotter	229
17108A Time Base	230
17170A DC Coupler	228
17171A DC Amplifier	228
17172A Time Base	229

# MODEL NUMBER INDEX

New product listings are printed in bold face type

17173A Null Detector .....	229	62005A-62048G Modular Power Supplies .....	222
17174B DC Offset .....	229	62212A-62215G Dual Output Modular Supplies .....	222
17175A Filter .....	229	<b>62312D Triple Output Modular Supply</b> .....	<b>222</b>
17176A Scanner .....	229	62410A Modular Supply Rack Mounting Tray .....	223
17177A AC/DC Converter DC Preamplifier .....	229	62411A Rack Tray Blank Front Panel .....	223
17178A DC Attenuator .....	229	62412A Rack Tray Blank Rear Panel .....	223
17400A High Gain Preamplifier .....	248	62413A Rack Tray Cooling Unit (45 cfm) .....	223
17401A Medium Gain Preamplifier .....	248	62414A Rack Slice Kit (for standard cabinets) .....	223
17402A Low Gain Preamplifier .....	248	62415A Rack Tray AC Distribution Panel .....	223
17403A AC Carrier Preamplifier .....	248	62416A Rack Tray Cooling Unit (160 cfm) .....	223
17404A DC Bridge Amplifier .....	248	62605J-62628J 200-300W Switching Power Supplies .....	222
17500A Multiple Span .....	242	62605L, 62605M, 62615M 300-600W Switching Power Supplies .....	222
17501A Multiple Span .....	242	63005C 110W Switching Power Supply .....	203
17502A Temperature Module .....	243	<b>63315D Triple Output Switching Power Supply</b> .....	<b>222</b>
17503A Single Span .....	243	69321B Multiprogrammer D/A Voltage Converter .....	600
17504A Single Span .....	243	69325A-69328A Amplifier Control Cards .....	600
17505A High Sensitivity .....	243	69330A Relay Output Card .....	600
17506A Single Span .....	243	69331A Digital Output Card .....	600
<b>18000</b>		69332A Open Collector Output Card .....	600
18641A PRT Temperature Probes .....	67	69335A Stepping Motor Control Card .....	600
18642A PRT Temperature Probes .....	67	69351B Voltage Regulator Card .....	600
18643A PRT Temperature Probes .....	67	69370A D/A Current Converter Card .....	600
18644A PRT Temperature Probes .....	67	69380A Breadboard Output Card .....	600
<b>30000</b>		69421A Voltage Monitor Card .....	600
33300 series Step Attenuators .....	414	69430A Isolated Digital Input Card .....	600
33311B/C Coaxial Switches .....	422	69431A Digital Input Card .....	600
33320 series Coaxial Step Attenuators .....	414	69433A Relay Output With Readback Card .....	600
33321 series Coaxial Step Attenuators .....	414	69434A Event Sense Card .....	600
33322 series Coaxial Step Attenuators .....	414	69435A Pulse Counter Card .....	600
33330B/C Coaxial Crystal Detectors .....	418	69436A Process Interrupt Card .....	600
34110A Carrying Case .....	51, 57, 65	69480A Breadboard Input Card .....	600
34111A High Voltage Probe .....	51, 57, 65	69500A Unloaded Resistance Output Card .....	600
34112A Touch-Hold Probe .....	51, 57, 65	69501A-69513A Power Supply Control Cards .....	600
34702A Multimeter .....	66	69600B Programmable Timer Card .....	600
34740A Display .....	66	69601B Frequency Reference Card .....	600
34750A Display .....	66	<b>80000</b>	
<b>40000</b>		85010A Basic Measurement Program Pac for 8501A/8505A & 9830A/B .....	447
43501B X-Ray System .....	607	<b>85010B Basic Measurement Program Pac for 8501A/8505A &amp; 9825A</b> .....	<b>447</b>
43804 X-Ray System .....	607	85030A Applications Pac for 8507A-9830A/B .....	447
43805 X-Ray System .....	607	<b>85030B Applications Pac for 8507B-9825A</b> .....	<b>447</b>
43807 X-Ray System .....	607	85031A APC-7 Calibration and Verification Kit for 8507A & B .....	447
<b>50000</b>		85032A 50Ω Type-N Calibration Kit for 8507A & B .....	447
59301A ASC11—Parallel Converter .....	26, 76	85033A SMA Calibration Kit for 8507A & B .....	447
59303A Digital-to-Analog Converter .....	26	<b>85036A 75Ω Type N Calibration Kit for 85097A &amp; B</b> .....	<b>447</b>
59304A Numeric Display .....	26	85426A Bias Insertion Network .....	449
59306A HP-1B Relay Actuator .....	26	85428B Minimum Loss Pad .....	449
59307A HP-1B VHF Switch .....	26	86200 series Sweeper Plug-ins for 8620C .....	394, 557
59308A HP-1B Timing Generator .....	26	86222A & B Sweeper Plug-ins for 8620C .....	392, 557
59309A HP-1B Digital Clock .....	26	<b>86240A/B/C Sweeper Plug-ins for 8620C</b> .....	<b>390, 557</b>
59310B HP-1B Computer Interface .....	26	86290A & <b>86290B Broadband Sweeper Plug-ins for 8620C</b> .....	388
59313A HP-1B Analog-to-Digital Converter .....	26	86300 series Sweeper Modules for 8620C .....	396
59401A Bus System Analyzer .....	25		
59403A HP-1B Common Carrier Interface .....	26		
59405A HP-1B Calculator Interface .....	26		
59500A Multiprogrammer HP-1B Interface .....	597		
59501A HP-1B Power Supply Programmer .....	212		
<b>60000</b>			
61000 Modular Power Supplies (OEM) .....	222		
61005C DC-to-DC Converter (single output) .....	222		
61315D DC-to-DC Converter (triple output) .....	222		
62000 & 63000 Modular Power Supplies (OEM) .....	222		

86601A RF Section for 8660A/C	360
86602B RF Section for 8660A/C	360
86603A RF Section for 8660A/C	360
86631B Auxiliary Section for 8660A/C	361
86632B AM/FM Section for 8660A/C	361
86633B AM/FM Section for 8660A/C	361
86634A Phase Modulation Section for 8660A/C	361
86635A $\Phi$ M, FM Section for 8660A/C	361

**90000**

<b>90100D Practical Transistor Series (Video Tape)</b>	<b>618</b>
<b>90420D Digital Troubleshooting (Video Tape)</b>	<b>619</b>
97001A Rechargeable Battery Pack for 970A	47
97002A AC/DC Current Shunt/Bench Cradle for 970A	47
97003A RF Adapter for 970A	47
97004A Accessory Kit for 970A	47
97010A Battery Charger for 970A	47
98032A 16-bit Duplex Interface	76, 585, 597
98033A BCD Input Interface	585
98034A HP-1B Interface	585
<b>98035A Clock/Timer/Pacer Interface</b>	<b>585</b>
<b>98036A Serial Interface</b>	<b>585</b>
98133A BCD Interface	585
98134A General Interface	585
98135A HP-1B Interface	585
98136A RS-232-C Serial Interface	585
0960-0054 SMA Female Short (5052)	420
0960-0055 SMA Male Short (5052)	420

1250-0076 90° BNC Male-Female	515
1250-0077 Type N Female to BNC Male	515
1250-0080 BNC Female to Female	515
1250-0082 Type N Male to BNC Male	515
1250-0176 Type N Male to Type N Female 90°	515
1250-0216 BNC Male to Male	515
1250-0559 Type N Tee, 1 Male, 2 Female	515
1250-0777 Type N Female to Type N Female	515
1250-0778 Type N Male to Male	515
1250-0780 Type N Male to BNC Female	515
1250-0781 BNC Tee 1 Male, 2 Female	515
1250-0846 Type N Tee, 3 Female	515
1250-1158 SMA Female to Female	515
1250-1159 SMA Male to Male	515
1250-1286 Right Angle BNC (f)	515
1250-1287 BNC (f) to BNC (f)	515
1250-1288 BNC (m) to BNC (m)	515
1250-1454 BNC Adapter Tip for HP Miniature Probes	172
<b>1250-1472 N (f) to N (f) Precision (50<math>\Omega</math>)</b>	<b>515</b>
<b>1250-1473 N (m) to BNC (m) Precision (50<math>\Omega</math>)</b>	<b>515</b>
<b>1250-1474 N (f) to BNC (f) Precision (50<math>\Omega</math>)</b>	<b>515</b>
<b>1250-1475 N (m) to N (m) Precision (50<math>\Omega</math>)</b>	<b>515</b>
<b>1250-1476 N (m) to BNC (f) Precision (50<math>\Omega</math>)</b>	<b>515</b>
<b>1250-1477 N (f) to BNC (m) Precision (50<math>\Omega</math>)</b>	<b>515</b>
<b>1250-1528 N (m) to N (m) (75<math>\Omega</math>)</b>	<b>515</b>
<b>1250-1529 N (f) to N (f) (75<math>\Omega</math>)</b>	<b>515</b>
1250-1530 N (m) Short (75 $\Omega$ )	420
1250-1531 N (f) Short (75 $\Omega$ )	420

<b>1250-1533 N (m) to BNC (m) (75<math>\Omega</math>)</b>	<b>515</b>
<b>1250-1534 N (f) to BNC (m) (75<math>\Omega</math>)</b>	<b>515</b>
<b>1250-1535 N (m) to BNC (f) (75<math>\Omega</math>)</b>	<b>515</b>
<b>1250-1536 N (f) to BNC (f) (75<math>\Omega</math>)</b>	<b>515</b>
1251-2277 Dual Banana plug to BNC Female	515
1251-2816 Dual Banana plug (for cable)	515
10004-69515 IC Probe Tip Adapter	176
10024-69501 Interface Pen Kit for 10024A	172

# HEWLETT-PACKARD INTERFACE BUS

Versatile interconnect system for instruments and controllers

- HP's implementation of IEEE Standard 488 and identical ANSI Standard MC 1.1
- Useful over wide range of problems, from simple to very complex—add capabilities as your system requirements grow
- Very broad selection of HP-IB instruments and accessory devices—available now
- Wide choice of computing controllers for the reduction, analysis, storage and management of measurement data

HP-IB

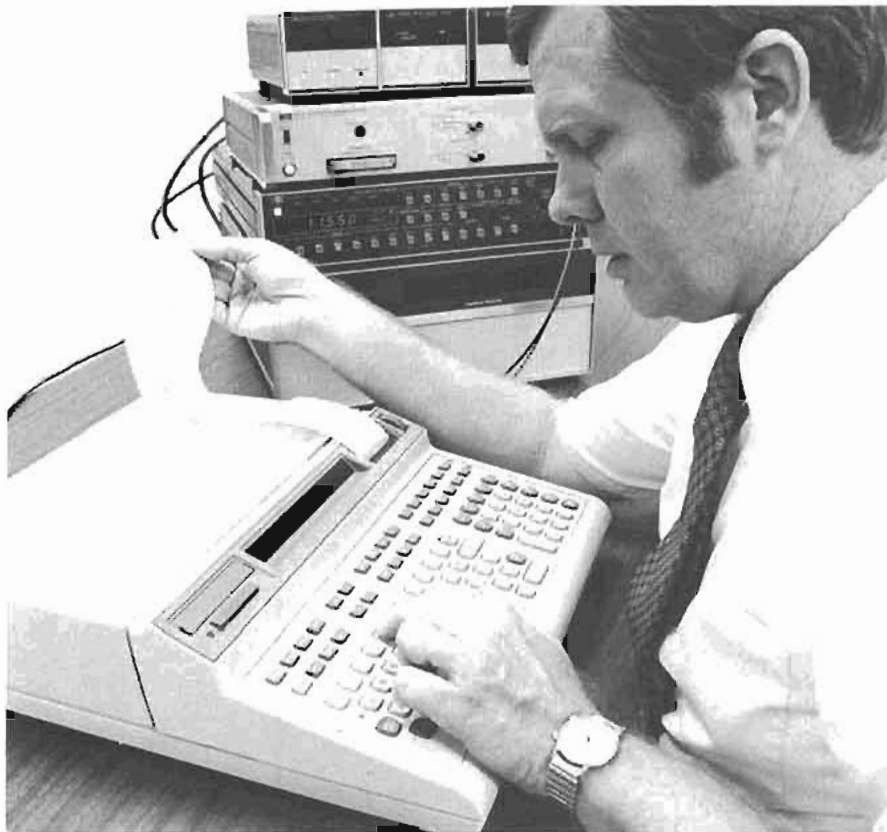

Make accurate, problem-oriented measurements, controlled by computer.

There are many measurement applications where interactive instruments coupled with a controller can provide superior, error-free results as compared with conventional manual methods.

Now, three things combine to reduce significantly the engineering costs of putting such a system together. These are: (1) the Hewlett-Packard Interface Bus, also known simply as "HP-IB"; (2) the growing number of "smart" instruments having internal processor capability; and (3) the broad choice of computing controllers, ranging from individual "friendly" keyboard units through those capable of multistation measurements and sophisticated data management.

### Benefits of a systems approach

The decision to use a "system" instead of conventional manual methods must be based on an engineering evaluation of benefits vs. costs. Among the many benefits associated with a systems approach:

- More consistent results in repeated

measurements—a system is not subject to operator fatigue.

- Greater throughput because systems are generally faster.
- More thorough testing because system speed allows more parameters to be measured in a shorter time.
- Results expressed in engineering or scientific units since many systems controllers are capable of on-line data manipulation.
- Greater accuracy because system errors can be measured automatically, stored, and accounted for in the results.
- "Adaptive" data acquisition wherein a system can be programmed to branch to other measurements to help pinpoint the problem when it senses an abnormal condition.

**Relationship of HP-IB to present and proposed interface standards:** Hewlett-Packard is committed to the overall advancement of measurement technology, and has for quite some time been working on the

problems of simplifying and standardizing instrument interconnection.

Concurrent with the considerable practical experience HP has gained (with both HP-IB and interface techniques in general) over recent years has been the growing international interest in establishing a suitable standard for programmable measuring apparatus—a standard that will allow instrument systems to be configured from the products made by different manufacturers. European organizations, particularly in Germany, have been instrumental in initiating an international standardization effort.

In mid-1972, HP began to participate in various national and international standardization bodies. The U.S. Advisory Committee, composed of diverse interests represented by both users and manufacturers, first established initial goals—and then adopted the interface concept utilized by the HP Interface Bus as an appropriate starting point. A draft document was subsequently written and evaluated by members of the Committee, and then submitted as the U.S. proposal to an IEC (International Electrotechnical Commission) Working Group in the autumn of 1972. Since then, the interface definition has undergone a number of minor changes to accommodate various needs at the international level.

In September 1974, the parent technical committee, IEC TC66, approved the main interface draft document for a formal ballot among the member nations of the IEC. Balloting took place in 1976, and it is anticipated that an IEC document will be available for publication in 1978. *The present definition of the HP-IB is compatible with the main IEC draft document.*

Meanwhile, the IEEE Standards Board has approved IEEE Standard 488-1975 "Digital Interface for Programmable Instrumentation", as published in April 1975.<sup>1</sup> The IEEE standard is based on work initiated by the IEC, and follows the general concepts of the document now under consideration by IEC member nations. *The HP Interface Bus is Hewlett-Packard's implementation of IEEE Standard 488.* (NOTE: In January 1976, the American National Standards Institute adapted the above and published it as ANSI Standard MC 1.1).

The standardized interface concept is now well accepted, and more than 250 products utilizing the concepts articulated in IEEE 488 are today available from more than 80 different manufacturers.

### Why the HP Interface Bus name?

As the list of HP products available with the "new digital interface" has grown, our customers have in the past sought a convenient way to identify those products having

<sup>1</sup>To purchase a copy of the 80-page IEEE Standard 488-1975, contact: The Institute of Electrical and Electronics Engineers, 345 East 47th Street, New York, N.Y. 10017.



the interface capability. In response, we in 1974 adopted the name "Hewlett-Packard Interface Bus" (commonly shortened to "HP Interface Bus" or simply "HP-IB"). We will continue to use the identifying name and this symbol:



Both will be used with appropriate HP products so that their interface capabilities may be readily identified.

As additional instrumentation interface standards become approved, HP will clearly indicate the relationship of the Hewlett-Packard Interface Bus to those standards — just as we have done with IEEE Standard 488 (and identical ANSI Standard MC 1.1).

It should be pointed out that as a practical matter, device-dependent operational characteristics have been excluded from the IEEE and proposed IEC Standards definitions. In this way, users retain maximum flexibility in selecting instruments from different manufacturers and in utilizing each instrument's particular capabilities to best advantage.

Relative to the great progress made in standardizing three of the four interface system elements (*mechanical, electrical, functional*), understanding the remaining device-dependent operational parameters referred to in the IEEE document is a relatively small but essential ingredient necessary to ensure complete operational systems.

It would be presumptuous for Hewlett-Packard to speak for other manufacturers; however, it is our objective to reduce as much as practical any device-related ambiguities associated with HP products operating per the IEEE Standard (and proposed IEC Standard). We expect to do this through product design considerations; through new message concepts, as well as further code and format guidelines; and through various printed materials and training activities.

### How the HP Interface Bus operates

All active interface circuitry is contained within the various HP-IB devices, and the interconnecting cable (containing 16 signal lines) is entirely passive. The cable's role is limited to that of interconnecting all devices together in parallel, whereby any one device may transfer data to one or more other participating devices.

Every participating device (instrument, controller, accessory module) must be able to perform at least one of the roles of *TALKER, LISTENER* or *CONTROLLER*. A *TALKER* can transmit data to other devices via the bus, and a *LISTENER* can receive data from other devices via the bus. Some devices can perform both roles

(e.g. a programmable instrument can *LISTEN* to receive its control instructions and *TALK* to send its measurement).

A *CONTROLLER* manages the operation of the bus system primarily by designating which devices are to send and receive data, and it may also command specific actions within other devices.

A minimum HP-IB system configuration consists of one *TALKER* and one *LISTENER*, but without a *CONTROLLER*. In this configuration, data transfer is limited to direct transfer between one device manually set to "talk only" and one or more devices manually set to "listen only" (e.g. a measuring instrument talking to a printer, for semi-automatic data logging).

The full flexibility and power of the HP-IB become more apparent, however, when one device which can serve as *CONTROLLER/TALKER/LISTENER* (e.g. calculator or computer) is interconnected with other devices which may be either *TALKERS* or *LISTENERS*, or both (e.g. frequency synthesizers, counters, power meters, relay actuators, displays, printers, etc.), depending on the application. An HP-IB computing controller participates in the measurement by scheduling measurement tasks, setting up individual devices so that they can perform these tasks, monitoring the progress of the measurement as it proceeds, and interpreting the results of the measurement. (See page 28 for additional details about HP-IB computing controllers.)

### HP-IB connections and structure

The 16 signal lines within the passive interconnecting HP-IB cable are grouped into three sets, according to their function.

Eight *DATA* lines carry coded messages in bit-parallel, byte-serial form to and from devices, with each byte being transferred from one *TALKER* to one or more *LISTENERS*. Data flow is bidirectional in that the same lines are used both to input program data and to output measurement data from an individual device. Data is exchanged asynchronously, enabling compatibility among a wide variety of devices. All interface messages (to set up, maintain, and terminate an orderly flow of device-dependent messages) are 7-bit coded. Device-dependent messages may be from 1 to 8 bits; however, the codes containing printable characters of the ASCII (American Standard Code for Information Interchange) code set are most commonly used, and messages containing numbers are typically presented in scientific notation (FORTRAN-type) format.

Three *DATA BYTE TRANSFER CONTROL* (handshake) lines are used to effect the transfer of each byte of coded data on the eight *DATA* lines.

The five remaining *GENERAL INTERFACE MANAGEMENT* lines ensure an

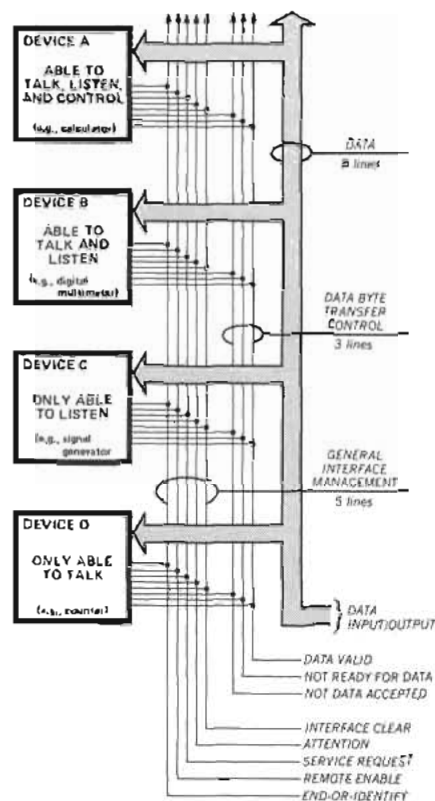

Interface connections and bus structure.



Rear panel switches are set so instrument will either be addressable by controller in a multi-device system, or will simply "talk only" to another device such as a printer.

orderly flow of information within the HP-IB system. One of these is called the "ATTENTION" line.

Several listeners can be active simultaneously, but only one talker can be active at a time. Whenever a talk address is put on the *DATA* lines (while *ATTENTION* is low), all other talkers are automatically unaddressed.

It is not possible in this limited space to go into detail on each signal line's role. But you should note that every HP-IB device need not be able to respond to all the lines. As a practical and cost-effective matter, each HP-IB device will usually be designed to respond only to those lines that are pertinent to its typical function on the bus. (Details appear in each device's operating manual.)

# HEWLETT-PACKARD INTERFACE BUS

Versatile interconnect system for instruments and controllers

## Products for "do-it-yourself" HP-IB system solutions

Hewlett-Packard has an extremely broad range of HP-IB instruments and computing controller capabilities, as indicated on the table below—capabilities you can use in assembling a wide variety of system solutions via HP-IB.

Each bench instrument is, by itself, an exceptional performer in terms of providing signals, making measurements, or recording results. Each has the additional capability

which allows its use in HP-IB instrumentation systems—either in "do-it-yourself" systems configured and assembled by users themselves, or in some of the standard systems which are designed, preassembled and supported by HP. While the HP-IB interface is optional in many instruments, it is increasingly becoming "standard" in some of the newer products.

Most principle functions on the instruments are HP-IB programmable. For specific details, please consult the appropriate catalog page, or the technical data sheet which is available for each product.

Just as with the instruments, HP's computing controllers (desktop computers and computer systems) which are available for use with HP-IB are all proven performers. Regardless of your need for reducing, analyzing, storing or managing measurement data, HP has a computing controller that should be right for your application.

## Individual Hewlett-Packard products available with HP-IB (IEEE 488)

Products related to:	Model	Product name/characteristics	See Page	
Stimulus	3320B	Option 007	348	
	3330B		350	
	3335A		345	
	5359A		276	
	6002A	Option 001	219	
	8016A	Option 001	228	
	8018A	Option 001	326	
	8165A		307 & 340	
	8620C	Option 011	386	
	8660A	Option 005	358	
	8660C	Option 005	358	
	8671A		364	
	8672A		362	
	Measurement	436A	Option 022	404
		1602A	Option 001	188
2804A		Option 010	605	
3437A			54	
3438A			56	
3455A			58	
3490A		Option 030	62	
3745A			546	
3745B			546	
3747A			546	
3747B			546	
4262A		Option 101	80	
4270A		Option 101	88	
4271B		Option 101	86	
4272A		Option 101	89	
4282A		Option 101	91	
4942A		Option 010	539	
4943A		Option 010	538	
4944A		Option 010	538	
5312A			278	
5328A		Option 011	270	
5340A		Option 011	288	
5341A		Option 011	288	
5342A		Option 011	290	
5345A		Option 011	262	
5363A			275	
5370A			277	
5420A*			505	
5501A		Option 251	602	
8501A			440	
8503A		Option 001	443	
8505A		Option 001	440	
8568A			478	
Storage	3964A	Option 007	254	
	3968A	Option 007	254	
			Storage also via Desktop Computers and Computer Systems	

### Standard HP-IB measurement systems

Many application requirements can be satisfied with a standard HP-IB measurement system—already preassembled, tested, and documented by Hewlett-Packard. Preconfigured systems save you design and setup time, and HP guarantees overall specified system performance. Installation and service contracts are available. See listing on the following page.

### Warranty considerations

Every HP-IB device (instrument or computing controller) carries the standard Hewlett-Packard warranty appropriate to that individual product—regardless of whether it is purchased separately as a stand-alone item for use in customer-assembled HP-IB systems, or furnished as part of a standard HP-IB system assembled by Hewlett-Packard.

HP additionally takes responsibility for

*standard HP-IB systems* performing as specified. However, software or interfacing which has not been provided by Hewlett-Packard as part of the standard system delivered by HP are not covered by this warranty.

In all cases, overall operational responsibility for those HP-IB systems assembled by a customer from individual HP-IB devices shall rest with the customer.

### Individual Hewlett-Packard products available with HP-IB (IEEE 488) capability

Products related to	Model	Product name/characteristics	See page
Display	1350A 5150A Option 001 9871A Option 001 9872A 59304A	Graphics Translator: for directed-beam CRT displays Alphanumeric Thermal Printer: 20 columns Character-Impact Printer: 132 columns Graphics Plotter: multicolor (4 colors) programmable Numeric Display: 12 LED characters, decimal point <i>Display also via Desktop Computers and Computer Systems</i>	184 256 587 239 26
Switching, Scanning, Translation or Timing	2240A 3070A 3495A 3754A* 3754A-H01* 3777A 6940B** 9412A*** 9413A*** 9414A*** 59301A 59303A 59306A 59307A 59308A 59309A 59313A 59403A 59501A	Measurement and Control Subsystem Data Entry Terminal Scanner: to 40 channels, low thermal and relay Access Switch (*requires 3755A switch controller) Distribution Switch (*requires 3755A) Telecommunications Channel Selector Multiprogrammer (**requires 59500A interface) Modular Switch (**requires 9411A switch controller) VHF Switch (**requires 9411A) Matrix Switch (***requires 9411A) ASCII-to-Parallel Converter: string to 16 characters Digital-to-Analog Converter Relay Actuator: for programmable switches, attenuators VHF Switch: two 50 Ohm, bidirectional, dc to 500 MHz Timing Generator Digital Clock: month, day, hour, minute, second Analog-to-Digital Converter HP-IB/Common Carrier Interface: RS232C or CCITT V24 Power Supply Programmer: isolated D-to-A converter	576 592 74 548 548 565 597 577 577 577 26
Control and Computation	9815A 9825A 9830A/B 9845A 21MX K-series 21MX M-series 21MX E-series HP 1000	Desktop Computer (uses 98135A Interface) Desktop Computer (uses 98034A Interface) Desktop Computer (uses 59405A Option 030 Interface) Desktop Computer System 45 (uses 98034A Interface) Computer-on-a-Board (2108X & 2109K, use 59310B Interface) Computers (2105A, 2108A & 2112A, use 59310B Interface) High-performance Computers (2109A & 2113A, use 59310B) Computer Systems (use 59310B Interface)	28 & 580 28 & 580 28 & 581 28 & 583 578 578 578 29 & 574
Interface Cabling	10631A 10631B 10631C 10631D	HP-IB Interconnection Cable: 1 m (3.3 ft) HP-IB Interconnection Cable: 2 m (6.6 ft) HP-IB Interconnection Cable: 4 m (13.2 ft) HP-IB Interconnection Cable: 0.5 m (1.6 ft) <i>For distance extension, also see Models 3070A and 59403A listed above.</i>	25 25 25 25
Design and Servicing	59401A	Bus System Analyzer	25

# HEWLETT-PACKARD INTERFACE BUS

Versatile interconnect system for instruments and controllers

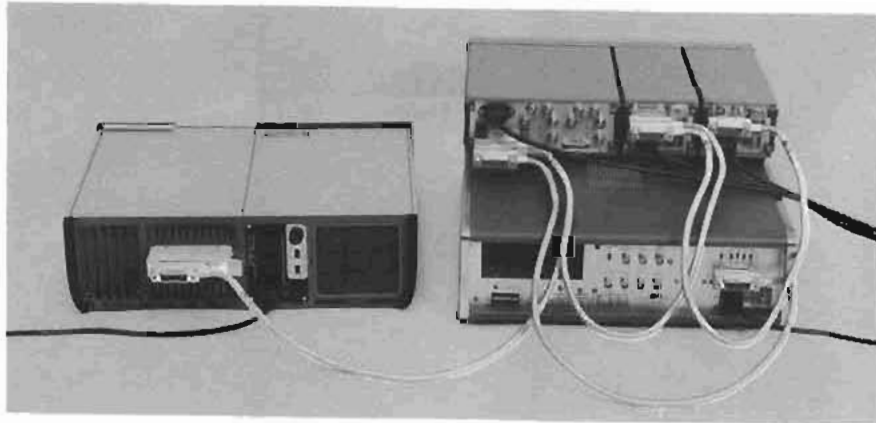

Rear view of 5-device HP-IB bench system. Note single and stacked connections.

## HP-IB specification summary

**Interconnected devices:** up to 15 maximum on one contiguous bus.

**Interconnection path:** star or linear bus network; total transmission path length 2 metres times number of devices or 20 metres, whichever is less (see HP59403A for extending operating distance).

**Message transfer scheme:** byte-serial, bit-parallel asynchronous data transfer using interlocked 3-wire handshake technique.

**Data rate:** one megabyte per second maximum over limited distances; 250-500 kilobytes per second typical over full transmission path (depends on device).

**Address capability:** primary addresses, 31 TALK and 31 LISTEN; secondary (2-byte) addresses, 961 TALK and 961 LISTEN. Maximum of 1 TALKER and up to 14 LISTENERS at a time.

**Control shift:** in systems with more than one controller, only one can be active at a time. A currently active controller can pass control to another, but only designated system controller can assume control over others.

**Interface circuits:** driver and receiver circuits are TTL-compatible.

**Connector lock screw compatibility:** HP-IB products delivered now and in re-

cent years are equipped with connectors having ISO metric-threaded lock screws and stud mounts. Please note that connector lock screws and stud mounts on very early HP-IB products are, unless changed, incompatible with the now-standard metric threading.

Two different metal finishes are used by HP to help you tell the difference between metric and non-metric connector parts. Whereas the older non-metric parts have a shiny nickel finish, all metric-threaded lock screws and stud mounts have a black finish and the letter "M" stamped on them.

A special HP-IB Metric Conversion Kit (Part Number 5060-0138) is available at modest cost to assist customers in converting connectors on older HP-IB products to be compatible with the standard metric-threaded connectors.

## Standard HP-IB measurement systems

Application	Model	System name/characteristics	See Page
Data Logging and Acquisition	3051A	Programmable Data Logger: economical data collection and analysis, interactive test capabilities.	72
	3052A	Automatic Data Acquisition: fast and precise low-level measurements, powerful computation.	73
Network Analysis	3040A	Network Analyzer: complete amplitude and phase characterization, 50 Hz to 95 MHz. Group delay optional.	435
	3042A	Automatic Network analyzer: same as 3040A, and includes the faster 9825A as computing controller.	435
	8409A	Automatic Microwave Network Analyzer: measures transmission and reflection parameters, 110 MHz to 40 GHz.	458
	8507A/B	Automatic RF Network Analyzer: measures complex impedance, transfer functions, group delay; 500 kHz to 1.3 GHz.	446
Spectrum Analysis	3044A	Spectrum Analyzer: precise amplitude and frequency measurements, 10 Hz to 13 MHz.	473
	3045A	Automatic Spectrum Analyzer: same as 3044A, and includes the faster 9825A as computing controller.	473
	8581A	Automatic Spectrum Analyzer: covers 100 Hz to 1.5 GHz; exceptional frequency tuning accuracy and resolution.	483
Frequency Stability Analysis	5390A	Frequency Stability Analyzer: short- and long-term characterization of precision frequency sources, 500 kHz to 23 GHz.	502
Transceiver Testing	8950B	Automatic Transceiver Test System: for AM and FM transceivers, 2 to 1000 MHz, transmitting to 100 W.	524
Digital Circuit Board Testing	DTS-70	Digital Test System: fast, accurate fault location on loaded printed circuit boards.	577

# HEWLETT-PACKARD INTERFACE BUS



Versatile interconnect system for instruments and controllers

Bus system analyzer, cables & accessory modules



59401A



10631A/B/C/D

## 59401A Bus system analyzer

The HP-IB (IEEE 488) concept has greatly simplified many of those things which have in the past made instrument interfacing a burdensome task. Even so, software errors can occur if the system designer does not completely understand the bus system or the capabilities of the instruments and other devices being interfaced. And hardware problems can occur if the instruments/devices are not functioning properly, or if they are not completely compatible with the bus standard.

The 59401A Bus System Analyzer is especially useful in design and service work. It simplifies and speeds up the diagnosis of software and hardware problems by allowing the user to see the status of all bus lines, including the actual characters on the bus data lines. Because the 59401A can also drive all bus lines, it can completely exercise another Talker, Listener or Controller — which is especially useful in verifying compatibility of new or user-designed products with the HP-IB.

There are several choices of analyzer operating speed. It may be operated at one character at a time (useful for software debugging), at 2 characters per second, or at regular bus speed. It may also be operated at a variable rate as determined by the external clock input.

The analyzer's 32 character memory can be used to store bus characters in the Listen mode, or to output characters to the bus in the Talk mode. When the analyzer is in the Compare mode, a stream of bus traffic may be stopped on a pre-selected character — and at that time, a trigger pulse is available, which is very useful when analyzing transient or timing problems related to the bus.

## 59401A Specifications

**Display:** monitors all bus lines. Represents data lines, any memory location, or DIO front panel switch settings; in octal code and ASCII character.

**Listen mode:** stores up to 32 characters of bus traffic in memory for real time and repetitive testing. In compare mode, halts bus traffic when a selected character is present, and user can display any one of the previous 31 characters stored in memory.

**Timing:** accept <750 ns; ready <750 ns.

**Talk mode:** bus lines can be driven directly from front panel switches; memory can be loaded from front panel switches for driving bus with a 32 character sequence.

**Timing:** (1) data changed >500 ns before DAV pulled low; (2) ATN driven low >1 μs before DAV pulled low; (3) DAV driven high <700 ns after NDAC is false; (4) DAV driven low <700 ns after NRFD is false, if conditions 1 and 2 are met.

**Operating speeds:** one character at a time, 2 characters per second, regular bus speed, or variable rate determined by external clock input; in either Listen or Talk mode.

**External clock input:** 1 standard power TTL gate input; ≤ 10 MHz repetition rate.

**Compare output:** provides 1 standard power TTL gate output (LOW TRUE) sync pulse when bus character is same as front panel switches.

**HP-IB load:** 1 bus load (capable of driving 14 other bus devices).

## General

**Temperature ranges:** operating, 0 to 50°C; storage, -40 to +75°C.

**Humidity:** 95% relative, 0 to 40°C.

**Power requirements:** 100, 120, 220 or 240 V +5%, -10%; 48 to 66 Hz; ≤42 VA.

**Size:** 145.5 H, 205.1 W, 495.3 mm D (5.730" × 8.075" × 19.500")

**Weight:** net, 5.64 kg (12.44 lb).

## Options and accessories

5061-0089 front handle kit

10831B 2 m (6.6 ft) bus cable, furnished

Price

\$15

N/C

## 59401A Bus System Analyzer

\$2700

## HP-IB Interconnection cables

Cables for interconnecting HP-IB devices are available in four different lengths. The connector block at both ends of each HP-IB cable (photo above) has a plug on one side and a matching receptacle on the other, so that several cables may be conveniently connected in parallel, thus simplifying system interconnection. Lock screws provide for secure mounting of each connector block to an HP-IB instrument, or to another cable connector block.

**SPECIAL NOTES:** (1) Metric threading is now standard on connector lock screws; read the "Connector lock screw compatibility" message in this section if you are using older HP-IB products. (2) HP-IB cables are not included with individual HP-IB devices, and must be ordered separately (exception: HP-IB computing controller interfaces include cable with connector).

## Ordering Information

10631A HP-IB Cable, 1 m (3.3 ft)

10631B HP-IB Cable, 2 m (6.6 ft)

10631C HP-IB Cable, 4 m (13.2 ft)

10631D HP-IB Cable, 0.5 m (1.6 ft)

Price

\$60

\$65

\$73

\$60

## HP-IB Accessory modules

Modules in the HP 59300, 59400 and 59500-series are ideal building blocks for use with instruments to extend measurement capabilities. Modules listed here can be interconnected via the HP-IB to HP measuring instruments, signal sources and recording devices capable of operating directly on the HP-IB. In addition, these modules frequently serve as useful ways to interconnect with devices which are not themselves capable of direct HP-IB operation.

Instrument requirements differ. Some only output or accept data on the HP-IB. Others can be remotely programmed by ASCII characters sent along the HP-IB. These modules can work with instruments on any of these levels with or without a controller. Each module having controls can be operated stand-alone from its front panel, or it can be placed in automatic operation under program control.

Module provision for stand-alone, local operation also has important system benefits. The operator can set up and check out the system under manual control, avoiding otherwise complex and time consuming error tracing. Each module has status indicator lights that make it easy to monitor operation.

# HEWLETT-PACKARD INTERFACE BUS

Versatile interconnect system for instruments and controllers

## Accessory modules



59301A

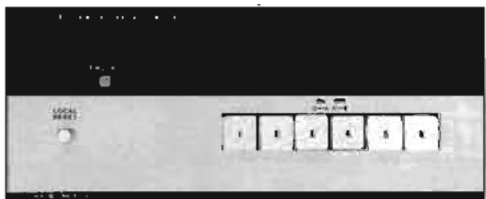

59306A



59307A



59308A



59313A



59501A



59303A



59304A



59309A

### 1350A graphics translator

Accepts digital information from the HP-IB (or optionally RS-232C) and converts it to X, Y, and Z analog voltages for driving high-resolution, directed-beam, non-storage CRT displays. An internal 2k word digital memory (RAM) stores the data, and is continually accessed in order to generate vectors or characters for refreshing one or more CRT displays. Each digital word can be a vector coordinate, or a ROM-generated upper or lower case ASCII character. An optional ROM provides an additional 512 user-definable vectors for generating graticules and special characters. (Additional details on page 184.)

### 59301A ASCII-to-parallel converter

Accepts byte-serial ASCII characters from the HP-IB and converts them to parallel output. A string of up to 16 characters terminated by linefeed is converted to 1-2-4-8 BCD and placed on the output lines; the linefeed character signals execution of a print command (strobe).

With the 59301A, instruments with the HP-IB interface can be operated with HP 5050B/5055A Printers (requires two output cables, HP 562-16C, not furnished). Or, the 59301A can be used with HP 6128C thru 6145A (Option J99) digitally-controlled power supplies, for HP-IB programmable voltage and current. The 59301A can additionally be used to control other functions using its hexadecimal format.

### 59303A digital-to-analog converter

Accepts an ASCII string and converts any three consecutive digits to analog voltage accurate to 0.1% in 30  $\mu$ s. Fully programmable via the HP-IB or operates stand-alone from the front panel. Offers three output modes for conversion: normal, offset, or plus-minus (9.99 volts to -9.99 volts) to make it convenient for operating strip chart recorders.

A primary application for the HP 59303A is to present on a logging device the data points being taken during a measurement, such as with the HP 5345A Counter. No controller is required for operation. Compatible logging devices include strip chart recorders, X-Y plotters, and displays.

### 59304A numeric display

Provides a highly visible readout of up to 12 ASCII characters (0 thru 9E, -). It can be addressed to display the output of measurement devices or the results from a calculator/desktop computer. It can also be used as a remote display in the "listen only" mode.

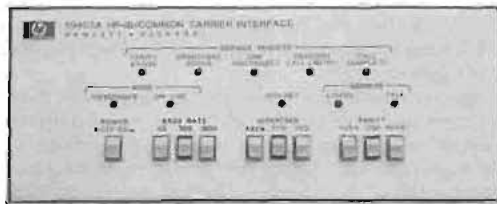

59403A



The distance between HP-IB devices may be extended by up to 1000 metres, using two 59403A's: even further with modems.

**59306A relay actuator**

Has six Form-C relays that provide for control of external devices either manually from front panel pushbuttons or remotely from the HP-IB. Relay contacts are specified to switch 24 V dc or 115 V ac @ 0.5 A. Use the 59306A with HP 8761A/B SPDT switches for HP-IB programmable microwave switching dc-18 GHz; use it with HP 8494 thru 8496G/H attenuators for HP-IB programmable attenuation dc-18 GHz (external power supply required).

**59307A dual VHF switch**

This module offers a pair of single throw 4-pole switches (dc to 500 MHz, 50 ohm) optimized for fast risetime (1 ns) pulse waveforms. Switches are independent and bidirectional, and can be operated either from front panel pushbuttons or remotely from the HP-IB.

**59308A timing generator**

Has two modes of operation—a pacing function which provides output at a specified rate, and a timing function which provides a delay with respect to a trigger for a specified period of time. Timed intervals can be selected by thumbwheel switches on the front panel, or can be programmed remotely from the HP-IB. Times from 1 μs to more than a day are available. Trigger inputs are available via front panel pushbutton and rear panel connector. Timing outputs are available for both TTL and ECL levels, with switch selection of a squarewave or pulse output positive or negative-going edge. Output pulses are 500 ns ± 100 ns wide, and rise time is < 50 ns.

**59309A digital clock**

Displays month, day, hour, minute and seconds, and upon command will output time via the interface bus. Time can be set into the clock by local control, or by remote commands received from the HP-IB. The clock accepts a small internal battery which can provide more than a day's standby during short power interruptions. Alternately, an external source such as D-sized batteries can sustain the clock for up to one year.

**59313A analog-to-digital converter**

This medium-speed 4-channel unit can accept a full scale input of ± 10 V dc on each channel, individually selectable in four ranges. It also has a program-controlled reverse channel for driving small signal lamps, relays, or TTL circuits. An HP-IB controller can com-

mand this unit to perform a single conversion, or initiate a series of internally-paced conversions at one of six selectable rates (up to 200/s if one channel; up to 50/s on each of four channels). Sampling can also be initiated externally by TTL transition or contact closure to ground.

**59403A HP-IB/common carrier interface**

Provides a way to extend the separation of component parts in an HP-IB system by more than the 20 metre maximum transmission path length specified in various interface Standards, and it is especially useful for production or remote site applications. Distances up to 1000 metres are possible by using two 59403A modules (one at each location) interconnected by a dedicated and shielded two-twisted-pair cable. And even longer distances can be achieved by using a telephone line (with appropriate modems) instead of the dedicated cable.

Each 59403A module converts HP-IB data and control lines to a serial bit stream of digital information for transmission over the dedicated or telephone lines, and vice versa in the reverse direction. In both cases, operation is full duplex, so that (for example) one HP-IB device at a remote location can request service from the controller at the same time the controller is sending data to another HP-IB device at the remote location.

The recommended dedicated cable is available from HP as Part Number 8120-1197 (Belden type 8723). The 59403A is designed to operate with 110, 300 and 1200 baud asynchronous or synchronous full duplex modems which are EIA RS232C or CCITT V24 compatible. In the U.S., Bell 103A modems with "soft carrier turn-off" are recommended for the direct dial (DDD) network. (Check your local telephone authorities regarding data communication regulations.)

**59501A power supply programmer (isolated DAC)**

This single-channel digital-to-analog converter can control a wide range of power supplies (output voltage, or current), as well as other analog programmable devices. It may also be used as a low level signal source, depending on the speed of the controller. It has two output ranges (0-1 and 0-10Vdc in unipolar mode; -1 to +1 and -10 to +10 V dc in bipolar mode), as well as photo-isolators which electrically separate HP-IB control and data lines from power supply circuitry by up to 600 V dc. (Additional details on page 212.)

Model	Description	Dimensions—max. height <sup>1</sup> × width × width × depth mm (inches)	Net Weight kg (lb)	Shipping Weight kg (lb)	Price
1350A	Graphics Translator	101.6 × 425.5 × 497.8 (4 × 16.8 × 19.6)	9.55 (21.0)	11.8 (26.0)	\$3000
59301A	ASCII-to-parallel Converter	101.6 × 212.9 × 294.6 (4 × 8.38 × 11.6)	1.70 (3.78)	2.32 (5.16)	\$575
59303A	Digital-to-analog Converter	101.6 × 105.9 × 294.6 (4 × 4.17 × 11.6)	2.61 (5.80)	3.17 (7.04)	\$950
59304A	Numeric Display	101.6 × 105.9 × 294.6 (4 × 4.17 × 11.6)	1.23 (2.73)	1.58 (3.51)	\$800
59306A	Relay Actuator	101.6 × 212.9 × 294.6 (4 × 8.38 × 11.6)	2.64 (5.87)	3.23 (7.18)	\$700
59307A	VHF Switch	101.6 × 212.9 × 294.6 (4 × 8.38 × 11.6)	2.64 (5.87)	3.23 (7.18)	\$750
59308A	Timing Generator	101.6 × 212.9 × 294.6 (4 × 8.38 × 11.6)	2.10 (4.67)	3.83 (8.51)	\$1150
59309A	HP-IB Digital Clock	101.6 × 105.9 × 294.6 (4 × 4.17 × 11.6)	1.70 (3.78)	2.84 (6.31)	\$1025
59313A	Analog-to-digital Converter	101.6 × 212.9 × 345.4 (4 × 8.38 × 13.6)	5.45 (12.0)	6.36 (14.0)	\$1500
59403A	HP-IB/Common Carrier Interface	101.6 × 212.9 × 430.0 (4 × 8.38 × 16.9)	4.50 (10.0)	6.10 (13.5)	\$1500
59501A	Power Supply Programmer	101.6 × 212.9 × 294.6 (4 × 8.38 × 11.6)	2.61 (5.80)	3.17 (7.04)	\$500

<sup>1</sup>Height above includes feet, with feet removed height is 88.1 mm (3.47").

# HEWLETT-PACKARD INTERFACE BUS

Versatile interconnect system for instruments and controllers

Computing controllers/interfaces



HP 9815A desktop computer (HP 98125A interface)



HP 9825A desktop computer (HP 98034A interface)



9845A

System 45 desktop computer (HP 98034A interface)

A separate controller is not required for simple HP-IB configurations (e.g. data logging). However, the full flexibility and potential of the Hewlett-Packard Interface Bus are more obvious when used with HP computing controllers.

## Role of a computing controller

In addition to managing the flow of information over the bus, the computing controller in an operating measurement system actively participates by scheduling measurement tasks, by setting up individual devices so they can perform the tasks, by monitoring the progress of the measurement as it proceeds, and by interpreting the results of the measurement.

HP computing controllers serve another important function by providing access to a large number of display, input/output and data storage peripherals. These include plotters, line printers, floppy disks, tape cassettes, etc. Additionally, HP computing controllers can perform the job of interfacing with other instrument subsystems or computer systems using serial communication links—thereby gaining access to common data bases, sharing results, etc.

Finally, a computing controller can provide the tools for program development. These will normally include an editor that can be used in generating source programs, debug aids that can be used in analyzing and modifying program flow, and a means of storing and recalling programs and/or results.

## Wide choice of HP computing controllers

Hewlett-Packard has a continuum of HP-IB (IEEE 488) computing controllers from which to select. If your interfaced-system application is of the "lab bench" variety (as in engineering design or metrology), you may prefer to use one of the desktop keyboard units such as the 9815A, 9825A, 9830A/B or System 45. On the other hand, if your application calls for complex or high volume production testing at multiple locations, simultaneously, and in several programming languages, your choice will probably be one of the solutions offered by the HP 1000 (incorporating a 21MX computer).

HP-IB interfaces for each computing controller are described below. For more comprehensive details on the computing controllers please consult pages 574 and 578-583.

### 98135A HP-IB Interface for 9815A

HP's most economical computing controller is the 9815A desktop unit, for handling the less complex tasks associated with small systems. If you are familiar with HP's hand-held personal calculators, you'll feel at home with the 9815A's Reverse Polish Notation (RPN) language. The keyboard has a 10-key numeric pad, 15 special function keys, program language and control keys, editing keys, and 28 scientific function keys. The 9815A has a 16-character numeric display, a thermal printer, and a high-speed bidirectional magnetic tape data cartridge system.

For HP-IB applications, the 9815A can accept one *HP 98135A Interface*, which allows the 9815A to communicate with up to a maximum of 14 HP-IB instruments or peripheral devices. If your application requires an interrupt capability, please see other HP computing controllers, since interrupt is not available with the 9815A/98135A.

### 98034A HP-IB Interface for 9825A or System 45

The 9825A desktop computing controller is an extremely flexible performer. It uses HPL, a high level, formula-oriented programming language which offers power and efficiency for handling equations, data manipulation, and input/output operations. HPL provides for subroutine nesting and flags, and allows 26 simple variables and 26 multidimensional array variables, limited only by the size of the 9825A's memory. Also, HPL has a language compatibility with the HP 9820A and HP 9821A, permitting programs for these earlier models to be converted for use with the 9825A.

Significant capabilities of the 9825A include two-level priority interrupt (for controlling several instruments or peripherals requiring attention at unpredictable rates or times), live keyboard, direct memory access, multi-dimensional arrays, automatic memory record and load, and an extended range of internal computation. The 9825A has a typewriter-like keyboard with upper/lower case, a numeric pad, and 12 special function keys (shiftable to 24). It has a





HP 1000 computer system (utilizing a 21MX controller and one or more HP 59310B interfaces)

built-in 32-character alphanumeric display, a 16-character printer (both upper/lower case), and a high-performance data cartridge system. There are three I/O slots and four ROM slots.

The 9800 System 45 (Model 9845A) is an integrated desktop computer for such applications as mathematical modeling, design analysis, production test control, text processing and linear programming. It provides fifteen levels of programmable priority interrupt and it includes a CRT display, an optional 80-character thermal line printer, enhanced BASIC language, and a unified mass storage system with two tape cartridge drives.

In the alpha mode, the CRT lists programs for viewing and editing, or displays data, keyboard inputs, user prompts and system messages. In the graphics mode, the CRT displays plots within a 560 x 455 dot matrix and allows dot-for-dot duplication of the graphic data in hard-copy form using the optional high-speed thermal printer.

System 45's language uses the same set of commands to address any selected storage medium, such as the HP 9885 Flexible Disk Drive, the HP 7900 Series large fixed disk drives, and the built-in 217 k-byte tape cartridges.

The HP 98034A Interface is required for operating the 9825A or 9845A in HP-IB applications. A 9825A equipped with a General I/O ROM can handle fundamental HP-IB input/output operations. With an Extended I/O ROM, the 9825A is capable of complete HP-IB control. All of these operations are available for the 9845A with just the Opt 320 I/O ROM. Up to four interfaces can be plugged directly into the 9800 System 45's I/O slots—and as many as 12 interfaces (up to 14 devices each) can be connected to a System 45 using a 9878A I/O Expander.

#### 59405A HP-IB interface for 9830A/B

BASIC language is used also with 9830A/B desktop computing controllers. Since BASIC is a standard computer language, programs you develop initially for 9830A/B HP-IB systems can be later adapted with minimum effort for use with a 21MX computing controller—if your HP-IB system requirements expand to require full computer capabilities available via the 21MX.

User-available read/write memory within mainframe ranges from a minimum of 3520 (8-bit) bytes in the standard HP 9830A, up to a maximum of 30,144 bytes in the HP 9830B with option 001. An external mass memory subsystem is available for allowing 9830A/B computing controllers to handle up to 4.8 million bytes of information. Standard 9830A/B's have 4 I/O slots, and many peripherals are available.

A 9830A or 9830B can control up to 14 HP-IB devices via an HP 59405A Option 030 Interface, plugged into one I/O slot—and an

appropriate ROM provided with the interface) also plugged into the computing controller.

#### 59310B HP-IB interface for HP 1000 (& 21MX-series)

The HP 1000 computer system is especially well suited for broad measurement and data management requirements such as those found in quality assurance, production testing, etc. This is because the HP 1000 (combining a 21MX computer and Real Time Executive Software) is capable of concurrently controlling multiple clusters of HP-IB test and measuring equipment which may be organized into separate physical or functional groupings, each of which may have up to 14 HP-IB devices per cluster. The HP 1000 also: (1) makes it possible to develop new programs while existing programs are actively controlling and communicating with the bus-interfaced devices; (2) can be programmed in HP Real Time BASIC, FORTRAN, and HP Assembly language; and (3) can be linked to distributed computer networks to achieve centralized test record maintenance, yield analysis, and work order scheduling and tracing.

Each separate bus cluster (of up to 14 HP-IB devices) connected to the HP 1000 requires one 59310B Interface. The 59310B is supported by a driver, utility software and a manual supporting operation in HP's memory-based RTE and disc RTE-II and RTE-III Real Time Executive systems. A diagnostic routine for quickly confirming correct operation is included with the interface, and each interface has a 4 metre cable terminated in an HP-IB connector with metric fasteners. Compatibilities between various HP computer systems, computers, and operating systems are indicated below. The 21MX Series computers include the HP 2105A, 2108, 2109, 2112, and 2113. Note that the 59310B interface may also be used with HP 2100A/S computers.

	HP 1000	HP 2105A	HP 2102/09 2112/13	HP 2100A/S
RTE-M:	Yes	Yes	Yes	No
RTE-II:	Yes	No	Yes	Yes
RTE-III:	Yes	No	Yes	No

#### HP-IB Interface ordering information

59310B: Interface, RTE-II/III for HP 1000	\$600
59405A Opt 030: interface for 9830A/B	\$1500
98034A: Interface for 9825A or 9845A	\$400
98135A: Interface for 9815A	\$600

#### Price

# AMPLIFIERS

General purpose amplifiers

Model 461A, 465A, 467A



461A



465A



467A

## 461A Description

This general purpose amplifier can be used as a preamplifier to raise the level of a signal or as a buffer.

The solid-state HP amplifier Model 461A provides stable 20 and 40 dB gain over a wide frequency range with fast rise time.

## 461A Specifications

**Frequency response:**  $\pm 1$  dB, 1 kHz to 150 MHz when operating into a 50  $\Omega$  resistive load (500 kHz reference).

**Gain at 500 kHz:** 40 dB  $\pm 0.5$  dB or 20 dB  $\pm 1.0$  dB, selected by front panel switch (inverting).

**Input impedance:** nominal 50  $\Omega$ .

**Maximum input:** 1 V rms or 2 V p-p pulse.

**Maximum dc input:**  $\pm 2$  V.

**Maximum output:** 0.5 V rms into 50  $\Omega$  resistive load.

**Equivalent wide-band input noise level:**  $< 40 \mu\text{V}$  in 40 dB position when loaded with 50  $\Omega$ .

**Distortion:**  $< 5\%$  at maximum output and rated load.

**Overload recovery:**  $< 1 \mu\text{s}$  for 10 times overload.

**Dimensions:** 76 mm H  $\times$  130 mm W  $\times$  279 mm D (3"  $\times$  5 1/8"  $\times$  11").

**Weight:** net, 1.8 kg (4 lb). Shipping, 2.7 kg (6 lb).

## 465A Description

HP's 465A amplifier provides 20 dB or 40 dB gain (X10 or X100) with flat frequency response from 5 Hz to 1 MHz with floating inputs.

## 465A Specifications

**Voltage gain:** 20 dB (X10) or 40 dB (X100), open circuit.

**Gain accuracy:**  $\pm 0.1$  dB, ( $\pm 1\%$ ) at 1 kHz.

**Frequency response:**  $\pm 0.1$  dB, 100 Hz to 50 kHz;  $< 2$  dB down at 5 Hz and 1 MHz.

**Output:**  $> 10$  V rms open circuit;  $> 5$  V rms into 50  $\Omega$  (0.5 W).

**Distortion:**  $< 1\%$ , 10 Hz to 100 kHz;  $< 2\%$ , 5 Hz to 10 Hz and 100 kHz to 1 MHz.

**Input impedance:** 10 M $\Omega$  shunted by  $< 20$  pF.

**Output impedance:** 50  $\Omega$ .

**Noise:**  $< 25 \mu\text{V}$  rms referred to input (with 1 M $\Omega$  source resistance).

**Dimensions:** 76 mm H  $\times$  130 mm W  $\times$  279 mm D (3"  $\times$  5 1/8"  $\times$  11").

**Weight net,** 1.8 kg (4 lb). Shipping, 3.2 kg (7 lb).

## 467A Description

HP's 467A Power Amplifier/Supply is a 10 watt peak power amplifier and  $-20$  V (to  $+20$  V) dc power supply. The wide band width offers low dc drift from dc to 1 MHz and 0.3% gain. With continuously variable gain and floating inputs, HP's 467A can also be used as a power supply.

## 467A Specifications

**Power amplifier**

**Voltage gain (non-inverting):** fixed steps: X1, X2, X5, X10. Variable: 0-10, resolution is better than 0.1% of full output.

**Accuracy:**  $\pm 0.3\%$  from dc to 10 kHz  $\pm 1.0\%$  from 10 kHz to 100 kHz;  $\pm 10\%$  from 100 kHz to 1 MHz with load of  $> 40 \Omega$ .

**Output:**  $\pm 20$  V p at 0.5 A p.

**Distortion:**  $< 0.01\%$  at 1 kHz;  $< 1\%$  at 100 kHz;  $< 3\%$  at 1 MHz.

**Input impedance:** 50 k $\Omega$  shunted by 100 pF.

**DC power supply**

**Voltage range:**  $> \pm 20$  V,  $\pm 10$  V,  $\pm 4$  V,  $\pm 2$  V,  $\pm 1$  V with adjustable vernier. Resolution: better than 0.1% of full output.

**Current:**  $\pm 0.5$  A p.

**Load regulation:** (front panel)  $< 10$  mV, no load to full load.

**Line regulation:**  $< 10$  mV for a  $\pm 10\%$  change in line voltage.

**General**

**Output impedance:** (front panel): 5 m $\Omega$  in series with 1  $\mu\text{H}$ .

**Current limit:**  $< 800$  mA.

**Dimensions:** 159 mm H  $\times$  130 mm W  $\times$  279 mm D (6 1/4"  $\times$  5 1/8"  $\times$  11").

**Weight:** net, 4.5 kg (10 lb). Shipping, 6.8 kg (15 lb).

## Ordering Information

461A Amplifier

465A Amplifier

467A Power Amplifier/Supply

**Price**

\$470

\$375

\$875

- Wide Band
- Flat Response
- Low Noise



The HP 8447 series of general purpose amplifiers combines high reliability and convenience.

### High performance

The performance of these amplifiers qualifies them for a number

of users: to improve the sensitivity of counters, spectrum analyzers, RF voltmeters, EMI meters, power meters and other devices without distortion or degradation of amplitude accuracy; to increase the maximum power available from a signal generator or sweeper.

### Broadband frequency coverage

The 8447 series offers an amplifier for nearly every application in the 100 kHz to 1.3 GHz frequency range. The wide bandwidths are compatible with other wideband instruments and accommodate wideband spectra.

### Options

A variety of options are available: a 75 Ω impedance model (Option 002) for applications such as television/FM broadcasting and CATV; two dual channel versions (Option 001-BNC connectors and Option 011-Type N connectors) which operate with dual channel systems such as oscilloscopes or network analyzers (or the channels may be cascaded for increased gain); Type N connectors rather than the standard BNC connectors (Option 010).

### General

**Weight:** net, 1.56 kg (3 pounds, 7 ounces). Shipping, 2.30 kg (5 lb, 1 oz).

**Size:** 85.8 H × 130 W × 216 mm D (3<sup>3</sup>/<sub>8</sub>" × 5<sup>1</sup>/<sub>8</sub>" × 8<sup>1</sup>/<sub>2</sub>").

**Power requirements:** 110 or 230 V ac ± 10%, 48-440 Hz, 15 watts.

### Ordering information

- 8447A Preamp
- 8447C Power Amp
- 8447D Preamp
- 8447E Power Amp
- 8447F Preamp-Power Amp

### Price

- \$650
- \$550
- \$725
- \$775
- \$1300

## Specifications

	8447A Preamp	8447C Power Amp	8447D Preamp	8447E Power Amp	8447F Preamp- Power Amp
Frequency Range	0.1-400 MHz	30-300 MHz	100 kHz-1.3 GHz	100 kHz-1.3 GHz	100 kHz-1.3 GHz
Typical 3 dB Bandwidth	50 kHz-700 MHz	10-400 MHz	50 kHz-1.4 GHz	50 kHz-1.4 GHz	50 kHz-1.4 GHz
Gain (Mean)	20 dB ± 0.5 dB at 10 MHz	30 dB ± 1 dB	26 dB ± 1.5 dB (20°C-30°C)	22 dB ± 1.5 dB (20°C-30°C)	
Gain Flatness Across Full Frequency Range	± 0.5 dB	± 1 dB	± 1.5 dB	± 1.5 dB	
Noise Figure	< 5 dB	< 11 dB	< 8.5 dB	< 11 dB typical	
Output Power for 1 dB Gain Compression	> +6 dBm	> +17 dBm	> +15 dBm typical	> +15 dBm	
Harmonic Distortion	-32 dB for 0 dBm output	-35 dB for +10 dBm output	-30 dB for 0 dBm output (typical)	-30 dB for +10 dBm output	
Typical Output for <-60 dB Harmonic Distortion	-25 dBm	-15 dBm	-30 dBm	-20 dBm	
VSWR	< 1.7	< 2.0	< 2.0 input < 2.2 output 1-1300 MHz	< 2.2 1-1300 MHz	
Impedance	50 Ω	50 Ω	50 Ω	50 Ω	
Reverse Isolation	> 30 dB	> 35 dB	> 40 dB	> 40 dB	
Maximum DC Voltage Input	± 10 V	± 10 V	± 10 V	± 10 V	
Options Available	001	002	001, 010, 011	010	010
Option Prices	add \$415	010 \$10	add \$515, 25, \$570	add \$25	add \$55

8447D AND 8447E COMBINED IN A SINGLE PACKAGE

# AMPLIFIERS

## Microwave power amplifiers

Models 489A, 491C, 493A & 495A



### Microwave TWT Amplifiers

Amplification of frequencies from 1 to 12.4 GHz is accomplished in four ranges by the Hewlett-Packard medium-power, microwave amplifiers. Each delivers at least 1 watt for a 1-milliwatt input — a gain of at least 30 dB.

All four TWT amplifiers have provision for amplitude modulation, and since the internal modulation amplifier is dc-coupled, remote programming and power leveling are possible. Sensitivity is high for large output power changes from relatively small modulation signals, obviating the need for an external modulation amplifier.

The dc amplifier has a gain of 20 dB and exhibits a passband from dc to 500 kHz when modulation index is in the neighborhood of 1 dB, as might be encountered in RF leveling. When the modulating levels are high, in the region of 20 volts, the passband will be a minimum of 100 kHz: a 20-volt change at the MOD INPUT produces a minimum of 20 dB off/on ratio.

Cathode current in the TWT is monitored by a front panel meter and can be conveniently controlled by the GAIN adjustment for rated power output, or for reducing tube current to extend tube life when full output power is not required. And helix, collector, and anode current can be measured at an easily accessible test point board. Combined with the 8620 or 8690 Sweep Oscillator they make an excellent high power swept source.

#### Advantages

DC coupled modulation circuitry allows power leveling and remote programming.

Periodic-permanent-magnet focusing means fewer alignment problems.

#### Applications

Antenna efficiency and pattern measurements.

Extends attenuation measuring systems capability by at least 30 dB.

RFI susceptibility tests.

### 489A-495A Specifications

**Output power:** 1 watt for an input of  $\leq 1$  mW.

**Gain:** 30 dB at rated output.

**Input/output:** impedance, 50 $\Omega$ ; connectors, type N female.

**Noise figure:**  $\leq 30$  dB.

#### Amplitude modulation:

**Sensitivity:** modulation input of  $> -20$  V peak reduces RF output by  $\leq 20$  dB from dc to 50 kHz.

**Frequency response:** dc to 500 kHz (3 dB).

**Pulse response:**  $< 1$   $\mu$ s rise and fall times.

**Size:** 140 H, 426 W, 467 mm D, (5 $\frac{1}{2}$ "  $\times$  16 $\frac{3}{4}$ "  $\times$  18 $\frac{3}{8}$ ").

**Weight:** net, 14.9 kg (33 lb). Shipping, 18.0 kg (40 lb).

	489A	491C	493A	495A
Frequency range (GHz)	1-2	2-4	4-8	7-12.4
Gain variation with freq. at rated output small signal across any 10% of band	$\leq 6$ dB	$\leq 6$ dB	$\leq 6$ dB	$\leq 6$ dB
across full band	$\leq 5$ dB	$\leq 5$ dB	$\leq 5$ dB	$\leq 5$ dB 1st 300 MHz
	$\leq 12$ dB	$\leq 12$ dB	$\leq 12$ dB	$\leq 10$ dB

#### Ordering Information

489A 1 to 2 GHz TWT Amplifier

491C 2 to 4 GHz TWT Amplifier

493A 4 to 8 GHz TWT Amplifier

495A 7 to 12.4 GHz TWT Amplifier

Opt 908: Rack Flange Kit (for all models)

Information on 12.4 to 18 GHz TWT on request

#### Price

\$3250

\$3250

\$3600

\$3600

add \$10

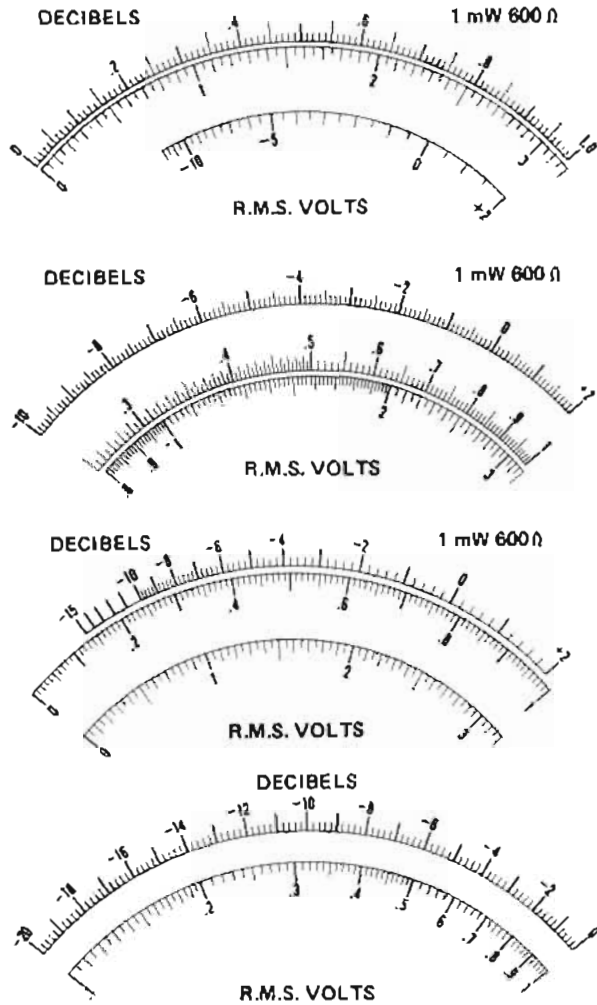

Figure 1. Four different types of meter scales available. (a) Linear 0-3 V and 0-10 V scales plus a dB scale. (b) Linear dB scale plus non-linear (logarithmic) voltage scales. (c) dB scale placed on larger arc for greater resolution. (d) Linear -20 to 0 dB scale useful for acoustical and communications applications.

### Analog voltmeter considerations

**Accuracy**—Before we can discuss meter accuracy, we must have a familiarity with the various meter scales available. Many instruments have meter scales marked in both volts and decibel (dB) units. It should be noted that dB and voltage are complements of each other. That is, if a voltage scale is made linear, the dB scale on the same meter face will be logarithmic or nonlinear. Likewise, if the dB scale is made linear, the voltage scale becomes nonlinear. The term "linear-log scale" is applied to an instrument that has a linear dB scale and, therefore, a nonlinear voltage scale. Several different types of meter faces are illustrated in Figure 1.

Analog meters (Figure 2) usually have nonlinearities and/or offsets present in the attenuators and amplifiers. The meter movement itself can have nonlinearities/ even with individually calibrated meter scales. Nonlinearities cause percent of read-

ing errors, and offsets cause percent of full scale errors. Percent of reading errors are constant no matter where the meter pointer is. Percent of full-scale error increases as the pointer goes further down scale.

Looking at instrument specification sheets, accuracy specifications are usually expressed in one of three ways: 1. percent of the full-scale value, 2. percent of the reading, 3. (percent of reading + percent of full-scale). The first is probably the most commonly used accuracy specification. The second (percent of reading) is more commonly applied to meters having a logarithmic scale. The last method has been used more recently to obtain a tighter accuracy specification on a linear-scale instrument.

Hewlett-Packard uses the two-part accuracy specification to take advantage of the upper-scale accuracy and yet maintain a reasonable specification for the lower portion of the scale.

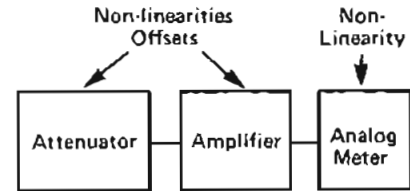

Figure 2. Non-linearities cause % of reading errors. Offsets cause % of full scale errors.

For a thorough evaluation of accuracy, the following should be considered: Does it apply at all input-voltage levels up to maximum overrange point? (Linearity specifications may be added to qualify this point.) Does it apply to all frequencies throughout its specified bandwidth? Does it apply on all ranges? Does it apply over a useful temperature range for the application? If not, is temperature coefficient specified?

### Selecting an analog voltmeter

1. For measurements involving dc applications, select the instrument with the broadest capability meeting your requirements.
2. For ac measurements involving sine waves with only modest amounts of distortion (<10%), the average-responding voltmeter can perform over a bandwidth extending to several megahertz.
3. For high-frequency measurements (>10 MHz), the peak-responding voltmeter with the diode-probe input is the most economical choice. Peak-responding circuits are acceptable if inaccuracies caused by distortion in the input waveform can be tolerated.
4. For measurements where it is important to determine the effective power of waveforms that depart from a true sinusoidal form, the true rms-responding voltmeter is the appropriate choice. In general, true-rms meters reveal only the rms value of an ac signal. Because they are ac coupled, most voltmeters have a frequency cut-off around 20 Hz. This restriction keeps the true-rms voltmeter from accounting for any low frequencies or dc components in a signal.

The 3403C RMS Digital Voltmeter measures dc plus ac from 2 Hz to 100 MHz. See page 52.

For very wide bandwidths (up to 1 GHz) and high-sensitivity measurements of sinusoidal or nonsinusoidal waveforms, the HP 3406A is the proper choice. Although the 3406A is average-responding, it has a sample hold output which makes analysis of waveforms possible.

For applications requiring monitoring signals with large excursions and in applications requiring log values to be plotted on a graphic recorder, the HP 7562A and HP 7563A log voltmeters provide a large dynamic range (110 dB) and displays the input on a single meter range while providing an output voltage that is the log of the input.

# ANALOG VOLTMETERS

## General information (cont.)

Table 1. HP analog instruments

DC VOLTMETERS	Voltage range	Frequency Range Accuracy at FS*	Input Impedance	Model	See Page
DC NULL VOLTMETER	$\pm 3 \mu\text{V}$ — $\pm 1 \text{ kV}$ end scale 0.1 $\mu\text{V}$ resolution (18 ranges)	dc $\pm 2\% \pm 1 \mu\text{V}$	100 k $\Omega$ —100 M $\Omega$ (depending on range) (infinite when nulled)	419A	35
DC VOLT-AMMETER	DC: $\pm 1 \text{ mV}$ , $\pm 300 \text{ V}$ (12 ranges) $\pm 1 \text{ mA}$ , $\pm 300 \mu\text{A}$ (12 ranges)	$\pm 3\%$ dc	10 M $\Omega$ all ranges	4304B	See Data Sheet
AC VOLTMETERS	Voltage Range	Frequency Range Typical Accuracy	Response Input Impedance	Model	See Page
RECHARGEABLE BATTERY AC VOLTMETER	1 mV—300 V (12 ranges)	5 Hz—2 MHz $\pm 2\%$ — $\pm 5\%$	Average 2 M $\Omega$ /10—<60 pF	403B	39
FIRST-RESPONSE AC VOLTMETER 100 kHz low-pass filter ac amplifier	100 $\mu\text{V}$ —300 V—90 dB— $\pm 52$ dB	20 Hz—4 MHz— $\pm 1\%$ $\pm 0.4\%$	Average 10 M $\Omega$ /10—25 pF	400F 400 FL	40
HIGH ACCURACY dB VOLTMETER 20 dB log scale (0 dB = 1 V)	-100 dB—60 dB (8 ranges)	20 Hz—4 MHz— $\pm 0.2$ dB— $\pm 0.4$ dB	Average 10 M $\Omega$ /10—<30 pF	400GL	40
HIGH ACCURACY AC VOLTMETER has dc output ( $\pm 0.5\%$ ) for driving recorder	1 mV—300 V—70 dB— $\pm 52$ dB	10 Hz—10 MHz— $\pm 1\%$ $\pm 0.5\%$	Average 10 M $\Omega$ /10—<25 pF	400DE 400 EL	40
RMS VOLTMETER provides rms readings of complex signals Has dc output for driving DVM's or recorders	1 mV—300 V (12 ranges)	10 Hz—10 MHz $\pm 1\%$ — $\pm 5\%$	10 M $\Omega$ /15—40 pF	3400A	41
SAMPLING RF VOLTMETER provides true rms measurements when used with 3400A. Many accessories	1 mV—3 V (8 ranges)	10 kHz to >1.2 GHz $\pm 3\%$ — $\pm 13\%$	Statistical Average; input Z depends on probe tip used	3406A	42
VECTOR VOLTMETER phase and amplitude measurements	100 $\mu\text{V}$ —10 V (9 ranges)	1 MHz—1 GHz $\pm 0.5$ dB— $\pm 1$ dB	Average 0.1 M $\Omega$ /2.5 pF	8405A	450
MILLOHMMEETER; two probes used when making 4 terminal measurements	0.001 to 1001 FS (11 ranges)	1 bit (fixed) $\pm 2\%$ FS	Max. output Voltage: 20 mV	4328A	78
HIGH RESISTANCE METER and picoammeter	0.5 M $\Omega$ to $2 \times 10^{14} \Omega$ FS (7 ranges) 0.05 pA —20 $\mu\text{A}$	Voltage: $\pm 16\%$ Current: $\pm 5\%$	Max. output Voltage: 1 kV	4329A	79
MULTIFUNCTION METERS	Voltage Range (Accuracy)	Current Range (Accuracy)	Resistance Range (Accuracy)	Model	See Page
BATTERY-OPERATED MULTIFUNCTION METER has 10 M $\Omega$ dc input impedance and 10 M $\Omega$ /20 pF ac input impedance	DC: $\pm 100 \text{ mV}$ to 1000 V ( $\pm 2\%$ ) 9 ranges AC: 10 mV— 300 V 10 Hz—1 MHz ( $\pm 2\%$ ) 10 ranges		10 $\Omega$ —10 M $\Omega$ mid- scale $\pm 5\%$ ; from 0.3 to 3 on the Meter scale (7 ranges)	427A	37
VERSATILE VOLTMETER has 100 M $\Omega$ dc input impedance and 10 M $\Omega$ /1.5 pF ac impedance	DC: $\pm 15 \text{ mV}$ to $\pm 1500 \text{ V}$ ( $\pm 2\%$ ) 11 ranges AC: 0.5 V— 300 V 20 Hz—>700 MHz ( $\pm 3\%$ ) at 400 Hz; 7 ranges	DC: $\pm 1.5 \mu\text{A}$ to $\pm 150 \text{ mA}$ ( $\pm 3\%$ ) 11 ranges	10 $\Omega$ —10 M $\Omega$ (center scale) $\pm 5\%$ to midscale: $\pm 5\%$ or $\pm 2\%$ of midscale (whichever is greater) 7 ranges	410C	38
CURRENT METERS	Current Range	Accuracy	Frequency Range	Model	See Page
DC MILLIAMMETER with clip-on probe eliminates direct connection	1 mA—10 A FS (9 ranges)	$\pm 3\%$	dc—400 Hz	428B	36
Log Voltmeter	Voltage Range	Accuracy Frequency Response	Input Impedance	Model	See Page
Logarithmic Voltmeter/Converter true RMS responding	80 dB (2 ranges): 1 mV—10 V or 10 mV—100 V	0.5 Hz—100 kHz $\pm 0.5$ dB;—3, +1 dB dc = $\pm 0.25$ dB	dc mode: 100 M $\Omega$ /100 pF ac mode: 1 M $\Omega$ /100 pF	7562A	43
Logarithmic Voltmeter/Amplifier	110 dB (1 range) 316 $\mu\text{V}$ —100 V dc	dc = $\pm 0.25$ dB $\pm 1.5$ dB	100 M $\Omega$ /100 pF	7563A	43

\*For exact accuracy refer to range designated.



## Description

Eighteen voltage ranges with  $0.1 \mu\text{V}$  resolution on the lowest range. Accuracy of this rechargeable battery-operated instrument is  $\pm 2\%$  of end scale  $\pm 0.1 \mu\text{V}$  on all ranges. Noise is less than  $0.3 \mu\text{V}$  p-p, and drift is less than  $0.5 \mu\text{V}/\text{day}$ .

An internal nulling voltage allows input voltages up to  $300 \text{ mV}$  to be nulled giving an infinite input impedance. Input impedance above  $300 \text{ mV}$  range is  $100 \text{ megohms}$ .

Seven pushbuttons allow rapid function selection. This dc null voltmeter operates from ac line or from internal rechargeable batteries. During operation from ac line, batteries are trickle-charged. A fast-charge pushbutton is provided to increase the charging rate, recharging batteries in approximately 16 hours. Battery voltage may be checked with the battery-test pushbutton. The zero pushbutton allows compensation for any internal offsets before measurement. When this pushbutton is depressed, the positive leg of the voltmeter is disconnected from the positive input terminal.

When the voltmeter pushbutton is depressed, HP 419A functions as a zero-center scale  $3 \mu\text{V}$  to  $1000 \text{ V}$  dc voltmeter.

When the AM pushbutton is depressed, HP 419A functions as a zero-center scale  $30 \text{ pA}$  to  $30 \text{ nA}$  ammeter.

## Specifications

### DC null voltmeter

Ranges:  $\pm 3 \mu\text{V}$  to  $\pm 1000 \text{ V}$  dc in 18 zero-center ranges.

Accuracy:  $\pm(2\%$  of range  $\pm 0.1 \mu\text{V})$ .

Zero control range:  $\geq 15 \mu\text{V}$ .

Zero drift:  $< 0.5 \mu\text{V}/\text{day}$  after 30 min warm-up.

Zero temperature coefficient:  $< 0.05 \mu\text{V}/^\circ\text{C}$ .

Response time: 3 s to within 95% of final reading on  $3 \mu\text{V}$  range; 1 s to within 95% of final reading on  $10 \mu\text{V}$  to  $1000 \text{ V}$  ranges.

Noise:  $< 0.3 \mu\text{V}$  p-p, input shorted. Noise amplitude approximates Gaussian distribution. RMS value (standard deviation) is  $< 0.075 \mu\text{V}$ . p-p noise value is  $< 0.3 \mu\text{V}$  95% of the time.

### Input characteristics

At null: infinite resistance on  $3 \mu\text{V}$  through  $300 \text{ mV}$  ranges in set null mode. Negative input terminal can be floated to  $\pm 500 \text{ V}$  dc from power line ground.

### Off null

Voltage range	Input resistance
$3 \mu\text{V} - 3 \text{ mV}$	$100 \text{ k}\Omega$
$10 \text{ mV} - 30 \text{ mV}$	$1 \text{ M}\Omega$
$100 \text{ mV} - 300 \text{ mV}$	$10 \text{ M}\Omega$
$1 \text{ V} - 1000 \text{ V}$	$100 \text{ M}\Omega$

Negative input terminal can be floated up to  $\pm 500 \text{ V}$  dc from power-line ground.

AC normal mode rejection: ac voltages  $50 \text{ Hz}$  and above and  $80 \text{ dB}$  greater than end scale affect reading  $< 2\%$ . Peak ac voltage not to exceed maximum overload voltage.

### DC ammeter

Ranges:  $\pm 30 \text{ pA}$  to  $\pm 30 \text{ nA}$  in 7 zero-center ranges.

Accuracy:  $\pm(3\%$  of range  $+ 1 \text{ pA})$ .

Zero control range:  $\geq 150 \text{ pA}$ .

Zero drift:  $< 5 \text{ pA}/\text{day}$  after 30 min warm-up.

Zero temperature coefficient:  $< 0.5 \text{ pA}/^\circ\text{C}$ .

Noise:  $< 3 \text{ pA}$  p-p, input shorted.

Input resistance:  $100 \text{ k}\Omega$  on all ranges.

### Amplifier

Gain:  $110 \text{ dB}$  on  $3 \mu\text{V}$  range, decreases  $10 \text{ dB}$  per range.

Output:  $0$  to  $\pm 1 \text{ V}$  at  $1 \text{ mA}$  maximum for end-scale reading. Output level adjustable for convenience when used with recorders.

Output resistance: depends on setting of output level control.  $< 35 \Omega$  when output control is set to maximum.

Noise:  $0.01 \text{ Hz}$  to  $5 \text{ Hz}$ : same as voltmeter (referred to input),  $> 5 \text{ Hz}$ :  $< 10 \text{ mV}$  rms (referred to output).

### General

Overload protection: the following voltages can be applied without damage to instrument.

$1 \text{ V}$  to  $1000 \text{ V}$  range:  $1200 \text{ V}$  dc.

$10 \text{ mV}$  to  $300 \text{ mV}$  range:  $500 \text{ V}$  dc.

$3 \mu\text{V}$  to  $300 \text{ mV}$  range:  $50 \text{ V}$  dc.

Operating temperature: instrument will operate within specifications from  $0^\circ\text{C}$  to  $50^\circ\text{C}$ .

Operating humidity:  $< 70\%$  R.H.

Storage temperature:  $-20^\circ\text{C}$  to  $+50^\circ\text{C}$ .

Power:  $115 \text{ V}$  or  $230 \text{ V} \pm 10\%$ ,  $48 \text{ Hz}$  to  $440 \text{ Hz}$ ,  $2 \text{ VA}$  max. or 4 internal rechargeable batteries (furnished). 30-hr operation per recharge. Operation from ac line permissible during recharge.

Size:  $156 \text{ H}$  (without removable feet),  $197 \text{ W}$ ,  $203 \text{ mm D}$  ( $6\frac{1}{4}'' \times 7\frac{3}{4}'' \times 8''$ ).

Weight: net,  $3.7 \text{ kg}$  ( $8.3 \text{ lb}$ ). Shipping,  $5.4 \text{ kg}$  ( $12 \text{ lb}$ ).

419A DC Null Volt-Ammeter

\$1000

# ANALOG VOLTMETERS

## 1 mA to 10 A clip-on dc milliammeter

### Model 428B

- No circuit interruption
- No circuit loading



## Description

Direct current from 1 milliampere to 10 amperes full scale can be measured without interrupting your measured circuit or producing loading errors. With the HP Model 428B Clip-on Milliammeter, cutting wire for insertion of current meters and calculating current from voltage and resistance readings are eliminated. All that is required for fast, accurate readings is to clip around the wire and select the proper current range.

The 428B measures current by utilizing a clip-on transducer that converts the magnetic field around the conductor to an ac voltage proportional to dc current. This voltage is detected and displayed as direct current on the 428B's meter. Since there is no direct contact with the circuit being measured, complete dc isolation is assured.

The meter responds to dc current only and is therefore not susceptible to common mode currents. However, low frequency currents up to 400 Hz can be measured by connecting an oscilloscope or voltmeter to the convenient front panel output; or this output can be used to drive a strip chart recorder for permanent long term records.

For even greater sensitivity, several loops of the measured conductor can be put through the probe, increasing sensitivity by the same factor as the number of turns used.

## Specifications

**DC current range:** 1 mA to 10 A full scale, nine ranges.

**Accuracy:**  $\pm 3\%$  of full scale  $\pm 0.15$  mA, from 0°C to 55°C (when instrument is calibrated to probe).

**Probe inductance:**  $< 0.5 \mu\text{H}$ .

**Probe Inducted voltage:**  $< 15$  mV p (worst case at 20 kHz and harmonics).

**Output:** variable linear output level with switch position for calibrated 1 V into open circuit (corresponds to full scale deflection). 1.5

V max. into open circuit in uncalibrated position.  $0.73 \pm .01$  V into 1 k $\Omega$  in calibrated position.

**Noise:** 1 mA range,  $< 15$  mV rms across 1 k $\Omega$ ; 3 mA range,  $< 5$  mV rms across 1 k $\Omega$ ; 10 mA through 10 A ranges,  $< 2$  mV rms across 1 k $\Omega$ .

**Frequency range:** dc to 400 Hz (3 dB point).

**AC rejection:** signals above 5 Hz with p value  $<$  full scale affect meter accuracy  $< 2\%$  (except at 40 kHz carrier frequency and its harmonics). On the 10 A range, ac p value is limited to 4 A.

**Power:** 115 or 230 V  $\pm 10\%$ , 50 to 60 Hz, approx. 75 VA max.

**Operating temperature range:**  $-20^\circ\text{C}$  to  $+55^\circ\text{C}$

**Storage temperature:**  $-40^\circ\text{C}$  to  $+65^\circ\text{C}$ .

**Probe insulation:** 300 V maximum.

**Probe tip size:** approximately  $1/8$ " by  $3/32$ " aperture diameter  $5/32$ ".

**Size:** cabinet: 292 H  $\times$  191 W  $\times$  368 mm D ( $11\frac{1}{2}$ "  $\times$   $7\frac{1}{2}$ "  $\times$   $14\frac{1}{2}$ "); rack mount: 177 H  $\times$  483 W  $\times$  330 mm D ( $6\frac{3}{4}$ "  $\times$  19"  $\times$  13").

**Weight:** net, 8.6 kg (19 lb). Shipping, 10.9 kg (24 lb) (cabinet); net, 10.8 kg (24 lb). Shipping, 14.4 kg (32 lb) (rack mount).

### Accessories available

**3529A Magnetometer Probe:** this probe measures magnetic field strength and direction. The component of magnetic field sensed is parallel to the cylindrical axis of the probe. Applications include the testing of magnetic materials for air shipment.

**Range:** 1 mG to 10 G full scale, nine ranges. 1 mG = 1 mA conversion factor.

**Accuracy:**  $\pm 3\%$  of full scale (0°C to  $+55^\circ\text{C}$ ) after calibration.

**Frequency range:** DC to 80 Hz (3 dB point).

**Weight:** net 0.45 kg (1 lb). Shipping 0.91 kg (2 lb).

### Ordering Information

3529A Magnetometer Probe

428B Analog Milliammeter (cabinet)

Price

\$119

\$1050



# ANALOG VOLTMETERS

Low-cost multi-function meter

Model 427A



427A



11096B

## Description

Hewlett-Packard's Model 427A is a portable, versatile, low cost multi-function meter which is valuable in any laboratory, production line, service department, or in the field. It is capable of measuring dc voltages from 100 mV to 1 kV full scale; ac voltage from 10 mV to 300 V full scale at frequencies up to 1 MHz (>500 MHz with the 11096B High Frequency Probe); and resistance from 10Ω to 10 MΩ center scale.

The 427A will operate continuously for more than 300 hours on its internal 22.5 V dry cell battery. AC line and battery operation is available with option 001.

## Specifications

### DC voltmeter

**Ranges:** ±100 mV to ±1000 V in 9 ranges in 10 dB steps.

**Accuracy:** ±2% of range.

**Input resistance:** 10 MΩ.

**AC normal mode rejection (ACNMR):** ACNMR is the ratio of the normal mode signal to the resultant error in readout. 50 Hz and above: >80 dB.

**Overload protection:** 1200 V dc.

### AC voltmeter

**Ranges:** 10 mV to 300 V in 10 ranges in 10 dB steps.

**Frequency range:** 10 Hz to 1 MHz.

**Response:** responds to average value, calibrated in rms.

### Accuracy

Frequency	Range	
		0.01 V to 30 V
10 Hz to 100 kHz	2% of range	
100 kHz to 1 MHz		

**Input impedance:** 10 mV to 1 V range, 10 MΩ shunted by <40 pF; 3 V to 300 V range, 10 MΩ shunted by <20 pF.

**Overload protection:** 300 V rms momentarily, 1 V range and below; 425 V rms max above 1 V range.

### Ohmmeter

**Ranges:** 10Ω to 10 MΩ center scale in 7 decade ranges. Accuracy (from 0.3 to 3 on scale): ±5% of reading.

**Source current (ohms terminal positive)**

Range	Open circuit Voltage	Short circuit Current
X 10	0.1 V	10 mA
X 100	0.1 V	1 mA
X 1 k	1 V	1 mA
X 10 k	1 V	100 μA
X 100 k	1 V	10 μA
X 1 M	1 V	1 μA
X 10 M	1 V	0.1 μA

## General

**Input:** may be floated up to ±500 V dc above chassis ground. Ohms input open in any function except ohms. Volts input open when instrument is off.

**Operating temperature:** 0°C to 50°C.

**Power:** >300 hr operation per battery.

**HP 427A:** 22.5 V dry cell battery. Eveready No. 763 or RCA VS102. **HP 427A Option 001:** battery operation or ac line operation, selectable on rear panel. 115 V or 230 V ±20%, 48 Hz to 440 Hz, 2 VA max.

**Size:** (standard 1/3 module): 159 H (without removable feet), 130 W, 203 mm D (6 1/4" × 5 1/4" × 8").

**Weight:** net, 2.4 kg (5.3 lb). Shipping, 3.6 kg (8 lb).

## Accessories available

**HP 11096A High Frequency AC Probe** extends range to >500 MHz. With the 11096A, you can measure 0.25 to 30 V rms signals out to 500 MHz with better than ±1 dB accuracy. Usable relative measurements can be made up to 1 GHz (3 dB point at 700 MHz). The 11096A is a peak-responding detector calibrated to produce a dc output proportional to the rms value of a sine wave input. Input impedance is 4 MΩ shunted by 2 pF.

## Options and accessories

**11075A High Impact Case.** A rugged case for carrying, storing and operating the 427A

**11096B High Frequency AC probe**

**11001A 45" test lead, dual banana plug to male BNC**

**11002A 60" test lead, dual banana plug to alligator clips**

**11003A 60" test lead, dual banana plug to pencil probe and alligator clip**

**10111A BNC female to dual banana adapter**

**11067A Test lead kit**

Price

\$115

\$90

\$17

\$12

\$12

\$17

\$5

## Ordering information

427A Multi-function Meter (includes batteries)

\$350

427A Option 001 AC power supply & battery

Add \$30

# ANALOG VOLTMETERS

General purpose multi-function voltmeter  
Model 410C



410C with 11036A

## Description

HP's Model 410C is a versatile general purpose instrument for use anywhere electrical measurements are made. This instrument measures dc voltages from 15 mV to 1500 V, direct current from 1.5  $\mu$ A to 150 mA full scale, and resistance from 0.2  $\Omega$  to 500 M $\Omega$ . With a standard plug-in probe, ac voltages at 20 Hz to 700 MHz from 50 mV to 300 V and comparative indications to 3 GHz are attainable.

## Specifications

### DC voltmeter

**Voltage ranges:**  $\pm 15$  mV to  $\pm 1500$  V full scale in 15, 50 sequence (11 ranges).

**Accuracy:**  $\pm 2\%$  of full scale on any range.

**Input resistance:** 100 M $\Omega$   $\pm 1\%$  on 500 mV range and above, 10 M $\Omega$   $\pm 3\%$  on 150 mV range and below.

### AC voltmeter

**Voltage ranges:** 0.5 V to 300 V full scale in 0.5, 1.5, 5 sequence (7 ranges)

**Frequency range:** 20 Hz to 700 MHz.

**Accuracy:**  $\pm 3\%$  of full scale at 400 Hz for sinusoidal voltages from 0.5 V-300 V rms. The ac probe responds to the positive peak-above-average value of the applied signal. The meter is calibrated in rms.

**Frequency response:**  $\pm 2\%$  from 100 Hz to 50 MHz (400 Hz ref.); 0 to -4% from 50 MHz to 100 MHz;  $\pm 10\%$  from 20 Hz to 100 Hz and  $\pm 1.5$  dB from 100 MHz to 700 MHz.

**Input impedance:** input capacitance 1.5 pF, input resistance > 10 M $\Omega$  at low frequencies. At high frequencies, impedance drops off due to dielectric loss.

**Safety:** the probe body is grounded to chassis at all times for safety. All ac measurements are referenced to chassis ground.

### DC ammeter

**Current ranges:**  $\pm 1.5$   $\mu$ A to  $\pm 150$  mA full scale in 1.5, 5 sequence (11 ranges).

**Accuracy:**  $\pm 3\%$  of full scale on any range.

**Input resistance:** decreasing from 9 k $\Omega$  on 1.5  $\mu$ A range to approximately 0.3  $\Omega$  on the 150 mA range.

**Special current ranges:**  $\pm 1.5$ ,  $\pm 5$  and  $\pm 15$  nA may be measured on the 15, 50 and 150 mV ranges using the dc voltmeter probe, with  $\pm 5\%$  accuracy and 10 M $\Omega$  input resistance.

### Ohmmeter

**Resistance range:** resistance from 10  $\Omega$  to 10 M $\Omega$  center scale (7 ranges).

**Accuracy:** zero to midscale:  $\pm 5\%$  of reading or  $\pm 2\%$  of midscale, whichever is greater;  $\pm 7\%$  from midscale to scale value of 2;  $\pm 8\%$  from scale value of 2 to 3;  $\pm 9\%$  from scale value of 3 to 5;  $\pm 10\%$  from scale value of 5 to 10.

### Amplifier

**Voltage gain:** 100 maximum.

**AC rejection:** 3 dB at 0.5 hz; approximately 66 dB at 50 Hz and higher frequencies for signals < 1600 V p or 30 times full scale, whichever is smaller.

**Isolation:** impedance between common and chassis is > 10 M $\Omega$  in parallel with 0.1  $\mu$ F. Common may be floated up to 400 V dc above chassis for dc and resistance measurements.

**Output:** proportional to meter indications; 1.5 V dc at full scale, maximum current, 1 mA.

**Output impedance:** < 3  $\Omega$  at dc.

**Noise:** < 0.5% of full scale on any range (p-p).

**DC drift:** < 0.5% of full scale/yr at constant temperature, < 0.02% of full scale/ $^{\circ}$ C.

**Overload recovery:** recovers from 100:1 overload in < 3 s.

### General

**Maximum input:** (see overload recovery). DC: 100 V on 15, 50 and 150 mV ranges, 500 V on 0.5 to 15 V ranges, 1600 V on higher ranges. AC: 100 times full scale or 450 V p whichever is less.

**Power:** 115 V or 230 V  $\pm 10\%$ , 48 Hz to 440 Hz, 13 VA (20 VA with 11036A AC Probe).

**Size:** 165 H (without removable feet),  $\times 130$  2 W  $\times 320.7$  mm D (6 1/2"  $\times$  5 1/8"  $\times$  11") behind panel.

**Weight:** net, 4 kg (8 lb). Shipping, 5.44 kg (12 lb).

**Accessories furnished:** detachable power cord, NEMA plug, 11036A AC Probe.

**Accessories available:** see Pages 514-517.

### Ordering information

410C Option 002 (less AC probe)

HP 410C with HP 11036A Detachable AC Probe

### Price

less \$44

\$99.00

# ANALOG VOLTMETERS

## 5 Hz to 2 MHz AC solid-state voltmeters

### Model 403B

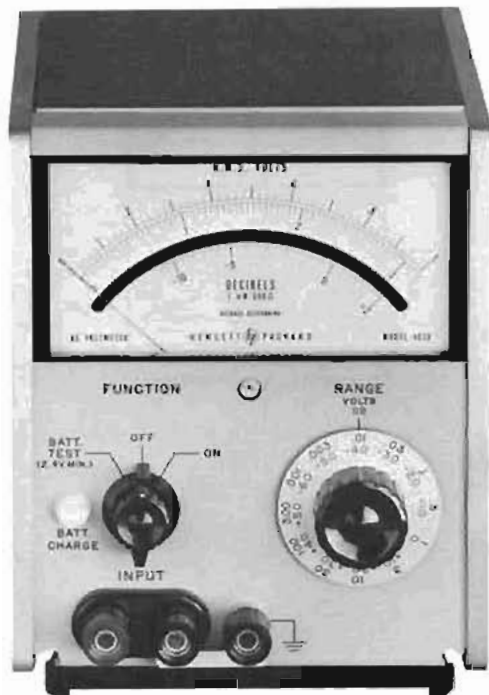

### Description

The Hewlett-Packard 403B AC Voltmeter is a versatile, general purpose instrument for laboratory and production work yet is ideal for use in the field since it is solid-state, battery operated, and portable.

It measures from 100 microvolts to 300 volts, covering 5 Hz to 2 MHz. It operates from internal batteries and thus may be completely isolated from the power line and external grounds, permitting accurate measurements at power line frequency and its harmonics without concern for beat effects. Isolation from external ground also permits use where ground loops are troublesome. Turnover effect and waveform errors are minimized because the meter responds to the average value of the input signal.

The 403B operates from an ac line as well as from the internal battery pack, and batteries recharge during ac operation. Battery charge may be easily checked with a front-panel switch to assure reliable measurements. Normally, about 60 hours of ac operation recharges the batteries; but an internal adjustment is provided which nearly doubles the charging rate. The Model 403B can be used while its batteries charge. A sturdy raut-band meter eliminates friction and provides greater precision and repeatability.

For improved resolution in dB measurements, the 403B Option 001 is available. This version spreads out the dB scale by making it the top scale of the meter.

### Specifications

HP Model	403B	403B Option 001
Range	0.001 to 300 V rms full scale, 12 ranges, in a 1, 3, 10 sequence. -60 dB to +50 dB in 12 ranges with 10 dB steps.	
Meter	Responds to average value of input waveform, calibrated in the rms value of a sine wave.	
Frequency Range	5 Hz to 2 MHz	5 Hz to 2 MHz
Accuracy	within $\pm 2\%$ of full scale from 10 Hz to 1 MHz; within $\pm 5\%$ of full scale from 5 to 10 Hz and 1 to 2 MHz, except $\pm 10\%$ 1 to 2 MHz on the 300 V range (0 to 50°C).*	within $\pm 0.20$ dB of full scale from 10 Hz to 1 MHz; within $\pm 0.4$ dB of full scale from 5 Hz to 2 MHz and 1 to 2 MHz, except $\pm 0.8$ MHz on the 300 V range (0 to 50°C).*
Input Impedance	2 M $\Omega$ ; shunted by $< 60$ pF; 0.001 to 0.03 V ranges; $< 30$ pF, 0.1 to 300 V ranges.	same as 403B
Maximum Input	Fuse protected; signal ground can be $\pm 500$ V dc from chassis.	same as 403B
Power	4 rechargeable batteries, 40 hr. operation per recharge, up to 500 recharging cycles; self-contained recharging circuit functions during operation from ac line.	same as 403B
Size	159 H (without removable feet) $\times$ 130 W $\times$ 203 mm D (5 $\frac{1}{8}$ " $\times$ 6 $\frac{1}{4}$ " $\times$ 8").	same as 403B
Weight	net, 2.9 kg (6 $\frac{3}{4}$ lb). Shipping, 3.6 kg (8 lb).	same as 403B
Price	\$525	add \$80

\*Use 100:1 Divider and 1011A Adapter to retain  $\pm 5\%$  ( $\pm 0.4$  dB) accuracy while measuring up to 425 V rms at 1 to 2 MHz.

## ANALOG VOLTMETERS

AC voltmeter, 10 Hz to 10 MHz

Models 400E, EL, F, FL, GL



## Specifications

	400E/EL*	400F/FL*	400GL
Voltage range	1 mV to 300 V f.s. 12 ranges	100 $\mu$ V to 300 V f.s. 14 ranges	-80 dB to -60 dB f.s. 8 ranges
Frequency range	10 Hz-10 MHz	20 Hz-4 MHz	20 Hz-4 MHz
Input impedance	10 M $\Omega$ on all ranges -25 pF to <12 pF depending on ranges	10 M $\Omega$ on all ranges <25 pF to <10 pF depending on ranges	10 M $\Omega$ on all ranges -300 pF to <15 pF depending on ranges
Accuracy	$\pm$ (% reading + % range) 3 mV-300 V ranges 10 Hz-40 Hz: $\pm(2.5 + 2.5)$ 40 Hz-2 MHz: $\pm(1 + 0)$ 2 MHz-4 MHz: $\pm(2.5 + 1.5)$ 4 MHz-10 MHz: $\pm(2.5 + 2.5)$  1 mV range 10 Hz-40 Hz: $\pm(2.5 + 2.5)$ 40 Hz-500 kHz: $\pm(1 + 0)$ 500 kHz-4 MHz: $\pm(2.5 + 2.5)$	$\pm$ (% reading + % range) 300 $\mu$ V-300 V ranges 20 Hz-40 Hz: $\pm(2 + 2)$ 40 Hz-100 kHz: $\pm(1 + 1)$ 100 kHz-1 MHz: $\pm(1/2 + 1/2)$ 1 MHz-2 MHz: $\pm(1 + 1)$ 2 MHz-4 MHz: $\pm(2 + 2)$  100 $\mu$ V range 30 Hz-60 Hz: $\pm(2 + 2)$ 60 Hz-100 kHz: $\pm(1 + 1)$ 100 kHz-500 kHz: $\pm(0.7 + 0.7)$	-60 dB range 20 Hz-40 kHz: $\pm 0.4$ dB 40 kHz-100 kHz: $\pm 0.2$ dB  -60 dB thru +46 dB ranges 20 Hz-40 Hz: $\pm 0.4$ dB 40 Hz-500 kHz: $\pm 0.2$ dB 500 kHz-2 MHz: $\pm 0.4$ dB 2 MHz-4 MHz: $\pm 0.2 - 0.8$ dB  -80 dB range 30 Hz-60 Hz: $\pm 1.4$ dB 60 Hz-100 kHz: $\pm 0.2$ dB 100 kHz-500 kHz: $\pm 0.2 - 0.8$ dB
Recovery		<2 s for 80 dB overload	
Overload		*500 V rms ac, 300 V dc	*1200 V rms max. input; 1000 V dc max. input
Calibration		Scale -10 to +2 dB, 10 dB between ranges, 100 divisions on 0 to 1 scale. The dB scale reads -10 to +2 dB; 10 dB between ranges.	Linear dB scale, 100 divisions from -20 to 0 dB. Long voltage scale 0 dB = 1 V.
Weight		Net, 2.7 kg (6 lb), Shipping, 4.1 kg (9 lb)	
Size		159 H (without removable feet) $\times$ 130 W $\times$ 279 mm D (5 1/4" $\times$ 5 1/4" $\times$ 11")	
Power		AC 115 or 230 V $\pm$ 10%, 48 to 440 Hz, 6 VA max. (DC External batteries + and - voltages between 35 V and 55 V)	
Price:	400E, \$525; 400 EL, \$650	400F, \$525; 400 FL, \$650	400 GL, \$550

\* NOTE: 400 EL same as 400E, and 400 FL same as 400F, except for calibration. Linear dB scale - 10 dB to -2 dB, 10 dB between ranges. Log voltage scales 0.3 to 1 and 0.8 to 3, 120 divisions from -10 dB to +2 dB. 400 FL accuracy is % of reading in dB only.

\* AC overload voltage increases with increasing frequency

# ANALOG VOLTMETERS

## 10 Hz to 10 MHz true RMS voltmeter

### Model 3400A



- 10 MHz bandwidth
- High crest factor for accurate pulse measurements
- Stable, linear dc output

- 1 mV full-scale sensitivity
- 10 MΩ input impedance
- Taut-band individually calibrated meter

#### RMS current

True rms current measurements can be made conveniently by using the HP Model 456A Current Probe with the Model 3400A. See page 517.

#### Specifications

**Voltage range:** 1 mV to 300 V full scale, 12 ranges.

**DB range:** -72 to +52 dBm (0 dBm = 1 mW into 600Ω).

**Frequency range:** 10 Hz to 10 MHz.

**Response:** responds to rms value (heating value) of the input signal for all waveforms.

**Meter accuracy:** % of full scale (20°C to 30°C)\*

10Hz	50Hz	1MHz	2MHz	3MHz	10MHz
±5%	±1%	±2%	±3%	±3%	±5%

**Ac-to-dc converter accuracy:** % of full scale (20°C to 30°C)\*

10Hz	50Hz	1MHz	2MHz	3MHz	10MHz
±5%	±0.75%	±2%	±3%	±3%	±5%

**Crest factor:** (ratio of peak to rms amplitude of input signal): 10 to 1 at full scale (except where limited by maximum input) inversely proportional to meter deflection (e.g., 20 to 1 at half-scale, 100 to 1 at tenth scale).

**Maximum continuous input voltage:** 500 V ac peak at 1 kHz on all ranges; 600 V dc on all ranges.

**Input impedance:** from 0.001 V to 0.3 V range: 10 MΩ shunted by <50 pF. From 1.0 V to 300 V range: 10 MΩ shunted by <20 pF ac coupled input.

**Response time:** for a step function, <5 s to final value.

**AC overload:** 30 dB above full scale or 800 V p, whichever is less, on each range.

**Output:** negative 1 V dc into open circuit at full-scale deflection, proportional to meter deflection from 10-100% of full scale, 1 mA maximum; nominal source impedance is 1000Ω. Output noise <1 mV rms.

**Power:** 115 or 230 V ±10%, 48 to 66 Hz, 15 VA max.

**Size:** 159 H (without removable feet) × 130 W × 279 mm D (6 1/4" × 5 1/8" × 11"); 1/2 module.

**Weight:** net, 3.3 kg (7 1/4 lb). Shipping, 4.5 kg (10 lb).

**Accessories furnished:** 10110A Adapter, BNC to dual banana jack.

Accessories available	Price
11001A Cable, 45 in. long, male BNC to dual banana plug	\$17
10503A Cable, 4 ft long, male BNC connectors	\$15
11002A Test Lead, dual banana plug to alligator clips	\$12
11003A Test Leads, dual banana plug to probe and alligator clip	\$12
11076A Carrying Case	\$135

#### Ordering Information

**3400A Opt 001** spreads out the dB scale by making it the top scale of the meter. Rear terminals in parallel with front panel terminals and linear log scale upper-most on the meter face are available on special order.

add \$30

#### 3400A RMS voltmeter

\$900

\* TC: ±0.1% from 0°C to 20°C and 30°C to 55°C.

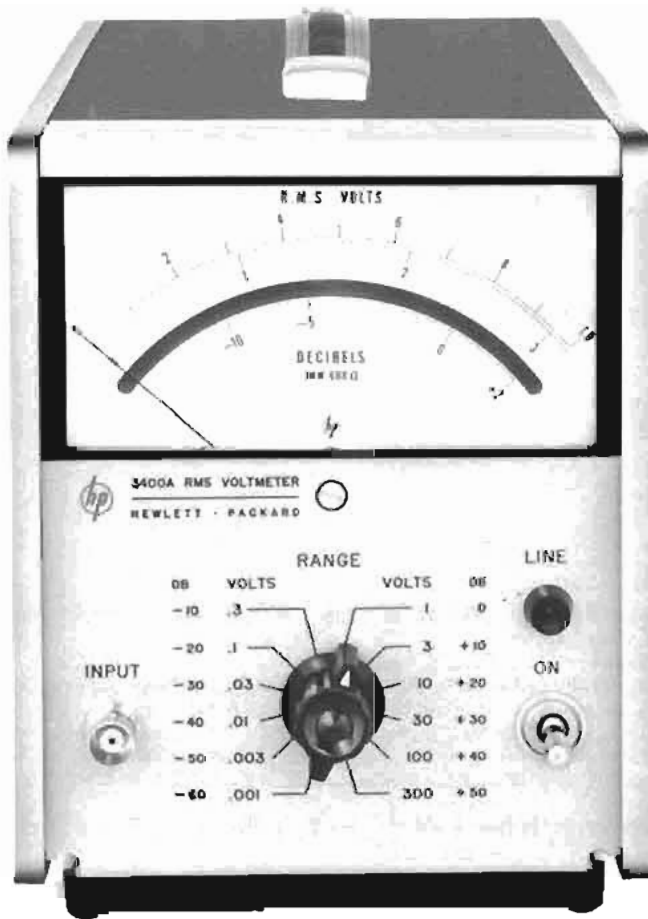

#### Description

The Hewlett-Packard Model 3400A is a true root-mean-square (rms) voltmeter, providing a meter indication proportional to the dc heating power of the input waveform.

Six-decade frequency coverage makes the 3400A extremely flexible for all audio and most rf measurements and permits the measurement of broadband noise and fast-rise pulses.

Pulses or other non-sinusoids with crest factors (ratio of peak to rms) up to 10:1 can be measured full scale. Crest factor is inversely proportional to meter deflection, permitting up to 100:1 crest factor at 10% of full scale.

Permanent plots of measured data and higher resolution measurements can be obtained by connecting an X-Y plotter, strip chart recorder or digital voltmeter to the convenient rear-panel dc output. The dc output provides a linear 0 to 1 volt drive proportional to meter deflection.

# ANALOG VOLTMETERS

## 10 kHz to 1.2 GHz RF Voltmeter

### Model 3406A



### Description

High frequency voltages can be measured easily with HP's 3406A Sampling Voltmeter. Employing sampling techniques, the HP 3406A has extremely wide bandwidth (10 kHz to 1.2 GHz) with high input impedance. Signals as small as 50  $\mu$ V can be resolved. Full scale sensitivity from 1 mV to 3 V is selected in eight 10 dB steps and may be read directly from -62 dBm to +23 dBm. Accessory probe tips convert the HP 3406A for voltage measurements in applications such as receivers, amplifiers and coaxial transmission lines.

Measurement can be retained on the 3406A meter by depressing a pushbutton located on the pen-type probe. This is useful when measurements are made in awkward positions where the operator cannot observe the meter indication and probe placement at the same time.

### Specifications

**Voltage range:** 1 mV to 3 V full scale in 8 ranges; decibels from -50 to +20 dBm (0 dBm = 1 mW into 50 $\Omega$ ); average-responding instrument calibrated to rms value of sine wave.

**Frequency range:** 10 kHz to 1.2 GHz; useful sensitivity from 1 kHz to beyond 2 GHz.

**Full-scale accuracy (%) with appropriate accessory** (after probe is properly calibrated)

10 kHz	20 kHz	25 kHz	100 kHz	500 MHz	700 MHz	1 GHz	1.2 GHz
$\pm 13$	$\pm 8$	$\pm 5$	$\pm 3$	$\pm 5$	$\pm 8$	$\pm 13$	

**Input impedance:** input capacity and resistance will depend upon accessory tip used. 100,000 $\Omega$  shunted by <2.1 pF at 100 kHz with bare probe; <10 pF with 11072A isolator tip supplied.

#### Sample hold output

Provides ac signal whose unclamped portion has statistics that are narrowly distributed about the statistics of the input, inverted in sign

(operating into >200 k $\Omega$  load with <1000 pF). Output is 0.316 V at f.s. on any range.

**Noise:** <175  $\mu$ V rms referred to input.

**Accuracy (after calibration):** 0.01 V range and above: same as full scale accuracy of instrument. 0.001 V to 0.003 V range: value of input signal can be computed by taking into account the residual noise of the instrument. Jitter: meter indicates within  $\pm 2\%$  pk of reading 95% of time (as measured with HP 3400A True RMS Voltmeter).

**RMS crest factor:** 0.001 V to 0.3 V, 20 dB: 1 V, 13 dB: 3 V, 3 dB.

#### Meter

**Meter scales:** linear voltage, 0 to 1 and 0 to 3; decibel, -12 to +3. Individually calibrated tant-band meter.

**Response time:** indicates within specified accuracy in <3 s. Jitter:  $\pm 1\%$  peak (of reading).

#### General

**DC recorder output:** adjustable from 0 to 1.2 mA into 1000 ohms at full scale, proportional to meter deflection.

**Overload recovery time:** meter indicates within specified accuracy in <5 s (30 V p-p max.).

**Maximum input:**  $\pm 100$  V dc, 30 V p-p.

**RFI:** conducted and radiated leakage limits are below those specified in MIL-6181D and MIL-1-16910C except for pulses emitted from probe. Spectral intensity of these pulses is nominally 50 nV/ $\sqrt{\text{Hz}}$ ; spectrum extends beyond 2 GHz.

**Temperature range:** instrument, 0°C to +55°C; probe, +10°C to +40°C.

**Power:** 115 or 230 V  $\pm 10\%$ , 48 Hz to 66 Hz, 25 VA max.

**Size:** 159 H (without removable feet)  $\times$  197 W  $\times$  279 mm D (6.25"  $\times$  7.75"  $\times$  11"); 1/2 module.

**Weight:** net, 5.4 kg (12 lb). Shipping, 6.8 kg (15 lb).

**Accessories:** refer to data sheet.

3406A RF Voltmeter

\$1600

# ANALOG VOLTMETERS

Logarithmic voltmeters, ac or dc log scaling

Models 7562A and 7563A



7562A



7563A

## Description

Hewlett-Packard Model 7562A is a wide range (80 db), single channel logarithmic voltmeter/converter designed to produce dc output voltages in a logarithmic relationship to dc input voltages or the true RMS value of an ac input voltage. It contains a true RMS detector which is not dependent on pure sinusoidal signals to achieve measurement accuracy. A self-contained meter calibrated in volts and dB results in an accurate voltmeter. A constant amplitude oscilloscope output makes the converter compatible with a variety of oscilloscope readout and phase meter applications.

The Model 7563A Logarithmic Voltmeter/Amplifier is a low cost, single channel, dc logarithmic amplifier with a very high dynamic range (110 dB) designed to produce a logarithmic-related dc output voltage for a very wide range of dc input voltages. A single input range of 316  $\mu$ V to 100V is coupled with an input polarity switch for ease and versatility of operation. A high input impedance (100 k $\Omega$ ) and a low output impedance (less than 5 $\Omega$ ) allows the 7563A to be used in systems or on the bench. A front panel meter calibrated in dB and mV provides instantaneous visual indication of operating levels. Applications include log scaling of recorder axes, pulse height analyzers, scope displays, and almost any circumstances where log compression of dc voltage ranges is required. Dual or single mounting capability is afforded by a field installable rack mounting adapter, utilizing a minimum of rack space.

## 7562A Specifications

### Performance specifications

#### AC and DC modes

##### Input

Dynamic range: 80 dB.

Voltage range: 1 mV to 10 V or 10 mV to 100 V selectable by front panel switch. Accepts either ac or positive signals.

##### Output

Voltage: 0 to 800 mV dc corresponding to 10 mV/dB.

Output impedance: 100 ohms.

##### DC mode

Accuracy:  $\pm 0.25$  dB at 25°C.

Input impedance: 100 k $\Omega$ , shunted by less than 100 pF; single ended.

Temperature coefficient:  $\pm 0.02$  dB/°C maximum.

Zero stability:  $\pm 0.25$  dB.

## AC mode

Input impedance: 1 M $\Omega$ , shunted by less than 100 pF; single ended.

Accuracy and frequency response: (at 25°C).

Range Setting	0.5 Hz	2	5	20	50	200 Hz	50 kHz	100 kHz	( $\leq 10$ V)	(>10 V)	
0.5 Hz	$\pm 1$ db	$\pm 0.5$ db					$\pm 1$ db	$\pm 1$ db	$\pm 1$ db	$\pm 1$ db	$\pm 1$ db
5 Hz			$\pm 1$ db	$\pm 0.5$ db			$\pm 1$ db	$\pm 1$ db	$\pm 1$ db	$\pm 1$ db	
50 Hz					$\pm 1$ db	$\pm 0.5$ db	$\pm 1$ db	$\pm 1$ db	$\pm 1$ db	$\pm 1$ db	

Temperature coefficient:  $\pm 0.04$  dB/°C maximum.

### Slewing speed:

Range setting	Minimum slewing speed
0.5 Hz	1 dB/s
5 Hz	10 dB/s
50 Hz	60 dB/s

Oscilloscope output: approx. 0.5 V rms regardless of input.

Crest factor: 5:1 unless limited by max. input voltage.

Maximum peak input voltage:  $\pm 25$  V on 1 mV to 10 V range;  $\pm 250$  V on 10 mV to 100 range.

### General specifications

Operating temperature: 10°C to 40°C.

Warm-up time: 20 minutes nominal.

Connectors: front and rear input and output BNC connectors.

Power requirements: 115/230 Vac, 50 to 400 Hz, 40 VA.

Dimensions: 88 mm Hl  $\times$  197 mm W  $\times$  292 mm D (3 $\frac{7}{16}$ "  $\times$  7 $\frac{7}{16}$ "  $\times$  11 $\frac{1}{2}$ ").

Weight: net, 3.6 kg (8 lb). Shipping 5.4 (12 lb).

## 7563A Specifications

### Performance specifications

#### Input

Dynamic range: 110 dB.

Voltage range: 316  $\mu$ V to 100 V. Accepts either positive or negative signals, selectable by front panel switch.

#### Output

Voltage: 0 to 1.1 V dc corresponding to 10 mV/dB. Rear terminals; adjustable to 1 to 10 mV/dB.

Output impedance: less than 5 $\Omega$  front panel, 300 $\Omega$  rear.

Meter accuracy: reading accurate to  $\pm 1.5$  dB, referred to output.

Input impedance: 100 k $\Omega$ , shunted by less than 100 pF, single ended.

Accuracy: (at 25°C).

316 $\mu$ V	1mV	10 V	31.6 V	100V
$\pm 0.5$ dB	$\pm 0.25$ dB	$\pm 1.0$ dB	$\pm 1.5$ dB	

Temperature coefficient:  $\pm 0.02$  dB/°C maximum and  $\pm 3$   $\mu$ V/°C referred to input.

Zero stability:  $\pm 0.25$  dB at constant temperature.

### Rise Time

Maximum Rise Time	
Signal Level	1 mV-10 V Range
316 $\mu$ V—1 mV	2000 $\mu$ s
1 mV—10 mV	400 $\mu$ s
10 mV—100 mV	40 $\mu$ s
100 mV—1 V	4 $\mu$ s
1 V—100 V	2 $\mu$ s

### General specifications

Operating temperature: 10°C to 40°C.

Warm-up time: 20 minutes nominal.

Connectors: front and rear input and output BNC connectors.

Power requirements: 115/230 V ac, 50 to 400 Hz, 40 VA.

Dimensions: 88.1 mm H  $\times$  197 mm W  $\times$  292 mm D (3 $\frac{7}{16}$ "  $\times$  7 $\frac{7}{16}$ "  $\times$  11 $\frac{1}{2}$ ").

Weight: net, 3.6 kg (8 lb). Shipping, 5.4 kg (12 lb).

### Ordering Information

7562A Logarithmic Voltmeter/Converter

7563A Logarithmic Voltmeter/Amplifier

### Price

\$1700

\$1280



Digital voltmeters (DVM's) offer many advantages over other types of voltmeters. Among the advantages of DVM's are greater speed, increased accuracy and resolution, reduction of operator errors and the ability to make automatic measurements.

Digital voltmeters display measurement results as discrete numerals rather than as a pointer deflection on a continuous scale. Human error and tedium are reduced by direct numerical readout, and operator training is minimized by automatic polarity and range-changing features of some DVM's.

Digital voltmeters are available to measure AC and DC voltages, current and resistance. Appropriate transducers can be used to measure other parameters such as strain or temperature. A popular use of DVM's is in automatic measurement systems. A system can be as simple as connecting the DVM digital output to a digital printer or as powerful as a calculator or computer controlled system that provides automatic data reduction and unattended operation.

#### A new generation of DVM's

Now a greater range of capability than ever before is available in a new generation of digital voltmeters. The technology of integrated circuits and microprocessors has resulted in new solutions ranging from a hand-held unit where the reading is at the point of measurement to powerful new systems voltmeters which can measure at thousands of readings per second.

New technology was developed to meet today's expanding measurement needs. For example, hybrid technology has allowed many functions to be placed on a single substrate. This has made possible instruments such as the 970A probe where the complete instrument is in a hand-held unit.

Other instruments such as the 3476A/B, 3435A, 3438A, 3466A and the 3465A/B have benefited by another new process-tantalum nitride on sapphire. Most digital voltmeter designs require a precision attenuator to scale the input voltage. Now a single chip replaces the attenuator which used up to 20

precision wirewound resistors. The benefits are lower cost, improved reliability, excellent stability, and better than 25 ppm/°C tracking.

To meet the expanding needs of our system users, HP has developed three new voltmeters. The heart of these voltmeters is a high-speed microprocessor tailored especially to system instrument requirements. An example of the resulting capability is automatic calibration that compensates for temperature changes and aging. Other benefits are self-test, self-diagnosis, and internal math capability which allows direct display in engineering units.

#### Abuse testing

DVM's are often subjected to accidental abuse. To assure survival, our instruments are designed to a new and tougher set of standards. For example, static discharge can be fatal to some integrated circuits so HP tests their designs by discharging  $>10^4$  V to any exposed metal. Input circuits should



be accident proof. HP DVM designs are tested by applying 240 V RMS to all input terminals and all combinations of input conditions. Some units are routinely exposed to rough use in field service applications requiring design and test to shock levels of 100 G's.

**HP-IB**

Hewlett-Packard offers three voltmeters which have HP-IB\* data interface. This versatile interconnect system allows communication with a growing number of instruments, calculators, and computers. Historically the high cost of interfacing related to the lack of interface standardization. Interfacing methods proliferated as each engineer designed custom links between instrumentation devices—resulting in different codes, formats, levels, and timing factors. Today there is a new interface concept tailored to general purpose instrumentation. It is commonly referred to as the IEEE 488 Bus, Hewlett-Packard Interface Bus (HP-IB). Industry acceptance is widespread for there are currently 200 Bus compatible instruments from 56 manufacturers and the list is growing.

**Noise rejection**

Source and type of noise are important in determining the type of noise rejection needed. There are two types of noise which may affect accuracy and sensitivity of a DVM: normal mode and common mode.

Normal mode noise enters the DVM with the signal and is super-imposed on it. Filtering is the simplest way to cut down on noise but it slows measurement speed. Integration "calculates" noise out of the measurement by looking at the input signal over a period of time equal to the period of expected noise. Filtering is advantageous for rejecting broadband noise, while integration is better for rejecting line related noise. Figure 1 shows typical noise rejection for filtering and integrating methods.

Common mode noise appears between the

DVM's input terminals and ground. It is usually caused by grounding differences between the DVM and the device being measured.

Errors caused by common mode noise may be reduced by a passive technique called "guarding." Guarding shunts the noise to ground and away from input terminals. By proper connection of the guard (Figure 2), a remarkable improvement can be seen in a DVM's ability to reject common mode noise.

"Effective" common mode rejection is the specification that usually appears in data sheets. Effective refers to the final reading. Effective CMR is the combined result of "pure" CMR due to guarding plus normal mode rejection of the instrument.

**Specifications**

**Resolution and sensitivity**

DVM's are classified according to the number of full digits. An overrange digit is an extra digit added to allow the user to read beyond full scale. This overrange digit is often called a "one-half" or a "partial" digit since it cannot display all numbers through 9. Overranging greatly extends a DVM's usefulness by maintaining resolution up to, and beyond, full scale. For example, if a signal changes from 9.999 V to 10.012 V, a four-digit DVM without overranging could measure the first voltage as "9.999 V," but would require a range change to make the second measurement with a resulting reading of "10.01 V." The 0.002 V change would not be seen. With overranging, the second measurement could be made as "10.012 V" with no loss of resolution.

Overrange can be expressed as either a percentage of full scale or as part of the range itself. A four-digit DVM with 100% overrange would have a maximum display of "19999." Alternatively, the range can be described as 2 V, 20 V, etc., with no overrange specification. The maximum display remains "19999." A specification of 20%

overrange would have a maximum reading of "11999." This can also be expressed as 1.2 V, 12 V, etc., range with no overrange.

Resolution is the ratio of the maximum number of counts that can be displayed to the least number of counts. Full-scale resolution of a five-digit DVM is 100,000 to 1, or 0.001%. Overranging is generally ignored in resolution.

Sensitivity refers to the smallest incremental voltage change that the DVM is able to detect. Mathematically, it is the lowest full-scale range multiplied by the resolution of the DVM. Sensitivity of a five-digit DVM with resolution of 0.001% and a 100 mV lowest full-scale range is 0.001% x 100 mV = 1 μV.

**Accuracy**

Accuracy is the exactness to which a voltage can be determined, relative to the Legal Volt maintained by the U.S. National Bureau of Standards. Accuracy specification equals errors involved in traceability to N.B.S. as well as errors made by the instrument.

To be meaningful, accuracy must be stated along with the conditions under which it will hold. These conditions should include time, temperature, line variations and humidity. Conditions specified should be realistic relative to intended use. For example, a DVM specified with a temperature range of 25°C ± 1°C would require a highly controlled environment, whereas ± 5°C would cover the majority of environments.

The period of time over which accuracy holds is especially important since it indicates the DVM's stability and how often it will have to be calibrated.

Accuracy is usually expressed as ± X% of reading, ± Y% of range, or preferably, as ± X% of reading ± N digits. To be meaningful, accuracy specifications must always consider the effects of time, temperature and humidity.

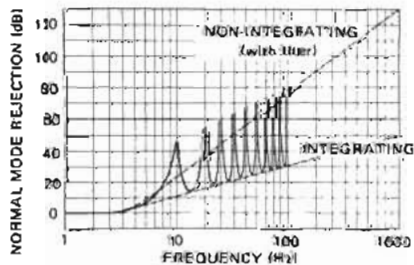

Figure 1. Normal mode noise rejection for two DVM's, one using filtering and the other using integration.

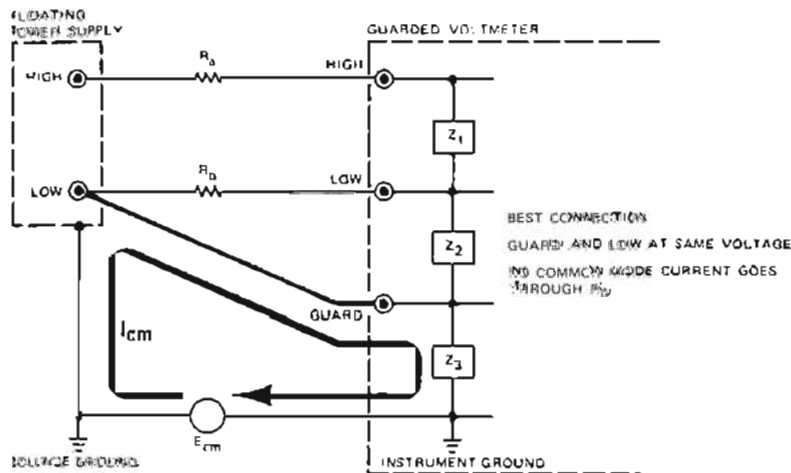

Figure 2. Best CMR connection—guard connected to low at source.

## DVM SELECTION GUIDE



3476A/B



3465A/B



3438A

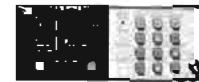

3437A



970A



3435A





3466A



3455A

### BENCH DVM'S

### SYSTEM DVM'S

FEATURES	• Handheld	• Low Cost	• Accuracy	• 1 $\mu$ V Sensitivity	• Autorange	• HP-IB	• High Speed	• High Performance
	• Autorange	• Autorange	• 10 Mill ( $\Omega$ )	• Bench/Field	• 1 $\mu$ V Sensitivity	• Low Cost	• HP-IB	• Auto Cal
	• 3 1/2 Digit	• 3 1/2 Digit	• 3 1/2 Digit	• 4 1/2 Digit	• 4 1/2 Digit	• 3 1/2 Digit	• 3 1/2 Digit	• 6 1/2/6 1/2 Digit
DC VOLTS								
MAX INPUT	500V	1000V	1200V	1000V	1200V	1200V	20V	1000V
MAX RDGS/SEC	3	3	4.7	2.5	4.7	4.7	5700	24
RANGES	100mV TO 500V	100mV TO 1000V	100mV TO 1200V	10mV TO 1000V	10mV TO 1200V	200mV TO 1200V	100mV TO 10V	100mV TO 1000V
SENSITIVITY	100 $\mu$ V	100 $\mu$ V	100 $\mu$ V	1 $\mu$ V	1 $\mu$ V	100 $\mu$ V	100 $\mu$ V	1 $\mu$ V
BASIC ACCURACY	$\pm$ 0.7% RDG. $\pm$ 2 DIGITS	$\pm$ 0.3% RDG. $\pm$ 1 DIGIT	$\pm$ 0.1% RDG. $\pm$ 1 DIGIT	$\pm$ 0.02% RDG. $\pm$ 1 DIGIT	$\pm$ 0.03% RDG. $\pm$ 1 DIGIT	$\pm$ 0.1% RDG. $\pm$ 1 DIGIT	$\pm$ 0.03% RDG. $\pm$ 2 DIGITS	$\pm$ .002% RDG. $\pm$ 1 DIGIT
AC VOLTS								
BANDWIDTH	3kHz	10kHz	100kHz	20kHz	100kHz	100kHz TRUE RMS		1 MHz TRUE RMS
RANGES	1 $\Omega$ TO 10M $\Omega$	1k $\Omega$ TO 10M $\Omega$	10 $\Omega$ TO 10M $\Omega$	100 $\Omega$ TO 10M $\Omega$	10 $\Omega$ TO 10M $\Omega$	10 $\Omega$ TO 10M $\Omega$		100 $\Omega$ TO 10M $\Omega$
RESISTANCE								
SENSITIVITY	1 $\Omega$	1 $\Omega$	10 mill $\Omega$	10 mill $\Omega$	1 mill $\Omega$	10 mill $\Omega$		1 mill $\Omega$
OPEN CRT. VOLT	<5V	<4V	<5V	<5V	<5V	<5V		<5V
CURRENT								
AC	97002A ACCESSORY	YES	YES	YES	YES TRUE RMS	YES		
DC	97002A ACCESSORY	YES	YES	YES	YES	YES		
GENERAL								
RANGING	AUTO	AUTO/HOLD	AUTO/MANUAL	MANUAL	AUTO	AUTO	MANUAL	AUTO/MANUAL
OVERRANGE	10%	10%	100%	100%	100%	100%	100%	50%
OTHER	BATTERY POWER DISPLAY INVERSION	BATTERY POWER POWER-3476B	BATTERY POWER OPT 002	BATTERY POWER 3465B	BATTERY POWER TRMS EITHER AC OR DC BIODE TEST		 INTERNAL TIMER SAMPLE HOLD	 GUARDED 4 TERMIN $\Omega$ MATH
DVM'S	970A	3476A/B	3435A	3465A/B	3466A	3438A	3437A	3455A
PAGE	47	48	50	68	70	58	54	59
PRICE	\$425	\$275—\$275	\$335—\$400	\$425—\$500	\$575—\$850	\$875	\$1800	\$3000—\$3200



- Puts a complete DMM in the palm of your hand
- Autoranging, autozero, autopolarity

## Description

Hewlett-Packard's 970A Probe Digital Multimeter is completely self-contained and autoranges through five ranges of AC and DC volts and ohms. This pocket-sized multimeter is ideal for field, lab, or bench application. All electronics, including display and batteries, are in one seven-ounce package. The basic 970A multimeter is provided with a set of batteries and the battery charger, the short probe tip and the belt carrying case as standard accessories.

HP's 970A Probe Digital Multimeter can be converted into a five-function bench instrument with optional 97002A Current Shunt/Bench Cradle. A six-position manual switch selects five ranges of AC and DC volts and ohms. Two general purpose binding posts accept wraparound, screw-down, clip-on or banana plug terminations.

The HP 97003A RF Adapter measures AC voltage over a frequency range of 100 kHz to 500 MHz from 0.25 V to 30 V. A broad line of tips, adapters and tees are also available.

## Specifications, Model 970A

### DC voltmeter

**Ranges:** 0.1 V, 1 V, 10 V, 100 V, 1000 V (500 V max input).

**Accuracy (20°C to 30°C):**  $\pm(0.7\%$  of reading + 2 digits).

**Input resistance:** 10 M $\Omega$ ,  $\pm 5\%$ .

**Input protection:**  $\leq 750$  V peak.

**Temperature coefficient:**  $\pm(0.05\%$  of reading + .02 digits)/°C.

### AC voltmeter

**Ranges:** 0.1 V, 1 V, 10 V, 100 V, 1000 V (500 V rms sine wave max input).

**Accuracy (20°C to 30°C)**

Range	45 Hz to 1 kHz	1 kHz to 3.5 kHz
1 V to 1000 V	$\pm(2\%$ of reading + 5 digits)	$\pm(3\%$ of reading + 5 digits)
0.1 V ( $\approx 3$ mV)	$\pm(2\%$ of reading + 5 digits)	$\pm(5\%$ of reading + 5 digits)

**Input resistance:** 10 M $\Omega$ ,  $\pm 5\%$ .

**Input capacitance:**  $\leq 30$  pF.

**Input protection:**  $\leq 750$  V peak.

**Temperature coefficient:**  $\pm(0.05\%$  of reading + .05 digits)/°C.

### Ohmmeter

**Ranges:** 1 k $\Omega$ , 10 k $\Omega$ , 100 k $\Omega$ , 1000 k $\Omega$ , 10,000 k $\Omega$ .

**Accuracy:** (20°C to 30°C):  $\pm(1.5\%$  of reading + 2 digits).

**Input voltage protection (resistor fused—clip mounted):**  $\leq 115$  V rms for up to 1 minute.  $\leq 250$  V rms for up to 10 seconds.

**Temperature coefficient:**  $\pm(0.05\%$  of reading + .02 digits)/°C.

### General

**Ranging:** automatic.

**Sample rate:** 3/second.

**Overrange:** 10%.

**Calibration cycle:** 1 year.

**Operating environmental conditions:**

**Temperature range:** 0°C to 40°C.

**Humidity:**  $\leq 95\%$  RH.

**Power:** rechargeable batteries.

**Typical operating time using fully charged battery:** 2 hours continuous at 25°C.

**Typical battery charging time:** 14 hours at 25°C. (Indefinite charging will not damage battery).

**Weight (with battery pack):** net, 200 g (7 oz). Shipping, 1.8 kg (4 lb).

**Size:** 165 L  $\times$  45 W  $\times$  30 mm D (6 $\frac{1}{2}$ "  $\times$  1 $\frac{3}{4}$ "  $\times$  1 $\frac{1}{4}$ ").

## 97002A Specifications

### DC ammeter

**Ranges:** 0.1 mA, 1 mA, 10 mA, 0.1 A, 1 A FS.

**Accuracy (20°C to 30°C):**  $\pm(2.5\%$  of reading + 2 digits).

### AC ammeter

**Ranges:** 0.1 mA, 1 mA, 10 mA, 0.1 A, 1 A FS.

**Accuracy (20°C to 30°C, >3% of range):** 45 Hz to 1 kHz:  $\pm(4\%$  of reading + 5 digits). 1 kHz to 3.5 kHz:  $\pm(7\%$  of reading + 5 digits).

**DC V, AC V, OHMS:** same as 970A specifications

### General

**Full range insertion voltage:**  $< 0.25$  V.

**Input protection:** 2 amp fast acting fuse.

**Weight:** net, 170 g (6 oz). Shipping, 1.8 kg (4 lb).

**Size:** 95 L  $\times$  95 W  $\times$  51 mm D (3 $\frac{3}{4}$ "  $\times$  3 $\frac{3}{4}$ "  $\times$  2").

## 97003A Specifications

**Response:** the 97003A is a peak responding detector and is calibrated to read rms value of a sine wave.

**Voltage range:** 0.25 V to 30 V rms.

**Max input:** 30 V rms ac; 200 V dc.

**AC to DC transfer accuracy when operating into HP 970A**

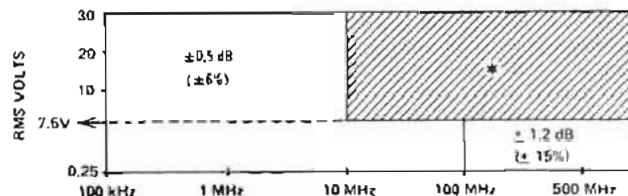

\*HP's 97003A is usable from 10 MHz to 500 MHz and 7.5 V rms to 30 V rms. It is not traceable to the United States National Bureau of Standards over that range.

**Input Impedance:** input resistance:  $> 25$  k $\Omega$ .

**Shunt capacitance:**  $< 3$  pF for plastic tips.  $< 4$  pF for metal high frequency adapter tip.

### General

**Accessories supplied:** ground lead, straight tip, battery charger, soft carrying case.

**Accessories available:** 11063A, 50-ohm tee; 11536A, 50-ohm tee; 10218A, BNC Adapter; 10219A, Type 874 Adapter; 10220A, Micro-dot Adapter. See data sheet for information on ordering chargers.

### Ordering Information

Item	Price
97001A extra rechargeable battery pack	\$27
97002A ac/dc current shunt/bench cradle	\$49
97003A RF adapter	\$88
97004A accessory kit	\$36
970A Digital Multimeter (includes soft carrying case, battery and charger)	\$425

# DIGITAL VOLTMETERS

Low-cost autoranging 3½ digit DMM

Model 3476A/B



## Description

If you measure current, voltage or resistance, you can use the 3476A/B to make these measurements faster and with fewer reading errors. This versatile instrument incorporates autorange to let you concentrate on your measurement, not the range or range multiplier. With autorange, readings always have the same multiplier: voltage always in volts, current in amps, and resistance in kilohms. In addition to autorange the 3476A/B has auto-zero and auto-polarity. Auto-zero eliminates the need to zero the instrument prior to a test, and auto-polarity lets you measure both positive and negative voltages without the inconvenience of reversing test leads.

The 3476A/B saves you time by combining the five most common measurements in one instrument. It measures AC voltage, DC voltage, AC current, DC current and resistance. In addition to these five basic measurements, the 3476A/B has additional features to save you time and effort. For example, there are two units to choose from. The lower cost 3476A operates on AC for your bench measurements. The 3476B will operate on either AC or nickel-cadmium batteries. Under battery operation you can break ground loops resulting in quieter readings or make measurements in remote locations. The 3476B will give you eight hours of continuous service before a recharge is required. Keep it plugged in and it will charge overnight and be ready for your next trip.

## Convenience

An instrument designed to make your most common measurements should be convenient to use. The 3476A/B was designed to be convenient. An example is the replacement of the input protection fuses. Replacement is easy—no disassembly or re-calibration is necessary—simply slide back the input terminal cover plate to expose the defective fuse. Convenience means attention to design detail. A multiposition bail allows convenient positioning. There is even a vertical detent for viewing from above. Another convenient detail is the shape of the case. Small instruments with pushbuttons have trouble staying put when the buttons are pressed. The 3476A/B solves this problem with a finger grip ridge allowing one-handed operation.

## 3476A/B specifications

### DC Voltmeter

Ranges:  $\pm 0.1100$  V  
 $\pm 1.100$  V  
 $\pm 11.00$  V  
 $\pm 110.0$  V  
 $\pm 1100$  V

Maximum display:  $\pm 0.1098$  V  
 $\pm 1.098$  V  
 $\pm 10.98$  V  
 $\pm 109.8$  V  
 $\pm 1098$  V

Maximum input: 1000 V (DC + Peak AC).

Accuracy (20°C to 30°C)\*

Range	Accuracy*
0.1100 V	$\pm (0.3\% \text{ of reading} - 2 \text{ digits})$
1.100 V 11.00 V	$\pm (0.3\% \text{ of reading} - 1 \text{ digit})$
110.0 V 1100 V	$\pm (0.4\% \text{ of reading} + 1 \text{ digit})$

Common mode rejection: (1 k $\Omega$  unbalance) > 100 dB @ 50 Hz, 60 Hz.

Input resistance: 10 M $\Omega$   $\pm 5\%$ .

Input protection: < 1100 V peak.

Temperature coefficient:  $\pm (0.05\% \text{ of reading} + 0.2 \text{ digit})/^\circ\text{C}$ .

### AC Voltmeter

Ranges: 0.1100 V  
1.100 V  
11.00 V  
110.0 V  
1100 V

Maximum Display: 0.1098 V  
1.098 V  
10.98 V  
109.8 V  
1098 V

Maximum Input: 700 V rms.

Accuracy: converter is average responding calibrated in rms (20°C to 30°C)\*

Ranges**	45 Hz to 2 kHz	2 kHz to 5 kHz	5 kHz to 10 kHz
1.100 V to 1100 V	$\pm (1.5\% \text{ of reading} + 4 \text{ digits})$	$\pm (3\% \text{ of reading} + 6 \text{ digits})$	$\pm (8\% \text{ of reading} + 10 \text{ digits})$
0.1100 V	$\pm (2\% \text{ of reading} + 6 \text{ digits})$	$\pm (5\% \text{ of reading} + 6 \text{ digits})$	$\pm (18\% \text{ of reading} + 10 \text{ digits})$

\*\*Ranges usable from 0.03 of range to full scale

**Common mode rejection:** (1 kΩ unbalance) >80 dB@ 50 Hz, 60 Hz.

**Input resistance:** 10 MΩ ±5%.

**Input capacitance:** <30 pF.

**Input protection:** <1100 V peak.

**Temperature coefficient:** ±(0.05% of reading + 0.5 digit)/°C.

**DC ammeter**

**Ranges:** ±0.110 A      **Max. display:** ±0.109 A  
 ±1.100 A                      ±1.098 A

**Accuracy:** (20°C to 30°C) ±(0.8% of reading + 2 digits).

**Impedance:** 1–1.5 ohm constant.

**Current protected:** 1.5 A fuse.

**Temperature coefficient:** ±(0.05% of reading + 0.2 digit)/°C.

**AC ammeter**

**Ranges:** 0.110 A      **Max. display:** 0.109 A  
 1.100 A                      1.098 A

**Accuracy (20°C to 30°C)\***

Ranges**	45 Hz to 2 kHz	2 kHz to 5 kHz
1.100 A	±(2% of reading + 4 digits)	±(3.5% of reading + 6 digits)
0.110 A	±(2.5% of reading + 6 digits)	±(5.5% of reading + 6 digits)

\*\* Ranges usable from 3% of range to full range

**Impedance:** 1–1.5 ohm constant.

**Current protected:** 1.5 A fuse.

**Temperature coefficient:** ±(0.05% of reading + 0.5 digit)/°C.

**Ohmmeter**

**Ranges:** 1.100 kΩ      **Max. display:** 1.098 kΩ  
 11.00 kΩ                      10.98 kΩ  
 110.0 kΩ                      109.8 kΩ  
 1100 kΩ                      1098 kΩ  
 11000 kΩ                      10980 kΩ

**Accuracy (20°C to 30°C)**

Ranges	Accuracy*
110.0 kΩ, 1100 kΩ	±(0.3% of reading + 1 digit)
11000 kΩ, 1.100 kΩ 11 kΩ	±(0.5% of reading + 1 digit)

\*90 day cal. cycle. Add (0.2% of reading to all functions+ 1 digit for AC V and AC I) for one year cal. cycle.

**Open circuit voltage:** <4 V.

**Input voltage protection:** <30 V rms continuous, fuse protected from 30 V to 250 V rms.

**Temperature coefficient:** ±(0.05% of reading + 0.2 digit)/°C.

**General**

**Range:** Automatic, Range Hold.

**Common to ground:** <500 V (peak).

**Sample rate:** ≈ 3/second.

**Overload indication:** horizontal bars.

**Operating environmental conditions**

**Temperature range:** 0°C to 40°C.

**Humidity:** <95% RH.

**Power:** 3476A AC line, 3476B AC line and batteries, <6 VA

Standard, 104–127 V ac; 54–66 Hz

Option 001, 86–106 V ac; 54–66 Hz

Option 002, 86–106 V ac; 48–54 Hz

Option 003, 190–230 V ac; 48–54 Hz

Option 004, 208–250 V ac; 48–54 Hz.

Note: No charge for options 001 through 004. Power options may be changed in field by rearranging jumpers. See manual for details.

**Batteries:** 4 rechargeable Nickel Cadmium Sub C size. Typical continuous operating time using fully charged batteries: 8 hours at 25°C. Typical battery charging time: 14 hours at 25°C with instrument turned off. Trickle charge with instrument on.

**Weight:** 3476A — net, 0.77 kg (1 lb 11 oz); shipping, 1.68 kg (3 lb 11oz). 3476B — net, 0.97 kg (2 lb 2 oz); shipping, 1.88 kg (4 lb 2 oz).

**Size:** 3476A/B: 5.8 H × 16.8 W × 20.6 cm D (2.3" × 6.6" × 8.1").



3476 A



11068 A

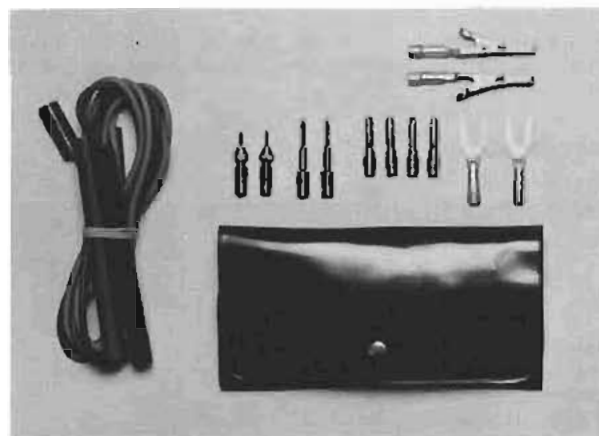

11067 A

Accessories***	Price
11096B RF probe 10 kHz to 700 MHz (with adaptors)	\$90
11067A Test Lead Kit	\$5
11068A Soft Carrying Case	\$20
Opt 910 Extra Manual	add \$2
Opt 005 3476A/B, Test Lead Kit, and Soft Carrying Case	add \$25

Ordering Information***	
3476A Digital Voltmeter	\$225
3476B Digital Voltmeter	\$275

\*\*\*Domestic U.S. prices only. Data subject to change.

## DIGITAL VOLTMETERS

3½ Digit, high accuracy DMM

Model 3435A



### Description

The 3435A is a 3½ digit multimeter providing five functions of ACV, DCV, ACI, DCI and  $\Omega$ . It is available with rechargeable batteries or AC line power only. The 34112A Touch-Hold probe provides "eyes-on" probing of AC and DC voltages by holding the 3435A display using a button on the probe. The 3435A case is rugged with a detent position carrying handle which is used also as a tilt stand.

### Specifications

#### DC voltmeter

Ranges:	Maximum display:
$\pm 200$ mV	$\pm 199.9$ mV
$\pm 2$ V	$\pm 1.999$ V
$\pm 20$ V	$\pm 19.99$ V
$\pm 200$ V	$\pm 199.9$ V
$\pm 1200$ V	$\pm 1199$ V

**Maximum input:** 1200 V (DC + Peak AC).

**Ranging:** automatic or manual.

**Sensitivity:** 100  $\mu$ V on 200 mV range.

**Polarity:** automatically sensed and displayed

**Accuracy:** 1 year, 15 to 30°C.

Range	Specifications
200 mV	$\pm (0.1\% \text{ of reading} + 2 \text{ digits})$
2 V to 1200 V	$\pm (0.2\% \text{ of reading} + 1 \text{ digit})$

**Temperature coefficient:** (0 to 15°C and 30 to 55°C)  $\pm (0.018\%$  of reading + 0.1 digit)/°C.

**Input resistance:** 10 M $\Omega$   $\pm 1\%$ .

**Input type:** floating, 500 V maximum, com. to ground.

**Normal mode rejection:** 40 dB at 50 Hz/60 Hz  $\pm 0.1$  Hz.

**Response time:** <0.7 second to within 1 digit of final value on one range. Add 1 second for each range change.

**Effective common mode rejection:** (1 k $\Omega$  unbalance) >120 dB at 50/60 Hz  $\pm 0.1\%$ .

#### DC Current

Ranges:	Maximum display:
$\pm 200$ $\mu$ A	$\pm 199.9$ $\mu$ A
$\pm 2$ mA	$\pm 1.999$ mA
$\pm 20$ mA	$\pm 19.99$ mA
$\pm 200$ mA	$\pm 199.9$ mA
$\pm 2000$ mA	$\pm 1999$ mA

**Maximum input:** current: 2 amp (fuse protected), Voltage: 250 V.

**Ranging:** manual only.

**Sensitivity:** 100 nA on 200  $\mu$ A range.

**Polarity:** automatically sensed and displayed.

**Accuracy:** 1 year, 15 to 30°C.

Range	Specifications
200 $\mu$ A to 20 mA	$\pm (0.3\% \text{ of reading} + 2 \text{ digits})$
2000 mA	$\pm (0.6\% \text{ of reading} + 2 \text{ digits})$

**Temperature coefficient:** (0 to 15°C and 30 to 55°C)  $\pm (0.028\%$  of reading + 0.1 digit)/°C.

**Voltage burden**

Range	Maximum Burden at Full Scale
200 $\mu$ A to 20 mA	<220 mV
200 mA	<240 mV
2000 mA	<400 mV

**Response time:** 0.7 second on any range to within 1 digit of final value.

#### AC voltmeter

**AC converter:** avg. responding rms calibrated.

Ranges:	Maximum display:
200 mV	199.9 mV
2 V	1.999 V
20 V	19.99 V
200 V	199.9 V
1200 V	1199 V

**Maximum Input:** 1700 V (DC + Peak AC), 10<sup>7</sup> volt-Hz max.  
**Ranging:** automatic or manual.  
**Sensitivity:** 100 μV on 200 mV range.  
**Accuracy:** (with display of ≥20 digits) 1 year, 15 to 30°C.

Range	Specifications
30 Hz - 50 Hz	±(1.5% of reading + 3 digits)
50 Hz - 20 kHz	±(0.3% of reading + 3 digits)
20 kHz - 100 kHz	±(1.5% of reading + 10 digits)

**Temperature coefficient:** (0 to 15°C and 30 to 55°C) ±(0.04% of reading + 0.2 digit)/°C.  
**Input impedance:** resistance: 5 MΩ. Shunt capacitance: <50 pF.  
**Response time:** 1.6 seconds to within 3 digits of final value on one range. Add 1.2 seconds for each range change.  
**Input type:** floating, 500 V maximum com. to ground.

**AC current**

Ranges:	Maximum display:
200 μA	199.9 μA
2 mA	1.999 mA
20 mA	19.99 mA
200 mA	199.9 mA
2000 mA	1999 mA

**Maximum Input:** current: 2 amp (fuse protected). Voltage: 250 V.  
**Ranging:** manual only.  
**Sensitivity:** 100 nA on 200 μA range.  
**Accuracy:** (with display of ≥20 digits) — 1 year, 15 to 30°C.

Current Range	Frequency of Input Signal	
	30 Hz	50 Hz
2000 mA	±(2% of reading + 4 digits)	±(1.2% of reading + 4 digits)
200 mA	±(1.7% of reading + 4 digits)	±(0.9% of reading + 4 digits)

**Temperature coefficient:** (0 to 15°C and 30 to 55°C) ±(0.05% of reading + 0.2 digit)/°C  
**Voltage burden**

Range	Maximum Burden at Full Scale
200 μA to 20 mA	<220 mV rms
200 mA range	<240 mV rms
2000 mA range	<400 mV rms

**Response time:** 1.6 seconds on any range to within 3 digits of final value.

**Input type:** floating, 500 V maximum com. to ground.

**Ohmmeter**

Ranges:	Maximum display:
20 Ω	19.99 Ω
200 Ω	199.9 Ω
2 kΩ	1.999 kΩ
20 kΩ	19.99 kΩ
200 kΩ	199.9 kΩ
2000 kΩ	1999 kΩ
20 MΩ	19.99 MΩ

**Input protection:** 250 V rms.  
**Ranging:** automatic or manual.  
**Sensitivity:** 10 milliohm on 20 Ω range.  
**Accuracy:** 1 year, 15 to 30°C.

Range	Specifications
20 Ω	±(0.5% of reading + 10 digits)
200 Ω - 2000 kΩ	±(0.2% of reading + 2 digits)
20 MΩ	±(0.8% of reading + 2 digits)

**Temperature coefficient:** (0 to 15°C and 30 to 55°C)

Range	Specifications
20 Ω - 2000 kΩ	±(0.04% of reading + 0.2 digit)/°C
20 MΩ	±(0.18% of reading + 0.2 digit)/°C

**Configuration:** 2 wire.  
**Open circuit voltage:** <5 V.  
**Current through unknown**

**Range:** 20 Ω, 200 Ω, 2 kΩ, 20 kΩ, 200 kΩ, 2 MΩ, 20 MΩ.  
**Current:** 5 mA, 5 mA, 500 μA, 50 μA, 5 μA, 500 nA, 50 nA.

**Response time:** 0.8 second to within 1 digit. Add 0.8 second for each range change.

**General**

**Calibration:** data sheet specifications guaranteed for 1 year.  
**Display:** 7 segment red 0.3 inch high LED's. Function and range annunciation.  
**Reading rate:** 2.4 - 4.7/s depending on input level.  
**A-D conversion:** dual slope.  
**Integration time:** 100 ms.  
**Ranging:** automatic or manual on ACV, DCV and ohms. Manual only on AC & DC current.  
**Storage temperature:** AC line power only, -40 to +75°C; with batteries, -40 to +65°C.

**Operating temperature:** (0 to 55)°C.

**Humidity:** 95% RH, +15 to +40°C.

**Power:** AC line: 48-440 Hz; 86-250 V (see configuration). Battery: rechargeable lead-acid 10 hours minimum continuous operation with full charge. Recharge time: 16 hours operating, 12 hours nonoperating. Batteries and charger available separately; consult operating manual. Total instrument power dissipated: AC only: 3 watts; with charger; 8 watts.

**Size**

3435A	3435A Option 002
23.81 cm (9 1/4") wide	20.96 cm (8 1/4") wide
9.84 cm (3 7/8") high	8.57 cm (3 3/8") high
27.62 cm (10 7/8") long	26.67 cm (10 1/2") long

**Weights:** 3435A 2.41 kg (5 lb 5 oz)  
 3435A Opt. 001 1.84 kg (4 lb 1 oz)  
 3435A Opt. 002 1.81 kg (4 lb)

**Configuration**

3435A, streamlined portable case with handle, AC line power. Batteries and charger included.  
 3435A Opt. 001, streamlined portable case, AC line power only.  
 3435A Opt. 002, Rack and Stack case, AC line power only. (Rack mount kit not included.)  
 All orders must include one of the power options: 86-106 V Opt. 100; 190-233 V Opt. 210; 104-127 V Opt. 115; 208-250 V Opt. 230.

**\*Accessories**

11000A Test leads, dual banana both ends.	\$17
11002A Test leads, dual banana to dual alligator.	\$12
11003A Test leads, dual banana to probe and alligator.	\$12
11096B RF Probe, 10 kHz to 700 MHz.	\$90
34110A Soft vinyl carrying/operating case.	\$25
34111A High-voltage probe 40 kV DC.	\$75
34112A Touch-Hold Probe.	\$40
11087A Test lead kit.	\$5
5061-0054 1/2 Module rack mount kit. (Available on Opt 002 only).	\$15

**Ordering information**

3435A	\$400
3435A Opt 001	less \$65
3435A Opt 002	less \$35

\*Domestic U.S. prices only.



# DIGITAL VOLTMETERS

True RMS voltmeter

Model 3403C

- DC and 2 Hz To 100 MHz
- 3 1/2 digit



## Description

The Model 3403C is usable from dc to 100 MHz. True rms is especially valuable for measurements of noise, multiplexed signals, modulated waves and signals with high harmonic content.

### dB display

The dB display option provides readings directly in dB, a major convenience to ac users. The dB reference to which the measurement is made is conveniently adjustable from the front panel to provide referenced dB measurements, or to provide a convenient means to offset the reading by as much as 13 dB for unreferenced measurements.

## Specifications

### Ranges

**Full range display:** 10.00 mV (ac only); 100.0 mV; 1.000 V; 10.00 V; 100.0 V; 1000 V.

**Overrange:** >90% on all ranges except as limited by max input voltage.

**Ranging Information:** front panel annunciators indicate overrange (approximately 190% of full range), or underrange (approximately 17% of full range) conditions.

### Performance

#### AC frequency range

**Slow response:** 2 Hz to 100 MHz.

**Fast response:** 25 Hz to 100 MHz.

### Response time

**Fast response:** 1 s.

**Slow response:** 10 s.

Instrument reads final reading  $\pm 0.1\%$  of input change in stated response time.

### Display rate

**Fast response:** 4 readings per s.

**Slow response:** 2 readings per s.

READING ACCURACY =  $\pm\%$  OF RANGE +  $\pm\%$  OF READING \*\*

RANGE	VOLTS			FREQUENCY (Hz)						
	DC	DC + AC	AC	DC	25	100K	1M	10M	100M	
1000V	.3	.3	.3	.2	.4*	.2	CAUTION: frequencies and ranges in this area may result in invalid readings without ranging indication.			
100V	.2	.2	.2	.2	.4*	.2				
10V	.2	.2	.2	.2	.4*	.2	.5	1	CAUTION: frequencies and ranges in this area may result in invalid readings without ranging indication.	
1V	.2	.2	.2	.2	.4*	.2	.5	1		
100mV	.6	.6	$\frac{2}{.4}$ $\frac{20mV}{.4}$	.2	.4*	.2	.5	2	2.5	10
10mV			$\frac{2}{.4}$ $\frac{2mV}{.4}$			.3	1.2	3	CAUTION: frequencies and ranges in this area may result in invalid readings without ranging indication.	

CAUTION: frequencies and ranges in this area may result in invalid readings without ranging indication.

\* DC + AC function and slow response time only

\*\* % of reading specification is representative of typical flatness.



**Functions**

**DC:** responds to dc component of input signal.  
**AC:** responds to true rms value of ac coupled input signal.  
**AC+ DC:** responds to true rms value of dc and ac input signal; reading is  $\sqrt{(dc)^2 + (ac\ rms)^2}$ .  
**Temperature coefficient:**  $\pm 0.1 \times$  reading accuracy\*/°C outside the 25°C  $\pm$  5°C temperature range.  
**Accuracy:** 90 days (25°C + 5°C, <95% RH, 17% of range to 190% of range).

**Input characteristics**

**Input impedance:** <10 MHz.  
**1 V to 1000 V range:** 10 M $\Omega$   $\pm$  10% shunted by 19 pF  $\pm$  10%.  
**10 mV and 100 mV range:** 20 M $\Omega$   $\pm$  10% shunted by 16 pF  $\pm$  10%.  
**10 MHz to 100 MHz** the following table gives maximum loading due to input shunt impedance across a terminated source.

System impedance (source and load)	Frequency	
	10 MHz	100 MHz
50 $\Omega$	1%	10%
75 $\Omega$	2%	20%

**Crest factor**

2 Hz to 25 Hz	2:1 at full range input.
>25 Hz	10:1 at full range input.

**Maximum input voltage**

**High to low:** 1000 V rms, 1500 peak or 10<sup>8</sup> V-Hz on any range.  
**Maximum dc voltage in ac mode:** 500 V dc.  
**Low to chassis:**  $\pm$ 500 V dc, when floated with special banana to BNC adapter.

**Options**

**Autorangeing (3403C option 001)**

**Automatic ranging:** uprange at approximately 190% of full range; downranges at approximately 17% of full range.  
**Autorange time:** fast response: 1 s per range change. Slow response: 10 s per range change.

**Remote control+ digital output+ autorangeing (3403C option 003):** Provides remote control of all front panel functions, ranges, digital output and autorangeing.

**dB display (3403C option 006)**

**Measurement range:** 108 dB (-48 dBV to +60 dBV).  
**Calibrated dB reference:** 0 dB= 1.000 V; reference level may be set for 0 dBm (600 $\Omega$ ) by adjusting front panel dB calibration adjustment.  
**Variable dB reference:** reference level may be shifted downward from calibrated position >13 dB.

\*Data from accuracy charts.

**dB recorder output:** output voltage: 200 mV for 20 dB. Output resistance: 1 k $\Omega$   $\pm$  500  $\Omega$ .  
**Accuracy:** 90 days (25°C + 5°C, <95% RF).

READING = ( $\pm$  dB) + ( $\pm$  dB)\*\*

RANGE	dB		FREQUENCY (Hz)										
	AC	DC+AC	DC	2	25	100K	1M	10M	100M				
1000V	.15	.15	.02	.04*	.02								
100V	.15	.15	.02	.04*	.02					.1			
10V	.15	.15	.02	.04*	.02					.05	.1		
1V	.15	.15	.02	.04*	.02					.05	.1	.25	1
100mV	.15	.15	.02	.04*	.02					.05	.2	.25	1
10mV	.15				.03					.12	.3		

 CAUTION: frequencies and ranges in this area may result in invalid readings without ranging indication.

\* DC + AC function and slow response time only

\*\* specification is representative of typical flatness.

**General**

**Operating conditions**

**Temperature range:** 0°C to 50°C.  
**Humidity:** <95% RH.

**Recorder output**

**Output voltage:** 1 V dc open circuit for full range input.  
**Output resistance:** 1 k $\Omega$   $\pm$  10%.

**Power:** 115 V or 230 V  $\pm$  10%, 48 Hz to 440 Hz, 35 VA max. (including all options).

**Input terminals:** BNC front panel connector standard for low to high terminals: rear panel connector available by internally reversing position of ac converter module.

**Weight:** including all options: net, 5 kg (11 lb). Shipping, including all options: Net, 7.2 kg (16 lb).

**Size:** 127 H  $\times$  234.9 W  $\times$  196.8 mm D (5"  $\times$  9 1/4"  $\times$  7 3/4").

**Accessories furnished:** floating adapter-banana to BNC.

**3403C True RMS Voltmeter**

\$2600  
add \$156

**Opt 001 autorangeing**

**\*Opt 003 remote control + digital output + autorangeing**

add \$355  
add \$315

**\*Opt 006 dB display**

\*Options 003 and 006 are available only as factory installed options.

# DIGITAL VOLTMETERS

High speed 3½ digit system voltmeter

Model 3437A



## Description

The Hewlett-Packard 3437A System Voltmeter has been designed to be used in systems. It is a 3½ digit high speed dc voltmeter with sample and hold. The standard unit measures DC volts, provides trigger delay, burst reading capability and Hewlett-Packard Interface Bus (HP-IB).

There are three DC floating input ranges: 0.1 V, 1.0 V and 10.0 V full scale with a maximum display of "1999". Sample and Hold allows the 3437A to be an instantaneous reading voltmeter. The trigger delay can be set from 0.1  $\mu$ s to 1.0 second and the number of readings can be set from 0 to 9999 readings.

## Typical operation

**Example:** set Delay to 1 ms and Number of Readings is set to 1000. The 3437A will now take 1000 readings spaced 1 ms apart upon receiving one trigger.

## Data output

All front panel switches are programmable from the HP-IB. Two data output formats are available: (1) ASCII output (Serial ASCII characters) and (2) Packed output (two 8-bit bytes on the HP-IB to send the complete reading).

## High speed

The Packed output mode allows more data to be stored in the calculator or computer as well as increasing the maximum reading rate from 3000 readings/second to greater than 5000 readings/second.

## Systems capability

The user may select the mode for which the voltmeter requests service from the controller (calculator or computer). Request Service can be programmed manually or automatically to request service for: (1) Data Ready, (2) Trigger Ignore, or (3) Invalid Program. Any combination of these three can be selected.

## Applications

**Waveform analysis**—The 3437A can be used to analyze a wide variety of waveforms. The delay and burst reading capability allows frequency, positive or negative peak values, RMS value and harmonic distortion to be measured. The accuracy of these measurements is comparable to more traditional measurement techniques.

**Transient signal analysis**—The 3437A is capable of measuring transient signals because of the wide bandwidth input (>1 MHz), high measuring speed and sample-and-hold.

**Fast AC measurements**—Sinusoidal signals of known frequency can be measured in less than one cycle of the signal. Very low frequency measurements can be made more quickly than with conventional techniques.

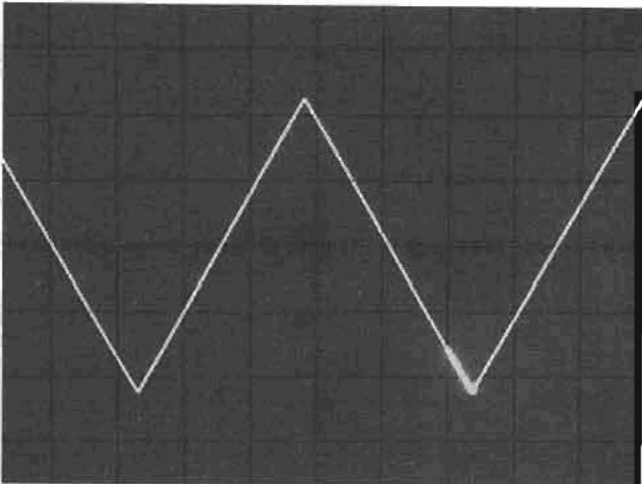

Figure 1 shows a signal to be measured by both an oscilloscope and the 3437A. The oscilloscope delayed sweep is used to intensify the point of interest. The delayed gate output is used to trigger the 3437A at the same point in time as indicated on the oscilloscope display. The voltage at the point of interest is now known to the accuracy of the 3437A.

**High speed scanning:** multiple input measurement applications can be satisfied with the 3437A and the HP 3495A Scanner. Reading rates of greater than 100 channels/second can be attained.

**Bench measurements:** in addition to systems applications, the 3437A can be used to improve oscilloscope amplitude and measurement accuracy.

#### Data-sheeted systems

The 3437A is part of the 3052A Data Acquisition System. (Refer to page 73). The 3052A includes the 3437A, 3455 5<sup>1/2</sup>/6<sup>1/2</sup> digit DVM, 3495A Scanner and 9825A Computer. The combination of the 3437A and 3455A voltmeters provides systems versatility such as high speed, system timing and high sensitivity measurements. The delay generator in the 3437A is used to provide timing triggers for the 3455A DVM. The 3455A provides 1 $\mu$ V sensitivity and high speed DC measurements with greater than 60 dB normal mode noise rejection.

## Specifications

### DC volts

Range	Max. Display	Overload Reading
10 V	$\pm 19.98$	$\pm 99.99$
1 V	$\pm 1.998$	$\pm 9.999$
0.1 V	$\pm .1998$	$\pm .9999$

**Ranging:** Manual or Remote.

### Performance

#### Static accuracy (90 days, 23°C $\pm$ 5°C)

10 V range:  $\pm 0.05\%$  of reading  $\pm 1.6$  digits.

1 V range:  $\pm 0.03\%$  of reading  $\pm 1.6$  digits.

0.1 V range:  $\pm 0.06\%$  of reading  $\pm 1.8$  digits.

#### Static accuracy (1 year, 23°C $\pm$ 5°C)

10 V range:  $\pm 0.05\%$  of reading  $\pm 2$  digits.

1 V range:  $\pm 0.03\%$  of reading  $\pm 2$  digits.

0.1 V range:  $\pm 0.06\%$  of reading  $\pm 2.2$  digits.

**Static accuracy temperature coefficient (0°C–50°C):**  $\pm 0.002\%$  reading/ $^{\circ}$ C  $\pm 0.05$  digits/ $^{\circ}$ C.

### Input characteristics

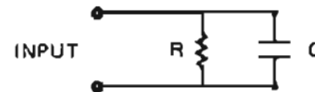

10 V range:  $R = 1\text{ M}\Omega \pm 20\%$ ;  $C < 75\text{ pF}$ .

1 V range:  $R > 10^6\Omega$ ;  $C < 75\text{ pF}$ .

0.1 V range:  $R > 10^6\Omega$ ;  $C < 75\text{ pF}$ .

**Maximum input voltage high to low on all ranges:**  $< \pm 30\text{ V peak}$ .

**Maximum voltage low to chassis:**  $\pm 42\text{ V peak}$ .

**Number of Readings (N Readings):** 0\*\* to 9.999.

\*Readings are not internally stored.

\*\*For  $N = 0$  the 3437 operates in delay mode only.

### Maximum reading rate (Remote, N Rdgs. $> 1$ , and a zero delay listener\*)

ASCII: 3600 Readings/s.

PACKED: 5700 Readings/s.

\*Actual Reading Rate is given by  

$$\frac{3600 (\text{listen rate}^{\dagger})}{3600 + (\text{listen rate}^{\dagger})}$$

ASCII:  $\frac{3600 + (\text{listen rate}^{\dagger})}{3600 + (\text{listen rate}^{\dagger})}$

PACKED:  $\frac{5700 (\text{listen rate}^{\dagger})}{5700 + (\text{listen rate}^{\dagger})}$

PACKED:  $\frac{5700 + (\text{listen rate}^{\dagger})}{5700 + (\text{listen rate}^{\dagger})}$

$^{\dagger}$  Listen rate is maximum speed that listener can accept data bytes.

### Delay

**N Rdgs. = 0 or 1**

**DELAY (setting):** 0 to 0.999 999 9 s in 0.1 $\mu$ s steps.

**N Rdgs.  $> 1$  (Remote and a zero delay listener\*)**

ASCII:  $0.0002778\text{ s} \leq \text{DELAY} \leq 0.9999999\text{ s}$ .

PACKED:  $0.0001754\text{ s} \leq \text{DELAY} \leq 0.9999999\text{ s}$ .

\*Minimum delay is a function of listener delay related by

ASCII:  $277.8\mu\text{s} + \text{listener delay}$ .

PACKED:  $175.4\mu\text{s} + \text{listener delay}$ .

### Accuracy (EXT. TRIG to DELAY OUT, 0°C to 50°C)

**Delay offset:** 100 ns  $\pm$  25 ns.

**Delay accuracy:**  $\pm 0.008\%$  DELAY + Delay offset.

**Delay repeatability (jitter) for N Rdgs. = 0 or 1**

DELAY of 0 or 0.1  $\mu$ s:  $\pm 2\text{ ns}$ .

DELAY of 0.2  $\mu$ s to 50 ms:  $\pm 10\text{ ns} + 0.0002\%$  DELAY setting.

DELAY of  $> 50\text{ ms}$ :  $\pm 110\text{ ns}$ .

### Input bandwidth (3 dB)

10 V range: 1.0 MHz.

1 V range: 1.1 MHz.

0.1 V range: 40 kHz.

### Settling time

10 V range: a 10 V step to within 20 mV of final value  $t = 7.5\mu\text{s}$ ; a

10 V step to within 200 mV of final value  $t = 700\text{ ns}$ .

1 V range: a 1 V step to within 2 mV of final value  $t = 1.5\mu\text{s}$ ; a 1 V

step to within 20 mV of final value in 700 ns.

0.1 V range: a 0.1 V step to within 200 $\mu$ V of final value  $t = 25\mu\text{s}$ ; a

0.1 V step to within 2 mV of final value in 700 ns.

### General

**Operating temperature:** 0 to 55°C.

**Storage temperature:**  $-40^{\circ}$ C to 75°C.

**Humidity range:**  $> 95\%$  R.H., 0°C to 40°C.

**Power:** 100 V, 120 V, 220 V, 240 V  $\pm 5\%$ ,  $-10\%$ , 48 Hz to 400 Hz line operation,  $< 60\text{ VA}$  with all options.

**Dimensions:** 88.9 H  $\times$  212.7 W  $\times$  527.1 mm D (3<sup>1/2</sup>"  $\times$  8<sup>3/8</sup>"  $\times$  20<sup>3/4</sup>").

**Weight:** net, 5.6 kg (12 lb 4 oz). Shipping, 7.6 kg (16 lb 12 oz).



# DIGITAL VOLTMETER

## HP-IB 5 Function DMM

Model 3438A



### Description

The 3438A is an autoranging  $3\frac{1}{2}$  digit Multimeter with 5 functions of ACV, DCV, ACI, DCI, and  $\Omega$ . It interfaces to the HP-IB providing both addressable and talk-only modes.

The addressable mode allows triggering either from the Calculating Controller (remote) or internally (local). Function and range are selected manually on the front panel with autoranging of volts and ohms.

### Specifications

#### DC Voltmeter

Ranges:	Maximum display:
$\pm 200$ mV	$\pm 199.9$ mV
$\pm 2$ V	$\pm 1.999$ V
$\pm 20$ V	$\pm 19.99$ V
$\pm 200$ V	$\pm 199.9$ V
$\pm 1200$ V	$\pm 1199$ V

Maximum Input: 1200 V (DC + peak AC).

Ranging: Automatic or manual.

Sensitivity:  $100\mu\text{V}$  on 200 mV range.

Polarity: Automatically sensed and displayed.

Accuracy (1 year, 15 to 30°C)

Range	Specifications
200 mV	$\pm(0.1\%$ of reading + 2 digits)
2 V to 1200 V	$\pm(0.1\%$ of reading + 1 digit)

Temperature coefficient: (0 to 15°C and 30 to 55°C)  $\pm (.018\%$  reading + 0.1 digit)/°C.

Input resistance: 10 meg  $\Omega \pm 1\%$ .

Input Type: floating, 500 V maximum, com. to ground.

Normal Mode Rejection: 40 dB at 50 Hz and 60 Hz  $\pm .1$  Hz.

Response time: <0.7 seconds to within 1 digit of final value on one range. Add 1 second for each range change.

Effective common mode rejection: (1 k $\Omega$  unbalance) > 120 dB at 50/60 Hz  $\pm 0.1\%$ .

#### DC Current

Ranges:	Maximum display:
$\pm 200$ $\mu\text{A}$	$\pm 199.9$ $\mu\text{A}$
$\pm 2$ mA	$\pm 1.999$ mA
$\pm 20$ mA	$\pm 19.99$ mA
$\pm 200$ mA	$\pm 199.9$ mA
$\pm 2000$ mA	$\pm 1999$ mA

Maximum Input: current: 2 amp (fuse protected); voltage: 250 V

Ranging: manual only.

Sensitivity: 100 nA on 200  $\mu\text{A}$  range.

Polarity: automatically sensed and displayed.

Accuracy (1 year, 15 to 30°C)

Range	Specifications
200 $\mu\text{A}$ to 20 mA	$\pm(0.3\%$ of reading + 2 digits)
2000 mA	$\pm(0.6\%$ of reading + 2 digits)

Temperature coefficient: (0 to 15°C and 30 to 55°C)  $\pm (.028\%$  of reading + 0.1 digits)/°C.

Voltage burden:

Range	Maximum Burden at Full Scale
200 $\mu\text{A}$ to 20 mA	< 220 mV
200 mA	< 240 mV
2000 mA	< 400 mV

Response time: 0.7 seconds on any range to within 1 digit of final value.

#### AC Voltmeter

AC Converter (average responding RMS calibrated)

Ranges:	Maximum Display:
200 mV	199.9 mV
2 V	1.999 V
20 V	19.99 V
200 V	199.9 V
1200 V	1199 V

**Maximum Input:** 1700 V (DC + Peak AC), 10<sup>7</sup> Volt-Hz max.

**Ranging:** Automatic or manual.

**Sensitivity:** 100  $\mu$ V on 200 mV range.

**Accuracy (with display of  $\geq$  20 digits 1 year, 15 to 30°C)**

Range	Specifications
30 Hz-50 Hz	$\pm$ (1.5% of reading $\pm$ 3 digits)
50 Hz-20 kHz	$\pm$ (0.3% of reading $\pm$ 3 digits)
20 kHz-100 kHz	$\pm$ (1.5% of reading $\pm$ 10 digits)

**Temperature coefficient:** (0 to 15°C and 30 to 55°C)  $\pm$  (0.04% of reading + 0.2 digit)/°C.

**Input Impedance:** resistance: 5 meg  $\Omega$ ; shunt capacitance: <50 pf.

**Response time:** 1.6 seconds to within 3 digits of final value on one range. Add 1.2 seconds for each range change.

**Input type:** floating, 500 V maximum com. to ground.

#### AC Current

Ranges:	Maximum display:
300 $\mu$ A	199.9 $\mu$ A
2 mA	1.999 mA
20 mA	19.99 mA
200 mA	199.9 mA
2000 mA	1999 mA

**Maximum Input:** current: 2 amp (fuse protected); voltage: 250 V.

**Ranging:** Manual only.

**Sensitivity:** 100 nA on 200  $\mu$ A range.

**Accuracy (With display of  $\geq$  20 digits 1 year, 15 to 30°C)**

**Temperature coefficient:** (0 to 15°C and 30 to 55°C)  $\pm$  (0.05% of reading + 0.2 digits)/°C.

**Voltage burden**

Range	Maximum Burden at Full Scale
200 $\mu$ A to 20 mA	< 220 mV RMS
200 mA range	< 240 mV RMS
2000 mA range	< 400 mV RMS

Current Range	30 Hz	50 Hz	10 kHz
2000 mA	$\pm$ (2% of reading + 4 digits)	$\pm$ (1.2% of reading + 4 digits)	$\pm$ (1.2% of reading + 4 digits)
200 mA	$\pm$ (1.7% of reading + 4 digits)	$\pm$ (0.9% of reading + 4 digits)	$\pm$ (0.9% of reading + 4 digits)
200 $\mu$ A	$\pm$ (1.7% of reading + 4 digits)	$\pm$ (0.9% of reading + 4 digits)	$\pm$ (0.9% of reading + 4 digits)

**Response time:** 1.6 seconds on any range to within 3 digits of final value.

**Input type:** floating, 500 V maximum com. to ground.

#### Ohmmeter

Ranges:	Maximum display
20 $\Omega$	19.99 $\Omega$
200 $\Omega$	199.9 $\Omega$
2 k $\Omega$	1.999 k $\Omega$
20 k $\Omega$	19.99 k $\Omega$
200 k $\Omega$	199.9 k $\Omega$
2000 k $\Omega$	1999 k $\Omega$
20 M $\Omega$	19.99 M $\Omega$

**Input protection:** 250 V RMS.

**Ranging:** automatic or manual.

**Sensitivity:** 10 milliohm on 20  $\Omega$  range.

**Accuracy (1 year, 15 to 30°C)**

Range	Specifications
20 $\Omega$	$\pm$ (0.5% of reading + 10 digits)
200 $\Omega$ to 2 M $\Omega$	$\pm$ (0.2% of reading + 2 digits)
20-M $\Omega$	$\pm$ (0.8% of reading + 2 digits)

**Temperature coefficient (0 to 15°C and 30 to 55°C)**

Range	Specifications
20 $\Omega$ -2 M $\Omega$	$\pm$ (0.04% of reading + 0.2 digits)/°C
20 M $\Omega$	$\pm$ (1.8% of reading + 0.2 digits)/°C

**Configuration:** 2 wire.

**Open circuit voltage:** < 5 V.

**Current through unknown**

**Range:** 20  $\Omega$ , 200  $\Omega$ , 2 k $\Omega$ , 20 k $\Omega$ , 2 M $\Omega$ , 20 M $\Omega$ .

**Current:** 5 mA, 5 mA, 500  $\mu$ A, 50  $\mu$ A, 5  $\mu$ A, 500 nA, 50 nA.

**Response time:** 0.8 seconds to within 1 digit. Add 0.8 seconds for each range change.

#### HP-IB

**Data output format:**

$\pm$ X.XXX E  $\pm$  X. X CR LF (13 byte, fixed)

#### DISPLAY EXPONENT FUNCTION

**Function Code:** DCV, 1; ACV, 2; DCI, 3; ACI, 4;  $\Omega$ , 5

**Overload Indication:**  $\pm$ 1.XXX E + 9

**Talk Modes (Selected by internal switch)**

**Addressed to talk**

**Local:** continuously sampling input; outputs on Bus when addressed to talk.

**Remote:** samples input only on command from controller.

**Talk only (used without controller)**

**Input:** switch selectable, front or rear.

**Reading rate:** is function of input level and ranging (2.5 to 4.7/sec. if in proper range).

**With Range change**

**ACV, ACI:** add 1.2 seconds for each range change. After arrival on proper range, the first six readings are always discarded. The seventh reading is output on Bus. Allow 1.6 seconds additional for first reading on Bus.

**DCV, DCI, k $\Omega$ :** Add 1 second for each range change. After arrival on proper range, the first reading is always discarded. Allow 310 ms additional for first reading on Bus.

#### General

**Calibration:** data sheet specifications guaranteed for 1 year.

**Display:** 7 segment red 0.3 inch high LED's. Function and range announcement.

**Reading rate:** 2.4-4.7/sec. depending on input level.

**A-D Conversion:** dual slope

**Integration time:** 100 msec.

**Ranging:** automatic or manual on ACV, DCV, and ohms. Manual only on AC & DC current.

**Storage temperature:** -40 to +75°C.

**Operating temperature:** (0 to 55)°C.

**Humidity:** 95% RH at +40°C.

**Power:** 48-440 Hz, 12 watts; 86-106 V Opt 100; 104-127 V Opt 115; 190-233 V Opt 210; 208-250 V Opt 230.

**Size:** 85.7 H  $\times$  209.6 W  $\times$  292.2 mm L (3<sup>3</sup>/<sub>16</sub>"  $\times$  8<sup>1</sup>/<sub>4</sub>"  $\times$  11<sup>1</sup>/<sub>2</sub>").

**Weight:** 2.8 kg (6 lb 5 oz).

#### Ordering Information

Item	Price
11000A Test leads, dual banana both ends	\$17
11002A Test leads, dual banana to dual alligator	\$12
11003A Test leads, dual banana to probe and alligator	\$12
11096B RF Probe 10 kHz to 700 MHz	\$87
34110A Soft vinyl carrying/operating case	\$25
34111A High-voltage Probe 40 kV DC	\$75
34112A Touch-Hold Probe	\$40
11067A Test lead kit	\$5
5061-0054 1/2 module rackmount kit (available on Opt 002 only)	\$15
10631A 1 m (39.37")	\$60
10631B 2 m (39.37")	\$60
10631C 4 m (39.37")	\$60

**3438A**  
Opt 100, 115, 210, 230

**\$875**  
N/C

## DIGITAL VOLTMETERS

5½/6½-digit DVM with Auto Cal

Model 3455A

- AutoCal
- Self test
- Bench/system
- AD/DC/OHMs
- High speed
- Removable reference



HP-IB

## Description

Hewlett-Packard's 3455A Digital Voltmeter is a microprocessor controlled 5½- or 6½-digit integrating voltmeter for bench or systems applications. The standard instrument measures DC volts, AC volts, and resistance. HP-IB I/O for systems applications is also standard.

## Measuring speed

The 3455A is fully guarded and has greater than 60 db normal mode noise rejection at reading rates of up to 24 readings per second on all DC ranges. Ohms reading rates are up to 12 readings/second and an AC fast mode gives reading rates of up to 13 readings/second at frequencies above 300 Hz.

## Performance

DC measurements can be made with up to 1 µV sensitivity. Ohms measurements are made with either a 2-wire or 4-wire mode. The High Resolution (6½-digit) mode gives DC and Ohms measurements with greater than 1 part per million resolution. AC voltage measurements can be made from 30 Hz to 250 kHz with the optional average responding converter.

## True rms

The standard true rms converter gives AC measurements from 30 Hz to 1 MHz. Complex signals with crest factors of up to 7:1 at full scale can be measured.

## Math

The math functions provide the user with unique computational capability. The Scale mode ( $\frac{X-Z}{Y}$ ) allows the user to offset, take ratios, or scale readings to give readouts in physical units. The % Error mode ( $\frac{X-Y}{Y} \times 100$ ) converts readings into percentage change from Y which is entered as a reference. For the math functions X is the present reading. Y and Z are previously entered readings or numbers entered from the front panel or by remote program.

## Auto Cal

The auto cal feature gives the user accurate DC volts and ohms measurements and simplifies calibration of these functions. The DC and ohms operating circuits are checked against internal references and any errors are corrected digitally. All dc and ohms adjustments are in a removable reference assembly.

## Serviceability

The self-test feature is used to aid in troubleshooting as well as verifying operation of the 3455A. Test verifies proper operation of the DC measuring circuits by comparing their parameters against predetermined limits. If a problem is found, the display is used to assist in finding the problem area by indicating which parameter is in error. Detailed troubleshooting can then be used to quickly isolate the problem.

Routine maintenance and calibration has been simplified with the removable reference assembly. Calibration of DC and ohms functions can be done by replacing the reference assembly with a recently calibrated one. Extra reference assemblies are available as HP accessory number 11177A. A spare assembly is ideal for one or more 3455A's. Calibrate DC and ohms in a 3455A without removing it from the bench or system. Just return the extra reference assembly to the cal lab or HP for calibration and have it back in time to calibrate the 3455 next time.

## Data-sheet systems

The 3455A is included as part of two standard systems. The 3051A and 3052A are fully integrated, tested, verified and specified as systems and come with complete systems software and documentation. These systems provide complete solutions to many of your measurement problems.

## 3051A Programmable Data Logger

The 3051A Programmable Data Logger has been specifically designed to solve your dedicated, long term data logging problems.

The 3051A consists of:

- 3455A DVM
- 3495A Scanner
- 9815A Calculator
- Special Data Logger ROM

Your data logging problems can be simplified with such features as:

- Thermocouple linearization
- Thermocouple reference junction
- Data analysis and processing
- Decision making and control capabilities
- Data formatting and storage
- Power fail-restart

Typical applications areas are:

- Plant monitoring
- Process monitoring
- Parameter testing

### 3052A Automatic data acquisition system

The 3052A Automatic Data Acquisition System has been designed to solve your data acquisition, control and automatic testing problems.

The 3052A consists of:

- 3455A DVM
- 3437A System Voltmeter
- 3495A Scanner
- 9825A Desktop Computer & ROMs

These 3052A features give you a wide range of problem solutions:

- Signal digitizing (>5000 readings/second)
  - High speed scanning (>100 channels/second)
  - System timing
  - Vectored interrupt system for simultaneous control and processing of multiple tasks
  - High speed data access and storage
  - Alphanumeric display for easy interaction with the operator
- Typical application areas are:
- R & D
  - Production testing & QA

For further information on either of these two systems refer to pages 72 and 73 or contact your local HP field engineer.

### HP Technology

HP has developed an instrument oriented microprocessor to provide the high performance of the 3455A. The microprocessor has a parallel architecture to give the high speed necessary to control the measurement processes of a bench/systems voltmeter. Two microprocessors are used: one for control of the measurement and the second for interface to the HP-IB and computation of the math functions.

Auto cal is a process by which the 3455A internally checks its DC and ohms operating circuits against internal references and corrects for errors. The benefits of auto cal are high accuracy and simplified calibration. Only four adjustments for calibration of DC and ohms are required and these are in the removable reference assembly. The microprocessor is also used to control the auto cal process and compute the correction factors.

The HP-developed fine-line tantalum nitride resistor technology used in several HP digital voltmeters is also used in the 3455A. This technology provides accurate temperature tracking resistors that result in excellent long term DC accuracy.

## Specifications

### DC Voltage

Ranges		Maximum Display	
High Resolution Off	High Resolution On	High Resolution Off	High Resolution On
0.1	—	±0.149999 V	—
1	1	±1.149999 V	±1.499999 V
10	30	±11.49999 V	±14.99999 V
100	100	±114.9999 V	±149.9999 V
1000	7500	±1149.999 V	±1000.000 V

### Performance (High Resolution Off)

#### Accuracy

24 hours 23°C ±1°C

- 10 V range: ±(0.002% of reading + 1 digit).
- 1 V range: ±(0.003% of reading + 1 digit).
- 0.1 V range: ±(0.004% of reading + 4 digits).
- 100 & 1000 V range: ±(0.004% of reading + 1 digit).

90 days 23°C ±5°C

- 10 V range: ±(0.005% of reading + 1 digit).
- 1 V range: ±(0.006% of reading + 1 digit).
- 0.1 V range: ±(0.007% of reading + 4 digits).
- 100 & 1000 V range: ±(0.007% of reading + 1 digit).

6 months 23°C ±5°C

- 10 V range: ±(0.008% of reading + 1 digit).
- 1 V range: ±(0.009% of reading + 1 digit).
- 0.1 V range: ±(0.010% of reading + 5 digits).
- 100 & 1000 V range: ±(0.010% of reading + 1 digit).

1 year 23°C ±5°C

- 10 V range: ±(0.013% of reading + 1 digit).
- 1 V range: ±(0.014% of reading + 1 digit).
- 0.1 V range: ±(0.015% of reading + 6 digits).
- 100 & 1000 V range: ±(0.015% of reading + 1 digit).

#### (High Resolution On)

#### Accuracy

24 hours 23°C ±1°C

- 10 V range: ±(0.002% of reading + 3 digits).
- 100 & 1000 V range: ±(0.004% of reading + 3 digits).
- 1 V range: ±(0.003% of reading + 4 digits).

90 days 23°C ±5°C

- 10 V range: ±(0.005% of reading + 3 digits).
- 100 & 1000 V range: ±(0.007% of reading + 3 digits).
- 1 V range: ±(0.006% of reading + 4 digits).

6 months 23°C ±5°C

- 10 V range: ±(0.008% of reading + 3 digits).
- 100 & 1000 V range: ±(0.010% of reading + 3 digits).
- 1 V range: ±(0.009% of reading + 5 digits).

1 year 23°C ±5°C

- 10 V range: ±(0.013% of reading + 3 digits).
- 100 & 1000 V range: ±(0.015% of reading + 3 digits).
- 1 V range: ±(0.014% of reading + 6 digits).

### Input characteristics

Input resistance: 0.1 V through 10 V range: >10<sup>10</sup> ohms. 100 V and 1000 V range: 10 megohm ±0.1%.

#### Maximum input voltage

- High to low input terminals: ±1000 V peak.
- Guard to chassis: ±500 V peak.
- Guard to low terminal: ±200 V peak.

Normal mode rejection (NMR): NMR is the ratio of the peak normal-mode voltage to the peak error voltage in the reading.

NMR at 50 or 60 Hz = 0.1%: >60 dB.

Effective common mode rejection (ECMR): ECMR is the ratio of the peak common-mode voltage to the resultant peak error voltage in the reading.

ECMR with 1 kΩ unbalance in low lead at

DC: >140 db.

50 Hz or 60 Hz = 0.1%: >160 db.

#### Maximum reading rate

	60 Hz Gate Length		50 Hz Gate Length	
	High Resolution Off	High Resolution On	High Resolution Off	High Resolution On
Local	5 rdg/s	3 rdg/s	3.5 rdg/s	2.5 rdg/s
Remote	24 rdg/s	6 rdg/s	22 rdg/s	5 rdg/s



# DIGITAL VOLTMETERS

## 5 1/2/6 1/2-digit DVM with Auto Cal

### Model 3455A (cont.)

#### AC Voltage (rms converter) (High Resolution On or Off)

Ranges: 1.00000 V      Maximum Display: 1.49999 V  
 10.0000 V            14.9999 V  
 100.000 V            149.999 V  
 1000.00 V            1000.00 V

Range selection: Manual, Automatic or Remote.  
 Function selection: ACV or Fast ACV.

#### Input characteristics

##### Input Impedance

Front terminals:  $2\text{ M}\Omega \pm 1\%$  shunted by less than 100 pf.  
 Rear terminals:  $2\text{ M}\Omega \pm 1\%$  shunted by less than 75 pf.

##### Maximum input voltage

High to low terminals:  $\pm 1414$  volts peak.\*\*\*  
 Guard to chassis:  $\pm 500$  V peak.  
 Guard to low terminal:  $\pm 200$  V peak.

\*\*\*Subject to a  $10^7$  volts-Hz limitation.

##### Maximum reading rate

	60 Hz Gate Length		50 Hz Gate Length	
	ACV	FAST ACV	ACV	FAST ACV
Local	1.3 rdg/s	4.5 rdg/s	1.1 rdg/s	3.5 rdg/s
Remote	1.3 rdg/s	13 rdg/s	1.1 rdg/s	12 rdg/s

#### Response time

##### ACV and FAST ACV

First reading to  $<0.1\%$  of step size when triggered coincident with step change when on correct range (for AC signals with no DC component).

#### AC voltage (average converter) Opt 001 (High Resolution On or Off)

Ranges: 1 V      Maximum Display: 1.49999 V  
 10 V            14.9999 V  
 100 V           149.999 V  
 1000 V           1000.00 V

Range selection: Manual, Automatic or Remote.  
 Function selection: ACV or Fast ACV.

#### Performance (rms converter)

##### Accuracy $\pm$ (% of reading + digits)\*

FAST ACV ACV	AC coupling				
	300 Hz-20 kHz 30 Hz-20 kHz	20 kHz-100 kHz	100 kHz-250 kHz**	250 kHz-500 kHz**	500 kHz-1 MHz**
24 hrs: 23°C = 1°C	0.04% + 40 digits	0.4% + 80 digits	1.8% + 200 digits	4% + 400 digits	5% + 1500 digits
90 days: 23°C = 5°C	0.50% + 50 digits	0.5% + 100 digits	2.0% + 250 digits	5% + 500 digits	6% + 2000 digits
6 mos: 23°C = 8°C	0.06% + 60 digits	0.6% + 130 digits	2.1% + 300 digits	5.1% + 600 digits	6.3% + 2400 digits
1 year: 23°C = 5°C	0.07% + 70 digits	0.7% + 160 digits	2.2% + 350 digits	5.3% + 700 digits	6.6% + 2800 digits

\*Guard must be connected to Low. On the 1000 V range add 0.01 ppm/volt-kHz.  
 AC  $<1\%$  of range and AC/DC: add 20 digits.

#### Input characteristics

Input Impedance: Front Terminals —  $2\text{ M}\Omega \pm 1\%$  shunted by less than 100 pf. Rear Terminals —  $2\text{ M}\Omega \pm 1\%$  shunted by less than 75 pf.

##### Maximum input voltage

High to low terminals:  $\pm 1414$  volts peak.\*\*\*  
 Guard to chassis:  $\pm 500$  V peak.  
 Guard to low terminal:  $\pm 200$  V peak.

\*\*\*Subject to a  $10^7$  volts-Hz limitation.

##### Maximum reading rate

	60 Hz Gate Length		50 Hz Gate Length	
	ACV	FAST ACV	ACV	FAST ACV
Local	1.3 rdg/s	4.5 rdg/s	1.1 rdg/s	3.5 rdg/s
Remote	1.3 rdg/s	13 rdg/s	1.1 rdg/s	12 rdg/s

#### Ohms

Ranges	Maximum Display	
	High Resolution Off	High Resolution On
0.100000 k $\Omega$	—	0.149999 k $\Omega$
1.00000 k $\Omega$	1.00000 k $\Omega$	1.49999 k $\Omega$
10.0000 k $\Omega$	10.0000 k $\Omega$	14.9999 k $\Omega$
100.000 k $\Omega$	100.000 k $\Omega$	149.999 k $\Omega$
1000.00 k $\Omega$	1000.00 k $\Omega$	1499.99 k $\Omega$
10000.0 k $\Omega$	10000.0 k $\Omega$	14999.9 k $\Omega$

Range selection: Manual, Automatic, or Remote.

Function selection: 2-wire k $\Omega$  or 4-wire k $\Omega$ .

#### Performance

##### (High Resolution Off)

Accuracy: 4-wire k $\Omega$

24 hours: 23°C  $\pm 1^\circ\text{C}$

0.1 k $\Omega$  range:  $\pm(0.003\%$  of reading + 4 digits).  
 1 k $\Omega$  range:  $\pm(0.003\%$  of reading + 1 digit).  
 10 k $\Omega$  range:  $\pm(0.005\%$  of reading + 2 digits).  
 100 k $\Omega$  range:  $\pm(0.002\%$  of reading + 2 digits).  
 1000 k $\Omega$  range:  $\pm(0.012\%$  of reading + 5 digits).  
 10 000 k $\Omega$  range:  $\pm(0.1\%$  of reading + 5 digits).  
 90 days: 23°C  $\pm 5^\circ\text{C}$   
 0.1 k $\Omega$  range:  $\pm(0.005\%$  of reading + 5 digits).  
 1 k $\Omega$  range:  $\pm(0.005\%$  of reading + 1 digit).  
 10 k $\Omega$  range:  $\pm(0.007\%$  of reading + 2 digits).  
 100 k $\Omega$  range:  $\pm(0.004\%$  of reading + 2 digits).  
 1000 k $\Omega$  range:  $\pm(0.014\%$  of reading + 5 digits).  
 10 000 k $\Omega$  range:  $\pm(0.100\%$  of reading + 5 digits).

#### Performance (average converter)

##### Accuracy $\pm$ (% of reading + digits)\*

FAST ACV ACV	300 Hz-500 Hz 30 Hz-50 Hz	500 Hz-1 kHz 50 Hz-100 Hz	1 kHz-100 kHz 100 Hz-100 kHz	100 kHz-250 kHz** 100 kHz-250 kHz**
	24 hrs: 23°C = 1°C	0.47% + 70 digits	0.32% + 50 digits	0.09% + 25 digits
90 days: 23°C = 5°C	0.05% + 70 digits	0.35% + 50 digits	0.1% + 25 digits	0.75% + 60 digits
6 mos: 23°C = 8°C	0.50% + 70 digits	0.40% + 60 digits	0.1% + 30 digits	0.75% + 70 digits
1 yr: 23°C = 5°C	0.50% + 70 digits	0.40% + 70 digits	0.12% + 35 digits	0.75% + 80 digits

\*Guard must be connected to Low. On the 1000 V range, add 0.01 ppm/volt-kHz. Specifications are for input levels above 1/100th of range.

\*\*Frequencies greater than 100 kHz specified on 1 and 10 V ranges only.



6 months: 23°C ± 5°C.

- 0.1 kΩ range: ±(0.005% of reading + 6 digits).
- 1 kΩ range: ±(0.005% of reading + 1 digit).
- 10 kΩ range: ±(0.007% of reading + 2 digits).
- 100 kΩ range: ±(0.004% of reading + 3 digits).
- 1000 kΩ range: ±(0.014% of reading + 5 digits).
- 10,000 kΩ range: ±(0.100% of reading + 5 digits).

1 year: 23°C ± 5°C

- 0.1 kΩ range: ±(0.006% of reading + 7 digits).
- 1 kΩ range: ±(0.006% of reading + 2 digits).
- 10 kΩ range: ±(0.008% of reading + 3 digits).
- 100 kΩ range: ±(0.005% of reading + 4 digits).
- 1000 kΩ range: ±(0.015% of reading + 6 digits).
- 10,000 kΩ range: ±(0.100% of reading + 6 digits).

4-wire kΩ

High Resolution On

24 hours: 23°C ± 1°C

- 1 kΩ range: ±(0.0025% of reading + 4 digits).
- 10 kΩ range: ±(0.0045% of reading + 4 digits).
- 100 kΩ range: ±(0.0020% of reading + 5 digits).
- 1000 kΩ range: ±(0.0120% of reading + 4 digits).
- 10,000 kΩ range: ±(0.1000% of reading + 4 digits).

6 months: 23°C ± 5°C

- 1 kΩ range: ±(0.0035% of reading + 5 digits).
- 10 kΩ range: ±(0.0060% of reading + 5 digits).
- 100 kΩ range: ±(0.0035% of reading + 6 digits).
- 1000 kΩ range: ±(0.0135% of reading + 5 digits).
- 10,000 kΩ range: ±(0.1000% of reading + 5 digits).

6 months: 23°C ± 5°C

- 1 kΩ range: ±(0.0040% of reading + 6 digits).
- 10 kΩ range: ±(0.0065% of reading + 6 digits).
- 100 kΩ range: ±(0.0040% of reading + 7 digits).
- 1000 kΩ range: ±(0.0140% of reading + 6 digits).
- 10,000 kΩ range: ±(0.1000% of reading + 6 digits).

1 year: 23°C ± 5°C

- 1 kΩ range: ±(0.0045% of reading + 7 digits).
- 10 kΩ range: ±(0.0070% of reading + 7 digits).
- 100 kΩ range: ±(0.0045% of reading + 8 digits).
- 1000 kΩ range: ±(0.0145% of reading + 7 digits).
- 10,000 kΩ range: ±(0.1000% of reading + 7 digits).

2-wire kΩ: all accuracy specifications are the same as 4-wire kΩ except add 0.0004 kΩ to all readings.

Input characteristics

Maximum voltage generated across unknown: < 5 volts for open circuit; < 4.7 volts for valid reading.

Signal source driving unknown (nominal): 0.1 kΩ, 1 kΩ & 10 kΩ ranges.

Overload protection

Non-Destruction: ±350 V peak.

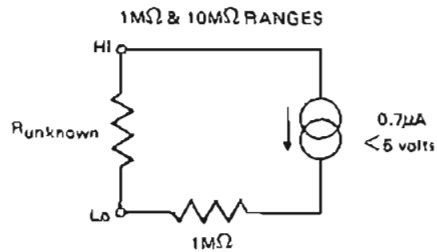
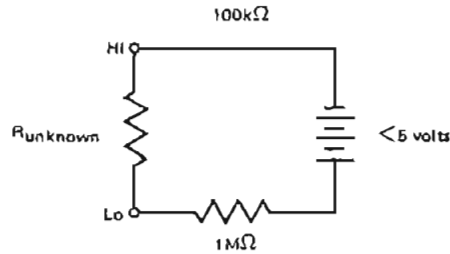
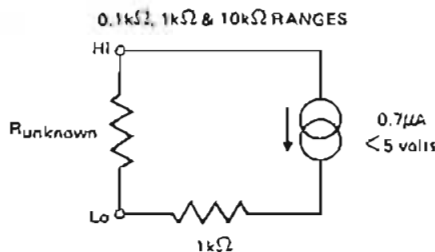

Maximum reading rate

	60 Hz Gate Length		50 Hz Gate Length	
	High Resolution Off	High Resolution On	High Resolution Off	High Resolution On
Local	4.5 rdg/s	2 rdg/s	4 rdg/s	1.8 rdg/s
Remote	12 rdg/s	3 rdg/s	11 rdg/s	2.5 rdg/s

Math

Scale ( $\frac{X-Z}{Y}$ ): X is present reading, Y and Z are previously entered readings, or numbers entered from the front panel or by external program.

Maximum number (entered or displayed): ±199,999.9.

Accuracy: ±(Accuracy of X reading ± 1 digit of displayed answer).

%Error ( $\frac{X-Y}{Y} \times 100\%$ ): X is present reading, Y is a previously entered reading, or number entered from the front panel or by external program.

Maximum number (entered or displayed): ±199,999.9.

Accuracy: ±(Accuracy of X reading ± 1 digit of displayed answer).

How to enter numbers in "Y" or "Z"

From a current displayed reading: press STORE "Y" or "Z".

From front panel: press ENTER "Y" or "Z". The front panel is now set for numerical entry. These numbers are in blue next to the keys. Enter number and press STORE "Y" or "Z".

By remote program: send program codes for equivalent front panel operations.

General

Power: 100 V, 120 V, 220 V ± 10%, 240 V ± 5% - 10%, 48 Hz to 400 Hz line operation; < 60 VA with all options.

Size: 85.7 H × 425.4 W × 520.7 mm D (3 3/8" × 16 3/4" × 20 3/8").

Weight: net, 9.38 kg (20 lb 11 oz). Shipping, 11.79 kg (26 lb).

Options

007: Average converter

3455A Digital Voltmeter

Price

less \$200

\$3200

# DIGITAL VOLTMETERS

Five-digit digital multimeter with self test

Model 3490A



HP-IB

## Description

Hewlett-Packard Model 3490A Multimeter is a five-digit integrating digital voltmeter. The basic instrument measures dc voltages, ac voltages, and resistances. Additional measurement capability is achieved by the addition of low cost options.

HP's 3490A uses a dual slope integrating techniques and is fully guarded, providing excellent noise immunity at five readings per second on all dc ranges. Ranging is automatic over all ranges on all functions. DC measurements can be made with  $1\mu\text{V}$  resolution on the 100 mV range. AC voltage measurements can be made from 20 Hz to 250 kHz in four ranges. The 1 V range provides  $10\mu\text{V}$  of ac voltage resolution. Ohms measurements can be made, utilizing the four-wire conversion technique which eliminates errors due to test lead resistances. Six ranges of ohms, including a  $100\Omega$  range, are provided. All functions and ranges include 20% overranging except the 1000 V range.

## Display

The 3490A uses Hewlett-Packard's light emitting diodes (LED's). These display digits are the seven segment type. The extremely high reliability of this LED display assures maximum life.

## Self-test

At the flip of a switch, Hewlett-Packard's 3490A Digital Multimeter sequences itself through 10 tests that check timing signals and autoranging circuits, validate the performance of most logic-circuit IC's and check the six-digit LED display. These tests, and six others provided by six additional front-panel switches, cut calibration costs and ensure the DMM is ready to make accurate measurements.



## DC functions

The standard 3490A includes five ranges of dc measurement capability from 100 mV to 1000 V. Measurements are made from the front panel at precise five readings/s, and at slower rates, using digitally controlled sampled rate selector. High input resistance,  $>10^{10}\Omega$  on 100 mV, 1 V, and 10 V range, assures accurate measurement of high impedance sources.

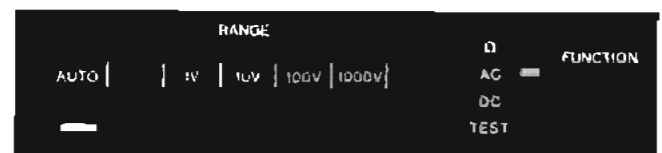

## AC functions

Four ranges of ac measurements are provided. The average ac value is accurately detected, and the rms value is displayed with five digits of resolution. Full autoranging, wide frequency response, and 20% overranging are designed-in features to permit easy operation.



## Ohms

Six ohms ranges are standard, and all ranges provide true four-wire ohms measurement capability. Maximum current through the unknown is approximately 1 mA. Over-voltage protection for ohms sensing terminals insures maximum protection against inadvertent application of a high voltage to ohms terminals. Over-voltage protection is provided to 250 V and fuse protection to 1000 V.

### Serviceability

HP's 3490A has been "designed for serviceability." Inside, the 3490's low parts density provides easy access for servicing. Test points and jumpers are keyed to detailed diagnostics.

Several diagnostic aids are available to further minimize 3490A repair time. A service video tape, Accessory No. 11128A, will demonstrate use of self-test and front panel symptoms to isolate failures. The 11126A accessory provides a set of IC reference boards with most of the 3490A logic IC's for use with HP 10529A Logic Comparator. Using these boards with the Logic Comparator, a faulty IC can be isolated in seconds without removing it from the circuit. Also, a spare parts set, Accessory No. 11127A, containing most critical components of the 3490A, will be available.

### Options

#### Systems applications

Model 3490A offers built-in flexibility for systems applications. HP's 3490A offers both HP-IB interface and a bit parallel (BCD coded) interface. This combination provides the necessary versatility to configure the lowest cost instrument system.

#### Ratio, opt 080

DC/DC and AC/DC three-wire ratio measurements can be conveniently added to the 3490A. This capability offers both auto-polarity and a selection of two reference ranges. The 1 V and 10 V ranges are specified from 10% to 120% of selected range. Ratio function is not programmable.

#### 50 Hz operation, opt 050; 60 Hz operation, opt 060

Maximum noise immunity is achieved when power line frequency is harmonically related to the sample period of the integrating DMM. Option 050 will maximize normal and common mode rejection for 50 Hz power line frequency, and Option 060 will provide this rejection for 60 Hz.

#### Sample/hold, option 040 and 045

Sample/hold provides HP's 3490A with extra and unique measurement capability.

The Sample/hold option has two modes of operation to solve difficult measurement problems.

**Track and hold:** in this mode, input voltage is held instantly upon receiving an external command. This mode is useful in digitization of repetitive or transient waveforms.

**Acquire and hold:** in this mode, a known delay is inserted to permit the input amplifier to settle to a specified accuracy. This is useful in measuring pulse height or any similar step input.

#### Digital output, opt 021 and remote control, opt 022

These options provide digital control and data output in the parallel BCD code of 8-4-2-1, either negative or positive true logic. Selection is accomplished by positioning an internal switch. The remote control option provides complete control of all functions, ranges, and external trigger commands. The digital output option provides nine columns of information which include function, polarity, data, and range. These options may be purchased separately to meet specific application requirements. Either of these options require Option 020 Systems Expand.

### BCD/remote

Both Option 021 and 022 require Option 020, BCD/Remote Expand. This option provides the required internal and external connectors to permit user installation of Digital Output, Opt 021 and/or Remote Control, Opt 022 and should be ordered as an initial option on HP's 3490A. This option includes rear terminals in parallel (switchable front/rear terminals are available as a special - H19).

### HP-IB data input/output, opt 030

The HP-IB option permits HP Model 3490A to operate on a single data/control bus with up to 14 other instruments. This serial code is an eight-bit byte typically using an ASCII-type coding. A unique "talker/listener" address structure makes the system's hardware more economical and associated software much simpler. The HP-IB is compatible with Hewlett-Packard Models 9815A, 9820A, 9821A, 9825A and 9830A calculators as well as Hewlett-Packard computers.

### Specifications

#### DC voltage ranges

**Full range display:**  $\pm 1.00000$  V,  $\pm 1.00000$  V,  $\pm 10.0000$  V,  $\pm 100.0000$  V,  $\pm 1000.00$  V.

**Overrange:** 20% on all ranges except 1000 V range.

**Range selection:** manual, automatic, or remote (optional).

#### DC voltage performance

**Accuracy**  $\pm$ (% of reading + % of range)

		0.1 V Range		1 V to 1000 V Range	
		% rdg.	% rng.	% rdg.	% rng.
24 hrs	(23°C $\pm$ 1°C)	$\pm(0.005 + 0.001)$		$\pm(0.004 + 0.002)$	
30 days	(23°C $\pm$ 5°C)	$\pm(0.01 + 0.005)$		$\pm(0.008 + 0.002)$	
90 days	(23°C $\pm$ 5°C)	$\pm(0.01 + 0.005)$		$\pm(0.01 + 0.002)$	
6 months	(23°C $\pm$ 5°C)	$\pm(0.013 + 0.005)$		$\pm(0.013 + 0.002)$	
1 year	(23°C $\pm$ 5°C)	$\pm(0.015 + 0.005)$		$\pm(0.015 + 0.002)$	

**DC voltage input characteristics:** fully guarded with 140 dB E.C.M.R. at dc and 60 Hz  $\pm 0.1\%$  with 1 k $\Omega$  imbalance between guard and low.

#### Maximum input voltage

**0.1 V to 1000 V ranges:**  $\pm 1500$  V peak.

**Guard to chassis:**  $\pm 500$  V peak.

**Guard to low:**  $\pm 200$  V peak.

#### Input resistance

**0.1 V to 10 V ranges:**  $> 2 \times 10^{14} \Omega$ . (<70% R.H.).

**100 V and 1000 V ranges:** 10 M $\Omega$   $\pm 0.15\%$ .

#### Maximum reading rate: 5 readings/s.

**Normal mode rejection ratio:** 50 Hz  $\pm 0.1\%$ ; 60 Hz  $\pm 0.1\%$ ;  $> 50$  dB.

#### Notes:

1. On the 1000 V range, add 0.04 ppm/volt to the % of reading specification.

2. Thermal EMF's generated external to the DVM may be compensated to achieve the % of range accuracy specified by utilizing the rear panel zero adjust provided in the 3490A.

#### AC voltage ranges

**Full range display:** 1.00000 V, 10.0000 V, 100.000 V, 1000.00 V.

**Overrange:** 20% on all ranges except 1000 V range.

**Range selection:** manual, automatic, or remote (optional).



# DIGITAL VOLTMETERS

## Five-digit digital multimeter with self-test

### Model 3490A (cont.)

#### AC voltage performance

Accuracy  $\pm$  (% of reading + % of range)

		20 Hz—50 Hz	50 Hz—100 kHz	100 kHz—750 kHz
24 hrs	(23°C $\pm$ 1°C)	$\pm(0.32 + 0.05)$	$\pm(0.09 + 0.025)$	$\pm(0.7 + 0.05)$
30 days	(23°C $\pm$ 5°C)	$\pm(0.35 + 0.05)$	$\pm(0.1 + 0.025)$	$\pm(0.75 + 0.05)$
90 days	(23°C $\pm$ 5°C)	$\pm(0.35 + 0.05)$	$\pm(0.1 + 0.025)$	$\pm(0.75 + 0.05)$
6 months	(23°C $\pm$ 5°C)	$\pm(0.40 + 0.05)$	$\pm(0.1 + 0.03)$	$\pm(0.75 + 0.07)$
1 year	(23°C $\pm$ 5°C)	$\pm(0.45 + 0.07)$	$\pm(0.12 + 0.035)$	$\pm(0.75 + 0.08)$

#### AC voltage input impedance

Without rear terminals: 2 M $\Omega$   $\pm$  1% shunted by < 65 pF.

With rear terminals: 2 M $\Omega$   $\pm$  1% shunted by < 90 pF.

AC voltage maximum reading rate: 1 reading/s.

AC voltage response time: < 1  $\mu$ s to within rated accuracy for a step input applied coincident with encoder trigger.

AC maximum input voltage: 1000 V rms;  $\pm$  1500 V peak.

#### Notes:

- Guard must be connected to low.
- On the 1000 V range, add 0.01 ppm/(volt-kHz).
- Frequencies > 100 kHz specified on 1 V and 10 V ranges only.
- Specifications are for input levels above 1/100th of full scale.

#### Ohms ranges

Full range display: .100000 k $\Omega$ , 1.00000 k $\Omega$ , 10.0000 k $\Omega$ , 100.000 k $\Omega$ , 1000.00 k $\Omega$ , 10000.0 k $\Omega$ .

Overrange: 20% on all ranges.

Range selection: manual, automatic, or remote (optional).

#### Ohms performance

Accuracy  $\pm$  (% of reading + % of range)

Note: Thermal EMF's generated external to the DVM may be compensated to achieve the % of range accuracy specified by utilizing the rear panel zero adjust provided in HP's 3490A.

		0.1 k $\Omega$	1 k $\Omega$ —100 k $\Omega$	1000 k $\Omega$	10,000 k $\Omega$
		% rdg. % rng.	% rdg. % rng.	% rdg. % rng.	% rdg. % rng.
24 hrs	(23°C $\pm$ 1°C)	$\pm(0.006 + 0.001)$	$\pm(0.005 + 0.001)$	$\pm(0.007 + 0.001)$	$\pm(0.025 + 0.001)$
30 days	(23°C $\pm$ 5°C)	$\pm(0.012 + 0.005)$	$\pm(0.010 + 0.002)$	$\pm(0.012 + 0.002)$	$\pm(0.035 + 0.002)$
90 days	(23°C $\pm$ 5°C)	$\pm(0.012 + 0.005)$	$\pm(0.012 + 0.002)$	$\pm(0.015 + 0.002)$	$\pm(0.035 + 0.002)$
6 months	(23°C $\pm$ 5°C)	$\pm(0.015 + 0.005)$	$\pm(0.015 + 0.002)$	$\pm(0.020 + 0.002)$	$\pm(0.040 + 0.002)$
1 year	(23°C $\pm$ 5°C)	$\pm(0.018 + 0.005)$	$\pm(0.018 + 0.002)$	$\pm(0.025 + 0.002)$	$\pm(0.050 + 0.002)$

#### Ohms terminal characteristics

Maximum voltage generated across unknown: 20 V for overload; 13 V for valid reading.

#### Ohms current thru unknown

0.1 k $\Omega$  to 10 k $\Omega$  range: 1 mA.

100 k $\Omega$  to 1000 k $\Omega$  range: 10  $\mu$ A.

10,000 k $\Omega$  range: 1  $\mu$ A.

#### Ohms overload protection

Nondestructive: 250 V rms.

Fuse destructive:  $\pm$  1000 V peak.

#### Ohms maximum reading rate

0.1 k $\Omega$  to 100 k $\Omega$  range: 5 readings/s.

1000 k $\Omega$  range: 4 readings/s.

10,000 k $\Omega$  range: 2 readings/s.

#### General

##### Data output (BCD), option 021

Data output is 1-2-4-8 TTL output which is compatible with HP 562A, 5050B, and 5055A Digital Recorders. Either high true or low true logic code can be selected with an internal switch.

Storage temperature: -40°C to +75°C.

#### Remote control, option 022

The remote control option uses a low true logic (BCD type) code. Required voltage levels for input signal and output signal levels are listed below.

#### BCD and remote terminals

	High Level	Low Level
DVM Inputs	+3.9 V $\pm$ 1.5 V, 100 $\mu$ A max	-0.3 V $\pm$ 0.3 V, 2 mA max
DVM Outputs	+3.9 V $\pm$ 1.5 V, 400 $\mu$ A max	-0.3 V $\pm$ 0.3 V, 15 mA max

Operating temperature: 0°C to 50°C.

Warm-up time: one hour warm-up required to meet all specifications on the 0.1 V range and the 0.1 k $\Omega$  range. Thirty minutes warm-up required to meet all other specifications.

Humidity range: < 95% R.H., 0°C to 40°C.

Power: 100 V, 120 V, 220 V, 240 V  $\pm$  5%, -10%, 48 Hz to 400 Hz line operation  $\leq$  60 VA with all options.

Size: 85.7 H  $\times$  425.4 W  $\times$  466.7 mm D (3 $\frac{3}{8}$ "  $\times$  16 $\frac{3}{4}$ "  $\times$  18 $\frac{3}{8}$ ").

Weight: net, 9.38 kg (20.7 lb). Shipping, 11.79 kg (26 lb).

Options	Price
020: BCD/remote expand, includes rear terminals in parallel	\$245
021: BCD*—full parallel, 1-2-4-8 code	\$305
022: Remote*—full parallel, 1-2-4-8 code	\$210
030: HP-1B remote control and data output	\$1045
040: Sample-and-hold*	\$545
045: Sample-and-hold (without Opt 020 or 030)	\$570
050 or 060: 50 Hz or 60 Hz operation	\$1/C
080: Three-wire ratio	\$245
Rack mounting kit furnished	

3490A Digital Multimeter (includes ac, dc, & ohms) \$2200

Opt 050: Noise Rejection for 50 Hz \$1/C

Opt 060: Noise Rejection for 60 Hz N/C

\*These options require BCD/Remote Expand Option 020 or HP-1B Opt 030.

Note: Rack mounting requires support in rear of instrument.

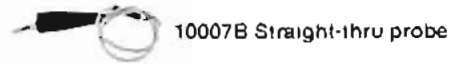

10007B Straight-thru probe



11067A Test lead kit

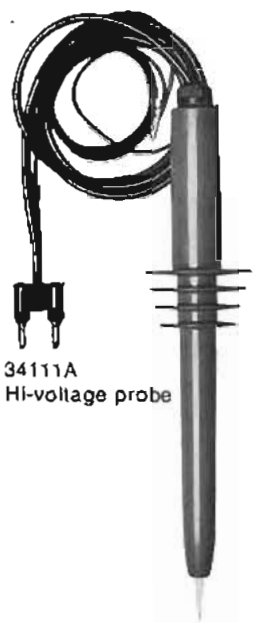

34111A  
Hi-voltage probe



11096B  
High frequency probe



34110A Soft vinyl carrying case



34112A Touch-hold probe

### 10007B, 10008B Probe

The 10007B and 10008B are straight-thru BNC probes with a retractable hook tip and 20 cm (8 in.) ground lead with alligator tip.

	Peak Voltage	Shunt Capacitance	Length
10007B	600 V	40 pF	1.1 m (3.5 ft.)
10008B	600 V	60 pF	1.8 m (6 ft.)

### 11067A Test lead kit

Includes two leads with many interchangeable tips to accommodate various applications.

### 11068A

Soft carrying case for 3476A and B DMM. Has shoulder strap and zippered opening for instrument and accessory pouch.

### 11096B High frequency probe

Converts dc voltmeter with 10 MΩ input to high-frequency ac voltmeter. Works with any dc voltmeter with 10 MΩ input impedance.

### 11096B Specifications

**Voltage range:** 0.25 to 30 V rms.

**Transfer accuracy (when used with 10 MΩ = 10% dc voltmeter)**

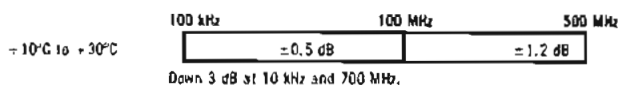

**Response:** peak responding. Calibrated to read rms value of sine wave.

**Input impedance:** 4 MΩ shunted by 2 pF.

**Maximum input:** 30 V rms ac; 200 V dc.

**Cable length:** 4' long (1219 mm).

**Accessories furnished:** High-Frequency Adapter; Straight Tip; Hook Tip; Ground Lead.

**Accessories available:** HP 10218A BNC Adapter; HP 10219A Type 874 Adapter; HP 10220A Microdot Adapter; HP 11063A 50Ω Tee.

### 34110A

Carrying case for 1/2 rack size instruments. Inside dimensions of 25.4 cm × 22.9 cm × 10.2 cm or 10" deep × 9" wide × 4" thick. Zipper flip top lid and zippered accessory pouch. Has shoulder carrying strap.

### 34111A DC Hi-voltage probe

1000:1 divider will accept up to 48 kV. Input Z = 10<sup>9</sup>Ω, divider accuracy. Meets specifications when connected to 10 MΩ input resistance instrument.

0-20 kV

<4%

30-40 kV

<2%

20-30 kV

Divider has interchangeable hook and pointed tip.

### 34112A Touch-hold probe

Allows user to hold DMM display by depressing button on probe body. Both AC and DC voltage up to 1200 V max. DC or AC RMS may be measured and held. Usable on the 3435A and 3465A and B.

### Ordering Information

10007B Probe	\$27
10008B Probe	\$27
11067A Test Lead Kit	\$5
11068A Soft Carrying Case for 3476A and B DMM	\$20
11096B High Frequency Probe	\$90
34110A Carrying Case for 1/2 Rack Size Instruments	\$25
34111A DC Hi-Voltage Probe	\$75
34112A Touch-Hold Probe	\$40

### Price:

# DIGITAL VOLTMETERS

## DVM Interchangeable displays

### Model 3470 system

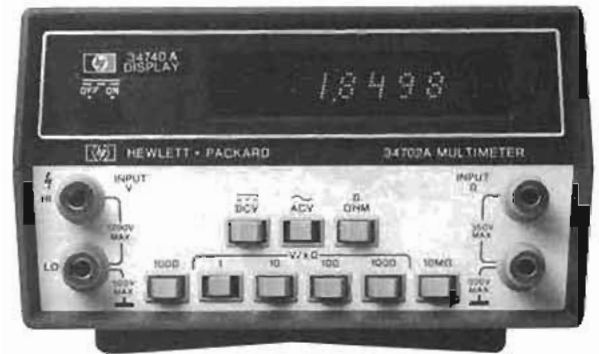

## Description

Hewlett-Packard's 3470 is a low cost line of DVM's using a flexible snap-together package. Two display sections provide a choice of four or five digits, both with 100% overranging and LED display. These displays lock onto an ac/dc/ $\Omega$  multimeter. In addition, a temperature module is available for use with the four-digit display section.

### 34740A Display

This 4½-digit display locks onto the 34702A voltmeter module to form a complete DVM using a clear, LED display with four full digits plus 100% overranging.

### 34750 Display

This 5½-digit display offers five-digit resolution with any 34702A voltmeter module. As with the 34740, it uses a LED display with 100% overranging.

### 34702A Multimeter

This **plug-on** provides four ranges of both ac and dc plus six ranges of **ohms**. AC function covers 45 Hz to 100 kHz. Ohms ranges are 100 $\Omega$  to 10 M $\Omega$  full scale.

### 2802A Thermometer

This unit includes a thermomodule (lower unit) which contains temperature measuring circuits, probe connections and operating controls; HP's 34740A 4½-digit display is included. Option 001 deletes the display for those that want to use their own 4½-digit display.

## 34702A Specifications

### DC voltage

Range:  $\pm 1$  V to  $\pm 1000$  V full scale in four decade ranges.

Display: 4-digit (34740A) or 5-digit (34750A).

## Full range display

Range	4-digit display	5-digit display
$\pm 1$ V	$\pm 1.0000$ V	$\pm 1.00000$ V
$\pm 10$ V	$\pm 10.000$ V	$\pm 10.0000$ V
$\pm 100$ V	$\pm 100.00$ V	$\pm 100.000$ V
$\pm 1000$ V	$\pm 1000.0$ V	$\pm 1000.00$ V

Overrange: 100% except 20% on 1000 V range.

Range selection: manual pushbuttons.

Accuracy (30 days, +23°C  $\pm$  5°C,  $\leq$  95% R.H.)

4-digit display:  $\pm (0.03\% \text{ rdg} + 0.01\% \text{ rng})$ .

5-digit display:  $\pm (0.02\% \text{ rdg} + 0.005\% \text{ rng})$ .

Temperature coefficient (0°C to +50°C)

4-digit display:  $\pm (0.0035\% \text{ rdg} + 0.001\% \text{ mg})/^\circ\text{C}$ .

5-digit display:  $\pm (0.0025\% \text{ rdg} + 0.0002\% \text{ mg})/^\circ\text{C}$ .

Stability (24 hours, +23°C  $\pm$  1°C)

4-digit display:  $\pm (0.01\% \text{ rdg} + 0.005\% \text{ mg})$ .

5-digit display:  $\pm (0.008 \text{ rdg} + 0.004\% \text{ mg})$ .

Reading rate

Display option	4-digit display	5-digit display
Opt 000 (50 Hz rejection)	5/s	5/s
Opt 050 (50 Hz rejection)	8/s	4/s

Input terminals: floating pair.

Input resistance: 11.11 M $\Omega$   $\pm$  0.2% on 1 V and 10 V ranges; 10.1 M $\Omega$   $\pm$  0.2% on 100 V range; 10 M $\Omega$   $\pm$  0.2% on 1 kV range.

Effective CMR: 1 k $\Omega$  unbalance: >80 dB at dc.

Normal mode rejection: >60 dB at 50 Hz  $\pm$  0.1% (Opt 050) or at 60 Hz  $\pm$  0.1% (Opt 060).

Maximum input voltage:  $\pm 1200$  V, high to low;  $\pm 500$  V low to chassis.

## AC Voltage

**Voltage range:** 1 V ac to 1000 V ac full scale in four decade ranges.  
**Full range display**

Range	4-digit display	5-digit display
1 V	1.0000 V	1.00000 V
10 V	10.000 V	10.0000 V
100 V	100.00 V	100.000 V
1000 V	1000.0 V	1000.00 V

Because the internal temperature differs on line and battery operation, references must be adjusted to retain this specification when type of power source is changed.

**Detector:** average-responding.

**Scale:** rms for a sine wave.

**Frequency range:** 45 Hz to 100 kHz.

**Accuracy (30 days, 23°C ± 5°C, ≤ 95% RH)**

Display	45 Hz to 20 kHz	20 kHz to 100 kHz
4-digit	±(0.25% rdg + 0.05% rng)	±(0.75% rdg + 0.05% rng)
5-digit	±(0.25% rdg + 0.05% rng)	±(0.75% rdg + 0.05% rng)

**Temperature coefficient (0°C to +50°C):** ±(0.03% rdg + 0.001% rng)/°C.

**Stability (24 hours, +23°C ± 1°C):**

45 Hz to 20 kHz: ±(0.15% rdg + 0.05% rng).

20 kHz to 100 kHz: ±(0.4% rdg + 0.05% rng).

**Response time:** < 2 s to within +0.3% of final value or 20 counts, whichever is greater.

**Input impedance:** 11.11 MΩ ± 0.2%, 80 pF shunt on 1 V and 10 V ranges; 10.1 MΩ ± 0.2%, 80 pF shunt on 100 V range; 10 MΩ ± 0.2%, 80 pF shunt on 1000 V range.

**Input terminals:** floating pair.

**Maximum input voltage:** 1200 V rms high to low, except 2.5 × 10<sup>5</sup> V Hz limit on 1 V range with minimum protection of 300 V rms and maximum of 1200 V p; ± 500 V, p, dc to 440 Hz low to chassis.

**Resistance**

**Range:** 100Ω to 10 MΩ full scale in 6 decade ranges

**Full range display**

Range	4-digit display	5-digit display
100Ω	100.00Ω	100.000Ω
1 kΩ	1.0000 kΩ	1.00000 kΩ
10 kΩ	10.000 kΩ	10.0000 kΩ
100 kΩ	100.00 kΩ	100.000 kΩ
1 MΩ	1.0000 MΩ	1.00000 MΩ
10 MΩ	10.000 MΩ	10.0000 MΩ

**Overrange:** 100% on all ranges.

**Accuracy (30 days, +23°C, ± 5°C ≤ 95% RH)**

Range	4-digit display	5-digit display
10 MΩ	±(0.25% rdg + 0.02% rng)	±(0.25% rdg + 0.015% rng)
Others	±(0.05% rdg + 0.02% rng)	±(0.045% rdg + 0.015% rng)

**Temperature coefficient (0° to +50°C)**

10 MΩ range: ±(0.035% rdg + 0.001% rng)/°C.

Other ranges: ±(0.006% rdg + 0.001% rng)/°C.

**Stability (24 hours, +23°C):**

10 MΩ range: ±(0.1% rdg + 0.01% rng).

Other ranges: ±(0.02% rdg + 0.02% rng).

**Input terminals:** floating pair (different from voltage input terminals).

**Current through unknown:** 10 mA on 100Ω range decreasing one decade per successively higher range.

**Overload protection:** ±350 Vp (248 V sine wave).

## 2802A Specifications

2802A Digital Thermometer is complete with 4½-digit HP 34740A display, less probe. Opt 050 for 50 Hz or Opt 060 for 60 Hz operation must be specified.

These specifications are "total system specifications" meaning they apply to both the instrument and the probe working together (not just the best electronic specifications for the instrument by itself). HP 2802A Thermometer specifications relate directly to system performance under actual working conditions.

**Ranges:** -200° to +600°C and -100° to +200°C.

**Resolution:** 0.1°C on -200°C to +600°C range. 0.01°C on -100° to +200°C range.

**Accuracy:** ±(0.5°C ± 0.25% of reading) on both ranges.

**Display:** 4½ digits LED on HP 34740A module.

**Stability:** ±0.2°C for seven days (23°C ± 5°C ambient).

**Linear analog output:** 1 mV/°C on -200° to +600°C range (-0.2 V to +0.6 V FS). 10 mV/°C on -100 to +200°C range (-1.0 V to +2.0 V FS). Voltage accuracy equal to that of digital display. Output impedance 1 kΩ on both ranges.

**Environmental standard:** HP 2802A Thermometer operates within these specifications in environments of 0° to 50°C and up to 95% relative humidity over most of this temperature range. After calibration in some arbitrary ambient temperature, instrument calibration remains valid with ambient temperature changes up to 10°C.

For the following probes, time constant is determined using water flowing at 1 m per second.

18641A Probe contains the sensor in the tip of a 13 cm (5 in.) stainless steel sheath, 6.4 mm (¼") diameter, with armored cable 1.8 m (6 ft.) long. It operates from -200 to +500°C, to +600°C short term. Cable movement must be prevented above 250°C. Time constant is five seconds.

18642A Probe is the same as the 18641A except that it has a Teflon-insulated cable 1.8 m long. This cable must be kept below 250°C.

18643A Probe contains the sensor in the tip of a 13 cm stainless steel sheath. For fast response, the last 5.1 cm (2") of the sheath tip is reduced to 0.32 cm (0.13") diameter. This probe operates from -200° to +500°C, to +600°C short term. It has a 1.8 m Teflon-insulated cable. This cable must be kept below 250°C. Time constant is 1.8 seconds.

18644A Probe Kit includes platinum sensor cartridge, 1.3 cm × 0.25 cm diameter, having two nickel leads, 1 cm × 0.03 cm diameter, cable connector, wiring diagram for four-wire hook-up. Time constant 0.5 sec.

**General**

**Operating temperature:** 0°C to 50°C.

**Storage temperature:** -40°C to 74°C.

**Power:** ≤ 8.7 VA at 100 V, 120 V, 220 V, +5%, -10% switchable; 48 Hz to 440 Hz.

**Weight**

34740A 4-digit display: net, 1.36 kg (3 lb). Shipping, 1.92 kg (4 lb 4 oz).

34750A 6-digit display: net, 1.36 kg (3 lb). Shipping, 1.92 kg (4 lb 4 oz).

2802A Thermomodule + display: net, 2.27 kg (5 lb). Shipping, 3.39 kg (7 lb 8 oz).

**Size:**

Display + meter: 98.4 H × 158.8 W × 247.7 mm D (3<sup>7</sup>/<sub>8</sub>" × 6<sup>1</sup>/<sub>4</sub>" × 9<sup>7</sup>/<sub>8</sub>").

**Accessories available:** 11096B High Frequency Probe, measures to 700 MHz. Accepts 0.25 V to 30 V signals with input impedance of 4 MΩ shunted by 2 pF; 11456A Read Out Test Card for testing and troubleshooting either display. 18641A Probe; 18642A Probe; 18643A Probe; 18644A Probe Kit.

**Options and accessories**

2802A Opt 001 bottom module only (less display) **Price** less \$420

Opt 050 50 Hz rejection } specify one **N/C**

Opt 060 60 Hz rejection } **N/C**

11096B High Frequency Probe \$90

11456A Read Out Test Card \$70

56A-16C Cable for operating 5055A Digital Recorder \$60

18641A Temperature Probe \$165

18642A Temperature Probe \$150

18643A Temperature Probe \$180

18644A Temperature Probe Kit \$105

## Ordering Information

2802A Digital Thermometer (includes 4½-digit display) **\$895**

34702A Multimeter **\$475**

34740A 4-digit display **\$475**

34750A 5-digit display **\$775**

# DIGITAL VOLTMETERS

1  $\mu\text{V}$  Sensitivity, 4½-digit, 5-function multimeter

Models 3465A and B



3465A



3465B

## Description

The 3465A and B are 4½ digit multimeters providing five functions of ACV, DCV, ACI, DCI and  $\Omega$ . They feature both portability and bench applications by offering a choice of line and battery power options. The 3465A is offered in the half-module rack and stack case. The 3465B is offered in the rugged streamlined synthetic case with a carrying handle. Both units accept the 34112A touch-hold probe for "eyes-on" measurements of AC and DC voltage.

## Specifications

### DC Voltmeter

**Voltage ranges:**  $\pm 20.000\text{ mV}$   
 $\pm 200.00\text{ mV}$   
 $\pm 2.0000\text{ V}$   
 $\pm 20.000\text{ V}$   
 $\pm 200.00\text{ V}$   
 $\pm 1000.0\text{ V}$

**Maximum Input:** 1000 VDC and peak AC.

**Sensitivity:** 1 microvolt on lowest range.

**Polarity:** automatically sensed and displayed.

**Accuracy** (1 year + 23°C  $\pm 5^\circ\text{C}$ ).

Range	Specifications
20 mV	$\pm 0.03\%$ of reading $\pm 2$ digits
200 mV thru 200 V	$\pm 0.02\%$ of reading $\pm 1$ digit
1000 V	$\pm 0.025\%$ of reading $\pm 1$ digit

**Temperature coefficient:** (0°C to 50°C):  $\pm 0.003\%$  of reading/ $^\circ\text{C}$ .

**Input resistance:**

Range	Specifications
20 mV thru 2 V	$\geq 10^9\Omega$
20 V thru 1000 V	10 M $\Omega \pm 1$

**Normal mode rejection:**  $> 60\text{ dB}$  at 50/60 Hz  $\pm 0.1\%$ .

**Effective common mode rejection:** (1 k $\Omega$  unbalanced) AC:  $> 120\text{ dB}$  at 50/60 Hz  $\pm 0.1\%$

### DC current

**Current ranges:**  $\pm 200.00\ \mu\text{A}$   
 $\pm 2.0000\text{ mA}$   
 $\pm 20.000\text{ mA}$   
 $\pm 200.00\text{ mA}$   
 $\pm 2000.0\text{ mA}$

**Maximum Input:** 2A from  $< 250\text{ V}$  source (fuse protected).

**Sensitivity:** 10 nA on lowest range.

**Polarity:** automatically sensed and displayed.

**Accuracy** (1 year + 23°C  $\pm 5^\circ\text{C}$ )

Range	Specifications
200 $\mu\text{A}$ , 2 mA	$\pm 0.07\%$ of reading $\pm 1$ digit
20 mA	$\pm 0.11\%$ of reading $\pm 1$ digit
200 mA, 2000 mA	$\pm 0.6\%$ of reading $\pm 1$ digit

**Temperature coefficient** (0°C to 50°C)

Range	Specifications
200 $\mu\text{A}$	$\pm 0.006\%$ of reading/ $^\circ\text{C}$
2 mA, 20 mA	$\pm 0.004\%$ of reading/ $^\circ\text{C}$
200 mA 2000 mA	$\pm 0.01\%$ of reading/ $^\circ\text{C}$

### Voltage burden

**Highest range:**  $< 700\text{ mV FS}$ .

**All other ranges:**  $< 250\text{ mV FS}$ .

### Ohmmeter

**Ohms ranges:** 200.00  $\Omega$   
2.0000 k $\Omega$   
20.000 k $\Omega$   
200.00 k $\Omega$   
2000.0 k $\Omega$   
20.000 M $\Omega$

**Protection:** 350 V (DC + peak AC); 250 V rms.

**Sensitivity:** 10 milliohm on lowest range.

**Accuracy** (1 year + 23°C  $\pm 5^\circ\text{C}$ )

Range	Specifications
200 $\Omega$	$\pm 0.02\%$ of reading $\pm 2$ digits
2 k $\Omega$ thru 2 M $\Omega$	$\pm 0.02\%$ of reading $\pm 1$ digit
20 M $\Omega$	$\pm 0.1\%$ of reading $\pm 1$ digit

**Temperature coefficient** (0°C to 50°C).

Range	Specifications
200 $\Omega$ thru 2 M $\Omega$	$\pm 0.0015\%$ of reading/ $^\circ\text{C}$
20 M $\Omega$	$\pm 0.004\%$ of reading/ $^\circ\text{C}$

**Configuration:** 2 wire.



**Open circuit voltage:** <5 V max.  
**Current through unknown**

Range	I
200Ω	1 mA
2 kΩ	1 mA
20 kΩ	10 μA
200 kΩ	10 μA
2000 kΩ	1 μA
20 MΩ	0.1 μA

**AC voltmeter**

**Voltage range:** 200.00 mV  
 2.0000 V  
 20.000 V  
 200.00 V  
 500 V

**Maximum input:** full scale to 10 kHz decreasing linearly to 50% of full scale at 20 kHz; except on 500 V range, 2 kHz.  
**Overload protection:** 600 V DC max.  
 500 V AC rms  
 800 V peak.

**Sensitivity:** 10 μV on lowest range.

**Accuracy:** converter is average responding calibrated to rms (1 year + 23°C ± 5°C)

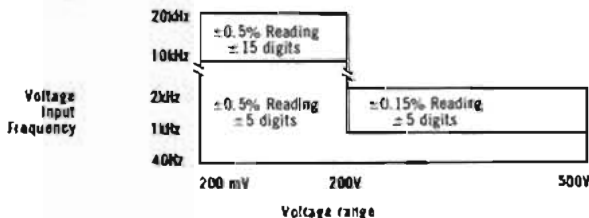

**Temperature coefficient:** (0°C to 50°C): ±0.005% of reading + 0.2 digit.

**Input impedance:** resistance: 1 MΩ, <100 pF shunt.

**AC current**

**Current range:** 200.00 μA  
 2.0000 mA  
 20.000 mA  
 200.00 mA  
 2000.0 mA

**Maximum input:** full scale to 10 kHz decreasing linearly to 50% of full scale at 20 kHz.

**Maximum input:** 2 A from <250 V source (fuse protected).

**Sensitivity:** 10 nA on lowest range.

**Accuracy:** (1 year + 23°C ± 5°C)

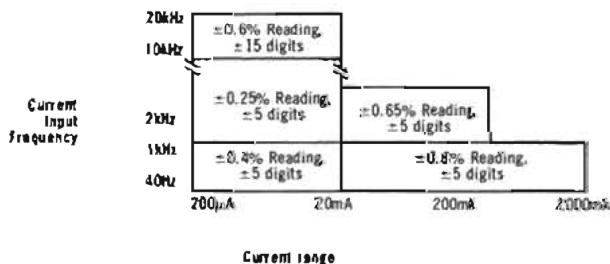

**Temperature coefficient:** (0°C to 50°C): ±0.01% of reading/°C.

**Voltage burden:**

1A range: <700 mV FS.

All other ranges: <250 mV FS.

**General**

**Integration time:** 100 ms.

**Reading rate:** 2½ readings per second.

**Display:** light-emitting diodes.

**Overload indication:** display blanks.

**Humidity range:** 95% @ 40°C.

**Operating temperature:** 0°C to +55°C. (Nickel Cadmium Batteries 0°C to +40°C).

**Storage temperature:** -40°C to +75°C. (Nickel Cadmium Batteries -40°C to +40°C).

**Size:**

3465B: 101.6 H × 212.7 W × 279.4 mm D (4" × 8½" × 11")

3465B: 97 H × 228 W × 276 mm D (3.82" × 8.92" × 10.86")

**Weights:** net, 2 kg (4.5 lbs). Shipping, 4.5 kg (10 lbs).

**Power (see Options):**

3465A: batteries or AC line; built in battery charger.

AC line: 86 to 127 V or 176 to 254 V, 48 to 440 Hz.

Batteries: 2 rechargeable Nickel Cadmium battery packs (HP 82001A's), provide 6 hours continuous use when fully charged. 14 hours to recharge batteries fully (instrument off).

3465B: batteries or AC line; built-in battery charger, batteries when fully charged provide 6 hours continuous operation. 8 hours to recharge batteries fully (instrument off). Must order one power line option.

**Options, accessories & parts (3465A)**

**Opt 001:** AC operation only (no battery packs supplied; battery charger built-in)

**Price**

less \$20

**Opt 002:** 4 type D alkaline dry cells, in lieu of 82001A's, provide 60 hours continuous use at 23°C; has receptacle for HP 82002A battery eliminator, 82002A not included

less \$100

**82001A** battery pack (uses 2 packs)

\$10 ea.

**82002A** Battery eliminator (hand-held calculator charger)

\$20

**1420-0224** Type D Alkaline cell (equal to U-2); 4 required

\$1 ea.

**3465B options (must specify one)**

100: 86 to 106 VAC line; 48 to 440Hz

N/C

115: 104 to 127 VAC line; 48 to 440Hz

N/C

210: 190 to 230 VAC line; 48 to 440Hz

N/C

230: 208 to 250 VAC line; 48 to 440Hz

N/C

**Ordering Information**

3465A DMM with two 82001A's & charger

**Price**

\$550

3465B DMM with batteries and charger\*

\$525

\*Must order one power line option



# DIGITAL VOLTMETERS

4 1/2 digit autoranging DMM

Model 3486A

- 1  $\mu$ V dc sensitivity
- 1 milliohm sensitivity
- True-Rms (DC + AC)
- Diode Test

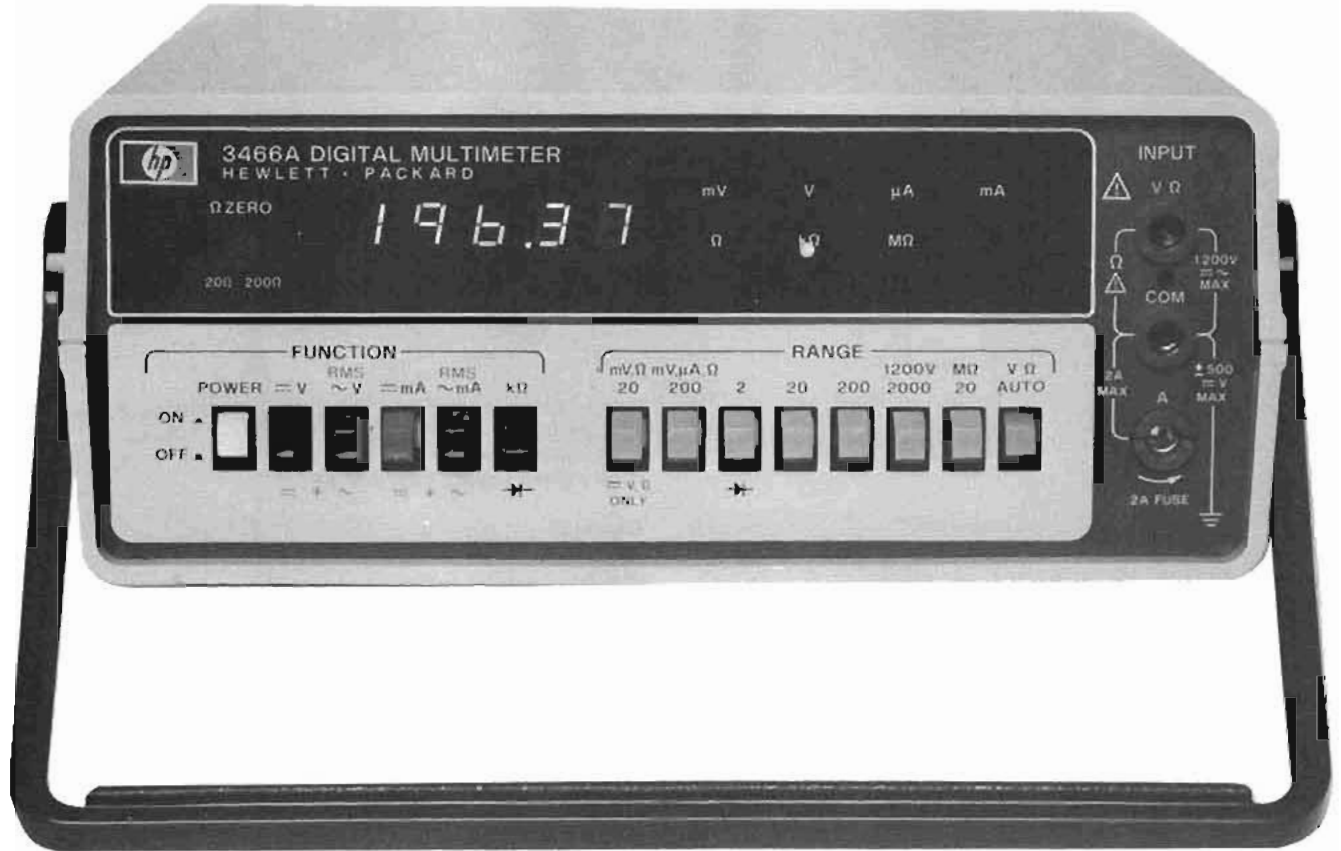

## Description

The 3466A is a 4 1/2 digit Multimeter with autoranging volts and ohms. Functional capability includes ACV, DCV, (AC + DC) V, ACI, DCI, (AC + DC) I,  $\Omega$ , and diode test. AC measurements are true-rms with selectable AC or DC coupling. Available with rechargeable batteries or AC power only, it has 1  $\mu$ V DC and 1 m $\Omega$  sensitivity with zero adjustment on lowest ranges to compensate for external offsets.

## Specifications

### DC Voltmeter

Voltage Range	Maximum Display
$\pm 20$ mV	19.999 mV
$\pm 200$ mV	199.99 mV
$\pm 2$ V	1.9999 V
$\pm 20$ V	19.999 V
$\pm 200$ V	199.99 V
$\pm 1200$ V	1199.9 V

Maximum Input:  $\pm 1200$  V maximum DC and peak AC.

Ranging: automatic or manual.

Sensitivity: 1  $\mu$ V on 20 mV range.

Accuracy: (1 yr., 18 to 28°C assuming rear panel zero adjustment on lowest two ranges)

Range	Specification $\pm$ (% of reading + # digits)
20 mV	(.05 + 3)
200 mV	(.04 + 1)
2 V $\rightarrow$ 200 V	(.03 + 1)
1200 V	(.035 + 1)

Input resistance: 10 meg  $\Omega \pm 0.5\%$  all ranges.

Normal mode rejection:  $\geq 60$  dB @ 50/60 Hz  $\pm 0.1\%$ .

Effective common mode rejection (1 K $\Omega$  unbalance): DC  $\geq 140$  dB @ 50/60 Hz  $\pm .1\% \leq 120$  dB

Input type: floating, 500 V maximum common to ground.

### DC Current

Current Range	Maximum Display
$\pm 200$ $\mu$ A	199.99 $\mu$ A
$\pm 2$ mA	1.9999 mA
$\pm 20$ mA	19.999 mA
$\pm 200$ mA	199.99 mA
$\pm 2000$ mA	1999.9 mA

Maximum Input: 2 amp from  $< 250$  V source (fuse protection).

Ranging: manual only.

Sensitivity: 10 nA on 200  $\mu$ A range.

Accuracy (1 yr., 18 to 28°C):

Range	Specification $\pm$ (% reading + # digits)
200 $\mu$ A through 20 mA	(.07 + 2)
200 mA	(0.15 + 2)
2000 mA	(0.5 + 2)

Input type: floating 500 V maximum Common to ground.

### AC Voltmeter

AC Converter: True-rms Responding True-rms Calibrated

Range	Maximum Display
200 mV	199.99 mV
2 V	1.9999 V
20 V	19.999 V
200 V	199.99 V
1200 V	1199.9 V

Maximum Input: (AC+DC):  $\pm 1700$  V (DC + Peak AC),  $10^7$  V. Hz. AC:  $\pm 600$  V DC: 1700 V (Peak AC+DC),  $10^7$  V. Hz.

Ranging: automatic or manual.

Sensitivity: 10  $\mu$ V on 200 mV range.

Crest factor: 4:1 at Full Scale.

Accuracy (with display of  $> 10\%$  of range): 1 yr., 18 to 28°C sinusoid waveform.

AC TRMS (20 Hz to 100 kHz)

Frequency Range	Specification $\pm$ (% of reading + # digits)
20 Hz to 30 Hz	(2 + 50)
30 Hz to 50 Hz	(1 + 30)
50 Hz to 20 kHz	(0.3 + 20)
20 kHz to 50 kHz	(1 + 40)
50 kHz to 100 kHz	(2 + 150)

DC + AC TRMS: DC + (20 Hz to 100 kHz).

DC + Frequency Range	Specification $\pm$ (% of reading + # digits)
20 Hz to 50 kHz	(1 + 80)
50 kHz to 100 kHz	(2 + 200)

Input Impedance: resistance 2 M $\Omega$ .  $\pm 2\%$  Shunt Capacitance  $< 50$  pF.

Input type: Floating, 500 V Maximum common to ground..

### AC Current

Current Range	Maximum Display
200 $\mu$ A	199.99 $\mu$ A
2 mA	1.9999 mA
20 mA	19.999 mA
200 mA	199.99 mA
2000 mA	1999.9 mA

Detector: true RMS.

Crest factor: 4:1 at Full scale with 4.5% accuracy at full scale.

Maximum Input: 2 Amp RMS from  $< 250$  V source (fuse protected).

Ranging: manual only.

Sensitivity: 10  $\mu$ A on 200  $\mu$ A range.

Accuracy: (with display  $\geq 10\%$  of range) 1 yr., 18°C to 28°C sinusoid waveform.

ACI RMS: 20 Hz to 10 kHz.

Range	Frequency	Specification $\pm$ (% of reading + # digits)
200 $\mu$ A-200 mA	20 Hz-30 Hz	2 + 50
	30 Hz-10 kHz	0.9 + 35
2000 mA	20 Hz-30 Hz	2 + 50
	30 Hz-10 kHz	1.2 + 20

(DC+AC) I RMS: DC + (20 Hz to 10 kHz).

All ranges: 20 Hz to 10 KHz,  $\pm$ (1.5% of reading + 80 digits).

Input type: floating, 500 V maximum common to ground.

### Ohms

Range	Maximum Display
20 $\Omega$	19.999 $\Omega$
200 $\Omega$	199.99 $\Omega$
2 k $\Omega$	1.9999 k $\Omega$
20 k $\Omega$	19.999 k $\Omega$
200 k $\Omega$	199.99 k $\Omega$
2000 k $\Omega$	1999.9 k $\Omega$
20 M $\Omega$	19.999 M $\Omega$

Range	Specification $\pm$ (% of reading + # digits)
20 $\Omega$ -200 $\Omega$	.08 + 2
2 k $\Omega$ -200 k $\Omega$	.03 + 1
2000 k $\Omega$	.04 + 1
20 M $\Omega$	.15 + 1

Input protection: 250 V RMS or 350 V (DC + peak AC).

Ranging: automatic or manual.

Sensitivity: 1 milliohm on 20 ohm range.

Accuracy: 1 yr., 18 to 28°C (assuming use of front panel zero on lowest two ranges).

Configuration: 2 wire.

Zero adjustment: range of 700 m $\Omega$ . Use on 20  $\Omega$ , and 200  $\Omega$  ranges.

Open circuit voltage:  $< 5$  V maximum.

Current through unknown:

Range 20  $\Omega$  200  $\Omega$  2 k $\Omega$  20 k $\Omega$  200 k $\Omega$  2000 k $\Omega$  20 M $\Omega$

Current 5 mA 5 mA 1 mA 100  $\mu$ A 10  $\mu$ A 1  $\mu$ A 100 nA

Diode Test  $\rightarrow \leftarrow$

Function:  $\rightarrow \leftarrow$  (k $\Omega$ ).

Current source: 1 mA  $\pm 1.5\%$ .

Diode voltage drop displayed in volts: 1.9999 volts maximum.

Open circuit voltage:  $< 5$  volts maximum.

Overload protection: 350 V (DC + peak AC).

### General

Display: 7 segments red 0.3 in high LED. Function and range annunciator.

Reading rate: 2.4 to 4.7/sec. depending on input level.

Remote trigger: shorting COM to A stops sampling in Volts functions.

Storage temperature: AC only,  $-55^\circ\text{C}$  to  $+75^\circ\text{C}$ ; with batteries,  $-55^\circ\text{C}$  to  $+65^\circ\text{C}$ .

Operating temperature: (0 to 55)°C.

Humidity: 95% RH at  $+40^\circ\text{C}$ .

Power: AC line; 48-440 Hz; 86-250 V.

Battery: rechargeable lead-acid 8 hours maximum continuous operation with full charge. Recharge time: 16 hours operating, 12 hours non-operating. Batteries and charger available separately, consult operating manual. Total power dissipated: AC only, 4 watts; with charger, 9 watts.

Size: 98.4 H  $\times$  238.1 W  $\times$  276.2 mm L (3 $\frac{7}{8}$ "  $\times$  9 $\frac{5}{8}$ "  $\times$  10 $\frac{7}{8}$ ").

Weight: 3466A: 2.9 kg (6 lb 5 oz).

3466A Opt 001: 2 kg (4 lb 7 oz).

Configuration: 3466A streamlined portable case with handle, AC line power, batteries and charger included—\$650; 3466A Opt 001, eliminate battery and charger, AC line power only—less \$75. All orders must include one of these line power options: Opt 100, 86-106 V; Opt 115, 104-127 V; Opt 210, 190-233 V; Opt 230, 208-250 V.

Accessories: one pair test probes furnished.

### Options

Opt 001

Opt 100, 115, 210, 230

less \$30

N/C

3466A

\$650



# DIGITAL VOLTMETER

## Programmable data logger

### Model 3051A

- Data collection
- Data analysis
- Decision making

- Thermocouple linearization
- File compiler



### General description

A programmable data logger is a system which can collect and analyze data, make decisions based on the data and interact with the test, process, experiment, instrument or system which generates the data.

The 3051A Programmable Data Logger consists of:

- 3495A Input Multiplexer
- 3455A High Accuracy/Resolution DVM
- 9815A Calculator with 2008 Step Memory
- System ROM

The 3051A is designed to provide a cost effective solution to:

- Your plant monitoring requirements for energy conservation, environmental impact and security.
- Your production process monitoring requirements for environmental impact, independent process evaluation and safety.
- Your dedicated parameter testing requirements for component test, subassembly test and data collection.
- Your quality assurance requirements for component test, subassembly test, equipment environmental test and data collection.

In the above applications the information may be about pressure, temperature, level, flow, facts about the environment, equipment status or equipment performance. The information can be processed providing that it exists or can be made to exist as an electrical signal. Several devices are available to translate the information into electrical signals (i.e. transducer outputs, sensor outputs, equipment output or instrument output). The electrical signals need to be measured in a time sequence, analyzed, recorded and limit decisions made. The signals may be either local or scattered over the length of a plant. The 3051A combines the features of a data logger and a programmable calculator into a low cost solution to these requirements.

### Hardware description

The hardware is fully integrated, specified, documented and tested as a system. The system is capable of measuring dc from 1  $\mu$  volt to 200 volts, ac from 10  $\mu$  volts to 200 volts, and ohms from 1 milliohm to 10 Megohms. It can measure 1  $\mu$  volt dc signals at a six channels per second rate in the presence of noise. The system's greater than 120 dB effective common mode rejection and greater than 60 dB normal mode rejection effectively cancel out unwanted offsets or superimposed noise signals. The 1  $\mu$  volt sensitivity in conjunction with the system's ROM allows temperature resolution to better than 0.1°C. The system can measure thermocouples and perform reference junction compensation at a rate of three channels

per second. The less than 2  $\mu$  volt differential thermal e.m.f. of the low thermal ten channel scanner card provides reliable measurements with minimum thermal uncertainty. A ten channel relay actuator card provides alarm and multiple switching functions. The system can scan from 1 to 80 channels of analog data. The number of data channels decreases by 10 for each relay actuator card used. A 9 channel low thermal reference junction scanner card which provides thermocouple measurement without external reference junctions is also available. The high speed data cartridge provides high speed file access and storage. Up to 10,000 six digit readings can be stored on the data cartridge. The user can communicate with the system via an alphanumeric keyboard. The system can communicate with the user by a numeric display and an alphanumeric thermal strip printer. This conversational interaction capability allows the system to be operated by personnel with no formal knowledge of programming or data logging. The auto restart capability allows the system to operate unattended. The auto restart and the optional 59403A Common Carrier Interface allows remote distributed system configurations.

### Firmware description

The system ROM contains J, K and T thermocouple linearization tables, a general linearization routine, four types of split precision data storage and string manipulation. The ROM allows the system to easily make thermocouple temperature measurements, linearize transducer data, store the data in an efficient manner and format alpha messages for output.

### Software

The file compiler allows easy application program generation by automatically combining programs and subroutines from separate tape files. For example, the data logger can be programmed without writing software. The user selects set-up routines (scan sequence, scan interval, channel range and function and scan mode), operating routines (check limits, convert to meaningful units, record). Then the user calls the file compiler which assembles the routines into an application program. Instrument verification software provides for easy system checkout and proof that the instruments are properly functioning. The calculator has built-in program editing, syntax checking and error message generation.

A report generator is supplied to format the data for the optional HP 9871A Plotter Printer.

For more information contact your local HP field engineer or nearest HP Sales Office for complete details about this low cost solution to measurement, analysis and decision making problems.

**3051A Programmable data logger from \$9550**

# DIGITAL VOLTMETERS

## Automatic data acquisition system

### Model 3052A



- Improve productivity in research and manufacturing
- Increase throughput and lower the cost in Q.A. testing
- Conserve plant energy through electric load monitoring/control
- Monitor pilot and production processes
- Perform on-line data analysis and processing
- Measure DC, AC, and Ohms

### Description

The 3052A Automatic Data Acquisition System combines speed, precision and repeatability in low level measurements with powerful computation and analysis capabilities. This system provides a highly capable yet economical solution to parameter testing, stimulus response and signal analysis applications in production test, laboratory and process monitoring/control areas.

### System configuration

The 3052A consists of the following:

- 3455A High Accuracy/High Resolution DVM
- 3437A High Speed Sampling DVM
- 3495A Input Multiplexer
- 9825A High Performance Calculator and ROMS
- Optional 9871A Printer/Plotter

Two digital voltmeters in the 3052A provide a unique combination of high speed and high accuracy measurements.

### Measurement

DC measurement rates up to 20 channels/second are possible with 1  $\mu$ V resolution on the 100 mV range. This sensitivity and dynamic range are required for example in thermocouple measurements with a 0.5°C or better resolution.

Excellent noise rejection and very low thermal uncertainty make the 3052A particularly suited for accurate, repeatable, low-level measurements even in the presence of noise. The >120 dB effective common-mode rejection of the 3455A/3495A effectively cancels out unwanted offsets or superimposed noise signals.

AC measurements can be made up to 1 MHz with the standard AC True RMS converter or up to 250 kHz with the optional average converter. A programmable Fast AC mode provides an AC measurement rate of up to 10 channels/second for inputs above 300 Hz.

Repetitive waveforms up to 1 MHz or low frequency transients (below 1 kHz) can be digitized by the 3437A High Speed Sampling DVM. With this DVM and 9825A Calculator, up to 5000 readings/second on a single high speed channel can be stored for further analysis.

By multiplexing the 3437A input with the Scanner, up to 125 channels/second can be measured with 100  $\mu$ V resolution and 3 1/2 digits. The sample-and-hold measuring technique of the 3437A makes it more suited for high quality inputs with minimum noise and common mode signals.

Resistance measurements can be made with either easy-to-connect 2-wire technique or the more accurate 4-wire method. Multiplexed high resistance measurements up to 15 megohms can be

made with the full accuracy of the 3455A.

### Data analysis

The 9825A Calculator can be programmed to perform any mathematical calculation required, from transducer linearization to statistical analysis. A new feature of the 9825A, multi-dimensional arrays, allows logical data organization and storage for complicated testing and a high speed bi-directional data cartridge provides bulk data storage.

### Output and control

A high degree of operator interaction with the system and its program is provided by the 32 character alpha-numeric display and the 16 character thermal printer. Program inputs, intermediate test conditions, or final results can be displayed or printed for more efficient testing.

The optional 9871A Character Impact Printer is ideally suited for producing finished test reports, completely documented problem solutions or typing on pre-printed forms, all under automatic control of the calculator. Simple charts and graphs can also be plotted with the bi-directional motions of the platen and print mechanism.

The system can assume an active role in application process by performing control, alarm, and multiple switching functions with the relay actuator cards in the 3495A. Each of these cards provides ten double-pole single-throw contact closures for connection to external devices.

### Software

In most systems, application software is expensive and time consuming to develop. With the 3052A, however, programming is greatly simplified and the system can be operational in a much shorter time.

The easy-to-learn programming language of the 9825A and the supplied instrument control routines allow the user without a sophisticated programming background to develop his own test software. For easy system installation and verification, the 3052A documentation and software package provides step-by-step instructions. In addition detailed operating instructions and modular example programs enable fast system start-up and easy operation. The 3052A is fully integrated, tested, verified, and specified as a system with complete software and documentation supplied to ensure that the system is ready to perform your specific task.

For more information, contact your local HP Field Engineer or nearest HP Sales Office.

3052A Automatic data acquisition system from \$16,000

## DIGITAL VOLTMETERS

## Multiplexer Scanner

Model 3495A

- Low level switching
- Multichannel closure
- Switched guard
- Relay actuation

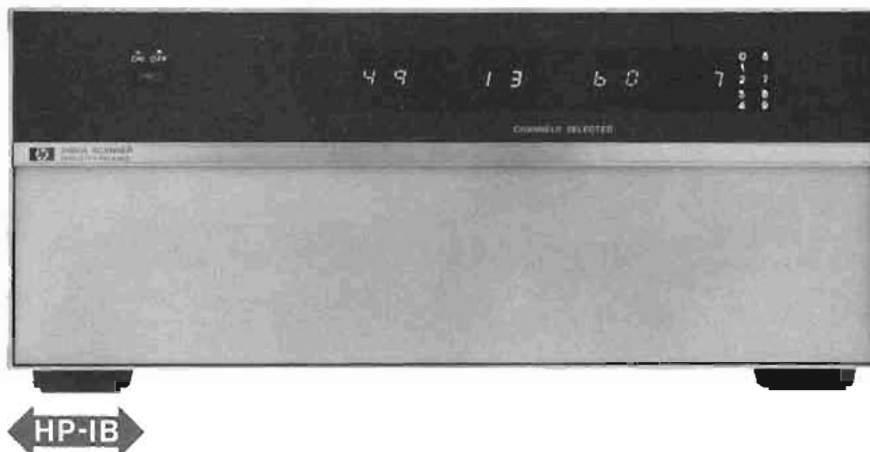

## Description

## General

Three types of assemblies are available for the HP 3495A Scanner. A Low Thermal Scanner for connection to low level sources such as thermocouples and strain gauges; a Relay Actuator assembly for distributing dc or ac voltages and for external control; a Low Thermal Reference Junction Relay assembly for thermocouple measurement without the need of external reference junctions. Each assembly contains 10 channels and the 3495A can hold up to four of these assemblies for a maximum of 40 channels. Multiple 3495A's may be used on the HP-IB to provide more than 40 channels.

## Low thermal assembly

The Low Thermal Assembly is a three-wire 10 to 1 multiplexer for connection to low level sources such as thermocouples and strain gauges. The signal switching relays for each channel are low thermal dry reed relays constructed in such a way as to minimize temperature gradients between high and low inputs. An uncertainty of  $<2\mu\text{V}$  thermal EMF is maintained through the Low Thermal Assembly. Each channel has a separate guard relay to minimize the effect of common mode voltage on low level measurements.

The Low Thermal Assembly has a break-before-make feature which assures that only one channel is closed at a time to prevent the possibility of connecting two inputs. However, the 3495A has a flexible addressing scheme between relay assemblies which permits multiple wire scanning for applications such as four-wire ohms measurements.

**Applications:** low level dc measurements; dc volts, ac volts, and resistance scanning.

**Transducer sensing:** thermocouples, thermistors, strain gauges, pH meters.

## Relay actuator assembly

The relay actuator assembly provides 10 independently programmable two-wire closures for controlling higher current relays, distributing low current dc or ac voltages, or external control functions. Each channel contains a two-pole armature type relay capable of switching up to two amps rms. This relay is more suited to higher current, lower voltage applications than the low thermal assembly.

Two normally open contacts for each relay are available on the channel terminal connector. Any combination of channels on this assembly may be closed or opened simultaneously.

**Applications:** process control, actuate visual or audio indicators, control higher current relays,  $8 \times 10$  Matrix switching.

## Specifications, 3495A scanner

## Low-thermal channels, option 001

**Number:** 10 to 40 fully guarded, multiplexed channels available in each scanner. Additional scanners can be used for more channels.

**Type:** three-pole, low-thermal dry reed relays. Third pole switches guard and is not low-thermal.

## Actuator channels, option 002

**CAUTION:** for use in circuits fused at two amperes or less.

**Number:** 10 to 40 noncommon channels available in each scanner. Additional scanners can be used for more channels.

**Type:** two-pole armature relay; four terminals per channel. Single unswitched guard for 10 channels. Ten independently controlled relays permit any number of channels to be closed simultaneously.

## Low-thermal reference junction channels, option 003

**Number:** 9 to 36 fully guarded, multiplexed channels for thermocouple inputs are available in each scanner.

**Type:** similar to option 001 low-thermal channels, except channel 0, is reserved for a temperature sensing thermistor that measures reference junction temperature.

Option	001	002
<b>Maximum contact ratings</b>		
Voltage	230 V peak	100 V rms
Current	200 ma	2 A rms
	(non-inductive)	
Power	2 V A	200 V A
Isolation	$>10^{11}\Omega$	(no spec)
<b>Maximum input voltage</b>		
Between any two terminals	230 V peak	230 V peak
Guard to chassis	200 V peak	200 V peak
Guard to low	200 V peak	200 V peak
<b>Uncertainty (differential EMF)</b>	$<2\mu\text{V}$	$<30\mu\text{V}$
Switching time	$<10\text{ ms}$	$<40\text{ ms}$

See data sheet for Opt 003 specifications.

## General

**Operating temperature:**  $0^{\circ}\text{C}$  to  $+55^{\circ}\text{C}$

**Humidity range:**  $<95\%$  R.H.,  $0^{\circ}\text{C}$  to  $+40^{\circ}\text{C}$

**AC power:** 100, 120, 220, or 240 volts ( $+5\%$ - $10\%$ ) 100 V A max. 48 to 66 Hz

**Size:** 190.5 H (including feet)  $\times$  428.6 W  $\times$  520.7 mm D (7.5"  $\times$  16.875"  $\times$  20.5")

**Weight:** 3495A: net, 17.5 kg (38.5 lb). Shipping, 21.1 kg (46.5 lb).

## Options and accessories

Order one or more Option 001, 002, 003 to obtain desired number of low thermal or actuator channels. Option 001, 002 and 003 may be used in any combination up to a total of four relay assemblies for each 3495A.

001: ten channel low thermal relay assembly

add \$600

002: ten channel relay actuator assembly

add \$400

003: nine channel reference junction relay assembly

add \$700

907: Front Handle Kit

add \$15

908: Rack Flange Kit

add \$10

909: Rack Flange & Front Handle Combination Kit

add \$20

3495A Scanner

\$1250



### Impedance/Z/θ, C, R, L, D & Q

Hewlett-Packard's family of impedance measurement instruments combine the familiar null measurement techniques with digital logic and feedback circuits to achieve simple and rapid operation without a sacrifice in precision. The basic specifications for Hewlett-Packard's impedance family is summarized on the opposite page. Frequency, Q, capacitance, inductance, resistance and basic accuracy can be traded off to select the most suitable instrument. For some instruments, capacitance and inductance are not the principal parameters but are secondary to the primary readout.

### Impedance considerations

There are two basic types of impedance measuring instruments: bridges and meters. In general, bridge type instruments have the best accuracy specifications. This type of instrument has found wide application and is the basis for the HP 4260A/4265B Universal Bridge, 4270A Automatic Capacitance Bridge, and 250B RX Meter.

In the past, bridge instruments have required considerable operator skill to obtain consistent results. However, the Universal Bridge was specifically designed to achieve rapid and consistent audio frequency measurements.

The evolution of bridge measurements has created the need for completely automatic instruments to rapidly characterize multi-conductor cables, variable capacitor diodes, and discrete capacitors. To satisfy these customer requirements, the 4270A Automatic Capacitance Bridge was developed. This instrument is completely programmable and displays capacitance and dissipation factor/conductance in digital form. BCD outputs are available for remote processing.

Impedance meters, in general, utilize constant current/voltage sources to excite the unknown impedance. Amplitude and phase sensitive voltmeters detect the real and reactive voltage/current components of the unknown. The display for most impedance meters is an analog meter. Although impedance meters do not have the accuracy of bridge instruments, they are less expensive and easy to use. The 4800A Vector Impedance Meter, and the 4332A LCR Meter utilize this principle. Impedance meters have analog outputs proportional to the displayed function.

The wide measurement ranges of the 4261A allow easy measurements of various kinds of components. This applications area is extended even more by the new HP 4262A with its additional frequency and

measurement ranges. The 4271B is particularly useful for measuring microcircuit parameters. The new 4272A and 4273A, with their built-in limit comparators, are especially convenient when measuring small and medium range capacitors respectively.

### Integration Into HP-IB system

Adding the HP-IB option to a component test instrument enables the instrument to be systemized into an HP-IB system. This permits high speed measurement of many components along with arithmetic processing of the data.

The HP-IB option (Opt 101) for LCR measuring instruments is available for HP models 4271B, 4270A, 4262A, 4272A and 4282A. Two functions are provided: talker (measured data transfer) and listener (measurement remote control). System controller may be an HP model 9830A with bus interface kit (HP 59405A OPT. 021, 030), or an HP model 9825A with HP-IB card (HP 98034A). If other system components such as a plotter, printer, scanner or measurement instrument are added to the system, the integrated system reaches a high level of usefulness. For example, it would provide a component manufacturer with inspection/reliability test capabilities in the quality control or in-process test/inspection departments. In semiconductor device measurements, the combination can process the especially needed complex arithmetic manipulation of the measured data for the various device characteristics.

Figure 1 is the block diagram of a semiconductor device characteristic measurement system using the 4271B Opt 101. This calculator controlled system graphically shows the relationships between either bias voltage (measured with digital multimeter) and capacitance (measured with the 4271B), or between impurity concentration and depletion layer width, on a graphic plotter. Bias is automatically applied to the device

capacitance measured as directed by the calculator.

### Summary

To help you select an impedance meter suitable to your needs the following guidelines may be used:

- (1) For a desired accuracy and cost range, select the instrument with the broadest capability in C, L, R & D or Q.
- (2) Bridge instruments will provide the best accuracies (0.1% to 1%). However, only the higher priced bridges offer the speed and convenience in measurement available in meter type instruments.
- (3) To obtain meaningful results, a parts user should make measurements at the same frequency and voltage level specified by the manufacturer.

For additional information on component measurements, Hewlett-Packard offers for sale a tutorial RCL video tape. The tape has three parts:

Part 1—Resistance (7 min.)—explains basic resistance measurements.

Part 2—Capacitance (11 min.)—format similar to Part 1—explains capacitance measurements.

Part 3—Inductance (11 min.)—develops the theory of inductors and their functions in circuits.

You may preview this video tape at your nearest HP Sales Office. Please call for an appointment. The tape (ID #90249C/D) is available in 1/2" EIAJ format (C) or 3/4" video cassette (D).

Hewlett-Packard's impedance instruments have been used in numerous diverse applications, from the measurement of the dielectric constant of liquids, to the wing to fuselage continuity of aircraft. If you have an unusual application or need assistance, contact your nearest Hewlett-Packard sales office for application information.

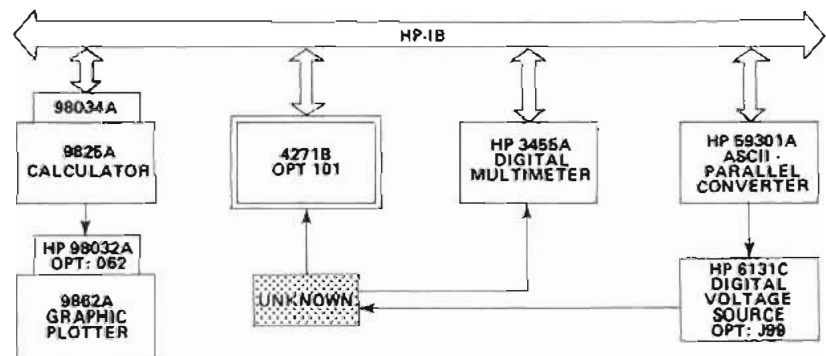

Figure 1. Measuring Semiconductor Characteristics (Typical System)



- Touch and read operation
- Wide range
- Low test voltage
- Guarded measurement



4332A

**Measuring frequency**

3 pF to 1000 pF ranges: 100 kHz  $\pm 5\%$ .  
 3 nF to 1000 nF ranges: 1 kHz  $\pm 5\%$ .  
 Voltage across sample: approximately 70 mV rms.  
 Accuracy (at 25°C):  $\pm [1\% \text{ reading} + (1.5 + 3/Q)\% \text{ of full scale} + 0.03 \text{ pF}]$ .

**Resistance measurement**

Range: 3  $\Omega$  to 1 M $\Omega$  full scale, 12 ranges.  
 Measuring frequency: 1 kHz  $\pm 5\%$ .  
 Voltage across sample: <1 mV rms.  
 Accuracy (at 25°C)  
 3  $\Omega$  to 30 k $\Omega$  ranges:  $\pm(0.5\% \text{ reading} + 2\% \text{ full scale} + 0.03\Omega)$ .  
 100 k $\Omega$  to 1000 k $\Omega$  ranges:  $\pm(1\% \text{ reading} + 2\% \text{ full scale})$ .  
 Analog outputs: 1.0 V dc full scale, independent of range in use and 1.0 V or 0.3 V dc full scale, corresponding to the range in use.  
 Output impedance: approximately 500 $\Omega$ .  
 Accuracy: better than meter reading accuracy by 0.5% full scale.  
 Overrange: 110% of full scale.

**General**

Response time: typically 0.25 s for analog outputs. Typically 1.0 s for meter.  
 Operating temperature: 0°C to 50°C.  
 Temperature coefficient:  $\pm 0.05\%$  of full scale/°C (0°C to 50°C).  
 DC bias: 100 V dc maximum can be applied from external source.  
 Power: 115 V/230 V  $\pm 10\%$ , 48 Hz to 66 Hz, 8VA.  
 Size: 130 H  $\times$  155 W  $\times$  279 mm D (5 $\frac{1}{8}$ "  $\times$  6 $\frac{1}{32}$ "  $\times$  11").  
 6 $\frac{1}{32}$ "  
 11").  
 Weight: net, 3.5 kg (7 lb 11 oz).  
 Accessories furnished: 16138A Test Leads, Power Cord 8120-1348.



16138A



16019A

**Description**

Hewlett-Packard's Model 4332A LCR Meter measures inductance, capacitance, and resistance with speed and accuracy. The instrument provides direct-readings of L, C, and R with linear meter scales. The 4332A is extremely useful for measurements of both linear and non-linear components such as semiconductor capacitor values, inductance of coils with ferrite core.

**Specifications**

**Inductance measurement**

Measurement equivalent circuit: series.  
 Range: 3  $\mu$ H to 1 H full scale, 12 ranges.  
 Measuring frequency  
 3  $\mu$ H to 1000  $\mu$ H ranges: 100 kHz  $\pm 5\%$ .  
 3 mH to 1000 mH ranges: 1 kHz  $\pm 5\%$ .  
 Voltage across sample: <1.5 mV rms.  
 Accuracy (at 25°C):  $\pm [1\% \text{ reading} + (1.5 + 3/Q)\% \text{ of full scale} + 0.03 \mu\text{H}]$ .

**Capacitance measurement**

Measurement equivalent circuit: parallel.  
 Range: 3 pF to 1  $\mu$ F full scale, 12 ranges.

Accessories available: 16019A Test Fixture  
 4332A LCR Meter  
 Opt 910: extra manual

\$59  
 \$1195  
 add \$9

# COMPONENT TEST

## Milliohmmeter

### Model 4328A

- 20  $\mu\Omega$  resolution on 1 m $\Omega$  range
- Four terminal measurement
- Low test voltage



4328A (with 16005A Probes Included)



16006A Probe (2 each included)

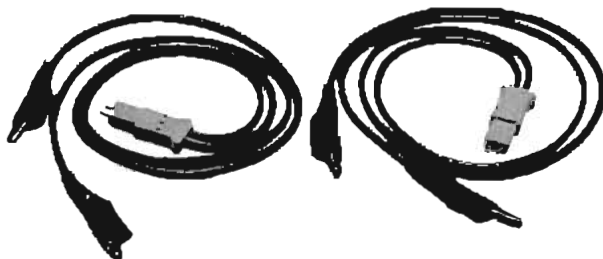

16007A/B Test leads (1 each included)

### Description

HP's 4328A Milliohmmeter is a portable instrument for measurement of low resistances. It uses a Kelvin Bridge method to obtain its high sensitivity but has incorporated both the current and voltage drives into one probe, so that only two probes are needed in actual measurement.

The range of the 4328A extends from one milliohm to 100 ohms full scale. Maximum sensitivity is 20 micro-ohms, making it ideal for measuring contact resistance of switches, relays, and connectors.

A unique phase discriminator in the meter circuit permits accurate resistive measurements on samples with a series reactance up to twice full scale resistance.

The milliohmmeter is internally driven by a one kilohertz signal. With an ac drive signal, dc bias up to 150 volts can be superimposed without affecting accuracy of measurement. Hence, HP's 4328A can make dynamic resistance measurements in forward-biased diodes.

Maximum voltage across any sample with proper range selection is less than 200 microvolts peak. In case of incorrect range setting, a maximum voltage of 20 millivolts peak will never be exceeded, so that explosive devices such as fuses and squibs can be safely checked.

The basic 4328A is line operated. With Opt 001, it can be operated from four rechargeable batteries for 15 continuous hours. A recorder output provides an output proportional to meter deflection.

### Specifications

**Range:** 0.001 to 100 ohms full scale in a 1, 3 sequence.

**Accuracy:**  $\pm 2\%$  of full scale. No additional error is caused by series reactance of samples up to two times full scale.

**Measuring frequency:** 1000 Hz  $\pm 100$  Hz.

**Voltage across sample:** 200  $\mu$ V peak at full scale.

**Maximum voltage across sample:** 20 mV peak in any case.

**Superimposed dc:** 150 V dc maximum may be superimposed on samples from an external source.

**Recorder output:** 0.1 V dc output at full scale meter deflection. output resistance approx. 1 k $\Omega$ .

Range (ohms)	Applied Current (mA)	Maximum Dissipation in Samples ( $\mu$ W)
0.001	150	23
0.003	50	8
0.01	15	2.3
0.03	5	0.8
0.1	1.5	0.23
0.3	0.5	0.08
1	0.15	0.023
3	0.05	0.008
10	0.015	0.0023
30	0.005	0.0008
100	0.0015	0.00023

### General

**Power requirements:** 115 or 230V switch  $\pm 10\%$ , 50 to 60 Hz, 1.5 VA.

**Weight:** 3.2 kg (7 lb).

**Size:** 155.1 H  $\times$  130 W  $\times$  279 mm D (6 $\frac{1}{32}$ "  $\times$  5 $\frac{1}{8}$ "  $\times$  11").

**Accessories furnished:** Model 16005A Probe, 16006A Probe and 16007A/B Test Leads, 16143A Probe Cable, Detachable Power Cord.

### Ordering Information

4328A Milliohmmeter

Opt 001: Rechargeable battery operation

Opt 910: extra manual

**Price**

\$1050

add \$54

add \$12.50

# COMPONENT TEST

## High resistance meter

### Model 4329A



- Wide range: 500 k $\Omega$  to 2  $\times$  10<sup>16</sup> $\Omega$

- Selectable test voltages: 10 V to 1000 V



### Description

The HP 4329A is a solid-state insulation resistance meter designed for easy, accurate and direct readings of the very high resistance values typically found in synthetic resins, porcelain, insulating oils and similar materials. It is also useful for measurements in electrical components like capacitors, transformers, switches and cables. Seven fully regulated dc test voltages (between 10 and 1000 V) are provided as test sources.

Selected scales are identified by illuminated indicators on the meter face. Selected resistance or current multiplying factors are also illuminated for rapid, error-free measurement. Three resistance scales and one current scale are provided. The HP 4329A is instantly convertible from ungrounded-to-grounded-sample operation via a simple relocation of the front panel ground strap from "guard" to "G" position. The instrument cabinet itself is always at ground potential. Test voltage shorts or sample breakdown currents will not damage instrument circuitry.

The HP 4329A also has a current measurement capability. Minute currents as low as 0.05 pA can be readily measured. The standard instrument package includes HP 16117A Low Noise Test Leads; these are used in most types of measurement.

### 4329A Specifications

#### Resistance measurement

**Range:** 500 k $\Omega$  to 2  $\times$  10<sup>16</sup> $\Omega$ .

**Accuracy:** (total accuracy is determined by test voltage and range used. At low resistance end of each scale, accuracy is  $\pm$  3%, near center scale  $\pm$  5%, and near the specified upper limit on the meter scale (see table below), accuracy is  $\pm$  10%. Accuracy is not specified above these limits. On all voltage ranges, if multiplier is set to Rmax., an additional  $\pm$  3% is included.

#### Current measurement

**Range:** 5  $\times$  10<sup>-14</sup> to 2  $\times$  10<sup>-6</sup> A in 8 ranges.

**Meter scale:** 0 to 20 in 40 linear divisions.

**Input resistance:** 10<sup>4</sup> to 10<sup>11</sup> $\Omega$   $\pm$  1%, depending on range.

**Accuracy:**  $\pm$  5% of full scale deflection (there can be an additional  $\pm$  3% error at the top decade).

#### General

**Recorder output:** 0 to 100 mV dc, proportional to meter deflection; 1k $\Omega$  output resistance.

**Power:** 115/230 V  $\pm$  10%, 50-60 Hz, approximately 3 VA.

**Size:** 166 H, 198 W, 224 mm D (6<sup>1</sup>/<sub>2</sub>"  $\times$  7<sup>3</sup>/<sub>32</sub>"  $\times$  8<sup>23</sup>/<sub>32</sub>").

**Weight:** 3.5 kg (7.7 lb).

**Accessory furnished:** HP 16117A Low Noise Test Leads.

**Accessory available:** Model 16008A Resistivity Cell.



### 16008A Description

The HP 16008A can safely, rapidly and conveniently measure the volume and surface resistivity of sheet insulation materials. Conversion from volume to surface resistivity measurement requires operation of one switch only; no lead interchange or disconnection is necessary. Designed for use with the HP 4329A Resistance Meter (other voltage supplies and picoammeters may be used), the complete system allows direct measurement of volume resistivity up to approximately 4  $\times$  10<sup>16</sup> $\Omega$  (on samples 0.1 cm thick)—and surface resistivity up to approximately 4  $\times$  10<sup>17</sup> $\Omega$ . Test voltages up to 1000 V may be used.

### 16008A Specifications

**Inner electrode:** 50 mm diam.

**Guard electrode:** 70 mm diam.

**Auxiliary electrode:** 100 mm  $\times$  120 mm.

**Maximum sample size:** 125 mm  $\times$  125 mm  $\times$  7 mm.

**Maximum test voltage:** 1000 V dc.

**Size:** 49 H, 198 W, 152 mm D (2"  $\times$  7<sup>23</sup>/<sub>32</sub>"  $\times$  6<sup>1</sup>/<sub>8</sub>").

**Weight:** 1.4 kg (3 lb).

#### Ordering information

Opt 010: extra manual

16008A Resistivity cell

4329A High resistance meter

#### Price

add \$12.50

\$455

\$1435

Test voltage	10 V	25 V	50 V	100 V	250 V	500 V	1000 V
Available resistance readings	5 $\times$ 10 <sup>4</sup> $\Omega$ to 2 $\times$ 10 <sup>16</sup> $\Omega$	1.25 $\times$ 10 <sup>5</sup> $\Omega$ to 5 $\times$ 10 <sup>16</sup> $\Omega$	2.5 $\times$ 10 <sup>5</sup> $\Omega$ to 1 $\times$ 10 <sup>16</sup> $\Omega$	5 $\times$ 10 <sup>5</sup> $\Omega$ to 2 $\times$ 10 <sup>16</sup> $\Omega$	1.25 $\times$ 10 <sup>6</sup> $\Omega$ to 5 $\times$ 10 <sup>16</sup> $\Omega$	2.5 $\times$ 10 <sup>6</sup> $\Omega$ to 1 $\times$ 10 <sup>16</sup> $\Omega$	5 $\times$ 10 <sup>6</sup> $\Omega$ to 2 $\times$ 10 <sup>16</sup> $\Omega$
Meter scale	5 to 20	.125 to 5	.25 to 10	5 to 20	.125 to 5	.25 to 10	.5 to 20
Upper limit	5	1.25	2.5	5	1.25	2.5	5

\*Accuracy of test voltage is  $\pm$  5%



# COMPONENT TEST

## Digital LCR Meter

Model 4262A

- Fully automatic balancing, ranging and circuit mode selection
- Test frequencies of 120 (100) Hz, 1 kHz and 10 kHz
- HP-IB, BCD and Comparator options available
- Microprocessor control features self test and deviation measurement capabilities

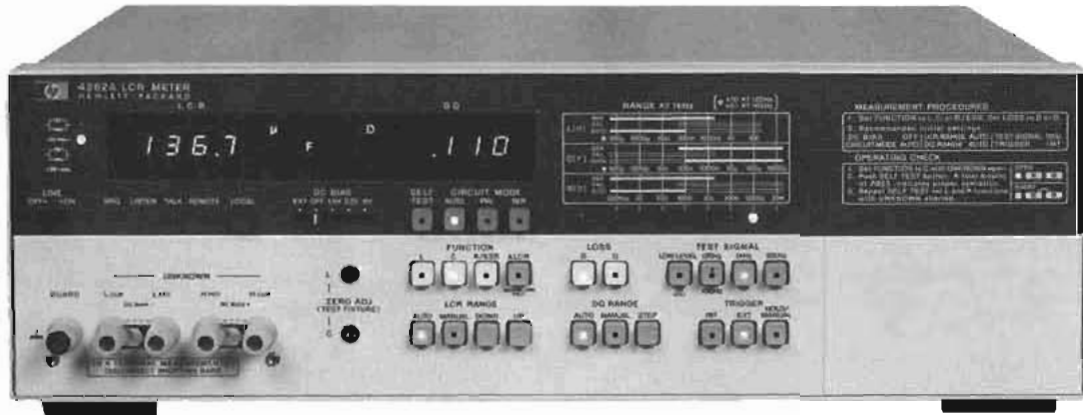

### Description

The HP 4262A is a 3½ digit microprocessor based Digital LCR meter that meets today's requirements for component measurements in the lab, on the production line and in the QA inspection area. The 4262A features fully automatic operation over a wide range of measurements. Simply select the function and loss parameter, one of three test frequencies and insert the device to be measured. The instrument does the rest—automatically selecting the proper measurement range and equivalent circuit mode.

In addition to automatic measurements and wide range, the 4262A features high accuracy (typically 0.2% of reading), 120 (100) Hz, 1 kHz, and 10 kHz measurement frequencies, 1 V test signal level (1 V or 50 mV in Cp mode), three internal DC bias levels (plus external) and series and parallel equivalent circuit modes. The microprocessor control allows other features such as an automatic self test capability and deviation measurements. These features make the 4262A capable of meeting the measurement needs of the diversified electronics industry by measuring such things as the parameters of semiconductors, pulse transformers, filter coils, electrolytic and film capacitors, or determining the internal resistance of a dry cell.

The arrangement of the front panel keyboard switches insure maximum operating convenience and error-free operation. When the instrument is turned on, the microprocessor automatically selects capacitance, dissipation factor, 1 kHz test signal, autorange, auto circuit mode selection, internal trigger and normal test voltage mode of operation. Individually LED lighted keys allow the user to easily determine the selected functions at a glance.

Several options are available for the user that needs systems capability. A BCD output of LCR and DQ data is available for use with a printer or calculator. If both data output and remote control

are required, HP-IB compatibility is available. A comparator option (for both LCR and DQ data) is also available.

### Specifications

**Parameters measured:** C-D or C-Q (1/2), L-D or L-Q (1/2), R (ESR).

**Display:** dual 3½ digit, maximum display of 1999 For D value greater than 10, maximum D display is 199.

**Measurement terminals:** 5-terminal configuration.

**Measurement circuit modes:** auto, parallel and series.

**Test frequencies:** 120 (100) Hz, 1 kHz and 10 kHz  $\pm 3\%$ .

**Range mode:** LCR—Auto and manual (up-down), D/Q Auto and manual (step).

**Trigger:** internal, external or manual.

**Deviation measurement:** when the  $\Delta$ LCR switch is depressed, the measurement value is stored in memory as a standard value. At the same time, the range is set to "Hold" and the display is offset to zero. Deviation is displayed as the difference between the stored value and subsequent measurement data. Deviation is in counts from -999 to 999.

**Offset adjustments:** front panel adjustments are provided to compensate for stray capacitance and residual inductance of the test fixtures.

**C:** 0 to 10 pF. **L:** 0 to 1  $\mu$ H.

**Self test indicators:** when the SELF TEST function is selected, the results of the test are displayed in the LCR and DQ window. Results are indicated by PASS, FAIL 1, FAIL 2 or FAIL 3.









**DC bias:** internal: 1.5 V, 2.2 V and 6 V (selectable on front panel). Accuracy  $\pm 5\%$ ; external: Provision for external DC bias (0 to +40V).

L-D and L-Q Measurement

Range	1	120 (100) Hz	1 kHz	10 kHz	100 $\mu$ H	1000 $\mu$ H	10 mH	100 mH	1000 mH	10 H	100 H	1000 H
Test Signal Level	1 V											
	AUTO											
Accuracy	1% $\pm$ 2 counts											
	AUTO											
Accuracy	0.2% $\pm$ 2 counts											
	AUTO											

1. Calculated from D value as a reciprocal number.  
2. Typical data, varies with value of D and number of counts.  
3. % of reading  $\pm$  counts. DQ in inductance reading in counts. Accuracy in this table apply when D  $\leq 100$ .

### R/ESR\*\* Measurement

Range	120 (100) Hz 1 kHz 10 kHz	1000 mΩ	10.00 Ω	100.0 Ω	1000 Ω	10.00 kΩ	100.0 kΩ	1000 kΩ	10.00 MΩ	
Test Signal Level *1		1 V								
		40 mA	10 mA	1 mA	100 μA	10 μA	-			
	AUTO	Same as  Mode				Same as  Mode				
Accuracy *2		0.2% + 2 counts				0.3% + 2 counts *3				
		0.2% + 2 counts				0.3% + 2 counts				
	AUTO	Same as  Mode				Same as  Mode				



















\*1 Typical data, varies with number of counts

\*2 ± 1% of reading + counts

\*3 ± [5% + 2 counts] on 10.00 MΩ range at 10 kHz test frequency.

\*\* The measurement range for ESR is from 1 mΩ to 19 kΩ (typical). These values vary depending on the series capacitance or inductance value of the device under test.

### C-D and C-Q Measurement

Range	C	120 (100) Hz 1 kHz 10 kHz	1000 pF 100.0 pF 10.00 pF	10.00 nF 1000 pF 100.0 pF	100.0 nF 10.00 nF 1000 pF	1000 nF 100.0 nF 10.00 nF	10.00 μF 10.00 μF 1000 nF	100.0 μF 10.00 μF 1000 nF	1000 μF 100.0 μF 10.00 μF	10.00 mF 1000 μF 100.0 μF	
	D	.001-19.9 (2 Ranges)									
D	.050-1000 (4 Ranges)										
Test Signal Level *2		1 V or 50 mV									
						10 μA	100 μA	1 mA	10 mA	40 mA	
	AUTO	Same as  Mode				Same as  Mode					
C Accuracy *3		0.2% + 2 counts				(Test signal level: 1 V)					
		0.5% + 3 Counts	0.3% + 2 counts				(Test signal level: 50 mV)				
		At 120 (100) Hz, 1 kHz				0.3% + 2 counts				0.5% + 2 counts	1% + 2 counts *4
		At 10 kHz				0.3% + 2 counts				1% + 2 counts	5% + 2 counts
AUTO	Same as  Mode				Same as  Mode						
D (1/Q) Accuracy *3		0.2% + (2 + 200/Cx) counts				At 120 (100) Hz, kHz (Test signal level: 1 V)					
		0.5% + (2 + 200/Cx) counts				At 10 kHz					
		0.3% + (2 + 1000/Cx) counts				At 120 (100) Hz, 1 kHz (Test signal level: 50 mV)					
		1.0% + (2 + 1000/Cx) counts				At 10 kHz					
		At 120 (100) Hz, 1 kHz				0.3% + (2 + Cx/500) counts				1% + (5 + Cx/500) counts	
	At 10 kHz				0.5% + (2 + Cx/500) counts				1% + (5 + Cx/500) counts		
AUTO	Same as  Mode				Same as  Mode						

\*1. Calculated from D value as a reciprocal number.

\*2. Typical data, varies with value of D and number of counts.

\*3. ± (% of reading + counts) C<sub>x</sub> is capacitance readout in counts. Accuracies in this table apply when D < 1.999.

\*4. 5% + 2 counts at 1 kHz.

**Accuracy:** All accuracies apply over a temperature range of 23°C ± 5°C (at 0°C to 55°C, error doubles)

### General

**Measurement time (typical)** for a 1000 count measurement on a low loss component on a fixed range:

1 kHz, 10 kHz: C/L 220-260 ms, R 120-160 ms

120 (100) Hz: C/L 900 ms, R 700 ms

When autorange is selected, the following times per range step must be added to the above time:

1 kHz, 10 kHz: 45 ms/180 ms per range step

120 (100) Hz: 150 ms/670 ms per range step

When the uncal lamp is lit, the faster ranging time is selected.

**Reading rate:** INT (Internal Trigger) approximately 30 ms between the end of a measurement cycle and the start of the next cycle. EXT (External Trigger) measurement cycle is initiated by a remote trigger input.

**Operating temperature and humidity:** 0°C to 55°C; to 40°C at 95% RH.

**Power requirements:** 100/120/220 VAC ± 10%, 240 Vac +5% - 10%; 48-66 Hz.

**Power consumption:** ≤ 55 VA with any option

**Size:** 147 H × 426 W × 345 mm D (5 3/4" × 16 3/4" × 13 3/4")

**Weight:** Approximately 8 kg (17.5 lbs).

**Accessories available:** 16061A: test fixture, direct coupled, 5-terminal; 16062A: test leads with alligator clips, 4-terminal (for low impedance measurements); 16063A: test leads with alligator clips, 3-terminal (for high impedance measurements).

**Options available** Opt 001: BCD data output of LCR and DQ data. Opt 004: Digital comparator for LCR and DQ data. Comparison output (HIGH, IN, LOW): visual, relay contact closure and TTL level. Not compatible with Opt 101. Opt 101: HP-IB Data Output and Remote Control. Not compatible with Opt 001 and 004.

Options and accessories	Price
001: BCD Output	\$240
004: Digital Comparator	\$580
010: 100 Hz Test Frequency	0
101: HP-IB Interface	\$395
908: Rack Flange Kit	\$10
910: Extra Manual	\$15
16061A Test Fixture	\$95
16062A Test Cables	\$49
16063A Test Cables	\$49

4262A Digital LCR Meter

\$2335



# COMPONENT TEST

## Universal bridge

### Model 4260A

- Electronic autobalance—single control null
- Digital readout for C, R, L
- Direction indicators for fast range selection and balance



## Description

Measurements of C, R, L, D (dissipation factor of capacitors), and Q are easily made with Hewlett-Packard's Model 4260A Universal Impedance Bridge.

Readout for C, R, and L is digital with the decimal point automatically positioned. Units of measurement and equivalent circuit automatically appear with a twist of the function switch. There are no multipliers or confusing nonlinear dials which need interpolation.

Operation is simple. Set the function knob for the parameter to be measured, adjust range switch for an on-scale indication, and obtain a null with CRL control. There are no interacting controls to adjust and readjust, nor any false nulls. A unique electronic autobalance circuit solves all these problems. Components with low Q or high D are as easy to measure as those without loss.

For D or Q measurements, switch out of auto and turn DQ control until another null is obtained. Only one adjustment is needed for each measurement.

Five bridge circuits are incorporated in HP's 4260A; each is composed of stable, high-quality components for good accuracy and linearity. An internal 1 kHz drives the bridge.

Nulling is easy. Illuminated pointers (<CRL>) automatically tell whether a null is up- or down-scale. Both range and CRL controls can be set watching these pointers.

Components may be biased by connecting a battery to rear terminals. An external oscillator and detector can be used for measurements in the 20 Hz–20 kHz range.

## Specifications

### Capacitance measurement

**Range:** 1000 pF to 1000  $\mu$ F, in 7 full scale ranges.

**Accuracy:**  $\pm(1\% + 1 \text{ digit})$ , from 1 nF to 100  $\mu$ F.  $\pm(2\% + 1 \text{ digit})$ , from 1 pF to 1 nF and 100  $\mu$ F to 1000  $\mu$ F.

### Dissipation factor

#### Range

Low D—(of series C): 0.001 to 0.12.

High D—(of parallel C): 0.05 to 50.

**Accuracy:** for C > 100 pF.

$$\text{Low D} \dots \dots + \frac{2}{\sqrt{D \text{ of reading}}} \%.$$

$$\text{High D} \dots \dots + (10 D \text{ of reading} + 4)\%.$$

$$- (10\sqrt{D \text{ of reading}} - 2)\%.$$

Add  $\pm 1$  dial division for frequencies other than 1 kHz.

### Inductance measurement

**Range:** 1000  $\mu$ H to 1000 H, in 7 full scale ranges.

**Accuracy:**  $\pm(1\% + 1 \text{ digit})$ , from 1 mH to 100 H.  $\pm(2\% + 1 \text{ digit})$ , from 1  $\mu$ H to 1 mH and 100 H to 1000 H.

### Quality factor

#### Range

Low Q—(of series L): 0.02 to 20.

High Q—(of parallel L): 8 to 1000.

**Accuracy:** for L > 100  $\mu$ H.

$$\text{Low Q} \dots \dots + \left( \frac{10}{Q \text{ of reading}} + 4 \right) \%.$$

$$- \left( \frac{10}{\sqrt{Q \text{ of reading}}} + 2 \right) \%.$$

$$\text{High Q} \dots \dots \pm 2 \sqrt{Q \text{ of reading}} \%.$$

Add  $\pm 1$  dial division for frequencies other than 1 kHz.

### Auto-balance

Eliminates need for DQ adjustments in parallel C and series L measurements at 1 kHz.

**Accuracy:** for D < 1 and Q > 1 add  $\pm 0.5\%$  to C and L accuracy specifications.

### Resistance measurement

**Range:** 10  $\Omega$  to 10 M $\Omega$ , in 7 full scale ranges.

**Accuracy:** 10 m $\Omega$  to 10  $\Omega$   $\pm(2\% + 1 \text{ digit})$ . 10  $\Omega$  to 1 M $\Omega$   $\pm(1\% + 1 \text{ digit})$ . 1 M $\Omega$  to 10 M $\Omega$   $\pm(2\% + 1 \text{ digit})$ .

### Oscillator and detector

**Internal oscillator:** 1 kHz  $\pm 2\%$ , 100 mV rms  $\pm 20\%$ .

**Internal detector:** tuned amplifier at 1 kHz; functions as a broadband amplifier for measurements with external oscillator.

### General

**Power:** 115 or 230 volts  $\pm 10\%$ , 50–60 Hz, approx. 7 VA.

**Size:** 166 H  $\times$  198 W  $\times$  279 mm D (6<sup>11</sup>/<sub>32</sub>"  $\times$  7<sup>23</sup>/<sub>32</sub>"  $\times$  11").

**Weight:** net, 5 kg (11 lb). Shipping, 6.8 kg (15 lb).

### Options

Opt 910: extra manual

### Price

add \$9

4260A Universal Bridge

\$1145

- High accuracy: 0.2%
- Wide range  
 C: 0.1 pF to 1111  $\mu$ F  
 L: 0.1  $\mu$ H to 1111 H  
 R: 0.1 m $\Omega$  to 1.111 M $\Omega$



4265B



16029 Test Fixture

## Description

Hewlett-Packard's Model 4265B Universal Bridge provides an economical way to make high precision measurements of L, C, or R and D or Q. Components can be measured in ranges of 0.1  $\mu$ H to 1111 H in inductance, 0.1 pF to 1111  $\mu$ F in capacitance and 0.1 m $\Omega$  to 1.111 M $\Omega$  in resistance. L and C measurements are performed over a wide range of loss with either series or parallel equivalent circuits selected by the function switch. Basic measurement accuracy is 0.2% of reading for L, C, and R.

Measurement frequency range is 50 Hz to 10 kHz with an external oscillator, and 1 kHz with internal oscillator. A dc measurement for resistance is also available with external dc power supply and null detector.

The front panel design provides appropriate space and convenient positioning of knobs for easy balancing. The rugged handle is used as the tilt stand at angles of 0, 40, or 60 degrees.

## Specifications

### Resistance measurement

**Full scale range:** 1000.0 m $\Omega$  to 1.0000 M $\Omega$ , 7 ranges.

**Overrange:** 11.1%.

**Minimum resolution:** 0.1 m $\Omega$ .

**\*\*Accuracy (at 1 kHz):**  $\pm(0.2\%$  of reading + 0.01% of F.S.),  $\pm(0.4\%$  of reading + 0.01% F.S.) for 1000.0 m $\Omega$  range.

**Residual resistance:** 1 m $\Omega$ .

### Inductance measurement

**Full scale range:** 1000.0  $\mu$ H to 1000.0 H, 7 ranges.

**Overrange:** 11.1%.

**Minimum resolution:** 0.1  $\mu$ H.

**\*\*Accuracy (at 1 kHz):**  $\pm(0.2\%$  of reading + 0.01% of F.S.),  $\pm(0.4\%$  of reading + 0.01% F.S.) for 1000.0  $\mu$ H range.

**Residual inductance:** 0.04  $\mu$ H (in series with 1 m $\Omega$ ).

**Loss factor range:** (at 1 kHz).

**Q of series L:** 0.001 to 10, accuracy  $\pm(5\%$  of reading + 2 minor divisions).

**Q of parallel L:** 1 to 1000, accuracy  $\pm(5\%$  of reading + 2 minor divisions) for 1/Q.

### Capacitance measurement

**Full scale range:** 1000.0 pF to 1000.0  $\mu$ F, 7 ranges.

**Overrange:** 11.1%.

**Minimum resolution:** 0.1 pF.

**\*\*Accuracy (at 1 kHz):**  $\pm(0.2\%$  of reading + 0.01% of F.S.),  $\pm(0.4\%$  of reading + 0.01% F.S.) for 1000.0  $\mu$ F range.

**Residual capacitance:** 0.4 pF.

**Loss factor range:** (at 1 kHz).

**D of series C:** 0.001 to 1, accuracy  $\pm(5\%$  of reading + 2 minor divisions).

**D of parallel C:** 0.1 to 1000, accuracy  $\pm(5\%$  of reading + 2 minor divisions) for 1/D.

\*For temperature of 25°C  $\pm$  3°C.

## General

### Internal oscillator

**Frequency:** 1 kHz  $\pm$  15 Hz.

**Output:** continuously variable with front panel control. Maximum voltage is 0.4 V rms.

### External oscillator

**Frequency range:** 50 Hz to 10 kHz or dc for resistance measurement.

**Internal detector:** tuned amplifier at 1 kHz. In 1 kHz position, maximum sensitivity of 10  $\mu$ V, selectivity better than 26 dB. In "flat," operates as a broad band detector from 50 Hz to 10 kHz.

**External dc bias:** capacitance measurements in Cs mode, maximum bias voltage of 250 V dc. Inductance measurements in Lp mode.

**Operating temperature:** 0° to 55°C.

**Power:** 100/120/200/240 V  $\pm$  10%; 48 to 440 Hz, 5 VA.

**Dimensions:** 376 mm H  $\times$  393 mm W  $\times$  115 mm D (14 $\frac{13}{16}$ "  $\times$  15 $\frac{3}{16}$ "  $\times$  4 $\frac{1}{2}$ ").

**Weight:** net, 5.5 kg (12.1 lb). Shipping, 7.1 kg (15.7 lb).

**Accessories furnished:** power cord, 2.3 m (7 $\frac{1}{2}$  ft). Crystal earphone.

**Accessories available:** model 16029A Test Fixture.

## Ordering Information

16029A Test Fixture

Opt 910: Extra Manual

4265B Universal Bridge

## Price

\$59

add \$9

\$1100



# COMPONENT TEST

## Digital LCR Meter

Model 4261A

- Fully automatic—autoranging
- Wide range C = 0.1 pF to 19 mF, L = 0.1  $\mu$ H to 1900 H, R = 1 m $\Omega$  to 19 M $\Omega$
- Low cost with high performance
- Versatile accessories/options
- High reliability



### Description

The Model 4261A Digital LCR Meter is a new, fully automatic instrument that satisfies many of today's user requirements in the LCR measurement field.

The 4261A features high speed, accurate measurements. The devices under test need only be connected and the function L, C, or R selected. The instrument automatically displays the desired parameter. Tedious balancing operations typically used in conventional manual bridges are completely eliminated. Measurement circuit mode (series or parallel) is also automatically selected.

Complementing its wide LCR measurement range, HP's 4261A has other features such as high accuracy (basically 0.2% of reading), high speed measurement (typically 4 per second), 120 Hz or 1 kHz measurement frequencies, 1 V or 50 mV test signal levels, internal bias sources and parallel or series equivalent circuit modes.

Measurements are taken using the five-terminal method, which easily converts to four, three or two terminals to meet most LCR measurement applications. For example, the four-terminal input

could be used to measure the capacitance of an electrolytic capacitor, the inductance of transformer or the internal resistance of a dry cell. The three-terminal input is appropriate for semiconductor junction capacitance or cable capacitance measurements. To fit these needs, three kinds of optional test leads and fixtures are available. The 4261A can easily measure parameters of pulse transformers, filter coils and electrolytes in addition to ordinary LCR components.

Expanded use features of this highly reliable instrument include optionally available digital output and remote control which enable a wide range of applications from the research laboratory to the production line.

### Specifications

**Parameter measured:** C-D (Capacitance & Dissipation Factor), L-D (Inductance & Dissipation Factor), and R (Resistance).

**Display:** 3½ digits, max. display 1900.

**Circuit mode:** Auto, Parallel and Series.

**Measuring circuit:** 5-terminal method.

**Range mode:** Auto or Range Hold.

**Measurement frequencies:** 120 Hz  $\pm 3\%$  or 1 kHz  $\pm 3\%$ .

**Trigger:** Internal, Manual or External.

**Measurement ranges, measurement accuracies & test signal levels:** see tables on next page for C-D, L-D, and R measurements. Accuracy applies over a temperature range of 23°C  $\pm 5^\circ$ C (at 0°C to 55°C, error doubles).

### DC Bias

**Internal source:** 1.5 V, 2.2 V, 6 V (selectable on front panel).

**Accuracy:**  $\pm 5\%$ .

**External source:** provision for external DC bias voltage of +30 V maximum at binding posts on rear panel.

### General

**Measuring time** typically approx. 1000 counts on fixed range for low loss measurements. Specific data follows:

1 kHz: C/L 220–260 ms, R: 120–160 ms.

120 Hz: C/L 900 ms, R 700 ms.

When auto range is selected, a range selection time of 180 ms at 1 kHz and a range step time 670 ms at 120 Hz is added to the above typical times.

**Reading rate:** internal trigger—approx. 30 ms between end of measurement and start of next cycle; External trigger—measurement cycle is initiated by remote trigger input.

**Data format:** + 1-2-4-8 BCD, TTL logic level, "1" (high level).

**Operating temperature:** 0°C to 55°C.

**Humidity:** to 95% RH at 40°C.

**Voltage requirements:** 100/120/220/240 V  $\pm 10\%$ , 48 to 66 Hz.

**Power consumption:**  $\leq 25$  VA with any option.

**Altitude:** 50,000 ft.

**Dimensions:** 132.6 mm H  $\times$  213 mm W  $\times$  422 mm D (5¼"  $\times$  8⅝"  $\times$  16⅜").

**Weight:** approx. 7.5 kg (16.5 lb).

### R Measurement







RANGE	120 Hz or 1 kHz	1000 m $\Omega$	10.00 $\Omega$	100.0 $\Omega$	1000 $\Omega$	10.00 k $\Omega$	100.0 k $\Omega$	1000 k $\Omega$	10.00 M $\Omega$
Test Signal Level Note 1		1 V							
		70 mA	10 mA	1 mA	100 $\mu$ A	10 $\mu$ A			
	AUTO	Same as  Mode				Same as  Mode			
R Accuracy Note 2		0.3% $\pm$ 2 counts							
		0.2% $\pm$ 2 counts							
	AUTO	Same as  Mode				Same as  Mode			

1. Typical data, varies with number of counts.

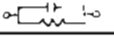
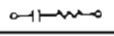
2.  $\pm$  (% of reading + counts).

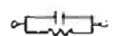
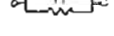

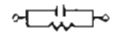



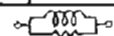
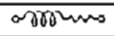

### C-D Measurement

RANGE	C	120 Hz 1 kHz	1000 pF 100.0 pF	10.00 nF 1000 pF	100.0 nF 10.00 nF	1000 nF 100.0 nF	10.00 μF 1000 nF	100.0 μF 10.00 μF	1000 μF 100.0 μF	10.00 mF 1000 μF	
	0.001 to 1.900, common to all C ranges.										
Test Signal Level Note 1		1 V or 50 mV									
		10 μA		100 μA		1 mA		10 mA		70 mA	
	AUTO	Same as  Mode				Same as  Mode					
C Accuracy Note 2		0.2% + 1 count + 0.2 pF				(Test signal level, 1 V)					
		0.5% + 3 counts		0.3% + 2 counts						(Test signal level, 50 mV)	
	AUTO	Same as  Mode				0.3% + 2 counts		0.5% + 2 counts		1% + 3 counts	
D Accuracy Note 2		0.2% + (2 + 200/Cx) counts				(Test signal level, 1 V)					
		0.3% + (2 + 1000/Cx) counts						(Test signal level, 50 mV)			
	AUTO	Same as  Mode				0.3% + (2 + Cx/500) counts		1% + (5 + Cx/500) counts			

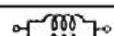
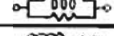
1 Typical data, varies with value of D and number of counts.  
 2 ± (% of reading + counts + α). Cx is capacitance readout in counts.  
 3 (5% + 2 counts) at 1 kHz.

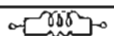
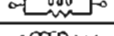
### L-D Measurement

RANGE	L	120 Hz 1 kHz	1000 μH 100.0 μH	10.00 mH 1000 μH	100.0 mH 10.00 mH	1000 mH 100.0 mH	10.00 H 1000 mH	100.0 H 10.00 H	1000 H 100.0 H		
	0.001 to 1.900, common to all L ranges.										
Test Signal Level Note 1		1 V									
		70 mA		10 mA		1 mA		100 μA		10 μA	
	AUTO	Same as  Mode				Same as  Mode					
L Accuracy Note 2		0.3% + 2 counts				1% + 2 counts					
		0.2% + 2 counts + 0.2 μH									
	AUTO	Same as  Mode				Same as  Mode					
D Accuracy Note 2		0.3% + (3 + Lx/500) counts				1% + (3 + Lx/500) counts					
		0.2% + (3 + 200/Lx) counts									
	AUTO	Same as  Mode				Same as  Mode					

1 Typical data, varies with value of D and number of counts.  
 2 ± (% of reading + counts + α). Lx is inductance readout in counts.

#### Accessories available

<b>16061A:</b> Test Fixture (direct coupled type), 5-terminal	Price	\$95
<b>16062A:</b> Test Leads with alligator clips, 4-terminal (for low impedance measurements)	Price	\$49
<b>16063A:</b> Test Leads with alligator clips, 3-terminal (for high impedance measurements)	Price	\$49

#### Options available

<b>Opt 001:</b> BCD Output of C/L/R and D (simultaneous)	add \$140
<b>Opt 002:</b> BCD Output of C/D, L/D and R (alternately)	add \$125

**Opt 003:** BCD Remote Control (except for DC bias function) add \$60

#### Ordering Information

<b>16061A</b> Test Fixture	Price	\$95
<b>16062A</b> Test Leads	Price	\$49
<b>16063A</b> Test Leads	Price	\$49
<b>Opt 001</b> BCD Output (Simultaneous)	add \$140	
<b>Opt 002</b> BCD Output (Alternately)	add \$125	
<b>Opt 003</b> BCD Remote Control	add \$60	

4261A Digital LCR Meter

\$1750

# COMPONENT TEST

## 1 MHz Digital LCR Meter

Model 4271B

- Automatic high-speed measurements of low value components
- Precision LCR and loss measurements
- HP-IB interface for easy systems integration

- Wide measurement range (resolution to overrange):  
 C: 0.001 pF to 1900.0 nF  
 L: 0.1 nH to 1900.0 mH  
 R: 0.001  $\Omega$  to 19.000 k $\Omega$



### Description

The HP 4271B 1 MHz LCR Meter meets the requirements of the laboratory, manufacturing and quality assurance where speed and accuracy are essential. Fully automatic inductance, capacitance and loss measurements can be made at the rate of up to 5 readings per second.

The four-terminal pair measurement technique used in the 4271B reduces errors due to electromagnetic coupling of leads as well as reducing residual inductance and stray capacitance. Offset adjustments are provided to cancel the residuals of the test fixtures.

Typical applications for the 4271B include microcircuit measurements, capacitance-voltage characteristics of semiconductor devices and passive component tests on devices such as ceramic and mica capacitors, reed relays and pulse transformers.

### Specifications

**Parameters measured:** capacitance and conductance (C-G) or capacitance and dissipation factor (C-D) using parallel equivalent

circuit. Inductance and dissipation factor (L-D) or inductance and resistance (L-R) using series equivalent circuit. R is equivalent series resistance.

**Display:** dual 4½ digit LED displays.

**Overrange:** 90% on C, G, L, and R; 60% on D.

**Test frequency:** 1 MHz  $\pm 0.01\%$ .

**Ranging:** automatic and manual. Remote control with Opt 101.

**Measurement terminals:** four-terminal pair construction.

**Offset adjustment:** offset adjustment compensates for (a) stray capacitance and residual conductance of test fixture; variable ranges are 1 pF and 1  $\mu$ S, or (b) residual inductance or residual resistance of test fixture. Variable ranges are 100 nH and 100 m $\Omega$ .

**DC Bias (optional)**

**Internal source:** DC bias is available as Opt 001 with the following specifications:

**Range:** 00.0 V to 39.9 V, variable in steps of 0.1 V.

**Accuracy:**  $\pm 0.2\%$  of setting  $\pm 5$  mV (when ambient temperature is at  $23^\circ\text{C} \pm 5^\circ\text{C}$  and warm-up time is more than 60 min.).

C—G and C—D

			RANGE 1	RANGE 2	RANGE 3	RANGE 4
Full Scale Display	C		10.000 pF	100.00 pF	1000.0 pF	10.000 nF
	G		100.00 $\mu$ S	1000.0 $\mu$ S	10.000 mS	100.00 mS
	D		1.0000 on all ranges when C reading is greater than 1500 counts			
Test Signal Level	HIGH		500 mV rms $\pm 10\%$			20 mVrms $\pm 20\%$
	LOW		20 mVrms $\pm 10\%$			
Accuracy (% of reading - counts)	C	HIGH	0.1 + 7	0.1 + 3	0.1 + 3	0.4 + 3
		LOW	0.2 - 8	0.2 + 2	0.2 + 3	
	G	HIGH	$0.2 + \left(7 + \frac{N_c}{1000}\right)$	$0.2 + \left(3 + \frac{N_c}{1000}\right)$	$1.2 + \left(2 + \frac{2 \cdot N_c}{1000}\right)$	
		LOW	$0.3 + \left(7 + \frac{2 \cdot N_c}{1000}\right)$	$0.3 + \left(3 + \frac{2 \cdot N_c}{1000}\right)$		
	D	HIGH	$1.0 - \left(10 + \frac{20,000}{N_c}\right)$	$1.0 + \left(10 + \frac{10,000}{N_c}\right)$		$1.0 + \left(15 + \frac{30,000}{N_c}\right)$
		LOW	$1.0 - \left(15 + \frac{30,000}{N_c}\right)$	$1.0 + \left(15 + \frac{20,000}{N_c}\right)$		
Overrange	C		90% all ranges			
	G		90% all ranges			
	D		60% all ranges			

\*When conductance reading is less than 1000 counts.

$N_c$  is the capacitance readout in counts.

## L—D and L—R

		RANGE 1	RANGE 2	RANGE 3	RANGE 4
Full Scale Display	L	1000.0 nH	10.000 μH	100.00 μH	1000.0 μH
	R	10.000 Ω	100.00 Ω	1000.0 Ω	10.000 kΩ
	D	1.0000 on all ranges when L reading is greater than 1500 counts			
Test Signal Level	HIGH	2 mA rms ± 20%	5 mA rms ± 10%	500 μA rms ± 10%	50 μA rms ± 10%
	LOW		200 μA rms ± 10%	20 μA rms ± 10%	2 μA rms ± 10%
*Accuracy ± (% of reading + counts)	L	HIGH	1.0 + 15	0.6 + 4	0.2 + 4
		LOW		0.6 + 6	0.3 + 6
	R	HIGH	$1.2 + \left( 8 + \frac{2 \cdot N_L}{1000} \right)$	$1.2 + \left( 2 + \frac{2 \cdot N_L}{1000} \right)$	$0.3 + \left( 2 + \frac{2 \cdot N_L}{1000} \right)$
		LOW			$0.5 + \left( 2 + \frac{2 \cdot N_L}{1000} \right)$
	D	HIGH	$1.0 + \left( -20 + \frac{30,000}{N_L} \right)$	$1.0 + \left( 15 + \frac{10,000}{N_L} \right)$	$1.0 + \left( 15 + \frac{20,000}{N_L} \right)$
		LOW		$1.0 + \left( 20 + \frac{20,000}{N_L} \right)$	$1.0 + \left( 20 + \frac{30,000}{N_L} \right)$
Overrange	L	90% All Ranges			
	R	90% All Ranges			
	D	60% All Ranges			

\*When resistance reading is less than 1000 counts.

 \*N<sub>L</sub> is the inductance reading in counts.

## Conductance, Resistance

		RANGE 1	RANGE 2	RANGE 3	RANGE 4	
G	Full Scale Display	100.00 μS	1000.0 μS	10.000 mS	100.00 mS	
	Test Signal Level	HIGH	500 mV rms ± 10%			
		LOW	20 mV rms ± 10%			
	Accuracy ± (% of Rdg + counts)	HIGH	0.2 + 8	0.2 + 4	1.2 + 4	
LOW		0.3 + 9	0.3 + 5			
R	Full Scale Display	10.000 Ω	100.00 Ω	1000.0 Ω	10.000 kΩ	
	Test Signal Level	HIGH	2 mA rms ± 20%	5 mA rms ± 10%	500 μA rms ± 10%	50 μA rms ± 10%
		LOW		200 μA rms ± 10%	20 μA rms ± 10%	2 μA rms ± 10%
	Accuracy ± (% of Rdg - counts)	HIGH	1.2 + 10	1.2 + 4	0.2 + 4	
LOW				0.3 + 4		

\*When capacitance or inductance is less than 1,000 counts.

 Accuracies listed in the above tables apply over a temperature range of 23°C ± 5°C. (At 0°C to 50°C, accuracy percentages are doubled.)  
 Warm-Up Time: One hour minimum required to meet all specifications.

**Output resistance:** 1.5 kΩ ± 10%. Bias voltage is applied to H<sub>COM</sub> terminal.

**Short circuit current:** less than 6 mA.

**Control:** controlled by HP Model 16023A DC Bias Controller (optionally available) or by the HP-1B when Opt 101 is installed.

**Control input connector:** HP P/N 1251-0143, 14-pin receptacle (Amphenol 57-40140).

**Mating connector:** HP Part No. 1251-0142 (Amphenol 57-30140).

**External source:** Provision for external dc bias voltage of ±200 V maximum to BNC connector (EXT INPUT) on rear panel. Max bias current 20 mA. Input resistance 10.5 kΩ ± 10%.

**Monitor output:** bias voltage monitoring BNC connector (MONITOR) on rear panel. Output resistance: 480 Ω ± 10% to H<sub>COM</sub> terminal.

**General**
**Measuring Speed**
**Fixed range:** 100 ms to 250 ms for C-G and L-R measurement. 160 ms to 400 ms for C-D and L-D measurements.

**Autorange:** 100 ms/range step added to above values.

**Operating temperature:** 0°C to 50°C.

**Relative humidity:** to 95% at 40°C.

**Power:** 100/120/220 V ± 10%, 240 V + 5% - 10%. 48-66 Hz, 80 VA max.

**Size:** 88 H × 425 W × 496 mm D (3<sup>11</sup>/<sub>16</sub>" × 16<sup>3</sup>/<sub>4</sub>" × 19<sup>11</sup>/<sub>16</sub>").

**Weight:** 10 kg (22 lb).

**Accessory furnished:** 16038A Test Fixture for radial and axial lead components.

**Ordering Information**

	Price
16021A Calibration Test Fixture (GR900 connector)	\$475
16022A General Purpose Test Fixture	\$414
16023A DC Bias Voltage Controller (used with Opt 001)	\$440
16032A Test Leads (BNC)	\$175
16033A Test Leads with miniature coaxial connectors	\$190
16034A Test Fixture for chip capacitor measurement	\$295
16039A Test Fixture with "D" offset	\$205
Opt 001: DC Bias supply: 0.0 V to 39.9 V	add \$245
Opt 002: C/L BCD output; may be used with Opt 003	add \$130
Opt 003: G/R/D BCD output. +8421 Code (see Opt 002)	add \$130
Opt 004: Parameter Serial BCD output; allows selection of: 1. (C or L) Data only; 2. (D or G or R) Data only; or 3. (C or L) and (D or G or R) Data -8421 Code	add \$220
Opt 010: 4271B Less Test Fixture 16038A	less \$155
Opt 101: HP-1B Data Output and Remote Control	add \$680

4271B 1 MHz Digital LCR Meter

\$4685



# COMPONENT TEST

## Capacitance bridge

Model 4270A

- Fully automatic
- 1 kHz to 1 MHz
- Measure from 18.000 pF to 1.2000  $\mu$ F Full Scale



### Description

A unique instrument from Hewlett-Packard, the 4270A Automatic Capacitance Bridge provides a wide variety of high speed measurements of both active and passive capacity values. Five-digit readout of capacitance from full-scale ranges of 18.000 pF to 1.2000  $\mu$ F is complemented by .001 pF resolution and measurement speed of 0.5 seconds. In addition, a second in-line 4-digit Nixie<sup>®</sup> display of capacitor loss is given simultaneously in terms of parallel conductance (G) or dissipation factor (D). In the laboratory, HP's 4270A will be extremely useful for examination of semiconductor junction capacities, input capacitances of amplifiers and other active devices, as well as analysis of stray capacity values, cables and simple capacitors. DC biasing, four frequencies from 1 kHz to 1 MHz and a fully guarded measurement will add to laboratory flexibility.

### Specifications

#### Measuring circuit

**Float:** guarded terminals of unknown are floated from ground.  
**L-ground:** one side of known terminals is grounded; guard is retained.

**Parameters measured:** capacitance, equivalent parallel conductance and dissipation factor.

**Measuring frequency:** 1 kHz, 10 kHz, 100 kHz and 1 MHz  $\pm$  1%.

#### Range modes

**Auto:** range selection and balance performed automatically.

**Hold:** range is held on fixed position, balance begins with most significant digit. Range determined by previous auto or track range selected or by manually stepping range step.

**Track:** range held on fixed position, balance begins with last digit.

**Balancing time:** typically 0.5 s.

**Measuring rate:** measurement cycle equals balance time plus display time. Balance time typically 0.5 s; display times selected by meas rate are 70 ms, 2 secs, 5 secs, and manual.

#### Test voltage across unknown

**Normal:** 1 V rms constant in pF or nF at 1 kHz, 0.1 V rms constant, in  $\mu$ F at 1 kHz, 0.5 V rms constant at 10 kHz, 100 kHz and 1 MHz.

**Low:** 1/5 of normal.

**Repeatability:**  $\pm$  2 digits at normal test voltage,  $\pm$  10 digits at low test voltage.

**DC bias:** Internal or external to  $\pm$  200 V, in hold and track mode.

#### Internal bias at float measurement

**Voltage:** 0 to 20 V dc; 0 to 200 V dc; continuously variable on front panel, monitored on rear panel.

**Dial accuracy:**  $\pm$  5% of full scale.

**Source resistance:** 100 k $\Omega$ .

**Polarity:** low unknown terminal (-), high unknown terminal (+) in float position of meas ckt control.

**Remote:** programmable by resistor with 250 $\Omega$ /V rate at 20 V range, 25 $\Omega$ /V rate at 200 V range.

**Remote accuracy:**  $\pm$  2% of full scale.

**Internal bias at L-ground:** an additional connection using a blocking capacitor and a coaxial cable is necessary for internal source.

### Available full scale ranges

Capacitance				Conductance	Dissipation Factor
1 kHz	10 kHz	100 kHz	1 MHz		
180.00 pF	18.000 pF			899.9n S	.8999
1800.0 pF*	180.00 pF	18.000 pF		8.999 $\mu$ S	
18.000 nF	1800.0 pF	180.00 pF	18.000 pF	89.99 $\mu$ S	
180.00 nF	18.000 nF	1800.0 pF	180.00 pF	899.9 $\mu$ S	
1.2000 $\mu$ F	180.00 nF	18.000 nF	1200.0 pF	8.999m S	

NOTE: heavy line encloses available full-scale ranges in L-GROUND full display of 0/G is obtained at TRACK MODE, and is limited by AUTO RESET of 1.5 sec at AUTO/HOLD MODE  
 \*Accuracy at L-GROUND is not specified on this range.

### Basic accuracy: $\pm$ % of reading; $\pm$ number of digits

	Frequency	1 kHz & 10 kHz	100 kHz	1 MHz
C	0 < 0.1	$\pm$ 0.1% $\pm$ 1 digit $\pm$ 0.01 pF	$\pm$ 0.3% $\pm$ 1 digit $\pm$ 0.01 pF	$\pm$ 1% $\pm$ 1 digit $\pm$ 0.02 pF
	Basic Accuracy 0.1 < 0 < 0.899	$\pm$ 0.2% $\pm$ 1 digit $\pm$ 0.01 pF	$\pm$ 0.5% $\pm$ 1 digit $\pm$ 0.01 pF	$\pm$ 2% $\pm$ 1 digit $\pm$ 0.01 pF
G	Basic Accuracy	$\pm$ 1% $\pm$ 10 digits		$\pm$ 3% $\pm$ 10 digits
D	Basic Accuracy	$\pm$ 1% $\pm$ (10 + Cs/Cx) digits		$\pm$ 3% $\pm$ (10 + Cs/Cx) digits

NOTE: CS: internal standard capacitor  
 CX: capacitance measured

**Outputs:** 4 line BCD.

#### Inputs

**Trigger hold off level:** level must be between 10 V and 15 V.

**Remote programming:** eight front-panel functions can be remotely controlled by external contact closure to ground with impedance less than 400 $\Omega$ . Programmable functions are reset, frequency, range mode, test voltage, loss meas, range step, dc bias, bias vernier.

**Operating temperature:** 0 $^{\circ}$ C to 50 $^{\circ}$ C.

**Power requirements:** 115 or 230 V ac  $\pm$  10%, 50 to 60 Hz (approximately 110 W).

**Weight:** net, 15.5 kg (34 lb). Shipping, 21.6 kg (48 lb).

#### Accessories available:

Accessories for HP's 4270A Automatic Capacitance Bridge:

The following adapters convert BNC Connectors on HP's 4270A to allow direct insertion of components. 16011A converts from BNC to binding posts. 16012A converts from BNC to test axial lead devices. It has a centrally located guard plane to reduce errors due to stray capacitance. 16013A converts from BNC to test vertical lead devices. It has a guard plane similar to 16012A. 11143A converts from BNC to clip leads. 44" overall length with third lead to preserve guard terminal.

#### Options and accessories

	Price
110: HP-IB Data Output & Remote Control	\$1890
Opt 910: Extra Manual	add \$35
16011A Test Fixture	\$64
16012A Test Fixture	\$71
16013A Test Fixture	\$71
16411A HP-IB Interface Kit	\$1890
11143A BNC Cable	\$39

4270A Automatic Capacitance Bridge

\$7225

# COMPONENT TEST

## 1 MHz Preset C Meter

### Model 4272A



- Simultaneous go/no go check on production line
- High accuracy—basically 0.1% of reading
- High speed measurements—8 per second



### Description

The 4272A 1 MHz preset C meter is a unique instrument in which a 5 digit "in-house" comparator is combined with 1 MHz capacitance measurement capability. Capacitance can be measured from 10 pF full scale (resolution 0.001 pF) to 1000 pF full scale (maximum display 1900 pF).

In addition to the comparator capability, the instrument can be set to high and low limits with the built-in thumbwheel switch. Limit indications include panel lamp display, relay contact and TTL output for HI, IN and LO comparisons.

The combination of measurement and comparator capability makes this instrument very applicable for production line GO/NO GO checking. When relatively small capacitors such as ceramic or mica are checked for quality in the production process, there is no necessity to read the digital display.

A GO/NO GO check requires only a glance at the HI-IN-LO lamp display. Decision type outputs can be utilized in an automatic selection system.

BCD data output for data processing of variable is optionally available.

### Specifications

**Parameter measured:** capacitance—equivalent parallel circuit by four terminal pair method.

#### Test signal

**Frequency:** 1 MHz  $\pm 0.01\%$ .

**Level:** 1 V rms  $\pm 10\%$ .

**Measurement range and accuracy:** 0.001 pF–1900.0 pF in 3 decade range, manually selected. Remote ranging is optionally available.

Range	Full Scale Display	Overrange	Accuracy*
10 pF	10.000 pF	50%	0.1 + 7
100 pF	100.00 pF	50%	0.1 + 3
1000 pF	1000.0 pF	each range	0.1 + 2

\* $\pm 1\%$  of reading + counts

Accuracy applies over a temperature range of 23°C  $\pm 5^\circ\text{C}$  at dissipation factors  $D < 0.1$  (At 0°C–50°C, error doubles). Warm-up time is  $> 60$  min.

**Offset adjustment:** offset adjustment compensates for stray capacitances of 0 to 1 pF and residual inductances of 0 to 100 nH existing at test fixture.

**Function:** compares measured value with HI and LOW LIMIT setting and provides HI, IN and LO comparison outputs.

**HI and LOW LIMIT SETTING RANGE:** 00000–19999 at each limit switch.

**Comparison output:** visual, relay contacts and TTL level.

**Visual:** 3 LED's indicate HI, IN or LO.

**Relay contacts:** 3 SPST contacts to circuit common for HI, IN or LO output.

**TTL level:** 3 open collector circuits to HI level (open) for HI, IN or LO output (Fanout max 30 mA).

**Measuring time:**  $< 120$  ms.

#### Reading rate

**Internal:**  $< 400$  ms. Between end of measurement and start of next cycle.

**External:** a new cycle may be started by pushing manual trigger button or by remote trigger input to remote trigger connector.

**Remote trigger input:** a measurement cycle may be initiated at remote trigger connector by changing logic level state from "0" (zero volts or connection to ground though less than 25 $\Omega$ ) to "1" (TTL high level or open), pulse width  $> 1 \mu\text{s}$ .

#### General

**Operating temperature & humidity:** 0°C to 50°C, relative humidity to 95% at 40°C.

**Power requirements:** 100/120/220/240 V  $\pm 10\%$ , 48–66 Hz.

**Power consumption:**  $\leq 60$  VA with any option.

**Dimensions:** 99 mm H  $\times$  426 mm W  $\times$  467 mm D.

**Weight:** approximately 10 kg.

**Accessories furnished:** 16032A Test Leads with BNC Connectors.



#### Accessories available

Accessories available	Price
16021A: Calibration connector	\$475
16022A: Test Fixture, General Purpose	\$415
16033A: Test Leads with Miniature Coaxial Connectors	\$190
16034A: Chip Capacitor Test Fixture	\$295
16038A: Test Fixture	\$175

**Note:** The above accessories are the same as for the 4271B.

#### Options available

002: BCD and Decision Outputs	add \$80
005: ASCII Code Input/Outputs for Calculator Interface. Utilizes HP 11202A I/O Card (Not Included)	add \$450
006: BCD Remote Control	add \$110
101: HP1B Data Output and Remote Control	add \$2080

4272A 1 MHz Preset C Meter

\$4260

# COMPONENT TEST

## 1 kHz Preset C Meter

Model 4273A

- Simultaneous Go/No-Go check on production line
- High accuracy—basically 0.1% of reading
- High speed measurements—6 per second

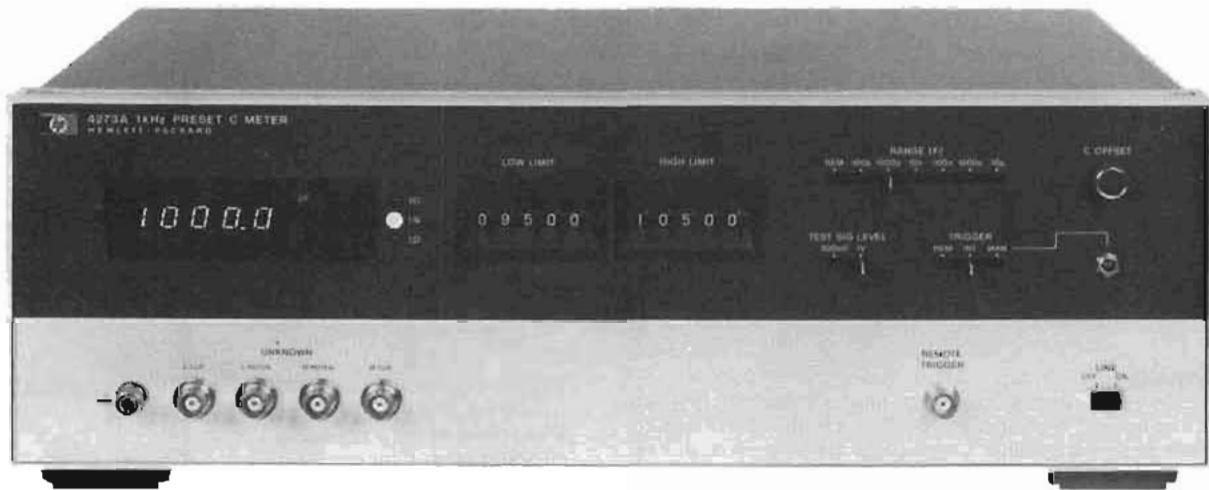

### Description

Most components are measured and their characteristics are evaluated at 1 kHz. The model 4273A 1 kHz Preset C Meter is a 4 digit capacitance meter which, combined with a 5 digit comparator, provides Go/No-Go information on medium range capacitors in production line testing or incoming inspection use.

The 4273A measures capacitance from 100.00 pF full scale (0.01 pF resolution) to 10.000  $\mu$ F full scale in six decade ranges with an overrange of 20%. The instrument's two test signal levels (1 Vrms and 300 mVrms) and wide measurement range covers most capacitor types, including plastic film, mica and ceramic capacitors. The 300 mV test level is especially useful when measuring the capacitance of semiconductor devices.

The 5-digit comparator allows upper and lower comparison limits to be set by thumbwheel switches on the front panel. The measured capacitance values are compared with the limit switch settings and the results are displayed on the front panel. This information is simultaneously applied to relay contact and TTL outputs on the rear panel connector for use with an automatic sorting machine. BCD output of measurement data is also provided.

Measurement time is important, especially in automatic sorting applications. The 4273A can typically make 4 measurements per second (assuming a transfer time of 100 ms). For higher sorting speeds, a high speed version, Option H01 is available.

The 5 terminal configuration of the unknown terminals and the capacitance offset capability insures accurate measurements and easier test fixture design for connection to the device under test.

### Specifications

#### Capacitance measurement

**Parameter measured:** capacitance — equivalent parallel by four terminal method.

**Test signal:** frequency: 1 kHz  $\pm$  2%; test level: 1 Vrms  $\pm$  10% and 300 mVrms  $\pm$  10%.

**Measurement range:** 100.00 pF — 10.000  $\mu$ F in 6 decade ranges, manually selectable. Remote ranging is optionally available.

**Overrange:** 20%.

**Accuracy:**  $\pm$ (0.1% of reading + 3 counts); conditions: accuracy applies over a temperature range of 23°C  $\pm$  5°C at dissipation factors of D < 0.1. At 0°C-50°C, error doubles. Warm-up time is 30 minutes.

**Offset adjustment:** compensates for stray capacitance of 0 to 10 pF.

#### Comparator

**Function:** compares measured value with H1 and LOW LIMIT settings and provides H1, IN and LO comparison outputs.

**H1 and LOW LIMIT setting ranges:** 00000-11999 at each limit switch

**Comparison outputs:** visual, relay contacts and TTL level.

**Visual:** 3 LED's indicate H1, IN or LO.

**Relay contacts:** 3 SPST contacts to circuit common for H1, IN or LO output.

**TTL level:** 3 open collector circuits to high level (open) for H1, IN or LO output (Fanout max. 40 mA).

#### General

**Measuring time:** < 150 ms.

**Reading rate:** Internal: < 300 ms. Between start of measurement and start of next cycle; external: after completion of a measurement cycle, a new cycle may be started by pushing the manual trigger button or by remote trigger input to the remote trigger connector; remote trigger input: a measurement cycle may be initiated at the remote trigger connector by changing the logic level state from "0" (zero volts or connection to ground through less than 25  $\Omega$ ) to "1" (TTL high level or open), pulse width;  $\geq$  20  $\mu$ s.

**BCD output:** connector: 50 pin, P/N 1251-0087 (Amphenol 51-40500-375). Mating connector is P/N 1251-0086 (Amphenol 57-30500-375).

**Output level:** TTL, "0" 0-0.4 V, "1" 2.4-5 V. Max. sink current 16 mA (8 mA for "out of range"), output impedance 300  $\Omega$ .

**Operating temperature & humidity:** 0°C to 50°C, relative humidity to 95% at 40°C.

**Power requirements:** 100/120/220/240 V  $\pm$  10%, 48-66 Hz.

**Power consumption:**  $\leq$  25 VA with any option.

**Size:** 147 H  $\times$  426 W  $\times$  349 mm D (5 $\frac{7}{8}$ "  $\times$  16 $\frac{5}{8}$ "  $\times$  13 $\frac{3}{4}$ ").

**Weight:** approx 8 kg (17.5 lb).

**Accessories furnished:** 16045A Test leads with BNC connectors.

**Options available:** 006: BCD remote control. H01: Hi speed version. 3 digit display with 4 digit comparator. Accuracy: 0.2% of reading. Measurement time: < 75 ms.

#### Ordering information

Opt 006: BCD Remote Control

Opt H01: Hi Speed Version

4273A 1 kHz Preset C Meter

Price

\$76

\$195

\$2575

# COMPONENT TEST

## Digital high capacitance meter

### Model 4282A



- Wide range—10 nF to 1 F full scale
- Dissipation factor or ohm-farad measurements
- Internal bias supply
- Digital and analog outputs for recording



16035A



16036A

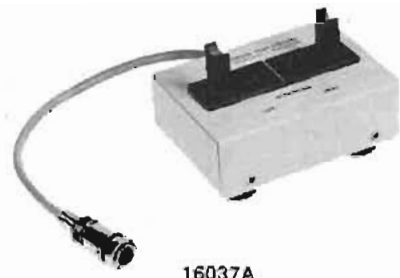

16037A

## Description

Hewlett-Packard's Model 4282A Digital High Capacitance Meter can make precision measurements on high value tantalum or aluminum electrolytic capacitors. Applications include both capacitor design measurements and production testing—either in incoming or outgoing inspection.

Two types of leads are supplied with the HP 4282A. One is the standard four-wire alligator clip style, and the other, comprises two specially designed clips that maintain the Kelvin four-wire measurement.

Two unique features of the HP 4282A are: alternating mode (alternately displays either capacitance and dissipation factor, (C-D), or capacitance and the product of ohms and farads, (C-ΩF) and the capability to double as a three-digit DVM.

Both digital and analog outputs are available for making permanent recordings.

The standard model has four measuring frequencies: 50, 60, 100, 120 Hz. These represent power line frequencies and their second harmonics. Most large value capacitors are used as filters in power supplies and are operated at these frequencies. If your application requires tests at other frequencies, please refer to Models 4260A, 4261A, 4262A, 4265B, 4270A and 4271B on the adjoining pages.

## Specifications

**Measuring functions:** capacitance, dissipation factor, \*ohm-farad and dc voltage. Selectable by function switch.

\***Ohm-farad:** the product of the capacitance and equivalent series resistance of the capacitor.

Function switch setting	Function and display
C	Capacitance measurement.
D	Dissipation factor measurement.
nF	Ohm-farad measurement.
C-D	Capacitance and dissipation factor measurements (alternately).
C-ΩF	Capacitance and ohm-farad measurements (alternately).
V	DC bias voltage or external voltage measurements.
	Note
	All measurements are continuously repeated as long as unknown is connected.

### Measuring ranges

Function	Full-scale display	Over ranging
C (capacitance)	10,000 nF to 1,0000 F, four full digits, 9 ranges in decade steps, manual selection.	18%
D (dissipation factor)	1.000 to 10.00, three full digits, 2 ranges, auto selection.	18%
$\Omega$ F (ohm farad)	1,000 $\Omega$ mF to 10,00 $\Omega$ mF three full digits, 2 ranges, auto selection.	18%
V (dc voltage)	10.00 V to 1 600 kV, three full digits, 3 lamps, in decade steps, manual selection (maximum voltage = 600 V).	18%

**Measuring circuit:** series equivalent circuit using four-terminal method.

**Measuring frequencies:** 50 Hz, 60 Hz, 100 Hz and 120 Hz (50 Hz and 60 Hz synchronized by line frequency). Accuracy:  $\pm 1.5\%$ .

### Measuring voltages

10 nF to 10 mF ranges: < 1 V rms.

100 mF range: < 0.1 V rms.

1 F range: < 10 mV rms.

**Accuracy:** (+23°C  $\pm 5^\circ$ C after half hour warm up):  $\pm(\%$  of reading +  $\%$  of full-scale).

### Capacitance

C Range	% of reading	% of full-scale
10 nF	1.0 + 0.9 • Crdg	0.2
100 nF	0.5 + 0.5 • Crdg	0.1
1 $\mu$ F to 1 mF	0.4 + 0.5 • Crdg	0.05
10 mF	1.0 + 0.5 • Crdg	0.05
100 mF	1.5 + 0.5 • Crdg	0.5
1 F	2.5 + 0.5 • Crdg	L0

### Dissipation factor

C Range	% of reading	% of full-scale
10 nF	1.5 + 0.5 • Drdg	0.2 • Cfs/Crdg + 0.3
100 nF to 1 mF	1.5 + 0.2 • Drdg	0.2 • Cfs/Crdg + 0.3
10 mF	1.5 + 0.2 • Drdg	0.2 • Cfs/Crdg - 0.5
100 mF, 1 F	1.5 + 0.2 • Drdg	0.2 • Cfs/Crdg + 3

### Ohm-farad

C Range	% of reading	% of full-scale
10 nF	1.0 + 0.5 • $\Omega$ Frdg	0.2 • Cfs/Crdg - 0.3
100 nF to 1 mF	1.0 + 0.2 • $\Omega$ Frdg	0.2 • Cfs/Crdg + 0.3
10 mF	1.0 + 0.2 • $\Omega$ Frdg	0.2 • Cfs/Crdg + 0.5
100 mF, 1 F	1.0 + 0.2 • $\Omega$ Frdg	0.2 • Cfs/Crdg + 3

**Drdg:** reading of dissipation factor.

**$\Omega$ Frdg:** reading of ohm-farad.

**Crdg:** reading of capacitance.

**Cfs:** full-scale of C range setting.

### DC voltage measurement accuracy

10 V range:  $\pm(0.05\%$  of reading + 0.1% of full-scale).

100 V and 1 kV ranges:  $\pm(0.2\%$  of reading + 0.1% of full-scale).

### Temperature coefficient

(referred to +23°C, and temperature range of 0°C to 50°C)

Function	Temperature coefficient
C	$\pm 0.02\%$ of reading/ $^\circ$ C
D, $\Omega$ F	$\pm 0.03\%$ of reading/ $^\circ$ C
V	$\pm 0.01\%$ of reading/ $^\circ$ C

**Option 001 Leakage Current Measurements adds following capabilities to standard model**

### Leakage current measurement ( $I_L$ )

**Range:** 1,000  $\mu$ A to 10,000 mA, 5 ranges three full digits.

**Overranging:** 18%.

**Accuracy:** 1  $\mu$ A range:  $\pm(2\%$  of reading + 2.0% of full-scale), 10  $\mu$ A to 10 mA ranges:  $\pm(2\%$  of reading + 0.3% of full-scale).

**Bias voltages:** internal source: 0 to 10 V, 0 to 100 V, 2 ranges, continuously variable over each range. Maximum current is 100 mA for 10 V range and 60 mA (for 1 minute) for 100 V range.

**External source:** usable up to 600 V dc across ext bias terminals on rear panel.

**Protective resistor:** 1k $\Omega$  for 100 V range and for external bias. 1 $\Omega$  for 10 V range.

### General

**DC bias voltage:** 0 to 10 V, continuously adjustable with DC bias control. Maximum charging current is 100 mA.

**Balancing time:** normally one second (when measuring on C ranges of 10 nF through 10 mF, capacitance value near full-scale, dissipation factor less than one and without dc bias).

**Reading rate:** continuously variable from 0.3 to 2 seconds with rate control.

**Reset:** initiates one reading by depressing Reset Int pushbutton or contact closure to ground or TTL low level at reset ext line. Mating plug for reset test jack: HP part No. 1251-0918.

**Digital output:** output signals: BCD + 1-2-4-8, data parallel, decimal point, function and unit, overload and unbalance, and polarity. Level

State	Level	Characteristics
Low	0.3 V $\pm$ 0.3 V	Max sink current 15 mA
High	3.9 V $\pm$ 1.5 V	Max load current 300 $\mu$ A

**Print command output:** negative going TTL pulse of approx. 1 ms.

**Printer hold input:** TTL low level or contact closure to ground.

**Connector:** mating, HP P/N 1251-0084; Amphenol 57-30360-375 (36-pin blue ribbon).

**Remote programming:** programmable functions, C-range,  $I_L$  range (option 001) and reset by TTL low level of contact closure to ground.

**Connector:** mating, HP P/N 1251-0084; Amphenol 57-30360-375 (36-pin blue ribbon).

**Analog output:** DC output of 1 V full-scale in proportion to displayed value.

**Accuracy:** add  $\pm 0.5\%$  of reading to accuracy specification.

**Operating environment:** 0°C to +50°C, <90% RH.

**Power requirements:** 100 V, 120 V, 220 V or 240 V  $\pm 10\%$ , 50 Hz or 60 Hz, approx. 70 VA.

**Dimensions:** 88.1 mm H  $\times$  425 mm W  $\times$  467 mm D (3 1/2"  $\times$  16 3/4"  $\times$  18 1/2").

**Weight:** net, 8.8 kg (19.5 lb). Shipping, 12.9 kg (28.5 lb).

### Accessories furnished

**16035A test leads:** four alligator clips.

**16038A test leads:** two alligator-jaw clips.

**Power cord:** 230 cm (7 1/2 ft), HP Part No. 8120-1378.

### Accessories available

**16037A:** Test Fixture

**16037A:** Opt 001 (vertical and axial lead devices)

**16413A:** HP-IB Interface Kit

**Price**

\$205

\$205

\$1890

### Options

**001:** Leakage current measurement

**101:** HP-IB Data Output and Remote Control

**908:** Rack Flange Kit

**910:** Extra Manual

add \$290

\$1890

add \$10

add \$35

**4282A Digital High Capacitance Meter**

**\$3600**



- Frequency range: 22 kHz to 70 MHz
- Q range: 5 to 1000



### Description

The direct-reading expanded scale of the 4342A permits measurement of Q from 5 to 1000 and readings of very small changes in Q resulting from variation in test parameters. The 4342A is solid state with the elimination of specially matched, fragile thermocouple components.

The 4342A will measure dissipation factor and dielectric constant of insulating materials. The Q meter can measure coefficient of coupling, mutual inductance, and frequency response of transformers. RF resistance, reactance, and Q of resistors and capacitors can also be determined.

Push button operation of frequency range and Q/ΔQ range selection provides straightforward measurement. Automatic indication of meter scales, frequency dials and frequency multipliers are featured, adding to simplicity and reading speed.

### Specifications

#### RF characteristics

**RF range:** 22 kHz to 70 MHz in 7 bands: 22 to 70 kHz, 70 to 220 kHz, 220 to 700 kHz, 700 to 2200 kHz, 2.2 to 7 MHz, 7 to 22 MHz, 22 to 70 MHz.

**4342A Opt 001:** 10 kHz to 32 MHz in 7 bands: 10 to 32 kHz, 32 to 100 kHz, 100 to 320 kHz, 320 to 1000 kHz, 1 to 3.2 MHz, 3.2 to 10 MHz, 10 to 32 MHz.

**RF accuracy:** ±1.5% from 22 kHz to 22 MHz; ±2% from 22 MHz to 70 MHz; ±1% at "L" point on frequency dial.

**4342A Opt 001:** ±1.5% from 10 kHz to 10 MHz; ±2% from 10 MHz to 32 MHz; ±1% at "L" point on frequency dial.

**RF Increments:** approximately 1% resolution.

#### Q measurement characteristics

**Q range:** 5 to 1000 in 4 ranges: 5 to 30, 20 to 100, 50 to 300, 200 to 1000.

**Q accuracy:** % of indicated value; (at 25°C)

	4342A & 4342A Opt. 001	4342A
Q	22 kHz—30 MHz	30 MHz—70 MHz
5—300	±7	±10
300—600	±10	±15
600—1000	±15	±20

**Q Increments:** upper scale: 1 from 20 to 100; lower scale: 0.5 from 5 to 30.

**ΔQ range:** 0 to 100 in 4 ranges: 0 to 3, 0 to 10, 0 to 30, 0 to 100.

**ΔQ accuracy:** ±10% of full scale.

**ΔQ Increments:** upper scale: 0.1 from 0 to 10; lower scale: 0.05 from 0 to 3.

#### Inductance measurement characteristics

**L range:** 0.09 μH to 1.2 H, direct reading at 7 specific frequencies.

**L accuracy:** ±3% after substitution of residuals (approx. 10 nH).

#### Resonating capacitor characteristics

**Capacitor range:** main dial: 25 to 470 pF; vernier dial —5 to +5 pF.

**Capacitor accuracy:** main dial: ±1% or 1 pF, whichever is greater; vernier dial ±0.1 pF.

**Capacitor increments:** main dial: 1 pF from 25 to 30 pF; 2 pF from 30 to 200 pF; 5 pF from 200 to 470 pF; vernier dial: 0.1 pF.

#### General

##### Rear panel outputs

**Frequency monitor:** 170 mV rms min. into 50Ω.

**Q analog output:** 0 to 1 V ±50 mV dc after 15 minutes warmup, proportional to meter deflection. Output impedance approximately 1 kΩ.

**Over limit signal output:** contact closure at the rear panel. Relay contact capacity 0.5 A/15 VA.

**Over limit display time:** selectable, 1 s or continuously on, after limit exceeded.

**Temperature range:** 0°C to 50°C.

**Power:** 115 or 230 V ±10%, 50—400 Hz, 25 VA max.

**Dimensions:** 129 mm H × 425 mm W × 414 mm D (5 1/8" × 16 1/2" × 16 3/16").

**Weight:** net, 14 kg (31 lb). Shipping, 18.45 kg (41 lb).

#### Accessories available:

HP 16014A: Series Loss Test Adaptor is designed for measuring low impedance components, low-value inductors and resistors, and also high-value capacitors. Using the adaptor adds convenience in connecting components in series with the test circuit of the 4342A Q Meter. This adaptor consists of a teflon printed-circuit base on which are mounted binding posts, to accept the Reference Inductors, and a pair of low-inductance series terminals for the unknown. HP 16462A: Auxiliary Capacitor is designed to extend the Q and L measurement capability of the 4342A Q Meter. It is especially useful for measuring small inductors at low frequencies.

HP 16470A reference inductors: A range of 20 inductors, any of which can be supplied separately, is available for use with the 4342A Q Meter for measuring the RF characteristics of capacitors, resistors, and insulating materials. These inductors have three terminals. One terminal is connected to the case to stabilize measurements.

#### Options & accessories

**Opt 001:** Frequency Range

**Opt 910:** Extra Manual

**16014A** Series Loss Test Adaptor

**16462A** Auxiliary Capacitor

**16470A** Reference Inductors, set of 20

#### Price

add \$170

add \$17.50

\$59

\$275

\$880

or \$44 ea.

# COMPONENT TEST

## Digital IC Tester

Models 5045A, 5046A

- Tests CMOS, ECL, TTL, DTL
- Printed record of IC failures
- Magnetic card programmable
- Tests IC's to 16 pins - 24 pins optional



### 5045A Digital IC Tester

The HP Model 5045A is a processor controlled, microprogrammed digital IC Tester. Well suited for high volume incoming inspection as well as engineering evaluation and failure analysis, it's simple enough to be used by an unskilled operator yet it includes capabilities usually found only in large, computer-based test systems. To test a device, all that's required is a preprogrammed magnetic card. Insert the card into the front panel slot, and the tester is ready to provide complete DC parametric and functional verification of one of the many devices listed in our comprehensive program catalog.

To provide a permanent record of individual IC failures as the test is being made, the quiet HP thermal printer has been included in the 5045A to record detailed failure information for every bad IC. Your operator just keeps on testing - the record is automatically kept and can be reviewed later or returned with the bad IC's to the manufacturer.

#### Tests all these families

ECL, CMOS, TTL, HTL, DTL

The universal pin electronics in the 5045A let each pin act as power supply, input, output, or open circuit. This provides the great flexibility and capability needed to test circuits all the way from basic gates to arithmetic logic units and ROM's. Devices with power supply voltages up to 15 volts or both positive and negative voltages up to 7.5 volts may be tested. As your testing requirements expand to new devices, your 5045A can be easily and inexpensively updated

by adding new program cards. The nominal cost of these cards means that you don't have to be satisfied with testing a small fraction of your circuit types. You can keep your program library complete - and still stay within your budget.

#### DC parametric and functional tests

The 5045A thoroughly tests devices both functionally and parametrically to ensure that those expensive failures don't get loaded into your PC boards. Functional tests check the ability of the device to correctly operate according to its truth table as the appropriate input stimulus is applied. DC parametric tests check the voltages and currents on device inputs and outputs under various conditions specified by the manufacturer. These tests eliminate almost all defective devices and avoid the expense of finding and replacing bad circuits once they have been soldered into PC boards and perhaps become part of a complex system.

#### Unique test technique

To provide the accuracy of direct comparison testing without expensive performance or reference boards, the 5045A uses a unique IC simulation technique. The correct functional operation of the device under test is simulated and this simulation is used as a reference. As both the device under test and simulator are driven with the same inputs, their outputs are compared on a step-by-step basis. If a failure occurs, the 5045A can indicate exactly where it happened by printed message or can stop on the failure so the fault can be investigated in more detail.

### Economical ROM testing

To test the many different truth tables which may be programmed in ROM's of the same generic type, it is not necessary to buy a card for each one. A single card containing stimulus information for the generic ROM type is loaded into the 5045A and the unique truth table of a known good ROM is "memorized" by the 5045A. The complete program is then recorded on a blank card for future use. Duplicates of any card may be made from the original by programming the 5045A, pressing "write", and then inserting a blank card.

### Automatic IC handlers

The 5045A was designed to work with automatic IC handlers needed for high volume testing. The special circuits which generate the fast rise and fall times for testing digital circuits are in a removable test deck which can be placed within inches of the IC being tested. Problems caused by long cables between handler and tester—ringing, oscillation, slow rise/fall times—are eliminated.

HP in cooperation with major automatic handler manufacturers, has designed custom interface kits for popular handlers. So, interfacing the 5045A and a handler requires nothing more than plugging the two together.

### Printer gives permanent copy of test results

A built-in thermal printer provides useful test information: a) it tells whether a program is loaded correctly and what program it is, b) it records the number of failed and passed IC's, and c) it provides failure analysis information for each failed IC.

In its failure analysis modes, the printer can provide very detailed information; a special voltage/current printout, for example. This makes the printer a digital multimeter PLUS!

### Self test feature

In an incoming inspection or production environment it is important to know your equipment is operating as it should. The tester has self-test cards to automatically exercise all major circuitry (the drivers and receivers for all pins, the central processor, the memory, and associated circuits). This way, you know every day that the tester is functioning correctly and that none of those bad IC's are getting into your production run, and cutting into your company's profits. Also included are diagnostic cards.

### Ordering the pre-programmed magnetic cards

The 5045A is programmed by pre-recorded magnetic cards available from HP. These cards, covering most common device types, are listed in our IC PROGRAM CATALOG. This catalog contains a wide variety of logic families and includes the majority of common device types. When additional programs are needed after the original purchase, they may be ordered through your local HP sales office or by mail with a prepaid coupon.

Each IC program ordered comes completed with both PASS/FAIL and DIAGNOSTIC test cards and includes duplicates of each. The PASS/FAIL test is used for the majority of testing since it is complete and fast (typical test time for MSI sequential devices is 300 ms). The DIAGNOSTIC test provides extra information by supplementing the PASS/FAIL card. Data sheets containing test descriptions and all parameters are included for both PASS/FAIL and DIAGNOSTIC cards.

## Condensed Specifications

### Test set-up method

Test conditions including parametric information, input stimulus and output data contained on magnetic card; program verified when loaded.

### Test structure

**Functional test:** truth table verified by comparing device under test to software-generated IC simulator (or, stored truth table for some circuits).

**Parametric test:** DC parameters tested to IC device manufacturers data sheet specs, except where limited by 5045A capabilities. Test limits indicated on sheet sent with each program card.

**Continuity test:** verifies pin contact by checking current flow in or out of active pins; test failure shown by front panel indicator.

### Test pattern generation

Test patterns derived using algorithmic techniques or from stored truth tables; tests individually tailored to each IC.

### Universal pin drivers

Same circuit drives or monitors each pin whether an input, output, power supply, clock or open. Voltages and currents individually programmable for each pin. No external test fixtures required.

**Voltage applied to the device under test** (Supply Voltage, Input Voltage, and Output Voltage)

Range (15 Volts)	Accuracy
-7.5 V $\leq$ to $<$ -1.875 V	$\pm$ 25 mV
-1.875V $\leq$ to $\leq$ +1.875 V	$\pm$ 15 mV
+1.875 V $<$ to $\leq$ +7.5 V	$\pm$ 25 mV

**Current applied to the device under test** (Supply Current, Input Current, and Output Current)

Range	Accuracy*
-200 mA $\leq$ to $<$ -2.5 mA	$\pm$ 0.4 mA or $\pm$ 6%
-2.5 mA $\leq$ to $\leq$ 2.5 mA	$\pm$ 10 $\mu$ A or $\pm$ 6%
2.5 mA $<$ to $\leq$ 200 mA	$\pm$ 0.4 mA or $\pm$ 6%

\*whichever is greater

**Slew rate:** 30 ns/volt.

### Rear panel outputs

**Automatic handler interface:** 14 pin Amphenol connector provides +5 V @ <100 mA, "End of Test", "Pass", "Fail", and "Fail Continuity" signals, accepts "Start Test". All signals are negative true TTL levels.

### General

**Power:** 100/120/200/240 V (+5%, -10%), 48-66 Hz, 240 VA.

**Size:** 19 H  $\times$  42.5 W  $\times$  58 cm D (7.5"  $\times$  16.7"  $\times$  22.8").

**Shipping weight:** 27.7 kg (61 lb.)

**Operating temperature:** 0°C to 50°C.

**Relative humidity:** 80%.

Prices: see page 97.

## 5046A Digital IC Test System

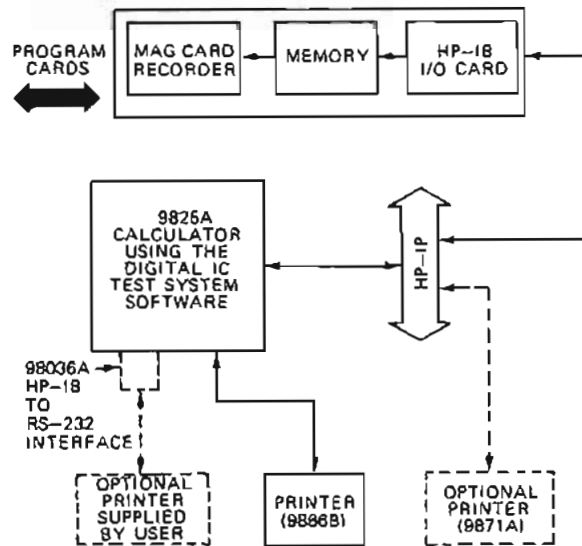

5046A DIGITAL IC TEST SYSTEM FUNCTIONAL BLOCK DIAGRAM

**COMPONENT TEST****Digital IC Test System****Models 5045A, 5046A (cont)**

- Modify existing device programs
- Generate one-of-a-kind device programs
- Change test parameters quickly, simply
- In-house programming - on your own schedule

**Description**

The HP 5046A Digital IC Test System gives you capability previously available only at the factory: the ability to write or change IC test programs to meet your special needs. Also, the 5046A consists of the same equipment used at the factory to generate all of the standard device programs listed in our IC Program Catalog.

Built around the 5045A IC Tester, 9825A Desktop Computer and 9866B Printer, the system allows you to program proprietary devices, change parameters, write your own special programs, or modify existing device programs to meet special testing needs. This helps you to keep information about proprietary devices confidential, it saves time by allowing in-house programming capability, and it allows you to evaluate devices, all by use of an HP-IB based, fully programmable system.

In incoming QA inspection departments, quality control is a key concern. New IC's need to be tested to assure conformance to design requirements - bad or marginal IC's can generate great costs if installed in production equipment, and sometimes IC specifications can change overnight.

The 5046A provides flexibility in these areas because device programs can be changed quickly and simply by a few keystrokes. The user simply loads in the device program, using either a magnetic card or a tape cassette, lists the program, keys in the changes and generates a new program.

The 5046A system is a complete system consisting of hardware and software — it is fully integrated, specified, documented and tested as a system prior to shipment. For easy on-site installation

and verification, full hardware and software manuals are provided. The operating and programming manual, for example, is written to three different levels, each progressively deeper, to enable easy start-up and operation, quick comprehension of the operating system and its hardware, and complete self-instruction on the system software.

Each system requires a printer for operation; the 5046A includes a Model 9866B Thermal Printer as standard equipment, and the Model 9871A Impact Printer is also available as an option (Opt 001). Other RS-232 compatible printers, supplied by the user, can be interfaced to the system in lieu of the 9866B by ordering the HP-1B to RS-232 interface (opt 002).

**Software**

The 5046A system software is stored on one standard 9825A tape cassette. The programs are accessible using the special function keys on the desktop computer. The software package consists of the following programs:

The Editor provides the capability to:

1. Enter IC test programs from the 9825A keyboard.
2. Read in source program from 9825A cartridges.
3. Modify source programs.
4. Store source programs on 9825A cartridges.
5. Provide on-line editing.
6. Print-out listing of source programs.

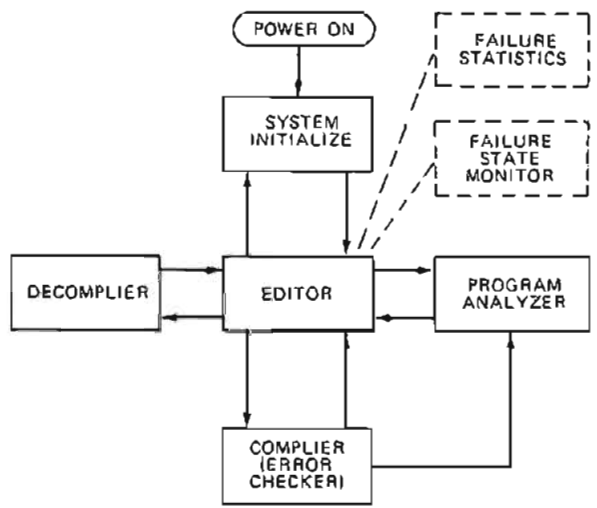

5046A DIGITAL IC TEST SYSTEM SOFTWARE ORGANIZATION

The Compiler provides the capability to:

1. Do syntax checking on source program statement.
2. Convert the source program into an object (machine code) program.
3. Output the object program to the 5045A IC Tester.

The Decompiler provides the capability to:

1. Read an object program from the 5045A IC Tester.
2. Generate the corresponding source program.

The Program Analyzer is used for error checking and debugging source program. It interrogates the 5045A processor as it is run through a completed test program, then prints the following:

1. Listing of actual test sequence.
2. Programmed test parameters for each pin in each test.
3. The '1' and '0' logic state for each pin in each test.

The Failure Statistics program provides the following:

1. Printout of failure by pin for each specific test failed.
2. Summary of failure and failure percentage for each test in the program.

The Failure State Monitor program interacts with the 5045A while an IC is being tested. When a failure is encountered, it displays the state in which the IC failed.

The Operating and Programming Manual provides detailed information and modular program examples that enable the user to quickly and easily learn the 5046A programming language (it isn't necessary to learn the 9825A HPL language in order to generate IC test programs).

To generate an original IC test program, the user need only understand the IC technology of the device under test (DUT) and be able to design simple logic circuits using Boolean techniques.

The manual provides step-by-step instruction for programming. In addition, individual chapters in the manual cover the HP test philosophy and testing techniques used with the TTL, ECL, CMOS and DTL technologies.

**Ordering Information**

5045A Digital IC Tester: standard 16-pin version; includes self-check and diagnostic cards, 16 and 24 pin dummy IC's and socket adapter.

5046A Digital IC Tester System: basic system includes 5045A IC Tester, 9825A Option 001 Desk Top computer with 98210A and 98213A plug-in ROM's, Programming Interface, 98034A HP-IB Interface and Model 9866B, Option 025 Thermal Printer, Programming Manual and 40 blank magnetic program cards.

Price  
\$9,500

\$25,000

**Options and accessories, 5045A/5046**

Opt 024: expands 5045A capability to 24 pins \$2,000  
Opt 025: Flat-Pack adapter for 14, 16 and 24 pin IC \$225

9164-0071: blank magnetic PASS/FAIL program card \$2

9164-0072: blank magnetic DIAGNOSTIC program card \$2

9281-0401: 250 foot roll of thermal printer paper for 5045A (minimum order: six rolls) \$2.40 ea.

9270-0488: 250 foot roll of thermal printer paper for 9866B (minimum order, two rolls) \$6.25 ea.

10845A: preprogrammed magnetic card for any device listed in the *Program Catalog* HP Publication Number 5952-7873) 1-9 \$30 ea.

10846A: book containing ten coupons, each redeemable for one IC program listed in the *IC Program Catalog* (HP Publication Number 5952-7873). Coupons are mailed to factory, programs sent by return mail. Coupons expire after two years 10-500 \$25 ea.

Automatic Handler Options, 5045A/5046A \$250

**Automatic Handler Options, 5045A/5046A**

Opt 004 ‡: interface package for IPT Model 806 automatic IC handler \$1,000

Opt 005 ‡: interface package for Sym-Tek model 7191ND automatic IC handler and other related models \$1,000

Opt 006 ‡: interface package for Daymarc 952/3 automatic IC handler \$1,000

Opt 007 ‡: interface package for Micro Component Technology Model 2608 automatic IC handler \$1,000

Opt 008 ‡: interface package for Delta Model 8040 ambient naked DIP handler \$1,000

Opt 009 ‡: interface package for Control Model H310 automatic IC handler \$1,000

Opt 010 ‡: interface package for PAE Model 3033LP naked DIP handler \$1,000

Opt 013 ‡: interface package for IPT Model 100A multi-size Ambient Test Handler \$1,000

‡: All interface packages include a test head, an interface board unique to the particular handler, and a cable to supply control signals to the handler.

**Options and accessories, 5045A only**

10844A: programming interface retrofit kit; contains all necessary parts, cables, interface board, and instructions to modify the 5045A for use in the 5046A Digital IC Test System. Programming manual and 40 blank magnetic program cards included. Price \$2,475

**Options and accessories, 5046A Only**

Opt 001: Substitute Model 9871 impact printer for 9866B and 98226A -\$275

Opt 002: Substitute 98036 HP-IB to RS-232 interface for 9866B and 98226A -\$3,275

Opt 125#: Delete Model 9825 desk top computer, 98034A, 98210A, and 98213A -\$9,150

Opt 145#: Delete Model 5045A IC Tester from system -\$9,500

Opt 166\*: Delete Model 9866B, Option 025, and 98226A cradle from system -\$3,275

\* Only one of these options can be on any one order.

\* The 5046A system should have a 9866B or 9871 (Opt 001) printer, or 98036 (Opt 002) HP-IB to RS-232 interface.

# COMPONENT TEST

Vector impedance meters, RX meter  
Models 4800A, 4815A, and 250B

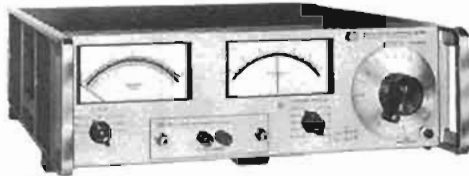

4800A



4815A

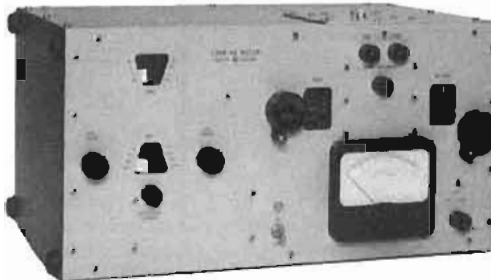

250B

## Model 4800A

HP's 4800A measures the vector impedance of components, complex networks, and other two-terminal devices. Besides measuring vector impedance, the 4800A measures component values. At frequencies that are decade multiples of  $1/2\pi$ , as marked on the frequency dial, L and 1/C are read directly if the phase is approximately  $\pm 90^\circ$ , respectively. R is equal to the impedance magnitude at frequencies where the phase is approximately  $0^\circ$ . The vector impedance meter also yields Q and inductor values by using either  $f_0/\Delta f$ ,  $R_p/\omega L$  or the  $\omega L/R_s$  technique.

### Specifications

#### Frequency characteristics

**Range:** 5 Hz to 500 kHz in five bands; 5 to 50 Hz, 50 to 500 Hz, etc.  
**Accuracy:**  $\pm 2\%$ , 50 Hz to 500 kHz;  $\pm 4\%$ , 5 to 50 Hz;  $\pm 1\%$  at 15.92 Hz on frequency dial from 159.2 Hz to 159.2 kHz;  $\pm 2\%$  at 15.92 Hz.

**Impedance measurement characteristics:** 1 ohm to 10 megohms in seven decade ranges from X1 to X10 M. Accuracy is  $\pm 5\%$  of reading.

**Phase angle measurement characteristics:**  $0^\circ$  to  $\pm 90^\circ$  in  $5^\circ$  increments. Accuracy is  $\pm 6^\circ$ .

**Direct capacitance measurement capabilities:** 0.1 pF to 10 000  $\mu$ F direct reading at decade multiples of 15.92 Hz. Accuracy is  $\pm 7\%$  of reading at decade multiples of 15.92 Hz. Accuracy is  $\pm 7\%$  of reading for D less than 0.1 at 159.2 Hz to 159.2 kHz.

**Direct inductance measurement capabilities:** 1  $\mu$ H to 100 000 H direct reading at decade multiples of 15.92 Hz. Accuracy is  $\pm 7\%$  of reading for Q greater than 10 from 159.2 Hz to 159.2 kHz.

**Measuring terminal characteristics:** both terminals above ground, neither may be grounded. Calibration resistor and shield provided.

**Size:** 133 H  $\times$  426 W  $\times$  467 mm D (5 $1/8$ "  $\times$  16 $3/4$ "  $\times$  18 $3/8$ ".)

**Weight:** net, 10.8 kg (24 lb). Shipping, 13.5 kg (30 lb).

**Power:** 115 or 230 V  $\pm 10\%$ , 48 to 440 Hz, 30 VA.

## Model 4815A

The HP 4815A RF Vector Impedance Meter provides all of the convenience of "probe and read" measurements. In use, the probe is connected directly into the circuit to be evaluated, frequency is selected, and complex impedance is read. This type measurement allows a straightforward adaption to various jigs and fixtures for special measurements. Where only component values are to be determined, a quick-mount adapter is provided to allow rapid measurements. For critical component applications, the unit to be evaluated may be mounted directly in its working circuit and its value determined in its actual environment, at the frequency of interest.

### Specifications

#### Frequency

**Range:** 500 kHz to 108 MHz in five bands.

**Accuracy:**  $\pm 2\%$  of reading;  $\pm 1\%$  of reading at 1.592 and 15.92 MHz.

**RF monitor output:** 150 mV minimum into 50 ohms.

#### Impedance magnitude measurement

**Range:** 1 ohm to 100 k $\Omega$ ; full-scale ranges: 10, 30, 100, 300, 1 k, 3 k, 10 k, 30 k, 100 k $\Omega$ .

**Accuracy:**  $\pm 4\%$  of full scale  $\pm (f/30 \text{ MHz} + Z/25 \text{ k}\Omega)\%$  of reading, where  $f$  = frequency in MHz and  $Z$  is in ohms.

**Calibration:** linear meter scale with increments 2% of full scale.

#### Phase angle measurement

**Range:**  $0^\circ$  to  $360^\circ$  in two ranges:  $0 \pm 90^\circ$ ,  $180^\circ \pm 90^\circ$ .

**Accuracy:**  $\pm (3 + f/30 \text{ MHz} + Z/50 \text{ k}\Omega)$  degrees where  $f$  = frequency in MHz and  $Z$  is in ohms. Calibrated in  $2^\circ$  increments.

**Size:** 185 mm H  $\times$  483 mm W  $\times$  476 mm D (7 $1/4$ "  $\times$  19"  $\times$  18 $3/4$ ".)

**Weight:** net, 17.6 kg (39 lb). Shipping 24.8 kg (55 lb).

**Power:** 105 to 125 V or 210 to 250 V, 50 to 400 Hz, 50 W.

## Model 250B

The 250B RX Meter measures two-terminal RF impedance in terms of equivalent parallel resistance and capacitance. The self-contained instrument includes a continuously tuned 0.5 to 250 MHz oscillator, high-frequency bridge, amplifier-detector, and null indicating meter. Connections may be conveniently made to the bridge terminals which are arranged for almost zero lead length.

### Specifications

**RF range:** 500 kHz to 250 MHz in eight bands,  $\pm 2\%$  accuracy, scale increments of approximately 1%.

#### Measurement characteristics

**Resistance:** range from 15 to 100 000 ohms.

Accuracy is  $\pm \left[ 2 + \frac{F}{200} + \frac{R}{5000} + \frac{Q}{20} \right] \pm 0.2$  ohms

$F$  = frequency in MHz,  $R$  = RX Meter  $R_p$  reading in ohms,  $Q$  =  $\omega CR \times 10^{-12}$ , where  $C$  = RX Meter  $C_p$  reading in pF; resistance calibration increments of approximately 3%.

**Capacitance:** range 0 to 20 pF (may be extended through use of auxiliary coils); Accuracy is  $\pm (0.5 \text{ pF} + 0.5F^2C \times 10^{-7})\% \pm 0.15$  pF,  $F$  = frequency in MHz,  $C$  = RX Meter  $C$  reading in pF; Calibration in 0.1 pF increments.

**Inductance:** range, 0.001  $\mu$ H to 100 mH (actual range depends on frequency; auxiliary resistors employed). Accuracy is same as capacitance accuracy given above.

**RF measurement voltage:** approximately 50 to 750 mV, depending on frequency.

**Size:** 263 H  $\times$  509 W  $\times$  343 mm D (10 $3/8$ "  $\times$  20 $1/16$ "  $\times$  13 $1/2$ ".)

**Weight:** net, 18 kg (40 lb). Shipping, 22.5 kg (50 lb).

**Power:** 105 to 125 volts or 210 to 250 volts, 50 to 400 Hz, 66 VA.

**Accessories available:** 00515A Coax Adapter Kit (Type N).

#### Options

908: Rack Flange Kit

#### Price

add \$10

#### Ordering Information

4815A RF vector impedance meter

4800A Vector impedance meter

250B RX Meter

00515A Coax Adapter Kit

\$3375

\$2100

\$4200

\$95



4440B



4437A

### 4440B Description

The Hewlett-Packard 4440B Decade Capacitor is a high accuracy instrument providing usable capacitances from 40 pF to 1.2 μF. Its 0.25% accuracy makes it an ideal aid for circuit design or as a working standard.

Use of silvered-mica capacitors in four decades of 100 pF provides higher accuracy, lower dissipation factors and good temperature coefficient. An air capacitor vernier provides 100 pF (from 40 pF to 140 pF) with resolution of 1 pF. Capacitors are housed in a double shield in such a way that increased capacitance from two terminals to three terminals is held to 1 pF.

### 4440B Specifications

**Capacitance:** 40 pF to 1.2 μF in steps of 100 pF with a 40 pF to 140 pF variable air capacitor providing continuous adjustment to better than 2 pF between steps.

**Direct reading accuracy:**  $\pm(0.25\% \pm 3 \text{ pF})$  at 1 kHz for three-terminal connection.

**Resonant frequency:** typical values of the resonant frequency are 450 kHz at 1 μF, 4 MHz at 0.01 μF and 40 MHz at 100 pF.

**Dissipation factor:** for  $C > 1040 \text{ pF}$ , 0.001 MAX at 1 kHz.  
for  $C < 1040 \text{ pF}$ , 0.005 MAX at 1 kHz.

**Temperature coefficient:**  $< -70 \text{ ppm}/^\circ\text{C}$ .

**Insulation resistance:** 5 GΩ minimum, after 5 minutes at 500 V dc.

**Maximum voltage:** 42 V dc or 30 V rms.

**Weight:** net, 2.5 kg (5 1/2 lb); shipping 3.6 kg (8 lb).

**Dimensions:** 76 mm H × 264 mm W × 152 mm D (3" × 11" × 6").

### 4436A/4437A Description

The Hewlett-Packard Models 4436A/4437A Attenuators provide accurate steps of attenuation with 0.1 dB resolution for power-level measurements, communication system tests, and gain or loss measurements on filters and amplifiers, and similar equipment.

### 4436A Specifications

**Maximum attenuation:** 119.9 dB.

**Attenuation increments:** 0.1 dB.

**Input/output impedance:** 600Ω, balanced.

**Frequency range:** dc to 1.5 MHz (0 to 110 dB); dc to 1 MHz (0 to 119.9 dB).

#### Accuracy

Attenuation	100 kHz	1 MHz	1.5 MHz*
0 to 60 dB	$\pm 0.1 \text{ dB}$	$\pm 0.2 \text{ dB}$	$\pm 0.2 \text{ dB}$
60 to 90 dB	$\pm 0.1 \text{ dB}$	$\pm 0.3 \text{ dB}$	$\pm 0.3 \text{ dB}$
90 to 110 dB	$\pm 0.2 \text{ dB}$	$\pm 0.5 \text{ dB}$	$\pm 0.5 \text{ dB}$
110 to 119.9 dB	$\pm 0.3 \text{ dB}$	$\pm 1.0 \text{ dB}$	

\*Typical value

**Maximum input power:** +30 dBm.

**DC isolation:** signal ground may be  $\pm 300 \text{ V}$  dc from external chassis.

**Dimensions:** 76 mm H × 198 mm W × 177 mm D (3" × 7 3/4" × 6 3/4").

**Weight:** net, 1.7 kg (3 1/2 lb). Shipping, 2.9 kg (6 1/2 lbs).

### 4437A Specifications

The Model 4437A is a 600 ohms unbalanced type, and its specifications are identical to the 4436A.

### 350D Description

Two attenuator sections make up the Hewlett-Packard 350D Attenuator. One section is a 100 dB attenuator, adjustable in 10 dB steps. The other is a 10 dB attenuator, adjustable in 1 dB steps.

### 350D Specifications

**Attenuation:** 0 to 110 dB, 1 dB and 10 dB steps.

**Power capacity:** 600Ω unbalanced; 5 W (55 V dc or rms) max, continuous duty.

**DC isolation:** signal ground may be  $\pm 500 \text{ V}$  dc from chassis.

#### Accuracy

##### 10 dB section

	0 dB	10 dB
dc to 100 kHz	$\leq 0.125 \text{ dB/step}$	
100 kHz to 1 MHz	$\leq 0.25 \text{ dB/step}$	

##### 100 dB section

	0 dB	70 dB	100 dB
dc to 100 kHz	$\leq 0.25 \text{ dB}$	$\leq 0.5 \text{ dB/step}$	
100 kHz to 1 MHz	$\leq 0.5 \text{ dB}$	$\leq 0.75 \text{ dB/step}$	

**Dimensions:** standard HP 1/2 module (system I) 159 H × 130 W × 203 mm D (6 1/4" × 5 1/8" × 8").

**Weight:** net, 1.8 kg (4 lb). Shipping, 2.7 kg (6 lb).

### Ordering information

4440B Decade Capacitor

4436A Attenuator

4437A Attenuator

350D Attenuator

**Price**  
\$595  
\$875  
\$595  
\$235

# DIGITAL CIRCUIT TESTERS

## Signature Analysis, IC Troubleshooters

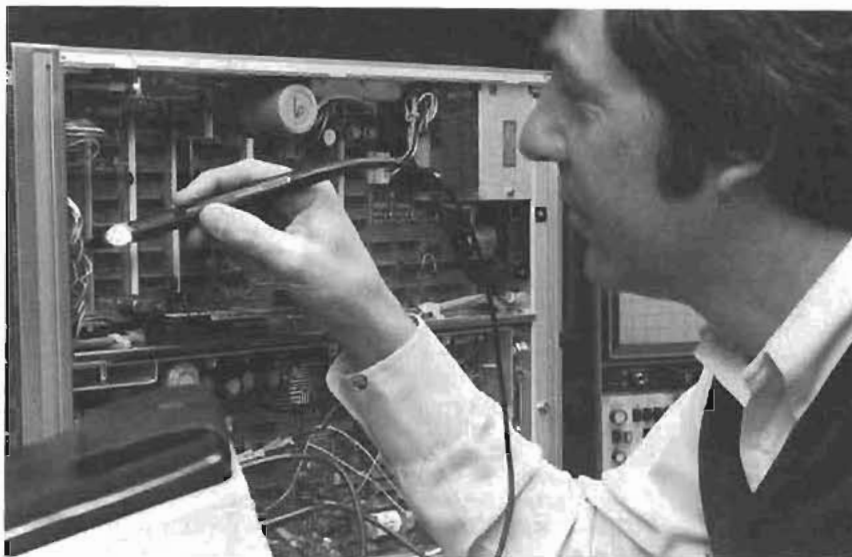

### Signature Analysis

#### Designing for serviceability

Today's microprocessor-based products are complex, high-density systems which can be just as difficult to troubleshoot and repair in the field as large computer systems. In order to reduce product service and support costs, manufacturers are including such service-oriented features as test points, self check modes, circuit partitioning and thorough service documentation. Now, a new measurement technique, Signature Analysis, enables digital designers to develop products which are field serviceable to the component level. Incremental design and production costs for including SA are negligible, and result in significant service support cost savings.

#### Signature analyzer

The new Model 5004A Signature Analyzer is an economical tool for field troubleshooting of complex logic circuits. It detects and displays digital signatures unique to the bit streams present at data nodes of a circuit under test. By comparing these actual signatures to the correct ones, a service technician can isolate a faulty component and replace it. The technique is especially useful in checking microprocessor-based products and high-speed state machines, where data streams are long and complex and where there are no conventional means of component-level troubleshooting.

By designing the digital portion of a product with the 5004A in mind, you can set up a service support program for component-level field repair, without having to invest in board exchange or in special-purpose test equipment.

Signature Analysis is also attractive for production line troubleshooting. The 5004A can detect speed-related failures in assembled systems, which may not have been caught by subassembly testers.

#### Economics of field service

To meet the service requirements of digital products, most support programs have relied on board exchange. This approach

minimizes down-time, yields economies of scale through centralized board repair, and enables field service personnel to repair a wide range of products, with minimum training.

As the number and complexity of digital products increases, however, the economic burden of board exchange becomes apparent:

- Inventory carrying costs for boards in various stages of float increase with the number of products installed.
- Administrative and handling costs are high, especially for products approaching obsolescence.
- Overseas support bogs down with long transit times, high duties, and import delays.
- System-related, "soft" failures are difficult to detect on individual boards, and some faulty boards are reintroduced into the exchange loop.

Signature Analysis can reduce these repair costs on microprocessor-based products by enabling field repair to the component level, and by testing fully assembled products, without board removal. The results are:

- Decreased cost of ownership for end-users (parts, downtime, training, etc.).
- Reduced warranty and support costs for manufacturers.
- Increased confidence in field repair results.

Experience shows that incremental development costs for designing Signature Analysis into a product run about 1%. Incremental hardware costs are largely offset by decreases in other material, since there is no longer a need to divide the hardware into replaceable modules. The 5004A and HP Application Note 222, *A Designer's Guide to Signature Analysis*, can help you take advantage of the technique.

### The IC Troubleshooters

#### General

The IC Troubleshooters have become the "digital screwdrivers" for today's

laboratories, production lines, service facilities and electronic classrooms. They are low-cost, hand-held "instruments-on-a-chip", and have proven very effective in the functional testing and troubleshooting of digital circuits. HP Application Note 163-1, *Techniques of Digital Troubleshooting*, can help put the IC Troubleshooters to work for you.

**Logic comparator:** the Model 10529A Logic Comparator utilizes the time-honored comparison technique to identify faulty nodes in a digital circuit. It tests an IC dynamically, in-circuit, by comparing output responses to those of a known-good IC which is plugged into the Comparator. Having located bad nodes, use other IC Troubleshooters to isolate the defective component causing the fault.

**Logic probes:** detect logic levels at any circuit point and display them via a band of light at the probe tip. A logic high is indicated by a bright light. A logic low extinguishes the light. A bad level causes a dim light. Pulse activity is stretched to provide a 10 Hz flashing light.

**Logic clips:** are multi-pin state indicators which clip directly onto ICs. The logic state of each pin is displayed by an individual LED, enabling the user to check the device's truth table.

**Logic pulser:** pulse stimulation is essential in checking digital logic circuits. Logic pulsers inject digital pulses between gates, without requiring the unsoldering of components. They automatically drive low nodes high, or high nodes low, with substantial override current.

**Current tracer:** often a bad node is identified, but the specific device causing the fault can only be isolated by cutting traces, or replacing circuit elements. The 547A Current Tracer eliminates just such "shot-gun" techniques by showing exactly where digital current pulses are flowing in the circuit. Use of current tracing techniques solves the most vexing troubleshooting problems: stuck data buses, solder-bridges, stuck nodes containing many circuit elements, and the wired-AND gate.

**Stimulus-response testing:** the Pulser/Probe or Pulser/Clip combination helps the user to identify the faulty circuits causing a system malfunction. These instruments permit arbitrary signal injection and readout between gates. Thus, an added capability is provided (the digital troubleshooter): the ability to stimulate a circuit and monitor it for an output response.

**Troubleshooting kits:** a variety of kits is available, combining IC Troubleshooters for stimulus-response testing. Each kit includes a carrying case, and offers a price saving over the individual instruments.

**Education:** the need for training in digital electronics continues to grow with the increase in IC design and usage. The Model 5035T Logic Lab meets this need with a complete introductory course, including an easy-to-use breadboard, state-of-the-art components, quality texts and a set of IC Troubleshooters. The fully coordinated package is ideal for industrial training, classroom courses and laboratory development.



- Dynamic multi-family logic indicators
- Pulse stretching for narrow pulses
- Bad level/open circuit detection

- One lamp, finger-tip display
- Pulse memory capability
- Overload protected

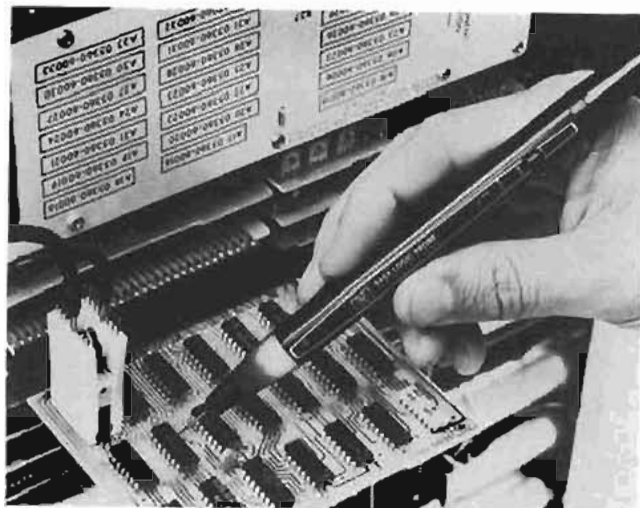

#### Input maximum pulse repetition

**Frequency:** TTL, 80 MHz; CMOS, 40 MHz.  
**Input overload protection:**  $\pm 120$  V continuous (dc to 1 KHz);  $\pm 250$  for 15 seconds (dc to 1 kHz).

**Pulse memory:** indicates first entry into valid logic level; also indicates return to initial valid level from bad level for pulse  $\geq 1$   $\mu$ s wide.

#### Power requirements

**TTL:** 4.5 to 15 V dc\*.  
**CMOS:** 3 to 18 V dc.  
**Maximum current:** 70 mA.  
**Overload protection:**  $\pm 25$  V dc for one minute.

**Accessory included:** Ground Clip (HP Part No. 00545-60105).

\* $\pm 5$   $\pm 10\%$  V dc power supply; usable to +15 V dc with slightly increased logic low threshold.

#### 10525T Logic probe

The Model 10525T Logic Probe provides TTL/DTL troubleshooting at low cost. Ideally suited to 5 volt logic applications, the 10525T has high input impedance, overload protection, and 50 MHz data rate capability. Available with accessory pulse memory and tip kit.

#### 10525T Specifications

**Input impedance:**  $>25$  k $\Omega$  in both the high and low state ( $<1$  low power TTL load).

**Logic one threshold:** 2.0 V  $\pm 0.4$ ,  $-0.2$  V.

**Logic zero threshold:** 0.8 V  $\pm 0.2$  V,  $-0.4$  V.

**Input minimum pulse width:** 10 ns.

**Input maximum pulse repetition frequency:**  $>50$  MHz.

**Input overload protection:**  $\pm 70$  volts continuous,  $\pm 200$  volts intermittent, 120 V ac for 30 seconds, 240 V ac for 10 seconds.

**Power requirements:** 5 V  $\pm 10\%$  at 60 mA; internal overload protection for voltages from +7 to -15 volts. Includes power lead reversal protection.

**Accessories included:** BNC to alligator clips; ground clip.

#### ECL logic probe

The HP Model 10525E Logic Probe extends the time-proven, cost-saving logic probe troubleshooting technique to high-speed ECL logic.

Operation of the ECL probe is analogous to that of the 10525T except the 10525E's high speed circuitry stretches single shot phenomena so that single pulses as narrow as 5 nanoseconds may be observed.

The 10525E may be powered directly from any  $-5.2$  volt source and its high input impedance minimizes circuit loading.

#### 10525E Specifications

**Input impedance:** 12 k $\Omega$  in both the high and low state.

**Logic one threshold:**  $-1.1$  V  $\pm 0.1$  V.

**Logic zero threshold:**  $-1.5$  V  $\pm 0.1$  V.

**Input minimum pulse width:** 5 ns.

**Input maximum pulse repetition frequency:** 50 MHz (typically 100 MHz at 50% duty cycle).

**Input overload protection:**  $\pm 70$  volts continuous, 200 volts intermittent, 120 V ac for 30 seconds.

**Power requirements:**  $-5.2$  V  $\pm 10\%$  at 80 mA; supply overload protection for voltages from -7 to +400 volts.

**Accessories included:** BNC to alligator clips, ground clip.

#### Accessories available

Accessory	Price
00545-60104 Tip Kit for 545A Probe	\$30
10525-60012 Tip Kit for 10525T Probe, 10526T Pulser	\$40
10525-60015 Pulse Memory for 10525T Probe	\$80

#### Ordering Information

545A Logic Probe	\$125
10525T Logic Probe	\$85
10525E Logic Probe	\$150

#### Logic probes

Logic Probes greatly simplify tracing logic levels and pulses through IC circuitry to find nodes stuck HIGH or LOW, intermittent pulse activity, and normal pulse activity. That's because they instantly show whether the node probed is high, low, bad level, open circuited, or pulsing.

Logic probes require a simple connection to the circuit under test's power supply, and they're ready to use. The strain-relieved power cord, and line-voltage protected tip insure long life and durability. High input impedance protects against circuit loading, not just in the HIGH state, but for logic LOWs as well.

#### 545A TTL/CMOS Logic probe

The HP Model 545A Logic Probe contains all the features built into other HP probes, plus switch-selectable, multi-family operation and built-in pulse memory. Employing the same straightforward one-lamp display as our other probes, the 545A operates from 4 to 18 volts in CMOS applications or from 4.5 to 15 V dc supplies in the TTL mode while maintaining standard TTL thresholds.

The probe's independent, built-in pulse memory and LED display help you capture hard to see, intermittent pulses. Just connect the probe tip to a circuit point, reset the memory, and wait for the probe to catch those hard to find glitches. The memory captures and retains a random pulse until reset.

The hand-held 545A is light, rugged, overload protected, and very fast: 80 MHz in TTL, 40 MHz in CMOS. It also employs unique new power supply connectors that enable you to power the probe using several different methods.

#### 545A Specifications

**Input current:**  $\leq 15$   $\mu$ A (source or sink).

**Input capacitance:**  $\leq 15$  pF.

#### Logic thresholds

**TTL:** Logic one 2.0  $\pm$  0.4,  $-0.2$  V dc. Logic zero 0.8  $\pm$  0.2,  $-0.4$  V dc.

**CMOS:** 3—10 V dc supply

Logic one:  $0.7 \times V_{supply} \pm 0.5$  V dc.

Logic zero:  $0.3 \times V_{supply} \pm 0.5$  V dc.

**CMOS:**  $\geq 10$ —18 V dc supply.

Logic ONE:  $0.7 \times V_{supply} \pm 1.0$  V dc.

Logic ZERO:  $0.3 \times V_{supply} \pm 1.0$  V dc.

**Input minimum pulse width:** 10 ns using ground lead (typically 20 ns without ground lead).

\* $\pm 5$   $\pm 10\%$  V dc power supply; usable to +15 V dc with slightly increased logic low threshold.

# DIGITAL CIRCUIT TESTERS & ANALYZERS

## Logic pulsers

Models 546A & 10526T

- In-circuit stimulation without unsoldering
- Automatic injection of proper polarity pulse
- Greatly simplifies digital troubleshooting

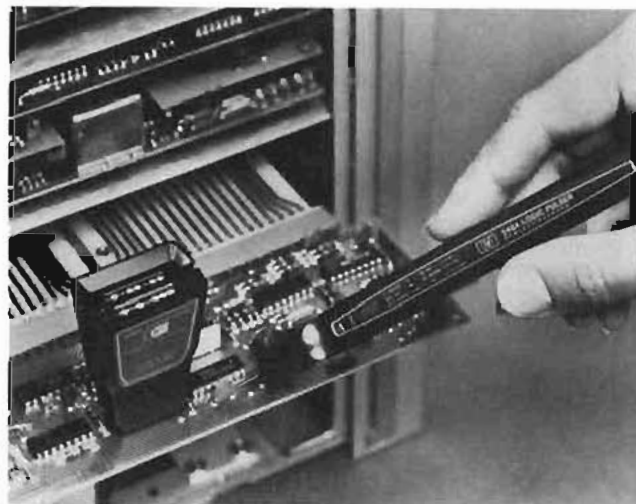

### Logic pulser

The Logic Pulser solves the old problem of pulsing ICs on digital logic boards for designers and troubleshooters. Merely touch the Pulser to the circuit under test, press the pulse button and all circuits connected to the node (outputs as well as inputs) are briefly driven to their opposite state. No unsoldering of IC outputs is required. Pulse injection is automatic so the user need not concern himself whether the test node is in the high or low state; high nodes are pulsed low and low nodes, high, each time the button is pressed.

The Pulser is essentially a pulse generator with high output current capability packed in a convenient, easy-to-use probe. Ability to source or sink up to 0.65 Amperes insures sufficient current to override IC outputs in either the high or low state. Output pulse width is limited so the amount of energy delivered to the device under test is never excessive. Additionally, the Pulser output is three-state so that the circuit under test is unaffected until the Pulser is activated.

Combining in-circuit pulse injection with the unique detection capabilities of Logic Probes, Logic Clips, and the 547A Current Tracer helps to focus new power on solving the problems of fault isolation. Pulser/Probe, Pulser/Clip, and Pulser/Tracer combinations enable the digital designer or troubleshooter to hold complete stimulus-response capability at his finger tips.

Gate operation is tested using the Pulser to drive the input and the probe monitors transmitted pulses at the output. When pulses are not received, place the Pulser and Probe on the same pin to detect if the failure is due to a short to ground or  $V_{cc}$ .

Testing sequential circuits is the domain of the Logic Clip and Logic Pulser. The Clip simultaneously monitors all output states while the Pulser applies clock and reset pulses to the device. Improper operation, if present is immediately obvious since the IC will not go through its prescribed sequences of states.

Finally, when Pulsers are used with the 547A Current Tracer, the Pulser acts as a current pulse source to enable exact location of faulty gates on a node, solder bridges, or stuck devices on bus structures.

### 546A Logic Pulser

Automatic polarity pulse output, pulse width, and amplitude control make for easy multi-family operation when you use the 546A Logic Pulser. But, the real surprise comes when you code in one of its six ROM-programmable output patterns (single pulses; pulse streams of either 1, 10, or 100 Hz; or bursts of 10 or 100 pulses). This feature allows you to continually pulse a circuit when necessary, and it also provides an easy means to put an exact number of pulses into counters and shift registers. Used with our multi-family of IC Troubleshooters, the 546A acts as both a voltage and current source in digital troubleshooting applications.

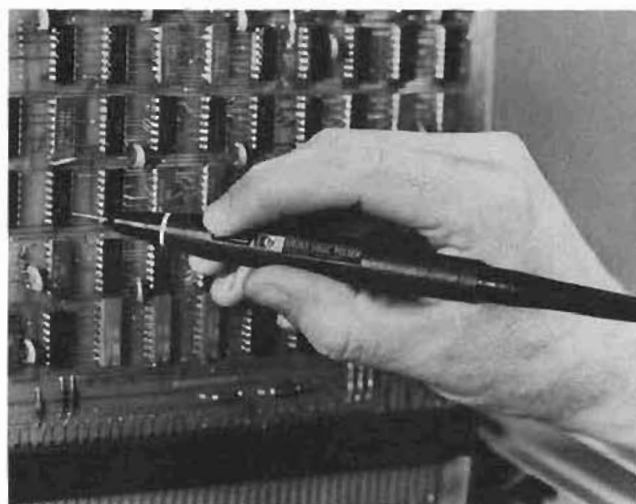

### 546A Specifications

#### Output

Family	Output Current	Pulse Width	Typical Output Voltage	
			HIGH	LOW
TTL/DTL	$\leq 650$ mA	$\geq 0.5$ $\mu$ s	$\approx 3$ V dc	$\leq 0.8$ V dc
CMOS	$\leq 100$ mA	$\geq 5.0$ $\mu$ s	$V(\text{supply}) - 1$ V dc	$\leq 0.5$ V dc

**Power supply requirements:** TTL—4.5 to 5.5 V dc at 35 mA, CMOS—3 to 18 V dc at 35 mA, protected to 25 V dc.

### 10526T Logic pulser

The economical 10526T provides dependable single-shot operation in TTL/DTL applications. Just press the pulse button, and the pulser delivers a single powerful pulse of the correct pulse width, polarity and amplitude.

### 10526T Specifications

**Output high pulse voltage:**  $> 2$  V at 0.65 A (1 A typical at  $V_{ps} = 5$  V, 25°C).

**Output low pulse voltage:**  $< 0.8$  V at 0.65 A (1 A typical at  $V_{ps} = 5$  V, 25°C).

**Output impedance, active state:**  $< 2$  ohms.

**Output impedance, off state:**  $> 1$  Megohm.

**Pulse width:** 0.3  $\mu$ s nominal.

**Input overload protection:**  $\pm 50$  volts continuous.

**Power supply input protection:**  $\pm 7$  volts (includes power lead reversal protection).

**Power requirements:** 5 V  $\pm 10\%$  at 25 mA.

**Accessories included:** BNC to alligator clips, ground clip.

### Accessories available

00545-60104: Tip Kit for 546A Pulser

10525-60012: Tip Kit for 10526T Pulser

10526-60002: Multi-Pin Stimulus Kit

### Price

\$30

\$40

\$25

### Ordering Information

546A Logic Pulser

\$175

10526T Logic Pulser

\$115

- Solves the "Wired-AND" Problem
- Displays in-circuit Digital Current flow
- All Family: 1 mA to 1A
- Finger-tip indicator

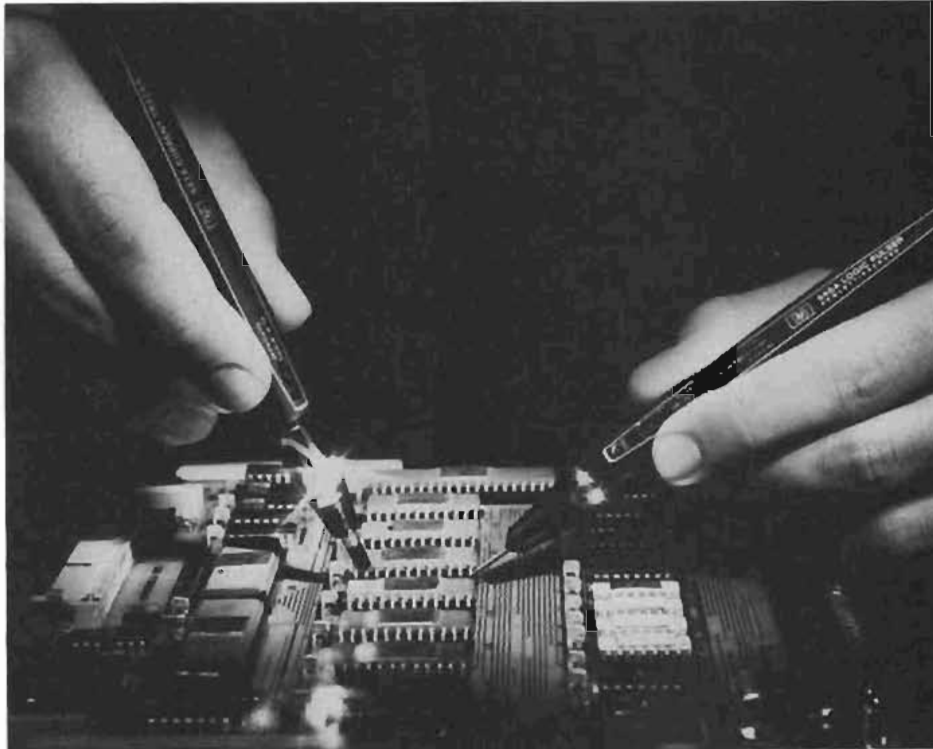

The 547A Current Tracer precisely locates low-impedance faults in digital circuits by locating current sources or sinks. On a shorted node, all points are stuck in one state by the short. Many similar troubleshooting problems such as shorted wired-AND/OR configurations, result in wasted time and excessive costs: several ICs have to be removed before finding the bad one, and in the process the circuit board may be damaged. Now, the 547A exactly pinpoints the one faulty point on a node, even on multilayer boards. In addition, the Tracer locates hairline solder bridges that manage to pass unnoticed until a circuit is operated for the first time.

Constructed as a hand-held probe, the Tracer is a sophisticated instrument designed to troubleshoot circuits carrying fast rise-time current pulses. The Tracer senses the magnetic field generated by these signals in the circuit (or, provided by a Logic Pulser), and displays transitions, single pulses, and pulse trains using a simple one-light indicator. Because it is not voltage sensitive, the Tracer operates on all logic families having current pulses exceeding 1 mA, and the repetition rates less than 10 MHz, including CMOS, where even lightly loaded outputs can have up to 2 to 3 mA typical current pulses.

Prior to introduction of the 547A, logic state indicators were limited to displaying voltage information. A node was HIGH, LOW, open, or pulsing. When a node is stuck, however, it may be trying to change state but isn't able to cross threshold levels. Use of the Current Tracer adds the final bit of information necessary to pinpoint just such logic faults on bad nodes. For example, on a bad node the Tracer can verify that the driver is functioning and also

show where the problem is by tracing current flow to the source or sink causing the node to be stuck.

To use the Tracer, simply align the dot on its tip at a reference point, usually the output of a node driver. Set the sensitivity control to indicate the presence of AC current activity. Then, trace the circuit to see where current is flowing. As you probe from point to point or follow traces, the lamp will change intensity, and when you find the fault the Tracer will indicate the same brightness found at the reference point.

### 547A Specifications

#### Input

**Sensitivity:** 1 mA to 1 A.

**Frequency response:** light indicates single-step current transitions; single pulses  $\geq 50$  ns in width; pulse trains to 10 MHz (typically 20 MHz for current pulses  $\geq 10$  mA).

**Risetime:** light indicates current transitions with risetime  $\leq 200$  ns at 1 mA.

#### Power supply requirements

**Voltage:** 4.5 to 18 Vdc.

**Input current:**  $\leq 75$  mA.

**Maximum ripple:**  $\pm 500$  mV above 5 V dc.

**Overvoltage protection:**  $\pm 25$  Vdc for one minute.

# DIGITAL CIRCUIT TESTERS & ANALYZERS

## Logic clips

Models 548A & 10528A

- Displays IC logic states at a glance
- Self-powered, self-contained
- No adjustments required



### Logic clips

The Logic Clip is an extremely handy service and design tool which clips onto dual-in-line-package (DIP) ICs, instantly displaying the states of all 14 or 16 pins. Each of the clip's 16 LEDs independently follows level changes at its associated pin. Lit diodes are logic High, extinguished diodes are Low.

The Logic Clip's real value is in its ease of use. It has no controls to be set, needs no power connections, and requires practically no explanation as to how it is used. The clip has its own gating logic for locating the ground and  $V_{cc}$  pins and its buffered inputs reduce circuit loading.

The Logic Clip is much easier to use than either an oscilloscope or a voltmeter when a logic designer or service engineer is interested in whether a circuit is in the high or low state, rather than its actual voltage. The Clip, in effect, is 16 binary voltmeters, and the user does not have to shift his eyes away from his circuit to make the readings.

The intuitive relationship of the input to the output—lighted diodes corresponding to high logic states—greatly simplifies the troubleshooting procedure. The user is free to concentrate his attention on his circuits, rather than on measurement techniques. Also, timing relationships become especially apparent when clock rates can be slowed to about 1 pulse per second.

When used in conjunction with the logic pulser, the Logic Clip offers unparalleled analysis capability for troubleshooting sequential circuits. The Clip attaches to the IC to be tested; the Pulser is then used to inject pulses between gates allowing it to supply signals to the IC under test absolutely independent of gates connected to the IC. All outputs may then be observed simultaneously on the Logic Clip. Deviations from expected results are immediately apparent as the Pulser steps the IC through its output states.

### 548 Multi-family logic clip

Fully automatic, protected to 30 V dc, and employing bright new

LEDs in its display, the 548A brings multi-family operation to the HP line of IC trouble shooters. The Clip can be externally powered, if desired, using a simple power connector.

### 548A Specifications

**Input threshold:**  $\geq(0.4 \times \text{Supply Voltage}) = \text{Logic High}$ .

**Input impedance:** 1 CMOS load.

**Input protection:** 30 V dc for 1 minute.

**Supply voltage:** 4-18 V dc across any two pins.

**Auxiliary supply input:** 4.5 to 18 V dc applied via connector. Supply must be  $\geq 1.5$  V dc more positive than any pin of IC under test.

**Supply current:** <50 mA

### 10528A Logic clip

Protection to +7 V dc, automatic operation, and low circuit loading in TTL/DTL applications helps make the 10528A a valuable replacement for more expensive test equipment like Scopes and voltmeters. The clip is, in effect, like 16 binary voltmeters, allowing the user to look at the circuit rather than having to shift his attention toward test equipment.

### 10528A Specifications

**Input threshold:**  $1.4 \pm 0.6$  V; TTL or DTL compatible (except gates with expander inputs).

**Input impedance:** one TTL load ( $-1.2$  mA typical per input).

**Input protection:** voltages  $< -1$  V or 17 V must be current limited to 10 mA.

**Supply voltage:**  $5$  V  $\pm 10\%$  across any two or more inputs.

**Maximum current consumption:** 120 mA.

### Ordering Information

548A Logic clip

10528A Logic clip

### Price

\$125

\$85

- Finds faulty nodes
- Dramatically cuts troubleshooting time
- Performs in-circuit IC testing with no unsoldering

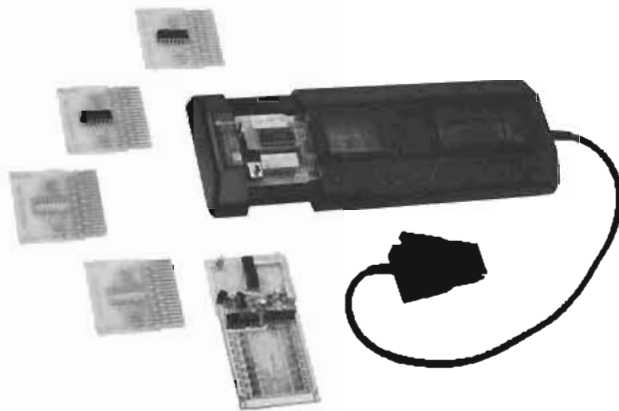

The Model 10529A Logic Comparator checks the operation of dozens of ICs in less than a minute per IC. The Comparator clips onto powered TTL or DTL ICs and detects functional failures by comparing the in-circuit test IC with a known good reference IC inserted in the Comparator. Any logic state difference between the test IC and reference IC is identified to the specific pin(s) on 14- or 16-pin dual in-line packages on the Comparator's display. A lighted LED corresponds to logic difference. The Logic Comparator can save considerable time in locating a faulty IC. There are no controls to be set and no power connections.

The procedure is very simple. First the IC to be tested is identified. An IC of the same type is placed in the Comparator's IC socket, or a reference board with an IC of the same type is inserted in the Comparator. The Comparator is clipped onto the test IC, and an immediate indication is given if the test IC operates differently from the reference IC. Even very brief dynamic errors are detected, stretched, and displayed.

The 10529A operates by connecting the test and reference IC inputs in parallel; thus the reference IC is exercised by input signals identical to those of the test IC. The outputs of the two ICs are compared; any differences in outputs are detected, and LEDs corresponding to the particular pin are lit on the Comparator's display. Intermittent errors as short as 200 nanoseconds (using the socket board) are detected, and the error indication on the Comparator's display is stretched for a visual indication. A failure on an input pin, such as an internal short, will appear as a failure on the IC driving the failed IC; thus a failure indication actually pinpoints a malfunctioning node.

Programming for the specific IC is easily accomplished by two different methods. First, the socket board included with the Comparator is inserted in the Comparator drawer. Outputs of the particular IC to be tested are selected via 16 miniature switches which tell the Comparator which pins of the reference IC are to be allowed to respond freely. The reference IC is then inserted into the socket and locked into place. An IC may be set up in seconds. Alternatively, if specific IC types are to be tested repeatedly, the reference IC may be soldered into one of the 10 reference boards provided with the Comparator. The reference board is programmed by opening the connections between the tests and reference ICs outputs and solder-bridging  $V_{cc}$  and ground.

When troubleshooting you want to know that the tester is operating properly. A test board is supplied with the Logic Comparator for this purpose. When inserted in the comparator the test board exercises all of the circuitry, test leads, and display elements to verify proper operation.

The Logic Comparator's ease of use and small size make it an invaluable addition to the troubleshooter's test gear either in the field or in the factory. With TTL and DTL failures that are functionally related, the Comparator can find bad nodes up to ten times faster than conventional signal tracing techniques. At its low price, the Logic Comparator can pay for itself in days.

**10541A:** twenty additional blank reference boards; identical to the 10 boards provided with the Logic Comparator, they allow additional ICs to be programmed for Comparator testing.

**K01-10541A:** twenty preprogrammed reference boards; 20 of the most common TTL ICs already programmed and ready for use with the Logic Comparator. The K01-10541A includes the following ICs: 7400 Quad 2-input NAND; 7402 Quad 2-input NOR; 7404 Hex inverter; 7408 Quad 2-input AND; 7410 Triple 3-input NAND; 7420 Dual 4-input NAND; 7430 8-input NAND; 7440 Dual 4-input NAND buffer; 7451 Dual 2-wide, 2-input AND-OR-INVERT; 7454 4-wide, 2-input AND-OR-INVERT; 7473 Dual J-K master-slave flip-flop; 7474 Dual D flip-flop; 7475 Quad bistable D latch; 7476 Dual J-K flip-flop with preset and clear; 7483 4-bit binary full adder; 7486 Quad 2-input exclusive-OR; 7490 Decade counter; 7493 4-bit binary counter; 74121 Monostable multivibrator; 9601 Monostable multivibrator, retriggerable.

### 10529A Specifications

**Input threshold:** 1.4 V nominal (1.8 V nominal with socket board). TTL or DTL compatible.

**Test IC loading:** outputs driving Test IC inputs are loaded by 5 low-power TTL loads plus input of Reference IC. Test IC outputs are loaded by 2 low-power TTL loads.

**Input protection:** voltages  $< -1V$  or  $> 7V$  must be current limited to 10 mA.

**Supply voltage:** 5 V  $\pm 10\%$ , at 300 mA.

**Supply protection:** supply voltage must be limited to 7 V.

**Maximum current consumption:** 300 mA.

#### Sensitivity

**Error sensitivity:** 200 ns with reference board or 300 ns with socket board. Errors greater than this are detected and stretched to at least 0.1 seconds.

**Delayed variation immunity:** 50 ns. Errors shorter than this value are considered spurious and ignored.

**Frequency range:** maximum operational frequency varies with duty cycle. An error existing for a full clock cycle will be detected if the cycle rate is less than 3 MHz.

**Accessories included:** 1 test board; 10 blank reference boards; 1 programmable socket board; 1 carrying case.

#### Accessories available

**10541A:** Twenty Blank Reference Boards for the Logic Comparator \$95

**K01-10541A:** Twenty Pre-programmed Boards for the Logic Comparator \$195

**10529A Logic Comparator** **\$525**

# DIGITAL CIRCUIT TESTERS & ANALYZERS

## Multi-family logic troubleshooting kits

Model 5021A, 5022A, 5023A

- Complete CMOS/TTL troubleshooting kits
- Stimulus-response capability
- In-circuit fault finding
- In-circuit analysis
- Dynamic and static testing
- Multi-pin testing



5021A

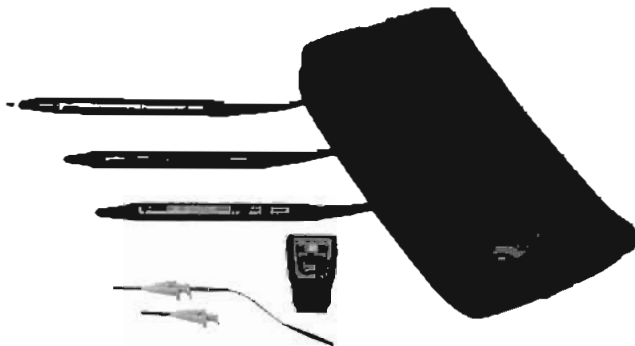

5022A



5023A

### Multi-family logic

#### 5021A Troubleshooting kit

The 5021A Kit combines multi-family Probe, Pulser and Clip into one handy kit for stimulus-response testing in lab, field and factory applications. Useful in dynamic or static circuits such as gates, flip-flops, and microprocessors, the 5021A kit instruments operate in TTL, CMOS, and most any other positive voltage logic families.

#### 5021A Specifications

##### 5021A contains

545A Logic Probe

546A Logic Pulser

548A Logic Clip

**Size:** 64 H × 146 W × 298 mm D (2.5" × 5.75" × 11.75").

**Weight:** net, 0.6 kg (13 oz). Shipping, 0.72 kg (16 oz).

#### 5022A Multi-family logic troubleshooting kit

The 5022A Kit brings the advantages of stimulus-response testing to both voltage and current domains in digital circuits. Now, for the first time, you can stimulate a circuit and exactly pinpoint logic faults as never before possible.

Start by locating a stuck node with the Pulser-Probe combination. Then, pulse the node and follow digital current pulse flow to the faulty circuit element using the 547A Current Tracer. This valuable addition to the IC Troubleshooter line exactly locates the low impedance point to troubleshoot stuck data busses, solder bridges, and three-state devices.

#### 5022A Specifications

##### 5022A contains

545A Logic Probe

546A Logic Pulser

547A Current Tracer

548A Logic Clip

**Size:** 64 H × 146 W × 298 mm D (2.5" × 5.75" × 11.75").

**Weight:** net, 0.43 kg (15 oz). Shipping, 0.51 kg (1 lb 2 oz).

#### 5023A Multi-family logic troubleshooting kit

The 5023A Kit includes all of our Multi-family troubleshooters, plus the TTL/DTL Logic Comparator in one complete lab, field, or factory troubleshooting kit. The comparator adds the ability to "map" and locate faulty logic responses by identifying incorrect static and dynamic logic state responses on 14 or 16-pin digital IC's.

Once bad nodes have been mapped using the Comparator, the Probe, Pulser, Current Tracer and Clip exactly locate logic faults in digital circuits.

#### 5023A Specifications

##### 5023A contains

545A Logic Probe

546A Logic Pulser

547A Current Tracer

548A Logic Clip

10529A Logic Comparator

**Size:** 225 H × 200 W × 337 mm D (8.875" × 7.875" × 13.25").

**Weight:** net, 1.64 kg (3 lb 10 oz). Shipping, 2.12 kg (4 lb 12 oz).

#### Accessories available

00545-60104: Tip Kit for 545A Probe, and 546A Pulser

10529-60002: Multi-Pin Stimulus Kit for 546A Pulser

10529-60006: External Reference Kit for 10529A

Comparator

10541A: Twenty blank reference boards for 10529A

Comparator

K01-10541A: Twenty pre-programmed reference

boards for 10529A Comparator

**Ordering Information**

**5021A Troubleshooting Kit**

**5022A Multi-family Logic Troubleshooting Kit**

**5023A Multi-family Logic Troubleshooting Kit**

#### Price

\$30

\$25

\$125

\$125

\$95

\$195

\$195

\$400

\$700

\$1200

# DIGITAL CIRCUIT TESTERS & ANALYZERS

Economical TTL/DTL Troubleshooting Kits

Models 5011T, 5015T & Accessories



5011T

### 5011T Logic troubleshooting kit

The HP 5011T Logic Troubleshooting Kit combines all the troubleshooting capability of four instruments, the 10529A Logic Comparator, the 10526T Logic Pulser, the 10525T Logic Probe, and the 10528A Logic Clip. The Logic Comparator attaches to 14- and 16-pin dual in-line TTL and DTL circuits. Both sequential and combinatorial logic are testable. The IC under test is allowed to operate normally while its outputs are compared against a reference IC of the same type inserted in the Comparator. Should the circuit under test operate improperly, the failure is detected and displayed on the hand held Comparator's panel. Sixteen LED's exactly pinpoint the failed node.

### 5011T Specifications

#### Includes

- 10525T Logic Probe
- 10526T Logic Pulser
- 10528A Logic Clip
- 10529A Logic Comparator

**Size:** 82.6 H x 203 W x 311.2 mm D (3.25" x 8" x 12.25")

**Weight:** net, 1.36 kg (3 lb). Shipping, 2.27 kg (5 lb).



5015T

### 5015T Logic troubleshooting mini kit

The HP 5015T Logic Troubleshooting Mini Kit combines the unique logic analysis capability of the 10525T Logic Probe, the 10526T Logic Pulser, and the 10528A Logic Clip into a single, handy kit. These three instruments provide stimulus/response capability for dynamic and static testing of in-circuit integrated circuits.

### 5015T Specifications

#### 5015T includes

- Model 10525T Logic Probe
- Model 10526T Logic Pulser
- Model 10528A Logic Clip

**Size:** 64 H x 133 W x 286 mm D (2.5" x 5.25" x 11.25")

**Weight:** net, 0.63 kg (1 lb 6 oz). Shipping, 0.74 kg (1 lb 10 oz).

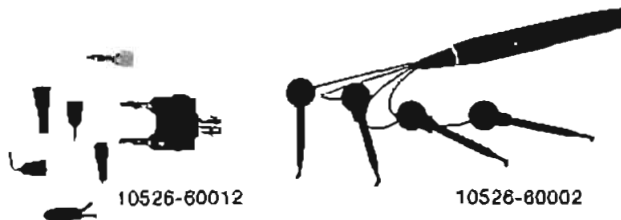

10526-60012

10526-60002

### Accessories available

	<b>Price</b>
10525-60012: Tip Kit	\$40
10526-60002: Multi-pin Stimulus Kit	\$25
10541A: Twenty Blank Comparator Reference Boards	\$95
K01-10541A: Twenty Pre-programmed Comparator Reference Boards	\$195

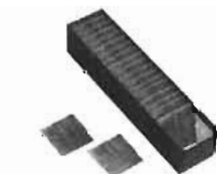

10541A



K01-10541A

### Ordering Information

5011T Logic Troubleshooting Kit	\$725
5015T Logic Troubleshooting Mini Kit	\$250

## DIGITAL CIRCUIT TESTERS

### Signature Analyzer, a $\mu$ P service solution

Model 5004A

- Field troubleshoot microprocessor-based products to the component level
- Improve the confidence level of field service
- Reduce warranty and service support costs
- Reduce the end-user's cost of ownership



5004A

#### The product

The HP 5004A Signature Analyzer is a tool for field troubleshooting of complex logic circuits. It recognizes and displays unique digital signatures associated with data nodes in a circuit under test. By comparing these actual signatures to the correct ones, a service technician can back-trace to a faulty node. The technique is especially useful in checking operation of microprocessor-based products and high-speed state machines, where data streams are long and complex and where there are no conventional means to troubleshoot to the component level.

By designing the digital portion of a product with the Signature Analyzer in mind, a manufacturer can provide field troubleshooting procedures for component level repair, without having to invest in a board exchange program, or in expensive special-purpose equipment.

Signature Analysis is also attractive for production line troubleshooting. The 5004A can detect speed-related failures in assembled systems, which may not have been caught by subassembly testers.

#### The technique

HP's patented Signature Analysis technique enables the 5004A to display a compressed, four-digit "fingerprint" of the data stream present at a node. This signature is generated from a linear feedback shift register in the 5004A, and is unique for a specific good node. Any fault associated with a device on that node will force a change in the data stream and, therefore, result in an erroneous signature.

The 5004A utilizes a 16-bit register, with maximal-length feedback taps. The data stream being measured is summed, modulo 2, with

the register feedback. The resulting probability of detecting an erroneous data stream is 99.998%. More importantly, the probability of detecting a single-bit error in a data stream is 100%. Signature Analysis detects time-related faults, such as mid-cycle displaced bits, which are not detectable by traditional transition and ones counting techniques.

The 5004A does not require programming, since the test stimulus is stored in the product under test. Gating and clock signals are also derived from the product under test.

#### The application

For a product which has been designed and documented for Signature Analysis, troubleshooting typically consists of:

- Switching the product to be tested into a test mode of operation.
- Attaching the 5004A's START, STOP, CLOCK, and GND leads to the test points of the product to be tested (no board or component removal required).
- Probing circuit nodes and observing the signatures displayed on the 5004A.
- Comparing them to correct signatures preprinted on a schematic or troubleshooting procedure in the service manual of the product under test.
- Isolating a faulty node by observing an erroneous signature.
- Tracing signatures back through gates and memory elements, until an element with correct inputs and faulty outputs is isolated.
- Replacing only the faulty component.

These steps can be performed quickly on-site, at a field service facility, or on a production line.





## 5004A Specifications

### Display

**Signature:** four-digit hexadecimal.  
**Characters:** 0,1,2,3,4,5,6,7,8,9,A,C,F,H,P,U.

### GATE, UNSTABLE SIGNATURE Indicators:

#### Panel lights

**Stretching:** 100 ms.

**Probe-tip Indicator:** light indicates high, low, bad-level and pulsing states.

**Minimum pulse width:** 10 ns.

**Stretching:** 50 ms.

**Probability of classifying correct data stream as correct:** 100%.

**Probability of classifying faulty data stream as faulty:** 99.998%.

**Minimum gate length:** 1 clock cycle.

**Minimum timing between gates (from last STOP to next START):** 1 clock cycle.

### Data Probe

**Input Impedance:** 50 k $\Omega$  to 1.4 V, nominal. Shunted by 7 pF, nominal.

#### Threshold

**Logic one:** 2.0 V +0.2 -0.3

**Logic zero:** 0.8V + 0.3 -0.2.

**Setup Time:** 15 ns, with 0.2 V over-drive. (Data to be valid at least 15 ns before selected clock edge).

**Hold Time:** 0 ns (Data to be held until occurrence of selected clock edge).

MEASUREMENT GATING EXAMPLE: POSITIVE-EDGE START, STOP, AND CLOCK

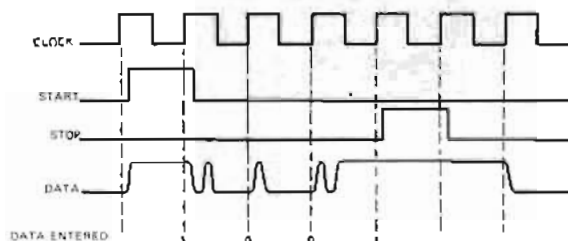

### Designing for signature analysis

Use of the 5004A Signature Analyzer requires that some test features be designed into the product to be tested.

First, a short repetitive test stimulus should be stored in the product's ROM. The routine stimulates circuit nodes, generating signatures detectable by the 5004A. It needs only to force a state change on each node, and does not have to create meaningful data. This stimulus can be merged with the product's self-check program, and enabled by a switch or jumper.

Second, data feedback paths should be opened, during part of the troubleshooting procedure, by switches, connectors, or disabling software. This prevents a fault from feeding back around, perturbing all data nodes.

Third, gating signals (START, STOP, CLOCK) should be brought out to test points for Signature Analyzer hookup.

HP Application Note 222, A Designer's Guide to Signature Analysis, provides examples and advice on designing products to be serviced by the 5004A.

### Operational features

The active DATA PROBE is also a TTL Logic Probe, similar to the HP 545A, indicating high, low, bad-level, and pulsing states, for additional troubleshooting information.

The gating inputs (START, STOP, and CLOCK) are brought out to an active pod, for fast response and low circuit loading.

Front-panel controls allow selection of either rising or falling edges of start, stop, and clock waveforms.

The GATE light indicates proper start/stop gating operation.

The UNSTABLE SIGNATURE light indicates a difference between successive signatures, alerting the user to intermittent faults, which may not be observed from the display.

The HOLD/RESET controls allow observation of signatures associated with one-shot operations, such as power-on routines.

The front-panel SELF-TEST feature allows go/no-go checkout of the entire Signature Analyzer, including probe, pod, and cables, increasing confidence in on-site service.

### Gating Input Lines

#### START, STOP, CLOCK Inputs

**Input Impedance:** 50  $\Omega$  to 1.4 V, nominal. Shunted by 7 pF, nominal.

**Threshold:** 1.4 V  $\pm$ 0.6 (0.1 V hysteresis, typical).

#### START, STOP Inputs

**Setup time:** 25 ns. (START, STOP to be valid at least 25 ns before selected clock edge).

#### CLOCK Input

**Maximum clock frequency:** 10 MHz.

**Minimum clock time in high or low state:** 50 ns.

**Overload protection (all inputs):**  $\pm$ 150 V continuous,  $\pm$ 250 V intermittent, 250 V ac for 1 minute.

### Operating Environment

**Temperature:** 0°C-55°C.

**Humidity:** 95% RH at 40°C.

**Altitude:** 4,600 m.

**Power Requirements:** 15 VA max. See Options below for power line voltage and frequency.

**Weight:** net, 2.5 kg (5.5 lb). Shipping 7.7 kg (17 lb)

**Size:** 90 H  $\times$  215 W  $\times$  300 mm D (3.50"  $\times$  5.50"  $\times$  12"). Dimensions exclude base, probe and pouch.

### 5004A Signature Analyzer

Opt 910: Extra manual

\$990  
add \$10

Orders must specify one of these power line options.

Opt 100: 100 V ac line, +5%, -10%, 48-440 Hz

Opt 120: 120 V ac line, +5%, -10%, 48-440 Hz

Opt 220: 220 V ac line, +5%, -10%, 48-66 Hz

Opt 240: 240 V ac line, +5%, -10%, 48-66 Hz

# DIGITAL CIRCUIT TESTERS & ANALYZERS

Logic labs

Models 5035A, 5035T

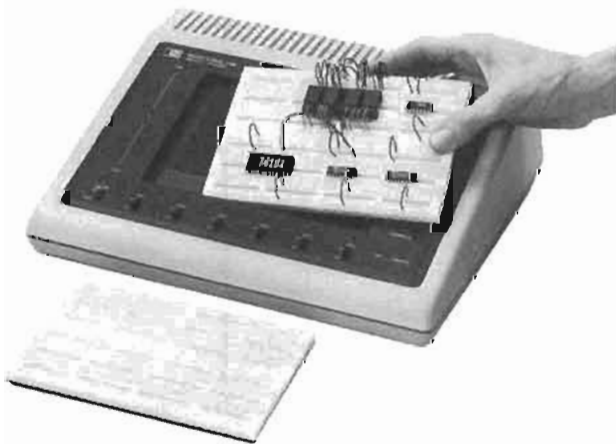

## 5035T Complete Logic Lab

Learn logic . . . the practical way. HP's Model 5035T Logic Lab combines theory and lab so you'll learn digital logic quickly, enjoyably, and memorably. Start by building simple circuits and work up to complete numerical readout clocks. Adopted by schools, industrial firms and individuals who want to keep up with the changing world of electronics, and enjoy doing it.

## 5035T Logic Lab ordering information

Includes

**5035A Mainframe** with removeable breadboard (see below)

"Practical Digital Electronics"—An Introductory Course

- Complete textbook
- 26 Experiment Workbook
- TTL/DTL Test Instruments
- 10525T Logic Probe
- 10526T Logic Pulser
- 10528A Logic Clip
- Wire and Component Kit
- 32 TTL, MSI, LSI ICs
- 285 Pre-stripped Wires
- 4 Large LED numerical displays
- IC Remover

Accessories available

1258-0121: Additional Breadboard Assembly

10656A: Set of 10 "Practical Digital Electronics" An Introductory Course-Texts and Lab Workbooks

10657A: Additional Component and Wire Kit

Price

\$62.50

\$150

\$150

5035T Logic Lab

\$750

## 5035A Logic Lab Mainframe

The 5035A Logic Lab Mainframe brings convenience and flexibility to breadboarding by allowing solderless connection of new circuit ideas. Fully self-contained, the mainframe has a 5-volt 1-amp power supply, two clocks, four LED indicators, six data switches, two 5-volt BNC connectors, and a handy removeable breadboard. To use it, just connect up circuits using standard 24-gauge wire, then power up either one or several breadboards to quickly and easily verify new circuits ideas before incurring expensive PC board layout and rework charges.

## 5035A Mainframe ordering information

**Power supply:** 5 volts  $\pm 5\%$ , over 0-1 Amp range; 10 mV rms ripple maximum. Continuous short circuit protection.

**Data switches:** 6 bounceless slide switches for TTL high/low outputs.

**LED Indicators:** 4 high/low indicators.

**Clocks:** 2 independent; 1 Hz and 100 kHz.

**Breadboard assembly (HP part number 1258-0121):** removable.

**Interconnections:** all power supply, data switch, LED indicator, and component contact points may be interconnected by standard 24-gauge hook-up wire.

**Power requirements:** 100/120/220/240 V ac  $\pm 5\%$ ,  $\pm 10\%$  50 or 60 Hz line frequency; 30 watts max; 0°C-55°C.

**Size:** mainframe, 311 H  $\times$  89 W  $\times$  267 mm D (3 1/2"  $\times$  12 1/4"  $\times$  10 1/2"). Breadboard assembly: 165 H  $\times$  114 W  $\times$  13 mm D (6 1/2"  $\times$  4 1/2"  $\times$  1/2").

**Weight:** net, 5.9 kg (13 lb). Shipping, 6.9 kg (15.13 lb).

Accessories available

1258-0121: Additional breadboard assembly

1540-0258: Heavy duty, padded vinyl carrying case

05035-60006: Wire interconnect kit (258 pre-stripped, assorted length and color, 24 gauge hook-up wires)

Price

\$62.50

\$15

\$15

5035A Logic Lab

\$425

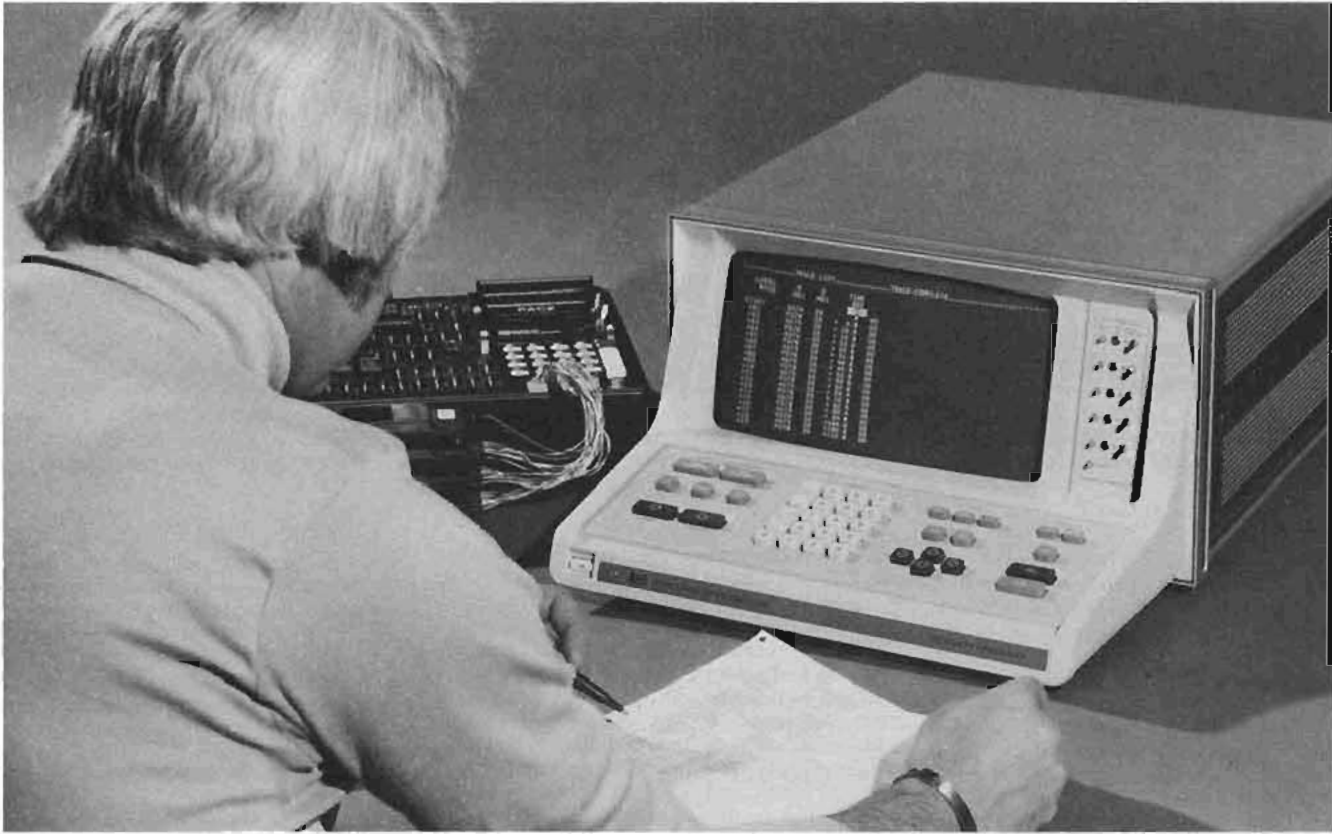

### Introduction

The increasing use of digital processors, such as computers and microprocessors, has created a concurrent need for new analysis equipment for use in the design, checkout, and troubleshooting of digital systems. It has become increasingly apparent that digital problems can best be solved by digital means. The instrumentation and theoretical foundations of these digital solutions come from the branch of electronics known as the data domain. There are many specific analysis systems and instruments that fit the data domain instrumentation category. These are discussed in relation to the design and troubleshooting tasks facing the designer and user of digital equipment.

### Software development

The growth of LSI IC technology, and one-chip processors and bulk memory circuits, has placed much emphasis on the time a designer spends on programming and program verification. Full software development involves three steps: software code generation, either simulation or emulation of the processor and memory circuits before the hardware is complete, and analysis in real time (e.g. at full system operating speed) on the hardware.

After code generation the greatest uncertainty occurs when the system is working to a degree, and design verification is the task. At this point, the task is functional analysis at system speed, a job that logic analyzers have been designed to aid.

### Logic analyzers

All logic analyzers share three basic blocks: data registration, data capture, and

data display. There are, however, substantial differences in the quality of each of these blocks, perhaps most easily discussed in terms of levels of sophistication. Table 1 illustrates these different capabilities.

Data-domain problems are manifested as an improper data sequence, for which the cause has yet to be determined. It is important to note that the problem effect is always functional whether the cause is functional or electrical. Consequently, the first analysis step is locating the malfunction in the data flow sequence.

Locating the problem in data flow with an external instrument requires data registration or synchronization followed by data

capture, possible message, and presentation to the user.

### Registration

Registration to a data stream by Logic Analyzers may be thought of as synonymous with triggering for oscilloscopes, trap for data communications monitors, and breakpoint for computer check-out panels. However it is a much more complex function than any of these others, embracing Pattern Recognition, Sequence Recognition, Data Indexing, Data Qualifier comparison, and Boundary Condition correlation.

Pattern Recognition can be as simple as acknowledging a gating flag, but more com-

	Data Registration	Data Capture	Data Display
Level 3	Sequential Pattern Recognition — Range or Boundary Triggering	Selective Data Storage — Elapsed Time/Count	Graphing — Mnemonic Disassembly — Split-field Machine Language
Level 2	Pattern Recognition — Word Count Delay	Qualified Storage	Matrix Map — Hex/Octal/Binary Word Display
Level 1	Gated Trigger — Clock Delay	Successive Storage	1's & 0's Display

Table 1. Levels of Logic Analyzer Sophistication.

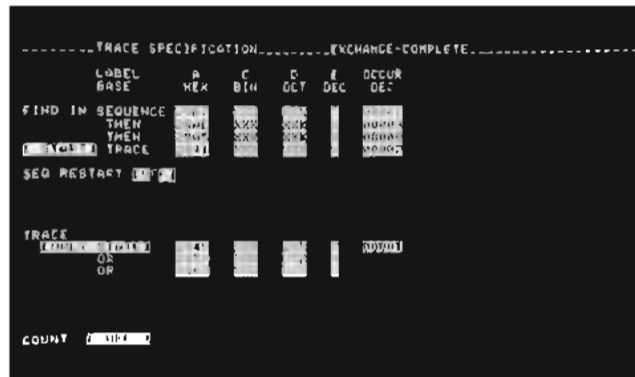

Figure 1. 1610A Logic State Analyzer trace specification for defining a test sequence that will capture a nested loop as well as only selected states in the loop.

LABEL BASE	A HEX	B BIN	C OCT	D DEC	E STATE COUNT	OCCUR
SEQUENCE	2887	000	286	1	41741	
SEQUENCE	288E	000	286	1	3317	
SEQUENCE	2895	000	286	1	2145	
START	2841	000	000	1	0	
+01	2842	000	232	1	*	
+02	2844	000	232	1	*	
+03	2846	000	280	1	*	
+04	284A	000	212	1	*	12
+05	284C	000	294	1	*	14
+06	2850	000	344	1	*	18
+07	2851	000	818	1	*	19
+08	2852	000	818	1	*	20
+09	2852	000	818	1	*	21
+10	2853	000	112	1	*	22
+11	2853	000	112	1	*	23
+12	2854	000	052	1	*	24
+13	2854	000	052	1	*	25
+14	2855	000	372	1	*	26
+15	2851	000	818	1	*	27
+16	2852	000	818	1	*	28

Figure 2. Adding a count-states specification to the 1610A trace specification in figure 1 results in a trace list showing the number of states (in decimal base) which occurred prior to and following the trace start.

monly involves an ANDing decision at a Data Read cycle on a parallel data bus. For instance, this may be thought of as an ANDing function equaling an address on an address bus.

Sequence Recognition, an important function that most early Logic Analyzers do not allow, is the ability to describe a word Directly Followed By another word, or a Loop Count capability where the same recognition must be made  $n$  times.

The most important use of sequential recognition is to analyze branching software, looping software, and in particular, to unravel nested loops to check for correct behavior. A very typical problem occurs when a system exits from a nested loop sequence prior to full completion. The first analysis question might be "does deviation occur?" which may be answered by setting up a full sequence registration specification and running the system to see if the specification is followed.

Data Indexing and Data Qualification, closely related to Selective Data Storage, are especially useful in longer programs. The indexing and qualification functions allow truncation of unnecessary steps, so that captured data is quality data rather than quantity data.

The HP Model 1610A Logic State Analyzer provides an excellent example of sequence recognition and data qualification capabilities in a logic analyzer. The 1610A Trace Specification allows you to define a sequence of from one to seven words which must be found in the specified order. To further qualify the sequence, each word in a sequence may be specified to occur from 1 to 65 536 times so you can capture the  $n$ th pass of a loop beginning at a given word. Figures 1 and 2 show a 1610A Trace Specification with a defined test sequence and qualification, and the resulting trace list.

Indexing and qualification capability is especially of value in two applications: (1) searching for uncommon conditions or infrequently occurring events in a long data-sequence, or (2) in trying to sort bulk data into its various components on a multiplexed bus. An extension of qualification is the need for handling multiphase clocks or

dual-clocked interfaces between peripherals and mainframes.

Range Triggers, which are preset Boundary Conditions, are a way of locating a class of problems that beset software designers. All too frequently, a designer will make an insignificant mistake in code (e.g. address 0202<sub>16</sub> instead of 0220<sub>16</sub>) which extracts an altogether different data word or operand from memory, resulting in a Jump or Gate instruction on a subsequent cycle that sends the system to the wrong area of memory. The better solution in many cases is to use a boundary condition statement (range trigger) as a trigger override which directs the analyzer to recognize a data word less than or greater than some assigned values.

The HP 1611A Logic State Analyzer for microprocessor based system analysis has the capability to include or exclude ranges of addresses by selecting less than or greater than limits and the desired address words (figure 3). Any or all of the trigger specifications can be further modified by requiring a predetermined pass count of up to 256 trigger occurrences before a trace begins. Additionally, trigger Enable and Disable conditions can be specified to establish the boundary conditions in which the selected trigger search may be allowed.

#### Data Storage

Virtually all data-domain instrumentation today gathers a data table or "trace" since data and data sequences are the parameters of concern. This, of course, requires that the instrument view data just the same as the machine under test. Binary thresholds must match, setup and hold times are crucial, and probe loading must not cause a problem to the circuit under test.

**Acquisition requirements:** there are some unusual speed and channel acquisition requirements imposed in data-domain measurements. For instance, data need not be gathered at rates above the data register speed of the system under test—this is 3 MHz or less for virtually all minicomputer and microprocessor systems today, and only 12.5 MHz for most parts of even large CPU's.

By contrast with these low data cycle times, setup and hold times have much

higher performance requirements. Setup time should be as short as possible, to accommodate multi-phase clock structures.

Micro and mini systems in several cases have setup time requirements under 20 ns (more than  $8 \times$  what we might expect from the instruction register clock rate). In nearly all cases, system hold time guarantees are 0 to perhaps 5 ns at best, imposing a strict instrument requirement of "zero positive hold time."

**Negative time storage:** an equally important consideration for data-domain testing is the fact that data faults are almost never controllable or easily reproducible. Thus, the classical stimulus-response testing so popular in time-domain and frequency-domain analysis is rendered impotent because of the vast complexity of the intermediate system. This gives a fault tracing question of "what happened before the failure at  $t_0$ ?", rather than the easier question of "what happens when we change the system at  $t_0$ ?"

Consequently, logic analysis equipment has put considerable emphasis on capturing "pre-trigger" or "negative time" events. Obviously, these historical records were gathered as they occurred—the "negative time" aspect refers to the decision to retain data that has already been captured. Consequently, a logic analyzer can record data over a long period, then make a decision that the captured data was of interest, and block out future events in order to keep the past history file.

**Channel width:** yet another important consideration is the total amount of data that must be collected at every event-time in order to characterize system behavior. In fact, this is the basic reason that these analysis techniques are termed **data domain**—since the status of a digital machine at any event-time is described by its functional data registers. The program counter, the instruction register, the accumulators and so forth contain specific coded data which collectively describe the machine status at any one event-time. In addition, most digital machines are built to operate on external data—to add, subtract, multiply or divide data, to make branching

ADDRESS	DATA	EXTERNAL
TRIGGER <= 4000		
>= 0100		
PRE-TRIGR=5		
ADRS	OPCODE/DATA	EXTERNAL
00AA	MOU B,A	0000 0101
00AB	LXI H,3779	0000 0101
00AE	XRA M	0000 0101
0779	7B READ	0000 0101
00AF	RRC	0000 0101
00B0	JC 0599	0000 0101
00B3	CALL 063E	0000 0101
37FF	00 WRITE	0000 0100
37FE	B6 WRITE	0000 0100
063E	LXI H,3778	0000 0101
0641	MOU A,M	0000 0101
3778	37 READ	0000 0101
0642	MOU M,H	0000 0100
3778	37 WRITE	0000 0101
0643	ANA A	0000 0101
0644	RNZ	0000 0101

Figure 3. The 1611A Logic State Analyzer allows you to interrogate ranges of memory addresses with the  $\geq$  and  $\leq$  limits to bracket memory bands.

decisions from data comparisons, and to accumulate, store, and process still more data. Thus, to select data domain as a descriptor for a way of analyzing digital logic machines suggests both an awareness of the machine's external function of working with digital data, and its internal operation in terms of an organized flow of data sequences.

Data domain analysis, then, is a set of analysis techniques concerned with designing, monitoring, and correcting the behavior of a digital machine as a function of its internal data sequences and its external data manipulations. Even for modest-size systems, this requires many channels for data acquisition. For example, to monitor the address, data, and control lines of most eight-bit microprocessor (e.g. 8080, 6800) requires 30 or more lines of simultaneous monitoring. The HP 1611A microprocessor analyzer provides for up to 40 input lines as well as eight additional input lines for tracing related events or for additional trigger qualifications.

**Storage recording:** we can now appreciate the dilemma often faced by the digital system "troubleshooter". When a system "crashes" on a very spasmodic, intermittent basis, it is very difficult to ascertain why. As a consequence, the "baby-sitting" mode of test has evolved, using a very deep memory to record the events leading to failure. However, the quantity of data able to be collected can quickly out-strip any finite memory. For example, the total dynamic memory required by a monitoring instrument for one second of operations of a large CPU could exceed 1.5 billion bits.

As a result of this very large memory requirement, the more capable logic analyzers offer various data compression techniques to aid in system monitoring. One powerful technique used is qualification of data storage as a function of external control lines. For example, ANDing the Write line with the Data Clock will store only Write commands, while Read commands or non-I/O transactions are ignored. Similarly, data sent only to a given point-of-sale terminal or a particular disc memory could be sorted by qualifying to that machine's specific bus address. Qualification in the general case can

be defined to include Clock Qualification (to handle multi-phase or even handshake structures), Flag or Control Line Qualification (such as Read or Write lines, and Data Qualification (usually in terms of address or instruction).

Bidirectional multiplexed data structures are best monitored (one may say "only monitored") with a sophisticated combination of qualification and selective storage. One further capability is essential for analysis of storage records thus compiled—the elapsed time and/or count between stored words.

**Data presentation**

The appropriate data presentation methods vary as a function of the measurement being made, as well as the skill level of the user. It is convenient to think of Global vs. Local analysis, where Global refers to overview or macroscopic presentations, and Local to tracing specific words or measuring between two events. Under the Global definition, we find Memory Maps and Graphs.

Local analysis, by contrast, may be concerned with only one transaction or excursion within a total memory map, and with the state flow leading up to that erroneous excursion. Perhaps it goes on to analyze the specific pulse timing on some handshake lines during that event-time, or to measure the elapsed time from a known good transaction to the fault condition. Local analyses are zoom lens interrogations of anomalies in the Global picture.

**Global measurements:** the 1600A Map is perhaps the most familiar global view available on data-domain instrumentation. This map (figure 4) is essentially a dot matrix array where any specific dot location corresponds to a specific sixteen-bit parallel word (the most significant eight-bit byte on the vertical axis and the least significant on the horizontal axis). The map mode allows fault perception at a glance, compared with lengthy time to scan a page of state table data. Most users quickly learn the patterns of various operational modes of the system under test, and can verify apparent proper performance or detect differences at a glance.

For specific address-space functions such

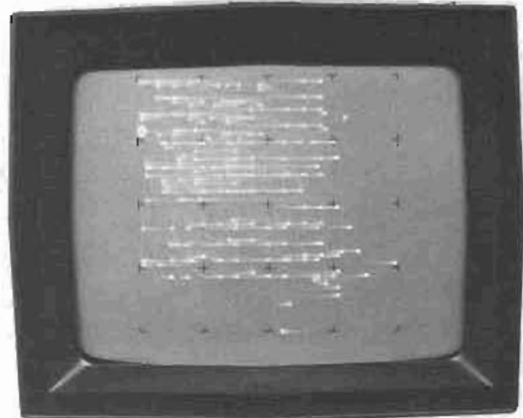

Figure 4. The 1600A map display offers an overall view of machine operation with each dot representing one sixteen-bit word. The line between dots is a vector whose brighter end is the "goes to" address.

as memory-mapped I/O, the array map provides an easy way to tell whether transactions of a given type are occurring.

A 1610A data flow graph (figure 5) is also a very useful pictogram for certain functions, not the least of which is portrayal of the time-sequential execution of weighted data. Subroutines and nested subroutines are easily discerned, showing up as repetitive sawtooth waveforms on such a graph. Upper and lower limits may be expanded or contracted for whatever zoom resolution is appropriate and "off-scale" indicators may be used as pre-set "boundary conditions," described under data registration. The graph provides an intermediate level of analysis between the wide-angle overview of the array map and the local, specific data table listing.

**Local measurements:** "Local" testing deals with the specific and particular, and as such is more often thought of as a "real" measurement by users. There are two basic measurements being made today—the Data Trace and the Delta Interval (time and count measurements).

There are many ways of displaying the data Trace (figures 2 and 3), each of which has merit for a given user. For example, the 1611A offers mnemonic disassembly while the 1610A provides Split HEX, OCTAL, and BINARY to handle address, data, and control lines simultaneously, each in the proper code.

Delta-Interval (time and count) measurements are a very powerful addition to data-domain instruments, especially those with good data-registration capability. Time and count measurements are available with both the general purpose HP 1610A and the HP 1611A microprocessor analyzer. The 1610A allows selection of time or state (word) count for all 64 words in memory, displayed in either absolute or relative mode. The absolute mode gives you the time or count between the trace position and a selected word, while the relative mode presents the time or count between each consecutively acquired state. This capability allows you to directly determine the time spent in loops, interrupts, or program time between steps.

In the 1611A the time or count between

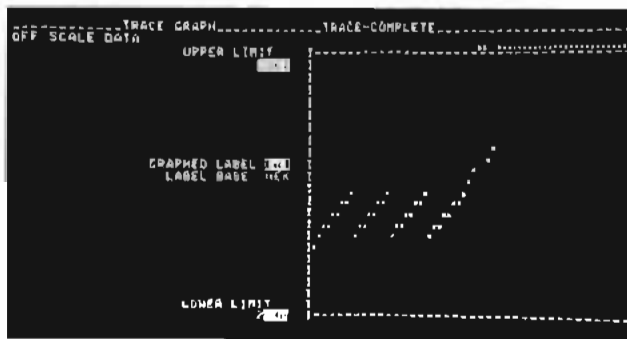

Figure 5. A 1610A trace graph may be selected to give you a view of all 64 states in the analyzer's memory. Each dot's vertical position is determined by its absolute numerical value and its horizontal position is determined by its sequence of occurrence. The ability to set upper and lower limits on the graph makes it easy to see the level of memory in which the program is operating.

events is measured by specific Enable and Disable conditions for the address, data, or external inputs, with the result displayed directly (figure 6).

#### Hewlett-Packard logic analyzers

**1600S:** Model 1600S is a general purpose Logic State Analyzer which provides convenient and flexible functional analysis of up to 32-channels of parallel data at clock speeds to 20 MHz. The display is presented in an easy-to-read one's and zero's format for fast functional analysis of data flow. Features include trigger arming, dual clock, separately configured data tables, display qualification, exclusive OR comparison of Tables A and B, dynamic mapping, and halt when A is not equal to B. An added advantage of this logic state analyzer is that it can be used in conjunction with the Model 10254A Serial-to-parallel Converter which converts serially formatted data to parallel for use with the 1600S. Another useful accessory is the Model 10253A Card Reader which may be used to load fixed data stored on cards into the 1600A Table B memory, providing a convenient method of performing comparative tests on digital components or systems.

**1602A:** Model 1602A is an easy-to-use but powerful keyboard controlled Logic State Analyzer designed with the technician in mind. Its self-teaching keyboard panel and a standard PC board edge connector probe, make the unit ideal for applications involving service and production. The 16-bit wide and 64-word deep memory operates at clock speeds to 10 MHz. Data may be registered with versatile pattern recognition trigger and digital delay. Measurements are displayed on the Analyzer's LED readout in hexadecimal, decimal, octal, or binary format, eliminating the need for base conversions by the operator.

Usefulness is further enhanced by the 1602A's portability (only ten pounds) and by its programmability. The 1602A Option 001 is HP-IB compatible, making automatic functional testing a reality by teaming it with a computing controller such as the Model

9825A. The 1602A can also act as a service tool for HP-IB systems.

**1610A:** Model 1610A is a general purpose Logic State Analyzer with a very powerful measurement set capable of checking complex digital systems from microprocessor based to minicomputers. The 1610A synchronously performs real time trace and count measurement to 10 MHz with powerful triggering capability on words up to 32-bits wide. The sophisticated measurement set is implemented with keyboard control and an interactive display using a menu concept to permit rapid entry of complex measurement parameters. Measurements of system activity are displayed in any mixture of hexadecimal, octal, binary, or decimal codes.

Features of the 1610A include Trace Specification with up to seven levels of sequential state conditions, a restart state for sequential conditioning, seven choices of trace qualification, and a state count or time interval which can be displayed in either absolute or relative modes. A state graph provides a selectable overview of state sequences (static or dynamic) presented as an X-Y display. The 1610A also includes a self-test mode which provides seven different self-tests for performance verification.

**1611A:** The Model 1611A is a keyboard controlled Logic State Analyzer dedicated to the design and troubleshooting of microprocessor based systems. The analyzer is configured to a specific microprocessor by ordering the appropriate personality module and is easily reconfigured. Four personality modules are presently available for use with the 6800, 8080, F8 and Z80 microprocessors with more planned for the future. Features include powerful triggering capability, time interval measurements, mnemonic display, and error messages to warn of improper operation or setup.

#### Logic analysis accessories

**Serial-to-parallel converter:** for functional analysis of serial data, the HP 10254A permits display of serial data together with the 1600A, 1607A, or 1600S Logic State Analyzer, with the same windowing



Figure 6. The 1611A time interval mode along with the ability to select enable and disable trigger conditions allow direct measurements of execution time in loops or subroutines

capabilities as for parallel data.

**Card reader:** when performing repetitive tests on digital components or systems, the HP 10253A provides a low cost method of performing simple or complete system checks. With a test procedure on cards, special operator training on the system under test is not needed—just insert a card in the card reader and look for intensified ones on the 1600A.

**Trigger probes:** the HP Model 10250A TTL Trigger Probe features a 4-bit AND gate trigger and selectable bit levels (HI, LO, OFF). The circuit-powered probe provides 4-bit pattern recognition triggering for digital signal analysis and may be used for both functional and electrical analysis. With the 10250A connected to the HP 1602A Logic State Analyzer rear panel Trigger or Clock Qualifier inputs, an additional four bits of qualification are available.

The HP Model 1230A trigger probe offers 8-bit parallel triggering capability with the addition of digital delay capability of 9998 clocks and synchronous or asynchronous operation. The 1230A provides versatile triggering capabilities for oscilloscope windowing to digital problem areas.

**Testmobiles:** several HP testmobiles offer convenient portability for HP Logic State Analyzers. The versatile 1008A can be used for the 1610A or 1611A with storage space for other test equipment and accessories. See page 180 for Testmobile information.

#### Education

Learning tools available include the Data Domain Measurement series Application Notes, and the four part videotape series, "The Data Domain, Its Analysis and Measurements." The latter is designed to provide instruction in logic state analysis measurement techniques and the debugging of processor-based systems. Measurements shown in these tapes include: paging, loops and map techniques, asynchronous measurements, lost program, I/O data transfer, memory access time, software programmable I/O ports and interrupts. Contact your local HP Sales Office for additional information on these training aids.



### 1610A Description

The Model 1610A keyboard controlled Logic State Analyzer offers general purpose measurements in microprocessor based systems, minicomputers, or virtually any digital circuit. The 1610A synchronously performs real time trace and count measurement to 10 MHz with powerful triggering capabilities on words up to 32 bits wide to allow you to capture the data of interest.

Measurements of system activity are displayed on the analyzer's CRT screen in selectable hexadecimal, octal, binary, or decimal codes. Setup for a measurement is aided with the Format and Trace specification menus which indicate the test parameters you are to enter. The events and activity that are captured and displayed from the system are gathered at clock transitions after the 1610A locates the specified trace position and then captures 64 words of data. The displayed trace may be a simple breakpoint with the trace position at the beginning, end, or center of the captured data; or, in a state sequence where one to seven words must be found in a specified order before data is captured. This state sequence permits you to directly locate sections of branched, looped, or nested loops of state flow. A selective trace of from one to seven words may be OR specified which allows only the words of interest to be captured and eliminates data that is not necessary for your measurement.

A count measurement capability allows you to perform a time or state count on all 64 traced states in either absolute or relative modes. With the count measurement you can determine how much time a program spends in loops, servicing interrupts, as well as the time between program steps. This measurement is performed simultaneously with the trace and all 64 words traced are assigned a count record which is displayed as positive or negative time in relation to the location of the trace position (absolute mode), or in relation to the previously acquired state (relative mode).

One complete measurement, including Format and Trace Specifications, may be internally stored to be recalled at a later time or for use in a trace compare mode. When a trace compare mode is called,

the display presents an exclusive OR tabular listing of the differences between the current and stored measurements. The trace compare mode may be also used to direct the Analyzer to continuously rerun a measurement until the current and stored measurements are equal or not equal and the 1610A automatically halts and retains the current measurement.

The 1610A includes a Trace Graph to provide a display of data magnitude versus time sequence for all 64 words in memory. Each dot representing a word is given a vertical displacement corresponding to its magnitude and is positioned horizontally in the order of its occurrence. The result is a waveform that offers a quick overview of program operation.

For increased confidence of the instrument's operation, there are self-tests for the keyboard, ROM/RAM, display, a trace test which includes all probe pods, an interrupt test, and a printer test.

Hard copy of both the Format and Trace specifications as well as the Trace List and Trace Compare can be obtained by adding a Hewlett-Packard printer (Model 9866A or 9866B). Rear panel printer outputs are included in the 1610A for direct interfacing.

#### Data entry

Entries are made in inverse video fields with the entry location indicated by a blinking cursor. Entry fields (enclosed with brackets) are multiple choice with the desired test parameter selected by using the Field Select key (e.g. positive or negative edge of clock transition). Trace specifications are entered through the keyboard directly in octal, hexadecimal, binary, or decimal notation which permits working in a familiar format without worrying about base conversions.

#### Menu

The displays which are called up by keyboard commands are referred to as menus because they include the selections for setting up test parameters and labeling of test results. These menus include Format Specification, Trace Specification, Trace List, Trace Compare, and Trace Graph.



## Model 1610A (cont.)

## Format specification

The formatting capabilities allow you to separate the 32 input data channels into the desired test parameters. This allows those data bits which act as a unit to be assigned to one of six labels (e.g. 16 bits of address bus assigned as "A" and 8 bits of data bus assigned as "D"). This labeling capability then permits all trace specifications to be assigned as a unit rather than on individual lines. Each assigned label may be independently defined in positive or negative logic as well as different bases of binary, octal, decimal, or hexadecimal. Another feature of this menu is that active channels are shown as exclamation marks (!) for a quick overview of system activity.

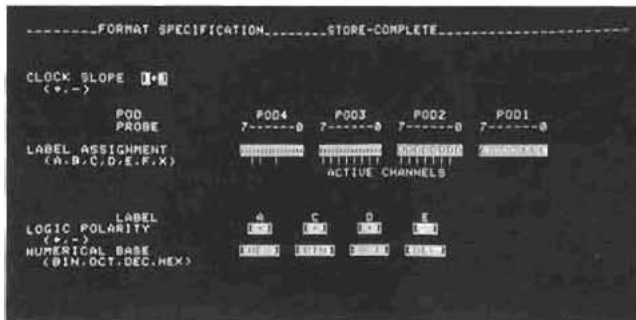

Format specification menu lets you define which group of bits will act as a unit by assigning labels which may be separately defined as to numerical base and polarity. The allowed selections are defined on-screen to minimize front panel controls.

## Trace specification

After the Format Specifications have been defined, the Trace Specification menu is called up and the measurement parameters are entered. The Trace measurement may be defined as a single word or may be in a sequence of from one to seven words which must be found in the specified order. The ability to select a sequence of words allows you to locate sections of branched, looped, or nested loops during machine operation. To further qualify the sequence, each word in a sequence may be specified to occur from 1 to 65 536 times so you can capture the nth pass of a loop beginning at a given word.



Typical trace specification for defining a test sequence that will capture a nested loop as well as only selected states in the loop.

## Trace list

When the Trace key is pressed, the 1610A searches for the word sequence defined in the Trace Specification. As the data is captured it is displayed on the CRT along with a line number and alphabetically formatted into the assigned labels and in their numerical base. The display contains 20 words, and Roll keys permit you to view the entire 64 word listing. To make it easier to locate the Trace position, which may be selected to start, be in the center, or end a trace, Start is spelled out on the display. Any count information is also presented adjacent to each word.

The count measurement may be specified to be either Time or State (word) count for all 64 words in memory and may be in either absolute mode or relative mode. The absolute mode gives you the time or count between the trace position and a selected word, while the relative mode presents the time or count between each consecutively acquired state. This allows you to directly determine the time spent in loops, interrupts, or program time between steps.

TRACE LIST		EXCHANGE-COMPLETE			
LABEL	A	C	D	E	TIME
BASE	HEX	BIN	OCT	DEC	DEC
SEQUENCE	2007	000	206	1	1 009 S
SEQUENCE	200E	000	206	1	85 80 MS
SEQUENCE	2005	000	206	1	6 349 MS
START	2041	000	000	1	
+01	2042	000	232	1	4.0 US
+02	2043	000	000	1	4.0 US
+03	2044	000	232	1	4.0 US
+04	2045	000	002	1	4.0 US
+05	2046	000	200	1	4.0 US
+06	2047	000	002	1	4.0 US
+07	2048	000	044	1	4.0 US
+08	2049	000	004	1	4.0 US
+09	204A	000	212	1	4.0 US
+10	204B	000	000	1	4.0 US
+11	204C	000	204	1	4.0 US
+12	204D	000	002	1	4.0 US
+13	204E	000	216	1	4.0 US
+14	204F	000	050	1	4.0 US
+15	2050	000	244	1	4.0 US
+16	2051	000	000	1	4.0 US

Trace list displays the label and numerical bases, as well as the sequence requirements and resulting state flow. This example also shows time in the relative mode which is the elapsed real time between each state and the previously acquired state.

## Trace graph

Trace Graph is a presentation of data magnitude versus time sequence which provides a display of all 64 words in memory. This graph allows you to see at a glance in which part of a program the machine under test is operating. Each word is displaced vertically according to its magnitude and positioned horizontally in order of its occurrence. The data to be graphed is selected by label with its base displayed on screen.

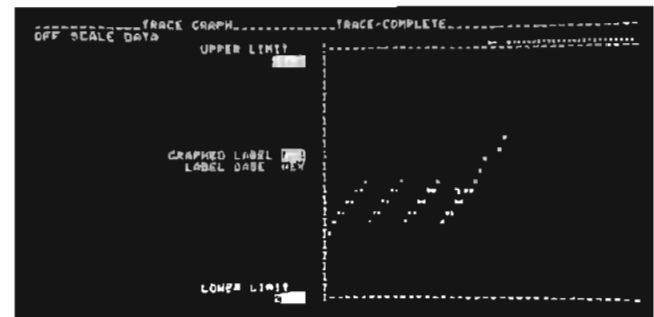

A trace graph may be selected to give you a view of all 64 states in the analyzer's memory. Each dot's vertical position is determined by its numerical value and its horizontal position is determined by its time sequence of occurrence.

## Trace compare

One complete trace measurement including format and specification may be stored internally which allows comparison between a current and stored measurement. The current and stored measurement may also be interchanged which allows you to quickly review the stored measurement as well as its specifications.

Trace Compare presents an exclusive OR tabular listing of the differences between the current and stored measurements. The listing is formatted and rolled as a trace list with identical bits displayed as zeros and different bits displayed as non-zeros. For example, in the octal base, 03 is equivalent to a binary 000 011 which means that the least significant bits are different in the two measurements. A compared Trace mode is also available which directs the 1610A to continuously rerun a measurement until the current and stored measurements are either equal or not equal which makes it much easier to capture intermittent problems.



**Probes**

Input data is sensed through 32 high impedance probes at rates to 10 MHz. Data probes are separated into four 8-bit pods for easier connection to a system, with a fifth probe pod for connecting to a clock source. To make it easier for connecting to different systems, the front section of each probe may be disconnected from its pod. This allows the individual probe leads for each probe pod to be wired to connectors for specific systems. Additional probe lead kits as well as probe tips are available separately as accessories.

TRACE COMPARE		COMPARED TRACE-COMPLETE			
LABEL BASE	A HEX	C BIN	D BIN	E DEC	COMPARED TRACE MODE
START	0000	000	00000000	0	---
+01	0000	000	00000000	0	---
+02	0000	000	00000000	0	---
+03	0000	000	00000000	0	---
+04	0000	000	00000000	0	---
+05	0000	000	00000000	0	---
+06	0000	000	00001110	6	---
+07	0000	000	00000000	0	---
+08	0000	000	00000000	0	---
+09	0000	000	00000000	0	---
+10	0000	000	00000000	0	---
+11	0000	000	00000000	0	---
+12	0000	000	00000000	0	---
+13	0000	000	00000000	0	---
+14	0000	000	00000000	0	---
+15	0000	000	00000000	0	---
+16	0000	000	00000000	0	---
+17	0000	000	00000000	0	---
+18	0000	000	00000000	0	---
+19	0000	000	00000000	0	---

The trace compare mode offers an exclusive OR comparison of stored versus active data. In this example, the 1610A stopped data acquisition when the active data was not equal to the stored data at state +06.

**Trigger outputs**

Once a fault is found, another type of analysis instrument, usually an oscilloscope, is often required to pinpoint the problem. The analyzer's Trigger Output is stable with respect to the system clock so an oscilloscope can be used for critical timing measurements. The Measurement Enable output is useful for gating clocks or interrupting the device under test or for added "clock stopper" circuits in other parts of the system.

**1610A Specifications**

**Clock and data inputs**

- Repetition rate: to 10 MHz.
- Input RC: 50 kΩ shunted by <math>\leq 14\text{ pF}</math> at the probe tip.
- Input bias current: <math>\leq 20\ \mu\text{A}</math>.
- Input threshold: TTL, fixed at approx +1.5 V; variable, = 10 Vdc.
- Maximum input: -15 V to +15 V.
- Minimum Input Swing: 0.5 V.
- Clock pulse width: 20 ns at threshold level.
- Data setup time: time data must be present prior to clock transition, 20 ns.
- Hold time: time data must be present after clock transition, 0 ns.

**Trigger and meas enable outputs**

**Trigger output (rear panel):** a 50 ns  $\pm$  10 ns positive TTL level trigger pulse is generated each time the trace position is recognized. If the trace position includes a word sequence, the pulse occurs when the last word is found. Trigger outputs continue until a new specification is traced or the Stop key is pressed. Pulse rep-rate is 0 to 10 MHz depending on input data rates. In continuous or compared trace modes, the internal display process blanks out pulses for 100  $\mu\text{s}$  at rep-rates of <math>\leq 20\text{ Hz}</math>.

**Measurement enable output (rear panel):** the positive TTL level measurement enable output goes high and remains high when the 1610A is looking for a trace position and goes low when a trace position is recognized or if the Stop key is pressed. In continuous or compared trace modes the transitions repeat each time the 1610A makes a new measurement.

Delay from input clock:  $\leq 150\text{ ns}$ .

**General**

- Memory depth: 64 data transactions; 20 transactions are displayed on screen, roll keys permit viewing all 64 data transactions.
- Time Interval: resolution, 100 ns; accuracy, 0.01%. Maximum time, 429.4 seconds.
- Events count: 0 to  $2^{32}-1$  events.
- Power: 100, 120, 220, 240 Vac; -10% to +5%; 48 to 63 Hz; 260 V A max.
- Size: 230 H  $\times$  425 W  $\times$  752 cm D (9 $\frac{1}{16}$ "  $\times$  16 $\frac{3}{4}$ "  $\times$  29 $\frac{3}{8}$ ").

**Operating environment**

- Temperature: 0°C to +55°C (+32°F to +132°F).
- Humidity: up to 95% relative humidity at +40°C (+104°F).
- Altitude: to 4600 m (15 000 ft).
- Vibration: vibrated in three planes for 15 min. each with 0.25 mm (0.010") excursions, 10 to 55 Hz.

Weight: net, 26.5 kg (58.5 lb). Shipping, 32.2 kg (71 lb).

Accessories supplied: four 10248A data probes, one 10247A clock probe, one 2.3 m (7.5 ft) power cord, one Operating manual, and one Service manual.

**Accessories**

**Probe lead kit:** the probe lead kit (HP P/N 10248-69501) provides a set of 12 probe lead cables and a ganging bar for one 10248A probe. These extra leads provide a convenient method of wiring special connectors to quickly interface with different systems.

**Probe tips:** separate probe tips (HP P/N 10230-62101) are available if needed for use with extra probe lead kits or as replacement tips.

**Ordering information**

- 1610A Logic State Analyzer
- Opt 001: adds 9866A Thermal Printer
- Opt 002: adds 9866B Thermal Printer
- 10248-69501 Probe Lead Kit
- 10230-62101 Probe Tip

- Price**
- \$9500
  - add \$3145
  - add \$3350
  - \$35 ea
  - \$2.50 ea

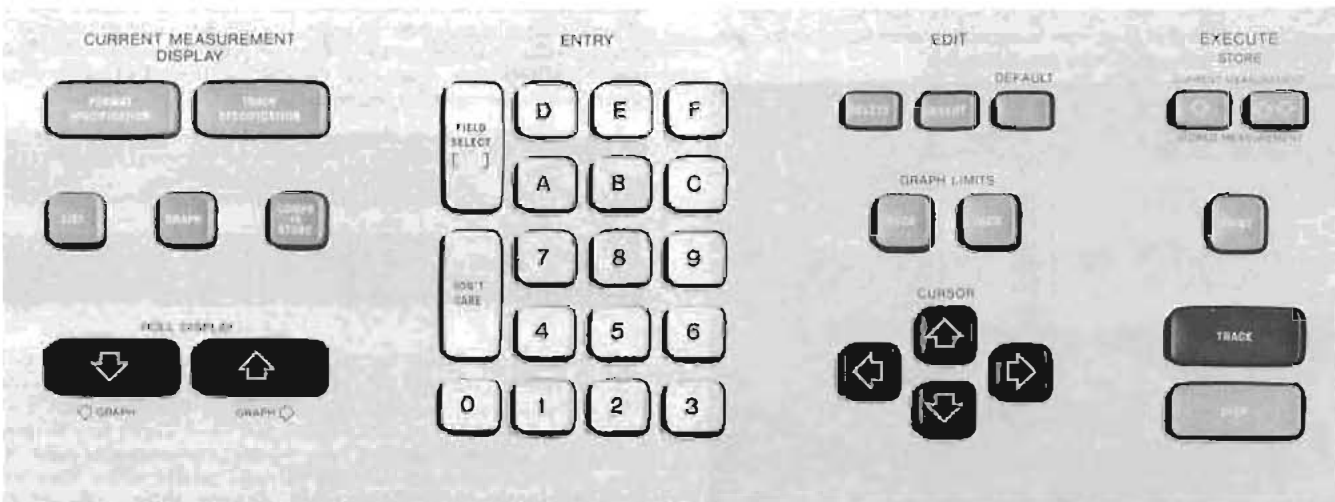

Logically arranged Logic State Analyzer keyboard, divided into functional blocks, and an interactive display, allow entry of complex measurements with a minimum of controls.

## LOGIC ANALYZERS

10 MHz, 16 bit general purpose

Model 1602A



HP-IB

**1602A Description**

Hewlett-Packard's new, extremely easy-to-use Model 1602A keyboard controlled Logic State Analyzer is for use in the design and troubleshooting of digital systems. The 16-bit wide and 64-word deep memory operates at clock speeds to 10 MHz allowing the instrument to capture virtually any 64-word sequence in a system. The data may be registered with versatile pattern recognition trigger and digital delay. Measurements of system activity are displayed on the Analyzer's LED readout in hexadecimal, decimal, octal, or binary format, which eliminates the need for base conversions by the operator. Keyboard entry of the desired trigger is in the same base as selected for the display.

A Hewlett-Packard Interface Bus option (HP's implementation of IEEE Standard 488) allows you to make automated functional tests of digital systems. This means more consistent and repeatable measurements as well as more thorough testing because the test speed of the automated system allows more measurements in a shorter time in both production and service environments.

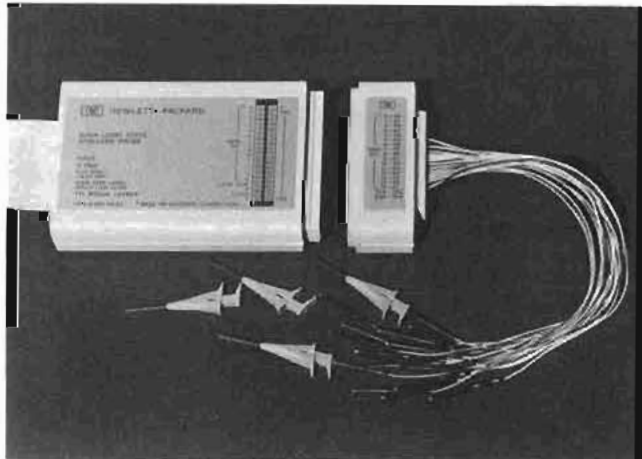
**Ease of use**

The 1602's keyboard with its key-per-function layout is basically self-teaching. Entry of triggering and display conditions is a series of self-explanatory keystrokes with all entries displayed as they are entered enabling you to check their accuracy every step of the way.

**Data Probe**

The simplicity of the Analyzer starts with the probe which is a single pod containing all 16 data lines, clock, qualifier, and ground. At the front of the pod is a standard edge connector which allows you to quickly move the test connection from an address bus to the data bus, control lines, or I/O structures. You need only incorporate a few simple mating printed circuit board connectors to your system.

**Tracing data flow**

Capturing data flow is also easy and only requires a logical sequence of key strokes. The first item to define is the Logic Polarity of your system by pressing the Logic Polarity key. The panel LED's indicate your selection, positive for high true and negative for low true. Next select the clock edge on which you want to gather data which is also indicated by panel LED's.

16

b 16

16

b 8

Now select the display format that you want to use for the test. If you are running tests on an address or data bus, you would most likely select either hexadecimal or octal display format. However, if the test is on an I/O bus with numerical data, decimal may be preferred. For activity on control lines, binary is a meaningful base. In all cases the display indicates the selected format with a base (b) notation on the right. The sample displays show selection of Hexadecimal (b16) and Octal (b8) bases respectively.

When power is turned on, the instrument is initialized with a word width of 16 which may also be displayed by pressing the Word Width key. Many times all of the input lines are not used and if you want to blank the more significant bits, just press the Word Width key and enter the number of bits to be displayed from 2 to 16. The sample display shows that Word Width = 2 was selected.



The desired data window is entered from the Trace Specification section of the keyboard. If you want to view data after the desired trigger point, press Trigger Plus Delay Starts Trace which directs the 1602A to start collecting data as soon as the Trace Specification is satisfied. If you are more interested in data preceding the trigger point, select Trigger Plus Delay Ends Trace. For either mode, Start or End, an LED indicates the selected mode.

To define a trigger point, press the Trigger = key and enter the desired trigger point. e.g. 2805, in the same format previously selected for the display. The selected trigger word is displayed for verification.



To enter a delay that will position the start of data collection a specific number of clock pulses from the trigger word, press the Delay = key and enter the number of desired clock pulses. The delay count is entered and displayed in decimal format. Delays of up to 65 535 clock pulses after the trigger point may be entered and used to either start or end data collection.

The trace specification is now complete and the 1602A is ready to capture data. Pressing the Trace key instructs the Analyzer to start looking for the trigger word. Once the trigger word is recognized, the Analyzer captures and stores 64 words in memory as defined by the preset trace specifications.

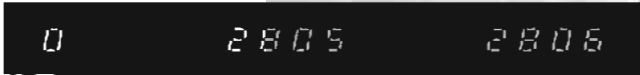

Two words are normally displayed in the viewing window. The number at the far left (0 in this example) is the memory location of the work 2805. The word on the far right is in the next higher location of the Analyzer's memory.

The data in the Analyzer's memory may be viewed on the display using the four keys in the display block. The Prior Word and Next Word key permit you to view the memory contents one word at a time, or if you hold a key, the memory contents will sequence rapidly through the display. The Word Number = key allows you to quickly address any memory location and the At Trigger Word key automatically restores the display to the trigger point.

### Measurement flexibility

This Analyzer, with all its operating simplicity, has the power required to capture more than basic data lists. For example, to determine if a data line is stuck in one state, a Trace Continuous mode permits the suspected line to be monitored for activity. The mode is entered by pressing TRACE followed by C and may be used with any number base.

To capture data on the ninth pass of a loop, a Delay By Events mode is available. Delay By Events is entered by pressing in sequence Delay =, E, and then entering in decimal format the desired number of events to 65 535.



The display then shows that the Analyzer is set to Delay By Events with an E, and also shows the selected number of events, 352. When Trace is pressed the 1602A will count the selected number of Events (trigger points) before capturing data.

For viewing consecutive occurrences at specific points, such as data being sent to a peripheral, a Trace Events Mode is provided. This mode is entered by pressing Trace followed by E which directs the 1602A to capture only the data that is described by the trigger word plus delay.

When additional qualification is needed for data collection, such as restricting the data to only reads, writes, or outputs, the rear panel trigger and clock qualifiers are available. These inputs are compatible with the HP Model 10250A TTL trigger probe allowing expansion to four qualifier inputs.

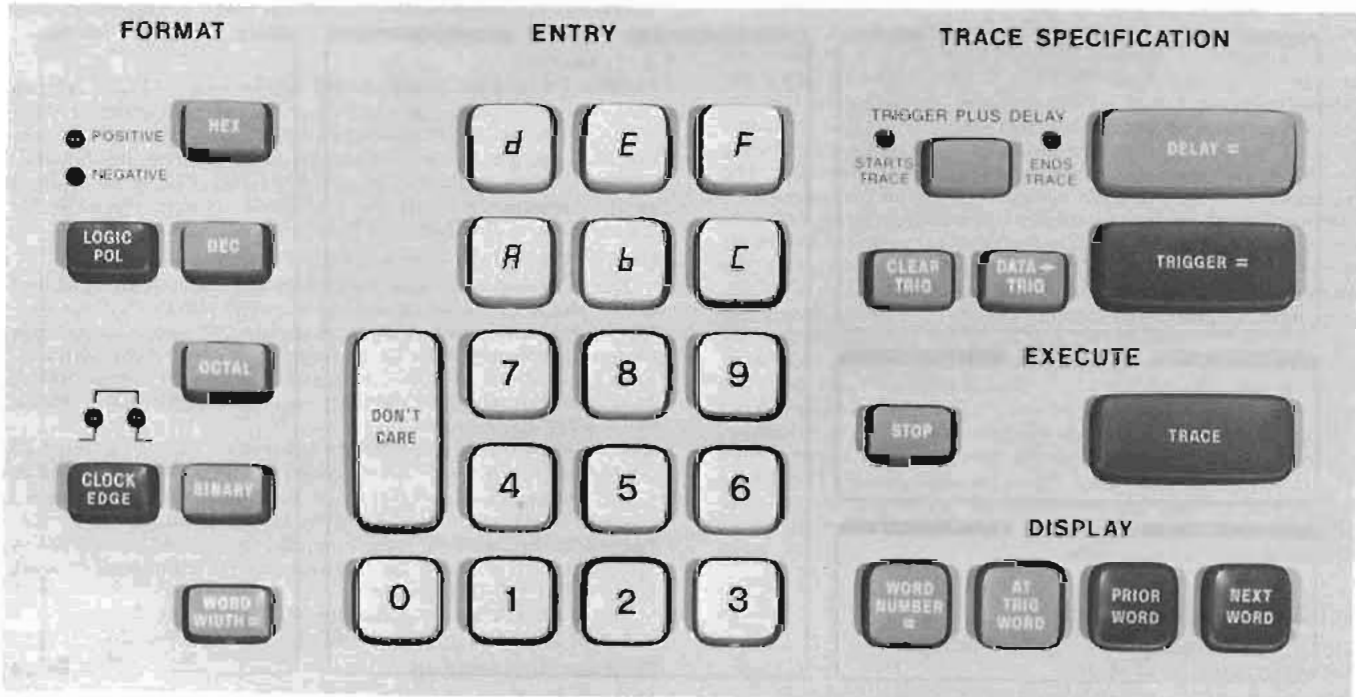

# LOGIC ANALYZERS

## Model 1602A (cont.)

Once a functional fault is located in execution of the program, another form of analysis instrument, usually an oscilloscope, is frequently desired to pinpoint the problem. The Analyzer's trigger output is stable with the system clock which allows an oscilloscope to be used for critical timing measurements.

A Trace Point Output is available for generating interrupt signals or for added "clock stopper" circuits in other parts of the system under test. The rear panel outputs can also be used to cascade 1602A's or other analyzers.

And, for those occasions where the data being gathered are mixtures of information from buses and control lines, a mixed mode of binary and either hex, decimal, or octal bases can be easily entered with a few keystrokes. Pressing Word Width = 16 and Hex 8 gives the display shown.

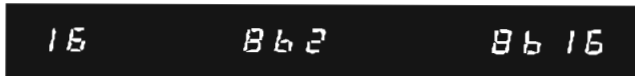

The resulting trace then displays the captured data in the format most convenient for analysis.



The analyzer also interacts with message codes which assist the operator in gathering and sorting data. The definitions of these message codes are included inside the top cover for easy reference.

For increased confidence of the Analyzer's operation, it performs a self-test during turn-on and indicates the results on the display. In addition, there is a multi-level diagnostic software which allows the Analyzer to identify virtually any internal fault.

### Automatic testing

An optional HP-IB interface is available which when combined with a Computing Controller and a suitable stimulus allows the data captured by the programmable 1602A to be transferred to the controller for analysis, providing fast, easily repeatable checkout in production and service. A learn mode, a feature of the 1602A HP-IB Interface, provides an easy way for a designer to program the analyzer with an HP Model 9825A or 9830A Computing Controller without using the formal HP-IB language. A few special function keys are all that is needed for most test programs, and the procedure for using them is also easy. Just make the measurement once using the 1602A and then press Learn on the computing controller. The system will then become conversational and ask for the test number, number of words of 1602A memory to be compared, desired measurement time limit, and which test to go to if the present test passes or fails. The computing controller then automatically reads the Analyzer's keyboard and memory and transfers this data to its cassette. The first test of the "test procedure" is now completed and documented. A complete test procedure can be rapidly generated and documented by using this method. To use the test procedure, simply connect to the system or device under test and press the special function "Run" key on the Computing Controller. Your "Automated" test system then sets up each test in the procedure, compares the data collected to the reference data stored on the cassette, and indicates where functional errors exist. This means that all your devices can be functionally tested in minutes, automatically, with identical procedures eliminating variations due to differences between operators.

### 1602A Specifications

#### Clock, data, and qualifier probe inputs

**Repetition rates:** to 10 MHz.

**Input load:** one low power Schottky gate (<400  $\mu$ A source).

**Input threshold:** TTL, fixed at approx 1.5 V.

**Maximum Input:** <+5.5 V.

#### Minimum Input

**Level:** >-0.5 V.

**Swing:** from  $\leq +0.4$  V (low) to  $\geq +2.4$  V (high).

**Clock pulse width:**  $\geq 25$  ns at threshold.

**Data setup time:** time data must be present prior to a clock transition, 35 ns at threshold.

**Hold time:** time data must be present after a clock transition, 0 ns.

#### Trigger and clock qualifier inputs (rear panel)

**Input load:** 8 mA max source.

**Maximum Input:** <+5.5 V.

#### Minimum Input

**Level:** >-0.5 V.

**Swing:** from  $\leq +0.4$  V (low) to  $\geq +2.5$  V (high).

**Setup time:** time data must be present prior to a clock transition, 40 ns with 10250A probe, 10 ns without probe

**Hold time:** time data must be present after a clock transition, 15 ns with 10250A probe, 30 ns without probe.

#### Trigger and trace point outputs

**High:**  $\geq 2$  V into 50 $\Omega$ .

**Low:**  $\leq 0.4$  V into 50 $\Omega$ .

#### Pulse duration (width)

**Trigger:** high for approximately one clock period.

**Trace point:** sets low when Trace key is pressed, returns high when the Trace Specification is met.

**Delay from Input clock:** <150 ns.

#### General

**Power:** 100, 120, 220, and 240 Vac; -10% +5%; 48 to 66 Hz; 50 VA max.

**Size:** 10.7 H  $\times$  27.5 W  $\times$  42.1 cm D (4 $\frac{7}{32}$ "  $\times$  10 $\frac{3}{16}$ "  $\times$  16 $\frac{9}{16}$ ").

#### Operating environment

**Temperature:** 0°C to +55°C (+32°F to +132°F).

**Humidity:** up to 95% relative humidity at +40°C (+104°F).

**Altitude:** to 4600 m (15 000 ft).

**Vibration:** vibrated in three planes for 15 min, each with 0.38 mm (0.015 in.) excursions, 10 to 55 Hz.

**Weight:** net, 4.5 kg (10 lb); shipping, 5.9 kg (13 lb).

**Accessories supplied:** one external probe pod, one connector with individual clock, ground, and data probe leads with tips, one 2.3 m (7.5 ft) power cord, one Operating and Service Manual.

**Probe interface:** the probe interface is a standard, two row, edge connector which may be easily added to instruments during development, providing easily accessed test points for production and field service requirements.

#### Accessories

**10250A TTL trigger probe:** model 10250A Trigger Probe offers a convenient method of expanding the qualification capabilities of the 1602A. With the 10250A connected to the 1602A rear panel Trigger or Clock Qualifier inputs, you have an additional four bits of qualification. The four inputs may be switched to H1, L0, or OFF (don't care) for selection of the desired qualification pattern. Power for the trigger probe is obtained from the circuit under test.

#### HP-IB controllers and accessories

The following computing controllers and accessories combined with a 1602A Option 001 provide a complete HP-IB Test System.

**Model 9825A computing controller:** Opt 002 with a 23 000 byte memory is recommended for maximum flexibility. Accessories required are Model 98210A String and Advanced Program ROM, Model 98213A General and Extended I/O ROM, and a Model 98034A HP-IB Interface Card.

**Model 9830A Opt 276 computing controller:** accessories required are Model 11272B or Opt 272 Extended I/O ROM, Model 11274B or Opt 274 String Variable ROM, Model 11279B or Opt 279 Advanced program ROM, and a Model 59405A HP-IB Interface Card.

**Software:** the following learn programs for the 9825A and 9830A controllers are available and virtually eliminate the need to learn controller or HP-IB language:

Model 10060A learn program for 9825A.

Model 10061A learn program for 9830A.

#### Ordering information

1602A Logic State Analyzer

Opt 001: HP-IB Interface

10250A TTL Trigger Probe

Price

\$1800

add \$300

\$95

# LOGIC ANALYZERS

Logic state analyzer for microprocessor based systems  
Model 1611A Opt A68, A80, 0F8 & Z80

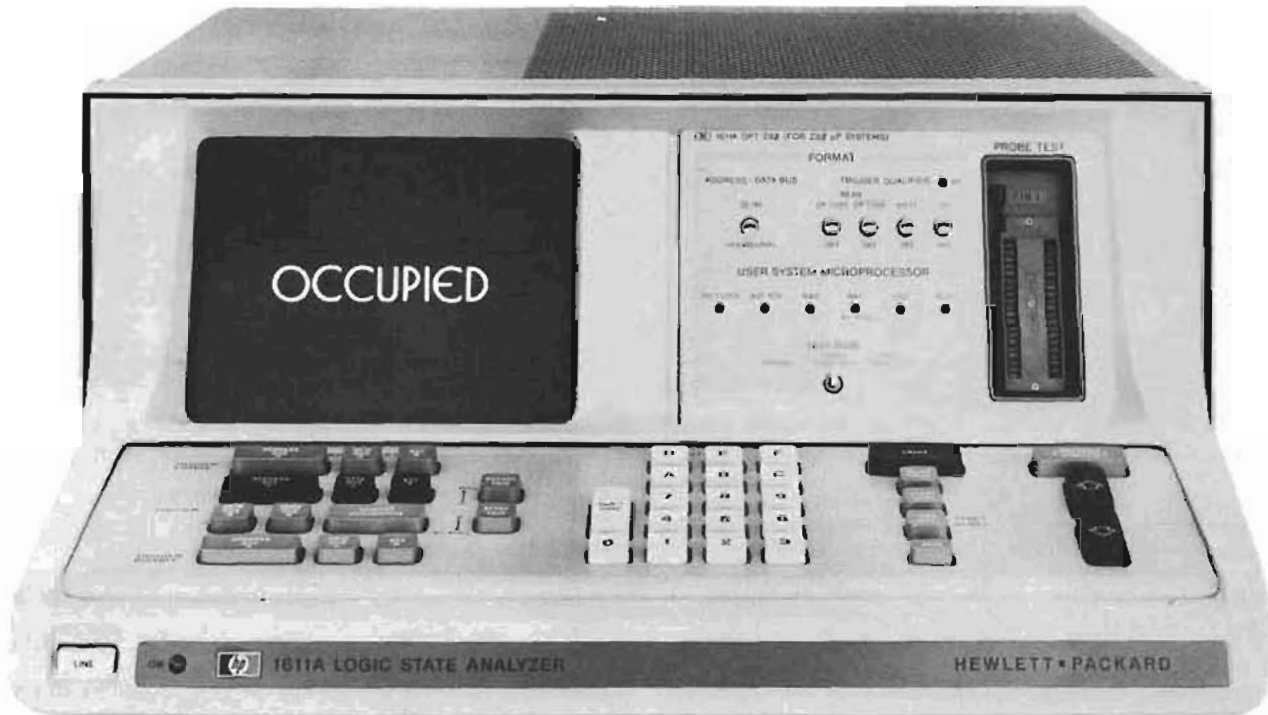

## Description

The Hewlett-Packard Model 1611A keyboard controlled Logic State Analyzer is dedicated to the design and troubleshooting of microprocessor based systems. For ease-of-use, a special probe offers two methods of connection to 40-pin microprocessors, a 40-pin clip and a 40-pin connector for interfacing with microprocessors in sockets. Measurements of system activity are displayed on the analyzer's CRT screen in selectable mnemonic or absolute codes of the microprocessor's own instruction set. The display is divided into three distinct fields of address, data, and external information. The events and activity displayed in the address and data fields are collected directly from the system microprocessor's address and data buses with an additional eight bits of binary information gathered by auxiliary probes for display of activity on control or other functional lines.

The relational triggering capabilities of the Analyzer permit the framing of a real-time data window around virtually any event, or set of related events—any desired sequence of system operations. With the 1611A you can selectively trace only those events of interest, eliminating irrelevant data. The Analyzer also accurately measures execution time, or counts selected events between two keyboard selected events. At a desired point, defined from a keyboard entry, the Analyzer can be commanded to halt microprocessor operation; then, if desired, the 1611A can control the following transactions in single or multiple steps. Keyboard entry of address or data bus trigger words may be made in either octal or hexadecimal notation and the external trigger information is entered in binary format.

To increase operator confidence in the instrument, it performs a self-test during the turn-on period and indicates the results on the CRT. The microprocessor probe data gathering circuits may also be checked by connecting the probe to the front panel probe test socket with the test results displayed on the CRT.

## Configuration

The convenience of a dedicated probe and mnemonic instruction decoding is possible only by configuring the Analyzer for specific microprocessors. On initial order, the 1611A is specified to fit a particular microprocessor. Option A68 for the 6800, Option A80 for the 8080, Option 0F8 for the F8, and Option Z80 for the Z80 are the presently available options, with more to follow.

All of the specialization is contained within two printed circuit

boards, a removable section of front panel, and the dedicated microprocessor probe. A personality module containing the parts to configure the 1611A to another microprocessor may be ordered separately, and easily exchanged in about 15 minutes.

## Option A68 (6800 Microprocessors)

**Note:** Model 10257B personality module may be ordered separately for installation in a 1611A to provide Opt A68 capability.

### Clock and data inputs

**Clock rate:** 70 kHz to 2.0 MHz; (70 kHz to 1.66 MHz with 10257B installed in 1611A with serial prefix below 1723A).

### Input loading

**A<sub>0</sub>-A<sub>15</sub>, R/W, VMA:** approx 1 MΩ shunted by approx 40 pF, including capacitance of 30.4 cm (12") connecting cable; approx 30 pF with 7.6 cm (3") cable.

**D<sub>0</sub>-D<sub>7</sub>, BA:** 20 μA max with V<sub>in</sub> = 2.7 V; -0.2 mA max with V<sub>in</sub> = 0.4 V.

**Halt:** 120 μA max with V<sub>in</sub> = 2.7 V; -0.2 mA max with V<sub>in</sub> = 0.4 V.

**Φ2:** 0.2 mA max with V<sub>in</sub> = 5 V; -0.4 mA max with V<sub>in</sub> = 0.4 V.

**Threshold:** 2.4 V to 5.5 V, logic 1 (high); -0.8 V to 0.8 V, logic 0 (low).

**Setup time:** A<sub>0</sub>-A<sub>15</sub>, R/W, VMA must be valid prior to falling edge of Φ2 clock for at least 250 ns. D<sub>0</sub>-D<sub>7</sub> must be valid prior to falling edge of Φ2 clock for at least 40 ns. Halt must be valid prior to rising edge of Φ2 clock for at least 75 ns.

**Hold time:** halt must be valid after rising edge of Φ2 clock for at least 10 ns. All other inputs must be valid after falling edge of Φ2 clock for at least 10 ns.

**Halt output:** TTL open-collector compatible output capable of sinking at least 8 ma when active.

### External probe inputs

**Current:** 50 μA max.

**Capacitance:** approx 25 pF measured at probe tip.

**Threshold:** 2.4 V to 5.5 V, logic 1 (high); -0.8 V to 0.8 V logic 0 (low).

**Setup time:** input must be present at least 250 ns prior to falling edge of Φ2 clock.

**Hold time:** input must be present at least 0 ns after falling edge of Φ2 clock.

## LOGIC ANALYZERS

Model 1611A Opt A68, A80, 0F8 &amp; Z80 (cont.)

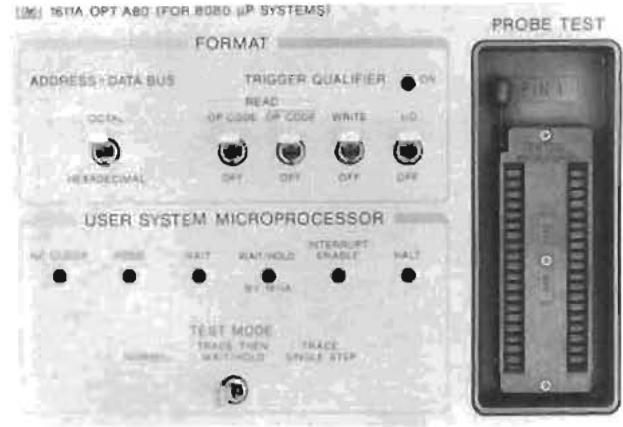

Opt A68

**Outputs****Low:** <0.4 V into 50Ω.**High:** >2.0 V into 50Ω (nominally 3.9 V into an open circuit).**Trigger output:** duration approx 75 ns in RZ format; delay approx 400 ns after the active edge of the  $\Phi 2$  clock pulse that defines a valid trigger.**Trace Point (┌):** provides a positive edge approx 400 ns after  $\Phi 2$  clock pulse that defines the specific valid trigger to be displayed on 1611A. If 1611A Delay is set so that trigger word is not displayed, Trace Point output occurs approx 400 ns after active edge of  $\Phi 2$  clock that defines the valid word immediately preceding the first displayed word.**Trace Point (┘):** complement of Trace Point (┌).**Microprocessor compatibility****Motorola:** 6800, 68A00, 68B00, 6802.**AMI:** 6800.**Note:** The 1611A Opt A68 is designed to be compatible with any microprocessors that meet specifications of the Motorola 6800.**Option A80 (8080 microprocessors)****Note:** Model 10258B personality module may be ordered separately for installation in a 1611A to provide Opt A80 capability.**Clock ( $\Phi 2$  only)****Repetition rate:** 300 kHz to 4 MHz.**Width:** 75 ns min for either high or low state.**Threshold:** 9 to 13 V, logic 1 (high); -1 to 0.8 V, logic 0 (low).**Input resistance:** approx 12 kΩ.**Input capacitance:** approx 25 pF, includes capacitance of 30.5 cm (12") cable, approx 15 pF with 7.6 cm (3") cable.**Data, Address, Wait, Ready, HLDA, INTE, SYNC****Threshold:** 3 V to 6 V, logic 1 (high); -1 to 0.8 V, logic 0 (low).**Input resistance:** approx 1 MΩ.**Input capacitance:** approx 25 pF, includes capacitance of 30.5 cm (12") cable, approx 15 pF with 7.6 cm (3") cable.**Setup and hold times:** timing measured at 8 V level for leading edge of  $\Phi 2$  and 1 V level for trailing edge.**Address and  $\mu P$  status on Data lines relative to leading edge of  $\Phi 2$  at  $T_2$ :** setup, 100 ns min; hold, 25 ns min.**Data relative to leading edge of  $\Phi 2$  at  $T_3$ :** setup, 100 ns min; hold, 25 ns min.**Sync relative to trailing edge of  $\Phi 2$  at  $T_1$ :** setup, 100 ns min; hold, 25 ns min.**Ready relative to trailing edge of  $\Phi 2$  at  $T_2$ :** setup, 80 ns min; hold, 0 ns min.**Ready output:** TTL open-collector compatible output capable of sinking at least 8 mA when active.**Outputs:** all timing relative to leading edge of  $\Phi 2$  in  $T_3$  cycle.**Low:** <0.4 V into 50Ω.**High:** >2.0 V into 50Ω (nominally 3.9 V into an open circuit).**Trigger:** duration, approx 75 ns (RZ format); delay approx 350 ns after the  $\Phi 2$  clock pulse which defines a valid trigger.**Trace point (┌):** provides a positive edge approx 350 ns after the  $\Phi 2$  clock that defines the specific valid trigger to be displayed on the 1611A. If the 1611A Delay is set such that the trigger is not displayed, the Trace Point Output occurs approx 350 ns after the  $\Phi 2$  clock that defines the valid trigger word immediately preceding the

Opt A80

first word displayed on the 1611A.

**Trace point (┘):** complement of Trace Point (┌).**External probe inputs****Resistance:** approx 1 MΩ.**Capacitance:** approx 25 pF measured at probe tip.**Threshold:** 2.4 V to 5.5 V, logic 1 (high); -0.8 V to 0.8 V, logic 0 (low).**Setup time:** input must be present for at least 250 ns prior to leading edge at  $\Phi 2$  clock at  $T_3$ .**Hold time:** input must be present for at least zero ns after falling edge of  $\Phi 2$  clock at  $T_3$ .**Microprocessor compatibility****Intel:** 8080, 8080A, 8080A-2, 8080A-1.**AMD:** 9080A, 9080A-1, 9080A-2, 9080A-4.**NEC:**  $\mu PD8080$ ,  $\mu PD8080A-E$ .**TI:** TMS8080, TMS8080A.**National:** INS8080A.**Note:** The 1611A Opt A80 is designed to be compatible with any microprocessor that meets specifications of the Intel 8080A.**Option 0F8 (F8 microprocessor)****Note:** Model 10259A personality module may be ordered separately for installation in a 1611A to provide Option 0F8 capability**Clock and write****Clock rate:** 100 kHz to 2 MHz.**Width:** 180 ns min for either high or low state.**Input current:** approx 50  $\mu A$ , logic 0 (low) and logic 1 (high).**Input capacitance:** approx 25 pF, includes capacitance of 30.4 cm (12") cable; approx 15 pF with 7.6 cm (3") cable.**Threshold:** 2.4 V to 5.5 V, logic 1 (high); -0.8 to 0.8 V, logic 0 (low).**Write period:** either 4 or 6 times the clock period.**Write pulse width:** max = clock period, min = clock period - 100 ns.**ROMC****Input current:** approx 22  $\mu A$ , logic 0 (low); approx 40  $\mu A$ , logic 1 (high).**Input capacitance:** approx 25 pF, includes capacitance of 30.4 cm (12") cable; approx 15 pF with 7.6 cm (3") cable.**Threshold:** 2 V min, logic 1 (high); 0.7 V max, logic 0 (low).**Setup time:** 200 ns min relative to the second falling edge of  $\Phi$  after Write goes low.**Hold time:** 80 ns min relative to falling edge of Write.**Data, I/O0, I/O1, EXT RES****Input current:** approx 200  $\mu A$ , logic 0 (low); approx 20  $\mu A$ , logic 1 (high).**Input capacitance:** approx 25 pF, includes capacitance of 30.4 cm (12") cable; approx 15 pF with 7.6 cm (3") cable.**Threshold:** 2 V min, logic 1 (high); 0.7 V max, logic 0 (low).**Setup and hold times**

If ROMC = 0, times are relative to the falling edge of Write.

**Data:** Setup, 200 ns min; Hold, 50 ns min.If ROMC  $\neq$  0, times are relative to the rising edge of Write.**Data:** Setup, 350 ns min; Hold, 50 ns min.**I/O0 and I/O1:** Setup, 300 ns min; Hold, 50 ns min.

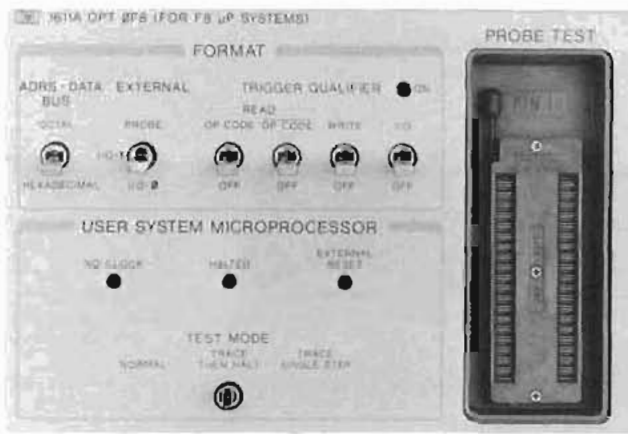

Opt 0F8

**External probe inputs**

**Input current:** approx 50  $\mu$ A, logic 0 or logic 1.  
**Input capacitance:** approx 25 pF measured at probe tip.  
**Threshold:** 2.4 V to 5.5 V, logic 1 (high); -0.8 V to 0.8 V, logic 0 (low).  
**Setup time:** 150 ns min relative to the rising edge of Write for ROMC  $\neq$  0, or to the falling edge of Write for ROMC = 0.  
**Hold time:** 0 ns min relative to the rising edge of Write for ROMC  $\neq$  0, or to the falling edge of Write for ROMC = 0.  
**Note:** all inputs have hysteresis.

**Halting**

The F8 CPU must be placed in the 1611A Probe socket to halt or single-step the F8 microprocessor.

**Outputs**

**Low:** <0.4 V into 50 $\Omega$ .  
**High:** >2.0 V into 50 $\Omega$  (nominally 3.9 V into an open circuit).  
**Trigger:** duration, approx 75 ns (RZ format); delay, approx 350 ns after the rising edge of Write if ROMC  $\neq$  0, and approx 350 ns after the falling edge of Write if ROMC = 0 during cycles that define a valid trigger.  
**Trace point (┌):** provides a positive edge approx 350 ns after the rising or falling edge of Write (as explained for Trigger Output) during the cycle that defines the specific valid trigger to be displayed on the 1611A. If the 1611A delay is set such that the trigger word is not displayed, Trace Point Output occurs for the cycle that defines the valid word immediately preceding the first displayed word.  
**Trace point (┐):** complement of Trace Point (┌).

**Microprocessor compatibility**

**Fairchild:** F8.  
**Mostek:** F8.

**Note:** The 1611A Opt F8 is compatible with any microprocessor that meets specifications of the Fairchild F8.

**Option Z80 (Z80 microprocessor)**

**Note:** Model 10260A personality module may be ordered separately for installation in a 1611A to provide Option Z80 capability.

**Clock, data, address, and control inputs**

**Clock rate:** 500 kHz to 2.5 MHz.  
**Input current:** approx 200  $\mu$ A, logic 0 (low); approx 20  $\mu$ A, logic 1 (high).  
**Input capacitance:** approx 25 pF, includes capacitance of 30.4 cm (12") cable; approx 15 pF with 7.6 cm (3") cable.  
**Threshold:** 2 V min, logic 1 (high); 0.7 V max, logic 0 (low).  
**Setup time:** Data, 100 ns min relative to rising edge of RD, WR, or IORQ. Address, 0 ns min relative to falling edge of RD, WR, or IORQ.  
**Hold time:** Data,  $\phi$ ns min relative to rising edge of RD, WR, or IORQ. Address, 300 ns min relative to falling edge of RD, WR, and IORQ.

**External probe inputs**

**Input current:** approx 50  $\mu$ A, logic 0 or logic 1.  
**Input capacitance:** approx 25 pF measured at probe tip.  
**Threshold:** 2.4 V to 5.5 V, logic 1 (high); -0.8 V to 0.8 V, logic 0 (low).  
**Setup time:** 150 ns min relative to rising edge of WR, RD, or IORQ.

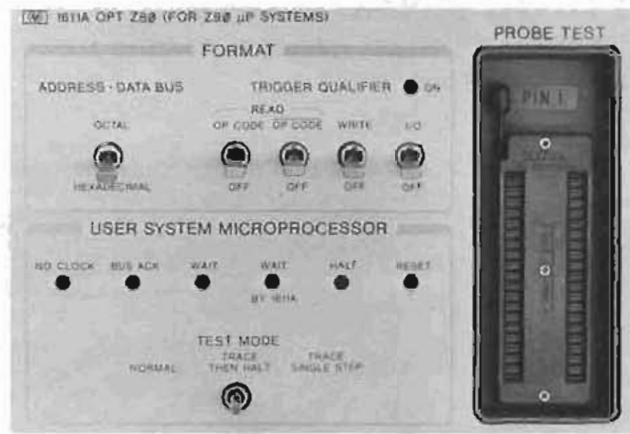

Opt Z80

**Hold time:** 0 ns min relative to rising edge of WR, RD, or IORQ.  
**Wait output:** TTL open-collector compatible output capable of sinking at least 8 mA when active.

**Outputs**

**Low:** <0.4 V into 50 $\Omega$ .  
**High:** >2.0 V into 50 $\Omega$  (nominally 3.9 V into an open circuit).  
**Trigger:** duration, approx 75 ns (RZ format); delay, approx 350 ns after the rising edge of RD, WR, or IORQ during the cycle that defines a valid trigger.  
**Trace point (┌):** provides a positive edge approx 350 ns after the rising edge of RD, WR, or IORQ that defines the specific valid trigger to be displayed on the 1611A. If the 1611A delay is set such that the trigger word is not displayed, Trace Point Output occurs for the cycle that defines the valid word immediately preceding the first displayed word.  
**Trace point (┐):** complement of Trace Point (┌).

**Microprocessor compatibility**

**Zilog:** Z80.  
**Mostek:** Z80.  
**Note:** The 1611A Opt Z80 is compatible with any microprocessor that meets specifications of the Zilog Z80.

**Microprocessor compatibility**

**Zilog:** Z80.  
**Mostek:** Z80.

**General**

**Connection between  $\mu$ P and 1611A input buffers:** one 40 pin dual in-line package connector with 30.5 cm (12") cable, one 40 pin male socket with 30.5 cm (12") cable, or one 40 pin male socket with 7.6 cm (3") cable.  
**Memory depth:** 64 data transactions; 16 transactions are displayed at one time, roll keys permit viewing all 64 transactions.  
**Time interval:** accuracy, 0.1%  $\pm$  1  $\mu$ s. Max time, (2<sup>24</sup>-1)  $\mu$ s (16.7 s).  
**Events count:** 2<sup>24</sup>-1 events (16.7 million) max.  
**Logic probe output power:** 5 V dc at 0.1 A max.  
**Power:** 100, 120, 220, 240 V ac; -10% +5%; 48 to 440 Hz; 120 VA max.

**Size:** 206 H x 426 W x 522 mm D (8 1/8" x 16 3/4" x 22 1/2").  
**Operating environment:** temperature, 0°C to +55°C (+32°F to 132°F); humidity, to 95% relative humidity at +40°C (+104°F); altitude to 4600 m (15 000 ft); vibrated in three planes for 15 min, each with 0.38 mm (0.015 in.) excursions, 10 to 55 Hz.

**Weight:** net, 15 kg (33 lb); shipping, 19.5 kg (43 lb).  
**Accessories supplied:** one microprocessor probe, external 8-bit probe; one 40 pin clip with 30.5 cm (12") cable, one 40 pin male socket with 30.5 cm (12") cable; one 40 pin male socket with 7.6 cm (3") cable; one 2.3 m (7.5 ft) power cord; and one Operating and Service Manual.

**Ordering Information**

1611A Opt A68 Logic State Analyzer for 6800 $\mu$ P	\$5200
1611A Opt A80 Logic State Analyzer for 8080 $\mu$ P	\$5200
1611A Opt 0F8 Logic State Analyzer for F8 $\mu$ P	\$5200
1611A Opt Z80 Logic State Analyzer for Z80 $\mu$ P	\$5200
Opt 910: extra set of product manuals	add \$20

**Personality modules for field installation**

10257B for 6800 $\mu$ P	\$1250
10258B for 8080 $\mu$ P	\$1250
10259A for 0F8 $\mu$ P	\$1250
10260A for Z80 $\mu$ P	\$1250

# LOGIC ANALYZERS

20 MHz, 32/16 bit general purpose

Models 1600S and 10253A

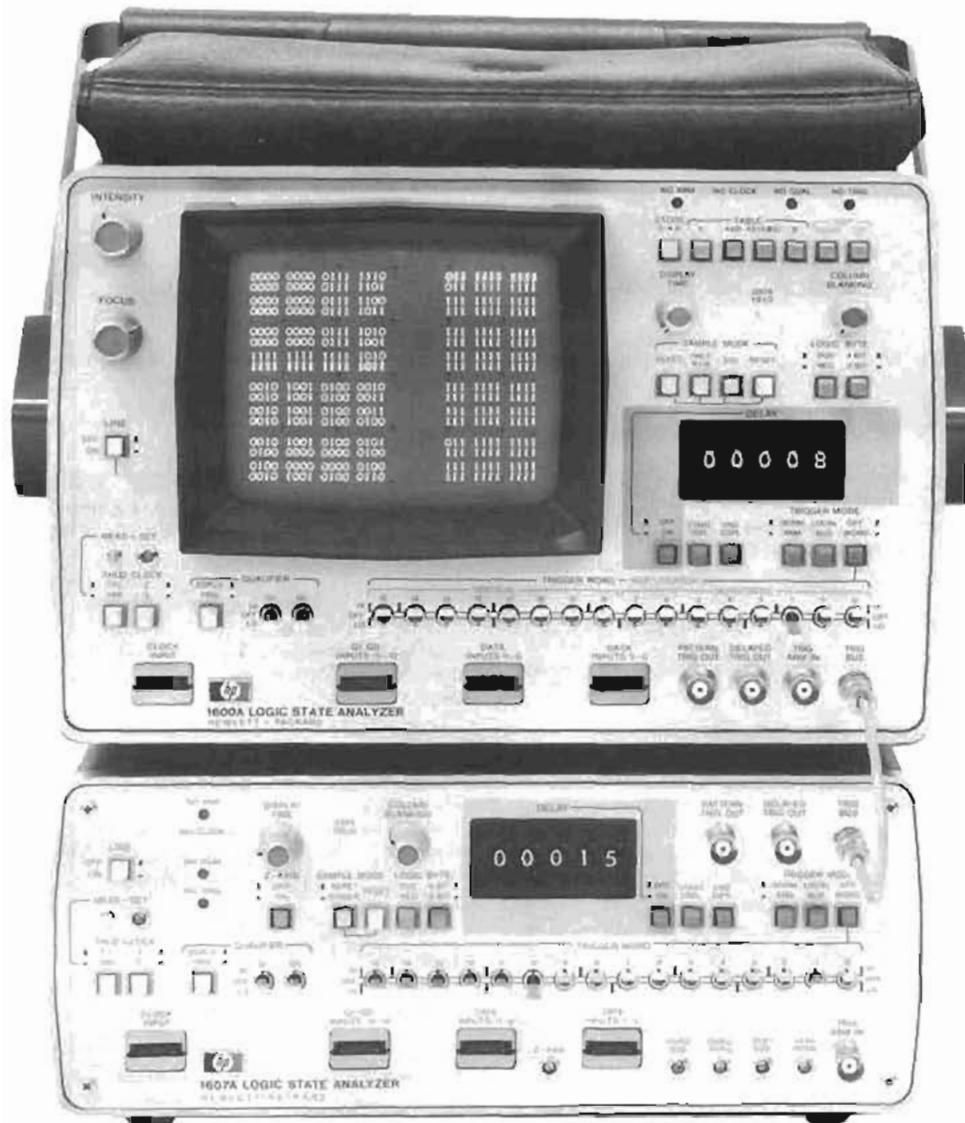

## 1600S Description

The 1600S Logic State Analyzer is a versatile, general purpose data domain instrument for use in design and troubleshooting of minicomputer and microprocessor based systems as well as other digital systems. Parallel data is captured at clock speeds to 20 MHz and presented in an easy-to-read one's and zero's display format for fast functional analysis of digital data flow. The ability to capture and display words up to 32-bits wide lets you observe, in real time, microcodes or addresses with resulting data, saving time in system design and development, hardware troubleshooting, software evaluation, and service and maintenance. Convenient and flexible functional analysis is provided by features such as sequential triggering, dual clock, separately configured data tables, display qualification, exclusive OR comparison of Tables A and B, dynamic mapping, and halt when A is not equal to B.

The 1600S consists of a 1600A Logic State Analyzer, a 1607A Logic State Analyzer, a 10236A Trigger Bus Cable, and a 10237A Data Cable. The Trigger Bus Cable logically AND's the trigger registers of both the 1600A and 1607A for a trigger word up to 36 bits wide (four qualifiers not displayed). The Data Cable connects the 1600A Table B memory to the 1607A to enable the display of words up to 32 bits wide, to display two 16-bit data sequences at the same

time - such as addresses and instructions, to display 32 consecutive 16-bit words, or for dual clock application. When the full system capabilities are not needed, the 1600A or 1607A may be used separately. The 1600A by itself is a complete logic state analyzer with 16-bit triggering plus two qualifiers, and a 32-bit wide table display as well as dynamic mapping. The 1607A needs only the proper oscilloscope or X-Y display for another complete analyzer, also with 16-bit triggering plus two qualifiers. Both the 1600A and 1607A have a pattern trigger output to trigger an oscilloscope for electrical analysis.

### Mapping program flow

The map display provides a dynamic overview of a system's operation—a pattern of dots interconnected with vectors that are unique for each area of program implementation. Each dot represents a specific word; its location indicates binary magnitude and its brightness indicates relative frequency of occurrence. The vectors between each dot allow you to observe the sequence of data transactions. The vector gets brighter as it moves toward a new point to show the direction of data flow.

With the map you can identify program loops, improper data flow, as well as lost portions of a program. You can also map single-shot events such as those in turn-on sequences.



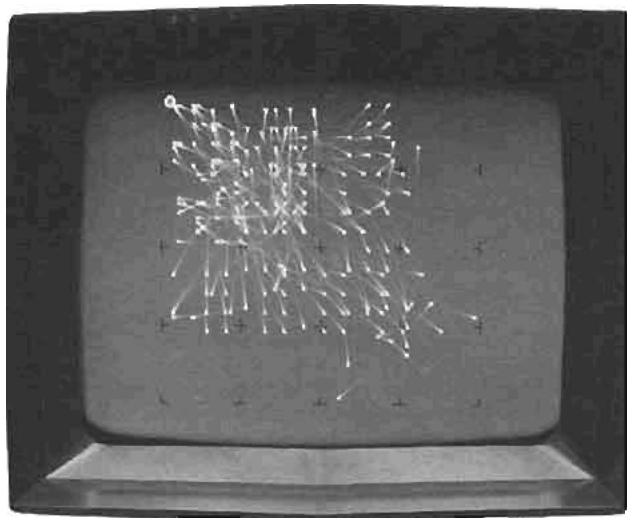

The map display offers an overall view of machine operation, with each dot representing one input word. The real time display allows you to identify program loops, improper data flow, as well as lost portions of a program.



In the exclusive OR mode, A & (A ⊕ B), A memory data is displayed on the left while the table on the right displays logic differences between A and B memories. This provides very fast "at-a-glance" comparisons.

### Table display

In the Table display mode you can display up to sixteen 32-bit words which allows you to view address and resultant data flow at the same time. You can look at events leading up to, surrounding, or following the trigger word; and delay up to 99 999 clock cycles beyond the trigger point to view events anywhere in a program. Two 16-bit by 16-bit table displays, A and B, can be used separately or in various combinations to satisfy a wide variety of applications.

### Exclusive OR mode

An exclusive OR mode, A & (A ⊕ B), makes comparison of Table A and Table B data easy by displaying any differences as intensified ones on Table B. This display mode allows you to quickly compare active data to known stored data, or to compare data from two active systems simultaneously.

Another useful mode is the halt when A does not equal B mode (A ⊙ B), which automatically halts and stores the data in the A memory when it does not equal the data in the B memory. Used in conjunction with the A & (A ⊕ B) mode, this mode frees you from the tedious waiting and watching for intermittent malfunctions.

### Display qualification

The 1600S has a total of four qualifier channels which in the Display Mode allow only selected data to be captured, greatly expanding the effectiveness of the memory since irrelevant or extraneous data is not strobed into memory. The 1607A pattern trigger output (PTO) can be used as a qualifier input to the 1600A which permits very sophisticated analysis of multiplexed buses in minicomputers.

### Sequential triggering

The 1600S permits you to define two events which must occur in sequence to trigger a data acquisition cycle. The trigger output of the 1607A can be used to arm the 1600A on a selected event, enabling it to look for the second event. Sequential triggering is useful for analyzing branch operations.

### Dual clock

The 1600A and 1607A may be clocked at different rates which permits you to examine simultaneously up to 16 bits on both sides of an I/O port even though state flow is from two different sources running at different speeds. You can also easily relate bus activity to events occurring elsewhere at different clock rates, such as system peripherals. Dual clock capability can be particularly useful in determining design incompatibilities between hardware and software in microcomputer-controlled systems.

### Start and End display triggering

Both the 1607A and the 1600A may be operated in the Start Display or End Display modes. In Start Display, the Analyzer triggers on a unique word established by the trigger word switches and displays that trigger word and the fifteen following words as they are clocked in. This is a valuable mode for paging through a system while following an algorithm to trace data flow.

End Display triggering captures events leading up to and including the trigger word, providing a "negative time" display. This is extremely helpful for troubleshooting, since you can trigger on an unallowed state or a fault and see where the machine malfunctioned rather than the end results of the error. In addition, delay may be combined with the End Display trigger to capture both positive and negative time data, allowing you to see events before and after the trigger event and reduce analysis time.

### Digital delay

When the data you want to see does not immediately follow the desired trigger word, delay can be used to position the sixteen word "window" an exact number of clock pulses from the trigger word. The 1600A and the 1607A each permit selection of up to 99 999 clock cycles of delay. Digital delay is used with the start and end display modes for precise paging through data, or indexing. It is useful for moving the display window past loops and measuring lengths of subroutines while maintaining a desired pattern trigger point.

### Trigger outputs

The 1600A and 1607A have trigger outputs that extend troubleshooting capabilities in digital circuit analysis by windowing oscilloscopes to the proper digital point in time for electrical analysis of circuit operation.

### Versatile miniature probes

The 1600S acquires data through six, 6-channel high impedance probes. Two separate clock probes allow connection to the desired strobe source. The miniature probe tips are small enough to connect to adjacent pins on DIP's, or can be slipped off the probe wire for direct connection to 0.6 mm (0.025 in.) square pins, IC test clips, Model 10024A IC clip, and wire wrap pins.

Individual probes are connected to each data or clock pod through a quick disconnect ganging-bar which permits hardwired or semipermanent connections to system nodes that do not need to be disturbed when the Logic State Analyzer and its probe pods are removed.

## Models 1600S and 10253 (cont.)



10253A Card Reader

## 1600S Specifications

## Clock and data inputs

Repetition rate: 0 to 20 MHz.

Input RC:  $40\text{ k}\Omega \pm 3\text{ k}\Omega$  shunted by  $\leq 14\text{ pF}$  (at the probe tip).

Input bias current:  $\approx 50\text{ }\mu\text{A}$ .

Input threshold: TTL, fixed at approx. +1.5 V; variable  $\pm 10\text{ Vdc}$ .

## Maximum input

Level: -15 to +15 Vdc.

Swing: 15 V peak from threshold.

## Minimum input

Swing:  $0.5\text{ V} + 5\%$  of p-p threshold voltage.

Clock pulse width: 20 ns at threshold.

Data pulse width: 25 ns at threshold.

Data setup time: time data must be present prior to clock transition, 20 ns.

Hold time: time data must be present after clock transition, 0 ns.

## Pattern and delayed trigger outputs

High:  $\geq 2\text{ V}$  into  $50\Omega$  (line driver interface).

Low:  $< 0.4\text{ V}$  into  $50\Omega$  (line driver interface).

## Pulse duration

Delayed trigger: approx. 25 ns (RZ format) at 1 V level.

Pattern trigger: approx. 25 ns in RZ format at 1 V level with delay set to zero or off. With delay on and not set to zero, pattern trigger output starts on receipt of a pattern trigger signal and ends when the delay ends.

## Trigger arm input

Impedance:  $50\Omega$ .

Level: low state, 0 V to  $< 0.4\text{ V}$ ; high state, 2 V to  $< 5\text{ V}$ .

Pulse width: 15 ns minimum at 1.5 V level.

Arming conditions: if the arming pulse positive edge occurs  $< 45\text{ ns}$  after a clock, triggering occurs on the same clock cycle that it is armed. If the arming pulse positive edge occurs  $> 75\text{ ns}$  after a clock, triggering occurs on the next clock cycle.

## 1607A X-, Y-, and Z-axis outputs

X-axis:  $< 0.6\text{ V}$  to  $> 6\text{ V}$  p-p,  $\pm 8\text{ V}$  max into  $\geq 100\text{ k}\Omega$ .

Y-axis:  $< 0.6\text{ V}$  to  $> 6\text{ V}$  p-p,  $\pm 8\text{ V}$  max into  $\geq 100\text{ k}\Omega$ .

Z-axis: 0 to 10 V p-p into  $\geq 1\text{ k}\Omega$ .

Display interface requirements: the 1607A interfaces with oscilloscope or display with the following input parameters (Not recommended for storage oscilloscopes or displays).

X and Y inputs: 0.1 to 1 V/div deflection factors; dc coupled input; and  $> 500\text{ kHz}$  bandwidth.

Z-axis input: dc coupled with positive blanking; full blanking must occur with 10 V input at 10 mA.

## General

Display rate: variable from  $< 200\text{ ms}$  to  $> 5\text{ s}$  (1600A),  $< 50\text{ ms}$  to  $> 5\text{ s}$  (1607A).

Power: 100, 120, 220, 240 Vac; -10%, +5%; 48 to 440 Hz; 120 VA max.

Logic probe power: rear panel BNC connector, +5 V, 0.1 A.

## Size

1600A: 197 H  $\times$  335 W  $\times$  540 mm L with handle ( $7\frac{3}{4}$ "  $\times$   $13\frac{3}{16}$ "  $\times$   $21\frac{1}{8}$ "); 460 mm ( $18\frac{1}{2}$ ") L without handle.

1607A: 121 H  $\times$  284 W  $\times$  460 mm D ( $4\frac{3}{4}$ "  $\times$   $11\frac{3}{16}$ "  $\times$   $18\frac{1}{8}$ ").

Operating environment: temperature, 0 to  $+55^\circ\text{C}$  ( $+32^\circ\text{F}$  to  $+130^\circ\text{F}$ ); humidity to 95% relative humidity at  $+40^\circ\text{C}$  ( $+104^\circ\text{F}$ ); altitude to 4600 m (15,000 ft); vibrated in three planes for 15 minutes each with 0.254 mm (0.010 in.) excursion, 10 to 55 Hz.

## Weight

Model 1600S: net, 19.1 kg (42 lb). Shipping, 22.7 kg (50 lb).

Model 1600A: net, 12.7 kg (28 lb). Shipping, 15.9 kg (35 lb).

Model 1607A: net, 6.4 kg (14 lb). Shipping, 8.2 kg (18 lb).

## Accessories supplied

1600S: six 10231C data probes, two 10230C clock probes, one 10236A Trigger Bus Cable, one 10237A Data Cable, two 2.3 m (7.5 ft) power cords, one accessory case for each analyzer, one 1600A and one 1607A Operating and Service Manual.

1600A or 1607A: three 10231C data probes, one 10230C clock probe, one accessory case, one Operating and Service Manual.

## Accessories

Card reader: Model 10253A Card Reader plugs directly into the 1600A and provides a convenient method of performing repetitive tests on digital components or systems. Cards provide a low cost method of storing fixed data that may represent a complete system test procedure or a simple QC test. Applications include incoming inspection, production testing, service and maintenance, engineering, and environmental testing.

Cards: special printed cards are in format required for loading data into the 1600A Logic State Analyzer Table B memory; 187 mm ( $7\frac{3}{8}$  in.) length cards are loaded into Table B in  $< 2\text{ s}$ .

Power: supplied by 1600A.

Weight: net, 1 kg (2.1 lb). Shipping, 1.8 kg (4 lb).

Operating environment: same as 1600A except: temperature,  $+10^\circ\text{C}$  to  $+40^\circ\text{C}$  ( $+50^\circ\text{F}$  to  $+104^\circ\text{F}$ ); humidity, to 80% relative humidity at  $+40^\circ\text{C}$  ( $+104^\circ\text{F}$ ).

Accessories supplied: one drum card, HP P/N 10253-90001; one exerciser card, HP P/N 10253-90002; 100 data cards, HP P/N 9320-3324; one interface box mounting bracket, HP P/N 01120-64701; and one Operating Note.

Serial-to-parallel converter: Model 10254A Serial-to-parallel Converter acts as the interface between a serial data system and a 1600A or 1607A, converting the serial data into parallel format for full utilization of these logic state analyzers in serial data stream analysis.

Trigger bus cable: Model 10236A Trigger Bus Cable interconnects the 1600A and 1607A to provide a 32-bit word capability (supplied with the 1600S).

Weight: net, 0.2 kg (6 oz). Shipping, 0.5 kg (1 lb).

Data cable: Model 10237A Data Cable interconnects the 1607A and 1600A to provide 32-bit data display (supplied with 1600S).

Weight: net, 0.23 kg (8 oz). Shipping, 0.5 kg (1 lb).

Rack mount adapter: Model 10491B Rack Mount Adapter, 222 mm ( $8\frac{3}{4}$  in.) high and 540 mm ( $21\frac{1}{4}$  in.) deep; adapts the 1600A to a standard 483 mm (19 in.) rack.

Weight: net, 1.4 kg (3 lb). Shipping, 2.3 kg (5 lb).

IC test clip: Model 10024A IC Clip allows convenient connection of analyzer probe leads to dual in-line packages, reducing the possibility of shorting between IC pins. Refer to page 172 for description of 10024A and other probe accessories.

## Ordering Information

	Price
1600S 32-channel Logic State Analyzer, includes a 1600A and 1607A	\$7100
Opt 910: extra set of manuals	add \$17.50
1600A 16-channel Logic State Analyzer	\$4200
Opt 910: extra Operating and Service Manual	add \$9
1607A 16-channel Logic State Analyzer	\$2900
Opt 910: extra Operating and Service Manual	add \$8.50
10236A Trigger Bus Cable (supplied with 1600S)	\$20
10237A Data Cable (supplied with 1600S)	\$60
10253A Card Reader	\$800
10491B Rack Mount Adapter	\$100
10024A IC Test Clip	\$15
10247-68701 Quick Disconnect Probe Lead Kit for 10230C Clock Probe	\$10
10231-68703 Quick Disconnect Probe Lead Kit for 10231C Data Probe	\$25
10230-62101 Probe Tip for use with Probe Lead Kits or as replacement tips	\$2.50

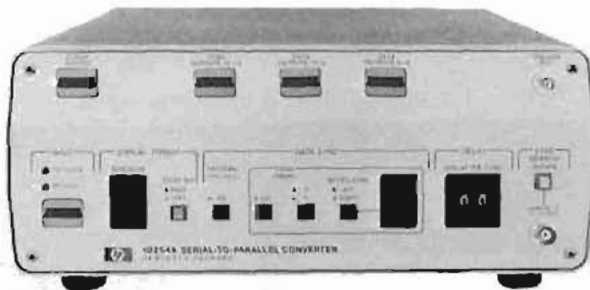

10254A

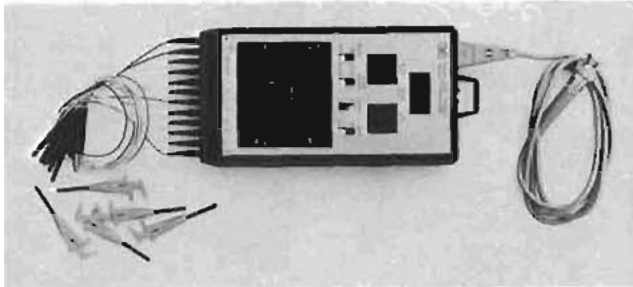

1230A

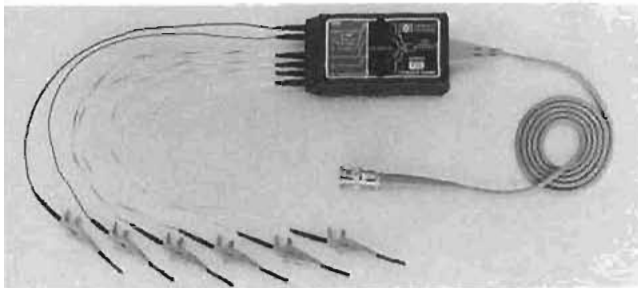

10250A

### 10254A Serial-to-parallel converter

**Specifications** (Accessory to the 1600A and 1607A Logic State Analyzers.)

#### Probe Inputs

**Rep rate:**  $\leq 10$  MHz in Edge Sync,  $\leq 7$  MHz in Pattern Sync.

**Input RC:**  $40 \text{ k}\Omega \pm 3 \text{ k}\Omega$  shunted by  $\leq 14 \text{ pF}$  (at the probe tip).

**Input threshold:** TTL, fixed at 1.5 Vdc; variable  $\pm 10$  Vdc selected at the logic state analyzer.

**Maximum input:** level,  $\pm 15$  Vdc; swing, 15 V peak from threshold.

**Pulse width:** 40 ns min at threshold.

**Setup time:** 50 ns, time data must be present prior to clock transition.

**Hold time:** 0 ns, time data must be present after clock transition.

#### Operating modes

##### Display format

**Bits/byte:** 1 to 16 bits (a byte is displayed as one line on the Analyzer).

**First bit, left/right:** configures displayed data for most significant bit left or right.

##### Data sync

**Pattern:** synchronizes on a unique pattern in the serial data stream selected with the logic state analyzer Trigger Word switches.

**Edge:** synchronizes on input probe sync signal with positive or negative edge selectable.

**Bytes/sync:** permits memory qualification by acquiring 1 to 16 bytes of data following a sync.

**Delay (bits after sync):** selects the number of clock pulses from 0 to 99 after a sync signal is received before data acquisition begins.

**Sync search:** Initiate pushbutton or a positive-going input pulse starts a new search cycle.

#### General

**Weight:** net, 3.2 kg (7 lb). Shipping, 5 kg (11 lb).

**Power:** +5 Vdc, +12 Vdc and -12 Vdc; supplied by the 1600A or 1607A Logic State Analyzer.

**Size:** 12.1 H  $\times$  28.4 W  $\times$  41.4 cm D ( $4\frac{3}{4}$ "  $\times$   $11\frac{1}{8}$ "  $\times$   $16\frac{5}{16}$ ").

**Accessories supplied:** one Model 10236A Trigger Bus Cable, four interface cables (HP P/N 10254-61601), and one Operating Note.

**Equipment required:** 1600A or 1607A plus a 10231C data probe from the 1600A, 1607A or ordered separately, for use as the 10254A input data probe (labels supplied with 10254A).

### 8 Bit trigger probe with delay

#### 1230A Specifications

##### Input

**Frequency:** 15 MHz max.

**Logic levels:** logic '0': 0 V to 0.8 V; logic '1': 2 V to 15 V.

**Current:**  $\sim 360 \mu\text{A}$  for logic '0' input ( $-400 \mu\text{A}$  for GATE input);  $100 \mu\text{A}$  for logic '1' input.

**Maximum input voltage range:** -1 V to +15 V.

##### Output (negative-going edge true)

**Logic '0':** 0.5 V max (60 mA current sinking capability).

**Logic '1':** 2 V min into  $50\Omega$  (40 mA source current).

#### Operating modes

##### Word recognition

**Synchronous pattern recognition:** trigger word input recognition only during pos. or neg. edge (selectable) of CLOCK input signal.

**Minimum setup time:** 20 ns.

**Minimum hold time:** zero ns.

**Asynchronous pattern recognition:** independent of CLOCK input.

**Maximum propagation delay after word recognition:** 45 ns.

**Minimum input pulse width:** 25 ns.

**GATE input:** for strobing or expanding word recognizer, GATE switch set to LO, GATE input pulse must be 20 ns longer than 'word-true' time. Set to HI, GATE input pulse must be 10 ns longer than 'word-true' time.

##### Events delay

**Delay range:** 1-9998 events start counting on pos. edge or neg. edge (selectable) of CLOCK input signal after word recognition.

#### General

**Power requirements:** 300 mA at 5 V.

**Voltage on power inputs:** +4.75 V to +15 V max dc. Protected against reverse polarity.

net, 454 g (1 lb). Shipping, 907 g (2 lb).

### 4 Bit trigger probe (TTL)

#### 10251A Specifications

##### Input

**Low level:** 0.8 V ( $-0.6$  V min);  $-0.8$  mA max at 0.4 V (0.5 standard TTL load).

**High level:** 2 V (5.0 V max);  $100 \mu\text{A}$  max at 2 V.

##### Output

**Swing:** 0.5 V to 4.5 V min into 1 megohm.

**Transition time:** 7 ns max from 0.6 V to 1 V; 50 ns min to 4 V with 1 megohm, 20 pF load.

##### Delay

**Propagation:** 30 ns max from any input to trigger output.

**Difference:** 10 ns max between any two inputs.

##### Power (supplied by circuit under test)

**Voltage:** +5 V  $\pm 5\%$ ;  $-0.4$  V to +7 V max.

**Current:** 30 mA max; normal operation, 17 mA.

**Overall length:** approx. 168 cm (66 in.).

**Weight:** net, 227 g (8 oz). Shipping, 907 g (2 lb).

**Accessories included:** six miniature probe tips, one Operating Note, and one vinyl carrying case.

#### Ordering information

10254A Serial-to-parallel Converter

1230A Logic Trigger

Opt 910: extra manual

10250A Trigger Probe (TTL)

#### Price

\$975

\$495

\$5.50

\$95

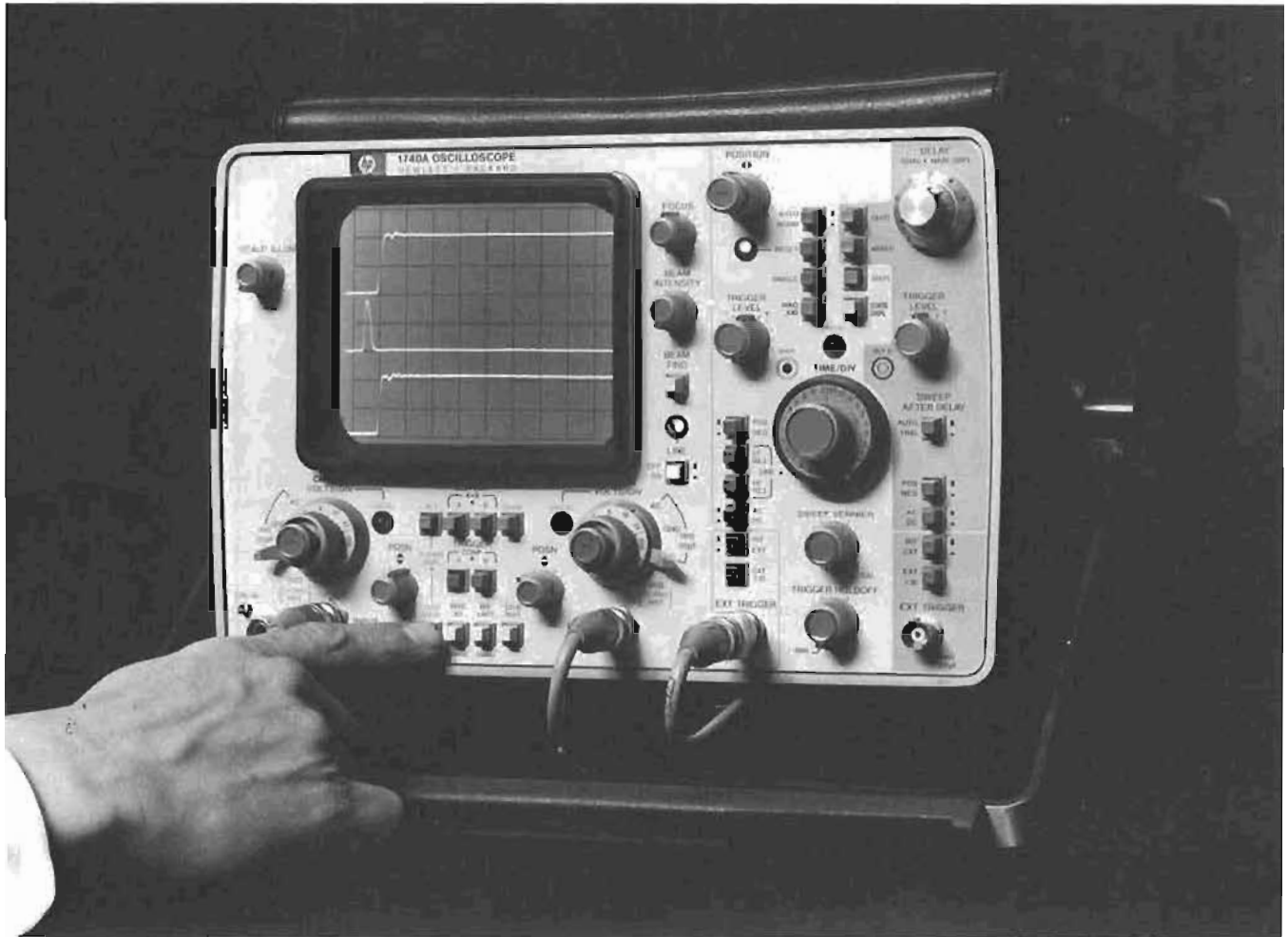

The oscilloscope—the most general purpose and basic tool of the electrical designer—has evolved into a very accurate and versatile measurement tool. With the rapid growth, in the past few years, of technology in integrated circuits, the measuring capabilities have increased tremendously. New capabilities include the Hewlett-Packard developed delta time measurements and the crystal referenced time base of the 1743A. In general, the most versatile test instrument has become even more accurate and more flexible.

Hewlett-Packard pioneered many of the measurement capabilities that are now taken for granted in oscilloscopes. A few of these are internal graticule CRT, beam finder, expansion mesh CRT, trigger holdoff, mixed sweep, general purpose sampling to 18 GHz, time domain reflectometry, and rugged variable persistence/storage.

#### Selecting an oscilloscope

Today's selection of an oscilloscope is not as easy as it was in previous years. The re-

cent technological changes have considerably improved the price performance ratios that are available. In addition, measurement requirements have also changed and expanded.

To make the best selection, use your immediate measurement applications as a starting point. Then look at your past and future requirements. After examining all of the possible measurement requirements, you will have an idea of the type of oscilloscope needed in your application. In a somewhat broad sense oscilloscopes can be classified in two categories, mainframes with plug-ins and nonplug-ins.

#### Plug-In oscilloscopes for the lab

The plug-in oscilloscope offers maximum flexibility by permitting general purpose measurements as well as retaining the capability to make specialty measurements. By carefully selecting a mainframe, you will be able to change the measurement capability by using different plug-ins rather than having another infrequently used spe-

cial purpose oscilloscope on hand. Plug-in oscilloscopes are usually called General Purpose Laboratory instruments because of the broad measurement capabilities.

General purpose lab scopes are used in basic circuit design for almost every electronic product and are most often configured as a 2 channel, wide band, delayed sweep instrument. As the general purpose measurement needs expand, the plug-in flexibility allows you to reconfigure your instrument to fit other applications.

In addition to general purpose dual channel plug-ins with bandwidths from 50 to 100 MHz, specialty plug-ins are also available—high sensitivity, differential/dc offset; four channels; standard, delayed, expanded, or mixed sweep operation; sampling bandwidths to 18 GHz; time domain reflectometry; spectrum analysis to 1500 MHz, and swept frequency testing from 100 MHz to 18 GHz. The flexibility of the plug-in system is considerable—it makes one instrument do many jobs.



Representative plug-in oscilloscopes from Hewlett-Packard's 180 series.

### High speed

Hewlett-Packard has three high speed delta time oscilloscopes that are ideal for use in the design, manufacturing, and testing of high speed computers and peripherals with fast interface logic, high speed digital communications and instrumentation, as well as high frequency rf applications.

Model 1722B with its microprocessor and LED display eliminates the time-consuming counting of divisions, interpolating between graticule lines, and multiplying by the appropriate scale factor. With microprocessor calculated results and direct LED readout, measurements are made without manual computation which saves time and reduces the possibility of human error. Delta time techniques improve accuracy of time interval measurements because the CRT is used as a nulling device which eliminates non-linearity errors. The delta time sweep measurement technique, developed by Hewlett-Packard simplifies transition time, propagation delay, clock phasing and other high-speed timing measurements. Two separate markers are used to enable the operator to see both start and stop points of the time interval simultaneously. These two markers also reduce the possibility of setting a measurement to the wrong event. In the delayed sweep mode, the start and stop mode are overlapped to obtain maximum accuracy with the improved resolution of optical nulling.

Models 1725A and 1715A both offer the delta time advantages of increased accuracy and ease-of-use. The 275 MHz 1725A and 200 MHz 1715A are available with an optional built-in DMM for direct readout of time interval. The time interval can also be read directly from the calibrated delay control or from an external DVM that is reading the scaled voltage output on the rear panel. Both oscilloscopes can be converted to the familiar single marker delayed sweep by selection of the delta time off mode.

### 100 MHz

Model 1740A is a 100 MHz oscilloscope

with a third channel trigger view for accurate general purpose measurements. This oscilloscope with its large 8 x 10 cm CRT offers delayed sweep measurements to 100 MHz at 5 mV/cm deflection factors. A X5 magnifier increases sensitivity to 1 mV/cm on both channels to 40 MHz without the need to cascade channels. As a further aid to measurement flexibility Option 101 to the 1740A provides rear panel inputs and switching circuits for interfacing with the Model 1607A Logic State Analyzer. This option permits single pushbutton switching between data domain table displays and time domain measurements. The functional 16 bit wide displays provided by the 1607A permit fast analysis of digital systems when you only need logic flow information. And, with the digital triggering capability of the 1607A coupled to the 1740A external trigger you have the ability to 'window' the time domain display to the digital problem area for electrical analysis. Option 101 is also available on the 1715A, 1722B, 1725A, 1741A, and 1743A.

Model 1741A offers the same operating features as the 1740A plus variable persistence/storage for a truly versatile general purpose oscilloscope. For viewing low rep rate fast transition time signals, the variable persistence mode allows you to adjust the trace for an optimum display. The 1741A storage CRT provides a bright, crisp stored trace with a writing speed of 100 cm/ $\mu$ s which is ideal for capturing single-shot and low rep rate signals common in today's digital circuits.

### Precision timing

Conventional oscilloscopes offer timing accuracies typically  $\pm 3\%$  of full scale, but with the addition of a crystal referenced time base in the new 100 MHz 1743A, timing accuracies of 0.002% of reading are obtained. This new type of time base offers several new measurement capabilities: unprecedented accuracy, calibrated sweep vernier so that the scope can be calibrated to your system's units of operation and still make

precision timing measurements, triggered delta time measurements so that the time interval readout will automatically track changes in the input signal without operator intervention, and first pulse measurement for highly accurate measurements on those hard to measure software generated pulses.

### 15 MHz

In the dc to 15 MHz range there are four models available, 1223A variable persistence/storage, 1220A and 1222A dual channel, and 1221A single channel, that are designed for industrial and educational applications, and production line testing. Logical front panel layout, large 8 x 10 division internal graticule, and automatic triggering reduce familiarization time and assure maximum efficiency in production and student environments.

### 500 kHz

Low frequency scopes which have about 500 kHz bandwidth are used in educational, medical, system monitors, engineering, production, and in some cases field service. These scopes could be classified as the "workhorses" of the electronics industry since they are most commonly found in system applications. The 1200 series scopes easily fill these requirements with their 100  $\mu$ V and 5 mV sensitivity, solid-state and lightweight construction, and reliable and stable operation. Also available are storage and variable persistence models which eliminate annoying flicker and retain single-shot traces that are common in bio-medical or electro-mechanical applications.

### Oscilloscope basics

Because the oscilloscope can display electrical signals which vary with time, it has become today's most widely used electronic measuring instrument. It produces a visual display of any physical quantity which can be represented as a voltage. This permits precise measurement and analysis of the phenomenon represented by the voltage.



Representative Hewlett-Packard nonplug-in oscilloscopes.

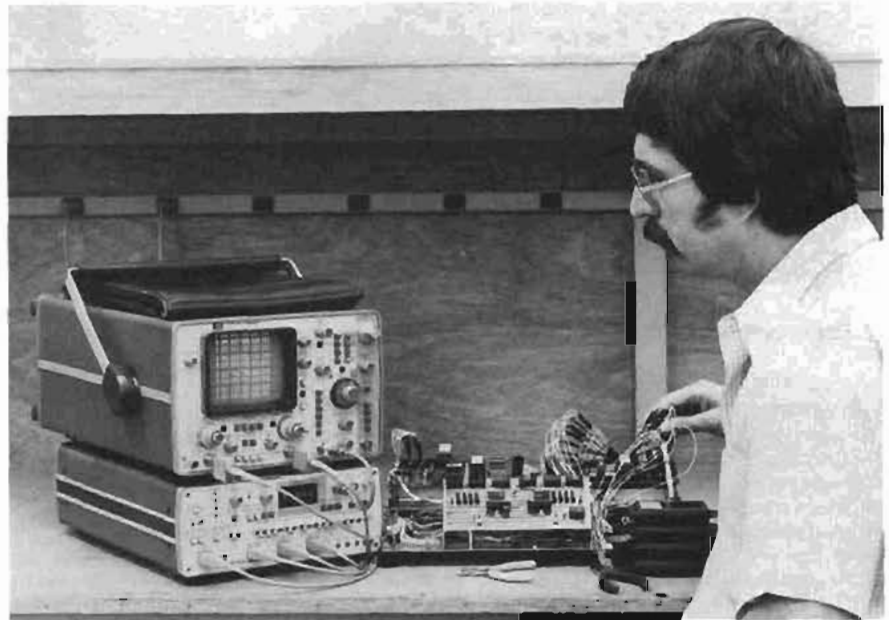

Option 101 to 1740A offers one button switching between Logic State Analysis and volts vs. time measurements.

### The cathode-ray tube

A CRT produces an electron beam whose movement is controlled by the vertical and horizontal amplifiers and by the power supplies which form, shape, and accelerate it. This electron beam strikes a phosphor screen and a visible glow results as the beam is moved.

Since the beam deflection can be calibrated against a grid (graticule) on the CRT face, amplitude and time measurements can be made. All Hewlett-Packard graticules are internal and in the same plane as the phosphor, eliminating parallax.

An expansion mesh, introduced by Hewlett-Packard in 1962, with a voltage on it produces an electrostatic field which bends the beam after its initial deflection at the electron gun structure. By controlling mesh radius, Hewlett-Packard CRT designers have produced increasingly larger display areas while simultaneously reducing the overall length of the tube.

Storage scopes are available with rugged variable persistence (the time it takes for the trace to fade to 10% of its original brightness). This is made possible by use of a storage mesh immediately behind the phosphor. Control circuits then determine the rate at which a display fades away after being stored as a charged pattern on the mesh.

### Vertical deflection system

Since the CRT is limited as to the range of deflection voltages which can be applied, a vertical amplifier and attenuator are used. These are accurately calibrated to provide a deflection factor related to the graticule (e.g., 5 mV/division).

### Horizontal deflection system

To deflect the electron beam horizontally, an amplifier and sweep generator are used. A sawtooth waveform generator sweeps the beam at a selectable uniform rate. With such a linear rate of sweep, calibration to the graticule is possible (e.g., 1 ms/division).

For meaningful displays, the horizontal deflection system must provide synchronizing circuits to start the sweep at a specific instant with respect to the measured waveform. Automatic triggering on Hewlett-Packard scopes makes starting of the sweep a quick, easy step.

### Power supplies

Scopes contain low and high voltage power supplies and determine, with the CRT, the maximum capability of a scope, especially of a mainframe.

Low voltage power supplies give operating power to scope circuits such as the vertical and horizontal amplifiers. The high voltage power supply forms and controls the CRT electron beam.

**Input probes**

Proper selection of well-designed probes will minimize circuit loading effects and provide the most accurate and useful waveform information. Improper matching of probe to scope will cause rise time errors in pulse measurements and cause both amplitude and phase errors in CW measurements.

The effects of resistive loading have been recognized for some time. High input impedances have been used to reduce the voltage division between circuit and measuring device. This technique will cause minimal error if measurements are at low frequencies and the circuit test point has a low impedance.

When these probing requirements are not met, inaccuracies result for one big reason: CAPACITANCE. And the effects of capacitance in the probe or scope input change drastically because of frequency.

Hewlett-Packard has pioneered in helping solve the capacitance problem in high frequency measurements by providing selecta-

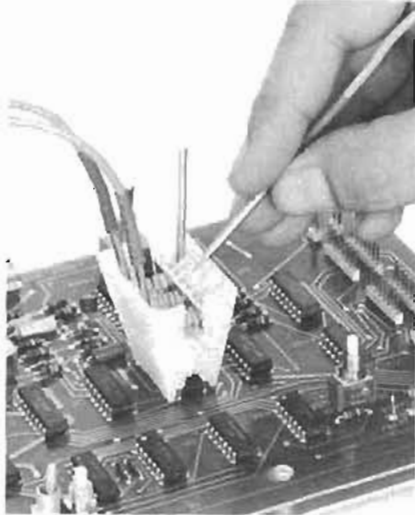

HP miniature probes and IC Test Clip permit easy probing of dual in-line packages with minimum probe loading.

ble input impedance—50 ohms or a high Z with low capacitance. This measurement convenience is available because of Hewlett-Packard's innovative design that uses thick-film attenuators.

**Sampling oscilloscopes**

Sampling oscilloscopes use a technique which is similar in principle to use of a stroboscope for study of periodic or varying motion.

Samples are taken on successive recurrences of a waveform. As each amplitude sample is taken later in time on the waveform, the CRT beam is deflected to the corresponding point where a visible dot is then displayed. The rate at which sampling occurs is very fast; thus the dots are displayed as a coherent-appearing waveform on the CRT.

Samples are obtained when a pulse "turns on" the sampling circuit for an extremely short time. During this interval the input waveform amplitude is measured, the samples are then effectively "stretched" in time, and amplified at relatively low bandwidths.

Thanks to fast-switching diodes developed by Hewlett-Packard—some even for use in other types of instrumentation—sampling scope bandwidths have progressed to the 18 GHz point.

**Militarized oscilloscopes**

A complete line of oscilloscopes modified to meet one or more specific military requirements is available through the nearest HP Sales Office.

- Plug-in 50 MHz 1551A Opt 021 Oscilloscope (AN/USM-281A) meets or exceeds requirements of MIL-O-24311. Rack mountable units available on request.
- Portable 50 MHz 1707B Opt 300 Oscilloscope (AN/USM-338) meets or exceeds requirements of MIL-T-28800A for Type II, Class 2, Style A.
- Portable 100 MHz 1740F Oscilloscope (equivalent to AN/USM-425 (V) 1).

- Portable 250 MHz 1720 AF Opt 021 Oscilloscope (AN/USM-426 (V) 1) meets or exceeds requirements of MIL-T-28800A for Type II, Class 4, Style C.

Contact your Hewlett-Packard Field Engineer for detailed specifications, price and availability.

**Oscilloscope accessories**

Cameras and adapters, testmodules, active and passive probes, and adapters to meet most any need are available to help you get the most out of your scope investment. See page 171.

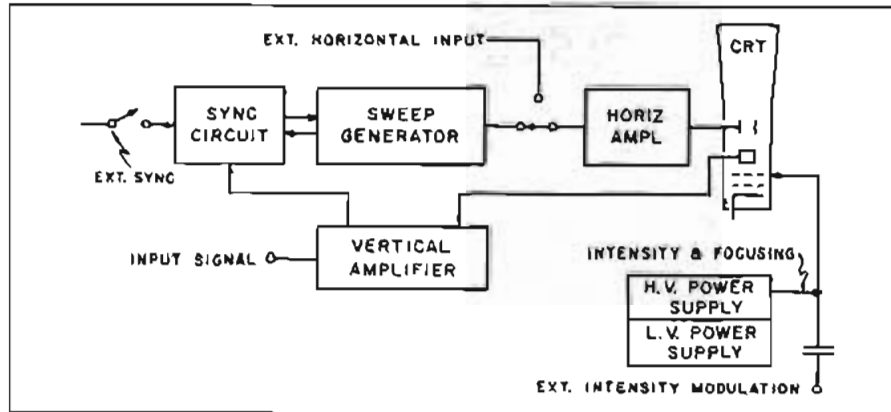

Typical oscilloscope block diagram.

**Oscilloscope Selection Chart**

Characteristics	1715A	1722B	1700 Series 1725A	1740A	1741A	1743A	180 Series	1220A	1220 Series 1221A	1222A	1223A	1200 Series 1200A/B	1201A/B	1205B
Bandwidth	200 MHz	275 MHz	275 MHz	100 MHz	100 MHz	100 MHz	0.5 to 100 MHz	15 MHz	15 MHz	15 MHz	15 MHz	500 kHz	500 kHz	500 kHz
Deflection Factors/Div.	5 mV to 5 V	10 mV to 5 V	5 mV to 5 V	5 mV to 20 V	5 mV to 20 V	5 mV to 20 V	100 μV Min.	2 mV to 10 V	2 mV to 10 V	2 mV to 10 V	2 mV to 10 V	0.1 mV to 20 V	0.1 mV to 20 V	0.1 mV to 20 V
Sweep Speeds/Inch, Mag.	10 ns to 0.5 s	10 ns to 0.5 s	10 ns to 0.5 s	50 ns to 2 s	50 ns to 2 s	50 ns to 2 s	5 ns to 1 s	0.1 s to 0.5 s	0.1 s to 0.5 s	0.1 s to 0.5 s	0.1 s to 2 s	1 μs to 5 s	1 μs to 5 s	1 μs to 5 s
Channels	2	2	2	2	2	2	1,2,4	2	1	2	2	2	2	2
Δ Time Measurements	•	•	•			•							•	
Variable Persistence Storage					•		•				•		•	
Sampling							•							
TDR							•							
Differential Inputs							•					•	•	•
Optional Logic State Switch	•	•	•	•	•	•								
LED Readout/DMM	Optional	•	Optional			•								
Page	136	132	136	139	139	139	148	168	168	168	168	188	168	168

\*Detailed selection chart for 180 Series oscilloscopes on page 148.

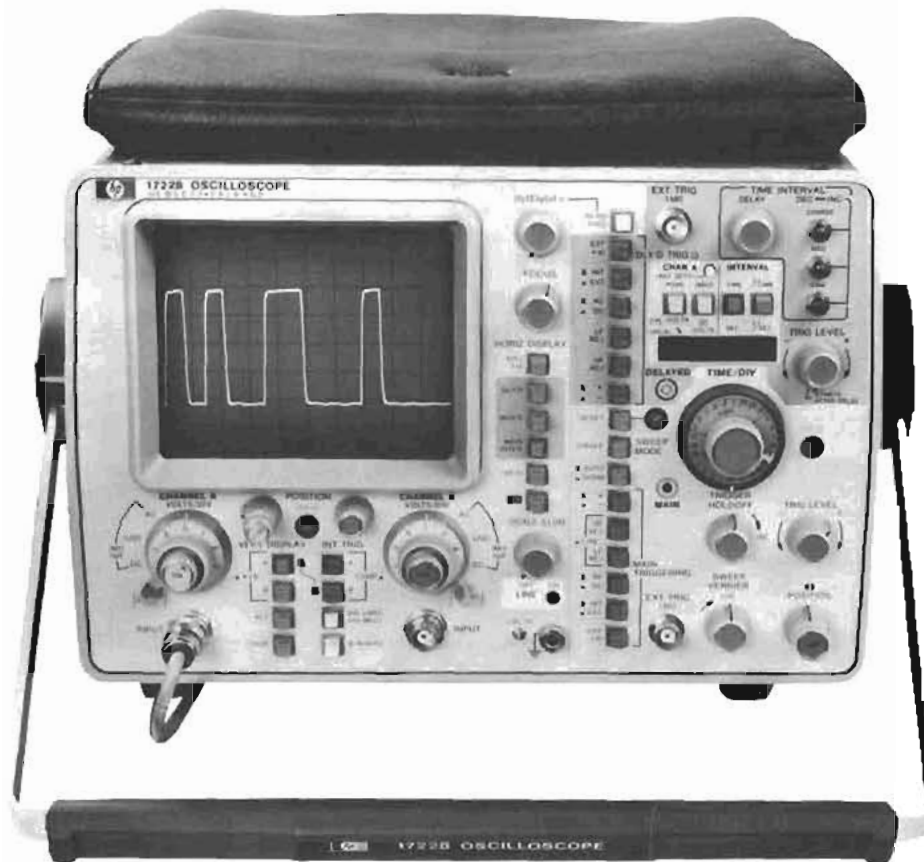

### 1722B Description

The Model 1722B is a 275 MHz bandwidth, 1 ns/div sweep speed dual channel oscilloscope with a built-in microprocessor and five function LED display for precise real time measurement. In addition to the conventional volts versus time CRT display, the microprocessor gives you direct readout of delta time, frequency, dc voltage, instantaneous voltage, and percent amplitude.

As well as increased accuracy offered by the microprocessor, you get a digital readout of the answer to your problem in considerably less time than it takes in a conventional scope. You also get a substantial improvement in measurement repeatability which makes the 1722B extremely useful in applications requiring comparison to a reference. For example, the 1722B's outstanding repeatability along with the 20 ps resolution makes it ideally suited for making clock phasing measurements in large computer timing applications.

#### Time interval measurements

Delta time sweep, developed by Hewlett-Packard, is used in the Time Interval Mode for making accurate measurements of rise time, pulse width, and propagation delay.

Time interval measurements can be made between two events on Channel A, two events on Channel B, or when in alternate mode, between an event beginning on Channel A and ending on Channel B. A DELTA TIME MEASUREMENT technique displays the start and stop points of your time interval as intensified markers. Select MAIN INTENSIFIED MODE and adjust marker width with the delay time/division control. Then set the first marker at  $t_1$  with the DELAY dial, and set the 2nd marker at  $t_2$  with the DECREASE-INCREASE controls (coarse, medium, or fine). The 3½ digit LED display automatically and continuously reads the time interval between the two markers ( $t_2-t_1$ ). Delta time measurements are always displayed in units of sec (exponent 0); ms (exponent -3);  $\mu$ s (exponent -6); or ns (exponent -9). For increased resolution, select DELAYED sweep mode. The two intensified portions will be displayed alternately. Achieving the maximum accuracy of the 1722B is a simple matter of overlapping the start and stop points using the DEC-INC switches! This technique eliminates any measurement errors due to vertical or horizontal drift. It also enables you to

compare two waveforms while comparing the time relationship between them.

The microprocessor not only keeps track of the distance between the two markers but automatically expands the measurement resolution by a factor of 10 whenever the two markers are within 1 cm of each other. For example, when making measurements on the 2 ms/div range a measurement of just over a division has a readout of 2.01 ms while a measurement of just under a division has a readout of 1.998 ms.

Accuracy in the time interval mode is basically 1%. The 1722B Data Sheet has more detailed information regarding measurement accuracy.

The microprocessor is not only used to calculate delta time but is also used to interrogate the function switches to help prevent inaccurate measurements. For example, the time interval mode is only valid in either the main intensified mode, where the two markers can be seen, or in the delayed sweep mode, where resolution and accuracy can be improved by overlapping the two delayed sweeps. In other modes where errors might be made (such as in main, mixed, and X-Y), the microprocessor automatically sets the display to zero. The display is also set to zero whenever the sweep vernier is out of the Cal detent or when the delayed trigger level is out of the Starts After Delay position.

#### 1/Time (frequency) measurements

The 1722B gives an automatic 3 or 4 digit display of the reciprocal of time. If a time interval measurement is the period of a waveform, then the 1/Time mode provides a direct readout of repetition rate or frequency. The microprocessor computes the reciprocal of whatever time interval has been set when in the Time mode. 1/Time display units are in Hz (exponent 0), kHz (exponent 3), or MHz (exponent 6). This very convenient measurement eliminates the need for calculations when setting up clock frequencies and measuring the frequency or repetition rate of a waveform. An application of both time and 1/Time modes is to preset a desired time interval or frequency, then through the technique of overlapping traces make an external adjustment to bring the system under test into specification.



**DC voltage measurements**

When the 1722B is operated in the Input (dc volts) mode you have a direct digital display of the average value of the waveform at the input to channel A. The display is 3½ digits with a sample rate of approximately 2/s and a response time of less than one second. The DVM is autoscaling from 95 mV full scale to 49 V full scale in the X1 range. In the X10 range, which automatically compensates for a 10:1 divider probe, full scale ranges are from 0.95 V to 470 V.

The technique for making dc voltage measurements is to ground the scope input and establish a reference level by pressing the reference set pushbutton. Then with the input impedance set to 1 megohm the digital readout displays the average value of the input waveform. The DVM measurement is made using a successive approximation algorithm controlled by the microprocessor which allows you to establish a reference level with respect to any voltage and enables differential dc measurements. For example, you can probe the base of a transistor, push the reference set button, then probe the emitter. The display gives you  $V_{be}$  directly.

**Instantaneous voltage measurements**

In the position mode you can measure the value of any point on a waveform which eliminates the need to count divisions from a baseline and multiply by the attenuator setting. A switch in the channel A input allows you to compensate for a 10:1 divider probe for a direct readout of voltage at the probe tip without any calculations. This measurement mode is useful for measuring peak voltage, power supply ripple, crossover and threshold points in logic circuits, or any other time when you need to know a precise voltage at a particular point on a waveform.

As with the dc voltage measurement, you select the reference point (usually ground) and measure the value of any point on a waveform with respect to the reference point. This measurement mode, like DC Volts, is autoscaling; the microprocessor auto-

matically keeps track of the attenuator setting to provide the correct voltage. If the dynamic range is exceeded the display dashes to indicate the overrange condition.

**Percentage measurement**

The Position Mode gives an automatic readout of percent when the vernier is out of CAL position. This measurement is made by establishing a 5 cm display between the 0 and 100% points with the 0% point positioned on a convenient graticule and zeroed with the Reference Set pushbutton. The desired point on the waveform is positioned on the reference graticule line using the position control and the percentage of that point with respect to the 0 and 100% points is automatically and continuously displayed. Applications for the percentage mode include measuring the 50% points on a pulse and percent of amplitude modulation of an rf carrier.

**Storage registers**

Storage registers in the microprocessor remember the value of the last setting of different modes. For example, when switching from the Time mode to a Voltage mode and back to Time the display automatically resets to the last display including the spacing between the markers. This memory capability makes it easier to re-establish a display after making measurements in other parts of a circuit.

The digital readout achieves considerable measurement time savings and improves repeatability over conventional scopes. This measurement repeatability makes the 1722B useful for applications where comparison measurements to a reference are required.

**High performance**

Model 1722B is a precision, wideband, high performance oscilloscope in all traditional vertical, horizontal, and triggering operations. Vertical deflection factors of 10 mV/div to 5 V/div with 2% attenuator accuracy cover most oscilloscope measurement requirements. The full bandwidth of 275 MHz is maintained in all calibrated and uncalibrated modes as well as over the full 0°C to +55°C temperature range.

For maximum measurement flexibility, there are switch-selectable 50Ω or 1 MΩ inputs with the full bandwidth available in either mode. The HP 10017A miniature probe with an input of 1 MΩ shunted by less than 8 pF is ideal for use with the 1 MΩ/11 pF inputs of these oscilloscopes. The small size of the 10017A allows probing in compact circuits where conventional probes are difficult or impossible to use. For convenient probing of dual in-line packages, the 10017A may be inserted into a 10024A IC test clip which eliminates the problem of holding the probe tip on an IC pin or possible shorting between pins. The IC test clip also provides built-in probe grounding which eliminates the problems associated with separate probe ground leads.

A crisp, bright trace over the full 8 × 10 cm display area offers easier, more accurate measurements. Beam intensity is automatically regulated for convenient viewing and increased CRT life, however, maximum intensity is maintained when viewing low rep rate, fast transition pulses. An automatic focus circuit reduces the need for focus readjustment with intensity level changes normally encountered in probing applications while retaining a front panel control for fine adjustments when desired.

Internal triggering is stable in excess of 275 MHz and requires only 1 cm of vertical deflection (0.5 cm to 50 MHz). The internal trigger sync takeoff is immediately after the attenuator for a stable display regardless of changes in position, vernier, or polarity controls. For external triggering applications, you only need 100 mV p-p to trigger in excess of 275 MHz and only 50 mV p-p to 100 MHz.

**Digital circuit analysis**

The HP 1607A Logic State Analyzer and Option 101 on the 1722B offers a convenient method of debugging and troubleshooting digital circuits. State Display Option 101 adds rear-panel inputs and internal switching circuits for switching between logic state display and analog display (voltage vs time). The ability to quickly switch between state and analog displays is very useful when workflow errors require analysis of electrical parameters to determine corrective measures.

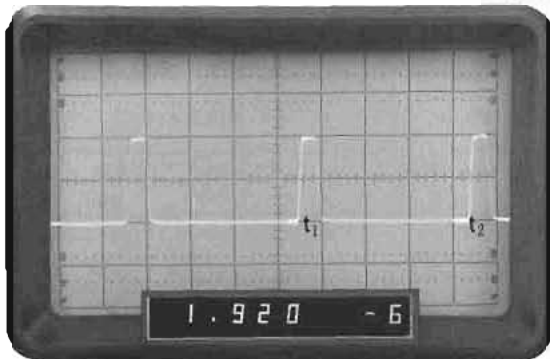

Two intensified markers are positioned to cover the start and stop points of the desired interval. The LED readout automatically and continuously displays the time between the two markers (1.92 μs).

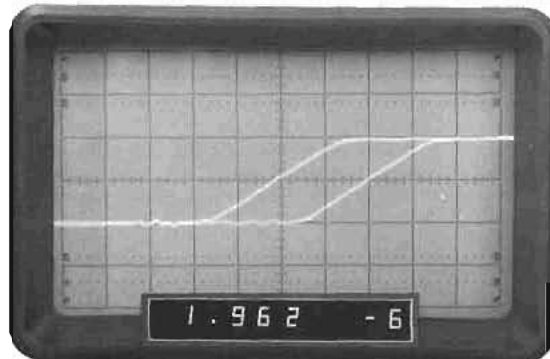

For increased accuracy, the scope is placed in the Delayed Sweep mode to display the two intensified traces alternately. When the two traces are made to coincide using the DEC—INC controls, maximum accuracy is achieved (1.962 μs, ±0.63%).

**Model 1722B (cont.)**
**1722B Specifications**
**Vertical display modes**

Channel A; channel B; channels A and B displayed alternately on successive sweeps (ALT); channels A and B displayed by switching between channels at approx. 1 MHz rate with blanking during switching (CHOP); channel A plus channel B (algebraic addition); X-Y (channel A vs. channel B).

**Vertical amplifiers (2)**

**Bandwidth:** ( $\leq 3$  dB down from a 6 div reference signal).

**DC-coupled:** dc to 275 MHz in both 50 ohm and high impedance input modes.

**AC-coupled:** approx. 10 Hz to 275 MHz.

**Bandwidth limit:** limits upper bandwidth to approx. 20 MHz.

**Rise time:**  $\leq 1.3$  ns.

**Deflection factor**

**Ranges:** 10 mV/div to 5 V/div (9 calibrated positions) in 1, 2, 5 sequence.  $\pm 2\%$  attenuator accuracy.

**Vernier:** continuously variable between all ranges; extends maximum deflection factor to at least 12.5 V/div. Front panel light indicates when vernier is not in CAL position.

**Polarity:** channel B may be inverted, front panel pushbutton.

**Signal delay:** input signals are delayed sufficiently to view leading edge of input pulse without external trigger.

**Input coupling:** selectable, AC or DC, 50 ohm (dc), or ground. Ground position disconnects input connector and grounds amplifier input.

**Input RC (selectable)**

**AC and DC:** 1 megohm  $\pm 2\%$  shunted by approx. 11 pF.

**50 ohm:** 50 ohms  $\pm 2\%$ ; SWR,  $\leq 1.3$  on 10, 20, and 50 mV ranges and  $\leq 1.15$  on all other ranges.

**Maximum input**

**AC and DC:**  $\pm 250$  V (dc + peak ac) at 1 kHz or less.

**50 ohm:** 5 V rms.

**A + B operation**

**Amplifier:** bandwidth and deflection factors are unchanged; channel B may be inverted for A - B operation.

**Differential (A - B) common mode:** CMRR is at least 40 dB from dc to 5 MHz decreasing to 26 dB at 50 MHz. Common mode signal amplitude equivalent to 12 cm with one vernier adjusted for optimum rejection.

**Trigger source**

Selectable from channel A, channel B, or composite.

**Channel A:** all display modes triggered by channel A signal.

**Channel B:** all display modes triggered by channel B signal.

**Composite:** all display modes triggered by displayed signal.

**Channel A input — dc volts**

**Display:** light emitting diodes (LED).

**Number of digits:** 3 $\frac{1}{2}$ .

**Display units:** 0 exponent indicates volts; -3 exponent indicates millivolts.

**X1 range:** 95 mV to 47 V full scale vertical deflection (10 mV/div to 5 V/div).

**X10 range:** 0.95 V to 470 V full scale vertical deflection (100 mV/div to 50 V/div with X10 probe).

**Accuracy:**  $\pm 0.5\%$  reading  $\pm 0.5\%$  full scale (full scale = 10 cm),  $+20^\circ\text{C}$  to  $+30^\circ\text{C}$ .

**Stability:** temperature coefficient,  $< \pm 0.02\%/^\circ\text{C}$ .

**Input impedance:** X1 range, 1 megohm shunted by approx. 11 pF;

X10 range (with X10 probe) 10 megohms shunted by approx. 10 pF.

**Sample rate:** approx. 2/s.

**Response time:**  $\leq 1$  s.

**Reference set:** meter may be zeroed permitting dc voltage measurements with respect to any voltage within selected range. Drift may be eliminated by the REF SET control.

**Overrange:** flashing display indicates overrange condition.

**Channel A position — volts (channel A vernier in CAL detent)**

With the following exceptions, specifications are the same as Channel A Input — DC volts.

**Measurement:** dc substitution method using channel A position control to determine voltage of any point on displayed waveform using any graticule line as reference.

**Bandwidth:** dc to 275 MHz ( $\leq 3$  dB down from a 6 div reference signal).

**Dynamic range:**  $\pm 6$  cm from ground referenced to center screen.

**Reference set:** meter may be zeroed, permits instantaneous voltage measurements with respect to any voltage within selected range.

**Accuracy:**  $\pm 1\%$  reading  $\pm 0.5\%$  of full scale (10X the volts/div range) measured at dc.

**Channel A position —% (channel A vernier out of CAL detent)**

**Measurement:** dc substitution method using channel A position control to determine percent of any waveform point with respect to user defined 0 and 100% points.

**Range:** 0 to  $\pm 140\%$  (calibrated with vernier so that 100% equals 5 div).

**Accuracy:**  $\pm 1\%$ .

**Zero reference:** meter may be zeroed to permit percent measurements with respect to any waveform point.

**Vertical output**

**Amplitude:** one division of vertical deflection produces approx. 100 mV output (dc to 50 MHz).

**Cascaded deflection factor:** 1 mV/div with both vertical channels set to 10 mV/div.

**Cascaded bandwidth:** dc to 5 MHz with bandwidth limit engaged.

**Source resistance:** approx. 100 ohms.

**Source selection:** trigger source set to channel A selects channel A output; trigger source set to channel B selects channel B output.

**Horizontal display modes**

Main, main intensified, mixed, delayed, mag X10, and X-Y.

**Main time base**
**Sweep**

**Ranges:** 10 ns/div to 0.5 s/div (24 ranges) 1, 2, 5 sequence.

**Accuracy**

Main sweep time/div	Accuracy (0°C to +55°C)	
	X1	X10
10 ns to 50 ns	$\pm 3\%$	$\pm 5\%$
100 ns to 20 ms	$\pm 2\%$	$\pm 3\%$
50 ms to 0.5 s	$\pm 3\%$	$\pm 3\%$

**Vernier:** continuously variable between all ranges; extends slowest sweep speed to at least 1.25 s/div. Vernier uncalibrated light indicates when vernier is not in CAL position.

**Magnifier:** expands all sweeps by a factor of 10; extends fastest sweep to 1 ns/div.

**Sweep mode**

**Normal:** sweep is triggered by internal or external signal.

**Automatic:** bright baseline displayed in absence of input signal from 10 ns/div to 20 ms/div. Triggering is same as normal above 40 Hz. Normal triggering is generally required for sweep speeds from 50 ms/div to 0.5 s/div.

**Single:** in Normal mode, sweep occurs once with same triggering as normal, reset pushbutton arms sweep and lights indicator; in Auto mode, sweep occurs once each time Reset pushbutton is pressed.

**Triggering**

**Internal:** dc to 50 MHz on signals causing 0.5 division or more vertical deflection, increasing to 1 division of vertical deflection at 300 MHz in all display modes. Triggering on line frequency is also selectable.

**External:** dc to 100 MHz on signals of 50 mV p-p or more increasing to 100 mV p-p at 300 MHz.

**External input RC:** approx. 1 megohm shunted by approx. 15 pF.

**Maximum external input:**  $\pm 250$  V (dc + peak ac) at 1 kHz or less.

### Trigger level and slope

**Internal:** at any point on the vertical waveform displayed.  
**External:** continuously variable from +1.0 V to -1.0 V on either slope of the trigger signal; +10 V to -10 V in (+10) mode.

**Coupling:** AC, DC, LF REJ, or HF REJ.

**AC:** attenuates signals below approx. 10 Hz.

**LF REJ:** attenuates signals below approx. 7 kHz.

**HF REJ:** attenuates signals above approx. 7 kHz.

**Trigger holdoff:** time between sweeps continuously variable exceeding one full sweep from 10 ns/div to 50 ms/div.

### Main Intensified

Intensifies that part of main time base to be expanded to full screen in delayed time base mode. Time interval control adjusts position of intensified portion of sweep. Rear panel intensity ratio control sets relative intensity of brightened segment.

### Delayed time base

#### Sweep

**Ranges:** 10 ns/div to 20 ms/div (20 ranges) in 1, 2, 5 sequence.

**Accuracy (0 to +55°C):** same as main time base.

**Magnifier (0 to +55°C):** same as main time base.

#### Triggering

**Internal:** same as main time base except there is no Line Frequency triggering.

**Starts after delay:** delayed sweep automatically starts at end of delay period.

**Trigger:** with delayed trigger level control out of detent (starts after delay) delayed sweep is triggerable at end of delay period.

**External:** dc to 100 MHz on signals of 50 mV p-p or more, increasing to 100 mV p-p at 300 MHz.

**External input RC:** approx. 1 megohm shunted by approx. 15 pF.

**Maximum external input:** ±250 V (dc + peak ac) at ≤1 kHz.

**Trigger level and slope:** same as main time base.

**Coupling:** same as main time base.

**Delay time range:** 0.5 to 10X Main Time/Div settings of 20 ns to 0.5 s (minimum delay, 50 ns).

#### Time Interval

**Delay time:** continuously variable from 10 ns to 5 s.

**Delay jitter:** refer to Time Interval Measurements, Stability.

#### Time Interval measurements

**Function:** measures time interval between two events on channel A (channel A display); between two events on channel B (channel B display); or between two events starting from an event on channel A and ending with an event on channel B (Alternate display).

**Display units:** 0 (s); -3 (ms); -6 (μs); or -9 (ns).

#### Accuracy

Main time base setting	Accuracy (+20°C to +30°C)
100 ns/div to 20 ms/div	±0.5% of measurement ±0.02% of full scale (for measurements < 1 cm). For measurements > 1 cm, ±0.5% of measurement ±0.05% of full scale.
50 ns/div*	±0.5% of measurement ±0.06% of full scale.
20 ns/div*	±0.5% of measurement ±0.12% of full scale.
50 ms/div to 0.5 s/div.	±3%

\*Starting after 50 ns of sweep.

**Resolution:** intervals < 1 cm, >0.01% of full scale; intervals > 1 cm, >0.1% of full scale; maximum display resolution, 20 ps.

**Stability (0 to +55°C):** short term, <0.1%. Temperature, ±0.03%/°C deviation from calibration temperature range.

#### Reciprocal of Time Interval Measurements, (1/time)

**Function:** calculates and displays the reciprocal of the measured time interval.

**Display units:** 0 (Hz); 3 (kHz); 6 (MHz).

**Accuracy:** same as Time Interval Measurements.

**Resolution:** same as Time Interval Measurements.

**Stability:** same as Time Interval Measurements.

#### Mixed time base

Dual time base in which the main time base drives the first portion of sweep and the delayed time base completes the sweep at the faster delayed sweep. Also operates in single sweep mode.

### X-Y operation

#### Bandwidth

**Y-axis (channel A):** same as channel A.

**X-axis (channel B):** dc to >3 MHz.

**Deflection factor:** 10 mV/div to 5 V/div (9 calibrated positions) in 1, 2, 5 sequence.

**Phase difference between channels:** <3°, dc to 3 MHz.

#### Cathode-ray tube and controls

**Type:** post accelerator, approx. 20.5 kV accelerating potential, aluminized P31 phosphor.

**Graticule:** 8 × 10 div internal graticule. 0.2 subdivision markings on major axes. 1 div = 1 cm. Rear panel adjustment aligns trace with graticule. Internal flood gun graticule illumination.

**Beam finder:** returns trace to CRT screen regardless of setting of horizontal, vertical, or intensity controls.

**Intensity modulation:** +8 V, ≥50 ns width pulse blanks trace of any intensity, useable to 20 MHz for normal intensities. Input R, 1 kΩ ±10%. Maximum input, +10 V (dc + peak ac).

**Auto-focus:** automatically maintains beam focus with variations of intensity.

**Intensity limit:** automatically limits CRT beam current to decrease possible CRT damage. Circuit response time ensures full writing speed for viewing low duty cycle, fast rise time pulses.

**Rear panel controls:** astigmatism, pattern, main/delayed intensity ratio, and trace align.

#### General

**Rear panel outputs:** main and delayed gates, -0.7 V to +1.3 V capable of supplying approx. 3 mA.

**Calibrator:** 1 kHz ±10% square wave; 3 V p-p ±1%; <0.1 μs rise time.

**Power:** 100, 120, 220, 240 V, -10%, +5%; 48 to 440 Hz; 110 VA max.

**Weight:** net, 13.6 kg (30 lb). Shipping, 19.5 kg (43 lb).

**Operating environment:** temperature, 0 to +55°C (+32°F to +130°F); humidity, to 95% relative humidity at +40°C (+104°F); altitude, to 4600 m (15 000 ft); vibration, vibrated in three planes for 15 min. each with 0.254 mm (0.010 in.) excursion, 10 to 55 Hz.

**Size:** 197 H × 335 W × 570 mm D with handle (7<sup>7</sup>/<sub>16</sub>" × 13<sup>11</sup>/<sub>16</sub>" × 22<sup>7</sup>/<sub>16</sub>""); 518 mm D without handle (20<sup>7</sup>/<sub>16</sub>").

**Accessories furnished:** one blue light filter; one front panel cover; one vinyl storage pouch; one 2.3 m (7.5 ft) power cord; two 10017A 10:1 divider probes; one Operating and Service Manual.

#### Recommended probes

**Divider probes for 1 megohm inputs:** 10014A, 10016B, 10017A, 10018A.

**Divider probe for 50 ohm inputs:** 10020A resistive divider.

**Active probes for 50 ohm inputs:** 1120A, and 1125A.

#### Options

**001:** U.S. fixed line cord

Price  
add \$15

**003:** probe power supply with two rear panel jacks for use with HP active probes. Provides power to operate two 1120A, 1124A, or 1125A active probes

add \$50  
less \$150

**090:** without probes

**091:** two 2 m (6.6 ft) 10018A, 10:1 probes in lieu two 10017A miniature probes

N/C

**092:** two 1.8 m (6 ft) 10016B, 10:1 probes in lieu of two miniature probes

N/C

**101:** logic state display interface for operation with Model 1607A Logic State Analyzer

add \$150

**910:** additional Operating and Service Manual

add \$27

#### Logic state analysis equip required for Opt 101

**1607A:** 16-Bit Logic State Analyzer includes three data probes and one clock probe.

\$2900

**Four 10502A:** 23 cm (9") cables. Three for X, Y, and Z interconnections and one for pattern triggering connection to the oscilloscope.

\$15 ea

**HP P/N 5081-1213 Adapter Plate and Strap** for mounting the 1722B on top of the 1607A.

\$23

#### Ordering information

1722B 275 MHz Oscilloscope with Microprocessor

\$4900

# OSCILLOSCOPES

## 200 MHz & 275 MHz $\Delta$ time Measurements

### Models 1715A & 1725A



Except for the bandwidth and volts/div control the Model 1715A Opt 034 is identical in appearance to the Model 1725A Opt 034 in this photo. Opt 034 offers direct LED readout of time interval measurements or ac and dc voltage or current and resistance measurements. Without Opt 034 the 1715A and 1725A offer delta time measurements using the calibrated time interval stop control and provide a scaled voltage rear panel output compatible with most DMM's.

### 1715A, 1725A Description

Hewlett-Packard's Models 1725A, 275 MHz, and 1715A, 200 MHz oscilloscopes offer improved dual channel, delta time measurements with the optional DMM for direct delta time readout and current, voltage, or resistance measurements. Vertical deflection factors of 10 mV/div to 5 V/div over the full bandwidth (5 mV/div to 150 MHz in the 1715A) offer the high performance required for both laboratory and field applications.

A large 8 x 10 cm display provides easy viewing of dual trace signals on which timing measurements can be made conveniently and accurately using the Hewlett-Packard developed delta time technique. For easier percentage measurements, reference lines of 0 and 100% amplitude are 5 divisions apart and markings for 10 and 90% and 20 and 80% are also provided for easier rise time measurements.

The 1715A or 1725A State Display Option 101 combined with the 1607A Logic State Analyzer provides convenient digital circuit analysis with the ability to quickly switch between logic state and electrical analysis.

#### Delta time measurements

These oscilloscopes offer two methods for making timing measurements: one is standard delayed sweep, using one intensified marker and the calibrated delay vernier knob to accurately measure time relationship; the second is the Hewlett-Packard developed system of dual intensified markers which significantly improves accuracy while conveniently reducing the time necessary to make a measurement. The latter, better known as the Delta Time measurement method, incorporates a system of two intensified markers which are two delayed sweeps displayed alternately.

The Delta Time measurement technique is to select the Main Intensified mode and position the first marker at  $t_1$  with the Time Interval Start control and position the second marker at  $t_2$  with the Time Interval Stop control. The difference between the two selected points is then read directly on the optional DMM or is available as a rear panel scaled voltage output compatible with most DMM's. Units of seconds, milliseconds, or microseconds are read on the Main Time/Div control.

This Delta Time technique makes timing measurements such as transition times, propagation delay, clock phasing, and other high-speed digital timing measurements faster and with more repeatability than was previously possible with standard delayed sweep oscilloscopes. Time interval measurements can be made between two events on channel A, two events on channel B, or between two events on alternate channels.

For increased resolution, Delayed Sweep mode is selected where the two intensified portions are displayed alternately. Maximum accuracy is achieved by superimposing the start and stop points using the Time Interval Stop control. Even without an external voltmeter and using only the Time Interval Stop control, this optical nulling technique reduces the chance of error in time interval measurements.

For added convenience, the Delta Time Capability can be selected with the time interval start marker on channel A or channel B. This eliminates the switching of probes when making interchannel measurements.

#### Optional direct delta time readout

The ability to add an optional 3 1/2 digit autoranging DMM to the basic oscilloscope enhances the ability to make timing measurements accurately and with convenience. Since the basic Delta Time

capability is contained in these Oscilloscopes. The optional DMM is available initially as Option 034 or can be ordered later as a field installable kit (P/N 01715-69501). With a flip of the switch on the oscilloscope, you can use the DMM to measure ac voltage, dc voltage, ac current, dc current, and resistance.

## 1725A, 1715A Specifications

### Vertical display modes

**Channel A; channel B:** channels A and B displayed alternately on successive sweeps (ALT); channels A and B displayed by switching between channels at approx 1 MHz rate with blanking during switching (CHOP); channel A plus channel B (algebraic addition); X-Y (channel A vs channel B).

### Vertical amplifiers (2)

**Bandwidth:** 3 dB down from a 6 div reference signal.

**DC-Coupled (1725A):** dc to 275 MHz in both 50 ohm and high impedance input modes.

**DC-Coupled (1715A):** dc to 200 MHz in both 50 ohm and high impedance input modes 10 mV/div to 5 V/div, to 150 MHz at 5 mV/div.

**AC-Coupled:** lower limit is approx 10 Hz.

**Bandwidth limit:** limits upper bandwidth to approx 20 MHz.

### Rise time

**1725A:** <1.3 ns.

**1715A:** <1.75 ns 10 mV/div to 5 V/div, <2.3 ns at 5 mV/div.

### Deflection factor

**Ranges (1725A):** 10 mV/div to 5 V/div (9 calibrated positions) in 1, 2, 5 sequence,  $\pm 2\%$  attenuator accuracy.

**Vernier:** continuously variable between all ranges; extends maximum deflection factor to at least 12.5 V/div. Front panel indicator lights when vernier is not in CAL position.

**Polarity:** channel B may be inverted, front panel pushbutton.

**Signal delay:** input signals are delayed sufficiently to view leading edge of input pulse without advanced trigger.

**Input coupling:** selectable, AC or DC, 50 ohms (dc) or ground. Ground position disconnects input connector and grounds amplifier input.

### Input RC (selectable)

**AC and DC:** 1 megohm  $\pm 2\%$  shunted by approx 11 pF.

**50 Ohm:** 50 ohms  $\pm 2\%$ ; SWR (1725A)  $\leq 1.3$  on 10, 20, and 50 mV ranges and  $< 1:15$  on all other ranges; SWR (1715A)  $\leq 1.3$  on 5, 10, 20, and 50 mV ranges and  $< 1:15$  on all other ranges.

### Maximum input

**AC and DC:**  $\pm 250$  V (dc + peak ac) at 1 kHz or less.

**50 Ohm:** 5 V rms.

### A + B operation

**Amplifier:** bandwidth and deflection factors are unchanged; channel B may be inverted for A—B operation.

**Differential (A—B) Common Mode:** CMR is at least 40 dB from dc to 5 MHz decreasing to 26 dB at 50 MHz. Common mode signal amplitude equivalent to 12 cm with one vernier adjusted for optimum rejection.

### Trigger source

Selectable from channel A, channel B, or Composite.

**Channel A:** all display modes triggered by channel A signal.

**Channel B:** all display modes triggered by channel B signal.

**Composite:** all display modes triggered by displayed signal.

### Vertical output

**Amplitude:** one division of vertical deflection produces approx 100 mV output, dc to 50 MHz in 1725A, dc to 25 MHz in 1715A.

**Cascaded deflection factor:** 1 mV/div with both vertical channels set to 10 mV/div.

**Cascaded bandwidth:** dc to 5 MHz with bandwidth limit engaged.

**Source resistance:** approx 100 ohms.

**Source selection:** trigger source set to channel A selects channel A output, to channel B selects channel B output.

### Horizontal display modes

Main, main intensified, delayed, mixed, X-Y, and mag X10. In main intensified, mixed, and delayed modes, selectable delta time with channel A start or channel B start time interval measurements are available.

### Main time base

#### Sweep

**Ranges:** 10 ns/div to 0.5 s/div (24 ranges) 1, 2, 5 sequence.

#### Accuracy

Main Sweep Time/Div	Accuracy (0°C to +55°C)	
	$\times 1$	$\times 10$
10 ns to 50 ns	$\pm 3\%$	$\pm 5\%$
100 ns to 20 ms	$\pm 2\%$	$\pm 3\%$
50 ms to 0.5 s	$\pm 3\%$	$\pm 3\%$

**Vernier:** continuously variable between all ranges; extends slowest sweep to at least 1.25 s/div. Vernier uncalibrated indicator lights when vernier is not in CAL position.

**Magnifier:** extends all sweeps by a factor of 10; extends fastest sweep to 1 ns/div.

#### Sweep mode

**Normal:** sweep is triggered by internal or external signal.

**Automatic:** bright baseline displayed in absence of input signal. Triggering is same as normal above 40 Hz.

**Single:** in Normal mode, sweep occurs once with same triggering as normal, reset pushbutton arms sweep and lights indicator; in Auto mode, sweep occurs once each time Reset pushbutton is pressed.

#### Triggering (1725A)

**Internal:** dc to 100 MHz on signals causing 0.5 division or more vertical deflection, increasing to 1 division of vertical deflection at 300 MHz in all display modes. Triggering on line frequency is also selectable.

**External:** dc to 100 MHz on signals of 50 mV p-p or more increasing to 100 mV p-p at 300 MHz. Maximum input,  $\pm 250$  V (dc + peak ac) at 1 kHz or less.

#### Triggering (1715A)

**Internal:** dc to 100 MHz on signals causing 0.5 division or more vertical deflection, increasing to 1 division of vertical deflection at 200 MHz in all display modes. Triggering on line frequency is also selectable.

**External:** dc to 100 MHz on signals of 50 mV p-p or more increasing to 100 mV p-p at 200 MHz. Maximum input,  $\pm 250$  V (dc + peak ac) at 1 kHz or less.

**External Input RC:** approx 1 megohm shunted by approx 15 pF.

#### Triggering level and slope

**Internal:** at any point on the vertical waveform displayed.

**External:** continuously variable from +1.0 V to -1.0 V on either slope of the trigger signal, +10 V to -10 V in divide by 10 mode ( $\pm 10$ ).

#### Coupling: AC, DC, LF REJ, or HF REJ.

**AC:** attenuates signals below approx 10 Hz.

**LF Reject:** attenuates signals below approx 7 kHz.

**HF Reject:** attenuates signals above approx 7 kHz.

**Trigger holdoff:** time between sweeps continuously variable, exceeding one full sweep from 10 ns/div to 50 ms/div.

#### Main Intensified

**Delayed Sweep:** intensifies that part of main time base to be expanded to full screen in delayed time base mode. Stop control adjusts position of intensified portion of sweep. Rear panel intensity ratio control sets relative intensity of brightened segment.

**$\Delta$ Time mode:** intensifies two parts of main time base to be expanded to full screen in delayed time base mode. "START" control positions the first intensified portion of the sweep; "STOP" control positions the second intensified portion of the sweep. Rear panel intensity control sets relative intensity of brightened segments.

#### Delayed time base

##### Sweep

**Ranges:** 10 ns/div to 20 ms/div (20 ranges) in 1, 2, 5 sequence.

**Accuracy (0°C to +55°C):** same as main time base.

**Magnifier (0°C to +55°C):** same as main time base.

##### Triggering

**Internal:** same as main time base except there is no Line Frequency triggering.



## Models 1715A &amp; 1725A (cont.)

**Starts After Delay:** delayed sweep automatically starts at end of delay period.

**Trigger:** with delayed trigger level control out of detent (starts after delay) delayed sweep is triggerable at end of delay period.

**External:** dc to 100 MHz on signals of 50 mV p-p or more, increasing to 100 mV p-p at 200 MHz. Maximum input,  $\pm 250$  V (dc + peak ac) at 1 kHz or less.

**External Input RC:** approx 1 megohm shunted by approx 15 pF.

**Trigger level and slope**

**Internal:** at any point on the vertical waveform displayed when in triggered mode.

**External:** continuously variable from +1.0 V to -1.0 V on either slope of the trigger signal. +10 V to -10 V in divide by 10 mode ( $\pm 10$ ).

**Coupling:** AC, DC, LF REJ, or HF REJ.

**AC:** attenuates signals below approx 10 Hz.

**LF Reject:** attenuates signals below approx 7 kHz.

**HF Reject:** attenuates signals above approx 7 kHz.

**Delay time range:** 0.5 to 10X Main Time/Div settings of 20 ns to 0.5 s (minimum delay 50 ns).

**Differential time measurement accuracy**

Main Time Base Setting	Accuracy - (+15°C to -35°C)
50 ns/div to 20 ms/div	$\pm 0.5\%$ $\pm 0.1\%$ of full scale
20 ns/div	$\pm 1\%$ $\pm 0.2\%$ of full scale
50 ms/div to 0.5 s/div	$\pm 3\%$

**Delay jitter:** <0.005% (1 part in 20 000) of maximum delay in each step.

**Time Interval ( $\Delta$ time mode)**

**Function:** measures time interval between two events on channel A (channel A display); between two events on channel B (channel B display); or between two events starting from an event on either channel A or B and ending with an event on either channel A or B (alternate display).

**Time interval output voltage:** varies from 50 V to 100 mV full scale. Full scale output voltage can be determined by multiplying the number on the TIME/DIV dial by 10 V (e.g., 0.05 s, 0.05 ms, or 0.05  $\mu$ s per div gives 0.5 V output full-scale).

**Accuracy:** measurement accuracy is the Time Interval Accuracy plus the external DVM accuracy.

Main Time Base Setting	Accuracy + (+20°C to +30°C)
100 ns/div to 20 ms/div	$\pm 0.5\%$ of reading $\pm 0.05\%$ of fs
50 ns/div	$\pm 0.5\%$ of reading $\pm 0.1\%$ of fs
20 ns/div	$\pm 0.5\%$ of reading $\pm 0.2\%$ of fs
50 ms/div to 0.5 s/div	$\pm 3\%$

\*Starting after 60 ns of sweep

**- Stability (0°C to +55°C):** short-term 0.005%. Temperature,  $\pm 0.03\%/^{\circ}\text{C}$  deviation from calibration temperature range.

**Mixed time base**

Dual time base in which the main time base drives the first portion of sweep and the delayed time base completes the sweep at the faster delayed sweep. Also operated in single sweep mode.

**X-Y operation****Bandwidth**

**Y-Axis (channel A):** same as channel A.

**X-Axis (channel B):** dc to >1 MHz.

**Deflection factor:** 5 mV/div to 5 V/div (10 calibrated positions) in 1, 2, 5 sequence.

**Phase difference between channels:** <3°, dc to 1 MHz.

**Cathode-ray tube and controls**

**Type:** post accelerator, approx 20.5 kV accelerating potential, aluminized P<sub>31</sub> phosphor.

**Graticule:** 8  $\times$  10 div internal graticule, 0.2 subdivision markings on

major horizontal and vertical axes. 1 div = 1 cm. Rear panel adjustment aligns trace with graticule. Internal floodgun graticule illumination.

**Beam flinder:** returns trace to CRT screen regardless of setting of horizontal, vertical, or intensity controls.

**Intensity modulation (Z-axis):** +8 V,  $\geq 50$  ns width pulse blanks trace of any intensity, usable to 20 MHz for normal intensities. Input R, 1 k $\Omega$   $\pm 10\%$ . Maximum input,  $\pm 10$  V (dc + peak ac).

**Auto-focus:** automatically maintains beam focus with variations of intensity.

**Intensity limit:** automatically limits beam current to decrease possibility of CRT damage. Circuit response time ensures full writing speed for viewing low duty cycle, fast rise time pulses.

**Rear panel controls:** astigmatism, pattern, main/delayed intensity ratio, and trace align.

**General**

**Rear panel outputs:** main and delayed gates, -0.7 V to +1.3 V capable of supplying approx 3 mA.

**Calibrator:** type, 1 kHz  $\pm 15\%$  square wave; 3 V p-p  $\pm 1\%$ , <0.1  $\mu$ s rise time.

**Power:** 100, 120, 220, and 240 Vac, -10% +5%, 48 to 440 Hz; 110 VA max

**Weight:** net, 12.9 kg (28.5 lb); shipping, 17.9 kg (39.5 lb).

**Operating environment:** temperature, 0°C to +55°C (+32°F to +130°F); humidity, to 95% relative humidity at +40°C (+104°F); altitude, to 4600 m (15 000 ft); vibration, vibrated in three planes for 15 min, each with 0.254 mm (0.010 in.) excursion, 10 to 55 Hz.

**Size:** 170 H  $\times$  335 W  $\times$  570 mm D with handle; 502 mm D without handle (7 $\frac{3}{4}$ "  $\times$  13 $\frac{1}{16}$ "  $\times$  22 $\frac{7}{16}$ ", 18 $\frac{1}{8}$ ").

**Accessories furnished:** one blue light filter; one front panel cover; two, 2 m (6.6 ft) 10018A miniature 10:1 divider probes with 1715A; two 1 m (3.3 ft) 10017A miniature 10:1 divider probes with 1725A; one 2.3 m (7.5 ft) power cord; one vinyl storage pouch; one Operating and Service Manual, and one kit (HP P/N 8120-2521) containing two test leads with Opt 034, 035.

**Options and accessories**

**Time Interval multimeter kit:** (HP P/N 01715-69501) adapts a standard Model 1715A or 1725A to an Opt 034, built-in, LED readout, delta time oscilloscope. The kit includes a multimeter, a new top oscilloscope cover, a vinyl storage pouch, and mounting hardware for fast installation.

**001:** fixed line power cord

**003:** probe power supply with two rear panel jacks for use with HP active probes. Provides power to operate two 1120A, 1124A, or 1125A active probes

**034:** built-in DMM (60 Hz operation)

**035:** built-in DMM (50 Hz operation)

**090:** without probes

**091 (1725A):** two 2 m (6.6 ft) 10018A, 10:1 probes substituted for two 10017A miniature probes

**091 (1715A):** two 1 m (3.3 ft) 10017A, 10:1 probes substituted for two 10018A miniature probes

**092:** two 1.8 m (6 ft) 10016B, 10:1 probes substituted for two miniature probes

**101:** STATE DISPLAY, single switch interface option for operation with the HP Model 1607A Logic State Analyzer. Adds interface circuits for switching between front panel inputs and rear panel logic state inputs.

**Logic state analysis equipment required for Option 101**

**1607A:** 16-bit Logic State Analyzer including three data probes and one clock probe

**Four 10502A:** 23 cm (9 in.) cables. Three for X, Y, and Z interconnections and one for pattern triggering connection to the oscilloscope

**HP P/N 5061-1213:** Adapter plate and strap for mounting the 1715A or 1725A on top of 1607A

**Ordering Information**

1725A 275 MHz Oscilloscope

1715A 200 MHz Oscilloscope

Price

\$375  
add \$15

add \$50

add \$325

add \$325

less \$150

N/C

N/C

N/C

N/C

N/C

N/C

N/C

add \$150

\$2900

\$15 ea

\$21

\$3300

\$3000

## 100 MHz, dual channel, crystal $\Delta$ time, storage Models 1740A, 1741A & 1743A

- Dual channel, 5 mV/div to 100 MHz
- 3rd Channel trigger view
- Selectable input impedance

- 100 cm/ $\mu$ s storage writing speed (1741A)
- Single shot auto-store (1741A)
- Auto-erase (1741A)
- High resolution time interval measurements (1743A)

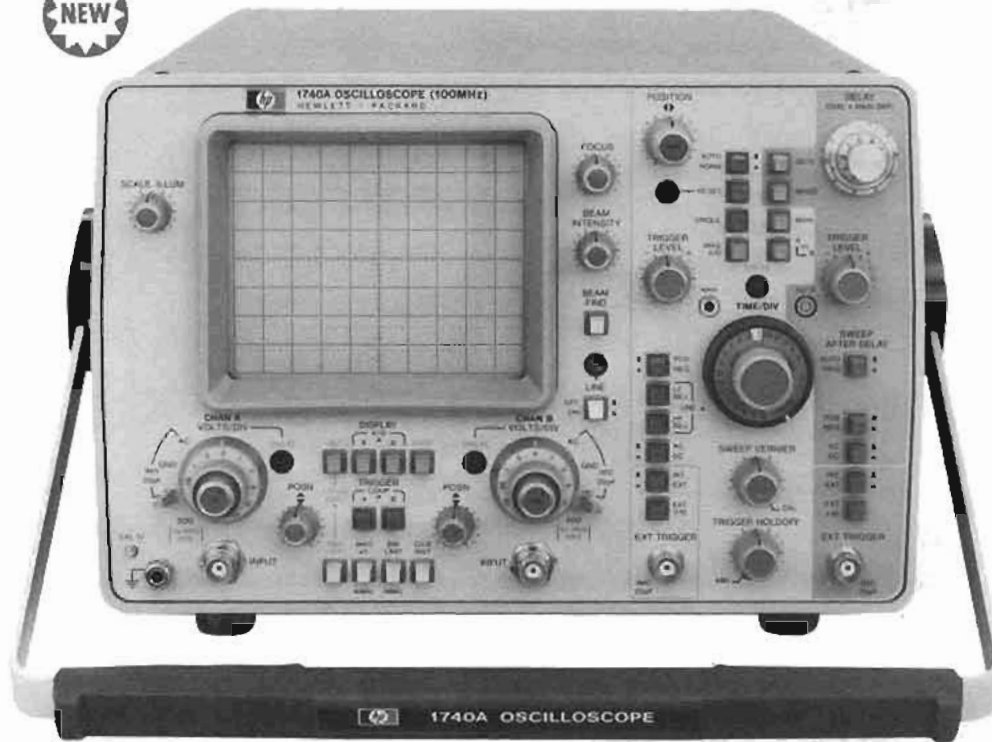

### 1740A, 1741A, 1743A (new) Description

#### Introduction

The Hewlett-Packard Model 1740A, 1741A, and 1743A 100 MHz, 5 mV/div, dual-channel oscilloscopes offer the high performance necessary to meet the demanding requirements of both laboratory and field applications. These oscilloscopes have the performance and features to make accurate measurements with ease. The carefully designed front panel includes a large, high-resolution CRT with logically arranged controls which reduce operator learning time and make repetitious measurements easier. Several features that make these oscilloscopes more versatile than the average 100 MHz portable oscilloscopes include a third channel trigger view for viewing the external trigger signal with both vertical channels; a X5 vertical magnifier for 1 mV/div deflection factors on both channels; selectable input impedance (1 M $\Omega$ /50 $\Omega$ ) for general purpose probing and precise rise time measurement; and a Logic State Display option for convenient switching between logic state and electrical analysis.

#### 1740A, 1743A 8 $\times$ 10 cm CRT

The CRT has a crisp, bright trace over the fully specified 8  $\times$  10 cm display area. An accelerating potential of 15 kV makes the display compatible with the 5 ns/cm sweep speeds for easier viewing of low rep rate, fast transition time signals. The small spot size of the lab quality CRT along with the no parallax internal graticule makes critical and difficult timing measurements easier to perform. An internal floodgun uniformly illuminates the CRT phosphor for high quality trace photos with a sharp well defined internal graticule.

#### 1741A Storage CRT

The Hewlett-Packard storage and variable persistence CRT offers a well defined trace with a storage writing speed of greater than 100 cm/ $\mu$ s and a burn resistant storage surface which is ideal for digital and general purpose applications. Storage operation is extremely easy with indicators that clearly show the mode of operation. A press of the store pushbutton automatically switches the

1741A to a deep store mode, with no screen illumination, for maximum storage time. Another press of the store pushbutton displays the stored trace.

For viewing low rep rate fast rise time signals, the variable persistence mode allows you to adjust the trace for an optimum display. By adjusting the persistence to match the rep rate you can integrate a trace to provide a sharp, clear display for accurate measurements of low duty-cycle pulse trains such as those from disc, tape, or drum peripheral units.

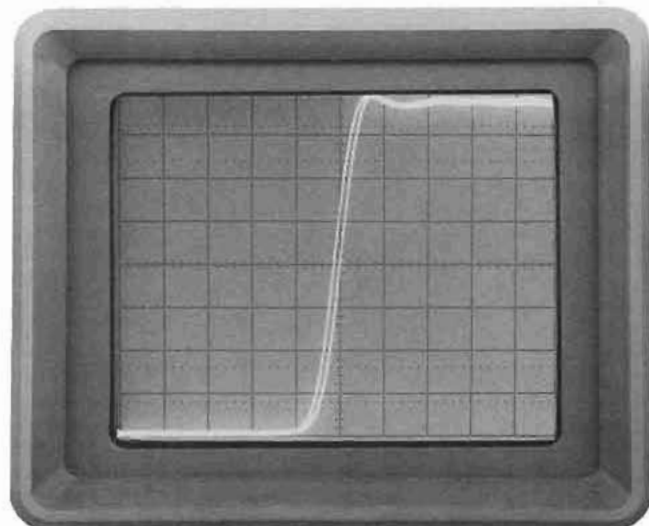

Exceptionally fine 1741A trace in the variable persistence mode permits high resolution timing measurements as shown with this dual trace, alternate display at a sweep speed of 5 ns/div.

Models 1740A, 1741A &amp; 1743A (cont.)



For maximum convenience in single-shot applications, an auto-store mode which operates in the single-shot mode, makes it easy to capture random events. To prevent the possibility of recording the wrong event, the 1741A automatically switches to the Normal triggering mode when single-shot mode of operation is selected. When your event occurs, the 1741A triggers and automatically switches from the Write mode to the Store mode which is shown by the indicators. To view the signal, a press of the Store/Display pushbutton displays your trace. For convenience, a push of the Erase pushbutton erases the CRT and resets the time base.

An auto-erase mode allows the 1741A to operate as if it is in a repetitive, single-shot mode even when a continuous signal is available. When in the auto-erase mode, the 1741A automatically switches to maximum persistence which provides maximum trace retention between erasures. This mode is convenient for setup of single-shot events by making it easier to obtain the optimum focus and intensity for a particular signal. Additionally, if you are displaying more than one trace, such as two or three channels, the 1741A will wait for the required number of sweeps to be displayed before automatically erasing the display.

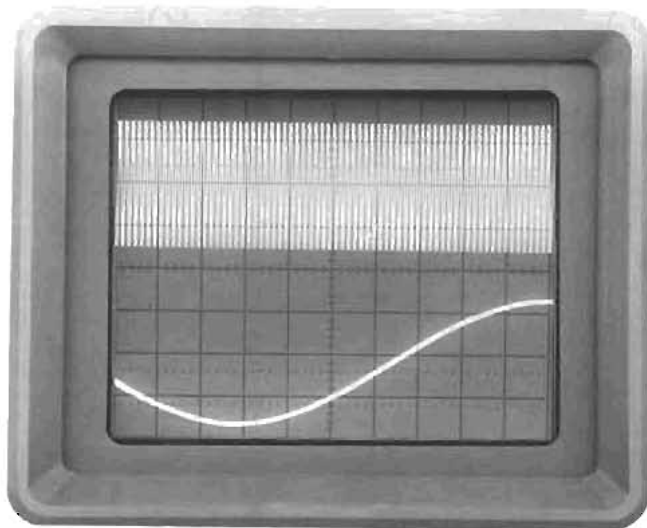

Third channel trigger view of the external trigger signal offers measurement convenience with the center screen threshold. The 2.5 ns fixed delay between the external trigger input and the displayed signal permits easier timing measurements.

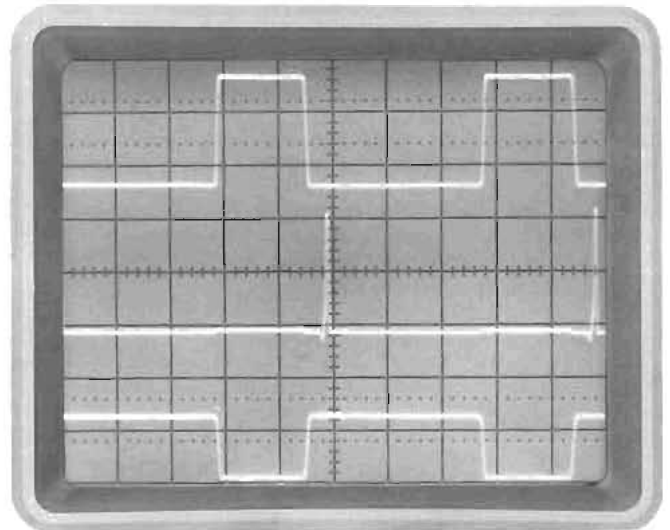

Triggering ability on two signals widely separated in frequency is clearly shown with these signals which have a ratio of 1000 to 1 while triggering in the composite mode.





**3rd channel trigger view**

In many applications, especially in digital circuits, it is necessary to use external trigger sources to maintain proper timing relationships and to know the time relationship of the trigger signal to the displayed events. By pressing the Trigger View pushbutton while in alternate or chop mode, the external trigger signal is displayed as a third channel with the trigger threshold at center screen. By adjusting the trigger level control, you can see which portion of the trigger signal is initiating the sweep. With the External Trigger input in the 1:1 mode, the deflection factor is 100 mV/div which is compatible with ECL levels and in the  $\times 10$  mode is 1 V/div which is compatible with TTL levels.

**Stable flexible triggering**

Stable internal triggering to greater than 100 MHz requires only 1 div of vertical deflection. To prevent annoying trace shift, the internal trigger sync take-off is immediately after the attenuator which maintains a stable display regardless of changes in position, vernier, or polarity controls. A full complement of easy-to-use pushbutton trigger controls assures you of the desired trigger signal conditioning for your measurement. In the external mode, triggering to 100 MHz only requires 100 mV and 50 mV to 50 MHz.

**Selectable Input Impedance**

For maximum measurement flexibility, these scopes have switch-selectable 1 megohm or 50 ohm inputs. This permits a high input impedance for general purpose probing with 10:1 divider probes for minimum circuit loading. The 50 ohm input with internal compensation and low reflections provides faithful pulse reproduction for accurate transition time measurements in circuits where low capacitive loading is required.

**Vertical amplifiers**

Vertical deflection factors are 5 mV/div to 20 V/div over the full 100 MHz bandwidth, full temperature range, and  $8 \times 10$  div display area with 3% attenuator accuracy. For two channel low level measurements requiring 1 mV/div and 2 mV/div deflection factors to 30 MHz (40 MHz in the 1740A), a  $\times 5$  magnifier is included which eliminates the need for cascading. This low level capability permits measurements on tape and disc heads or power supply ripple with a convenient front panel pushbutton. The 20 V/div setting allows you to make convenient measurements of power line signals while using standard 10:1 divider probes.

**Serviceability**

Access to the uncluttered interior for calibration and servicing is fast with the easy-to-remove covers. Innovations in circuit design

along with custom integrated hybrid circuits reduce calibration time because of a minimum of adjustments. Wire harnesses and interconnection cables between boards are reduced with an interface board which connects the main boards together. This interface board helps to reduce service time and reassembly errors normally encountered with instruments containing many cables. The 1740A, 1741A, and 1743A do not require a fan or ventilating holes for convection cooling which reduces the amount of dust and dirt that can accumulate inside the scope.

**1743A Crystal accurate timing**

The 1743A incorporates a 100 MHz crystal timing reference for delta time measurements rather than the traditional analog ramp reference. This internal crystal reference offers 10 ns resolution which is enhanced with time interval averaging to produce 100 ps timing resolution. The time between the two intensified marks is displayed on a five digit LED readout with an accuracy of 0.002% plus or minus one count. For intervals of less than five microseconds the one count corresponds to plus or minus 100 ps while at intervals of greater than two microseconds the one count becomes insignificant and the accuracy can be considered to be  $\pm 0.002\%$  of reading.

**First pulse measurements**

The 1743A, by using a crystal reference, allows you to measure time intervals relative to the leading edge of the first pulse in the delayed sweep mode. This ability is particularly useful for high resolution measurements on low duty cycle pulses. Because the measurement can be made using the same pulse that triggers the main sweep, the sweep speed can be set for optimum resolution and accuracy.

**Triggered measurements**

The triggered delay mode of the 1743A offers excellent pulse width, period, and propagation delay measurement capability. The triggered delta sweep mode automatically performs the desired measurements without any of the complex operations usually needed with delayed sweep measurements. By selecting the appropriate start and stop slopes (one positive and one negative for width measurements and both the same for period measurements) you can conveniently read out the period or width measurement while directly viewing the exact trigger level at which the measurement is being made.

Also available is the ability to make duty cycle measurements quickly. In the intensified mode, measure the pulse width and period with the direct LED readout. Then a simple ratio calculation provides an accurate answer.

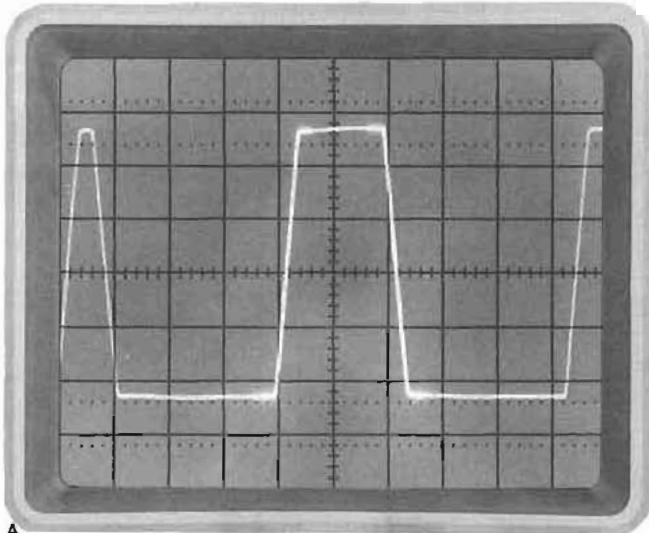

A

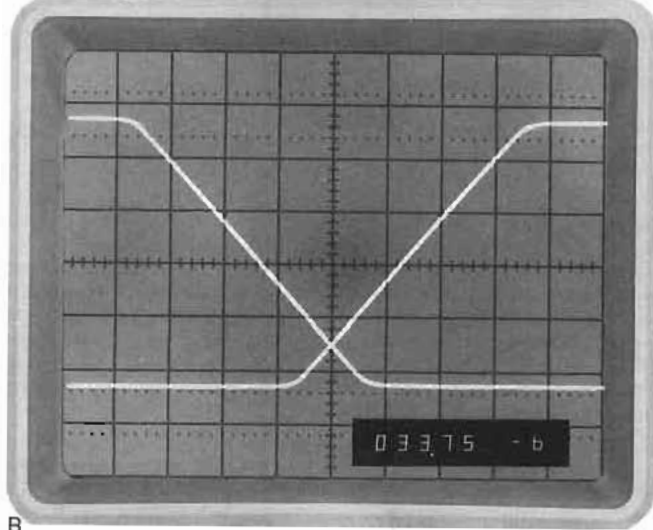

B

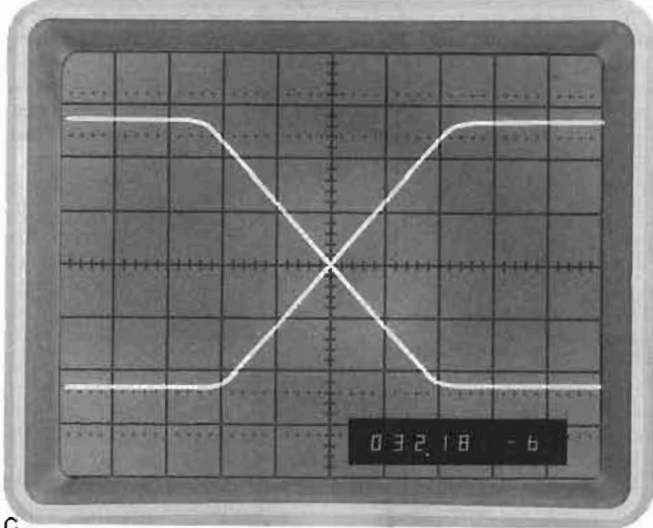

C The 1743A makes accurate timing measurements automatically in the Triggered Sweep After Delay mode. When you select the desired starting slope (positive) and stopping slope (negative) (A), the 1743A automatically overlays the traces at the signal's trigger level (B) and provides a time interval readout on the LED's of 33.75—6 seconds (33.75  $\mu$ s). The trigger level can be viewed while being adjusted to the exact level desired (C). In this example the trigger level is adjusted to the 50% points for measuring a pulse width of 32.18—6 seconds (32.18  $\mu$ s) with 0.002%  $\pm$  1 count accuracy.

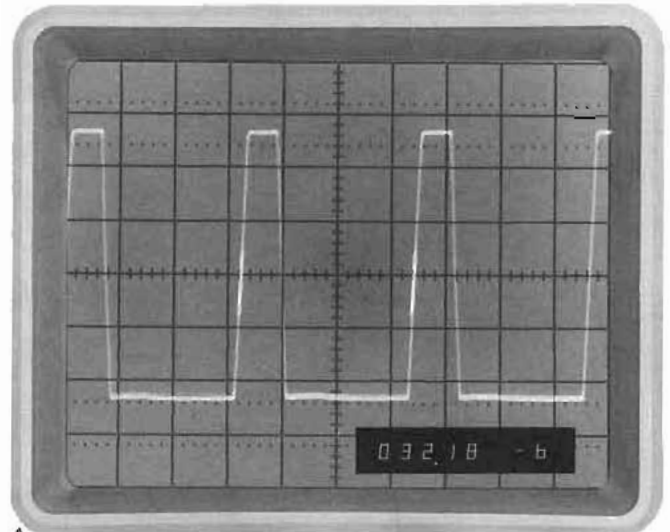

A

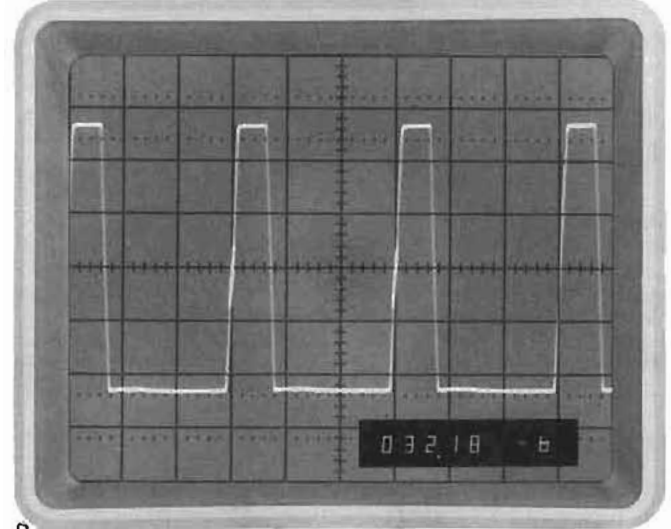

B

Model 1743A crystal timing permits you to use the sweep vernier to calibrate the CRT graticule in your system's units of operation. In this example, with the sweep vernier calibrated, the period is 32.18 microseconds (A) and with the sweep vernier uncalibrated to allow 3 major divisions to be one clock cycle, the crystal maintains the accurate delta time readout of 32.18 microseconds (B).

#### Sweep vernier

Crystal timing now allows you to use the sweep vernier out of its detent position to calibrate the CRT divisions for various measurements without uncalibrating the LED time readout. For example, you can set up the graticule lines to represent clock periods and then make two channel measurements of other signals related to the precalibrated "clock" signal.

The sweep vernier increases the display resolution by up to three times. With the vernier in detent, the resolution of a full screen display is a maximum of one part in 50 000 and with the vernier full ccw, full screen resolution is a maximum of one part in 150 000. When the measured time interval exceeds one part in 100 000 (5 digits), the LED displays two decimal points under the exponent which implies a sixth digit of one to the left of the LED display.

Another use of the uncalibrated sweep vernier is to use a faster sweep to provide more resolution of the LED readout. For example, by switching from a 1  $\mu$ s/div range to a 0.5  $\mu$ s/div range the last digit of the five digit display becomes hundreds of picoseconds instead of tens of nanoseconds. The same display of the 1  $\mu$ s/div sweep can now be obtained on the 0.5  $\mu$ s/div sweep by adjusting the sweep vernier.

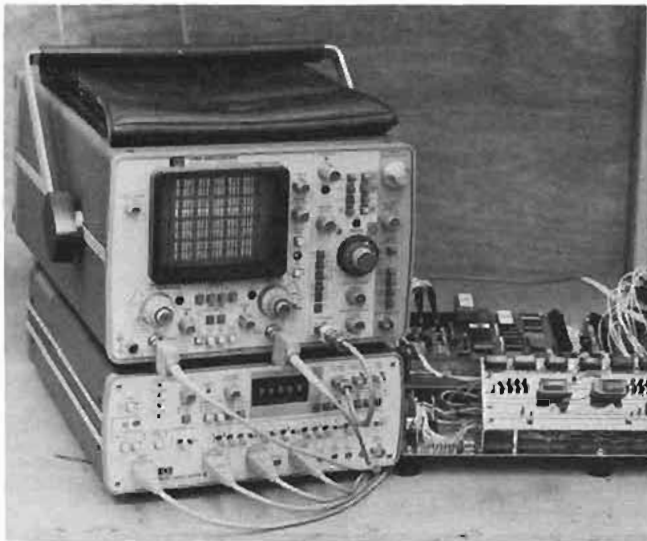

Logic State Display Option 101 offers convenient one button switching between logic state and electrical analysis without changing probe or cable connections

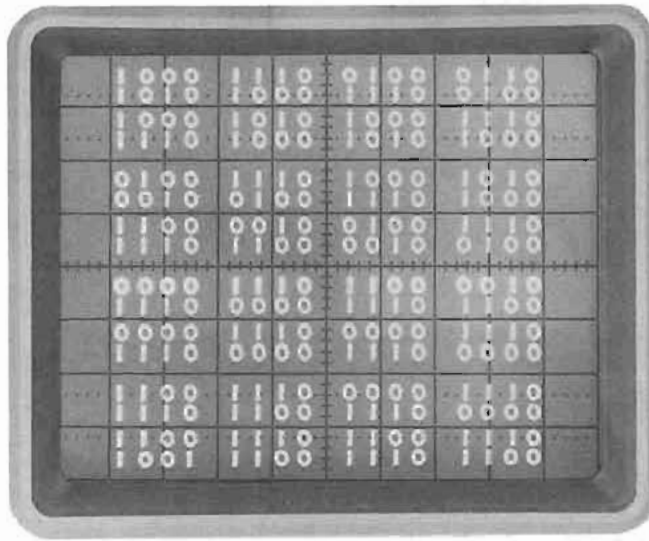

Word triggering with the Analyzer's digital memory and digital delay permits viewing events leading up to and following the trigger word for faster troubleshooting.

## Digital circuit analysis

### Logic State Display Opt 101

With the increasing use and complexity of digital circuits in new products, the debugging and troubleshooting of a digital system can be very difficult. The 1740A, 1741A, or 1743A Logic State Display Option 101, plus a 1607A Logic State Analyzer and four 10502A interconnecting cables, offer a solution to digital troubleshooting with the combination of logic state and electrical analysis. The 1740S is also available which consists of a 1740A Option 101, a 1607A, and four interconnecting cables with a bracket and strap for combining into a single package. The Logic State Display Option 101 adds rear panel inputs with internal switching circuits for single pushbutton switching between the standard front panel inputs and the rear panel state display inputs without changing cables. This single pushbutton switching capability is very useful when digital

word flow errors require analysis of electrical parameters to determine corrective measures.

The 1607A's digital Delay mode makes it possible to position the 16 word oscilloscope display window a desired number of clock pulses from the trigger word. The Delay mode coupled with the End Display mode allows you to monitor the events that lead up to and follow a fault. By comparing the algorithm with the data display, erroneous operation is quickly identified.

Switching to the electrical analysis mode permits probing of the circuit nodes to determine if an electrical problem exists that could be causing the machine to improperly execute an instruction. This internal switching between state and electrical analysis requires no resetting of controls or changing of cables.

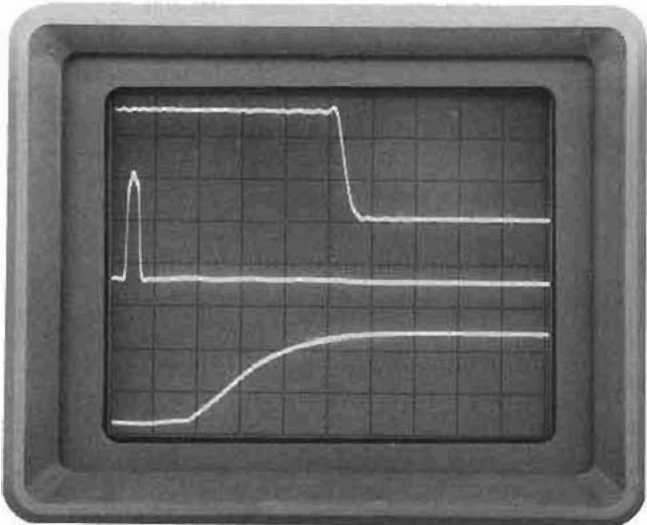

Time relationship of two very low rep rate signals is clearly shown with the variable persistence capability of the 1741A. The stable triggers required for this alternate sweep display to maintain time relationship were generated by the 1607A Logic State Analyzer.

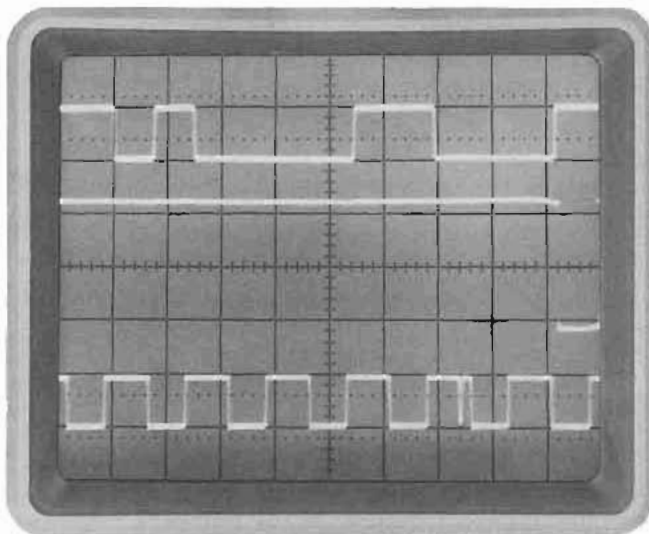

Analog display of digital data shows race condition pulse (top trace) which is defined in time by the 3rd channel trigger view. With the trigger signal defined by a 16-bit word you know when the problem occurs to reduce troubleshooting time.



## 1740A, 1741A, 1743A Specifications

### Vertical display modes

Channel A; channel B; channels A and B displayed alternately on successive sweeps (ALT); channels A and B displayed by switching between channels at an approximate 250 kHz rate with blanking during switching (CHOP); channel A plus channel B (algebraic addition); and trigger view.

**Vertical amplifiers (2)** Bandwidth and Rise Time at all deflection factors from 0°C to +55°C.

**Bandwidth:** (1740A, 1743A) 3 dB down from 8 div reference signal; (1741A) 3 dB down from 6 div reference signal.

**DC-coupled:** dc to 100 MHz in both 50 Ω and 1 M Ω input modes.

**AC-coupled:** approx 10 Hz to 100 MHz, 1 Hz with 10:1 divider probes.

**Bandwidth limit:** limits upper bandwidth to approx 20 MHz.

**Rise Time:**  $\leq 3.5$  ns measured from 10% to 90% points of a 6 div input step.

### Deflection factor

**Ranges:** 5 mV/div to 20 V/div (12 calibrated positions) in 1, 2, 5 sequence, accurate within 3%.

**Vernier:** continuously variable between all ranges, extends maximum deflection factor to at least 50 V/div. UNCAL light indicates when vernier is not in the CAL position.

**Polarity:** channel B may be inverted, front panel pushbutton.

**Delay line:** input signals are delayed sufficiently to view leading edge of input pulse without advanced trigger.

**Input coupling:** selectable AC or DC, 50 Ω (dc), or ground. Ground position disconnects input connector and grounds amplifier input.

### Input RC (selectable)

**AC or DC:** 1 M Ω  $\pm 2\%$  shunted by approx 20 pF.

**50 ohm:** 50 Ω  $\pm 3\%$ .

### Maximum input

**AC or DC:** 250 V (dc + peak ac) or 500 V p-p at 1 kHz or less.

**50 ohms:** 5 V rms.

### A + B operation

**Amplifier:** bandwidth and deflection factors are unchanged; channel B may be inverted for A-B operation.

**Differential (A-B) common mode:** CMR is at least 20 dB from dc to 20 MHz. Common mode signal amplitude equivalent to 8 divisions with one vernier adjusted for optimum rejection.

### Vertical magnification (X5)

**Bandwidth:** 3 dB down from 8 div reference signal.

**DC-coupled:** (1740A, 1743A) dc to approx 40 MHz; (1741A) dc to approx 30 MHz.

**AC-coupled:** (1740A, 1743A) approx 10 Hz to 40 MHz; (1741A) approx 10 Hz to 30 MHz.

**Rise time:** (1740A, 1743A)  $\leq 9$  ns; (1741A)  $\leq 12$  ns (measured from 10% to 90% points of 8 div input step).

**Deflection factor:** increases sensitivity of the 5 and 10 mV/div deflection factor settings by a factor of 5 with maximum sensitivity of 1 mV on channels A and B.

### Trigger source

Selectable from channel A, channel B, composite, or line frequency.

**Channel A:** all display modes triggered by channel A signal.

**Channel B:** all display modes triggered by channel B signal.

**Composite:** all display modes triggered by displayed signal except in Chop. In Chop mode trigger signal is derived from channel A.

**Line frequency:** trigger signal is derived from power line frequency.

### Trigger view

Displays internal or external trigger signal. In Alternate or Chop mode, channel A, channel B, and the trigger signals are displayed. In channel A or B mode, Trigger View overrides that channel. Internal trigger signal amplitude approximates vertical signal amplitude. Ext trigger signal deflection factor is approx 100 mV/div or 1 V/div in EXT  $\times 10$ . Triggering point is approx center screen. With identically timed signals to a vertical input and the Ext trigger input, trigger signal delay is 2.5 ns  $\pm 1$  ns (1740A, 1741A), 3.5 ns  $\pm 1$  ns (1743A).

### Horizontal display modes

Main,  $\Delta$  time (1743A), main intensified (1740A, 1741A), mixed, delayed (1740A, 1741A), mag X10, and A vs. B.

## Main and delayed time bases

### Ranges

**Main:** 50 ns/div to 2 s/div (24 ranges) in 1, 2, 5 sequence.

**Delayed:** 50 ns/div to 20 ms/div (18 ranges) in 1, 2, 5 sequence.

### Accuracy

Sweep Time/Div	Accuracy		Temp Range
	X1	X10	
50 ns to 20 ms	$\pm 3\%$ $\pm 2\%$ $\pm 3\%$	$\pm 4\%$ $\pm 3\%$ $\pm 4\%$	0°C to +15°C +15°C to +35°C +35°C to +55°C

\*Add 1% for 50 ms to 2 s ranges.

**Main sweep vernier:** continuously variable between all ranges, extends slowest sweep to at least 5 s/div. UNCAL light indicates when vernier is not in CAL position. 1743A LED readout is always calibrated.

**Magnifier (X10):** expands all sweeps by a factor of 10, extends fastest sweep to 5 ns/div.

### Calibrated sweep delay (1740A, 1741A)

**Delay time range:** 0.5 to 10  $\times$  Main Time/Div settings of 100 ns to 2 s (minimum delay 150 ns).

### Differential time measurement accuracy

Main Time Base Setting	Accuracy (+15°C to +35°C)
100 ns/div to 20 ms/div 50 ns/div to 2 s/div	$\pm (0.5\% - 0.3\% \text{ of full scale})$ $\pm (1\% - 0.7\% \text{ of full scale})$

\*Add 1% for temperatures from 0°C to +15°C and +35°C to +55°C.

**Delay jitter:**  $< 0.002\%$  (1 part in 50 000) of maximum delay in each step from +15°C to +35°C;  $< 0.005\%$  (1 part in 20 000) from 0°C to +15°C and +35°C to +55°C.

### Calibrated sweep delay (1743A)

**Delay time range:** 0 to 10  $\times$  Main Time/Div settings of 100 ns to 2 s.

### Differential time measurement accuracy

**Accuracy:**  $\pm 0.002\%$  of reading ( $\pm 1$  count from +15°C to +35°C;  $\pm 0.005\%$  of reading  $\pm 1$  count from 0°C to +15°C and +35°C to +55°C).

### Time Resolution of $\pm 1$ Count

Sweep Range/Div	$\pm 1$ Count	Averages
0.1 $\mu$ s, 0.2 $\mu$ s, 0.5 $\mu$ s	$\pm 100$ ps	10 000
1 $\mu$ s, 2 $\mu$ s, 5 $\mu$ s	$\pm 1$ ns	1000
10 $\mu$ s, 20 $\mu$ s, 50 $\mu$ s	$\pm 10$ ns	100
0.1 ms, 0.2 ms, 0.5 ms	$\pm 100$ ns	10

For intervals greater than 0.5 ms,  $\pm 1$  count becomes insignificant and the accuracy can be considered a percent of reading.

**Readout:** 5 digit LED plus exponent.

**Crystal Aging:** 0.0005% per year.

**Delay jitter:** same as 1740A, 1741A.

## Triggering

### Main sweep

**Normal:** sweep is triggered by internal or external signal.

**Automatic:** bright baseline displayed in absence of input signal. Above 40 Hz, triggering is same as normal. For stable triggering at approx 40 Hz and below, use Normal triggering.

**Single:** automatically switches triggering to Normal and the sweep occurs once with same triggering as Normal, reset pushbutton arms sweep and lights indicator. (1741A) Single sweep is also initiated with Erase pushbutton, sweep is armed after the erase cycle.

**Internal:** dc to 25 MHz on signals causing 0.3 div (1740A, 1741A), 0.5 div (1743A) or more vertical deflection, increasing to 1 div (1740A, 1741A), 1.5 div (1743A) of vertical deflection at 100 MHz in all display modes (required signal level is increased by 2 when in Chop mode and by 5 when X5 vertical magnifier is used). Triggering on line frequency is also selectable.

**External:** dc to 50 MHz on signals of 50 mV p-p (1740A, 1741A), 65 mV p-p (1743A) or more, increasing to 100 mV p-p (1740A, 1741A), 150 mV p-p (1743A) at 100 MHz (required signal level is increased by 2 when in Chop mode).

### Delayed sweep (sweep after delay)

**Auto:** delayed sweep automatically starts at end of delay period.

**Trig:** delayed sweep is armed and triggerable at end of delay period.

**Internal:** dc to 25 MHz on signals causing 0.3 div (1740A, 1741A), 1 div (1743A) or more vertical deflection, increasing to 1 div (1740A, 1741A), 2 div (1743A) of vertical deflection at 100 MHz in all display modes (required signal level is increased by 2 when in Chop mode and by 5 when X5 vertical magnifier is used).

**External:** dc to 50 MHz on signals of 50 mV p-p (1740A, 1741A), 100 mV p-p (1743A) or more increasing to 100 mV p-p (1740A, 1741A), 200 mV p-p (1743A) at 100 MHz (required signal level is increased by 2 when in Chop mode).

**External Input RC:** approx 1 M $\Omega$  shunted by approx 20 pF.  
**Maximum external Input:** 250 V (dc + peak ac) or 500 V p-p at 1 kHz or less.

**Level and slope**

**Internal:** at any point on the positive or negative slope of the displayed waveform.

**External:** continuously variable from +1 V to -1 V on either slope of the trigger signal, +10 V to -10 V in divide by 10 mode ( $\pm 10$ ).

**Coupling:** AC, DC, LF REJ, or HF REJ.

**AC:** attenuates signals below approx 20 Hz.

**LF Reject (main sweep):** attenuates signals below approx 4 kHz.

**HF Reject (main sweep):** attenuates signals above approx 4 kHz.

**Trigger holdoff (main sweep):** increases sweep holdoff time in all ranges.

**Calibrated mixed time base**

Dual time base in which the main time base drives the first portion of sweep and the delayed time base completes the sweep at the faster delayed sweep. Also operates in single sweep mode. Accuracy, add 2% to main time base accuracy.

**A vs. B operation**

**Bandwidth**

**Channel A (Y-axis):** same as channel A.

**Channel B (X-axis):** dc to 5 MHz.

**Deflection factor:** 5 mV/div to 20 V/div (12 calibrated positions) in 1, 2, 5 sequence.

**Phase difference between channels:** <3 $^\circ$ , dc to 100 kHz (75 kHz, 1743A).

**Cathode-ray tube and controls (1740A, 1743A)**

**Type:** Hewlett-Packard, 12.7 cm (5 in.) rectangular CRT, post accelerator, approx 15 kV accelerating potential, aluminized P31 phosphor.

**Graticule:** 8  $\times$  10 div (1 div = 1 cm) internal non-parallax graticule, 0.2 subdivision markings on major horizontal and vertical axes and markings for rise time measurements. Internal floodgun graticule illumination.

**Beam finder:** returns trace to CRT screen regardless of setting of horizontal, vertical, or intensity controls.

**Z-axis Input (Intensity modulation):** +4 V,  $\geq 50$  ns width pulse blanks trace of any intensity, usable to  $\leq 10$  MHz for normal intensity. Input R, 1 k $\Omega$   $\pm 10\%$ . Maximum input  $\approx 20$  V (dc + peak ac).

**Rear panel controls:** astigmatism and trace align.

**Cathode-ray tube and controls (1741A)**

**Type:** Hewlett-Packard, 12.7 cm (5 in.) rectangular CRT, post accelerator, approx 7.5 kV accelerating potential, aluminized P31 phosphor.

**Graticule:** 8  $\times$  10 div (1 div = 0.85 cm) internal, non-parallax graticule, 0.2 subdivision markings on major horizontal and vertical axes, with markings for rise time measurements. Graticule illumination is achieved with Persistence control set to minimum.

**Beam finder:** returns trace to CRT screen regardless of setting of horizontal and vertical controls.

**Z-axis Input (Intensity modulation):** +4 V,  $\geq 50$  ns width pulse blanks trace of any intensity, usable to  $\leq 10$  MHz for normal intensity. Input R, 1 k $\Omega$   $\pm 10\%$ . Maximum input  $\approx 20$  V (dc + peak ac).

**Operating modes:** write, store, display, auto-store, auto-erase, and conventional (rear panel control).

**Persistence**

**Variable:** approx 100 ms to 1 min.

**Conventional:** natural persistence of P31 phosphor (approx 40  $\mu$ s).

**Storage writing speed:**  $\geq 100$  cm/ $\mu$ s (118 div/ $\mu$ s) over center 7  $\times$  9 div (with viewing hood).

**Storage time**

**Display mode:** at least 10s at 22 $^\circ$ C.

**Store mode:** at least 30s at 22 $^\circ$ C.

**Brightness:** approx 170 cd/m $^2$  (50 f) increasing to approx 340 cd/m $^2$  (100 f) depending on brightness control setting.

**Erase time:** approx 300 ms.

**Rear panel controls:** astigmatism, trace align, conventional pushbutton, and view time.

**General**

**Rear panel outputs:** main and delayed gates, 0.8 V to  $> +2.5$  V capable of supplying approx 5 mA.

**Amplitude calibrator (0 $^\circ$ C to +65 $^\circ$ C)**

Output voltage	1 V p-p into $\geq 1$ M $\Omega$ 0.1 V p-p into 50 $\Omega$	$\pm 1\%$
Rise time	$\leq 0.1$ $\mu$ s	
Frequency	approx 1.4 kHz	

**Power:** 100, 120, 220, 240 V ac  $\pm 10\%$ ; 48 to 440 Hz; 100 VA max.  
**Weight:** (1740A net, 13 kg (28.6 lb). Shipping, 17.7 kg (39 lb). (1741, 1743A) net 13.8 kg (30.5 lb). Shipping 17.7 kg (39 lb).

**Operating environment:** temperature 0 $^\circ$ C to  $\pm 35$  $^\circ$ C; humidity to 95% relative humidity at +40 $^\circ$ C; altitude, to 4600 m (15 000 ft); vibration, vibrated in three planes for 15 min. each with 0.254 mm (0.010 in.) excursion, 10 to 55 Hz.

**Size:** (1740A) 197 H  $\times$  335 W  $\times$  597 mm D (7 $3/4$ "  $\times$  13 $3/16$ "  $\times$  23 $1/4$ ") with handle, 492 mm D (19 $3/8$ ") without handle; (1741A) 616 mm D (24 $1/4$ ") with handle, 552 mm D (21 $3/4$ ") without handle; (1743A) 613 mm D (23 $1/2$ ") with handle, 549 mm D (21 $3/8$ ") without handle.

**Accessories furnished:** one blue light filter HP P/N 01740-02701, one front panel cover, one 2.3 m (7.5 ft) power cord, one vinyl accessory storage pouch, one Operators Guide and one Service Manual, two Model 10041A 10:1 divider probes approx 2 m (6.6 ft) long. The 1741A also includes one Model 10173A RFI filter and contrast screen, and one Model 10140A viewing hood.

**Options**

**Price**

**001:** fixed power cord (U.S. only) in lieu of detachable power cord add \$15

**101:** Logic State Display single pushbutton (Gold Button) interface Option for operation with the HP Model 1607A Logic State Analyzer. Permits single pushbutton switching between functional 16 channel logic state analysis and electrical analysis of digital data. Option 101 removes the A vs. B mode and replaces it with the State Display pushbutton and adds interface circuits for switching between front panel inputs and rear panel logic state inputs. add \$105

**810:** extra set of product manuals add \$8.50

**1740A Opt 910** add \$12.50

**1741A Opt 910** add \$18

**1743A Opt 910**

**Logic state analysis equipment required for Option 101**

**1807A:** 16-Bit Logic State Analyzer including three data probes and one clock probe. \$2900

**Four 10502A:** 23 cm (9") cables. Three for X, Y, and Z interconnections and one for pattern triggering connection to the oscilloscope. \$15 ea.

**Adapter plate and Strap:** (HP P/N 5060-1213) for mounting the 1743A on top of the 1607A. \$21

**1740S:** includes 1740A 100 MHz oscilloscope with Opt 101, Model 1607A Logic State Analyzer, four 10502A 23 cm (9") BNC interconnecting cables with adapter plate and strap (HP P/N 5061-1213) for combining into a single package. \$5275

**Ordering information**

**1740A** 100 MHz Oscilloscope \$2195

**1741A** 100 MHz Storage Oscilloscope \$3950

**1743A** 100 MHz  $\Delta$  Time Oscilloscope \$3300

# OSCILLOSCOPES

General purpose plug-in scopes, to 18 GHz

Model 180 series

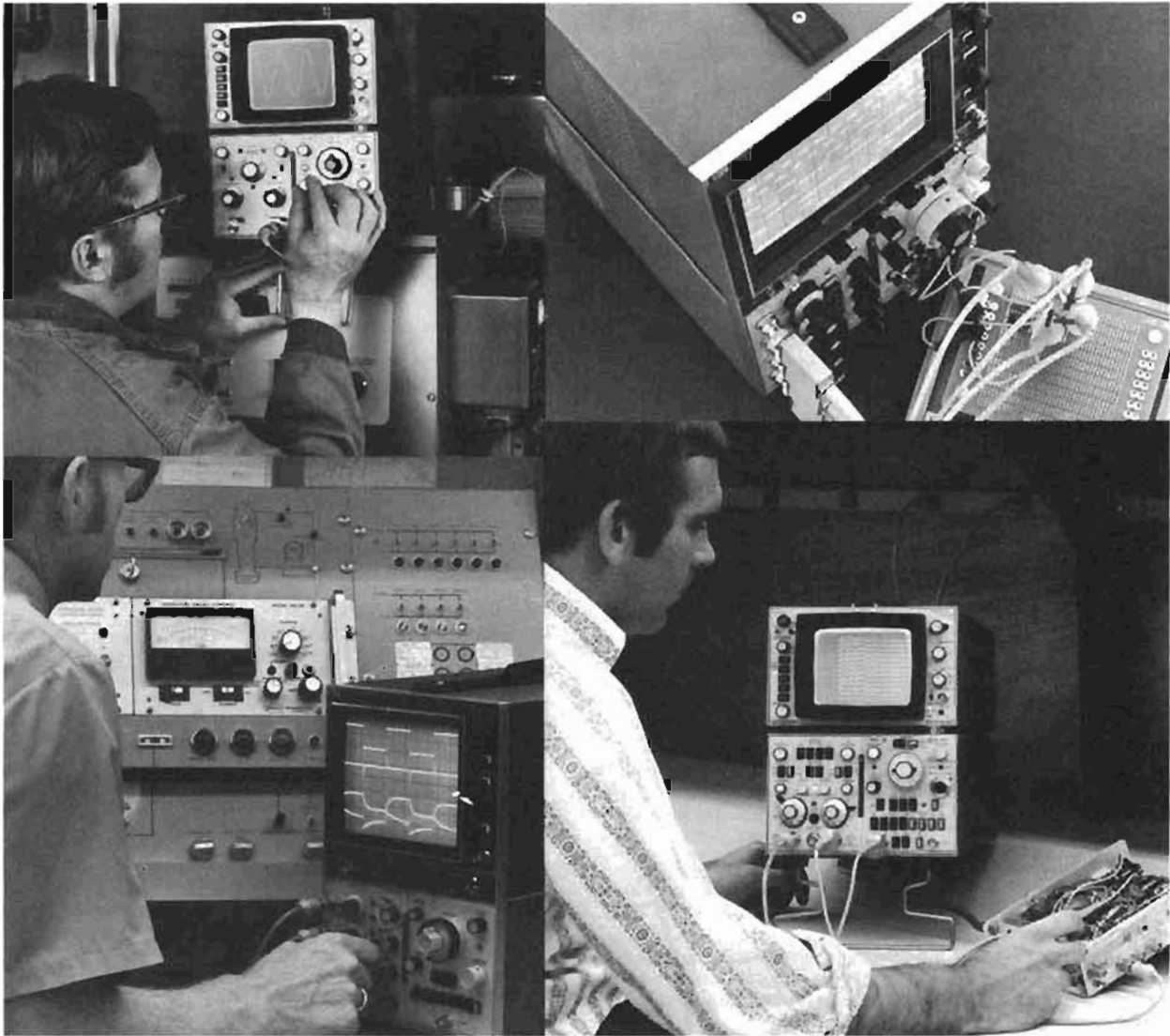

## Introduction

The 180 plug-in oscilloscope combines high performance, plug-in versatility, and operating ease to give you a flexible operating system with laboratory quality throughout. Whether you require four channel real time measurements to 100 MHz, sampling to 18 GHz, 170 ps rise time Time Domain Reflectometry, High Resolution Spectrum Analysis, or precision Swept Frequency testing, each of these and more are available in a compact package with a large CRT display.

The focal point for performance is the mainframe with a high quality CRT for accurate measurements. Four mainframes, including one with a large screen, and a selection of plug-ins allow you to configure an oscilloscope for general purpose use through 100 MHz, 18 GHz sampling, Time Domain Reflectometry, Spectrum Analysis, and Network Analysis. You can meet your present measurement needs, selecting only those plug-ins to meet present requirements at minimum cost, yet keep the full capability of the mainframe for future requirements.

Models 180C, 180D, and 182C mainframes have bright, easy to see displays for maximum resolution and measurement accuracy. Models 180C and 180D each have a CRT display with a full  $8 \times 10$  cm internal graticule and a writing speed of  $1500 \text{ cm}/\mu\text{s}$ . For multi-trace viewing and easy-to-see displays, the 182C CRT display has a

large  $8 \times 10$  division (one division equals 1.29 cm) internal graticule.

Storage/variable persistence mainframes give you the widest selection of general purpose and high speed storage applications. Advances in processing and target material have resulted in a very rugged storage surface as well as extremely high writing speeds. This storage surface is so burn resistant that special operating procedures are not required, extending the versatility of storage measurements to general purpose applications.

Storage writing speeds of  $100 \text{ cm}/\mu\text{s}$  are available in the 184A and 184A Option 005, which allows you to capture those elusive transients that were too fast for other storage scopes to record. With these fast writing speeds you can easily make pulse timing adjustments, locate noise pulses and missing bits from low duty-cycle digital signals. Low duty-cycle pulse trains from disc, tape, or drum peripheral units can also be viewed through repetitive sweeps by using variable persistence to build up the intensity of dim traces.

For medium speed storage and variable persistence applications, Models 181A/AR mainframes are available. Variable persistence mode, in both models, allows you to adjust display retention time to match the speed of slowly changing signals for maximum viewing ease. This allows direct viewing of complete waveforms without clutter in electromechanical, biomedical, chemical, geological, oceanographical, and many other areas with slowly changing signals.



A selection of time base plug-ins gives you a choice of single or main and delayed sweeps with magnified sweep speeds to 5 ns/div in 180 mainframes. Models 1820C and 1825A have triggering capabilities to 150 MHz and the 1821A triggers in excess of 50 MHz. Models 1821A and 1825A have calibrated delayed and mixed sweeps for accurate timing measurements and detailed examination of selected portions of waveforms.

### Sampling

Models 1810A and 1811A sampling plug-ins provide fast, easy low level, high frequency measurements. The 1810A looks and operates like a real time plug-in which reduces familiarization time for accurate, low-level measurements to 1 GHz. Measurements to 18 GHz are available with the 1811A and the 1430C remote feedthrough sampling head. The remote sampling head reduces measurement errors at high frequencies by eliminating long high frequency interconnecting cables. The feedthrough method of measurement in the sampling head increases accuracy by allowing measurements to be made while the system is operating with its own loads.

### Time domain reflectometry

Time Domain Reflectometry is a fast, convenient technique for measuring the electrical characteristics of transmission systems. This measurement technique provides a display of the impedance profile of a system showing magnitude, nature, and distance of discontinuities. Model 1818A is an easy-to-use 170 ps rise time TDR plug-in for design and installation evaluation of transmission or interconnecting systems. For critical design work or system installations, the 1815B with its remote sampling head will display discontinuities as close as 6.4 mm (0.25 inch) with a system rise time of 35 ps.

### Logic state analysis

The 1607A Logic State Analyzer combined with a 180 or 182 oscilloscope provides a complete logic analyzer system for functional measurements of digital systems at speeds to 20 MHz. The 1607A analog outputs connect to the 180 or 182 scope de-coupled X (Ext Horiz), Y-, and Z-axis inputs to provide a 16 x 16 bit data field display of 1's and 0's. The 180 or 182 scopes may also be triggered by the 1607A to display waveforms related to the logic flow at a preselected point. In the data domain the analyzer/scope combination displays the logic states so you can pinpoint a problem. Then, in the time domain, the 1607A triggers the scope where the problem occurs for electrical analysis.

### Spectrum analysis

The 8557A (350 MHz) and 8558B (1500 MHz) Spectrum Analyzer plug-ins display the absolute amplitude of the frequency components of an input signal. Applications include: distortion and modulation measurements, mixer characterization, filter measurements and absolute power measurements.

Operation of both analyzers is extremely simple; only three controls are needed for most measurements. Two controls set the frequency scale, and one is used for the amplitude scale. Measurements can be made from +20 dBm (2.24 volts) to -117 dBm (320 nV) on a 70 dB distortion-free display. The 8557A features a full span of 350 MHz; the 8558B as wide as 1000 MHz, and for more detailed analysis, both can scan a range as narrow as 50 kHz.

### Swept frequency testing

Hewlett-Packard's Model 8755 series Frequency Response Test Sets are precision detection and display systems for making the basic microwave measurements of insertion gain/loss and return loss (SWR) from 15 MHz to 18 GHz. Available in either cabinet- or rack-mount configuration, the 8755 system is useful for characterizing such networks as amplifiers, filters, attenuators, antennas, etc.

The 8755 system has been specifically designed to achieve a full 60 dB dynamic range when used with solid state sweepers (HP 8620 series) which typically have an output level in excess of +10 dBm. The 60 dB dynamic range from +10 to -50 dBm means it is possible to view a full 40 dB of return loss with couplers having a 20 dB auxiliary arm coupling factor.



### Real time measurements

A selection of high performance, vertical real time plug-ins assures the right plug-in for most measurement applications. Real time, dual channel plug-ins are available in 500 kHz, 50 MHz, and 100 MHz bandwidths with deflection factors of 100 μV, and 5 mV. Additional measurement capability is provided by four channel 100 MHz, and 50 MHz plug-ins and a differential/dc offset plug-in with 40 MHz bandwidth.



# OSCILLOSCOPES

General purpose plug-in scopes, to 18 GHz



## 180 System Selection Charts

MAINFRAMES		
Model No.	Description	Page
180C/D	High speed, $8 \times 10$ cm Internal graticule (180D rack style)	152
181A/AR	5 cm/ $\mu$ s storage writing speed/variable persistence (181AR rack style)	149
182C	Large screen, $8 \times 10$ div Internal graticule (10.3 $\times$ 12.9 cm)	151
184A	100 cm/ $\mu$ s storage writing speed/variable persistence	150
184A Opt 005	400 cm/ $\mu$ s storage writing speed/variable persistence	150

Model No.	VERTICAL PLUG-INS						SAMPLING (Vertical Section)		
	1801A	1803A	1804A	1805A	1806A	1809A	*1810A	**1815B	**1811A
Bandwidth MHz	50	40 (30)	50	100	0.5	100	1 GHz	12.4 GHz	18 GHz
Min. deflection factor/div	5 mV (500 $\mu$ V Opt 001 cascaded)	10 mV (1 mV cascaded)	20 mV	5 mV	100 $\mu$ V	10 mV	2 mV	5 mV	2 mV
Channels	2 (Opt 001, 1 cascaded)	1 diff	4	2 (1 cascaded)	2 (both diff)	4	2	1	2
Input RC	1 M $\Omega$ /25 pF	1 M $\Omega$ /27 pF	1 M $\Omega$ /25 pF	1 M $\Omega$ /13 pF or 50 $\Omega$	1 M $\Omega$ /45 pF	1 M $\Omega$ /12 pF or 50 $\Omega$	50 $\Omega$	50 $\Omega$	50 $\Omega$
Differential input	yes	yes (with dc offset)	no	yes	yes	yes	yes	no	yes
Page	154	154	156	153	154	158	160	162	160

Model No.	TIME BASE PLUG-INS			SAMPLING (Time Base Section)			TDR		FREQUENCY-DOMAIN PLUG-INS		
	1820C	*1821A	1825A	*1810A	**1815B	**1811A	*1818A	**1815B	8557A	8558B	*8755B
Ext Trig Freq (MHz)	150	100	150	>1 GHz	18 GHz with trigger countdown	18 GHz with trigger countdown	<170 ps rise time TDR system	<25 ps rise time TDR	Spectrum Analyzer 0.1-350 MHz. Measurements from -117 dBm to -20 dBm	Spectrum Analyzer plug-in, 0.1-1500 MHz. Measurements from -117 dBm to -38 dBm.	Sweep Amplitude Analyzer plug-in measures insertion gain/loss and return loss from 15 MHz to 18 GHz.
Int Trig Freq.	Determined by Vert. Amp. Plug-in			1 GHz			Calibrated in feet and metres	Calibrated in metres			
Sweep Speeds/div <sup>4</sup>	5 ns 1 s	10 ns 1 s	5 ns 1 s	100 ps (expanded) -50 $\mu$ s	10 ps -1 $\mu$ s	10 ps (expanded) -1 $\mu$ s					
Delayed and mixed sweep	No	Yes	Yes	No	No	No					
Page	158	158	159	160	162	160	162	162	165, 486	165, 486	424

### NOTES

1. Double width plug-ins.
2. Requires remote sampling head.
3. Requires Remote Pulse Generator.
4. Includes X10 mainframe magnification.
5. For vertical plug-ins up to 50 MHz.
6. Requires remote modulator and detectors.



180 Mainframes: storage, 5 cm/ $\mu$ s writing speed  
Models 181A/AR

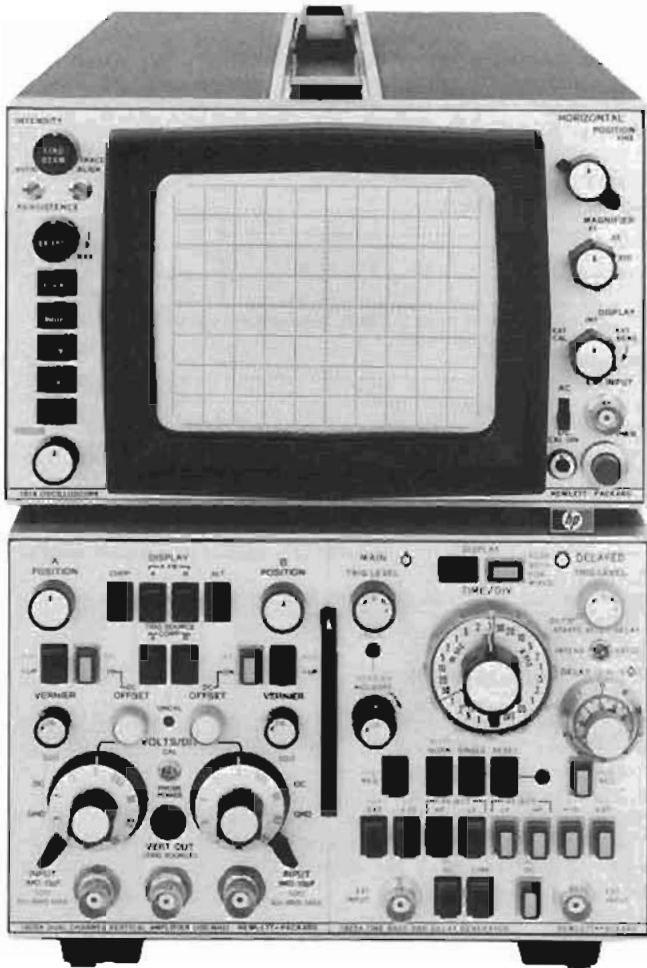

## 181A/AR specifications

### Cathode ray tube and controls

**Type:** post-accelerator storage; approx 8.5 kV accelerating potential; aluminized P31 phosphor.

**Graticule:** 8  $\times$  10 div internal graticule, 0.2 subdivision markings on major horizontal and vertical axes. 1 div = 0.95 cm. Front panel adjustment aligns trace with graticule.

**Beam finder:** returns trace to CRT screen regardless of horizontal or vertical control setting.

### Intensity modulation (external input)

**Input:** approx +2 V.  $\geq 50$  ns pulse width will blank trace of normal intensity.

**Input R:** approx 5 k $\Omega$ .

**Maximum Input:**  $\pm 20$  V (dc + peak ac).

### Persistence

**Normal:** natural persistence of P31 phosphor (approx 40  $\mu$ s).

**Variable:** from  $<0.2$  s to  $>1$  min.

### Storage writing speed

**Write mode:**  $>20$  cm/ms.

**Max write mode:**  $>5$  cm/ $\mu$ s.

**Brightness:**  $>342.6$  cd/m $^2$  (100 f).

**Storage time:** from Write mode to Store, trace may be stored at reduced intensity for  $>1$  hour; to View mode, traces may be viewed at normal intensity for  $>1$  minute. From Max Write mode to Store, traces may be stored at reduced intensity for  $>5$  minutes; to View mode, traces may be viewed at normal intensity for  $>15$  seconds.

**Erase:** manual, pushbutton erasure takes approx 300 ms.

### Horizontal amplifier

#### External Input

**Bandwidth:** dc-coupled, dc to 5 MHz; ac-coupled, 5 Hz to 5 MHz.

**Deflection Factor:** 1 V/div in X1; 0.2 V/div in X5; 0.1 V/div in X10.

**Vernier:** provides continuous adjustment between ranges.

**Dynamic range:**  $\pm 20$  V.

**Maximum Input:** 600 V dc (ac-coupled input).

**Input RC:** approx 1 megohm shunted by approx 30 pF.

**Sweep magnifier:** X5, X10; accuracy,  $\pm 5\%$  with 3% accuracy time base.

### Outputs

Four rear panel emitter follower outputs for main and delayed gates, main and delayed sweeps, or vertical and horizontal outputs when used with TDR/sampling plug-ins. Maximum current available  $\pm 3$  mA. Outputs will drive impedances  $\geq 1000$  ohms without distortion.

### General

**Calibrator:** approx 1 kHz square wave, 3  $\mu$ s rise time; 10 V p-p into  $\geq 1$  megohm; accuracy,  $\pm 1\%$ .

**Operating environment:** temperature, 0 to +55°C (+32°F to +130°F); humidity, to 95% relative humidity at 40°C (104°F); altitude, to 4600 m (15 000 ft); vibration, vibrated in three planes for 15 min, each with 0.254 mm (0.010 in.) excursion, 10 to 55 Hz.

### Dimensions

**Cabinet Model, 181A:** 289 mm H  $\times$  200 mm W  $\times$  540 mm D behind panel (11 $\frac{3}{8}$ "  $\times$  7 $\frac{7}{8}$ "  $\times$  21 $\frac{1}{4}$ ").

**Rack Model, 181AR:** 132.6 mm H  $\times$  425 mm W  $\times$  543 mm D overall (5 $\frac{3}{32}$ "  $\times$  16 $\frac{9}{16}$ "  $\times$  21 $\frac{3}{8}$ "); 493 mm (19 $\frac{3}{8}$ ") D behind rack mount tabs.

### Weight (without plug-ins)

**Model 181A (cabinet):** net, 10.9 kg (24 lb). Shipping, 15.4 kg (34 lb).

**Model 181AR (rack):** net, 11.8 kg (26 lb). Shipping, 17.2 kg (38 lb).

**Power:** 115 or 230 V  $\pm 10\%$ , 48 to 440 Hz; 115 watts at normal line with plug-ins; max mainframe power, 225 VA.

**Accessories supplied:** 2.3 m (7  $\frac{1}{2}$  ft) power cord, Model 10178A mesh contrast filter, blue plastic light filter (HP P/N 5060-0548), one Operating and Service Manual. A rack mount kit (HP P/N 5060-0552) and 2 clip-on probe holders (HP P/N 5040-0464) are supplied with the 181AR rack model.

### 181T/TR

181T cabinet and 181TR rack model mainframes are related to 8557A, 8558B, and 8755B plug-ins; with non-buffered rear panel auxiliary outputs. For detailed information refer to an 8557A, 8558B, or 8755 series data sheet.

### Options

**H49:** Model 181A with remote programming capability for Write, Max Write, Normal, Store, View, and Erase functions. Programming is accomplished with contact closure, DTL, or TTL logic sources

**Price**  
add \$515

**910:** additional Operating and Service Manual

add \$8

### Ordering information

181A Storage Oscilloscope, Cabinet Style

\$2450

181AR Storage Oscilloscope, Rack Style

\$2550

# OSCILLOSCOPES

180 Mainframe: storage, 100 cm/ $\mu$ s writing speed

Model 184A

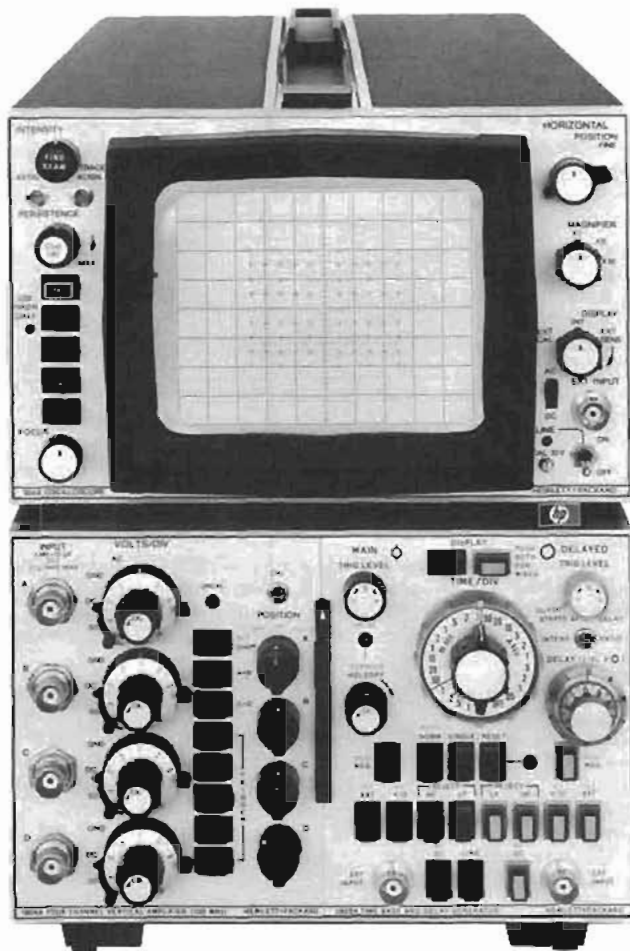

## 184 Mainframe Description

The Model 184A cabinet style variable persistence and storage mainframe provides writing speeds of 100 cm/ $\mu$ s or with Option 005, 400 cm/ $\mu$ s (with viewing hood). These writing speeds are fast enough that traces you previously had to photograph to see can now be viewed directly in normal ambient light. A FAST mode optimizes writing speed by switching the CRT display to reduced scan while maintaining calibration and resolution. A second graticule, for the FAST mode, is superimposed in the center of the screen and a front panel light indicates when the scope is the FAST mode.

## 184A Specifications

### Cathode-ray tube and controls

**Type:** post-accelerator storage tube; aluminized P31 phosphor.

**Graticule:** 8  $\times$  10 div internal graticule, 0.2 div subdivisions on major axes. 1 div = 0.95 cm. 8  $\times$  10 div internal graticule superimposed in center of normal scope graticule (for fast writing speed mode). 1 div = 0.475 cm. Front panel adjustment aligns trace with graticule.

**Beam finder:** returns trace to CRT screen regardless of setting of horizontal or vertical control setting.

### Intensity modulation (external input)

**Input:** approx +2 V,  $\geq$  50 ns pulse width will blank trace of normal intensity.

**Input R:** approx 5 k $\Omega$ .

**Maximum Input:**  $\pm$ 20 V (dc + peak ac).

**Writing modes:** conventional (non-storage), standard, and fast (variable persistence and storage). Pressing STORE and either STD or FAST provides maximum persistence with floodguns off for a ready-to-write state. The CRT will remain primed and ready-to-write for the storage time of  $>$  10 min. in STD/STORE and  $>$  30 s in FAST/STORE.

### Persistence

**Conventional:** natural persistence of P31 phosphor (approx 40  $\mu$ s).

**Variable:** from  $<$  50 ms to  $>$  1 min.

### Storage writing speed

Model No.	Standard*	Fast**
184A	$>$ 0.2 cm/ $\mu$ s	$>$ 100 cm/ $\mu$ s
184A Opt 005	$>$ 0.2 cm/ $\mu$ s	$\sim$ 400 cm/ $\mu$ s

\*Adjustable writing speeds to approx 10 cm/ $\mu$ s are available with rear panel controls

\*\*Calibrated 3.8  $\times$  4.75 cm reduced scan area

### Brightness

**Standard:**  $>$  342.6 cd/m<sup>2</sup> (100 f).

**Fast:**  $>$  173.3 cd/m<sup>2</sup> (50 f).

### Storage time

**Standard writing speed:** variable from  $>$  1 min at normal intensity to  $>$  10 min. at reduced brightness.

**Fast writing speed:** variable from  $>$  10 s (8 s for Opt 005) at normal intensity to  $>$  30 s at reduced brightness. Storage time may vary with wide temperature changes. Specifications are for normal room temperature (+22°C).

**Erase:** manual, pushbutton erasure takes approx 300 ms.

### Horizontal amplifier

#### External input

**Bandwidth:** dc-coupled, dc to 5 MHz, ac-coupled, 5 Hz to 5 MHz.

**Deflection factor:** 1 V/div in X1; 0.2 V/div in X5; 0.1 V/div in X10; accuracy,  $\pm$ 5%. Vernier provides continuous adjustment between ranges.

**Dynamic range:**  $\pm$ 20 V.

**Maximum Input:** 600 V dc (ac-coupled input).

**Input RC:** approx 1 megohm shunted by approx 30 pF.

**Sweep magnifier:** X5, X10; accuracy,  $\pm$ 5% (with 3% accuracy time base).

### Callibrator

**Type:** approx 1 kHz square wave, 3  $\mu$ s rise time.

**Voltage:** 10 V p-p into  $\geq$  1 megohm; accuracy,  $\pm$ 1%.

### Outputs

Four rear panel emitter follower outputs for main and delayed gates, main and delayed sweeps, or vertical and horizontal outputs when used with TDR/Sampling plug-ins. Maximum current available,  $\pm$  3 mA. Will drive impedances  $\geq$  1000 ohms without distortion.

### General

**Operating environment:** temperature, 0 to +55°C (+32°F to +130°F); humidity, to 95% relative humidity at 40°C (104°F); altitude, to 4600 m (15 000 ft); vibration, vibrated in three planes for 15 min. each with 0.254 mm (0.010 in.) excursion, 10 to 55 Hz.

**Dimensions:** 289 mm H, 200 mm W, 540 mm D behind panel (11<sup>3</sup>/<sub>8</sub>"  $\times$  7<sup>7</sup>/<sub>8</sub>"  $\times$  21<sup>1</sup>/<sub>4</sub>").

**Weight:** (without plug-ins) net, 10.9 kg (24 lb). Shipping, 15 kg (33 lb).

**Power:** 115 or 230 V  $\pm$  10%, 48 to 440 Hz, 115 watts at normal line with plug-ins. Max mainframe power, 225 VA.

**Accessories supplied:** 2.3 m (7<sup>1</sup>/<sub>2</sub> ft) power cord, Model 10178A mesh contrast filter, blue plastic light filter (HP P/N 5060-0548), one Operating and Service Manual.

### Options

**005:** Fast Storage CRT

**910:** additional Operating and Service Manual

### Price

add \$500

add \$15

184A Storage Mainframe (Cabinet)

\$2725

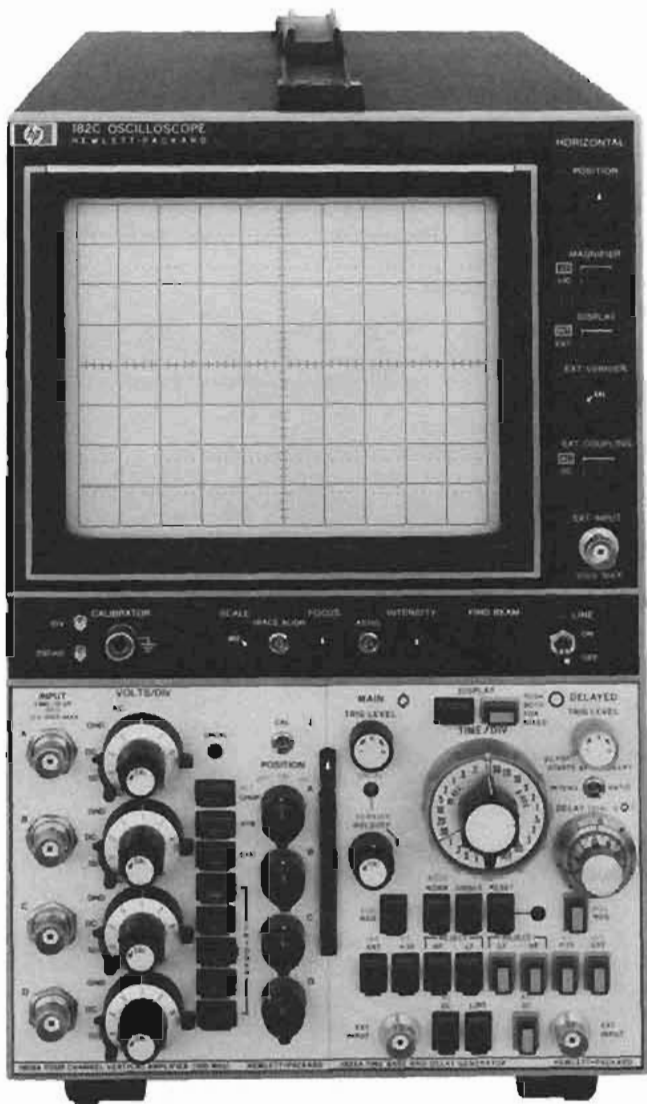

### 182C Specifications

#### Cathode-ray tube and controls

**Type:** post accelerator, 21 kV accelerating potential; aluminized P31 phosphor.

**Graticule:** 8 × 10 div internal graticule, 0.2 div sub-divisions on major axes, 1 div = 1.29 cm. Front panel adjustment aligns trace with graticule. Scale control illuminates CRT phosphor for viewing with hood or taking photographs.

**Beam finder:** returns trace to CRT screen regardless of setting of horizontal, vertical, or intensity controls.

#### Intensity modulation (external input)

**Input:** approx +2 V, ≥50 ns pulse width will blank trace of normal intensity, Input R approx 5 kΩ.

**Maximum input:** ±20 V (dc + peak ac).

#### Horizontal amplifier

##### External input

**Bandwidth:** dc-coupled, dc to 5 MHz; ac-coupled, 5 Hz to 5 MHz.

**Deflection factor:** 1 V/div, X1; 0.1 V/div, X10; accuracy, ±5%. Vernier provides continuous adjustment between ranges.

**Dynamic range:** ±20 V.

**Maximum input:** ±300 V (dc + peak ac).

**Input RC:** 1 megohm shunted by approx 30 pF.

**Sweep magnifier:** X10; accuracy, ±5% (with 3% accuracy time base).

**Calibrator:** approx 1 kHz square wave, <3 μs rise time; 250 mV p-p and 10 V p-p into ≥1 megohm, ±1%.

#### Outputs

Four rear panel emitter follower outputs for main and delayed gates, main and delayed sweeps, or vertical and horizontal outputs when used with TDR/Sampling plug-ins. Maximum current available, ±3 mA. Will drive impedances ≥1000 ohms without distortion.

#### General

**Operating environment:** temperature, 0 to +55°C (+32°F to +130°F); humidity, to 95% relative humidity at 40°C (104°F); altitude, to 4600 m (15000 ft); vibration, vibrated in three planes for 15 min, each with 0.254 mm (0.010 in.) excursion, 10 to 55 Hz.

**Dimensions:** 338.1 mm H × 201.6 mm W × 498.5 mm D overall (13<sup>3</sup>/<sub>16</sub>" × 7<sup>7</sup>/<sub>16</sub>" × 19<sup>5</sup>/<sub>16</sub>").

**Weight:** (without plug-ins) net, 12.2 kg (27 lb). Shipping, 15.4 kg (34 lb).

**Power:** 115 or 230 V ±10%, 48 to 440 Hz, <110 watts with plug-ins at normal line. Max mainframe power, 200 VA.

**Accessories supplied:** 2.3 m (7<sup>1</sup>/<sub>2</sub> ft) power cord, blue plastic light filter (HP P/N 5060-0547), one Operating and Service Manual.

### 182C Description

Model 182C mainframe provides large, easy-to-read displays on a 16.5 cm (6<sup>1</sup>/<sub>2</sub> in.) CRT with 100 MHz capability. A parallax free, internal graticule allows accurate readings from any angle or from a distance which is extremely useful in systems testing. The large display also improves measurement accuracy of displays such as four channel, differential/dc offset, sampling, and time domain reflectometer measurements.

The cathode-ray tube has 21 kV accelerating potential for bright displays of low repetition rate signals. Particular attention to electron optics in the CRT assures that the large display size does not cause degradation of the trace. Internal flood guns provide graticule illumination which allows adjustment of background illumination for optimum contrast of graticule and trace for easy-to-read three-shade photographs. A find beam control reduces setup time by returning the beam to the display area regardless of vertical, time base, or intensity control settings.

### 182T

Cabinet model mainframe related to 8557A, 8558B, and 8755B plug-ins; non-buffered rear panel auxiliary outputs; and P39 medium-persistence CRT phosphor. For detailed information refer to an 8557A, 8558B or 8755B data sheet.

#### Options

**010:** mainframe without rear panel main and delayed sweep and gate outputs

**010:** additional Operating and Service Manual

#### Price

less \$100

add \$10

#### Ordering Information

182C Oscilloscope Mainframe

182C Option 010 (see Options)

\$1500

\$1400

# OSCILLOSCOPES

## 180 Mainframes: high writing speed

### Models 180C/D

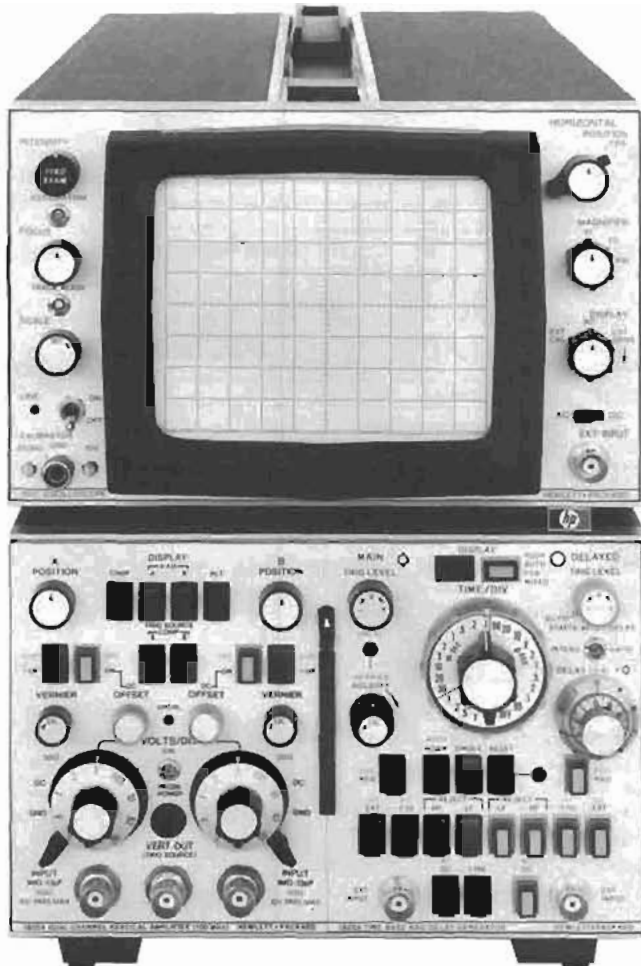

### 180 C/D Specifications

#### Cathode-ray tube and controls

**Type:** post accelerator, approx 15 kV accelerating potential; aluminized P31 phosphor.

**Graticule:** 8 × 10 div internal graticule. 1 div = 1 cm. 0.2 div subdivisions on major axes. Front panel recessed screwdriver adjustment aligns trace with graticule. Scale control illuminates CRT phosphor when viewing with hood or taking photographs.

**Beam finder:** returns trace to CRT screen regardless of setting of horizontal, vertical, or intensity controls.

#### Intensity modulation (external input)

**Input:** approx +2 V. ≥50 ns pulse width will blank trace of normal intensity.

**Input R:** approx 5 kΩ.

**Maximum Input:** ±20 V (dc + peak ac).

**Photographic writing speed:** 1500 cm/μs. Measured using P31 phosphor, 10 000 ASA film without film fogging and HP Model 195A camera (1.3 lens, 1:0.5 object-to-image ratio). Writing speed may be increased substantially by using film fogging techniques, P11 phosphor, and faster camera lenses.

#### Horizontal amplifier

##### External input

**Bandwidth:** dc to 5 MHz dc-coupled; 5 Hz to 5 MHz ac-coupled.

**Deflection Factor:** 1 V/div, X1; 0.2 V/div, X5; 0.1 V/div, X10; accuracy ±5%. Vernier provides continuous adjustment between ranges.

**Dynamic range:** ±20 V.

**Maximum Input:** 600 V dc (ac-coupled input).

**Input RC:** approx 1 megohm shunted by approx 30 pF.

**Sweep magnifier:** X5, X10, accuracy ±5% (with 3% accuracy time base).

#### Outputs

Four rear panel emitter follower outputs for main and delayed gates, main and delayed sweeps, or vertical and horizontal outputs when used with TDR/Sampling plug-ins. Maximum current available, ±3 mA. Outputs will drive impedances of ≥1000 ohms without distortion.

#### General

**Calibrator:** approx 1 kHz square wave, <3 μs rise time; 250 mV p-p and 10 V p-p into ≥1 megohm; accuracy, ±1%.

**Operating environment:** temperature, 0 to +55°C (+32°F to +130°F); humidity, to 95% relative humidity at 40°C (104°F); altitude, to 4600 m (15 000 ft); vibration, vibrated in three planes for 15 min, each with 0.254 mm (0.010 in.) excursion, 10 to 55 Hz.

#### Dimensions

**Cabinet model, 180C:** 289 mm H × 200 mm W × 540 mm D behind panel (11<sup>3</sup>/<sub>8</sub>" × 7<sup>7</sup>/<sub>8</sub>" × 21<sup>1</sup>/<sub>4</sub>").

**Rack model, 180D:** 132.6 mm H × 425 mm W × 543 mm D overall (5<sup>1</sup>/<sub>8</sub>" × 16<sup>3</sup>/<sub>4</sub>" × 21<sup>1</sup>/<sub>4</sub>"); 493 mm (19<sup>3</sup>/<sub>8</sub> in.) D behind rack mount tabs.

#### Weight (without plug-ins)

**Model 180C (cabinet):** net, 10.4 kg (23 lb). Shipping, 15.4 kg (34 lb).

**Model 180D (rack):** net, 11.8 kg (26 lb). Shipping, 17.2 kg (38 lb).

**Power:** 115 or 230 V, ±10%; 48 to 440 Hz; normally <110 watts with plug-ins at normal line. Max mainframe power, 200 VA.

**Accessories supplied:** 2.3 m (7<sup>1</sup>/<sub>2</sub> ft) power cord, blue plastic light filter (HP P/N 5060-0548), one Operating and Service Manual. A rack mount kit (HP P/N 5060-0552) and 2 clip-on probe holders (HP P/N 5040-0464) are supplied with the 180D rack model.

### 180TR

Rack model mainframe related to 8557A, 8558B, and 8755B plug-ins; non-buffered rear panel auxiliary outputs; and P39 medium-persistence CRT phosphor. For detailed information refer to an 8557A, 8558B or 8755 series data sheet.

#### Options

**010:** deletes rear panel outputs for main and delayed gates and main and delayed sweeps

**910:** additional Operating and Service Manual

#### Price

less \$100

add \$7.50

#### Ordering Information

180C Cabinet Style Mainframe

\$1450

Opt 010: (see Options)

\$1350

180D Rack Style Mainframe

\$1550

Opt 010: (see Options)

\$1450

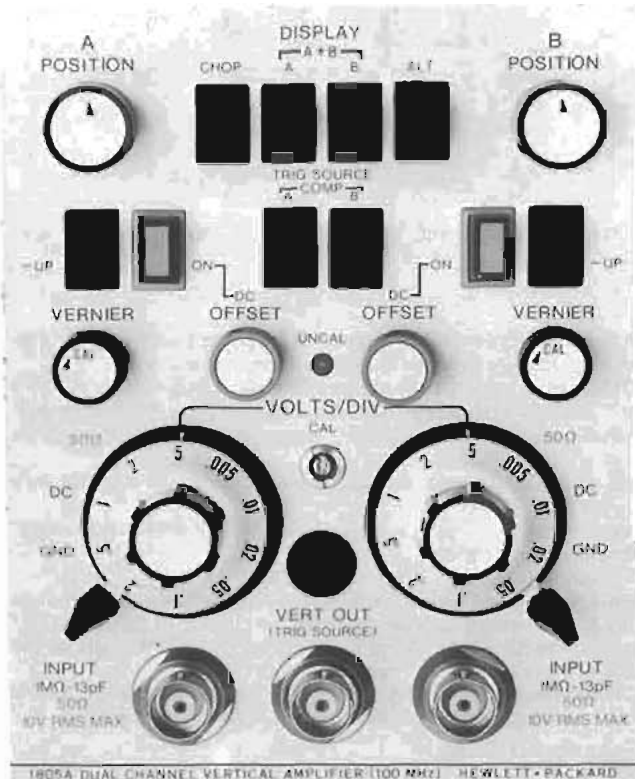

1805A

### 1805A Specifications

#### Modes of operation

Channel A: channel B; channels A and B displayed alternately on successive sweeps (ALT); channel A and B displayed by switching between channels at approx 400 kHz rate (CHOP) with blanking during switching; channel A plus channel B (algebraic addition).

#### Each channel (2)

**Bandwidth:** (measured with or without 10014A probe, 3 dB down from 8 div reference signal from a terminated 50 ohm source.)

**DC-coupled:** dc to 100 MHz.

**AC-coupled:** approx 10 Hz to 100 MHz (lower limit is approx 1 Hz with 10014A probe).

**Rise time:** <3.5 ns measured with or without 10014A probes, 10% to 90% points of 6 div input step from a terminated 50 ohm source.)

#### Deflection factor

**Ranges:** 5 m/div to 5 V/div (10 calibrated positions) in 1, 2, 5 sequence;  $\pm 2\%$  attenuator accuracy.

**Vernier:** provides continuous adjustment between deflection factor settings and extends maximum deflection factor to at least 12.5 V/div. Front panel light indicates when vernier is not in CAL position.

**Polarity:** + up or - up, selectable.

**Signal delay:** input signals are delayed sufficiently to view leading edge of input pulse without advanced trigger.

**Input coupling:** AC, DC, 50 ohms (dc), or ground. Ground position disconnects input connector and grounds amplifier input.

#### Input RC

**AC and DC:** 1 megohm  $\pm 1\%$  shunted by approx 13 pF. Constant on all ranges.

**50 ohm:** 50 ohms  $\pm 2\%$ , SWR <1.2 at 100 MHz on all ranges.

#### Maximum Input

**AC and DC:**  $\pm 300$  V (dc + peak ac) at 1 kHz or less,  $\pm 150$  V (dc + peak ac) on 5 m/div range at 1 kHz or less.

**50 ohm:** 10 V rms (dc-coupled input).

**Dynamic range:** 6 div at 100 MHz increasing to 16 div at  $\leq 15$  MHz.

**Positioning range:** 16 div.

#### A + B operation

**Amplifier:** bandwidth and deflection factors are unchanged; either channel may be inverted for  $\pm A \pm B$  operation.

**Differential Input (A - B) common mode:** CMR is at least 40 dB from dc to 1 MHz for common mode signals of 16 div or less; CMR is at least 20 dB at 50 MHz for common mode signals of 6 div or less.

#### Triggering

**Source:** selectable from channel A, channel B, or a composite (Comp) signal from A and B in any display mode. Composite is channels A and B signals switched for Alt and Chop modes and added for A and B mode. Vernier and position controls do not affect A, B, or composite trigger signals. A and B signals are independent of polarity selection.

#### Frequency

Time Base Plug-in	Trigger frequency*	Required Vertical Deflection
1820C, 1825A	dc-50 MHz	1/2 div
	dc-100 MHz	1 div
1821A	dc-50 MHz	1 div

\*all display modes except Chop, dc to 100 kHz in Chop.

#### Offset

$\pm 200$  div of offset. Allows offset of dc or ac signals up to the dynamic range and maximum input

#### Vertical signal output

(selected by trigger source switch)

**Bandwidth:** >50 MHz into 50 ohms.

**Amplitude:** >50 mV for each division of display into 50 ohms with usable amplitudes up to 500 mV p-p.

**Source Impedance:** approx 50 ohms.

#### General

**Operating environment:** same as 180 C/D mainframes.

**Weight:** net, 2.3 kg (5 lb); shipping, 3.6 kg (8 lb).

**Accessories supplied:** two 10014A 10:1 voltage divider probes approx. 1.1 m (3 1/2 ft) long, one Operating and Service Manual.

#### Recommended probes

10014A, 10016B passive probes, 10017A, 10018A miniature passive probes, 10026A, 10027A miniature 50  $\Omega$  probes, 10020A resistive divider probe kit, and the 1120A and 1125A active probes maintain full performance of the 1805A.

#### Ordering information

1805A Dual Channel Vertical Amplifier

Opt 003: without probes

Opt 910: additional Operating and Service Manual

#### Price

\$1550

less \$120

add \$10

# OSCILLOSCOPES

180 Verticals: 0.5 MHz, 50 MHz and dc offset

Models 1801A, 1806A & 1803A

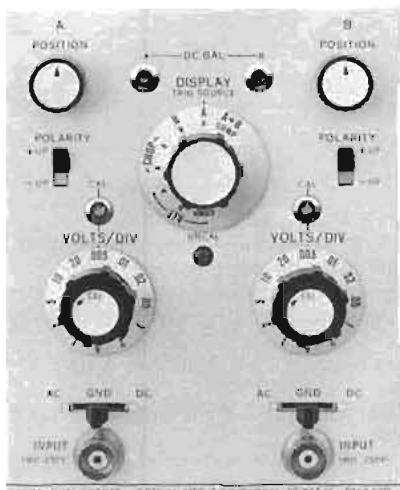

1801A



1806A

## 1801A, 1806A Specifications

### Modes of operation

Channel A; channel B; channels A and B displayed alternately on successive sweeps (ALT); channels A and B displayed by switching between channels at approx 400 kHz rate (1801A), 100 kHz (1806A), in CHOP mode with blanking during switching; channel A plus channel B, algebraic addition (1801A).

### Each channel (2)

**Bandwidth** (measured with or without a Model 10004D probe (1801A), Model 10001A/B probe (1806A), 3 dB down from 8 div reference signal from a terminated 50 ohm source.)

**DC-coupled:** (1801A) dc to 50 MHz, (1806A) dc to 500 kHz.

**AC-coupled:** (1801A) approx 8 Hz to 50 MHz, (1806A) approx 2 Hz to 500 kHz. Lower limit (1801A) is approx 0.8 Hz with 10004D probe, (1806A) approx 0.2 Hz with 10001A/B probe.

**Bandwidth limit switch (1806A):** limits bandwidth to approx 50 kHz.

**Rise time:** (1801A) <7 ns (measured with or without 10004D probe, 10% to 90% of 8 div input step from a terminated 50 ohm source).

### Deflection factor

**Ranges:** (1801A) 5 mV/div to 20 V/div (12 positions) in 1, 2, 5 sequence; (1806A) 100  $\mu$ V/div to 20 V/div (17 positions) in 1, 2, 5 sequence;  $\pm$ 3% attenuator accuracy.

**Vernier:** provides continuous adjustment between deflection factor settings and extends maximum deflection factor to at least 50 V/div. Front panel light indicates when vernier is not in CAL position.

**Polarity:** (1801A) +up or -up, selectable.

**Signal delay:** (1801A) input signals are delayed sufficiently to view leading edge of input without advanced trigger.

**Input:** (1806A) differential or single-ended on all ranges, selectable.

**Input coupling:** (1801A) selectable, AC, DC, or Ground; ground position disconnects signal input and grounds amplifier input. (1806A) selectable AC, DC, or OFF for both + and - inputs; OFF position disconnects signal input and grounds amplifier input for reference.

**Input RC:** (1801A) approx 1 megohm shunted by approx 25 pF; (1806A) approx 1 megohm shunted by approx 45 pF; constant on all ranges.

### Maximum input (1801A)

**DC-coupled:**  $\pm$ 350 V (dc + peak ac) at 10 kHz or less,  $\pm$ 150 V (dc + peak ac) on 5 mV/div range at 10 kHz or less.

**AC-coupled:**  $\pm$ 600 V dc.

**Maximum input (1806A):**  $\pm$ 400 V (dc + peak ac).

### A + B operation (1801A)

**Amplifier:** bandwidth and deflection factors are unchanged; either channel may be inverted for  $\pm A \pm B$  operation.

**Differential input (A-B) common mode:** CMR is at least 40 dB at 5 mV/div and at least 20 dB on other ranges for frequencies between dc and 1 MHz and for common mode signals of 24 div or less.

**Input isolation (1806A):**  $\geq$ 80 dB between channels at 500 kHz with shielded connectors.

**Noise (1806A):** <20  $\mu$ V, measured tangentially at full bandwidth.

### Common mode (1806A)

**Frequency:** dc to 10 kHz on all ranges.

**Rejection ratio:**  $\geq$ 100 dB (100 000 to 1) with dc-coupled input on 100  $\mu$ V/div range, decreasing 20 dB per decade of deflection factor to  $\geq$ 40 dB on the 200 mV/div range; CMR is  $\geq$ 30 dB on the 500 mV/div to 20 V/div ranges.

**Maximum signal:**  $\pm$ 10 V (dc - peak ac) on 100  $\mu$ V/div to 200 mV/div ranges;  $\pm$ 400 V (dc + peak ac) on all other ranges.

### Triggering (1801A)

**Source:** for channel A, B, or A + B, on the signal displayed; Chop is selectable from channel A or B; All is selectable from channel A, B, or Comp (channels A and B switched).

**Frequency:** dc to 50 MHz on signals causing 0.5 div or more vertical deflection in all display modes except Chop; dc to 100 kHz in Chop mode.

### Triggering (1806A)

**Source:** for channel A or B, on the signal displayed; Chop is selectable from channel A or B; All is selectable from channel A, B, or Comp (channels A and B switched).

**Frequency:** dc to >500 kHz on signals causing 0.5 div or more vertical deflection in all display modes except Chop; dc to 100 kHz in Chop.

### General

**Operating environment:** same as 180C/D mainframe.

**Weight:** net, 1.8 kg (4 lb). Shipping, 3.6 kg (8 lb).

**Accessories supplied:** (1801A) two 10004D, 10:1 divider probes, approx 1.1 m (3 1/2 ft), one Operating and Service manual; (1806A) two BNC to dual banana plug binding post adapters (HP P/N 1250-1264), one Operating and Service Manual.

**Recommended probes:** the 10004D, 10005D, and 10006D passive divider probes and 10040A, 10041A, 10042A miniature passive divider probes maintain full performance of the 1801A; the 10001A/B, 10002A/B, 10003A passive divider probes and 10021A, 10022A miniature passive probes maintain full performance of the 1806A.

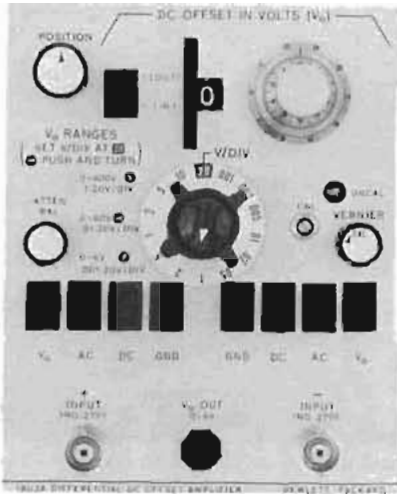

## 1803A Specifications

### Vertical deflection

**Bandwidth:** (measured with or without 10004D probe, 3 dB down from 8 div reference signal from a terminated 50 ohm source.)

**DC-coupled:** dc to 40 MHz from 0.005 V/div to 20 V/div; dc to 30 MHz on 0.001 V/div and 0.002 V/div or when using  $V_0$  range of 0 to 6 V or two most sensitive volts/div settings for other  $V_0$  ranges.

**AC-coupled:** lower bandwidth is approx 2 Hz, upper bandwidth is the same as dc-coupling. Lower bandwidth is approx 0.2 Hz with 10004D probe.

**Rise time:** <10 ns for deflection factors of 0.005 V/div to 20 V/div; <12 ns on 0.001 V/div and 0.002 V/div, on  $V_0$  range of 0 to 6 V and on the most sensitive volts/div settings for other  $V_0$  ranges. Measured with or without 10004D probe; 10% to 90% of 8 div input step from terminated 50 ohm source.

### Deflection factor

**Ranges:** from 0.001 V/div to 20 V/div (14 calibrated positions) in 1, 2, 5 sequence; attenuator accuracy  $\pm 3\%$ .

**Vernier:** provides continuous adjustment between deflection factor settings and extends maximum deflection factor to at least 50 V/div. Front panel light indicates when vernier is not in CAL position.

**Input coupling:** AC, DC, Ground, or  $V_0$  for both + and - inputs. Ground disconnects signal input and grounds amplifier input.

**Input RC:** approx 1 megohm shunted by approx 27 pF, constant on all ranges.

### Maximum input

$V_0$ Range	Deflection Factor	Maximum Input (dc - peak ac)
0 to 5 V	0.001 V/div to 0.02 V/div	$\pm 15$ V
0 to 6 V	0.05 V/div to 0.2 V/div	$\pm 150$ V
0 to 6 V	0.5 V/div to 20 V/div	$\pm 600$ V
0 to 60 V	0.01 V/div to 0.2 V/div	$\pm 150$ V
0 to 60 V	0.5 V/div to 20 V/div	$\pm 600$ V
0 to 600 V	0.1 V/div to 20 V/div	$\pm 600$ V

### Overload recovery

**6 V overload:** within  $\pm 10$  mV of final signal value in 0.3  $\mu$ s or less, with  $\pm 5$  mV in 1  $\mu$ s or less, and within 1 mV in 1 ms or less.

**60 V overload:** within  $\pm 100$  mV of final signal value in 0.3  $\mu$ s or less, within  $\pm 50$  mV in 1  $\mu$ s or less, and within  $\pm 10$  mV in 1 ms or less.

**600 V overload:** within  $\pm 1$  V of final signal value in 0.3  $\mu$ s or less, within  $\pm 0.5$  V in 1  $\mu$ s or less, and within  $\pm 100$  mV in 1 ms or less.

**Common mode rejection:** measured at a deflection factor of 0.001 V/div. (CMR decreases with increasing deflection settings.)

Frequency Range	CMR	Common Mode Input Sinewave (max p-p)
dc to <100 kHz	$\geq 20,000:1$ ( $\approx 86$ dB)	10 V
100 kHz to <1 MHz	$\geq 10,000:1$ ( $\approx 80$ dB)	10 V
1 MHz to <10 MHz	$\geq 5,000:1$ $\geq$ Freq in MHz	10 V (freq in MHz)
20 MHz	$\geq 50:1$ ( $\approx 34$ dB)	1 V
60 Hz	$\geq 2,000:1$ ( $\approx 66$ dB)*	10 V

\*AC-coupled (all others dc-coupled).

### DC offset

$V_0$ Range	Deflection Factor	Comparison Accuracy
0 to $\pm 6$ V	0.001 V/div to 0.02 V/div	$\pm (0.15\% + 8$ mV)
	0.05 V/div to 0.2 V/div	$\pm (0.75\% + 8$ mV)
	0.5 V/div to 2 V/div	$\pm 1\%$
	5 V/div to 20 V/div	$\pm 3\%$
0 to $\pm 60$ V	0.01 V/div to 0.2 V/div	$\pm (0.4\% + 8$ mV)
	0.5 V/div to 2 V/div	$\pm (0.75\% + 8$ mV)
	5 V/div to 20 V/div	$\pm 3\%$
0 to $\pm 600$ V	0.1 V/div to 2 V/div	$\pm (0.65\% + 0.8$ V)
	5 V/div to 20 V/div	$\pm 3\%$

**$V_0$  output:** calibrated dc offset voltage available at front panel connector, continuously variable from 0 to  $\pm 0.006$  V, 0 to  $\pm 0.06$  V, 0 to  $\pm 0.6$  V or 0 to  $\pm 6$  V. Accuracy of the 6 V range is  $\pm 0.15\%$  of reading  $\pm 8$  mV, when driving a resistance of 10 megohms or higher.

### Triggering

DC to 40 MHz on signals causing 0.5 div or more vertical deflection.

### General

**Operating environment:** same as 180C/D mainframe.

**Weight:** net, 2.3 kg (5 lb). Shipping, 4.5 kg (10 lb).

**Accessories supplied:** one Operating and Service Manual.

### Recommended probes

Models 10004D, 10005D, and 10006D passive probes and 10040A, 10041A, 10042A miniature passive probes maintain full performance of the 1803A.

### Ordering information

	Price
1803A Dual Channel Vertical Amplifier	\$1000
Opt 001: channel B output and X5 magnifier	add \$155
Opt 003: without probes	less \$110
Opt 090: 1.8 m (6 ft) 10006D probes in lieu of 10004D	N/C
Opt 091: 3 m (10 ft) 10005D probes in lieu of 10004D	N/C
1806A Dual Channel Vertical Amplifier	\$850
Opt 910: additional Operating and Service Manual	add \$6
1806A Dual Channel Vertical Amplifier	\$850
Opt 910: additional Operating and Service Manual	add \$5
1803A Dual Channel Vertical Amplifier	\$1500
Opt 910: additional Operating and Service Manual	add \$5

# OSCILLOSCOPES

180 Verticals: 4 channel, 100 MHz & 50 MHz

Models 1809A & 1804A

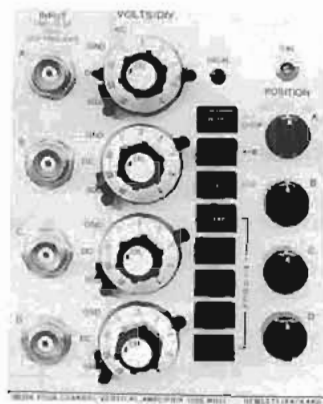

1809A

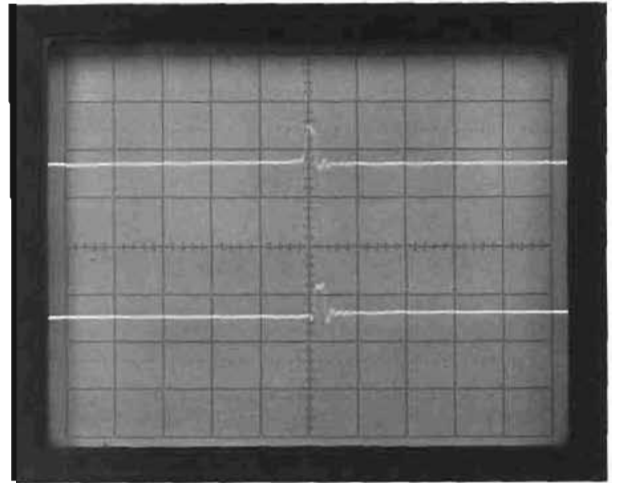

1809A in dual differential mode (A + B) and (C + D) shows transient state (race condition) occurring at count 8 of a TTL decade divider between both Q1 and Q2 (upper trace) and Q2 and Q3 (lower trace).

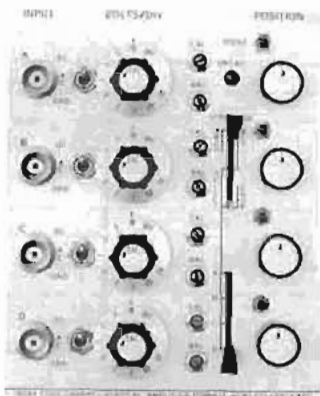

1804A

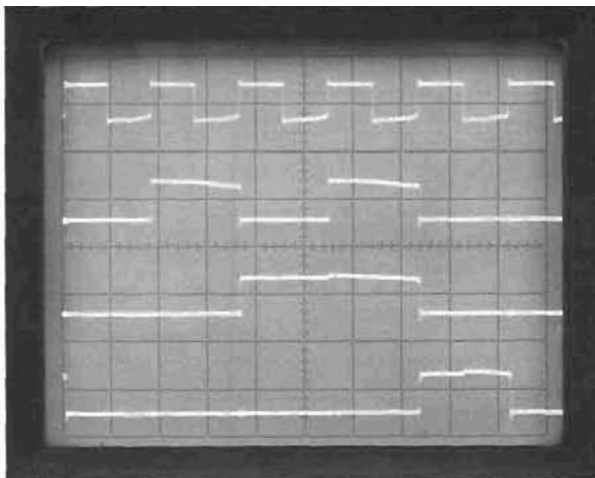

Four channel display shows ease of making timing measurements of the Q outputs on a TTL decade divider.

## Description

Model 1809A, 100 MHz four channel vertical amplifier plug-in provides accurate multi-trace, 10 mV/div measurements in both digital and analog applications. Its wide bandwidth coupled with 5 ns/div sweep speeds allows high resolution timing measurements in digital circuits. Multi-channel timing measurements are also aided with the ability to select the alternate sweep mode or a fast chop mode with a 1 MHz chop rate for 2 channels or 500 kHz rate for all four channels.

A thick film, planar attenuator with selectable 1 megohm or 50 ohms input impedance precedes an MSI integrated circuit amplifier to attain 100 MHz bandwidth at 10 mV/div deflection factors. The 1 megohm (ac or dc) input has only 12 pF shunt capacitance for minimal loading in probing applications. For accurate 50 ohm measurements, a precision, dc-coupled, internal 50 ohm input termination may be selected with a front panel switch. The 50 ohm termination maintains low SWR and pulse fidelity by compensating for normal input capacitance which is not possible with external terminations.

The flexible trigger source selection allows timing measurements referenced from channel A, B, C, or D or each channel triggered independently in composite mode. Any channel may be used as the trigger source whether it is displayed or not.

Any of the four channels may be inverted with a convenient front panel switch. In addition, the ADD mode gives you the capability of looking at two pairs differentially ( $\pm A \pm B$ ), ( $\pm C \pm D$ ) or ( $\pm A \pm B$ ),  $\pm C$ ,  $\pm D$  which makes measurements in balanced or differential lines easy.

Model 1804A provides four channel measurement capability to 50 MHz with 20 mV/div deflection factors and is particularly useful in low speed logic applications. Deflection factors from 20 mV/div to 10 V/div assure measurement compatibility with most logic levels. Trace identification is conveniently obtained with a pushbutton on each channel which moves the respective trace approximately 1/2 division.

A wide selection of trigger sources increases measurement versatility by allowing you to select the trigger mode to fit your particular application. In Chop or Alternate mode, you can trigger on any channel to see the time relationship with the other three channels. In the composite mode, each channel triggers separately for direct comparison of signals in spite of time delays or for display of asynchronous signals.



## 1809A Specifications

### Modes of operation

Channels A, B, C, or D or any combination displayed alternately on successive sweeps (ALT) or chopped (CHOP) with blanking during switching; either channels A and B or C and D may be algebraically added ( $\pm A \pm B$ ) or ( $\pm C \pm D$ ). Approximate chop rate for two channels displayed is 1 MHz, 3 channels is 667 kHz, 4 channels is 500 kHz.

### Each channel (4)

**Bandwidth** (measured with or without 10014A probe, 3 dB down from a terminated 50 ohm source.)

**DC-coupled:** dc to 100 MHz.

**AC-coupled:** approx. 10 Hz to 100 MHz. Lower limit is approx. 1 Hz with 10014A probe.

**Rise time:** <3.5 ns. Measured with or without 10014A probe, 10% to 90% of 6 div input step from a terminated 50 ohm source.

### Deflection factor

**Ranges:** from 0.01 V/div to 5 V/div (9 calibrated positions) in 1, 2, 5 sequence.

**Attenuator accuracy:**  $\pm 2\%$ .

**Vernier:** provides continuous adjustment between all deflection factor ranges. Extends maximum deflection factor to at least 12.5 V/div.

**Signal delay:** input signals are delayed sufficiently to view leading edge of input without advanced external trigger.

**Input coupling:** ac, dc, 50 ohms (dc), or ground. Ground position disconnects input connector and grounds amplifier input.

### Input RC (selectable)

**AC or DC:** 1 megohm  $\pm 1\%$  shunted by approx. 12 pF.

**50 ohm:** 50 ohms  $\pm 2\%$ . SWR, 1.3 at 100 MHz on all ranges.

### Maximum input

**AC and DC:**  $\pm 300$  V (dc + peak ac) at 1 kHz or less;  $\pm 150$  V (dc + peak ac) on 10 mV/div range at 1 kHz or less.

**50 ohm:** 10 V rms (dc-coupled input).

**Polarity:** any channel may be inverted for  $\pm A$ ,  $\pm B$ ,  $\pm C$ , or  $\pm D$  operation.

### Algebraic addition (A + B), (C + D)

**Amplifier:** bandwidth and deflection factors are unchanged, any channel may be inverted for ( $\pm A \pm B$ ) or ( $\pm C \pm D$ ) operation.

**Differential input (A - B) or (C - D) common mode:** CMRR is at least 20 dB from dc to 80 MHz on all ranges.

### Triggering

**Source:** selectable from channel A, B, C, D, or composite (on displayed signals) in all display modes.

### Frequency

Time Base Plug-In	Trigger frequency*	Required Vertical Deflection
1820C, 1825A	dc—50 MHz dc—100 MHz	1/2 div 1 div
1821A	dc—50 MHz	1 div

\*All display modes except Chop, dc to 100 kHz in Chop.

### General

**Weight:** net, 3.2 kg (7 lb). Shipping, 4.5 kg (10 lb).

**Operating environment:** same as 180C/D mainframes.

**Accessories supplied:** one Operating and Service Manual.

### Recommended probes

Models 10014A, 10015A, 10016B, 10017A, and 10018A will maintain 1809A bandwidth and rise time in the high impedance (ac or dc)

mode. Models 10020A, 1125A, 10026A, and 10027A will maintain bandwidth and rise time in the 50 ohm input mode.

## 1804A Specifications

### Modes of operation

Channels A, B, C, or D or any combination displayed alternately on successive sweeps (ALT) or chopped (CHOP) with blanking during switching. Approximate chop rate for two channels displayed is 500 kHz, 3 channels is 333 kHz, and 4 channels is 250 kHz.

### Each channel (4)

**Bandwidth** (measured with or without 10004D probe, 3 dB down from 8 div reference signal from a terminated 50 ohm source.)

**DC-coupled:** dc to 50 MHz.

**AC-coupled:** approx. 10 Hz to 50 MHz (lower limit is approx. 1 Hz with 10004D probe).

**Rise time:** <7 ns (measured with or without 10004D probe, 10% to 90% of 8 div input step from a terminated 50 ohm source).

### Deflection factor

**Ranges:** from 0.02 V/div to 10 V/div (9 calibrated positions) in 1, 2, 5 sequence.

**Attenuator accuracy:**  $\pm 3\%$ .

**Vernier:** provides continuous adjustment between deflection factor settings and extends maximum deflection factor to at least 25 V/div. Front panel light indicates when vernier is out of CAL position.

**Signal delay:** input signals are delayed sufficiently to view leading edge of input pulse without advanced external trigger.

**Input coupling:** AC, DC, and Ground. Ground disconnects input signal and grounds amplifier input.

**Input RC:** approx. 1 megohm shunted by approx. 25 pF, constant on all ranges.

### Maximum input

**DC-coupled:**  $\pm 350$  V (dc + peak ac);  $\pm 150$  V (dc + peak ac) on 20 mV/div at 10 kHz or less.

**AC-coupled:**  $\pm 400$  V dc.

**Trace identification:** pushbutton control displaces respective trace approx. 0.5 div.

### Triggering

**Source:** selectable on signal from any channel in either Chop or Alt mode, or successively from displayed signal on each channel in Alt mode.

**Frequency:** dc to 50 MHz on signals causing 0.5 div or more vertical deflection in all display modes except Chop. DC to 200 kHz in Chop mode.

### General

**Operating environment:** temperature, 0 to 55°C (+32°F to +130°F); humidity, to 95% relative humidity at 40°C (104°F); altitude, to 4.6 km (15 000 ft); vibration, vibrated in three planes for 15 min, each with 0.254 mm (0.010 in.) excursion, 10 to 55 Hz.

**Weight:** net, 2.3 kg (5 lb). Shipping, 3.6 kg (8 lb).

**Accessories supplied:** one Operating and Service Manual.

### Recommended probes

10004D, 10005D, 10006D passive probes and, 10040A, 10041A, 10042A miniature passive probes, maintain full performance of the 1804A.

### Ordering information

1809A 100 MHz 4 Channel Amplifier  
 Opt 910: additional Operating and Service Manual  
 1804A 50 MHz 4 Channel Amplifier  
 Opt 910: additional Operating and Service Manual

### Price

\$2300  
 add \$14  
 \$1400  
 add \$7.50

# OSCILLOSCOPES

## 180 Time bases: single & delayed

### Models 1820C & 1821A

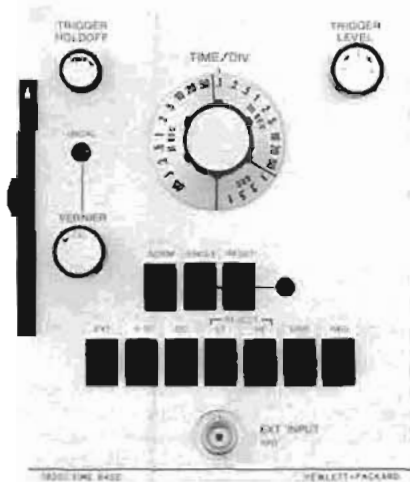

1820C



1821A

## 1820C Specifications

### Time base

#### Sweep

**Ranges:** 0.05  $\mu$ s/div to 1 s/div (23 positions) in 1, 2, 5 sequence;  $\pm 3\%$  accuracy with vernier in CAL position.

**Vernier:** continuously variable between ranges, extends slowest sweep to at least 2.5 s/div. Front panel light indicates when vernier is not in CAL position.

**Magnifier:** (mainframe) expands fastest sweep to 5 ns/div.

#### Sweep mode

**Normal:** triggered by an int, ext, or power line signal.

**Automatic:** bright baseline displayed in absence of trigger signal.

Triggering is same as Normal except low frequency limit is 40 Hz.

**Single:** in Normal, sweep occurs once with same triggering as Normal (reset pushbutton arms and lights indicator); in Auto, sweep occurs once each time reset pushbutton is pressed.

### Triggering

**Internal:** refer to vertical plug-in specifications.

**External:** dc to 50 MHz on signals 50 mV p-p or more increasing to 100 mV at 100 MHz and 150 mV at 150 MHz.

**Line:** power line frequency signal.

#### Level

**Internal:** at any point on the vertical waveform displayed.

**External:** continuously variable from +2V to -2V on either slope of trigger signal, from +20 V to -20 V in  $\times 10$  setting.

**Slope:** pushbutton selection of + or - slope of trigger signal.

**Coupling:** front panel selection of AC, DC, HF Reject or LF Reject. AC attenuates signals below approx. 20 Hz. LF reject attenuates signals below approx. 15 kHz. HF reject attenuates signals above approx. 15 kHz.

**Trigger holdoff:** time between sweeps continuously variable, exceeding one full sweep on all ranges.

### General

**Operating environment:** same as 180C/D mainframe.

**Weight:** net. 1.4 kg (3 lb). Shipping, 3.2 kg (7 lb).

## 1821A Specifications

### Main time base

#### Sweep

**Ranges:** from 0.1  $\mu$ s/div to 1 s/div (22 positions) in 1, 2, 5 sequence;  $\pm 3\%$  accuracy with vernier in CAL position.

**Vernier:** continuously variable between all ranges; extends slowest sweep to at least 2.5 s/div.

**Magnifier:** (mainframe) expands fastest sweep to 10 ns/div.

#### Sweep mode

**Normal:** triggered by an int, ext, or power line signal.

**Automatic:** bright baseline displayed in absence of input signal.

Triggering same as normal except low frequency limit is 40 Hz for

internal or external modes.

**Single:** sweep occurs once with same triggering as normal; reset pushbutton with indicator light.

### Delayed time base

Delayed time base sweeps after a time delay set by Main time base and Delay controls.

#### Sweep

**Ranges:** from 0.1  $\mu$ s/div to 50 ms/div (18 positions) in 1, 2, 5 sequence;  $\pm 3\%$  accuracy with Vernier in CAL position.

**Vernier:** continuously variable between all ranges; extends slowest sweep to at least 125 ms/div.

**Magnifier:** (mainframe) expands fastest sweep to 10 ns/div.

### Triggering

#### Main and delayed time base

**Internal:** refer to vertical plug-in specifications.

**External:** from dc to 50 MHz on signals 0.5 V p-p or more, increasing to 100 MHz on signals 1 V p-p or more.

**Line:** power line frequency signal.

**Level and slope:** internal, at any point on the vertical waveform displayed; external, continuously variable from +3 V to -3 V on either slope of the sync signal, from +30 V to -30 V in  $\times 10$ .

**Automatic (delayed only):** triggered at end of set time delay.

**Coupling:** front panel selection of AC, DC, ACF, or ACS. AC attenuates signals below approx. 20 Hz. ACF (ac-fast) attenuates signals below approx. 15 kHz. ACS (ac-slow) attenuates signals above approx. 30 kHz.

**Trace Intensification:** intensifies that part of Main time base to be expanded to full screen on Delayed time base. Rotating Delayed time base sweep switch from Off position activates intensified mode. Front panel screwdriver adjust sets relative intensity of brightened segment.

#### Delay (before start of Delayed sweep)

**Time:** continuously variable from 0.1  $\mu$ s to 10 s.

**Accuracy:**  $\pm 1\%$  of differential delay  $\pm 2$  minor divisions of delay dial. Time jitter is  $< 0.005\%$  (1 part in 20 000) of maximum delay of each step.

**Trigger output:** (at end of Delay time) approx. 1.5 V with  $< 50$  ns rise time from 1000 ohm source resistance.

**Mixed time base:** dual time base in which Main time base drives first portion of sweep and delayed time base completes sweep at up to 1000 times faster. Also operates in single sweep mode.

### General

**Operating environment:** same as 180 C/D mainframes.

**Weight:** net. 1.8 kg (4 lb). Shipping, 3.6 kg (8 lb).

### Ordering Information

1821A Time Base and Delay Generator

Opt 910: additional Operating and Service Manual

1820C Time Base

Opt 910: additional Operating and Service Manual

Price

\$925

add \$5

\$925

add \$7.50

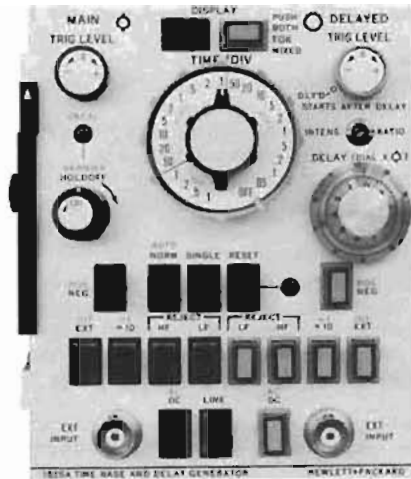

1825A

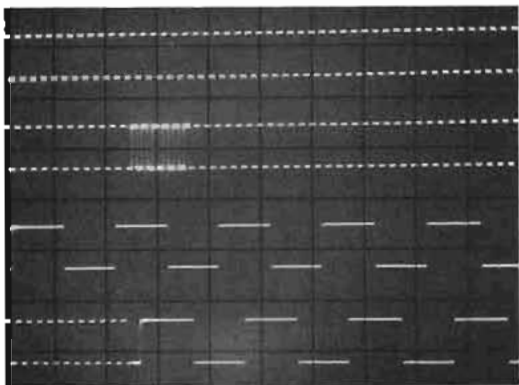

Main sweep  
Intensified main sweep  
Delayed sweep  
Mixed sweep

Multiple exposure shows four modes of operation for 1825A, with time relationship maintained in all modes.

### 1825A Description

Model 1825A time base and delay generator provides sweep speeds ranging from 0.05  $\mu\text{s}/\text{div}$  to 1 s/div in 23 positions. Delay times are continuously variable from 50 ns to 10 s and are accurate to 0.75% with extremely low jitter of 1 part in 50,000. Also, a calibrated mixed sweep mode is provided. A mainframe X10 magnifier increases sweep-speed capability to 5 ns/div with 5% accuracy.

One knob control makes triggering easy in main, delayed, and mixed modes. Stable, accurate time displays are provided in main, delayed, and mixed modes with the highly sensitive 50 mV external trigger capability at 50 MHz which increases to only 150 mV at 150 MHz. Trigger synchronization is maintained when switching between main, delayed, and mixed modes, further simplifying use.

Front panel controls are logically arranged for quick familiarization and easy use. Pushbuttons eliminate front panel clutter and reduce the possibility of errors. Easy-to-operate pushbuttons establish main, delayed, and mixed modes of operation.

Trigger level controls on main and delayed sweeps allow selection of the triggering point on the desired portion of the signal for almost every measurement application. Also, the +10 function provides a wide dynamic range of triggering in both external and internal modes of operation.

External trigger sensitivity of 50 mV on both main and delayed sweeps allows a 10:1 divider probe to be used to reduce circuit loading at trigger pick-off points and reduces the possibility of circuit malfunction caused by the measuring instrument.

### 1825A Specifications

#### Main time base

##### Sweep

**Ranges:** 0.05  $\mu\text{s}/\text{div}$  to 1 s/div (23 positions) in 1, 2, 5 sequence;  $\pm 3\%$  accuracy with vernier in CAL position.

**Vernier:** continuously variable between ranges, extends slowest sweep to at least 2.5 s/div. Front panel light indicates when vernier is not in CAL position.

**Magnifier:** (on mainframe) expands fastest sweep to 5 ns/div, accuracy  $\pm 5\%$ .

##### Sweep mode

**Normal:** sweep is triggered by an internal, external, or power line signal.

**Automatic:** bright baseline displayed in absence of trigger signal. Triggering is same as Normal except low frequency limit is 40 Hz.

**Single:** in Normal, sweep occurs once with same triggering as Normal; reset pushbutton arms sweep and lights indicator; in Auto, sweep occurs once each time reset pushbutton is pressed.

#### Delayed time base

Delayed time base sweeps after a time delay set by Main time base and Delay controls. Delayed time base is triggered on first trigger pulse after set delay or automatically triggers after set delay when delayed level control is in detent position.

##### Sweep

**Ranges:** 0.05  $\mu\text{s}/\text{div}$  to 20 ms/div (18 positions) in 1, 2, 5 sequence;  $\pm 3\%$  accuracy.

**Magnifier:** (on mainframe) expands fastest sweep to 5 ns/div, accuracy  $\pm 5\%$ .

#### Triggering

**Internal:** refer to vertical amplifier plug-in specifications.

**External:** dc to 50 MHz on signals 50 mV p-p or more increasing to 100 mV p-p at 100 MHz and 150 mV p-p at 150 MHz.

**Line:** power line frequency signal (Main only).

#### Level

**Internal:** at any point on the vertical waveform displayed.

**External:** continuously variable from +2 V to -2 V on either slope of trigger signal, from +20 V to -20 V in  $\div 10$  setting.

**Slope:** pushbutton selects either positive or negative slope of trigger signal.

**Coupling:** front panel selection of AC, DC, HF Reject, or LF Reject.

**AC:** attenuates signals below approx. 20 Hz.

**LF reject:** attenuates signals below approx. 15 kHz.

**HF reject:** attenuates signals above approx. 15 kHz.

**Trigger holdoff:** time between sweeps continuously variable, exceeding one full sweep on all ranges (Main only).

#### Delay (before start of delayed sweep)

**Time:** continuously variable from 50 ns to 10 s.

**Accuracy:**  $\pm 0.75\%$  of differential delay  $\pm 2$  minor divisions of delay dial.

**Time jitter:** 0.002% (1 part in 50,000) of maximum delay on each range.

#### Trace Intensification

In Main sweep mode, intensifies that part of main time base to be expanded to full screen in delayed time base mode. Rotating time base switch from OFF position activates intensified mode.

#### Calibrated mixed sweep

Combines Main and Delayed sweeps into one display. Sweep is started by the Main time base and is completed by the faster Delayed time base. Delayed sweep start is aligned with start of intensified marker.

#### General

**Operating environment:** same as 180C/D mainframes.

**Weight:** net, 1.8 kg (4 lb). Shipping, 2.7 kg (6 lb).

**Accessories supplied:** one Operating and Service Manual.

#### Ordering Information

1825A Time Base and Delay Generator

\$875

Opt 910: additional Operating and Service Manual

add \$7.50

# OSCILLOSCOPES

## 180 Samplers: 1 GHz & 18 GHz

### Models 1810A, 1811A & 1430C

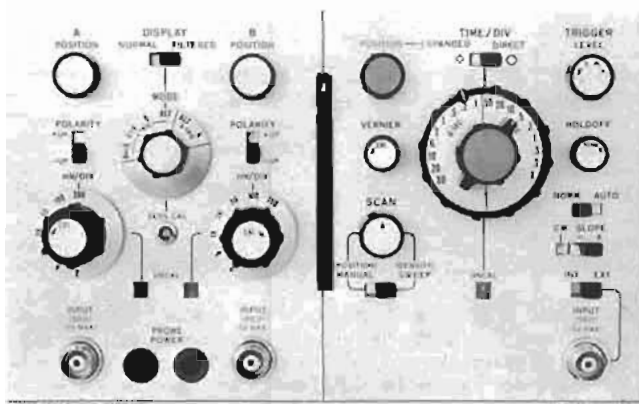

1810A



1811A

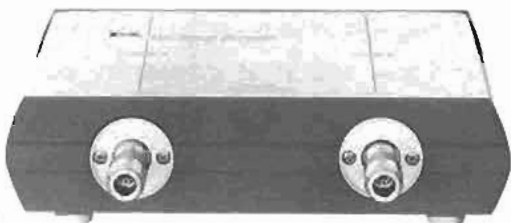

1430C

## 1810A Specifications

### Modes of operation

Channel A; channel B; channels A and B displayed on alternate samples (ALT); channel A plus channel B (algebraic addition); and channel A versus channel B.

### Vertical channels

**Bandwidth:** dc to 1 GHz.

**Rise time:** <150 ps.

**Pulse response:**  $\leq \pm 5\%$  or 3 mV p-p (overshoot and perturbations) in normal display mode.

### Deflection factor

**Ranges:** 2 mV/div to 200 mV/div (7 calibrated positions) in 1, 2, 5 sequence;  $\pm 3\%$  accuracy.

**Vernier:** provides continuous adjustment between all deflection factor ranges; extends minimum deflection factor to <1 mV/div. Front panel light indicates when vernier is not in CAL position.

**Polarity:** + up or - up.

**Dynamic range:** > 1.6 V.

**Positioning range:** >= 1 V on all deflection factors.

**Input R:** 50 ohms,  $\pm 2\%$ .

**Maximum Input:**  $\pm 5$  V (dc + peak ac).

**SWR:** <1.1 to 300 MHz, increasing to <1.5 at 1 GHz.

**Reflection coefficient:** <6%, measured with HP Model 1415A TDR.

### Random noise

**Normal:** <2 mV, observed from center 80% of dots.

**Filtered:** reduces noise at least 2 to 1.

**Isolation between channels:**  $\geq 40$  dB with 350 ps rise time input.

**Time difference between channels:** <100 ps.

**A + B operation:** bandwidth and deflection factors are unchanged; either channel may be inverted for  $\pm A \pm B$  operation.

### Time base

#### Ranges

**Normal:** 10 ns/div to 50  $\mu$ s/div (12 calibrated positions) in a 1, 2, 5 sequence.  $\pm 3\%$  accuracy with vernier in calibrated position.

**Expanded:** direct reading expansion up to X100 in seven calibrated steps on all normal times scales, extends the range to 100 ps/div. Accuracy is  $\pm 4\%$  (10 ps/div,  $\pm 10\%$  using the mainframe magnifier).

**Vernier:** continuously variable between ranges; increases fastest sweep to <40 ps/div. Front panel light indicates when vernier is not in CAL position.

### Triggering

#### Mode

**Normal:** trigger level control can be adjusted to trigger on a wide variety of signals.

**Automatic:** triggers automatically on most signals with a minimum of adjustment of the level control. A baseline is displayed in the absence of an input signal.

#### Internal

**Source:** selectable; channel A triggers channel A or alternate; channel B triggers channel B, alternate, A + B, or A vs B.

**Sine wave:** 30 mV p-p for signals from 1 kHz to 200 MHz, 100 mV p-p for signals from 200 MHz to 1 GHz for jitter of <30 ps plus 1% of 1 period. Useful triggering can be obtained with 5 mV signals.

**Pulse:** 30 mV peak, 3 ns wide pulses for <30 ps jitter. Useful triggering can be obtained with 5 mV signals.

#### External

**Sine wave:** 30 mV p-p for signals from 1 kHz to 1 GHz for jitter of <30 ps plus 1% of 1 period. Useful triggering can be obtained with 5 mV signals.

**Pulse:** 30 mV peak, 3 ns wide pulses for <30 ps jitter. Useful triggering can be obtained with 5 mV signals.

#### Either Internal or external

**Auto:** 50 mV p-p for CW signals from 10 kHz to 200 MHz for <30 ps jitter plus 2% of 1 period (may be used to 1 GHz with increased jitter). Pulse triggering requires 50 mV peak, 3 ns wide pulses for <30 ps jitter.

**Level and slope:** level control minimizes jitter and is variable over  $\pm 800$  mV range on either slope of sync signal.

**Coupling:** ac coupling attenuates signals below approx. 1 kHz.

**Variable holdoff:** variable over at least a 3:1 range in all sweep modes.

**Marker position:** intensified marker segment indicates point about which the sweep is to be expanded (automatically dimmed with increasing persistence in 181 and 184 mainframes).

#### Scan

**Internal:** dot density, continuously variable from <100 to >1000 dots full screen or from approx. 500 to 2000 dots in filtered mode.

**Manual:** scan is positioned manually by front panel control.

### General

**Probe power:** supplies power to operate two HP active probes.

### Recorder outputs

**Vertical:** an uncalibrated 1 V vertical output from each channel is provided at the rear panel of 180 system mainframes.

**Horizontal:** an uncalibrated 0.75 V amplitude signal is provided at the rear panel of 180, 181, 182, and 184 mainframes.

**Operation environment:** same as 180C/D mainframes.

**Weight:** net, 3.2 kg (7 lb). Shipping, 5 kg (11 lb).

**Accessories supplied:** one Operating and Service Manual.

## 1811A Specifications

### Modes of operation

Channel A: channel B; channels A and B displayed on alternate samples (ALT); channel A plus channel B (algebraic addition); and channel A versus channel B.

### Vertical channels

#### Deflection factor

**Ranges:** 2 mV/div to 200 mV/div (6 calibrated positions) in 1, 2, 5 sequence; accuracy  $\pm 3\%$ .

**Vernier:** provides continuous adjustment between all deflection factor ranges; extends minimum deflection factor to  $< 1$  mV/div. Front panel light indicates when vernier is not in CAL position.

**Polarity:** + up or - up.

**Positioning range:**  $\geq 1$  V on all deflection factors.

**A + B operation:** bandwidth and deflection factors are unchanged; either channel may be inverted for  $\pm A \pm B$  operation.

### Time base

#### Ranges

**Normal:** 1 ns/div to 5  $\mu$ s/div (12 calibrated positions) in a 1, 2, 5 sequence.  $\pm 3\%$  accuracy with vernier in calibrated position.

**Expanded:** direct reading expansion up to X100 in seven calibrated steps on all normal time scales; extends the range to 10 ps/div. Accuracy is  $\pm 4\%$  (1 ps/div.  $\pm 10\%$  using the mainframe magnifier).

**Vernier:** continuously variable between ranges; increases fastest sweep to  $< 4$  ps/div.

### Triggering

**Auto:** triggers automatically on most signals with a minimum of level control adjustment. A baseline is displayed in the absence of an input signal.

**Normal:** trigger level control may be adjusted to trigger on a wide variety of signals.

**CW:** 80 mV p-p for sine wave signals from 1 kHz to 1 GHz for jitter of  $< 10$  ps plus 1% of 1 period of trigger signal. Useful displays can be obtained with trigger signals as low as 5 mV. Triggering may be extended to 18 GHz with HP Model 1104A/1106B trigger countdown

**Slope:** triggers on 50 mV/peak, 3 ns wide pulses, for  $< 30$  ps jitter.

**Level and slope:** continuously variable from +800 mV to -800 mV on either slope of sync signal.

**Coupling:** ac coupling attenuates signals below approx 1 kHz.

**Variable holdoff:** variable over at least a 3:1 range in all sweep modes.

**Marker position:** intensified marker segment indicates point about which the sweep is to be expanded (automatically dimmed with increasing persistence in 181 and 184 variable persistence/storage mainframes).

#### Scan

**Internal:** dot density, continuously variable from  $< 100$  to  $> 1000$  dots full screen or from approx. 500 to  $> 2000$  dots in filtered mode.

**Manual:** scan is positioned manually by front panel control.

**Trigger output:** 1 ns, 1.5 V into 50 ohms.

### General

**Probe power:** supplies power to operate HP active probe.

#### Recorder outputs

**Vertical:** an uncalibrated 1 V vertical output signal from each channel is provided at the rear panel of 180 series mainframes.

**Horizontal:** an uncalibrated 0.75 V amplitude signal is provided at the rear panel of 180, 181, 182 or 184 mainframes.

**Operating environment:** same as 180C/D mainframes.

**Weight:** net, 2.3 kg (5 lb). Shipping, 5 kg (11 lb).

**Accessories supplied:** one Operating and Service Manual.

## 1430C Specifications

### Sampling head

**Rise time:** approx. 20 ps ( $< 28$  ps observed with 1105A/1106B pulse generator and 909A Option 012, 50 ohm load).

**Bandwidth:** dc to  $> 18$  GHz.

**Overshoot:**  $< 7.5\%$ .

**Noise:** approx. 10 mV observed noise on CRT excluding 10% of random dots. Noise decreases to approx. 2.5 mV on the automatically filtered 2 mV/div and 5 mV/div ranges and all other ranges when display switch (on 1811A) is set to filtered position.

**Dynamic range:** 1 V p-p.

**Low frequency distortion:**  $\leq \pm 5\%$ .

**Maximum safe input:**  $\pm 3$  volts.

#### Input characteristics

**Mechanical:** type N female connectors on input and output ports.

**Electrical:** 50 ohm feedthrough, dc-coupled. Reflection from sampler is approx. 10%, measured with a 40 ps TDR system. Pulses emitted from sampler input are approx. 10 mV amplitude and 5 ns duration.

**Time difference between channels:**  $< 5$  ps.

**Isolation between channels:**  $\geq 40$  dB over sampler bandwidth.

**Connecting cable length:** 1.5 m (5 ft).

### General

**Weight:** net, 1.8 kg (4 lb). Shipping, 4.1 kg (9 lb).

**Accessories supplied:** two 50 ohm loads with type N male connectors (HP Model 909A Option 012), one 1.5 m (5 ft) sampling head to 1811A interconnecting cable (HP P/N 5060-0540), and one Operating and Service Manual.

#### \*Components required for sampling systems

<b>1811A Sampling plug-in</b>
Sampling to 18 GHz with 1430C Sampling Head (Type N Female Input/output connectors)
<b>Trigger Accessories</b>
$< 1$ GHz: Cable 11500A Type N Male to Type N Male 1.8 m (6 ft), Adapter 1250-0077 Type N Female to BNC Male.
1 GHz to 10 GHz: 1104A Trigger Countdown, 1108A Tunnel Diode, Adapter 1250-0847 GR Type 874 to Type N Male, 1109B High Pass Filter, 11170C Male BNC to Male BNC Trigger Cable 1.2 m (4 ft).
1 GHz to 18 GHz: 1104A Trigger Countdown, 1106B Tunnel Diode, 1109B High Pass Filter, 11170C Male BNC to Male BNC Trigger Cable 1.2 m (4 ft).
<b>TDR with 1430C Sampling Head</b>
1105A Pulse Generator, 1106B Tunnel Diode 20 ps tr, 11170C Male BNC to Male BNC Trigger Cable 1.2 m (4 ft).
1105A Pulse Generator, 1108A Tunnel Diode 60 ps tr, Adapter 1250-0847 GR 874 to Type N Male, 11170C 1.2 m (4 ft) Male Bnc to Male BNC Trigger Cable.

\*Use any 180 series mainframe

### Ordering Information

	Price
<b>1810A Sampler</b>	\$2350
Opt 910: additional Operating and Service Manual	add \$7.50
<b>1811A Sampler</b>	\$2100
Opt 910: additional Operating and Service Manual	add \$12.50
<b>1430C Sampling Head, 18 GHz</b>	\$3250
Opt 910: additional Operating and Service Manual	add \$3.50
1104A Trigger Countdown	\$270
1105A Pulse Generator	\$320
1106B (Type N Connector)	\$650
1106B Opt. 001 (APC-7 connector)	\$700
1108A (GR-874 Connector)	\$350
Recommended Accessory: HP Model 1109B High Pass Filter	\$230

# OSCILLOSCOPES

180 TDR: 35 & 170 ps rise time

Models 1815B, 1817A & 1818A

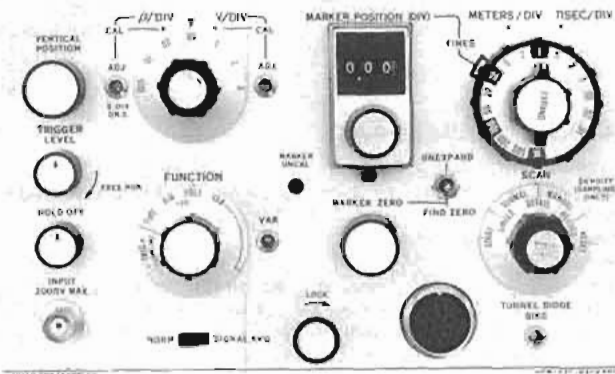

1815B

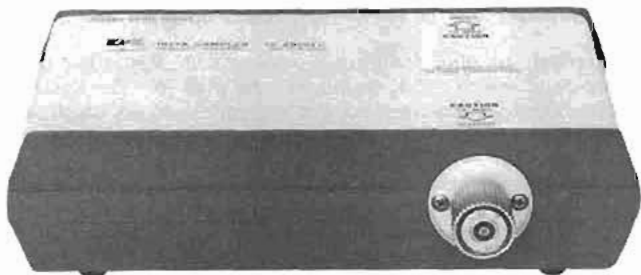

1817A

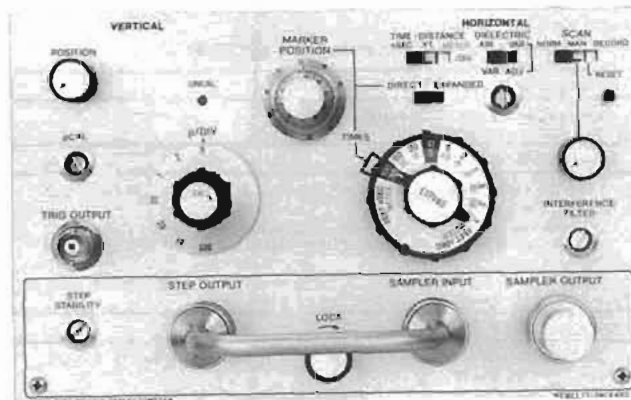

1818A

## 1815B Description

Model 1815B provides calibrated 35 ps system rise time, time domain reflectometry and 12.4 GHz (28 ps rise time) sampling capability with a remote feedthrough sampling head for extremely accurate measurements. This TDR system can locate impedance discontinuities in transmission systems up to 10 000 metres long and also allows measurement of discontinuities spaced only a few millimetres apart. As a single channel, general purpose sampling oscilloscope, you have deflection factors to 2 mV/div and sweep times to 10 ps/div.

## 1815B Specifications

Unless indicated otherwise, TDR and sampling performance specifications are the same. Where applicable, TDR specification is given first, followed by Sampler specification in parentheses. Model 1815B is calibrated in metres.

### Vertical

**Scale:** reflection coefficient  $\rho$  (volts) from 0.005/div to 0.5/div in 7 calibrated ranges; 1, 2, 5 sequence.

**Accuracy:**  $\pm 3\%$ ; TDR only,  $\pm 5\%$  on 0.01/div and 0.005/div in signal average mode.

**Vernier:** provides continuous adjustment between ranges; extends scale to  $>0.002$ /div.

**Signal average:** reduces noise and jitter approx. 2:1.

### Horizontal

**Scale:** provides up to a 10 000 metre display window with round-trip time or distance (time) in four calibrated decade ranges of 1/div, 10/div, 100/div, and 1000/div. Concentric expand control provides direct read-out in 28 calibrated steps in 1, 2, 5 sequence from 0.01 ns/div to 1000 ns/div or from 0.01 metre/div to 1000 metres/div.

**Accuracy:** time,  $\pm 3\%$ ; distance (TDR only)  $\pm 3\%$ ,  $\pm$  variations in propagation velocity.

**Marker position:** indicator, calibrated in divisions, provides direct read-out of round-trip time or distance (time), number of divisions  $\times$  decade range in units/div. Front panel light indicates when vernier is not in CAL position.

**Marker zero:** ten-turn control provides variable reference for marker position dial, allows direct read-out of round trip or distance (time) between two or more displayed events.

**Zero finder:** permits instant location of marker reference.

**Dielectric, TDR only:** calibrated for air,  $\epsilon = 1$  and for polyethylene,  $\epsilon = 2.25$ . Also provides settings for dielectric constants  $\epsilon = 1$  to  $\epsilon =$  approx 4.

### Triggering, sampling only

**Pulses:**  $<50$  mV for pulses 5 ns or wider for jitter  $<20$  ps.

**CW:** signals from 500 kHz to 500 MHz require at least 80 mV for jitter  $<2\%$  of signal period plus 10 ps; usable to 1 GHz. CW triggering may be extended to 18 GHz with HP models 1104A/1106B trigger countdown.

### Recorder outputs

Approx 100 mV/div; vertical and horizontal outputs at BNC connectors on rear panel of mainframe.

### Display modes

Replicative scan, normal or detail; single scan; manual scan; record.

### General

**Operating environment:** temperature, 0 to  $+55^\circ\text{C}$  ( $+32^\circ\text{F}$  to  $+130^\circ\text{F}$ ); humidity, to 95% relative humidity at  $40^\circ\text{C}$  ( $104^\circ\text{F}$ ); altitude, to 4600 m (15 000 ft); vibration, vibrated in three planes for 15 min. each with 0.254 mm (0.010 in.) excursion, 10 to 55 Hz.

**Weight:** net, 2.3 kg (5 lb). Shipping, 4.5 kg (10 lb).

## 1817A (28 ps Tr) sampler specifications

### TDR system (requires 1106B Opt 001)

**System rise time:**  $<35$  ps incident as measured with Model 1106B Opt 001.

**Overshoot:**  $\leq \pm 5\%$ .

**Internal reflections:**  $<10\%$  with 45 ps TDR; use reflected pulse from shorted output.

**Jitter:**  $<15$  ps; with signal averaging, typically 5 ps. Internal pickup:  $\rho \leq 0.01$ .

**Noise:** measured tangentially as a percentage of the incident pulse when terminated in 50 ohms and operated in signal averaging mode.  $<1\%$  on 0.005/div to 0.02/div;  $<3\%$  on 0.05/div to 0.5/div.

**Low frequency distortion:**  $\leq \pm 3\%$ .

**Maximum safe input:** 1 volt.

**Tunnel diode mount:** direct connection of 1106B Opt 001 to 1817A.

### Sampler system

**Rise time:**  $<28$  ps.

**Input:** 50 ohm feedthrough.

**Dynamic range:** 1 V p-p.

**Maximum safe input:** 3 volts.

**Low frequency distortion:**  $\leq \pm 3\%$ .

### Noise

**Normal:** <8 mV tangential noise on 0.01 V/div to 0.5 V/div.  
Noise decreases automatically on 0.005 V/div range.  
**Signal average:** reduces noise and jitter approx. 2:1.

### General

**Weight:** net, 1.4 kg (3 lb). Shipping, 5 kg (11 lb).

### Accessories supplied

**Cable, plug-in to sampler:** connects sampler (1817A) to plug-in (1815B). HP P/N 5060-0441.

**Cable, tunnel diode to sampler:** connects tunnel diode (1106B Opt 001 or 1108A) to sampler, type N male connectors on each end. HP P/N 01817-61603.

### Recommended accessories

**Trigger source:** external trigger source is required for triggering above 500 MHz. 10 GHz source is provided by the 1104A Trigger Countdown with the 1108A Tunnel Diode Mount. 18 GHz source is provided by the 1104A Trigger Countdown with the 1106B Opt 001 Tunnel Diode Mount.

## 1106B Opt 001 (20 ps Tr)/1108A (60 ps Tr) tunnel diode mounts specifications

Tunnel diode is required for a TDR system. Refer to sampling head specifications for mounting requirements.

**Amplitude (both):** >200 mV into 50 ohms.

**Rise time:** 1106B Opt 001 approx. 20 ps; 1108A, <60 ps.

**Output impedance:** 50 ohms,  $\pm 2\%$ .

**Source reflections:** 1106B Option 001, <10% with 45 ps TDR; 1108A, <10% with 145 ps TDR.

**Weight (both):** net, 0.5 kg (1 lb). Shipping, 1.4 kg (3 lb).

### \*Components required for TDR/sampling systems

1815B TDR/SAMPLING PLUG-IN
1817A SAMPLING HEAD (APC-7 Input/Output Connectors)
TDR, 35 ps tr 1106B Opt 001 Tunnel Diode
<b>SAMPLING up to 12.4 GHz</b> Termination, 50 ohm Model 909A, APC-7 connector
<b>TRIGGER ACCESSORIES</b> < 500 MHz Adapter 1250-0750 APC-7 to Type N Female 1150A Cable Type N Male to Type N Male, 1.8 m (6 ft) Adapter 1250-0077 Type N Female to BNC Male
<b>500 MHz to 10 GHz</b> 1104A Trigger Countdown 1108A Tunnel Diode Adapter 1250-0847 GR Type B74 to Type N Male 1109B High Pass Filter Adapter 1250-0750 APC-7 to Type N Female 11170C Male BNC to Male BNC Trigger Cable, 1.2 m (4 ft)
<b>500 MHz to 18 GHz</b> 1104A Trigger Countdown 1106B Opt 001 Tunnel Diode Adapter 1250-0748 APC-7 to Type N Male 1109B High Pass Filter Adapter 1250-0750 APC-7 to Type N Female 21170C Male BNC to Male BNC Trigger Cable, 1.2 m (4 ft)

\*Use any 180 series mainframe

## 1818A Description

The 1818A Time Domain Reflectometer plug-in with a 180 series mainframe gives you a completely integrated wide band system for testing of transmission lines, strip lines, cables, connectors, and many other devices in high frequency systems. The easy-to-use controls provide accurate direct distance calibrated displays of up to 300 metres or 1000 feet with dielectric materials from  $\epsilon = 1.0$  (air) to  $\epsilon = 4.0$ . This allows you to quickly determine the magnitude and nature of each resistive or reactive discontinuity in coaxial components such as attenuators, cables, connectors, and delay lines in microwave or pulse circuits. You can also locate and identify faults such as shorts, opens, loose connectors, defective tap offs, splices, and mismatches with measurement resolution as close as 2.54 cm.

## 1818A Specifications

### System (in reflectometer configuration)

**Rise time:** <170 ps.

**Overshoot:**  $\leq 5\%$  overshoot and ringing (down to  $1/2\%$  in 3 ns).

**Internal reflections:** <10% (does not limit resolution).

**Reflectometer sensitivity:** reflection coefficients as small as 0.001 can be observed.

### Signal channel

**Rise time:** approx. 150 ps.

**Reflection coefficient:** 0.5/div to 0.005/div in a 1, 2, 5 sequence.

**Input:** 50 ohms, feedthrough type.

**Noise and internal pickup, peak:** 0.1% of step (terminated in 50 ohms).

**Dynamic range:**  $\pm 0.5$  volt.

**External signal level:** up to 1 V peak may be safely applied to the Sampler output connector.

**Attenuator accuracy:**  $\pm 3\%$ .

### Step generator

**Amplitude:** approx. 0.25 V into 50 ohms (0.5 V into open circuit).

**Rise time:** approx. 50 ps.

**Output impedance:** 50 ohms  $\pm 1$  ohm (dc-coupled).

**Drop:** <1% in 1  $\mu$ s.

### Distance/time

**Distance scale:** 3 metres/div and 30 metres/div; 10 ft/div and 100 ft/div. Accuracy,  $\pm 3\%$ .

**Variable dielectric:**  $\epsilon = 1$  to  $\epsilon = 4$ .

**Time scale:** 10 ns/div and 100 ns/div. Accuracy,  $\pm 3\%$ .

**Magnification:** X1 to X100 in a 1, 2, 5 sequence provides time scales down to 0.1 ns/div and distance scales to 0.03 metres/div or 0.1 ft/div. Accuracy of the basic sweep is maintained at all magnifier settings.

**Delay control:** 0 to 10 div of unmagnified sweep. Accuracy,  $\pm 3\%$ .

**Jitter:** <20 ps.

### General

#### Recorder outputs

**Vertical:** approx. 1 V vertical output signal is provided at the rear panel of 180 series mainframes.

**Horizontal:** approx. 1 V horizontal output signal is provided at the rear panel of a 180, 181, 182 or 184 mainframe.

**Operating environment:** temperature, 0 to  $+35^\circ\text{C}$  ( $35^\circ\text{C}$  to  $55^\circ\text{C}$  with small increase in system rise time); humidity, to 95% relative humidity at  $40^\circ\text{C}$  ( $104^\circ\text{F}$ ); altitude, to 4600 m (15 000 ft); vibration, vibrated in three planes for 15 min. each with 0.254 mm (0.010 in.) excursion, 10 to 55 Hz.

**Weight:** net, 2.3 kg (5 lb). Shipping, 5 kg (11 lb).

**Accessories supplied:** type N connector assembly. One 50 ohm load with Type N male connector. One Operating and Service Manual.

### Ordering Information

	Price
1815B TDR/Sampler (calibrated in metres)	\$1750
Opt 910: additional Operating and Service Manual, covers 1815B and 1817A	add \$5
1817A 28 ps Rise Time Sampling Head	\$2050
1104A Trigger Countdown	\$270
1106B Opt 001 20 ps Tunnel Diode Mount	\$700
1108A 60 ps Tunnel Diode Mount	\$350
1818A Time Domain Reflectometer	\$1315
Opt 910: additional Operating and Service Manual	add \$13
10457A Adapter, 50 $\Omega$ GR to 75 $\Omega$ Type N female (converts 1818A 50 $\Omega$ output to 75 $\Omega$ system.)	\$120

# OSCILLOSCOPES

180 Sampling & TDR accessories

Models 1104A, 1105A, 1106B, 1108A & 1109B



1104A

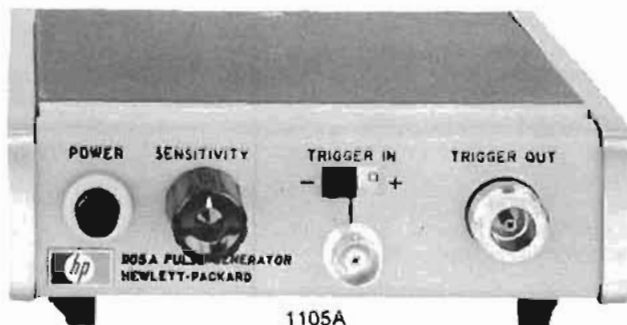

1105A



1106B



1108A



1109B



908A

## 1104A/1106B/1108A Specifications

1104A/1106B 18 GHz trigger countdown

1104A/1108A 10 GHz trigger countdown

### Input

**Frequency range:** (1106B) 1 GHz to 18 GHz. (1108A) 1 GHz to 10 GHz.

**Sensitivity:** (1106B) signals 100 mV or larger up to 12.4 GHz, produce <20 ps of jitter (200 mV required to 18 GHz). (1108A) signals up to 50 mV or larger up to 10 GHz produce <20 ps jitter.

**Maximum safe input:**  $\pm 1$  V.

**Input impedance:** dc resistance approx 50 ohms. Reflection from input connector is <10% using a 40 ps TDR system.

**Signal appearing at input connector:** approx 250 mV.

### Output

**Center frequency:** approx 100 MHz.

**Amplitude:** typically 150 mV.

### Connectors

**1104A:** input, type N male; trigger output, BNC female.

**1106B:** input, type N male; output, type N female.

**1106B Opt 001:** input, APC-7; output, type N female.

**1108A:** input, GR Type 874; output type N female.

### Weight

**1104A:** net, 0.9 kg (2 lb). Shipping, 1.8 kg (4 lb).

**1106B or 1108A:** net 0.5 kg (1 lb). Shipping, 0.9 kg (2 lb).

## 1105A/1106B/1108A Specifications

1105A/1106B/20 ps pulse generator

1105A/1108A/60 ps pulse generator

### Output

**Rise time:** approx 20 ps with 1106B, (<60 ps with 1108A), <28 ps observed with HP Model 1411A/1430C 28 ps Sampler and 50 ohm termination HP Model 909A Option 012.

**Overshoot:**  $\pm 7.5\%$  as observed on 1411A/1430C with 909A Option 012.

**Droop:** <3% in first 100 ns.

**Width:** approx 3  $\mu$ s.

**Amplitude:** 1+200 mV into 50 ohms.

### Output characteristics (1106B/1108A)

**Mechanical:** (1106B) Male Type N input connector, Female Type N output connector; (1108A) GR-874 input connector, Female Type N output connector.

**Electrical:** dc resistance, 50 ohms  $\pm 2\%$ . Source reflection, <10%, using a 40 ps TDR system. DC offset V, approx 0.1 V.

### Triggering

**Amplitude:** at least  $\pm 0.5$  V peak required.

**Rise time:** <20 ns required. Jitter <15 ps when triggered by 1 ns rise time sync pulse.

**Width:** >2 ns.

**Maximum safe input:** 1 volt.

**Input impedance:** 200 ohms, ac-coupled through 20 pF.

**Repetition rate:** 0 to 100 kHz; free runs at 100 kHz.

**Accessories supplied (with Model 1105A):** one 1.8 m (6 ft) 50 ohm cable with Type N Male connectors on each end, HP Model 10132A.

### Weight

**1106B or 1108A:** net, 0.5 kg (1 lb). Shipping, 0.9 kg (2 lb).

**1105A:** net, 0.9 kg (2 lb). Shipping, 1.4 kg (3 lb).

## 1109B High-pass filter

The 1109B High-Pass Filter transmits only frequencies above 1 GHz. It is useful for blocking the 100 MHz "kickout" encountered when using a tunnel diode countdown to view high frequency signals on a sampling oscilloscope. The 1109B is designed for use with the Model 1104A/1106B Trigger countdown.

## 1109B Specifications

**Lower bandwidth limit:** 3 dB down at 3 GHz, nominal.

### Input characteristics

**Mechanical:** male type N input connector; Female Type N output connector.

**Electrical (with output terminated in 50 ohms)**

**Reflection:** <10% using 40 ps TDR system.

**SWR:** typically 1.1 up to 10 GHz increasing to 2 at 15 GHz.

**DC Resistance:** 50 ohms  $\pm 2\%$  shunted across line.

**Weight:** net, 0.45 kg (1 lb). Shipping, 0.9 kg (2 lb).

## Other sampling accessories

**50 ohm loads:** Models 908A with Type N male connector (4 GHz) and 909A Option 012 with Type N male connector (18 GHz).

**50 ohm adapters:** Model 11524A has Type N Female and APC-7 connectors; Model 11525A has Type N Male and APC-7 connectors.

**Air line extension:** Model 11566A, 10 cm, APC-7 connector. Model 11567A, 20 cm, APC-7 connector.

### Ordering information

1104A Trigger Countdown	\$270
1105A Pulse Generator	\$320
1106B 20 ps Tunnel Diode Mount	\$650
1108A 60 ps Tunnel Diode Mount	\$350
1109B High Pass Filter	\$230
908A 50 ohm Termination	\$50
909A Opt 012 50 ohm Termination	\$90
11524A 50 ohm Adapter	\$85
11525A 50 ohm Adapter	\$95
11566A Air Line Extension	\$170
11567A Air Line Extension	\$195

### Price



- Economic spectrum analysis 0.01 to 1500 MHz
- Simple, 3 knob operation
- Direct signal power display in dBm

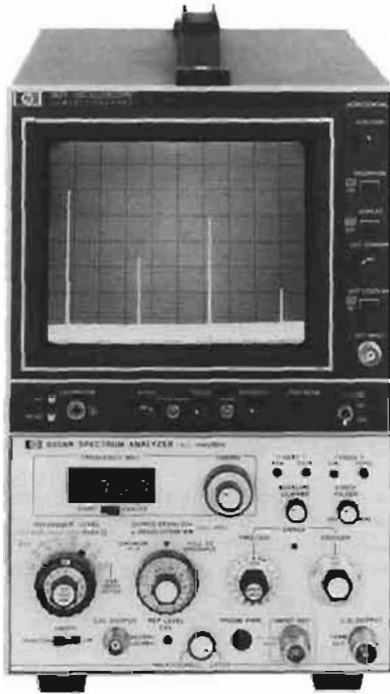

8558B/182T

### 8558B and 8557A Spectrum Analyzers

The 8557A/8558B Spectrum Analyzers plug into any 180 series oscilloscope mainframe to provide low cost 0.01 to 350 MHz or 0.1 to 1500 MHz performance with high amplitude and frequency accuracy, and they're easy to use.

#### Simple three knob operation

For most measurements only three controls are required; one for amplitude calibration and two for frequency calibration. The center or start frequency of the display is shown on a digital readout, and the analyzer automatically selects the resolution bandwidth and proper scan time to provide calibrated measurements with any desired frequency scan.

#### Absolute amplitude calibration

Signal levels can be read directly from the CRT display in dBm (or dBmV for option 002) without the use of external standards or calculations. The signal level represented by the top CRT graticule line is always indicated by the reference level control, and scale factors of 10 dB/div, 1 dB/div, and linear can be selected.

#### Optional 75 ohm input impedance

Two options are available which allow measurements in 75 ohm systems: Option 001 has 75 ohm impedance and retains the dBm power calibration; Option 002 has 75 ohm impedance with the amplitude calibrated in dBmV for measurements in systems such as CATV.

- Resolution bandwidths from 1 kHz to 8 MHz
- Optional 75Ω input impedance
- Companion tracking generator (for 8558B only)

#### Companion tracking generator

The 8444A Option 058 Tracking Generator provides a calibrated RF signal matching exactly the 8558B analyzer tuned frequency. This makes swept frequency tests, such as insertion loss, and return loss measurement, possible over 0.5 to 1300 MHz frequency range. The 8444A Option 058 is specified on page 488.

#### Suggested displays

The 8557A/8558B Spectrum Analyzers will function with any 180-series display. However, the following are suggested: for low cost, large screen display, the Model 182T is ideal; the Model 181T offers variable persistence and storage; and the Model 180TR offers a rack mount configuration. Each of these displays provides a long persistence P39 phosphor (except variable persistence displays) and four non-buffered rear panel outputs compatible with most X-Y recorders.

### 8557A and 8558B Specifications

#### Frequency specifications

**Frequency display span:** (on a 10-division CRT horizontal axis): 8557A: F (full span, 0.01–350 MHz), 12 calibrated spans from 20 MHz/div to 5 kHz/div in a 1, 2, 5 sequence; 8558B: 14 calibrated spans from 100 MHz/div to 5 kHz/div. In 0 kHz/div both analyzers become fixed-tuned receivers.

**Digital frequency readout:** indicates center frequency or start frequency of the frequency display scan.

#### Stability

**Residual FM:** less than 1 kHz peak-to-peak for time  $\leq 0.1$  sec.

**Noise sidebands:** more than 75 dB (8557A), 65 dB (8558B) below CW signal, 50 kHz or more away from signal with a 1 kHz resolution bandwidth and full video filter.

#### Resolution

**Bandwidth ranges:** 3 dB resolution bandwidths of 1 kHz to 3 MHz in a 1, 3, 10 sequence.

**Resolution bandwidth selectivity:** 60 dB/3dB resolution bandwidth ratio  $< 15:1$ .

**Video filter:** post-detection filter used to average displayed noise.

#### Amplitude specifications

##### Absolute amplitude calibration range

**Log calibration range:** from -117 dBm to +20 dBm (8557A), +30 dBm (8558B) in 10 dB steps. Reference level vernier, 0 to -12 dB continuously.

**Log display ranges:** 10 dB/div on a 70 dB display, and 1 dB/div on an 8 dB display.

**Linear display:** from 2.2 microvolts (-100 dBm) full scale to 2.24 volts (+20 dBm) 8557A, 7.1 volts (+30 dBm) 8558B full-scale in 10 dB steps.

##### Dynamic range

**Average noise level:**  $< -107$  dBm with 10 kHz resolution bandwidth (0 dB input attenuation).

**Spurious responses:** for input signal level  $\leq$  Optimum Input Level setting, all image and out-of-band mixing responses, harmonic and intermodulation distortion products are more than 70 dB below input signal level, 1 MHz to 350 MHz (8557A), 5 MHz to 1500 MHz (8558B); 60 dB below, 20 kHz to 1 MHz (8557A), 100 kHz to 5 MHz (8558B).

**Residual responses:** (no signal present at input):  $< -100$  dBm with 0 dB input attenuation.

##### Calibrator

**Amplitude:** -30 dBm  $\pm 1.0$  dB.

**Frequency:** 250 MHz (8557A), 280 MHz (8558B)  $\pm 50$  kHz, crystal controlled.

##### Input specifications

**Input impedance:** 50Ω nominal.

Typical reflection coefficient  $< 0.27$  (1.74 SWR) 8557A,  $< 0.20$  (1.5 SWR) 8558B for all Optimum Input Level settings except -40 dBm (0 dB Input Attenuation).

**Input connector:** BNC female (8557A), type N female (8558B).

**Input attenuator:** 50 dB range (8557A), 70 dB range (8558B).

**Price and further information:** see pages 488 & 486.

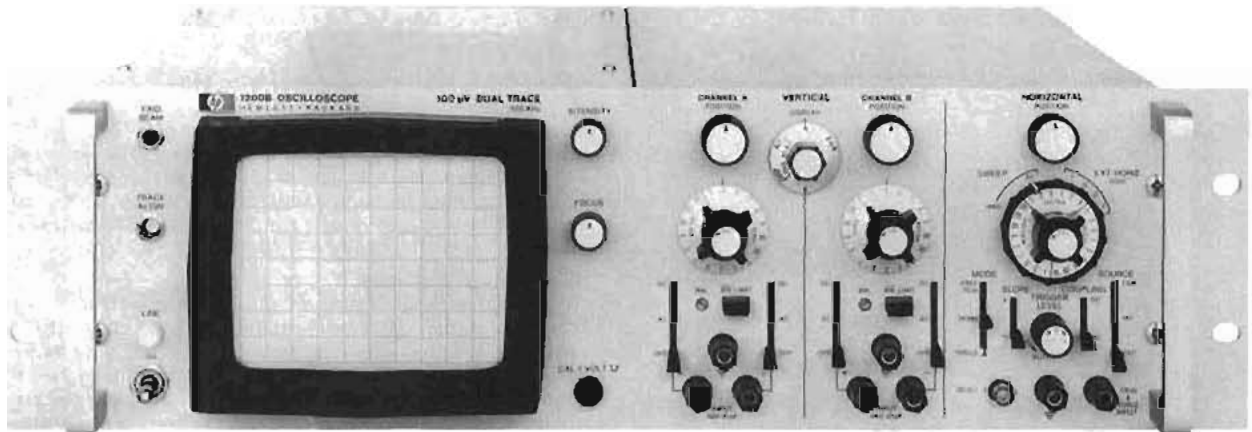

1200B

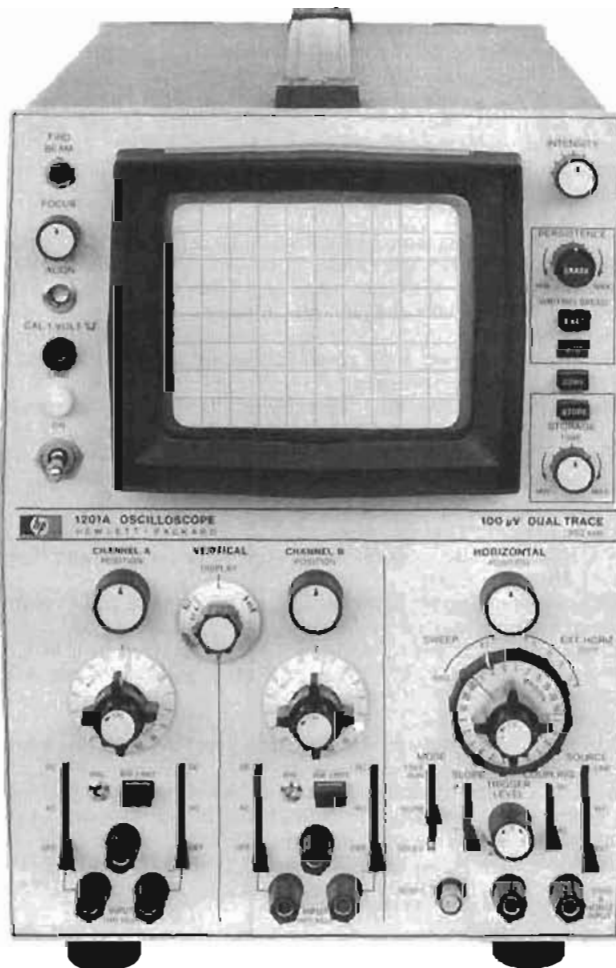

1201A

### Vertical amplifiers specifications

**Modes of operation:** channel A; channel B; channels A and B (either Chop or Alternate triggered by channel A), Chop frequency is approx. 100 kHz; channel A vs B (A-vertical, B-horizontal).

**Bandwidth:** dc-coupled, dc to 500 kHz; ac-coupled, 2 Hz to 500 kHz. A bandwidth limit switch (1200 and 1201) selects upper bandwidth limit to approx. 50 kHz or 500 kHz.

**Rise time:** 0.7  $\mu$ s max.

### Deflection factor

**Ranges (1200 and 1201):** from 0.1 mV/div to 20 V/div (17 positions) in 1, 2, 5 sequence.

**Ranges (1205):** from 5 mV/div to 20 V/div (12 positions) in 1, 2, 5 sequence.

**Attenuator accuracy:**  $\pm 3\%$  with vernier in calibrated position.

**Vernier:** continuously variable between all ranges; extends maximum deflection factor to at least 50 V/div.

**Noise (1200 and 1201):**  $< 20 \mu$ V measured tangentially at full bandwidth.

**Input:** differential or single-ended on all ranges.

### Common mode

**Frequency:** dc to 10 kHz.

### Rejection ratio

**1200 and 1201:** 100 dB (100 000 to 1) with dc-coupled input on 0.1 mV/div range, decreasing by  $< 20$  dB per decade of deflection factor to at least 40 dB on the 0.2 V/div range; CMR is at least 30 dB on 0.5 V/div to 20 V/div ranges. Maximum signal is  $\pm 10$  V (dc + peak ac) on 0.1 mV/div to 0.2 V/div ranges;  $\pm 400$  V (dc + peak ac) on all other ranges.

**1205:** 50 dB with dc-coupled input on 5 mV/div to 0.2 V/div ranges; CMMR is at least 30 dB on the 0.5 V/div to 20 V/div ranges. Maximum signal is  $\pm 3$  V (dc + peak ac) on 5 mV/div to 0.2 V/div ranges;  $\pm 300$  V (dc + peak ac) on all other ranges.

**Input coupling:** selectable AC, DC, or OFF for both + and - inputs.

**Input RC:** approx. 1 M $\Omega$  shunted by approx. 45 pF.

**Maximum input:**  $\pm 400$  V (dc + peak ac).

**Internal trigger source:** on channel A signal for A, Chop, and Alternate displays, on channel B signal for B display.

**Isolation:**  $> 80$  dB between channels at 500 kHz, with shielded input connectors.

**Phase shift:** A vs B mode,  $< 1^\circ$  to 100 kHz with verniers in calibrated position.

### Time base specifications

#### Sweep

**Ranges:** from 1  $\mu$ s/div to 5 s/div (21 positions) in 1, 2, 5 sequence;  $\pm 3\%$  accuracy with vernier in calibrated position.

**Vernier:** continuously variable between ranges; extends slowest sweep to at least 12.5 s/div.

**Magnifier:** direct reading X10 magnifier expands fastest sweep to 100 ns/div with  $\pm 5\%$  accuracy.

#### Automatic triggering

Baseline is displayed in absence of an input signal.

**Internal:** 50 Hz to above 500 kHz on most signals causing 0.5 division or more vertical deflection. Triggering on line frequency also selectable.

**External:** 50 Hz to above 1 MHz on most signals at least 0.2 V p-p.

**Trigger slope:** positive or negative slope on internal, external, or line trigger signals.

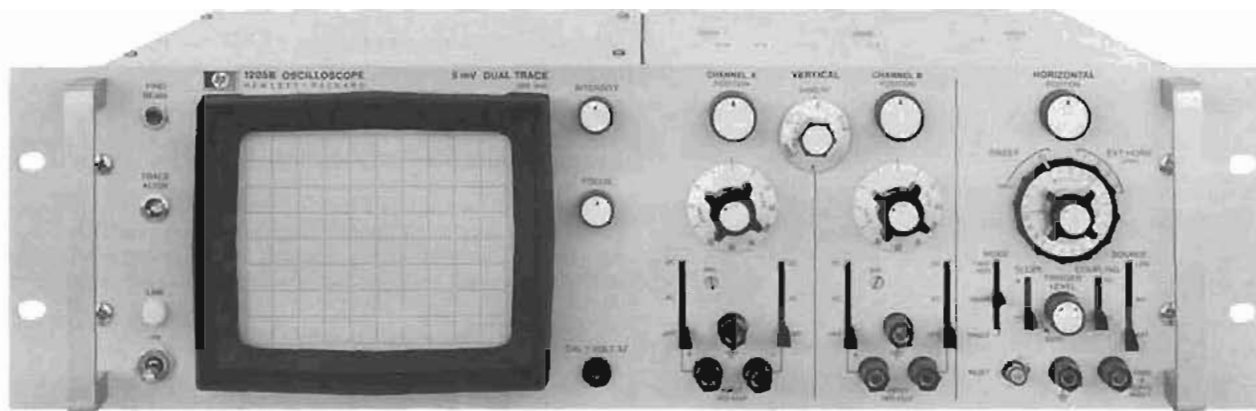

1205B

#### Amplitude selection triggering

**Internal:** dc to above 500 kHz on signals causing 0.5 division or more vertical deflection.

**External:** dc to 1 MHz on signals at least 0.2 V p-p. Input impedance is approx. 1 M $\Omega$  shunted by approx. 20 pF.

**Trigger level and slope:** internal, at any point on vertical waveform displayed; or continuously variable from +100 V to -100 V on either slope of the external trigger signal.

**Trigger coupling:** dc or ac for external, line, or internal triggering. Lower ac cutoff is 2 Hz for external; 5 Hz for internal.

**Single sweep:** selectable by front panel switch. Reset switch with armed indicator light.

**Free run:** selectable by front panel switch.

**Maximum input:**  $\pm 350$  V (dc + peak ac).

#### Horizontal amplifier

**Bandwidth:** dc-coupled, dc to 300 kHz; ac-coupled, 2 Hz to 300 kHz.

**Deflection factor:** ranges, 0.1 V/div, 0.2 V/div, 0.5 V/div, and 1 V/div. Vernier, continuously variable between ranges; extends maximum deflection factor to at least 2.5 V/div.

**Maximum input:**  $\pm 350$  V (dc + peak ac).

**Input RC:** approx. 1 M $\Omega$  shunted by approx. 20 pF.

**Input:** single-ended on all ranges.

#### Cathode-ray tube and controls specifications

**Beam finder:** returns trace to CRT screen regardless of setting of horizontal, vertical, or intensity controls.

**Intensity modulation:** +2 V signal blanks trace of normal intensity. +8V signal blanks any intensity trace. DC-coupled rear panel input; amplifier rise time, approx. 200 ns; input R approx. 5 k $\Omega$ .

#### Standard CRT, 1200, 1205

**Type:** mono-accelerator, approx. 3000 V accelerating potential, P-31 phosphor standard.

**Graticule:** 8  $\times$  10 div internal graticule, 0.2 subdivision markings on horizontal and vertical major axes; 1 div = 1 cm. Front panel recessed screwdriver adjustment aligns trace with graticule.

#### Variable persistence/storage CRT, 1201

**Type:** post-accelerator, variable persistence storage tube; approx. 10.5 kV accelerating potential; aluminized P-31 phosphor.

**Graticule:** 8  $\times$  10 div internal graticule, 0.2 subdivision markings on major axes; 1 div = 0.95 cm. Front panel recessed screwdriver adjustment aligns trace with graticule.

#### Persistence storage characteristics

(Referenced to a centered 7  $\times$  9 div area in STD mode and to a centered 6  $\times$  8 div area in FAST mode.)

**Persistence:** conventional, natural persistence of P-31 phosphor, approx. 40  $\mu$ s; variable, continuously variable from 0.2 s to >1 min. in STD mode; and from 0.2 s to 15 s in FAST mode.

**Storage writing speed:** STD mode, 20 div/ms; FAST mode, 0.5 div/ $\mu$ s.

**Brightness:** 343 cd/m<sup>2</sup> (100 fl) in write mode.

**Storage time:** STD writing speed variable from approx. 1 min. to >2 hours. Fast writing speed, variable from approx. 15 s to >15 min.

**Erase:** pushbutton erasure takes approx. 1.2 s. Write gun is blanked and sweep is reset until erasure is completed.

#### General specifications

**Calibrator:** 1 V = 1.5% line frequency square wave.

#### Dimensions

**Cabinet models (designated by A suffix):** 298 mm H  $\times$  211 mm W  $\times$  475 mm D (11 $\frac{3}{4}$ "  $\times$  8 $\frac{3}{16}$ "  $\times$  18 $\frac{1}{16}$ ").

**Rack models (designated by B suffix):** 133 mm H  $\times$  483 mm W  $\times$  466 mm D overall; 423 mm D behind front panel (5 $\frac{1}{2}$ "  $\times$  19"  $\times$  18 $\frac{3}{16}$ ").

**Power requirements:** 115/230 V  $\pm$ 10%, 48 to 440 Hz, 150 VA max.

#### Weight

1200A: net, 11.4 kg (25 lb). Shipping, 15.7 kg (34 $\frac{1}{2}$  lb).

1200B, 1205B: net, 10.2 kg (22 $\frac{1}{2}$  lb). Shipping, 15.9 kg (35 lb).

1201A: net, 13.6 kg (30 lb). Shipping, 17.9 kg (39 $\frac{1}{2}$  lb).

1201B: net, 12.5 kg (27 $\frac{1}{2}$  lb). Shipping, 18.2 kg (40 lb).

#### Vertical output signals specifications (Opt 015)

**Output:** 0.3 V/div  $\pm$ 10%, 0 V offset unaffected by position control setting.

**Bandwidth:** dc to 500 kHz.

**Dynamic range:**  $\pm 3.5$  V.

**Maximum slewing rate:** 12 V/ $\mu$ s with 300 pF load.

**Minimum load RC:** 10 k $\Omega$  shunted by approx. 300 pF.

**Source impedance:** approx. 300 ohms.

#### Options

**006:** rack models only, rear input terminals wired in parallel with front panel vertical and horizontal input terminals. Vertical input shunt capacitance is increased to approx. 100 pF. Horizontal input shunt capacitance is increased to approx. 75 pF.

**009:** variable persistence/storage models only, remote erase through rear panel banana jack, shorting to ground provides erasure (not compatible with Opt. 006).

**015:** vertical channel signal outputs through rear panel connectors.

**910:** additional Operating and Service Manual

1200A/B

1201 A/B

1205B

#### Price

add \$60

add \$25

add \$125

add \$15

add \$16

add \$12.50

#### Ordering Information

1200A or 1200B Dual Channel, 100  $\mu$ V Oscilloscope \$1575

1201A or 1201B Dual Channel, 100  $\mu$ V Storage Oscilloscope \$2500

1205B Dual Channel, 5 mV Oscilloscope \$1500

# OSCILLOSCOPES

15 MHz, dual/single, storage, general purpose

Models 1220A, 1221A, 1222A & 1223A

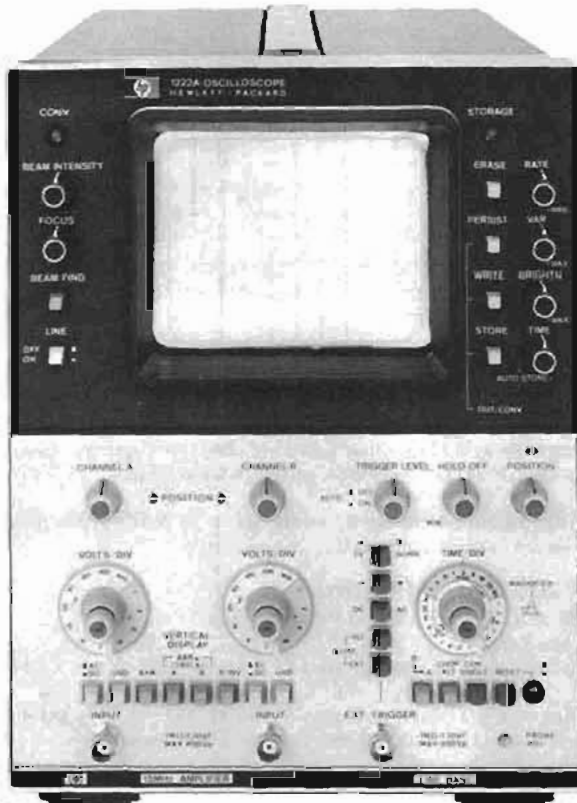

1223A

## 1223A Description

Hewlett-Packard Model 1223A is a versatile, easy-to-use 15 MHz oscilloscope with a rugged, performance proven CRT that gives you a choice of conventional, variable persistence, or storage operation. Storage operation is extremely easy with indicators that clearly show whether you are in a storage mode or conventional mode of operation. Storage controls are located directly under the storage mode indicator for convenient selection of the Store, Write, Variable Persistence, and/or Erase mode to meet your particular requirements. Store and Write times are both variable for adjusting viewing time vs intensity as desired. An auto store mode makes it easy to capture random single-shot events, automatically. The versatile erase controls let you erase manually, remotely, or automatically with a variable erase rate feature that allows you to adjust the viewing time of the displayed signal. And Variable Persistence provides bright flicker-free viewing of low rep rate, fast rise signals.

Additional features include an  $8 \times 10$  division internal graticule for parallax free measurements; variable trigger holdoff to correct unstable trigger conditions; and selectable chop or alternate sweep mode.

## Triggering

The operator can select the source of the sweep trigger (internal, line, external ac, dc, or TV) as well as trigger on either the positive or negative going transitions of the signal. Further flexibility is added by the ability to preset the signal amplitude required to trigger the sweep, assuring that perturbations below the desired amplitude do not trigger the oscilloscope. A trigger holdoff control eliminates double triggering on complex digital waveforms and maintains a full-screen, calibrated sweep.

Automatic triggering assures that a base-line is present even in the absence of a signal or if the trigger level control is set beyond the range of the trigger signal. With automatically triggered sweep, displays are stable because the observed signal itself determines when a sweep should start.

## Storage/variable persistence CRT

The  $8 \times 10$  division Hewlett-Packard post-accelerator storage CRT, with 8.5 kV accelerating potential, aluminumized P31 phosphor, and mesh storage, offers a bright, crisp trace in both conventional and storage modes. For maximum convenience in single-shot applications, an auto-store mode which operates in the single-shot mode, makes it easy to capture random events.

For viewing low rep rate fast rise time signals, the variable persistence mode allows you to adjust the trace for an optimum display. By adjusting the persistence to match the rep rate you can integrate a trace to provide a sharp, clear display for accurate measurements of low duty-cycle pulse trains such as those from disc, tape, or drum peripheral units.

## TV sync

The built-in TV sync separator assures stable, automatic triggering on frame or line for convenient TV troubleshooting. With the instrument's times-ten magnifier, signals can be pulled out easily. The calibrated time base makes it easy to identify timing problems in vertical or horizontal TV circuits. The external horizontal input allows vector presentations of color CRT drive signals. Dual channels make it easy to set color demodulator circuits.

## Optional accessories

General purpose probing is provided with the Model 10013A 10:1 divider probe with 10 megohms input shunted by only 13 pF. It extends input range to 100 V/div and multiplies input impedance without degrading frequency response. A standard System-II rack mounting adapter kit, Model 10173A RFI filter, and contrast screen are also available.

## 1220A, 1221A, 1222A Description

Hewlett-Packard Models 1220A/1222A (dual channel) and 1221A (single channel) 15 MHz oscilloscopes are high quality instruments with the performance necessary for a wide variety of applications. Features include a large  $8 \times 10$  cm internal graticule for no-parallax measurements, 3% vertical attenuator accuracy, 4% horizontal accuracy, calibrated sweep times from 0.5 s/div to 0.1  $\mu$ s/div, dc coupling, automatic triggering, a sweep magnifier to expand the display up to ten times for detailed analysis, a pushbutton beam finder, X-Y display capability, TV sync separator, and in the 1222A delay lines permit the leading edges of pulses to be viewed.

## Easy operation

The human engineered front panel with functionally grouped controls and color-coded pushbuttons makes measurements easier and faster. Inputs are protected to 400 V, reducing chances of accidental electrical damage. Automatic triggering assures that a base-line is present even in the absence of a signal or if the trigger level control is set beyond the range of the trigger signal. And, although the dual channel Models 1220A and 1222A operate in either a chopped or alternate mode, the operator need not concern himself with making a choice since the Time/Div switch automatically selects the best display mode.

The basic stability of the solid-state circuits and components used throughout is such that internal adjustments have been reduced to a minimum. This decreases calibration requirements and provides real savings over the oscilloscope's lifetime. Recalibration, when necessary, is simple and straightforward compared to most other oscilloscopes.

## Triggering

Even though the instruments are easy to operate, these oscilloscopes have the flexibility for multi-purpose use. The operator can select the source of sweep trigger (internal, external, ac line, TV) and he can select the trigger slope, adding to the oscilloscope's versatility by allowing triggering on either the positive or negative going transitions of the signal. Further flexibility is added by the ability to preset the signal amplitude required to trigger the sweep, assuring that perturbations below the desired amplitude will not trigger the oscilloscope.

With automatically triggered sweep, displays are stable because the observed signal itself determines when a sweep should start. Automatic triggering produces a free running trace in the absence of a signal for fast setup. It locks onto any input signal of the proper polarity and amplitude.

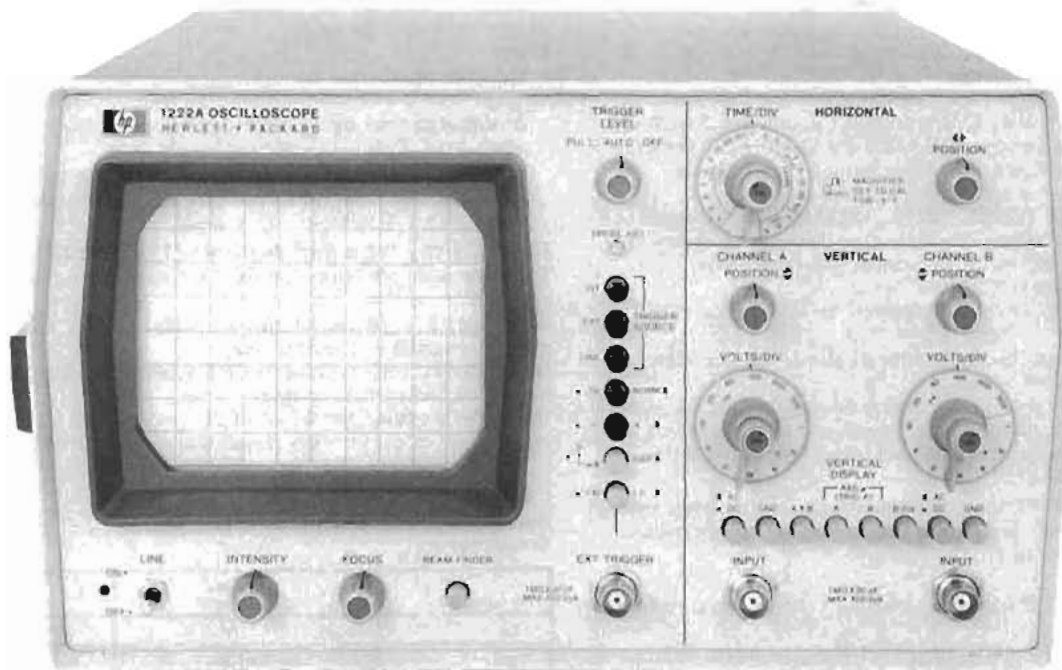

1222A

## CRT

The internal  $8 \times 10$  cm CRT graticule eliminates parallax errors that occur when the graticule is external to the CRT. The 3% vertical accuracy combined with the no-parallax graticule enables the oscilloscope to be used as a voltmeter as well as for waveform display. CRT beam intensity can be modulated through a rear panel Z-axis input.

## X-Y Inputs

Phase shift measurements through the vertical amplifiers in the 1222A permit maximum measurement flexibility with the wide selection of deflection factors. In Models 1220A and 1221A, external signals can be applied to the horizontal deflection amplifiers. This X-Y capability permits X-Y plots or Lissajous figures with a phase shift of less than  $3^\circ$  to 100 kHz.

## TV Sync

Refer to the TV sync paragraph in the 1223A Description.

## Rugged lightweight design

These oscilloscopes are, except for the CRT, entirely of solid-state design, resulting in low power consumption. The consequent low heat has made possible a rugged, lightweight cabinet with a vinyl-clad aluminum cover that is resistant to shock and moisture. A convenient side-panel handle and stabilizing feet on the opposite side make handling easy. This allows these oscilloscopes to be used in areas where ruggedness is a necessity. These areas include production lines, numerically controlled machinery, process control equipment, automotive, aircraft and marine electronics, and communications.

## Optional accessories

An optional front panel cover, Model 10117A, is available to protect the instrument during transportation and gives storage space for probes and other accessories. General purpose probing is provided with the Model 10013A 10 to 1 divider probe with 10 megohms input shunted by only 13 pF. It extends input range to 100 V/cm and multiplies input impedance without degrading frequency response. With a rack mount kit, Model 10119A, the oscilloscopes can be mounted to occupy only 22.2 cm (8 $\frac{3}{4}$  inches) of vertical space.

## 1220A, 1221A, 1222A, 1223A Specifications

### Modes of operation (1220A, 1222A, 1223A)

Channel A; channel B; channel B inverted (1222A); channel A  $\pm$  B (1222A, 1223A); channels A and B displayed alternately on succes-

sive sweeps (Alt); triggering by A channel; channels A and B displayed by switching between channels at approx 200 kHz (300 kHz, 1223A) rate with blanking during switching (Chop). (1220A, 1222A) Automatic selection of alternate or chop mode—chop, at speeds from 0.5 s/cm to 1 ms/cm, alternate, 0.5 ms/cm to 0.1  $\mu$ s/cm. (1223A) Chop or Alt selectable.

**Vertical amplifiers** (2 in 1220A/1222A/1223A, 1 in 1221A)  
**Bandwidth** (3 dB down from 50 kHz, 6 div reference signal from a terminated 50 ohm source.)

**DC-coupled:** dc to 15 MHz.

**AC-coupled:** lower limit is approx 2 Hz.

**Rise time:** approx 23 ns (measured from 10% to 90% points of 6 div input step from a terminated 50 ohm source).

### Deflection factor

**Ranges:** from 2 mV/cm to 10 V/cm (12 calibrated positions) in 1, 2, 5 sequence. (1220A, 1221A, 1222A)  $\pm$ 3% Accuracy with vernier in calibrated position on 20 mV/cm to 10 mV/cm ranges,  $\pm$ 5% accuracy on 2 mV/cm, 5 mV/cm, and 10 mV/cm ranges. (1223A)  $\pm$ 3% Accuracy with vernier in calibrated position on 10 mV/div to 10 V/div ranges,  $\pm$ 5% accuracy on 2 mV/div and 5 mV/div ranges.

**Vernier:** continuously variable between all ranges, extends maximum deflection factor to at least 25 V/cm.

**Polarity (1222A, 1223A):** Channel B may be inverted, front panel pushbutton.

**Signal delay:** input signals are delayed sufficiently to view leading edge of input signal without advanced external trigger.

**Input RC:** AC or DC, approx 1 megohm shunted by approx 30 pF.

**Input coupling:** AC, DC, or GND. GND position disconnects input connector and grounds amplifier input.

**Maximum Input:**  $\pm$ 400 V (dc + peak ac).

### A + B operation (1222A, 1223A)

**Amplifier:** bandwidth and deflection factors are unchanged; channel B may be inverted for A-B operation.

**Differential (A-B) common mode (1222A, 1223A):** CMR is at least 30 dB from dc to 1 MHz.

### Time base

#### Trigger Source (1223A)

**Channel A:** display modes A, A and B, A and B INV triggered by channel A signal.

## Models 1220A, 1221A, 1222A &amp; 1223A (cont.)

**Channel B:** display modes B, B INV triggered by channel B signal.

**A + B (composite signal):** display modes A + B, A - B, triggered by displayed signal.

**Sweep**

**Ranges:** (1220A, 1221A, 1222A) from 0.1  $\mu$ s/cm to 0.5 s/cm (21 ranges) in 1, 2, 5 sequence, (1223A) from 0.1  $\mu$ s/div to 2 s/div (22 ranges) in 1, 2, 5 sequence;  $\pm$ 4% accuracy over full scale with Magnifier/Expander in calibrated position.

**Sweep trigger mode (1220A, 1221A, 1222A):** sweep is triggered by internal or external signal. Bright baseline displayed in absence of input signal except with 1222A in Normal triggering mode.

**Sweep trigger modes (1223A)**

**Normal (Auto off):** sweep is triggered by internal or external signal or line.

**Automatic (Auto on):** bright baseline displayed if trigger signal is absent for longer than 500 ms.

**Single:** in Normal mode, sweep occurs once with same triggering as normal, reset pushbutton arms sweep and lights indicator; in Auto mode, sweep occurs once each time Reset pushbutton is pressed.

**Trigger holdoff (1223A):** time between sweeps continuously variable up to 10 times. Allows triggering on complex signals without loss of time base calibration.

**Triggering**

**Internal:** dc to 15 MHz on signals causing 1 div or more vertical deflection.

**External:** dc to 15 MHz on signals of 0.1 V p-p or more.

**External input RC (1220A, 1221A, 1222A):** approx 1 megohm shunted by approx 30 pF.

**External input R (1223A):** approx 1 megohm.

**Line:** triggers on line frequency.

**Trigger coupling:** ac or dc attenuates signals below 10 Hz.

**TV sync:** separator for + or - video, requires 1 div of video signal to trigger, automatic frame (0.5 s/div to 100  $\mu$ s/div except 1223A, 2 s/div to 100  $\mu$ s/div) and line select (50  $\mu$ s/div to 0.1  $\mu$ s/div). Usable also as a low pass filter.

**Level and Slope**

**Internal:** at any point on the positive or negative slope of the displayed waveform.

**External:** (1220A, 1221A, 1222A) continuously variable from +0.5 V to -0.5 V on either slope of the trigger waveform;  $\div$  10 extends trigger range to +5V to -5 V. (1223A) continuously variable from +1 V to -1 V on either slope of the trigger signal.

**Calibrated X-Y operation (1222A, 1223A)**

Operation is via channel A (X-axis) and channel B (Y-axis).

**Bandwidth:** X-axis dc to 1 MHz, otherwise see Vertical Amplifiers Bandwidth specifications.

**Accuracy:** see Vertical Amplifiers Deflection Factor specifications. X-Y phase shift less than 3° at 100 kHz.

**Cathode-ray tube and controls (1223A)**

**Type:** post accelerator storage tube, approx 8.5 kV total accelerating potential, aluminum P-31 phosphor.

**Graticule:** 8  $\times$  10 div (1 div = 0.94 cm) internal graticule; 0.2 subdivision markings on major horizontal and vertical axes; 10% and 90% lines for 6 and 8 division reference.

**Intensity modulation (Z-axis):** grounding a signal, dc to 1 MHz, blanks trace of any intensity; positive TTL voltage or greater unblanks trace; input voltage limits -1 V peak to +15 V peak, from source capable of sinking 2.5 mA.

**Beam finder:** returns trace to CRT screen regardless of settings of horizontal and vertical controls.

**Persistence**

**Conventional:** natural persistence of P-31 phosphor (approx 40  $\mu$ s).

**Variable:** from <0.1 s to >1 min.

**Storage time**

**Store mode:** at minimum writing speed (20 div/ms) and minimum setting of Store Time control, storage time is a minimum of one minute at minimum brightness. At higher writing speeds minimum storage time decreases to 10 s at 1000 div/ms writing speed.

**Auto store mode:** cumulative time to capture and store a single event is  $\leq$  2 hours.

**Storage writing speed:** continuously variable from 20 div/ms (8  $\times$  10 div) to  $\geq$  1000 div/ms (6  $\times$  8 div).

**Erase**

**Manual:** pushbutton for overriding automatic or remote erasure cycle.

**Automatic:** time between erasure cycles variable from 1 s to 1 min.

**Remote:** single erase signal activated by grounding rear panel Remote Erase Input (or connection to TTL low level). Max voltage input -1 V peak to +15 V peak.

**Cathode-ray tube and controls (1220A, 1221A, 1222A)**

**Type:** mono-accelerator, approx 2 kV accelerating potential, P-31 phosphor.

**Graticule:** 8  $\times$  10 cm internal graticule; 0.2 cm subdivisions on major horizontal and vertical axes.

**Beam finder:** returns trace to CRT screen regardless of setting of horizontal and vertical controls.

**Intensity modulation:** +5 V (TTL compatible) 1 Hz to 1 MHz blanks trace of any intensity. Input R approx 1 k $\Omega$ . Maximum input, 7 V rms.

**External horizontal input (1220A/1221A)**

**Bandwidth:** dc to 1 MHz.

**Coupling:** dc.

Expander	X Mode Attenuator	Deflection Factor
Cal.	1:1	1 V/cm
Cal.	1:10	10 V/cm
cw	1:1	100 mV/cm

Continuous adjustment between ranges by Expander.

**Input RC:** approx 1 megohm shunted by approx 30 pF.

**X-Y Phase shift:** <3° at 100 kHz.

**General**

**Probe adjust:** approx 0.5 V p-p, 1 kHz square wave for adjusting probe compensation.

**Power:** (1220A, 1221A, 1222A) 100, 120, 220, 240 V, +5% - 10%, 60 VA max. 88 VA max. (1223A).

**Weight:**

1220A: net, 7.3 kg (16 lb). Shipping 11.3 kg (25 lb).

1221A: net, 7.0 kg (15 1/2 lb). Shipping 10 kg (22 lb).

1222A: net, 7.3 kg (16 lb). Shipping, 12.3 kg (27 lb).

1223A: net, 11.9 kg (26 1/4 lb). Shipping, 15 kg (33 lb).

**Dimensions**

1220A, 1221A, 1222A: 181 H  $\times$  311.2 W  $\times$  412.8 mm D (7.13"  $\times$  12.25"  $\times$  16.25").

1223A: 265.9 H  $\times$  212.3 W  $\times$  421.6 mm D, 476 mm D overall (10.47"  $\times$  8.36"  $\times$  16.60", 18.75" overall).

**Environment**

**Operating temperature:** 0°C to +45°C (+32°F to 113°F) except 1223A, 0°C to +55°C (+32°F to +130°F).

**Non-operating temperature:** -40°C to +75°C (-40°F to +167°F).

**Relative Humidity:** to 95% at +40°C (+104°F).

**Altitude:** to 4600 m (15 000 ft).

**Vibration:** vibrated in three planes for 15 minutes each with 0.254 mm (0.01 in) excursion, 10 to 55 Hz.

**Accessories furnished:** one blue light filter, one power cord, one fuse for 100 V, 120 V, 220 V or 240 V operation, and one Operating and Service Manual.

**Accessories available**

10117A: Front Panel Cover (1220A, 1221A, 1222A) \$28

10119A: Rack Mount Kit (1220A, 1221A, 1222A) \$80

Note: Probes are not supplied, recommended probe

10013A: 10:1 Divider Probe (see page 173) \$39

**Ordering Information**

1220 Dual Channel Oscilloscope \$795

Opt 910: extra Operating and Service Manual add \$5.50

1221A Single Channel Oscilloscope \$795

Opt 910: extra Operating and Service Manual add \$12.50

1222A Dual Channel Oscilloscope \$895

Opt 910: extra Operating and Service Manual \$6.50

1223A Storage, Variable Persistence Oscilloscope \$2250

Opt 910: extra Operating and Service Manual add \$10

Price

\$28

\$80

\$39

\$795

add \$5.50

\$795

add \$12.50

\$895

\$6.50

\$2250

add \$10



Typical miniature 10:1 divider probe, bottom, and 50Ω probe, top (accessories shown are supplied with each probe).

### Miniature oscilloscope probes

Hewlett-Packard's series of miniature oscilloscope probes easily access test points in densely populated circuits. These small, light-weight probes, which fit in the hand much like a pencil, simplify previously difficult measurements. The basic probe is a small (2.4 mm diameter, 25 mm long) cylinder with a needle-like tip which is used with a variety of interfacing/insulating accessories to meet a variety of testing situations. The narrow body provides easier access to test points in congested areas without worrying about accidental shorts to adjacent leads.

### Conventional probing

An insulating sleeve added to the basic probe provides a miniature version of the traditional oscilloscope probe. In this configuration, the probe looks and handles like a small-scale version of the traditional oscilloscope probe except that the forward barrel insulator is retractable which makes the traditional slip-on insulators for protection against shorts unnecessary. With the barrel insulator retracted, the ground spring configures the probe with a very short ground lead for high-frequency point-to-point probing.

With the barrel insulator in the forward position, the probe is used with the 20 cm flexible ground lead for probing where this type of grounding allows adequate response fidelity. The probe tip makes positive metallic contact to narrow conductors and penetrates commonly-used protective coatings while the extended insulating sleeve prevents shorts to closely-spaced adjacent leads.

With the barrel insulator retracted and using the flexible ground lead, the probe may be used with the slip-on hook tip (figure 1) for attaching to various component leads. For monitoring signals on dual in-line packages, a slip-on IC probe tip adapter allows connection to closely spaced leads without shorting (figure 3).

### DIP probing

By removing the probe's insulating sleeve and using the accessory clip (10024A), you can monitor points on 14- and 16-pin DIP's with improved pulse fidelity (figure 3) and without worrying about shorting adjacent pins.

In this application, the clip is installed on the DIP, a circuit interface pin is inserted into the appropriate position, and one or more

OSCILLOSCOPE/MINIATURE PROBE COMPATIBILITY AND PROBE CHARACTERISTICS								
HP Oscilloscope/ Plug-in Model No. and Bandwidth	Probe Model No.	Approx Overall Length in Metres (ft)	Division Ratio	Input R	Shunt Capacitance	Compensates Scope Input C	Max DC Volts	Price
1725A/275 MHz 1722A/275 MHz	10017A	1 m (3.3)	10:1	1 MΩ	8 pF	9 to 14 pF	300	\$80.
1715A/200 MHz 1809A/100 MHz 1085A/100 MHz	10018A	2 m (6.6)	10:1	1 MΩ	10 pF	9 to 14 pF	300	\$90
1741A/100 MHz	10040A	1 m (3.3)	10:1	1 MΩ	9 pF	20 to 30 pF	300	\$90
1741A/100 MHz/1740A/100 MHz	10041A	2 m (6.6)	10:1	1 MΩ	12 pF	20 to 24 pF	300	\$90
1743A/100 MHz	10042A	3 m (9.8)	10:1	1 MΩ	15 pF	20 to 26 pF	300	\$90
All Scopes with high Z inputs (may reduce bandwidth)	10021A	1 m (3.3)	1:1		36 pF		300	\$45.
	10022A	2 m (6.6)	1:1		62 pF		300	\$45.
All Scopes with 50Ω inputs and signal sources with a 50Ω source impedance	10026A	1 m (3.3)	1:1	50Ω Z			2 Amps	\$45.
	10027A	2 m (6.6)	1:1	50Ω Z			2 Amps	\$45.

Accessories supplied with each probe: one retractable hook tip, one alligator clip, one 20 cm (8") ground lead, four indicator sleeves (A, B, C, D), one grounding spring, and one Operating Note.  
 \*These miniature probes may be used with other oscilloscopes and test instruments with the proper input capacitance with no noticeable bandwidth degradation. However, due to variations of input characteristics, the probes may require recalibration for optimum performance.



10024A IC Test Clip

BNC-to-probe  
Adapter

probes are inserted to contact the desired package leads. The circuit interface pin contacts reference planes in the clip to provide a ground reference for any probe inserted in the clip. This grounding arrangement is extremely effective: high-speed pulse fidelity achieves a level previously associated only with probe-to-BNC adapters or high frequency, point-to-point probing. In addition, the clip makes it extremely easy to monitor two channel signals while using a third probe to provide an external trigger signal.

The circuit interface pins have a section of insulation which allows them to be inverted from the grounding position for using other types of probes to couple signals into or out of an IC. When the circuit interface pins are used in this position they are isolated from the ground bus in the IC clip.

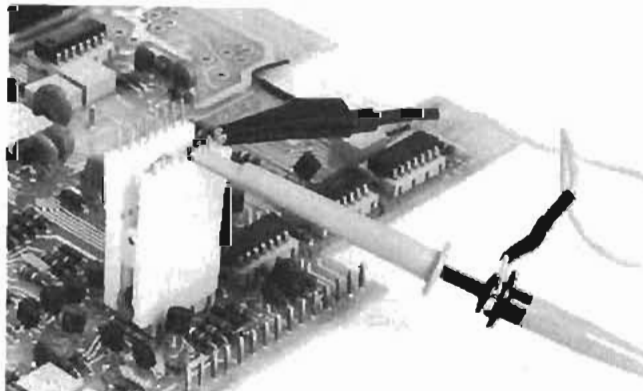

Figure 1. With the slip-on hook tip and flexible ground lead in place, the miniature probe can be used like a conventional probe for attachment to test points or component leads.

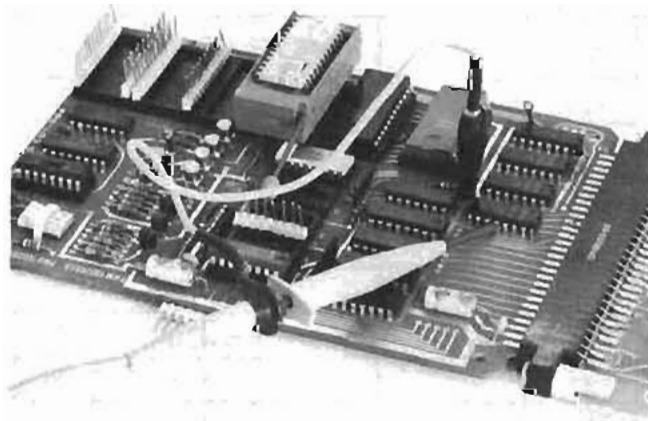

Figure 2 The slip-on IC probe tip adapter provides convenient connection to closely spaced leads on DIP's without shorting.

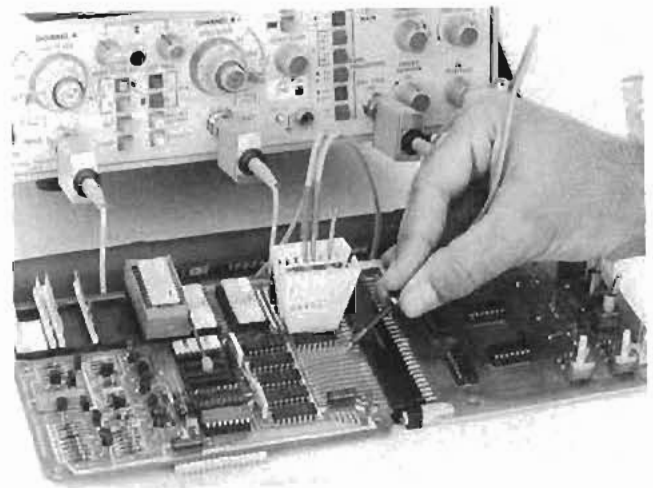

Figure 3. Miniature probe with insulating sleeves removed is held in place on an IC lead by the optional IC clip. The circuit interface pin in the right hand corner of the clip can be inserted at any lead position to ground reference planes that contact the barrel of the probe(s). Rise times as short as 1.3 ns are preserved by this arrangement. The hand held probe's insulating tip has been retracted to allow the spring ground tip to establish a ground-reference point at the end of the barrel for measurements of high speed signals.

By using the 50Ω, 1:1 probes, you can insert signals from a pulse generator to determine the IC's response. In other applications, the circuit containing the IC may be removed from the instrument and it can be powered through the 50Ω probes, the IC clip, and the interface pins. This means that the IC clip, circuit interface pins, and miniature probes provide you with a complete testing system for locating IC faults.

Additional circuit interface pins are available in packages of 12 pins so that the clip can be used with other instruments. Each pin has a tip on each end so that probes such as those on HP Logic State Analyzers can be connected for fast, functional checks of circuit operation.

#### Digital trigger probes

Model 10250A (TTL) 4-bit Trigger Probe is a useful service, production, and design trouble-shooting tool that offers digital pattern triggering to enhance the use of oscilloscopes, logic analyzers, and other test equipment.

The compact Model 1230A 8-bit Logic Trigger unit generates a trigger output pulse (TTL compatible) from parallel digital pattern recognition with digital delay capability for oscilloscopes or other externally triggered test equipment.

For 4 and 8 bit parallel trigger probe specifications and prices refer to page 127.

#### Miniature probe accessories

**Probe tip kits:** to increase probing versatility Models 10036B and 10037B probe tip adapter kits are supplied with slip-on 6/32 screw adapter for interfacing with any 6/32 probe adapter tip. This means that your present supply of 6/32 adapter tips, as well as future adapter tips, may be used with these miniature probes. Refer to page 176 for ordering information.

#### Ordering Information

	Price
10024A IC Test Clip for easy probing of dual in-line packages; includes 4 insulated circuit interface pins.	\$15
10024-69501 interface Pin Kit for 10024A; includes 12 interface pins.	\$10
1250-1454 BNC to probe adapter permits the miniature probes to be connected to BNC connectors to maintain fast pulse response.	\$8.25



### Standard probe/instrument compatibility

Scope/ Plug-In	1200 Series	1220 Series	1715K/1725A	1722B	1740A, 1741A, 1743A	1801 thru 1804A	1805A	1806A	1809A	1810A	1811A	1819B
Probe												
10001A	X	X			L	L		X				
10001B	X	X			L	L		X				
10002A	X	X			L	L		X				
10002B	X	X			L	L		X				
10003A	X	X			L	L		X				
10004D		X			X	X						
10005D		X			L	X						
10006D		X			X	X						
10007B	X	X	L	L	L	L	L	X	L			
10008B	X	L	L	L	L	L	L	X	L			
10013A	X	X				L		X				
10014A			X	X			X		X			
10015A			X	X			X		X			
10016B			X	X			X		X			
10020A			X	X	X		X		X	L	L	L
1120A			X	X	X		X		X	L	L	L
1124A			L	L	L		L		L	L	L	L
1125A			X	L	X		X		X	L	L	L

Notes:  
 X Indicates that probe will maintain the bandwidth of the instrument.  
 L Indicates that probe may limit the bandwidth of the instrument.

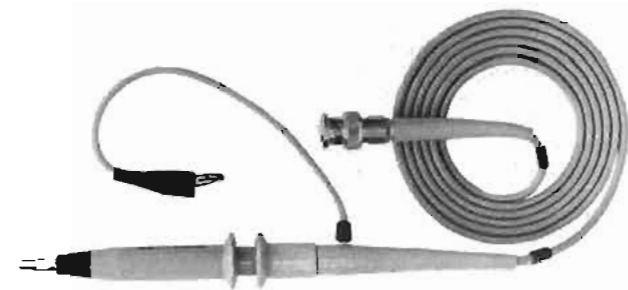

10001-10003A

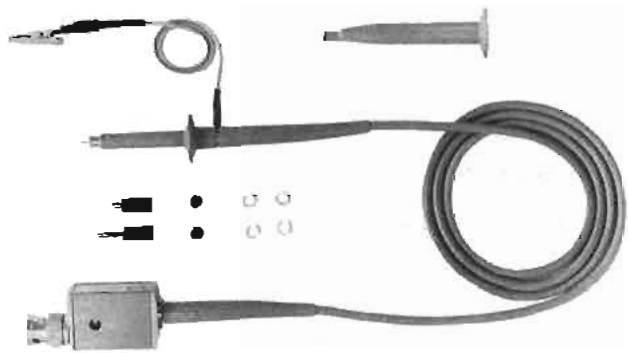

10004D-10006D, 10014A, 10015A, 10016B

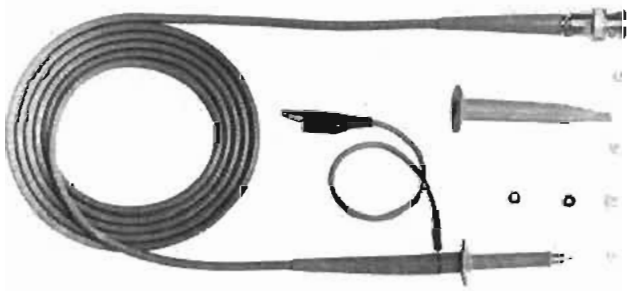

10007B, 10008B

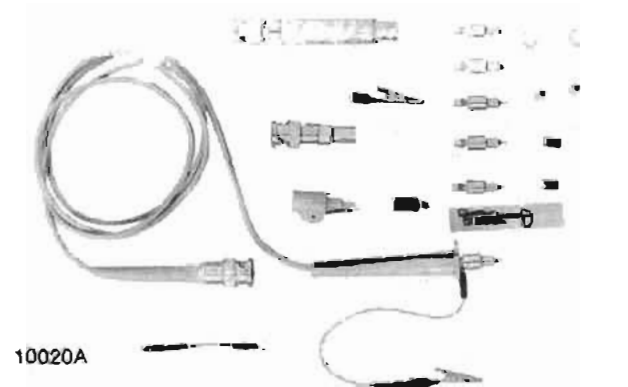

10020A

### Standard divider probe specifications

Model No.	Division Ratio	Resistance MΩ	Shunt Capacitance	Compensates Scope Input Capacities	Max DC Volts	Overall Length m (ft)	Price
10001A	10:1	10	10 pF	15-55	600	1.5 (5)	\$60
10001B	10:1	10	20 pF	15-45	600	3.0 (10)	\$60
10002A	50:1	9	2.5 pF	15-55	1000	1.5 (5)	\$60
10002B	50:1	9	5 pF	15-55	1000	3.0 (10)	\$60
10003A	10:1	10	10 pF	15-55	500	1.3 (4)	\$60
10004D	10:1	10	10 pF	20-30	500	1.1 (3.5)	\$65
10005D	10:1	10	17 pF	20-30	500	3.0 (10)	\$65
10006D	10:1	10	14 pF	20-30	500	1.8 (6)	\$65
10007B	1:1	—	40 pF	—	600	1.1 (3.5)	\$32
10008B	1:1	—	60 pF	—	600	1.8 (6)	\$32
10013A	10:1	10	13 pF	24-45	500	1.8 (6)	\$39
10014A	10:1	10	10 pF	9-13	500	1.1 (3.5)	\$65
10015A	10:1	10	10 pF	9-13	500	2.7 (9)	\$65
10016B	10:1	10	14 pF	9-13	500	1.8 (6)	\$75

### 10020A Resistive dividers

Division Ratio	Input R <sup>*</sup> (ohms)	Division Accuracy	Max V <sup>**</sup> (rms)	Input C (pF)
1:1	50	—	6	—
5:1	250	±3%	9	<0.7
10:1	500	±3%	12	<0.7
20:1	1000	±3%	15	<0.7
50:1	2500	±3%	25	<0.7
100:1	5000	±3%	35	<0.7

\*When terminated in 50 ohms.  
 \*\*Limited by power dissipation of resistive element

Probe length (overall): approx. 121.9 cm (4 ft).  
 Weight: net, 0.45 kg (1 lb). Shipping, 1.36 kg (3 lb).  
 Accessories supplied: blocked capacitor, BNC adapter tip, 6-32 adapter tip, alligator tip, boot extension, cable assy's 5.1 cm (2 in.) and 15.2 cm (6 in.) ground, spanner tip, insulating cap, colored sleeve.

10020A Resistive Divider Probe Kit **\$140**



1120A

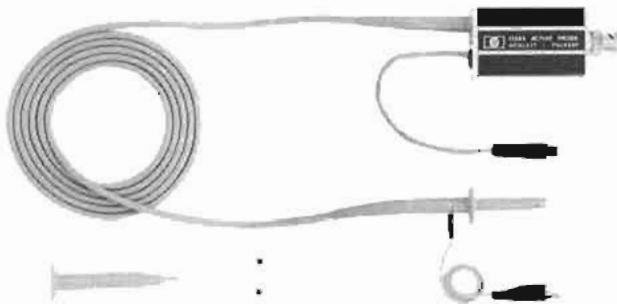

1124A



1122A

### 1120A 500 MHz active probe

For probing high source impedances at high frequencies, the Model 1120A 1:1 active probe provides a probe tip impedance of 100 k $\Omega$  shunted by approx 3 pF at 100 MHz. When used with the 10:1 or 100:1 divider tips, the shunt capacitance is <1 pF at 100 MHz. The 50 ohm output provides the optimum impedance match for 50 ohm input plug-ins for accurate measurements. Power is supplied by instruments with probe power jacks or the 1122A probe power supply.

### 1120A Specifications

(Measured with output connected to a 50 ohm load.)

**Bandwidth:** (measured from a terminated 50 ohm source) dc-coupled, dc to >500 MHz; ac-coupled, <1.5 kHz to >500 MHz.

**Pulse response:** (measured from a terminated 50 ohm source) rise time, <0.75 ns; perturbations, <±10% measured with 1 GHz sampler.

**Dynamic range:** ±0.5 V with ±5 V dc offset.

**Noise:** approx 2.5 mV (measured tangentially).

**Input RC:** 100 k $\Omega$ , shunt capacitance approx 3 pF at 100 MHz; with 10:1 or 100:1 dividers, shunt capacitance is <1 pF at 100 MHz.

**Maximum input:** ±80 V.

**Weight:** net. 1.8 kg (4 lb). Shipping, 3.2 kg (7 lb).

**Power:** supplied by oscilloscopes with probe power jacks or a Model 1122A probe power supply.

**Length:** 1.2 m (4 ft) overall; with Option 001, 1.8 m (6 ft).

### Accessories furnished

**Model 10241A 10:1 divider:** increases input R to approx 1 megohm shunted by <1 pF at 100 MHz.

**Model 10243A 100:1 divider:** increases input R to approx 1 megohm shunted by <1 pF at 100 MHz.

**Model 10242A bandwidth limiter:** reduces bandwidth to approx 27 MHz shunted by approx 6 pF and reduces gain <2%.

**Also included:** slip-on hook tip, 6.4 cm (2.5 in.) ground lead, spare probe tips, a slip-on BNC probe adapter, two red ID sleeves, and a probe divider adjustment tool (PN 5020-0570).

### 1124A 100 MHz active probe

Model 1124A Active Divider Probe provides high voltage, general purpose probing capabilities for instruments having 50 ohm inputs without selectable high impedance inputs. This 10 megohm 10 pF probe allows direct measurements of 100 volts, in the 100:1 division ratio mode, from dc to 100 MHz. In the 10:1 division ratio mode, input voltage range is ±10 volts. Power is supplied by instruments with probe jacks or the 1122A probe power supply.

### 1124A Specifications

(Measured when connected to a 50 ohm load.)

**Bandwidth:** (measured from a terminated 50 ohm source) dc-coupled, dc to 100 MHz; ac-coupled, 2 Hz to 100 MHz.

**Pulse response:** (measured from a terminated 50 ohm source) rise time, <3.5 ns; perturbations, 5% p-p. Measured with pulse rise time of >2.5 ns.

**Attenuation ratio:** 10:1 ±5%; 100:1 ±5%.

**Dynamic range:** X10, ±10 V; X100, ±100 V.

**Input RC:** 10 megohms shunted by approx 10 pF.

### Maximum safe input

**DC-coupled:** X10, ±300 V (dc + peak ac) ≤100 MHz; X100, ±500 V (dc + peak ac) ≤100 MHz.

**AC-coupled:** X10, ±300 V (dc + peak ac) ≤100 MHz. DC component must not exceed ±200 V; X100, ±500 V (dc + peak ac) ≤100 MHz. DC component must not exceed ±200 V.

**Accessories supplied:** one 20.3 cm (8 in.) ground lead, one retractable hook tip, and two probe tip insulating caps.

**Power:** supplied by instruments with probe power jacks or Model 1122A probe power supply

**Weight:** net. 0.2 kg (6 oz.). Shipping, 0.91 kg (2 lb).

**Length:** approx 1.5 m (5 ft) overall.

**Available accessory:** 10131B 91.4 cm (36 in.) extender cable (refer to 1122A Probe Power Supply). Required for use with 1700 oscilloscopes with probe power option.

### 1122A Probe power supply

Model 1122A is a regulated power supply that provides power for operating active probes. The power supply provides all power requirements for simultaneous operation of up to four active probes.

### 1122A Specifications

**Probe driving capability:** up to four HP active probes.

**Power output:** -12.6 and +15 V, ±3%.

**Power input:** 115 V or 230 V ±10%, 48 to 440 Hz, 40 W (with four probes).

**Weight:** net. 2.7 kg (6 lb). Shipping, 3.63 kg (8 lb).

**Accessories supplied:** four Model 10131B 91.4 cm (36 in.) extender cables.

### Ordering information

1120A 500 MHz Active Probe

1120A Opt 001, 1.8 m (6 ft) length

1122A Probe Power Supply

1124A 100 MHz Active Probe

Price

\$595

add \$35

\$425

\$170

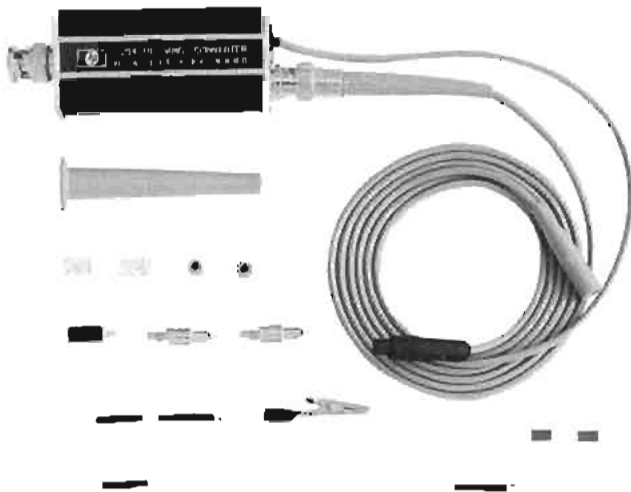

1125A



1111A



1110A

### 1125A Impedance converter probe

Model 1125A 250 MHz Impedance Converter Probe for oscilloscopes with 50 ohm inputs is ideal for ECL and other offset logic circuit measurements. This active divider probe provides a high impedance of approximately 100 kilohms to low frequencies with both the 10:1 and 100:1 divider tips, which drops to a low impedance at high frequencies. The dual impedance feature gives you the advantages of low dc circuit loading, high maximum voltage ratings,

and high fidelity rise time measurements. Probe tip shunt capacitance is  $<0.7$  pF. Power is supplied by scopes with probe power jacks or the 1122A probe power supply.

#### 1125A Specifications

**Attenuation ratio:** (oscilloscope gain may be adjusted for 10:1 and 100:1 division ratio) 10.5:1 and 105:1,  $\pm 5\%$ .

**Dynamic range at probe tip:** X10,  $\pm 4$  V; X100,  $\pm 40$  V.

#### Input impedance at probe tip

**High frequency:** approx 500 ohms (X10) or 5 k $\Omega$  (X100) shunted by 0.7 pF (in X10 or X100 modes).

**Low frequency:** approx 100 k $\Omega$  (dc-coupled).

#### Maximum Input

**All modes:**  $\pm 300$  V (dc + peak ac) with  $\pm 200$  V max dc component.

**X10:** dc to 500 Hz, 200 V rms; decreasing 6 dB per octave to 12 V rms at 10 kHz.  $\geq 10$  kHz, 12 V rms is max allowable continuous input.

**X100:** dc to 1.5 kHz, 200 V rms; decreasing 6 dB per octave to 35 V rms at 10 kHz.  $\geq 10$  kHz, 35 V rms is max allowable continuous input.

**Bandwidth** (with X10 or X100 tip and supplied 1.3 m (4 ft) cable)

**DC-coupled:** dc to 250 MHz.

**AC-coupled:** 20 Hz to 250 MHz.

**Pulse response in X10 or X100:**  $\leq \pm 5\%$  perturbations measured from a terminated 50 ohm source.

**Accessories supplied:** one 1.2 m (4 ft) 50 ohm cable, one X10 divider tip, one X100 divider tip, one probe handle, two red color coding sleeves, two clear plastic insulating caps, two jade gray insulating caps, one 5.1 cm (2 in) 6-32 ground lead, one 15.2 cm (6 in.) 6-32 ground lead, one 6-32 adapter tip and one 6-32 alligator tip.

**Power:** supplied by instruments with probe power jacks or a Model 1122A probe power supply.

**Length:** approx overall length, 147.3 cm (58").

**Weight:** net, 0.2 kg (6 oz). Shipping, 0.9 kg (2 lb).

### 1111A AC current amplifier

**Deflection factor:** (with a 50 mV/div oscilloscope deflection factor) in X1, 1 mA/div to 50 mA/div; in X100, 100 mA/div to 5 A/div; 1, 2, 5 sequence in X1 or X100.

**Accuracy:** in X1,  $\pm 3\%$ ; in X100,  $\pm 4\%$ .

**Rise time:** 18 ns.

**Noise:**  $<100$   $\mu$ A p-p, referenced to input signal.

**Maximum ac current:** above 700 Hz, 50 A p-p; below 700 Hz, decreases at 1.4 A/20 Hz.

**Output impedance:** 50 ohms.

**Size:** 38.1 H  $\times$  130.2 W  $\times$  152.4 mm D (1 1/2"  $\times$  5 1/8"  $\times$  6").

**Weight:** net, approx. 0.91 kg (2 lb). Shipping, 1.36 kg (3 lb).

**Power:** 115 or 230 V  $\pm 10\%$ , 50 to 440 Hz, 1.5 watts.

### 1110A Current probe

**Sensitivity:** without 100 ohm termination, 1 mV/mA; with 100 ohm termination, 0.5 mV/mA.

**Accuracy:**  $\pm 3\%$ .

#### Bandwidth

**Lower -3 dB point:** without 100 ohm termination, approx 1700 Hz; with 100 ohm termination, approx 850 Hz.

**Upper -3 dB point:** with 4 pF capacitive load, approx 45 MHz; with 30 pF capacitive load, approx 35 MHz.

**Rise time:** with 4 pF capacitive load, approx 7 ns; with 30 pF capacitive load, approx 9 ns.

**Insertion Impedance:** approx 0.01 ohm shunted by 1  $\mu$ H; capacitance to ground  $<3$  pF.

**Maximum dc current:** 0.5 A.

**Maximum ac current:** 15 A p-p above 4 kHz; decreasing below 4 kHz at 3.8 A/kHz rate.

**Weight:** net, 0.45 kg (1 lb). Shipping, 0.91 kg (2 lb).

**Dimensions:** probe aperture, 3.9 mm (3/16") diameter; overall length, 1.5 m (5 ft).

#### Ordering information

1125A Impedance Converter Probe

1111A Current Amplifier

1110A Current Probe

#### Price

\$220

\$370

\$150

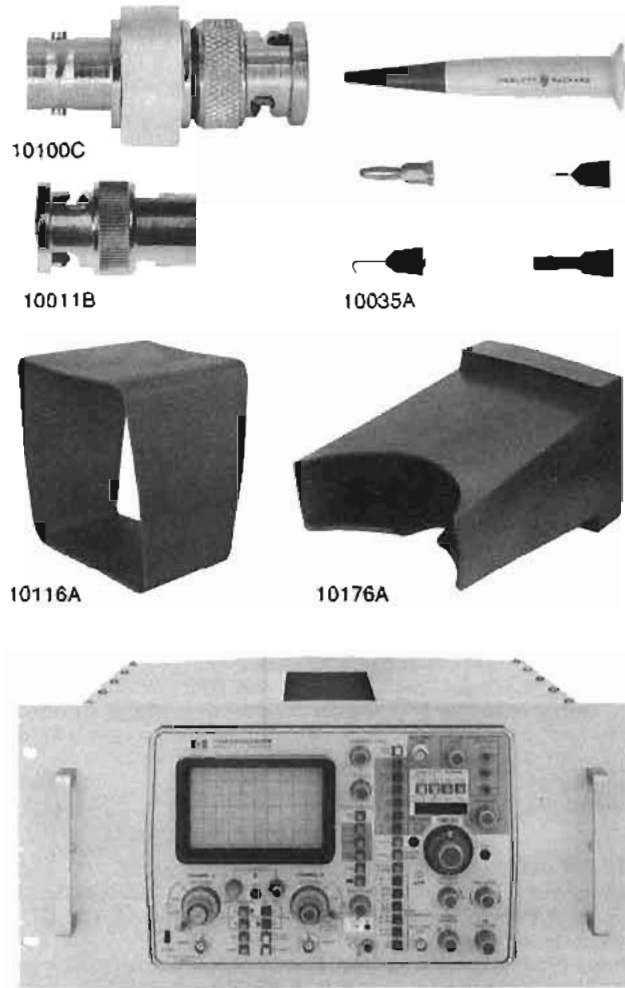

10491B

### Probe accessories

#### Terminations

**10100C:** 50 ohm feedthrough.

**10100B:** 100 ohm ( $\pm 2$  ohm) feedthrough for 1110A current probe.

#### Probe tip adapters

**10011B BNC probe tip adapter:** for probes 10004D-10006D, 10007B, 10008B, 10013A, 10014A, 10015A, 10016B, and 1124A.

**HP P/N 10004-69515 IC probe tip adapter:** provides convenient connection to dual in-line packages for probes 10004D-10006D, 10007B, 10008B, 10013A, 10014A, 10015A, 10016B, and 1124A.

#### Probe tip kits

Probe tip kits, Models 10036B and 10037B, extend usefulness of 10004D, 10005D, 10006D, 10007B, 10008B, 10013A, 10014A, 10015A, 10016B, 1124A standard size probes and HP miniature probes. Model 10036B includes an assortment of tips for the following: 2.0 mm (0.08 in.) jack; 0.6 mm (0.025 in.) and 11.4 mm (0.045 in.) square pin; 1.0 mm-1.6 mm (0.040-0.062 in.) dia pin; and a long pin tip. Model 10037B includes six 0.6 mm (0.025 in.) square pin tips. Probe tip kit Model 10035A for 10001A-10003A probes contains pincer jaw, banana tip, pin tip, and spring tip.

Model 10034A probe adapter kit consists of an assortment of 6-32 screw-on tips, and two ground lead cables which allow many methods of connecting the ground leads in a circuit. A 6-32 slip-on adapter allows these tips to be used on 10004D-10006D, 10007B, 10008B, 10013A, 10014A, 10015A, 10016B, and 1124A probes. The kit consists of one 15.2cm (6 in.) and one 30.5 cm (12 in.) ground lead, one hook tip, one alligator tip, one pin tip, one tip for 0.6 mm (0.025 in.) square pins, one banana tip, and one slip-on to 6-32 adapter.

### Servicing and viewing accessories

#### Plug-in extender

**Model 10407B:** 180 system extender (metal frame extends both plug-ins). Allows calibration and maintenance while a unit is operating.

#### Viewing hoods

**10116A:** collapsible light shield for 1220 series oscilloscopes.

**10140A:** collapsible viewing hood for 1700 series and 1223A oscilloscopes.

**10178A:** viewing hood for 12.7 cm (5 in.) rectangular CRT bezels.

#### Light filters

**10173A:** RFI filter and contrast screen for 1700 series and 1223A oscilloscopes.

**10178A:** metal mesh contrast screen for 181, 184 oscilloscopes.

**Amber plastic filter:** HP P/N 5020-0530, for 12.7 cm (5 in.) rectangular CRT.

**Smoke gray plastic filter:** HP P/N 5020-0567, for 12.7 cm (5 in.) rectangular CRT.

**Blue plastic filter:** HP P/N 5060-0548, for 12.7 cm (5 in.) rectangular CRT.

**Blue light filter:** HP P/N 01740-02701 for 1700 series and 1223A oscilloscopes

#### Rack mount slides and adapters

##### 1700 series oscilloscopes, 1600A Logic State Analyzer

**10491B rack mount adapter:** adapts 1700 series oscilloscopes and 1600A Logic State Analyzer to standard 483 mm (19") rack; 222 mm (8 $\frac{3}{4}$ ") high, 540 mm (21 $\frac{1}{4}$ ") deep.

##### 180 and 181 rack style oscilloscopes

A slide adapter is required to secure an oscilloscope to the slides.

**Fixed slides:** HP P/N 1490-0714, 55.9 cm (22").

**Pivot slides:** HP P/N 1490-0719, 55.9 cm (22").

**Slide adapter:** HP P/N 1490-0768 (required for all slides).

#### Front panel cover

**HP P/N 5040-0516:** provides front panel protection for 1700 series oscilloscopes, 1600A Logic State Analyzer.

#### Ordering Information

	Price
10100C 50 ohm Feedthrough Termination	\$22
10100B 100 ohm ( $\pm 2$ ohm) Feedthrough Termination	\$26
10011B BNC Probe Tip Adapter	\$12
10004-69515 IC Probe Tip Adapter	\$5
10034A Probe Tip Kit	\$32
10035A Probe Tip Kit	\$10
10036B Probe Tip Kit	\$35
10037B Probe Tip Kit	\$30
10407B Plug-in Extender	\$150
10116A Light Shield for 1220 series oscilloscopes	\$13
10140A Viewing Hood for 1700 series and 1223A oscilloscopes	\$15
10176A Viewing Hood for 12.7 cm (5 in.) rect. CRT	\$19
10173A RFI Filter and Contrast Screen for 1700 series and 1223A oscilloscopes	\$10
10178A Metal Mesh Contrast Screen for 181, 184 oscilloscopes	\$22
5020-0530 Amber Plastic Filter for 12.7 cm (5 in.) rectangular CRT	\$10.50
5020-0567 Smoke Gray Plastic Filter for 12.7 cm (5 in.) rectangular CRT	\$18
5060-0548 Blue Plastic Filter for 12.7 cm (5 in.) rectangular CRT	\$5
01740-02701 Blue Light Filter for 1700 series and 1223A oscilloscopes	\$170
10491B Rack Mount Adapter for 1700 series oscilloscopes, 1600A Logic State Analyzer	\$100
1490-0714 Fixed Slides for 180, 181 rack style oscilloscopes	\$75
1490-0719 Pivoted Slides for 180, 181 rack style oscilloscopes	\$105
1490-0768 Slide Adapter, required for securing slides to 180, 181 rack style oscilloscopes	\$85
5040-0516 Front Panel Cover for 1700 series oscilloscopes, 1600A Logic State Analyzer	\$9



123A



197A

### 123A Description

Model 123A is a lightweight compact camera which fits directly on HP 1700 series oscilloscopes with 6 × 10 div CRT's. The camera does not require external power and only weighs 1.6 kg (3½ lb) making it ideal for use in field applications. The 123A has a range finder for easy focusing using a split image technique. This range finder also serves as a viewing port so that you can make minor CRT intensity and graticule illumination adjustments with the camera in place. For convenience in setting up the display the camera has a swing-away feature allowing full visibility of the CRT screen. Controls are color coded for optimum settings and are located outside of the camera for easy reading and fast adjustment to reduce initial setup time.

The 123A mounts directly or with adapters to the oscilloscopes as listed in the oscilloscope/camera adapter table.

### 123A Specifications

**Reduction ratio:** continuously adjustable from 1:1 to 1:0.65.  
**Lens:** 56 mm, f/3.5 lens; aperture ranges f/3.5, f/4, f/5.6, f/8, f/11, f/16, and f/22.  
**Shutter speeds:** 1/60, 1/100, 1/150, 1/200, 1/250, 1/2, and 1 second, and Bulb. Cable has thumbscrew lock for time exposures. X-type contacts provided to trigger or synchronize other equipment with shutter release.  
**Graticule illumination:** supplied by the oscilloscope.  
**Camera back:** 83 mm × 108 mm (3¼" × 4¼"). Polaroid® pack back.  
**Mounting:** lift on/off mounting with positive lock. Mounts directly on HP 1700 series oscilloscope with 6 × 10 div CRT's. Adapters are available to fit other scopes, see Camera Accessories.  
**Range finder:** viewing port provides split image of the CRT to allow setting of the focus.  
**Viewing:** range finder viewing port allows viewing the CRT with camera in position. Camera swings away for wide angle viewing.  
**Focus:** adjustable with camera back closed or open; split image focusing plate provided for use when object-to-image ratio is changed.  
**Size:** 122 H × 192 W × 220 mm D (7<sup>9</sup>/<sub>16</sub>" × 4<sup>13</sup>/<sub>16</sub>" × 8<sup>13</sup>/<sub>16</sub>" ).  
**Weight:** net, 1.6 kg (3½ lb). Shipping, 2.3 kg (5 lb).  
**Accessories furnished:** combination split image focusing plate and reduction ratio scale, and instruction manual.

\*Polaroid® by Polaroid Corp.

### 197A Description

Model 197A is a versatile, general purpose oscilloscope camera that can be used for many trace recording applications. All controls

are located outside of the camera for easy reading and fast adjustment during setup. The controls are also color coded for optimum settings for most photos which reduces initial setup time.

An electronically-controlled shutter, with all solid-state circuits for reliable operation, provides accurate exposure times from 1/60 to 4 seconds. The shutter may be operated remotely by providing a closure to ground and a contact closure is provided when the shutter is open to allow synchronization of other equipment.

The reduction ratio (i.e., object-to-image ratio) may be varied from 1:1 to 1:0.7 with a screwdriver adjustment. This allows the optimum amount of a graticule to be photographed, which is useful when making multiple exposures or when used on different size graticules. The camera can be quickly focused to match the reduction ratio with the split-image focus plate supplied with the camera.

The 197A is supplied with an 83 mm × 108 mm (3¼" × 4¼") Polaroid pack back. The back may be rotated 90° from the normal horizontal position to a vertical position and can be moved through 11 detented positions for multiple exposures. It may also be replaced with a Graflok® back which allows use of sheet or roll film.

\*Graflok® by Graflex, Inc.

### 197A Specifications

**Reduction ratio:** continuously adjustable from 1:1 to 1:0.7. Reference scale provided on focus plate.

**Lens:** 75 mm, f/1.9 high transmission lens; aperture ranges f/1.9 to f/16.

**Shutter speeds:** 1/60, 1/100, 1/150, 1/200, 1/250, 1, 2, 4 seconds, Time and Bulb; shutter has a sync contact closure output for triggering external equipment and an input jack for remote operation.

**Graticule illumination:** supplied by oscilloscope. Refer to Options for internal graticule illumination.

**Camera back:** 83 mm × 108 mm (3¼" × 4¼") Polaroid pack back (another back is available, see Options); backs may be interchanged without refocusing and may be rotated in 90-degree increments.

**Mounting:** lift on/off mounting with positive lock, swing-away hinging to left. Mounts directly on most HP oscilloscopes with 12.7 cm (5") round or rectangular CRT's. Adapters are available to fit other scopes and displays, see Camera Accessories.

**Viewing:** low-angle, direct viewing through a flexible facemask.

**Multiple exposure:** back can be moved through 11 detented positions (½ cm per detent at 1:0.9 object-to-image ratio).

**Focus:** adjustable focusing with lock; split image focusing plate provided.

**Dimensions:** 267 H × 194 W × 356 mm D (10½" × 7¾" × 14").

**Weight:** net, 4.5 kg (10 lb). Shipping, 7.3 kg (16 lb).

**Power:** 115 V ± 10%, 48 to 440 Hz, 6 watts.

**Accessories furnished:** comb. split image focusing plate and reduction ratio scale, 2.3 m (7.5 ft) power cord, and instruction manual.

### Options

Options	Price
003: Graflok back in place of pack back (on initial order)	N/C
006: replaces standard 197A adapter with 10375A adapter to directly fit 1332A, 1333A, and 1335A displays. Adds shutter open light indicator*	add \$25
007: meets UL listing requirements for medical and dental electronic equipment (minimum order 10)	add \$25
008: replaces standard 197A adapter with 10376A adapter to directly fit 1223A, 1715A, 1725A, 1740A, 1741A, 1743A oscilloscopes	add \$50
012: factory wired for 230 V operation	N/C
H02: provides internal graticule illumination using ultraviolet light with an OFF, ON switch. Not required for oscilloscopes with graticule illumination*	\$125

### Ordering Information

123A Oscilloscope Camera	\$615
Opt 910: additional manual	add \$7.50
197A Opt 001: Oscilloscope Camera (less ultraviolet light)	\$870
Opt 910: additional manual	add \$3.50

\*When Options 006 and H02 are ordered together, shutter open light indicator is not included. Either option may be converted back to a standard 197A by HP P/N 90197-62201.



10353A



10352B



10361A



10362A



10363A



10106A



10367A



10369A



10370A



10371A



10372A



10375A



10376A



10377A



16491A

### Film backs for 197A camera

Model 197A has the Polaroid Film Back as standard equipment. The Graflok Back may be ordered initially as an option at no extra charge.

**10353A Pack film back:** uses Polaroid Land Film, 83 mm × 108 mm (3 1/4" × 4 1/4"), with eight exposures.

**10352B Graflok back:** requires a film holder available from local camera stores. The back accepts Polaroid Land 102 mm × 127 mm (4" × 5") film holder, standard cut-film holders, film-pack adapters,

and roll film holders. For additional information about film holders that will fit the Graflok back, contact your local camera stores.

### Camera bezel adapters

The following Hewlett-Packard adapters provide mounting of Hewlett-Packard, Tektronix, and Dumont cameras to Hewlett-Packard as well as Tektronix and Dumont oscilloscopes. Refer to the oscilloscope/camera adapter table for a cross-reference of these adapter/camera/oscilloscope combinations.



10358B



10374A

**10361A:** adapts Tektronix C12 camera to HP 127 mm (5") rectangular CRT (180C style bezels).

**10362A** adapts Tektronix C27 and C50 cameras to HP 127 mm (5") rectangular CRT (180C style bezels); C50, C51, C52, C53 require Tektronix battery pack.

**10363A:** adapts Tektronix C30A, C31, C32, or C40 cameras to HP 127 mm (5") rectangular CRT (180C style bezels).

**10106A:** adapts Tektronix C30A, C31, C32, or C40 cameras to HP 1700 series scopes with 6 x 10 div CRTs.

**10367A:** adapts 195A & 197A cameras to HP 182 scope.

**10369A:** adapts 123 camera to HP 127 mm (5") rectangular CRT (180C style) & HP 127 mm (5") round CRT.

**10370A:** adapts 123A camera to HP 182 large screen CRT.

**10371A:** adapts 123A camera to Tektronix 422/453/454/485 scopes.

**10372A:** adapts 123A camera to Tektronix 464/465/466/475.

\***10375A:** adapts 197A, 195A cameras to 1332A, 1333A, & 1335A displays, Tektronix 600, 5100, & 7000 series scopes.

\***10376A:** adapts 195A & 197A cameras to 1700 series with 8 x 10 div CRT's and 1223A scopes.

**10377A:** adapts Tektronix C30A, C31, C32, or C40 cameras to HP 1700 series with 8 x 10 div CRT's and 1223A scopes.

**16491A:** adapts 123A camera to 1700 series with 8 x 10 div CRT's and 1223A scopes.

\*See 197A Options 006 & 008 before ordering these adapters for 197A

### Carrying cases

**10358B:** constructed of fiberglass and aluminum with padding for protection during transit. The carrying case will accommodate the 195A, 197A, & 198A cameras.

**10374A:** carrying case for 123A camera with storage space for 1 pack of film.

### Ordering information

	Price
10353A Pack Film Back	\$130
10352B Graflok Back	\$180
10361A Camera Adapter	\$27
10362A Camera Adapter	\$27
10363A Camera Adapter	\$45
10106A Camera Adapter	\$50
10366B Camera Adapter	\$20
10367A Camera Adapter	\$34
10369A Camera Adapter	\$50
10370A Camera Adapter	\$28
10371A Camera Adapter	\$28
10372A Camera Adapter	\$30
10375A Camera Adapter	\$90
10376A Camera Adapter	\$65
10377A Camera Adapter	\$65
16491A Camera Adapter	\$130
10358B Carrying Case	\$140
10374A Carrying Case	\$30

Oscilloscope/Camera Adapter Table <sup>1</sup>													
OSCILLOSCOPE	CAMERA												
	HEWLETT-PACKARD					TEKTRONIX INC.				DUMONT			
HEWLETT-PACKARD	123A	*195A	*198A/B	197A	*198A	C12	C27	C30A/31/32/40	C50 Series	450A-1	453A-1	450A-7B	321A
5-in. Round CRT	10369A	Direct	Direct	Direct	Direct	---	---	---	---	Direct	Direct	Direct	Direct
5-in. Rectangular CRT <sup>2</sup>	10369A	Direct	*10360A	Direct	Direct	*10361A	*10362A	10363A	*10362A	*10360A	*10360A	*10360A	*10360A
182	10370A	10367A	---	10367A	---	---	---	---	---	---	---	---	---
1332A/1333A/1335A	7	10375A	---	*10375A	---	5	5	5	Direct	---	---	---	---
1700 Series (6 x 10 div CRT's)	Direct	---	---	---	---	---	---	10106A	---	---	---	---	---
1700 Series, 1223A (8 x 10 div CRT's)	16491A	10376A	---	*10376A	---	---	---	10377A	---	---	---	---	---
<b>Notes</b>													
5-in. Round 549	10369A & *10355A	*10355A	*10355A	*10355A	*10355A	1. This chart only includes HP adapter and camera compatibility, for other combinations, contact your Field Engineer.							
5-in. Rect. & 560 Series	---	10356A	---	*10356A	10356A	2. The 10361A and 10362A adapter hinge mounts interfere with the Find Beam pushbutton on 180 mainframes.							
529 Series	10369A & 10356A	10356A	---	10356A	10356A	3. Model 195A, 198A/B, 198A cameras and 10355A, 10360A camera adapters are no longer in production.							
464/465/466/475	10372A	---	---	---	---	4. 197A Option 008 includes the 10376A which directly fits 1715A, 1725A, 1740A, 1741A, 1743A, 1223A scopes.							
422/453/454/485/323/324	10371A	---	---	---	---	5. Tektronix Inc. cameras with adapters for 7000 series scopes can be used with HP 1332A, 1333A, & 1335A Displays.							
600, 5100 & 7000 series	---	10375A	---	*10375A	---	6. 197A Option 006 includes the 10376A which fits HP 1332A, 1333A, & 1335A displays, Tektronix 600, 5100 & 7000 series oscilloscopes directly.							
DUMONT	7. Adapter available on special order, contact your HP Field Engineer.												
5-in. Round CRT	10369A & *10355A	*10355A	Direct	*10355A	*10355A	8. Tektronix C50, C51, C52, C53 require Tektronix battery pack.							
9. 5 in. rectangular CRT's with 180C type bezels, e.g. 1600A.													

# OSCILLOSCOPES

Testmobiles: save bench space, easily moved

Models 1007A, 1008A, 1114A & 1117B



1007A Opt 006

1008A Opt 005



1114A

1117B

## Introduction

Hewlett-Packard Testmobiles offer convenient portability for your oscilloscopes or instrumentation systems. The top tray on these testmobiles may be tilted for positioning your instrument for easy operation. The selection of testmobiles range from a basic model designed to hold a single oscilloscope or other instrument such as the 1114A, to a testmobile that can be adapted to provide a complete mobile test system, such as the 1008A or 1117B. Refer to the testmobile/instrument compatibility chart for assistance in selecting the testmobile that will best fit your requirements.

## Testmobile/Instrument compatibility

Testmobile Model Number	Instrument
1007A	All Hewlett-Packard 180, 1200, 1220, and 1700 Series cabinet style oscilloscopes, or other instruments that meet the height and weight requirements.
1008A	All Hewlett-Packard instruments that are configured to be mounted in a standard 48.3 cm (19 in.) rack and meet the testmobile height and weight requirements.
1114A	180 and 1200 cabinet style, and 1220 and 1700 Series, 1600A, 3580A
1117B	All instruments listed above.

## 1007A, 1008A Description

The 1007A and 1008A testmobiles provide a sturdy, lightweight, stable platform for your oscilloscope or instrumentation system. Large mar-resistant rubber wheels with a wide track move quietly and smoothly, even over uneven floor surfaces. The top trays on these testmobiles are convenient table-top height and can be tilted to

a convenient viewing angle between 30° above and 30° below the horizontal position with a total of seven detent positions in 10° increments. The caps on each side rail are designed to conveniently hold three probes to reduce the possibility of damaging probes not in use.

Many options are available so that the 1007A or 1008A can be easily tailored to your specific requirements. Refer to the 1007A/1008A Option Selection Chart to select the testmobile and options best suited to your requirements.

## 1007A, 1008A Option selection chart\*

Price

Option	Model	Price
Opt 001: storage shelf, load limit 18 kg (40 lb).	1007A 1008A	add \$ 30 add \$ 35
Opt 002: storage shelf and lower cabinet, load limit 18 kg (40 lb) on each.	1007A 1008A	add \$ 90 add \$100
Opt 003: 15 cm (6") locking drawer with shelf on top, load limit 11 kg (25 lb) in drawer and 18 kg (40 lb) on shelf.	1007A 1008A	add \$150 add \$160
Opt 004: two storage cabinets with shelf on top, combined load limit, cabinets and shelf, 45 kg (100 lb).	1007A 1008A	add \$145 add \$145
Opt 005: storage cabinet and drawer in upper position with shelf on top, load limit 18 kg (40 lb) on shelf, 18 kg (40 lb) in cabinet and 11 kg (25 lb) in drawer.	1007A 1008A	add \$205 add \$215
Opt 006: storage cabinet with shelf on top, and drawer in lower position, load limit 18 kg (40 lb) on shelf, 18 kg (40 lb) in cabinet, and 11 kg (25 lb) in drawer.	1007A 1008A	add \$205 add \$215
Opt 007: two locking drawers with shelf on top, load limit 18 kg (40 lb) on the shelf and 11 kg (25 lb) in each drawer.	1007A 1008A	add \$280 add \$275
Opt 008: power strip with five outlets for convenient instrument operation. This option not compatible with basic testmobile and must be ordered with one of other options (001 thru 007).	1007A 1008A	add \$ 30 add \$ 30

\*Load limits of these options are in addition to those of the basic testmobile limits in the specifications.

## 1007A, 1008A Specifications

Compatibility: see Testmobile/Instrument compatibility chart.

Tilt angle: -30° to +70° in seven 10° positions.

### Load limits

1007A: 34 kg (75 lb) on tilt tray.

1008A: 45 kg (100 lb) on tilt tray; when instruments are rack mounted on the bottom of the tray, the max weight on the tilt tray is 27 kg (60 lb) and 18 kg (40 lb) on the rack mounts.

**Safety:** although many Hewlett-Packard instruments may be stacked on top of each other while on a laboratory bench, these stacked instruments may not be stable on a testmobile. The following size limits and the maximum weights for the basic testmobiles and the various options must not be exceeded.

1007A: the Model 1007A is designed for use with any HP cabinet style instrument that does not exceed 315 mm (12<sup>3</sup>/<sub>8</sub>") width and a dept of 508 mm (20") as measured from the front casting. The height of the instrument(s) *must not* exceed 330 mm (13"); if the instrument is less than 127 mm (5") high the tie-down strap will not operate properly.

1008A: the Model 1008A is designed for use with any HP rack width instrument that does not exceed a depth of 508 mm (20") as measured from the front casting (i.e. 1610A or 1611A). The height of the instrument(s) *must not* exceed 330 mm (13"); if the instrument is less than 127 mm (5") high the tie-down strap will not operate properly.

Dimensions: see outline drawings.

Wheel size: 102 mm (4") diameter.

### Weight, basic testmobile

1007A: net, 11 kg (25 lb) Shipping, 19 kg (41 lb).

1008A: nt, 13 kg (29 lb). Shipping, 22 kg (48 lb).

## 1114A Description

Model 1114A is a general purpose testmobile designed for 180 and 1200 cabinet style, and 1220 and 1700 series oscilloscopes, without special adapters. A channel in the tilt tray positions the front feet of the oscilloscope and a nylon tie-down strap securely holds the instrument in place. The combination tilt tray handle/release lever allows one-hand adjustment of viewing angle, from 15° below horizontal to 60° above. A base tray provides space for other instruments/accessories. Large rear wheels allow easy pushing over carpeted or rough floor surfaces, and locking front casters hold the testmobile in position.



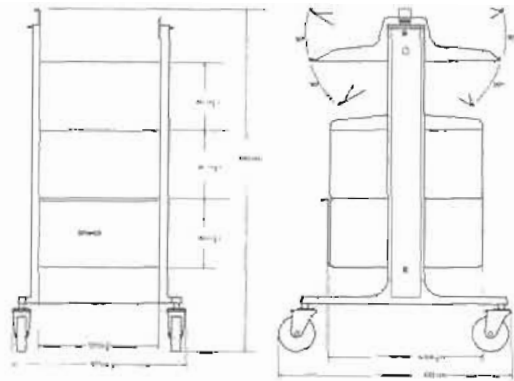

1007A

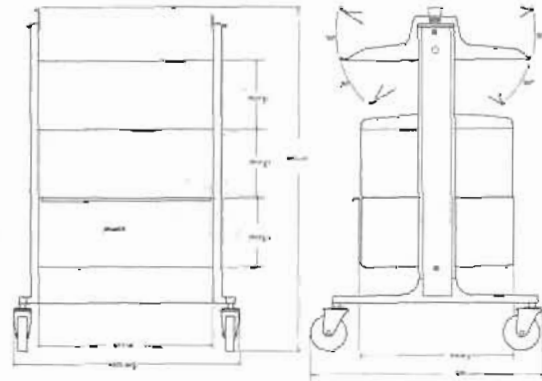

1008A

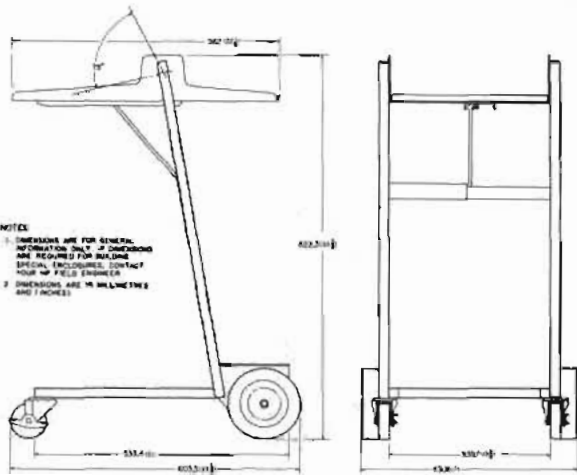

1114A

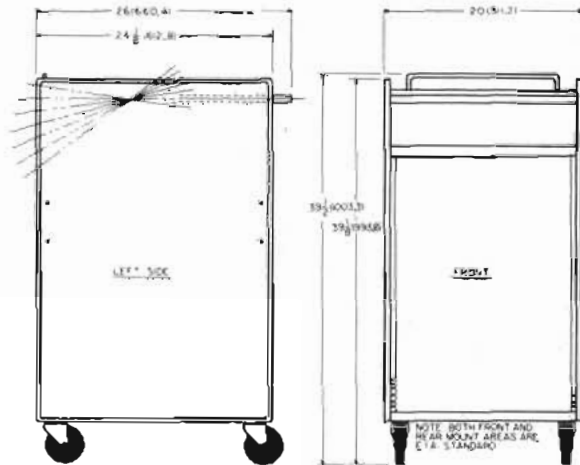

1117B

**1114A Specifications**

**Compatibility:** see Testmobile/Instrument Compatibility chart.  
**Tilt angle:** 75° range in 12 steps (60° above, 15° below horizontal).  
**Load limits:** 18 kg (40 lb) on tilt tray and 18 kg (40 lb) on lower tray.  
**Safety:** the 1114A is designed for one cabinet style instrument that does not exceed 279 mm (11") in height on the tilt tray.  
**Dimensions:** see outline drawing.  
**Wheel size:** 76 mm (3") diameter, locking caster (front); 152 mm (6") diameter (rear).  
**Weight:** net, 12.7 kg (28 lb). Shipping, 15 kg (33 lb).

**1117B Description**

Model 1117B for cabinet and rack model instruments provides tilt tray angles from -15° to +30° in 7½° increments for easy viewing. In addition, other instruments can be mounted in the standard EIA racks of the lower compartment. Rack mounting depth is 58.4 cm (23") and power distribution is supplied. Optional accessory drawers 7.6 cm (3") and 20.3 cm (8") deep are available to provide convenient storage space. The drawers may be installed in many vertical positions of the lower compartment, allowing room for other rack mounted equipment.

**1117B Specifications**

**Compatibility:** cabinet or 48.3 cm (19") rack model oscilloscopes. See Testmobile/Instrument Compatibility chart.  
**Tilt angle:** -15° to +30° in 7½° steps.  
**Load limits:** 45 kg (100 lb) on tilt tray and 56.7 (125 lb) below the tray.

**Safety:** the 1117B is designed to accommodate instruments that do not exceed 406 mm (16") in height on the tilt tray.  
**Dimensions:** see outline drawing.  
**Wheel size:** 102 mm (4") diameter.  
**Weight:** net, 41.3 kg (91 lb). Shipping, 49.4 kg (109 lb).  
**Instrument mounting hardware supplied:** 8 screws for rack mounting instruments (HP P/N 2731-0002); 8 cup washers (HP P/N 3050-0007); 8 nylon washers (HP P/N 3050-0248); 8 Tinnerman nuts (HP P/N 0590-0172).

**Optional accessories**

**Model 10475A:** 7.6 cm (3") drawer.  
**Weight:** net, 4.1 kg (9 lb). Shipping, 5.9 kg (13 lb).  
**Model 10476A:** 20.3 cm (8") drawer.  
**Weight:** net, 5.4 kg (11 lb). Shipping, 8.2 kg (18 lb).

**Ordering information**

See 1007A, 1008A Option Selection Chart for option prices for these testmobiles.

- 1007A Testmobile \$210
- 1008A Testmobile \$230
- 01008—68701 Rack Mount Kit for 1008A, 13.3 cm (5.25") high for mounting under the tilt tray \$33
- 01008—68702 Rack Mount Kit for 1008A, 19 cm (7.50") high for mounting under the tilt tray \$43
- 1114A Testmobile \$160
- 1117B Testmobile less drawers \$375
- 10475A 7.6 cm (3") drawer for 1117B \$70
- 10476A 20.3 cm (8") drawer for 1117B \$90

**Price**

# CATHODE-RAY TUBE DISPLAYS

Displays for OEM applications

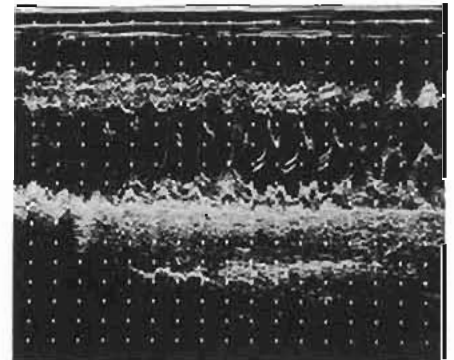
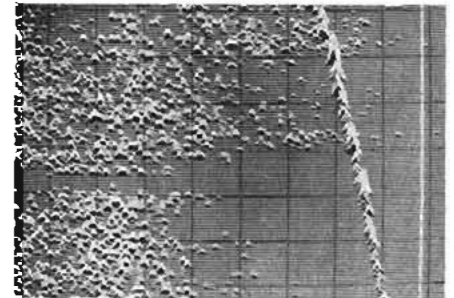
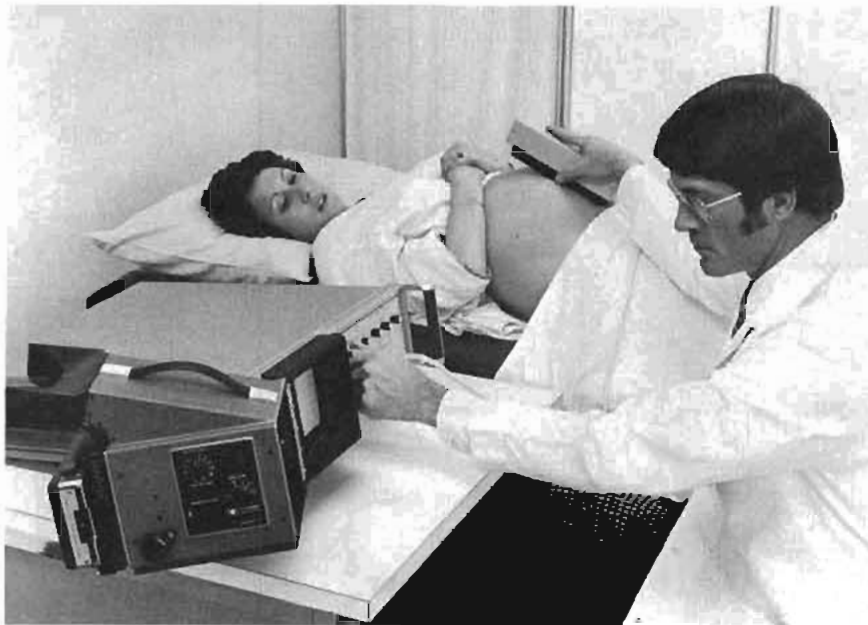
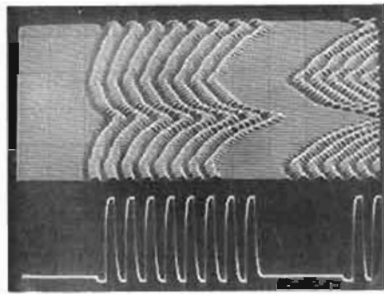
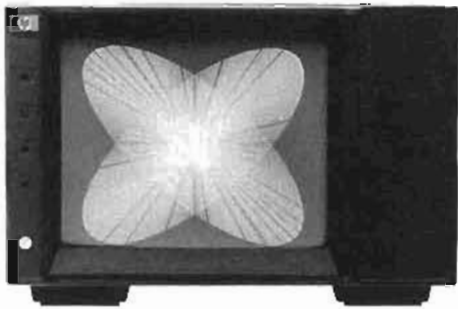

Hewlett-Packard's cathode-ray tube displays offer OEM's and end users top performance, versatility, and reliability for all types of systems—from spectrum, network, and chemical analyzers, and automatic test systems to computer graphics and radar. These displays are complete units which include the cathode-ray tube, vertical and horizontal deflection amplifiers, a video (Z-Axis) amplifier, and high and low voltage power supplies. A Graphics Translator is available which accepts digital data from the Hewlett-Packard interface bus (HP-IB) or RS-232C interface bus and converts it to analog voltages for driving the non-storage HP small screen and large screen displays.

Performance features include high resolution, high writing speed, constant light output, bright easy-to-read displays, and reduced power requirements. Versatility is assured with a variety of standard options that allow you to tailor a display to your system's needs. Reliability and serviceability are built into these displays with well-designed interior layout, plug-in board construction, and other features made possible by Hewlett-Packard's highly developed CRT technology.

The yokeless electrostatic deflection used in HP displays increases writing speed, reduces power requirements, and simplifies operation when compared to magnetic deflection displays. The most important ad-

vantage is that characters and vectors can be written about ten times faster than with magnetic displays.

### Graphics translator

Model 1350A Graphics Translator accepts digital data from an interface bus and converts it to X, Y, and Z analog voltages for driving electrostatic non-storage displays. The 1350A is compatible with the Hewlett-Packard interface bus (HP-IB) and the RS-232C interface bus (optional), and the HP non-storage small screen and large screen displays.

### Small screen displays

Model 1340A features flexibility, convenience, and cost effectiveness, making it ideal for most instrumentation systems. Resolution, viewing area, and brightness are suitable for spectrum, network, vibration, transient, pulse height, and digital logic analyzers. The 1340A may be ordered in a variety of configurations: with or without a cabinet, with or without control panel, with dc supply, or almost any combination to allow easy integration into a system or instrument.

Model 1332A is a high resolution, high brightness display with a 158.8 mm (6 1/4 inch) diagonal CRT with an overall height of only 133.4 mm (5 1/4 in.). The 1332A is designed to meet the stringent requirements of medical diagnostic and instrumentation sys-

tem applications. The major features in the 1332A include a small crisp spot size that varies by no more than 10% over the quality area; multiple gray levels with focus independent of intensity setting; high stability of position, gain, and brightness; regulated CRT filament voltage to reduce light output variations with changes in line voltage; large 115 cm<sup>2</sup> display area; bright 22.5 kV CRT; and Underwriters Laboratories Listing.

One application of the 1332A is in medical diagnostic ultrasound. In this valuable diagnostic technique, a focused beam of harmless ultrasound energy is used to detect the internal structure of the body. This technique is especially fruitful in obstetrics, as it is often able to reveal potential problems early in pregnancy, with no danger of harmful side effects to mother or fetus. The 1332A's brightness and large screen area allow easy viewing, while its stable light output and uniform spot size characteristics yield high quality photographs for later study and for permanent records.

5 MHz bandwidth, large display area, and excellent picture quality make the 1332A ideal for use in instrumentation systems. System applications include spectrum analyzers, network analyzers, automatic test systems, Fourier analyzers, spectrophotometry, chemical analysis, and nuclear magnetic resonance.

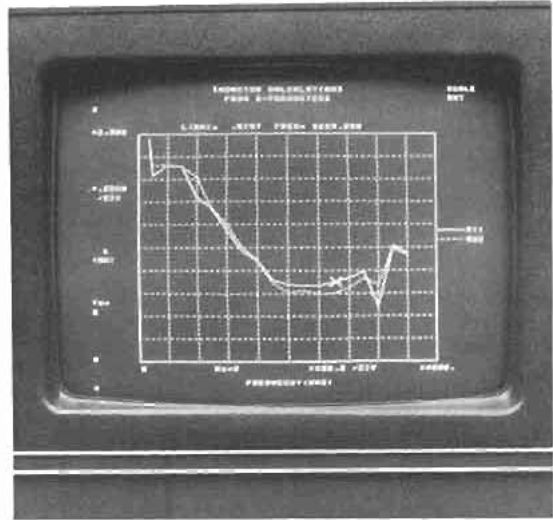
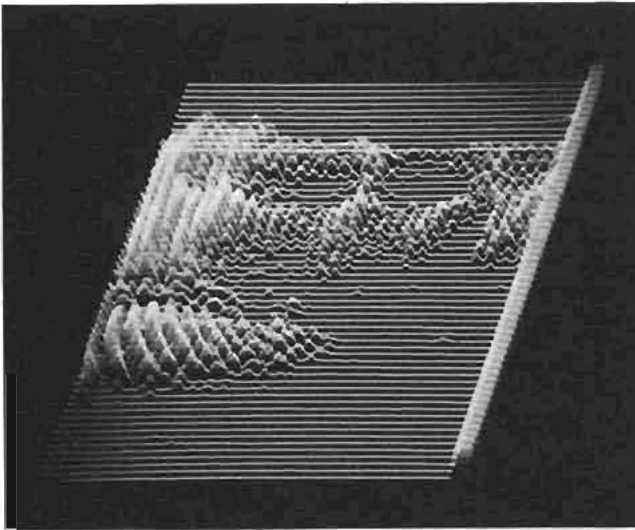

The 1333A is a high resolution  $8 \times 10$  cm display especially designed to permit diagnostic-quality photographs from state-of-the-art nuclear, ultrasonic, thermographic, and X-ray scanning systems. The small 0.02 mm spot size, wide range of gray scales, good contrast, and stable light output provide exceptional image quality, a necessity in medical diagnostic systems and applications requiring precisely controlled image parameters. Image quality combined with high luminous power density and speed make the 1333A ideal for recording rapid sequence dynamic studies in nuclear medicine and for capturing transient displays in ultrasound work.

Model 1336A Display Module's 100-lines/cm resolution makes it ideal for all high-resolution imaging requirements such as multi-imaging gamma cameras, scanning electron microscopes, and scanning auger microprobes. This display uses a mono-accelerator CRT to produce an intense 0.1 mm (0.0039") diameter spot. Internal switches allow selection of X, Y, and Z amplifier characteristics. The gamma corrected Z-axis amplifier gain characteristic causes the CRT light output to vary linearly within 20% in response to Z-axis input signal changes. This gamma correction is especially convenient for photographic recording when using film having a linear but narrow dynamic range.

The 1336A Display Module is powered by the 1336P Power Supply Module which may be separated from the 1336A for application flexibility.

#### Small screen storage displays

Model 1335A high resolution, storage CRT display offers medical and instrumentation OEM users a variable persistence, storage, and non-storage CRT display with excellent performance. Outstanding picture quality and amplifier performance with a

frame designed for OEM use make the 1335A a significant advancement in storage displays.

A stored resolution of approximately 20 lines per cm (50 lines per in.) with a spot size that is relatively independent of intensity setting or Z-axis input signals enhances the CRT image in applications requiring focusing over a wide range of intensity levels. Variable persistence allows the elimination of flicker in some presentations with the ability to increase the persistence to match the refresh rate.

The 1335A CRT is optimized for information display and offers a high resolution image with excellent contrast and uniformity in medical diagnostic applications. Fine image detail and a well focused spot at all intensity levels and positions make the 1335A ideal for use in Spectrum, Fourier, Network, and Chemical Analysis as well as automatic test systems.

In system applications, the 1335A offers flexibility in selecting Erase, Store, Write, Conventional and Variable Persistence modes. These operating modes can be selected with the manual front panel controls, remote program inputs, or a combination of both.

#### Large screen displays

Five large screen graphic displays are available for OEM computer graphic and instrumentation applications. Linear writing speed, in these displays, is an unmatched  $25.5 \text{ cm}/\mu\text{s}$  (10 in./ $\mu\text{s}$ ) for visible writing and is capable of slew rates in excess of  $255 \text{ cm}/\mu\text{s}$  (100 in./ $\mu\text{s}$ ) when the spot does not have to be seen. These speeds are attained with a yokeless, electrostatic deflection system which consumes much less power than the multiwinding coils of magnetic deflection systems. Maximum power consumption of these displays is a low 110 watts compared to 500 or more for others. Additionally, the much faster response of electro-

static deflection permits as much as 10 times the amount of information to be displayed in a given period as that of magnetic displays.

Fast amplifier response (5 MHz bandwidth) and electrostatic CRT deflection also simplifies system programming since vectors and characters can be written randomly from anywhere in the display area in less time than the sequential programming necessary for faster scan magnetic displays. Since coils are not used for deflection, no delay line is needed to properly synchronize Z-axis blanking with spot movement thus reducing the possibility of display smearing and also making the display easier to interface with a system.

Model 1321A has a 533 mm (21 inch) diagonal display with excellent geometry and linearity and a small 0.51 mm (0.020 inch) spot size. The large  $305 \times 305$  mm ( $12 \times 12$  inch) quality area is ideal for presenting complex graphic information while using the additional viewing area for character writing.

Model 1317A is a 432 mm (17 inch) diagonal display which is the largest X-Y display presently made that mounts directly in a 483 mm (19 inch) rack with its long CRT axis horizontal. This large, high resolution display is ideal for the readout in computer graphic and instrumentation systems, since it mounts directly in standard 483 mm (19 inch) EIA racks.

Models 1310A (483 mm, 19 inch, diagonal) and 1311A (356 mm, 14 inch, diagonal) displays are housed in optional attractive plastic covers which when ordered with a tilt stand, make them ideal for table top applications.

Model 1304A has a 20 cm (7.9 in.)  $\times$  25 cm (9.8 in.) display area. The cabinet is fully compatible with the Hewlett-Packard System-11 modular enclosure system for more versatility in OEM applications and better access for servicing.

# CATHODE-RAY TUBE DISPLAYS

## Graphics translator

### Model 1350A

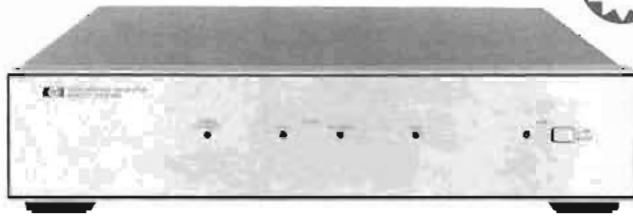

The 1350A Graphics Translator draws all 96 upper and lower case letters and most of the special characters of the full ASCII set. They can be drawn in four different sizes and be rotated 90°.

## 1350A Description

### Introduction

The Model 1350A Graphics Translator converts digital data to X, Y, and Z analog for driving high resolution directed beam non-storage displays such as the HP small screen and large screen displays. The 1350A accepts digital information from the Hewlett-Packard interface bus (HP-IB) or RS-232C interface bus (optional) and stores the data in a 2K word digital memory (RAM) which is continually accessed to generate vectors or characters to refresh one or more directed beam displays. TTL outputs allow different information to be presented on different displays. Each digital word can be a vector coordinate or an upper or lower case ASCII character. A character ROM generates the vectors for each ASCII character, therefore each character uses only one word of RAM. An optional ROM will provide an additional 512 user definable vectors for gratitudes and special characters. The use of stroke vectors results in a much higher resolution display than is possible with a raster scan technique.

The RAM memory can be divided into 32 addressable and selectively erasable files. A file of information can be flashed on and off for highlighting display information of special interest, e.g., a malfunctioning pump in a process control system. Erasing a waveform that intersects other waveforms and gratitudes does not leave blank spaces at intersections, which is a common problem with raster scan displays.

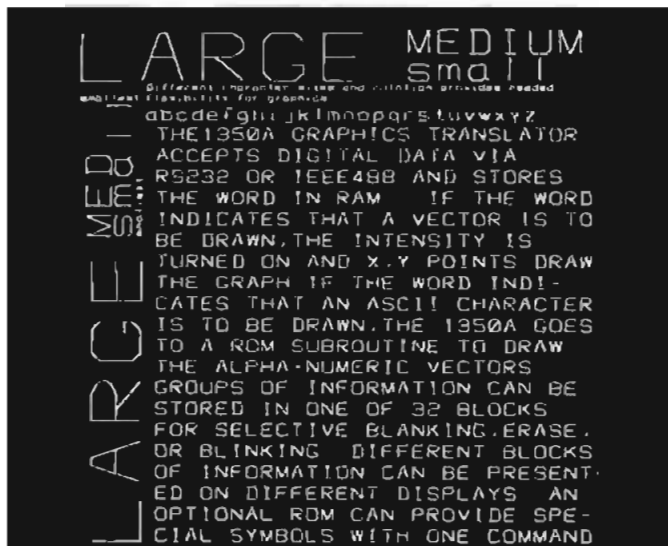

The 1350A Graphics Translator is recommended for use with directed beam displays with at least 3 MHz bandwidth to take advantage of the 1350A high speed vector generating capability. Use of the HP 1332A, 1333A, 1336A or 1340A small screen displays or the HP 1304A, 1310A, 1311A, 1317A or 1321A large screen displays will insure bright vectors with good contrast.

### Applications

**Integrated circuit layout:** the selectable 32 files of memory of the graphics translator soft copy can represent 32 different layers of an IC, providing quick layer by layer analysis to insure every rectangle is in the correct layer and location.

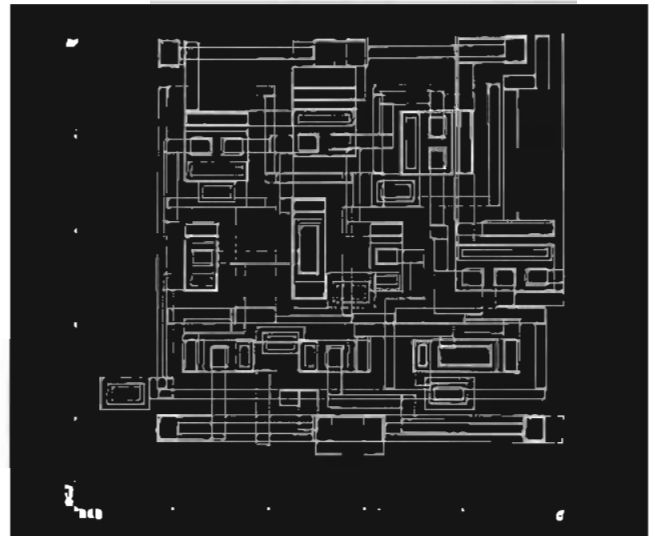

**Data acquisition:** the 1350A is ideal for generating a dynamic display of information from an automatic data acquisition system such as the HP 3052A controlled by the HP 9825A computer. The higher quality display generated and the ability to highlight any of the 32 files of memory, make real time decision making or analysis of the data easy.

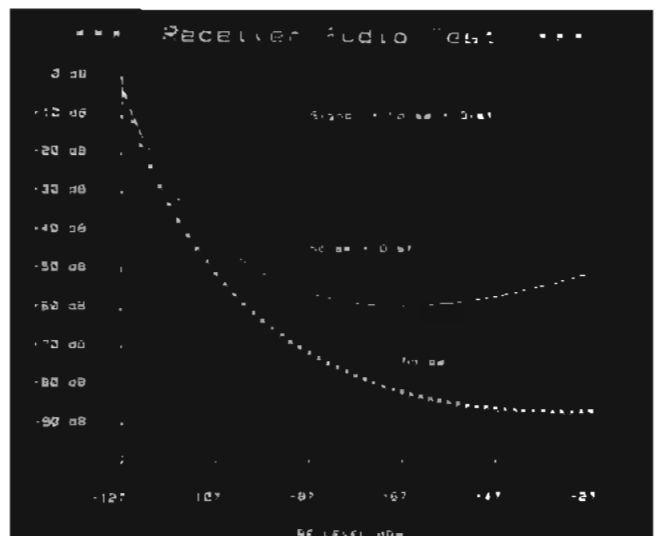

**Digitizing PC board and IC layouts:** soft graphics provide instant verification that the HP 9864A Digitizer graphics tablet information is correct.

**Analytical instrumentation:** soft copy for generating gas and liquid chromatographs data displays permits checking of and adjustment of temperatures, flow rates, and solvent preparation before a hard copy printout or X-Y plotter recording is made.



**Harbor and river navigational radar systems:** the harbor, shoreline, and labeling can be placed in different memory files from ship location, velocity, and direction vectors. If a particular ship is in potential danger, parameters can be made to flash for emphasis.

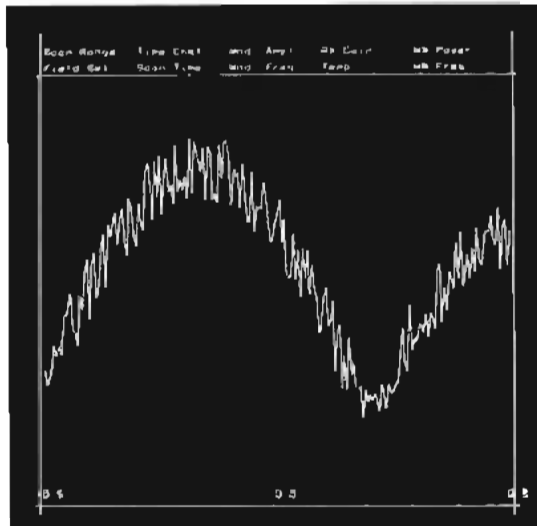

**Process control systems:** complicated process control systems require high resolution graphic representation for analysis and quick update.

**Numerical control:** soft copy display plots of tool path reveal programming errors before actual machining is done. An alphanumeric listing with text mode permits quick location of errors.

**Additional applications include:** land use layout; auto and air-frame design; aircraft simulation and trainer; air traffic control; building, bridge, and tunnel design; structural analysis of components; molecular structure display; highway design and analysis; medical EKG/EEG analysis; and financial and stock market analysis.

### 1350A Specifications

**Input interface:** 16-bit (bit parallel, byte serial) HP-IB listener only that conforms to IEEE 488-1976. Data acceptance rate is 2  $\mu$ s per character.

**X, Y analog output:** +0.2 Vdc to +1.2 Vdc into 50 $\Omega$ . X, Y analog vectors between addressable points. Positive up and to the right.

**Z analog output:** 0 to 1 V unblanked, -1 V blanked, into 50 $\Omega$ .

**Refresh rate:** dependent on total length of vectors displayed. Contact your HP Field Engineer for exact refresh rate for a given application.

**Addressable resolution:** 1000  $\times$  1000 points.

#### Memory

2048 Vectors or characters.

**Addressable files:** 32 which can be erased or blanked. Files may be of any length.

**Addressable write pointer:** allows new data to be written from that address forward.

#### Character generators

8  $\times$  12 Resolution stroke characters. Modified full ASCII set (compatible with HP 9825A keyboard).

**4 Programmable sizes:** 1X, 2X, 4X, 8X.

80 Characters per line and 51 lines (not to exceed memory size) at 1X character size.

**2 Programmable orientations:** 0 $^\circ$  and 90 $^\circ$ .

Character strokes are stored in plug-in ROM. 4 TTL blanking outputs for presenting information from different memory files on different displays.

#### General

**Input connector:** rear panel, conforms to IEEE 488-1976.

**Output connectors:** 3 rear panel BNC's for X, Y, Z, with shields grounded.

#### Front panel

**Indicator lights:** power interrupt, listen data, listen program, talk, power on.

**On/off switch**

#### Operating environment

**Temperature:** (operating) 0 $^\circ$ C to +55 $^\circ$ C (+32 $^\circ$ F to +130 $^\circ$ F);

(non-operating) -40 $^\circ$ C to +70 $^\circ$ C (-40 $^\circ$ F to +158 $^\circ$ F).

**Humidity:** to 95% relative humidity at 40 $^\circ$ C (+104 $^\circ$ F).

**Altitude:** (operating) to 4600 m (15 000 ft); (non-operating) to 6300 m (20 000 ft).

**Shock:** 30 g level with 11 ms duration and 1/2 sine wave shape.

**Vibration:** vibrated in three planes for 15 min. each with 0.25 mm (0.010") excursion, 10 to 55 Hz.

**Power:** selectable 100, 120, 220 or 240 Vac, +5%, -10%, 48 Hz to 440 Hz, max power 100 VA (approx 100 W). Average power dissipation at 60 Hz and 120 V without any options is approx 74 W.

**Size:** approx. 88 mmH 426 mmW 498mmD (3.5"  $\times$  16.8"  $\times$  19.6")

**Weight:** net, 9.5 kg (21 lb). Shipping, 11.8 kg (26 lb).

**Accessories supplied:** one 2.3 m (7.5 ft) line cord (90 $^\circ$ IEC to NEMA 5-15P, 3 conductor for use in Canada, Mexico, Japan, and U.S.), one Operating Guide.

#### Options

**001:** RS-232C interface with selectable baud rates in lieu of HP-IB interface

**010:** Additional character ROM with 512 user definable vectors for graticules and special characters. Each character can use from 1 to 512 of the 512 available vectors. This is the only limit on the number of special characters.

**Note:** special options can also be provided to substitute any desired characters for the modified full ASCII set normally provided, e.g., TTY ASCII instead of HP 9825A keyboard symbol set, or foreign characters, etc. Contact your HP Field Engineer for information.

**Price**  
N/C

contact  
your sales  
office for  
information

1350 Graphics Translator

\$3000

# CATHODE-RAY TUBE DISPLAYS

Small screen displays

Model 1340A

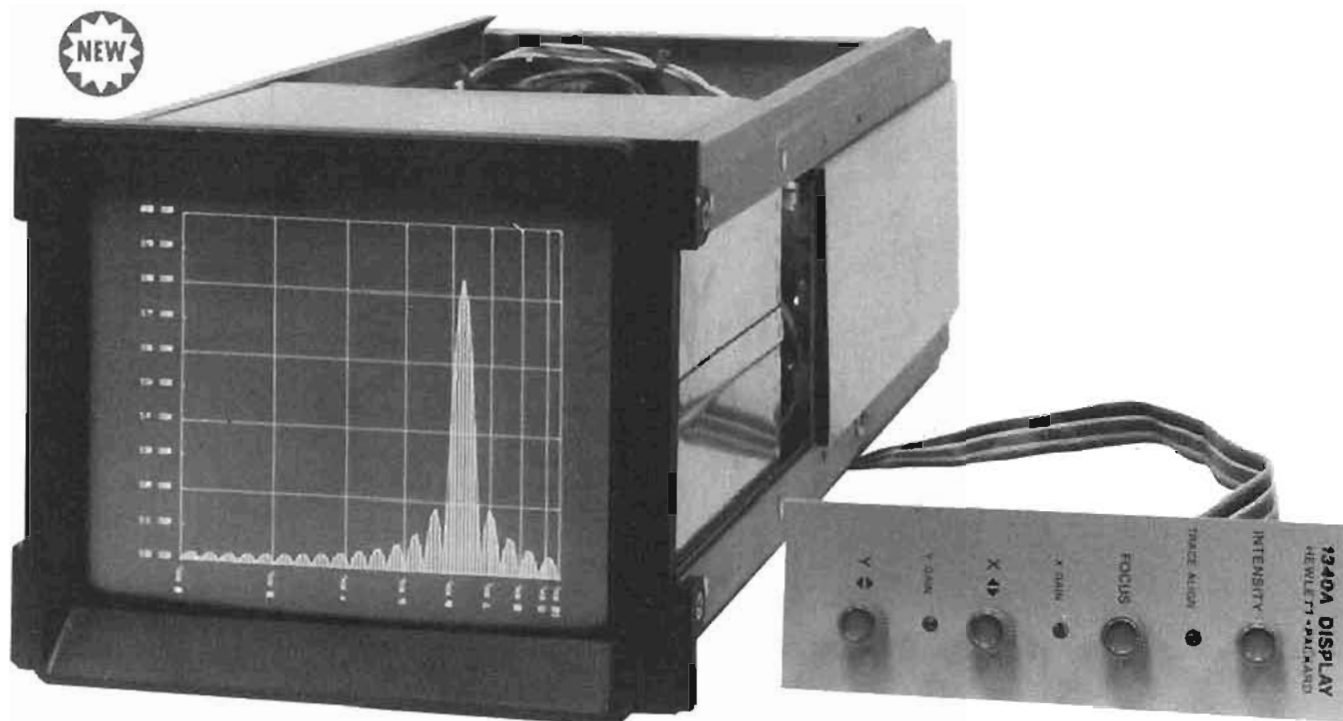

1340A Option 31 installed in 10380A cabinet

## 1340A Description

The Model 1340A small screen display offers flexibility, convenience, and cost-effectiveness for OEM system designers. The basic display module is rugged and easy to integrate into an instrument or system console.

The functional controls for intensity, focus, X and Y position, X and Y gain, and trace alignment can be located to suit your design criteria. The standard display module includes a control panel that can be located to the right of the module or in a remote position. With Option 001 you can omit the control panel and use your own controls. Since the above functions are dc inputs (0-5 volts) to the integrated-circuit amplifiers, you can provide them from an appropriate part of your circuitry.

## Electronics

The benefits of the 1340A come from a new approach to electrical and mechanical design. Integrated circuits contain most of the X and Y amplifier components as well as the Z-axis circuitry, improving reliability as well as reducing cost. X and Y attenuators, input impedance, polarity, and bandwidth limiting are internally switch selectable. This provides flexibility to designers and inventory convenience when you use the 1340A in more than one instrument or system.

In addition to the optional display unit without control panel, many OEM designers will appreciate the dc supply option of the 1340A. This option deletes the power transformer, rectifiers, and power line cable. Power must be supplied from your own instrument or system. Three voltages are required: unregulated 24 Vdc, and regulated -15 Vdc and 165 Vdc.

## Mechanical Construction

The mechanical design of the 1340A module is a form of unitized construction, which is extremely rugged without a cabinet. The display integrates easily into almost any instrument or system console design.

If you wish to simplify the cabinet design for your system, there are several OEM cabinets for the 1340A (see Options). These are attractively styled and designed to accommodate circuitry for a variety of instrument applications.

## Serviceability

Ease of servicing is inherent to the 1340A. The use of IC amplifiers minimizes the number of discrete components that can fail. Reliability of the design has been verified by extensive testing.

The power supply and amplifier boards are easily removed, giving you several service options: remove the entire module for service off-site, substitute pc boards and repair removed boards at a central location, or on-site, component level repair. Your Field Engineer can arrange an HP service support plan to meet your needs.

## Applications

The price-performance range of the 1340A makes it ideal for almost every instrumentation system. Resolution, viewing area, and brightness are suitable for spectrum, network, vibration, transient, pulse height, and digital logic analyzers. The CRT writes a clear, crisp trace either directly from analog circuits or from digital memory on a refreshed basis.

The 1340A can be used in a number of non-destructive test systems or instruments. The dc gain adjustment is helpful in remotely programming changes of the parameters being displayed. This capability is often useful in magnetic test systems and could be a benefit in ultrasonic test instruments.

The 1340A is adaptable to geophysical measurement systems, particularly the dc power Option 002. This option simplifies integration into your system and reduces the weight of the display. The reduced weight is a benefit with airborne receivers or other systems that require minimum size and weight.

The 1340A may also be used as a basic display for communication system analyzers, chemical and scientific analysis systems, and some medical diagnostic systems. And it provides an economical operator interface in special production test systems. With the optional full rack module cabinets you have space to mount your own test system circuitry.

## 1340A Specifications

For complete specifications contact your HP Field Engineer.

### Vertical and horizontal amplifiers

**Rise time:**  $\leq 120$  ns (10% to 90% points) for full screen deflection (or less).

**Bandwidth:** dc to  $>3$  MHz (3 dB down) for 5 cm or less deflection.

**Phase Shift:**  $<3^\circ$  to 1 MHz for full screen signal inputs.

**Deflection factor:** 100 mV/div. Front panel adjustable from 80 to 200 mV/div. Internal 5:1 attenuators for X and Y inputs. 1 div=1.2 cm (0.47 in.)

**Linear writing speed:**  $\leq 25$  cm/ $\mu$ s (10 in./ $\mu$ s).

**Settling time:** signal settles to within one spot diameter of final value in  $\leq 300$  ns for any on-screen position. Initial off-screen deflection, if any, must not exceed specified dynamic range.

**Linearity:** 5% of full scale along major axes.

**Input RC:** approx 1 M $\Omega$  shunted by  $\leq 50$  pF. Internally switchable to 50 $\Omega$ .

#### Drift

**Position:**  $\leq 0.5$  mm/hr (0.02 in./hr) and  $\leq 1$  mm (0.04 in) in 24 hours with covers installed after 15 min. warmup.

**Gain:**  $< 1\%$  under all combinations of specified line voltage with covers installed after 15 min. warmup and temperature between +20°C and +55°C (+68°F and +131°F).

**Crosstalk:**  $< 0.25$  mm (0.01") with one input terminated in 50 $\Omega$  and the other axis excited by a 1 V, 500 kHz signal;  $< 0.5$  mm (0.02") at 3 MHz when driven from a 50 $\Omega$  source.

#### Z-axis amplifier

**Rise time:**  $< 70$  ns (cw bandwidth is approx 5 MHz).

**Blanking range:** a 1 V change in the Z input voltage causes a full scale change in brightness. The cutoff level can be set from +0.2 Vdc to -1 Vdc with the intensity control.

**Blanking polarity:** a positive going input voltage into the Z input increases brightness. Internally switchable polarity.

**Input RC:** approx 1 M $\Omega$  shunted by  $\leq 40$  pF. Internally switchable to 50 $\Omega$ .

**Maximum input:**  $\pm 50$  V (dc + peak ac) with 1 M $\Omega$  input impedance;  $\pm 3.5$  V (dc + peak ac) for 50 $\Omega$  input impedance.

**Gain:** internally adjustable over 2:1 attenuation range.

#### Cathode-ray tube

**Type:** post deflection accelerator, approx 6.6 kV accelerating potential. Aluminized P31 phosphor, electrostatic focus and deflection.

**Viewing area:** 114 cm<sup>2</sup> (17.7 in.<sup>2</sup>); 8  $\times$  10 division area; 1 div=1.2 cm (0.5 in.).

**Graticule:** internal, parallax free, non-illuminated.

**Spot size:**  $< 0.38$  mm (0.015") at center screen and less than .57 mm (0.022") throughout quality area, measured using shrinking raster method. Line resolution at center screen is approx 25 lines/cm (64 lines/in.).

**Trace align:** rotates X-axis into geometric alignment with CRT viewing area.

#### General

**Input connectors:** BNC female connector for each axis mounted to rear panel, with shield grounded.

**Line power:** 100, 120, 220, or 240 Vac selectable on rear panel. +5% to -20%; 48 Hz to 400 Hz. Average power dissipation at 60 Hz and 120 Vac is approx 30 watts.

**Size:** 128 H (front panel opening)  $\times$  163 W  $\times$  438 mm D (5.1"  $\times$  6.4"  $\times$  17.2").

**Weight:** Opt 315: net 6.8 kg (15 lb), with covers and seat. Shipping 8.6 kg (19 lb).

#### Operating environment

**Temperature:** 0°C to +55°C (+32°F to +131°F); -40°C to +70°C (-40°F to +158°F) non-operating.

**Humidity:** 5% to 95% relative humidity at +40°C (+104°F).

**Altitude:** to 4600 m (15 000 ft.); 15 300 m (50 000 ft.), nonoperating.

**Shock:** 30 g level shock, 11 ms duration, and 1/2 sine wave shape.

**Vibration:** vibrated in three planes for 15 min. each with 0.38 mm (0.015 in.) excursion, 5 Hz to 55 Hz; 1 min./octave, 10 min. each resonance.

**Accessories supplied:** one blue contrast filter, one operators guide, one 2,3 (7.5 ft) line cord (90° IEC to NEMA 5-15 P, 3-conductor) for use in Canada, Mexico, Japan and the United States. (Contact your HP Field Engineer for other line cords.)

#### Options and accessories

Model 10380A Cabinet and Frame Kit provides an empty 13.4 cm (5 1/4") high half-rack module for mounting beside the 1340A. The kit includes the half-rack module, connecting hardware for the 1340A, and full rack width top and bottom covers. The kit plus a display gives you a complete instrument cabinet in which to install your own system components.



1340A Option 315 Installed In 10380A cabinet

Option 317 includes a 1340A display module with a complete full-rack cabinet and space to mount the 1340A module plus your own system components. The overall length is 51 mm (2") shorter than the 10380A Cabinet; however, the display module occupies less total space than the 1340A Option 316 mounted in the 10380A.

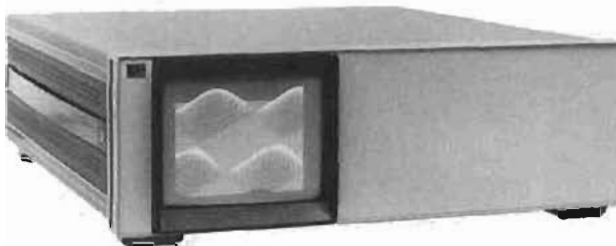

1340A Option 317

**NOTICE TO USERS:** The 1340A is designed and manufactured primarily for OEM system applications. Therefore, without Option 315 or Option 317, protective covers are not provided and internal wiring connections of HAZARDOUS VOLTAGES ARE EXPOSED. Operator protection from these hazardous voltages must be provided by the purchaser and/or user of the instrument. If in doubt, ORDER OPTION 315 or OPTION 317.

#### Options

The options listed are unique to the 1340A. Power cord and safety options listed for other small screen displays are also available on the 1340A. Contact your HP Field Engineer for complete 1340A Options listing and prices.

#### Module options

**001:** Display Module without control panel

**002:** Display Module and control panel with dc input voltages

#### Cabinet options

**315:** Display Module with System 11 133 mm (5 1/4") high, half-rack width cabinet, 381 mm (15") long and with control panel

**316:** Display Module with rear bracket for mounting in 10380A (side-by-side cabinet) or 10386A (vertically stacked cabinet) with 457 mm (18") side struts. Front casting, rear casting, two 457 mm (18") struts, no covers.

**317:** Display Module with system 11 133 mm (5 1/4") high, full-rack width cabinet with 381 mm (15") long struts, 448 mm (17 3/8") overall length. Painted blank front panel included

#### CRT Options

**039:** P39 aluminized phosphor, with 8  $\times$  10 div graticule

**604:** P4 aluminized phosphor, no graticule

**631:** P31 aluminized phosphor, no graticule

**639:** P39 aluminized phosphor, no graticule

#### Ordering information

1340A Display Module (with control panel)

10380A Cabinet and Frame Kit (side-by-side)

10386A Cabinet and Frame Kit (vertically stacked)

#### Price

less \$25

less \$50

add \$50

add \$35

add \$100

add \$30

add \$30

add \$30

add \$30

\$925

\$150

\$150

# CATHODE-RAY TUBE DISPLAYS

Small screen displays

Models 1332A, 1333A, 1335A & 1336S



1332A



1333A

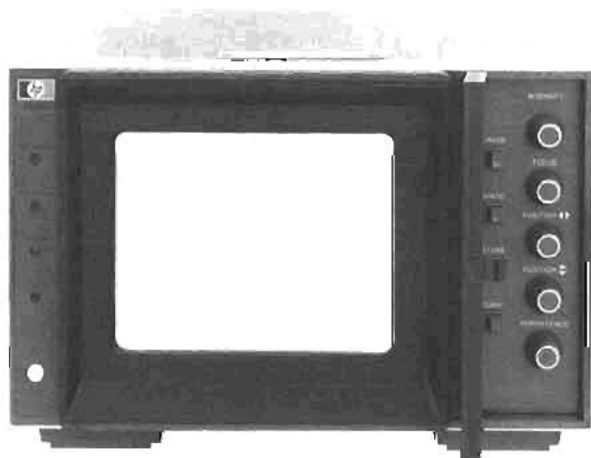

1335A

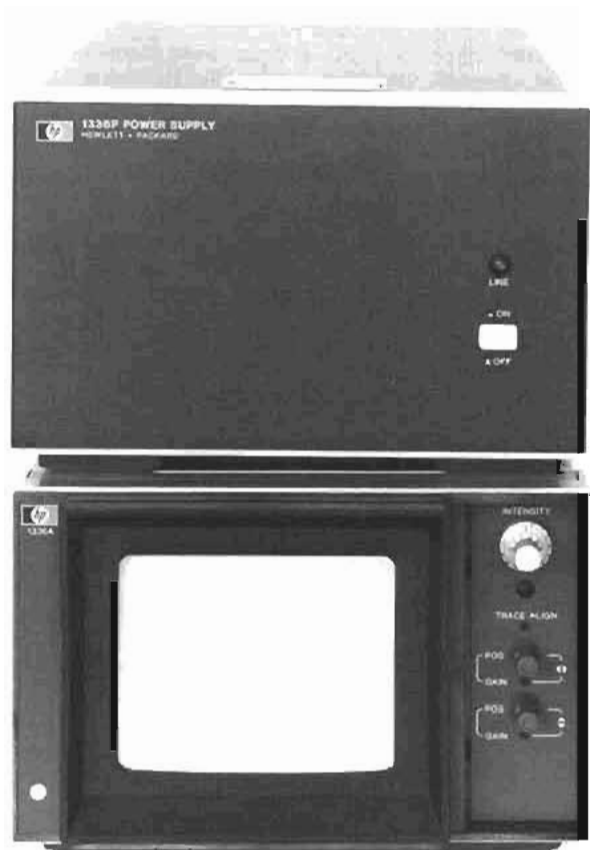

## 1332A, 1333A, 1335A, and 1336S Description

Models 1332A, 1333A, 1335A, and 1336S are high-quality cathode-ray tube displays designed to satisfy a wide range of OEM medical and electronic instrument display needs to 5 MHz. The major differences between these displays are their CRT's which are optionally available with or without internal, parallax free graticules.

Model 1332A has a large  $9.6 \times 11.9$  cm display area with the resolution and picture quality required for medical diagnostic systems plus a bright display for differentiating between many gray shades, or for viewing in brightly lighted areas.

Model 1333A has a high resolution CRT with an  $8 \times 10$  cm viewing area specifically optimized for photographic applications such as gamma camera systems. The 1333A's combination of high resolution, luminous power density, and speed permits crisp easy-to-read, diagnostic-quality photographs to be obtained from state-of-the-art nuclear, ultrasonic, thermographic, and X-ray scanning systems.

Model 1335A's high resolution  $8 \times 10$  cm storage display offers medical and instrumentation OEM users a variable persistence, storage, and non-storage CRT display with excellent performance. Outstanding picture quality and amplifier performance combine to make the 1335A a significant advancement in storage displays.



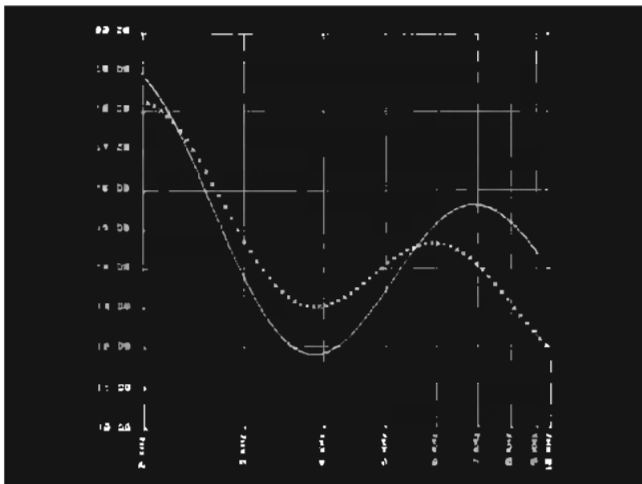

HP's small screen displays are ideally suited to all types of measurement systems applications such as spectrum and network analysis, Fourier analysis, automatic measurement, or in conjunction with Model 1350A Graphic Translator as a readout for HP-IB measurement systems, as illustrated here.

Model 1336S consists of an 8 x 10 cm display module (1336A) and a separate power supply module (1336P) for mounting flexibility. The 100-lines/cm resolution display is ideal for all high resolution imaging requirements.

The 1332A, 1333A, and 1335A have post deflection accelerator CRT's to assure a bright, crisp trace. The 1336S display uses a new mono-accelerator CRT design to produce an intense 0.1 mm (0.004") diameter spot and exceptional resolution with low power consumption. An opaque aluminum layer behind the phosphor (except in model 1336S, which is non-aluminized) enhances trace brightness while blocking stray light from the CRT filaments that could reach photographic film during time exposures.

Regulated, low power write gun and flood gun filaments assure a constant light output under varying line conditions. More importantly, the low power filament operation significantly extends CRT life and eliminates grid and other stray emissions common to older, less efficient designs.

Models 1332A, 1333A, 1336A/P, and 1335A (Opt 330) are listed with Underwriters Laboratories in accordance with the UL 544 Medical Safety Standard which defines detailed patient protection requirements. Regular inspection of our production facility by UL assures you that this patient protection is built into the display that you purchase.

The 1332A, 1333A, and 1335A are 13.3 cm (5 1/4 in.) high, half rack width, 49.5 cm (19 1/2 in.) long packages that can be combined with identical empty modules to form an attractive full width horizontal or vertically stacked OEM instrument. The 1336A Display Module has the same dimensions and the 1336P Power Supply Module has the same height and width but is 33.5 cm (13 3/16") deep. If the 1336A/P are to be mounted together, 1336P Option 018 may be ordered to provide the same cabinet depth as the 1336A, with locking hardware to form a standard EIA rack width unit.

**Picture clarity**

**Model 1332A:** spot size is only 0.305 mm (0.012 in.) diameter at high intensity levels and remains focused over the entire range of inten-



Ultra-high resolution uniform light output, and long-term stability of the Model 1336S yield optimum photographic image quality as illustrated in this full body gamma camera bone study.

sity levels. This resolution makes the 1332A well suited for applications requiring sharp focusing on multiple gray shades or varying writing speeds with frequent video drive level changes. Spot resolution, within the quality area, varies by less than 10% making the display especially useful in applications where sharp focus is required throughout the quality area. An example of this is where alphanumeric characters are mixed with traces, curves, or graphs.

The large 9.6 cm x 11.9 cm viewing area and bright display make the 1332A ideal for the OEM with both visual and some photographic requirements. Display brightness lets you view the display

# CATHODE-RAY TUBE DISPLAYS

Models 1332A, 1333A, 1335A & 1336S

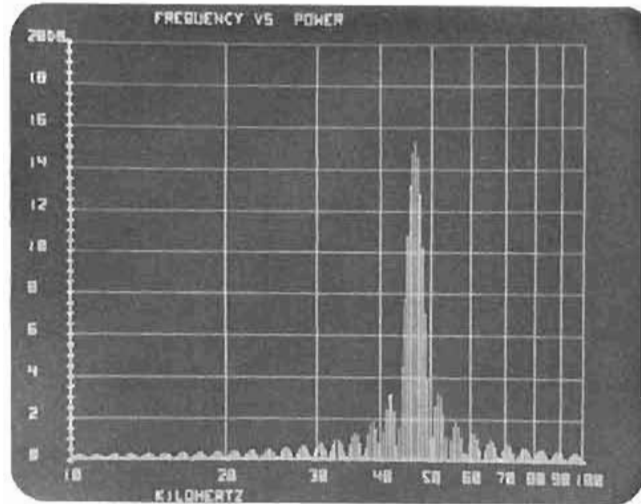

Fine image detail and a well-focused spot at all intensity levels make the 1335A ideal for use in Spectrum, Fourier, Network, and Chemical analysis as well as automatic test systems.

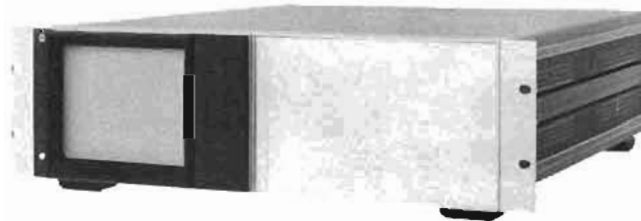

Empty half-width frame, available as an accessory, provides an attractive full-width or double-height package with an integrated appearance with space for your special circuits.

in high ambient light conditions while maintaining resolution and gray shades for photographic work. Whenever uniform photographic recording of the display becomes critical, the 1333A or 1336S should be used.

**Model 1333A:** is specifically designed for photographic recording where display uniformity and high resolution images are essential. Spot size is a crisp 0.20 mm (0.008 in.) diameter everywhere on its 8 x 10 cm display, which allows resolution of 193 354 picture elements. The spot remains round and sharply focused in all areas of the screen and at varying intensity levels, eliminating the need to readjust focus or astigmatism controls. No compromises are needed for optimizing overall image sharpness in applications where all areas of the screen contain critical information and the Z-axis drive level varies widely. For displays that do not require the entire screen, sharply focused alphanumeric messages such as patient identification or operator instructions can be inserted along the extreme edges and corners for maximum use of the display area.

Light output uniformity is fully specified, both overall and for small increments, which assures you that the information content of the display is an accurate representation of the input signals. Additionally, light output drift is specified, including all effects of the Z-axis amplifier, high voltage supply, and CRT. A regulated dc CRT filament voltage is also used to assure constant light output independent of line voltage fluctuations. The regulated dc filament voltage also reduces the possibility of interference patterns resulting from correlation between input signal frequencies and the high voltage oscillator or power line frequencies.

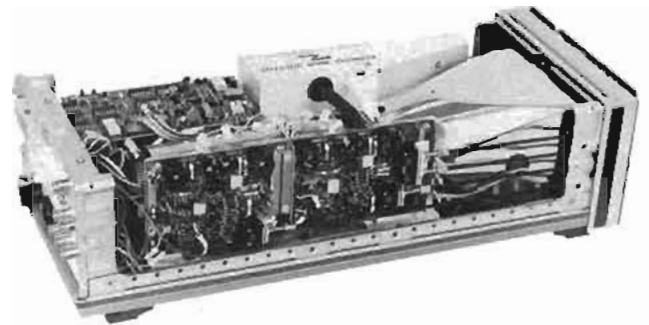

The well-designed interior layout and use of plug-in boards, multiconductor cables, and multi-pin connectors make the 1332A, 1333A, 1335A, and 1336S very serviceable.

**Model 1335A:** the CRT can be operated in non-storage, storage, or variable persistence modes. In the non-storage mode (called CONVENTIONAL), the CRT operates similar to a mono-accelerator conventional CRT with an exceptionally small spot that focuses uniformly over the entire quality area. Resolution is approximately 40 lines per cm (100 lines per in.). In addition, spot size is relatively independent of intensity settings or Z-axis input signals, eliminating the need to refocus at each intensity setting. This characteristic enhances the CRT image in applications requiring the CRT to focus on a wide range of intensity levels. Applications include those where markers intensify areas of interest, where characters or vectors are written, and anywhere that the writing speed or drive levels of the beam vary. The light output remains extremely stable because of regulated CRT filament voltages and an exceptionally stable Z-axis amplifier.

The same excellent CRT performance is maintained in the Variable Persistence operating mode. Persistence is continuously adjustable with a front panel control, from approximately 0.20s to full storage. This mode allows you to eliminate flicker on some presentations by increasing the persistence to match the refresh rate. The variable persistence mode is selected by pressing the WRITE pushbutton.

The storage CRT is preset to store dots having a Z-axis width of 1  $\mu$ s or greater for up to 30 minutes. The storage mode offers the greatest contrast because the background is completely dark. An internal adjustment allows an increase of writing speed to capture faster signals with reduced storage time and trace to background contrast. Another adjustment may be used to enhance either the storage time of the trace or the stored brightness of the stored images. Stored resolution is over 20 lines per cm (50 lines per in.) and stored traces retain sharp details.

**Model 1336S:** the 1336S 100-lines/cm resolution makes this display ideal for all high-resolution imaging requirements such as multi-imaging gamma cameras, scanning electron microscopes, and scanning auger microprobes. A mono-accelerator CRT with an accelerating potential of 5 kV produces an intense, 0.1 mm (0.004") diameter spot. New contributions in electron gun and circuit design make it possible to provide this high resolution with only 100 watts power consumption.

The CRT is designed to prevent spurious light from reaching photographic film during long time exposures. Light output uniformity is tested to assure that the information content of the displayed image is an accurate representation of the input signals.

Considerable effort has been taken in developing the structural, thermal, RFI, and modular characteristics of this mechanical frame to provide you with the best possible display for your OEM system.

All frequently used controls are adjustable from the front panel for maximum accessibility when the display is mounted in a rack, cabinet, or system. The most frequently used controls, such as intensity, focus, and position have knobs while infrequently used controls such as astigmatism, trace align, and X and Y gain are screwdriver adjustments. The 1336A has a 10-turn dial on the intensity control to allow precise resetting of trace brightness for repeatable photographic results. A front panel door covers the controls of the 1332A, 1333A, and 1335A for a more pleasant appearance and reduces the chance of misadjustment by untrained personnel. The ac line switch is mounted on the rear panel to prevent inadvertent turn-off and allows the display to be powered through the common system power bus.

#### Serviceability

Construction of these displays is modular, rugged, and extremely serviceable. Printed circuit boards are plug-in type with interconnections through edge connectors and multiconductor wire strips that connect to sockets on the boards. Serviceability also extends to CRT replacement which, with a knowledgeable technician, can be accomplished in approximately ten minutes. Calibration time is kept to a minimum with easily accessed and independent adjustments.

#### Options and accessories

A wide range of options are available to permit you to tailor the display to your specific requirements: refer to Specifications for a complete listing. Accessories available include rack mounting kits, OEM half module frames and rack slides, and BNC shorting caps for use with certain Options. For convenient system interconnection, Model 10488A 3.6 m (12 ft) Display Cable is available as an accessory. Model 197A Opt 001/006 camera is adapted for direct recording of 1332A, 1333A, 1335A, and 1336A displays. Refer to the individual display data sheets for a complete description of accessories.

## 1332A, 1333A, 1335A, and 1336A/P Specifications

### Vertical and horizontal amplifiers

#### Response (1332A, 1333A, 1335A)

**Rise time:**  $\leq 70$  ns (10% to 90% points) for full screen deflection or less.

**Bandwidth:** dc to approx 5 MHz for 7.6 cm (3") deflection (1332A), 5.1 cm (2") deflection (1333A, 1335A).

**Phase shift (1332A, 1335A):**  $< 1^\circ$  dc to 1 MHz (measured with X and Y gain set to max).

**Deflection factor (horizontal and vertical):** 100 mV/div (1 V p-p for 10 div deflection horizontal; 0.8 V p-p for 8 div deflection, vertical). Adjustable from approx 80 mV/div to 200 mV/div (1336A, 100 mV/div to 200 mV/div).

**Settling time:** (1332A, 1333A, 1335A) signal settles to within one spot diameter of final value in  $\leq 300$  ns. (1336A) signal settles to within  $\pm 0.5$  spot diameter of final value in  $< 500$  ns.

**Linear writing speed (1332A, 1333A, 1335A):**  $\geq 25.4$  cm/ $\mu$ s (10 in./ $\mu$ s).

**Inputs:** rear panel BNC connectors with shield grounded. (1336A) fully differential. (1332A, 1333A, 1335A) fully differential inputs available, see Options.

**Input RC:** (1332A, 1333A, 1335A) approx 1 M $\Omega$  shunted by  $\leq 60$  pF. (1336A) approx 10 k $\Omega$  shunted by  $\leq 70$  pF; internally switchable to 50 $\Omega$ .

**Maximum Input:**  $\pm 50$  V (dc + peak ac) for high input impedance.  $\pm 2.5$  V (dc + peak ac) for 50 $\Omega$  input impedance.

**Dynamic range:** beam may be deflected off screen up to  $\frac{1}{2}$  screen diameter in any direction provided that the zero input position is on screen, without degradation of specification.

**Crosstalk:** (1332A, 1333A, 1335A)  $\leq 0.254$  mm, 0.010 in., (1336A)  $\leq 0.038$  mm, 0.0015 in., with one input terminated in 50 $\Omega$  and the other axis excited by a 1 V, 500 kHz signal.

#### Drift

**Position:**  $\leq 0.5$  mm/hr and  $\leq 1.02$  mm (0.040 in.) in 24 hr with covers installed and after 15 min. warmup.

**Gain:**  $< 1\%$  under all combinations of specified line voltage with covers installed after 15 min. warmup and temperature between  $+20^\circ\text{C}$  and  $+55^\circ\text{C}$  ( $+68^\circ\text{F}$  and  $+131^\circ\text{F}$ ).

**Common mode rejection ratio:** (1332A, 1333A, or 1335A Opt 106 only) at least 40 dB (100:1) up to 10 kHz for 1 V (full screen) inputs; at least 25 dB (18:1) at 1 MHz for 1 V (full screen) inputs.

#### Z-axis amplifier

**Rise time:** (1332A, 1333A, 1335A)  $\leq 25$  ns, (1336A)  $\leq 40$  ns; cw bandwidth approx 5 MHz.

**Blanking range:** a 1 V change in Z-axis input voltage causes a full scale change in brightness.

**Linearity (1336A):** light output varies linearly with Z-axis input voltage within 20%.

**Blanking polarity:** (1332A, 1333A, 1335A) a positive-going input Z-axis voltage increases brightness. (1336A) fully differential; a positive or negative-going input into the positive or negative inputs, respectively, increases brightness.

**Input:** rear panel BNC connectors with shield grounded. (1336A) fully differential. (1332A, 1333A, 1335A) fully differential inputs available, see Options.

**Input RC:** (1332A, 1333A, 1335A) approx 1 megohm shunted by  $< 60$  pF. (1336A) approx 10 k $\Omega$  shunted by  $< 70$  pF; internally switchable to 50 $\Omega$ .

**Maximum Input:**  $\pm 50$  V (dc + peak ac) for high input impedance;  $\pm 2.5$  V (dc + peak ac) for 50 $\Omega$  input impedance.

**Gain:** internally adjustable over 2.5:1 attenuation range.

**Light output stability (drift):** spot photometer measurements of light output made at one hour intervals will not vary more than 10% from previous measurement for any location within the useable display area, under all specified conditions of line voltage and temperature with intensity set to  $> 5\%$  of peak brightness.

#### Cathode-ray tube (1332A)

**Type:** electrostatic focus and deflection, approx 22.5 kV accelerating potential, aluminized P31 phosphor (see Options for other phosphors).

**Viewing area:** 114 cm<sup>2</sup> (17.7 in.<sup>2</sup>), approx 9.6 cm vertically by 11.9 cm horizontally (3.8 in.  $\times$  4.7 in.).

**Quality area:** center 9 div horizontally and center 7 div vertically.

**Graticule:** 8  $\times$  10 div internal graticule. 1 div = 1.2 cm (0.47 in.).

**Spot size:**  $\leq 0.3$  mm (0.012 in.) at center screen. Does not vary by more than 10% over entire quality area with intensity held constant, measured using shrinking raster method. Line resolution is approx 31.5 lines/cm (80 lines/in.).

**Line brightness:** at least 170 cd/m<sup>2</sup> (50 ftl) at a writing speed of 0.254 cm/ $\mu$ s (0.1 in./ $\mu$ s). 60 Hz refresh rate, P31 phosphor, 0.3 mm (0.012 in.) spot size.

**Geometry:**  $< 3\%$  pincushion and barrel distortion over useable display area.

**Linearity:**  $< 3\%$  of full scale along major axes.

#### Cathode-ray tube (1333A)

**Type:** electrostatic focus and deflection, approx 12 kV accelerating potential, aluminized P31 phosphor.

**Viewing area:** 80 cm<sup>2</sup> (12.4 in.<sup>2</sup>), 8 cm vertically by 10 cm horizontally (3.1 in.  $\times$  3.9 in.).

# CATHODE-RAY TUBE DISPLAYS

Models 1332A, 1333A, 1335A & 1336S (cont.)

**Quality area:** 8 cm vertically by 10 cm horizontally (3.1 in. × 3.9 in.).

**Graticule:** none, see Options.

**Spot size:** ≤0.20 mm (0.008 in.) over entire quality area. Measured using shrinking raster method, line resolution is approx 49 lines/cm (125 lines/in.).

#### Light output

**Line brightness:** 34.3 cd/m<sup>2</sup> (10 ft) at a writing speed of 0.254 cm/μs (0.1 in./μs), 60 Hz refresh rate, P31 phosphor, 0.02 mm (0.008 in.) spot size.

**Uniformity:** with a 1:1 photograph of the CRT display using Polaroid Type 107-084 film, input signals adjusted for uniform stimulation of the entire CRT screen area and exposure parameters adjusted for an average reflection density of 0.3 to 0.6 in the resultant print, the difference between any two points on the photograph in a centered 7 × 9 cm rectangular area is less than one step on a Kodak 12-step gray scale.

**Linearity:** <3% of full scale along major axes.

**Stray emission:** no stray emissions from the CRT will be visible on Polarity Type 107 ASA 3000 film after a 30 min. time exposure with the camera lens set to f/1.9, 1:1 magnification ratio.

#### Cathode-ray tube (1335A)

**Type:** electrostatic focus and deflection, approx 8.5 kV accelerating potential, aluminized P31 phosphor.

**Viewing area:** 72.2 cm<sup>2</sup> (11.2 in.<sup>2</sup>), approx 8 cm vertically by 10 cm horizontally (3.1 in. × 3.9 in.).

**Quality area:** center 9 div horizontally and center 7 div vertically.

**Graticule:** 8 × 10 div internal graticule, 1 div = 0.95 cm (0.37 in.).

**Geometry:** <3% pincushion and barrel distortion over useable display area.

**Linearity:** <3% of full scale along major axes.

#### Conventional (non-store) parameters

**Spot size:** 0.254 mm (0.010 in.) over entire quality area. Measured using shrinking raster method. Non-stored line resolution is approx 39 lines/cm (100 lines/in.).

**Line brightness:** 68 cd/m<sup>2</sup> (20 ft) at a writing speed of 0.254 cm/μs (0.1 in./μs), 60 Hz refresh rate, P31 phosphor, 0.0254 mm (0.010 in.) spot size.

**Persistence:** approx 40 μs.

#### Storage parameters

**Stored resolution:** approx 20 lines/cm (51 lines/in.).

**Brightness:** >680 cd/m<sup>2</sup> (>200 ft) in WRITE mode.

**Erase time:** <500 ms.

**Storage time:** >1 min. at full brightness in WRITE mode, extending to >30 min. in STORE mode at lower brightness.

**Variable persistence:** continuously adjustable from 0.2 s to full storage (one minute).

**Dot writing time:** will store a dot anywhere inside the quality area having an unblanking time of 1 μs.

**Writing speed:** >50 cm/ms.

#### Cathode-ray tube (1336A)

**Type:** mono accelerator, approx 5 kV accelerating potential, P11 phosphor, electrostatic focus and deflection.

**Viewing area:** 80 cm<sup>2</sup> (12.4 in.<sup>2</sup>), approx 8 cm vertically by 10 cm horizontally (3.1 in. × 3.9 in.).

**Quality area:** a 7 × 9 cm rectangle with a 1 cm radius on each corner.

**Graticule:** none (see Options).

**Resolution:** 100 lines/cm (254 lines/in.) within quality area, measured using shrinking raster method.

**Spot shape:** ratio of major to minor diameter of spot ≤1.5:1 within quality area.

**Light output:** 3.5 μW using a 4 × 4 cm 128-line focused raster with an 80% duty cycle and a 1 cm<sup>2</sup> radiometric detector in contact with the CRT face, P11 phosphor. With P31 phosphor, 6 μW (see Options).

#### Light output uniformity

**Overall:** the light output varies by ≤16% between any two points within the quality area.

**Incremental:** the derivative of light output with respect to position is ≤6%/cm averaged over any 2% p-p change anywhere within the quality area.

**Geometry:** <3% pincushion or barrel distortion within quality area.

**Linearity:** <3% of full scale along major axes.

#### Remote programming (1335A)

(TTL compatible, except Variable Persistence)

**Remotely programmable functions:** Erase, Write, Store, Conventional, and Variable Persistence.

**Remote selection:** a single TTL control line disables the front panel Erase, Write, Store, Conventional, and Variable Persistence functions and transfers control to the remote inputs.

**Control enable:** separate TTL inputs to enable front panel Erase and/or Variable Persistence controls during remote operation.

**Variable persistence:** an external dc voltage between 0 and +10 V sets the persistence. Or, a pot can be connected through the Remote Input connector to control persistence if 10 Vdc is not available.

**Erase verify:** a TTL High output during Erase (will drive ten low power gates).

#### Safety protection (1332A, 1333A, 1335A)

**Implosion:** transparent safety panel between CRT and bezel protects viewer (Opt 561 or 330).

**X-ray emission:** <0.5 mr/hr measured with Victoreen Model 440 RF/C.

**UL listing:** with Opt 315 and 561 meets Underwriters Laboratories Listing 478 for Electronic Data Processing Equipment; with Opt 330 meets Underwriters Listing for Dental and Medical Electronic Equipment.

**NOTICE:** these displays are designed and manufactured primarily for OEM system applications. Therefore, without Opt 315 or Opt 330, the top and bottom protective covers are not provided and internal wiring connections of HAZARDOUS VOLTAGES ARE EXPOSED and operator protection must be provided by the purchaser and/or user of the instrument. If in doubt order Opt 315 or 330 which provide the covers.

#### Safety protection (1336A/P)

**UL listing:** meets Underwriters Laboratories Listing 478 for Electronic Data Processing Equipment and Underwriters Listing 544 for Dental and Medical Electronic Equipment.

**X-ray emission:** <0.5 mr/hr measured with Victoreen Model 440 RF/C.

#### General

**Input connectors:** (1332A, 1333A, 1335A) rear panel BNC for X, Y, and Z inputs with shields grounded. (1336A) two rear panel BNC for each axis.

**Front panel controls (1332A, 1333A, 1335A)**

**Knobs:** position X, position Y, focus, and intensity.  
**Pushbuttons (1335A):** Erase, Write, Store, and Conventional.  
**Screwdriver adjustments:** Trace Align, Astigmatism, Gain X, and Gain Y.

**Front panel controls (1336A)**

**Knobs:** Intensity (10-turn knob with turns-counting dial), Position X, Position Y.  
**Screwdriver adjustments:** Trace align, X gain, Y gain, Focus (focus adjustment requires special tool, supplied with Model 1336A).

**Line power indicator:** front panel lamp.

**Operating environment:** temperature, 0°C to +55°C (+32°F to +131°F), non-operating, -40°C to +70°C (-40°F to +158°F); humidity, 5% to 95% relative humidity at +40°C (+104°F); altitude, to 4600 m (15 000 ft), non-operating to 7000 m (25 000 ft); shock, 30 g level with 11 ms duration and 1/2 sine wave shape; vibration, vibrated in three planes for 15 min, each with 0.254 mm (0.010 in.) excursion, 0.38 mm (0.015 in.) excursion, for 1336A/P, 10 to 55 Hz.

**Line power (1332A, 1333A, 1335A):** selectable 100, 120, 220, or 240 Vac, +5%, -10% (-20%, 1333A; 48 Hz to 66 Hz\*; max power (1332A) 50 VA (approx 40 W), (1333A) 60 VA (approx 50 W), (1335A) 65 VA (approx 55 W). Average power dissipation at 60 Hz and 120V without any options is approx 24 W (1332A), approx 40 W (1333A) approx 35 W (1335A).

**Line power (1336A/P):** selectable 100, 120, 220, or 240 V ac, +5% to -20%; 48 to 66 Hz\*; max power 125 VA (approx 100 W).

\*Units meet all electrical specifications 48-440 Hz, but do not meet ac line to chassis leakage requirements of UL 544 (Medical and Dental) Listing above 66 Hz.

**Size:** 146 H (including feet) x 213 W x 524 mm D (5 3/4" x 8 3/8" x 20 5/8"). Standard 1336P Power Supply is 335 mm D (13 1/2"); order 1336P Opt 018 for same depth as 1336A

**Weight**

**1332A, 1333A, 1335A:** net, 8.6 kg (19 lb) with covers and feet; shipping, 10.5 kg (23 lb). Covers, feet, tilt stand, and trim are not supplied with standard displays.  
**1336A:** net, 7.1 kg (15 1/2 lb). Shipping 10.2 kg (22 1/2 lb).  
**1336P:** net, 7 kg (15 1/2 lb). Shipping 10 kg (22 lb).

**Accessories supplied (1332A, 1333A, 1335A):** one blue contrast filter, one 2.3 m (7.5 ft) line cord (90° IEC to NEMA 5-15P, 3-conductor for use in Canada, Mexico, Japan, and the United States), one Operating and Service Manual, and for the 1335A one remote program connector.

**Accessories supplied (1336S):** one clear CRT implosion shield, one Operator's Note, one 2.3 m (7.5 ft) line cord (90° IEC to NEMA 5-15P, 3-conductor for use in Canada, Mexico, Japan and the United States), one 1.5 m (5 ft) cable for interconnection of power supply and display module.

**OPTIONS (1332A, 1333A, 1335A) Price**

**X and Y amplifiers**

**Deflection factor**  
 100: 500 mV/div, 5 p-p for full-screen deflection add \$20  
 101: 1 V/div, 10 V p-p for full-screen deflection add \$20

**Polarity**  
 105: negative X and Y inputs move beam up and right (BNC connectors) N/C  
 106: full differential inputs, shield grounded (BNC connectors) add \$25

**Input Impedance**  
 110: 50 ohms add \$10

**Rise time**  
 120 (1332A): 25 ns X & Y amplifier rise time add \$200

**Z-axis Input (video amplifier)**

**Blanking range**  
 200: 0 to 5 V add \$10  
 201: 0 to 10 V add \$10

**Polarity**  
 205: negative input unblanks trace, BNC connector with shield grounded N/C

**206:** fully differential input, BNC connector with shield grounded add \$15

**Input Impedance**  
 210: 50 ohms add \$10

**Gain characteristics**  
 215: light output varies linearly (±20%) with a linear change in Z-axis input voltage (gamma correction) add \$15

**Digital input**  
 216: TTL blanking level. High state (+2.5 V to +5 V) blanks any analog Z-input signal. Low state (0.0 V to 0.8 V) returns blanking to analog Z-axis input. add \$50

**Cathode-ray tube**

**Graticule/phosphor type**

**004 (1332A):** P4 aluminized phosphor with 8 x 10 div internal graticule add \$30

**007\* (1332A):** P7 aluminized phosphor with 8 x 10 div internal graticule and amber contrast filter add \$30

**011 (1332A, 1333A):** P11 aluminized phosphor with 8 x 10 div internal graticule add \$30

**031 (1333A):** P31 aluminized phosphor with 8 x 10 div internal graticule N/C

**039 (1332A):** P39 aluminized phosphor with 8 x 10 div internal graticule add \$30

**604 (1332A):** P4 aluminized phosphor without internal graticule add \$30

**607\* (1332A):** P7 aluminized phosphor with amber filter, without internal graticule add \$30

**611 (1332A, 1333A):** P11 aluminized phosphor, without internal graticule add \$30

**631 (1332A, 1335A):** P31 aluminized phosphor, without internal graticule N/C

**639 (1332A):** P39 aluminized phosphor without internal graticule add \$30

\*P39 phosphor is recommended in lieu of P7.  
**Magnetic shield**  
 560 (1332A): full magnetic shield on CRT add \$95

**Contrast filters**

**NOTE:** the plastic filter serves as integral implosion protection for the viewer, therefore these displays cannot be ordered without the standard or an optional filter

**561:** clear, replaces filter supplied with standard and some optional phosphors, and is required for UL EDP Equipment Listing N/C

**582 (1332A, 1335A):** clear, RFI coated surface also includes metalized front panel add \$150

## CATHODE-RAY TUBE DISPLAYS

Models 1332A, 1333A, 1335A &amp; 1336S (cont.)

## General

## AC line cords

300: 2.3 m (7.5 ft) removable, 240 V max, 3-conductor 90° IEC to Great Britain, Singapore N/C

301: 2.3 m (7.5 ft) removable, 240 V max, 3-conductor IEC to Australia, New Zealand N/C

302: 2.3 m (7.5 ft) removable, 240 V max, 3-conductor 90° IEC to East and West Europe N/C

303: 2.3 m (7.5 ft) removable, 240 V max, 3-conductor IEC to NEMA 6-15P (USA, Canada, Japan, Mexico) N/C

304: 77 cm (30 in.) coiled, extends to 1.8 m (6 ft), removable, 120 V max, 3-conductor IEC to NEMA 5-15P (USA, Canada, Japan, Mexico) (not available with Opt 315 or 330) add \$5

307: hospital grade power cord add \$10

## AC line voltage tolerance

310 (1332A, 1336A): +5%, -20% tolerance at 100, 120, 220, 240 Vac setting. Increases power dissipation to approx 50 watts (1332A), 60 watts (1335A) add \$50

## Front and rear panel modifications

322: replaces standard intensity control with a 10-turn control with counting dial add \$50

323: front panel screwdriver adjustments on left side of front panel changed to internal adjustments add \$10

324: (1332A, 1333A) adds 25-pin connector to X, Y, and Z-axis signal inputs wired to the positive signal inputs (input capacitance is increased to approx 120 pF) add \$30

325 (1332A): scale illumination to illuminate phosphor background for photographing internal graticule (available with standard P31 phosphor and Opt 011 and 039 only) add \$60

326: front panel controls on right side changed to screwdriver adjustments. These include intensity, focus, position X, and position Y (also includes scale illumination when Opt 325 is ordered for 1332A). When Opt 322 is specified with Opt 326, the intensity control is as described in Opt 322 and the focus, position X, and position Y become screwdriver adjustments add \$25

## Safety protection

315: includes covers, feet, trim, and tilt stand (required for UL EDP Equipment Listing) add \$70

330: meets requirements for UL Listing for Dental and Medical Electronic Equipment. Includes special three-conductor ac line cord, specially marked covers, feet, tilt stand, trim, UL label, and Opt 561 add \$75

580: meets requirements for Canadian Standards Association Safety Certification. Includes Opt 315 with CSA labeling add \$75

## Operating/service literature

910 (1332A): extra set of product manuals \$4

910 (1333A, 1335A): extra set of product manuals \$5

## OPTIONS (1336A Display Module)

## X and Y amplifiers

## Deflection factor

100\*: 500 mV/div, 5 V p-p for full screen deflection add \$5

101\*: 1 V/div, 10 V p-p for full screen deflection add \$5

## Input impedance

110: 50 ohms add \$5

## Z-axis Input (video amplifier)

## Blanking range

200\*: 0 to 5 V add \$5

201\*: 0 to 10 V add \$5

## Digital Input

216: TTL blanking level. High state (+2.5 V to +5 V) blanks any analog Z-input signal. Low state (0.0 V to

0.8 V) returns blanking to analog Z-axis input. Rear panel input through BNC connector

217: same as 216 except polarity reversed add \$50

## Cathode-ray tube

## Graticule/phosphor type

011: P11 phosphor with 8 × 10 div internal graticule (1 div = 1 cm) N/C

031: P31 phosphor with 8 × 10 div internal graticule (1 div = 1 cm) add \$30

631: P31 phosphor in place of P11, without internal graticule add \$30

## Front and rear panel modifications.

323: all knob controls on front panel (Intensity, Position X, Position Y) changed to screwdriver adjustments add \$25

324: add 25-pin connector to rear panel. X, Y, and Z-axis signal inputs wired to the positive signal inputs (input capacitance is increased to approx 120 pF) add \$30

## Safety

331: meets HTM8 listing for use in Medical Equipment add \$50

332: meets CSA standard for use in Medical Equipment add \$50

333: meets VDE standard for use in Medical Equipment add \$50

## OPTIONS (1336P Power Supply Module)

## AC line cord

300: 2.3 m (7.5 ft) removable, 240 V max, 3-conductor 90° IEC to Great Britain, Singapore N/C

301: 2.3 m (7.5 ft) removable, 240 V max, 3-conductor IEC to Australia, New Zealand N/C

302: 2.3 m (7.5 ft) removable, 240 V max, 3-conductor 90° IEC to NEMA 5-15P (USA, Canada, Japan, Mexico) N/C

303: 2.3 m (7.5 ft) removable, 240 V max, 3-conductor IEC to NEMA 5-15P (USA, Canada, Japan, Mexico) N/C

304: 77.2 cm (30 in.) coiled, extends to 1.8 m (6 ft) removable, 120 V max, 3-conductor IEC to NEMA 5-15P (USA, Canada, Japan, Mexico) add \$25

NOTE: units ordered with Opt 300-304 are not UL Listed for use in medical and dental systems (UL 544).

## Safety

331: meets HTM8 listing for use in Medical Equipment add \$50

332: meets CSA standards for use in Medical Equipment add \$50

333: meets VDE standards for use in Medical Equipment add \$50

## Connecting cable

001: 0.3 m (1 ft) interconnecting cable in lieu of 1.5 m (5 ft) cable N/C

002: no interconnecting cable for supplying power to display module N/C

## Cabinet length

010: cabinet length same as 1336A. Includes locking hardware to attach power supply module to display module. Assembled pair are one standard EIA rack width. Rack mounting flanges, with or without handles, and pivoting or fixed slides are available for rack mounting the combined units: see Cabinets, System II. add \$25

Ordering information:  
1332A Small Screen Display \$1400  
1333A Small Screen Display \$1700  
1335A Small Screen Display \$2030  
1336S (Complete System) \$4450  
ODM discounts available

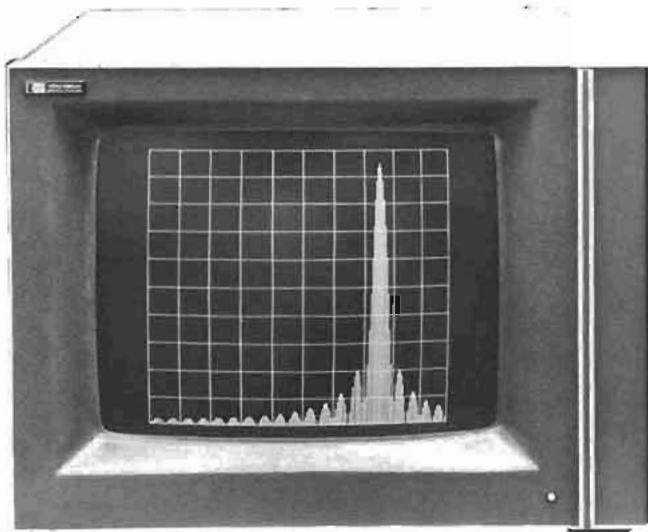

1304A

## 1304A, 1310A, 1311A, 1317A, 1321A

### Description

Hewlett-Packard's Models 1304A, 1310A, 1311A, 1317A, and 1321A Large Screen Displays offer the high writing speed and fast settling time needed in high density information systems such as computer graphic, analytical research, and radar. The advanced electrostatic deflection systems used in these displays provide writing speeds of 25 cm/ $\mu$ s (10 in./ $\mu$ s), and large and small step settling times of 1  $\mu$ s or less. The yokeless electrostatic deflection also simplifies operation, eliminates geometric correction circuits and unnecessary delay lines, and reduces power requirements and weight. High CRT accelerating potentials of 27 or 28.5 kV assure bright, easy-to-read displays, and a small spot size gives you a crisp, clear image over the large quality area.

The Model 1304A offers high writing speed and fast settling time, and is a cost-effective solution for applications such as Fourier or spectrum analysis, chemical or physical analysis, calculator-based graphics, or other applications where information density does not require the higher resolution of the 1310A, 1311A, 1317A, or 1321A. The display is housed in the Hewlett-Packard System-II modular chassis with its mounting flexibility and selection of accessory hardware.

The 1310A, 1311A, 1317A, and 1321A are electrically almost identical but offer a wide variety of display sizes and configurations to fit almost any high-speed, large screen OEM display requirements.

The 1321A has the highest overall resolution (screen area divided by spot size) of any HP CRT display, making it the choice for computer graphics or other applications where maximum information density is the main consideration. The 1317A is ideal for standard 48.3 cm (19 in.) rack-mount applications requiring the largest possible screen area in the minimum vertical rack space. For tabletop applications such as remote monitors, Models 1310A and 1311A offer an attractive modern styled stand-alone package. Both of these displays may be mounted in standard 48.3 cm (19 in.) racks or in your own customer designed enclosures.

### 1304A Specifications

#### Vertical and horizontal amplifiers

**Risetime:**  $\leq 70$  ns, 10% to 90% points, for full screen deflection or less.

**Bandwidth:** dc to 5 MHz (3 dB down) for 10 cm (3.9 in.) deflection or less.

**Phase shift:**  $< 1^\circ$  to 250 kHz for full screen signal inputs.

**Deflection factor:** front panel adjustable from 80 to 320 mV/div. 1 div = 20 mm (0.8 in.). Internally selectable 5:1 or 10:1 attenuators independently settable for X and Y inputs.

**Linear writing speed:**  $> 25$  cm/ $\mu$ s ( $> 9.8$  in./ $\mu$ s).

**Settling time:** (large and small step) signal settles to within one spot diameter of final value in  $\leq 300$  ns for any on screen final location. Initial off screen deflection (if any) must not exceed specified dynamic range.

**Repeatability:**  $< 0.15\%$  error (full screen) for readdressing a point from any on or off screen location within the specified dynamic range.

**Crosstalk:**  $< 0.25$  mm (0.01 in.) with one input terminated in 50 $\Omega$  and the other axis excited by a 1 V, 500 kHz signal ( $< 0.5$  mm at 5 MHz, when driven from a terminated 50 $\Omega$  source).

**Inputs:** fully differential; BNC connectors have grounded shields.

**Input RC:**  $\geq 100$  k $\Omega$  shunted by  $\leq 65$  pF. Can be set to 50 $\Omega$  internally.

**Maximum input:**  $\pm 50$  V (dc + peak ac) for high impedance input termination;  $\pm 2.5$  V (dc + peak ac) for 50 $\Omega$  input termination.

**Polarity:** a positive signal input to the (+) input moves beam up or to the right. A negative signal input to the (-) input moves the beam up or to the right.

**Position:** front panel controls allow undeflected spot to be set off screen from anywhere within the viewing area. Spot position with both inputs shorted and position pots electrically centered is at approx geometric center of the viewing area.

**Dynamic range:** beam may be deflected off screen up to  $\frac{1}{2}$  screen diameter in any direction provided that the zero input position is on screen without degradation of specifications.

#### Drift

**Position:** 1.0 mm/hr. (0.04 in./hr.) and a max of 2.5 mm (0.1 in.) in 24 hrs with covers installed after 15 min. warmup.

**Gain:**  $\leq 1\%$  under all conditions of specified line voltage with covers installed after 15 min. warmup and temperature between  $+20^\circ\text{C}$  and  $+55^\circ\text{C}$  ( $+68^\circ\text{F}$  and  $+131^\circ\text{F}$ ).

**Crosstalk:**  $< 0.25$  mm (0.01 in.) with one input terminated in 50 $\Omega$  and the other axis excited by a 1 V, 500 kHz signal ( $< 0.5$  mm at 5 MHz).

#### Z-axis amplifier

**Risetime:**  $< 25$  ns (cw bandwidth is approx 5 MHz).

**Blanking range:** a 1 V change in Z-axis input voltage causes a full scale change in brightness (internally switch-selectable to 5 V or 10 V). The cutoff level can be set from  $+0.2$  Vdc to  $-1$  Vdc with the intensity control. With the intensity control full ccw, brightness is limited to a safe level for any Z-axis input voltage.

**Blanking polarity:** fully differential. A positive or negative going input voltage into the positive or negative inputs, respectively, increases brightness.

**Input:** fully differential; BNC connectors have grounded shields.

**Input RC:**  $\geq 100$  k $\Omega$  shunted by  $\leq 65$  pF. Can be set to 50 $\Omega$  internally.

**Maximum input:**  $\pm 50$  V (dc + peak ac) for high impedance input termination;  $\pm 2.5$  V (dc + peak ac) for 50 $\Omega$  input termination.

**Gain:** internally adjustable over 2.5:1 attenuation range.

**Focus correction:** amplifier automatically corrects focus voltage for changes in grid to cathode voltage.

#### Cathode-ray tube

**Type:** post deflection accelerator, approx 27 kV accelerating potential. Aluminized P31 phosphor, electrostatic focus and deflection.

**Viewing area:** 500 cm<sup>2</sup> (77.4 in.<sup>2</sup>); 20 cm (7.9 in.) vertically by 25 cm (9.8 in.) horizontally.

**Graticule:** none with standard instrument (see 1304A Options).

**Quality area:** 20 cm (7.9 in.) vertically by 25 cm (9.8 in.) horizontally.

#### Resolution

**Spot size:**  $< 0.5$  mm (0.02 in.) (with 30 V drive from gnd to cathode) over entire quality area measured using shrinking raster method.

**Lines:** approx 20 lines/cm (50 lines/in.); measured with shrinking raster method, inside quality area.

**Line brightness:**  $\geq 19.2$  cd/m<sup>2</sup> (5.6 f) at writing speed of 2.5 mm/ $\mu$ s (0.1 in./ $\mu$ s), 60 Hz refresh rate, P31 phosphor, and focused spot.

**Linearity:**  $< 3\%$  of full scale along major axes.

**Geometry:**  $< 3\%$  pincushion and barrel distortion within quality area.

## CATHODE-RAY TUBE DISPLAY

Models 1304A, 1310A, 1311A, 1317A &amp; 1321A (cont.)

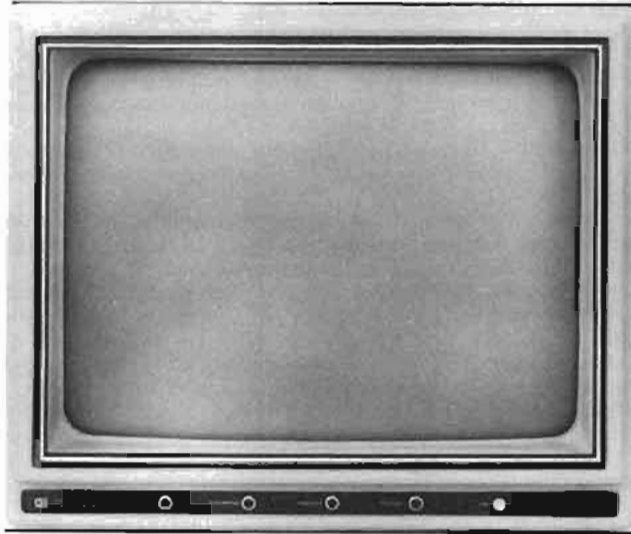

1310A

**Trace align:** rotates X-axis into geometric alignment with CRT viewing area.

**Orthogonality:** separately aligns Y-axis perpendicular to X-axis.

#### Safety protection

**Implosion and Impact:** CRT meets UL safety requirements and exceeds requirements of IEC 348 (IEC 65).

**High voltage:** anode lead is permanently bonded to CRT.

**X-ray emission:** <0.5 mr/hr measured with Victoreen Model 440 RF/C.

**UL listings:** standard instrument meets requirements of UL 478 for Electronic Data Products, thereby meeting OSHA (Sub-part S) approval. Option 330 meets requirements of UL 544 for medical and dental equipment. See 1304A Options (Operator Safety) for additional safety standard compliances.

#### General

**X, Y, and Z Inputs:** rear panel BNC female connectors, two for each axis.

**Front panel controls:** located behind door on front panel. Knobs—Intensity, Focus, X Position, Y Position. Screwdriver adjustments—Trace Align, X Gain, Y Gain, Astigmatism.

**Line indicator:** front panel green LED.

**Power:** selectable 100, 120, 220, or 240 Vac +5%, -20%; 48 to 66 Hz\*; max power 100 VA (approx 85 W). Average power dissipation at 60 Hz and 120 Vac is approx 60 W.

\* NOTE: these displays meet all electrical specifications from 48 to 440 Hz, but do not meet the ac line to chassis leakage requirements of UL 544 (Medical and Dental) listing above 66 Hz.

**Size:** 321 H × 425 W × 530 mm D (12 5/8" × 16 3/4" × 20 3/4").

**Weight:** net, 20 kg (44 lb.); shipping, 28.2 kg (62 lb.).

**Operating environment:** temperature: 0°C to +55°C (+32°F to +131°F)—non-operating, -40°C to +70°C (-40°F to +158°F); humidity, 5% to 95% relative humidity at +40°C (+104°F); altitude, to 4600 m (15 000 ft)—non-operating to 15 300 m (50 000 ft); vibration, vibrated in three planes for 15 min, each with 0.38 mm (0.015 in.) excursion, 5 Hz to 55 Hz, 1 min. per octave, 10 min. each resonance.

**Accessories supplied:** one Operating and Service Manual, one 2.3 m (7.55 ft) line cord (90° IEC to NEMA 5-15P, 3-conductor) for use in Canada, Mexico, Japan, and the United States. See 1304A Options for other available line cords.

### 1310A, 1311A, 1317A, 1321A Specifications

#### Vertical and horizontal amplifiers

**Rise time:** ≤75 ns, 10% to 90% points, for full screen deflection or less.

**Bandwidth:** dc to approx 5 MHz (3 dB down) for 8.9 cm (3.5 in.) deflection or less in 1311A, 10.2 cm (4 in.) in 1317A, 12.7 cm (5 in.) in 1310A or 1321A.

**Phase shift:** <0.1° to 50 kHz and <1° to 250 kHz for full screen signal inputs.

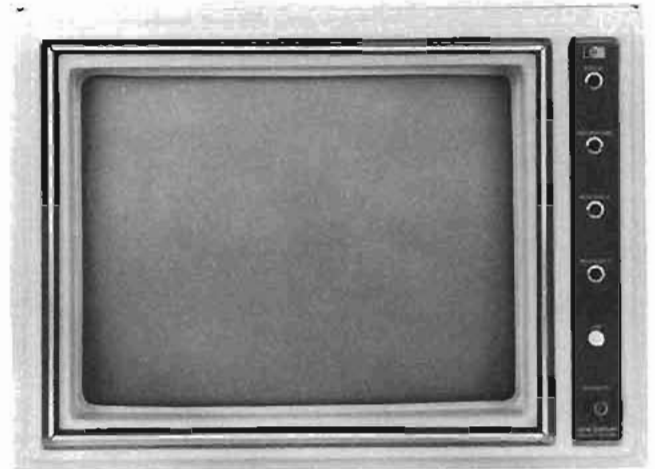

1311A

**Deflection factor:** (1317A, 1321A) front panel adjustable through the range indicated.

**1317A:** from approx 39 mV/cm (100 mV/in.) to 69 mV/cm (175 mV/in.).

**1321A:** from approx 33 mV/cm (83 mV/in.) to 58 mV/cm (147 mV/in.).

**Deflection factor (1310A, 1311A):** front panel adjustable through the range indicated.

	Vertical	Horizontal
1310A	from approx 35.8 mV/cm (90 mV/in.) to 60.9 mV/cm (153 mV/in.)	from approx 26.2 mV/cm (67 mV/in.) to 45.9 mV/cm (117 mV/in.)
1311A	from approx 46.3 mV/cm (118 mV/in.) to 81 mV/cm (207 mV/in.)	from approx 35.8 mV/cm (90 mV/in.) to 60.9 mV/cm (153 mV/in.)

**Linear writing speed:** >25.4 cm/μs (>10 in./μs).

**Settling time:** (large step) signal settles to within 1 spot diameter of final value in <500 ns (1310A, 1311A, 1321A), <1 μs (1317A), for any on or off screen movement. Off screen deflection not to exceed one screen diameter. (Small step) signal settles to within 0.25 mm (0.010 in.) of final value in <200 ns for any 2.5 mm (0.10 in.) step.

**Repeatability:** <0.15% error (full screen) for re-addressing a point from any on or off screen direction. Off screen deflection not to exceed one screen diameter.

**Crosstalk:** <0.38 mm (<0.015 in.) with one input terminated in 50Ω and the other input excited by a 1 V, 500 kHz signal.

**Spot jitter and motion:** (1310A, 1311A, 1321A) <0.13 mm (<0.015 in.); (1317A) <0.25 mm (<0.010 in.).

**Inputs:** (1310A, 1311A) BNC connectors with floating shield; (1317A, 1321A) BNC connectors with grounded shield. Separate differential inputs (shield grounded) available for 1317A, 1321A; see Options.

**Input RC:** center conductor 10 kΩ shunted by approx 40 pF. Shield input (1310A, 1311A only) is 47Ω to ground and can be replaced with 10 kΩ for full differential input. A switchable 50Ω termination between shield and ground is also provided.

**Maximum Input:** ±50 V (dc + peak ac) for high impedance input termination, ±5 V (dc + peak ac) for 50Ω input termination.

**Polarity:** positive vertical input moves beam up; positive horizontal input moves beam right. Polarity can be reversed by changing internal lead connections.

**Position:** front panel controls allow undeflected spot to be set off screen from anywhere within the viewing area. Spot position with both inputs shorted and position pots electrically centered is at approx geometric center of the viewing area.

**Dynamic range:** at least ±1.5 screen diameters from center screen. **Linearity:** (1310A, 1311A, 1321A) 1% of full scale display along major axes within quality area; (1317A) <3% of full scale display along major axes within quality area.

**Drift:** 1.3 mm/hr. (0.05 in./hr.) and 2.5 mm (0.10 in.) in 24 hours with covers installed after 1/2 hr warmup.



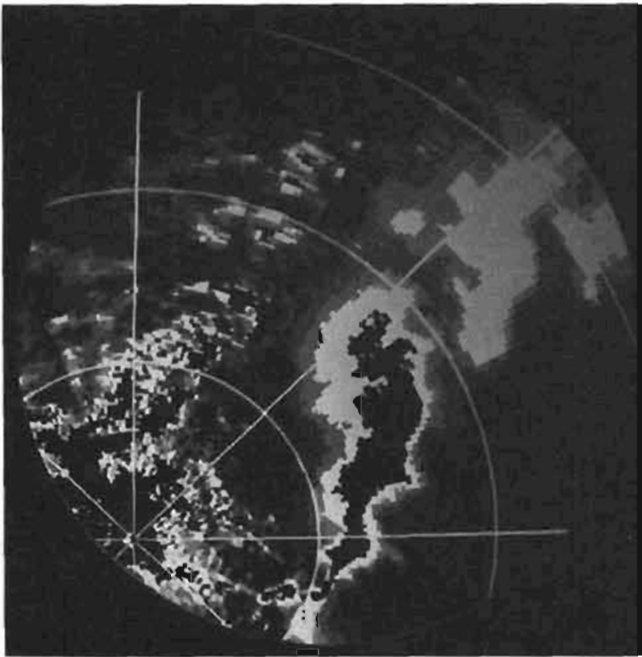

The yokeless electrostatic deflection system used in HP large screen displays results in low power consumption and increased reliability, important factors in remote locations such as this round-the-clock weather radar. Notice the line of tornados and rain squalls. (Photo courtesy of Bendix Avionics, Inc.)

#### Z-axis amplifier

**Rise time:** <20 ns (cw bandwidth is approx 15 MHz).

**Blanking range:** a 1 V change in Z-axis input voltage causes a full scale change in brightness. The cutoff level can be set from 0 Vdc to -1 Vdc with the intensity control.

**Blanking polarity:** positive input unblanks CRT, internally reversible for negative unblanking.

**Input:** BNC connector (shield grounded). Differential input available on 1317A, 1321A; see Options.

**Input RC:** approx 10 k $\Omega$  shunted by approx 60 pF. 50 $\Omega$  termination may be selected with internal switch.

**Maximum Input:**  $\pm 50$  V (dc + peak ac) for high impedance input termination,  $\pm 5$  V (dc + peak ac) for 50 $\Omega$  input termination.

**Offset:** (1317A, 1321A) internal adjustment provides  $\pm 1$  V offset (continuous) to blanking range.

**Gain:** internally adjustable over 2.5:1 attenuation range.

#### Cathode-ray tube

**Type:** post deflection accelerator, approx 28.5 kV accelerating potential; P31 aluminized phosphor standard (refer to Options for other phosphors); electrostatic focus and deflection.

#### Viewing area

**1310A:** 48 cm (19") diagonal; approx 28 cm (11") vertically by 38 cm (15") horizontally.

**1311A:** 36 cm (14") diagonal; approx 22 cm (8½") vertically by 28 cm (11") horizontally.

**1317A:** 43 cm (17") diagonal; approx 26 cm (10¼") vertically by 34 cm (13½") horizontally.

**1321A:** 53 cm (21") diagonal; approx 30 cm (12") vertically by 35 cm (14") horizontally.

#### Quality area

**1310A:** 27.9 cm (11") by 27.9 cm (11").

**1311A:** 21.6 cm (8½") by 21.6 cm (8½").

**1317A:** 25.4 cm (10") by 25.4 cm (10").

**1321A:** 30.5 cm (12") by 30.5 cm (12").

**Spot size and resolution:** measured using shrinking raster method, at center screen, at indicated drive level.

Model	Spot Size	Resolution	Drive Level (Volts above cutoff at CRT grid)
1310A 1317A 1321A	0.51 mm (0.020 in.)	19.7 lines/cm (50 lines/in.)	50 V
1311A	0.38 mm (0.015 in.)	26.3 lines/cm (66.7 lines/in.)	30 V

**Spot size within quality area:** measured using shrinking raster method, no more than 1.5 times spot size at center screen.

**Line brightness:**  $\geq 82.4$  cd/m<sup>2</sup> (24 f) at a writing speed of 2.5 mm/ $\mu$ s (0.1 in./ $\mu$ s), 60 Hz refresh rate, P31 phosphor, 0.51 mm (0.02 in.) spot size on 1310A, 1317A, 1321A, and 0.38 mm (0.015 in.) spot size on 1311A.

**Geometry:** (1317A, 1321A) <3% (1317A), <2% (1321A) pincushion and barrel distortion within quality area.

**Phosphor protection:** circuit automatically detects absence of beam deflection and limits beam current to a safe but viewable level.

**Dynamic focus:** automatically corrects spot geometry for position on screen and beam intensity (video drive level).

**Contrast ratio:** 4:1 or greater with 340 cd/m<sup>2</sup> (100 f) ambient light and CRT face in a vertical plane. Measured by photometrically summing the trace and background brightness and then dividing by background brightness.

**Trace align:** rotates X-axis into geometric alignment with CRT viewing area.

**Orthogonality:** separately aligns Y-axis perpendicular to X-axis.

#### Safety Protection

**Implosion and Impact:** CRT meets UL implosion and impact safety requirements and exceeds requirements of IEC 348 (IEC 65).

**High voltage:** anode lead is permanently bonded to CRT.

**X-ray emission:** <0.5 mr/hr measured with Victoreen Model 440 RF/C.

#### UL listings

**1310A, 1311A:** Opt 008 meets requirements of UL 544 for Medical and Dental equipment.

**1317A, 1321A:** standard instrument meets requirements of UL 478 for Electronic Data Products, thereby meeting OSHA (Subpart S) approval. Opt 008 meets requirements of UL 544 for Medical and Dental equipment.

#### General

**X, Y, Z inputs:** rear panel BNC female connectors. X and Y inputs have a floating shield and the Z input has a grounded shield.

#### Front panel controls

**1310A, 1311A:** controls and adjustments located on front panel include Intensity (knob control), Focus, Astigmatism, X position, and Y position (screwdriver adjustments). Additional screwdriver adjustments located behind a front panel mask are Trace Align, Orthogonality, Gain X, Gain Y.

**1317A, 1321A:** Intensity, Position X, Gain X, Position Y, Gain Y, Trace Align, Orthogonality, Focus, and Astigmatism controls located below the CRT behind a hinged door.

**Line Indicator:** lamp mounted behind front panel (behind hinged door on 1317A, 1321A).

#### Power

**1310A, 1311A:** 115 Vac  $\pm 10\%$  or 230 Vac  $\pm 10\%$ , 48 Hz to 66 Hz\*; max power 115 VA (approx 100 W).

**1317A, 1321A:** selectable 100, 120, 220, or 240 Vac  $\pm 5\%$ ,  $-10\%$ ; 48 to 66 Hz\*; max power in 1317A, 115 VA (approx 100 W), in 1321A, 135 VA (approx 110 W).

\* NOTE: these displays meet all electrical specifications from 48 to 440 Hz, but do not meet the ac line to chassis leakage requirements of UL 544 (Medical and Dental) listing above 66 Hz.

# CATHODE-RAY TUBE DISPLAYS

Models 1304A, 1310A, 1311A, 1317A & 1321A (cont.)



1317A with standard rack mount ears fits in 48.3 cm (19 in.) rack



1321A

## Dimensions

**1310A, 1311A:** (approx overall dimensions without rack mount adapters or tilt stand) 1310A, 422 H × 497 W × 660 mm D (16<sup>5</sup>/<sub>8</sub>" × 19<sup>7</sup>/<sub>16</sub>" × 26"); 1311A, 319 H × 425 W × 578 mm D (12<sup>7</sup>/<sub>16</sub>" × 16<sup>3</sup>/<sub>4</sub>" × 22<sup>3</sup>/<sub>4</sub>"). Contact your local HP Field Engineer for a data sheet with dimensional drawings.

**1317A:** approx 410 H (including feet) × 419 W × 572 mm D overall (16<sup>1</sup>/<sub>4</sub>" × 16<sup>1</sup>/<sub>2</sub>" × 22<sup>1</sup>/<sub>2</sub>").

**1321A:** approx 483 H (with feet) × 527 W × 632 mm D overall (19" × 20<sup>3</sup>/<sub>4</sub>" × 24<sup>7</sup>/<sub>8</sub>").

## Weight

**1310A:** net, 24 kg (53 lb); with covers 26.8 kg (59 lb). Shipping, 32.2 kg (92 lb).

**1311A:** net, 18.1 kg (40 lb); with covers 20.4 kg (45 lb). Shipping, 28.1 kg (53 lb).

**1317A:** net, 26.3 kg (58 lb). Shipping, 33.4 kg (75 lb).

**1321A:** net, 36.3 kg (80 lb). Shipping, 43.1 kg (95 lb).

**Operating environment:** temperature, 0 to +55°C (+32°F to +131°F)—non-operating, -40°C to +70°C (-40°F to +158°F); humidity, to 95% relative humidity at +40°C (+104°F); altitude, to 4600 m (15 000 ft)—non-operating, to 7600 m (25 000 ft); vibration, vibrated in three planes for 15 min. each with 0.25 mm (0.010 in.) excursion, 10 to 55 Hz.

## Accessories supplied

**1310A, 1311A:** rack mount adapter, front panel cover, one power cord, and one Operating and Service Manual.

**NOTICE TO USERS:** the 1310A and 1311A are designed and manufactured primarily for OEM systems applications. Therefore, without Opt 003, the Top and Bottom Protective Covers are not provided and internal wiring connections of HAZARDOUS VOLTAGES ARE EXPOSED. Operator protection from these hazardous voltages must be provided by the purchaser and/or user of the instruments. If in doubt, ORDER OPT 003.

**1317A, 1321A:** one 2.3 m (7.5 ft) power cord, and one Operating and Service Manual.

## 1304A Options and accessories

Options	Price
<b>X and Y amplifiers</b>	
<b>Deflection factor</b>	
100': 500 mV/div, 5 V p-p for full screen deflection	add \$5
101': 1 V/div, 10 V p-p for full screen deflection	add \$5
<b>Input impedance</b>	
110': 50Ω	add \$5
<b>Z-axis Input (video amplifier)</b>	
<b>Blanking range</b>	
200': 0 to 5 V	add \$5
201': 0 to 10 V	add \$5
<b>Input impedance</b>	
210': 50Ω	add \$5
<b>Digital Input</b>	
216: TTL blanking level. High state (+2.5 V to +5 V) blanks any Z-axis analog input signal. Low state (0.0 V to 0.8 V) returns blanking to analog Z-axis input. Input through rear panel BNC connector	add \$50
217: same as 216, except polarity reversed	add \$50
218: 4-bit binary input allows binary selection of 16 levels of gray shades, TTL levels. Settling time ≤300 ns. Levels linear within ±20%. Includes 25 pin program connector mounted to rear panel. When Option 218 is ordered with Option 216 or 217, TTL blanking input is provided through both a BNC connector and the 25 pin remote connector.	add \$100

## Cathode-ray tube

### Graticule/phosphor type

**004:** P4 aluminized phosphor with 10 × 12 div internal graticule (1 div = 2.0 cm, 0.79 in.)

**031:** P31 aluminized phosphor with 10 × 12 div internal graticule (1 div = 2.0 cm, 0.79 in.)

**039:** P39 aluminized phosphor with 10 × 12 div internal graticule (1 div = 2.0 cm, 0.79 in.)

**604:** P4 aluminized phosphor in lieu of P43

**639:** P39 aluminized phosphor in lieu of P43

### Contrast filters

**561:** clear anti-glare filter replaces standard neutral density contrast filter

**563:** blue anti-glare filter replaces standard neutral density contrast filter

### General

#### AC line cords

**300:** 2.3 m (7.5 ft) removable, 240 V max, 3 conductor 90° IEC to Great Britain, Singapore

**301:** 2.3 m (7.5 ft) removable, 240 V max, 3 conductor IEC to Australia, New Zealand

**302:** 2.3 m (7.5 ft) removable, 240 V max, 3 conductor IEC to East and West Europe

**303:** 2.3 m (7.5 ft) removable, 240 V max, 3 conductor IEC to NEMA 5-15 P (USA, Canada, Japan, Mexico)

**304:** 77.2 cm (30 in.) coiled, extends to 1.8 m (6 ft) removable, 120 V max, 3 conductor IEC to NEMA 5-15 P (USA, Canada, Japan, Mexico) (not available with Opt 330)

**306:** 2.3 m (7.5 ft) removable, 3 conductor IEC to Switzerland

**307:** hospital grade power cord

#### Rear panel connector

**324:** adds 25 pin connector to rear panel. X, Y, and Z-signal inputs wired to the positive signal inputs (NOTE: input capacitance increases to approx 120 pF)

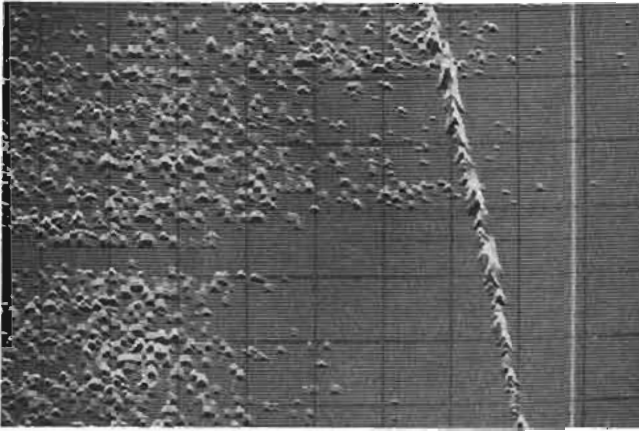

HP large screen displays are ideal for high density information such as this waterfall display, showing machine vibration frequency and amplitude versus time.

(Photo courtesy of Spectral Dynamics, Inc.)

**Operator safety**

- 330:** meets UL Listing 544 for Medical and Dental Electronic Equipment. Includes special three conductor ac line cord, specially marked covers, and UL label add \$50
- 331:** meets HTM8 Listing for use in Medical Equipment add \$50
- 332:** meets CSA standards for use in Medical Equipment add \$50
- 333:** meets VDE standards for use in Medical Equipment add \$50

\*These options are internally switch selectable on standard 1304A displays.

**Accessories**

- Front handle kit (P/N 5061-0093):** includes front handles that fit on each side of the front panel frame, with attaching hardware. (NOTE: these handles cannot be used with Rack Flange Kit P/N 5061-0081.) \$45
- Rack flange kit (P/N 5061-0081):** is used to mount the 1304A in a standard 48.3 cm (19 in.) EIA or RETMA rack. Kit includes two 31.1 cm (12 1/4 in.) high flanges and attaching hardware. (NOTE: these mounting flanges are not compatible with Front Handle Kit P/N 5061-0093) \$25
- Rack flange and front handle combination kit (P/N 5061-0087):** includes two 31.1 cm (12 1/4 in.) high flanges for mounting the 1304A in a standard 48.3 (19 in.) EIA or RETMA rack, two front handles, and attaching hardware \$60
- Fixed slide kit (P/N 1494-0017):** provides fixed chassis slides for installing the 1304A in an HP rack enclosure; for other rack enclosures, one slide adapter bracket kit, P/N 1494-0023, is required \$45
- Pivoting slide kit (P/N 1494-0026):** provides pivoting chassis slides for installing the 1304A in an HP rack enclosure; for other rack enclosures, one slide adapter bracket kit, P/N 1494-0023, is required \$95
- Slide adapter bracket kit (P/N 1494-0023):** is required for installing a 1304A in non-HP rack enclosures with chassis slide kits P/N 1494-0017 or 1494-0026 \$20
- Input signal cable, Model 10488A:** provides convenient connection between the display and signal source. The cable contains three color-coded 50Ω coaxial cables with three male BNC connectors on each end for the X, Y, and Z-inputs. Approx length is 3.6 m (12 ft) \$55

**1310A, 1311A, 1317A, 1321A Options and accessories**

- Options** Price
- 003:** (1310A, 1311A) top and bottom covers with tilt stand. 1310A front panel nomenclature oriented for reading in the horizontal position. (Rack mount adapter not supplied with Opt 003 instruments.) add \$250

- 005:** green contrast filter for 1310A, 1311A, or 1317A add \$50
- 006:** blue contrast filter for 1321A add \$60
- 008:** blue contrast filter for 1310A add \$45
- 008:** blue contrast filter for 1311A add \$30
- 008:** blue contrast filter for 1317A add \$50
- 008:** blue contrast filter for 1321A add \$60
- 008:** (1310A, 1311A) meets UL Listing 544 for Medical and Dental Electronic Equipment; includes covers add \$175
- 008:** (1317A, 1321A) meets UL Listing 544 for Medical and Dental Electronic Equipment add \$25
- 009:** (1310A, 1311A) tilt stand for use with Opt 008 instruments add \$175
- 050:** (1317A, 1321A) TTL blanking level. High state, +2.5 V to +5 V blanks any analog Z-input. Low state, 0.0 V to 0.8 V returns blanking to analog Z-axis input add \$25
- 051:** (1317A, 1321A) differential inputs to X, Y, and Z amplifiers. Inputs for each axis through separate BNC connectors (shields grounded) add \$25
- 052:** (1317A, 1321A) 4-bit binary Z-axis input provides 16 levels of gray shades (TTL compatible). Settling time ≤300 ns add \$100
- 053:** (1317A, 1321A) linear light output (±20%) with respect to Z-axis drive change (gamma correction) add \$50
- 054:** (1317A, 1321A) same as 050 except polarity reversed add \$25
- 055:** (1317A) fixed slides for EIA standard rack, 48.3 cm (19 in.) add \$100
- 604:** aluminized P4 phosphor in lieu of P31 add \$30
- 607:** aluminized P7 phosphor in lieu of P31, includes amber contrast filter with anti-glare surface add \$100
- 639:** aluminized P39 phosphor in lieu of P31 add \$30

**Accessories**

- Cover kits:** (1310A, 1311A) top and bottom cover for field installation. For desk top operation, a tilt stand is required since the covers are not designed to support an instrument.
  - 1310A Cover Kit P/N 01310-68710 \$140
  - 1311A Cover Kit P/N 01311-68709 \$140
- Tilt stand kits:** (1310A, 1311A) provide field installation of tilt stand for stand alone operation.
  - 1310A Tilt Stand Kit P/N 01310-68702 \$235
  - 1311A Tilt Stand Kit P/N 01311-68702 \$280
- Rack mounting kits:** (1310A, 1311A) rack mounting adapters are supplied with standard instruments on initial order or may be ordered as a kit.
  - 1310A Rack Mount Kit P/N 01310-68701 \$70
  - 1311A Rack Mount Kit P/N 01311-68701 \$70
- Slide kits:** (1310A, 1311A) fixed slide kits are available for mounting the 1310A and 1311A Displays in a standard 48.3 cm (19 in.) rack. A pivoting slide kit is also available for the 1311A.
  - 1310A Fixed Slide Kit P/N 01310-68704 \$210
  - 1311A Fixed Slide Kit P/N 01311-68704 \$200
  - 1311A Pivoting Slide Kit P/N 01311-68705 \$140
- 1310A Front panel Inserts:** allow changing orientation of front panel control nomenclature for ease of reading when 1310A mounting is changed (rotated 90°).
  - For vertically mounted display order P/N 01310-00202 \$11
  - For horizontally mounted display order P/N 01310-00204 \$7
- Input signal cable, Model 10488A:** (1310A, 1311A, 1317A, 1321A) refer to 1304A Accessories for description \$55

**Ordering Information**

- |  |              |
|--|--------------|
| <b>1304A Large Screen Display</b>            | <b>Price</b> |
| Opt 910: extra manual                        | add \$7      |
| <b>1310A 48 cm (19 in.) Display</b>          | \$3800       |
| Opt 910: extra manual (covers 1310A & 1311A) | add \$8.50   |
| <b>1311A 36 cm (14 in.) Display</b>          | \$3500       |
| Opt 910: extra manual (covers 1310A & 1311A) | add \$8.50   |
| <b>1317A Large Screen Display</b>            | \$3600       |
| Opt 910: extra manual                        | add \$16     |
| <b>1321A Large Screen Display</b>            | \$4200       |
| Opt 910: extra manual                        | add \$17     |
- OEM discounts available

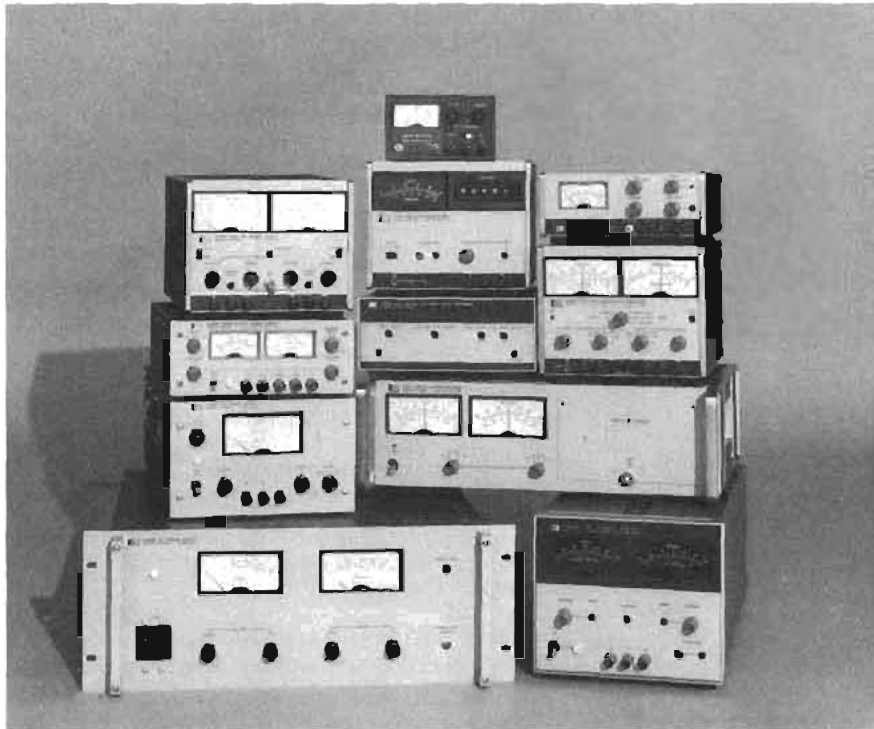

### Introduction

Hewlett-Packard power supplies are available in many types, sizes, and ratings. There are laboratory supplies used in circuit development, modular supplies for power systems, high power supplies for industrial processes, and many special purpose supplies ranging from constant-current sources to bipolar power supply amplifiers.

### The true value of a power supply

The best power supply for the job must first satisfy all the physical criteria: voltage and current ratings, performance specifications, size, and features. But equally important are the less tangible aspects that affect the real cost of ownership. Such factors as the experience and expertise of the manufacturer's engineering staff should be considered. Are his designs conservative—does he use quality components/does he have established QA procedures?

If you have a problem or need application assistance, are the manufacturers' reps accessible, responsive, and knowledgeable? Are spare parts and service available on a world-wide scale?

These factors do not show up on a spec sheet, but are closely related to a company's capability and responsibility towards its customers. When you purchase a power supply from Hewlett-Packard, you receive guaranteed product performance plus all the intangibles that add up to long-term value—and it usually costs no more.

### Regulation techniques

HP power supplies are designed using one of four proven stabilization techniques: series, switching, SCR, and SCR pre-regulator/series regulator.

**Series regulation:** this technique uses a feedback loop to control the voltage drop across a series-pass transistor located between the rectified dc input and the output terminals of the power supply. The feedback network senses changes in the output voltage and develops an error signal which adjusts the drop across the series transistor such that it maintains the output terminal voltage at the desired level. Good regulation (0.001% to 0.05%), low ripple and noise (50  $\mu$ V to 1 mV), and fast transient response (<50  $\mu$ s) characterize this type of regulator.

With all its attributes of excellent performance and circuit simplicity, the series regulator has one drawback; it is relatively inefficient (typically 30 to 40%). Heat sinks are employed to dissipate the heat generated by the series transistors and this necessarily increases the size and weight of the supply.

All linear OEM modular and low power lab supplies use this technique.

**Extended range series regulation:** this technique uses a pair of triac switches with appropriate control logic to automatically select different transformer secondary taps depending on the output voltage and current demand placed on the supply, and the AC input voltage and frequency. Several voltage-current combinations can thereby

be supplied from the input rectifier to the following series regulator. This extends the range of voltage (or current) output available within the power rating of the supply beyond that obtained from a simple series regulator. Model 6002A uses this technique.

**Switching regulation:** this technique regulates the output voltage by essentially switching a series transistor on and off at a rapid rate (about 20 kHz) and delivering this "chopped" current to an output filter. A feedback network senses changes in the output and feeds back a correction signal which adjusts the transistors on-off duty cycle to maintain a constant output voltage. Since a transistor dissipates very little power when it's fully on or off, the regulator has excellent efficiency (typically 65-80%).

Besides low power dissipation, another advantage of this technique is that the high pulse repetition rates make possible the use of transformers, inductors, and filter capacitors that are much smaller than those required for operation at power line frequencies.

Stabilization performance of the switching regulator is somewhat lower than the series regulator (typically 0.2% regulation; 20 mV rms, 40 mV p-p ripple and noise) but well suited for the majority of OEM system applications.

**SCR regulation:** in many high power applications, the tight regulation and low ripple and noise characteristics of the series regulator can be beneficially traded for economy, efficiency, and compact size. This is where the SCR regulator is most valuable. Typical performance specifications for SCR supplies are 0.05 to 1% regulation, 50 mV rms, 500 mV p-p ripple and noise, 50-200 ms transient response, and 70% efficiency. Regulation is accomplished by sensing both the AC input and DC output of the supply and generating a firing pulse for SCR's located in two legs of a bridge rectifier. If the output voltage tries to decrease, the control circuit generates the firing pulse earlier in the input half cycle. More voltage is then passed through the SCR to the output filter to raise the output voltage to the correct level.

**SCR pre-regulator/series regulator:** this technique incorporates the best of both worlds, and is used in most medium to high power, high performance power supplies. In these supplies, the SCR pre-regulator changes the rectifier output in coordination with the output voltage of the supply so that only a small voltage drop is maintained across the series pass transistor. This reduces the power dissipation in the series elements and greatly improves the efficiency (up to 70%). Typical performance specifications are similar to series regulated supplies except for slower transient response.

### Selecting power supplies

**By model number:** if you know the model number, you can find the power supply description page from the numerical index in the front of this catalog.

**By voltage rating:** the condensed listing on the following two pages lists power supplies in order of output voltage rating. The referenced catalog page covers detailed specifications

## Specification definitions

**Ambient temperature:** the temperature of the air immediately surrounding the power supply.

**Auto-parallel operation:** a master-slave connection of the outputs of two or more supplies used for obtaining a current output greater than can be obtained from one supply.

**Auto-series operation:** a master-slave connection of the outputs of two or more supplies used for obtaining a voltage greater than can be obtained from one supply.

**Auto-tracking operation:** a master-slave connection of two or more supplies each of which has one of its output terminals in common with one of the output terminals of all of the other supplies.

**Complementary tracking:** a master-slave interconnection of two supplies in which the voltage of the slave is equal to or proportional to that of the master and of opposite polarity with respect to a common point.

**Compliance voltage:** the output voltage of a power supply operating in the constant-current mode.

**Constant-current (CC) power supply:** a power supply that stabilizes output current with respect to changes in influence quantities. Thus, for a change in load resistance, the output current remains constant while the output voltage changes by whatever amount necessary to accomplish this.

**Constant-voltage (CV) power supply:** a power supply that stabilizes output voltage with respect to changes in influence quantities. Thus, for a change in load resistance, the output voltage remains constant while the output current changes by whatever amount necessary to accomplish this.

**Constant-voltage/constant-current (CV/CC) power supply:** a power supply that operates as a constant voltage power supply or a constant-current power supply depending on load conditions. It acts as a constant-voltage source for comparatively large values of load resistance and as a constant-current source for comparatively small values of load resistance.

**Constant-voltage/current-limiting (CV/CL) power supply:** a power supply similar to a constant-voltage/constant current supply except that at comparatively small values of load resistance, its output current is limited instead of being stabilized.

**Crowbar:** see overvoltage protection.

**Current limiting:** the action of limiting the output current of a constant-voltage supply to some predetermined maximum value (fixed or adjustable) and automatically restoring the output voltage to its normal value when the overload or short circuit is removed. There are three types of current limiting: 1) by constant-voltage/constant-current crossover, 2) by decreasing the output voltage as the current increases, 3) by decreasing both voltage and current as the load resistance decreases (referred to as foldback or cutback current limiting).

**Drift:** the maximum change of an output voltage or current during an 8-hour period following a 30-minute warmup, with all influence and control quantities maintained constant during the warm-up time and the period of drift measurement. Drift includes both periodic and random deviations over the bandwidth from zero frequency (dc) to a specified upper frequency limit (usually 20 Hz).

**Load effect:** formerly known as load regulation, load effect is the change in the steady-state value of the stabilized output voltage or current resulting from a full-load change in the load current of a constant-voltage supply or the load voltage of a constant-current supply, with all other influence quantities maintained constant.

**Load effect transient recovery time:** the time interval between a specified step change in the load current of a constant-voltage supply (usually a full-load or 5-amp change, whichever is smaller) or in the load voltage of a constant-current supply and the instant when the stabilized output quantity returns to and stays within the specified transient recovery band.

**Master-slave operation:** a method of interconnecting two or more supplies such that one of them (the master) serves to control the others (the slaves). The outputs of the slave supplies always remain equal to or proportional to the output of the master. The outputs of

the master supply and of one or more slaves may be connected in series, in parallel, or with just their negative or positive output terminals in common. (See also complementary tracking.)

**Nominal value:** the value that exists "in name only", not the actual value. For example, in the case of a power supply with a calibrated output control, the nominal value is the value indicated by the control setting. For a supply with a fixed output, the nominal output is the output indicated on the nameplate. The nominal value of a 120-volt  $\pm 10\%$  line voltage is 120 volts.

**Output impedance:** the complex ratio of a sinusoidal voltage and sinusoidal current at the output terminals, the one being caused by the other and being of external origin.

**Overcurrent protection:** protection of the power supply and/or connected equipment against excessive output current.

**Overtemperature protection:** protection of the power supply or parts of it against temperatures exceeding specified values.

**Overvoltage protection:** protection of the power supply and/or connected equipment against excessive output voltage. Overvoltage protection is usually by means of a crowbar protection circuit, which rapidly places a low resistance shunt across the supply's output terminals to reduce output voltage to a low value if a predetermined voltage is exceeded. A supply equipped with an overvoltage crowbar must also be protected by a means of limiting or interrupting output current.

**PARD (acronym for periodic and random deviation):** the term PARD replaces the former term ripple and noise. PARD is the periodic and random deviation of a dc output voltage or current from its average value, over a specified bandwidth (20 Hz to 20 MHz; except Models 6515A-6525A: 1 Hz to 20 MHz) and with all influence and control quantities maintained constant.

**Programming speed:** the maximum time required for the programmed output voltage or current to change from a specified initial value (usually zero or maximum output) to a value within a specified tolerance band of a specified newly programmed value (for most models 99.9% or 0.1% of maximum output, respectively; 99% and 1% for the 6104A-6116A, 6177C-6186C, and 6427B-6483C) following the onset of a step change in the programming input signal.

**Remote control:** also referred to as remote programming, remote control is the setting of the power supply voltage, current, or other function by means of an external control quantity such as a variable resistance, voltage, or current, or a digital signal.

**Remote sensing:** remote sensing, or remote error sensing, is a means by which a power supply monitors the stabilized voltage directly at the load using extra sensing leads. The resulting circuit action compensates for voltage drops in the load leads (up to a specified limit).

**Resolution:** the smallest change in output voltage or current that can be obtained using the front panel controls.

**Reverse voltage protection:** protection of the power supply against reverse voltage applied at the output terminals.

**Slave operation:** see master-slave operation.

**Source effect:** formerly known as line regulation, source effect is the change in the steady-state value of the stabilized output voltage or current resulting from any change in the source voltage within its specified range, with all other influence quantities maintained constant. Source effect may be measured at any output voltage and current within rating.

**Temperature effect coefficient:** the maximum steady-state change in a power supply's output voltage or current per degree Celsius following a change in the ambient temperature within specified limits, with all other influence quantities maintained constant.

**Voltage limiting:** the action of limiting the output voltage of a constant-current supply to some predetermined maximum value (fixed or adjustable) and automatically restoring the output current to its normal value when the load conditions are restored to normal. There are two types of voltage limiting: 1) by constant-voltage/constant-current crossover, 2) by decreasing the output current as the voltage increases.

**Warm-up time:** the time interval after switching on a power supply until it complies with all performance specifications.

# POWER SUPPLIES

Condensed listing

DC Volts	DC Amps (Max)	Type	Model	Page
4-5.5	8	Low Cost Lab	6384A†	205
0 ± 5 & ± 20 Dual Range	1	BPSA*	6825A†	218
0 = 5 & = 50 Dual Range	1	BPSA*	6826A†	219
5 = 0.50	2	Modular	62005A†	222
5 = 0.50	4	Modular	62005C†	222
5 = 0.50	8	Modular	62005E†	222
5 = 0.50	16	Modular	62005G†	222
5, 5-12, 5-12 Microprocessor	3, 0.6, 0.6	Modular	62312D	222
5, & = 12 to 15, = 0.25 Triple	18 & 2A max	Modular	63315D†	222
5 = 0.25	22	DC-to-DC	61005C	222
5 = 0.25	22	Modular	63005C†	222
5 & 12 to 15, = 0.25 Triple	18 & 2A max	DC-to-DC	61315D	222
5 = 0.50	40 & 10A	Modular	62605I†	222
5 = 0.25	40	Modular	62605J†	222
5 = 0.25	60	Modular	62605L†	222
5 = 0.25	100	Modular	62605M†	222
0-6, 0 = 20, Triple	2.5 & 0.5	Low Cost Lab	62368†	204
0-7.5	3	Low Cost Lab	62038†	205
0-7.5	5	Gen. Purpose	6281A†	208
0-8	1000	High Pwr.	6464C†	210
0-10	1	Low Cost Lab	6213A†	204
0-10	1	Low Cost Lab	6214A†	204
0-10	2	Prec. Volt	6113A†	216
0-10	10	Gen. Purpose	6282A†	208
0-10	20	Gen. Purpose	62568†	208
0-10	50	Gen. Purpose	62598†	208
0-10	100	Gen. Purpose	62608†	208
0 = 10 & 0 = 10 Dual Range	0.5	BPSA*	6827A†	219
12 = 0.60	1.5	Modular	62012A	222
12 = 0.60	3	Modular	62012C†	222
12 = 0.60	6	Modular	62012E†	222
12 = 0.60	12	Modular	62012G†	222
12 = 0.60	23	Modular	62612J†	222
= 12 = 0.60 Dual	1.4	Modular	62212A†	222
12-5, 12-5.5 Microprocessor	0.6, 0.6, 3	Modular	62312D	222
= 12 to = 15 & 5 = 0.25 Triple	2 & 18A max	Modular	63315D†	222
= 12 = 0.60 Dual	3.3	Modular	62212E†	222
= 12 = 0.60 Dual	6	Modular	62212G†	222
0-15	200	High Pwr.	6453A†	210
15 = 0.75	1.25	Modular	62015A†	222
15 = 0.75	2.5	Modular	62015C†	222
15 = 0.75	5	Modular	62015E†	222
15 = 0.75	10	Modular	62015G†	222
15 = 0.75	20	Modular	62615J†	222
-15 = 0.75 Dual	1.25	Modular	62215A†	222
= 15 & 5 = 0.25	2 & 18 max	Modular	63315D†	222
= 15 = 0.75 Dual	3	Modular	62215E†	222
= 15 = 0.75 Dual	5.2	Modular	62215G†	222
0-16 or 0-18	600 or 500	High Pwr.	6446C†	210
0-18 & 0 = 20 Dual Tracking	1 & 0.5	Low Cost Lab	6237B†	208

DC Volts	DC Amps (Max.)	Type	Model	Page
0 = 20, 0-6 Triple	0.5 & 2.5	Low Cost Lab	62368†	204
0 = 20, 0-18 Triple	0.5 & 1	Low Cost Lab	6237B†	204
0-20 & 0-40 Dual Range	0.6 & 0.3	Low Cost Lab	6204B†	205
0-20 & 0-40 Two Dual Range	0.6 & 0.3	Low Cost Lab	6205B†	205
0-20	1	Prec. Volt.	6111A†	218
0-20	1.5	Low Cost Lab	62018†	205
0-20 & 0-40 Dual Range	1.5 & 0.75	Low Cost Lab	62008†	205
0-20 & 20-40 Dual Range	2 & 1	Prec. Volt.	6114A†	216
0-20	3	Gen. Purpose	6284A†	206
0-20 & 0-20 Two Outputs	3 & 3	Gen. Purpose	6253A†	208
0-20	10	Gen. Purpose	6263B†	208
0-20	10	Gen. Purpose	6286A†	206
0-20	15	High Pwr.	6427B†	210
0-20	20	Gen. Purpose	62648†	208
0-20	45	High Pwr.	6428B†	210
0-20	50	Gen. Purpose	62618†	208
20-40 & 0-20 Dual Range	1 & 2	Prec. Volt.	6114A†	216
0-24	3	Gen. Purpose	6224B†	208
24 = 1.20	1.75	Modular	62024C†	222
24 = 1.20	3.75	Modular	62024E†	222
24 = 1.20	7.5	Modular	62024G†	222
24 = 1.20	12.5	Modular	62624J†	222
0-25	0.4	Low Cost Lab	6215A†	204
0-25	0.4	Low Cost Lab	6216A†	204
0-25 & 0-50 Dual Range	1 & 0.5	Gen. Purpose	6220B†	208
0-25 & 0-25 Two-Tracking	2	Gen. Purpose	6227B†	214
28 = 1.40	0.7	Modular	62028A†	222
28 = 1.40	1.5	Modular	62028C†	222
28 = 1.40	3.25	Modular	62028E†	222
28 = 1.40	6.5	Modular	62028G†	222
28 = 1.40	10.7	Modular	62628J†	222
0-30 & 0-60 Dual Range	1 & 0.5	Low Cost Lab	6206B†	205
0-36	10	High Pwr.	6433B†	210
0-36	100	High Pwr.	6456B†	210
0-36	300	High Pwr.	6469C†	210
0-40 & 0-20 Dual Range	0.3 & 0.6	Low Cost Lab	6204B†	205

†Available on GSA Contract Number GS-005-04663.

•May be used with the 59501A HP-IB Isolated D/A Converter/Power Supply Programmer.

\*May be used with the 6940B Multiprogrammer when equipped with Option 040.

•BPSA = Bipolar Power Supply/Amplifier.

†Available on GSA Contract Number GS-005-04663.

•May be used with the 59501A HP-IB Isolated D/A Converter/Power Supply Programmer.

\*May be used with the 6940B Multiprogrammer when equipped with Option 040.

•BPSA = Bipolar Power Supply/Amplifier.

DC Volts	DC Amps (Max.)	Type	Model	Page
0-40 & 0-20 Dual Range	0.3 & 0.6	Low Cost Lab	6205B†♦	205
0-40	0.5	Prec. Volt.	6112A†♦♦	216
0-40	0.75	Low Cost Lab	6202B†♦	205
0-40 & 0-20 Dual Range	0.75 & 1.5	Low Cost Lab	6200B†♦	205
0-40 & 0-40 Two Outputs	1.5 & 1.5	Gen. Purpose	6255A†♦	206
0-40	1.5	Gen. Purpose	6285A†♦♦	206
0-40	3	Gen. Purpose	6262B†♦♦	208
0-40	5	Gen. Purpose	6266B†♦♦	208
0-40	5	Gen. Purpose	6291A†♦	206
0-40	10	Gen. Purpose	6267B†♦♦	208
0-40	25	High Pwr.	6434B†♦	210
0-40	30	Gen. Purpose	6268B†♦♦	208
0-40	50	Gen. Purpose	6269B†♦♦	208
48 ± 2.40	0.45	Modular	62048A†	222
48 ± 2.40	1	Modular	62048C†	222
48 ± 2.40	2	Modular	62048E†	222
48 ± 2.40	4	Modular	62048G†	222
0-50	0.2	Low Cost Lab	6217A†	204
0-50	0.2	Low Cost	6218A†	204
0-50 (Compliance)	0-0.5	Prec. Cur.	6177C†♦	218
0-50 & 0-25	0.5 & 1	Gen. Purpose	6220B†♦♦	206
0-50 & 50-100 Dual Range	0.8 & 0.4	Prec. Volt.	6115A†♦♦	216
0-50 & 0-50 Two-Tracking	1	Gen. Purpose	6228B†♦♦	214
0-50	1.5	Gen. Purpose	6226B†♦♦	206
50-100 & 0-50 Dual Range	0.4 & 0.8	Prec. Volt.	6115A†♦♦	216
0-50	10-4	HP-IB	6002A	213
0-50	5	Dig. Prog. Volt.	6129C†	224
0-50	1	Dig. Prog. Volt.	6130C†	224
0-50	1	BPSA*	6824A†♦	219
0-60 & 0-30 Dual Range	0.5 & 1	Low Cost Lab	6206B†♦	205
0-60	1	Gen. Purpose	6294A†♦♦	206
0-60	3	Gen. Purpose	6296A†♦	206
0-60	3	Gen. Purpose	6271B†♦♦	208
0-60	5	High Pwr.	6438B†♦	211
0-60	15	Gen. Purpose	6274B†♦♦	208
0-60	15	High Pwr.	6439B†♦	211
0-64	50	High Pwr.	6459A†♦	210
0-64	150	High Pwr.	6472C†	210
0-100 (Compliance)	=0.016	Dig. Prog. Cur.	6140A	224
0-100	0.1	Low Cost Lab	6211A†	204
0-100	0.1	Low Cost Lab	6212A†	204

†Available on GSA Contract Number GS-00S-04-663.

♦May be used with the 59501A HP-IB Isolated D/A Converter/Power Supply Programmer.

◆May be used with the 6940B Multiprogrammer when equipped with Option 040.

\*BPSA = Bipolar Power Supply/Amplifier.

DC Volts	DC Amps (Max.)	Type	Model	Page
0-100	0.2	Prec. Volt.	6116A†♦	216
0-100(Compliance)	0.25	Prec. Cur.	6181C†♦	218
0-100	0.75	Gen. Purposa	6299A†♦♦	206
0-100	0.5	Dig. Prog. Volt.	6131C†	224
0-100	100	High Pwr.	6475C†♦	210
0-120	2.5	High Pwr.	6443B†♦	210
0-160	0.2	Low Cost Lab	6207B†♦	205
0-220	50	High Pwr.	6477C†♦	210
0-300 (Compliance)	0.1	Prec. Cur.	6186C†♦	218
0-300	35	High Pwr.	6479C†♦	210
0-320	0.1	Low Cost Lab	6209B†♦	205
0-320	1.5	Gen. Purpose	895A†	208
0-440 or 0-500 or 0-600	25 or 20 or 15	High Pwr.	6483C†♦	210
1-600	1.5	High Pwr.	6448B†	210
0-1000	0.2	High Volt.	6521A†	215
0-1600	0.005	High Volt.	6515A†	215
0-2000	0.1	High Volt.	6522A†	215
0-3000	0.006	Prec. Volt.	6110A†	218
0-3000	0.006	High Volt.	6516A†	215
0-4000	0.05	High Volt.	6525A†	215

†Available on GSA Contract Number GS-00S-04663.

♦May be used with the 59501A HP-IB Isolated D/A Converter/Power Supply Programmer.

◆May be used with the 6940B Multiprogrammer when equipped with Option 040.

\*BPSA = Bipolar Power Supply/Amplifier.

## Power Supply Digital Programming Interfaces

Description	Model	Page
<b>HP-IB Isolated D/A Converter/Power Supply Programmer:</b> one channel, two programmable ranges. Provides HP-IB interface for programming either output voltage, or current (where current programming is available as described in specifications for individual power supply model) of power supplies designated with a ♦ symbol in the above condensed listing "model" column. Interfacing details are covered in publication 5952-3990.	59501A	212
<b>Multiprogrammer:</b> a highly versatile I/O expander and converter that can control up to 240 power supplies from one HP-IB port or one 16-bit duplex I/O channel. It will control output voltage and current of power supplies designated with a ★ symbol in the above condensed listing "model" column when they are equipped with Option 040. Additional Multiprogrammer capabilities include digital I/O for monitoring crowbars, relays for output switching, A/D converters for measuring power supply output, timers for automatic power supply sequencing, etc. Ask your HP field engineer for the 48-page Multiprogrammer Data Sheet, publication number 5952-3982, for complete details.	6940B	597

# POWER SUPPLIES

Low cost lab: compact, single and triple outputs

Models 6211A-6218A, 6236B and 6237B

- 10W output . . . Low ripple and noise
- Compact, Impact-resistant stackable case
- Short-circuit proof



6211A, 6218A

## Description

These popular low-cost bench supplies are designed for general laboratory use and are equipped with front-panel mounted voltage controls, a combination volt/ammeter, and output binding posts. Output voltage is continuously variable, via coarse and fine controls from 0 V to 15% above the maximum rated output. A switch selects either output voltage or current for display on the panel meter.

Load connections are made via three binding posts. Either the + or the - post may be grounded through an adjacent GND terminal or the supply may be operated floating at up to 300 volts above ground.

The Constant Voltage/Constant Current Models have concentric coarse and fine current controls which allow setting the current-limit point to any value within the current rating. Using these controls, the CV/CC supplies can also be operated as constant current sources with 500  $\mu$ A load regulation. All CV/CC models can be connected in series or parallel.

The Constant Voltage/Current Limiting (CV/CL) Model supplies are short-circuit protected by a fixed current limiting circuit which is activated at approximately 120% of rated load current. The CV/CL models can be connected in series only.

## Ratings

Volts	Amps	Model	Load Effect	Source Effect	PARD Rms/p-p	Mode
0-10	1	6213A	4 mV	4 mV	200 $\mu$ A/1 mV	CV/CL
0-10	0-1	6214A	4 mV	4 mV	200 $\mu$ A/1 mV	CV/CC
0-25	0.4	6215A	4 mV	4 mV	200 $\mu$ A/1 mV	CV/CL
0-25	0-0.4	6216A	4 mV	4 mV	200 $\mu$ A/1 mV	CV/CC
0-50	0.2	6217A	4 mV	4 mV	200 $\mu$ A/1 mV	CV/CL
0-50	0-0.2	6218A	4 mV	4 mV	200 $\mu$ A/1 mV	CV/CC
0-100	0.1	6211A	8 mV	4 mV	200 $\mu$ A/1 mV	CV/CL
0-100	0-0.1	6212A	8 mV	4 mV	200 $\mu$ A/1 mV	CV/CC

AC Power Requirements: 115 V  $\pm$  10%, 1 $\phi$  48-440 Hz; (for 230 V operation, order optn. 028).

**Size:** 133 H  $\times$  83 W  $\times$  368 mm D (3.25"  $\times$  5.25"  $\times$  8").

## Accessories and options

1421A Rack kit for one, two, or three supplies.

Opt 028: 230 V ac single phase input

## Ordering information

6213A, 6215A, 6217A CV/CL Low Cost Lab Supplies

6211A CV/CL Low Cost Lab Supply

6214A, 6216A, 6218A CV/CC Low Cost Lab Supplies

6212A CV/CC Low Cost Lab Supply

## Price

\$45

N/C

\$130

\$160

\$155

\$185

- 0 to 6 V & 0 to  $\pm$ 20 V, Model 6236B
- 0 to 18 V & 0 to  $\pm$ 20 V, Model 6237B
- Variable tracking control

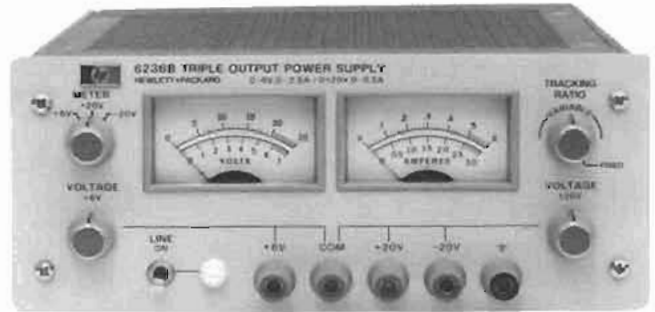

6236B, 6237B

## Description

Microprocessors, digital and linear integrated circuits, and displays used in lab development frequently require triple output power supplies for operating prototypes. The 6236B and 6237B are valued additions to the design bench due to their multiple output voltages, small size, ease of operation and application-related performance.

These compact constant-voltage/current-limiting supplies combine 0 to  $\pm$  20 V tracking outputs rated at 0.5 amps with a single output rated at 0 to + 6 volts at up to 2.5 amps in the 6236B, and 0 to + 18 volts at 1 amp in the 6237B.

Controls, meters, and binding posts are logically arranged on a neatly laid out front panel. One voltage control simultaneously adjusts the 20 V and -20 V outputs, which track within 1% to power operational amplifiers and circuits requiring balanced voltages. A tracking ratio control can disable the 1:1 tracking feature and set the negative output to a lower voltage than that of the positive output. Once the tracking ratio control has established a voltage ratio between the positive and negative outputs, the ratio remains constant as the  $\pm$  20 V voltage control varies both outputs. Another voltage control sets the 0 to +6 V (6236B) or 0 to +18 V (6237B) output. All outputs are protected against overload and short-circuit damage by fixed current limiting circuits.

## Specifications (both models, unless otherwise indicated)

### DC Output

6236B: 0 to 6 V (2.5 A at 6 V reducing to 1 A at 0 V); and 0 to +20 V and -20 V at 0.5 A with variable dual tracking.

6237B: 0 to 18 V at 1 A; and 0 to +20 V and -20 V at 0.5 A, with variable dual tracking.

AC Input: 120 V ac nominal, 104 V to 127 V, 47-63 Hz, 112 W, 1.2 A.

Load effect (load regulation): 0.01% + 2 mV (all outputs).

Source effect (line regulation): 0.01% + 2 mV (all outputs).

PARD (ripple & noise): 0.35 mV rms, 1.5 mV p-p (20 Hz to 20 MHz).

Resolution: 20 mV for 6 V output, 70 mV for other outputs.

Drift (stability): following 30-minutes warm-up is 0.1% + 5 mV.

Output voltage overshoot: no overshoot.

Temperature coefficient: 0.02% + 1 mV output change per degree C.

Temperature ratings: operating: 0 to 40°C; storage: -40 to +75°C.

Size: 89 H  $\times$  216 W  $\times$  319 mm D; (3.50"  $\times$  8.50"  $\times$  12.50").

Weight: 4.3 kg (9.5 lb).

Color: olive gray.

## Options and accessories

Opt 100: 87-106 V, 47-63 Hz input

Opt 220: 191-233 V, 47-63 Hz input

Opt 240: 208-250 V, 47-63 Hz input

14513A Rack Kit for one supply

14523A Rack Kit for two supplies

## Ordering information

6236B Triple Output Power Supply

6237B Triple Output Power Supply

## Price

N/C

N/C

N/C

\$15

\$25

\$345

\$345



## Low cost lab: general bench applications

Models 6200B—6209B, and 6384A

- Short-circuit proof
- Floating output (up to 300 V above ground)—can be used as a positive or negative source
- Remote sensing

- Bench or rack mounting
- Multi-function meter



6200B—6203B, 6207B,  
6209B, CV/CC

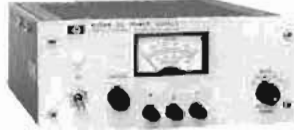

6204B, 6206 CV/CL



6205B CV/CL  
Two, Dual Range Outputs



6384A CV/CL

### Description

#### Models 6200B—6209B

This series of low-cost bench supplies includes nine models covering an output voltage range from 0–7.5 V to 0–320 V. All models equipped with coarse and fine output voltage controls (except Models 6207B and 6209B, which have 10-turn voltage controls), volt/ampere meter, meter function/range switch, and front and rear output terminals. In addition, on the dual-range models (6204B–6205B), an output range switch permits the selection of either a high or a low output voltage range.

Model 6205B combines the versatility of a dual power supply with the flexibility of auto-parallel and auto-series operation to extend the output ratings of this supply to 20 V/1.2 A, 40 V/0.6 A, and 80 V/0.3 A. In addition, using the supply's auto-tracking capability, opposite polarity voltages ( $\pm 20$  V,  $\pm 40$  V) can conveniently be obtained from this one supply.

The Constant-Voltage/Current-Limiting supplies (6204B–6205B), are short-circuit protected by a fixed current limiting circuit which is activated at approximately 110% of rated load current. The current-limit point can be reduced by changing the value of a single internal resistor. For the Constant-Voltage/Constant-Current supplies, concentric coarse and fine current controls allow the current-limit point to be set to any value within the current rating. Using these controls, the CV/CC supplies can also be operated as constant-current sources.

Units may be bench operated or rack mounted individually or in pairs using accessory rack mounting hardware.

### Specifications

#### Model 6384A

This low-cost bench supply is designed specifically for use with digital-logic integrated circuits. Its output ratings and superior performance, combined with the protection of built-in overvoltage crowbar and current limiting circuits, make it an excellent IC supply for both laboratory and systems use.

#### Specifications—general

**Drift:** 0.1%  $\pm$  5 mV per 8 hours (6384A, 0.3%  $\pm$  10 mV after 2-hour warm-up).

**Temperature coefficient, per °C:** 0.02%  $\pm$  1 mV (6384A, 3 mV/°C).

**Load effect transient recovery:** 50  $\mu$ s to recover within 10 mV of nominal output voltage. (50  $\mu$ s and 40 mV for 6384A).

**Overvoltage protection crowbar (optional on 6200B–6206B)**

**Option 011 on 6200B–6206B:** adjustment range from 2.5 V to 104% of maximum rated output of supply, plus 2 V. Minimum operating setting (margin) is 104% of nominal output, plus 2 V.

**Standard feature on 6384A:** trip voltage factory set at 6.25 V; field adjustable down to 5 V.

**Temperature ratings:** operating, 0 to 50°C. Storage, –40 to +75°C. These supplies are convection cooled.

#### Rear panel terminals

**DC output:** 6200B–6209B have front and rear output terminals; Model 6384A has only rear output terminals.

**Remote sensing:** terminals are provided to correct for load lead voltage drop.

**Auto-series, auto-parallel, and auto-tracking operation:** Models 6200B–6209B have terminals for multiple supply operation.

**Size:** 89 H  $\times$  216 W  $\times$  317 mm D (3.50"  $\times$  8.50"  $\times$  12.50").

**Weight:** net, 4.5 kg (10 lb). Shipping, 5.4 kg (12 lb).

RATINGS		PERFORMANCE							GENERAL	
DC Output		Model	Load Effect	Source Effect	PARO rms/p-p	Control Mode and Resolution	Remote Control Coefficients	Power* 115 V ac $\pm$ 10%	Options*	Price
Voltage	Amps									
4–5–5	0–8	6384A	2 mV	2 mV	1 mV/5 mV	CV/CL 15 mV/NA	NA	48–63 Hz 1.4 A, 120 W	28	\$390
0–7.5	0–3	6203B	5 mV	3 mV	200 $\mu$ V/1 mV	CV/CC 5 mV/2 mA	200(1)/V $\pm$ 1% 500(1)/A $\pm$ 10%	48–440 Hz 0.9 A, 70 W	9, 11, 15, 28	\$275
0–20	0–1.5	6201B	0.01% $\pm$ 4 mV	0.01% $\pm$ 4 mV	200 $\mu$ V/1 mV	CV/CC 5 mV/1 mA	200(1)/V $\pm$ 1% 1 k(1)/A $\pm$ 10%	48–440 Hz 0.8 A, 66 W	9, 11, 15, 28	\$275
Basic range 0–20 for 0–40	0–0.6 0–0.3	6204B	0.01% $\pm$ 4 mV	0.01% $\pm$ 4 mV	200 $\mu$ V/1 mV	CV/CL 10 mV/NA	200(1)/V $\pm$ 1% NA	48–440 Hz 0.4 A, 24 W	9, 11, 15, 28	\$250
Dual range 0–20 or 0–40	0–1.5 0–0.75	6200B	0.01% $\pm$ 4 mV	0.01% $\pm$ 4 mV	200 $\mu$ V/1 mV	CV/CC 10 mV/2 mA	200(1)/V $\pm$ 1% 0.5 k(1)/A $\pm$ 10% or 1 k(1)/A $\pm$ 10%	48–440 Hz 0.9 A, 70 W	9, 11, 15, 28	\$281
Two dual ranges 0–20/0–40 and 0–20/0–40	0–0.6/0.3 0–0.6/0.3	6205B	0.01% $\pm$ 4 mV	0.01% $\pm$ 4 mV	200 $\mu$ V/1 mV	CV/CL 10 mV/NA	200(1)/V $\pm$ 1% N/A	48–440 Hz 0.5 A, 50 W	9, 11, 15, 28 40	\$300
Dual range 0–30 or 0–60	0–1 0–0.5	6206B	0.01% $\pm$ 4 mV	0.01% $\pm$ 4 mV	200 $\mu$ V/1 mV	CV/CL 10 mV/NA	300(1)/V $\pm$ 1% N/A	48–440 Hz 1 A, 66 W	9, 11, 15, 28	\$300
0–40	0–0.75	6202B	0.01% $\pm$ 4 mV	0.01% $\pm$ 4 mV	200 $\mu$ V/1 mV	CV/CC 10 mV/1 mA	200(1)/V $\pm$ 1% 1 k(1)/A $\pm$ 10%	48–440 Hz 0.8 A, 66 W	9, 11, 15, 28	\$255
0–160	0.2	6207B	0.02% $\pm$ 2 mV	0.02% $\pm$ 2 mV	500 $\mu$ V/40 mV	CV/CC 25 mV/500 $\mu$ A	300(1)/V $\pm$ 1% 75 k(1)/A $\pm$ 10%	48–63 Hz 1 A, 60 W	9, 15, 28	\$325
0–320	0–0.1	6209B	0.02% $\pm$ 2 mV	0.02% $\pm$ 2 mV	1 mV/40 mV	CV/CC 40 mV/200 $\mu$ A	300(1)/V $\pm$ 1% 150 k(1)/A $\pm$ 10%	48–63 Hz 1 A, 60 W	9, 15, 28	\$325

\*For 230 V ac  $\pm$  10% operation, order Opt 0, 28. See page 220 for complete option descriptions.

# POWER SUPPLIES

General purpose: 25–200 W output

Models 6220B–6299A

- Constant voltage/constant current operation
- Remote sensing and programming
- Auto-series, -parallel, & -tracking operation



6281A, 6284A, 6289A,  
6294A, 6299A



6220B, 6224B, 6226B

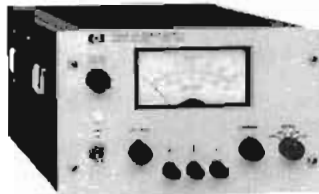

6282A, 6286A,  
6291A, 6296A



6253A, 6255A

- Front and rear output terminals
- Floating output—use as positive or negative source
- Bench or rack mounting

## Description

### 6281A–6299A

This series of medium-power Constant-Voltage/Constant-Current power supplies is available in two power ranges: 37–75 watts (packaged in 3½-inch high half-rack cases), and 100–200 watts (packaged in 5½-inch high half-rack cases). All models except 6294A and 6299A have separate coarse and fine voltage and current controls that allow the voltage and current outputs to be varied from zero to the maximum rated values. The latter two models have ten-turn voltage controls. Crossover from constant-voltage to constant-current operation occurs automatically when the load current exceeds the value established by the current control settings. A four-position meter function switch selects either of two output voltage or output current ranges (X1, X0.1) for display on the panel meter.

The 37–75 watt models are of the series-regulated type. They have excellent regulation and ripple characteristics and include a special output-capacitor discharge circuit for improved programming speed. The 100–200 watt models employ a series-regulator/SCR-preregulator configuration to achieve the high efficiency necessary for a convection-cooled package of this size. They also have excellent regulation, low ripple and noise, and moderate programming speeds.

### 6253A and 6255A

These versatile dual-output models each contain two identical, independently-adjustable 60-watt power supplies in a full-rack width case. The regulator, voltage and current control, and metering circuits of each section of the supply are electrically identical to those of the individual 37–75 watt models described above.

## Specifications

RATINGS			PERFORMANCE							
DC Output			Load Effect		Source Effect		PARO (rms/p-p)		Drift (stability)	
Volts	Amps	Model	Voltage	Current	Voltage	Current	Voltage	Current	Voltage	Current
0–7.5	0–5	6281A	5 mV	0.01% + 250 μA	0.01% + 2 mV	0.01% + 250 μA	200 μV/1 mV	4 mA rms	0.1% + 2.5 mV	0.1% + 12.5 mA
0–10	0–10	6282A	0.01% + 1 mV	0.05% + 1 mA	0.01% + 1 mV	0.05% + 1 mA	500 μV/25 mV	5 mA rms	0.1% + 2.5 mV	0.1% + 25 mA
0–20	0–3	6253A*	0.01% + 4 mV	0.01% + 250 μA	0.02% + 2 mV	0.01% + 250 μA	200 μV/1 mV	2 mA rms	0.1% + 2.5 mV	0.1% + 7.5 mA
0–20	0–3	6284A	0.01% + 4 mV	0.01% + 250 μA	0.01% + 2 mV	0.01% + 250 μA	200 μV/1 mV	2 mA rms	0.1% + 2.5 mV	0.1% + 7.5 mA
0–20	0–10	6286A	0.01% + 1 mV	0.05% + 1 mA	0.01% + 1 mV	0.05% + 1 mA	500 μV/25 mV	5 mA rms	0.1% + 2.5 mV	0.1% + 25 mA
0–24	0–3	6224B	0.01% + 4 mV	0.01% + 250 μA	0.01% + 2 mV	0.01% + 250 μA	200 μV/1 mV	200 μA/1 mA	0.1% + 2.5 mV	0.1% + 7.5 mA
0–25	0–1	6220B**	0.01% + 2 mV	0.01% + 250 μA	0.01% + 2 mV	0.01% + 250 μA	200 μV/2 mV	200 μA/1 mA	0.1% + 5 mV	0.1% + 5 mA
0–40	0–1.5	6255A*	0.01% + 3 mV	0.01% + 250 μA	0.01% + 2 mV	0.01% + 250 μA	200 μV/1 mV	500 μA rms	0.1% + 2.5 mV	0.1% + 4 mA
0–40	0–1.5	6289A	0.01% + 2 mV	0.01% + 250 μA	0.01% + 2 mV	0.01% + 250 μA	2000 μV/1 mV	500 μA rms	0.1% + 2.5 mV	0.1% + 4 mA
0–40	0–5	6291A	0.01% + 1 mV	0.05% + 1 mA	0.01% + 1 mV	0.05% + 1 mA	500 μV/25 mV	3 mA	0.1% + 2.5 mV	0.1% + 12.5 mA
0–50	0–1.5	6226B	0.01% + 2 mV	0.01% + 250 μA	0.01% + 2 mV	0.01% + 250 μA	200 μV/1 mV	200 μA/1 mA	0.1% + 2.5 mV	0.1% + 4 mA
0–60	0–1	6294A	0.01% + 2 mV	0.01% + 250 μA	0.01% + 2 mV	0.01% + 250 μA	200 μV/1 mV	500 μA rms	0.1% + 2.5 mV	0.1% + 2.5 mA
0–60	0–3	6296A	0.01% + 1 mV	0.05% + 1 mA	0.01% + 1 mV	0.05% + 1 mA	500 μV/25 mV	3 mA rms	0.1% + 2.5 mV	0.1% + 7.5 mA
0–100	0–0.75	6299A	0.01% + 2 mV	0.01% + 250 μA	0.01% + 2 mV	0.01% + 250 μA	200 μV/1 mV	500 μA rms	0.1% + 2.5 mV	0.1% + 2 mA

\*Models 6253A and 6255A contain two identical, independently-adjustable power supplies.

\*\*Model 6220B has a single, dual range output with ratings of 0–25 V at 0–1 A or 0–50 V at 0–0.5 A.

By combining the versatility of a dual power supply with the flexibility of auto-series and auto-parallel operation, twice the maximum rated output voltage or current of each section can be obtained from the one supply. In addition, using the supply's auto-tracking capability, opposite-polarity voltages ( $\pm 20$  V for Model 6253A or  $\pm 40$  V for Model 6255A) are possible.

#### 6220B, 6224B, and 6226B

These Constant-Voltage/Constant-Current supplies are designed for general laboratory use. All have excellent regulation, low ripple and noise, and high speed programming characteristics. Large easy-to-read meter scales, 10-turn voltage and current controls, and front and rear output terminals enhance ease of operation. Model 6220B is a dual-range instrument with output ratings of 0–25 V at 0–1 A or 0–50 V at 0–0.5 A. It is the only model of the three employing convection cooling. Models 6224B and 6226B have single outputs of 0–24 V at 0–3 A and 0–50 V at 0–1.5 A, respectively.

#### Accessories and options

The accessories and options available for use with Models 6220B–6299A are listed on page 220.

### Specifications—general

**Load effect transient recovery:** time, 50  $\mu$ s. Level, 15 mV.

**Meter accuracy:** 3% of full scale.

**Power:** standard input voltage is 115 V ac  $\pm 10\%$ . Order option 028 for 230 V ac  $\pm 10\%$  operation. Input power frequency, maximum input current, maximum power consumption are: 6220B, 48–440 Hz, 0.5 A, 44 W; 6224B, 48–63 Hz, 1.8 A, 164 W; 6226B, 48–63 Hz, 1.8 A, 164 W; 6253A, 48–440 Hz, 2.6 A, 235 W; 6255A, 48–440 Hz, 2.6 A, 235 W; 6281A, 48–440 Hz, 1.3 A, 118 W; 6282A, 57–63 Hz, 3.5 A, 200 W; 6284A, 48–440 Hz, 1.5 A, 128 W; 6286A, 57–63 Hz, 5.5 A, 320 W; 6289A, 48–440 Hz, 1.3 A, 110 W; 6291A, 57–63 Hz, 5.5 A, 280 W; 6294A, 48–440 Hz, 1.3 A, 114 W; 6296A, 57–63 Hz, 4.5 A, 250 W; 6299A, 48–440 Hz, 1.5 A, 135 W.

**Size:** 6220B, 6224B, & 6226B: 166 H  $\times$  130 W  $\times$  294 mm D (6 $\frac{1}{2}$ "  $\times$  5 $\frac{1}{8}$ "  $\times$  11 $\frac{3}{16}$ "). 6253A, 6255A: 87 H  $\times$  483 W  $\times$  403 mm D (3 $\frac{3}{16}$ "  $\times$  19"  $\times$  15 $\frac{7}{16}$ "). 6281A, 6284A, 6289A, 6294A, 6299A: 87 H  $\times$  209 W  $\times$  398 mm D (3 $\frac{3}{16}$ "  $\times$  8 $\frac{1}{32}$ "  $\times$  15 $\frac{3}{16}$ "). 6282A, 6286A, 6291A, 6296A: 131 H  $\times$  210 W  $\times$  435 mm D (5 $\frac{1}{32}$ "  $\times$  8 $\frac{1}{4}$ "  $\times$  17 $\frac{1}{16}$ ").

**Temperature:** operating, 0 to 55°C; storage, –40 to 75°C.

### Specifications, continued

REMOTE CONTROL FEATURES								GENERAL					
Resistance Coefficient		Voltage Coefficient		Speed, UP*		Speed, DOWN*		Overvoltage		Weight		Options $\Delta$	Price
Voltage	Current	Voltage	Current	NL	FL	NL	FL	Range	Margin	Net	Shipping		
200 $\Omega$ /V $\pm 1\%$	200 $\Omega$ /A $\pm 10\%$	1 V/V $\pm 1\%$	0.2 V/A $\pm 10\%$	1 ms	2 ms	10 ms	6 ms	2.5–10 V	4% +2 V	6.4 kg/14 lb	7.2 kg/16 lb	9, 11, 15, 28, 40	\$380
200 $\Omega$ /V $\pm 1\%$	100 $\Omega$ /A $\pm 10\%$	1 V/V $\pm 1\%$	100 mV/A $\pm 10\%$	70 ms	200 ms	9 s	40 ms	1–13 V	7% +1 V	11.3 kg/25 lb	13.6 kg/30 lb	5, 9, 11, 15, 28, 40	\$499
200 $\Omega$ /V $\pm 1\%$	500 $\Omega$ /A $\pm 10\%$	1 V/V $\pm 1\%$	0.33 V/A $\pm 10\%$	30 ms	80 ms	400 ms	100 ms	2.5–23 V	4% +2 V	12.7 kg/28 lb	17.7 kg/39 lb	9, 10, 11, 15, 28, 40	\$565
200 $\Omega$ /V $\pm 1\%$	500 $\Omega$ /A $\pm 10\%$	1 V/V $\pm 1\%$	0.33 V/A $\pm 10\%$	30 ms	80 ms	400 ms	100 ms	2.5–23 V	4% +2 V	6.4 kg/14 lb	7.2 kg/16 lb	9, 11, 15, 28, 40	\$296
200 $\Omega$ /V $\pm 1\%$	100 $\Omega$ /A $\pm 10\%$	1 V/V $\pm 1\%$	100 mV/A $\pm 10\%$	150 ms	150 ms	9 s	70 ms	2–22 V	7% +1 V	10.8 kg/26 lb	13.1 kg/29 lb	5, 9, 11, 15, 28	\$485
200 $\Omega$ /V $\pm 1\%$	500 $\Omega$ /A $\pm 10\%$	1 V/V $\pm 1\%$	0.33 V/A $\pm 10\%$	4 ms	10 ms	50 ms	15 ms	NA	NA	7.3 kg/16 lb	9.5 kg/21 lb	15, 28, 40	\$459
200 $\Omega$ /V $\pm 1\%$	1 V/A $\pm 10\%$ 2 V/A $\pm 10\%$	1 V/V $\pm 1\%$	1 V/A $\pm 10\%$ 2 V/A $\pm 10\%$	12 ms	30 ms	200 ms	30 ms	NA	NA	5.9 kg/13 lb	6.8 kg/15 lb	15, 28, 40	\$429
200 $\Omega$ /V $\pm 1\%$	500 $\Omega$ /A $\pm 10\%$	1 V/V $\pm 1\%$	0.66 V/A $\pm 10\%$	15 ms	45 ms	200 ms	40 ms	2.5–44 V	4% +2 V	12.7 kg/28 lb	17.7 kg/39 lb	9, 10, 11, 15, 28, 40	\$600
200 $\Omega$ /V $\pm 1\%$	500 $\Omega$ /A $\pm 10\%$	1 V/V $\pm 1\%$	0.66 V/A $\pm 10\%$	15 ms	45 ms	200 ms	40 ms	2.5–44 V	4% +2 V	6.4 kg/14 lb	7.2 kg/16 lb	9, 11, 15, 28, 40	\$310
200 $\Omega$ /V $\pm 1\%$	200 $\Omega$ /A $\pm 10\%$	1 V/V $\pm 1\%$	200 mV/A $\pm 10\%$	275 ms	275 ms	13 s	275 ms	6–43 V	7% +1 V	11.3 kg/25 lb	12.7 kg/28 lb	5, 9, 11, 15, 28	\$499
200 $\Omega$ /V $\pm 1\%$	500 $\Omega$ /A $\pm 10\%$	1 V/V	1 V/A	20 ms	65 ms	200 ms	50 ms	NA	NA	7.3 kg/16 lb	8.2 kg/18 lb	15, 28, 40	\$455
300 $\Omega$ /V $\pm 1\%$	1 k $\Omega$ /A $\pm 10\%$	1 V/V $\pm 1\%$	1 V/A $\pm 10\%$	25 ms	80 ms	2 s	175 ms	5–65 V	4% +2 V	5.9 kg/13 lb	6.8 kg/15 lb	9, 11, 15, 28, 40	\$330
300 $\Omega$ /V $\pm 1\%$	500 $\Omega$ /A $\pm 10\%$	1 V/V $\pm 1\%$	333 mV/A $\pm 10\%$	600 ms	600 ms	5 s	1.1 s	5–66 V	7% +1 V	11.3 kg/25 lb	12.7 kg/28 lb	5, 9, 11, 15, 28	\$499
300 $\Omega$ /V $\pm 1\%$	1 k $\Omega$ /A $\pm 10\%$	1 V/V $\pm 1\%$	1.3 V/A $\pm 10\%$	25 ms	200 ms	1.5 s	200 ms	20–106 V	4% +2 V	5.9 kg/13 lb	6.8 kg/15 lb	11, 15, 28, 40	\$345

$\Delta$  See page 220 for complete option and accessory descriptions.

\*Up = increasing output voltage. NL = No output load current. FL = Full rated output load current.

# POWER SUPPLIES

General purpose: 120–2000 W output

Models 6256B–6274B & 895A

- Built-in overvoltage protection\*
- Constant voltage/constant current operation
- Remote programming and sensing
- Remote sensing
- Auto-series, -parallel, and -tracking operation
- $\leq 50 \mu\text{sec}$  load transient recovery

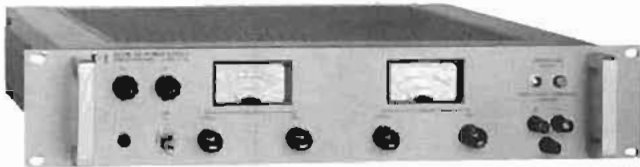

6263B, 6265B, 6266B, 6271B

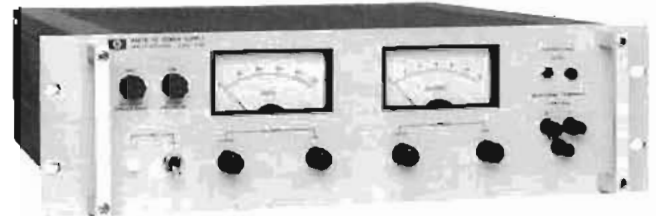

6256B, 6264B, 6267B

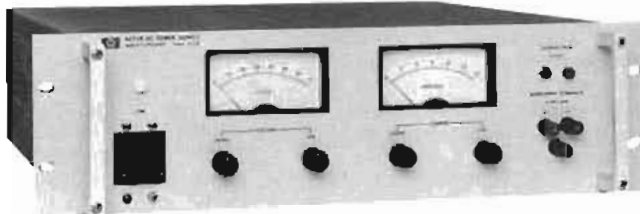

6274B



895A

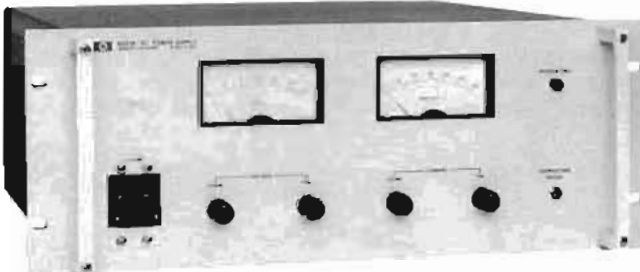

6259B, 6260B, 6261B, 6268B, 6269B

## Models 6256B–6274B

This series of high-performance Constant Voltage/Constant Current supplies includes thirteen models with output ratings from 10 to 60 V. All models employ a transistor series-regulator/triac-preregulator circuit to achieve high efficiency, excellent regulation, low ripple and noise, and moderate programming speeds in a compact full-rack width package.

Separate coarse and fine voltage and current controls allow the voltage and current outputs to be varied from zero to the maximum rated value. Crossover from constant voltage to constant current operation occurs automatically when the load current exceeds the value established by the current control settings.

\*These six features apply to 6256B–6274B Only.

## Specifications†

RATINGS		PERFORMANCE									
DC Output		Model	Load Effect		Source Effect		PAR (rms/p-p)		Drift (stability)		
Volts	Amps		Voltage	Current	Voltage	Current	Voltage	Current	Voltage	Current	
0–10	0–20	6266B	0.01% + 200 $\mu\text{V}$	0.02% + 500 $\mu\text{A}$	0.01% + 200 $\mu\text{V}$	0.02% + 500 $\mu\text{A}$	200 $\mu\text{V}/10 \text{ mV}$	5 mA rms	0.03% + 500 $\mu\text{V}$	0.03% + 6 mA	
0–10	0–50	6259B	0.01% + 200 $\mu\text{V}$	0.02% + 1 mA	0.01% + 200 $\mu\text{V}$	0.02% + 1 mA	500 $\mu\text{V}/5 \text{ mV}$	25 mA rms	0.03% + 2 mV	0.03% + 10 mA	
0–10	0–100	6280B	0.01% + 200 $\mu\text{V}$	0.02% + 2 mA	0.01% + 200 $\mu\text{V}$	0.02% + 2 mA	500 $\mu\text{V}/5 \text{ mV}$	50 mA rms	0.03% + 2 mV	0.03% + 20 mA	
0–20	0–10	6263B	0.01% + 200 $\mu\text{V}$	0.02% + 500 $\mu\text{A}$	0.01% + 200 $\mu\text{V}$	0.02% + 500 $\mu\text{A}$	200 $\mu\text{V}/10 \text{ mV}$	3 mA rms	0.03% + 500 $\mu\text{V}$	0.03% + 6 mA	
0–20	0–20	6264B	0.01% + 200 $\mu\text{V}$	0.02% + 500 $\mu\text{A}$	0.01% + 200 $\mu\text{V}$	0.02% + 500 $\mu\text{A}$	200 $\mu\text{V}/10 \text{ mV}$	5 mA rms	0.03% + 500 $\mu\text{V}$	0.03% + 6 mA	
0–20	0–50	6261B	0.01% + 200 $\mu\text{V}$	0.02% + 1 mA	0.01% + 200 $\mu\text{V}$	0.02% + 1 mA	500 $\mu\text{V}/5 \text{ mV}$	25 mA rms	0.03% + 2 mV	0.03% + 10 mA	
0–40	0–3	6265B	0.01% + 200 $\mu\text{V}$	0.02% + 500 $\mu\text{A}$	0.01% + 200 $\mu\text{V}$	0.02% + 500 $\mu\text{A}$	200 $\mu\text{V}/10 \text{ mV}$	3 mA rms	0.03% + 500 $\mu\text{V}$	0.03% + 3 mA	
0–40	0–5	6266B	0.01% + 200 $\mu\text{V}$	0.02% + 500 $\mu\text{A}$	0.01% + 200 $\mu\text{V}$	0.02% + 500 $\mu\text{A}$	200 $\mu\text{V}/10 \text{ mV}$	3 mA rms	0.03% + 500 $\mu\text{V}$	0.03% + 3 mA	
0–40	0–10	6267B	0.01% + 200 $\mu\text{V}$	0.02% + 500 $\mu\text{A}$	0.01% + 200 $\mu\text{V}$	0.02% + 500 $\mu\text{A}$	200 $\mu\text{V}/10 \text{ mV}$	3 mA rms	0.03% + 2 mV	0.03% + 3 mA	
0–40	0–30	6288B	0.01% + 200 $\mu\text{V}$	0.02% + 2 mA	0.01% + 200 $\mu\text{V}$	0.02% + 2 mA	1 mV/5 mV	20 mA rms	0.03% + 2 mV	0.03% + 5 mA	
0–40	0–50	6289B	0.01% + 200 $\mu\text{V}$	0.02% + 2 mA	0.01% + 200 $\mu\text{V}$	0.02% + 2 mA	1 mV/5 mV	25 mA rms	0.03% + 2 mV	0.03% + 10 mA	
0–60	0–3	6271B	0.01% + 200 $\mu\text{V}$	0.02% + 500 $\mu\text{A}$	0.01% + 200 $\mu\text{V}$	0.02% + 500 $\mu\text{A}$	200 $\mu\text{V}/10 \text{ mV}$	3 mA rms	0.03% + 500 $\mu\text{V}$	0.03% + 3 mA	
0–60	0–15	6274B	0.01% + 200 $\mu\text{V}$	0.02% + 500 $\mu\text{A}$	0.01% + 200 $\mu\text{V}$	0.02% + 500 $\mu\text{A}$	200 $\mu\text{V}/20 \text{ mV}$	5 mA rms	0.03% + 2 mV	0.03% + 5 mA	
0–320	0–1.5	895A	0.007% or 20 mV	—	0.007% or 20 mV	—	1 mV rms	—	0.1% + 5 mV	—	

† Refer to page 201 for complete specification definitions.

Additional features include built-in overvoltage crowbar protection; remote error sensing; and auto-series, auto-parallel, and auto-tracking operation. The crowbar trip point adjustment and associated overvoltage indicator are conveniently located on the front panel.

Auto-series, auto-parallel, and auto-tracking connections should ordinarily include no more than three supplies. If a specific application requires the use of more than three supplies in any of the three connections, consult your local HP Field Engineer for additional information.

All dc output, ac input, sensing, control, and programming connections are made to rear-panel terminals. Either the positive or negative output terminal may be grounded or the supplies may be operated floating at up to 300 volts above ground. Models 6256B, 6263B, 6264B, 6265B, 6266B, 6267B, and 6271B are convection cooled. All other models in this series employ cooling fans.

### Model 895A

Model 895A is a general purpose Constant-Voltage/Current-Limit supply. Output voltage is adjustable from 0–320 V via a front panel 10-turn potentiometer with concentric lock and a single-turn fine control. Separate voltage and current meters provide continuous indication of power supply outputs. High performance specifications include 0.007% line and load regulation and 1 mV rms ripple and noise. Remote sensing and programming are standard features.

#### Accessories and options

The accessories and options available for use with Models 6256B–6274B, 895A are listed on page 220.

### Specifications—general

**Load effect transient recovery:** time—50  $\mu$ sec. Level—10 mV  
**Resolution:** voltage control—less than 0.02%. Current control—less than 0.15%.

**Temperature coefficient per °C:** 0.01% of output plus 200  $\mu$ V (895A—0.03% + 1.5 mV).

**Temperature ratings:** operating, 0 to 55°C; Storage, –40 to 75°C.

**Remote control programming:** these power supplies are capable of being programmed in constant voltage and constant current operation by using an external resistance or DC voltage with coefficients as shown in the table below.

Rear terminal wiring configurations for remote control operation are specified in the operation and service manual supplied with the power supply. For remote control programming procedures and timing considerations, contact your local HP field engineer.

**Power:** input voltage is 115 V ac or 230 V ac  $\pm$ 10%, 57–63 Hz. For other input voltage and frequency options available, see option listing below and page 220. Standard input voltage, maximum input current, and maximum power are: 6256B, 115 V ac, 5 A, 375 W†; 6259B, 230 V ac, 6 A, 850 W†; 6260B, 230 V ac, 12 A, 1600 W†; 6261B, 230 V ac, 12 A, 1500 W†; 6263B, 115 V ac, 4.5 A, 350 W\*; 6264B, 115 V ac, 8 A, 600 W†; 6265B, 115 V ac, 3 A, 180 W\*; 6266B, 115 V ac, 4 A, 325 W\*; 6267B, 115 V ac, 8 A, 550 W†; 6268B, 230 V ac, 12 A, 1600 W†; 6269B, 230 V ac, 18 A, 2500 W†; 6271B, 115 V ac, 4 A, 300 W\*; 6274B, 115 V ac, 15 A, 1200 W†; 895A, 115 V ac, 8.7 A, 585 W†.

\*Three-wire, five-foot AC power cord included with power supply.

†Three-terminal barrier strip provided on power supply for AC power connections.

**Size:** 6263B, 6265B, 6266B, 6271B: 83.7 H  $\times$  483 W  $\times$  479.4 mm D (3.296"  $\times$  19"  $\times$  18.875"). 6256B, 6264B, 6267B, 6274B: 127 H  $\times$  483 W  $\times$  479.4 mm D (5.00"  $\times$  19"  $\times$  18.875"). 6259B, 6260B, 6261B, 6268B, 6269B: 173 H  $\times$  483 W  $\times$  479.4 mm D; (6.812"  $\times$  19"  $\times$  18.875") 895A: 128.6 H  $\times$  483 W  $\times$  463.6 mm D (5.062"  $\times$  19"  $\times$  18.25").

**Typical output impedance:** approximated by a resistance in series with an inductance: 6256B, 0.1 m $\Omega$ , 1  $\mu$ H; 6259B, 50  $\mu$  $\Omega$ , 1  $\mu$ H; 6260B, 20  $\mu$  $\Omega$ , 1  $\mu$ H; 6261B, 100  $\mu$  $\Omega$ , 1  $\mu$ H; 6263B, 500  $\mu$  $\Omega$ , 1  $\mu$ H; 6264B, 200  $\mu$  $\Omega$ , 1  $\mu$ H; 6265B, 2 m $\Omega$ , 1  $\mu$ H; 6266B, 1 m $\Omega$ , 1  $\mu$ H; 6267B, 500  $\mu$  $\Omega$ , 1  $\mu$ H; 6268B, 200  $\mu$  $\Omega$ , 1  $\mu$ H; 6269B, 100  $\mu$  $\Omega$ , 1  $\mu$ H; 6271B, 5 m $\Omega$ , 1  $\mu$ H; 6274B, 1 m $\Omega$ , 1  $\mu$ H; 895A, 40 m $\Omega$ , 16  $\mu$ H.

### Specifications, continued

REMOTE CONTROL FEATURES								GENERAL					
Resistance Coeff.		Voltage Coeff.		Speed Up*		Speed Down*		Overvoltage		Weight		Options $\Delta$	Price
Voltage	Current	Voltage	Current	NL	FL	NL	FL	Range	Margin	Net	Shipping		
200 $\Omega/V \pm 1\%$	10 $\Omega/A \pm 10\%$	1 V/V $\pm 1\%$	25 mV/A $\pm 10\%$	60 ms	60 ms	5 sec	100 ms	2–12 V	5% + 1 V	15.8 kg/35 lb	18.1 kg/40 lb	5, 9, 10, 15, 22, 27, 28, 40	\$679
200 $\Omega/V \pm 1\%$	4 $\Omega/A \pm 10\%$	1 V/V $\pm 1\%$	10 mV/A $\pm 10\%$	70 ms	70 ms	200 ms	100 ms	2–12 V	5% + 2 V	31.3 kg/69 lb	35.3 kg/78 lb	5, 9, 10, 15, 22, 26, 27, 40	\$1050
200 $\Omega/V \pm 1\%$	2 $\Omega/A \pm 10\%$	1 V/V $\pm 1\%$	5 mV/A $\pm 10\%$	70 ms	70 ms	200 ms	75 ms	2–12 V	5% + 2 V	43.9 kg/97 lb	48 kg/106 lb	5, 9, 10, 15, 16, 22, 27, 40	\$1160
200 $\Omega/V \pm 1\%$	100 $\Omega/A \pm 10\%$	1 V/V $\pm 1\%$	50 mV/A $\pm 10\%$	150 ms	150 ms	7 sec	350 ms	2–23 V	5% + 1 V	15.4 kg/34 lb	18.6 kg/41 lb	5, 9, 10, 15, 22, 27, 28, 40	\$433
200 $\Omega/V \pm 1\%$	10 $\Omega/A \pm 10\%$	1 V/V $\pm 1\%$	25 mV/A $\pm 10\%$	140 ms	140 ms	10 sec	180 ms	2.5–23 V	5% + 1 V	21.3 kg/47 lb	24.5 kg/54 lb	5, 9, 10, 15, 22, 27, 28, 40	\$720
200 $\Omega/V \pm 1\%$	4 $\Omega/A \pm 10\%$	1 V/V $\pm 1\%$	10 mV/A $\pm 10\%$	150 ms	150 ms	250 ms	250 ms	2–23 V	5% + 2 V	35.3 kg/78 lb	39.4 kg/87 lb	5, 9, 10, 15, 22, 26, 27, 40	\$1080
200 $\Omega/V \pm 1\%$	300 $\Omega/A \pm 10\%$	1 V/V $\pm 1\%$	167 mV/A $\pm 10\%$	275 ms	275 ms	12 sec	1.5 sec	2.5–45 V	5% + 1 V	15.4 kg/34 lb	18.6 kg/41 lb	5, 9, 10, 15, 22, 27, 28, 40	\$560
200 $\Omega/V \pm 1\%$	200 $\Omega/A \pm 10\%$	1 V/V $\pm 1\%$	100 mV/A $\pm 10\%$	275 ms	275 ms	13 sec	1.5 sec	2.5–45 V	5% + 1 V	15.4 kg/34 lb	18.6 kg/41 lb	5, 9, 10, 15, 22, 27, 28, 40	\$633
200 $\Omega/V \pm 1\%$	100 $\Omega/A \pm 10\%$	1 V/V $\pm 1\%$	50 mV/A $\pm 10\%$	275 ms	275 ms	13 sec	750 ms	2.5–45 V	5% + 1 V	17.7 kg/39 lb	20.8 kg/46 lb	5, 9, 10, 15, 22, 27, 28, 40	\$720
200 $\Omega/V \pm 1\%$	6 $\Omega/A \pm 10\%$	1 V/V $\pm 1\%$	16.7 mV/A $\pm 10\%$	300 ms	300 ms	1 sec	650 ms	4–45 V	5% + 1 V	34.4 kg/76 lb	38.1 kg/84 lb	5, 9, 10, 15, 22, 26, 27, 40	\$1060
200 $\Omega/V \pm 1\%$	4 $\Omega/A \pm 10\%$	1 V/V $\pm 1\%$	10 mV/A $\pm 10\%$	350 ms	350 ms	1 sec	600 ms	4–45 V	5% + 1 V	40.3 kg/89 lb	44 kg/98 lb	5, 9, 10, 15, 22, 27, 40	\$1110
300 $\Omega/V \pm 1\%$	300 $\Omega/A \pm 10\%$	1 V/V $\pm 1\%$	167 mV/A $\pm 10\%$	600 ms	600 ms	7 sec	2 sec	6–56 V	5% + 1 V	15.4 kg/34 lb	18.6 kg/41 lb	5, 9, 10, 15, 22, 27, 28, 40	\$600
300 $\Omega/V \pm 1\%$	67 $\Omega/A \pm 10\%$	1 V/V $\pm 1\%$	33.3 mV/A $\pm 10\%$	600 ms	600 ms	40 sec	800 ms	6–66 V	5% + 1 V	21.7 kg/48 lb	24.5 kg/54 lb	5, 9, 10, 15, 22, 27, 28, 40	\$840
300 $\Omega/V$	—	—	—	—	—	—	—	NA	NA	22.8 kg/50 lb	29.4 kg/65 lb	—	\$895

\*Up = increasing output voltage. NL = No output load current. FL = Full rated output load current  
 $\Delta$ : See page 220 for complete option and accessory descriptions.

# POWER SUPPLIES

General purpose: 300—11,000 W output

Models 6427B—6483C

- Outstanding value—low cost/watt
- Up to 75% efficiency at full output
- Constant voltage/current operation

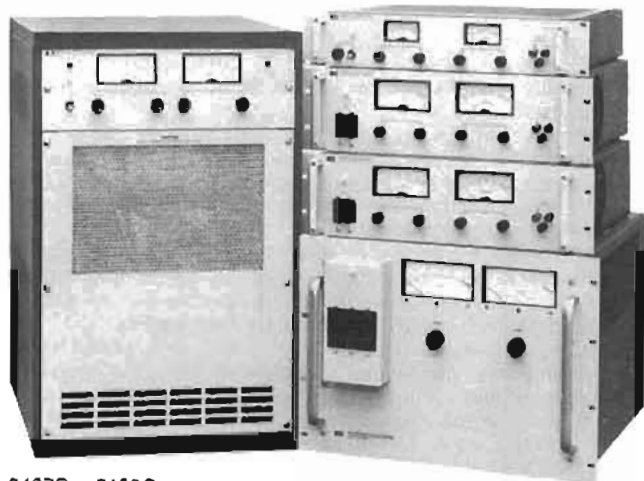

6427B—6483C

## Description

This series of SCR-regulated power supplies is designed for high-power applications requiring a fixed or variable DC source with moderate regulation and ripple. For supplies with better regulation, faster response time, and lower ripple, see models 6256B-6274B and 895A, on page 208.

## Operating features

All supplies in this series are of the Constant-Voltage/Constant-Current type. Large easy-to-read panel meters continuously monitor output voltage and current.

## Specifications†

RATINGS		PERFORMANCE								
DC Output		Model	Load Effect		Source Effect			PARO $\Delta$ p-p/rms	Temperature Coefficient	Drift
Volts§	Amps§		Voltage	Current	Voltage	Current	PARO $\Delta$ p-p/rms			
0-8	0-1000	6464C	0.05% +5 mV	0.1% +1 A	0.05% +5 mV	0.1% +1 A	80 mV/1V	0.03% +100 $\mu$ V	0.3% +1 mV	
0-15	0-200	6453A	0.2% +10 mV††	1% or 2 A††	0.2% +10 mV††	1% or 2 A††	150 mV rms	0.05% +2 mV	0.25% +10 mV	
0-16 or 32*	0-600 or 500*	6466C	0.05% +5 mV	0.1% +0.6 A	0.05% +5 mV	0.1% +0.6 A	160 mV/1 V	0.03% +200 $\mu$ V	0.2% +1 mV	
0-20	0-15	6427B	20 mV	150 mA	10 mV	150 mA	40 mV/400 mV	0.05% +5 mV	0.15% +15 mV	
0-20	0-45	6428B	40 mV	450 mA	20 mV	450 mA	40 mV/500 mV	0.05% +5 mV	0.15% +15 mV	
0-36	0-10	6433B	36 mV	100 mA	18 mV	100 mA	36 mV/400 mV	0.03% +5 mV	0.1% +15 mV	
0-36	0-100	6456B	0.2% +10 mV††	1% or 1 A††	0.2% +10 mV††	1% or 1 A††	180 mV rms	0.05% +2 mV	0.25% +10 mV	
0-36	0-300	6489C	0.05% +5 mV	0.1% +0.3 A	0.05% +5 mV	0.1% +0.3 A	180 mV/1 V	0.03% +400 $\mu$ V	0.15% +1 mV	
0-40	0-25	6434B	40 mV	200 mA	18 mV	200 mA	40 mV/500 mV	0.03% +5 mV	0.1% +20 mV	
0-60	0-5	6438B	60 mV	50 mA	30 mV	50 mA	120 mV/400 mV	0.03% +10 mV	0.1% +30 mV	
0-60	0-15	6439B	120 mV	150 mA	60 mV	150 mA	60 mV/500 mV	0.03% +10 mV	0.1% +30 mV	
0-64	0-50	6459A	0.2% +10 mV††	1% or 0.5 A††	0.2% +10 mV††	1% or 0.5 A††	160 mV rms	0.05% +2 mV	0.25% +10 mV	
0-64	0-150	6472C	0.05% +100 mV	0.1% +0.15 A	0.05% +100 mV	0.1% +0.15 A	160 mV/2V	0.03% +4 mV	0.15% +16 mV	
0-110	0-100	6475C	0.05% +100 mV	0.1% +0.1 A	0.05% +100 mV	0.1% +0.1 A	220 mV/2 V	0.03% +5 mV	0.15% +20 mV	
0-120	0-2.5	6443B	120 mV	25 mA	60 mV	25 mA	240 mV/400 mV	0.03% +20 mV	0.1% +60 mV	
0-220	0-50	6477C	0.05% +100 mV	0.1% +50 mA	0.05% +100 mV	0.1% +50 mA	330 mV/2 V	0.03% +8 mV	0.15% +35 mV	
0-300	0-35	6479C	0.05% +100 mV	0.1% +35 mA	0.05% +100 mV	0.1% +35 mA	330 mV/3 V	0.03% +11 mV	0.15% +45 mV	
0-440, 500 or 600	0-25, 20, 15*	6483C	0.05% +100 mV	0.1% +35 mA	0.05% +100 mV	0.1% +35 mA	600 mV/5 V	0.03% +20 mV	0.15% +80 mV	
1-600	5 mA-1.5 A	6448B	1 V	40 mA	600 mV	15 mA	600 mV/2 V	0.03% +100 mV	0.1% +300 mV	

††Refer to page 201 for complete specification definitions.

††Specified for combined line and load regulation.

‡ For operation with a 50 Hz input (possible only with Option 05), the rms ripple and transient response specifications are increased by 50%.

\* The output current rating is given in the same order corresponding with the voltage rating.

Input and output power, remote sensing, remote programming, and auto-series, -parallel, and -tracking connections are made to bus bars and terminal blocks on the rear panel.

## Protective features

In addition to the overload protection inherent in Constant Voltage/Constant Current operation, there are many other built-in protective features included in these supplies. The features vary within the three model classifications as follows:

**6427B-6448B:** (1) Reverse voltage protection. (2) Fused AC input.

**6453A, 6456B, 6459A:** (1) AC line loss protection circuit monitors 3-phase input and cuts off SCR's and opens output bus if a phase drops out; operation resumes when AC input returns to normal. (2) 3-phase input circuit breaker. (3) Optional internal crowbar (Option 006) protects load from overvoltage condition.

**6464C-6483C:** (1) High-temperature protection thermostat opens input to power transformer and lights front panel indicator if supply overheats. (2) Prolonged overload protection circuit is activated and lights front panel indicator if output current exceeds approximately 115% of maximum rating. (3) Optional internal crowbar (except on 6464C) protects load from overvoltage condition. (4) Turn-on circuit limits peak line current during start-up into low impedance loads. (5) Phase-balance circuit permits operation with line-to-line input voltage imbalance up to 8%. (6) Overcurrent and over-voltage circuits of master and slave supplies used in auto-series, -parallel, or -tracking operation can be interlocked.

## Auto-series, -parallel, -tracking operation

Supplies may be connected in auto-series, or auto-tracking. (Except 6448B and 6483C, which cannot be connected in auto-series.)

Up to three lower power models (6427B-6448B) may be connected in any of the above configurations. Higher-power model (6453A/6483C) interconnection should ordinarily include no more than two supplies.

## Remote sensing

Remote sensing permits regulation at the load connection, rather than at the output terminals of the power supply. In all cases, there are limits to the permissible load-lead voltage drops, as follows:

Models 6427B-6448B: 2 volts in negative output lead.

Models 6453A, 6456B, 6459A: 1 volt in negative output lead.

Models 6464C-6483C: 3 volts in negative output lead.

§ Under light loading conditions, power supply may not meet all published specifications. The graph on the next page defines the permissible operating regions for CV and CC modes of operation.

For operation with a 50 Hz input (possible only with Option 05), output current is linearly derated from 100% at 40°C to 80% at 50°C.

POWER SUPPLY OUTPUT RESTRICTIONS AS A FUNCTION OF LOADING

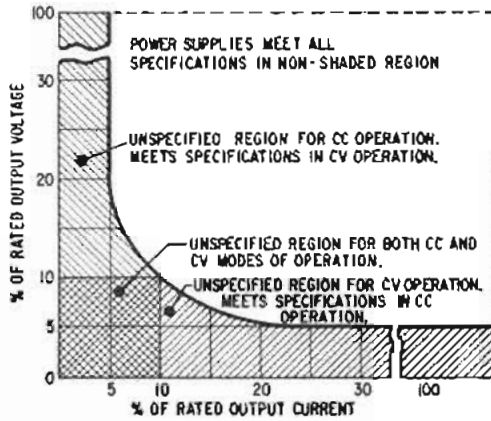

**Remote programming**

The voltage and current outputs of the supplies can be programmed by a remote resistance, or, for most models, a voltage source. Programming speeds and coefficients are detailed in the specifications table.

**AC power requirements**

The AC power requirements vary with the three model classifications (see option listings). When powered from a 50 Hz source (possible with Option 005), the rms ripple and transient response specifications increase by 50%. The p-p ripple specification is unchanged by line frequency.

**Dimensions**

Models 6427B, 6433B, 6438B and 6443B: 89 H x 483 W x 445 mm D (3 1/2" x 19" x 17 1/2").

**Specifications, continued**

Models 6428B, 6434B, 6439B, & 6448B: 133 H x 483 W x 426 mm D (5 1/4" x 19" x 16 1/4").

Models 6453A, 6456B, & 6459A: 356 H x 483 W x 464 mm D (14" x 19" x 18 1/4").

Models 6484C, 6466C, 6489C, 6472C, 6475C, 6477C, 6479C, & 6483C: 667 H x 426 W x 664 mm D (26 1/4" x 19" x 26 1/8").

**Options**

**AC, Input power**

6427B-6448B

Std: 115 V ac, ±10%, single phase, 57-63 Hz

027: 208 V ac, ±10%, single phase, 57-63 Hz

028: 230 V ac, +10%, single phase, 57-63 Hz

005: realignment for 50 Hz operation

6453A, 6456B, 6459A: AC input connections are by means of a 4-conductor connector at rear of unit. A matching Hubbell No. 7413G plug (HP part number 1251-1570) is furnished.

001: 208 V ac, ±10%, 3-phase, 15.5 A/phase, 57-73 Hz

002: 230 V ac, ±10%, 3-phase, 14 A/phase, 57-63 Hz

031: 380 V ac, ±10%, 3-phase, 8.5 A/phase, 57-63 Hz

032: 400 V ac, ±10%, 3-phase, 8.0 A/phase, 57-63 Hz

003: 460 ac, ±10%, 3-phase, 7 A/phase, 57-63 Hz

005: realignment for 50 Hz operation

6484C-6483C: AC input connections are by means of enclosed 4-wire terminal block.

001: 208 V ac, ±10%, 3-phase, 55 A/phase, 57-63 Hz

002: 230 V ac, ±10%, 3-phase, 50 A/phase, 57-63 Hz

031: 380 V ac, ±10%, 3-phase, 30 A/phase, 57-63 Hz

032: 400 V ac, ±10%, 3-phase, 28.5 A/phase, 57-63 Hz

003: 460 V ac, ±10%, 3-phase, 25 A/phase, 57-63 Hz

005: realignment for 50 Hz operation

006: internal overvoltage protection crowbar

6459A, 6477C, 6479C, 6483C

6453A, 6456B

6472C, 6475C

6469C

6466C

**Price**

N/C

N/C

N/C

N/C

N/C

N/C

add \$55

add \$55

N/C

N/C

N/C

N/C

add \$200

add \$200

add \$210

N/C

add \$345

add \$395

add \$460

add \$510

add \$570

REMOTE CONTROL												GENERAL			
Resolution V C		Load Transient Recovery <sup>b</sup>	Resistance Coefficient		Voltage Coefficient		Up		Down		Net		Options <sup>▲</sup>	Price	
			Voltage	Current	Voltage	Current	HL	FL	HL	FL	Kg	lb			
6 mV	1 A	100 ms, 500 mV	200Ω/V ±2%	1Ω/A ±2%	1 V/V ±1%	6.2 mV/A ±7%	1.6 s	0.6 s	6 s	0.1 s	235	518	1, 2, 3, 5, 23, 31, 32	\$4530	
65 mV	1 A	50 ms, 150 mV	200Ω/V ±2%	1Ω/A	0.4 V/V	30 mV/A	1 s	0.5 s	20 s	0.2 s	108	238	1, 2, 3, 5, 6, 10, 31, 32	\$1980	
18 mV	0.5 A	100 ms, 500 mV	200Ω/V ±2%	1.66Ω/A ±2%	1 V/V ±1%	10.3 mV/A ±7%	1.6 s	0.6 s	15 s	0.2 s	226	500	1, 2, 3, 5, 6, 23, 31, 32	\$3910	
10 mV	7.5 mA	200 ms, 200 mV	200Ω/V ±2%	20Ω/A	1 V/V	NA	0.3 s	1.4 s	100 s	1.4 s	16.3	36	5, 10, 27, 28	\$540	
10 mV	22.5 mA	200 ms, 200 mV	200Ω/V ±2%	6Ω/A	1 V/V	NA	0.2 s	0.7 s	65 s	0.7 s	30.4	67	6, 10, 27, 28	\$780	
9 mV	5 mA	200 ms, 200 mV	200Ω/V ±2%	30Ω/A	1 V/V	NA	0.3 s	1.4 s	110 s	1.4 s	14.9	33	5, 10, 27, 28	\$535	
90 mV	0.5 A	50 ms, 300 mV	200Ω/V ±2%	2Ω/A	166 mV/V	60 mV/A	1 s	0.5 s	60 s	0.5 s	108	238	1, 2, 3, 5, 6, 10, 31, 32	\$1850	
36 mV	0.3 A	100 ms, 500 mV	200Ω/V ±2%	3.33Ω/A ±2%	1 V/V	20.6 mV/A ±7%	1.6 s	3 s	20 s	0.5 s	226	500	1, 2, 3, 5, 6, 23, 31, 32	\$3680	
10 mV	12.5 mA	200 ms, 200 mV	200Ω/V ±2%	12Ω/A	1 V/V	NA	0.3 s	1.2 s	75 s	1.2 s	30.4	67	5, 10, 27, 28	\$745	
9 mV	2.5 mA	200 ms, 300 mV	300Ω/V ±2%	60Ω/A	1 V/V	NA	0.5 s	2.5 s	200 s	2.5 s	14	31	5, 10, 27, 28	\$540	
9 mV	7.5 mA	200 ms, 600 mV	300Ω/V ±2%	20Ω/A	1 V/V	NA	0.3 s	1.3 s	75 s	1.3 s	27.6	61	5, 10, 27, 28	\$690	
110 mV	0.25 A	50 ms, 600 mV	300Ω/V ±2%	4Ω/A	94 mV/V	120 mV/A	1 s	0.5 s	45 s	0.7 s	108	238	1, 2, 3, 5, 6, 10, 31, 32	\$1850	
64 mV	0.15 mA	100 ms, 750 mV	300Ω/V ±2%	6.7Ω/A ±2%	1 V/V ±3%	41.2 mV/A ±7%	1.4 s	2.5 s	55 s	0.7 s	226	500	1, 2, 3, 5, 6, 23, 31, 32	\$3680	
22 mV	0.1 A	100 ms, 1 V	300Ω/V ±2%	10Ω/A ±2%	1 V/V ±3%	62 mV/A ±7%	1.5 s	2 s	80 s	0.7 s	226	500	1, 2, 3, 5, 6, 23, 31, 32	\$3550	
30 mV	1.3 mA	200 ms, 600 mV	300Ω/V ±2%	120Ω/A	1 V/V	NA	0.5 s	2 s	210 s	2 s	14	31	5, 10, 27, 28	\$500	
44 mV	50 mA	100 ms, 2 V	300Ω/V ±2%	20Ω/A ±2%	1 V/V ±3%	124 mV/A ±7%	1.5 s	2 s	95 s	1 s	226	500	1, 2, 3, 5, 6, 23, 31, 32	\$3450	
60 mV	35 mA	100 ms, 3 V	300Ω/V ±2%	28.6Ω/A ±2%	1 V/V ±3%	177 mV/A ±7%	1.5 s	2 s	75 s	1.6 s	226	500	1, 2, 3, 5, 6, 23, 31, 32	\$3550	
60 mV	25 mA	100 ms, 5 V	300Ω/V ±2%	40Ω/A ±2%	1 V/V ±3%	0.25 V/A ±7%	1.5 s	2 s	120 s	2 s	226	500	1, 2, 3, 5, 6, 23, 31, 32	\$3910	
60 mV	0.75 mA	200 ms, 3 V	300Ω/V ±2%	600Ω/A	1 V/V	NA	0.2 s	1 s	45 s	2 s	27.6	61	5, 10, 27, 28	\$720	

<sup>b</sup>For operation with a 50 Hz input (possible only with Option 005), the rms ripple and transient response specifications are increased by 50%.

<sup>▲</sup>See page Z20 for complete option and accessory descriptions.

# POWER SUPPLIES

## General Purpose: HP-IB Programmer

### Model 59501A

- HP-IB power supply control
- HP-IB-to-power-supply isolation
- Programmable range



HP-IB

### Description

The 59501A is an isolated digital-to-analog converter designed to provide a convenient interface between the Hewlett-Packard Interface Bus and HP power supplies. With the 59501A, a wide range of DC voltages and currents becomes automatically controllable via the HP-IB. With proper wiring, the built-in isolation devices protect other instrumentation on the HP-IB from damage that could be caused by power supply outputs. In addition, an internal control circuit holds the output level near zero until programmed data is received. A programmable High/Low range control improves resolution by ten-to-one.

Power supply control is accomplished through the 59501A's programmable output voltage and programming network (see figure 1). By making the appropriate connections between the 59501A's rear terminals and the remote programming terminals on the supply, the output voltage (or current) of the supply can be programmed from zero to its full rated output. The 59501A front panel controls provide fast and easy calibration of power supply outputs. The Zero Adjust enables the user to correct for small offsets in power supply response to programmed inputs. The Power Supply Full Scale Adjust (part of programming network) enables the user to set the maximum output desired from the power supply when the 59501A is programmed to its maximum value. For example, this adjustment would normally be used to calibrate the maximum programmable output of a 320Vdc power supply to 320 volts. However, it could also be used to set the maximum to 200 volts.

In addition to its ability to program power supplies, the 59501A also can be used directly as a low level DC signal source. Unipolar and bipolar output modes are available with output voltages programmable from zero to 9.99 volts, or minus 10.0 to plus 9.98 volts. Output current up to 10 millamps is available and is automatically limited to protect the 59501A and user equipment. The 59501A produces a full scale voltage change in approximately 250  $\mu$ sec from the time the digital data is received

- Programmable 10-volt DC output
- Unipolar/Bipolar operation
- Fast digital to analog conversion

### Specifications

#### Digital to Analog Converter

**DC Output voltage:** programmable in high or low ranges within the voltage limits shown below. Output mode is unipolar or bipolar and is selected by a rear panel switch.

**Unipolar:** 0 to 9.99 V (low range, 0 to 0.999 V).

**Bipolar:** -10 to +9.98 V, (low range, -1 to +0.998 V).

**DC Output current:** 10 mA maximum.

**PARD (Ripple and Noise):** 2 mV rms/10 mV p-p.

**Resolution:** unipolar, 10 mV (low range, 1 mV). Bipolar, 20 mV (low range, 2 mV).

**Accuracy:** specified at 23°C  $\pm$  5°C.

**Unipolar:** 0.1% + 5 mV (low range, 0.1% + 1 mV).

**Bipolar:** 0.1% + 10 mV (low range, 0.1% + 2 mV).

**Stability:** change in output over 8 hour interval under constant line, load, and ambient following a 30 minute warm-up. Stability is included in accuracy specification measurements over the temperature range indicated.

**Unipolar:** 0.04% + 0.5 mV (low range, 0.04% + 1 mV).

**Bipolar:** 0.04% + 1 mV (low range, 0.04% + 2 mV).

**Temperature Coefficient:** unipolar, 0.01%/°C + 0.5 mV/°C (low range, 0.01%/°C + 0.1 mV/°C). Bipolar, 0.01%/°C + 0.5 mV/°C (low range, 0.01%/°C + 0.1 mV/°C).

**Zero adjust:** plus or minus 250 millivolts.

**D/A Full scale adjust:** plus or minus 5%.

**Programming speed:** the time required for output to go from zero to 99% of programmed output change is 250  $\mu$ sec (measured with resistive load connected to output terminals).

#### Power Supply Programming

**Programming network specifications:** in the following specifications, M represents the calibrated full scale value of the supply being programmed and P is the actual programmed output. The full scale value (M) can be any value within the supply's output range and is calibrated with the 59501A programmed to its maximum high range output.

**Accuracy:** specified at 23°C  $\pm$  5°C.

**Unipolar:** 0.05% M + 0.25% P (low range, 0.01% M + 0.25% P).

**Bipolar:** 0.1% M + 0.25% P (low range, 0.02% M + 0.25% P).

**Isolation:** 600 Vdc between HP-IB data lines and output terminals.

**Temperature Coefficient:** 0.005% M/°C + 0.015% P/°C (low range, 0.01% M/°C + 0.015% P/°C).

**Programming resolution:** 0.1% M (low range, 0.01% M).

**Programming speed:** D/A programming speed plus the programming speed of the power supply.

#### General

**Temperature range:** operating: 0 to 55°C, Storage: -40 to 75°C.

**Power:** 100, 120, 220, or 240 Vac (16% -13%) 47-63 Hz, 10 VA (selectable on rear panel).

**Size:** 101.6 H x 212.9 W x 294.6 mm D (4" x 8.38" x 11.6")

**Weight:** Net 1.36 kg (3 lb). Shipping 1.81 kg (4 lb).

#### Ordering Information

59501A HP-IB Isolated D/A Power Supply Programmer

10631A HP-IB cable 1 m (3.3 ft)

10631B HP-IB cable 2 m (6.6 ft)

10631C HP-IB cable 4 m (13.2 ft)

#### Price

\$500

\$ 60

\$ 65

\$ 75

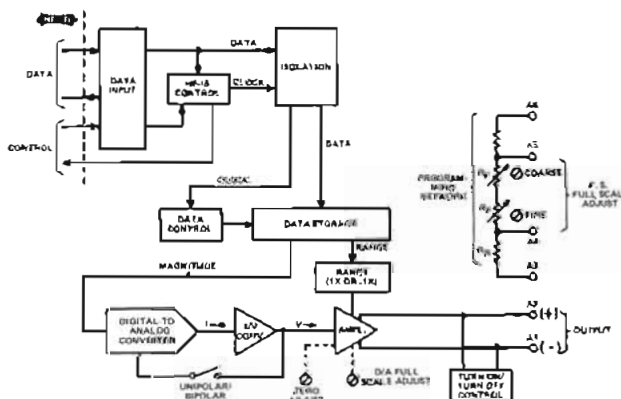



# POWER SUPPLIES

## General Purpose: 200 watt, extended range

### Model 6002A



- 200-watt extended range
- Constant-voltage/constant-current operation
- HP-IB programming option

- Built-in overvoltage protection crowbar
- CV/CC operating status indicators
- Remote analog programming and sensing



#### Description

The Model 6002A offers a new level of performance and usefulness in laboratory power supplies. It employs a unique regulation control concept that automatically yields a continuous span of voltage and current ratings within the basic 200-watt power rating boundary. This is beneficial in that more current is available at lower voltages, and higher voltages are available at a given current level than can be obtained from conventional 200-watt supplies.

Conventional 200-watt power supplies, rated for 50 volts or 20 volts can operate only within the shaded regions shown in Figure 1. The 6002A not only provides the outputs of the two conventional supplies, but also delivers the extra output capability shown between 20 and 50 volts.

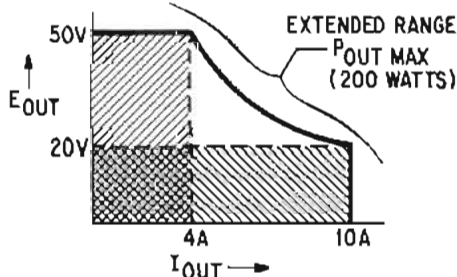

Figure 1.

This "extended range" capability of the 6002A provides the user with a single power supply that can cover a wide variety of applications in the lab or as a system component without his having to specify both the output voltage and current.

#### System features/remote control

Analog programming of output voltages and current can be accomplished through the use of remotely controlled resistance or voltage applied to rear panel terminals. Additional control terminals are provided for remote load voltage sensing, auto-series or parallel operation, and for remotely activating the crowbar circuit. A pulse pulse output from the crowbar terminal indicates the overvoltage circuit has been self-activated. A voltage step change appearing on terminal indicates a changeover to or from constant-current operation.

#### HP-IB option

Digital programming via Opt 001 permits control of output voltage or current by the Hewlett-Packard Interface Bus (HP-IB). Two programmable ranges allow better resolution below 10 volts or 2 amps. The selection of HP-IB control of either voltage or current is done by rear panel switches.

#### Specifications

**DC output:** voltage and current output can be adjusted over the ranges indicated by front panel controls, analog programming, or an optional HP-IB interface.

**Voltage:** 0-50 V. **Current:** 0-10 A.  
Maximum 200 Watts output from 20 V to 50 V.

**Load effect:** constant-voltage, 0.01% +1 mV. Constant-current, 0.01% +1 mA.

**Source effect:** CV, 0.01% +1 mV; CC, 0.01% +1 mA.

**PARD (ripple and noise):** rms/p-p, 20 Hz to 20 MHz; CV, 1 mV/10 mV; CC, 5 mA rms.

**Temperature coefficient:** CV, 0.02% +200  $\mu$ V/ $^{\circ}$ C; CC 0.02% +5 mA/ $^{\circ}$ C.

**Drift:** CV, 0.05% + 1 mV/8 hrs; CC, 0.05% + 5 mA/8 hrs.

**Resolution:** front panel controls: CV, 10 mV; CC, 10 mA.

**Output impedance:** approximately 0.5 m $\Omega$  in series with 1  $\mu$ H.

**Load transient recovery:** 100  $\mu$ s for output voltage to recover within 15 mV of nominal voltage setting following a load current change of 50% to 100% or 100% to 50% of full load current.

**Remote control coefficients:** resistance programming: CV, 1 k $\Omega$ /V  $\pm$ 7%. CC, 100 $\Omega$ /A  $\pm$ 7%. Voltage programming: CV 1 V/V  $\pm$ 20 mV. CC, 50 mV/A  $\pm$ 10%.

**Response time:** maximum time for output voltage to change between 0 to 99.9% or 100% to 0.1% of maximum rated output voltage. Up Programming: no load, 100 ms; full load, 100 ms. Down - Programming: no load, 400 ms; full load, 200 ms.

**Overvoltage protection:** trip voltage adjustable from 2.5 V to 60 V.

**DC output isolation:** 150 V dc.

**Power:** 100, 120, 220, or 240 V ac (-13%, +6%), 48-63 Hz.

**Temperature rating:** 0 $^{\circ}$ C to 55 $^{\circ}$ C operating, -40 $^{\circ}$ C to +75 $^{\circ}$ C storage. Supply is cooled by built-in fan.

**Size:** 180 H  $\times$  212 W  $\times$  422 mm D (6.97"  $\times$  8.36"  $\times$  16.6").

**Weight:** net, 14.5 kg (32 lb). Shipping, 15.9 kg (35 lb).

#### HP-IB Option

**Programmable ranges:** high (0-50 V or 0-10 A), low (0-10 V or 0-2 A).

**Programming speed:** same as response time.

**Accuracy:** Hi range: CV, 0.2% +25 mV; CC, 0.2% +25 mA.

Lo range: CV, 0.2% + 10 mV; CC, 0.2% +25 mA.

**Resolution:** Hi range: CV, 50 mV; CC, 10 mA.

Lo range: CV, 10 mV; CC, 2 mA.

**Isolation:** 250 Volts dc from bus data lines to power supply.

#### Options

**001:** HP-IB Interface

**Price**  
add \$350

6002A Extended Range DC Power Supply

\$800

# POWER SUPPLIES

General Purpose: dual-tracking outputs

Models 6227B & 6228B

- Two 50-watt power supplies for independent or tracking operation
- Built-in overvoltage protection crowbars

- Auto-parallel and auto-series capability
- Constant-current in addition to constant-voltage outputs



6227B

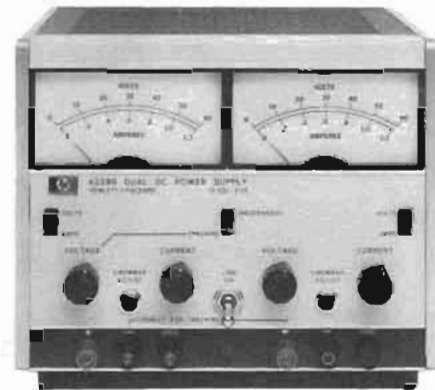

6228B

## Description

These versatile lab supplies each house two identical 50 W regulated power supplies. A convenient front panel switch selects either independent or tracking operation. In the tracking mode, the right supply tracks the left within  $0.2\% \pm 2$  mV. The tracking mode is especially useful for powering operational amplifiers, push-pull stages, deflection systems, or any application where plus and minus voltages must track with insignificant error. The independent mode permits operation of the two supplies individually, in auto-parallel or in auto-series.

Each side of the dual supply can be operated as a constant-voltage or constant-current source, and each has its own crowbar for over-voltage protection. In the tracking mode, an overvoltage condition in either supply trips both crowbars. The power supply outputs are isolated up to 300 V from output to chassis or output to output.

## Specifications

**DC output:** 6227B, 0-25 V @ 0-2 A; 6228B, 0-50 V @ 0-1 A.

**AC input:** 115 or 230 V ac  $\pm 10\%$ , 48-63 Hz, 260 W. Selected by rear panel switch.

**CV load effect (load regulation):** for a load current change equal to the current rating of the supply:  $0.01\% + 1$  mV.

**CC load effect:** for a load voltage change equal to the voltage rating of the supply:  $0.01\% + 250$   $\mu$ A.

**Source effect (line regulation):** for a change in line voltage between 104 and 127 V ac or 208 and 254 V ac at any output voltage and current within rating; CV, 1 mV; CC, 100  $\mu$ A.

**PARD (ripple and noise):** at any line voltage and under any load condition within rating (20 Hz to 20 MHz); CV, 250  $\mu$ V rms/4 mV p-p; CC, 250  $\mu$ A rms/2 mA p-p.

**Temperature coefficient:** output change per degree Celsius change in ambient following 30-minute warm-up; CV,  $0.02\% + 300$   $\mu$ V; CC,  $0.02\% + 300$   $\mu$ A (6227B);  $0.02\% + 150$   $\mu$ A (6228B).

**Drift (stability):** total drift in output (dc to 20 Hz) over 8-hour interval under constant line, load, and ambient following 30-minute warm up; CV,  $0.2\% + 2$  mV; CC,  $0.2\% + 3$  mA ( $0.2\% + 1.5$  mA, 6228B).

**Remote resistance programming:** CV,  $200\Omega/V \pm 1\%$ ; CC,  $500\Omega/A \pm 10\%$  (6227B),  $1\text{ k}\Omega/A \pm 10\%$  (6228B).

**Programming speed (CV):** up-programming: no load, 40 ms/50 ms; full load, 200 ms/350 ms. Down-programming: no load, 400 ms/1s; full load, 75 ms/50 ms.

**Output impedance (typical):** approximated by a resistance in series with an inductance: 2 m $\Omega$ /2 $\mu$ H (6227B); 6 m $\Omega$ /6 $\mu$ H (6228B).

**Resolution (fine control):** voltage, 5 mV (6227B), 10 mV (6228B);

current, 1 mA (6227B), 0.5 mA (6228B).

**Internal overvoltage crowbars:** during independent operation, each supply is protected by its own crowbar. In the tracking mode, an overvoltage in either supply results in firing both crowbars.

**Trip voltage margin:** the minimum trip voltage above the operating output voltage of the supply to prevent false crowbar tripping: 7% of the output voltage  $\pm 1.5$  V.

**Trip voltage range:** 6227B, 5-28 V dc. 6228B, 5-55 V dc.

**Tracking error:** in tracking mode, the slave supply is matched within  $0.2\% \pm 2$  mV of the master.

**Transient recovery time:** in constant voltage, the output will recover in 50  $\mu$ sec to within 10 mV of its nominal value for a resistive load change demanding an output current change equal to the current rating of the supply. The nominal output voltage is defined as the mean between the no load and full load voltages.

## Temperature ratings

**Operating:** 0°C to 55°C.

**Storage:** -40°C to +75°C.

**Cooling:** natural convection.

**Weight (net/shipping):** 11/12.9 kg (24/28 lb).

**Size:** 155 H  $\times$  197 W  $\times$  310 mm D (6 $\frac{1}{4}$ "  $\times$  7 $\frac{3}{4}$ "  $\times$  12 $\frac{1}{4}$ ").

**Finish:** mint gray panel with olive gray case.

## Options

**009:** four ten-turn output voltage and current controls replace all four concentric coarse and fine voltage and current controls.

**015:** four 3-digit graduated turns-counting dials and 10-turn controls replace concentric coarse and fine voltage and current controls.

**040:** interfacing for Multiprogrammer operation. Prepares standard HP power supplies for resistance programming by the HP Multiprogrammer.

## Accessories

5060-8762: rack kit for mounting one or two dual supplies

5060-8760: filler panel to block unused half of rack when mounting only one dual supply

## Ordering information

6227B Dual Tracking Power Supply

6228B Dual Tracking Power Supply

**Price**  
add \$100

add \$250

add \$150

\$55

\$11

\$725

\$725

# POWER SUPPLIES

General purpose: high voltage output  
Models 6515A-6525A



- Short circuit proof
- Precise voltage control—four-decade thumbwheel or switch-and vernier
- Convection cooling

- Floating output—can be used as a positive or negative source
- Front-panel meters
- Bench or rack mounting



6521A, 6522A, 6525A

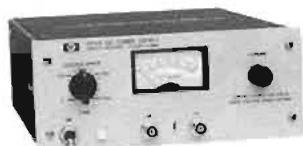

6515A



6516A

## Description

### 6521A, 6522A, 6525A

This series of high performance power supplies has broad application both in the laboratory and in the system. They have sufficient output current to power devices such as TWT's, klystrons, magnetrons, backward-wave oscillators, high-power gas lasers, electron-beam welding devices, etc. Output voltage is set easily and precisely by a three-decade thumbwheel switch plus a thumbwheel vernier providing 0.002% resolution. In constant-voltage operation, a single-turn current control allows the current-limit point to be set to any value within the current rating. In constant-current operation, the current control varies the output current while the voltage controls (thumbwheels) provide an adjustable voltage limit. The supplies are protected against reverse voltage that could be generated by an active load. Protection from reverse current requires pre-loading the supply with a dummy load to ensure that the supply outputs current through the entire operating cycle of the load. Either the positive or negative terminal may be grounded or the supply may be operated floating at up to 2000 V above ground.

### 6515A and 6516A

These high-voltage power supplies are lower in cost and output power than the 6521A-6525A supplies. Their small size, low price, and short-circuit-proof operation make them excellent high-voltage laboratory supplies, or high-voltage system supplies where current requirements are no more than 6 mA.

Model 6515A employs a sixteen-position rotary switch and a ten-turn vernier control to adjust the output voltage. The rotary switch selects output voltage increments from 0 to 1500 V in 100-volt steps; the vernier control permits fine adjustment (100 mV resolution) over any 100-volt span. Model 6516A uses a three-decade thumbwheel

switch plus a thumbwheel vernier for convenient and precise (1.0 V resolution) output voltage control.

Non-adjustable current-limit protection is provided on both models. On Model 6516A, the current-limit point is fixed at approximately 8 mA. On Model 6515A, the current limit value varies with the selected output voltage range as follows (voltage range/current limit): 0-300 V/7.5 mA, 400-700 V/65 mA, 800-1100 V/32 mA, 1200-1500 V/25 mA. Both supplies are protected against reverse voltages that could be generated by an active load. Pre-loading is necessary to protect the supplies from reverse currents. Either the positive or negative terminal may be grounded or the supply may be operated floating at up to 1000 V above ground. Units are packaged in half-rack-width cases. They may be bench operated or mounted individually or in pairs using accessory rack-mounting kits.

## Specifications

### 6521A, 6522A, 6525A

**Accuracy:** 1% of thumbwheel switch setting.

**Temperature rating:** operating, 0 to 55°C; storage, -40 to +75°C.

**Temperature coefficient, per °C:** voltage, 0.012% of +1 mV. Current: 6521A, 0.2% + 0.2 mA; 6522A, 0.2% + 0.1 mA; 6525A, 0.2% + 0.05 mA.

**Output impedance, typical:** 0.1 ohm in series with 1 μH.

**Load effect transient recovery:** 50 μs to recover within 0.005% or 20 mV, whichever is greater.

**Output modes:** automatic cross-over constant-voltage/constant-current.

**Meters:** 2% of full scale accuracy. Scales: 6521A: 0-1 kV & 0-200 mA; 6522A: 0-2 kV & 0-100 mA; 6525A: 0-4 kV & 0-50 mA.

**Power:** 115 V ac ±10%, 48-440 Hz, 4 A, 270 W.

**Weight:** net, 19 kg (42 lb). Shipping, 28.5 kg (63 lb).

**Size:** 133 H × 483 W × 457 mm D (5.25" × 19" × 18").

### 6515A and 6516A

**Accuracy:** 6516A, 1% of thumbwheel switch setting.

**Temperature rating:** operating, 0 to 55°C; storage, -40 to +75°C.

**Temperature coefficient, per °C:** voltage, 0.02% + 2 mV.

**Load effect transient recovery:** 100 μs to recover within 0.01% or 16 mV, whichever is greater.

**Output modes:** constant voltage with fixed current limit.

**Meters:** 2% of full scale accuracy. Scales: 6515A: 1.8 kV; 6516A: 3.5 kV.

**Power:** 6515A: 115 V ac ±10%, 60 ±0.3 Hz, 0.16 A, 19 W.

6516A: 115 V ac ±10%, 57-63 Hz, 1 A, 40 W.

**Weight:** 6515A: net, 4.1 kg (9 lb). Shipping, 5.0 kg (11 lb). 6516A: net, 7.7 kg (17 lb). Shipping, 9.5 kg (21 lb).

**Size:** 6515A, 89 H × 216 W × 299 mm D (3.50" × 8.50" × 11.75"). 6516A, 133 H × 216 W × 406 mm D (5.25" × 8.50" × 16").

RATINGS			PERFORMANCE										GENERAL	
DC Output		Model	Load Effect		Source Effect		PAR (rms/p-p)		Drift		Resolution		Options	Price
Volts	mA		Voltage	Current	Voltage	Current	Voltage	Current	Voltage	Current	V	C		
0-1000	0-200	6521A	0.005% or 20 mV*	2% or 1 mA*	0.005% or 20 mV*	1 mA	1 mV/500 mV	2 mA rms	0.036% + 3 mV	0.25% + 0.5 mA	20 mV	0.6 mA	None	\$1185
0-1600	5	6515A	0.01% or 16 mV*	NA	0.01% or 16 mV*	NA	2 mV/15 mV	NA	0.05% + 5 mV	NA	100 mV	NA	15, 19	\$365
0-2000	0-100	6522A	0.005% or 20 mV*	2% or 1 mA*	0.005% or 20 mV*	1 mA	1 mV/500 mV	1 mA rms	0.036% + 3 mV	0.25% + 0.25 mA	40 mV	0.3 mA	None	\$1195
0-3000	5	6516A	0.01% or 16 mV*	NA	0.01% or 16 mV*	NA	1 mV/50 mV	NA	0.05% + 5 mV	NA	1 V	NA	19	\$495
0-4000	0-50	6525A	0.005% or 20 mV*	2% or 1 mA*	0.005% or 20 mV*	1 mA	1 mV/500 mV	500 μA rms	0.036% + 3 mV	0.25% + 0.12 mA	80 mV	0.15 mA	None	\$1195

\*whichever is larger.

▲See page 220 for complete option and accessory descriptions.

## POWER SUPPLIES

Special purpose: precision sources  
Models 6110A-6116A

- 0.025% output voltage accuracy
- 5-minute warm-up
- Built-in overvoltage crowbar



6110A



6111A, 6112A, 6113A, 6116A



6114A, 6115A

## Specifications†

RATINGS			PERFORMANCE							Drift (Stability)	
DC Output		Model	Load Effect		Source Effect		PAR (rms/p-p)		Temperature coefficient	8-hour	90 day
Volts	Amps		Voltage	Current	Voltage	Current	Voltage	Current			
0-10	0-2	6113A	0.001% + 100 $\mu$ V	NA	0.001%	NA	40 $\mu$ V/100 $\mu$ V	NA	0.001% + 10 $\mu$ V	0.01% + 100 $\mu$ V	—
0-20	0-1	6111A	0.001% + 100 $\mu$ V	NA	0.001%	NA	40 $\mu$ V/100 $\mu$ V	NA	0.001% + 10 $\mu$ V	0.01% + 100 $\mu$ V	—
0-20, 20-40	0-2, 0-1	6114A	0.0005% - 100 $\mu$ V + 100 $\mu$ V	0.01% + 500 $\mu$ A	0.0005% + 40 $\mu$ V	0.005% + 40 $\mu$ A	40 $\mu$ V/200 $\mu$ V*	200 $\mu$ A/1 mA	0.001% + 15 $\mu$ V	0.0015% + 15 $\mu$ V	0.0075% + 30 $\mu$ V**
0-40	0-0.5	6112A	0.001% + 100 $\mu$ V	NA	0.001%	NA	40 $\mu$ V/100 $\mu$ V	NA	0.001% + 10 $\mu$ V	0.01% + 100 $\mu$ V	—
0-50, 50-100	0-0.8, 0-0.4	6115A	0.0005% - 50 $\mu$ V	0.01% + 500 $\mu$ A	0.0005% + 100 $\mu$ A	0.005% + 20 $\mu$ A	40 $\mu$ V/200 $\mu$ V*	200 $\mu$ A/1 mA	0.001% + 15 $\mu$ V	0.0015% + 15 $\mu$ V	0.0075% + 30 $\mu$ V
0-100	0-200 mA	6116A	0.001% + 100 $\mu$ V	NA	0.001%	NA	40 $\mu$ V/100 $\mu$ V	NA	0.001% + 10 $\mu$ V	0.01% + 100 $\mu$ V	—
0-3000	0-6 mA	6110A	0.001% + 100 $\mu$ V	NA	0.001%	NA	2 mV/5 mV	NA	0.001% + 50 $\mu$ V	0.01% + 500 $\mu$ V	—

† Refer to page 201 for complete specification definitions and page 220 for option descriptions.  
\*\* Specified with final decade pot set to zero. If pot is set to value other than zero, pot wiper jump effect may cause drift of 0.0015% + 200  $\mu$ V (90-day).

\* 200  $\mu$ V p-p noise is typical with a maximum 400  $\mu$ V p-p spike of less than 1  $\mu$ sec duration occurring repetition rate of twice power line frequency under worst case conditions of high line, full output voltage. When operated at 400 Hz input, peak-to-peak ripple is less than 10 mV.

- Constant-voltage/current-operation
- Thumbwheel or ten-turn voltage controls
- 0.1% output voltage accuracy

## Description

## 6114A, 6115A

These 40-watt precision power supplies are ideal for applications where an accurate, highly stable, and easy-to-use source of dc voltage is required. Both models feature automatic dual range operation. For example, Model 6114A can supply 0-20 V at 0-2 A, and 20-40 V at 0-1 A, without manual range switching. Automatic output current range crossover occurs when the supply is providing greater than one-half of the maximum rated output voltage.

## Output voltage controls

Pushbutton voltage controls on Models 6114A and 6115A allow the output voltage to be set rapidly and accurately. The setting is displayed in large, easy-to-read numerals. A fifth digit, set via a thumbwheel on the switch assembly, provides output voltage resolution of 200  $\mu$ V.

## Output current controls

A front-panel control allows the output current to be set to any desired value within the maximum rating. Using this control, the supplies can be operated as constant-current sources with 0.01% current regulation. A light-emitting diode current mode indicator immediately lights either when the supply is operated in the gross current limit region, or when the output current level established by the setting of the front panel control is reached.

### Remote programming

These supplies can be remote programmed by means of an external voltage or resistance. When remote resistance programmed, put voltage accuracy is 0.01% plus the accuracy of the remote programming resistor, and output current accuracy is 0.25% plus the accuracy of the remote programming resistor.

For computer controlled applications, these supplies are designed to be digitally programmed with the HP Model 6940B Multiprogrammer or 6941B Multiprogrammer Extender. They can also be used with the 59501A HP-IB Isolated D/A Power Supply Programmer.

### Overvoltage protection

A circuit technique used in these supplies causes the output voltage to drop completely to zero once the overvoltage protection circuit has been triggered, rather than to only 1-3 V as is typical with other SCR crowbars. This same circuit technique also permits the trip threshold to be set as low as 0.5 V, thus providing load protection at very low output voltage levels.

### 6111A, 6112A, 6113A and 6116A

Although these 20-watt precision power supplies do not provide quite the level of performance and flexibility of Models 6114A and 6115A, they are lower in cost and are suitable for many precision power applications. Output voltage is adjusted by a five-decade thumbwheel voltage programmer for convenient and precise (100  $\mu$ V resolution) adjustment of output voltage. A single-turn current control allows full-range adjustment of the current-limit point. Additional features include a volt/ampere meter and associated meter function switch. The four-position function switch selects either of two output voltage or output current ranges (X1, X0.1) for display on the panel meter.

The  $\delta$ -c output of these supplies is floating, allowing the supplies to be used as either positive or negative sources. Terminals for +OUT, -OUT, and GND are provided on both the front and rear of the supply. The rear terminal strip also includes terminals for remote resistance programming, remote sensing, and auto-series, auto-tracking operation.

Units are packaged in 5 $\frac{1}{4}$ -inch high, half-rack cases which may be bench operated or rack mounted using accessory rack mounting hardware.

### 6110A

Model 6110A is designed for applications requiring a precise and stable source of high-voltage dc power. Output voltage is set easily and precisely by a five-digit thumbwheel programmer providing 2 mV resolution. A non-adjustable current-limit circuit protects the supply from all overload conditions regardless of degree or duration. Plus and minus output connectors (Type UG-931/U) are provided on the front panel. Mating connectors (Type UG-932/U) are supplied with each unit. Either the positive or the negative terminal may be grounded, or the supply may be operated floating at up to 1,000 volts above ground. Units are packaged in 5 $\frac{1}{4}$ -inch high, half-rack cases which are suitable for bench or rack installation.

### General specifications—(see table also)

**Temperature rating:** all precision models; operating 0° to 50°C. Storage, -40° to +75°C.

**DC output isolation:** output terminals of precision models may be floated up to 300 V above ground. High voltage precision model 6110A may be floated to 1000 V.

**Remote sensing:** provided on all precision models except 6110A. **Power:** 104-127 or 208-250 V ac selected by switch, 48-440 Hz, 150 VA maximum.

**Size:** 166 H  $\times$  197 W  $\times$  336 mm D (6 $\frac{1}{2}$ "  $\times$  7 $\frac{3}{4}$ "  $\times$  13 $\frac{1}{4}$ ").

**Weight:** net, 7.7 kg (17 lb). Shipping, 9.5 kg (21 lb).

### 6111A, 6112A, 6113A and 6116A

**Power:** 115 V ac  $\pm$  10%, 43-63 Hz, 0.5 A, 52 W (for 230 V, order Optn. 028).

**Size:** 133 H  $\times$  216 W  $\times$  318 mm D (5 $\frac{1}{4}$ "  $\times$  8 $\frac{1}{2}$ "  $\times$  12 $\frac{1}{2}$ ").

**Weight:** net, 5 kg (11 lb). Shipping, 6.8 kg (14 lb).

### 6110A

**Power:** 115 V ac  $\pm$  10%, 57-63 Hz, 1 A, 50 W (for 230 V, 50 Hz, order Opt 019).

**Size:** 133 H  $\times$  216 W  $\times$  406 mm D (5 $\frac{1}{4}$ "  $\times$  8 $\frac{1}{2}$ "  $\times$  16").

**Weight:** net, 8.6 kg (19 lb). Shipping, 10.4 kg (23 lb).

Accuracy	Resolution	Output Z (Typical)	Load Transient Recovery	Output Mode	REMOTE CONTROL								GENERAL			
					Resistance Coefficient		Voltage Coefficient		UP*		DDWN*		Overvoltage Protection	Options <sup>†</sup>	Price	
					Voltage	Current	Voltage	Current	NI	FL	NI	FL				
0.1% + 1 mV	20 $\mu$ V	0.2 m $\Omega$ -1 $\mu$ H	NA	CV/CL	1 k $\Omega$ /V $\pm$ 0.3%	NA	1 V/V $\pm$ 0.1%	NA	NA	NA	NA	NA	NA	Opt 11, 3-13 V	11, 28, 40	\$495
0.3% + 5 mV	200 $\mu$ V	0.5 m $\Omega$ + 1 $\mu$ H	NA	CV/CL	1 k $\Omega$ /V $\pm$ 0.3%	NA	1 V/V $\pm$ 0.1%	NA	NA	NA	NA	NA	NA	Opt 11, 2.5-23 V	11, 28, 40	\$495
0.025% + 1 mV	200 $\mu$ V	0.05 m $\Omega$ + 3 $\mu$ H	< 30 $\mu$ s, 50 mV	CV/CC	2 k $\Omega$ /V $\pm$ 0.03%	500 $\Omega$ /A $\pm$ 0.25%	1 V/V $\frac{1}{2}$	0.5 V/A $\pm$ 1%	1.75 s	1.75 s	350 ms	100 ms	STD, 0.5-45 V	9, 15	\$755	
0.1% + 1 mV	200 $\mu$ V	2 m $\Omega$ + 1 $\mu$ H	NA	CV/CL	1 k $\Omega$ /V $\pm$ 0.1%	NA	1 V/V $\pm$ 0.1%	NA	NA	NA	NA	NA	NA	Opt 12, 2.5-45 V	11, 28, 40	\$495
0.025% + 1 mV	200 $\mu$ V	0.05 m $\Omega$ + 3 $\mu$ H	< 50 $\mu$ s, 50 mV	CV/CC	2 k $\Omega$ /V $\pm$ 0.01%	1 k $\Omega$ /A $\pm$ 0.25%	1 V/V $\frac{1}{2}$	1 V/A $\pm$ 1%	4.5 s	4.5 s	500 ms	175 ms	STD, 0.5-110 V	9, 15	\$775	
0.05% + 1 mV	200 $\mu$ V	10 m $\Omega$ + 1 $\mu$ H	NA	CV/CL	1 k $\Omega$ /V $\pm$ 0.1%	NA	1 V/V $\pm$ 0.1%	NA	NA	NA	NA	NA	NA	Dpt 02, 20-105 V	11, 28	\$495
0.1% + 100 mV	20 mV	—	NA	CV/CL	NA	NA	NA	NA	NA	NA	NA	NA	NA	19	\$800	

▲ See page 32-22 for complete option and accessory descriptions.

◆ UP = increasing output voltage. NI = No output load current. FL = Full meter output load current.

† Accuracy is equal to accuracy of remote programming device  $\pm$  200  $\mu$ V.



# POWER SUPPLIES

Special purpose: constant current sources  
Models 6177C, 6181C & 6186C

- Continuously variable voltage limit
- Output useful to micro-ampere region

- High output impedance—no output capacitor



6177C, 6181C

6186C

## Description

These solid-state constant-current sources are ideal for semiconductor circuit development, component testing, and precision electroplating applications.

Their high-speed remote programming characteristics make these supplies useful in testing and sorting semiconductors, resistors, relays, meters, etc. The ability to superimpose ac modulation on the dc output permits the supplies to be used for measurement of dynamic or incremental impedance of circuit components.

## Specifications

**Load effect (load regulation):** less than 25 ppm of output +5 ppm of range switch setting for a load change which causes the output voltage to vary from zero to maximum.

**Source effect (line regulation):** less than 25 ppm of output +5 ppm of range switch setting for a change in the line voltage from 104 to 127 V ac (or 127 to 104 V ac) at any output current and voltage within rating.

**Load effect transient recovery:** less than 800  $\mu$ s for recovery to within 1% of nominal output current following a full load change in output voltage. (On 6186C, recovery time for 100 mA/10 mA/1 mA ranges is 1 ms/1.6 ms/4 ms, respectively.)

**Temperature coefficient:** output change per degree C is less than 75 ppm of output current +5 ppm of range switch setting.

**Drift (stability):** less than 100 ppm of output current +25 ppm of range switch setting. Stability is measured for eight hours after one hour warm-up under conditions of constant line, load, temperature, and output setting.

**Resolution:** 0.03% of range switch setting.

**Temperature rating:** operating 0, to 55°C, storage, -40 to +75°C.

### Accessories

5060-8764: rack adapter for rack mounting one or two 6177C or 6181C supplies

5060-8762: rack adapter for rack mounting one or two 6186C supplies

5060-8530: filler panel for Models 6177C, 6181C

5060-8760: filler panel for Model 6186C

### Price

\$50

\$55

\$11

\$11

### Options

015: three-digit graduated turns-counting current control replaces front panel current knob

028: 230 V ac  $\pm$  10%, single-phase input. Models 6177C and 6181C only

add \$50

N/C

### Ordering information

6177C, 6181C Constant Current Source

6186C Constant Current Source

\$645

\$875

Model		6177C	6181C	6186C
Output Current $I_o$		0-500 mA	15-250 mA	0-200 mA
Voltage Compliance $\Delta$		0-50 V dc	0-100 V ac/dc	0-50 V dc
Output Ranges	A	0-5 mA	0-2.5 mA	0-1 mA
	B	0-20 mA	0-25 mA	0-5 mA
	C	0-500 mA	0-250 mA	0-100 mA
AC Input		115 V ac $\pm$ 10%, 48-63 Hz 0.8 A, 55 W at 115 V ac for 230 V ac, see Option 028	120 V ac $\pm$ 10%, 48-63 Hz 0.8 A, 55 W at 115 V ac for 230 V ac, see option 028	115/230 V ac, 48-63 Hz 0.8 A, 90 W at 115 V ac 115/230 V ac, 50 Hz
Constant Current Remote Programming	Voltage Control (accuracy, 0.5% of output current $\pm$ 0.4% of range)	Range A 20 mV/mA Range B 20 mV/mA Range C 7 mV/mA	1 V/mA 100 mV/mA 30 mV/mA	10 V/mA 1 V/mA 300 mV/mA
	Resistance Control 1% of output current $\pm$ 1.04% of range	Range A 40 ohms/mA Range B 40 ohms/mA Range C 2 ohms/mA	2 ohms/mA 200 ohms/mA 20 ohms/mA	20 ohms/mA 1 k $\Omega$ /mA 100 ohms/mA
	Voltage Limit Remote Programming	Voltage Control (Accuracy 20%) Resistance Control Accuracy	1 V/V 0.75 ohms/V 25%	1 V/V 435 ohms/V 25%
Typical Output Impedance (R in parallel with C) <sup>†††</sup>		Range A R = 320 Meg, C = 500 pF Range B R = 35 Meg, C = 0.005 $\mu$ F Range C R = 3.5 Meg, C = 0.05 $\mu$ F	R = 1210 Meg, C = 10 pF R = 133 Meg, C = 100 pF R = 123 Meg, C = 1000 pF	R = 10,000 Meg, C = 900 pF R = 1,000 Meg, C = 200 pF R = 100 Meg, C = 1500 pF
RMS (Ripple and Noise), rms p-p (dc to 20 MHz) with either output terminal grounded.		Range A 1.6 $\mu$ A rms/40 $\mu$ A p-p Range B 3 $\mu$ A rms/200 $\mu$ A p-p Range C 150 $\mu$ A rms/2 mA p-p	0.8 $\mu$ A rms/20 $\mu$ A p-p 6 $\mu$ A rms/100 $\mu$ A p-p 100 $\mu$ A rms/500 $\mu$ A p-p	0.7 $\mu$ A rms/50 $\mu$ A p-p 2 $\mu$ A rms/50 $\mu$ A p-p 20 $\mu$ A rms/500 $\mu$ A p-p
Programming Speed: from 0 to 99% of range switch setting with a resistive load. <sup>†††††</sup> (Output Current Modulation)		5 ms	5 ms	10 ms
Dimensions		7 1/2" (H) x 3 1/2" (D) = 124 x 120 137 mm (H) x 88 mm (D) = 333 mm (D)	12 1/2" (H) x 3 1/2" (D) = 120 x 120 165 mm (H) x 88 mm (D) = 418 mm (D)	7 1/2" (H) x 4 1/2" (D) = 129 x 120 137 mm (H) x 158 mm (D) = 423 mm (D)
Weight (Net Shipping)		4.53 kg (10 lb) 5.9 kg (13 lb)	4.02 kg (9 lb) 4.5 kg (10 lb)	4.5 kg (10 lb) 5.9 kg (13 lb)

<sup>†††</sup>This network is a simplified representation of a complex network. The formula  $Z = R/(1 + j\omega C)$  is used for frequencies up to 1 MHz by substituting the values given for R and C. Above 1 MHz, the output impedance is greater than the formula would indicate.

<sup>††††</sup>Output current can be modulated 100% up to 50 Hz, percent modulation decreases linearly to 10% at 500 Hz.

<sup>†††††</sup>For operation above 40°C the maximum output current must be reduced linearly to 80% of rating at 55°C (maximum temperature).

<sup>††††††</sup>Minimum voltage obtainable with voltage limit control is 0.5 V.

# POWER SUPPLIES



Special purpose: dc power supply/amplifiers

Models 6824A-6827A

- High-speed remote programming
- Overload protection
- Wide-band response



6825A-6827A



6824A

## Description

The Power Supply/Amplifier is a general-purpose instrument useful in any laboratory engaged in research and development of electronic systems, circuitry, or components. The unit can be operated in one of two basic operating modes: power supply or amplifier. Terminals at the rear permit access to various internal control points to further expand the operational capabilities of the instrument. The resulting flexibility lends the Power Supply/Amplifier to an almost unlimited number of applications.

### Models 6825A through 6827A

These models feature dual-range output, Constant-Voltage/Constant-Current operation, and metering of the ac and dc output voltage and current. Output voltage and current as a dc supply, or gain as a power amplifier, are remotely controllable and are compatible with Hewlett-Packard Multiprogrammer Systems.

As a dc power supply, the unit can furnish a bipolar, Constant-Voltage or Constant-Current output. It can be remotely programmed with a resistance, voltage, or current and its high speed programming characteristics adapt it to a wide variety of laboratory and production testing applications. The supply can sink, as well as source, current permitting it to serve as a variable load device.

As a direct-coupled power amplifier, each unit offers a signal-to-noise ratio of approximately 80 dB at full output with low distortion and a frequency response up to 40 kHz in the fixed gain mode.

### Model 6824A

Although this model does not provide quite the level of performance and flexibility of Models 6825A through 6827A, it is lower in cost and is suitable for many applications.

As a power supply, this unit offers Constant-Voltage/Current-Limiting operation, remote programming, and Auto-Series, Auto-Parallel operation.

As a power amplifier, the unit exhibits a high signal-to-noise ratio with a 20 dB gain from dc to 10 kHz. It is useful in servo systems, as a pulse or oscillator amplifier, for motor control, and a variety of other applications.

## General specifications

**Temperature:** operating, 0 to 55°C, storage, -40 to +75°C.

**Power:** 6824A, standard input voltage is 104-127 V ac, 48-63 Hz. Order Option 028 for 230 V  $\pm$  10% operation. 6825A, & 6826A, 6827A, switchable, 100, 120, 220, or 240 V ac, -13% +6%, 48-63 Hz, 150 W.

**Dimensions:** 6824A, 131 H  $\times$  209 W  $\times$  303 mm D (5<sup>1</sup>/<sub>16</sub>"  $\times$  8<sup>7</sup>/<sub>32</sub>"  $\times$  11<sup>13</sup>/<sub>16</sub>"). 6825A, 6826A & 6827A, 155 H  $\times$  198 W  $\times$  316 mm D (6<sup>1</sup>/<sub>16</sub>"  $\times$  7<sup>23</sup>/<sub>32</sub>"  $\times$  12<sup>7</sup>/<sub>16</sub>").

**Weight:** 6824A, 7.7 kg (17 lb), 6825A, 6826A & 6827A, 8.2 kg (18 lb).

## Power supply specifications

RATINGS		PERFORMANCE													
DC Output		Model	LOAD EFFECT		Source Effect		Pard (rms/p-p)		Transient Recovery		Resolution		Output Z (Typical)	Options $\Delta$	Price
Volts	Amps		Voltage	Current	Voltage	Current	Voltage	Current	Time	Level	Voltage	Current			
-5 V to +5 V/ -20 V to +20 V	0-2.0 A Both Ranges	6825A	0.01% + 1 mV	0.01% + 250 $\mu$ A	0.01% + 3 mV	0.01% + 250 $\mu$ A	10/30 mV	5/15 mA	100 $\mu$ s	20 mV	40 mV	6 mA	0.5 m $\Omega$ , 1.5 $\mu$ H	9	\$475
-5 V to +5 V/ -30 V to +50 V	0-1.0 A Both Ranges	6826A	0.01% + 1 mV	0.01% + 250 $\mu$ A	0.01% + 5 mV	0.01% + 250 $\mu$ A	5/35 mV	0.8/5 mA	100 $\mu$ s	50 mV	100 mV	3 mA	1 m $\Omega$ , 1.5 $\mu$ H	9	\$495
-10 V to +30 V/ -100 V to +100 V	0-0.5 A Both Ranges	6827A	0.01% + 1 mV	0.01% + 250 $\mu$ A	0.01% + 10 mV	0.01% + 250 $\mu$ A	10/50 mV	0.4/5 mA	100 $\mu$ s	100 mV	200 mV	1.5 mA	2 m $\Omega$ , 4 $\mu$ H	9	\$525
-50 V to +50 V	0-1.0 A	6824A	0.02% + 5 mV	—	0.02% + 5 mV	—	10 mV rms	—	100 $\mu$ s	0.02% + 5 mV	—	—	—	9, 28	\$505

† Refer to page 263 for complete specification definitions.

‡ See page 220 for complete option and accessory descriptions.

## Power amplifier specifications

RATINGS		PERFORMANCE										
Output		Model	Voltage Gain		Frequency Response, $\pm$ 1, -3 dB		Distortion at full output		Input Z (Typical)	Programming Coefficients		
Volts	Amps		Fixed	Variable	Fixed Gain	Variable Gain	100 Hz	10 kHz		Gain*	Voltage	Current
10 V p-p or 40 V p-p	2 A pk	6825A	1X 4X	0-2X 0-8X	dc - 40 kHz	dc - 15 kHz	0.1% THD	0.5%	10 k $\Omega$	R/(10.24 k $\Omega$ ) 4 R/(10.24 k $\Omega$ )	1 V/V 4 V/V	2 A/V
10 V p-p or 100 V p-p	1 A pk	6826A	1X 10X	0-2X 0-32X	dc - 40 kHz	dc - 15 kHz	0.1% THD	0.5%	10 k $\Omega$	R/(10.24 k $\Omega$ ) 10 R/(10.24 k $\Omega$ )	1 V/V 10 V/V	1 A/V
20 V p-p or 200 V p-p	0.5 A pk	6827A	2X 20X	0-2X 0-40X	dc - 30 kHz	dc - 15 kHz	0.1% THD	1%	10 k $\Omega$	2 R/(10.24 k $\Omega$ ) 20 R/(10.24 k $\Omega$ )	2 V/V 20 V/V	1 A/V
100 V p-p	1 A pk	6824A	—	0-10X	—	dc - 10 kHz	0.1% THD	—	2 k $\Omega$	—	1 V/V	—

\* Rf is the gain programming resistance.

# POWER SUPPLIES

## Options and accessories

For low cost lab, general, and special purpose models

A wide range of options is available to modify standard models to meet the requirements of a particular application. Various low cost lab, general purpose and special purpose power supply descriptions are found on pages 204 through 219. To determine which options are available for a particular power supply, refer to the appropriate product page. Always check the AC input voltage, current, and frequency requirements for the standard model and the AC power available in the area or country where the power supply will be used. If options are required, they must be specified with the order.

### Options

**005:** 50 Hz ac input; optimizes power supplies that require adjustment/modification for 50 Hz operation. Order only when listed as required in specifications for a particular model.

**009:** ten-turn output controls. Replaces single-turn output voltage and current controls (where applicable and available). 6114A, 6115A, 6204B, 6206B-6209B, 6294A, 6299A and 6824A-6827A  
6200B-6203B, 6205B, 6256B-6291A, and 6296A  
6227B, 6228B, 6253A, and 6255A

**010:** chassis slides. For access to rack mounted power supplies. 6256B, & 6263B-6267B  
6253A, 6255A, 6259B-6261B, 6268B, 6269B, & 6427B-6448B  
6453A, 6456B & 6459A

**011:** internal overvoltage protection crowbar. Protects delicate loads against power supply failure or operator error. Dual output models have dual crowbars  
Single output models, where available.

Dual output models. 6205B, 6253A, & 6255A

**015:** three-digit graduated turns-counting dial and ten-turn controls for output voltage and current (where applicable and available). Improves resettability of power supply output

6177C, 6181C, 6186C, and 6515A

6114A, 6115A, 6204B, 6206B, & 6220B-6226B

6207B, 6209B, 6294A & 6299A

6200B-6203B, 6205B, 6256B-6291A, & 6296A

6227B, 6228B, 6253A, & 6255A

**018:** 115 V ac  $\pm 10\%$  single phase input. Consists of replacing power transformer and circuit breaker, and reconnecting bias transformer, RFI choke and fans. For model 6260B only

**019:** 230 V ac  $\pm 10\%$ , 50  $\pm 0.3$  Hz, single phase input. Consists of replacing input transformer, line cord and fuse. Option 019 applies only to models 6110A, 6515A, & 6516A

**022:** voltage and current programming adjust. Allows the V and I programming coefficients and zero output to be conveniently adjusted to 0.1% accuracy via access holes in the rear panel. Consists of four potentiometers and resistors located inside the rear panel. Option 022 applies only to models 6256B-6274B

**023:** rack mounting attachments. Factory installed for mounting model 6464C-6483C in a standard 19" rack.

**026:** 115 V ac  $\pm 10\%$ , single phase input. Consists of replacing the input circuit breaker and reconnecting the power transformer, bias transformer, RFI choke, and fans. Option 026 applies only to models 6259B, 6261B, and 6268B

**027:** 208 V ac,  $\pm 10\%$ , single phase input. Consists of reconnecting power transformer taps, and other components where necessary. Order only when listed in the specifications for a particular model

**028:** 230 V ac  $\pm 10\%$ , single phase input. Consists of reconnecting power transformer taps, and other components where necessary. Order only when listed in the specifications for a particular model

**040:** multiprogrammer interface. Prepares standard HP power supplies for resistance programming by the 6940B Multiprogrammer or 6941B Multiprogrammer Extender. This option includes Option 022, special calibration, and protection check-out procedures (where required)

### Price

N/C

\$30

\$60

\$100

\$85

\$160

\$250

\$70

\$130

\$50

\$75

\$100

\$125

\$250

\$80

\$50

\$60

\$30

N/C

N/C

N/C

6111A-6113A

\$40

6205B, 6220B, 6224B, 6226B, 6256B-6274B, &

6281A-6299A

\$75

6464C, 6466C, 6469C, & 6472C

\$100

6227B, 6228B, 6253A & 6255A

\$150

**100:** 87-106 V ac, 47-63 Hz, single phase input

N/C

**220:** 191-233 V ac, 47-63 Hz, single phase input

N/C

**240:** 208-250 V ac, 47-63 Hz, single phase input

N/C

(Note: options 100, 220, and 240 are for models 6236B and 6237B only, and consist of setting an internal AC voltage selection switch and selecting appropriate line fuse.)

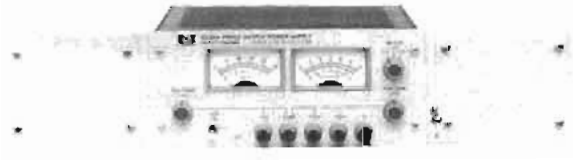

14513A Rack Kit for one 3½" high supply

14515A Rack Kit for one 5¼" high supply



14523A Rack Kit for two 3½" high supplies

14525A Rack Kit for two 5¼" high supplies

### Accessories

**14513A:** 3½" high rack kit for one supply

\$25

14513A and 14523A rack kits apply to the following models: 6200-6209B, 6236B, 6237B, 6281A, 6284A, 6289A, 6294A, 6299A, 6515A

**14523A:** 3½" high rack kit for two supplies

\$15

**14515A:** 5¼" high rack kit for one supply

\$30

**14525A:** 5¼" high rack kit for two supplies

\$20

14515A and 14525A rack kits apply to the following models: 6110A-6113A, 6116A, 6282A, 6286A, 6291A, 6296A, 6516A, 6824A.

**14521A:** rack kit for one, two or three supplies

\$45

Includes two filler panels. 14521A rack kit applies to the following models: 6211A-6218A.

**5060-8762:** adapter frame for rack mounting one or two ½ rack width units or one, two or three ⅓ rack width units

\$55

This frame applies to the following models: 6114A, 6115A, 6186C, 6220B, 6224B-6228B, 6825A, 6826A, 6827A.

**5060-8764:** adapter frame for rack mounting one or two ½ rack width units.

\$50

This frame applies to the following models: 6177C, 6181C.

**5060-8759:** Blank Filler Panel

\$10

This ⅓ rack width panel applies to the following models: 6220B, 6224B, 6226B.

**5060-8760:** Blank Filler Panel

\$11

This ½ rack width panel applies to the following models: 6114A, 6115A, 6186C, 6227B, 6228B, 6825A, 6826A, 6827A.

**5060-8530:** Blank Filler Panel

\$11

This ½ rack width panel applies to the following models: 6177C, 6181C.

**14545A:** casters—set of four

\$50

Snap-on casters for one 6464C-6483C power supply. (For rack mounting information on these supplies, see Opt 023)



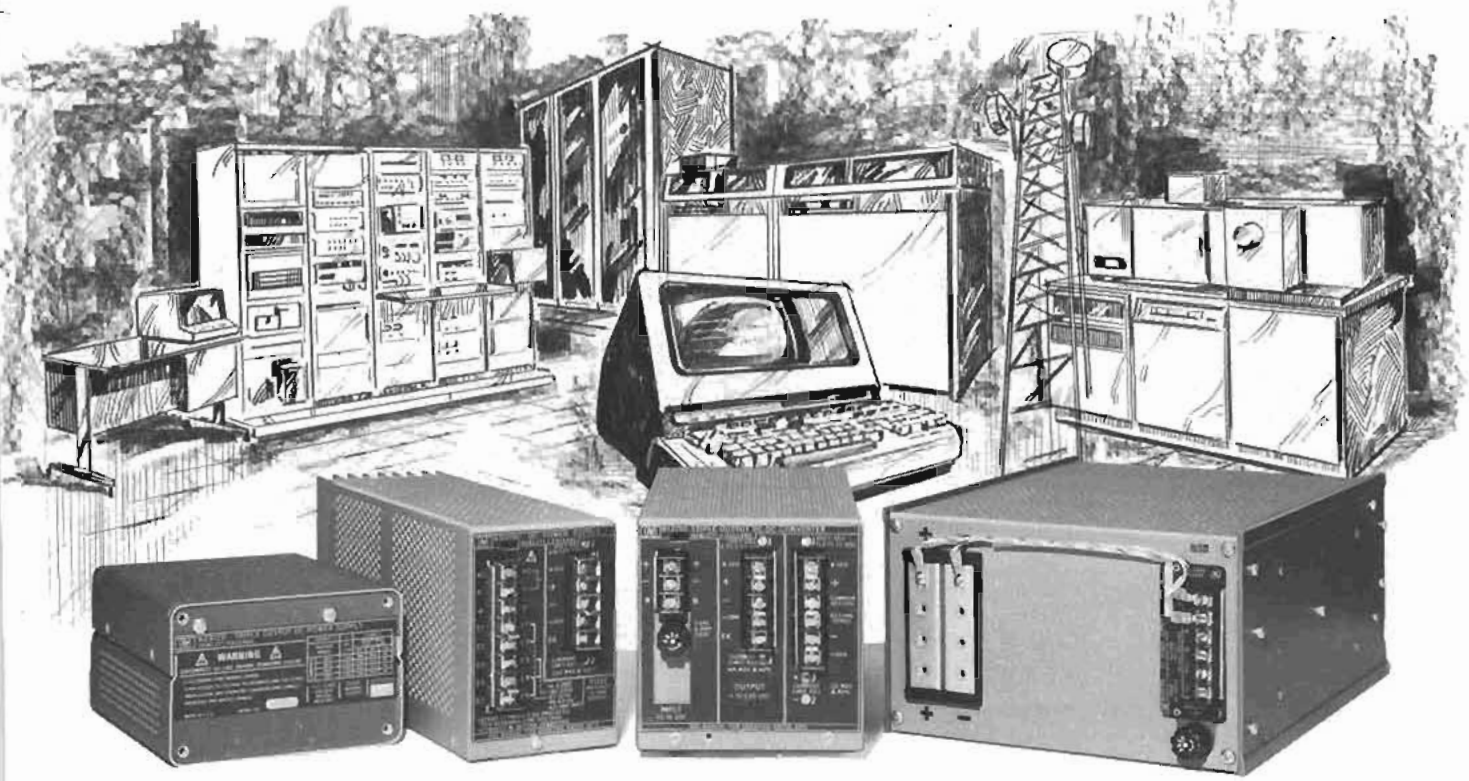

### Introduction

The selection of a power supply for today's system requires a critical and prudent evaluation. Sophisticated system electronics have placed more demands on the supply and, as always, the power supply is the very heart of your system. If it stops delivering power, your system will cease to operate.

Your evaluation should include not only the more obvious technical and cost considerations, but also a look at some of the less tangible factors that make up the total purchasing power of your OEM dollar.

### Quality

HP's OEM supplies are totally proven before they are introduced. Each product goes through a complete development cycle, consisting of: (a) Engineering Breadboarding; (b) Lab Prototyping; (c) Production Prototyping; and (d) Production Pilot Runs. At each phase the units are evaluated for safety, specification compliance, environmental performance, workmanship, and serviceability. In addition, all models undergo formal life and environmental testing at a certified facility before introduction.

### MTBF

Mean Time Between Failure (MTBF) is a figure of merit that can be calculated and actually verified. It is a number that is often quoted but seldom understood. Frequently, the MTBF's of different manufacturers cannot be compared because they are calculated by different means. HP employs a comprehensive and conservative method of determining MTBF. A component data base is maintained to provide actual component failure statistics and the MTBF is adjusted downward, if necessary, to reflect the actual working environment that the components will be exposed to.

Moreover, in products where new design concepts are used, we verify their reliability by running an actual MTBF life test. Such was the case with the 62605M where Mil Spec 781B, Test Plan IV, was utilized. As indicated by the curve, after 140,000 hours of testing the design hypothesis was verified.

Life Test Acceptance Curve — 62605M

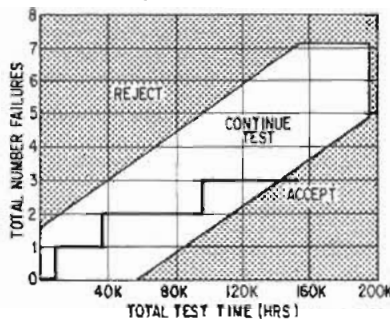

Although this method is expensive and time consuming, it assures you of the HP quality that you have come to accept.

### Safety

To assist you in complying with tightening safety regulations, all HP modular power supplies (including switching regulated) are designed to meet UL specs for U. S. applications. Considerations have also been given to international safety regulations. Only when the manufacturer can provide you with a UL yellow card number, can you be assured of UL compliance.

### Service Support

Hewlett-Packard's service support is an

other contributing factor in the lasting value of their products. HP is ready to respond to your service needs with an extensive chain of world-wide service and spare parts facilities. Staffed by competent technical personnel, these facilities can provide minimum turn-around time and are backed by the full resources of the manufacturing division. In addition, all units are shipped with a complete Operating and Service Manual.

### Special Design Group

In some applications off-the-shelf power supplies may not meet your needs. In these instances, our Special Design Group can provide product modifications, assembled power systems, and applications assistance to help with your specific requirement.

### Make or Buy

A crucial question in the make or buy decision is whether or not you have the technical and financial resources available to manufacture your own supplies.

It is important not to underestimate the difficulty involved in a power supply design. When evaluating your technical capabilities keep in mind that: (a) Modern power supplies are state of the art components; (b) Time will be required for electrical and mechanical definition as well as for design, lab and production prototypes and evaluation; and (c) Engineers will be diverted from other projects.

To assist you in the cost aspects of your evaluation, we have prepared application note 236-1. This note assists you in conducting a Return on Investment (ROI) analysis by revealing both the obvious and hidden costs incurred in the manufacture of your own power supplies. Contact your local HP sales office for a free copy.



# POWER SUPPLIES

OEM Modular: The total solution concept.

Model series 61000-63000

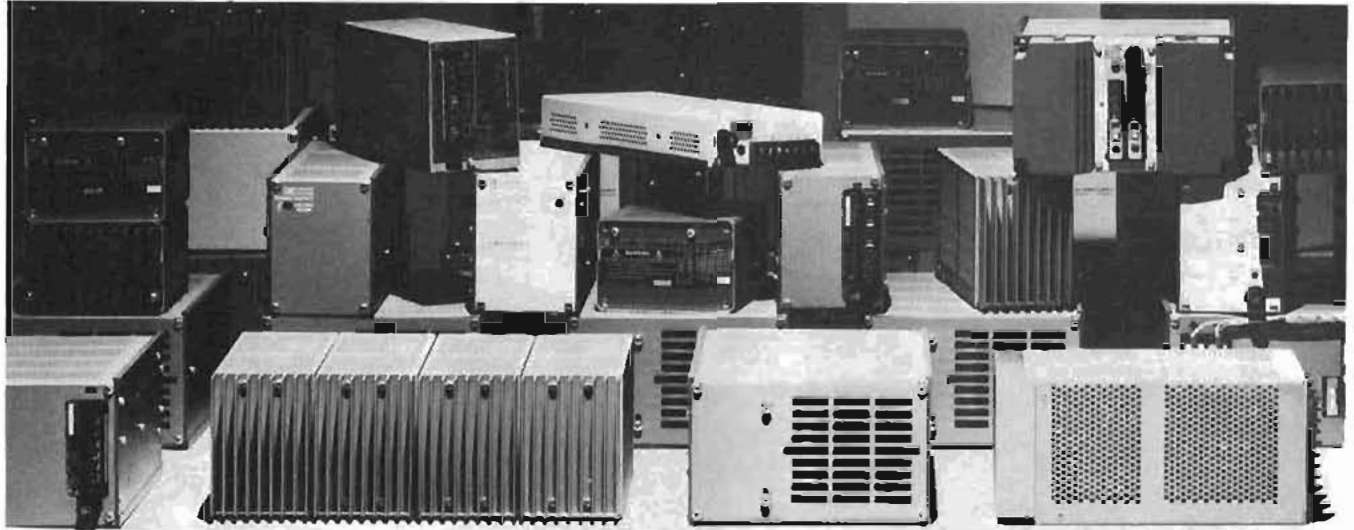

## EXAMPLE OR RATINGS AVAILABLE.

Contact your local HP Field Engineer for information on models to meet your specific requirements.

### Single Output—UL yellow card E51529

	Linear Regulated				20 kHz Switching Regulated			
	A-Series	C-Series	E-Series	G-Series	63000C-Series	J-Series	L-Series	M-Series
5 V	62005A (2.0A)	62005C (4.0A)	62005E (8.0A)	62005G (16.0A)	63005C (22.0A)	▲62605J (40.0A)	62605L (60.0A)	62605M (100.0A)
12 V	62012A (1.5A)	62012C (3.0A)	62012E (6.0A)	62012G (12.0A)	(Note 2)	▲62612J (23.0A)	(Note 1)	(Note 1)
18 V	62015A (1.25A)	62015C (2.5A)	62015E (5.0A)	62015G (10.0A)	(Note 2)	▲62615J (20.0A)	(Note 1)	62615M (40.0A)
24 V	62024A (0.75A)	62024C (1.75A)	62024E (3.75A)	62024G (7.5A)	—	▲62624J (12.5A)	(Note 2)	(Note 2)
28 V	62028A (0.7A)	62028C (1.5A)	62028E (3.25A)	62028G (6.5A)	—	▲62628J (10.7A)	(Note 2)	(Note 2)
48 V	62048A (0.45A)	62048C (1.0A)	62048E (2.0A)	62048G (4.0A)	—	—	(Note 2)	(Note 2)
List Price*	\$175	\$225	\$240	\$330	\$375	\$590 ▲4595	\$560	\$700

### Dual-Output—UL yellow card E51529

+12 V	62212A (1.4A)	—	62212E (3.3A)	62212G (6.6A)	—	—	—	—
+15 V	62215A (1.25A)	—	62215E (3.0A)	62215G (5.2A)	—	—	—	—
List Price*	\$215	—	\$275	\$410	—	—	—	—

### Triple-Output—UL yellow card E51529

	Linear Regulated	20 kHz Switching Regulated
	Model 62312D	Model 63315D
Output 1	4.75 to 5.25 V 3A	4.75 to 5.25 V 18A (Note 3)
Output 2	4.75 V at 0.38A, to 12.6 V at 0.60A	+11.4 to +15.75 V 2A (Note 3)
Output 3	4.75 V at 0.38A, to 12.6 V at 0.60A	-11.4 to -15.75 V 2A (Note 3)
List Price*	\$145	\$485

### DC-to-DC Converters

Output Ratings	Single Output	Triple Output
	Model 61005C	Model 61315D
	4.75 to 5.25 V at 22A	(Same as Model 63315D) Note 3
List Price*	\$400	\$525

1. Special ratings on special order basis at no additional cost.

2. Special ratings on special order basis at additional cost.

3. The outputs of the Models 61315D and 63315D can be operated anywhere within their 18A, 2A, and 2A individual current ratings providing the total output power is within a 110-watt total output rating.

\* Quantity and OEM discounts are available. These prices apply to domestic U.S.A. customers only.

## HP's technical support

- Standard products
- Modified products
- Systems power requirements
- Power supply cooling
- Criteria for make-or-buy analysis



OEM Modular Power Supply Technical Data and AN 236-1 are available from your local HP Field Engineer.

## Power systems

- Custom designed systems are available assembled, tested and documented by Hewlett-Packard
- System component units for "do-it-yourself" power system solutions

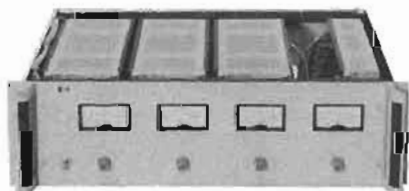

## Custom systems

Custom power systems can be assembled by installing suitable combinations of single and dual-output linear supplies and switching regulated supplies in rack mounting trays. If desired, Hewlett-Packard will assemble, wire, and test complete power supply systems to customer specifications using these modular power supplies and rack mounting accessories. Meters, switches, input and output connectors, and other components will be installed to meet your specific needs. Consult your local Hewlett-Packard Field Engineer for price and delivery information.

## Accessories for power systems

The Model 62410A Rack Mounting Tray can accommodate any combination of Series 62000 linear supplies, Series 62200 dual linear supplies, and Series 62600 switching-regulated supplies totaling a full rack width or less. It can be installed in a 19-inch rack directly or on slides. Detachable handles are included. The 62411A Blank Front Panel has a 2.25-inch clearance when installed on the tray for meters, switches, test jacks, and the model 62412A Blank Rear Panel has a 2.75-inch clearance behind the panel to allow for the addition of connectors, terminal blocks, and fuse holders. Model 62413A Cooling Unit delivers 45 CFM of cooling air while occupying only 1.75-inches of rack space. The 62414A Slide Kit has a 20-inch slide for use with standard 19-inch wide racks of 20-inch depth. (Not for HP 29400A or -B cabinets.) Model 62415A AC Distribution Panel is a mounting tray rear panel with a 3-terminal barrier strip, line cord, and fuse holder already installed. The 62416A Cooling Unit is 5.25 inches high and delivers 150 CFM of rack cooling air. A 12692B Slide Kit has 22-inch slides for use with HP 29400A or -B cabinets.



62411A

62412A



62415A

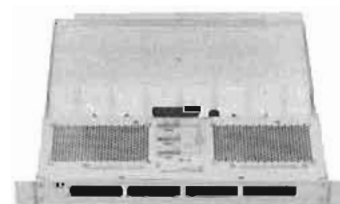

62413A



62414A

62410A

12692B

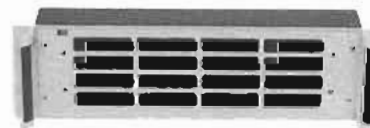

62416A



## POWER SUPPLIES

Digitally controlled: binary or BCD

Models 6129C-6131C & 6140A

- Digitally programmable in binary or BCD
- HP-IB compatible option J99 & 59301A
- Fast, accurate, bipolar output
- Digital inputs isolated from analog output
- Internal storage of digital data
- Digitally programmable current latch (on DVS models) or voltage limit (on DCS model)



### Digital voltage sources

HP's family of digital voltage sources (DVS's) includes models 6129C, 6130C, and 6131C. All models are programmable in binary or 8421 BCD and have many system-oriented features that enhance their use in automatic testing and control environments. Among these features are: isolation between the digital input and analog output lines, digital storage of programmed inputs, programmable current latch, analog input, and current monitoring terminals.

#### Isolation

All digital lines of the DVS's are isolated from the analog output. This feature is essential in automatic test systems to avoid forming ground loops that could impair system operation and damage the computer and instruments.

Nearly all computer manufacturers ground the power supplies for the digital I/O logic to the mainframe of the computer, which is connected to the ac power line ground. If a DVS did not have isolation, one of its analog output terminals would be connected to the digital input common line.

#### Internal storage

The DVS's internally store the computer's output magnitude (voltage setting), polarity, range, and output latch/limit digital inputs when the computer's gate command is received. When the DVS has finished processing the digital input, it notifies the computer by transmitting its flag. Since the DVS stores the digital data, the computer does not have to continually refresh the DVS; it is free to carry out other important tasks. The DVS maintains its programmed output indefinitely, changing the output only when the computer changes the digital input data and sends another gate command.

In addition to eliminating the need for redundant programming by the computer, internal storage also facilitates the control of multiple DVS's from a single computer I/O channel. The number of DVS's that can be controlled from a single I/O channel depends on the capabilities of the computer's I/O data bus drivers. Most computers can easily drive up to eight DVS's.

### Programmable current latch

Overcurrent protection is provided by a current latch circuit which can be externally programmed to one of eight values between 2% and 100% (six values for the 6131C) of the unit's rated output current. When activated, the current latch circuit turns off the output power amplifier reducing the output current to less than 20 mA. The reaction time of the current latch circuit (time between the start of a current overload and turn off of the power amplifier) can be adjusted by adding an external capacitor at the rear terminals. The upper current limit is safeguarded by a separate fixed current limit circuit that prevents the output current from exceeding 110% of the current rating. The computer is continuously informed of possible current overload or current latch conditions by status outputs which are fed back to the programming source.

### Analog input

In automatic test systems, it is often desirable to inject an ac "wobble" on top of a programmable dc level to measure impedance at various voltage levels, to simulate worst case power supply conditions for a module under test, or measure component parameters such as dynamic gain or transconductance. Many automatic control systems require this feature to provide "dither" for the system. All DVS's provide an analog input to fulfill this need.

### Current monitoring terminals

The output current of all DVS's can be measured without upsetting voltage accuracy by connecting a voltmeter across the current monitoring terminals on the rear barrier strip.

### Digital current sources

The Digital Current Source, Model 6140A is ideally suited for system applications requiring a rapidly programmable, high-precision source of current.

The isolation, internal storage, and analog input features described for the DVS's also apply to the DCS's. In addition, the DCS's have programmable voltage limiting and voltage monitoring terminals.

## Models 6129C-6131C, & 6140A (cont.)

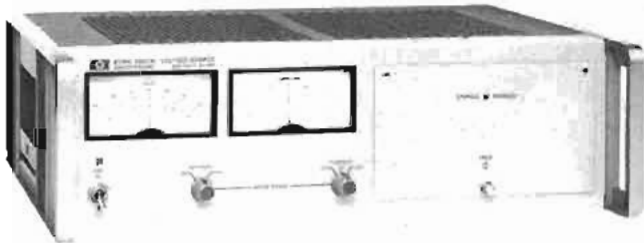

6130C, 6131C

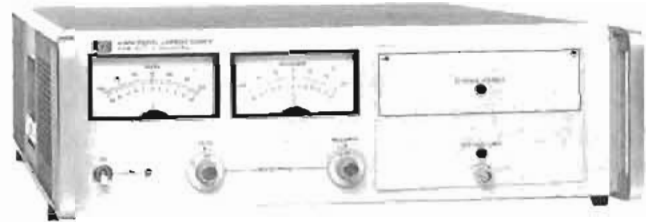

6140A

### Common specifications

#### AC power input

6129C: 115/230 V ac, 48-63 Hz; 6.4 A, 780 W @ 115 V ac; 115/230 V ac switch-selected.  
 6130C, 6131C: 115 V ac  $\pm 10\%$ , 48-440 Hz; 1.2 A, 100 W.  
 6140A: 115/230 V ac, 48-63 Hz; 1.2 A, 100 W @ 115 V ac; 115/230 V ac switch-selected.

#### Dimensions

6129C: 266.7 H  $\times$  425.5 W  $\times$  542.9 mm D (10 $\frac{1}{2}$ "  $\times$  16 $\frac{3}{4}$ "  $\times$  21 $\frac{3}{8}$ ").  
 6130C, 6131C: 133.4 H  $\times$  425.5 W  $\times$  396.9 mm D (5 $\frac{1}{4}$ "  $\times$  16 $\frac{3}{4}$ "  $\times$  15 $\frac{3}{8}$ ").  
 6140A: 133.4 H  $\times$  425.5 W  $\times$  542.9 mm D (5 $\frac{1}{4}$ "  $\times$  16 $\frac{3}{4}$ "  $\times$  21 $\frac{3}{8}$ ").

#### Weight

6129C: net, 35 kg (78 lb). Shipping, 39 kg (85 lb).  
 6130C, 6131C: net, 15 kg (32 lb). Shipping, 18 kg (40 lb).  
 6140A: net, 17 kg (38 lb). Shipping, 20 kg (44 lb).

#### Cooling

6130C, 6131C: are convection cooled.  
 6129C, 6140A: are forced air cooled.

**Programming time:** less than 300  $\mu$ sec for output to settle to within 0.1% of programmed change. Range change requires 2 ms.

	Binary Instruments Option J20 & 084		BCD Instruments Option J99 & 083	
	X1 Range	X10 Range	X1 Range	X10 Range
6129C Output Accuracy Resolution	$\pm 16.384$ V, 5 A 1.5 mV 0.5 mV	$\pm 50.00$ V, 5 A 15 mV 5 mV	$\pm 9.999$ V, 5 A 1.5 mV 1 mV	$\pm 50.00$ V, 5 A 15 mV 10 mV
6130C Output Accuracy Resolution	$\pm 16.384$ V, 1 A 3 mV 0.5 mV	$\pm 50.00$ V, 1 A 10 mV 5 mV	$\pm 9.999$ V, 1 A 3 mV 1 mV	$\pm 50.00$ V, 1 A 10 mV 10 mV
6131C Output Accuracy Resolution	$\pm 16.384$ V, 0.5 A 3 mV 0.5 mV	$\pm 100.00$ V, 0.5 A 10 mV 5 mV	$\pm 9.999$ V, 0.5 A 1 mV 1 mV	$\pm 99.99$ V, 0.5 A 10 mV 10 mV
6140A Output Accuracy Resolution	$\pm 16.384$ mA, 100 V 1 $\mu$ A $\pm 0.01\%$ 0.5 $\mu$ A	$\pm 163.84$ mA, 100 V 10 $\mu$ A $\pm 0.03\%$ 5 $\mu$ A	$\pm 9.999$ mA, 100 V 14 $\mu$ A $\pm 0.01\%$ 1 $\mu$ A	$\pm 99.99$ mA, 100 V 10 $\mu$ A $\pm 0.01\%$ 10 $\mu$ A

#### Accessories furnished:

1251-0086 50-contact rear plug.  
 5060-7948 Plug-in extender board for DVS models.  
 5060-7948/5060-7982 Two plug-in extender boards for DCS.

#### Software for HP computers

Drivers in the form of punched paper tape with accompanying operating manuals are available for Hewlett-Packard BCS, DOS, RTE, and BASIC software operating systems. Contact your HP Field Engineer for prices and ordering information.

#### AC power option

028: transformer tap change for 230 V ac  $\pm 10\%$ , single-phase input on 6130C and 6131C.

#### Standard interface options

J20: binary interface for 12661A I/O programmer card for Hewlett-Packard computers

J99: interfacing DCPS's with calculator-based test/control systems. All DCPS's may be modified to be compatible with ASCII-to-Parallel Converter, Model 59301A in calculator-based systems. In addition to DCPS modification, two items are supplied as part of Option J99: (1) a 1.83 m cable to connect DCPS to Model 59301A; (2) J99 Interface Note, containing Installation Instructions, Software Listings, Operating Instructions, and Diagnostics.

063: BCD interface for microcircuit logic levels  
 064: binary interface for microcircuit logic levels

#### Price

N/C

N/C

\$170

N/C

N/C

#### Special options

If none of the standard interface options meet your requirements, quotations for special options may be obtained from your Hewlett-Packard field engineer.

#### Accessories available

14533B Pocket programmer permits manual programming of all input functions by switch closure  
 14534A Pocket programmer extension cable (3 ft)

14535A HP computer interface kit includes 12661A computer I/O card, 14539A cable, verification software and BCS Driver. Up to eight DCPS's may be controlled from one 14535A

14539A cable connects the first DCPS in a chain of up to eight instruments to the 12661A DVS programming card for Hewlett-Packard computers

14536A chaining cable connects an additional DCPS to the existing chain of DCPS's

\$150

\$75

\$1700

\$170

\$170

#### Ordering information

6129C Digital Voltage Source \$3150  
 Opt 908: Rack Flange Kit add \$15  
 6130C, 6131C Digital Voltage Source \$1900  
 6140A Digital Current Source \$2750  
 Opt 908: Rack Flange Kit add \$10

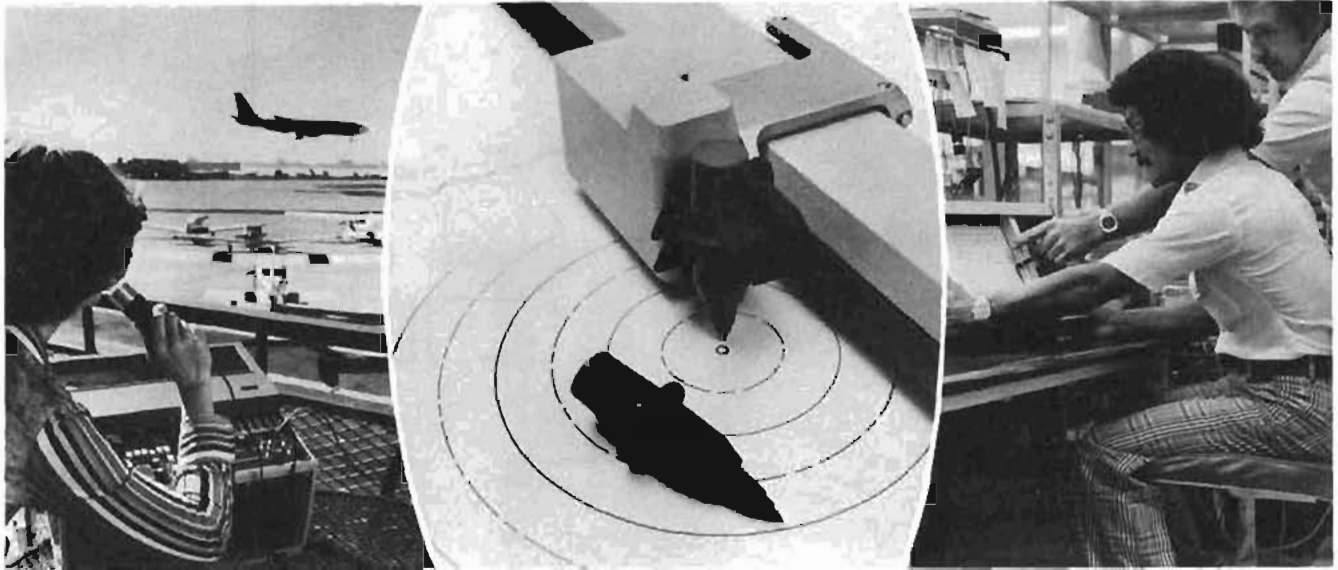

### Introduction

Hewlett-Packard offers a wide selection of recorders and plotters that record and display data accurately, quickly, and reliably. Some application areas are manufacturing, education, laboratories, R & D, and hospitals. The recorders can also be utilized by the original equipment manufacturer (OEM) to fulfill the need for recording and displaying data from the OEM's equipment. Models may be chosen from X-Y, strip chart, oscillographic, and instrumentation tape recorders, as well as graphic plotters for computer, timeshare, and calculator users.

#### X-Y recorders

These recorders are designed to plot Cartesian coordinate graphs from dc electrical information. They may be selected in two basic chart sizes and from three basic levels of performance depending upon measurement needs. Certain models have high sensitivity and high common mode rejection. Models are available with and without time sweep capability. Metric and English instruments may also be selected. Additionally, two-pen models capable of simultaneously plotting two curves may also be chosen. Finally, whether the application be in Bio-Medical, Chemical, Material Testing, etc., a wide variety of X-Y Recorders is available to fit the requirement.

#### Plug-in modules

To expand the versatility and application of one group of X-Y Recorders, plug-in modules are provided. If an application changes, the needed measurement capability is attainable by simply adding an inexpensive plug-in. Recorders utilizing the modules are the 7004B and 7034A. Modules include Amplifiers, Time Bases, DC Offset, Filters, Null Detectors, and Scanners. The flexibility inherent in the plug-in concept will allow the user to meet the constantly changing requirements of laboratory measurement.

#### Graphic plotters

Complete graphic capability to computers or terminals, with a minimum of programming effort and software, is available from Hewlett-Packard Graphic Plotters. Simple commands and data formats, which can be generated by almost any computer in any language, are used to control the plotter.

The newest additions to the expanding Graphic Plotter family include the advanced-designed 7221A and 9872A. Both models are microprocessor plotters that produce high quality, multicolor (red, green, blue, black pens) graphic plots on any size chart up to 280 mm x 432 mm (ISO A3.) The 7221A plots from remote processing facilities; the standard EIA RS232C/CCITT V.24 asynchronous serial ASCII interface operates at any of eight switch selectable baud rates from 75 to 2400 BAUD. The 9872A plots through HP-IB interface to a calculator, computer, or other controller using the IEEE 488-1975 standard interface.

#### Strip chart recorders

HP Strip Chart Recorders produce accurate records in rectilinear coordinates. All two-pen models permit both channels to realize the full resolution of the chart width simultaneously, since the pens can overlap on the same chart without interference.

Selection of a servo-driven strip chart recorder depends upon the specific application. The 7100 Series and 7130A Series models offer one-pen and two-pen servo drive systems. The 7123A and 7143A offer single-pen only and utilize the linear motors with only one moving part. The 7155B battery-operated unit is useful in field applications as well as laboratory uses.

#### Oscillographic recorders

Time correlation of multiple channels of data, instantaneous read-out, and the capability to use calibrated units of the customer's choice are just some of the advantages of using direct writing Oscillographic Recorders. Permanent and easily reproduced records of signals from dc to 150 Hz can be made. From two to eight channels of recording are available, depending upon the recorder model selected.

With appropriate plug-in signal conditioners, the recorders can record electrical signals from microvolts to volts. Add transducers and they can make records of all types of physical measurements, such as force, position, strain, stress, acceleration, and temperature.

#### Plug-in preamplifiers

A wide line of preamplifiers is available for pressurized ink system recorders which provide unmatched flexibility.

#### Instrumentation tape recorders

The 3964A and 3968A are instrumentation tape recorders that provide significant benefits by recording on 1/4" tape as compared to recording on 1/2" tape. The units are designed to meet the demands of the individual and OEM users. Versatility, portability, and durability are additional characteristics of these units.

Many standard features are also supplied. They include E-to-E mode for FM recording, Tape/Tach servo, Equalization, Remote Control, AC/DC calibrator, Flutter compensation, Voice capability, Unipolar operation (FM only), and Re-recording (Dubbing).

#### Recorder supplies kit

Recorder supplies; pen, paper, ink; for X-Y, Strip Chart, Oscillographic, Graphic Plotter, or Instrumentation Tape Recorders are available in starter kits. These kits can ensure uninterrupted operation or unnecessary delay to recorder performance due to unexpected overuse, or lack, of pen, paper, ink, or other recorder supplies.

To order a Recorder Supplies Starter kit, refer to the appropriate instrument(s) in this catalog. Model numbers are assigned to the desired kit. A complete list of all supplies available is listed in the Recorder supplies catalog.

1:1 RECORDERS

Model	Description	Chart Size ISO (Inches)	No. of Pens	Time Base	Max. Sensitivity		Standard Writing Method	Plug-In
					mV/cm	mV/in.		
7010B	ODM	A4 (8 1/2 x 11)	1	Option	5	10	Disposable Pen	No
7015B	Lab—General Purpose	A4 (8 1/2 x 11)	1	Standard	5	10	Disposable Pen	No
7034A	Fast Response, AC Capability	22 cm x 28 cm (8 1/2 x 11)	1	Plug-in	0.25	0.5	Disposable Pen	Yes
7035B	General Purpose	22 cm x 28 cm (8 1/2 x 11)	1	1710BA Plug-On	0.4	1.0	Disposable Pen	No
7040B	Fast Response, AC Capability	28 cm x 42 cm (11 x 17)	1	Plug-in	0.25	0.5	Disposable Pen	Yes
7040A	OEM	A3 (11 x 17)	1	Option	0.2	0.5	Disposable Pen	No
7041A	ODM Fast Response	A3 (11 x 17)	1	Option	0.2	0.5	Disposable Pen	No
7044A	General Purpose	A3 (11 x 17)	1	Option	0.25	0.5	Disposable Pen	No
7045A	Fast Response	A3 (11 x 17)	1	Option	0.25	0.5	Disposable Pen	No
7046A	Fast Response	A3 (11 x 17)	2	Option	0.25	0.5	Disposable Pen	No
7047A	Fast Response	A3 (11 x 17)	1	Standard	0.02	0.05	Disposable Pen	No

PLOTTERS

Model	Description	Code	Interface	Data Transmission Rate	Maximum Plotting Speed	Plot Accuracy	Repeatability	Printer Commands	Numerical Resolution
7202A	Terminal Plotter Connects between Computer Terminal & MODEM	Serial ASCII	EIA RS232C (CCITT V24) or 20 mA TTY	10, 15 or 30 Char/s Asynchronous	105 Vectors/min	Within 0.076	>0.18 mm	Mnemonic	1 in 10,000 or 0.01%
7203A	High Speed Terminal Plotter, Connects between Computer Terminal & MODEM	Serial ASCII	EIA RS232C (CCITT V24) only	10 or 30 Char/s Asynchronous	450 Vec/min Dependent on Vector slope & Length	Within 0.01 mm	>0.18 mm	Single ASCII Character	1 in 2500 or 0.04%
7210A	Computer Plotter, Connects to Computer Mainframe	Parallel BCD (8421) or Binary	Binary Option 001 includes HP 2100/210A Interface	Synchronous by Handshake	1200 Vec/min. Dependent on Vector slope & Length	Within 0.1 mm	>0.16 mm	Determined by status of bit in first data pass	1 in 10,000 or 0.01%
7221A	High Speed Four Color Programmable Remote Terminal Plotter	Serial ASCII	EIA RS232C (CCITT V.24)	Switch selectable 7.5 to 240 Char/s Asynchronous	36 cm/s in each axis Programmable	±0.2% deflection ±0.2 mil	For given Pen 0.1 mm For Pen to Pen 0.2 mm	41 Programmable High Level Commands	0.025 mm (0.001 inch) Programmable
9822A	High Speed Four Color Programmable Plotter	Parallel ASCII	HP-IB conforms to IEEE 488-1975	Up to 1 Megabit/s	360 m/s or each axis	±0.2% deflection ±.02 mil	For given Pen 0.1 mm For Pen to Pen 0.2 mm	38 two letter mnemonic commands	0.025 mm (0.001 inch) Programmable

STRIP CHARTS

Model	Description	Chart Width		No. of Channels	Standard No. Chart Speeds	Chart Speed Range				Standard Writing Method	Maximum Sensitivity mV (mV/in.) Full Scale	Signal Input Sensitivity
		in.	cm.			Min cm/hr	Max cm/min	Min in./hr	Max in./min			
62D	Lab—ODM	12	5	1	8	2.5	20	1	8	Caply ink pen w/replace cart	5 (6)	10 Spans
7143A	OEM	12		1	Deter. by Opt.	3	15	1	6	Disp. Ink Pen	1 (1.2)	Single Span
7155B	Lab—OEM	12	5	1	7	1	12			Disp. Ink Pen	1 (1.2)	16 Spans
7100B	Lab—OEM	25	10	2	12	2.5	5 cm/s	1	2 in./s	Caply ink pen w/replace cart	0.1 (0.1)	Plug-In
7101B	Gen Purpose—OEM	25	10	1	12	2.5	5 cm/s	1	2 in./s	Caply ink pen w/replace cart	0.1 (0.1)	Plug-In
7123A	OEM	25	10	1	Deter. by Opt.	3	15	1	6	Disp. Ink Pen	1 (1)	Single Span
7130B	OEM	25	10	2	Deter. by Opt.	3	15	1	6	Disp. Ink Pen, Thermal Opt.	1 (1)	Single Span
7131A	OEM	25	10	1	Deter. by Opt.	3	15	1	6	Disp. Ink Pen, Thermal Opt.	1 (1)	Single Span
7132A	Lab	25	10	2	8	2.5	15	1	6	Disp. Ink Pen, Thermal Opt.	1 (1)	52 Spans
7133A	Lab	25	10	1	8	2.5	15	1	6	Disp. Ink Pen, Thermal Opt.	1 (1)	11 Spans

OSCILLOGRAPHIC RECORDERS

System	No. of Channels x Chart Width (mm)	Writing Method	With Amp Model No.	Max Sensitivity mV/div	Vertical Rack Space Requirement	
					(mm)	Inches
7402A	2 x 50	Preamplified Ink	17400A thru 17404A	0.001, 1, 20	267	10 1/2
7404A	4 x 40	Preamplified Ink	17400A thru 17404A	0.001, 1, 20	267	10 1/2
7414A	4 x 40	Thermal	8800 Series Preamps	0.001	267	10 1/2
7415A	6 x 40 8 x 40	Thermal	8800 Series Preamps	0.001	451 406	17 1/2 16 0

INSTRUMENTATION TAPE RECORDERS

Model	Description	Tape Speeds (Opt)	FM Response	Direct Response	Size	Weight
3964A	Four Channel, Multi Speed on 1/4 inch (6.3 mm) wide tape	15, 3 1/2, 3 1/4, 1 1/2, 1 1/4, 1 1/2, 1 1/4	DC-5000 Hz @ 15 ips DC-156 Hz @ 1 1/2 ips	70-64000 Hz @ 15 ips 56-2000 Hz @ 1 1/2 ips	420 H x 427 W x 256 mm D	79.5 kg
3968A	Eight Channel, Multi Speed on 1/4 inch (6.3 mm) wide tape	25, 7 1/2, 3 1/4, 1 1/2, 1 1/4, 1 1/2, 1 1/4	DC-5000 Hz @ 15 ips DC-156 Hz @ 1 1/2 ips	500-64000 Hz @ 15 ips 100-2000 Hz @ 1 1/2 ips	445 H x 427 W x 256 mm D (17.5" x 16.7" x 10.1")	113 kg

# RECORDERS & PRINTERS

Fast response X-Y recorder, plug-in-modules

Models 7004B, 7034A, & 17170 series plug-ins

• High performance

• Plug-in versatility

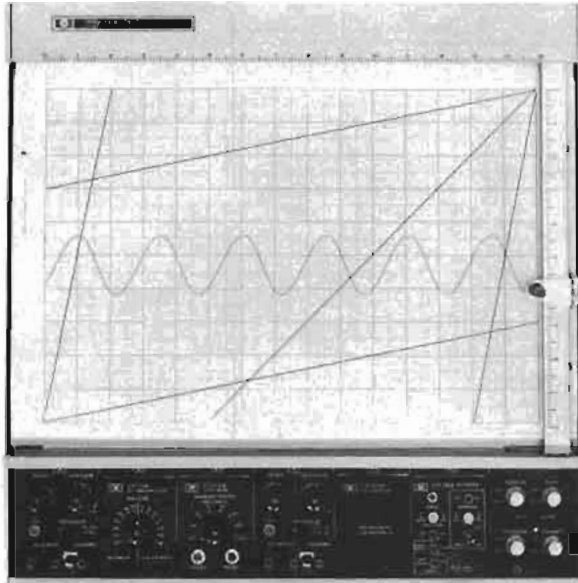

7004B

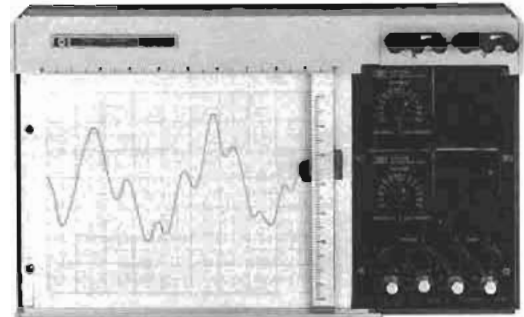

7034A



17170A



17171A



17172A

The Hewlett-Packard Models 7004B and 7034A provide acceleration of more than  $3800 \text{ cm/s}^2$  ( $1500 \text{ in./s}^2$ ) and slewing speed of  $76 \text{ cm/s}$  ( $30 \text{ in./s}$ ). The high acceleration allows the pen to follow small, quick input changes. Front and rear guard terminals are available for signal inputs. Guarding helps eliminate the common mode voltage effects that are troublesome when recording from low-level sources such as thermocouples, strain gauges and similar sources. Additional features include the proven Autogrip electrostatic paper hold-down, the disposable ink pen, a RECORD/SETUP switch, knob locks, five-way binding posts, tilt stand, to name a few.

Selection of the plug-ins is dependent upon the type of X-Y recorder, as well as purpose. Two plug-ins per axis are placed in the mainframe. Each may be used individually or in series by setting the front panel switch.

## 7004B, 7034A, 17170 Series plug-ins specifications

### 7004B and 7034A Performance specifications

**Plug-ins:** accept 4 single-width; 2 per axis.

**Type of input:** floating and guarded signal pair. Available through front panel or rear connector.

**Zero set:** may be set  $\pm 1 \text{ fs}$  from zero index.

**Zero check switches:** pushbutton in each axis allows verification of recorder's zero position without removal or shorting of input signal.

**Mainframe accuracy:**  $\pm 0.2\%$  of full scale.

**Range vernier:** lockable, covers 2.5 times range setting.

**Slewing speed:** more than  $75 \text{ cm/s}$  ( $30 \text{ in./s}$ ) independent of line voltage & frequency.

**Acceleration:** more than  $3800 \text{ cm/s}^2$  ( $1500 \text{ in./s}^2$ ).

**Reference stability:** better than  $0.003\%/^{\circ}\text{C}$ .

**Terminal based linearity:**  $\pm 0.1\%$  of full scale.

**Resetability:**  $\pm 0.05\%$  of full scale.

### 7004B and 7034A General specifications

**Paper holddown:** autogrip grips charts up to size of platen.

**Pen lift:** local and remote control (contact closure or TTL).

**Dimensions:** 7004B:  $267 \text{ mm H} \times 445 \text{ mm W} \times 121 \text{ mm D}$  ( $10\frac{1}{2}'' \times 17\frac{1}{2}'' \times 4\frac{3}{4}''$ ), 7034A:  $267 \text{ mm H} \times 445 \text{ mm W} \times 121 \text{ mm D}$  ( $10\frac{1}{2}'' \times 17\frac{1}{2}'' \times 4\frac{3}{4}''$ ).

**Weight:** 7004B: net  $12.7 \text{ kg}$  ( $28 \text{ lb}$ ). Shipping  $14.1 \text{ kg}$  ( $42 \text{ lb}$ ). 7034A: net  $7.3 \text{ kg}$  ( $16 \text{ lb}$ ). Shipping  $14.1 \text{ kg}$  ( $31 \text{ lb}$ ).

**Power:**  $115$  or  $230 \text{ V ac} \pm 10\%$ ,  $50$  to  $400 \text{ Hz}$ , approx.  $85 \text{ VA}$  (dependent on plug-in).

### 17170A DC Coupler specifications

**Input range:** single, fixed calib range of  $50 \text{ mV/cm}$  ( $100 \text{ mV/in.}$ ).

**Input resistance:**  $1 \text{ M}\Omega$  constant.

**Common mode rejection:**  $120 \text{ dB}$  at dc &  $70 \text{ dB}$  at  $50 \text{ Hz}$  & above with  $100\Omega$  between low side & guard connect point with source imped.  $10 \text{ k}\Omega$  or less.

### 17171A DC Amplifier specifications

**Input ranges:**  $0.25, 0.5, 1, 2.5, 5, 10, 25 \text{ mV/cm}$ ,  $0.05, 0.1, 0.25, 0.5, 1, 2.5, 5 \text{ V/cm}$  ( $0.5, 1, 2, 5, 10, 20, 50 \text{ mV/in.}$ ,  $0.1, 0.2, 0.5, 1, 2.5, 10 \text{ V/in.}$ ).

**Input resistance:**  $1 \text{ M}\Omega$ .

**Common mode rejection:**  $120 \text{ dB}$  at dc &  $100 \text{ dB}$  at  $50 \text{ Hz}$  & above with  $100\Omega$  between low side & guard connect point at  $0.25 \text{ mV/cm}$  ( $0.5 \text{ mV/in.}$ ). CMR on others decreases  $20 \text{ dB/decade}$  step in attenuation.

**System accuracy:**  $\pm 0.2\%$  full scale.



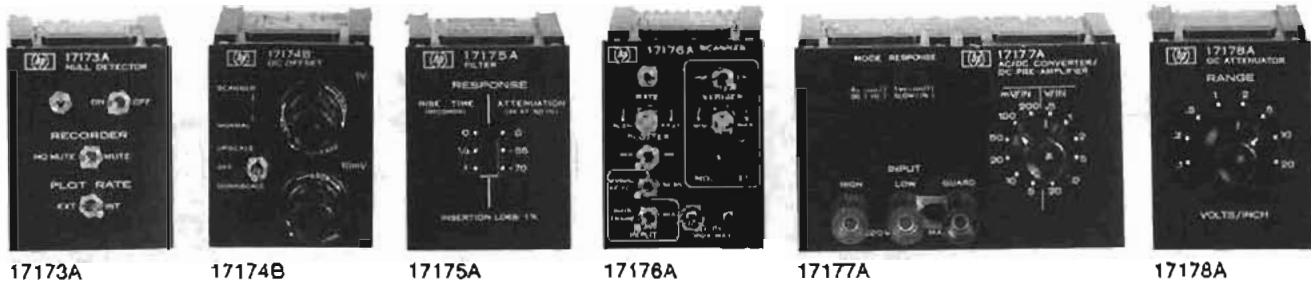

17173A 17174B 17175A 17176A 17177A 17178A



17012B/C

**17172A Time base specifications**

**Sweep speeds:** 0.25, 0.5, 1, 2.5, 5, 10, 25, 50 s/cm (0.5, 1, 2, 5, 10, 20, 50, 100 s/in.).

**System accuracy:** ±1% of fs on 6 fastest ranges; ±2.5% on remaining 2.

**17173A Null detector specifications**

**Plot rate:** up to 50 plots/s.

**Enable/disable:** required disable voltage +3 V min. to +20 V max. Required enable voltage—0 V dc or no connect. Other voltage combinations available on request.

**Muting:** local or remote.

**Plotting accuracy:** ±0.25% of full scale.

**17174B DC Offset specifications**

**Offset:** <1 mV to approx. 1 V.

**Controls:** 2 lockable, 10-T high resolution controls (<1 mV to approx. 10 mV & <1 mV to approx. 1 V). An offset polarity switch allows upscale or downscale zero offset.

**Offset voltage stability:** >0.005%/°C.

**17175A Filter specifications**

**Input ranges:** -5 to +45 V dc, 10 V ac max p-p.

**Maximum source impedance:** 1 kΩ; higher impedance decreases filter response.

**Rejection:** >55 dB at 50 Hz & higher (1/4 s rise time) or >70 dB at 50 Hz & higher (1 s rise time). Front panel selection.

**17176A Scanner specifications**

**Input:** front panel miniature binding posts isolated from ground (high & low only). Mainframe input—utilizes existing input connectors.

**Attenuator:** fixed attenuator in decade steps from X1 to X0.00). Variable attenuator provides continuous coverage.

**Input impedance:** 100 kΩ.

**Accuracy:** 0.2% of full scale.

**Scan rate:** adjust. from 0.1 to 4 s/scan.

**17177A AC/DC Converter DC preamplifier specifications**

**Input ranges:** 2.5 mV/cm to 10 V/cm (5 mV/in. to 20 V/in.) in 1, 2, 5 steps.

**Minimum usable input (ac only):** ±0.2% of full scale.

**Maximum allowable input:** 300 V peak.

**Type of input:** floating & guarded sig. pair. No rear inputs.

**Input impedance:** 1 MΩ shunted by less than 40 pF.

**Maximum allowable source resistance:** 10kΩ.

**Common mode rejection:** 80 dB at dc & 50 Hz & above with 100Ω floating & guarded connect point & at 2.5 mV/cm (5 mV/in.). CMR on other ranges, decreases 20 dB/decade step in attenuation.

**Rise/fall time (ac only, 10-90%):** Slow response (5 Hz to 100 kHz) 2.5 s max; fast response (50 Hz to 100 kHz) 0.5 s max.

**Calibration (ac only):** responds to average value of input waveform; calib in rms value of sinewave.

**Accuracy (% of fs):** DC—±0.5%; AC (fast response)—±0.25% from 150 Hz to 50 kHz, ±0.5% from 50 Hz to 150 Hz & 50 kHz to.

100 kHz; AC (slow response)—±0.25% from 30 Hz to 50 kHz from 5 Hz to 30 Hz & 50 kHz to 100 kHz.

**Linearity (ac):** expressed as % of fs, measuring from 0.5% of fs.

5 Hz	50 Hz	50 kHz	100 kHz
=0.35%	=0.25%	=0.35%	

**Warmup time:** 3 minutes nom.

**Zero drift (referred to input):** ±30 μV/°C.

**Offset:** up to 1 fs of offset using recorder's zero.

**Size:** double width occupies both plug-in spaces in axis.

**17178A DC Attenuator specifications**

**Input ranges:** 0.05, 0.1, 0.25, 0.5, 1, 2.5, 5, 10 V/cm (0.1, 0.2, 0.5, 1, 2, 5, 10, 20 V/in.).

**Input resistance:** 1MΩ.

**Common mode rejection:** 120 dB at dc & 70 dB at 50 Hz & above with 100Ω between low side & point where guard is connected (at 50 mV/cm or 100 mV/in.). Other ranges CMR decreases 20 dB/decade step in attenuation.

**System accuracy:** ±0.2% of full scale.

**Options and accessories**

	Price
001: metrically scaled & calibrated (7004B/7034A)	N/C
002: X-axis retrans pot. 5 kΩ ±0.1% linearity (7004B)	\$100
004: power supply for 17005-04 increment chart adv. (7004B)	\$55
001: metrically scaled (17170A/17171A/17172A/17177A/17178A)	N/C
001: +3 to 20 V enable, 0 V disable (17173A)	\$25
001: symbol plotting capability (6) (17012B/C)	\$30
002: -3 to -20 V disable, 0 V enable (17173A)	\$25
003: -3 to -20 V enable, 0 V disable (17173A)	\$25
908: rack mount kit	add \$20
910: extra manual	add \$15
17024A Recorder Supplies Starter Kit—English (7034A)	\$41
17025A Recorder Supplies Starter Kit—Metric (7034A)	\$43
17026A Recorder Supplies Starter Kit—English (7004B)	\$49
17027A Recorder Supplies Starter Kit—Metric (7004B)	\$55

**Ordering information**

7004B X-Y Recorder (28.26 × 43.18 cm) (11" × 17")	\$2100
7034A X-Y Recorder (21.59 × 28.26 cm) (8½" × 11")	\$2040
17005A Chart Advance (7004B only)	\$1600
17170A DC Coupler Plug-in	\$60
17171A DC Amplifier Plug-in	\$410
17172A Time Base Plug-in	\$300
17173A Null Detector	\$380
17174B DC Offset Plug-in	\$190
17175A Filter Plug-in	\$165
17176A Scanner Plug-in	\$545
17177A AC/DC Converter Plug-in	\$750
17178A DC Attenuator Plug-in	\$215
17012B/C Point Plotter	\$165



# RECORDERS & PRINTERS

## General performance X-Y recorder, time base

Models 7035B & 17108A

- Floating Guarded Inputs

- Disposable pens

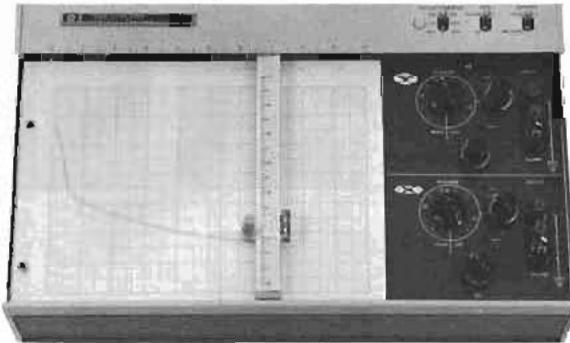

7035B

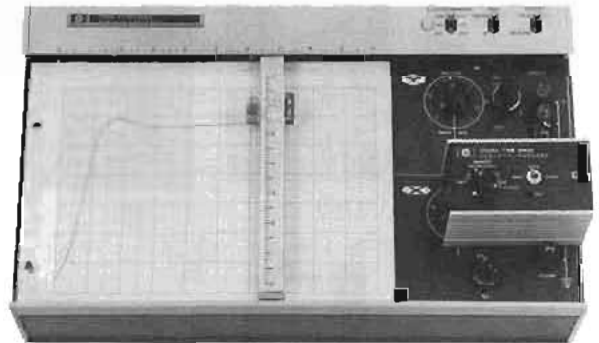

7035B with 17108A

The 7035B is a high-quality, low cost instrument designed for use in general purpose applications. Each axis has an independent servo system with no interaction between channels. The 7035B plots two graphs from two dc signals representing the function being measured.

Input terminals accept either open wires or plug-type connectors. Five calibrated ranges from 0.4 mV/cm (1 mV/in.) to 4 V/cm (10 V/in.) are provided in each axis. A variable range control permits scaling of signal for full scale deflection. High input impedance (1 megohm on all but the first two ranges), floated and guarded input, and 0.2% accuracy is provided.

Each closed-loop servo system uses a high-gain, solid-state servo amplifier, servo motor, long-life balance potentiometers, photo-chopper, low pass filter, guarded inputs, and attenuator and balance circuit.

A plug-in time base, Model 17108A, operates on either axis to provide five sweep speeds from 0.2 to 20 s/cm. The unit is self-contained, external, and designed to directly plug into the 7035B input terminals. Any number of recorders may be driven simultaneously, provided the combined parallel input resistance is 20 k $\Omega$  or more.

### 7035B Specifications

#### Performance specifications

##### Input ranges

**Metric:** 0.4, 4, 40, 400 mV/cm and 4 V/cm.

**English:** 1, 10, 100 mV/in.; 1 and 10 V/in. Continuous vernier between ranges.

**Types of inputs:** floated and guarded signal pair; rear input connector.

##### Input resistance

Range	Input resistance
0.4 mV/cm (1 mV/in.)	Potentiometric (essentially infinite at null)
Variable	11 k $\Omega$
4 mV/cm (10 mV/in.)	1 M $\Omega$
Variable	100 k $\Omega$
40 mV/cm (100 mV/in.)	100 k $\Omega$
Variable	1 M $\Omega$
400 mV/cm (1 V/in.)	1 M $\Omega$
Variable	1 M $\Omega$
4 V/cm (10 V/in.)	1 M $\Omega$
Variable	1 M $\Omega$

**Normal mode rejection:** >30 dB at 60 Hz; 18 dB/octave above 60 Hz.

**Maximum allowable source impedance:** no restrictions except on fixed 0.4 mV/cm (1 mV/in.) range. Up to 20 k $\Omega$  source impedance will not alter recorder's performance.

**Accuracy:**  $\pm 0.2\%$  of full scale.

**Linearity:**  $\pm 0.1\%$  of full scale.

**Resetability:**  $\pm 0.1\%$  of full scale.

**Zero set:** zero may be set up to one full scale in any direction from zero index. Lockable zero controls.

**Slewing speed:** 50 cm/s. (20 in./s) nominal at 115 V.

**Common mode rejection:** conditions for the following data are line frequency with up to 1 k $\Omega$  between the positive input and guard connection point. Max. dc common mode voltage is 500 V.

Range	DC (CMR)	AC (CMR)
Metric	English	
0.4 mV/cm	1 mV/in.	130 dB
4 mV/cm	10 mV/in.	110 dB
40 mV/cm	100 mV/in.	90 dB
400 mV/cm	1 V/in.	70 dB
4 V/cm	10 V/in.	50 dB
		100 dB
		80 dB
		60 dB
		40 dB
		20 dB

#### General specifications

**Paper holddown:** autogrip electric paper holddown grips 216 mm  $\times$  279 mm (8 1/2 in.  $\times$  11 in.) charts or smaller. Special paper not required.

**Pen lift:** electric pen lift capable of being remotely controlled.

**Dimensions:** 265 mm H  $\times$  445 mm W  $\times$  121 mm D (10 3/8"  $\times$  17 1/2"  $\times$  4 3/4").

**Weight:** net, 8 kg (18 lb). Shipping, 10.9 kg (24 lb).

**Power:** 115 or 230 V  $\pm 10\%$ , 50 to 60 Hz, approximately 45 VA.

### 17108A Specifications

**Sweep speeds:** 0.2, 0.4, 2, 4, 20 s/cm (0.5, 1, 5, 10, 50 s/in.).

**Accuracy:** 5% of recorder full scale.

**Linearity:** 0.5% of full scale (20°C to 30°C).

**Output voltage:** 0 to 1.5 V.

**Power:** replaceable mercury battery (100 hr).

#### 7035B Options and accessories

**Opt 001:** metric calibration

**Opt 003:** retransmitting potentiometer on X-axis 5 k $\Omega$   $\pm 3\%$

**Opt 020:** modification for use with models 3580A and 3581A/C

**Opt 908:** rack mount kit

**Opt 910:** extra manual

17108A Time Base Plug-In

17108AM Time Base Plug-In (metric)

17024A Recorder Supplies Starter Kit—English

17025A Recorder Supplies Starter Kit—Metric

Price  
N/C

add \$90

add \$295

add \$15

add \$10

\$260

\$260

\$41

\$43

7035B General Purpose X-Y recorder

\$1475

• Low Cost

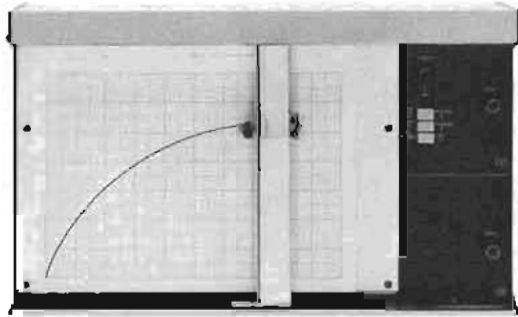

7010B

The 7010B is a low cost, one-pen X-Y recorder that accepts either ISO A4 or 8½ × 11 inch chart size. Featuring maximum electrical and mechanical flexibility, it is specifically designed for the OEM user concerned with cost and space. Options include sensitivity from 5 mV/cm, a time base sweep with remote TTL triggering, input filters, electric pen lift with TTL remote control, control panel, and carrying case.

A low cost, full capability X-Y recorder, the 7015B offers full recording without add-on options or external equipment. Full capability features include Internal Time Base, Matched Input Filters, Remote Pen Lift, and TTL Level Remote Control. The internal time base can be slowed to ¼ hour sweep and has automatic pen control and remote triggering for sweep start and reset. The filters reduce the always present signal noise. Remote pen lift provides the assurance of an acceptable graph during a quick plot. TTL level remote control provides an easy interface with external equipment or systems.

Standard equipment on both units includes the electrostatic paper holddown, rear connector, and disposable pen writing system which includes a universal pen holder that will accept most commercial fiber tipped pens.

### Performance specifications

#### Ranges

**Input voltages:** 7010B—single range, 0.1 V/in. (Metric opt.: 5 mV/cm).

**7015B—Metric Option:** 5 mV/cm, 50 mV/cm, 500 mV/cm.

**English:** 0.01 V/in., 0.1 V/in., 1 V/in. Vernier adjustment overlapping all ranges.

**Time Base:** 7015B 0.5, 1, 5, 10, 50, 100 s/in. (Option 001, metric calibration is 0.1, 0.5, 1, 5, 10, 50 s/cm). Remote sweep start and reset via TTL level or contact closure.

**Type of Inputs:** 7010B—Floating with inputs thru rear connector on circuit board; 7015B—Floating with inputs thru binding posts or rear connector on circuit board. Mating rear connectors furnished for both units.

**Input resistance:** 1 MΩ constant.

**Normal mode rejection:** 7015B—greater than 50 dB at 50 and 60 Hz (40 dB/decade roll-off above 60 Hz).

**Common mode rejection:** 100 dB ac (decreases 20 dB/decade step in attenuation). Measured with 1k unbalance in HI terminal on most sensitive range.

**Common mode voltage:** 40 V dc and peak ac maximum (conforms to IEC 348).

**Accuracy:** ±0.3% of full scale at 25°C (includes linearity and resetability). For 7015B add ±0.2% of deflection when on other than most sensitive range. Temperature coefficient ±0.02%/°C. Time Base 1.5% ±0.1%/°C.

**Resetability:** less than 0.2% of full scale.

**Overshoot:** less than 2% of full scale.

**Slowing Speed:** greater than 50 cm/s (20 in./s).

**Zero set:** 7015B—zero may be placed anywhere on writing area or electrically offscale up to one full scale from zero index. Adjustment by 10-dum high resolution control.

**Environmental:** operating temperature 0°C to 55°C; relative humidity 95% RH to 40°C.

• Full Capability

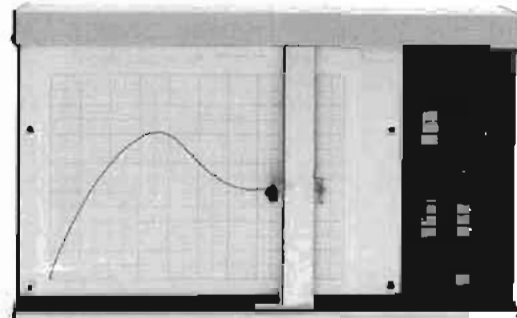

7015B



### General specifications

**Writing system:** fiber tipped disposable pen. For specialized applications, a universal pen holder is provided to accept most commercial fiber tipped pens.

**Writing area:** 18 × 25 cm (7 × 10").

**Platen size:** holds ISO A4 (21 × 29.7 cm) and 8½ × 11 in. chart size or smaller.

**Size:** 267 H, 432 W, 135 mm D (10.50" × 17" × 5").

**Chart holddown:** autogrip electric chart A4 holddown grips chart size or smaller.

**Pen lift:** 7010B—manual (electric with TTL remote control is optional); 7015B—electric (remote via TTL level or contact closure).

**Power:** switch selectable for 100, 120, 220, 240 V ac ± 5-10%; 47.5 to 440 Hz; 70 VA maximum.

**Weight:** net, 7.2 kg (16 lb); shipping 10 kg (22 lb).

### Options and accessories

#### 7010B

001: Metric calibration N/C

002: Control panel—provides power on/off, power indicator light, servo standby, chart hold, zero controls, and if ordered, electric pen lift \$75

003: Electric pen lift (remote via TTL or contact closure) \$65

004: Delcies recorder case less \$10

005: X-axis single sensitivity 10 mV/in. (5 mV/cm with Opt 001) N/C

006: X-axis single sensitivity 1 V/in. (0.5 V/cm with option 001) N/C

007: Y-axis single sensitivity 10 mV/in. (5 mV/cm with Opt 001) N/C

008: Y-axis single sensitivity 1 V/in. (0.5 V/cm with Opt 001) N/C

009: X-axis sweep rate of 1 s/in. (0.5 s/cm with Opt 001\*) \$600

010: X-axis sweep rate of 10s/in. (5 s/cm with Opt 001\*) \$100

011: Carrying case (not to be used for shipping) \$105

012: Input filter (both axes) \$40

013: Rear Connector (37 pin subminiature "D") \$65

\*Options 009 and 010 include electric pen lift

#### 7015B

001: Metric calibration N/C

004: Carrying case (not to be used for shipping) \$105

908: Rack mount kit \$15

910: Extra manual \$10

17024A Recorder Supplies Starter Kit—English \$41

17025A Recorder Supplies Starter Kit—Metric \$43

908: Rack mount kit \$15

7010B OEM X-Y Recorder \$1075

7015B Lab X-Y Recorder \$1325



# RECORDERS & PRINTERS

OEM, Dedicated applications X-Y recorders

Models 7040A & 7041A

- Rugged one-piece casting
- Over 40 options

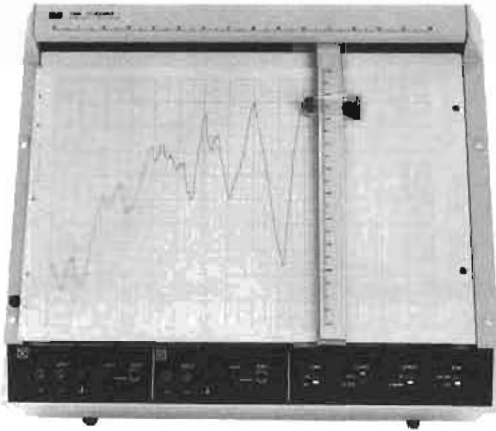

7040A-038

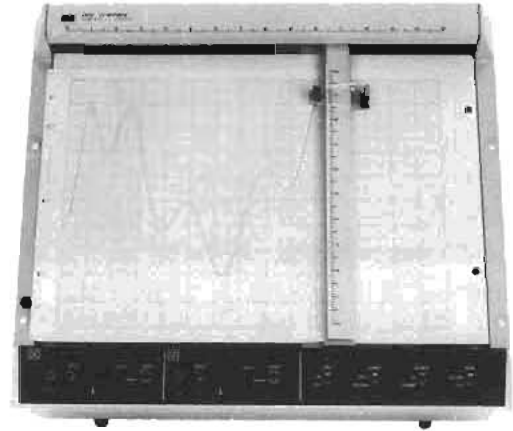

7041A-038

The 7040A and 7041A X-Y recorders are specifically designed for dedicated, single-purpose recording applications. The 7040A is a medium-speed unit while the 7041A is a high-speed unit featuring fast acceleration for applications where recording time is critical or incoming data is at a high rate.

Both models use a one-piece aluminum casting mainframe which eliminates the need for critical mechanical adjustments. They are also equipped with the Autogrip paper holddown system and the quick-change disposable pen.

Additionally, over 40 options give these recorders the ability to be customized for the needed application. Most of the options can be easily and quickly installed or changed in the field. This includes a control panel (Option 038) which would provide the basic recorder functions such as zero set, servo, pen, and chart operation. Other options include a time base, a plug-in X-axis event marker, TTL logic remote control, plus a variety of input ranges.

A functional and quantity discount is available for both units when qualified for the OEM purchase agreement.

## 7040A & 7041A Specifications

**Input ranges:** single range from 0.2 to 500 mV/cm (0.5 mV/in. to 1 V/in.), specified by option choice.

**Type of Input:** floating, 200 V dc or peak ac max; internal polarity switch; inputs through rear barrier strip or optional connector.

**Input resistance:** 1 M $\Omega$  constant.

**Common mode rejection:** 100 dB dc; 80 dB at line frequency.

### Stewing speed

7040A: 50 cm/s (20 in./s) min.

7041A: 76 cm/s (30 in./s) min.

### Acceleration (peak)

7040A: Y axis 2540 cm/s<sup>2</sup> (1000 in./s<sup>2</sup>); X axis 1270 cm/s<sup>2</sup> (500 in./s<sup>2</sup>).

7041A: Y axis 7620 cm/s<sup>2</sup> (3000 in./s<sup>2</sup>); X axis 5080 cm/s<sup>2</sup> (2000 in./s<sup>2</sup>).

**Accuracy:**  $\pm 0.2\%$  of full scale.

**Sweep:** optional, single range.

**Zero set:** external control provided by user; front panel controls available as Option 038.

**Paper holddown:** autogrip electric paper holddown grips ISO A3 or 11" x 17" charts or smaller.

**Pen lift:** electric pen lift controlled remotely by contact closure; TTL logic level provided by Option 039.

**Size:** 356 H x 483 W x 165 mm D (14" x 19" x 6 1/2"); rack mounting structure integral with unit.

**Weight:** net, 13.2 kg (29 lb). Shipping, 16.8 kg (37 lb)

**Power:** 100, 120, 220, 240 V ac  $\pm 5\%$ , 47 S to 440 Hz, 130 VA.

## Options

**Input range** specify one range option for each axis; must be both English or both metric

X	Y	Range	Price	X	Y	Range	Price
001	007	0.5 mV/in.	\$100	013	019	0.2 mV/cm	\$100
002	008	1 mV/in.	\$100	014	020	0.5 mV/cm	\$100
003	009	10 mV/in.	\$100	015	021	5 mV/cm	\$100
004	010	100 mV/in.	\$50	016	022	50 mV/cm	\$50
005	011	500 mV/in.	\$50	017	023	100 mV/cm	\$50
006	012	1 V/in.	\$50	018	024	500 mV/cm	\$50

Note: other ranges available on special order.

**Sweep range** specified by option, X axis only; accuracy  $\pm 1\%$  of full scale  $\pm 0.1\%/^{\circ}\text{C}$  max; TTL logic start and reset

X	Sweep	Price	X	Sweep	Price
025	1 s/in.	\$150	030	0.5 s/cm	\$150
026	5 s/in.	\$150	031	5 s/cm	\$150
027	10 s/in.	\$150	032	5 s/cm	\$150
028	50 s/in.	\$150	033	10 s/cm	\$150
029	100 s/in.	\$150	034	50 s/cm	\$150

Note: other sweep ranges available on special order

035: event marker, upper margin of X axis add \$100

036: control panel; for line, pen lift, chart, servo standby, zero, and zero check; add 44 mm (1 3/4") to height add \$140

039: TTL logic remote control; for pen lift and servo standby; also event marker if installed add \$60

040: rear connector; X, Y input signals and retransmitting potentiometers, time base controls, Autogrip add \$90

servo standby, pen lift, event marker and Option 039 control lines brought to a single locking connector

041: side trim panels and dust cover (356 mm, [14"]) add \$20

for standard unit

042: side trim panels and dust cover (400 mm, [15 3/4"]) add \$20

for unit with Option 038 installed

910: extra manual add \$10

17026A Consumable Starter Kit—English \$49

17027A Consumable Starter Kit—Metric \$55

**Ordering information**

7040A Medium speed X-Y recorder \$1275

7041A High speed X-Y recorder \$1485

Note: OEM discounts available on both models.

# RECORDERS & PRINTERS

## Two-pen, three parameter X-Y/Y recorder

### Model 7046A



- Small pen separation

- Virtually no overshoot

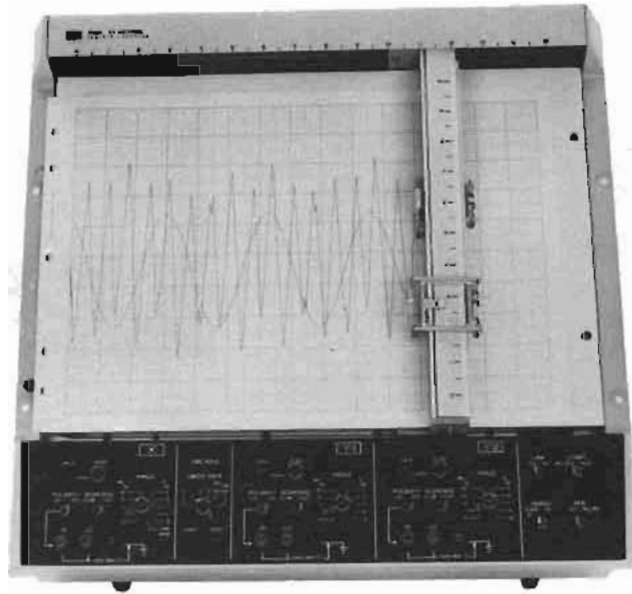

The Model 7046A is a general-purpose 2-pen laboratory X-Y recorder designed to assure high quality recordings without sacrificing ruggedness, reliability and high performance so necessary for a laboratory recorder. The unit has dynamic performance that surpasses most 2-pen recorders by offering Y-axis acceleration exceeding 6350 cm/s<sup>2</sup> (2500 in./s<sup>2</sup>). This high acceleration plus very little overshoot results in the 7046A reproducing a wide range of fast changing input signals.

A front panel polarity switch that switches pen direction, and the response switch which reduces the speed of the unit, are also available. The Autogrip paper holddown system which holds ISO A3, up to 27.9 cm x 43.2 cm (11 x 17 in.) size paper is also standard.

### 7046A Specifications

#### Performance specifications

**Input ranges:** metric calibration available in 0.25, 0.5, 2.5, 5, 25 mV/cm; 0.05, 0.25, 0.5, 2.5, 5 V/cm (0.5, 1, 5, 10, 50 mV/in.; 0.1, 0.5, 1, 5, 10 V/in.). Continuous vernier between ranges.

**Type of input:** floating and guarded, 500 V dc or peak ac maximum. Polarity reversal switch located on front panel, guard internally connected. Inputs through front panel binding posts or rear connector.

**Input resistance:** 1 megohm constant on all ranges.

**Common mode:** 110 dB dc and 90 dB at 50 Hz and above (exceed 130 dB dc and 110 dB ac under normal lab environmental conditions) with 1 kΩ between HI and LO terminals, CMV applied between ground and LO, and attenuator on most sensitive range. On other ranges, CMR decreases 20 dB per decade step in attenuation.

**Slewing speed:** Fast Response, 76 cm/s (30 in./s) minimum; Slow Response, 36 cm/s (15 in./s) typical.

**Acceleration (peak, fast response only):** Y-axis 6350 cm/s<sup>2</sup> (2500 in./s<sup>2</sup>), X-axis 3800 cm/s<sup>2</sup> (1500 in./s<sup>2</sup>).

**Accuracy:** ±0.2% of full scale (includes linearity and deadband) at 25°C. Temp Coefficient ±0.01% per °C.

**Range accuracy:** ±0.2% of full scale ±0.2% of deflection (includes linearity and deadband) at 25°C. Temp Coefficient ±0.01% per °C.

**Deadband:** 0.1% of full scale.

**Overshoot:** 1% of full scale (maximum).

**Zero set:** zero may be placed anywhere on the writing area or electrically off scale up to one full scale from zero index.

**Environmental (operating):** 0 to 55°C and <95% relative humidity (40°C).

#### General specifications

**Writing mechanism:** servo actuated ink pens.

**Writing area:** 25 cm x 38 cm (10" x 15").

**Paper holddown:** autogrip electric paper holddown grips ISO A3 or 11 in. x 17 in. Special paper not required.

**Pen lift:** electric (remote, via contact closure or TTL level).

**Dimensions:** 441 mm H x 483 mm W x 173 mm D (17<sup>3</sup>/<sub>8</sub>" x 19" x 6<sup>1</sup>/<sub>2</sub>""); rack mounting structure integral with unit.

**Power:** 115 or 230 volts ac ±10%, 48 to 400 Hz, 175 VA.

**Weight:** net, 16 kg (35 lb). Shipping, 21.4 kg (47 lb).

#### Options and accessories

007: metric calibration

001: time base

**Sweep rates:** Metric calibration is 0.25, 0.5, 2.5, 5, 25, 50 s/cm (0.5, 1, 5, 10, 50, 100 s/in.).

**Accuracy:** 1% at 25°C (Temp. Coeff. ±0.1%/°C max).

**General:** switchable to X-axis. Start and reset by front panel control, remote by momentary contact closure to ground or TTL levels. Automatic reset at full scale, recycle accomplished by continuous start signal.

002: event marker

Writes in upper margin, aligned with X-axis position of Y pen, approximately 0.12 cm (0.05 in.) excursion completed 50 ms after application of signal. Controlled remotely by contact closure to ground or by TTL levels. Contact resistance: 4 kΩ (maximum).

910: extra manual

17028A Recorder Supplies Starter Kit/English

17054A Recorder Supplies Starter Kit/Metric

7046A 2-pen, X-Y/Y, recorder

Price  
N/C  
add \$225

add \$100

add \$10

\$46

\$52

\$3270

# RECORDERS & PRINTERS

## High performance X-Y recorders

Models 7044A, 7045A, & 7047A

- High dynamic response

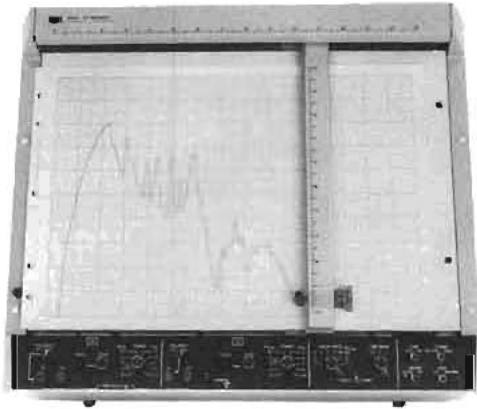

7044A

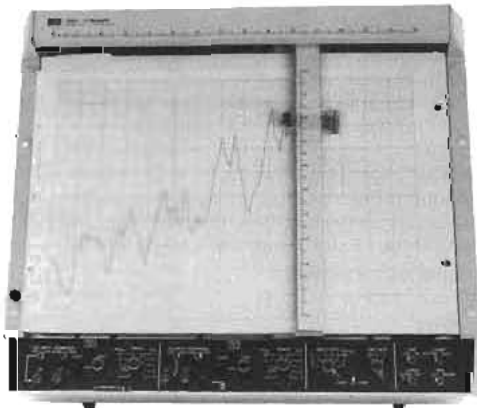

7045A

- Performs laboratory measurements

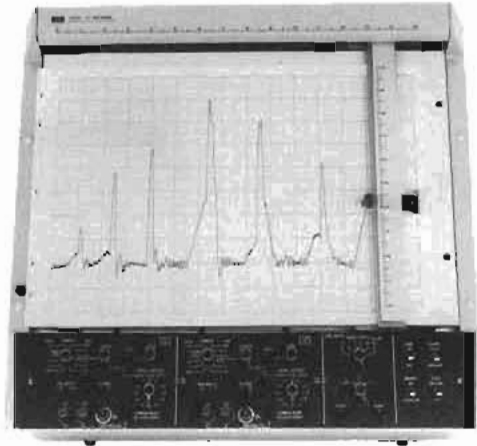

7047A

The Models 7044A, 7045A, and the 7047A are general purpose X-Y recorders specifically designed to offer the needed requirements to perform laboratory measurements. This allows for a wide range of quick-changing signals to be reproduced accurately and dependably. The 7044A is a medium-speed recorder designed for most general-purpose applications. The 7045A and 7047A offer higher speed and Y-axis acceleration exceeding  $7620 \text{ cm/s}^2$  ( $3000 \text{ in./s}^2$ ).

Other outstanding features found on the recorders include 10 calibrated dc input ranges on each axis of the 7044A and 7045A from  $0.25 \text{ mV/cm}$  to  $5 \text{ V/cm}$  ( $0.5 \text{ mV/in.}$  to  $20 \text{ V/in.}$ ) and 12 calibrated dc input ranges on each axis of the 7047A from  $0.02 \text{ mV/cm}$  to  $5 \text{ V/cm}$  ( $0.05 \text{ mV/in.}$  to  $10 \text{ V/in.}$ ). In between, a 1-5-10 sequence is used (except for the  $0.02 \text{ mV/cm}$ , most sensitive range setting of the metric option on the 7047A.) On all three, arbitrary full scale voltage ranges may be established with the vernier control in conjunction with the calibrated dc ranges.

Additionally, these recorders are equipped with front panel polarity switches which reverse pen direction, eliminating the need for reversing the input leads. The 7045A and 7047A are provided with a RESPONSE switch which allows the user to slow the response of the recorder for easier setup. The 7047A preamplifiers for the X and Y axes are contained in two specially designed aluminum enclosures. These contain chopper dc amplifiers and have the unique serviceability feature of being removable and operational outside of the mainframe, using the cable extender included in the Accessory Kit.

Also available on all models is the continuous duty, aluminum framed dc servo motor; the X-axis of the 7045A and 7047A contain the larger, faster motor. This reduces overheating and wear if the pen is driven offscale for an indefinite time. The trouble-free Autogrip electrostatic holddown platen capable of holding ISO A3 and 11 in.  $\times$  17 in. size chart paper is included, as well as a disposable pen with four color choices, and plastic coated wirewound balance potentiometer. Latest circuitry design and assembly techniques have also been incorporated, thereby reducing failure and maintenance time.

Options include the Time Base (standard on the 7047A) Event Marker and Metric Scaling, TTL Remote Control and Rear Connector are standard on all models.

### 7044A, 7045A Specifications

#### Performance specifications

**Input ranges:**  $0.25, 0.5, 2.5, 4, 25 \text{ mV/cm}; 0.05, 0.25, 0.5, 2.5, 5 \text{ V/cm}$  (English calibration available in  $0.5, 1, 5, 10, 50 \text{ mV/in.}; 0.1, 0.5, 1, 5, 10 \text{ V/in.}$ ). Continuous vernier between ranges.

**Type of Input:** floating and guarded, 500 V dc or peak ac maximum. Polarity reversal switch located on front panel, guard internally connected. Inputs through front panel 5-way binding posts or rear connector.

**Input resistance:** 1 megohm constant on all ranges.

**Common mode:** 110 dB dc and 90 dB at 50 Hz and above (exceeds 130 dB dc and 110 dB ac under normal lab environmental conditions) with 1 k $\Omega$  between HI and LO terminals. CMV applied between ground and LO, and attenuator on most sensitive range. CMR decreases 20 dB per decade step in attenuation.

**Slowing speed**

**7044A:** 50 cm/s (20 in./s) minimum.

**7045A:** Fast Response, 76 cm/s (30 in./s) minimum. Slow Response, 36 cm/s (15 in./s) typical.

**Acceleration (peak)**

**7044A:** Y-axis 2540 cm/s<sup>2</sup> (1000 in./s<sup>2</sup>). X-axis 1270 cm/s<sup>2</sup> (500 in./s<sup>2</sup>).

**7045A:** (Fast Response only) Y-axis 7620 cm/s<sup>2</sup> (3000 in./s<sup>2</sup>). X-axis 5080 cm/s<sup>2</sup> (2000 in./s<sup>2</sup>).

**Accuracy:**  $\pm 0.2\%$  of full scale (includes linearity and deadband) at 25°C. Temp Coefficient  $\pm 0.01\%$  per °C.

**Range Accuracy:**  $\pm 0.2\%$  of full scale  $\pm 0.2\%$  of deflection (includes linearity and deadband) at 25°C. Temp Coefficient  $\pm 0.01\%$  per °C.

**Deadband:** 0.1% of full scale.

**Overshoot:** 7044A—2% of full scale (maximum). 7045A—1% of full scale (maximum).

**Zero set:** zero may be placed anywhere on the writing area or electrically off scale up to one full scale from zero index.

**Environmental (operating):** 0° to 55°C and <95% relative humidity (40°C).

**General specifications**

**Writing mechanism:** servo actuated ink pen.

**Writing area:** 25 cm  $\times$  38 cm (10"  $\times$  15").

**Paper holddown:** autogrip electric paper holddown grips ISO A3 or 11 in.  $\times$  17 in. charts or smaller. Special paper not required.

**Pen lift:** electric. (Remote via TTL.)

**Dimensions:** 400 mm H, 483 mm W, 165 mm D (15 $\frac{3}{4}$ "  $\times$  19"  $\times$  6 $\frac{1}{2}$ " ); rack mounting structure integral with unit.

**Power:** 115 or 230 V ac  $\pm 10\%$ , 48 to 400 Hz; 7044A, 135 VA; 7045A, 175 VA.

**Weight:** net, 13.7 kg (30 lb). Shipping, 19.1 kg (42 lb).

**7044A & 7045A Options**

006: metric calibration

001: time base

Sweep rates: 0.25, 0.5, 2.5, 5, 25, 50 s/cm (0.5, 1, 5, 10, 50, 100 s/in.).

Time Base Accuracy: 1.0% at 25°C

Temp Coefficient  $\pm 0.1\%$  per °C

General: Switchable to either X or Y axis. Start and reset by front panel control, remote by momentary contact closure to ground or TTL levels. Automatic reset at full scale, recycle accomplished by continuous start signal.

002: event marker: writes in upper margin, aligned with X-axis position, approximately 0.13 cm (0.05 in.) excursion completed 50 ms after application of signal. Controlled remotely by contact closure to ground or by TTL levels.

**7047A Specifications**

**Performance specifications**

**Input ranges:** 0.02, 0.05, 0.1, 0.5, 1, 5 mV/cm; 0.01, 0.05, 0.1, 0.5, 1, 5 V/cm (0.05, 0.1, 0.5, 1, 5, 10 mV/in.; 0.05, 0.1, 0.5, 1, 5, 10

V/in.). Continuous vernier between ranges.

**Type of input:** floating and guarded (front input only). Employs a unique common mode driver circuit that eliminates the need for connecting CMV to the recorder if CMV is less than or equal to 10 V pk.

**Input resistance:** 1 megohm constant on all ranges.

**Accuracy:**  $\pm 0.2\%$  of full scale (includes linearity and deadband) at 25°C. Temp Coefficient  $\pm 0.01\%$  per °C.

**Range accuracy:**  $\pm 0.2\%$  of full scale  $\pm 0.2\%$  of deflection (includes linearity and deadband) at 25°C. Temp Coefficient  $\pm 0.01\%$  per °C.

**Deadband:** 0.1% of full scale.

**Common mode rejection:** 140 dB dc and 130 dB ac with 1 k $\Omega$  imbalance in either the high or low terminal (exceeds 150 dB under normal laboratory conditions.) CMR decreases 20 dB per decade step in attenuation.

**Normal mode rejection:** 30 dB minimum at line frequency with FILTER IN. (50 dB typical at 60 Hz and 40 dB typical at 50 Hz).

**Slowing speed:** 76 cm/s (30 in./s) minimum. 97 cm/s (38 in./s) typical under normal lab conditions.

**Acceleration (peak):** Y-axis 7620 cm/s<sup>2</sup> (3000 in./s<sup>2</sup>)  
X-axis 5080 cm/s<sup>2</sup> (2000 in./s<sup>2</sup>)

**Overshoot:** 1% of full scale maximum.

**Calibrated zero offset:** provides eleven scales of calibrated zero offset in both axes. Switchable in steps of one full scale from +1 to -10 scales.

**Offset accuracy:** at 25°C,  $\pm 0.1\%$  of full scale times N where N = number of scales of offset.

**Temperature coefficient:**  $\pm 0.004\%$  of full scale times N per °C.

**Time base:** speeds of 0.1, 0.5, 1, 5, 10, 50 s/cm (0.5, 1, 5, 10, 50, 100 s/in.). Switchable into X or Y axis.

**Time base accuracy:** 1.0% at 25°C. Temp Coefficient  $\pm 0.1\%$  per °C.

**General specifications**

**Writing mechanism:** servo actuated ink pen.

**Writing area:** 25 cm  $\times$  38 cm (10"  $\times$  15").

**Paper holddown:** autogrip electric paper holddown grips ISO A3 or 11 in.  $\times$  17 in. charts or smaller. Special paper not required.

**Pen lift:** electric (remote via TTL level).

**Dimensions:** 441 mm H  $\times$  483 mm W  $\times$  173 mm D (17 $\frac{1}{4}$ "  $\times$  19"  $\times$  6 $\frac{3}{4}$ " ); rack mounting structure integral with unit.

**Power:** 115 or 230 V ac  $\pm 10\%$ , 48 to 66 Hz, 180 VA maximum.

**Weight:** net, 18.6 kg (41 lb). Shipping, 24 kg (53 lb).

**7047A Options**

001: metric calibration

Ranges are 0.02, 0.05, 0.10, 0.50, 1, 5 mV/cm; 0.01, 0.05, 0.1, 0.5, 1, 5 V/cm

002: event marker

**Marking area:** in margin at same X coordinate as recorder pen

**Excursion:** approximately 0.050 inch

**Actuation time:** stroke complete 50 ms after application of signal

**Ink capacity:** 0.45 cc cartridge, cartridge reloading type. Writing distance 500 ft minimum

**Options and accessories (all models)**

910: extra manual

17026A Recorder Supplies Starter Kit—English

17027A Recorder Supplies Starter Kit—metric

**Ordering Information**

7044A Medium speed X-Y recorder

7045A High speed X-Y recorder

7047A High sensitivity X-Y recorder

Price  
N/C  
add \$225

add \$100

Price  
N/C

add \$100

add \$15

\$49

\$55

\$1875

\$2255

\$3330



# RECORDERS & PRINTERS

Digital input graphic plotters for terminal applications

Models 7202A & 7203A



7202A



7203A

The 7202A Graphic Plotter brings complete graphic capability to the computer terminal with a minimum of programming effort and software overhead. ASCII characters are utilized in a brief and concise format to represent the high resolution absolute position coordinates. Simple mnemonic commands control the plotting modes—Plotter off, plot lines, or plot points. Only a few program statements are needed to bring full graphic display to the terminal. Scale the data with a simple formula and add a single print statement to cause the four-digit integer X and Y coordinates to be printed on a line and plotted. The result is the final graph.

A 7203A brings high-speed graphic display to the computer terminal. Serial ASCII characters transmitted by the computer system are independent, single character commands to provide increased flexibility and control. Data scaling and conversion into the proper ASCII character representation is easily handled by a program subroutine. Four ASCII characters representing X and Y coordinates are transmitted by the system for each data print. Moves of any length up to the maximum plot dimension can be made at any angle. Plotter control subroutines are available for most Hewlett-Packard timeshare systems (i.e. Option 006 for HP 2000/ACCESS systems) to handle all scaling, binary code conversion and timing considerations. Merely define the range of the data and the speed of the terminal.

Convenient front panel scaling controls of the Plotters permit selection of any plot size or position on any style paper up to 11 × 17 inches. The paper is held secure by an electrostatic holddown system. Clean, convenient disposable pens are available in four colors.

#### 7202A performance specifications

**Plotting surface:** 12.7 × 12.7 cm to 25.4 × 38.1 cm (5" × 5" to 10" × 15")

**Plotting maneuvers:** plots lines or points.

**Speed:** up to 105 vector/min.

**Numerical code:** ASCII; X and Y represented by four-digit integers (separated by at least one space).

**Numerical resolution:** 1/10,000 (0.01%).

**Plot accuracy:** better than 0.076 mm (0.03").

**Resettability:** 0.18 mm (0.007") maximum.

**Data rate:** 110, 150, or 300 baud, switchable.

**Controls:** power, chart hold, terminal mute, line/local, pen down, graph limits, character/sec.

**Indicators:** power, error, plot.

**Resettability:** 0.18 mm (0.007 in.) maximum.

**Data rate:** 110, 150, or 300 baud, switchable.

**Controls:** power, chart hold, terminal mute, line/local, pen down, graph limits, character/sec.

**Indicators:** EIA RS232C or 20 mA current loop, select configuration option desired. Other interface configurations available. Contact factory.

**Move length:** 76.2 mm (3") max. with pen down; 254 mm (10") max. with pen up.

**Power requirements:** 115/230 V ac, 48 to 400 Hz, 100 VA.

#### 7203A performance specifications

**Plotting surface:** front panel scalable up to 25.4 × 38.1 cm (10" × 15" to 10" × 15").

**Plotting maneuvers:** pen or position. Pen and position maneuvers are independent commands.

**Speed:** up to 450 vectors per minute.

**Numerical code:** binary; X and Y represented by ASCII character pairs.

**Numerical resolution:** 1/2500 (0.04%).

**Plot accuracy:** better than 0.10 mm (0.04").

**Resettability:** 0.18 mm (0.007") maximum.

**Controls:** power, chart hold, mute, line/local, pen up, pen down, graph limits, character/sec.

**Indicators:** power, error, plot.

**Data rate:** 110 or 300 baud, switchable.

**Interface:** EIA RS232C.

**Move length:** any length at any angle with appropriate software subroutine.

**Power requirements:** 100, 115, 200, or 230 V ± 10%, 48 to 66 Hz, 100 VA maximum.

#### 7202A and 7203A general specifications

**Paper size:** any size up to 29.9 × 43.2 cm (11" × 17").

**Writing method:** ink, disposable pens.

**Dimensions:** 216 mm H × 508 mm W × 511 mm D (8 1/2" × 20" × 20 1/4").

**Weight:** 18.1 kg (40 lb); shipping 23.6 kg (52 lb).

#### Options

001: EIA RS232 MODEM interface

Price

N/C

003: EIA RS232 terminal interface

N/C

004: ASR33

N/C

908: Extra manual

add \$13.50

#### For 7203A

001: EIA RS232 MODI-M interface

N/C

002: EIA RS232 terminal interface

N/C

005: Software SUBROUTINE for HP 2000C/1

add \$20

006: Software SUBROUTINE for HP 2000 ACCESS and HP 3000

add \$20

910: Extra manual

add \$24

#### Accessories:

17026A Recorder Supplies Starter Kit—English

\$49

17027A Recorder Supplies Starter Kit—Metric

\$55

#### Ordering information

7202A Graphic Plotter (must order Opt 001, 003, or 004) \$4100

7203A Graphic Plotter (must order Opt 001 or 002) \$4100



# RECORDERS & PRINTERS

## Graphic plotter for computer applications



Model 7210A

- High speed, high resolution graphics
- Built-in vector generator
- Absolute or relative coordinates

- Versatile "handshake" interface
- Accepts binary or BCD codes



7210A

The Hewlett-Packard Model 7210A Digital Plotter is an output peripheral designed for use with computers and computer systems. The exceptional speed, resolution, and accuracy are available at the low cost normally associated with analog plotters, yet the 7210A does not require the higher system overhead of incremental plotters.

It can be added easily to either your computer or terminal. Accepting either Binary or BCD codes under full program control, the pen can make up to 20 moves per second at any angle. The internal microprocessor allows typical operation with less than 250 16-bit words of computer memory.

Any sheet type graph paper, up to 27.9 × 43.2 cm (11" × 17"), with or without preprinted grids, may be used. The Autogrip paper hold-down system solidly grips the paper. Four colors of ink are available in clean, disposable pens that can be changed quickly and easily.

### 7210A Specifications

**Plotting surface:** 25.4 × 38.1 cm (10" × 15").

**Plotting area:** front panel scalable up to 25.4 × 38.1 cm (0" × 0" to 10" × 15").

**Plotting maneuvers:** pen or position. Pen and position maneuvers are independent commands.

**Vector generation:** automatic. A command to perform a position maneuver will cause the Plotter to traverse a straight line path to any specified point on the platen.

**Vector length:** limited only by the plotting surface.

**Vector speed:** up to 30.5 cm/sec (12 in./second). The speed is dependent upon the slope of the line. Plotter will process up to 20 vectors/second.

**Numerical code:** position data is received in BCD (8421) or Binary.

**Plotting modes:** absolute coordinates and relative coordinates.

**Numerical resolution:** 1/10 000 (0.01%).

**Plot accuracy:** better than 0.10 cm (0.04") in 38.1 cm (15").

**Resettability:** 0.18 mm (0.007") max.

**Writing method:** ink, disposable pens. Four colors available.

**Paper size:** any size up to 27.9 × 43.2 cm (11" × 17").

**Power:** 100 V, 115 V, 200 V, or 230 V ± 10% (choice of 4 positions at rear panel), 48 to 66 Hz., 100 watts maximum.

**Weight:** net, 18.1 kg (40 lbs.). Shipping 23.6 kg (52 lb.).

### Accessories supplied

	HP Part Number
1. Accessory Kit	07210-80010
1 Pkg Disposable Pens, Red (5)	5081-1190
1 Pkg Disposable Pens, Blue (5)	5081-1191
1 Pkg Disposable Pens, Black (5)	5081-1193
1 Slidewire Cleaner	5080-3605
1 Fuse for (for 230 V operation)	2110-0080

2. Operating Manual	07210-90000
3. Interface Manual	07210-90002
4. Mating Connector	
1 50-Pin Connector	1251-2771
1 Hood	1251-2769
2 Jackscrews	1251-2770
5. Dust Cover	4040-0477
6. Graph Paper, 20 sheets (English)	9270-1004
7. Graph Paper, 20 sheets (Metric)	9270-1024
8. Power Cord 2.3 m (7.5 ft)	8120-1348

### Supplies available

	HP Part Number
Disposable Pens (package of 5)	
Red	5081-1190
Blue	5081-1191
Green	5081-1192
Black	5081-1193

Graph Paper (box of 100 sheets)	Plot Area	HP Part Number
Linear	25 cm × 38 cm	9270-1024
Linear	10 in. × 15 in.	9270-1004
Linear	18 cm × 25 cm	9270-1023
Linear	7 in. × 10 in.	9270-1006
Semi-Log	10 in. × 2 cycle	9280-0159
Semi-Log	10 in. × 3 cycle	9280-0160
Semi-Log	2 cycle × 15 in.	9280-0169
Semi-Log	3 cycle × 15 in.	9280-0168
Log-Log	2 cycle × 3 cycle	9280-0167
Log-Log	3 cycle × 2 cycle	9280-0165
Log-Log	3 cycle × 4 cycle	9280-0171
Blank (with scaling points)	10 in. × 15 in.	9280-0180

### Accessories available

	Price
17260A plotter stand (includes mounting plate)	\$110
17261A mounting plate	\$20
17026A Recorder Supplies Starter Kit—English	\$49
17027A Recorder Supplies Starter Kit—Metric	\$55
Carrying/transit case (p/n 9211-1377)	\$226

### Options

001: interface to HP 2100 and 21MX Series Computer, includes all hardware and software.	add \$860
910: Extra manual.	add \$27

7210 Digital Plotter **\$3750**

OEM discounts available.

# RECORDERS & PRINTERS

## Programmable 4-color remote terminal plotter

Model 7221A

- RS232C/CCITT V.24 Interface
- Programmable selection of 4 pens
- Arc and circle generation



The HP 7221A is a microprocessor controlled plotter (ISO A3 size) that produces low cost, multicolor, high quality graphic plots from remote terminal processing facilities. The standard EIA RS232C/CCITT V.24 asynchronous serial ASCII interface operates at any of eight switch selectable baud rates from 75 to 2400 BAUD. Internal arc, circle, dashed lines and character generation capability combine with 40 high level commands to provide simplified programming. An 1150 byte input data buffer, optionally expandable to 3086 bytes, allows operation at higher speeds. Up to 64 macroinstructions may be defined and stored in the data buffer. Internal self test and confidence test capability verifies correct plotter and interface circuitry operation.

HP-Plot/21, a library of high level Fortran subroutines available for HP computer systems and major timeshare services, provides all data formatting and communications. The user accesses all of the plotter's capability through familiar program call statements.

### 7221A Specifications

**Plotting area:** Y-axis 280 mm (11"), X-axis 400 mm (15.75"). Accommodates up to ISO A3 and 280 × 432 mm (11" × 17") chart paper.

**Plotting accuracy:** ±0.2% of deflection ±0.2 mm (0.008").

**Repeatability:** for given pen 0.10 mm (0.004"), pen-to-pen 0.20 mm (0.008").

**Addressable resolution:** smallest addressable move 0.25 mm (0.001").

**Speed:** maximum: 360 mm/s (14 in/s) in each axis, 509 mm/s (20 in/s) on 45° angle; programmable: pen speed may be adjusted to any one of 36 speeds from 10 mm/s (0.4 in/s) to 360 mm/s (14 in/s) in 10 mm/s (0.4 in/s) increments under program control.

**Vector length:** no limit—any length vector within plotter's mechanical limits will be plotted to within previously mentioned accuracy.

**Offscale plotting:** when offscale data received by plotter, automatically calculates intercept of that vector and currently defined plotting area and proceeds to that point. As additional offscale data received, plotter monitors location of this data and resumes plotting once onscale data received by again calculating new intercept with defined plotting area then plotting from that intercept to on-scale data point. Plotting accuracy and repeatability specifications are preserved.

**Character plotting speed:** 3 characters/s typically for 2.5 mm (0.01 in.) characters.

**Pen control:** remote control by program commands; local control by front panel switches; capable of up to 20 operations/s. Local control provides vector rates of 4.2 mm/s (slow) and 932 mm/s (fast) (0.167 ips and 3.67 ips).

**Power requirements:** source 100 V, 120 V, 220 V, 240 V - 10% +5%, switch selectable, 240 W maximum.

**Environmental range:** temperature 0°C to 55°C; relative humidity 5% to 95% (below 40°C).

**Size:** 189 H × 497 W × 455 mm D (7.5" × 19.5" × 18").

**Weight:** net 18.2 kg (40 lb). Shipping 25.4 kg (56 lb).

**Interface:** standard RS-232C/CCITT V.24 asynchronous serial ASCII with switch selectable baud rates of 75, 110, 150, 200, 300, 600, 1200, or 2400 baud.

### Accessories supplied

	HP Part Number
1. Accessory kit	09872-60070
4 Pkgs Disposable Pens (4-color pack, one of each red, blue, green, black)	5060-6810
1 Digitizing Sight	09872-60027
2. Operating and Programming Manual	07221-90001
3. Dust Cover	9222-0564
4. Power Cord (appropriate cord supplied)	-
5. Male-to-Male Interface Cable RS-232C/CCITT V.24	07221-60157
6. Graph Paper, Standard Grid, English, 10 Sheets	9270-1004
7. Graph Paper, Standard Grid, Metric 10 Sheets	9270-1024

### Supplies available

Disposable Pens (package of 5)		
Red		5060-6784
Blue		5060-6785
Green		5060-6786
Black		5060-6787
4-color Pack, one each of red, blue, green black		5060-6810
Graph Paper (box of 10 sheets)		
Linear	25 cm × 38 cm	9270-1024
	10 in × 15 in.	9270-1004
	18 cm × 25 cm	9270-1023
	7 in. × 10 in.	9270-1006
Semi-Log	10 in. × 2 cycle	9280-0159
	10 in. × 3 cycle	9280-0160
	2 cycle × 15 in.	9280-0169
	3 cycle × 15 in.	9280-0168
Log-Log	2 cycle × 3 cycle	9280-0167
	3 cycle × 2 cycle	9280-0165
	3 cycle × 4 cycle	9280-0171
Blank	10 in. × 15 in.	9280-0180
Smith Chart (box of 50)	7.25 in. Diameter	9280-0137
	7.15 in. Diameter Expanded	9280-0147

### Manuals

Operating and Service Manual	07221-90000
HP-PLOT/21 Software Manual	07221-90002

Software available: HP-PLOT/21 GRAPHIC PACKAGE consists of user's manual, loading instructions and set of 86 FORTRAN subroutines (in source form) on 9-track magnetic tape.

	Price
72021A Graphics Package	\$50
<b>Specify Option:</b>	
001: HP 3000 Series II (800 bpi, ASCII)	N/C
002: HP 3000 Series II (1600 bpi, ASCII)	N/C
003: GE Mark III Timeshare (1600 bpi, EBCDIC)	N/C
004: Timeshare X (DEC PDP-10, 800 bpi, ASCII)	N/C

### Options

001: Additional 2048 bytes of input	\$225
-------------------------------------	-------

### 7221A Graphic Plotter

\$4600

## Programmable 4-color plotting for system applications

**Model 9872A**

- Programmable selection of 4 pens
- HP-IB interface
- Error free offscale data handling
- 38 executable commands

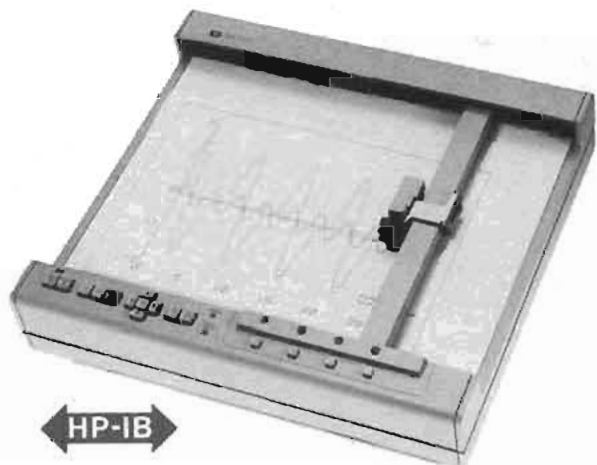

**Character plotting speed:** 3 characters/s typically for 2.5 mm (0.01 in.) characters.

**Pen control:** local control by front panel switches or remote control by desk top computer program commands; capable of >20 operations/s.

**Power requirements:** source 100 V, 120V, 220 V, 240 V – 10% +5%, switch selectable. 240 W max.

**Environmental range:** temperature 0°C to 55°C; relative humidity 5% to 95% (below 40°C).

**Size:** 189 H × 497 W × 455 mm D (7.5" × 19.5" × 18").

**Weight:** net 18.2 kg (40 lb); shipping 25.4 kg (56 lb).

Accessories supplied	HP Part Number
1. Accessory Kit	09872-60070
4 Pkgs Disposable Pens (4-color pack, one of each, red, blue, green black)	5060-6810
1 Digitizing Sight	09872-60027
2. Operating and Service Manual	09872-90002
3. Dust Cover	9222-0564
4. Power Cord (appropriate cord supplied)	- -
5. Graph Paper, Standard Grid, English, 10 Sheets	9270-1004
6. Graph Paper, Standard Grid, Metric, 10 Sheets	9270-1024

### Supplies available

Disposable Pens (package of 5)	
Red	5060-6784
Blue	5060-6785
Green	5060-6786
Black	5060-6787

### Graph Paper (box of 100 sheets)

Linear	25 cm × 38 cm	9270-1024
	10 in × 15 in.	9270-1004
	18 cm × 25 cm	9270-1023
	7 in. × 10 in.	9270-1006
Semi-Log	10 in. × 2 cycle	9280-0159
	10 in. × 3 cycle	9280-0160
	2 cycle × 15 in.	9280-0169
	3 cycle × 15 in.	9280-0168
Log-Log	2 cycle × 3 cycle	9280-0167
	3 cycle × 2 cycle	9280-0165
	3 cycle × 4 cycle	9280-0171
Blank	10 in. × 15 in.	9280-0180
Carrying Case		1540-0483
HP-IB card for use with 9825A and 9831A		98034A

Cables: If using multiple HP-IB instruments order one of the following:

10631A HP-IB Cable	1 m (3.23 ft)
10631B HP-IB Cable	2 m (6.56 ft)
10631C HP-IB Cable	4 m (13.12 ft)
10631D HP-IB Cable	0.5 (1.64 ft)

Manual  
Interface and Programming Manual 09872-90003

ROMS available

9825A ROMS: 98215A (for 9872A) Plotter General I/O ROM  
98216A (for 9872A) Plotter General I/O-Extended I/O ROM

9831A ROM: 98223B Matrix-Plotter ROM

Options	Price
015: for use with 9815A (includes interface cable with ROM)	\$400
025: for use with 9825A (98034A HP-IB Card not supplied)	NC
031: for use with 9831A (9831A HP-IB Card not supplied)	NC

9872A Graphic Plotter \$4200

The Hewlett-Packard Model 9872A is a microprocessor-based HP-IB plotter that produces high quality, multicolor graphic plots on any size chart up to 280 mm × 432 mm (ISO A3). The 9872A offers exceptional line and character quality with addressable moves as small as 0.025 mm (0.001 in.). Thirty-eight different instructions are built in to equip the Plotter with capabilities, such as point digitizing, labeling, character sizing, and window plotting. The 9872A, interfaced through the Hewlett-Packard Interface Bus (conforms to IEEE 488-1975), connects to any HP-IB compatible calculator, computer, or other controller.

This Plotter is designed to be useful in statistics, medicine, numerical control, surveying, and engineering design. Whether tabulated, measured, or computed, the 9872A quickly prepares multicolor plots of good line quality and high resolution.

### 9872A Specifications

**Plotting area:** Y-axis 280 mm (11"), X-axis 400 mm (15.75") accommodates up to ISO A3 and 280 mm × 432 mm (11" × 17") chart paper.

**Plotting accuracy:** ±0.2% of deflection ±0.2 mm (0.008").

**Repeatability:** for given pen 0.10, (0.004"), pen-to-pen 0.20 mm (0.008").

**Addressable resolution:** smallest addressable move 0.025 mm (0.001").

**Speed:** maximum: 360 mm/s (14 in/s) in each axis, 509 mm/s (20 in/s) on 45° angle; programmable: pen speed may be adjusted to any one of 36 speeds from 10 mm/s (0.4 in/s) to 360 mm/s (14 in/s) in 10 mm/s (0.4 in./s) increments under program control.

**Vector length:** no limit— any length vector within plotter's mechanical limits will be plotted to within previously mentioned accuracy.

**Offscale plotting:** when offscale data received by plotter, automatically calculates mechanical limit intercept of that vector and proceeds to that point. As additional offscale data received, plotter monitors location of this data and resumes plotting, once on-scale data received, by again calculating new mechanical limit intercept and plotting from that limit to on-scale data point. Plotting accuracy and repeatability specifications are preserved.

# RECORDERS & PRINTERS

## Compact strip chart recorder

Model 680

- Multi-range—Compact

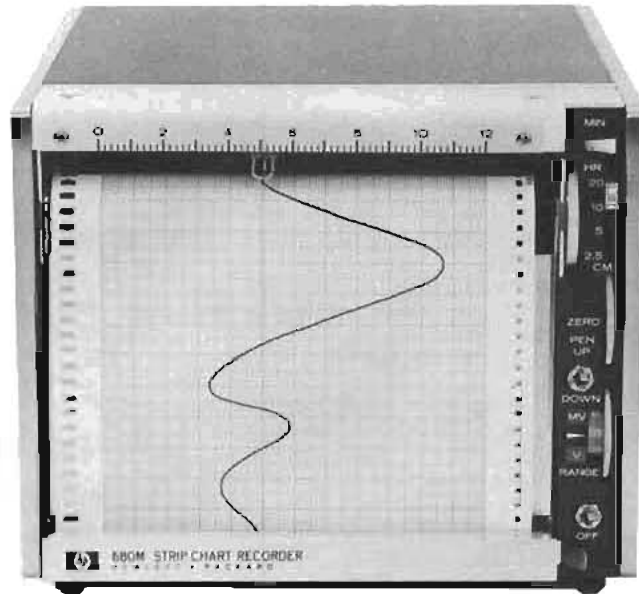

680M

The Hewlett-Packard Model 680 (2 cm (5 in.) strip chart recorders provide high accuracy and fast response for a wide range of performance for general or specialized use. The 680 is equipped with multirange spans, multispeed chart transport, full range zero set, and electric pen lift. Model 680 is useful as a monitor for instrumentation with dc outputs and for digital devices utilizing digital to analog converters.

Features include modular construction with all-transistor circuitry, synchronous motor chart drive, and full-view tilting chart magazine.

### 680 Specifications

#### Performance specifications

**Spans:** ten calibrated spans; Metric—6, 12, 60, 120, 600 mV; 1.2, 6, 12, 60, 120 V (English—5, 10, 50, 100, 500 mV; 1, 5, 10, 50, 100 V).

**Type of input:** input floating with respect to ground.

**Maximum dc common mode voltage:** 500 V.

**Input resistance:** 200 k $\Omega$ /V (166 k $\Omega$ /V, metric models) full scale, through 10 V span; 2 M $\Omega$  on all others. Constant 100 k $\Omega$  input resistance on all spans, Option H02.

**Common mode rejection:** dc 100 dB on most sensitive range. Decreases 20 dB per decade step in attenuation.

**Accuracy:**  $\pm 0.2\%$  of full scale.

**Response time:** maximum, 0.5 s full scale.

**Resetability:** 0.1% of full scale.

**Chart speed:** synchronous motor driver; Metric—2.5, 5, 10, 20 cm/min; 2.5, 5, 10, 20 cm/hr (English—1, 2, 4, 8 in./min; 1, 2, 4, 8 in./hr). Option 008, gear ratio 16/1 instead of 60/1 speeds— $1/16$ ,  $1/8$ ,  $1/4$ ,  $1/2$ , 1, 2, 4, 8 in./min.

**Zero set:** adjustable over full span.

#### General specifications

**Writing mechanism:** ink.

**Pen lift:** electric, controlled by local switch or remote contact closure.

**Power:** 115/230 V, 60 Hz, 22 VA.

- High accuracy, fast response

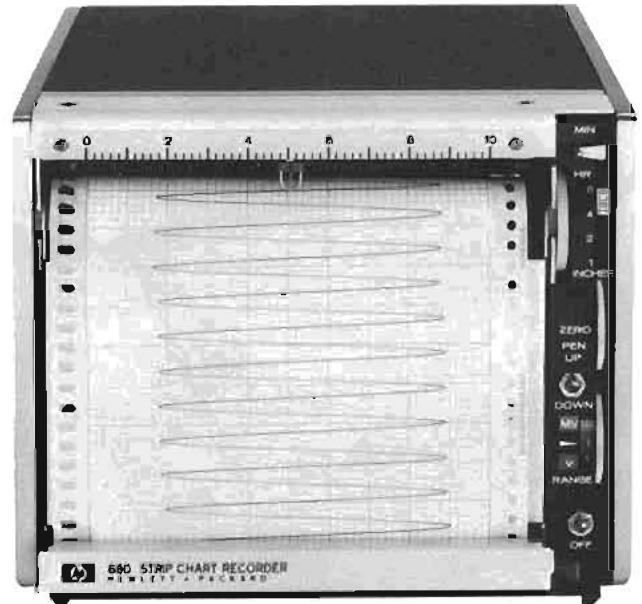

680

**Weight:** net, 5 kg (11 lb); shipping 7.6 kg (17 lb).

**Dimensions:** 165 H  $\times$  197 W  $\times$  219 mm D (6 $\frac{1}{2}$ "  $\times$  7 $\frac{3}{4}$ "  $\times$  8 $\frac{5}{8}$ ").

#### Accessory kit supplied with each instrument—

##### Ink Writing:

1. Slidewire, cleaner, slidewire lubricant, remote pen lift connector, spare pen; pen cleaning wire, syringe, four cartridges each of red ink and blue ink.
2. One roll of graph paper.
3. Power Cord 2.1 m (7 ft).
4. Instruction Manual.
5. *Your Strip Chart Recorder*—a brief manual.

#### Options and accessories

**001:** with installed 5 k $\Omega$ , 0.1% linearity retransmitting potentiometer

add \$100

**002:** with ink event marker installed

add \$75

**003:** with installed high-low limit switches

add \$150

**008:** with 16/1 instead of 60/1 speed reducer

add \$50

**009:** with remote chart drive switch

add \$40

**010:** For 50 Hz operation

N/C

**014:** glass door with lock

add \$150

**018:** disposable pen tips

N/C

**910:** extra manual

add \$10

**H01:** 1 mV span added (H01-680)

add \$70

1.2 mV span added (H01-680M)

add \$70

**H02:** 100 k $\Omega$  input resistance, all spans

add \$100

Note: options H01 and H02 not compatible.

#### Recorder supplies starter kits

17046A English

\$33

17047A Metric

\$38

#### Ordering Information

680M Strip chart recorder (metric)

\$1250

680 Strip chart recorder (English)

\$1250

OEM discounts available



- Modular design
- Low silhouette



7123A



7143A

The Hewlett-Packard Models 7123A and 7143A Strip Chart Recorders are designed specifically for dedicated recording applications. High reliability, excellent performance, plus a large assortment of options allow custom tailoring to each application. These 3 1/2-inch high recorders conserve rack space without sacrificing chart capabilities.

### 7123A and 7143A Specifications

#### Performance specifications

**Input ranges:** single span, 1 mV thru 100 V (specified by option).

**Type of input:** single ended, floating.

**Input resistance:** 1 MΩ constant on all spans.

**Normal mode rejection (at line frequency):** >6 dB (>66 dB with optional filter).

**Common mode rejection:** >100 dB at dc; >60 dB at line frequency.

**Response time:** < 1/8 s (< 1/2 s for spans below 1 V) with less than 10 kΩ source impedance.

**Overshoot:** < 1% of full scale.

**Accuracy (including linearity and deadband):** 7123A ±0.25% of full scale at 25°C. Temp Coeff 0.01%/°C; 7143A ±0.4% of full scale at 25°C. Temp Coeff 0.01%/°C.

**Deadband:** 7123 — 0.1% of full scale; 7143A — 0.2% of full scale.

**Zero drift:** < ±0.2 μV/°C ±0.03% full scale/°C for 7143A; ±0.015% full scale/°C for 7123A.

**Reference stability:** ±0.002%/°C.

**Chart speeds:** speed determined by option choice.

**Chart speed accuracy:** synchronous with line frequency.

**Zero set:** left hand, adjustable ±1 full scale (right hand optional).

**Environmental (operating):** 0° to 55°C; 95% relative humidity (40°C).

#### General specifications

**Writing mechanism:** disposable ink pen.

**Grid width:** 7123A — 25 cm (10 in.); 7143A — 12 cm (5 in.).

**Chart length:** 28.5 metres (95 ft).

**Pen lift:** manual (remote optional on 7123A).

**Size:** 7123 — 81 H × 432 W × 495 mm D (3 1/2" × 17" × 19 1/4"); 7143 — 81 H × 216 W × 495 mm D (3 1/2" × 8 1/2" × 19 1/4").

**Power:** 115/230 V ±10%. Option 060 — 60 Hz, 60 VA; Option 050 — 50 Hz, 60 VA.

**Weight:** 7123A — net, 19 kg (42 lb). Shipping, 23 kg (51 lb). 7143A — net, 11.3 kg (25 lb). Shipping, 15 kg (33 lb).

#### Options

**Span:** Must specify one. Front scale determined by Metric or English chart speed.

7123A, 7143A	Span	Price	7123A, 7143A	Span	Price
001	1 mV	\$225	008	1 V	\$50
002	5 mV	\$225	009	5 V	\$50
003	10 mV	\$150	010	10 V	\$50
004	50 mV	\$150	011	50 V	\$50
005	100 mV	\$150	012	100 V	\$50
006	500 mV	\$150			

**Chart speeds:** Must specify one basic speed or one basic chart speed and one reducer or one multiple speed.

016	6 in./min	\$25	022	15 cm/min	\$25
017	4 in./min	\$25	023	10 cm/min	\$25
018	1 in./min	\$25	024	5 cm/min	\$25
019	1/2 in./min	\$25	025	3 cm/min	\$25
020	1/4 in./min	\$25	026	15 cm/hr	\$25
021	1 in./hr	\$25	027	3 cm/hr	\$25

**Variable speed options:** dual speed with speed reducer (not compatible with Options 045, 048, 092).

028:	60:1 Speed reducer*	\$50
029:	10:1 Speed reducer*	\$50
030:	4:1 Speed reducer*	\$50
044:	2:1 Speed reducer*	\$50

\*The slowest speed must not be less than 2.54 cm (1 in./hr).

#### Options requiring power supply

Options	Price
041: Option power supply	\$75
031: Remote speed change	\$50
032: Remote chart on-off (not compatible with Opt 045 & 048)	\$50
033: Remote pen lift (7123A Only)	\$75
040: Limit switches	\$225
034: Event marker (right hand) ink	\$75

#### Multiple speeds (7123A only)

045: 4 speeds; 1/4, 1/2, 1, 2 in./min plus external input	\$225
048: 4 speeds; 0.5, 1, 2.5, 5 cm/min plus external input	\$225

#### Other options and accessories

039: Retracting potentiometer (5 kΩ, ±0.5% linearity, 10 V dc max).	\$75
007: Input filter, 1 mV thru 5 mV spans	\$100
013: Input filter, 10 mV thru 100 V spans	\$50
014: RH Zero hard right (scale, 10 to 0)	N/C
015: RH Zero soft (scale, 10 to -0.5, 7123 only)	N/C
043: Rack slides (7123 only)	\$100
035: Chart integrator (7123 only)	\$850

**Analytical option combinations.** (7123A only). The following three options are for analytical applications such as chromatography and include 1 mV span, input filter for added line frequency rejection (60 dB), right hand zero, mini-gray control panels, and chart speeds as indicated.

090: 1/2 and 1/4 in./min	\$425
091: 1 and 1/2 in./min	\$425
092: 1/4, 1/2, 1, 2 in./min plus external input (not compatible with Options 028, 029, 030, 031, 032, 044)	\$635
908: Rack mount kit (7123 only)	\$15
910: Extra manual	\$15

#### Ordering information

7123A Strip Chart Recorder (25 cm or 10 in.)	\$1150
7143A Strip Chart Recorder (12 cm or 5 in.)	\$980

# RECORDERS & PRINTERS

Lab strip chart recorders, plug-in modules

Models 7100B, 7101B, 17500A thru 17506A

- One and two pen mainframes
- Seven plug-in modules

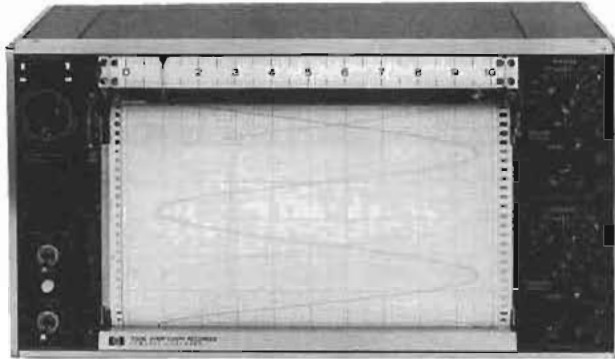

7100B

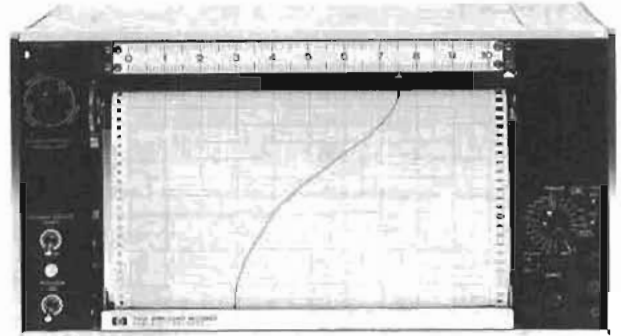

7101B



17500A



17501A



17502A



17506A



17506A

The Hewlett-Packard Models 7100B and 7101B Strip Chart Recorders are basic recorder frames containing all the mechanical and electrical elements for strip chart recording. A wide line of interchangeable plug-ins complete their recording ability. Model 7100B has two independent pens and requires two input modules; Model 7101B is a single pen recorder and requires one input module.

## 7100 Series specifications

### Performance specifications

**Response time:** <0.5s (50 Hz), <0.6 s.

**Linearity (terminal based):**  $\pm 0.1\%$  full scale.

**Resetability:**  $\pm 0.1\%$  full scale.

### Chart Speeds

**7100BM/7101BM:** 2.5, 5, 15, 30 cm/h; 1.25, 2.5, 5, 15, 30 cm/min; 1.25, 2.5, 5 cm/s.

**7100B/7101B:** 1, 2, in./h; 0.1, 0.2, 0.5, 1, 2 in./min; 0.1, 0.2, 0.5, 1, 2 in./s.

**Chart speed accuracy:** synchronous with line frequency.

### General specifications

**Writing system:** servo actuated ink pen.

**Grid width:** 25 cm or 10 in.

**Chart length:** 36 m or 120 ft.

**Pen lift:** manual (remote optional).

**Power** 115/230 V  $\pm 10\%$ , 60 Hz (50 Hz optional)

**7100B:** 65 VA; **7101B:** 42 VA.

### Weight

**7100B:** net, 11.8 kg (26 lb). Shipping, 18.2 kg (40 lb).

**7101B:** net, 10.9 kg (24 lb). Shipping, 17.3 kg (38 lb).

### Dimensions

**7100B/7101B series (cabinet):** 304 mm H, 445 mm W, 210 mm D (12"  $\times$  17 $\frac{1}{2}$ "  $\times$  8 $\frac{1}{4}$ ").

**7100B/7101B (rack):** 222 mm H, 483 mm W, 210 mm D (8 $\frac{23}{32}$ "  $\times$  19"  $\times$  8 $\frac{1}{4}$ ").

### 17500A/17501A Specifications

#### Voltage spans

**17500A:** 5, 10, 50, 100, 500 mV; 1, 5, 10, 50, 100 V full scale.

**17501A:** 1, 2, 5, 10, 20, 50, 100, 200 mV; 0.5, 1, 2, 5, 10, 20, 50, 100 V full scale.

**Accuracy:**  $\pm 0.2\%$  of full scale.

**Input resistance:** 1 megohm at null on all fixed calibrated and variable spans except 100 k $\Omega$  in the variable mode on the four most sensitive spans on the 17500A only.

**Interference rejection:** dc common mode; 120 dB on the four most sensitive spans of the 17500A and the three most sensitive of the 17501A. Line frequency, 100 dB on the four most sensitive spans of 17500A and the three most sensitive of 17501A.

**Zero-set:** adj. full scale, plus one full scale of suppression. 5 scales of zero suppression available on the 17501A.

**Maximum source impedance:** up to 10 k $\Omega$  source impedance will not alter the recorder's performance on the four most sensitive spans of the 17500A and the six most sensitive of the 17501A. No source impedance restrictions on spans above 100 mV full scale.

### 7100 Series options

Option descriptions	7100B 7101B	Price
Retransmitting 5 k $\Omega$ Potentiometer	Channel 1 Channel 2	004 \$75 016 \$75
High-Low Limit Switches (Each Limit SPDT with 0.5 A, 30 V dc contacts)	Channel 1 Channel 2 Both Channels	005 \$75 017 \$75 018 \$150
Event Marker	Left side: ink Both sides: ink	012 \$50 014 \$100
Remote Control	Pen Lift Chart ON-OFF	006 \$75 007 \$40
Right Hand Zero 50 Hz Operation	Hard (scale, 10 to 0) Soft (scale, 10 to -0.5) <sup>1,2</sup>	020 N/C 025 N/C 010 N/C
Locking Glass Door		011 \$175
Integrator (Integrates Channel 2 if 2 pen unit) <sup>1,2</sup>		015 \$1050
Disposable Pen Tips		024 N/C
Mint Gray Control Panel		029 N/C
Rack mount		908 \$ 20
Extra manual		910 \$ 10

1. Not compatible with event marker (right hand), retransmitting potentiometer (Channel 2), or metric calibration.
2. Requires special Hewlett-Packard chart paper.
3. Not compatible with metric models.

**Reference stability:** 0.005%/°C.

**Weight:** net, 0.9 kg (2 lb). Shipping, 2.2 kg (5 lb).

#### 17502A Specifications

**Voltage spans:** single span to match cold-junction thermocouples of types J, K, R, S, and T.

**Accuracy:**  $\pm 0.5\%$  or  $\pm 1^\circ\text{C}$ , (whichever is greater); refer to NBS CIR 561, dated 1955.

**Input resistance:** potentiometric.

**Interference rejection:** dc common mode, 120 dB; line frequency, 100 dB.

**Weight:** net, 1.8 kg (4 lb). Shipping, 3.2 kg (7 lb).

#### 17503A Specifications

**Voltage span:** 1 mV.

**Type of input:** floating (500 V dc max) rear input only.

**Input resistance:** potentiometric.

**Maximum allowable source resistance:** 5 k $\Omega$ .

**Normal mode rejection:** >60 dB at 60 Hz.

**Common mode rejection:** 120 dB (dc) and 100 dB (60 Hz).

**Accuracy:**  $\pm 0.2\%$  full scale.

**Reference stability:** 0.005%/°C.

**Zero set:**  $\pm 1$  scale.

**Weight:** net 0.9 kg (2 lb). Shipping, 2.2 kg (5 lb).

#### 17504A Specifications

**Voltage spans:** 5 mV thru 100 V, determined by range card, no vernier.

**Type of input:** floating (500 V dc max) rear input only.

**Input resistance:** 1 M $\Omega$  at null on all spans.

**Maximum allowable source resistance:** 10 k $\Omega$ .

**Normal mode rejection:** >60 dB at 60 Hz.

**Common mode rejection:** 120 dB (dc) and 90 dB (60 Hz) (four most sensitive range cards).

**Accuracy:**  $\pm 0.2\%$  full scale.

**Reference stability:** 0.005%/°C.

**Zero set:**  $\pm 1$  scale, screwdriver adjust.

**Weight:** net, 0.9 kg (2 lb). Shipping, 2.2 kg (5 lb).

#### 17505A/17506A Specifications

**Voltage spans**

**17505A:** .1, .2, .5, 1, 2, 5, 10, 20, 50, 100, 200, 500 mV; 1, 2, 5, 10, 20, 50, 100 V full scale.

**17506A:** any one of the above spans (specify).

**Accuracy:**  $\pm 0.25\%$  of full scale.

**Input resistance:** 1 M $\Omega$  at null.

**Interference rejection:** dc CMR: 120 dB on most sensitive span. Line frequency CMR: 100 dB on most sensitive span. Line frequency normal mode: 17505A: switchable, 60 dB or 100 dB. 17506A: 100 dB.

**Zero set:** +2, -1.5 scales. Optional calibrated offset of +1 to -10 scales in one scale steps on 17505A.

**Zero stability:**  $\pm 1 \mu\text{V}$  after one hour.

**Maximum source impedance:** 10 k $\Omega$  on nine most sensitive spans; no source impedance restrictions on spans above 100 mV full scale.

**Reference stability:** 0.005%/°C.

**Weight:** net, 0.9 kg (2 lb). Shipping, 2.2 kg (5 lb).

#### Plug-In options

##### 17500A/17501A/17502A

**001:** 5 scale zero suppression (17501A) add \$55

**002:** calibrated for use with Integrator (8 in. span) N/C  
(17500A/17501A)

**029:** mint gray control panel N/C

**910:** extra manual add \$5

##### 17503A

**001:** detector Selector Switch \$25

**002:** 50 Hz N/C

**003:** calibrated for use with Integrator (8 in. span) N/C

**029:** mint gray control panel N/C

**910:** extra manual add \$5

##### 17504A

**001:** 50 Hz N/C

**002:** calibrated for use with Integrator (8 in. span) N/C

**010-019:** range cards (specify opt) N/C

##### 17505A

**001:** +1 to -10 scales of calibrated offset in one scale steps. Accuracy  $\pm 0.25\%$  per step add \$115

**002:** calibrated for use with Integrator (8 in. span) N/C

**003:** 50 Hz N/C

**029:** mint gray control panel N/C

**910:** extra manual add \$5

##### 17506A

**002:** calibrated for use with Integrator (8 in. span) N/C

**003:** 50 Hz N/C

**005-023:** spans (specify one) N/C

**029:** mint gray control panel N/C

**910:** extra manual add \$5

#### Recorder Supplies starter kits

17029A—English \$43

17030A—Metric \$46

#### Ordering information

##### Single Channel

7101B, 7101BM Strip chart recorder \$1450

##### Dual Channel

7100B, 7100BM Strip chart recorder \$2000

##### Plug-ins

17500A Multiple span plug-in \$425

17501A Multiple span plug-in \$500

17502A Temperature plug-in \$525

17503A Single span plug-in \$425

17504A Single span plug-in \$400

17505A High sensitivity plug-in \$550

17506A (specify voltage span) \$400

# RECORDERS & PRINTERS

## OEM 10-inch strip chart recorders

Models 7130A & 7131A

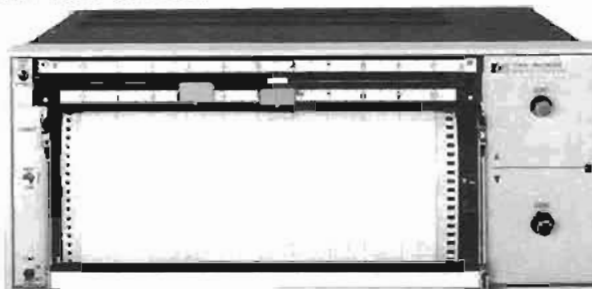

7130A

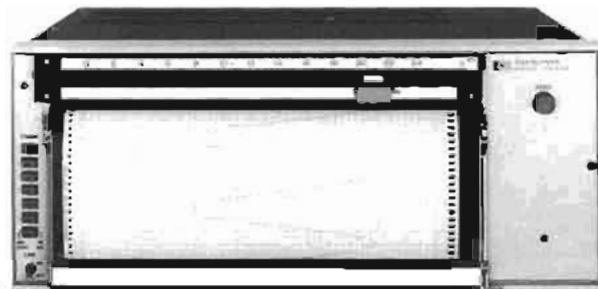

7131A

The Model 7130A is a 10-inch, two-pen recorder; the 7131A is a 10-inch, one-pen recorder. Spans and chart speeds are selected by options.

### 7130A and 7131A Specifications

#### Performance specifications

**Input ranges:** single span, 1 mV thru 100 V (specified option).

**Type of Input:** single ended, floating.

**Maximum allowable source resistance  $R_s$ :** 10 k $\Omega$ .

**Normal mode rejection (at line frequency):** >40 dB.

**Common mode rejection:** >120 dB at dc & >100 dB at line frequency.

**Response time:** <1/2 s.

**Overshoot:** <2% of full scale.

**Accuracy (including linearity and deadband):**  $\pm 0.2\%$  of full scale at 25°C.

**Deadband:**  $\pm 0.1\%$  of full scale.

**Chart speeds:** speed determined by option choice.

**Chart speed accuracy:**  $\pm 0.08\%$  plus line frequency accuracy.

**Zero set:** left hand, adjustable  $\pm 1$  full scale (right hand optional).

**Environmental (operation):** 0°C to 55°C, 95% RH (40°C).

#### General specifications

**Writing mechanism:** disposable ink pens (thermal writing option).

**Grid width:** 25 cm or 10 in.

**Chart length:** 27 metres or 90 ft.

**Pen lift:** manual (electric or independent optional).

**Dimensions:** 178 mm H, 432 mm W, 340 mm D (7" x 17" x 13 3/8").

**Power:** 7130A, 7131A: 115/230 V  $\pm 10\%$ , 60 Hz, 120 VA.

7130B, 7131B: 115/230 V  $\pm 10\%$ , 50 Hz, 120 VA.

**Weight:** net, 12.3 kg (27 lb); Shipping, 17.4 kg (38 lb).

**Accessory kits:** two-channel (7130A), 07130-60055; one-channel (7131A), 07131-60109; thermal writing (7130A/7131A), 07130-60068.

**Span:** must specify one for each channel; spans may be different. The front scale is determined by choice of English or metric chart speed. The 500 series options are for the lower channel of the 7130A only.

Option				Option			
Span	Upr Chnl	Lwr Chnl	Price	Span	Upr Chnl	Lwr Chnl	Price
1 mV	001	501	\$200	1 V	008	508	\$50
5 mV	002	502	200	5 V	009	509	50
10 mV	003	503	150	10 V	010	510	50
50 mV	004	504	150	50 V	011	511	50
100 mV	005	505	150	100 V	012	512	50
500 mV	006	506	150				

**Chart speeds:** must specify one basic speed.

Speed	Option	Price	Speed	Option	Price
6 in./min	016	\$25	15 cm/min	022	\$25
4 in./min	017	25	10 cm/min	023	25
1 in./min	018	25	5 cm/min	024	25
1/2 in./min	019	25	3 cm/min	025	25
1/4 in./min	020	25	15 cm/hr	026	25
1 in./hr	021	25	3 cm/hr	027	25

#### Speed reducers

	Option	Price		Option	Price
60:1 Speed Reducer*	028	\$50	4:1 Speed Reducer*	030	\$50
10:1 Speed Reducer*	029	\$50	2:1 Speed Reducer*	031	\$50

\*The slowest speed resulting from the addition of a speed reducer must not be less than 2.54 cm/hr (1 in./hr).

#### Multiple speeds

4 speed: 1/4, 1/2, 1, 2, in./min, plus extern input

4 speed: 0.625, 1.25, 2.5, 5 cm/min plus external input

Option Price

046 \$170

049 \$170

#### Options requiring option power supply

Option Power Supply

041 \$75

8 chrt spds: 1, 2, 4, 6 in./min & hr + ext inpt

045 \$200

8 chrt spds: 2.5, 5, 10, 15 cm/min & hr + ext inpt

048 \$200

Remote Speed Change\*

032 \$50

Remote Chart On-Off\*

033 \$50

Remote Pen Lift\*

036 \$50

Right Hand Event Marker\*

(not compatible with option 054)

037 \$75

Right Hand Event Marker Thermal\*

(must order option 054)

038 \$150

Left Hand Event Marker\*

037 \$75

\*Actuated by contact closure to ground or TTL levels. Closed circuit current 1.5 mA (maximum), open circuit voltage  $\geq 1.5$  V (minimum).

#### Other Options

Upr Chnl Lwr Chnl

Retransmitting Potentiometers	040	540	\$75
Limit Switches*	044	544	\$150
Input Filter (1-500 mV)	007	507	\$100
Right Hand Zero Hard, Scale 10 to 0	014		N/C
Right Hand Zero Soft, Scale 10 to -0.5	015		N/C
Independent Mech. Pen Lift (7130 only)	034		N/C
Rack Slides	042		\$75
Capillary Ink Pen & Cartridge	053		\$100
Thermal Writing: Model 7130A**	054		\$275
Model 7131A**	054		\$200
Rear Control Connector	056		\$50
50 Hz & 60 Hz Operation	050, 060		N/C
Rack Mounting Brackets	908		\$15
Extra Manual	910		\$10

\*Contact rating 1 A at 1.5 V, 0.5 A at 250 V non-inductive.

\*\*Recommended for pen speeds below 5 inches per second.

**Analytical option combinations:** the following options are for analytical applications such as chromatography and include 1 mV span each channel, right hand soft zero, front panel detector switch on the 7131A, and two chart speeds as indicated.

	Option	7130	7131
2 speeds: (1/2 and 1/4 in./min)	090	\$525	\$360
2 speeds: (1 and 1/4 in./min)	091	\$525	\$360
4 speeds: (2, 1, 1/2, 1/4 in./min)	092	\$670	\$455

#### Recorder supplies starter kits

17036A Recorder Supplies Starter Kit—English	\$51
17037A Recorder Supplies Starter Kit—Metric	\$51
17038A Recorder Supplies Starter Kit—English-Thermal	\$47
17039A Recorder Supplies Starter Kit—Metric-Thermal	\$47
17040A Recorder Starter Kit—English-R.H. soft zero	\$51

#### Ordering information

7130A OEM Two-Pen Recorder	\$1800
7131A OEM One-Pen Recorder	\$1450



# RECORDERS & PRINTERS

## Laboratory 10-inch strip chart recorder

### Models 7132A & 7133A



- Multi-range attenuators

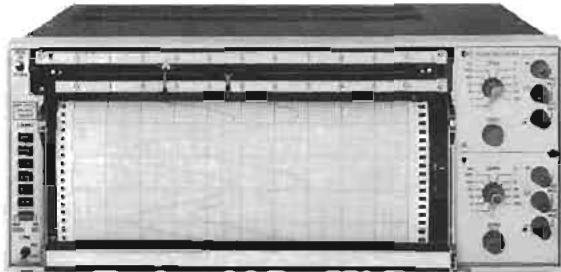

7132A—Opt 054

The Hewlett-Packard Models 7132A two-pen and 7133A one-pen Strip Chart Recorders are laboratory instruments equipped with standard features that qualify them to accommodate your laboratory or scientific application needs.

The 7132A and 7133A are equipped with multi-range attenuators providing eleven input ranges from 1 mV to 100 V full scale in a 1-5-10 sequence. Both models have eight chart speeds of 2.5, 5, 10, 15 cm/minute and 2.5, 5, 10, 15 cm/hour (1, 2, 4, 6 inches per minute and 1, 2, 4, 6 inches per hour). Disposable ink pens are standard. These pens provide a clear, continuous trace, and are easily replaced.

Modular construction facilitates easy removal of the servo module for inspection and maintenance of the drive system, slidewire, or pen lift. The elimination of slip clutches in the servo module contributes to quiet, reliable operation. In addition, should the pen go off scale, the amplifier gain is automatically reduced, preventing noise or damage to the equipment. A stepper motor chart drive eliminates mechanical shifting of gears.

The chart magazine may be adjusted to any of three angles to provide a comfortable writing surface. Chart paper may be automatically rolled up or fed out of the recorder. A convenient front panel indicator lets you know when the paper supply is low.

In addition to multi-range capability, the Models 7132A and 7133A offer as standard features: Eight Chart Speeds, Disposable Pens, Remote Pen Lift, and Remote Chart On/Off.

Options include: Metric Calibration, Right Hand Zero (Hard), Right Hand Marker, 50 or 60 Hz Operation, and thermal writing.

## 7132A and 7133 A Specifications

### Performance specifications

**Input ranges:** eleven ranges from 1 mV to 100 V full scale in 1-5-10 sequence with overlapping vernier.

**Type of Input:** single ended, floating.

**Input resistance:** 1 megohm on all ranges.

**Maximum source resistance:** 10 k $\Omega$  (to within rated response).

**Normal mode rejection (at line frequency):** greater than 40 dB.

**Common mode rejection:** greater than 120 dB dc and 100 dB ac.

**Accuracy:**  $\pm 0.2\%$  of full scale (includes linearity and deadband) at 25°C. Temp coefficient  $\pm 0.01\%$  per °C.

**Range accuracy:**  $\pm 0.2\%$  of full scale  $\pm 0.2\%$  of deflection (includes linearity and deadband) at 25°C. Temp Coefficient  $\pm 0.01\%$  per °C.

**Deadband:** 0.1% of full scale.

**Response time:** less than 0.5 second.

**Overshoot:** less than 2% of full scale.

**Chart speeds:** 2.5, 5, 10, 15 cm/min, and 2.5, 5, 10, 15 cm/hour (1, 2, 4, 6 inches/minute, and 1, 2, 4, 6 inches/hour).

**Chart speed accuracy:**  $\pm 0.08\%$  plus line frequency accuracy.

**Zero set:** provides three full scales of offset.

**Environmental (operating):** 0 to 55°C, less than 95% relative humidity (40°C).

### General specifications

**Writing mechanism:** disposable ink pens (thermal writing optional).

- Disposable pens

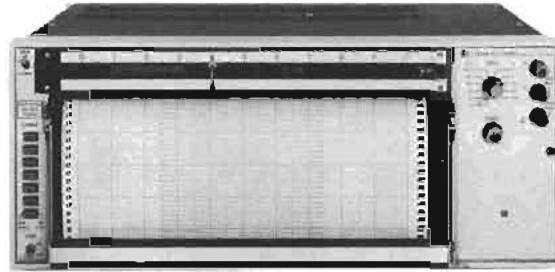

7133A—Opt 054

**Grid width:** 25 cm (10 inches).

**Chart length:** 30 metres (100 ft).

**Pen lift:** solenoid operated with remote capabilities.

**Power:** 115/230 V  $\pm 10\%$ , 50 or 60 Hz, 120 VA.

**Dimensions:** 178 mm H, 432 mm W, 340 mm D (7"  $\times$  17"  $\times$  13 $\frac{1}{8}$ ").

**Weight:** net, 12.3 kg (27 lb). Shipping, 17.4 kg (38 lb).

**Supplies furnished with each instrument:**

- Accessory kit:
  - Disposable Pens—Blue (Package of 3)
  - Disposable Pens—Red (Package of 3)
  - Plastic Kit Box
  - Slidewire Cleaner
  - Flexible Tubing, 0.032 ID, 0.4 ft
  - Pen Cleaning Assembly
  - Syringe for Pen Cleaning
- Operating and Service Manual
- One roll of Chart Paper
  - Chart Paper, English
  - Chart Paper, Metric
  - Chart Paper, Thermal—English
  - Chart Paper, Thermal—Metric
- Power Cord (2.1 meters or 7 ft)
- Ink Cartridge, Black (for Event Marker)
- Your Strip Chart Recorder—a brief manual

### Options & accessories

**001:** metric calibration. Provides chart speeds of 2.5, 5, 10, and 15 cm per minute, and 2.5, 5, 10, and 15 cm per hour

**014:** Right Hand Zero (Hard). Positive voltage input causes pen to deflect from right to left N/C

**037:** Right Hand Event Marker (not compatible with Opt 054) add \$75

**038:** Thermal Event Marker (Opt 054 required) add \$150

**537:** 7132A Only. Left Hand Event Marker (Not Available with Thermal Writing, Option 054) add \$75

**050:** 50 Hz Line Power N/C

**060:** 60 Hz Line Power N/C

**054:** Thermal Writing, Model 7132A (recommended for pen speed below 5"/s) add \$275

**054:** Thermal Writing, Model 7133A (recommended for pen speed below 5"/s) add \$200

**908:** Rack mount brackets add \$15

**910:** Extra manual add \$10

**Recorder supplies starter kits**

17036A English \$51

17037A Metric \$51

17038A English—Thermal \$47

17039A Metric—Thermal \$47

**Ordering Information**

7132A Laboratory Two-Pen Recorder \$2250

7133A Laboratory One-Pen Recorder \$1675

# RECORDERS & PRINTERS

Portable, battery power strip chart recorder

Model 7155B

- Under 30 pounds with internal battery
- 12 centimeter chart width
- Operates at  $-28^{\circ}\text{C}$  to  $+65^{\circ}\text{C}$



7155B

The Hewlett-Packard 7155B is a 12 cm portable strip chart recorder designed especially for field applications while maintaining laboratory specifications. It is a rugged, light-weight instrument weighing under 30 pounds with the rechargeable battery installed. The standard unit operates on external dc or ac from 48 to 440 Hz. The optional internal battery, which operates for nine hours on a single charge, may be selected. The instrument operates within HP Class A temperature range ( $-28^{\circ}\text{C}$  to  $+65^{\circ}\text{C}$ ); a first in the strip chart recording field.

This unit is provided with 16 calibrated spans, seven chart speeds, and a totally-electronic transmission that eliminates the need for mechanically shifting the gears. Additional standard items include the disposable pen, front plexiglass cover, three chart magazine tilt angles, and easy access to PC boards for serviceability. A sealed jelled electrolyte battery is optionally available.

## 7155B Specifications

### Performance specifications

**Input ranges:** 0.1 mV/cm thru 10 V/cm in a 1, 2, 5 sequence with overlapping vernier (12 cm full scale).

**Type of input:** single ended, floating.

**Input resistance:** 1 megohm.

**Maximum allowable source resistance:** 5 k $\Omega$  for rated response.

**Common mode rejection:** 100 dB dc and 80 dB ac.

**Full scale response time:** 0.6 sec to within rated accuracy.

**Overshoot:** 1% of full scale maximum.

**Accuracy:**  $\pm 0.4\%$  of full scale (includes linearity and deadband) at  $25^{\circ}\text{C}$ . Temp Coefficient  $\pm 0.01\%$  per  $^{\circ}\text{C}$ .

**Range accuracy:**  $\pm 0.4\%$  of full scale  $\pm 0.2\%$  of deflection (includes linearity and deadband) at  $25^{\circ}\text{C}$ . Temp Coefficient  $\pm 0.01\%$  per  $^{\circ}\text{C}$ .

**Chart speeds:** 30, 10, 5, 2.5, 1 minute/cm; 30 and 10 sec/cm.

**Chart speed accuracy:**  $\pm 1\%$ .

**Environmental (operating):**  $-28^{\circ}\text{C}$  to  $+65^{\circ}\text{C}$  <95% relative humidity ( $40^{\circ}\text{C}$ ).

### General specifications

**Writing mechanism:** disposable ink pens.

**Grid width:** 12 cm.

**Chart length:** 21 metres (70 ft).

**Pen lift:** mechanical.

**Weight:** net 14 kg (30 lb) with battery option installed.

**Dimensions:**

**Power:** external ac (48 to 440 Hz, 85 V to 130 V or 172 V to 260 V). External dc (10.5 to 36 V, 0.5 amp typical 0.9 amp maximum independent of voltage).

### Supplies furnished

*Your Strip Chart Recorder:*—a brief manual

Operating and service manual

Chart paper, 21.3 m (70 ft)

Power cord, 2.3 m (7.5 ft)

Accessory kit includes:

DC connector

slidewire cleaner

3 red disposable pens

3 red event marker pens (if ordered)

### Options

**005:** right hand zero

(Positive voltage input causes pen to deflect from right to left).

**006:** event marker

Contact closure on rear panel causes approximately 0.06 cm (0.025 inch) deflection of event pen. Marking occurs along left hand edge of paper.

**008:** internal battery

The jelled electrolyte battery operates nine hours on a single charge (at  $25^{\circ}\text{C}$ ). Recharging is from external AC only and requires approximately 14 hours to full charge. Instrument may be operated while charging.

**910:** extra manual

Recorder Supplies Starter Kit  
17051A Recorder Supplies Starter Kit

Price  
N/C

add \$150

add \$330

add \$10

\$54

7155B Portable strip chart recorder

\$1700

## Two and four-channel oscillographic recorders

Models 7402A, 7404A, & 17400A series preamps

- Instant drying ink

- Interchangeable plug-ins

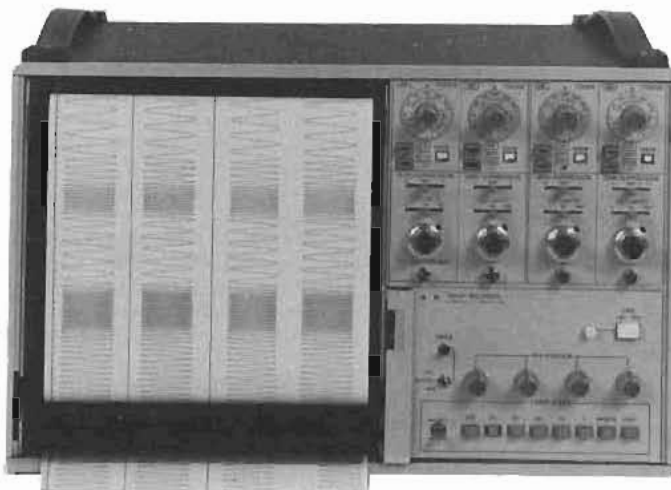

7404A

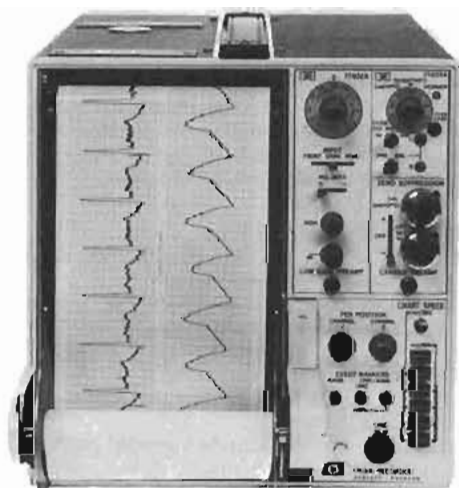

7402A

The Hewlett-Packard Models 7402A and 7404A are rectilinear, low pressure ink writing oscillographic recorders, which, when used with interchangeable 17400A Series Preamplifiers, measure and record one to four input signals against time. The 7402A Recorder is portable and records on either two 50 mm channels or a single 100 mm channel. The 7404A is a four channel recorder, but will also record on two 80 mm channels.

Clear traces that dry immediately on contact with the paper are produced by the pressurized ink system of these units. The pen is constructed with stainless steel with a tough carbide tip. Pens can last the life of the instrument. Four chart speeds are provided on the 7402A, while 12 are available on the 7404A. Remote control of the chart speed is either by contact closure or TTL.

The 7402A may be equipped with a Left Hand Event Marker (Option 001), Right Hand Event Marker/Timer (Option 008), or Left and Right Hand Event Marker/Timer (Option 003). It may be actuated by a front panel pushbutton labeled MARK or by remote contact closure or TTL through the rear terminal strip. On Option 003, a 1 SEC toggle switch provides one second timing sequences; Option 008 provides marks in second or minute sequences. The 7404A records event marks in Channel 1 (Left Edge) and provides automatic mark-per-second or mark-per-minute sequences when the

front panel sec-mark-min toggle switch is set to SEC or MIN position. A mark may be recorded when the MARKER/TIMER pushbutton is pressed. Additionally, it can be actuated by a remote marker command through a rear panel connector or by remote contact closure or TTL. Event markers for channels 2, 3, and 4 are available as Options 013, 014, and 015, respectively.

Oscillographic recorders with plug-ins can be used to measure parameters such as voltage, pressure, flow, force, displacement, and temperature with respect to time. These recorders can be used in applications such as line production, troubleshooting, or physical measurements.

### 17400A High gain

This plug-in is equipped to handle all normally encountered dc signal sources. A unique error indicator is included to signal over-driven inputs. It provides 1  $\mu\text{V}/\text{div}$  sensitivity, 1 megohm input resistance, guarded and floated inputs, and calibrated zero suppression.

### 17401A Medium gain

Stable and solid, this dc-coupled preamplifier provides the basic signal conditioning required to cover the majority of applications. The optional calibrated zero suppression supports 1 mV/div maximum sensitivity balance-to-ground inputs.

### 17402A Low gain

As an economical unit, no compromises are made in basic performance. The single-ended input is available through a conventional rear connector as well as convenient front panel binding posts. Eight calibrated ranges are provided from 20 mV/div to 5 V/div.

### 17403A AC Carrier

The 17403A supplies excitation of 5 v at 2.4 kHz to the passive transducer and receives the returning transducer output. The 17403A operates with full or half-bridge transducers including transformer, strain gage, and potentiometer types. Front panel selection of nine different input sensitivity ranges from 0.1 mV/V/full scale is provided. When used, a 2.4 kHz Carrier Frequency Oscillator must be ordered for the mainframe.

### 17404A DC Bridge

This plug-in supplies dc excitation voltage to the transducer and receives the returning transducer output. Front panel selection of seven input sensitivity ranges from 0.1 mV/div to 10 mV/div are provided.

## 7402A, 7404A, 17400A Series plug-ins specifications

### 7402A General specifications

**Number of channels:** two analog channels. One event marker/timer (optional); one event marker (optional).

## Models 7402A, 7404A, &amp; 17400 series (cont.)

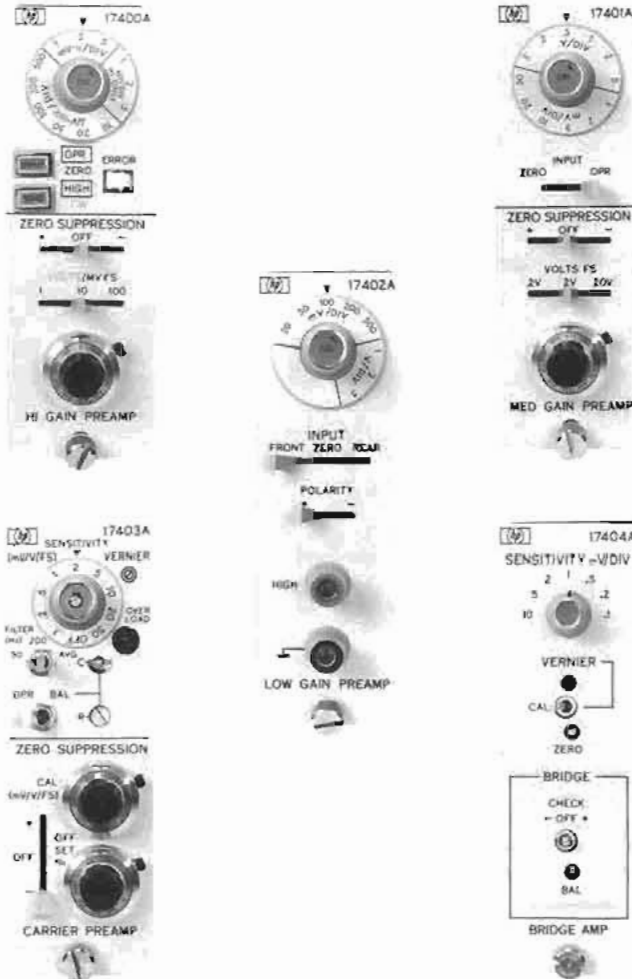

**Chart description:** 50 mm wide channels with 50 div full scale. Time lines every 1 mm. Chart length 84 m (275 ft).

**Chart speeds:** 1, 5, 25, 125 mm/s controlled by front panel, rear panel TTL or contact closure.

**Chart speed accuracy (at 25°C):**  $\pm 0.5\%$  plus power line frequency variation. Temp coeff 0.01%/°C.

**Chart weave:**  $\pm 0.25$  mm maximum.

**Zero:** adjustable to  $\pm 30$  div either side of grid center.

**Writing system:** blue-black ink with rectilinear presentation; 55 cc with replaceable throw-away cartridge.

**Environmental (operating):** 0°C to 55°C and up to 95% relative humidity from 25°C to 40°C for mm/s speeds (80% relative humidity for mm/min.)

**Power:** 110/120/220/240 V ac  $\pm 5\%$  - 10%.

**Weight:** net, 18.2 kg (40 lb) with 2 17400A's & paper. Shipping, 26.9 kg (59 lb).

**Size:** 284 H  $\times$  253 W  $\times$  384 mm D (11 $\frac{1}{8}$ "  $\times$  9 $\frac{7}{8}$ "  $\times$  15 $\frac{1}{8}$ ").

#### 7404A General specifications

**Number of channels:** four analog channels. Left hand event marker/timer.

**Chart description:** 40 mm wide channels with 50 div full scale. Time lines every 1 mm. Chart length 84 m (275 ft).

**Chart speeds:** 5, 10, 25, 50, 100, 200 mm/s and mm/min controlled by front panel, rear panel TTL or contact closure.

**Chart speed accuracy (at 25°C):** same as 7402A.

**Chart weave:** same as 7402A.

**Zero:** same as 7402A.

**Writing system:** same as 7402A.

**Environmental (operating):** same as 7402A.

**Power:** 100/115/200/230 V ac  $\pm 10\%$  60 Hz, 300 VA.

**Weight:** net, 31.4 kg (69 lb). Shipping, 43.2 kg (95 lb).

**Size:** 290 H  $\times$  438 W  $\times$  384 mm D (11 $\frac{3}{8}$ "  $\times$  17 $\frac{1}{4}$ "  $\times$  15 $\frac{1}{8}$ ").

#### 17400A with 7402A and 7404A

**Input ranges:** 1, 2, 5, 10, 20, 50, 100, 200, 500  $\mu$ V/div; 1, 2, 5, 10, 20, 50, 100, 200, 500 mV/div; 1, 2, 5 V/div. Continuous vernier between ranges.

**Type of Input:** differential, floated and guarded. Inputs thru rear connector.

**Maximum allowable input (continuous):** 500 V dc on 10 mV/div range and above; other ranges 120 V dc or 120 V ac rms.

**Input resistance:** 1 Megohm (min.)

**Common mode rejection:** 150 dB dc and 140 dB at line frequency with 1 k $\Omega$  source imbalance. 90 dB dc and 80 dB at 60 Hz on 10 mV/div range and above.

**Maximum allowable common mode voltage:**  $\pm 200$  V dc max voltage.

**Frequency response:** for 10 divisions deflection -3 dB at 110 Hz on 10  $\mu$ V/div range and above.

**Rise time (typical, 10 to 90% of full scale deflection):** 7.5 ms.

**Overshoot:** less than 2% of full scale.

**Accuracy (on calibrated range, at 25°C, includes linearity):**  $\pm 1\%$  of full scale. Temp Coeff 0.06%/°C. Allows for ability to interchange unit without recalibration.

**Range accuracy (at 25°C, includes linearity):**  $\pm 1\%$  of full scale  $\pm 0.2\%$  of reading. Temp Coeff 0.06%/°C. Allows for ability to interchange unit without recalibration.

**Zero suppression:** 1, 10, 100 V on 10 mV/div range and above; other ranges 1, 10, 100 mV. Continuous calibrated vernier between suppression steps.

**Zero suppression accuracy:**  $\pm 0.5\%$  of suppression  $\pm 0.5\%$  of full scale.  $\pm 0.02\%$ /°C.

#### 17401A with 7402A and 7404A

**Input ranges:** 1, 2, 5, 10, 20, 50, 100, 200, 500 mV/div; 1, 2, 5 V/div. Continuous vernier between ranges.

**Type of Input:** balanced to ground. Inputs thru rear connector.

**Maximum allowable input (continuous):** 230 V rms on 500 mV/div range and above; other ranges 120 V rms.

**Input resistance:** 1 Megohm (min.)

**Common mode rejection:** greater than 50 dB dc to line frequency with 100 ohm source imbalance.

**Maximum allowable common mode voltage:** 250 V dc or peak ac on 500 mV/div and above; other ranges 15 V dc or peak ac.

**Frequency response:** 7402A — For 10 div deflection -3 dB at 140 Hz; 7404A — For 10 div deflection -3 dB at 150 Hz.

**Rise time (typical, 10 to 90% of full scale deflection):** 7 ms.

**Overshoot:** less than 2% of full scale.

**Accuracy (on calibrated range, at 25°C, includes linearity):**  $\pm 1\%$  of full scale. Temp Coeff 0.06%/°C. Allows for ability to interchange unit without recalibration.

**Range accuracy (at 25°C, includes linearity):**  $\pm 1\%$  of full scale  $\pm 0.2\%$  of reading. Temp Coeff 0.06%/°C. Allows for ability to interchange unit without recalibration.

**Zero suppression:** (optional) 0.2, 2, 20 V. Continuous calibrated vernier between suppression steps.

**Zero suppression accuracy:**  $\pm 0.5\%$  of suppression  $\pm 0.5\%$  of full scale.  $\pm 0.02\%$ /°C.

#### 17402A with 7402A and 7404A

**Input ranges:** 20, 50, 100, 200, 500 mV/div; 1, 2, 5 V/div. Continuous vernier between ranges.

**Type of Input:** single ended. Inputs thru front or rear connector.

**Maximum allowable input (continuous):** 230 V rms on 200 mV/div range and above; other ranges 120 V rms.

**Input resistance:** 1 Megohm (min.)

**Frequency response:** 7402A — For 10 div deflection -3 dB at 140 Hz; 7404A — For 10 div deflection -3 dB at 150 Hz.

**Rise time (typical, 10 to 90% of full scale deflection):** 7 ms.

**Overshoot:** less than 2% of full scale.

**Accuracy (on calibrated range, at 25°C, includes linearity):**  $\pm 1\%$  of full scale. Temp Coeff 0.06%/°C. Allows for ability to interchange unit without recalibration.

**Range accuracy (at 25°C, Includes linearity):** ±1% of full scale ±0.2% of reading. Temp Coeff 0.06%/°C. Allows for ability to interchange unit without recalibration.

**17403A with 7402A and 7404A**

**Input ranges:** 0.1, 0.2, 0.5, 1, 2, 5, 10, 20, 50 mV/V full scale. Continuous vernier between ranges. Also provides division of above sensitivities by 100.

**Type of Input:** differential, floating.

**Maximum allowable input (continuous):** 50 V rms at 2.4 kHz.

**Input resistance:** 100 k at 2.4 kHz.

**Common mode rejection:** 120 dB dc to line frequency with 1 kΩ source imbalance.

**Maximum allowable common mode voltage:** ±200 V dc or peak ac.

**Frequency response:** 7402A—For 10 div deflection -3 dB at 140 Hz; 7404A—For 10 div deflection -3 dB at 150 Hz. For Preamp only—output available on rear of recorder. Filter switch to 50 -3 dB at 50 Hz; rolloff 40 dB/decade. Filter switch to 200 -3 dB at 200 Hz; rolloff 40 dB/decade. Filter switch to AVG—Time constant 1.0 s ±10% dc to 0.16 Hz; rolloff 20 dB/decade.

**Rise time (typical, 10 to 90% of full scale deflection):** preamp filter switch to 50 or 200; 7.5 ms. Preamp filter switch to AVG; 1 s. **Overshoot:** less than 2% of full scale.

**Accuracy (on calibrated range, at 25°C, includes linearity):** ±0.6% of full scale at 25°C. Temp Coeff 0.06%/°C.

**Range accuracy (at 25°C, Includes linearity):** ±0.6% of full scale ±0.2% of reading. Temp Coeff 0.06%/°C.

**Zero suppression:** ten turn control from 0 to 100% of full scale.

**Zero suppression accuracy:** 0.5% of setting ±0.5% of full scale.

**Drift (zero line referenced to input):** ±0.2 μV/V/week (includes excitation drift).

**Source resistance:** compensated by front panel adjustment.

**Balance controls:** R Balance ±5 mV/V Temp Coeff ±1.8 μV/V/°C.

**Quadrature rejection:** 40 dB at 2.4 kHz. Quadrature tolerance: 2:1.

**Transducer excitation:** full Bridge—5.0 V rms ±5% 2.4 kHz ±3%. Half Bridge—One half full bridge excitation.

**Excitation load resistance:** 100 ohms min. (Unlimited output short circuit duration.)

**17404A with 7402A and 7404A**

**Input ranges:** 0.1, 0.2, 0.5, 1, 2, 5, 10 mV/div with overlapping vernier between ranges.

**Type of Input:** differential, floating and guarded.

**Maximum allowable input (continuous):** 17 V dc or peak ac.

**Input resistance:** 100 k (min).

**Common mode rejection:** 100 dB dc and 80 dB at line frequency with 1 k source imbalance.

**Maximum allowable common mode voltage:** ±165 V dc or peak ac.

**Frequency response:** 7402A—For 10 div deflection -3 dB at 140 Hz; 7404A—For 10 div deflection -3 dB at 150 Hz. Amplifier only (output available on rear of recorder). -3 dB at 3 kHz.

**Rise time (typical, 10 to 90% of full scale deflection):** 7 ms.

**Overshoot:** less than 2% of full scale.

**Accuracy (on calibrated range, at 25°C, includes linearity):** ±1.0% of full scale at 25°C (excludes excitation supply errors). Temp Coeff. 0.06%/°C.

**Range accuracy (at 25°C, Includes linearity):** ±1.0% of full scale at 25°C (excludes excitation supply errors). Temp Coeff 0.06%/°C.

**Drift (zero line referenced to input):** ±0.2% μV/V/week (includes excitation drift).

**Source resistance:** 1 kΩ max.

**Balance controls:** unloaded bridge completion board. Front panel balance and cal controls (balance up to 5 V).

**Transducer excitation:** 5 V dc ±1.0%.

**Excitation load resistance:** 50 ohms min. (Unlimited output short circuit duration.)

**Accessories supplied**

Description	HP Part Number
1. Model 7402A Operating and Service Manual	07402-90005
Model 7404A Operating and Service Manual	07404-90000
2. Chart Paper (One 275 ft (84 m) roll)—7402A	9280-9258

Chart Paper (One 275 ft (84 m) roll)—7404A	9280-0293
3. Ink Cartridge (55 cc, installed)	07402-60066
4. Rear Plug-in Connectors (2 each 7402A, 4 each 7404A)	1251-1895
5. Power Cord (7.5 ft (2.3 m))	8120-1378
6. Miscellaneous Fuses (spares for internal supplies)	17999-15126
7. Pen Cleaning Wires	07402-20048
8. Ink Line Plugs, 3 each	

**Supplies/accessories available**

Description	HP Part Number
7402A Paper: 275 ft (84 m) roll, two 50 mm channels	9280-0258
7402A Paper: 275 ft (84 m) roll, one 100 mm channel	9280-0276
7404A Paper: 275 ft (84 m) roll, four 50 div channels	9280-0293
7404A Paper: 275 ft (84 m) roll, two 100 div channels	9280-0294
Ink Cartridge (55 cc)	07402-60066
Mobile cart for 7404A	1064A-018
Input Adapter Plug	17133A

**Field Installation Kits as follows:**

Rack Mounting Kit for 7402A	07402-60023
Rack Mounting Kit for 7404A	07404-60074
Rack Mounting Kit for 7404A in 1064A-018 Cart	07404-60082
Paper Take-up Kit for 7402A	07402-60022
Paper Take-up Kit for 7404A	07404-60076
Hard Cover Kit for 7402A	07402-60062
Hard Cover Kit for 7404A	07404-60072
Opt 011 Circuit Board for Models 7402A/7404A	07402-60252

**7402A Options**

001: Event marker (left hand)	add \$100
003: Event marker (left hand) and event marker/timer (right hand) for 1 s intervals.	add \$200
004: 50 Hz power line operation	N/C
005: Paper take-up (external)	add \$150
008: Event marker/timer (right hand) for minutes and seconds (not compatible with Opt 001 or 003)	add \$175
009: 60:1 speed reducer	add \$225
010: Hard cover (not compatible with Opt 005 or 908)	add \$50
011: 2.4 kHz oscillator for use with 17403A	add \$50
016: White paint	add \$100
017: UL544 Listing, white paint	add \$375
018: UL544 Listing, standard paint	add \$325
908: Rack mount adapter	add \$120

**7404A Options**

004: 50 Hz power line operation	N/C
005: Paper take-up (external)	add \$200
010: Hard cover (not compatible with Opt 005, 012 or 908)	add \$75
011: 2.4 kHz oscillator for use with 17403A	add \$50
012: Rack mount adapter for use with 1064A mobile cart	add \$100
013: Channel 2 event marker	add \$65
014: Channel 3 event marker	add \$65
015: Channel 4 event marker	add \$65
016: white paint	add \$100
908: Rack mount adapter	add \$150

**Ordering Information**

7402A Mainframe (less plug-ins)	\$2400
7404A Mainframe (less plug-ins)	\$4550
17400A High Gain Pre-amplifier	\$810
17401A Medium Gain Pre-amplifier	\$285
17401A Opt 001 (Zero suppression)	add \$140
17402A Low Gain Pre-amplifier	\$190
17403A AC Carrier Pre-amplifier	\$750
17404A DC Bridge Amplifier	\$545
17052A Recorder Supplies Starter Kit—7402A	\$45
17053A Recorder Supplies Starter Kit—7404A	\$54

# RECORDERS & PRINTERS

Two, four and eight-channel oscillographic recorders

Models 7702B, 7414A, 7418A & 8800 series signal conditioners

- Versatile configurations
- Thermal writing

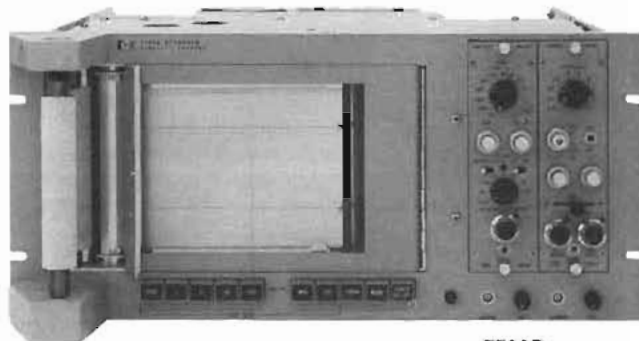

7702B

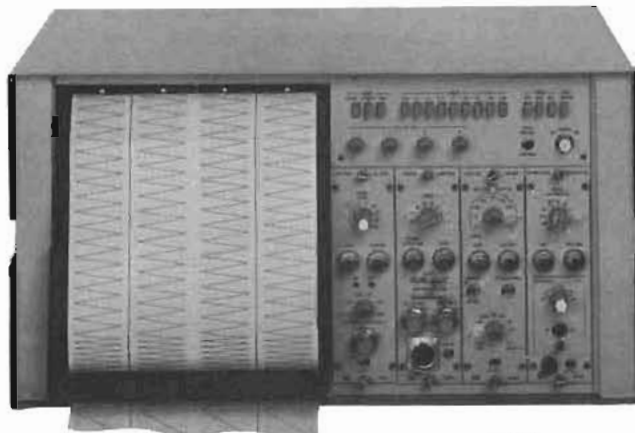

7414A

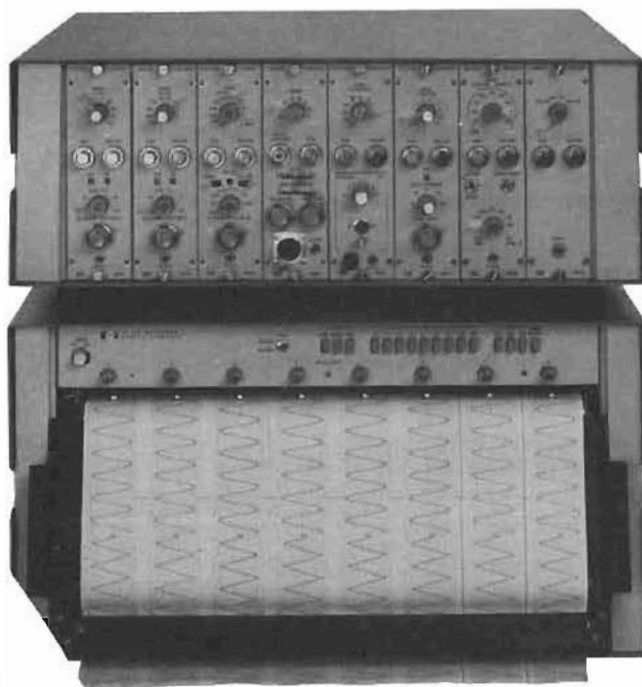

7418A

The Hewlett-Packard Models 7702B 2-channel, 7414A 4-channel, and 7418A 6- and 8-channel Oscillographic Recorders provide permanent reproducible records of multichannel, real-time, low frequency data. They can be contained in a single benchtop package, a mobile cart, or in an upright cabinet. The unit selected, depending upon channel needs, represents a unique combination of reliability, high performance, and flexibility. A complement of the 8800 Series Plug-In Signal Conditioners results in a system capable of meeting many measurements requirements.

Thermal writing tips in Models 7414A and 7418A, featuring long stylus life and recilinear presentations, are provided. A 500-sheet, Z-fold chart paper pack loads easily, allows for convenient data review, and storage capability. Two event markers are supplied. One is activated by either a one-second or one-minute front panel timer button, the other by the event button. Both markers can be activated remotely.

## 7702B, 7414A, 7418A, 8800 Series plug-in specifications

### 7702B General specifications

**Chart speeds:** 1, 5, 20, and 100 mm/sec; plus eight optional.

**Markers:** event-right side marker standard, center marker optional.

**Chart paper:** two 50 mm wide channels each with 50 div; time lines every 1 mm; roll type Permapaper®.

**Paper loading and takeup:** front panel loading and paper take-up.

**Power:** 115/230 V ac  $\pm 10\%$ , 60 Hz, 230 VA (including plug-ins), 50 Hz optional

**Dimensions:** 221.5 H  $\times$  482.6 W  $\times$  438.2 mm D (8 $\frac{3}{4}$ "  $\times$  19"  $\times$  17 $\frac{1}{2}$ "") for standard rack. For Portable Case: 235 mm H  $\times$  498 mm W  $\times$  546 mm D (9 $\frac{3}{4}$ "  $\times$  19.6"  $\times$  21.5"). For Mobile Cart: 997 mm H  $\times$  680 mm W  $\times$  521 mm D (39 $\frac{1}{4}$ "  $\times$  26 $\frac{3}{4}$ "  $\times$  20.5").

**Weight:** 27.2 kg (60 lb) for rack mount; 40.4 kg (89 lb) in Portable Case; 59 kg (130 lb) in Mobile Cart.

### 7414A General specifications

**Chart speeds:** 0.25, 0.5, 1.0, 2.5, 10, 25, 50, 100 mm/s. Speed regulation  $\pm 1\%$ . Paper weave less than 0.5 mm. Speed selected via front panel pushbuttons.

**Limiting:** electrical limiting keeps stylus within a range of 1.5 mm beyond edge of channel.

**Markers:** event—local or remote control (monopolar), located on right side, between channels 3 and 4. Timed—1 min or 1 sec interval (monopolar), located on left side, between channels 1 and 2.

**Chart paper:** four 40 mm wide channels each with 50 div; time lines every 1 mm; heat sensitivity Z-fold Permapaper® with green grid lines available in packs of 500 sheets, each 30 cm (12").

**Paper loading:** no threading required.

**Remote operation:** rear panel connector provides for chart drive and event marker.

**Power:** 115/230 V ac  $\pm 10\%$ , 60 Hz, 350 VA (includes plug-ins) 50 Hz optional.

**Size:** 266.7 H  $\times$  482.6 W  $\times$  577.9 mm D (10 $\frac{1}{2}$ "  $\times$  19"  $\times$  22 $\frac{3}{4}$ ""). Projection: 76.2 mm (3") from rack front.

**Weight:** net, 50.5 kg (112 lb). Shipping, 59.5 kg (132 lb).

### 7418A General specifications

**Chart speeds:** 0.5, 1, 2.5, 5, 10, 25, 50, 100, 200 mm/sec. Speed regulation  $\pm 1\%$ . Paper weave less than 0.5 mm. Speed selected via front panel pushbuttons.

**Remote operation:** rear panel connector provides for chart drive and event marker, optional extra markers. Remote connector supplies  $-20$  V.

**Power:** 115/230 V ac  $\pm 10\%$ , 60 Hz. Recorder only 575 VA; system plug-ins 695 VA.

**Size:** rack: 266.7 H  $\times$  482.6 W  $\times$  577.9 mm D (10 $\frac{1}{2}$ "  $\times$  19"  $\times$  22 $\frac{3}{4}$ ""). Projection: 76.2 mm (3") from front of rack.

**Weight:** 50 kg (110 lb) including driver amplifiers.



8801A



8802A



8803A



8805A

**8801A with 7702B, 7414A and 7418A**

**Input ranges:** 5, 10, 20, 50, 100, 200, 500, 1000 mV/div; accuracy  $\pm 1\%$ .

**Max calibrated sensitivity and max fs Input:** 5 mV/div (gain 20) 250 V.

**Input circuit & Input frequency range:** resist. 500 k $\Omega$   $\pm 1\%$  each side bal to gnd; parallel with approx. 100 pF.

**Rise time (10 div, 10-90%, 4% overshoot):** 5 ms.

**Calibration (referred to input):** 100 mV,  $\pm 1\%$ , internal.

**Output frequency response (-0.5 dB at 50 div):** 50 Hz.

**Zero suppression:**  $\pm 10$  and  $\pm 100$  V V for single-ended or diff. signals. 10-T pot sets precise values of zero suppression voltages;  $\pm 50$  V max suppress on 5, 10, 20 mV/div ranges; max error of suppression  $\pm 0.5\%$  of suppression range, and 1% of indicated suppression.

**Output noise, max (less trace width):** 0.2 div, p-p.

**Zero drift, 20° to 40°C, 103 to 127 V (less trace width):** temp—1.25 div/10°C, 0.5 div/hr, constant ambient. Line voltage—0.15 div.

**Common mode rejection and tolerance:** 48 dB min, dc to 150 Hz;  $\pm 50$  V max on other ranges for  $< 1\%$  change in differential sensitivity.

**Output linearity (less trace width):** 0.25 div, after calibration for zero error to center scale +20 div.

**8802A with 7702B, 7414A and 7418A**

**Input ranges:** 1, 2, 5, 10, 20, 50, 100, 200, 500, 1000 mV/div; accuracy  $\pm 1\%$ .

**Maximum calibrated sensitivity and max fs Input:** 1 mV/div (gain 100) 50 V.

**Input circuit and Input frequency range:** resist 180 k $\Omega$   $\pm 1\%$ , each side bal to gnd, parallel with approx 100 pF.

**Rise time (10 div, 10-90%, 4% overshoot):** 5 ms.

**Calibration (referred to input):** 20 mV,  $\pm 1\%$ , internal.

**Output frequency response (-0.5 dB at 50 div):** 50 Hz.

**Zero suppression:**  $\pm 2$  V and 20 V for single-ended or differential signals; 10-T pot sets precise values of zero suppression voltages;  $\pm 12.5$  max suppression on 1, 2, 5 mV/div ranges; max error of suppression  $\pm 0.5\%$  of suppression range and 1% of indicated suppression.

**Output noise, max (less trace width):** 0.2 div, p-p.

**Zero drift, 20° to 40°C, 103 to 127 V (less trace width):** same as 8801A.

**Common mode rejection and tolerance:** 48 dB min, dc to 60 Hz, 1000 mV/div range; 48 dB min, dc to 150 Hz other ranges  $\pm 12.5$  V on 1, 2, 5 mV/div ranges;  $\pm 125$  V on 10, 20, 50 mV/div ranges;  $\pm 500$  V max other ranges for less than 1% change in differential sensitivity.

**Output linearity (less trace width):** same as 8801A.

**8803A with 7702B, 7414A and 7418A**

**Input ranges:** 1, 2, 5, 10, 20, 50, 100, 200, 500, 1000, 2000, 5000  $\mu$ V/div; 10, 20, 100, 200, 500, 1000, 2000, 5000 mV/div; accuracy  $\pm 1\%$  on 5000  $\mu$ V/div to 20  $\mu$ V/div ranges,  $\pm 2\%$  on 10  $\mu$ V/div to 1  $\mu$ V/div; accuracy of  $\times 1000$  attenuator  $\pm 1\%$ .

**Maximum calibrated sensitivity and max fs Input:** 1  $\mu$ V/div (gain 100,000) 250 V.

**Input circuit and Input frequency range:** 1 M $\Omega$  min on  $\mu$ V range,

independent of gain; 5 M $\Omega$  on mV range; floating and guarded.

**Rise time (10 div, 10-90%, 4% overshoot):** 5 ms. 6% overshoot.

**Calibration (referred to input):** 200  $\mu$ V  $\pm 1\%$  internal on  $\mu$ V/div range; 200 mV  $\pm 1\%$  internal on mV/div range.

**Output frequency response (-0.5 dB at 50 div):** 50 Hz.

**Zero suppression:**  $\mu$ V ranges  $\pm 1$ ,  $\pm 10$ ,  $\pm 100$  mV; mV ranges  $\pm 1$ ,  $\pm 10$ ,  $\pm 100$  V, 10-T pot sets precise values of zero suppression voltages; accuracy  $\pm 1\%$  suppression range.

**Output noise, max (less trace width):** 1.5 mm p-p at 1  $\mu$ V/div; 0.1 div, p-p min gain.

**Zero drift, 20% to 40%, 103 to 127 V (less trace width):** temp— $\mu$ V range 1  $\Omega$ /10°C referred to input,  $\pm 0.26$  div/10°C for 0 output &  $\pm 0.65$  div/10°C for fs output. mV range, 1 mV/10°C referred to input,  $\pm 0.26$  div/10°C for 0 output. Line voltage 0-0.07 div; fs 0.35 div.

**Common mode rejection and tolerance:**  $\mu$ V range, max source unbal of 1 k $\Omega$ ; 160 dB min at dc, 120 dB min at 60 Hz; mV range, max source unbal of 500 k $\Omega$ ; 100 dB min at dc, 60 dB min at 60 Hz dc, 300 V pk; 60 Hz, 1  $\mu$ V/div, 10 V rms; 2  $\mu$ V/div, 20 V rms; 5  $\mu$ V/div, 50 V rms; 10  $\mu$ V/div and 10 mV/div, 100 V rms; 20  $\mu$ V to 5000  $\mu$ V/div and 20 mV to 5000 mV/div, 200 V rms.

**Output linearity (less trace width):** 1 mV range 0.35 div, others 0.25 div after calibrating for zero error at center scale and +20 div.

**8805A/B with 7702B, 7414A and 7418A**

**Input ranges:** X1, 2, 5, 10, 20, 50, 100, 200; accuracy  $\pm 2\%$ .

**Maximum calibrated sensitivity and max fs Input:** 10  $\mu$ V rms/div (gain 10,000 rms ac to dc); 100 mV rms.

**Input circuit and Input frequency range:** input impedance—8805A approx 10 k $\Omega$ ; 8805B 1 M $\Omega$   $\pm 10\%$ ; single-ended. Min load resistance across excitation 100 $\Omega$ . Max impedance in series with input (transducer output impedance) 5 k $\Omega$ . Excitation—floating source 5 V rms nominal at 2400 Hz  $\pm 2\%$ . Internal full bridge—half bridge switch grounds C.T. of excitation for use with half bridge transducer.

**Rise time (10 div, 10-90%, 4% overshoot):** 5.6 ms.

**Calibration (referred to input):** 2%  $\pm 0.02\%$  of transducer fs output. Adjust by Cal Factor control; accuracy  $\pm 55$   $\mu$ V/V out of 10 mV/V. 8805B switchable Cal voltage to 2%, 10%, 50%, or 100%  $\pm 1\%$  of fs.

**Output frequency response (-0.5 dB at 50 div):** 50 Hz.

**Zero suppression:** 0-100% of transducer full load load rating, for transducers having Cal Factor up to 10 mV/V at full load, 10-T pot with calibration dial; accuracy—1 dial div  $\pm 0.5\%$  of suppression range. Zero Supp Polarity switch, Separate R Bal control allows bucking of inphase unbal to  $\pm 3$  mV/V regardless of Cal Factor.

**Output noise, max (less trace width):** approx. 0.2 div, p-p.

**Zero drift, 20% to 40%, 103 to 127 V (less trace width):** temp—0.45 div/10°C; Line voltage—0.25 div.

**Common mode rejection and tolerance:** quadrature rejection and tolerance:  $> 40$  dB. Tolerance error:  $< \pm 2\%$  fs when quadrature voltage equal to twice in-phase signal required for center to edge deflection on chart. C Balance control permits bucking of transducer's quad unbalance of up to  $\pm 5$  mV/V.

**Output linearity (less trace width):** 0.4 div after calibrating for zero error at center scale and +20 div.

# RECORDERS & PRINTERS

## Two, four and eight-channel oscillographic recorders

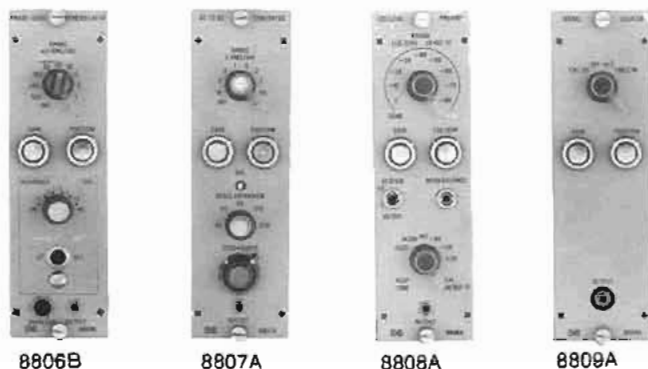

8806B

8807A

8808A

8809A

### 8806B with 7702B, 7414A and 7418A

**Input ranges:** sig input—0.5, 1, 2.5, 10, 20, 50, 100, 200, 500 mV/div;  $\pm 1\%$ , 50 Hz to 10 kHz;  $\pm 2\%$ , 10 kHz to 20 kHz;  $\pm 3\%$ , 20 kHz to 40 kHz. Reference voltage—3 to 20 V rms, 20 to 133 V rms.

**Maximum calibrated sensitivity and max fs input:** 0.5 mV rms/div (gain 200 rms ac to dc) 25 V rms.

**Input circuit and input frequency range:** signal input—transformer isolated, floating point and guarded; resistance approx 1 M $\Omega$ . Reference input: differential, transformer coupled; resistance approx 500 k $\Omega$  each side to ground, may be used single ended. 50 Hz to 40 kHz in 6 bauds with variable frequency plug-in; 60 Hz, 400 Hz and 5 kHz fixed frequency phase shifter plug-in; special order phase shifter plug-ins 50 Hz to 40 kHz.

**Rise time (10 div, 10-90%, 4% overshoot):** 5 ms (5 kHz ref).

**Calibration (referred to input):** 1 V rms internal at carrier reference frequency;  $\pm 1\%$  50 Hz to 10 kHz;  $\pm 2\%$  10 kHz to 20 kHz;  $\pm 3\%$  20 kHz to 40 kHz.

**Zero suppression:** none. Phase shifter plug-ins allow control of reference phase over 360°. Fixed frequency: 0° to 90° dial; 2° graduations; any of 4 quadrants by panel switches; dial accuracy within  $\pm 3^\circ$ . Variable frequency: adjust thru 360°.

**Output noise, max (less trace width):** 7  $\mu$ V  $\times$  sq root of frequency response, referred to input.

**Zero drift, 20° to 40°C, 103 to 127 V (less trace width):** temp: 0.5 div/10°C; Line voltage: 0.25 div.

**Common mode rejection and tolerance:** CM: >40 dB up to 10 kHz 500 V rms, max. Quadrature tolerance: equal to amplitude of a fs, in-phase signal.

**Output linearity (less trace width):** 0.4 div after calibrating for zero error at center scale and +20 div.

### 8807A with 7702B, 7414A and 7418A

**Input ranges:** 0.02, 0.05, 0.1, 0.2, 0.5, 1, 2, 5, 10 V rms/div,  $\pm 2\%$  (midband). Scale expansion: X1, 2, 5, 10, 20,  $\pm 2\%$ .

**Maximum calibrated sensitivity and max fs input:** 1 mV rms/div (gain 100 rms ac to dc). 20 mV rms/div with X1 scale expansion 500 V rms.

**Input circuit and input frequency range:** approx 1 M $\Omega$  resistive in parallel with 10 pF and stray cable capacitance; floating and guarded. Standard model: 330 Hz to 100 kHz; Opt 001: 50 Hz to 100 kHz.

**Rise time (10 div, 10-90%, 4% overshoot):** 11.2 ms. Opt 001: 70 ms, approx 10% overshoot.

**Calibration (referred to input):** 1 V internal  $\pm 1\%$ ; approx 500 Hz. **Output frequency response (-0.5 dB at 50 div):** 54 Hz (3 dB at 10 div). Opt 001—9 Hz.

**Zero suppression:** up to 100% of fs on any range can be suppressed; 10-T pot with calibrating dial. Scale expansion: 5, 10, 20, or 50% of fs can be expanded to cover full chart.

**Output noise, max (less trace width):** baseline offset/noise: 2 mV rms referred to input +0.025 div  $\times$  scale expansion

**Zero drift, 20° to 40°C, 103 to 127 V (less trace width):** temp 0.03 div/10°C  $\times$  scale expansion +0.35 div/10°C; at constant ambient 0.005 div/hr  $\times$  scale expansion. Line voltage 0.005 div  $\times$  scale expansion +0.1 div.

**Common mode rejection and tolerance:** 60 dB min at 60 Hz; 40 dB min at 400 Hz with up to 10 k source unbalance;  $\pm 500$  V pk.

**Output linearity (less trace width):** 0.55 div +0.05 div  $\times$  scale expansion, 330 Hz to 5 kHz; Opt 001: 60 Hz to 5 kHz, after calibration for zero error at lower and upper ends of printed coordinates.

### 8808A with 7702B, 7414A and 7418A

**Input ranges:** 50 dB span: bottom scale -80, -70, -60, -50, -40, -20, -10, and 0 dB below 1 V (i.e., 100  $\mu$ V, 320  $\mu$ V, 1, 3.2, 10, 32, 100, 320 mV and 1 V). 100 dB span: bottom scale -80, -70, -60, and -50 dB below 1 V.

**Maximum calibrated sensitivity and max fs input:** 100  $\mu$ V rms sine wave corresponds to bottom scale output, -80 dB below 1 V 320 V rms.

**Input circuit and input frequency range:** single ended, resistance 1 M $\Omega$  min. 5 Hz to 100 kHz for <3 dB down from the midband level on "Slow" response range; 500 Hz to 100 kHz on "Fast" response range.

**Rise time (10 div, 10-90%, 4% overshoot):** fast: 20.5 ms (875 dB/s) Slow: 2 s (9 dB/s).

**Calibration (referred to input):** internal from oscillator at approx 500 Hz. -80, -30, and +20 dBV = dB ref. to 1 V (100  $\mu$ V, 32 mV and 10 V) -80 +20 dBV internally adjustable: -30 dBV accuracy  $\pm 0.25$  dB (at 115 V line at 25°C).

**Output noise, max (less trace width):** 50 dB range: 0.8 div, p-p. 100 dB range: 0.4 div, p-p (max noise at bottom of recording chart).

**Output linearity (less trace width):** departure from log characteristics 50 dB: 1.25 div, 100 dB: 1 div, after calibrating for zero error at lower and upper ends of printed coordinates.

### 8809A with 7702B, 7414A and 7418A

**Input ranges:** continuously adjustable from 20 to 50 mV/div.

**Maximum calibrated sensitivity and max fs input:** 30 mV/div (gain 3.33). 0 to +2.5 V or 0 to -2.5 V.

**Input circuit and input frequency range:** switch selected: 1500  $\Omega$   $\pm 2\%$  or 100 k $\Omega$  min, incremental; single ended.

**Rise time (10 div, 10-90%, 4% overshoot):** 5 ms.

**Calibration (referred to input):** 600 mV  $\pm 2\%$ , internal.

**Output frequency response (-0.5 dB at 50 div):** 50 Hz.

**Output noise, max (less trace width):** 0.1 div, p-p.

**Zero drift, 20° to 40°C, 103 to 127 V (less trace width):** temp: 0.4 div/10°C at 30 mV sensitivity. Line voltage: 0.3 div.

**Common mode rejection and tolerance:** 50,000: 1 at dc.

**Output linearity (less trace width):** 0.4 div after calibrating for zero error at center scale and +20 div.

### 8820A with 7418A

**Sensitivity:** 0.05 V/div (Amplifier Gain 2).

**Maximum fs input:** 250 V (edge to edge).

**Input ranges (attenuation):** 0.05, 0.1, 0.2, 0.5, 1, 2, 5 V/div. Attenuator accuracy  $\pm 2\%$ .

**Input circuit:** single ended, 1 M $\Omega$  min.

**Frequency response:** dc to <0.5 dB down at 50 Hz (50 div p-p); dc to <3 dB down at 100 Hz (10 div p-p).

**Rise time (10 div, 10-90%, 4% overshoot):** <6 ms.

**Output linearity (less trace width):** linear within  $\pm 0.25$  div after setting mechanical zero of stylus to within  $\pm 1$  div of chart center and calibrating for zero error at center scale and  $\pm 20$  div.

**Drift, 20° -40°, 115 V  $\pm 10\%$ , 60 Hz (less trace width):** temp: <0.5%/10°C; Line voltage:  $\leq 0.2$  div.

**Calibration:** 1 V  $\pm 1\%$  calibration voltage in each channel, plus 1 common 1 V  $\pm 1\%$  calibration voltage for all channels.

**Temp rating:** operating: 0°C to +55°C; storage: -40°C to 75°C.

### 8821A with 7418A

**Sensitivity:** 0.001 V/div (Amplifier Gain 100).

**Maximum fs input:** 250 V (edge to edge).

**Input ranges (attenuation):** 0.001, 0.002, 0.005, 0.010, 0.020, 0.050, 0.1, 0.2, 0.5, 1, 2, 5 V/div. Attenuator accuracy (dc)  $\frac{1}{2}\%$  on 0.001 to 0.050 V/div ranges; 1% on 0.1 to 5 V/div ranges.

**Input circuit:** balanced, floating and guarded, 9 M $\Omega$  constant for all gain settings (0.001 to 0.050 V/div); 4.5 M $\Omega$  each side to ground (0.1 to 5 V/div).

**Common mode rejection:** 100 dB at 60 Hz, 0.001 V/div sensitivity, 1 k $\Omega$  source unbalance decreases to 66 dB at 0.05 V/div, 66 dB at 60 Hz, 0.01 to 5 V/div sensitivity, 1 k $\Omega$  source unbalance.

**Common mode tolerance:**  $\pm 20$  V on 0.001 to 0.05 V/div ranges (6 most sensitive);  $\pm 250$  V on 0.1 to 5 V/div ranges (6 least sensitive).

**Frequency response:** dc to <0.5 dB down at 50 Hz (50 div, p-p); dc to <3 dB down at 100 Hz (10 div p-p).





8821A



8820A

**Rise time** (10 div, 10–90%, 4% overshoot): <6 ms.  
**Output linearity** (less trace width): same as 8820A.  
**Drift**, 20° to 40°C, 115 V ±10%, 60 Hz (less trace width): same as 8820A.  
**Calibration**: +0.02 V ±1% on 6 most sensitive ranges. Simulates +2 V ±2% at input on 6 least sensitive ranges.  
**Temperature rating**: same as 8820A.

**7702B Options**

- 002: Portable Case and Cover add \$225
  - 003: One-Channel Decrease less \$55
  - 005: Mobile Cart (1062A) add \$350
  - 008: 50 Hz Operation add \$55
  - 009: Speeds 2.5, 5, 25, and 50 mm/sec (50 Hz) add \$90
  - 010: Speeds 2.5, 5, 25, and 50 mm/sec (60 Hz only) N/C
  - 011: 60:1 Speed Reduction (60 Hz) add \$205
  - 012: 60:1 Speed Reduction (50 Hz) add \$205
  - 015: Extra Event Marker installed between channels add \$90
  - 018: 60 Hz Speed Kit 2:1 Reduction. Speeds of 0.5, 2.5, 10, 50 mm/sec. (Not compatible with Opt 010, 011) add \$190
  - 019: 50 Hz Speed Kit 2:1 Reduction. Speeds of 0.5, 2.5, 10, and 50 mm/sec. (Not compatible with Opt 009 and 012) add \$190
- Note: Option 008 required when ordering Option 009, 012, or 019.

**7414A Options**

- 001: Rack mount (include slides, mounting hardware; delete case) N/C
- 008: 50 Hz operation N/C
- 012: 1 channel decrease; extreme RH channel deleted, blank panel instal; not compatible with Opt 015 less \$225
- 015: Extra Event Marker, installed between channel 2 and 3; not compatible with Opt 012 add \$40
- 025: 50 Hz speed reduction, 60:1 (Opt 008 required) add \$320
- 026: 60 Hz speed reduction, 60:1 add \$320
- 054: Installed in mobile cart. Includes paper takeup drawer add \$575

**7418A Options**

- 001: 6 channel Hot-Tip Therm Recorder only\* (includes takeup tray) (\*For plug-in preamps, Opt 030 Power Supply required; for Bank Amps, select 1 of options 031–034) less \$620
- 002: Rack mount kit add \$205
- 003: Bench top configuration add \$260
- 004: 63-in. Cabinet (includes 7-in. drawer) add \$1350
- 005: 42-in. Cabinet (includes 7-in. drawer) add \$1350
- 006: 28-in. Portable cart (includes Opt 002) add \$950
- 008: 50 Hz operation N/C
- 009: 230 V ac operation N/C
- 014: Extra Event Marker between Channels 4 & 5 add \$90
- 015: Extra Event Marker between Channels 5 & 6 add \$90
- 025: 50 Hz speed reduction 60:1 (Opt 008 required) add \$310
- 026: 60 Hz speed reduction 60:1 add \$310
- 030: 8848A plug-in preamp power supply (required for operation of 8800 Preamps) add \$1170
- 031: 8820A 8-channel bank amp (not compatible with Opt 001) when ordering separately, order 8820A for 6 channels, see Opt 033 add \$1650
- 032: 8821A 8-channel bank amp (not compatible with

- Opt 001) when ordering separately, order 8821A for 6 channels, see Opt 034 add \$2780
- 033: 8820A 6-channel bank amp (not compatible with 7418A 8-channel) when ordering separately, order 8820A Opt 002 add \$1650
- 034: 8821A 6-channel bank amp (not compatible with 7418A 8-channel) when ordering separately, order 8821A Opt 002 add \$2575

**8801A, 8802A, & 8809A Options**

- 001: Bench top unit with power supply & portable case add \$460

**8803A Options**

- 001: Bench top unit with power supply & portable case add \$555

**8805A Options**

- 001: Bench top unit with power supply & portable case add \$535
- 002: Harmonic filter kit (required when 267, 268, 270, or 1280B/C transducers are used) add \$30

**8805B Options**

- 001: Bench top unit with power supply and portable case add \$490
- 002: delete Harmonic Filter less \$25

**8806B Options**

- 001: Bench top unit with power supply & portable case add \$490
- 002: Variable frequency phase shifter plug-in, 50 Hz to 40 kHz add \$260
- 003: calibrated phase shifter plug-in, 60 Hz add \$205
- 004: calibrated phase shifter plug-in, 400 Hz add \$165
- 005: calibrated phase shifter plug-in, 5 kHz add \$165

**8807A Options**

- 001: 50 Hz to 100 kHz signal filter N/C
- 002: Dc plug-in N/C
- 003: Bench top unit with power supply & portable case add \$460

**8808A Options**

- 001: Bench top unit with power supply & portable case add \$460

**8820A Options**

- 002: 2-channel reductions N/C

**8821A Options**

- 002: 6 channel bank amp less \$205

**Ordering Information**

- 7702B 2-channel oscillographic recorder \$2990
- 7414A 4-channel oscillographic recorder \$5300
- 7418A 6 to 8-channel oscillographic recorder \$7000
- 8801A Low gain preamplifier \$430
- 8802A Medium gain preamplifier \$430
- 8803A High gain preamplifier \$865
- 8805A Carrier preamplifier \$650
- 8805B Carrier preamplifier with Harmonic Filter \$825
- 8806B Phase sense demodulator preamplifier \$790
- 8807A Ac/dc converter preamplifier \$945
- 8808A Logarithmic preamplifier \$890
- 8809A Signal coupler preamplifier \$160
- 8820A Low gain bank amplifier \$2100
- 8821A Medium gain bank amplifier \$3100

# RECORDERS & PRINTERS

Instrumentation tape recorders, tape degausser

Models 3964A, 3968A, and 13064A

- 1/4-inch magnetic tape benefit
- Selectable FM/Direct electronics



3964A



13064A

- Eight channels or four channels
- Laboratory, field, medical applications



3968A



The instrumentation tape recorders, the 3964A, 4-channel and 3968A, 8-channel, utilizing a 1/4-inch format, are designed to meet the demands of the individual and OEM users. Versatility, portability, and durability are three important characteristics of these recorders. Excellent performance is assured in the laboratory, field, or medical environment.

These reasonably priced units are equipped with many standard features usually only found on more expensive recorders.

The 13064A Tape Degausser erases previous magnetic recordings from an entire reel of tape. Cleanly erased tape is an indispensable factor for obtaining optimum performance.

### 3964A/3968A standard features

**"E-to-E" mode for FM recording:** input signal is automatically transferred to the output when in fast forward, rewind, or stop. Simplifies recorder setup and calibration.

**Tape/Tach servo:** in the reproduce mode the capstan servo can be controlled either by the internal tach frequency or for maximum time base accuracy from a pre-recorded signal on one of the data channels.

**Equalization:** direct electronics can be optimized for a wide variety of tapes.

**Remote control:** multi-pin connector located at rear of instrument provides remote control and state (TTL or contact closure) for all tape speeds and operational modes.

**AC/DC calibrator:** provides internal AC/DC voltage source for setting up input and output levels for each of the data channels. Voltage levels and channel monitoring selected with pushbutton ease.

**Flutter compensation:** available with the flip of a switch. Flutter modulation introduced during the record mode is eliminated providing an improvement in FM signal-to-noise ratio by up to 12 dB.

**Voice capability:** recorded data can be voice annotated on Channel 4 of 3964A or Channel 8 of 3968A with press-to-talk microphone.

**Unipolar operation for FM recording:** when a signal has a positive only or negative only deviation, the FM input reference level can be offset to plus or minus full deviation to permit full utilization of the channel's dynamic range.

**Re-recording (dubbing):** FM data cards can be set up for dubbing, allowing duplicate recordings to be made with minimum degradation to signal-to-noise.

### 3964A and 3968A specifications

#### Transport specifications

**Tape width:** 1/4 inch (6.3 mm).

**Reel size:** standard 7-inch (177.8 mm) plastic reel; totally enclosed by reel cover.

**Heads:** 3964A—one four-track record and one four-track reproduce using in-line track configuration. 3968A—one eight-track record and one eight-track reproduce. Interlaced odd-even track configuration.

**Tape speeds:** 1 1/2, 3 1/4, 7 1/2, 15 ips.

**Capstan drive:** DC motor with phaselock servo.

**Tape speed accuracy:** ±0.2% (tach servo).

**Time base error (tape servo)**

Tape speeds	15	7 1/2	3 1/4	1 1/2	1 1/4	1 1/2
TBE (microsec)	±4	±5	±7.5	±15	±25	±50

#### Flutter

Tape Speed (ips)	Pass Band (Hz)	Flutter (% p-p)	Tape Speed (ips)	Pass Band (Hz)	Flutter (% p-p)
15	0.2-2500	0.35	1 1/2	0.2-312	0.50
7 1/2	0.2-1250	0.35	1 1/4	0.2-156	0.70
3 1/4	0.2-625	0.40	1 1/2	0.2-78	1.50

**Tape motion controls:** forward, reverse record; forward, reverse play; fast forward; fast rewind; stop; pushbutton selectable.

#### Start and stop times (typical)

Tape speeds	15	7 1/2	3 1/4	1 1/2	1 1/4	1 1/2
Start (sec)	3	1.50	0.90	0.50	0.50	0.50
Stop (sec)	0.30	0.30	0.30	0.30	0.30	0.30

**Rewind time (typical):** 1800 foot (549 m) reel in 100 seconds; 2300 foot (701 m) reel in 145 seconds.

**Braking:** fail-safe mechanical differential brakes.

**End-of-tape sensing:** tape drive stops automatically at the end of tape.

**Reel revolution counter:** 4-digit revolution counter with pushbutton reset.

### FM record/reproduce specifications (using 3M-888 Tape or equivalent)

Tape Speed	Carrier Center Frequency	Passband <sup>1</sup> (Hz)	Signal-to-Noise Ratio	
			3964A	3968A
15	27	DC-5000	48	46
7 1/2	13.50	DC-2500	48	46
3 3/4	6.75	DC-1250	48	46
1 7/8	3.38	DC-625	46	46
1 3/16	1.69	DC-312	44	44
1 5/32	0.85	DC-156	40	40

1. Frequency response over passband is  $\pm 1.0$  dB referenced to 10% of upper band edge frequency.
2. Signal measured with carrier deviation  $\pm 40\%$  of upper passband without flutter compensation. Output filters of reproduce amplifiers selected for constant amplitude response. May also be selected for linear phase (transient) response.

**Flutter compensation:** can improve signal-to-noise by up to 4 dB under static conditions and as much as 12 dB under conditions of vibration. Selected by rear panel switch.

**Distortion:** total harmonic distortion  $< 1.2\%$  @ 15 to 1 7/8 ips,  $< 2\%$  @ 1 3/16 to 1 5/32 ips.

**Linearity:**  $\pm 0.3\%$  of peak-to-peak output for best straight line through zero at  $\pm 40\%$  deviation.

**DC Drift:**  $\pm 0.1\%$  (max) of full scale output per °C.

**Input level:** 1 V to 30 V (peak-to-peak); continuously adjustable.

**Input impedance:** 100 k $\Omega$  nominal, shunted by  $< 100$  pF single-ended.

**Output level:** 1 to 5 V (peak-to-peak); continuously adjustable.

**Output impedance:** 50 ohms nominal, single-ended.

**Non-bias recording:** available by internal jumper selection.

### Direct record/reproduce specifications (using 3M-888 Tape or equivalent)

Tape Speed (ips)	Passband ( $\pm 3$ dB) <sup>1</sup>		S/N Ratio (dB) <sup>2</sup>	
	3964A	3968A	3964A	3968A
15	70-64,000 Hz	500-64,000 Hz	38	36
7 1/2	50-32,000 Hz	250-32,000 Hz	38	36
3 3/4	50-16,000 Hz	100-16,000 Hz	38	36
1 7/8	50-8,000 Hz	100-8,000 Hz	38	36
1 3/16	50-4,000 Hz	100-4,000 Hz	31	35

1. Reference to 10% of upper band edge.
2. Referenced to a 500 Hz sine wave with a maximum of 1% third harmonic distortion when reproduced at 3 3/4 ips.

**Input level:** 1 V to 30 V (p-p); continuously adjustable.

**Input impedance:** 100 k $\Omega$  nominal, single-ended.

**Output level:** 0.5 to 5 V (p-p); continuously adjustable.

**Output impedance:** 50 ohms nominal, single-ended.

#### Signal monitoring

**Meter modes:** peak AC or DC (selected by front panel switch).

**Meter accuracy (peak AC mode):** better than  $\pm 1/2$  dB for signals with duty cycle of 20% or greater.

**Selector:** front panel pushbuttons select metered channels.

#### Calibrator

**Signal source:** pushbutton selectable internal or external signal source.

**Internal signal source:** peak AC and  $\pm$  DC levels of 0, 1.0, 1.414, 2.5, 5.0, and 10.0 volts.

**Level of accuracy:**  $\pm 2\%$  of selected voltage.

**AC frequency:** 500 Hz  $\pm 5\%$   $< 0.25\%$  second or third harmonic distortion.

#### Voice annotation

**Modes of operation:** data only, voice only, or data interrupted by voice.

**Microphone:** dynamic, hand-held, with press to talk switch.

**Record level:** automatic leveling.

**Monitoring:** built-in speaker, headphone jack.

#### General specifications

**Size:** 3964A—400 mm H  $\times$  427 mm W  $\times$  256 mm D (15.7"  $\times$  16.8"  $\times$  10.1"); 3968A—445 mm H  $\times$  427 mm W 256 mm D (17.5"  $\times$  16.8"  $\times$  10.1").

**Weight:** without inverter: 3964A—29.5 kg (65 lb); 3968A—31.3 kg (69 lb). With inverter (Opt 021): 3964A—25.0 kg (55 lb); 3968A—26.8 kg (59 lb).

**Power requirements:** 100, 120, 220, or 240 V,  $\pm 5\%$ ,  $-10\%$ , 48-66 Hz, 110 W average.

**Temperature:** storage,  $-40^\circ\text{C}$  to  $75^\circ\text{C}$ ; operating,  $0^\circ\text{C}$  to  $55^\circ\text{C}$ ; tape limit,  $10^\circ\text{C}$  to  $40^\circ\text{C}$ .

**Altitude:** storage, 15 240 m (50,000 ft.); operating, 4500 m (15,000 ft.).

**Humidity:** the system, excluding tape limitations, will operate from 10% to 95% RH ( $25^\circ\text{C}$  to  $40^\circ\text{C}$ ), non-condensing.

**Shock:** 30 g maximum (11 ms) non-operating.

**Mounting:** supplied with rack mounting kit for standard 19-inch equipment racks.

### 13064A Tape Degausser Specifications

**Tape size:** 1/4-inch (6.33 mm) tape on reels up to 10 1/2 inch (266 mm) in diameter.

**Erase:** 60 dB minimum.

**Duty cycle:** one minute ON—three minutes OFF.

**Size:** 67 H  $\times$  133 W  $\times$  171 mm D (2.6"  $\times$  5.25"  $\times$  6.75").

**Weight:** approximately 4.3 kg (9 1/2 lb).

**Power requirements:** 115 V ac  $\pm 10\%$ , 50-60 Hz (Opt 001), 230 V ac  $\pm 10\%$ , 50-60 Hz (Opt 002).

**Options 3964A/3968A**

**001:** FM Record/Reproduce. Provides one FM data card. Specify number of FM channels required when ordering. Price add \$350

**002:** Direct Record/Reproduce. Provides one Direct data card. Specify number of Direct channels required when ordering. add \$315

**003:** rear Input/Output Connectors. A rear panel with BNC input and output connectors for each channel and in parallel with front panel connectors. add \$65

**004:** Locking Knobs. Factory installed, screwdriver adjustable locking knobs ensure input level setting on a given channel(s) is not accidentally changed (four on 3964A, eight on 3968A). add \$35

**005:** metric speed designations. Provides metric speed designations of 38.10, 19.05, 9.52, 4.75, 2.38 and 1.19 cm/s on front panel speed selector pushbuttons. N/C

**007:** HP-IB Remote Control. HP-IB compatible remote control of all tape speeds and operational modes. add \$350

**009** UL listed (UL standard No. 544 Safety standard for Medical and Dental equipment) includes white paint. \$250

**010:** UL listed (UL Std. No. 544 Safety Standard for Medical and Dental Equipment), standard colors. add \$200

**021:** DC-AC Inverter, operates from 12 and 28 VDC in addition to standard AC voltages. \$650

**024:** loop adapter. Simplifies data analysis application requiring continual replay of significant data. A tape loop from 5 to 30 feet can be accommodated by this option. add \$475

**026 and 027:** rack mounting/rack slides. Rack slides, which provide  $90^\circ$  instrumentation rotation. add \$110

Opt 026, Rack Slides for 19" racks add \$135

Opt 027, Rack Slides for HP cabinets add \$150

**041:** IRIG servo reference frequency. Changes standard servo reference from 27 kHz to 25 kHz at 15 ips. add \$200

**070:** overlap. With two 3964A or 3968A units, option provides automatic play/record commands for second recorder when first unit electronically senses tape is low. add \$30

**910:** extra manual add \$30

**Transit case:** moisture and dustproof; vibration and shock proof.

3964A part no. 13107A \$250

3968A part no. 13106A \$250

**Ordering information**

3964A 4-channel Instrumentation Tape Recorder Mainframe \$4900

3968A 8-channel Instrumentation Tape Recorder Mainframe \$6400

13064A Tape Degausser (specify Opt 001 or 002)<sup>1</sup> \$100

<sup>1</sup> 115 V ac or 230 V ac operation, respectively

# RECORDERS & PRINTERS

Alphanumeric, 20 column thermal printer  
Model 5150A

- Silent operation
- Optional scanner and clock
- Alphanumeric

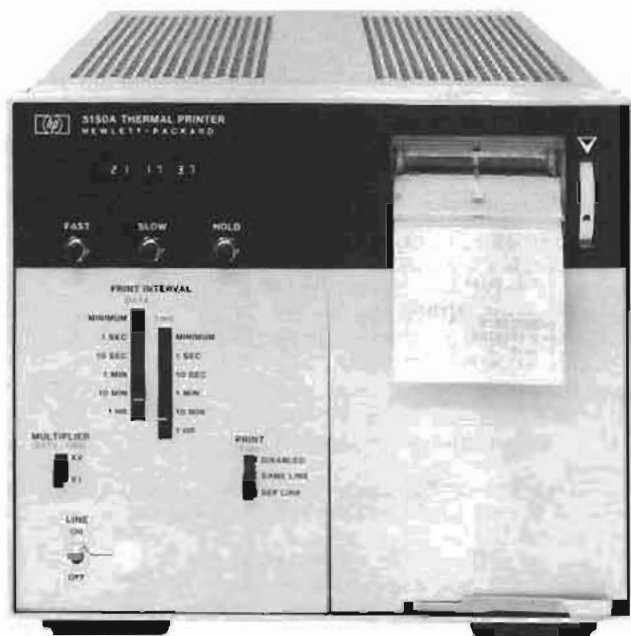

HP-IB 5150A Opt 004

## General

The 5150A Thermal Printer is a versatile instrumentation printer designed to accept and record up to 20 columns of data from most HP digital instruments. Because it uses a thermal printing technique, it is extraordinarily quiet while in operation. Two input interfaces are available (one must be specified with the order) to allow data input from the HP Interface Bus (use Option 001) or from BCD-coded sources (use Option 002). Other options which add to the flexibility of this printer are the Option 003 Scanner, which can sequentially address and interrogate up to 13 instruments on the HP-IB, and the Option 004 Clock, which can be used with either the HP-IB or BCD Interfaces.

### Opt 001 HP-IB Interface

With Option 001 installed, the printer can accept up to 20 ASCII characters per line via the HP-IB. Input are interpreted according to the 64 member upper-case ASCII character set. With this interface, the printer can also serve as an "addressable listener" in a controller-based HP-IB system.

### Opt 002 BCD Interface

With Option 002 installed, the printer will accept 10 columns of TTL-level BCD data. Two Options 002s may be installed for 20-column print-out from one or two sources. The standard 16-member character set consists of 0 through 9, +, -, V, A, R, and (blank). Special characters sets which draw from the 64-character upper-case ASCII set may also be specified.

### Opt 003 scanner

With both Options 001 and 003 installed, the printer can log data from up to 13 instruments on the HP-IB. Operation is asynchronous; that is, the printer will address the lowest address instrument, wait for data, print, then go to the next instrument.

### Opt 004 clock

Used with either the HP-IB Interface or BCD Interface, this option gives the printer two additional capabilities: it can control the elapsed time between successive data printouts, and it can print the time of day immediately following each data printout. When used with the Option 003 Scanner, the clock controls the elapsed time between the initiation of successive scans.

## Specifications

**Character print:** 5 × 7 dot matrix.

**Printing rate:** 3 lines per second.

**Line spacing:** approximately 6 lines per inch (2.5 lines per cm).

**Paper advance mechanism:** direct drive, stepping motor.

**Paper:** thermal sensitive, in rolls or fan-folded (one roll supplied).

**Operating environment:** 0°C to 50°C temperature; 95% relative humidity (85% RH with fan-folded paper).

**Power:** 100, 120, 220, or 240 volts, 48 to 440 Hz (50 or 60 Hz only for Opt 004), 100 VA.

**Dimensions:** half-rack module, 178 mm H × 216 mm W × 356 mm D (7" × 8 1/2" × 14 1/4").

**Weight:** approx. 7 kg (16 lb) (5150A +1 option).

**HP-IB Interface (Opt 001)**

**Columns:** 20.

**Printed character set:** 64 ASCII characters (columns 2, 3, 4, and 5 of ANSI X3.4-1968, except "↑" in column 5, row 14).

**Input Logic Levels:** TTL (low <0.4 V, High >2.5 V).

**Data format:** byte-serial with storage, compatible with HP-IB.

**Inhibit (output):** holds NRFD line of HP Interface Bus low following receipt of either CR or LF (selectable) until print is completed. This interval is approx. 250 ms minimum, or the duration of Option 004 Clock data print interval with clock in Hold mode.

**BCD Interface (Opt 002)**

**Columns:** 10 (20 columns with two Options 002s installed).

**Character set:** 0 through 9, +, -, V, A, R, and (blank).

**Input Logic Levels:** TTL (low <0.4 V, High >2.5 V).

**Data format:** parallel BCD (8421); switch selects + or - true logic.

**Print command:** pos. or neg. TTL transition; 2 kΩ input impedance.

**Inhibit (output):** + or -, same levels as above; remains at true level until print is completed (approx. 250 ms minimum) or during Option 004 Clock data print interval with clock in Hold mode.

**Scanner (Opt 003)**

**Instruments scanned:** 1 to 13.

**Cycle time of scan:** limited by the slowest of (a) response of instruments scanned, (b) 3 samples per second, or (c) Data Print Interval setting on Option 004 Clock.

**Compatibility:** HP Interface Bus (utilizes ASCII code).

**Identifier:** labels data line of each instrument with letters A-M.

**Protect feature:** bypasses non-responding instrument after 3 sec.

**Clock (Opt 004)**

**Data print interval:** selectable by front panel switches: minimum, 1 s, 2 s, 10 s, 20 s, 1 min, 2 min, 10 min, 20 min, 1 hr, 2 hrs. Print interval will be that of input device if it is slower than the selected interval.

**Time print interval:** selectable by front panel switch, same intervals as above (intervals shorter than data interval prevented).

**Time print format:** selectable by front panel switch: Disabled, same as data, or separate line from data.

**Display:** six-digit, seven-segment LED display of hours, minutes, seconds (00:00:00 to 23:59:59); settable via front panel switches.

**Time base:** line frequency (50 or 60 Hz, selectable by jumper).

### Operating supplies/accessories

	Price
562A-16C General purpose BCD Interface Cable	\$85
9281-0401 Roll of paper, 76 metres (box of six)	\$2.20
05150-60002 HP-IB Interface Kit	\$220
05150-60005 BCD Interface Kit	\$135
05150-60008 Scanner Kit	\$275
10533A BCD Interface Cable for 5300A	\$225
10631A Interface Bus Cable, 1 metre	\$60
10631B Interface Bus Cable, 2 metres	\$65
10631C Interface Bus Cable, 4 metres	\$75

### Options

001: HP-IB Interface	add \$250
002: BCD Interface	add \$125
003: Scanner	add \$250
004: Clock	add \$350
005: BCD Interface Cable (562A-16C)	add \$85
910: Extra manual	add \$15

5150A Thermal Printer

\$900

- 10 lines/sec.
- 10 columns of data
- 4-line  $\pm$  8421 BCD

- TTL Logic Levels
- Ink or pressure sensitive printing

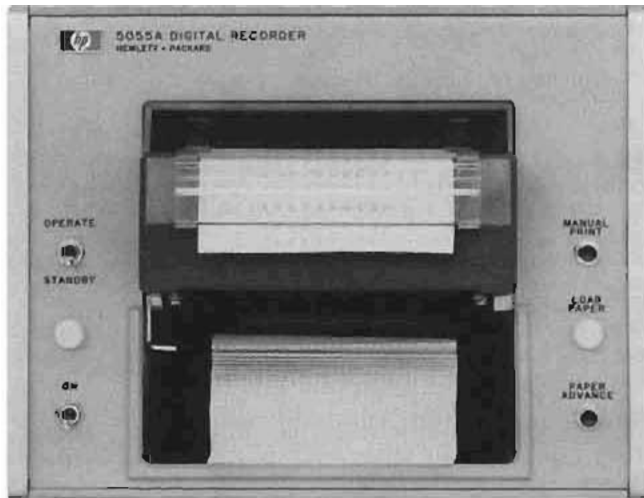

5055A

## Description

### General

The Hewlett-Packard Model 5055A Digital Recorder provides a high-performance economical method of making permanent records of digital data. It prints up to 10 columns of data from 4-line BCD data sources at rates up to 10 lines/sec. Printing is asynchronous; i.e. the print cycle starts the instant the external print command is received and requires only 100 ms under any condition. The eight inch cabinet width allows for either bench use or side-by-side rack mounting, using the HP Adapter Frame, 5060-0797. The codes offered are  $\pm$ 8421, selectable by a rear panel switch. Each column has an individual print wheel with 16 characters—10 numeric and 6 non-numeric. Special wheels can be ordered at minimal cost. The 5055A is supplied complete for 10 columns of printed data and accepts TTL compatible integrated circuit logic levels. Leading zeros are suppressed when the printer is used with HP instruments which have blanking.

### Reliability

Reliability is enhanced by design simplicity; i.e. there are an unusually small number of moving parts in the printer. The printer mechanism, manufactured by Hewlett-Packard, is a modified version of a mechanism whose reliability and serviceability has been demonstrated in other H-P printers for many years.

### Ink or pressure sensitive printing

The 5055A prints in ink on regular paper or on pressure sensitive paper. For ink printing, the mechanism includes a continuously rotating ink roller—inherently more reliable than a start-stop ribbon mechanism. Paper loading is easy from the front, and when the paper runs out an alarm lamp lights and recording stops automatically. An output signal is provided for inhibiting the data source.

### Versatile

Each column has an individual print wheel which can be changed independently of the other 9 wheels if a different character set is desired. This can apply to as many columns as desired. Special print wheels can be factory installed or may be field installed at a later date. Both can be done at a nominal cost.

## Specifications

### Printing

**Accuracy:** identical to input device used.

**Print cycle time:** 100 ms.

**Printing rate:** 10 lines/sec maximum, asynchronous.

**Line spacing:** fixed, 4 to 5 lines per inch.

**Printing:** ink roller or pressure sensitive paper. Pressure sensitive paper is recommended for operation under extreme temperature.

**Print wheels:** 16 positions, numerals 0 to 9, +, -, V, A,  $\Omega$ , \*; special wheels available.

**Column capacity:** supplied complete for 10-column operation.

### Electrical

**Data input:** parallel entry, BCD  $\pm$ 8421 (selected by rear panel switch).

**Blanking:** Hewlett-Packard counters with blanking will give insignificant zero suppression when blanked digits output is (1111). May be defeated with rear panel switch.

**Logic levels:** high state  $\geq +2.4$  V, +5 V maximum (open input line results in high state); low state  $\leq +0.4$  V (1.6 mA max., low), 0 V minimum.

**Print command:** line 1-low to high transition causes print (nominal 1k $\Omega$  input impedance), line 2-high to low transition causes print (nominal 400 $\Omega$  input impedance). Voltage levels are same as logic levels above, and a minimum pulse width of 0.5  $\mu$ s is required.

**Inhibit voltage:** (+) inhibit = transition from ( $\geq 0$ ,  $\leq 0.4$  V) to ( $\geq 2.4$  V,  $\leq 5.0$  V) upon receipt of print command. Remains at high state until paper advance occurs, approximately 85 ms ( $\leq$  mA in low state). (-) inhibit = inverse of (+) inhibit.

### General

**Operating temperature:** 0°C to +50°C with pressure sensitive paper, +10°C to +40°C with ink roller.

**Input connector:** amphenol 57-40500-375, HP Part No. 1251-0087, 50-pin female. Mating input cable connector: amphenol type 57-30500-375, HP Part No. 1251-0086, 50-pin male.

**Front panel controls:** power switch, power on indicator light, manual print pushbutton, manual paper advance pushbutton, out-of-paper light, standby/operate switch. (Paper loaded from front.)

**Power:** 115 or 230 V  $\pm$  10%, 60 or 50 Hz (two-speed motor pulley incorporated), approx. 25 W idle, 55 W at 10 lines/sec.

**Dimensions:** cabinet: 154 mm H  $\times$  203 mm W  $\times$  406 mm D (6 $\frac{3}{32}$ "  $\times$  8"  $\times$  16").

**Weight:** net, 10 kg approx. (18 $\frac{1}{2}$  lb). Shipping, 8.9 kg (22 lb).

### Operating supplies/accessories

	Price
9260-0071 Ink roller (black)	\$16.50
9281-0386 Standard paper (250' pad)	\$2.50
9281-0387 Pressure sensitive paper (305' pad)	\$4.50
5060-0797 Rack adapter frame	\$55
10533A Interface Cable for 5300A	\$225

### Options

001: 50 Hz line operation

002: 562A-16C input cable interconnects with 3450B, 3480C/D, 5326A/B/C, and 8443A

N/C  
add \$85

### 5055A Digital Recorder

Supplied with Ink roller (9260-0071), one pad standard paper (9281-0386) and one pad pressure sensitive paper (9281-0387). Each pad provides two loadings of recorder

\$1900



# RECORDERS & PRINTERS

## Versatile 18-column BCD digital printer

Model 5050B

- 20 lines/sec.
- Up to 18 columns of data
- 4-line  $\pm$  8421, + 4221 BCD



5050B

### Description

#### Compatible

This recorder is compatible with a wide range of Hewlett-Packard solid state and integrated circuit instruments and a wide variety of other equipment. It prints up to 18 columns of 4 line BCD data from one or two sources up to 20 lines/sec.

#### Versatile

The user can easily change code to +8421, -8421, or +4221 by an inexpensive substitutable code disc, and can change print wheels to have a different code and/or character set in each column. Character suppression allows suppressing a character in each column.

#### Storage

An optional data storage feature is available at extra cost to reduce the time required to transfer data to the recorder. This means that the data source is inhibited for only about 0.1 ms out of a print cycle of 50 ms duration, compared to being inhibited during the complete print cycle without storage.

### Specifications

#### Printing

**Accuracy:** identical to input device used.

**Print cycle time:** 50 ms.

**Printing rate:** 20 lines/sec, max (asynchronous).

**Line spacing:** adjustable, 3.5 to 4.5 lines/inch.

**Printing:** ink roller or pressure sensitive paper. Pressure sensitive paper is recommended for operation under extreme temperatures.

**Print wheels:** 16 positions, numerals 0 through 9, -, +, Z, V,  $\Omega$ , \*; special wheels available at minimal cost.

#### Electrical

**Input requirements without data storage:** parallel entry, BCD ( $\pm$ 8421, +4221), "1" state must differ from "0" state by  $>4.5$  V but  $<75$  V.

**Input requirements with data storage:** parallel entry, BCD, "1" state must differ from "0" state by  $>1.3$  V but  $<35$  V. Input drive  $\geq 100$   $\mu$ A. Data must be on lines when print command occurs and remain until release of holdoff (85  $\mu$ s after print command).

**Transfer time:** 50 ms without storage, 0.1 ms with storage.

- Storage option
- Ink or pressure sensitive printing

#### General

**Operating temperature:**  $-20^{\circ}\text{C}$  to  $+55^{\circ}\text{C}$  with pressure sensitive paper,  $+10^{\circ}\text{C}$  to  $+40^{\circ}\text{C}$  with ink roller.

**Power:** 115 or 230 V  $\pm 10\%$ , 50 to 60 Hz, about 100 W idle, 190 W at 20 lines/sec. 50 Hz model with 20 prints/second also available.

**Dimensions:** cabinet: 226 mm H  $\times$  426 mm W  $\times$  467 mm D (8 1/2"  $\times$  16 3/4"  $\times$  18 3/8").

**Weight:** net, 18 kg (40 lb). Shipping, 24 kg (53 lb).

### Opt 055 clock for 5050B printer

**General:** the Option 055 Clock provides a compact, convenient and versatile method for recording time—with 0.1 second resolution—along with other data measurements being recorded by the 5050B Printer. In addition Option 055 serves as an automatic measuring-recording system programmer by allowing printing at preselected time intervals.

**High resolution:** easy to read display tubes indicate time to 23 hours, 59 minutes, 59 seconds. In the printout there is a seventh digit available for indicating tenths of a second.

#### Specifications

**Time base:** selectable to be 50 Hz, 60 Hz or external. External requires 10 pps negative pulse.

#### Print Interval

**Internal:** selectable to be 1s, 10s, 1 min., 10 min., or 1 hour between prints.

**External:** rates up to 20 prints per second.

**Time of measurement accuracy:** time recorded may be 0.1s less than correct time  $\pm$  line accuracy.

**Visual Indication:** 6 in-line digital display tubes indicate to 23 hours, 59 minutes, 59 seconds.

**Printed output:** seven digits indicate to 23 hours, 59 min., 59.9s.

**BCD output code:** +8421 or -8421 selectable. Output adaptable to other recorder codes.

**Print format:** time printable in any recorder column.

**Clock set:** 4 switches electronically set clock to desired initial time.

**Power:** 115 V or 230 V  $\pm 10\%$ , 50 Hz or 60 Hz.

**Weight:** net, 1.4 kg (3 lb).

#### Operating supplies

9281-0386 Standard paper (1 pad)

9281-0387 Pressure sensitive paper (1 pad)

#### Price

\$2.50

\$4.50

#### Options

001: 8421 "1" state positive code disc

002: 8421 "1" state negative code disc

003: 4221 "1" state positive code disc

N/C

N/C

N/C

All three code discs are supplied with each 5050B at no charge. However, one of the above options must be specified so the 5050B can be delivered with the desired disc installed.

010: 50 Hz operation

add \$25

015: Motor Control

add \$125

020: Column Boards (one required, in addition to basic instrument, for each two columns to be operated)

add \$185 ea.

032: Input cable, one per data source

add \$85 ea.

050: Storage for 20 columns

\$575

051: Storage for 10 columns

add \$300

055: Clock (factory installed)

add \$1350

(Price of kit for field installation available on request.)

061: Package for 5360A

add \$2250

908: Rack Flange kit

add \$35

910: Extra manual

add \$5

5050B Digital Recorder

\$3150



## Introduction

The digital electronic frequency counter has come a long way since the first versions appeared over two decades ago. Once the luxury of large metrology labs and some crystal manufacturers, the frequency counter is now common-place in laboratories, on production lines, as a service tool and in automatic instrumentation systems. Moreover, counters have become increasingly more versatile and more powerful in the measurements they perform, thereby finding much wider applications. When Hewlett-Packard introduced the 524A in 1952 it was considered a milestone: the counter could measure frequencies up to 10 MHz, or the time between two electrical events to a resolution of 100 ns. Twenty-five years later, HP's product lines features counters that can measure the frequency of a 40 mV signal at 23 GHz completely automatically, or can resolve time to 20 ps, the same time it takes light to travel about 5 mm.

### Basic counter measurements

The basic measurements which counters are cable of performing are described in this section.

#### Frequency

This fundamental measurement is performed by totalizing the number of input cycles or events for a precisely known period of time. The total count that results is proportional to the unknown frequency, and logic circuits internal to the counter position the decimal point such that the display directly indicates the input frequency. The

time reference is usually derived from a precision quartz oscillator internal to the counter.

Using this basic technique allows measurements to 500 MHz to be made. Several methods are available, however, to extend this frequency range to 23 GHz and more. These are described in more detail below.

#### Period

This inverse of frequency, this capability is sometimes offered to provide the user with high resolution, low frequency measurements. In digital systems a period measurement represents the average bit to bit time of the input signal.

#### Totalize

The measurement is similar to frequency except that the user now controls the time over which the measurement takes place. With digital systems becoming more prevalent, this fundamental measurement assumes considerable importance. The HP 5345A, with its ability to totalize at a 500 megabit rate, represents the state of the art at this time.

#### Ratio

The ratio between two input frequencies is a measurement that is also offered by some counters, the major application for ratio is measurement of harmonically related signals.

#### Scaling

Some counters offer the capability of providing a digital output signal whose frequency is a scaled or divided version of the input frequency.

### Time Interval

The measurement of the time between two events or the time between two points on a common event, commonly referred to as time interval, is of major importance and is used in a wide variety of applications.

The  $\pm 20$  pS single shot resolution of the 5370A represents today's state of the art. This unit utilizes a new concept of phase locked vernier interpolation which eliminates quantization errors. HP also pioneered the concept of time interval averaging, whereby for repetitive inputs substantial improvement in resolution over the single shot measurement can be obtained.

Time interval averaging is offered in four HP counters (5370A; 5345A; 5328A and 5308A). Also available for precision time interval measurements is the 5363A Time Interval Probes box usable with any time interval counter. The 5363A has a  $\pm 10$  volt dynamic range as well as a built in calibration feature and digitally set trigger voltages to eliminate the major uncertainties associated with TI measurements. The 5363A is fully programmable via the HP Interface Bus for systems applications.

All manner of time interval measurements are discussed in detail in Application Note AN 191 "Time Interval Measurement With an Electronic Counter" available on request from any Hewlett-Packard sales office.



## Application Note 172: The Fundamentals of Electronic Frequency Counters

This forty-four page application note describes in detail the measurements mentioned above. In addition, the key considerations in making frequency and time measurements, plus the major characteristics required of a counter for certain applications are also described. For those readers who require more than the brief resumé above, this application note is available on request at any Hewlett-Packard sales office.

The contents of AN 172 are as follows:

- Introduction
- Fundamentals of Electronic Counters
- More About the Basic Frequency Counters
- Input Considerations
- Oscillator Characteristics
- Sources of Measurement Error
- Prescaling—Increasing the Frequency Response
- Normalizing and Preset Counters
- Period Measuring Frequency Counters
- Time Interval
- Input Considerations
- Trigger Level
- Measurement Accuracy
- Increasing Accuracy and Resolution
- Microwave Frequency Measurements
- Heterodyne Conversion
- Transfer Oscillator
- Some Examples of Component Technology
- The major types of electronic counters

While counters can potentially offer all the measurements capabilities described above, they essentially fall into four classes: frequency counters; universal counters; microwave counters and reciprocal counters. These are described below.

### Frequency counters

These counters offer the basic capability of frequency measurement and in addition sometimes provide some or all of the other measurements described above except time interval. HP has a wide range of counters that fall into this class including: a) the 5380 low cost bench series, a family of three counters featuring 80 MHz—7 digit, 225 MHz—8 digit and 520 MHz—9 digit instruments; b) the 5300 portable, battery operated snap-on series with the 5303B snap-on covering 525 MHz and the 5305B 1300 MHz counter.

Table 1. Frequency counters summary

Model No.	Frequency Range	Number of Digits	Time Base	Other Functions*
5300A/5301A	10 MHz	6	$3 \times 10^{-7}$	T
5381A	80 MHz	7	$3 \times 10^{-7}$	
5382A	225 MHz	8	$3 \times 10^{-7}$	
5383A	520 MHz	9	$3 \times 10^{-7}$	
5300B/5303B	525 MHz	8	$3 \times 10^{-7}$	
5300B/5305B	1300 MHz	8	$3 \times 10^{-7}$	
5341A Opt. 008	1500 MHz	10	$1 \times 10^{-7}$	
5341A	4500 MHz	10	$1 \times 10^{-7}$	
5340A	18000 MHz	8	$3 \times 10^{-7}$	
5342A	18000 MHz	11	$1 \times 10^{-7}$	A, FO, AO

\* See legend opposite page

Table 2. Universal counter summary

Model No.	Frequency Range	Time Interval Resolution		Time Base	Other Functions*
		Single Shot	Averaging		
5300A/5304A	10 MHz	100 ns	—	$3 \times 10^{-7}$ per Month	P, MPA, T, R
5300A/5302A	50 MHz	100 ns	—	$3 \times 10^{-7}$ per Month	MPA, T, R
5300A/5308A	75 MHz	100 ns	100 ps	$3 \times 10^{-7}$ per Month	P, MPA, T, R
5328A	100 MHz	100 ns or 10 ns	10 ps	$3 \times 10^{-7}$ per Month	P, MPA, T, R, E, V**
5345A	500 MHz	2 ns	2 ps	$5 \times 10^{-7}$ per Day	P, MPA, T, R
5328A Opt 030	512 MHz	100 ns or 10 ns	10 ps	$3 \times 10^{-7}$ per Month	P, MPA, T, R, E, V**
5328A Opt 031	1300 MHz	100 ns or 10 ns	10 ps	$3 \times 10^{-7}$ per Month	P, MPA, T, R, E, V**
5370A	100 MHz	$\approx 20$ ps	1 ps	$1 \times 10^{-7}$ per Month	P, MPA, T, T, AE, E

\* See legend opposite page

\*\* Optional function

### Universal counters

These instruments provide time interval capability in addition to the other measurements provided by the frequency counter. The 5302A snap-on is a perfect example of such an instrument featuring 50 MHz frequency, 100 ns time interval plus period, ratio and totalize. Another member of the same family, the 5308A is ideally suited as a general purpose bench instrument, for in addition to the 5302A capabilities the 5308A offers time interval averaging, totalizing (with electronic start, and stop) and frequency to 75 MHz. The 5304A snap-on especially oriented towards time interval featuring adjustable hold-off. The 5328A (100 MHz) and 5328A Opt 031 (1300 MHz) are high performance rack mount instruments programmable (Opt 011) via the HP Interface Bus. Time interval averaging gives resolution to 10 ps on repetitive signals and Opt 040 also has 10 ns one shot resolution. Finally, the 5345A offers a 500 MHz bandwidth, with totalizing, ratio and period capability to this speed (50 ps), plus 2 ns single shot time interval and 2 ps time interval averaging! This extremely powerful instrument features plug-in flexibility (see page 238), and a reciprocal frequency measurement mode (see below).

### Microwave counters

These instruments provide high accuracy frequency measurements into the microwave spectrum. The 5342A harmonic heterodyne microwave counter automatically measures frequencies to 18 GHz under microprocessor control, 1 Hz in 1 second, and features resolution and wide-band FM tolerance. The keyboard controls allow the user to program his own frequency offsets. The amplitude option will simultaneously display input frequency and input level for readily monitoring microwave devices and equipment. The 5340A automatic transfer oscillator counter can measure frequency from 10 Hz to 18 GHz via a single input at  $-35$  dBm sensitivity! The 5341A automatic heterodyne counter provides coverage to 4.5 GHz using the switchable filter technique for super fast acquisition times. The 5354A is a 4 GHz heterodyne converter that plugs into the 5345A mainframe and provides extremely high resolution automatic measurements for CW and pulsed RF down to pulse width of 20 ns. Application Note 173 discusses automatic pulsed RF measurements in detail. Application Note 190 discusses making frequency measurements to 40 GHz with counter accuracy using a 4 GHz Microwave Counter together with readily available microwave generators and mixers.

Table 3. Microwave counter summary

Model No.	Frequency Range	Technique	Time Base	Sensitivity	Number of Digits
5354A*	4 GHz	Auto Heterodyne	$5 \times 10^{-7}$ Day	$-10$ dBm	11
5341A	4.5 GHz	Auto Heterodyne	$1 \times 10^{-7}$ Month	$-20$ dBm	10
5254A/5255A/5256A**	10-18 GHz	Manual Heterodyne	$3 \times 10^{-7}$ Day	$-13$ dBm	8
5357A**	18 GHz	Manual Transfer Osc	$3 \times 10^{-7}$ Day	$-7$ dBm	8
5340A	24 GHz	Auto Transfer Osc	$3 \times 10^{-7}$ Month	$-35$ dBm	8
5242A	18 GHz	Auto Harm Heterodyne	$1 \times 10^{-7}$ Month	$-25$ dBm	11

\* Plug-in to 5345A Counter

\*\* Plug-in to 5245 Series Counter or 5345A with adapter



### Reciprocal counters

A special class of frequency counters, referred to as reciprocal counters, are also available from Hewlett-Packard. The distinction between these and conventional counters is that the latter provides 1 Hz resolution in one second, whereas the resolution of the reciprocal counter is proportional to the frequency of the internal counted clock. The four instruments available are summarized in Table 4 below. Note that both the 5360A and 5345A are plug-in instruments and hence the high mainframe resolving power offered by both apply to any of the compatible plug-ins. These two instruments also have pulsed RF measurement capability via an external gate mode. In addition the 5345A includes a unique frequency averaging mode that allows high resolution measurements on repetitive pulses even if pulse width is 50 nsecs. The 5370A extends the reciprocal technique by means of phase locked vernier interpolation to give the ultimate in resolution. Frequency measurements to better than 10 digits may be made in 1 sec.

### HP Interface bus

The more recently introduced counters (and other HP digital instruments) have a digital input/output structure which is compatible with the interface bus which is Hewlett-Packard's implementation of the IEEE Digital Interface Standard 488-1975. HP Desktop Calculators in the 9820/21A/30A Series and Minicomputers in the HP 2100/21MX Series are also compatible with the interface bus, making it possible to expand the capabilities of the individual in-

struments even into areas of real time data reduction and control. Interfacing is available for interconnecting up to 14 compatible devices on one I/O slot. The HP 59310A Computer Interface serves for minicomputers and the HP 59405A HP-IB Calculator Interface interconnects up to 14 devices using one I/O slot and one ROM. At this time, compatible instruments are the 5345A, 5340A, 5341A, 5328A, and 5312A (for 5300B system). Accessories in the 59300A Series and the 5150A Thermal Printer are also compatible.

**Table 4. Reciprocal frequency counters**

Model No.	Frequency Range	Measurement Resolution	Number of Digits	Time Base	Sensitivity
5300A/5307A	2 MHz	$3 \times 10^{-7}$	6	$3 \times 10^{-7}$ per Month	10 mV rms
5323A	20 MHz	$1 \times 10^{-7}$	7	$3 \times 10^{-7}$ per Month	100 mV rms
5360A/5365A	320 MHz	$5 \times 10^{-11}$	12	$5 \times 10^{-10}$ per Day	20 mV rms
5345A	500 MHz	$2 \times 10^{-11}$	11	$5 \times 10^{-10}$ per Day	20 mV rms
5370A	100 MHz	$1 \times 10^{-10}$	16	$3 \times 10^{-7}$ per Month	20 mV rms

**Table 5. Counter selection guide**

Classification	Description	Frequency	Functions*	Time Base	Price	Page
5381A, 5382A & 5383A Low Cost	Traditional HP quality and reliability at new low prices.	To 520 MHz	f	$3 \times 10^{-7}$ /Mo. (Optional) $1 \times 10^{-7}$ /Mo.	From \$295	287
5300 Series Economic Portable	Select from 8 plug-ons to meet present needs. Move up in functions or frequency range when needed. Battery pack, D to A converter and HP interface Bus output module extend versatility.	To 1300 MHz	f, P, MPA, TI, TI AVG, T, R, V, E	$3 \times 10^{-7}$ /Mo. Optional $1 \times 10^{-7}$ /Mo.	From \$685	278
5328A Universal Counter	A new high performance universal counter with sub nano-second time interval averaging capability that can include high frequency measurement. DVM or HP interface Bus options.	To 1300 MHz	f, P, MPA, TI TI AVG, T, R, V, E	$3 \times 10^{-7}$ /Mo. Optional to $1.5 \times 10^{-7}$ /Mo.	From \$1300	270
5245 Series General Purpose Plug-in Counters	Two mainframes and 9 plug-ins provide unmatched versatility. Plug-ins provide up to 18 GHz frequency, 10 nsec time interval and voltage capabilities.	To 18 GHz	f, P, MPA, TI T, R, V	$1 \times 10^{-7}$ /Mo. ( $< 3 \times 10^{-7}$ /Day)	From \$4675	286
5345 Series High Performance Plug-in Counters	A new series of high performance mainframe and plug-ins, exceeding 500 MHz direct count, 2 nsec time interval, and 4 GHz automatic pulsed RF measurements.	To 18 GHz	f, P, MPA, TI, TI AVG, T, R E	$1.5 \times 10^{-7}$ /Mo. ( $< 5 \times 10^{-7}$ /Day)	From \$4400	282
5340, 5341, 5342A Automatic Counters	Broad band, high sensitivity, microwave frequency measurements 10 Hz - 1.5 GHz, 10 Hz - 4.5 GHz and 10 Hz - 23 GHz.	To 23 GHz	f	Optional to $1.5 \times 10^{-7}$ /Mo. ( $< 5 \times 10^{-7}$ /Day)	From \$4900	288
5370A	Highest resolution frequency measurements and time interval measurements to $\pm 20$ ps resolution.	100 MHz	16	$3 \times 10^{-7}$ /Mo.	\$6500	277
5360 Computing Systems	Accurate frequency measurements available plus time interval measurements to 100 psecs.	To 18 GHz	f, P, MPA, TI	$1.5 \times 10^{-7}$ /Mo. ( $< 5 \times 10^{-7}$ /Day)	From \$6900	287

\*Legend for Functions

f = Frequency	A = Amplitude	V = Voltage
P = Period	TI AVG = Time Interval Average	E = Electronically Controlled Totalize
MPA = Multiple Period Average	T = Totalize	Fo = Frequency Offsets
TI = Time Interval	R = Ratio	Ao = Amplitude Offsets

# ELECTRONIC COUNTERS

## 500 MHz plug-in counter

### Model 5345A



The 5345A Electronic Counter represents the most advanced general purpose instrument in the Hewlett-Packard Counter Product line. Utilizing state of the art monolithic bipolar integrated circuit technology especially designed and manufactured at Hewlett-Packard, this instrument provides unsurpassed power, versatility and flexibility in frequency and time measurements.

#### Major mainframe features

**Frequency:** direct from Dc to 500 MHz—Reciprocal technique provides high measurement resolution.

**Time Interval:** resolution of 2 ns single shot.

**Averaging:** new modulated clock technique gives true averages under all conditions. T.I. resolution extended to 2 ps. Frequency averaging improves RF pulse measurements similarly.

**Totalize:** to 500 megabit rate on both A and B inputs. A  $\pm$  B functions also available.

**Ratio:** from DC to 500 MHz on both inputs.

**Fully programmable:** provides great flexibility when used with calculators and computers.

**Plug-in versatility:** two plug-ins presently available (see page 268) with an on-going R&D program to extend this number. In addition the 10590A plug-in adapter allows most existing 5245 plug-ins to be used.

#### Signal input circuits

**Signal conditioning:** fully optimized front end includes switchable

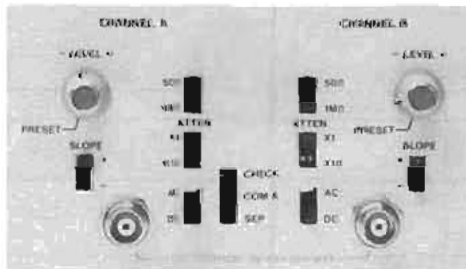

Figure 1. Input Switches

50 $\Omega$ /1 M $\Omega$  input impedances, DC/AC coupling, and slope selection that assures triggering on any waveform.

**Sensitivity, dynamic range:** highly sensitive wideband amplifiers

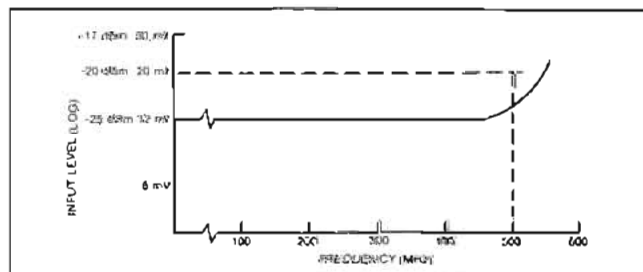

Figure 2. Typical Amplifier Sensitivity

- 500 MHz Direct Counting
- 20 mV Sensitivity DC to 500 MHz
- 2 ns Single Shot T.I. Resolution
- Averaging to 2 ps resolution
- Pulsed RF and Microwave Measurements
- Programmable for systems applications via HP-IB

assure measurements on even the lowest level sinusoidal and digital signals. The inputs also feature an extremely wide linear dynamic range of  $-2$  to  $+0.5$  V dc that greatly increases measurement versatility, especially on digital input signals.

#### Frequency measurements

**Reciprocal capability:** one of the advantages of measuring period

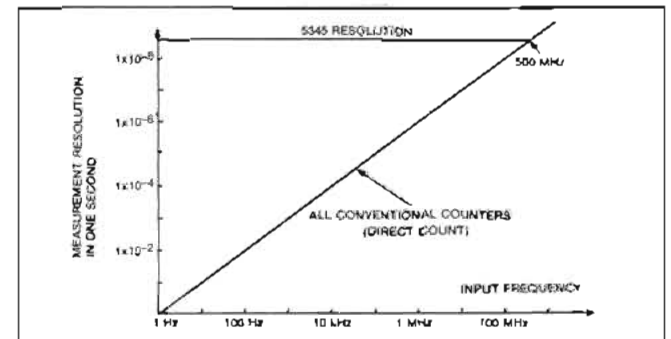

Figure 3. Measurement Resolution

and computing the frequency is that measurement resolution is independent of input frequency and at the maximum to which the instrument is capable of resolving. Thus for example, a 1 MHz input can be resolved to  $2 \times 10^{-9}$  ( $=0.002$  Hz) in one second, whereas the conventional counter provides 1 Hz resolution, some 500 times less.

#### Measurement speed

Mode of Operation	Readings per Second
Normal Operation (Max. sample rate)	10
Externally gated	500
Externally gated	500
Computer dump	9,000

The extremely high resolution obtained in one second can be traded for measurement speed. For example a 100  $\mu$ s gate time provides a resolution of  $2 \times 10^{-9}$  yet the measurement can now be made 5000 times a second, thus making the 5345A an invaluable tool in high speed data acquisition systems.

**Ext. gated capability:** via the rear panel gate control input; this capability allows the operator to determine at what point in real time and for how long the measurement is to be made. This capability essentially replaces the front panel "sample rate" and "gate time" controls.

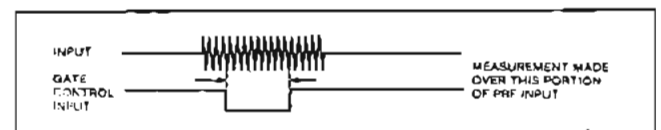

Figure 4. External Gate Control

The major application is in the measurement of pulsed RF signals. **Frequency averaging:** the minimum pulse width for which the input frequency can be measured is 20 ns. The single shot measurement resolution is  $2 \times 10^{-9}$  divided by the GATE TIME. This resolution can be improved up to 1000 times by a unique mode of operation known as frequency averaging that is built into the mainframe. The only requirement for this mode is that the signal is repetitive.

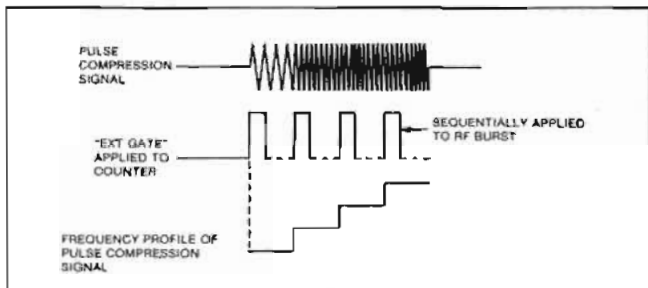

Figure 5. Frequency Averaging to Increase Resolution

In addition to greatly enhancing narrow pulse measurement capability, the frequency averaging mode also allows higher resolution on pulse profile measurements.

#### Time Interval

**Precision measurement:** the single shot time interval measurement resolution of the 5345A is 2 ns, which is the time it takes light to travel approximately 2 ft—the 5345A is an extremely high resolving time measuring device.

**Trigger level:** quantitative high speed time interval measurements are provided by the 5345A since the user can simply determine where triggering occurs even on complex waveforms. The method of determination involves measuring the DC levels at which triggering occurs. These DC levels are available at rear panel BNC's.

The ability to determine trigger level, together with high sensitivity and wide dynamic range of the inputs greatly enhances the versatility and power of the 5345A in time interval measurements.

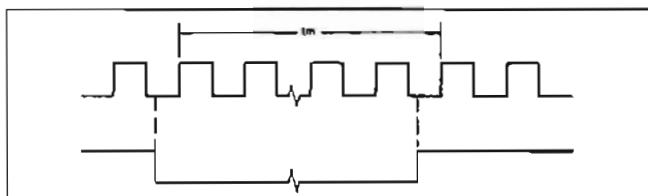

Figure 6. Using EXT GATE to Measure  $T_m$

**Ext. gate capability:** external gating adds even more versatility to the time interval measurements of the 5345A, as measurements such as that shown in figure (6) indicate.

**Time interval averaging;** for repetitive inputs a successive number of measurements may be automatically averaged by the 5345A, obtaining up to 1000 times improvement in resolution (2 ps). This averaging mode may be used irrespective of whether the instrument is in the conventional or ext. gate mode of operation.

#### Totalize

**High speed:** the 5345A has the ability to totalize to a 500 megabit

rate through either or both A and B inputs. Coupled with the high sensitivity and full signal conditioning of both channels, this capability enables measurements to be made on most modern digital systems.

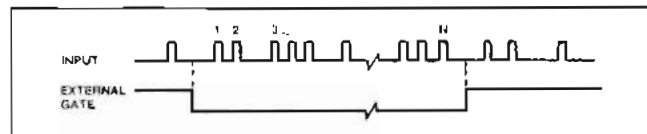

Figure 7. Selecting a Portion of a Pulse Train

**Ext. gate capability:** using the external gated mode allows the user to select only the desired portion of the input pulse train for measurement.

#### A ± B Modes

The A—B mode is used for comparison tests between high speed reference and test signals applied to the two mainframe inputs.

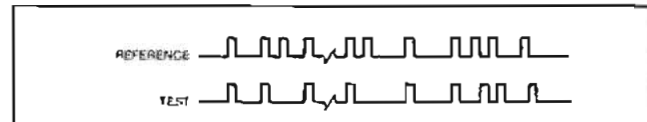

Figure 8. Comparison Measurements

Any difference between the total number of events accumulated in each channel is indicated by the 5345A display after the measurement is completed.

The primary application for the A + B mode is in the measurement of NRZ signals. By setting the "A" trigger slope to "+" and the B slope to "-" allows all transitions and hence bits of the NRZ signal to be counted. Thus 1 gigabit NRZ waveforms can be measured.

This mode of operation does not introduce any limitations—maximum input rate is 500 megabits on either channel and external gating may be used.

#### Ratio

This measurement represents the ratio of the number of events occurring through channel B divided by the number occurring through channel A. The major features are: a) that the measurement or comparison (similar to the A ± B totalize modes); and, b) the frequency or bit rate of either channel can vary from DC to 500 MHz. These features allow this measurement to be extremely useful in digital systems and synthesizer check out.

#### Digital I/O

Option 011 provides complete digital input-output capability (except slope and level control) to the 5345A. Digital output is a bit parallel, byte serial ASCII coded format and the I/O structure conforms to the Hewlett-Packard Interface Bus (HP-IB) standard. This option is particularly recommended for a bench top calculator controlled environment.

Option 012 is similar to Option 011, but includes programmable control of slope and level. Option 012 is recommended for a computer controlled environment.

The model 59310A Interface Kit provides a complete operational package for use with the HP 2100 Series Computers. Similarly, other interface kits allow the user to interface the 5345A Option 011 or 012 and other HP-IB compatible devices to the 9820, 9825 and 9830 Series HP Calculators.



## Model 5345 (cont.)

## 5345A Condensed specifications

## Frequency/period measurements

**Range:** 0.00005 Hz to 500 MHz.

**Accuracy:**  $\frac{\pm 2 \times 10^{-6}}{\text{gate time}} \pm \text{trigger error}^* \pm \text{time base error}$ .

**Gate time:** 1000 seconds to 100 nanoseconds in decade steps; <50 ns in MIN position.

## Time Interval/time interval average

**Range:** 10 nsec to 20,000 sec.

**Minimum dead time:** 10 nsec.

**Trigger pulse width:** 1 nsec minimum width input at minimum voltage input.

## Accuracy

**Time Interval:**  $\pm \text{trigger error}^{**} \pm 2 \text{ ns} \pm \text{time base error}$ .

**Time Interval averaging:**

$$\pm \frac{\text{trigger error}^{1/2} \pm 2 \text{ nsec}}{\sqrt{\text{intervals averaged}}} \pm 0.7 \text{ nsec} \pm \text{time base accuracy}$$

not affected by harmonics of clock frequency.

## Resolution:

**Time Interval:** 2 nsec.

**Time Interval average:**

$$\pm \frac{2 \text{ nsec}}{\sqrt{\text{intervals averaged}}} \pm 2 \text{ picoseconds}$$

\*Trigger error for sinewaves of 40 dB signal-to-noise amplitude ratio is  $\leq (\pm 0.3\%$  of one period  $\div$  number of periods averaged). If peak noise amplitude is greater than 10 millivolts, additional miscounting may occur (this situation can arise when measuring high-level outputs of broadband synthesized signal sources).

\*\*For any wave shape, trigger error is less than

$$\pm \frac{0.0025 \mu\text{s}}{\text{Signal Slope}} \pm \frac{1 \text{ nV}}{\mu\text{s}}$$

## Ratio B/A

**Range:** both channels accept dc to 500 MHz.

**Accuracy:**  $\pm \text{L.S.D.} \pm \text{trigger error}^*$ .

## Start/stop

**Range:** both inputs dc to 500 MHz.

**Modes:** A, A $\pm$ B determined by rear panel switch.

## Scaling

**Range:** dc to 500 MHz.

**Scaling factor:** selectable by GATE TIME setting. Scaling factor equals GATE TIME setting/ $10^{-9}$  seconds.

**Input:** input signal through channel A.

**Output:** output frequency equals input frequency divided by scaling factor. Rear panel BNC supplies 80% duty cycle TTL compatible pulses.

## Input channels A and B

**Range:** 0 to 500 MHz dc coupled 50 $\Omega$  and 1 M $\Omega$ ; 4 MHz to 500 MHz ac coupled, 50 $\Omega$ ; 200 Hz to 500 MHz ac coupled, 1 M $\Omega$ .

**Impedance:** selectable, 1 M $\Omega$  shunted by less than 30 pF or 50 $\Omega$  (nominal).

**Sensitivity:** X), 20 mV rms sine wave and 60 mV peak-to-peak pulse X10, 250 mV rms sine wave and 750 mV peak-to-peak pulse.

**Dynamic range:** 50 $\Omega$  & 1 M $\Omega$ : 20 mV to 250 mV rms sine wave (X1); 250 mV to 2.0 V rms (X10).

**Trigger level:** adjustable over  $\pm 1.3$  V dc.

**Output:** rear panel BNC connectors bring out CHAN A TRIG LEVEL and CHAN B TRIG LEVEL for convenient DVM monitoring. Accurate to  $\pm 15$  mV.

## Common input

In this mode the signal is applied to channel A.

**Range:** ac coupled 50 $\Omega$ , 4 MHz to 400 MHz; ac coupled 1 M $\Omega$ , 300 Hz to 400 MHz.

**Impedance:** 50 $\Omega$  remains 50 $\Omega$ ; 1 M $\Omega$  becomes 500 k $\Omega$  shunted by <60 pF.

**Sensitivity:** 50 $\Omega$ : 40 mV rms; 1 M $\Omega$ : No change.

**Dynamic range:** 50 $\Omega$ : 40 mV to 500 mV rms (X1); 500 mV to 4 V rms (X10); 1 M $\Omega$ : No change.

## General

**Display:** 11 digit LED display and sign. Annunciator displays msec to nsec, k to n,  $\mu$ Hz to GHz. Decimal point is positioned with DISPLAY POSITION control or positioned after the first, second or third most significant digit if DISPLAY POSITION is in AUTO. Leading zeros are suppressed.

**Overflow:** asterisk is illuminated when display is overflowed.

**Sample rate:** continuously variable from <0.1 sec to >5 sec with front panel control. In HOLD position the last reading is maintained until the counter is reset.

**External arm input:** counter can be armed by a -1.0 V signal applied to the rear panel 50 $\Omega$  input.

**External gate input:** same conditions as for EXT ARM.

**Gate output:** >1 volt into 50 $\Omega$ .

## Time base

**Standard high stability time base:** crystal frequency, 10 MHz (J0544A).

## Stability

**Aging rate:**  $< 5 \times 10^{-10}$  per day.

**Short term:**  $< 1 \times 10^{-11}$  for 1 sec average.

**Temperature:**  $< 7 \times 10^{-9}$ , 0 $^{\circ}$ C to 55 $^{\circ}$ C.

**Opt 001:** crystal frequency, 10 MHz.

## Stability

**Aging rate:**  $< 3 \times 10^{-7}$  per month.

**Short term:**  $< 2 \times 10^{-9}$  rms for 1 sec.

**Temperature:**  $< 2 \times 10^{-9}$ , 25 $^{\circ}$ C to 35 $^{\circ}$ C.

$< 5 \times 10^{-6}$ , 0 $^{\circ}$ C to 55 $^{\circ}$ C.

**Line voltage:**  $< 1 \times 10^{-4}$ ,  $\pm 10\%$  from nominal.

**Self test:** a 100 MHz signal is internally applied.

**External frequency standard input:** input voltage >1.0 V rms into 1 k $\Omega$  required from source of 1, 2, 2.5, 5, or 10 MHz  $\pm 5.0 \times 10^{-6}$  ( $\pm 5 \times 10^{-6}$  for opt. 01). Input can be sine or square wave.

**Frequency Standard Output:** >1 V rms into 50 $\Omega$  at 10.0 MHz sine wave.

**Operating temperature:** 0 $^{\circ}$ C to 55 $^{\circ}$ C.

**Power requirements:** 100/120/220/240 V rms  $\pm 5\%$  -10% 48 to 66 Hz, maximum power 250 VA.

**Weight:** 17 kg (37 lb).

## Options and accessories

**001:** Room Temperature Time Base

**Price**

less \$350

**010:** Digital output only. HP Interface Bus format, talk only. Useful with 59301A ASCII-to-Parallel Converter and 5050B or 5055A Digital Printers

add \$250

**011:** Digital Input/Output same as Opt 010, Compatible with HP Interface Bus and allows 5345A to be remotely programmed

add \$800

**012:** Digital I/O similar to Opt 011. Includes slope and level control

\$1450

add \$10

**908:** Rack flange kit

**K13-59992A:** includes state machine tester as an aid for trouble-shooting the arithmetic processor

\$2250

**10595A Board extender kit:** useful for troubleshooting plug-in boards while in operation

\$475

**10590A Plug-in adapter:** adapts 5245 series plug-ins to 5345 (see next page)

\$700

**K15-59992A Standby power unit:** plug-in to maintain oscillator operation for prolonged periods without line voltage

\$1200

## Available reference material

5345A Data Sheet

5345A Users Handbook

AN-173 Recent Advances in Pulsed RF and Microwave Measurements

AN-173-1 Dynamic Measurement of Microwave VCO's

AN-174 Applications Series on Counter/Calculator Instrument Groupings

AN-190 40 GHz Frequency Measurements

AN-191 Precision Time Interval Measurements

HP Journal June 1974

I.D. #90337D Color Video Tape Applications and Demonstrations

5345A Plug-In Counter

\$4400

- Fully automatic to 4 GHz
- Pulse Measurements
- Frequency averaging



5354A

- Count a group of events between A and B
- Frequency sum and difference measurements

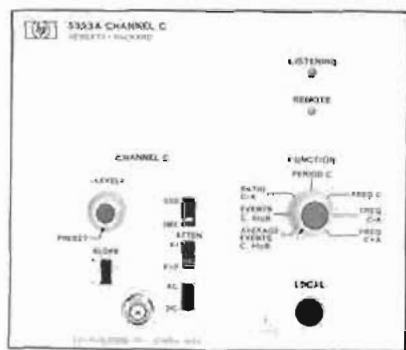

5353A



10590A

### 5354A Automatic frequency converter

The 5354A translates not only the microwave signal but all its modulation directly to the 500 MHz window of the counter (via the heterodyne technique). It allows signals with a large amount of FM to be easily characterized.

Perhaps even more powerful is its ability to take direct measurements on the carriers of very narrow microwave pulses. Pulse measurements can be easily automated.

**Range:** 15 MHz to 4 GHz.

**Sensitivity:** -10 dBm (70 mV rms) auto mode, -20 dBm typical (22 mV rms) Manual/Pulse mode to 20 dBm (2.2 V rms).

**Input signal capability:** CW signals. Pulsed microwave signals. Signals with very high FM content.

**RF Pulse width:** determined by counter GATE TIME setting.

**FM Sensitivity:** overlap at band edges  $\pm 10$  MHz. Maximum deviation at band center

$\pm 250$  MHz, above 1 GHz and below 500 MHz.

$\pm 125$  MHz, between 500 MHz and 1 GHz.

**Operating modes:** Automatic and Manual.

**Automatic:** measures lowest frequency signal of sufficient amplitude to trigger counter.

**Manual:** measures signal within selected band. Signals of sufficient amplitude between 15 MHz and 525 MHz will also be counted.

**Acquisition time:**

**Automatic mode:** CONT, WAVE, <2 ms; PULSED R.F. <1 s.

**Manual mode:** when proper band has been selected CONT, WAVE <5  $\mu$ s; PULSED R.F. <20 ns.

**Options**

011: remote control via HP Interface Bus and L.O.  $\pm 1$  F.

**Price**

add \$200

5354A Automatic Frequency Converter

\$3400

### 5353A Channel C plug-in

The 5353A Channel C Plug-In consists of a third input to the 5345A Counter. When the plug-in counting capability is combined with the mainframe gating capability it becomes quite easy to make frequency sum and frequency difference measurements.

For high speed digital applications, the greatest benefit the plug-in offers is the ability to count a specific group of events while ignoring others. This measurement is required in many applications such as computer peripheral testing and digital communications systems. It is accomplished in the events C between A and B mode by applying a start signal to CHAN A and a stop signal to CHAN B while applying the data to be counted to CHAN C.

**Range:** dc coupled: 0 to 500 MHz; ac coupled: 1 M $\Omega$ : 200 Hz to 500 MHz; 50 $\Omega$ : 4 MHz to 500 MHz.

**Impedance:** 50 $\Omega$  (nominal), or 1 M $\Omega$  shunted by less than 30 pF.

**Sensitivity:** variable to 20 mV rms sine wave and 60 mV peak-to-peak pulse. Attenuator settings are X1 and X10.

**Modes of operation:** Frequency C + A; Frequency C - A; Period C; Frequency C; Ratio C/A; Average Events C, A to B; Events C, A to B.

**Events accuracy:** Plus or minus one count worst case.

**Options**

011: Digital Input. Full compatibility with HP Interface Bus. Provides for digital control over all functions excluding amplifier.

**Price**

add \$250

5353A Channel C plug-in

\$1250

### 10590 Plug-in adapter

The 10590A allows the user to interface any of the 5245 series of plug-ins (except the 5264A) to the 5345A (see page 254 for details on these plug-ins). The major application is to extend the frequency range to 18 GHz via the 5255A, 5256A and 5257A plug-ins. In addition the adapter is "intelligent" in that it detects the plug-in being used and automatically adjusts the 5345 accordingly.

10590A Plug-in adapter

\$700



# ELECTRONIC COUNTERS

General purpose plug-in counters

Model 5245L

- Highest performance in general purpose counters
- Wide selection of plug-ins provide unmatched versatility
- Extremely high reliability proven from over forty million hours of field operation



5245L

The 5245L has gained unprecedented popularity due to its high performance, flexibility and years of proven stability. Even though its performance has been recently upstaged by the 5345A, the 5245L is still considered the standard of the industry for instruments of this type with more 5245L counters in operation today than all other plug-in counters combined.

The 5245 series consists of a family of mainframes and a series of plug-ins. The plug-ins provide frequency measurement to 18 GHz, high sensitivity, time interval and preset capability. The wide choice of mainframes and plug-ins means that virtually any measurement task performable by counters can be accomplished by appropriate selection within this family.

The 5245 series counters are not only leaders in terms of performance and versatility, they are unsurpassed in the industry for ruggedness, wide operating temperature range, and field-proven reliability.

The following is a description of the 5245L mainframe. The other mainframes are similar to the 5245L. The main differences are delineated in these condensed specifications. Refer to the 5245 series data sheet for complete details and specifications on all mainframes and plug-ins.

## Specifications

### 5245L

#### Frequency measurements

Range: dc to 50 MHz.

Gate time: 1  $\mu$ s to 10 seconds in decade steps.

Accuracy:  $\pm 1$  count  $\pm$  time base accuracy.

#### Period average measurements

Range: dc to 1 MHz for single period; dc to 300 kHz for multiple period.

Periods averaged: 1 period to  $10^5$  periods in decade steps.

Accuracy:  $\pm 1$  count  $\pm$  time base accuracy  $\pm$  trigger error\*.

Mainframe measurement functions: frequency, period, period average, ratio, scaling.

#### Signal Input

Sensitivity: 100 mV rms.

Coupling: AC and DC.

Impedance: 1 M $\Omega$  in parallel with approx. 25 pF all ranges.

Attenuation: step attenuator provides nominal sensitivities of 0.1, 1, and 10 V rms (SENSITIVITY switch).

Trigger Level: continuously adjustable over  $\pm 3$  V multiplied by the setting of the SENSITIVITY switch.

Compatible 5245 series plug-ins: all.

Time base: 10 MHz oscillator, aging rate  $< 3 \times 10^{-9}$ /day.

Display: 8 digits.

Operating temperature range:  $-20^\circ\text{C}$  to  $+65^\circ\text{C}$ .

Weight: net, 14.4 kg (32 lb) with blank plug-in panel.

Size: 133 H  $\times$  425 W  $\times$  416 mm D (5 $\frac{1}{4}$ "  $\times$  16 $\frac{3}{4}$ "  $\times$  16 $\frac{3}{8}$ ").

#### Options

908: Rack Flange Kit

5245L 50 MHz Electronic Counter

Price

add \$35

\$4675

\*Trigger error is  $< \pm 3\%$  of one period  $\div$  number periods averaged; for signals with 40 dB signal-to-noise ratio and 100 mV rms amplitude; error decreases as signal to noise ratio increases.



5360A

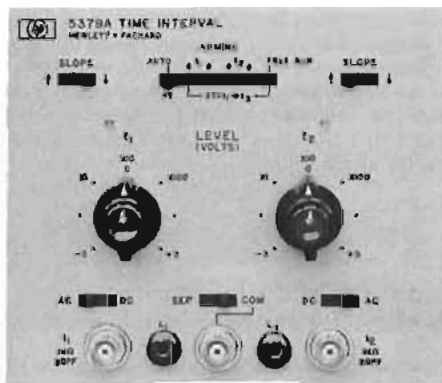

5379A



5375A

The Computing Counter is a general purpose precision digital instrument with built-in arithmetic capability. It can measure the time between two events to a resolution of 100 pico-seconds, about the time it takes light to travel one inch.

The Computing Counter's unique measurement technique employs extensive use of digital computation. Thus the mainframe contains an arithmetic unit which is an inherent, indispensable part of the measurement cycle. The arithmetic capability of the machine has been made available to the user via several programming devices. This allows the system to be programmed to solve equations where measurements are the variables, in real time. This capability enormously increases the power of the Computing Counter System.

Key specifications include a dc to 320 MHz direct count frequency range, measurement resolution of 1 part in  $10^{10}$  per second of gate time, and  $\pm 100$  psec single shot time interval resolution using the 5379A Time Interval plug-in. A detailed description of the Computing Counter System and complete specifications are contained in the Computing Counter data sheet, available upon request.

#### 5379A Time Interval plug-in

With the 5379A Time Interval Plug-In, the Computing Counter becomes a high precision and versatile time interval meter. Measurements can be made down to zero and even "negative" times by virtue of a unique arming scheme. Single shot events can be measured with  $\pm 100$  psec resolution and an accuracy of  $\pm 1$  nsec. By programming the Computing Counter from any of a number of programming devices (such as the 5375A Keyboard), the average of a number of measurements can be displayed to resolutions better than 5 psec.

#### 5375A Keyboard

The 5375A provides the Computing Counter with the capability to add, subtract, multiply, divide and perform square root, logarithm and exponential functions. Decision capability and branching are possible also. Electrical outputs are made available for limit testing and peak to peak measurements.

#### 10536A Plug-In Adapter

The 10536A Adapter is a versatile accessory which allows nine of the 5245 series plug-ins to be used in the Computing Counter. Frequency range can be extended to 18 GHz with these plug-ins.

#### Ordering Information

- 5360A Computing Counter
- Opt 908: Rack Flange Kit
- 5379A Time Interval Plug-In
- 5375A Keyboard
- 10536A Plug-In Adapter

	Price
5360A Computing Counter	\$10000
Opt 908: Rack Flange Kit	add \$10
5379A Time Interval Plug-In	\$1500
5375A Keyboard	\$2000
10536A Plug-In Adapter	\$650

# ELECTRONIC COUNTERS

Plug-Ins for 5245L/M, 5246L, 5248L/M & 5345A

Models 5252A—5262A



5253B

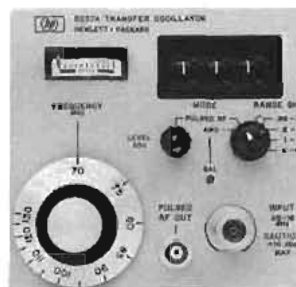

5257A



5254C



5255A



5256A

The 5245 series of plug-ins adds greatly to the versatility of the 5245 series of plug-in counters. In addition, these plug-ins enhance the measurement capability of the 5345A Electronic Counter and the 5360A Computing Counter by the use of plug-in adapters which provide an interface between the plug-in and the 5345A and 5360A mainframes. A compatibility summary for presently available plug-ins is shown below, followed by brief descriptions of the individual plug-ins. Refer to the 5245 series data sheet for complete details and specifications for all the plug-ins.

### Plug-in compatibility summary

**5345A compatibility (using 10590A plug-in adapter):** all except the 5264A.

**5360A compatibility (using 10536A plug-in adapter):** all except the 5262A, 5264A, 5265A, and 5267A.

**5245L/M compatibility:** all.

**5248L/M compatibility:** all.

**5246L compatibility:** all except the 5264A.

### Specifications

**5253B Heterodyne converter**

\$1150

**Frequency range:** 50 MHz to 512 MHz.

**Sensitivity:** -13 dBm to +13 dBm.

**Mixing frequencies:** 50 to 500 MHz in 10 MHz steps.

**Input coupling:** ac.

**Accuracy:** maintains counter accuracy.

**Input impedance:** 50Ω.

**5254C Heterodyne converter**

\$1700

**Frequency range:** 150 MHz to 3 GHz.

**Sensitivity:** -13 dBm to +13 dBm.

**Mixing frequencies:** 0.15 to 3 GHz in 50 MHz steps.

**Input coupling:** ac.

**Accuracy:** maintains counter accuracy.

**Input impedance:** 50Ω.

**Auxiliary outputs:** 1 MHz-50 MHz.



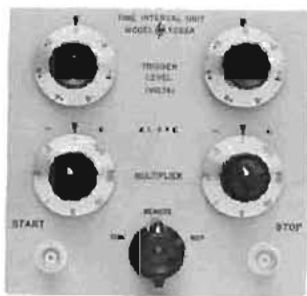

5262A

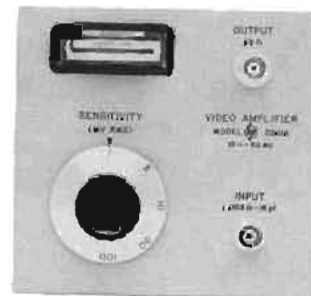

5261A

**5255A Heterodyne converter** \$2750  
**Frequency range:** 3 GHz to 12.4 GHz.  
**Sensitivity:** -7 dBm to +10 dBm.  
**Mixing frequencies:** 2.8 to 12.4 GHz in 200 MHz steps.  
**Input coupling:** dc.  
**Accuracy:** maintains counter accuracy.  
**Input impedance:** 50Ω.  
**Auxiliary input:** 1 MHz-200 MHz at 5 mV sensitivity.  
**Auxiliary output:** 1 MHz-200 MHz.

**5256A Heterodyne converter** \$3225  
**Frequency range:** 8 GHz to 18 GHz.  
**Sensitivity:** -7 dBm to +10 dBm.  
**Mixing frequencies:** 8 to 18 GHz in 200 MHz steps.  
**Input coupling:** dc.  
**Accuracy:** maintains counter accuracy.  
**Input impedance:** 50Ω.  
**Auxiliary input:** 1 MHz-200 MHz at 5 mV sensitivity.  
**Auxiliary output:** 1 MHz-200 MHz.

**5257A Transfer oscillator** \$3275  
**Frequency range:** 50 MHz to 18 GHz.  
**Input signal:** CW, pulsed RF or FM modulated.  
**Sensitivity:** -7 dBm, 50 MHz to 15 GHz; -4 dBm, 15 GHz to 18 GHz.

**APC lock range:** approximately ±0.2% of input frequency.  
**Pulse carrier frequency measurements:** minimum pulse width: 0.5 μs. Minimum repetition rate: 10 pulses per second.  
**Input impedance:** 50Ω.  
**VFO stability:** typically  $1 \times 10^{-7}$  per minute after 2 hours.

**5262A Time Interval unit** \$850  
**Range:** 1 μs to 10<sup>8</sup> s (to 10<sup>6</sup> s with 5246L).  
**Resolution:** 0.1 μs.  
**Input sensitivity:** 100 mV rms.  
**Start-Stop:** independent or common channels.  
**Trigger slope:** positive or negative on Start and Stop channels, independently selected.  
**Trigger amplitude:** both channels adjustable from -250 to +250 V peak.  
**Input repetition rate:** better than 2 MHz.  
**Input impedance:** from 10 kΩ/80 pF at ×0.1 multiplier setting to 10 MΩ/20 pF at ×100 setting.

**5261A Video amplifier** \$595  
**Bandwidth:** 10 Hz to 50 MHz.  
**Input sensitivity:** 1 mV.  
**Input impedance:** 1 MΩ/15 pF.  
**Auxiliary output:** 40 dB gain max into 50Ω; 300 mV rms max output undistorted into 50Ω; source impedance 50Ω.

## ELECTRONIC COUNTERS

## 100 MHz Universal counter

## Model 5328A

- 100 MHz, 512 MHz and 1300 MHz
- 100 ns or 10 ns time interval
- T.I. averaging to 10 ps resolution
- "armed" measurements
- DVM options
- HP-IB interface option



HP-IB Model 5328A

## Description

The 5328A, thru the use of the latest technology (such as a ROM controlled measurement cycle) and a modular design, provides you with the optimum in universal counter price/performance. Optional modules allow you to tailor the performance of the 5328A to meet your particular measurement needs. In many instances, however, the standard 5328A offers all the capability you're ever likely to need:

**Burst and CW measurements to 100 MHz:** special gating circuits start a measurement only when the input signal is present, allowing burst frequencies to be made as easily as CW measurements. The option 030 channel C extends this capability to 512 MHz; option 031, to 1300 MHz.

**Single shot time interval measurements:** the standard universal module's 100 ns single shot resolution meets or exceeds the requirements for a wide range of applications such as mechanical and electromechanical device timing (relays), time of flight measurements (ballistics), sonar ranging, radio ranging and navigation.

**Time interval averaging:** resolution better than 10 ps ( $10^{-11}$  seconds) for repetitive time intervals as short as 100 ps.

**Period, period average, ratio, totalize, scale:** extra problem solving power for your special requirements.

**Armed measurements:** versatile arming modes (controlled by a rear panel switch) allow the real time control over when a measurement begins. Useful for measurements such as frequency burst profile and frequency sweep linearity.

**Trigger lights:** trigger light blinks when channel is triggering; light is ON when input is above trigger level; OFF when input is below trigger level. Simplifies trigger level adjustments.

**High performance marker outputs:** marker outputs (operational to 100 MHz) indicate where channel is triggering in real time for oscilloscope monitoring applications. Provides measurement feedback to the operator for greatly simplified measurement set-ups.

These features and capabilities make the 5328A an excellent choice for general purpose lab use, electronic service, and production test. For more demanding applications, a variety of options offer extended performance at a modest increase in price.

### Summary of characteristics

Model No.	Description	Features
5328A	Universal Counter	Frequency to 100 MHz, 100 ns single shot T.I.; T.I. averaging; Period, Period Avg; ratio; totalize; Oven oscillator with aging rate $< 5 \times 10^{-10}$ /day
Opt. 010	High Stability Time Base	
Opt. 011	HP-IB Interface	Allows 5328A to output data and be controlled via the HP Interface Bus.
Opt. 020	DVM	Single ended DVM for trigger level and external voltage measurements.
Opt. 021	High Performance DVM	Floating DVM for trigger level and high accuracy external voltage measurements.
Opt. 030	512 MHz Channel C	Frequency measurements to 512 MHz; 9 digit display.
Opt. 031	1300 MHz Channel C	Frequency measurements to 1300 MHz; 9 digit display.
Opt. 040	High Performance Universal Module	Same as standard 5328A but with 10 ns single shot T.I.; improved T.I. averaging; improved T.I. accuracy; measurements with delay; T.I. A-B marker; hysteresis compensation; switchable input impedance (1 M $\Omega$ /50 $\Omega$ ).
Opt. 041	Programmable Input Module	Full remote programming of all universal module controls thru opt. 011; 10 ns single shot T.I.; switchable 1 M $\Omega$ /50 $\Omega$ input impedance.

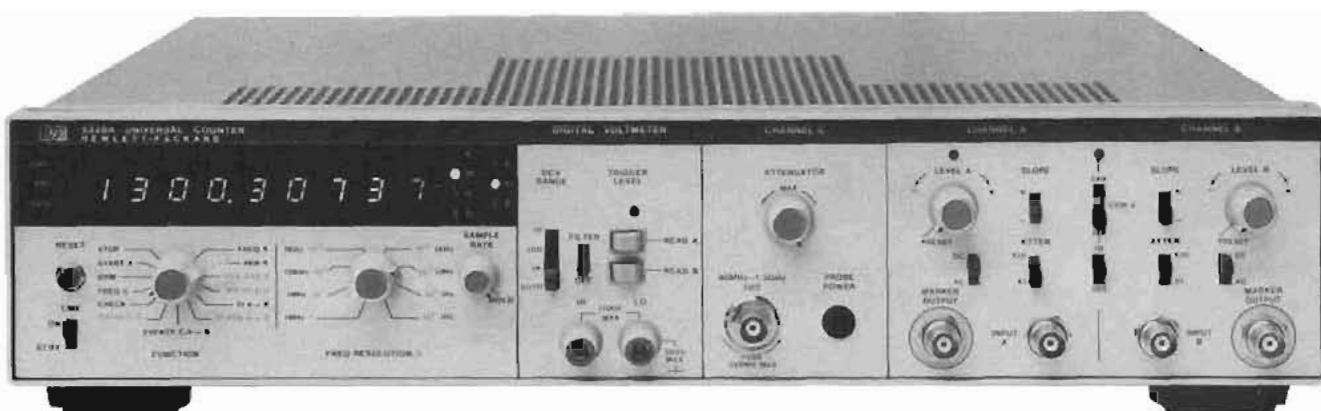

5328A with Opt 021, 031, 041

## 5328A Option descriptions

### High stability time base (Opt 010)

The standard time base for the 5328A is a room temperature 10 MHz crystal providing a long term aging rate of less than 3 parts in  $10^7$  per month. The option 010 oven oscillator offers excellent short term and temperature stability which can contribute to higher measurement accuracy. The low aging rate of  $< 5 \times 10^{-10}$ /day permits reduced intervals between time base calibrations.

### HP Interface bus for systems use (Opt 011)

The option 011 HP-IB Interface brings the full capability and power of the HP Interface Bus. The 5328A can accept program code words over the HP-IB which remotely program various front and rear panel controls. In addition, measurement results may be output over the bus to HP-IB compatible instruments, calculators, or computers.

Remotely programmable controls include FUNCTION selection, RESOLUTION selection, ARMING, SAMPLE RATE (max. or manual), RESET, measurement modes, output modes, and display modes. Option 041 adds programming of channel A and B input signal conditioning controls.

### Digital voltmeters (Opt 020, 021)

The unique combination of an integrating digital voltmeter with a universal counter produces a superb general purpose measuring instrument. By using a voltage to frequency conversion technique, the incremental cost of adding DVM capability to the 5328A is very low.

Two DVM options are available: the option 020 DVM with single-ended input and the option 021 High Performance DVM with floating input. You can use these DVMs to measure channel A and B trigger levels and external voltages. Since a built-in DVM greatly simplifies time interval measurement set-ups, it is highly recommended that one of the DVM options be selected, particularly if time interval measurements are one of your major applications.

### High frequency channel C (Opt 030, 031)

With a high frequency channel C module the 5328A is ideally suited for use in a wide variety of communications measurements. Option 030 gives direct count measurements to 512 MHz with 15 mV rms sensitivity; option 031 counts to a full 1300 MHz with 20 mV rms sensitivity. Typical applications include servicing, maintaining,

calibrating, and monitoring communications transmitters and receivers such as found in two-way radio, radio and television broadcasting, mobile radio, and common carrier multiplexing and transmission.

### Extended capability universal modules (Opt 040, 041)

Options 040 and 041 give extended performance for time interval measurements. Option 040 is designed for bench use and includes "delay" capability for increased measurement versatility. Option 041 adds full programming of the input signal conditioning controls.

Both of these options generate a 100 MHz clock to give 10 ns single shot resolution for time interval measurements. This resolution is useful in applications such as computer/peripheral timing measurements, logic timing measurements, RADAR ranging, and optical ranging.

For improved time interval averaging performance, the options have input channels adjusted for delay matching to better than 2 ns. Additionally, options 040 and 041 use a jittered clock in T.I. AVG. function to give averaging even for those cases when the input repetition rate is synchronous with the counter's internal timebase.

Selectable input impedance adapts the counter to the measurement environment: 50  $\Omega$  for fast signals in a 50  $\Omega$  environment, 1 M  $\Omega$  to reduce circuit loading or to use with scope probes.

The "delay" feature of option 040 allows you to disable the inputs from triggering for selected periods of time (20  $\mu$ s to 20 ms). Delay is useful for ignoring high amplitude noise such as from chattering relays or ignoring stop pulses in multiple stop T.I. measurements.

Option 041 allows remote programming of input trigger level, slope, coupling, and attenuator setting. Under remote control, the input impedance is independently selectable on the A and B channels. Also, a remote "Invert" function switches the A and B channel signals internally. "Invert" gives exceptional flexibility for two channel time interval measurements.

### Retrofit kits

Retrofit kits, available for all options, allow you to upgrade the performance of your 5328A in response to your changing measurement requirements.

The condensed specifications on the following pages highlight some of the important performance characteristics of the 5328A and its options. Complete specifications and detailed applications information are available in the 5328A data sheet.

## Model 5328A (cont.)

Opt 020  
DVMOpt 021  
High Performance DVMOpt 030  
512 MHz  
Channel COpt 031 1300 MHz  
Channel C

10855A Preamp

## Digital voltmeter modules

## Digital voltmeter measurements†

DVM (Opt 020 and 021): trigger levels of input channels A and B and external voltages may be measured.

Maximum sensitivity	Opt 020	Opt 021
Meas. time: 10 s (N = 10 <sup>2</sup> ) 1 s (N = 10 <sup>3</sup> ) 0.1 s (N = 10 <sup>4</sup> ) 10 ms (N = 10 <sup>5</sup> ) 1 ms (N = 10 <sup>6</sup> )	1 mV 1 mV 2 mV 20 mV 200 mV	10 $\mu$ V 100 $\mu$ V 1 mV 10 mV 100 mV
Range	0 to $\pm$ 125 V dc	$\pm$ 10, $\pm$ 100, $\pm$ 1000 V dc, and Autorange
Accuracy (20 min. warm-up)	$\pm$ 0.5% reading $\pm$ 4 mV	$\pm$ 0.03% reading $\pm$ 0.004% range; for 1000 V range: $\pm$ 0.087% reading $\pm$ 0.004% range
Input terminals	Single ended	Floating pair
Input impedance	10 M $\Omega$	10 M $\Omega$
Normal mode rejection ratio	>60 dB at 60 Hz 150 Hz $\pm$ 0.1%	>80 dB at 50 Hz or greater with filter on
Effective common mode rejection ratio (1 k $\Omega$ unbalance)		DC: $\pm$ 120 dB AC: $\pm$ 120 dB for multiples of 60 Hz (50 Hz) with filter on
Maximum input	$\pm$ 500 V	HI to LO: $\pm$ 1100 V all ranges, LO to chassis ground: $\pm$ 500 V
Trigger level Measurements	2 mV display resolution	1 mV display resolution, trigger level reading automatically multiplied by setting of attenuator switch if using Opt 040 or 041 universal modules

†Performance: 60 days at 23°C  $\pm$  5°C and RH < 80%

## Channel C modules

Input characteristics	Opt 030	Opt 031
Sensitivity	15 mV rms	20 mV rms
Coupling	dc	ac
Trigger level	0 V, fixed	0 V, fixed
Impedance	50 $\Omega$	50 $\Omega$
Maximum input	5 V rms	5 V rms, $\pm$ 5 V dc
Input protection	fused	fused
Attenuator	No	Variable for optimum noise suppression on signals to 5 V rms

## Frequency C measurements

	Opt 030	Opt 031
Range	5–512 MHz (direct count)	90–1300 MHz (prescaled, $\times$ 4)
Resolution	1 MHz to 0.1 Hz in decade steps	1 MHz to 0.1 Hz in decade steps
Accuracy	$\pm$ 1 count $\pm$ timebase error	$\pm$ 1 count $\pm$ timebase error

## Ratio C/A measurement

	Opt 030	Opt 031
Range: A C	0–10 MHz 5–512 MHz	0–10 MHz 90–1300 MHz
General		
Probe power	No	Power to operate 10855A Preamp or HP active probe

## Events C, A to B (with Opt 030 only)

the number of events at the C input are totaled during the synchronized time interval defined by inputs to channels A and B. The synchronized time interval is a multiple of 100 ns with the standard universal module; a multiple of 10 ns with Opt 040 or 041 universal modules.

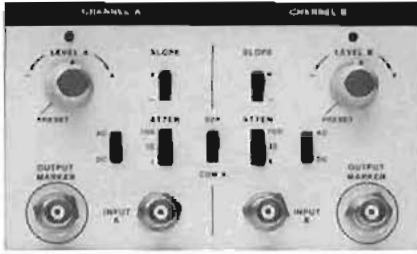

Standard Universal Module

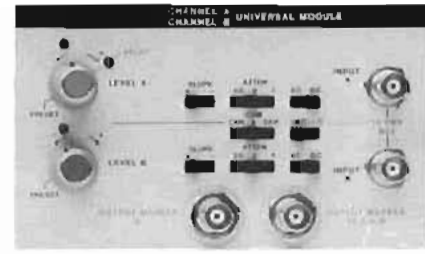

Opt 040 High Performance Universal Module



Opt 041 Programmable Input Universal Module

**Accessories**  
**10855A Preamp:** (for use with Opt 031): gives >22 dB gain with ±1 dB flatness over the entire frequency range of the Opt 031 1300 MHz Channel C. For more details see page 286.

**Universal modules, channels A and B**

Input characteristics	Standard	Opt 040, Opt 041
Sensitivity: 0-40 MHz (ac coupled) 20 Hz-40 MHz (dc coupled) 40-100 MHz	25 mV rms 25 mV rms 50 mV rms	25 mV rms 25 mV rms 50 mV rms
Min pulse width	5 ns, 140 mV p-p	
Coupling	ac or dc, switchable	
Impedance	1 MΩ, 40 pF shunt	1 MΩ (or 50Ω), switchable
Trigger level	variable ±2.5 V times atten setting	
Trigger slope	independent selection of + or - slope	
Attenuators	X1, X10, X100	Opt 040: X1, X2, X20 Opt 041: X1, X10
Dynamic range	25 mV to 1 V rms times attenuator setting for 0-40 MHz; 50 mV to 500 mV times attenuator setting for 40-100 MHz	
Channel Input	Separate or Common A	Separate, Common A, or Check
Delay	No	Opt 040 only: 20µs to 20 ms
Programmable Controls	No	Opt 041 only: level, slope, coupling, atten, impedance, SEP-COM-CHK
<b>Frequency A measurement</b>		
Range	0-100 MHz, direct count	
Resolution	1 MHz to 0.1 MHz in decade steps	
Accuracy	±1 count, ±1 timebase error	
<b>Period A measurement</b>		
Range	0-10 MHz	
Resolution	100 ns to 1 s in decade steps	10 ns to 0.1 s in decade steps
Accuracy	±1 count ± timebase error ± trigger error*	

Period Average A measurements		
Range	0-10 MHz	
Resolution	100 ns to 0.01 ps in decade steps	10 ns to 0.01 ps in decade steps
Accuracy	±1 count displayed ± timebase error ± trigger error* / N	
<b>Time Interval A to B measurements</b>		
Range	100 ns to 10 <sup>6</sup> s	10 ns to 10 <sup>6</sup> s
Resolution	100 ns to 1 s in decade steps	10 ns to 0.1 s in decade steps
Accuracy	±1 count ± timebase error ± trigger error*	
<b>Time Interval average A to B</b>		
Range	0.1 ns to 10 s	0.1 ns to 1 s
Resolution	±100 ns ± trigger error* / √N ±10 ps	±10 ns ± trigger error* / √N ±10 ps
Accuracy	± resolution ± 4 ns ± timebase error	± resolution ± 2 ns ± timebase error
Min. pulse width	25 ns	10 ns
Min. dead time (from each stop event to next start event)	150 ns	40 ns
<b>Ratio B/A measurements</b>		
Range: A/B	0-10 MHz / 0-100 MHz	
<b>Totalizing and scaling, Start A</b> The number of counts at the A input are totalized for N = 1 on the resolution switch. For N > 1, A/N is totalized and the scaled output (A/N) is available at the Timebase Out rear panel connector.		
Range: N = 1 / N > 1	0-100 MHz / 0-10 MHz	

\* Trigger error is < 0.3% of one period for sinewaves of 40 dB S/N or better and amplitude equal to sensitivity of counter. For any waveshape, trigger error is less than

$$\begin{aligned} & \pm 2 \times \frac{\text{peak noise voltage}}{\text{signal slope}} \\ & \left( \text{or } \frac{\pm 0.025 \mu\text{s}}{\text{signal slope in } V/\mu\text{s}} \text{ for 40 dB S/N} \right) \end{aligned}$$

**Model 5328A (cont.)**
**Measurements with delay (Opt 040)**

Delay mode is activated by the inner concentric knob on Level A control of option 040 Universal Module. A red LED indicates delay is activated. In delay mode, Channel A triggers and is then disabled from triggering again until the delay times out (disabled state occurs within 1  $\mu$ s after triggering.) Channel B is continuously disabled until the delay times out. After the delay, both A and B are enabled. The delay time may be measured by placing the counter in T.I.A B and the Universal Module in check (CHK).

**Delay range:** 20  $\mu$ s to 20 ms continuously adjustable.

**Minimum dead time:** 1  $\mu$ s between stop and next start (T.I. average measurements only).

**General**

**Display:** 9 digit LED display, Ninth digit used only with channel C functions (FREQ. C, Ratio C/A, Events C, A B).

**Blanking:** suppresses display of unwanted zeros to left of most significant digit.

**Storage:** holds reading between samples; can be overridden by rear panel switch.

**Sample rate:** variable from less than 2 ms between measurements to HOLD which holds display indefinitely.

**Gate output:** rear panel output, TTL levels; high when counter gate open.

**Timebase output:** rear panel output; TTL levels.

**Check signal:** with function switch in CHECK, counter should display 10 MHz + 1 count. With options 040 and 041, place function switch in FREQ A and universal module in CHECK (CHK). Counter should display 100 MHz  $\pm$  1 count.

**Trigger lights:** light is ON when input is above trigger level; OFF when input is below trigger level; BLINKING when channel is triggering. Operate over full frequency range of 0–10 MHz.

**Marker outputs:** indicate actual change of state of input Schmidt trigger for channels A and B with <20ns delay. Output levels into 50 $\Omega$  are 0 to –100 mV for the standard universal module, 0 to –50 mV for option 040, and 0 to +1 V for option 041. Outputs are protected from inadvertently applied voltage to  $\pm$ 5 V dc.

**Arm:** rear panel switch turns arming ON or OFF. With arming ON the measurement is armed by an input other than the input involved in the measurement. The following are armed by an event at B: Freq A, Period A, Period Avg A, Freq C, DVM, Ratio C/A; the following are armed by an event at C: T.I. A $\rightarrow$ B, Events C, A $\rightarrow$ B, Ratio B/A.

**Operating temperature:** 0° to 50°C.

**Power requirements:** 100/120/220/240 V rms, +5%, –10% (switch selectable), 48–66 Hz; 150 VA max.

**Timebase oscillators**
**Standard crystal oscillator**

**Frequency:** 10 MHz.

**Aging rate:** <3  $\times$  10<sup>-7</sup>/month.

**Temperature:** <2.5  $\times$  10<sup>-9</sup>, 0° to 50°C.

**Line voltage:** <1  $\times$  10<sup>-7</sup> for 10% change.

**Opt 010 oven oscillator**

**Frequency:** 10 MHz.

**Aging rate:** <5  $\times$  10<sup>-10</sup>/day after 24-hour warm-up.

**Short term:** <1  $\times$  10<sup>-10</sup> rms/s.

**Temperature:** <7  $\times$  10<sup>-9</sup>, 0° to 50°C.

**Line Voltage:**  $\pm$ 5  $\times$  10<sup>-9</sup> for 10% variation.

**Warm-up:** within 5  $\times$  10<sup>-6</sup> of final value in 20 min.

**Ext. freq. std. Input:** 30 kHz to 10 MHz signal of amplitude >1.0 V rms into 1 k $\Omega$ . Maximum input: 5 V p-p. Correct readings. With options 040 and 041 the following constraints apply: ext. freq. std. must be 10 MHz for Period Avg., T.I. Avg., Period (N=1), and T.I. (N=1).

**HP-IB Interface (Opt 011)**

Option 011 provides digital output of measurement data ("talker") as well as input for remote program control ("listener").

**Programmable features:** function, resolution, sample rate (max or manual control), arming, display modes, measurement cycle modes, output modes, and reset commands. Option 041 adds control of channel A and B trigger level, slope, attenuator, coupling, input impedance, and SEP-COM-CHECK selection.

**HP-IB commands:** responds to the following bus commands (see HP-IB Users Guides for definitions)—Unlisten, Untalk, Local Lockout, Device Clear, Serial Poll Enable, Serial Poll Disable, Go to Local, Selected Device Clear, and Group Execute Trigger.

**Service request (SRQ):** if enabled, indicates end of measurement.

**Maximum data output rate:** 500 readings/sec.

**Accessories**

5363A Time Interval Probe: solve many of the "hidden" problems of precision time interval measurements. The 5363A Time Interval Probes minimize circuit loading, give calibrated trigger level settings, increase input dynamic range, and allow differential channel delay calibration. See opposite page for more details.

**Options and accessories**

	<b>Price</b>
<b>010:</b> High Stability Timebase	\$525
<b>011:</b> HP-IB Interface	\$350
<b>020:</b> DVM	\$200
<b>021:</b> High Performance DVM	\$500
<b>030:</b> 512 MHz Channel C	\$400
<b>031:</b> 1300 MHz Channel C	\$600
<b>040:</b> High Performance Universal Module	\$350
<b>041:</b> Programmable Input Controls Module	\$950
<b>907:</b> Front Handle Kit	\$15
<b>908:</b> Rack Flange Kit	\$10
<b>909:</b> Rack Flange and Front Handle Combination Kit	\$20
<b>10855A:</b> Preamp	\$225
<b>5363A:</b> Time Interval Probes	\$1900

**5328A Universal Counter**
**\$1300**

- Solves major T.I. problems
- Precisely defines trigger points
- Greatly improves dynamic range



HP-IB programmable Time Interval Probes

- Equalizes system timing errors
- Active probes minimize circuit loading
- Measures to zero time interval

The 5363A calibration procedure equalizes out such system delays and allows the counter and probes to be set for 0.0 ns. When a counter with a minimum T.I. range is used (such as HP 5345 or 5328A) a fixed offset of 10.0 ns can be switched in allowing the counter to measure down to zero time interval.

#### Automated operation

Under calculator control the standard HP-IB capability allows the probes and a counter to perform a wide variety of automated waveform analysis. In the lab or production line complex measurements or go-no-go decisions can be made with push button simplicity. For further details refer to the 5363A Technical Data Sheet and AN 191 on Time Interval Measurements.

#### Specifications

**Dynamic range:** +9.99 V to -9.99 V.

**Voltage resolution:** 10 mV.

**Time resolution:** depends on counter used (typ. 10 ps with 5345A T.I. Avg).

**Impedance:** 1 MΩ shunted by <15 pF.

**Effective bandwidth:** 350 MHz (or 1 ns rise time).

**Minimum pulse width:** input signal must remain below and above trigger point for at least 5 ns (i.e., max repetition rate of square wave = 100 MHz).

#### Absolute accuracy

$$\pm 1 \text{ ns} = \frac{\text{START trigger level accuracy}}{\text{START signal slew rate at trigger point}} \pm \frac{\text{STOP trigger level accuracy}}{\text{STOP signal slew rate at trigger point}}$$

**Trigger level accuracy (A&B)\*:** =  $\pm 8 \text{ mV} \pm 0.2 \text{ mV}/^\circ\text{C} \pm 0.15\%$  of trigger point.

**Differential trigger level accuracy (A&B)\*:** used when A&B are set to the same voltage, same slope, and identical wave forms:  $\pm 3 \text{ mV} = 0.3\%$  of trigger point.

**Max Input voltage:** 30 V peak.

**Linear operating range:**  $\pm 10 \text{ V}$

**Output to counter:** separate start and stop channels. -0.5 to +0.5 V into 50Ω, <2 ns rise time.

**Trigger level outputs:** trigger point setting  $\pm 75 \text{ mV}$ .

**Delay compensation range:** 2 ns adjustable about 0.0 ns or 10.0 ns.

**Power:** 100, 120, 220 or 240 V ac (+5 -10%); 48 to 440 Hz; 30 VA max.

**Weight:** 16.2 kg (7 lb, 6 oz.).

**Dimensions:** rack height 88.9 mm (3 1/2"); half rack width module 212 mm (8 3/8"); depth 248 mm (11 1/4").

**Environmental:** operating temperature 0°C to 55°C.

**Systems interface:** HP-IB programming of all functions except delay adjust vernier (which can be measured in a system).

\*After calibration and within the range between 100 mV or 3% (whichever is greater) from the top or bottom of input signal.



#### Recommended counters

	Price
5345A Electronic Counter; 2 ns single shot T.I., True T.I. averaging	\$4,400
5328A Opti-040 Universal Counter; 10 ns single shot T.I., True T.I. averaging	\$1,650
5360A/5379A Computing Counter; 1 ns T.I. accuracy, 0.1 ns resolution for single shot events	\$11,500
5370A Universal Time Interval Counter 20 ps single shot, true T.I. averaging	\$11,500

#### 5363A Accessories

10229A Hook Tip	\$5
10218A BNC to Probe Adapter	\$11
1250-0655 BNC Tee to Probe Adapter	\$15
10100C 50Ω Feedthru termination for non-50Ω T.I. counter	\$22
10821A Accessory Kit with 2 each of above plus adapters	\$125

#### 5363A Time Interval Probes

\$2250

#### Repeatable measurements

The 5363A provides the necessary input signal conditioning to allow a precision time interval counter to make highly accurate and repeatable measurements on time varying waveforms. No longer are

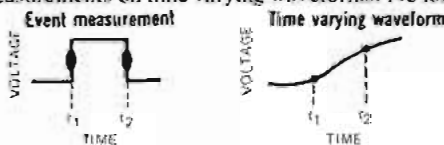

counters restricted to "event" type measurements. Counters such as the 5345A, 5328A and 5360A can now be adapted to make measurements such as rise time, fall time, slew rate, propagation delay and phase jitter analysis.

#### Trigger point calibration

A unique scheme of Trigger Point Calibration is used instead of hysteresis compensation to assure that the value selected on the digital dials or via the HP-IB is the actual triggering point rather than some unspecified "best estimate" of the trigger point or the center of the hysteresis window.

#### 20 V dynamic range with 10 mV resolution

Greatly improved dynamic range allows the trigger point to be selected in 10 mV increments from -9.99 V to +9.99 V covering the range of most commonly used logic circuits. The use of attenuators on traditional T.I. counters to extend their range increases the effective hysteresis window by the same attenuation amount. This prevents trigger points close to the top or bottom (i.e. 10% or 20% points) of the waveform from being selected and sometimes creates "holes" where certain trigger points cannot be selected at all. The wide dynamic range of the 5363A overcomes these problems.

#### Minimized circuit loading

Active high impedance, low capacitance probes minimize circuit loading and pulse distortion while permitting test points to be monitored without the need for built-in pulse transformers or impedance matching devices. Each probe contains both a start and a stop channel so that a rise time into a device can be measured with one probe, the rise time out of the device with the other and the propagation delay thru the device can be measured between the probes.

#### Systematic timing errors eliminated

Delays through probes, cables and the inherent differential delays inside the counters' timing channels (i.e., <700 ps in 5345A) limit the absolute accuracy of the time interval measurement to some unknown but fixed amount.

## ELECTRONIC COUNTERS

High resolution time synthesizer

Model 5359A

- Precise digital delays 0-160 ms
- Jitter <100 ps
- Increments 50 ps

- Programmable
- Fully synced to external trigger

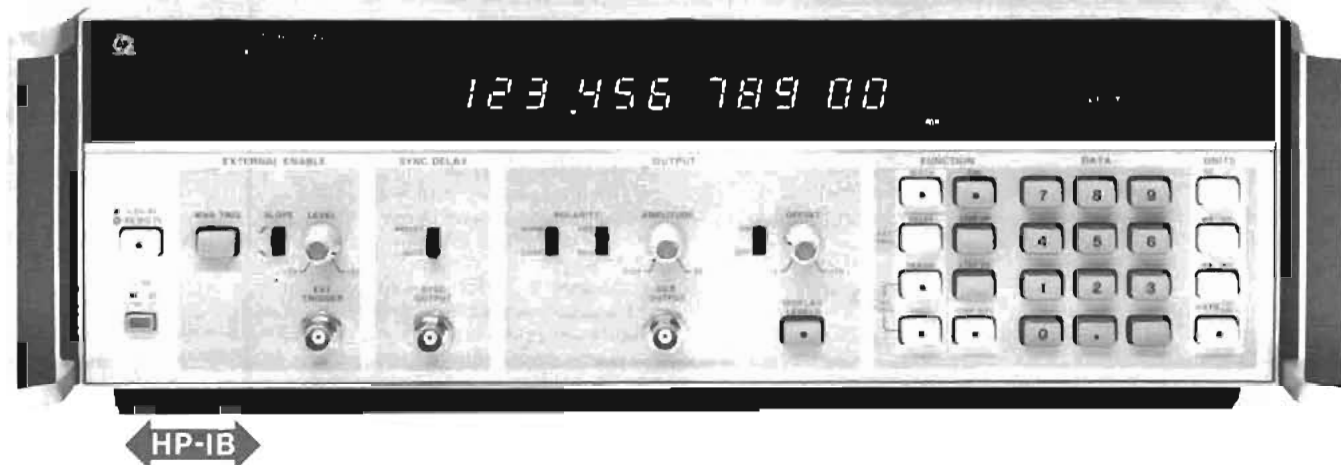

The 5359A Time Synthesizer produces two extremely precise, low jitter time delays. These delays,  $T_d$  and  $T_w$ , are individually selectable by means of the keyboard, in 50 ps or greater steps to generate delays of up to 160 ms.

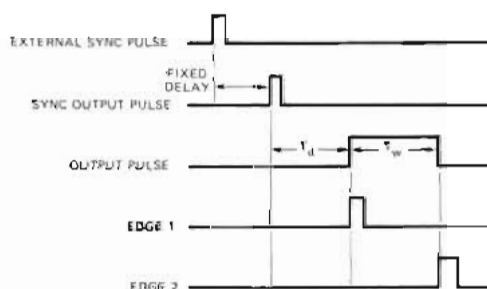

The 5359A has many applications and may be used for the calibration of Radar, Loran, DME and Tacan Systems, or for precision generation of delayed sweeps in oscilloscopes, and for extremely accurate "time positioning" control of external gates on frequency counters. In component and circuit test, the instrument may be used for extremely accurate delay line simulation.

## Specifications

### Modes

**External Trigger Mode:** the delays from the sync out to the beginning of the output pulse, and the width of the output pulse, are selected.

**Internal Trigger Mode:** the "period" or "frequency", and the width of the output pulse, are selected.

### Range

**Delay  $T_d$ :** 0 nS to 160 mS.

**Width  $T_w$ :** 5 nS to 160 mS (width & delay  $\leq$  160 mS).

**Period:** 100 nS min. or width + 80 nS, 160 mS max.

**Frequency:** same as corresponding "period".

**Repetition rate:** 10 MHz max.

**Accuracy:**  $\pm 1$  nS  $\pm$  time base error.

**Insertion delay:** fixed at <130 nS; selectable as <30 nS for delays >100 nS.

**Jitter:** typical 100 pS RMS; maximum 200 pS RMS

**External trigger input:** -2 V to +2 V slope selectable.

**Sync output:** 1 V - 50 $\Omega$ ; 5 V - 1 M $\Omega$ . Width 35 nS nominal.

### Output pulse

**Amplitude:** 0.5 V to 5 V into 50 $\Omega$ .

**Polarity:** positive or negative.

**Offset:** -1 V to 1 V, or OFF.

**Transition time:** <5 nS.

External voltage must not be applied. Offset and Amplitude voltage into 50 $\Omega$  may be displayed

**EDGE 1 OUTPUT (rear panel):** occurs in Sync with leading edge of output pulse (same spec. as Sync out).

**EDGE 2 OUTPUT (rear panel):** occurs in Sync with falling edge of output pulse (same spec. as Sync out).

**Events mode:** substitutes external input (to 100 MHz) for the internally counted clock (Delay and width must both be specified in events and not time).

**Triggered frequency mode:** the same as internal frequency mode except the output is a burst beginning in synchronism with an external trigger signal, and continues for the duration of this signal.

**Calibrate mode:** performs an internal calibration to remove the effects of internal delay differences.

**External probes:** provides outputs to control the 5363A probes and accepts inputs from the probes to include external devices in the calibration loop.

**HP-IB:** All controls except trigger levels are programmable.

### Time base

**Frequency** 10 MHz

**Aging**  $<3 \times 10^{-7}$ /month

**Temperature**  $<2.5 \times 10^{-6}$ , 0°C to 50°C

**Line voltage**  $1 \times 10^{-7}$  for 10% change

### 001 High stability time base

**Frequency** 10 MHz. Aging  $5 \times 10^{-10}$ /day.

**Temperature**  $3 \times 10^{-9}$ , 0° to 55°

**Size:** 146.1 H  $\times$  425.5 W  $\times$  520.7 mm D (5.75"  $\times$  16.75"  $\times$  20.50").

**Weight:** 30 lbs.

### Options and accessories

**001:** High Stability Time Base

**908:** Rack Flange Kit

**10870A:** Service Kit

**Price**

add \$575

add \$20

add \$430

5359A Time Synthesizer

\$6500



- 20 ps single shot time interval counter
- Statistics
- Automatic calibration of systematic errors
- Positive or negative time intervals
- Frequency and period to 100 MHz

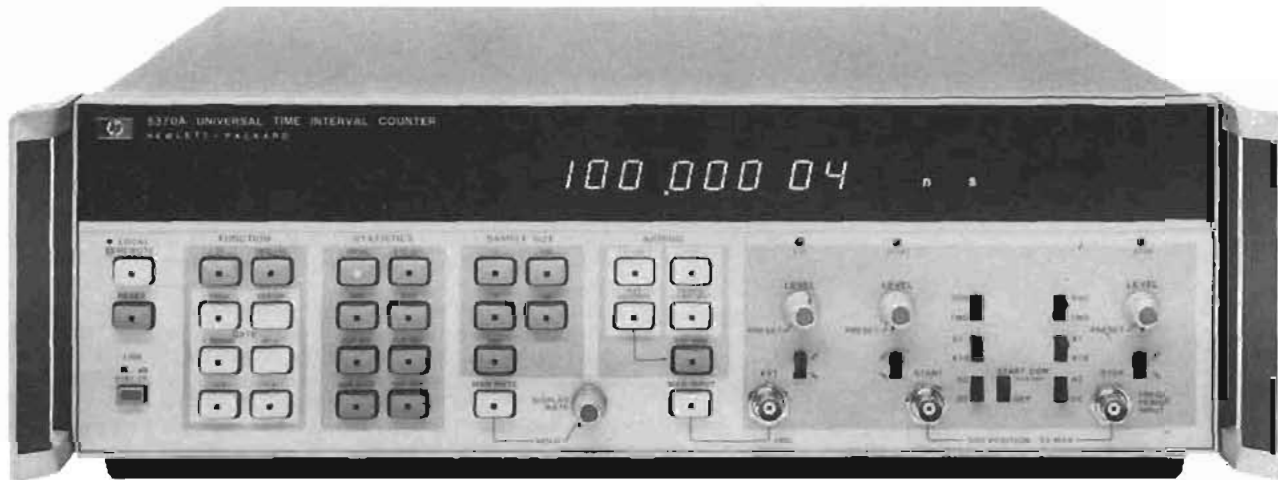

5370A



The 5370A Universal Time Interval Counter represents the highest resolution single-shot time interval counter available today. The counter utilizes a new concept of phase locked vernier interpolation, which allows single-shot time interval measurements with  $\pm 20$  ps resolution, and  $\pm 100$  ps accuracy. This technique allows positive, zero, and negative time intervals to be measured. High resolution period and frequency measurements may also be made.

All major front panel controls including trigger level are programmable by means of the Hewlett-Packard Interface Bus (HP-IB).

User convenience is increased by the inclusion of a microprocessor, which extends the usefulness of the instrument by offering the statistical functions of mean, standard deviation, max, and min for repetitive time intervals. A user-defined time interval reference is included for the cancellation of systematic errors.

The high resolution time interval capability makes the instrument ideal for IC testing, radar and laser ranging, digital communications, ballistics and nuclear measurements.

#### Functions

**TI:** Time Interval function measures time difference from START channel to STOP channel.

**Trig lev:** Measures the trigger levels of START and STOP channels and displays both levels simultaneously.

**Freq:** Measures the frequency of the STOP channel signal by taking the reciprocal of a period average.

**Period:** Measures a period average of STOP channels events.

#### Statistics

**Sample size:** push-button selectable to 1, 100, 1 K, 10 K, and 100 K samples.

**Mean:** displays the mean estimate which is the average for the selected sample size.

**Std dev:** displays a standard deviation estimate for the selected sample size.

**Min:** displays the minimum time interval measured within the selected sample size.

**Max:** displays the maximum time interval measured within the selected sample size.

## 5370 Specifications

### Input Amplifiers

**Bandwidth:** DC to 500 MHz (at DC, 50 $\Omega$  or 1 M $\Omega$ )  
4 MHz to 500 MHz (AC, 50 $\Omega$ )  
200 Hz to 500 MHz (AC, 1 M $\Omega$ )

**Sensitivity:** X1-40 mV peak to peak  
X10-400 mV peak to peak

**Dynamic range:** X1 40 mV to 1 V peak to peak.  
X10 0.4 V to 7.0 V peak to peak at 50 $\Omega$ .  
0.4 V to 10 V peak to peak at 1 M $\Omega$ .

**Trigger level:** adjustable from -1.3 V to 0.5 V.

### Range

$\pm$  TI: -10s to 10s.

+ TI only Arm Mode: +10 ns to +10s.

**Resolution:**  $\pm 20$  ps minimum.

**Accuracy:** with respect to user-defined reference,  $\pm$  time base accuracy  $\pm$  jitter  $\pm$  trigger error.

**Jitter:** typical 35 ps RMS; maximum 100 ps RMS.

**Trigger error:**  $\pm 2 \times \frac{\text{noise peak voltage}}{\text{signal slope V}/\mu\text{s}}$   $\mu\text{s}$ .

**Frequency/period average measurement range:** 0-100 MHz.

**Max data rate:** 100 M bits.

**Gate time:** 1 period, 0.01s, 0.1s, 1s.

### Timebase

**Frequency:** 10 MHz.

**Aging:**  $< 3 \times 10^{-7}$ /month.

**Temperature:**  $< 2.5 \times 10^{-4}$ , 0°C to 50°C.

**Display:** 16 digits, suppressed leading zeros.

**Size:** 133 H  $\times$  426 W  $\times$  521 mm D (5 $1/4$ "  $\times$  16 $3/4$ "  $\times$  20 $1/2$ ").

**Weight:** 32 lbs.

### Options and accessories

**001:** High Stability Time Base

**008:** Rack Flange Kit

**10870A:** Service Kit

### Price

add \$575

add \$20

add \$430

5370A Universal Time Interval Counter

\$6500

# ELECTRONIC COUNTERS

Plug-on modular/portable counter system

Model 5300 A/B system & 5301A-5312A



## 5300 Measuring system

The 5300 measuring system marks a new era of high performance and versatility for low cost counters.

### Features include

- 10 MHz, 50 MHz, 525 MHz and 1.3 GHz
- 100 ns Time interval resolution and time interval averaging
- Up to 8 digits
- Auto ranging
- Unique time interval hold off
- Expandable with interchangeable modules
- Optional FCC type approved TCXO time base
- Portable-battery operation with all modules
- Compact and rugged
- High reliability MOS/LSI circuitry and LED display
- Designed for quick & easy owner-servicing
- Output via BCD, HP Interface Bus (HP-IB), or D to A converters

## Description

Large scale integration and solid state display technology have helped to produce a uniquely versatile and capable counter at a surprisingly low cost. Easy to use and reliable, this counter does what is important—solves your measurement problems while saving your money. Versatility and antiobsolescence come from modular construction. Take your choice from two mainframes and select the snap on module that you need now. Expand the capability later with more modules, if and when you need them. You can expand the capability of your 5300 Measuring system to match your expanding needs and budget. Hewlett-Packard is engaged in an on-going program to develop expanded capabilities for the 5300 as shown by the "new modules" just added in this catalog. An optional battery pack provides portable cord-free operation of any of the modules, eliminating power problems and ground loops. The new plug-between digital to analog converter gives you an analog output that can drive a strip chart recorder, providing hard copy of any of the 5300 System's measurements. You can now easily obtain hard copy recordings of frequency drifts, time interval shifts, ratio changes, ohms variations, and even totalized levels from the 5300 system and its plug-between D to A converter. The BCD output and HP-IB module lets you interface digitally with other instruments and systems. This is versatility that truly avoids obsolescence and optimizes your instrument dollars.

## Unique benefits

Snap-together modularity allows you to match the display/mainframe capabilities with the functional module of your choice to match your present needs. Additional modules can be added as your measurement needs and budget expand, including the selection of three center modules which allows you to add a battery, a D to A Converter, or an HP-IB output to your system when and if you need them. Frequencies up to 1.3 GHz can be measured with this portable precision frequency counter. Single time intervals can be measured with 100 ns resolution. Time interval averaging up to 10<sup>5</sup> intervals allows you much greater resolution than ever available before in a counter of this price range.

## Auto ranging

Auto ranging is included in many of the functions, enhancing the ease of operation by automatically selecting a correct gate time to fill the display. Any frequency within the range of the 5301A, 5302A, 5304A, 5307A and 5308A may be counted with the counter's logic circuits automatically selecting the correct gate time up to 1 second for maximum resolution without exceeding the display range. In the 5302A and 5304A auto ranging is also provided for the Period Average function to select the number of periods to be averaged. The high performance 5308A Universal Counter provides autoranging in the Frequency, Period Average, Ratio, and Time Interval average modes, a first for counters in any price range.

## Time Interval holdoff

Time interval holdoff is a unique feature of the 5304A Time/Counter module. This feature allows you to add a fixed delay between the start of a time interval measurement and the enabling of the stop channel. Thus any electrical pulses or irregularities in a waveshape that occur between the desired trigger points can be ignored. Even the delay itself can be measured with the 5304A.

5300A 6 DIGIT MAINFRAME									\$500	pg 280
5300B 8 DIGIT MAINFRAME									\$460	pg 280
5310A BATTERY PACK									\$275	pg 288
5311B DIGITAL TO ANALOG CONVERTER									\$395	pg 285
5312A ASCII INTERFACE									\$350	pg 285
Model	Frequency MHz	Period	Period Average	Time Interval	Time Interval Average	Totalize	Ratio	Multimeter ACV, DCV, (1)	High Resolution Reciprocal	
5301A	10					•				\$325 pg 281
5302A	50	•	•	•		•	•			\$325 pg 281
5303B	525									\$825 pg 282
5304A	10		•	•		•				\$385 pg 262
5305B	1300									\$800 pg 283
5306A	10							•		\$950 pg 283
5307A	2								•	\$395 pg 284
5308A	75	•	•	•	•	•	•			\$450 pg 284

### Typical Configurations



5300B, 5310A, 5305B

Frequency Measurement System  
for Mobile Communications  
Go Anywhere Portability



5300A, 5311B, 5306A

Trend Recording System for Volt-  
age, Resistance, and Frequency  
Graphic Copy for Visual Analysis



5300B, 5312A, 5308A

Data Acquisition System for Mea-  
surement and Recording of Data  
Reduction of All Measurements

#### High resolution

High resolution at low frequencies is provided by the 5307A counter module. This easy to use counter makes a period average measurement, inverts it and displays the result as a frequency, thereby providing the high resolution of a period measurement and the ease of use of a frequency measurement automatically.

#### Digital and analog output

Digital output is available in BCD format (standard in 5300A mainframe) or ASCII format via the HP Interface Bus (to be used with 5300B mainframe) to provide interfacing with digital printers or with desktop calculators and other data processing equipment. Analog output for long term monitoring with strip chart recorders is provided by a digital to analog converter. This provides the capability to generate hard copy results of any of the measurements made by any of the 5300 modules.

#### Battery pack

A snap between battery pack provides a truly portable, light weight, go-anywhere measuring system for any of the 5300 Systems.

#### Serviceability

Reliability and easy servicing have been major design criteria for all of the 5300 modules. The small number of components and the use of modular design techniques allows problems to be easily traced to functional blocks. A check function is built into most of the functional modules to allow immediate checking of the basic counter circuits from the front panel. A user oriented service support package is available that provides plug-in cards with automatic diagnostic routines that allow the 5300 mainframes to troubleshoot themselves. Features like these make the net cost of owning either a 5300A or 5300B Measuring System less than that of conventional counters.

## 5300 A/B systems (cont.)



5300A



5300B



### 5300A and 5300B measurement system mainframe

The mainframe units provide the system with power, reference frequency, display, counting logic and timing control.

The 5300A has a six digit, dot matrix display, standard time base, external time base input and BCD output as a standard rear panel output. The 5300B has an 8-digit 7-segment display, standard time base or optional TCXO time base, external time base input and no digital output from the mainframe. See mainframe/plug-on display chart below for number of display digits with a particular mainframe and plug-on combination.

#### Time-base

**Standard crystal frequency:** 10 MHz.

#### Stability

**Aging rate:** <3 Parts in 10<sup>7</sup>/mo.

**Temperature:** <±5 Parts in 10<sup>6</sup>, 0° to 50°C.

**Typically:** <±2 Parts in 10<sup>6</sup>, 15° to 40°C.

**Line voltage:** <±1 Part in 10<sup>7</sup> for 10% line variation.

**Oscillator output:** 10 MHz, Approximately 1 V rms at rear panel BNC, 100Ω source impedance.

**External input:** 1 MHz to 10 MHz, 1 V rms into 200Ω.

**Opt 001 High stability time base (5300B only)**

**Frequency:** 10 MHz.

#### Stability

**Aging rate:** <1.2 parts in 10<sup>6</sup>/year.

**Temperature:** <±5 parts in 10<sup>7</sup>, 0° to 50°C.

**Line voltage:** <±5 parts in 10<sup>6</sup> for 10% line variation.

**Oscillator output:** 10 MHz, approximately 1 V rms at rear panel BNC, 200Ω source impedance.

**External input:** 1 to 10 MHz, 1 V rms into 500Ω.

#### General

**Display:** 6 Digit, Dot Matrix (5300A) or 8 Digit, 7 Segment Matrix (5300B). Solid state LED display (Gallium Arsenide Phosphide Light Emitting Diodes) including decimal point and annunciator units.

**Overflow:** LED Light indicates when display range is exceeded.

**Display storage:** holds reading between samples. Sample rate: Sample rate control adjusts the delay from the end of one measurement to the start of a new measurement. Continuously variable from less than 50 msec to greater than 5 seconds. HOLD position: display can be held indefinitely. Reset: Front panel pushbutton switch resets all registers and initiates new measurement. Reset input by contact closure to ground or TTL type low level also available on rear panel connector (5300A only).

**Operating temperature:** 0° to 50°C.

**Power requirements:** 115 or 230 volts ±10%, 50 to 400 Hz, 25 VA maximum (depends on plug-on module). Mainframe power without

plug-on nominally 5 watts. Battery operation: with 5310A rechargeable battery pack (see 5310A specifications).

#### Digital output (5300A only)

Digital serial, 4-bit BCD parallel available at rear panel connector.

**Code:** 4-line 1-2-4-8 BCD, "1" state low, TTL type logic levels.

**Decimal point:** decimal point code (Binary "1111") automatically inserted at correct digit position.

**Print command:** positive step, TTL output.

**Holdoff:** contact closure to ground or TTL low level, inhibits start of new measurement cycle.

**Connector:** 20-pin PC connector. Mating connector Viking 2VH10/1JN or equivalent.

**Parallel data output:** available from Printer Interface. See 10533A specification.

**Note:** digital output for 5300B Mainframe is provided by 5312A HP-IB Interface module.

**Weight:** net, 1.5 kg (3 1/8 lb). Shipping, 2.5 kg (5 1/2 lb).

**Dimensions:** (with snap-on module): 89 mm H × 160 mm W × 248 mm D (3 1/2" × 6 1/4" × 9 3/4").

#### Mainframe/plug-on compatibility

Plug-on	Display Digits	
	with 5300A	with 5300B
5301A	6	7
5302A	6	7
5303B	6	8
5304A	6	7
5305B	6	8
5306A (Frequency)	6	7
(ACV, DCV, OHMS)	5	5
5307A	6	6
5308A	N/A	8

#### Accessories

**Digital Recorder Interface:** (for use with 5300A, BCD output) See 10533A Specifications, Page 255

**10548A Service support package:** Contains an interface card and 4 diagnostic cards for easy trouble shooting of 5300A or 5300B, Page 260

**18019A Leather carrying case:** Holds 5300A or 5300B, snap-on module and 5310A battery pack plus accessories

#### Rack mount kits

Rack mount kit	Price
10851A Single	\$46
10852A Double	\$40
10853A Single/with plug-between	\$40
10854A Double/with plug-between	\$40

#### Ordering instructions

5300A 6 digit mainframe	\$500
5300B 8 digit mainframe	\$460
Opt 001: TCXO (5300B only)	add \$180

- 10 MHz
- Auto ranging
- External gate

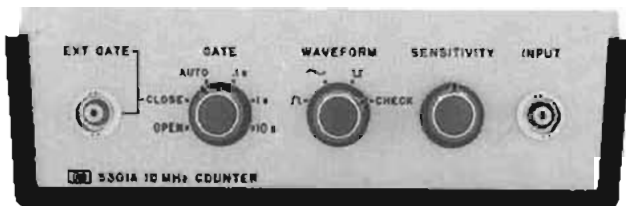

5301A

### 5301A 10 MHz frequency counter module

#### Input

**Range:** 10 Hz to 10 MHz.

**Sensitivity (min):** 25 mV rms sine wave 50 Hz to 1 MHz, 50 mV rms sine wave 10 Hz to 10 MHz; 150 mV p-p pulse at minimum pulse width, 50 ns. Sensitivity variable to 2.5 V rms.

**Impedance:** 1 MΩ shunted by less than 30 pF.

**Overload protection:** 500 V (dc + peak ac), 250 V rms dc to 400 Hz, 10 V rms at 10 MHz.

**Trigger level:** selectable positive, negative, or zero volts.

#### Frequency measurement

**Range:** 10 Hz to 10 MHz.

**Gate times:** manually selected 0.1, 1, or 10 seconds AUTO position selects gate time to 1 second for maximum resolution.

**Accuracy:** ± 1 count ± time base accuracy.

#### Open/close (totalizing)

**Range:** 10 MHz max count rate.

**External gate:** gate signal by contact closure to ground or TTL low.

#### General

**Check:** counts internal 10 MHz reference frequency.

**Operating temperature:** 0° to 50°C.

**Power requirements:** including mainframe, nominally 8 watts.

**Weight:** net, 0.9 kg (2 lb). Shipping, 1.5 kg (3 1/4 lb).

**Dimensions:** see Mainframe.

5301A 10 MHz Frequency Counter Module \$225

### 10533A Recorder interface specifications

The 10533A accessory provides an interface between the 5300A measurement system mainframe and a standard parallel-input recorder such as the HP 5055A. The interface module provides conversion from the 5300A serial data output to a standard parallel format.

**Output format:** 10 parallel digits; 6 data, 1 decimal point, 1 overflow, 1 exponent and 1 exponent sign.

**Code:** 4-line 1-2-4-8 BCD; "1" state low TTL levels.

**Decimal point:** floating decimal point automatically inserted at correct digit position. Coded "1111" ("\*" on standard HP 5055A print wheels). Internal jumper wire removes decimal point from data format if desired.

**Overflow:** coded "1111" ("\*") printed in first printer column when 5300A overflow light is on.

**Exponent:** ±0, ±3, ±6 corresponding with 5300A measurement units.

**Print command:** negative step, TTL levels.

**Inhibit Input:** +2.0 V or higher prevents the 5300A from recycling.

**Power requirements:** 100 mA at 5 volts, provided by 5300A mainframe.

10533A Recorder Interface \$225

\*For any wave shape, trigger error is less than

$$= \frac{0.0105 \mu s}{\text{Signal Slope (V/}\mu\text{s)}}$$

For period average this is less than ± 0.3% of one period + period average for signals with 40 dB or better signal-to-noise ratio.

- 50 MHz universal counter
- Automatic or manual gate selection
- 100 nsec time interval resolution

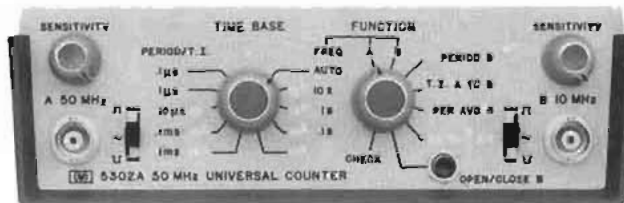

5302A

### 5302A 50 MHz universal counter module

#### Input channels A and B

**Range:** channel A: 10 Hz to 50 MHz, Channel B: 10 Hz to 10 MHz.

**Sensitivity (min):** 25 mV rms sine wave 50 Hz to 1 MHz, 50 mV rms sine wave 10 Hz to 10 MHz, 100 mV rms sine wave at 50 MHz, 150 mV p-p pulse at minimum pulse width, 50 ns. Sensitivity variable to 2.5 V rms.

**Impedance:** 1 MΩ shunted by less than 30 pF.

**Overload protection:** 500 V (dc + peak ac), 250 V rms, dc to 400 Hz, 10 V rms above 10 MHz.

**Trigger level:** selectable positive, negative, or zero volts.

**Slope:** automatically switched to trigger on positive slope for positive pulse and negative slope for negative pulse. Positive slope for sinusoidal inputs.

**Marker outputs:** rear BNC, TTL low level while gate is open.

#### Frequency

**Range:** channel A: 10 Hz to 50 MHz, prescaled by 10; channel B: 10 Hz to 10 MHz.

**Gate times:** manually selected 0.1, 1, or 10 seconds. AUTO position selects gate time to 1 second for maximum resolution.

**Accuracy:** ± 1 count ± time base accuracy.

#### Time interval

**Range:** 500 nsec to 1000 seconds.

**Input:** channels A and B.

**Resolution:** 100 ns to 1 ms in decade steps.

**Accuracy:** ± 1 count ± time base accuracy ± trigger error\*.

#### Period

**Range:** 10 Hz to 1 MHz.

**Input:** channel B.

**Resolution:** 100 ns to 1 ms in decade steps.

**Accuracy:** ± 1 count ± time base accuracy ± trigger error\*.

#### Period average

**Range:** 10 Hz to 1 MHz.

**Input:** channel B.

**Periods averaged:** 1 to 10<sup>4</sup> automatically selected.

**Frequency counted:** 10 MHz.

**Accuracy:** ± 1 count ± time base accuracy ± trigger error\*.

#### Ratio

**Display:** F<sub>A</sub>/F<sub>B</sub> times multiplier (N), N = 10 to 10<sup>7</sup>, selectable in decade steps.

**Range:** channel A: 10 Hz to 1 MHz, Channel B: 10 Hz to 10 MHz.

**Accuracy:** ± count of F<sub>B</sub> ± trigger error of F<sub>A</sub>\*.

#### Open/close (totalizing)

**Range:** 10 MHz max.

**Input:** channel B opening and closing of gate initiated by front panel pushbutton switch.

#### General

**Check:** counts internal 10 MHz reference frequency.

**Operating temperature:** 0° to 50°C.

**Power requirements:** including mainframe, nominally 10 watts.

**Weight:** net, 0.9 kg (2 lb). Shipping, 1.5 kg (3 1/4 lb).

**Dimensions:** see Mainframe.

5302A 50 MHz Universal Counter Module \$325



## 5300A/B System (cont.)

- CW or burst to 525 MHz
- Automatic gain control and fused input
- FCC type approved

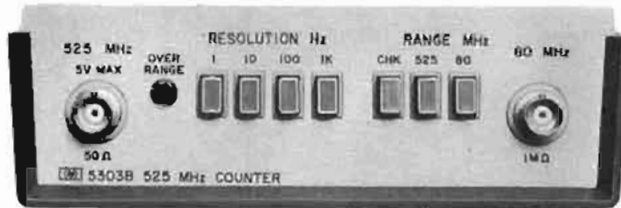

5303B

## 5303B Frequency counter module

This counter module was especially designed for servicing and calibrating mobile communications equipment and AM & FM broadcast equipment. An automatic gain control (AGC) amplifier has been provided on the 80 MHz channel. This provides ease of use by compensating for input level variations and rejecting noise up to 50% of the peak-to-peak level of the input signal. The front end circuitry of the 525 MHz channel is fuse protected against high input signal levels that would normally cause expensive frontend damage. The addition of the battery pack makes this an ideal portable instrument for the lab or the field.

## Input channel A (CW or burst)

**Range:** DC to 525 MHz, prescaled by 8.

**Sensitivity (fixed):**

100 mV rms sine wave, dc to 500 MHz.

125 mV rms sine wave, 500 MHz to 525 MHz.

Signal must pass through zero.

**Impedance:** 50Ω.

**Overload protection:** 5 V rms (input circuitry fuse protected).

## Input channel B (CW or burst)

**Range:** 50 Hz to 80 MHz, direct.

**Sensitivity (automatic):**

25 mV rms sine wave, 100 Hz to 50 MHz.

50 mV rms sine wave, 50 Hz to 100 Hz and 50 MHz to 80 MHz.

Sensitivity is adjusted automatically by AGC (automatic gain control). Effective up to input clipping levels of 10 V p-p.

**Impedance:** 1 MΩ shunted by less than 40 pF.

**Overload protection:** 250 V rms, 50 Hz to 10 KHz decling to 10 V rms above 10 MHz.

## Frequency measurement

**Resolution:** (selectable): 1, 10, 100, 1000 Hz.

**Accuracy:** ±1 digit ± time base accuracy.

## General

**Check:** counts internal 10 MHz reference frequency.

**Overflow:** light indicates display exceeded.

**Operating temperature:** 0° to 50°C.

**Power requirements:** including mainframe, nominally 10 watts.

**Weight:** net, 0.9 kg (2 lb). Shipping, 1.5 kg (3¼ lb).

**Dimensions:** see mainframe.

5303B 525 MHz Counter

\$825

Opt 001:

add \$180

High stability time base (for use with 5300A)

**Frequency:** 10 MHz.

**Stability**

**Aging rate:** < 1.2 part in 10<sup>6</sup>/year.

**Temperature:** < ±5 parts in 10<sup>7</sup>, 0° to 50°C.

**Line voltage:** < ±5 parts in 10<sup>6</sup> for 10% line variation.

**Oscillator output:** 10 MHz, approximately 1 V rms at rear panel BNC, 200Ω source impedance.

**External input:** 1 to 10 MHz, 1 V rms into 500Ω.

\*For any waveshape, trigger error is less than

$$= \frac{0.005 \mu\text{s}}{\text{Signal Slope (V}/\mu\text{s})}$$

\*\*Trigger error is less than ±0.3% of one period ÷ periods averaged for 40 dB or better signal-to-noise ratio.

- Matched input amplifier
- Time interval hold-off
- 100 nsec time interval resolution



5304A

## 5304A Timer/counter module

## Input channels A and B

**Range:** DC coupled: 0 to 10 MHz, AC coupled: 100 Hz to 10 MHz.

**Sensitivity (min):** 25 mV rms sine wave to 1 MHz, 50 mV rms sine wave to 10 MHz, 150 mV p-p pulse at minimum pulse width, 40 nsec. Sensitivity can be decreased by 10 or 100 times using ATTENUATOR switch.

**Impedance:** 1 MΩ shunted by less than 30 pF.

**Overload protection:** 250 V rms on X10 and X100 attenuator settings. On X1 attenuator setting 120 V rms up to 1 kHz, decreasing to 10 V rms at 10 MHz.

**Trigger level:** PRESET position centers triggering about 0 volts, or continuously variable over the range of -1 V to +1 V times attenuator setting.

**Slope:** independent selection of triggering on positive or negative slope.

**Channel inputs:** common or separate lines.

**Gate output:** rear panel BNC. TTL low level while gate is open.

## Time Interval

**Range:** 500 ns to 10<sup>4</sup> sec.

**Input:** channels A and B; can be common or separate.

**Resolution:** 100 ns to 10 ms in decade steps.

**Accuracy:** ±1 count ± time base accuracy ± trigger error\*.

**Time interval holdoff:** front panel concentric knob which inserts variable delay of approximately 100 μs to 100 ms between START (channel A) and enabling of STOP (channel B); may be disabled. Electrical inputs during delay time are ignored. Delay may be digitally measured in CHECK and TIME INTERVAL positions. Delay output: rear panel BNC. TTL low level during delay time.

## Period average

**Range:** 10 Hz to 1 MHz.

**Input:** channel A.

**Period averaged:** 1 to 10<sup>3</sup> automatically selected.

**Frequency counted:** 10 MHz.

**Accuracy:** ±1 count ± time base accuracy ± trigger error\*\*.

## Frequency

**Range:** 0 to 10 MHz.

**Input:** channel A.

**Gate times:** manually selected 0.1, 1, or 10 seconds. AUTO position selects gate time to 1 second for maximum resolution.

**Accuracy:** ±1 count ± time base accuracy.

## Open/close (totalizing)

**Range:** 10 MHz max.

**Input:** channel A opening and closing of gate initiated by front panel pushbutton switch.

## General

**Check:** inserts internal 10 MHz reference frequency into channels A and B.

**Operating temperature:** 0° to 50°C.

**Power requirements:** including mainframe, nominally 10 watts.

**Weight:** net, 0.9 kg (2 lb). Shipping, 1.5 kg (3¼ lb).

**Dimensions:** see mainframe.

5304A. Timer/counter module

\$385

- 1300 MHz
- Pre-amplifier Power
- Fast high resolution tone measurements



5305B

**5305B 1300 MHz frequency counter module**

Input Channel A (CW OR BURST)  
**Range:** 90 MHz to 1300 MHz, prescaled by 16.  
**Sensitivity:** 20 mV rms.  
**Impedance:** 50Ω.  
**Attenuator:** continuously variable to give optimum noise suppression for signals up to 3.5 V rms.  
**Overload protection:** 5 V rms, maximum. Input circuitry is fuse protected; fuse is located in BNC connector and is accessible from the front panel.  
**Operating dynamic range:** >47 dB.

Input Channel B (Normal and High Resolution Mode)  
**Range:** 50 Hz to 100 MHz, direct count in normal mode. 50 Hz to 10 kHz in high resolution mode. In the high resolution mode the 5305B uses a phase-locked multiplier to increase resolution X1000 over normal measurement resolution.  
**Sensitivity:** 20 mV rms.  
**Impedance:** 1 MΩ shunted by less than 40 pF.  
**Overload protection:** 250 V rms from 50 Hz to 10 kHz, declining to 10 V rms above 10 MHz.  
**Automatic hold:** in high resolution mode, the last valid reading is held in display when input is terminated.

**Frequency Measurement**  
**Resolution (selectable)**  
**Normal mode (50 Hz to 1300 MHz):** 0.1 Hz to 10 000 Hz in decade steps corresponding to gate times of 10 s to 0.0001 s in decade steps on channel B and to gate times of 160 s to 0.0016 s in decade steps on channel A.  
**High resolution mode (50 Hz to 10 kHz):** 0.0001, 0.001, 0.01, 0.1, 1, 10 Hz corresponding to 10, 1, 0.1, 0.01, 0.001, 0.0001 second gate times on channel B.  
**Accuracy:** ±1 digit displayed ± time base accuracy.  
**Display:** Hz, kHz, MHz with positioned decimal point.

**General**  
**Check:** counts internal 10 MHz reference frequency to check counting circuits.  
**Operating temperature:** 0°C to 50°C.  
**Power requirements:** nominally 12 watts including mainframe.  
**Weight:** net, 1.0 kg (2¼ lb). Shipping, 1.8 kg (4 lb).  
**Size:** with mainframe, 89 H (3½") × 160 W (6¼") × 248 mm L (9¾").  
**Compatible mainframes:** 5300B (8 digits).

**Accessory**  
**10855A Preamp:** 22 dB gain with ±1 dB flatness from 2 MHz to 1300 MHz. See 14.28.  
**5305B 1300 MHz counter**

	<b>Price</b>
10855A Preamp: 22 dB gain with ±1 dB flatness from 2 MHz to 1300 MHz. See 14.28.	\$225
<b>5305B 1300 MHz counter</b>	<b>\$900</b>

- DC volts, AC volts, ohms and frequency

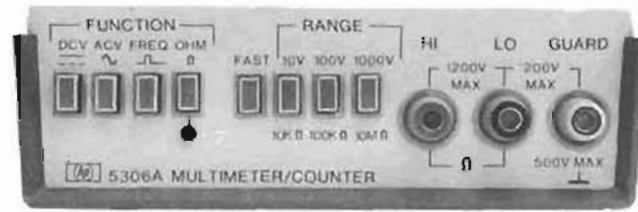

5306A

**5306A Digital multimeter/counter module**

**DC voltage**

Range	Accuracy (60 days, 23°C ±5°C, <60% RH)	Sensitivity
10 V	±(0.03% of reading + 0.003% of range)	100 μV
100 V	±(0.03% of reading + 0.003% of range)	1 mV
1000 V	±(0.097% of reading + 0.03% of range)	10 mV

**Temperature coefficient:** ± (0.002% of reading/°C + 0.0002% of range/°C).  
**Sample times:** normal, 0.5 sec; Fast, 0.05 sec.  
**Input:** floating pair, 10 MΩ resistance, all ranges.  
**Effective common mode rejection (1 kΩ imbalance):** DC: >80 dB; 50 Hz or 60 Hz ±0.1%; >80 dB.  
**Normal mode rejection:** 50 Hz or 60 Hz ±0.1%; >50 dB.  
**Maximum input**  
**High to low:** 1100 V dc all ranges.  
**Low to Guard:** ±200 V dc or peak ac.  
**Guard to Ground:** ±500 V dc or 240 V rms at 50 or 60 Hz.

**AC voltage**

Range	Frequency	Accuracy (60 days, 23°C ±5°C, <80% RH)
10 V	40 Hz to 10 kHz	±(0.98% of reading + 0.02% of range)
	10 kHz to 100 kHz	±(0.98% of reading + 0.10% of range)
100 V	40 Hz to 500 Hz	±(1.5% of reading + 0.05% of range)
	40 Hz to 500 Hz	±(1.5% of reading + 0.05% of range)

**Temperature coefficient**  
**10 V and 100 V range:** ±(0.5% of reading + .003% of range/°C).  
**1000 V range:** ±(0.5% of reading + .003% of range/°C).  
**Input impedance:** 10 MΩ shunted by <75 pF maximum.  
**Maximum input voltage:** (see DC voltage specification).  
**Effective common mode rejection (1 kΩ imbalance):** DC: >80 dB; 50 Hz or 60 Hz ±0.1%; >50 dB (10 V range).

**Ohms**

Range	Accuracy (60 days, 23°C, ±5°C, <80% RH)	Sensitivity
10 kΩ	±(0.5% of reading + 0.003% of range)	0.1Ω
100 kΩ	±(0.5% of reading + 0.003% of range)	1Ω
10 MΩ	±(0.75% of reading + 0.003% of range)	100Ω

**Temperature coefficient:** ±(0.0002% of range/°C).  
**Current through unknown:** 1 mA on 10 kΩ range; 100 μA on 100 kΩ range; 1 μA on 10 MΩ range.  
**Overload protection:** 10 kΩ range; 240 V rms for 1 min. 140 V rms continuous (warning lamp indicates overvoltage) 100 kΩ, 10 MΩ ranges; 240 V rms continuous.

**Frequency**  
**Range:** 40 Hz to 10 MHz.  
**Sensitivity (min):** 50 mV rms to 1 MHz; 125 mV rms to 10 MHz.  
**Trigger level:** automatically adjusts to 40% of peak level of input.  
**Overload protection:** 1000 V rms. On 10 V range: 240 V rms from 40 Hz to 400 kHz, 10<sup>3</sup> V Hz from 400 kHz to 10 MHz.  
**Gate times:** normal: 1 sec, fast: 0.1 sec.  
**Accuracy:** ± 1 count ± time base accuracy.  
**Power requirements:** including mainframe, nominally 12 watts.  
**Weight:** net, 1.1 kg (2.3 lb). Shipping, 1.7 kg (3.6 lb).

**5306A Digital Multimeter/Counter** **\$625**

## 5300A/B System (cont.)

- High resolution at low frequencies
- 10 mV rms sensitivity
- 100 Hz and 10 kHz low pass filters

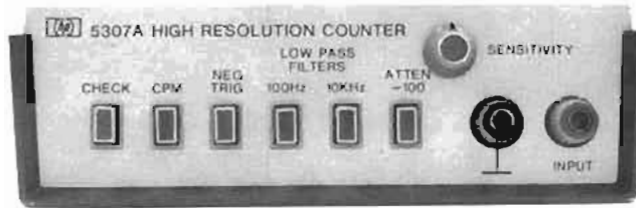

## 5307A High resolution counter module

5307A is a period average measuring frequency indicating (reciprocal) counter, that provides very high resolution measurements in a minimum of time: (i.e. 60.0000 Hz in  $< 1/2$  second). The CPM mode converts Hz to counts/minute.

## Input

**Range:** Hz mode: 5 Hz to 2 MHz. CPM mode: 50 to 10 M counts/minute (0.8333 Hz to 166 kHz).

## Sensitivity (Min.)

10 mV rms	5 Hz–1.2 MHz	120 CPM–10 MCPM
25 mV rms	1.2 MHz–2.0 MHz	50 CPM–120 CPM

## Pulses:

- For low-duty cycle pulses ( $< 15\%$ ).
- 15 mV peak for 250 nsec pulses.
- 100 mV peak for 100 nsec pulses.

Basic sensitivity can be varied continuously up to 2.5 V rms by adjusting sensitivity control.

**Attenuator:**  $\div 1$  or  $\div 100$  effectively raises basic input sensitivity by a factor of 100 (10 mV  $\rightarrow$  2.5 V to 1 V  $\rightarrow$  250 V).

## Low pass filters (3 dB Point)

	100 Hz	10 kHz
Max. Attenuation	60 dB	40 dB
Roll-off	20 dB per Decade	

## Impedance

- No filters 1 M $\Omega$  shunted by  $< 50$  pF
- 100 Hz filters 1 M $\Omega$  shunted by series of 100 k $\Omega$  and 0.015  $\mu$ F
- 10 kHz filters 1 M $\Omega$  shunted by series of 100 k $\Omega$  and 150 pF

## Coupling: AC coupled amplifier.

**Overload protection:** 200 V rms below 10 kHz;  $2 \times 10^6$  V Hz rms to 0.4 MHz; 5 V rms above 0.4 MHz; 300 V rms with  $\div 100$  attenuator.

**Trigger level:** selected positive or negative for optimum triggering from sinusoidal inputs or  $\pm$  pulses.

## Frequency measurement

**Periods averaged:** automatically selected for maximum resolution. Two periods are averaged for signals up to 100 Hz. Periods averaged increase decade for decade up to 200,000 periods averaged above 1 MHz.

**Measurement time:** varies from 312 msec for a display of 170000 to 815 msec for a display of 999000. Hold-off adjustable from .35  $\mu$ sec to 3.5  $\mu$ sec and 1 msec to 10 msec.

**Accuracy:**  $\pm 3 \times 10^{-5} \pm$  trigger error\*\*  $\pm$  time base error.

**Display:** Hz mode: Hz and MHz with automatic decimal point. CPM mode: M with automatic decimal point.

## General

**Check:** measures internal reference frequency. Displays 1.00000 MHz in Hz mode. 100 000 M in CPM mode.

**Operating temperature:** 0°C to 50°C.

**Power requirements:** including Mainframe, nominally 10 watts.

**Weight:** net, 0.98 kg (2 lb). Shipping, 1.5 kg (3 1/4 lb).

## 5307A High resolution counter

S395

\*\*  $3 \times 10^{-5}$  is due to reciprocity scheme and is worst case  
\* For any wave shape, trigger error ( $\mu$ s) is less than

$$0.005 \mu\text{s} = \frac{\text{Signal Slope (V/\mu s)}}{1000}$$

For period average this is less than  $\pm 0.3\%$  of one period  $\rightarrow$  periods averaged for signal with 40 dB or better signal-to-noise ratio.

- 75 MHz
- Time interval averaging
- Auto ranging or manual operation



## 5308A Universal counter/timer module

## Input (channels A and B)

**Range:** DC coupled: 0 to 75 MHz, AC coupled: 20 to 75 MHz.

**Sensitivity:** (min) 25 mV rms to 10 MHz, 50 mV rms to 75 MHz 150 mV p-p pulse at pulse width of 10 nsec.

**Impedance:** 1 M $\Omega$  shunted by less than 50 pF.

**Overload protection:** X1: 125 V rms to 400 kHz declining to 10 V rms at 75 MHz. X10: 250 V rms to 4 MHz declining to 13 V rms at 75 MHz.

**Trigger level:** variable over the range of  $\pm 2.0$  V and  $\pm 20$  V.

**Slope:** independent selection of triggering on + or - slope.

**Rear outputs:** gate, trigger levels and time base/scaling.

## Frequency

**Range:** 0 to 75 MHz. Channel A or Channel B.

**Gate times:** 8 selectable times from 1  $\mu$ s to 10 s.

**Accuracy:**  $\pm 1$  count  $\pm$  time base accuracy.

## Frequency ratio

**Display:** Fa/Fb, 1 to  $10^6$  periods selectable manual or auto.

**Range:** channel A: 0 to 75 MHz. Channel B: 0 to 5 MHz.

**Accuracy:**  $\pm 1$  count of Fa  $\pm$  trigger error of Fb.\*\*

## Period

**Range:** 0 Hz to 5 MHz, Channel B.

**Resolution:** 100 nsec to 10 sec.

**Accuracy:**  $\pm 1$  count  $\pm$  time base accuracy  $\pm$  trigger error.\*\*

**Display:**  $\mu$ s, ms or s with positioned decimal point.

## Period average

**Range:** 0.1–5 MHz; (200 nsec to 10 sec), Channel B.

**Periods averaged:** 1– $10^6$  selectable manual or automatic.

**Accuracy:**  $\pm 1$  count  $\pm$  time base accuracy  $\pm$  trigger error.\*\*

## Time interval

**Range:** 200 nsec to  $10^6$  sec, 25 ns minimum pulse width.

**Inputs:** separate A and B or Common B.

**Resolution:** 100 nsec to 10 sec.

**Accuracy:**  $\pm 1$  count  $\pm$  (time base accuracy  $\pm$  trigger error).\*\*

**Display:**  $\mu$ s, ks or s with positioned decimal point.

## Time interval average

**Range:** 1 ns to 10 s, dead time between intervals 200 ns.

**Inputs:** channels A and B separate or common B.

**Intervals averaged:** 1 to  $10^6$ , selectable manual or automatic.

**Accuracy:**  $\pm$  time base accuracy  $\pm 5$  ns.

$$\pm \frac{[\text{Trigger Error}^{**} \pm 100 \text{ ns}]}{\sqrt{\text{Intervals Averaged}}}$$

## Totalize

 totalizes Channel A while Channel B is low.

 totalizes Channel A between pulses on Channel B.

**Range:** 75 MHz in X1 Position, 5 MHz in X10<sup>6</sup> positions.

**Accuracy:**  $\pm 1$  count  $\pm$  trigger error\*\* on Channel B.

## General

**Auto position:** automatically sets time base to give maximum resolution within 1.1 second measurement time for Frequency, Frequency Ratio, Period Average, and Time Interval Average.

**Operating temperature:** 0°C to 50°C.

**Power requirements:** including 5300B, nominally 15 watts.

**Weight:** net, 0.9 kg (2 lb). Shipping, 1.5 kg (3 1/4 lb).

**Note:** compatible with 5300B only.

## 5308A 75 MHz Timer/counter

S450



- Three modes of operation
- Battery compatible
- Column selective

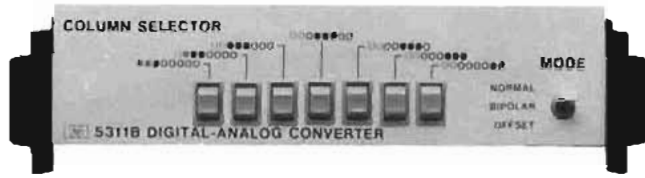

5311B

### 5311B Digital to analog converter module

The 5311B Digital to Analog Converter conveniently snaps in-between the mainframe and plug-on module of any 5300 system. It provides high resolution, expanded scale analog output of any of the 5300 system measurements. With the 5311B you can select any three consecutive digits, or the right-hand two of the mainframe display for conversion to analog output. This makes it possible to focus on just that part of the display that contains the important information. Now your stripchart recorder can give you a permanent record of any functional measurement made by any 5300 measurement system. Easy to use, just snap it in place. The 5311B can also be used with the 5310A battery pack to provide a rugged, portable, go-anywhere monitoring system. Three modes of output makes it possible to tailor the output to the application.

#### Operating modes

Three modes selectable by switch on front panel.

**Normal mode:** analog output is directly proportional to digital input. Digital 000 produces zero output; 999 produces full scale output.

**Plus/minus mode:** digital 000 produces center scale output; -999 produces zero output; 999 produces full scale output.

**Offset mode:** 500 produces zero output; 000 produces midscale output; 499 produces full scale output. This mode effectively adds 500 to digital input to acquire half scale offset. Compatible with all mainframes and plug-on modules.

Mode	Output		
	0 to 50% of Scale	50% of Scale	50% to 100% of Scale
Normal	0 to 499	500	501 to 999
Plus/Minus	-999 to -001	000	001 to 999
Offset	500 to 999	000	001 to 499

#### Output selection

Manual pushbuttons to select any three consecutive digits or the last two digits of the Mainframe display.

#### Output ranges

**Potentiometric Recorder Output:** 0.1 V, 1.0 V, or 10 V full scale into >20 k $\Omega$ . Dual banana plugs.

**Galvanometer Recorder Output:** 1 mA full scale into <1.5 k $\Omega$  phone jack.

#### General

**Accuracy:**  $\pm 0.25\%$  of range  $\pm 50 \mu V/^\circ C$  on potentiometric output,  $\pm 20 nA/^\circ C$  on galvanometer output after calibration for appropriate range.

**Calibration:** zero and full scale calibration switch and adjustments on rear panel.

**Transfer time:** <5 ms.

**Operating temperature:** 0° to 50°C.

**Power requirements:** nominally 1 watt.

**Weight:** net, 0.8 kg (1.7 lb). Shipping, 1.4 kg (3.0 lb).

**Size:** Digital-to-Analog Converter plugs between Mainframe and plug-on module. Increases height of instrument by 38.4 mm (1.5").

5311B Digital-Analog Converter

\$395

- Expanded digital output
- ASCII format



5312A

### 5312A ASCII (HP-IB) interface module

The ASCII Interface Module snaps in between the 5300B and any plug-on module. It provides digital Output capability via the HP Interface Bus. This is an easy to implement method of interfacing any 5300 system that utilizes the 8-digit 5300B mainframe with any HP-IB compatible printer.

The 5312A outputs fifteen bits of information in the following format.

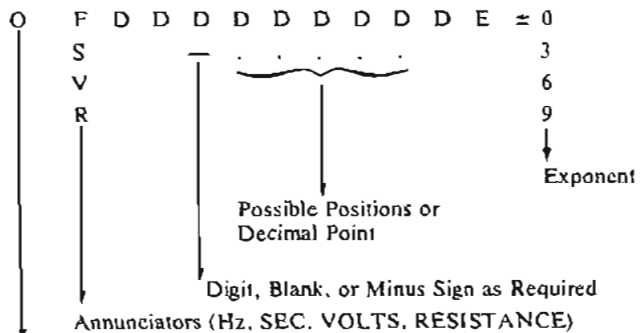

Overflow indicator

#### General

**Sample rate:** controlled by mainframe front panel control or by setting rate of reset command (when in listening mode, counter can be reset by sending "initialize" command).

**Transfer time:** 20 milliseconds.

**Transfer rate:** maximum of 40 reading/Sec depending on capabilities of plug-on.

**Indicator lights:** indicates if instrument is in Talk or Listen Modes.

**Self test mode:** checks functioning of basic interface.

```
OF 0171135E+0
F 10171.92E+3
F 10173.10E+3
F 10173.38E+3
```

```
F 2.3175E+3
R 2.3409E+3
R 2.3759E+3
```

```
OV 0.0000E+0
V -2.1655E+0
V -2.1654E+0
```

```
F 1076268E+0
```

Samples of digital output from 5300 measuring system utilizing the 5312A HP-IB converter and the 5150A thermal printer. Note the indication of function, decimal position, exponent and overflow when required.

**Programmability:** front panel controls are not programmable.

**Note:** the 5312A is not compatible with the 5300A mainframe which contains its own BCD Digital Output.

5312A ASCII Interface

\$350

## ELECTRONIC COUNTERS

5300A/B System (cont.)

5310A &amp; 10855A



5310A Battery pack

**5310A Battery pack module**

Provides battery power to 5300A mainframe and snap on modules from rechargeable nickel-cadmium cells.

The 5310A Battery Pack is easily inserted between the 5300A or 5300B mainframe and any functional module, providing a truly portable measurement system. Low voltage strobed solid state displays and the MOS/LSI IC design of the mainframes make efficient battery operation possible. The front panel warning light indicates a low battery condition. Any 5300 system with the battery inserted will automatically switch over to battery operation in the event of power failure, providing extra reliability for unattended operation. Floating operation is also possible with the 5310A Battery Pack, thus avoiding ground loops.

**Battery capacity:** 48 watt-hours, nominal. Minimum 3, typically 5 hours of continuous operation at charging and operating temperature (20° to 30°C).

**Recharging time:** 18 hours from minimum level (indicated by Low Voltage Indicator) to full charge.

**Battery voltage:** 12 Vdc.

**Low voltage indicator:** solid state warning light begins to glow at approximately 90% discharge.

**Line failure protection:** allows instrument to be operated in LINE position with automatic switch-over to battery power if line voltage fails. Batteries receive trickle charge in LINE position to maintain charge.

**Operating temperature:** operating: 0° to 50°C. Charging: 0° to 40°C, mainframe not operating.

**Power requirements:** charging power via mainframe, nominal 7.5 watts.

**Weight:** net, 2.3 kg (5 lb). Shipping, 2.9 kg (6 1/4 lb).

**Accessories furnished:** shoulder carrying strap.

**Dimensions:** battery pack plugs between 5300A or 5300B mainframes and any plug-on module. Increase height of instrument by 38.4 mm (1.5 in).

5310A Battery pack module

\$275

**10548A Service support package**

The unique HP 10548A Service Kit provides an easy and efficient means of trouble shooting the 5300A or 5300B mainframes. The four diagnostic cards, shown in use above, contain 16 self running tests that locate problems to the component level. Complete diagnostic flow charts in the manuals provide further step by step procedures. When failures are diagnosed, repair is simple. All components are easily accessible by merely removing a single screw and snapping out the main PC board.

10548A Service support package

\$95

**11096B High frequency probe**

Allows the 5306A to make high frequency ac voltage measurements. This probe is used for ac voltage measurements of 0.25 volt to 30 volts over a frequency range of 10 kHz to 700 MHz with an accuracy of  $\pm 0.5$  dB from 100 kHz to 100 MHz and  $\pm 1.2$  dB to 500 MHz over 10° to 30°C. Three probe tip accessories are supplied to extend the probe's versatility.

11096B High frequency probe

\$90

- 2 MHz to 1300 MHz
- $\geq 22$  dB gain
- 50  $\Omega$  input and output impedance
- Fuse protected input



10855A

**10855A Broadband preamp**

The 10855A Preamp gives a minimum of 22 dB gain to enhance measurements of very low-level signals. The 10855A operates conveniently with a variety of HP measuring instruments having probe power outlets, or will work with a separate power supply. The 10855A Preamp includes several major features to aid your measurements:

**$\geq 22$  dB gain:** from 2 MHz to 1300 MHz boosts broadband signals.

**$\pm 1$  dB flat response:** reduces distortion in non-sinusoidal waveforms

**50  $\Omega$  Input and output impedances:** match high frequency environments.

**Fuse protected input:** prevents costly damage.

**Excellent reverse isolation:**  $> 45$  dB.

The 10855A Preamp is especially useful where the source signal is at a very low level. It also helps where divider probes are used to reduce circuit loading. The 10855A Preamp can operate from the HP 1122A Probe Power Supply for use with instruments that do not have a probe power outlet.

**Compatible Hewlett-Packard products**

These products presently have probe power outlets that will drive the 10855A Preamp.

5305B	1300 MHz Frequency Counter
5328A/031	1300 MHz Universal Counter
8505A	Network Analyzer
8553B	Spectrum Analyzer RF Section
8557A	Spectrum Analyzer
8558B	Spectrum Analyzer
1810A	1 GHz Scope Plug-in (Sampling)
1811A	Sampling Time Base and Vertical Amplifier
1841A	Time Base and Delay Generator
1122A	Probe Power Supply

**Specifications**

**Frequency range:** 2 MHz–1300 MHz.

**3 dB Bandwidth:** 1 MHz–1400 MHz, typical.

**Gain (minimum):** 22 dB; 24 dB typical.

**Gain flatness across full frequency range:**  $\pm 1$  dB.

**Noise figure:**  $< 8.5$  dB typical.

**Output power for 1 dB gain compression:** 0 dBm.

**Harmonic distortion:**  $-30$  dB for  $-15$  dBm output, typical.

**Output for  $< -60$  dB harmonic distortion:**  $-25$  dBm, typical.

**VSWR:** input and output,  $< 2.2$ .

**Impedance:** 50  $\Omega$  nominal.

**Reverse isolation:**  $> 45$  dB.

**Maximum input:** 3.5 V rms ( $+24$  dBm), fuse protected.

**General**

**Current required at  $+15$  V supply:** 40 mA (mating connector included).

**Weight:** net, 0.03 kg (1 oz.). Shipping, 0.1 kg (7 oz.).

**Size:** 25 H  $\times$  15 W  $\times$  80 mm L (1"  $\times$  3/4"  $\times$  3 1/8").

10855A Broadband preamp

\$225

# ELECTRONIC COUNTERS

Low cost counters for frequency measurements

Models 5381A, 5382A & 5383A



5381A



5382A



5383A

## Description

### General

The 5381A, 5382A and 5383A are a logical result of H-P's long standing leadership in frequency counter development. Leadership in quality, technology and efficient production procedures allows H-P to offer a price/performance combination in these three precision instruments unequalled in their product category. These counters are designed to deliver reliable, high quality operation in such diverse areas as: Production Line Testing, Service and Calibration (2-Way Radio and test equipment), Frequency Monitoring, Education and Training.

### Resolution

The 5381A, 5382A and 5383A employ the direct counting technique and with 7, 8 and 9 digits respectively offer resolution of 10 Hz in 0.1 sec, 1 Hz in 1 sec and 0.1 Hz in 10 seconds.

## Specifications

### 5381A

**Frequency range:** 10 Hz to 80 MHz.

**Sensitivity:** 25 mV rms—30 Hz to 20 MHz, 50 mV rms—10 Hz to 80 MHz.

**Input impedance:** 1 M $\Omega$ , <50 pF.

**Input attenuation:** X1, X10, X100.

**Accuracy:**  $\pm 1$  count  $\pm$  timebase error.

**Resolution:** direct count: 1 Hz in 1 second.

**Gate times:** 0.1 second, 1 second, 10 seconds.

**Display:** 7 LED Digits.

**Rear panel Input:** sensitivity: TTL levels or 2.5 V rms.

**Ratio:** Rear Panel Input, 10 kHz to 2 MHz.

**External frequency standard:** Rear Panel Input, 1 MHz.

### Timebase

**Frequency:** 1 MHz.

**Aging:** <0.3 ppm/month.

**Temperature:**  $\pm 10$  ppm 0°C to 40°C.

**Line voltage:**  $\pm 1$  ppm for 10% line change.

### 5382A

**Frequency range:** 10 Hz to 225 MHz.

**Sensitivity:** 25 mV rms—30 Hz to 10 MHz, 50 mV rms—10 Hz to 225 MHz.

**Input impedance:** 1 M $\Omega$ , <40 pF.

**Input attenuation:** X1, X10, X100.

**Accuracy:**  $\pm 1$  count  $\pm$  timebase error.

**Resolution:** direct count: 1 Hz in 1 second.

**Gate time:** 0.1 second, 1 second, 10 seconds.

**Display:** 8 LED Digits, nonsignificant zero blanking.

**Rear panel Input:** sensitivity: 250 mV rms.

**Ratio:** Rear Panel Input, 100 kHz to 10 MHz.

**External frequency standard:** Rear Panel Input, 10 MHz.

### Timebase

**Frequency:** 10 MHz.

**Aging:** <0.3 ppm/month.

**Temperature:**  $\pm 2.5$  ppm 0°C to 40°C.

**Line voltage:**  $\pm 0.5$  ppm for 10% line change.

### 5383A

**Frequency range:** 10 Hz to 520 MHz.

### Sensitivity

1 M $\Omega$ : 25 mV rms—20 Hz to 10 MHz.

50 mV rms—10 Hz to 50 MHz.

50  $\Omega$ : 25 mV rms—20 Hz to 520 MHz.

**Input impedance:** selectable: 1 M $\Omega$ , <40 pF or 50  $\Omega$ .

**Input attenuation:** 1 M $\Omega$   $\times$  1,  $\times$  10; 50  $\Omega$   $\times$  1—fuse protected.

**Accuracy:**  $\pm 1$  count  $\pm$  timebase error.

**Resolution:** direct count: 1 Hz in 1 second.

**Gate time:** 0.1 second, 1 second, 10 seconds.

**Display:** 9 LED Digits, nonsignificant zero blanking.

**Display test:** RESET function (activated with GATE TIME switch) illuminates all segments of all digits.

**Rear panel Input:** sensitivity: 250 mV rms.

**Ratio:** Rear Panel Input, 100 kHz to 10 MHz.

**External frequency standard:** Rear Panel Input, 10 MHz.

### Timebase output

**Frequency:** 10 MHz timebase.

**Voltage:** 200 mV p-p into 50  $\Omega$  load.

**Control:** active with Rear Panel Internal/External switch in internal position.

### Timebase

**Frequency:** 10 MHz.

**Aging:** <0.3 ppm/month.

**Temperature:**  $\pm 2.5$  ppm 0°C to 40°C.

**Line voltage:**  $\pm 0.5$  ppm for  $\pm 10\%$  line change.

### TCXO Option

**Opt 001:** (available for all models) Temperature Compensated Crystal Oscillator Timebase

**Frequency:** 10 MHz.

**Aging:** <0.1 ppm/month.

**Temperature:** <1 ppm 0°C to 40°C.

**Line voltage:**  $\pm 0.1$  ppm for  $\pm 10\%$  line change.

**Note:** Timebase output available for both 5382A and 5383A with Option 001. Rear Panel Input not available.

### 5380 Family general data

**Overflow:** LED lamp indicator when most significant digit overflows.

**Reset:** manual selection of reset occurs when GATE TIME switch is between three normal positions.

**Package:** rugged, high strength metal case.

**Operating temperature:** 0°C to 40°C.

**Power requirements:** 100, 120, 220, 240, V rms (+5%, -10%) 48-440 Hz; 20 VA maximum.

**Weight:** net, 2.2 kg (4 $\frac{3}{4}$  lb). Shipping, 2.8 kg (6 lb).

**Dimensions:** 98 H  $\times$  160 W  $\times$  248 mm D (3 $\frac{1}{2}$ "  $\times$  6 $\frac{1}{4}$ "  $\times$  9 $\frac{3}{4}$ ").

### Ordering information

5381A Frequency Counter

5382A Frequency Counter

5383A Frequency Counter

Opt 001: TCXO (all models)

### Price

\$395

\$495

\$650

add \$100

# ELECTRONIC COUNTERS

## Automatic microwave counters

Models 5340A & 5341A

- Single input 10 Hz to 18 GHz
- Automatic amplitude discrimination
- High sensitivity -35 dBm
- Optional extension to 23 GHz
- High AM and FM tolerance
- Exceptional reliability



5340A **HP-IB**

The 5340A Frequency Counter provides a modern, easily used, more versatile instrument for the direct measurement of frequencies from 10 Hz through 18 GHz via a single input connector. Utilizing new microwave samplers incorporated in advanced phase-lock loops, this counter excels in virtually every specification parameter. It is therefore suited to a wider range of applications than ever before possible for a fully automatic microwave counter.

The exceptional sensitivity of this instrument enhances measurement in the microwave field, where signals are commonly low level and many times are connected via directional couplers or lossy devices. Wide tolerance of AM, FM, and residual noise insure accurate measurement of microwave carrier frequencies despite the presence of these deviations. Automatic amplitude discrimination allows the 5340A to choose the largest signal in a spectrum (250 MHz to 18 GHz) and measure only that signal's frequency, ignoring all others.

Access to the HP Interface Bus via Option 011 provides a particularly flexible system interface. The ability to program octave range via this input allows reduction of acquisition time to typically less than 40 ms. AN 181-1 describes the use of a calculator-controlled measurement system built around the HP Interface Bus for microwave component testing.

### 5340A Specifications

#### Signal Input

##### Input 1

- Range:** 10 Hz to 18 GHz.
- Symmetry:** sinewave or squarewave input (40% duty factor, worst case).
- Sensitivity:** -30 dBm, 10 Hz to 500 MHz; -35 dBm, 500 MHz to 10 GHz; -25 dBm, 10 to 18 GHz.
- Dynamic range:** 37 dB, 10 Hz to 500 MHz; 42 dB, 500 MHz to 10 GHz; 32 dB, 10 GHz to 18 GHz.
- Impedance:** 50Ω.
- VSWR:** <2:1, 10 Hz-12.4 GHz; <3:1, 12.4-18 GHz.
- Connector:** Precision Type N.
- Coupling:** dc to load, ac to instrument.
- Damage level:** +30 dBm. (Total power (ac + dc) not to exceed 1 watt).
- Acquisition time:** <150 ms mean typical.

##### Input 2

- Range:** 10 Hz-250 MHz direct count.
- Sensitivity:** 50 mV rms, 150 mV p-p pulses to 0.1% duty factor; minimum pulse width 2 ns.
- Impedance:** 1 MΩ shunted by <25 pF.
- Connector:** type BNC female.

#### Coupling: ac.

**Maximum input:** 200 V rms, 10 Hz to 100 Hz; 20 V rms, 100 Hz to 100 kHz; 2 V rms, 100 kHz to 250 MHz.

**Automatic amplitude discrimination:** automatically selects the strongest of all signals present (within 250 MHz to 18 GHz phase-lock range), providing signal level is: 6 dB above any signal within 200 MHz; 10 dB above any signal within 500 MHz; 20 dB above any signal, 250 MHz-18 GHz.

**Maximum AM modulation:** any modulation index as long as the minimum voltage of the signal is not less than the sensitivity specification.

#### Time Base

**Crystal frequency:** 10 MHz.

#### Stability

- Aging rate:** <3 × 10<sup>-7</sup> per month.
- Short term:** <5 × 10<sup>-10</sup> rms for 1 second averaging time.
- Temperature:** <±2 × 10<sup>-6</sup> over the range of 0°C to 50°C.
- Line variation:** <±1 × 10<sup>-7</sup> for 10% line variation from nominal.

**Output frequency:** 10 MHz, ≥2.4 V square wave (TTL compatible) available from rear panel BNC.

**External time base:** requires 10 MHz approximately 1.5 V p-p sine wave or square wave into 1 kΩ via rear panel BNC. Switch selects either internal or external time base.

**Optional time base (Opt 001) aging rate:** <5 × 10<sup>-10</sup> per day after 24 hour warm-up for less than 24 hour off-time.

#### General

- Accuracy:** ±1 count ± time base error.
- Resolution:** front panel switch selects 1 MHz, 100 kHz, 10 kHz, 1 kHz, 100 Hz, 10 Hz, or 1 Hz.
- Display:** eight in-line long life display tubes with positioned decimal point and appropriate measurement units of kHz, MHz, or GHz.
- Self check:** counts and displays 10 MHz for resolution chosen.
- Sample rate:** controls time between measurements. Continuously adjustable from 50 ms typical to 5 seconds. HOLD position holds display indefinitely. RESET button resets display to zero and activates a new measurement.
- Operating temperature:** 0°C to 50°C.
- Power:** 115 V or 230 V ±10%, 48-66 Hz, 100 VA.
- Weight:** net, 11.3 kg (25 lb). Shipping, 14.1 kg (31 lb).
- Size:** 88.2 H × 425 W × 467 mm D (3<sup>1</sup>/<sub>2</sub>" × 16<sup>3</sup>/<sub>4</sub>" × 18<sup>3</sup>/<sub>4</sub>").

#### Options

- 001: High Stability Time Base add \$500
- 002: Rear Panel Connectors add \$105
- 011: Remote Programming-Digital Output (HP-IB) add \$390
- H10: Frequency Extension to 23 GHz add \$150
- 908: Rack Flange Kit add \$10

5340A Frequency Counter

\$6200

- Automatic or manual band-selection
- Wide FM tolerance
- Optional 1.5 GHz range

- Fast acquisition time
- High sensitivity
- Fully automatic diagnostics



5341A



The new 5341A Frequency Counter performs exceptionally fast measurements of frequency up to 4.5 GHz. Using a unique HP-designed microwave switchable filter, its automatic heterodyne measurement technique insures high tolerance of FM on the measured signal. In the normal mode of operation, the 5341A will automatically measure and display the lowest CW signal within its sensitivity; in the manual mode, the operator can choose to search within any of ten frequency bands which cover the counter's full range. Also at the operator's command, a convenient routine provides "qualifiers" in the display for complete diagnostic information concerning both the measured signal and the counter's internal operation.

The high sensitivity (-15 dBm in automatic mode, -20 dBm in manual) of the 5341A makes it ideal for measurement of low-level signals in the testing of UHF and microwave components and equipment. An extremely fast acquisition time (100 μsec in manual mode) makes this counter the optimum choice for systems applications.

Option 003 limits the frequency range of the 5341A to 1.5 GHz, at a considerably reduced cost. Option 011 connects the 5341A to the high-speed HP Interface Bus for data output and complete programmability, including the ability to remotely select the manual search bands.

### 5341A Specifications

#### Signal Input

##### Input 1

- Range:** 50 MHz to 4.5 GHz.
- Impedance:** 50Ω nominal.
- Connector:** precision Type N.
- Sensitivity:** -15 dBm (AUTO operating mode); -20 dBm (MANUAL operating mode).
- Maximum input:** +20 dBm.
- Damage level:** +30 dBm.
- Operating modes:** AUTO: counter automatically selects and displays lowest frequency within its sensitivity range; MANUAL: Measurement band is selected manually, and counter measures within a 525 MHz range above displayed band number (in the 500 MHz and 750 MHz bands, counter measures within a 250 MHz range).
- Measurement time:** acquisition time + gate time.
- Acquisition time:** 600 μs (AUTO operating mode); 100 μs (MANUAL operating mode).
- FM tolerance:** 30 MHz peak-to-peak worst case. Tolerates 500 MHz peak-to-peak (0-500 MHz and 1.0-4.5 GHz) and 250 MHz peak-to-peak (500 MHz to 1.0 GHz) in center of bands.

##### Input 2

- Range:** 10 Hz to 80 MHz.
- Impedance:** 1 MΩ, shunted by 50 pF.
- Connector:** type BNC female.
- Coupling:** ac.
- Sensitivity:** 10 millivolts.
- Maximum input:** 5 volts peak-to-peak.
- Damage level:** 400 volts dc; 250 volts rms ac, 10 Hz to 100 kHz, decreasing 6 dB per octave to 80 MHz.

##### Time base

**Crystal frequency:** 10 MHz.

##### Stability

- Aging rate:** < 1 × 10<sup>-7</sup> per month.
- Temperature:** < ±1 × 10<sup>-7</sup>, ±10% from nominal.

**Output frequency:** 10 MHz, ≥2.4 V square wave (TTL compatible) available from rear panel BNC.

**External time base:** requires 10 MHz approximately 1.5 V p-p sine wave or square wave into 1 kΩ via rear panel BNC. Switch selects either internal or external time base.

**Optional time base (Opt 001) aging rate:** < 5 × 10<sup>-10</sup> per day after 24 hour warm-up for less than 24 hour off-time.

##### General

- Accuracy:** ± count ± time base error
- Resolution:** front panel switch selects 1 MHz, 100 kHz, 10 kHz, 1 kHz, 100 Hz, 10 Hz, or 1 Hz.
- Display:** ten-digit sectionalized LED display and appropriate measurement units of kHz, MHz, or GHz.
- Self check:** counts and displays 1 GHz for resolution chosen.
- Sample rate:** continuously adjustable from 40 msec to 10 seconds and HOLD.
- Operating temperature:** 0°C to 50°C
- Power:** 115 or 230 volts, with +5% to -10% tolerance, 48 to 66 Hz, 104 VA
- Remote programming and digital output:** optional (Option 011) via 24-pin, series 57 Microribbon connector. Program and output information are 7-bit ASCII code. Compatible with HP Interface Bus.
- Weight:** Net 10.5 kg (23 lb). Shipping 13.2 kg (29 lb).
- Size:** 88.2 H × 425 W × 467 mm D (3<sup>11</sup>/<sub>32</sub>" × 16<sup>3</sup>/<sub>4</sub>" × 18<sup>3</sup>/<sub>8</sub>").

##### Options

- 001: High Stability Time Base
- 002: Rear Panel Connectors
- 003: 1.5 GHz Frequency Range
- 011: Remote Programming-Digital Output (HP-IB)
- 908: Rack Flange Kit

##### Price

- add \$500
- add \$105
- less \$1000
- add \$390
- add \$10

5341A Frequency Counter

\$4950

# ELECTRONIC COUNTERS

## AUTOMATIC MICROWAVE COUNTER

Model 5342A

- Microprocessor controlled
- Automatic measurement to 18 GHz
- Wide FM tolerance
- Simultaneously display input level
- High sensitivity
- Automatic or manual operation



### Description

The 5342A automatic microwave counter provides frequency and amplitude measurement coverage from 10 MHz through 18 GHz in a highly portable package.

The powerful and versatile microprocessor controlled keyboard can accomplish offset tasks as a standard feature as well as providing user interactive diagnostic information. The eleven-digit display is sectionalized for easy readout to one hertz resolution.

The 5342A uses a harmonic heterodyne down conversion technique which combines the best performance features of the heterodyne converter and transfer oscillator techniques. Now wide FM tolerance is achievable along with high input sensitivity, and automatic amplitude discrimination. Automatic amplitude discrimination allows for the measurement of the largest signal present in the spectrum (500 MHz-18 GHz) while ignoring all others.

### Amplitude measurements (Opt 002)

Option 002 adds for the first time in a microwave counter the ability to measure input level of the incident sinewave signal. The instrument then displays this level in dBm. The eleven-digit LED display simultaneously presents frequency to 1 MHz resolution and amplitude to 0.1 dB resolution. An added benefit from Option 002 is that dynamic range is extended so that frequency measurements to +20 dBm are accomplished. This extended dynamic range is also available without the amplitude measurement capability by ordering Option 003.

### FM Tolerance

The ability to measure a carrier frequency while being frequency modulated has broad appeal in the communications industry and elsewhere. The 5342A can tolerate 50 MHz peak-to-peak worst case FM in the wide mode, or the normal mode with accompanying faster acquisition time can be selected which gives 20 MHz peak-to-peak worst case FM.

### Offset functions

The power and versatility of the microprocessor controlled keyboard allow the user to perform offset functions by way of a few keystrokes. Frequency values to 1 Hz resolution can be added to or subtracted from the measured incoming frequency for IF offset applications and also for monitoring variances about a given frequency value. With Option 002 installed, this same offset capability is applied to the amplitude measurements being displayed. At any time, these offset values can be recalled to the display for reviewing.

### Digital-to-analog converter (Special Opt H01)

The ability to convert any three consecutive displayed digits (frequency or amplitude) into an analog voltage output on the rear panel of the 5342A is added by special option H01. This makes the monitoring of microwave oscillator frequency drift easy to make with only a strip chart recorder.

### HP Interface Bus for systems use (Opt 011)

The full power of HP-IB (IEEE488-1975) is brought to fruition with the addition of Option 011. Front and rear panel controls can now be remotely programmed and measurement results can be outputted to HP-IB-compatible instruments, calculators, or computers. This interface also can select a given frequency in the manual mode and reduce acquisition time to typically less than 1 msec.

## 5342A Specifications

### Signal Input

#### Input 1

**Frequency range:** 500 MHz to 18 GHz.  
**Sensitivity:** 500 MHz to 12.4 GHz: -25 dBm. 12.4 GHz to 18 GHz: -20 dBm.  
**Maximum input:** +5 dBm (see Opt 002, 003 for higher level).  
**Dynamic range:** 500 MHz to 12.4 GHz: 30 dB. 12.4 GHz to 18 GHz: 25 dB.  
**Impedance:** 50 ohms, nominal.  
**Connector:** precision Type N female.  
**Damage level:** +25 dBm.  
**Overload Indication:** displays dashes when input level exceeds +5 dBm.  
**Coupling:** DC to load, AC to instrument.  
**SWR:** <2:1, 500 MHz - 12.4 GHz  
 <3:1, 12.4 GHz - 18 GHz.

#### FM Tolerance: Switch selectable (rear panel)

**FM (Wide):** 50 MHz peak-to-peak worst case.  
**CW (Normal):** 20 MHz peak-to-peak worst case.  
**For modulation rates from DC to 10 MHz.**

**AM Tolerance:** any modulation index provided the minimum signal level is not less than the sensitivity specification.

**Automatic amplitude discrimination:** automatically measures the largest of all signals present, providing that signal is 6 dB above any signal within 500 MHz; 20 dB above any signal, 500 MHz - 18 GHz.

#### Modes of Operation

**Automatic:** counter automatically acquires and displays highest level signal within sensitivity range.  
**Manual:** center frequency entered to within  $\pm 50$  MHz of true value.

#### Acquisition time

**Automatic mode, normal FM:** 530 msec worst case.  
**Automatic mode, wide FM:** 2.4 sec worst case.  
**Manual mode:** 1 msec after frequency entered.

#### Input 2

**Frequency range:** 10 Hz to 520 MHz direct count.  
**Sensitivity:** 50  $\Omega$ : 10 Hz to 520 MHz: 25 mV rms. 1 M $\Omega$ : 10 Hz to 25 MHz: 50 mV rms.  
**Impedance:** selectable 1 M $\Omega$ , <50 pF or 50  $\Omega$  nominal.  
**Coupling:** AC.  
**Connector:** type BNC female.  
**Maximum Input**

50  $\Omega$ : 3.5 V rms (+24 dBm) or 5 V DC, fuse protected  
 1 M $\Omega$ : 200 V DC + 5.0 V rms

#### Time Base

**Crystal frequency:** 10 MHz.

#### Stability

**Aging rate:** <1  $\times 10^{-7}$  per month.  
**Temperature:** < $\pm 1 \times 10^{-9}$  over the range 0°C to 50°C.  
**Short term:** <1  $\times 10^{-9}$  for 1 second averaging time.  
**Line variation:** < $\pm 1 \times 10^{-7}$  for 10% change from nominal.

**Output frequency:** 10 MHz,  $\geq 2.4$  V square wave (TTL compatible) 1.5 V p-p into 50  $\Omega$  available from rear panel BNC.

**External time base:** requires 10 MHz, 1.5 V p-p sine wave or square wave into 1 K $\Omega$  via rear panel BNC connector. Switch selects either internal or external time base.

#### Optional time base (Opt 001)

**Crystal frequency:** 10 MHz.

#### Stability

**Aging rate:** <5  $\times 10^{-10}$ /day after 24-hour warm-up.  
**Temperature:** <7  $\times 10^{-9}$  over the range 0°C to 50°C.  
**Short term:** <1  $\times 10^{-11}$  for 1 s avg. time.

**Line variation:** <1  $\times 10^{-9}$  for 10% change from nominal.

**Warm-up:** <5  $\times 10^{-9}$  of final value 20 minutes after turn-on, at 25°C

signal within 500 MHz; 20 dB above any signal, 500 MHz - 18 GHz.

#### Modes of Operation

### General

**Accuracy:**  $\pm 1$  count  $\pm$  time base error.  
**Resolution:** front panel push buttons select 1 Hz to 1 MHz  
**Display:** 11 digit LED display, sectionalized to read GHz, MHz, KHz, and Hz.  
**Self-check:** selected from front panel pushbuttons displays 75 MHz for resolution chosen.  
**Frequency offset:** selected from front panel pushbuttons. Displayed frequency is offset by entered value to 1 Hz resolution.  
**Sample rate:** variable from less than 20 ms between measurements to HOLD which holds display indefinitely.  
**IF out:** rear panel BNC connector provides 25 MHz to 125 MHz output of down-converted microwave signal.  
**Operating temperature:** 0°C to 50°C.  
**Power requirements:** 100/120/220/240 V rms, +5%, -10%, 48-66 Hz; 100 VA max.  
**Accessories furnished:** power cord, 229 cm (7 $\frac{1}{2}$  ft).  
**Weight:** net 9.1 Kg (20 lb). Shipping 11.4 Kg (25 lbs).  
**Size:** 133 H  $\times$  213 W  $\times$  498 mm D (5 $\frac{1}{4}$ "  $\times$  8 $\frac{3}{8}$ "  $\times$  19 $\frac{5}{8}$ ").

#### Amplitude Measurement (Opt 002)

##### Input 1

**Frequency range:** 500 MHz - 18 GHz.  
**Dynamic range (frequency and level):**  
 -22 dBm to +20 dBm 500 MHz to 12.4 GHz  
 -15 dBm to +20 dBm 12.4 GHz to 18 GHz  
**Maximum operating level:** +20 dBm.  
**Damage level:** +25 dBm.  
**Overload Indication:** displays dashes when input level exceeds +20 dBm nominal.  
**Resolution:** 0.1 dBm.  
**Accuracy:**  $\pm 1.5$  dB (excluding mismatch uncertainty).  
**SWR:** <2:1 (amplitude measurement).  
 <5:1 (frequency measurement).

**Measurement time:** 100 ms + frequency measurement time.  
**Display:** Simultaneously displays frequency to 1 MHz resolution and input level.

##### Input 2 (50 $\Omega$ impedance only)

**Frequency range:** 10 MHz-520 MHz.  
**Dynamic range (frequency and level):** -11 dBm to +20 dBm.  
**Damage level:** +24 dBm.  
**Resolution:** 0.1 dBm.  
**Accuracy:**  $\pm 1.5$  dB (excluding mismatch uncertainty).  
**SWR:** <1.8:1.

**Measurement time:** 100 ms + frequency measurement time.  
**Display:** Simultaneously displays frequency to 1 MHz resolution and input level.

#### Extended Dynamic Range (Opt 003)

**Frequency range:** 500 MHz to 18 GHz.  
**Sensitivity:** 500 MHz to 12.4 GHz: -22 dBm.  
 12.4 GHz to 18 GHz: -15 dBm.  
**Maximum operating level:** +20 dBm.  
**Dynamic range:** 500 MHz to 12.4 GHz: 42 dB.  
 12.4 GHz to 18 GHz: 35 dB.  
**Damage level:** +25 dBm.  
**SWR:** <5:1.

#### Options and accessories

Options and accessories	Price
001: High Stability Time Base	add \$500
002: Amplitude Measurement	add \$1000
003: Extended Dynamic Range	add \$375
011: Digital Input/Output (HP-IB)	add \$350
K70-5992A: Rack Mounting adapter kit with slot for access to front connectors from rear.	
H01: Digital-to-Analog Converter	add \$250
5061-2002: Bail Handle Kit	\$20
908: Rack Mounting Adapter Kit Transit Case	\$25
9211-2682 Transit Case	\$175
500 MHz to 18 GHz	\$4500
12.4 GHz to 18 GHz	
<b>Maximum operating level:</b> +20 dBm.	
<b>Damage level:</b> +25 dBm.	

Hewlett-Packard offers Frequency Standards and clocks which provide accurate frequency, time interval and timekeeping capabilities. Further, Hewlett-Packard standards provide means for comparing these quantities against national standards such as the National Bureau of Standards (NBS) and the U.S. Naval Observatory. Units of frequency or time cannot be kept in a vault for ready reference. They must be generated for each use, hence be regularly compared against recognized primary standards.

Frequency Standard and clock systems manufactured by Hewlett-Packard are used for control and calibration at observatories, national centers for measurement standards, physical research laboratories, missile and satellite tracking stations, communication systems, radio navigation systems, manufacturing plants and radio monitoring and transmitting stations.

#### Types of frequency standards

At the present time, three types of frequency standards are in common use. These are:

1. The cesium atomic beam controlled oscillator.
2. The rubidium gas cell controlled oscillator, and
3. The quartz crystal oscillator.

Hewlett-Packard is the only manufacturer of all three types of frequency standards. Of these three standards, the first is a primary frequency standard and the last two are secondary frequency standards. The distinction between a primary standard and a secondary standard is that the primary standard does not require any other reference for calibration; whereas the secondary standard requires calibrations both during manufacturing and at intervals during use depending on the accuracy desired.

#### Cesium beam frequency standard

Cesium beam standards are in use whenever the goal is a very high accuracy primary frequency standard. In fact, the NBS frequency standard itself is of the cesium beam type. The cesium beam standard is an atomic resonance device which provides access to one of nature's invariant frequencies in accord with the principles of quantum mechanics. The cesium standard is a true primary standard and requires no other reference for calibration.

TABLE 1

Comparison of Frequency Standards

Standard	Principal construction feature	Principal advantage
Cesium Atomic Beam Resonator Controlled Oscillator.	Atomic beam interaction with field-minimum disturbances of resonating atoms due to collisions and extraneous influences.	High intrinsic reproducibility and long-term stability. Designated as primary standard for definition of time interval.
Rubidium Gas Cell Resonator Controlled Oscillator.	Gas buffered resonance cell with optically pumped state selection.	Compact and light weight. High degree of short-term stability.
Quartz Crystal Oscillator.	Piezoelectrically active quartz crystal with electronic stabilization.	Very compact, light and rugged. Inexpensive.

The HP Model 5061A and the new 5062C are portable cesium beam standards proved capable of realizing the cesium transition frequency approaching levels of accuracy and long term stability achieved by large-scale laboratory models. Recent beam tube improvements have made the short-term stability comparable to that of the Rubidium Frequency Standard. With this improved performance cesium standards now have the capability of rapid measurement to high precision along with the excellent long term stability necessary for timekeeping.

#### Rubidium frequency standard

Rubidium frequency standards feature a high order of both short-term and long-term frequency stability. These are both important in certain fields such as deep-space communications, satellite ranging, and doppler radar.

Rubidium standards are similar to cesium beam standards in that an atomic resonant element prevents drift of a quartz oscillator through a frequency lock loop. Yet the rubidium gas cell is dependent upon gas mixture and gas pressure in the cell. It must be calibrated and then it is subject to a small degree of drift. The drift is typically 100 times less than the best quartz crystal standard.

#### Quartz crystal oscillators

Quartz oscillators are used in virtually every frequency control application including atomic standards. The excellent short-term stability and spectral purity of the quartz oscillators used in Hewlett-Packard atomic standards contribute to the high quality of the output signal of these standards. For less demanding applications where some long-term drift can be tolerated, quartz oscillators are used as independent frequency sources. The quartz oscillator designs have improved over the years to provide a relatively low cost, small-size source of frequency.

However, an inherent characteristic of crystal oscillators is that their resonant frequency change with time. After an initial aging period of a few days to a month, the rate-of-change of frequency or aging rate is almost constant. Over a long period the accumulated drift could amount to a serious error, and periodic frequency checks are needed to maintain an accurate quartz crystal frequency standard.

#### Stability

Stability is specified in two ways. Long term stability refers to slow changes in the average frequency with time due to secular changes in the resonator and is usually expressed as a ratio,  $\Delta/f$  for a given period of time. For quartz oscillators this is often termed "aging rate" and specified in "parts per day." Rubidium standards being more stable are specified in "parts per month." On the other hand, Cesium Beam Standards are primary units with no systematic drift. Therefore, the frequency of these primary standards is guaranteed to a specified accuracy.

Short-term stability refers to changes in frequency over a time sufficiently short so that change in frequency due to long term effects is negligible.

Short-term stability is usually specified as the rms average of a number of measurements each over a specified period of time. The longer the averaging time used, the more any deviation is obscured since the average must approach the mean or nominal output frequency in the long run. Hewlett-Packard specifies the short-term stability of its standards in accordance with the definition developed by the National Bureau of Standards and others.\* Measurements conforming to this definition can be easily made with available test equipment including the HP 5360A Computing Counter. Figure 1 is a comparison of the short-term stability of various frequency standards.

\*Statistics of Atomic Standards, D. Allan, Proceedings of IEEE, Feb. 1966, page 221.



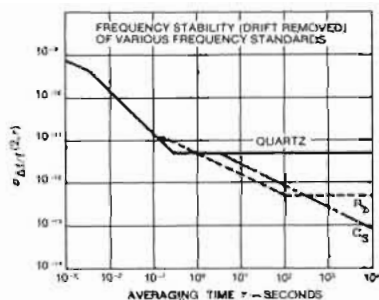

Figure 1. Short term stability of various standards.

**Spectral purity**

Spectral purity is the degree to which a signal is coherent, or, expressed in another way, a single frequency with a minimum of sideband noise power. It is very desirable to have high spectral purity in a standard signal. This is especially important in applications where the standard frequency is multiplied to very high or microwave frequencies so that the frequency spectrum of the signal will be reasonably narrow.

The signal and its frequency spectrum are analogous to a frequency modulated wave where the total power is constant. If the frequency multiplying device is broadband, the ratio of the total sideband power to the signal power increases as the square of the multiplying factor. With frequency multiplication the signal-to-noise ratio will be degraded 6 dB per octave and 20 dB per decade.

Hewlett-Packard oscillators are designed to give exceptional spectral purity. One method of indicating spectral purity is with a phase noise plot. Figure 2 shows the performance of the HP 5061A, Opt. 004 Cesium Beam Atomic Frequency Standard.

**Frequency standards and clocks**

Frequency standard and clocks have no fundamental differences—they are based upon dual aspects of the same phenomenon. Time and frequency are intangible quantities which can be measured only with respect to some physical quantity. The basic unit of time, the second, is defined as the duration of 9,192,631,770 periods of transition within the cesium atom. Conversely an unknown

frequency is determined by counting the number of cycles over the period of a second. The Master Clock at the U.S. Naval Observatory, one of the world's most accurate clocks, is made of an ensemble of more than a dozen Hewlett-Packard cesium beam frequency standards. The USNO directly controls the distribution of precise time and time interval (frequency) from Naval radio stations, LORAN-C (operated by U.S. Coast Guard), Omega and Satellite Navigation Systems. Hewlett-Packard portable cesium standards, "flying clocks," are used to periodically check the synchronization between these stations and the Master Clock.

Hewlett-Packard cesium beam standards are widely used to drive precision clocks because of the extremely good long-term stability and reliability of this primary standard. If a quartz oscillator or other secondary standard is used, it must be evaluated for rate of drift and be corrected periodically.

**Time scale**

The time interval of the atomic time scale is the International Second, defined in October 1967 by the Thirteenth General Conference of Weight and Measures. Since January 1972 the frequency offset between UTC and Atomic Time has been zero and the UTC time scale is kept in synchronism with the rotation of the earth to within ±0.9 second by step-time adjustments of exactly 1 second, when needed.

The U.S. National Bureau of Standards (NBS) and USNO provide the official basis for Standards Time for the United States. The UTC signal is broadcast from the NBS stations WWV and WWVB and by several others stations throughout the world. (See Hewlett-Packard Application Note 52-1, Fundamentals of Time and Frequency Standards, for a list of stations broadcasting time signals).

**Standby power supplies**

Minimum down-time, important for any system, is vital to a time standard. Its worth depends directly on continuity of operation. Noninterrupted operation is also important to ultra-precise quartz oscillators.

Hewlett-Packard standby power supplies ensure continued operation despite line interruptions, and operate over a range of ac line voltage to supply regulated dc to oper-

ate frequency standards and frequency dividers and clocks. The batteries in the supplies assume the full load immediately when ac power fails.

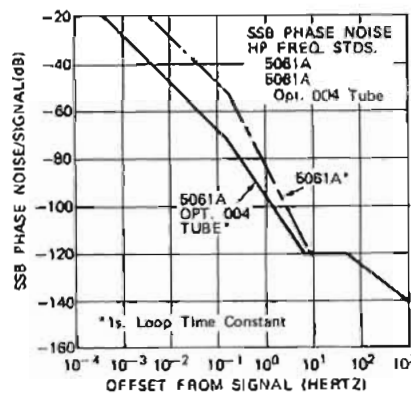

Figure 2. 5061A Phase Noise

**Hewlett-Packard time and frequency standard**

The Hewlett-Packard House Standard at the Santa Clara Division consists of an ensemble of four Hewlett-Packard Cesium Beam Standards each with the Option 004 High Performance Tube.

The standard is compared to the U.S. Naval Observatory Master Clock in Washington, D.C. by means of Loran D and TV Line 10 measurements through the USASTRATCOM satellite system. It is also compared with the U.S. National Bureau of Standards Frequency Standard (NBS FS) at Boulder, Colorado by means of LORAN-C through the Naval Observatory. The frequency uncertainty of the standard is within a few parts in 10<sup>13</sup> with respect to the standards maintained by the NBS and the USNO.

Time is maintained relative to the Naval Observatory and the National Bureau of Standards master clocks to an accuracy of better than ±2.5 microseconds. This accuracy is verified with Flying Clock trips from the Naval Observatory to both Hewlett-Packard Santa Clara Division and Hewlett-Packard Geneva. Both locations have been designated U.S. Naval Observatory Time Reference Stations.

# FREQUENCY & TIME STANDARDS

## Atomic frequency standards

Models 5061A, 5082C, 5065A

### 5061A

- Primary standard,  $\pm 1 \times 10^{-11}$  accuracy
- Proven reliability
- World-wide usage

### 5061A, Opt 004

- Accuracy  $\pm 7 \times 10^{-12}$
- Settability  $\pm 1 \times 10^{-13}$
- Short term  $5 \times 10^{-12}$  (1 sec avg)



5061A

## Introduction

Hewlett-Packard Atomic Frequency Standards have become the world-wide standards for frequency and time keeping since the introduction of the 5060A Cesium Standards in 1964. With the introduction of the 5062C the user now has a choice of four different frequency standards to satisfy a wide variety of applications:

1) 5061A Cesium Beam Frequency Standard. This standard with an accuracy of  $\pm 1 \times 10^{-11}$  was introduced in 1967 to replace the 5060A. The high accuracy and excellent reliability of these units have gained world-wide acceptance of HP frequency standards.

2) 5061A with Option 004 High Performance Cesium Beam Tube. With the Unique design features in this improved Cesium Beam Tube, the 5061A accuracy is  $\pm 7 \times 10^{-12}$  and short term stability is improved by a factor of 10.

3) 5062C Cesium Beam Frequency Reference. This new unit with its small cesium beam tube is designed for on-line system applications where a rugged primary standard is required.

4) 5065A Rubidium Frequency Standard. This instrument features excellent long and short term stability performance at approximately one-half the cost of a cesium standard.

The units are described in detail on the following pages and the specifications are combined in a table to facilitate the comparison and selection of the best unit to suit the user's application.

### Principles of operation

The basic block diagram of both cesium and rubidium standards is the same (see Figure 1). The output of the 5 MHz Crystal Oscillator

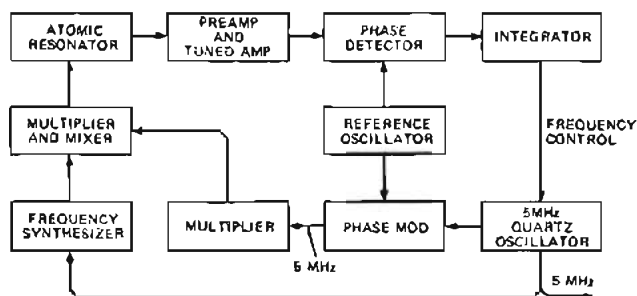

Figure 1. Block diagram of atomic frequency standards.

is multiplied and synthesized to the atomic resonance frequency (6834+ MHz for rubidium and 9192+ MHz for Cesium). The signal is frequency modulated to sweep through the atomic resonance frequency causing the beam intensity in the cesium tube or transmitted

light through the rubidium cell to vary. The output signal is amplified and through a phase detector controls the frequency of a low noise 5 MHz quartz crystal oscillator. This oscillator provides the 5 MHz output. Dividers produce 1 MHz and 100 kHz outputs.

The invariant resonance frequency of the cesium atoms passing through the microwave cavity maintain the output frequency of the cesium standard constant to extremely high accuracy. The accuracy is in part a function of the microwave cavity length and is highest in the 5061A with the long cavity of the high performance beam tube.

In the rubidium standard a buffer gas is required to reduce collisions between the rubidium atoms in the gas cell and the resonant frequency varies slightly with the pressure of the buffer gas. As a result, the rubidium standard has to be calibrated and the frequency drifts slowly with time because of small changes in gas pressure and other effects within the rubidium cell and lamp. Offsetting this disadvantage are: 1) high signal-to-noise ratio of the rubidium cell output which results in excellent short term stability and; 2) a lower cost standard because of the simpler rubidium cell and associated electronics.

Each of the instruments has front panel controls, a circuit check switch and meter for monitoring performance. These and other controls are protected by a panel door. Front panel lights indicate any interruption of continuous operation and that the crystal oscillator is locked to the atomic resonance.

**Applications:** starting with their initial usage as reference standards in national laboratories the applications of HP atomic standards have expanded to include use in operational systems such as the LORAN C and OMEGA navigation transmitters, satellite tracking and guidance stations, very long base line interferometers, navigation receivers based on direct distance measurement (LORAN Rho-Rho), geophysical survey positioning systems and communications systems. Precise timing for frequency control is required for some secure communication systems and to improve efficiency of PCM and spread spectrum systems.

**Cesium standard accuracy:** the cesium beam standard is a primary frequency standard. A cesium beam tube carefully constructed along with the required supporting electronics will, when independently aligned, put out the correct frequency within very narrow limits. The frequency spread of the output for over 250 independently aligned 5061A standards with the standard beam tube is shown in Figure 2. It can be seen from this data that the frequency perturbations in the standard beam tube are so small that all the units are within  $\pm 5 \times 10^{-12}$  of each other and of the NBS frequency. The one signal standard deviation is  $1 \times 10^{-13}$  between units. This performance is intrinsic to the 5061A and is achieved without calibration. The absolute accuracy, intrinsic reproducibility and absence of any perceptible long-term drift or aging are important advantages of cesium standards and assure that the output frequency of a cesium standard is always within the specified accuracy.



E21-5061A

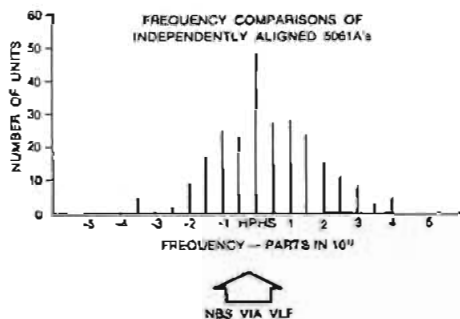

Figure 2. Frequency of independently aligned 5061A Cesium Beam Standards with standard beam tube.

**5061A Cesium beam standard**

The first Hewlett-Packard Cesium Beam Standard, the 5060A, was introduced in 1964. This was followed in 1967 with the improved 5061A and in 1973 with the high performance beam tube option for the 5061A. Over this 11 year period the accuracy and reliability of Hewlett-Packard cesium standards has been demonstrated and these standards have become the world-wide standard for frequency and time keeping. The 5061A has provision for an optional digital divider and reliable, easy-to-read LED clock (Option 001) and for a battery with 1/2 hour standby power capacity with automatic charging (Option 002).

**Reliability and Warranty:** over 25 million operation hours have proven the performance and reliability of Hewlett-Packard cesium beam standards in various world-wide applications. The units have provided dependable microsecond accuracy in aircraft, ship and fixed environments.

A three-year warranty on the 5061A and the standard cesium beam tube is provided as a result of proven field reliability over an extended period. This warranty includes replacement of the cesium beam tube if it should fail within the warranty period. Typically, beam tube life has been in excess of four years.

**5061A with Opt 004, high performance cesium beam tube**

The Hewlett-Packard Model 5061A primary frequency standard with the Option 004 cesium beam tube offers increased stability and accuracy in the instrument which has become the worldwide standard of frequency and time keeping since its introduction in 1967. Improvements in magnetic shielding, ruggedization and environ-

mental performance permit improved performance and expansion of navigation and communication systems that have been made practical by the 5061A.

The design concept of the high performance beam tube includes unique HP designed dual beam optics with higher beam intensity to accomplish better short term stability and greater immunity to effects of shock and vibration. A 50 percent increase in resonance cavity length without change in the overall beam tube size contributes to better accuracy and settability because of the high Q of the narrower resonant line width. This tube retains the unique cesium standard feature of virtually no long term instability or aging.

The intrinsic accuracy is improved to  $\pm 7 \times 10^{-12}$  which provides an excellent reference standard without need of calibration. If desired, as in many timekeeping applications, two or more units may be calibrated to determine the difference in rate or may be adjusted to the same frequency. With the improved settability specifications of  $1 \times 10^{-13}$  small changes in frequency are accomplished rapidly and accurately. A provision for degaussing the tube without adversely affecting the instrument operation allows removal of any residual magnetic field in the tube. This is important in achieving the settability performance.

The short term stability specification is improved by a factor of ten with the new tube. The  $5 \times 10^{-12}$  (1 sec avg.) performance compares very favorably with that of rubidium type standards which are noted for their excellent short term stability. An important advantage from the better short term stability is the capability to make measurements to 1 sigma precision of  $1 \times 10^{-12}$  in about one minute compared to the two hours required previously. The 5061A with the Option 004 High Performance Tube has the same high reliability as the 5061A with the standard tube. The new high performance tube is warranted for 14 months (10 000 hours) and is designed to have the same long life as the standard tube.

**10653A/B/C Retrofit kit**

The high performance beam tube may be installed in place of the standard tube in existing HP 5060A or 5061A Cesium Standards. The 10653A/B/C Kit includes the new tube and the parts necessary for installation. Further information on the 10653A/B/C Retrofit Kit is available from HP Sales Offices.

**10638 Degausser**

The Model 10638A Degausser is designed for use with the Option 004 High Performance Beam Tube to achieve settability of  $\pm 1 \times 10^{-13}$  and reproducibility of  $\pm 3 \times 10^{-12}$ . The degausser removes residual magnetic fields in the beam tube which slowly decay and cause a small frequency change. The degausser should be used when initially setting up the 5061A with Option 004 or after the instrument has been moved or adjusted.

**1081A/B LED clock kit**

The LED Clock readout is available as a retrofit kit to replace the mechanical clock used in earlier models of the 5061A and in the 5065A Rubidium Standard.

**E21-5061A Flying clock**

The E21-5061A consists of a 5061A Cesium Beam Standard with Option 001 LED Clock and K02-5060A Power Supply joined together to make one portable unit. The power supply, which can be operated from 6 or 12 V dc, 24 to 30 V dc, or 115/230 V  $\pm 10\%$ , 50 to 400 Hz, will provide approximately 7 hours standby power (from sealed nickel-cadmium batteries) for the 5061A Cesium Beam Standard.

This wide range of operating power capabilities enables the E21-5061A to operate on local power in virtually any country in the world. Operation is approved aboard commercial aircraft. The seven hours of standby capability make it possible to travel where there is no power available and, of course, allow the E21-5061A to conveniently be transported between power sources and operated in almost any air or surface vehicle as a "flying clock" (see Hewlett-Packard Journal, August 1966 and December 1967).

The Option 004 tube, because of the improved shielding, offers a significant increase in accuracy under the varying earth's magnetic field conditions experienced by flying clocks and is a desirable addition to the E21-5061A. In addition, the better short term stability permits more accurate and rapid comparison of standards. The Option 002 Battery may also be added to increase standby capability.

# FREQUENCY & TIME STANDARDS

## Atomic frequency standards

Models 5061A, 5062C, 5065A (cont.)

- Primary frequency/time reference
- Fast warm-up
- Rugged, reliable

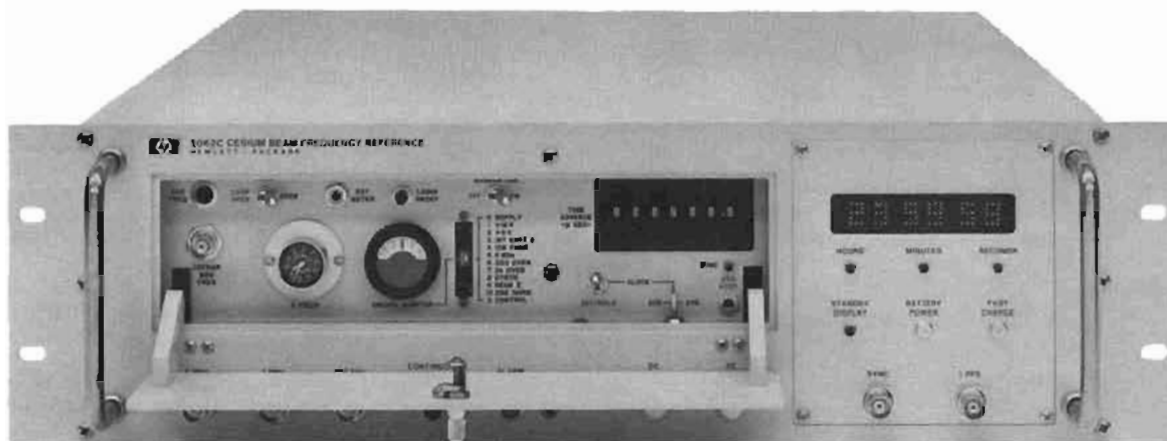

5062C

### 5062C Cesium beam frequency reference

The Model 5062C Cesium Beam Frequency Reference is a rugged and compact precision oscillator designed for use in surface and airborne systems such as shipboard navigation systems and air transport communication systems. It combines the precision of a laboratory primary standard with the rugged, compact features required for on-line system operations in the extreme environments sometimes encountered in ships and aircraft.

Features important for system operation are the expanded operating temperature range ( $-28^{\circ}\text{C}$  to  $+65^{\circ}\text{C}$ ), 20 minute warm-up, frequency accuracy of within  $\pm 3$  parts in  $10^{11}$  (including temperature and magnetic field effects) with negligible long-term drift and no need for calibration.

The basic design of the Model 5062C is patterned after that of the Hewlett-Packard Model 5060A and the 5061A Cesium Beam Clocks, but this rugged unit is 25% smaller in size. Yet, space is provided for an optional clock and standby batteries. Other features such as special output frequencies or a time code generator may be added. The key to the smaller size is a newly developed, small, rugged cesium beam tube. This tube, approximately six inches long and four inches diameter, includes all the features of the sixteen inch tube used in the HP 5061A to insure high accuracy and stability plus long life. In addition, multiple cesium beams assure accuracy under the shock, vibration and acceleration encountered in operating systems.

New, compact electronics compliment the small beam tube in accomplishing the 5062C design. Plug-in keyed printed circuit cards assure ease of maintenance. Particular attention has been given to both the electronics and mechanical design to the temperature, shock and vibration encountered in system applications. The resulting rugged design assures stable operation under extreme environmental conditions. The 5062C meets many of the requirements of MIL-E-16400 specification for ship and shore equipment. These include the wide operating temperature range, the 400 pound hammer blow specified by MIL-S-901 and the Type I shipboard vibration of MIL-STD-167-1 (4–50 Hz).

With minor circuit additions the rugged, commercial, design of the 5062C meets the operating requirements of military specification MIL-F-28811 (EC). The nomenclature, 0-1695/U has been assigned to this version of the instrument which is identified as the 5062C, Option 010. The added features are described below.

**Reliability:** the unit incorporates conservatively designed circuits to

insure reliability. Similar designs in the 5061A Cesium Beam Standard have demonstrated mean time between failures (MTBF) in excess of 40,000 hours in laboratory environments.

Ease of maintenance was included along with reliability and ruggedness as design goals of the 5062C. The front panel circuit monitoring switch and meter permit checks for proper operation and monitoring of critical functions. In the event of a malfunction, troubleshooting is simplified by well marked test points on the circuit cards and mother boards. Board extenders permit access to individual boards while operating. The circuit boards are keyed to assure that they are properly located. The few board adjustments are readily accessible when the instrument covers are removed. The 5062C is supplied with pivot slides for easy access when the unit is rack mounted. All these features simplify troubleshooting and minimize mean time to repair (MTTR) in the event of failure.

**Options:** the 5062C is designed to include clock and battery options and space is available to add other features required to meet systems requirements. Special output frequencies, time code generators, and additional buffered outputs may be added. The following standard options are available.

**Option 001 Digital clock:** this option adds a front panel LED display of hours, minutes and seconds. A digital divider generates one pulse-per-second from 5 MHz. This master pulse may be synchronized to a reference pulse. The digital clock and the clock 1 PPS are adjustable in phase with respect to the master pulse in 0.1 microsecond steps.

**Option 002 Standby battery:** the sealed gelled-electrolyte battery provides a minimum of one hour standby at  $25^{\circ}\text{C}$  after full charge. The battery is automatically recharged after use. When external power fails, the standby battery assures continuous output without interruption.

**Option 003 Digital clock and standby battery:** this option combines Option 001 and 002.

**Option 010 Time-code generator:** this option includes the Option 001 Digital Clock and Option 002 Standby Battery along with other special features required to meet the operating requirements of the 0-1695/U Frequency Standard, Cesium Beam in accordance with Military Specification MIL-F-28811(EC). These include a time code generator, four one-pulse-per-minute outputs, additional 5 MHz outputs, added RFI shielding and special rear panel and mating connectors. The rugged design of the 5062C meets the environmental requirements of the military specification.

- Compact, low-price atomic standard
- Long term drift rate  $<1 \times 10^{-11}/\text{mo}$
- Short term stability  $<5 \times 10^{-13}$ (100 sec avg)



### 5065A Rubidium frequency standard

The HP Model 5065A is an atomic-type secondary frequency standard which uses a rubidium vapor resonance cell as the stabilizing element. As a result, it has long term stability of better than  $1 \times 10^{-11}$  per month which exceeds that of high quality quartz oscillator frequency standards by 50 to 100 times. Furthermore, it has excellent short term stability. These features contribute to its desirability as a coherent signal source, as a master oscillator for radio and radar systems where special requirements for stability and/or narrow bandwidth must be met, as a precision time keeper where the better performance of a cesium beam primary standard is not required, and as a house frequency standard for improved accuracy with fewer NBS calibrations compared to that required with quartz standards.

Front panel controls and circuit check meter of the 5065A are protected by a panel door. The magnetic field control provides fine frequency adjustment with which the frequency can be set to a precision of better than  $2 \times 10^{-12}$  without reference to a chart. The 5 MHz low noise quartz oscillator is phase locked to the atomic frequency and provides the standard 5 MHz, 1 MHz, and 100 kHz outputs. The circuit check meter with selector switch monitors key voltages and currents for routine maintenance readings, calibration procedures, and fault finding.

The 5065A is designed for assured operation—to give the user confidence that the standard output signals are correct and locked to the atomic frequency. Logic within the unit maintains power to a "continuous operation" light on the front panel. If operation is interrupted, even momentarily, for any reason the light goes out and stays out until manually reset. An integrator limit light warns when the frequency correcting servo loop is approaching the limit of its dynamic range.

The HP Model 5065A is contained in a small sized package and is lightweight in comparison to a cesium beam standard. Additionally the rubidium resonance cell is much more frequency stable than quartz oscillators while subjected to shock and vibration, EMC, humidity, and magnetic field effects.

**Reliability and warranty:** the most significant module in the HP 5065A in terms of performance is the Rubidium Vapor Frequency Reference (RVFR). This temperature controlled, magnetically shielded unit includes the Rb gas cell and a photo sensitive detector designed for maximum possible reliability. Field experience, in-

cluding several million hours of operation, have demonstrated this reliability and the module is now warranted for a period of three years. This increased warranty protects the owner in the event of random failure.

The Option 001 Digital Clock has an easy to read LED time-of-day display. The olive black upper panel provides a dark background around the readout for excellent contrast and readability. Initial clock setting is accomplished by means of pushbuttons easily accessible by removing the top cover. The LED display offers high reliability, freedom from errors due to mechanical shock, and performance over the full environmental range of the 5065A. A sync button on the digital divider permits automatic synchronization of this 1 PPS pulse to an external pulse. The clock 1 PPS is adjustable in decade steps from  $1 \mu\text{s}$  to 1 s, with respect to the synchronized reference, with 6 thumbwheel switches. A screwdriver adjustment allows fine continuous adjustment over a range of  $1 \mu\text{sec}$ .

To conserve battery power, the display is not illuminated when ac power is not available. A STANDBY READ pushbutton below the display is used for readout when operating on the internal battery or external dc.

The LED clock readout is available as a retrofit kit, HP Model 10810A/B, to replace the mechanical clock in earlier models of the 5065A. Contact your Hewlett-Packard sales office for full details.

The Option 002 Standby Battery provides the 5065A with a minimum of 10 minutes standby power at 25°C. Switchover from line to battery is automatic so there is no interruption of operation if ac line power should fail. A front panel ac interruption light warns when ac power has failed or has been disconnected. Fast or float charging rates may be selected when ac power is available.

The Option 003 combines the Option 001 Clock and Option 002 Battery and should be specified if both Options 001 and 002 are required.

### E21-5065A Portable time standard

E21-5065A Portable Time Standard is a complete system for precision timekeeping and for transporting time from one location to another. It consists of the 5065A Rubidium Standard with digital clock and divider (Option 001) and the K02-5060A Power Supply with 6 or more hours standby capability. The component units are held together by side bars, and the interconnecting cables are protected by a back cover.



# FREQUENCY & TIME STANDARDS



## Atomic frequency standards

Models 5061A, 5062C, 5065A (cont.)

Instrument:	5061A Opt 004	5061A	5062C	5065A
AC Magnetic Field: 50, 60 and 400 Hz $\pm 10\%$	$<2 \times 10^{-14}$ for 2 Gauss peak	$<2 \times 10^{-14}$ for 2 Gauss peak	$<2 \times 10^{-14}$ for 2 Gauss peak	$<5 \times 10^{-14}$ for 1 Gauss peak
Vibration with isolators:	MIL-STD-167-1 MIL-T-21200	MIL-STD-167-1 MIL-T-21200	MIL-STD-167-1	MIL-STD-167-1
Shock:	MIL-E-5400, Class 1 (30 G)			
	1 MIL-T-21200, C.1		MIL-E-16400	MIL-T-21200, C.1
EMC:	MIL-STD-461, Notice 3, Class A			
<b>General</b>				
Power: AC:	50, 60 or 400 Hz $\pm 10\%$ , 115/230 V $\pm 10\%$			
DC:	43 W 22 to 30 V 27 W	43 W 22 to 30 V 27 W	48 W 22 to 30 V 33 W	49 W 23 to 30 V 35 W
Option 001: Add (AC/DC)	10/7.5 W	10/7.5 W	12/7.5 W	10/7.5 W
Option 002: Add (AC/DC)	22/4.5 W	22/4.5 W	25/3 W	6/0 W
Option 010: Add (AC/DC)			62/15 W	
Dimensions (H x W x D): mm inches:	221 x 425 x 416 8 3/4 x 16 3/4 x 16 3/4	221 x 425 x 416 8 3/4 x 16 3/4 x 16 3/4	133 x 482 x 533 5 1/4 x 19 x 21	133 x 425 x 416 5 1/4 x 16 3/4 x 16 3/4
Weight: (lb/kg)	70/31.8	67/30.5	50/22.7	34/15.4
Option 001: Add (lb/kg)	2/0.9	2/0.9	5/2.3	2/0.9
Option 002: Add (lb/kg)	5/2.3	5/2.3	15/6.8	3.5/1.6
<b>Option 001, Clock</b>				
1 PPS Outputs: Master: Clock:	Front & Rear BNC	Front & Rear BNC	Rear BNC Front & Rear BNC	Front & Rear BNC
Amplitude:	10 V peak into 50 $\Omega$ load			
Width:	20 $\mu$ s min	20 $\mu$ s min	20 $\mu$ s min $\pm 5\%$	20 $\mu$ s min
Rise Time:	$<50$ ns	$<50$ ns	$<20$ ns	$<50$ ns
Fall Time:	$<2$ $\mu$ s	$<2$ $\mu$ s	$<1$ $\mu$ s	$<2$ $\mu$ s
Filter, pulse-to-pulse:	$<5$ ns, rms	$<5$ ns, rms	$<5$ ns, rms	$<5$ ns, rms
Synchronization:	Automatic, 10 $\pm 1$ $\mu$ s delay	Automatic, 10 $\pm 1$ $\mu$ s delay	Auto., 10 within $\pm 500$ ns	Auto., 10 $\pm 1$ $\mu$ s delay
Clock pulse adjustment range:	1 $\mu$ s to 1 s	1 $\mu$ s to 1 s	0.1 $\mu$ s to 1 s	1 $\mu$ s to 1 s
Clock display:	Solid State Digital			
Option 002, Standby Power Supply Capacity at 25°C with Option 001 Clock:	30 Minutes	30 Minutes	One Hour	10 Minutes
Recharge, Fast/Float:	Automatic, fast charge			Switch

### Ordering Information

5061A Cesium Beam Frequency Standard

Opt 001: Clock

Opt 002: Standby Power Supply

Opt 003: Clock and Standby Power Supply

Opt 004: High Performance Beam Tube

Opt 908: Rack Flange Kit

E21-5061A Flying Clock

Consists of: 5061A with Opt 001 (not included in

E21 price) and K02-5060A Standby Power Supply.

Weight: 64 kg (141 lb).

Size: 425 W x 405 W x 546 mm D (16 3/4" x 15 1/2" x 21 1/2") (includes handles).

10638A Degausser

Weight: 1.2 kg (3 lb).

Size: 130 H x 77 W x 279 mm D (5 1/8" x 3 1/32" x 11").

### Price

\$20,450

add \$2125

add \$1025

add \$3150

add \$3250

add \$15

add \$4500

\$880

5062C Cesium Beam Frequency Reference

Opt 001: Clock

Opt 002: Standby Power Supply

Opt 003: Clock and Standby Power Supply

Opt 010: Clock, Battery, Time-Code Generator

5065A Rubidium Frequency Standard

Opt 001: Clock

Opt 002: Standby Power Supply

Opt 003: Clock and Standby Power Supply

Opt 908: Rack Flange Kit

E21-5065A Portable Time Standard

Consists of: 5065A with Opt 001 (not included in

E21 price) and K02-5060A Standby Power Supply.

Weight: 50 kg (110 lb).

Size: 425 H x 405 W x 546 mm D (16 3/4" x 15 1/2" x 21 1/2") (includes handles).

\$19,000

add \$2150

add \$1025

add \$3175

add \$5750

\$9250

add \$2125

add \$495

add \$2620

add \$10

add \$4500

# FREQUENCY & TIME STANDARDS

## Quartz frequency standards

Models 105A/B

- High spectral purity
- Well-buffered outputs
- Aging  $< 5 \times 10^{-10}$  per day

105B

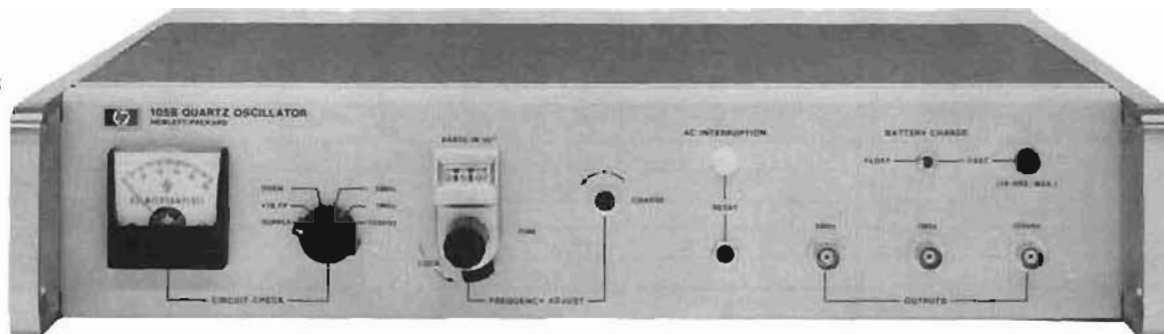

Models 105A and B Quartz Oscillators provide state-of-the-art performance in precision frequency and time systems because of their excellent long and short term stability characteristics, spectrally pure outputs, unexcelled reliability, and ability to operate under a wide range of environmental conditions. They fill a need for a small and economical yet highly stable precision quartz oscillator for frequency and time standards. Both models can be operated from the ac line; the 105B has a built-in 8-hour standby battery for uninterrupted operation should line power fail. Both have 5 MHz, 1 MHz and 100 kHz buffered sinusoidal outputs with excellent short term stability (5 parts in  $10^{12}$  rms for 1 s averaging time) and aging rate ( $< 5$  parts in  $10^{10}$  per day).

The 105A/B features rapid warm-up. Typically, the oscillator will be within 1 part in  $10^9$  of the previous frequency in 30 minutes after an "off" period of 24 hours. The basis of these oscillators is an extremely stable 5 MHz, 5th overtone quartz crystal developed by Hewlett-Packard. New technologies in the crystal mounting and packaging have resulted in a cleaner crystal which in turn has a lower aging rate. The crystal, oscillator and AGC circuit are all enclosed in a proportional oven which reduces the temperature effects on these components and circuits.

The 68 mm  $\times$  68 mm  $\times$  137 mm (2.7"  $\times$  2.7"  $\times$  5.4") package containing the oven enclosed crystal oscillator with AGC circuit and buffer amplifier are available separately as a component oscillator, the K07-105A, for use in equipment where a high quality 5 MHz source is required. Details are available from Hewlett-Packard sales offices.

Particular care was taken to provide a spectrally pure 5 MHz output which, when multiplied high into the microwave region, provides signals with spectra only a few cycles wide. Spectra less than 1 Hz wide can be obtained in X-band (8.2 to 12.4 GHz). The stability and purity of the 5 MHz output make it suitable for doppler measurements, microwave spectroscopy, and similar applications where the reference frequency must be multiplied by a large factor.

### Specifications

**Outputs:** 5 MHz, 1 MHz, 100 kHz; 1 V rms into 50  $\Omega$  front and rear connectors.

**Clock output:** 1 MHz or 100 kHz; 0.5 V rms into 1 k $\Omega$ , rear connector. Normally supplied wired for 1 MHz output.

#### Frequency stability

**Aging rate:**  $< 5 \times 10^{-10}$  per 24 hours.

**Short-term stability:** for 5 MHz output only.

$\tau$ (sec)	$\sigma$ $\Delta f/f$ (2, $\tau$ )	$\sigma$ $\Delta t$ (2, $\tau$ )sec
$10^{-2}$	$1.5 \times 10^{-10}$	$1.5 \times 10^{-11}$
$10^{-1}$	$1.5 \times 10^{-11}$	$1.5 \times 10^{-12}$
$10^0$	$5 \times 10^{-12}$	$5 \times 10^{-13}$

**Temperature:**  $< 2.5 \times 10^{-9}$  total change 0°C to 50°C.

**Load:**  $\pm 2 \times 10^{-11}$  open to short circuit, 50  $\Omega$  R, L or C load change.

**Supply voltage:**  $\pm 5 \times 10^{-11}$  for 22-30 V dc from 26 V dc reference and for 115/230 V  $\pm 10\%$ .

**Warm-up (at 25°C):** to within  $1 \times 10^{-7}$  of previous frequency in 15 min.,  $1 \times 10^{-8}$  in 20 min.,  $1 \times 10^{-9}$  in 30 min.

**Distortion (5 MHz, 1 MHz, 100 kHz) below rated output**

**Harmonic:**  $> 40$  dB.

**Non-harmonic:**  $> 80$  dB.

**Signal-to-noise ratio:** for 1 and 5 MHz,  $> 90$  dB in a 30 kHz noise BW (5 MHz output filter BW is approximately 100 Hz).

#### Frequency adjustments

**Fine:**  $5 \times 10^{-8}$  range with digital dial reading parts in  $10^{11}$ .

**Coarse:**  $1 \times 10^{-6}$  front panel screwdriver control.

**Phase locking:** external +5 V to -5 V allows  $> 2 \times 10^{-8}$  frequency control for locking to external source.

#### Environmental

**Temperature, operating:** 0°C to +50°C.

**Temperature, storage:** -40°C to +75°C (+50° for 105B).

**Altitude:** 15,24 km (50,000 ft.).

**Shock:** MIL-T-21200 (30 Gs).

**Vibration:** MIL-STD-167 and MIL-T-21200.

**Electromagnetic compatibility (EMC):** MIL-1-6181D.

**Standby supply capacity:** model 105B only, 8 hours at 25°C ambient temperatures.

**Power requirements:** 115/230 V  $\pm 10\%$ , 50-400 Hz at 17 W (70 W warm-up) for 105A. For 105B add 1 W for float charge and 12 W for fast charge, 22-30 V dc at 6.4 W (10.3 W warm-up).

**Size:** 88 H  $\times$  425 W  $\times$  286 mm D (3 $\frac{1}{2}$ "  $\times$  16 $\frac{3}{4}$ "  $\times$  11 $\frac{1}{4}$ ").

**Weight:** 105A — net, 8 kg (16 lb). Shipping, 10.5 kg (23 lb). 105B — net, 11 kg (24 lb). Shipping, 14 kg (31 lb).

#### Options

908: Rack Flange Kit

910: Extra manual

#### Price

add \$10

add \$10.50

#### Ordering information

105A Quartz Oscillators

105B Quartz Oscillators

\$2800

\$3250



- Excellent spectral purity
- Low power
- Fast warm-up

- High reliability
- Rugged
- Compact

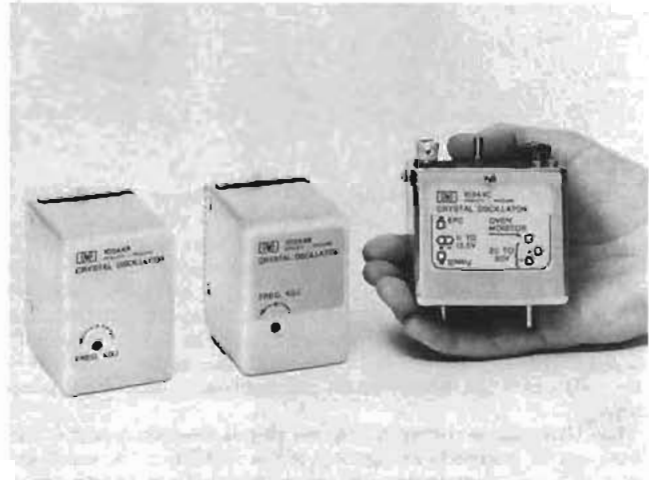
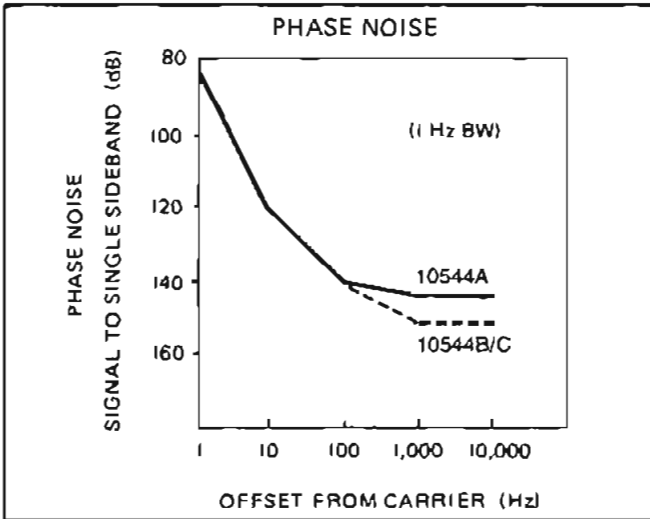

The 10544 Quartz Crystal Oscillators were developed by Hewlett-Packard to meet the needs for compact, high stability oscillators in test equipment and systems. Their excellent short-term stability and high spectral purity are especially desirable in applications where multiplication and synthesis are used to generate microwave frequencies. Rugged construction and high quality components assure high reliability and optimum performance. With the extremely low aging rate of these oscillators, significant cost savings can be realized at the end user by reducing the frequency of calibration needed to stay within FCC accuracy requirements.

The crystal for the oscillator is supported in a new rugged mounting in a cold-welded, high bake-out enclosure. The housing around the crystal enclosure is massive with high thermal conductivity which contributes both to rapid warmup and excellent temperature stability. The oscillator, AGC amplifier and oven control circuits are all inside a thermally insulated oven. Rigid plastic foam with extremely low thermal conductivity is used to provide thermal insulation and firm mechanical support for the oven enclosure.

The 10544A has low power consumption because of the use of a switching regulator in the oven controller circuits. The 10544B/C uses a dc oven controller which requires a little bit more power but results in better phase noise and short-term stability specifications. The 10544C has provisions for shock mounting and uses SMB snap-on rf connectors for the 10 MHz output and for the EFC input, versus PC-board connectors in the A and B versions. Other differences are listed in the specification section.

The 10544 oscillators are ideally suited for use in communication and navigation systems, synthesizers, time-code generators, counters and spectrum analyzers. The 10 MHz output frequency is a convenient starting point since it is easily divided or multiplied.

A screwdriver adjustment through the top of the oven enclosure permits frequency adjustment over a range of  $2 \times 10^{-6}$  (20 Hz), yet the control is sensitive enough to allow adjustment to better than  $1 \times 10^{-8}$  (0.01 Hz). Frequency can also be controlled electronically over a 1 Hz range with an externally applied voltage.

### Specifications

	10544A	10544B/C
<b>Output:</b>	10 MHz	10 MHz
	$1.0 \pm 0.2$ V rms	$0.6 \pm 0.1$ V rms
<b>Impedance:</b>	1000 $\Omega$	50 $\Omega$
<b>Aging rate (after 24-hour warmup):</b>	$< 5 \times 10^{-10}$ /day.	
<b>Short term stability:</b>		
Averaging time(s)		
$10^{-4}$	$5 \times 10^{-8}$	$1 \times 10^{-8}$
$10^{-3}$	$5 \times 10^{-9}$	$1 \times 10^{-9}$
$10^{-2}$	$5 \times 10^{-10}$	$1 \times 10^{-10}$
$10^{-1}$	$5 \times 10^{-11}$	$1 \times 10^{-11}$
$10^0$	$1 \times 10^{-11}$	$1 \times 10^{-11}$
$10^1$	$1 \times 10^{-11}$	$1 \times 10^{-11}$
$10^2$	$2 \times 10^{-11}$	$2 \times 10^{-11}$
<b>Temperature:</b>	$< 7 \times 10^{-9}$ (0 to 71°C)	
<b>Load:</b>	$< 5 \times 10^{-10}$	$< 5 \times 10^{-9}$
	( $\pm 25\%$ load change)	( $\pm 10\%$ load change)
<b>Warmup:</b>	Within $5 \times 10^{-9}$ of final value 20 min. after turn on.	
<b>Frequency adjustment</b>		
Coarse:	$> 2 \times 10^{-6}$ (20 Hz)	
Fine (EFC):	$> 1 \times 10^{-7}$	
<b>Harmonic distortion:</b>	$> 25$ dB from rated output	
<b>Non-harmonic distortion:</b>	$> 80$ dB	
<b>SSB phase noise ratio (1 Hz bw)</b>		
For offsets of 1 Hz:	83 dB	85 dB
10 Hz:	120 dB	120 dB
100 Hz:	140 dB	140 dB
1000 Hz:	145 dB	150 dB
10000 Hz:	145 dB	150 dB
<b>Power:</b>	3W	4.5W
<b>Case size:</b>	72 H x 52 W x 62 mm D (2.8" x 2" x 2.4")	
<b>Weight:</b>	0.31 kg (11 oz.).	

### Price

Quantity	10544A	10544B	10544C
1 to 4:	\$625	\$690	\$775
5 to 9:	600	665	745
10 to 25:	575	635	715
25 to 49:	525	580	650

# FREQUENCY & TIME STANDARDS

## Distribution amplifier

### Model 5087A

- Versatile with 3 input and 12 output channels
- Low noise, high stability, and isolation

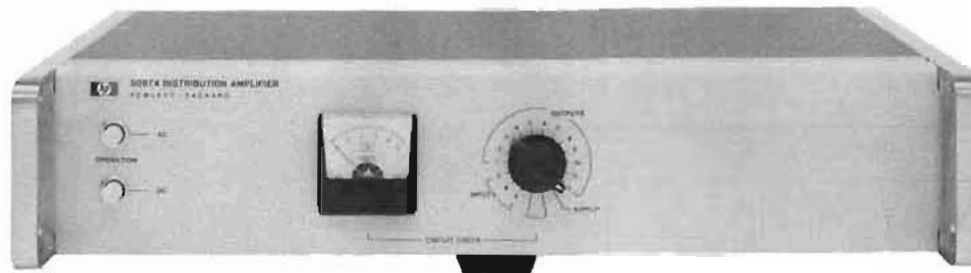

The Hewlett-Packard Model 5087A Distribution Amplifier provides the isolation and flexibility required for distribution of the output of high quality frequency standards. Low distortion and excellent isolation make it ideal for providing multiple outputs from atomic or crystal frequency standards. The 3 input channels will accept 10 MHz, 5 MHz, 1 MHz or 100 kHz in any combination. The number of outputs for each channel is selectable up to a total of 12 outputs. The output levels are individually adjustable from 0 to 3 V rms. All input and output levels are monitored on a front panel meter.

The Distribution Amplifier features plug-in modular construction, short circuit isolation, exceptional phase stability, low noise and cross-talk, and uninterrupted switchover to standby dc in event of ac power failure.

The shielding around each input and output plug-in amplifier assures minimum noise and crosstalk. The tuned output amplifiers provide clean signals and high channel-to-channel isolation.

The instrument is designed for maximum versatility and can be supplied to meet a wide variety of special requirements. The standard configuration of input and output amplifiers is shown in Figure 1.

Several other commonly used configurations are also available and special combinations of the various input and output modules can be supplied. Input and output amplifiers can be added or the configuration easily changed at any time.

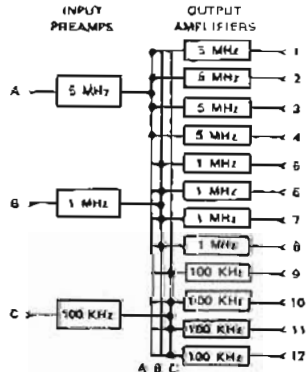

Figure 1. 5087A Distribution Amplifier with Option 031, Standard Configuration input and output amplifiers.

## Specifications

**Inputs** (up to three, rear panel BNC)

**Frequencies:** 10 MHz, 5 MHz, 1 MHz or 100 kHz.

**Level:** 0.3 to 3.0 V rms, 50 ohms.

**Outputs** (up to 12 rear panel BNC)

**Frequencies:** 10 MHz, 5 MHz, 1 MHz or 100 kHz.

**Level:** 0-3 V into 50 ohms (screwdriver adjustment).

**Harmonic distortion:** >40 dB below rated output.

**Non-harmonic distortion:** >80 dB below rated output.

## Isolation

**Load** (open or short on any other channel)

**Amplitude change:** 0.1 percent.

**Phase change:** <0.1 ns at 5 or 10 MHz.

<0.5 ns at 1 MHz.

<5.0 ns at 100 kHz.

**Injected signal:** 1 V signal up to 50 MHz applied to any output except 10 MHz, will be down more than 60 dB in all other outputs; 10 MHz output channel will be down more than 50 dB.

**SSB phase noise (5 MHz):** >145 dB below signal in 1 Hz BW for frequencies >1 kHz from carrier.

**Short term stability degradation (5 MHz)** <1 × 10<sup>-12</sup> in 10 kHz band. (1 s average).

## Environmental

**Temperature:** MIL-E-16400, Class 4.

**Operating:** 0-50°C; storage: -62° to +75°C.

## Stability

**Amplitude:** ±0.5 dB, 0° to 50°C.

**Phase:** <0.1 ns/°C., 5 and 10 MHz.

**EMC:** MIL-STD-461A.

**Humidity:** 95% at 40°C.

**Vibration:** MIL-STD-167.

**Altitude:** up to 30,000 ft.

**Shock:** MIL-T-21200, Class I and MIL-E-5400 (30 Gs).

## General

**Power:** 115 or 230 V ±10%, 48 to 440 Hz, 20 VA, max, or 22-30 V dc, 500 milliamperes, max.

**Dimensions:** 88 mm H × 425 mm W × 286 mm D (3<sup>1</sup>/<sub>2</sub>" × 16<sup>3</sup>/<sub>4</sub>" × 11<sup>1</sup>/<sub>4</sub>").

**Weight:** typical. Opt 031—Net 7 kg (15 lb).

## Options

**Normal configurations** (input and output amplifiers)

031: 5, 1 and 0.1 MHz inputs and 4 outputs at each frequency

032: Single 5 MHz input and 12 outputs

033: Single 10 MHz input and 12 outputs

034: Single 5 MHz input, 4 each outputs at 5, 1 and 0.1 MHz

## Special configurations

**Input preamplifiers** (up to 3 total)

004: Input Preamplifier (0.1 to 10 MHz)

005: 5 to 1 MHz Input Divider

006: 1 to 0.1 MHz Input Divider

011: 5 to 10 MHz Input Doubler

013: 10 to 5 MHz Input Divider

014: 10 to 1 MHz Input Divider

**Output amplifiers** (up to 12 total)

001: 5 MHz Output Amplifier

002: 1 MHz Output Amplifier

003: 0.1 MHz Output Amplifier

012: 10 MHz Output Amplifier

908: Rack Flange Kit

5087A: Distribution Amplifier Mainframe

## Price

add \$1106

add \$1050

add \$1050

add \$1200

add \$35

add \$90

add \$90

add \$90

add \$90

add \$90

add \$90

add \$90

add \$90

add \$90

add \$10

\$1100

- 12 Amp-hr capacity
- Sealed nickel-cadmium cells
- Used in "flying clocks"

- 18 Amp-hr capacity
- Vented nickel-cadmium cells

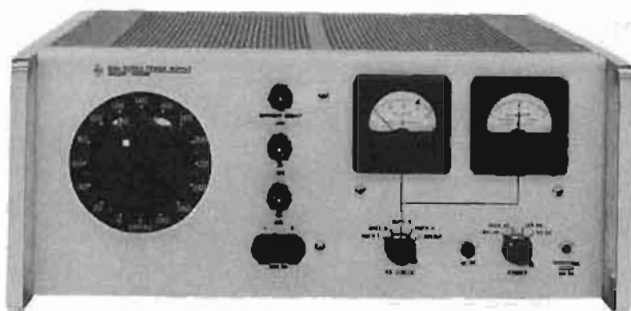

K02-5060A

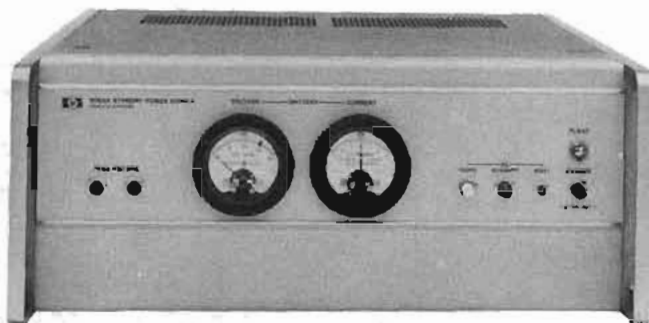

5085A

The HP Models 5085A and K02-5060A Standby Power Supplies furnish dc power to keep frequency or time standard systems operating during extended interruptions of ac line power. For applications where it is essential to maintain continuous operation and avoid loss of precise time, the use of a standby power supply is an absolute necessity. These units are designed for use with the Hewlett-Packard Cesium Beam Standards, Rubidium Vapor Standards, Quartz Oscillators and other equipment which will operate from 22 to 30 V dc. No switching is used in transferring power from line to battery operation and back again thus assuring uninterrupted operation.

#### HP K02-5060A

The K02-5060A is a very versatile unit which was designed specifically as a portable power supply for the 5061A and 5065A "Flying Clocks" where it is necessary to operate from a wide range of power sources along with the standby capability to maintain continuous operation where no external power is available. A special inverter permits operation from a 6 or 12 V dc car battery in addition to the 115/230 V ac and 24-30 V dc capability. The 12 ampere-hour standby batteries are the sealed, nickel-cadmium type and thus spill-proof. Mounting hardware is available to attach the K02-5060A to either the 5061A or 5065A Standards to make a portable standard, the E21-5061A or E21-5065A.

#### HP 5085

The HP 5085A is intended for installation where 115 or 230 V ac is available. Vented nickel-cadmium batteries with an 18 ampere-hour guaranteed capacity (derated from 25) are used. They provide about 10 hours of standby power for the 5061A Cesium Standard or 5065A Rubidium Standard (at average ambient temperature of 25°C).

Front panel lights indicate mode of operation, report fuse failure, and ac interrupt. A float-charge switch permits rapid recharge after an ac power failure.

#### K02-5060A Specifications

##### Input and output voltages

Input	Output
6 or 12 V dc	0-230 V, 60 Hz nominal
115 or 230 V ac, 50-400 Hz	0-230 V ac
24-30 V dc	24-30 V dc

Standby battery, 26 ± 4 V dc available at all times.

AC and both dc inputs may be connected simultaneously.

Output current: 0.5 A ac, 2 A dc.

Standby capacity: 12 ampere-hour at 25°C, 7 hours standby when used in E21-5061A, 6 hours in E21-5065A.

Recharging: 1.6 hours recharging time required for each ampere hour of discharge.

Alarm indicator: external power failure.

Panel meters: voltmeter, ammeter indicating voltage and current of 4 internal batteries and load.

Battery: four paralleled rechargeable battery packs each containing 20 sealed nickel-cadmium cells. Packs may be removed individually without interfering with power supply operation.

#### Temperature

Operating: 0 to 50°C.

Storage: -40 to 60°C.

Dimensions: 177 mm H × 425 mm W × 416 mm D (6<sup>7</sup>/<sub>32</sub>" × 16<sup>3</sup>/<sub>4</sub>" × 16<sup>3</sup>/<sub>4</sub>").

Weight: net, 30.5 kg (67 lb).

Accessories furnished: ac and dc input and output cables.

#### 5085A Specifications

Output voltage: 24 ± 2 V dc at rated current.

Output current: 2 amperes (2.5 A for 30 min.).

Standby capacity: (at 25°C) 18 amp-hrs. after 48 hours charge.

Alarm indicators: panel lamps indicate: (1) FUSE FAILURE, (2) AC POWER, (3) AC INTERRUPT, (4) CHARGE.

Remote alarm provisions: SPDT relay contacts provided at rear terminals for operating remote alarm from separate power system.

Panel meters: battery voltage and charge/discharge current.

Power requirements: 115 or 230 ± 10% V ac; 50 to 400 Hz (2.0 A max. at 115 V line).

Battery (supplied): vented nickel-cadmium 25 ampere-hour capacity derated to 18 ampere-hours. Periodic maintenance required.

Additional (external) battery provision: rear connector.

#### Temperature

Operating: 0 to 50°C.

Storage: -40 to 75°C.

Dimensions: 177 mm H × 425 mm W × 416 mm D (6<sup>7</sup>/<sub>32</sub>" × 16<sup>3</sup>/<sub>4</sub>" × 16<sup>3</sup>/<sub>4</sub>").

Weight: net, 34.1 kg (75 lb). Shipping, 45.9 kg (101 lb) including battery. Option 001 (no batteries) is 22.8 kg (50 lb) less.

Accessories furnished:

AC Power Line Cable, 6 ft. long, DC Output Connector. Instrument Extension Slides (for std. 24" deep rack).

#### Ordering Information

5085A (complete with batteries)

Opt 001: without batteries

K02-5060A

#### Price

\$2706

less \$640

\$3700



The wide range of quality pulse and word generators available from Hewlett-Packard includes a cost effective solution for most pulse testing applications. Instruments range from inexpensive units ideal for clocking simple logic circuits to high performance models offering precise control of all pulse parameters which are ideal for detailed parametric analysis. Units from 1 MHz to 1000 MHz and without output voltages ranging from a few volts to 100 V. This wide range of instrument capabilities lets you choose a pulse generator exactly tailored to your testing needs.

In addition to technical performance, important design emphasis is always placed on the ruggedness, reliability, and serviceability of every Hewlett-Packard pulse generator. This means, for example, that all outputs are fully protected against open and short circuit conditions and that only the highest quality components are used. The result is that each of these instruments, from

the simplest to the most advanced, is a high value generator that should provide you excellent service.

#### Pulse generator functional blocks

Pulse generators are made up of several basic functional blocks. Included are repetition rate, delay, width, and slope generators, and output amplifiers. Specific pulse generators may include some or all of these functional blocks, depending on the complexity and intended applications area. The basic pulse generator functional blocks are described below.

The repetition rate generator is an oscillator that determines the period of the pulse train; the time from the start of one pulse to the beginning of the next one.

The output of the repetition rate generator drives the delay generator and is supplied to the front panel trigger output as a reference and synchronizing signal.

The delay generator enables shifting the

pulse in time by delaying it a variable length of time with respect to the trigger output. It also furnishes the double pulse mode of operation, in which the first pulse is directed straight to the width generator with zero delay and a second pulse is produced after the delay interval.

The width generator provides adjustment of the duration of the output pulse. The selected pulse width is independent of frequency, remaining constant as the frequency is varied. The slope generator enables setting the rise and fall times of the output signal to simulate desired test conditions.

The output amplifier block amplifies and conditions the pulse for clean transmission to an external 50 ohm environment and also includes attenuator and offset circuitry. The attenuator provides adjustment of the amplitude of the output pulse; offset controls permit a DC shift of the entire pulse either above or below ground. Most amplifiers also include a pulse complementing function to allow pulse duty cycles to approach 100%, and provide selectable positive and negative-going pulses as well.

The external input provides a means of controlling or synchronizing the generator with external signals. It functions in a number of different operating modes. In External Trigger mode the repetition rate generator is disabled and one output pulse is produced for each pulse received at the external input. Manual triggering of single pulses is also afforded.

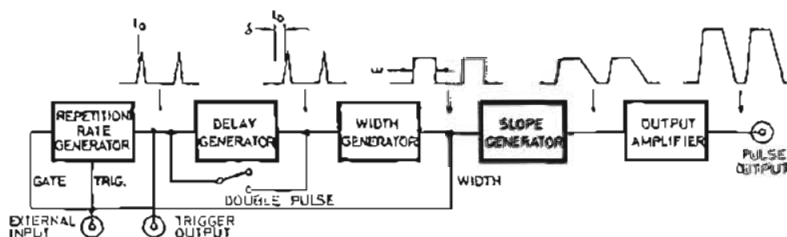

PULSE GENERATOR BLOCK DIAGRAM

In Gate mode the repetition rate generator is synchronously switched on as long as the External Input is held high. A pulse burst is thus produced whose frequency is determined by the internal rate generator and whose length is determined by the width of the externally applied signal. Synchronous gating assures that the pulse burst always starts with zero phase and that the last pulse of the burst is always completed, even if the gating signal is removed during the pulse.

In External Width mode the external signal is applied to the input of the slope generator. Rise and fall times as well as amplitude and offset are determined by the pulse generator; the period and duration of the input signal are unchanged.

#### 50 ohm source impedance

All Hewlett-Packard pulse and word generators have constant 50 ohm source impedance, a feature very important in producing clean output pulses. Signal reflections from the circuit under test are effectively absorbed by the 50 ohm source thus avoiding re-reflection to the tested circuit. The

internal 50 ohm source also enables back-terminated operation in which high impedance loads may be driven without an external terminating resistor.

Many HP generators provide, in addition, a switch selectable 50 ohm source. The pulse generator output stage is a current source which produces its maximum voltage when its total available current is concentrated in a single 50 ohm load. Thus to achieve maximum output voltage, only one 50 ohm termination may be used, located either at the source or at the load. With a switch selectable source impedance you can choose the best termination configuration for your application. Highly capacitive loads, for example, are best driven from a 50 ohm source without a terminating resistor at the load. Low capacitance loads are best driven from a high impedance source with the 50 ohm termination placed at the load.

#### Independent parameters

All variable pulse parameters on Hewlett-Packard pulse generators can be adjusted completely independently of one another. This means, for example, if pulse

offset is varied, the amplitude is not affected, and if pulse frequency is adjusted, transition times and width remain constant. A further feature is complete specification of all pulse parameters including thorough specification of pulse perturbations and jitter. Thus you always know what pulses to expect from your generator.

#### Counted burst generation

Applications such as digital circuit design or radar testing often require a burst of pulses with an exact predetermined length. A digital system, for example, could be clocked to a particular state at its operating frequency using such a pulse burst. A shift register or counter could be given a desired number of pulses. A counted burst mode of operation is available in several Hewlett-Packard generators and greatly simplifies burst generation. The number of pulses desired is simply dialed into a thumbwheel switch and a burst of this length will be produced upon command. All pulse parameters (frequency, width etc.) may then be varied without affecting the number of pulses in the burst.

### Pulse Generators

Model No.	214A	8010A	8005B	8011A	8012B	8013B	8015A	8007B	8062A	1900 System
Max. rep. rate (MHz)	1	10	20	20	50	50	50	100	250	25
Output V into 50Ω	±100	±5 to 10	±5 to 10	±8 to 16	±5 to 10	±5 to 10	±8 to 16 to 30	±5	±5, ECL	±5 to ±50
Number of outputs	1	2 indep.	3 to 11	1	1	2	2 indep.	1	2	4, - and COM <sup>2</sup>
Min. trans. times	15 ns	14 ns var.	10 ns var.	10 ns	5 ns var.	3.5 ns	6 ns var.	2 ns var.	1 ns var.	350 ps (var.)
Width	50 ns to 10 ms	20 ns to 1 s	25 ns to 3 s	25 ns to 100 ms	10 ns to 1 s	10 ns to 1 s	10 ns to 1 s	5 ns to 50 ms	2 ns to 0.5 ms	0 to 40 ns
Delay	•	•	•	•	•	•	•	•	•	•
Offset V into 50Ω		±2	±2		±2.5	±2.5	±7 to ±14	±4	±2	±1.5 to ±5
External Input	•	•	•	•	•	•	•	•	•	•
Double pulse mode	•	•	•	•	•	•	•	•	•	•
Selectable Z <sub>s</sub>			•		•	•	•			•
Other				burst			burst			programmable

### Word Generators

Model No.	8006A	8016A	8018A	8760A
Max. rep. rate (MHz)	10	50	50	150
No. of channels	2	9	2	1
Bits per channel	16/32	32/64/128/256	1024	3 to 10
Output V into 50Ω	+2.5/-5	ECL/TTL (var.)	15	3.2
Width/delay control	•	•	•	•
RZ/NRZ formats	•	•	•	•
PRBS	•	•	•	•
Programmable	•	•	•	•

### 8080 Subnanosecond Pulse/Word Generator System

	Rep. rate gen.		Delay gen.	Word generator	Output amplifiers	
Model No.	8081A	8091A	8092A	8084A	8083A	8083A
Max. rep. rate (MHz)	300	1000	1000	300	300	1000
Output V into 50Ω	300 mV p-p	500 mV p-p	600 mV p-p	1 channel 16, 32, 64 bits/channel Clock output First/Last bit trig RZ/NRZ	±2/ECL	±1.2/ECL
Outputs	1 (int)	1 (int)	2 (int)		2 (NORM/COMP)	1
Min. trans. times	1.2 ns	0.5 ns	0.5 ns		800 ps	300 ps
Delay/Advance			9.9 ns			
Offset V into 50Ω			[Free -2]		±1	±1.2
Ext. trig/gate	•	•	•	•	•	

# PULSE & WORD GENERATORS

## General information

The counted burst feature is included in the 8165A programmable signal source and is optionally available in the 8011A and 8015A pulse generators.

### Human engineering

Careful attention to human engineering as well as extensive experience in the design of instrument front panels has enabled Hewlett-Packard to produce pulse and word generators with logical front panel layout and controls that are easy to operate. On many Hewlett-Packard pulse generators timing parameters are adjusted by horizontally oriented controls and amplitude parameters by vertically oriented controls, exactly as these timing and amplitude parameters are displayed on an oscilloscope. In addition the physical relationship of pulse period, delay, and width controls minimizes the risk of incompatible control settings. Reduced operator familiarization time and faster setup of the desired pulse are direct benefits.

## Pulse generator applications

### Digital integrated circuits

Digital circuit development, covering such logic families as TTL, ECL, and CMOS is a very important pulse generator applications area.

**MOS/CMOS:** MOS, and particularly CMOS, is a popular logic family due to its very low power dissipation, high packing density, and high noise immunity. The 8015A and 8011A pulse generators are ideal for MOS and CMOS applications, providing the high amplitude, 16 volt test pulses that these circuits require. The 8015A even produces 30 volt pulses when both its output channels are combined. The 1915A and 1917A output stages for the 1900 system are also suited to MOS/CMOS application.

**ECL:** Emitter Coupled Logic features toggle rates over 100 MHz and propagation delays ranging into the subnanosecond region. The 8082A pulse generator is well suited for ECL applications ranging up to 250 MHz. Pulse transition times variable down to a state-of-the-art 1 ns match the 8082A to any test specification. A low reactance 50 ohm source helps ensure clean pulses at the device under test, and preset ECL output levels can be selected with a single switch. Applications above 250 MHz are covered by the 8080 system. See the following paragraphs on subnanosecond applications.

**TTL:** Transistor-transistor logic is the most popular logic family. A wide range of Hewlett-Packard generators, including the 8005B, 8011A, 8012B, and 8007B, are well suited to testing these devices. The 250 MHz 8082A with its 5 volt amplitude is also

well suited here, and provides frequency coverage for future faster applications.

### Subnanosecond applications

Modern research in telecommunications, IC design, fiber optics, and in the nuclear area often requires pulses with transition times in the subnanosecond region. To meet these needs, Hewlett-Packard has developed the modular 8080 system. This system, fastest of all HP's pulsers, provides transition times down to 300 ps and repetition rates to 1 GHz. The system is modular so that a pulse generator can be tailored to fit a particular testing requirement. The 8084A module brings word generation capability at rates up to 300 MHz to the system.

### High voltage applications

Radar and power semiconductor testing as well as materials and other forms of basic research often require very high power output pulses. Model 214A offering 100 V/2 A performance and model 1915A with 50 V/1 A are ideal for these applications.

### System applications

Spurred by the need to reduce testing time and costs, the use of automatic and semi-automatic test systems is rapidly expanding. A primary component in such systems is a signal source whose parameters can be remotely programmed by a computer or other system controller.

The 8165A programmable signal source produces sine, square, and triangle waves over a frequency range of 0.001 Hz to 50 MHz. All parameters and operating modes are remotely programmable via the HP-IB. This instrument with its 0.001% frequency accuracy, 20 volt output amplitude, and 5 ns transition times is ideally suited to the requirements of system applications.

The 1900 series, in conjunction with the 6940B multiprogrammer is a fully programmable pulse generator system providing repetition rates up to 25 MHz.

## Word generators

In contrast to a pulse generator, which normally provides continuous streams of pulses, a word generator produces digital waveforms with bit content programmed by the user. Digital information is normally encoded such that a high level or pulse represents a logical one and a low level or lack of a pulse represents a logical zero. Thus the user may determine his digital word to be 1100110 and program his word generator to produce 3 pulses followed by 2 spaces, then 2 pulses and finally a single space.

Word generators are used to produce the complex waveforms necessary for integrated circuit testing, telecommunications system development, and for interface simulation. Word generation may be serial, in which data is produced on only a single

channel, or parallel, in which many channels of information are simultaneously produced. A repetition rate generator (clock generator) and output amplifier are normally also included to produce a self-contained unit fully capable of delivering data to a device under test.

### Word generator applications

**Parallel:** the 50 Mbit/s 8016A is designed for applications where a source of parallel data is required. This 8-channel word generator delivers 32 individually programmable bits from each of its channels. Channels can also be serialized to produce patterns up to 256 bits long. Adjustable pulse width and interchannel delays enhance the usefulness of the 8016A enabling full parametric as well as functional testing. An HP-IB interface provides rapid loading of the instrument's memory or integration into an automatic test system. Typical applications areas include testing complex MSI and LSI integrated circuits as well as parallel interface design.

**Serial:** the 8016A is excellent in applications where long streams of serial data are required. Typical areas include data terminal and disc controller design, SDLC pattern simulation, bubble memory and charge coupled device testing, and all forms of serial interface and bus development.

The 50 Mbit/s 8018A serial data generator contains 2048 bits of serial memory which can be output as a single channel or as 2 channels of 1024 bits each. Pattern length can be anything from 3 to 2048 bits and the data stream can be divided into serial words for testing systems that are byte, character or word oriented. Generation of pseudo-random binary sequences (PRBS) is also included. As with the 8016A, an HP-IB interface enables rapid, remote loading of the bit pattern.

Another important applications area for the 8018A and other word generators is in testing of telecommunications systems. The word generator is used to insert a known digital pattern into the system. The model 8084A word generator module for the 8080 system can supply 64-bit data patterns with repetition rates up to 300 M bits per second in either RZ or NRZ formats. Pseudorandom binary sequences (PRBS) and variable content digital words useful in communications testing applications are also produced by the 8006A, 1925A, 1930A, and 3760A.

The 3760A has been specifically designed for communications applications and provides variable length PRBS and WORD patterns at repetition rates to 150 M bits per second. A second data output delayed 8 bits with respect to the main output is optionally available. The 3760A may be used with the 3761A Error Detector to make bit-by-bit error rate measurements.

# PULSE GENERATORS

## 50 MHz programmable signal source

### Model 8165A



- 1 MHz to 50 MHz
- sine, ramp and pulse waveforms
- counted burst

- 20 Vpp amplitude
- Fully programmable
- Storage of operating parameters

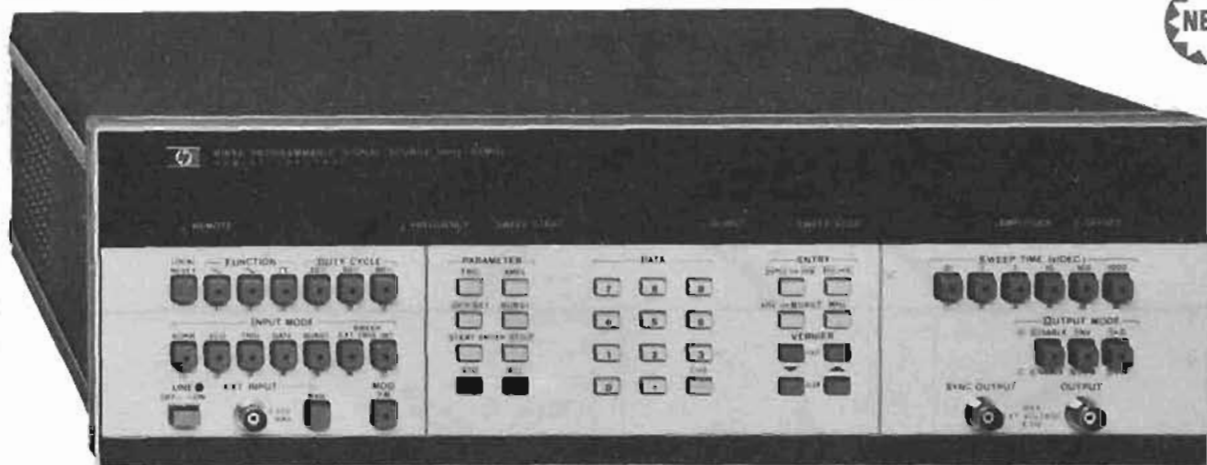

8165A with Sweep Option 001

50%  
Symmetry/  
duty cycle

Sine

Triangle

Square

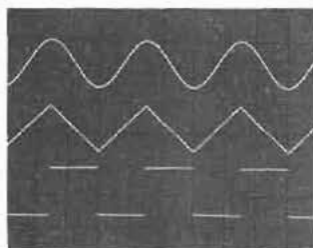

20%  
Symmetry/  
duty cycle

Ramp

Square

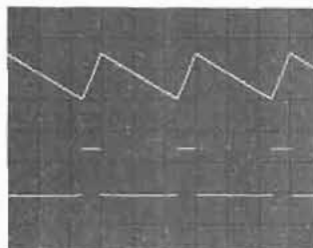

80%  
Symmetry/  
duty cycle

Ramp

Square

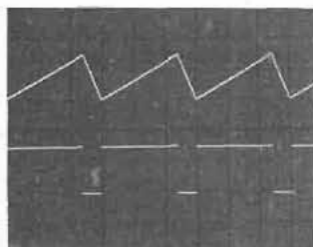

### Introduction

The 8165A Programmable Signal Source generates sinewaves, triangles, ramps, square waves and pulses over a frequency range of 1 MHz to 50 MHz. The pushbutton front panel controls and the LED parameter display enable rapid and accurate setting of parameters with no repeatability problems. When you include other features such as microprocessor control, remote programmability of all parameters, and seven operating modes, you have a versatile signal source in just a single instrument that can be used in a wide range of applications.

### Microprocessor control

The 8165A contains a microprocessor-controlled interface and keyboard designed to simplify operating and programming. Whether operating the instrument from its keyboard or from a controller via the HP-IB, the microprocessor simplifies parameter and data entry.

It also checks for illegal operations, incompatible settings, and sets up front panel displays. The microprocessor greatly simplifies front panel operation by enabling any parameter to be changed using only 3 steps; a PARAMETER key, DATA keys, and an ENTRY key.

### Operating set storage

Up to 10 complete operating sets (functions and parameters) can be stored in the built-in memory. Subsequently you can recall any of the 10 sets instantaneously by pressing only two keys or using one program statement. And you don't have to worry about losing operating sets if the 8165A is accidentally switched off or if the power fails. Internal batteries preserve the current and stored operating sets for up to four weeks.

### Stability, accuracy and resolution

The use of phase lock loop techniques, plus a 10 MHz internal or external crystal reference, ensures very stable output frequencies with an accuracy of  $\pm 1 \times 10^{-4}$  deviation from programmed value. Resolution is four digits over the frequency range of 1 MHz to 50 MHz. For example, in the frequency range 1-9.999 MHz, this is equivalent to a resolution of 1  $\mu$ Hz.

### Multiple waveform generation

The multiple waveforms that can be generated by the 8165A suit it to a wide range of digital and analog applications. Sine, triangle or square waves can be generated at frequencies up to 50 MHz. Ramps and rectangular pulses with 20% or 80% duty cycle/symmetry can be generated at frequencies up to 19.99 MHz.

### Operating modes

The 8165A can be operated in any of seven different modes: normal, trigger, gate, voltage controlled oscillator (VCO), sweep, counted burst, and frequency modulation (FM). This wide range of modes enables the 8165A to be used in any operating environment.

### Output capability

The 8165A has been designed to fulfil the requirements of analog and digital testing. The source impedance can be set to 50 ohms or 1 k ohms for best termination, i.e. minimum distortion and reflection in each application. The 8165A can also be used as a current source, or supply a variable dc level.

### HP-IB programming

The use of a microprocessor makes the 8165A very easy to program across the HP-IB, and ideal in automatic test systems. All operating parameters and functions can be programmed and in learn mode the 8165A can report its status and its current or stored operating sets. Programming is further simplified by the codes on the instrument front panel. The framed mnemonics are the ASCII characters required for programming.

For specifications, see page 341.

# PULSE GENERATORS

8080 System—general information  
1 GHz/ 300 MHz pulse/word generator system

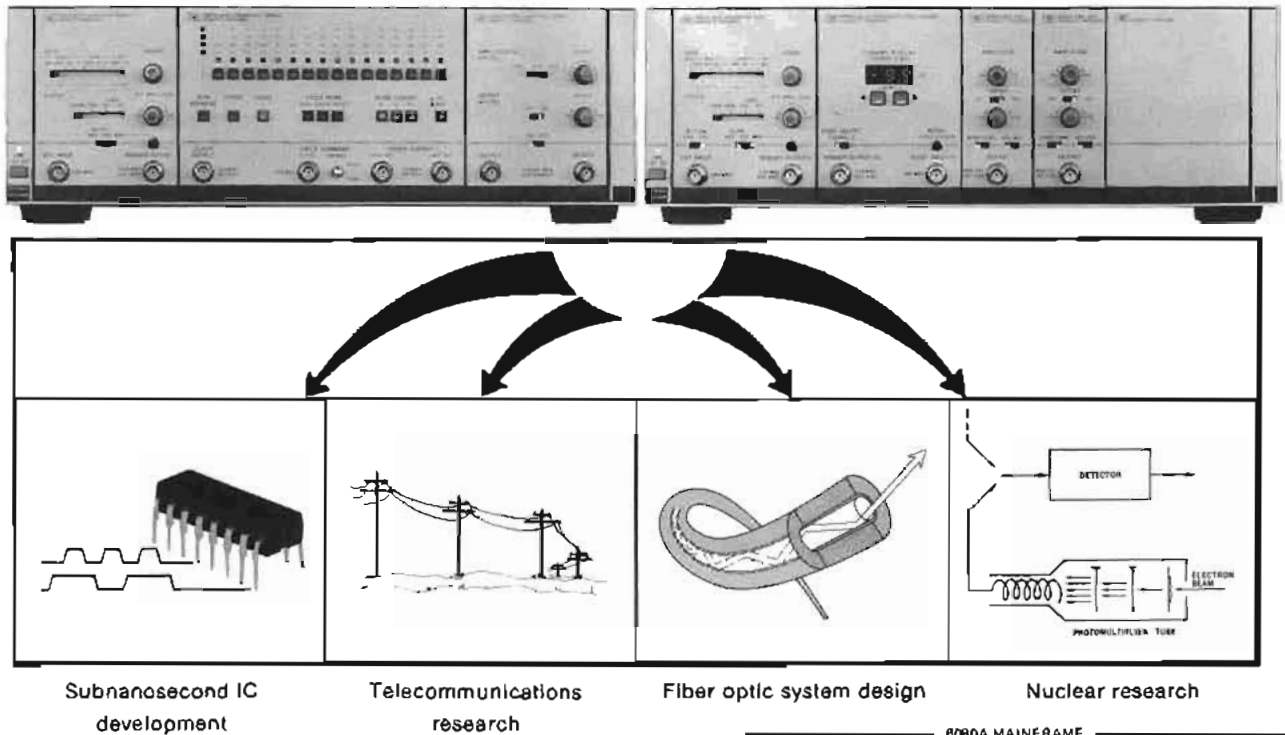

## General introduction

The Hewlett-Packard 8080 Pulse/Word Generator System is a powerful new tool in the design of subnanosecond logic and communications systems. The 8080 system combines the waveform generation techniques necessary for testing today's high speed circuits with the modularity for future system upgrading and expansion.

Flexibility built into the system gives you a choice of components from two fully compatible module families. Building blocks are available for either 300 MHz or 1 GHz operation. You can incorporate valuable test capabilities such as pulse advance and delay, interchannel delay, word generation and multichannel operation in your system. The result is a high performance, precision pulse generator tailored to fit your application at minimum cost.

## System description

Each of the 8080 system modules is a typical pulse or word generator functional block. Repetition rate generators and output amplifiers are available for either 300 MHz or 1 GHz operation. The 64-bit serial word generator module brings high speed data stream capability to the system, and a 1 GHz delay generator/frequency divider provides interchannel delay in 100 ps increments, as well as half-frequency operation. The full-rack-width mainframe houses and powers the modules.

Using these modules you can configure systems with capabilities covering a broad spectrum of stimulus applications. A basic square wave signal source, for example, consisting of repetition rate generator and output amplifier can provide clocking signals for assemblies of logic circuits. More complex systems, even multi-mainframe, can produce single or multichannel data streams optimized for subnanosecond PCM research or IC testing.

The combination of pulse and word generation capability in an integrated system makes possible economical, easy-to-use testing solutions. Modular flexibility eliminates the redundancies inherent in less convenient combinations of separate instruments and ensures easy expansion at a later date should test requirements change.

The two systems described as follows are typical of the wide range of systems that can be configured using the fully compatible 8080 modules.

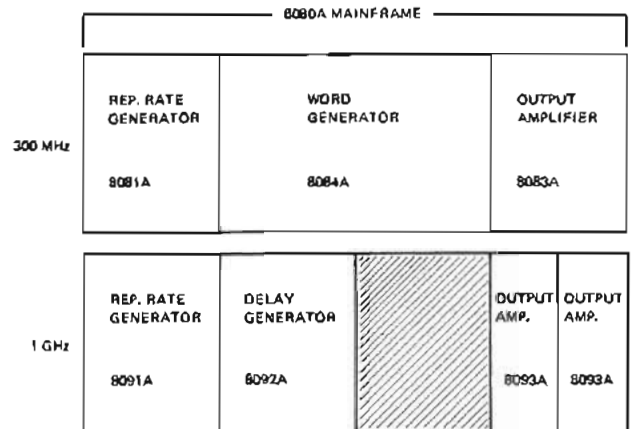

Typical systems showing full range of modules available

## 1 GHz pulse generator system

Models 8091A repetition rate generator, 8092A delay generator/frequency divider, and two 8093A output amplifiers form a versatile 1 GHz pulse generator system. The system includes two output stages with fully independent level controls and the capability to offset the outputs timewise from one another. This system configuration and the waveforms it generates are ideal for testing the fastest integrated and discrete digital circuits and optical components. Major features of this system include:

- 1 GHz repetition rate
- $\leq 300$  ps transition times
- $\pm 1.2$  V output amplitude (into 50 ohms)
- interchannel pulse advance and delay
- selectable half-frequency operation on one channel

Model 8092A delay generator/frequency divider module provides the system with two innovative measurement capabilities very useful, for example, in dynamic testing of high speed clocked devices. The first of these is interchannel delay. Delay is produced from one channel with respect to the other. Secondly, the repetition rate of one of the channels can be set to half of the frequency of the other. The two output waveforms thus provide the clock and data signals necessary for flip-flop and shift register testing.



- Powers all 8080 series modules
- Full RFI shielding



8080A Mainframe

Option 909

15400A

15401A

15402A

The full frequency output drives the tested device's clock input, and the half frequency waveform supplies the data input. Setup and hold times are easily determined by adjusting the interchannel delay. With counter circuits, the same technique can be applied to measure the setup time required between count enable and clock inputs.

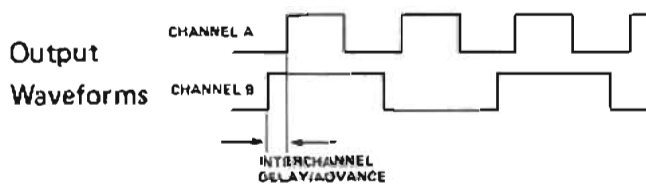

The full and half frequency outputs of the generator contain each of the four digital combinations of two bits. Thus all types of dual input gates can also be tested. Possibilities include determination of proper functional operation, propagation delay, and sensitivity to race-induced signal overlaps.

Formerly two separate, synchronized pulse generators have been required to perform the above measurements. The 8080 system provides all the necessary capabilities in a single, integrated solution, and with the testing precision afforded by 300 ps rise and fall time test pulses.

### 300 MHz Word generator system

Combining the Model 8084A word generator module with a repetition rate generator and an output amplifier produces a high performance 300 MHz serial data generator. The variable content digital bit stream and synchronizing clock of such a system provide the waveforms necessary for test and development of integrated circuits and telecommunications systems components such as shift registers, modulators and multiplexers.

The Model 8081A repetition rate generator supplies the system clock. It drives the word generator module at rates from 10 Hz to 300 MHz. The Model 8083A output amplifier applies amplitude, rise-time and pulse shape parameters to the word generator output signal and conditions it to provide clean waveforms to an external 50 ohm environment. Major features of the system include

- selectable word length—16, 32 or 64 bits
- 300 MHz clock rate
- $\leq 800$  ps transition times
- $\pm 2$  V output amplitude into 50 ohms

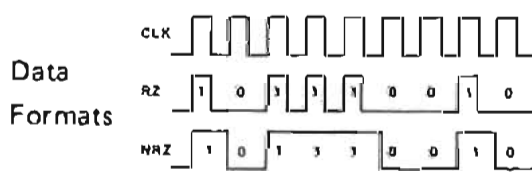

With a single switch you can rapidly select preset ECL-compatible signal levels. When different or more precise levels are required, output pulse amplitude and offset are also separately adjustable. The word generator module gives you a choice of RZ or NRZ data format and provides word framing signals to trigger an oscilloscope. Simultaneous data and data signals, supplied by the complementary output amplifier, are particularly useful for testing balanced transmission line systems and line receivers or for simulating dual-ended IC outputs.

### 8080A Description

The Model 8080A Mainframe provides housing and DC power supplies for the 8080 system modules. The modules are built in  $\frac{1}{8}$ ,  $\frac{1}{4}$  and  $\frac{1}{2}$  mainframe widths and can be accommodated in the mainframe in any position and combination.

Systems can be reconfigured very easily; the modules are slid into the required position in the mainframe and secured with screws. The high frequency signal connections between modules are then made internally using 50 ohm coaxial cable with SMC connectors.

The ease with which modules can be exchanged greatly improves serviceability because a defective module can be isolated rapidly and repaired or exchanged. Ease of maintenance is further enhanced by the free access provided to all circuits and assemblies in the system.

The entire system is RFI shielded including a power line filter and sealing gaskets on the modules.

### 8080A Specifications

#### Compatibility

**Electrical:** provides power for all modules in any combination of  $\frac{1}{8}$ ,  $\frac{1}{4}$  or  $\frac{1}{2}$ -size modules.

**Mechanical:** mainframe compartments accept up to two  $\frac{1}{2}$ -size, four  $\frac{1}{4}$ -size or eight  $\frac{1}{8}$ -size modules in any combination.

#### General

**Operating temperature range:** 0°C to 55°C.

**Power:** 115 V or 230 V,  $\pm 10\%$ ,  $-22\%$ . Frequency 48 Hz to 66 Hz single phase. Up to 200VA. Power available for modules 55 watts etc.

**Weight:** net 5 kg (11 lb). Shipping, 8.7 kg (19.3 lb).

**Dimensions:** 133 mm H  $\times$  426 mm W  $\times$  422 mm D (5.24"  $\times$  16.77"  $\times$  16.61")

#### Options and accessories

Options and accessories	Price
907: front handle kit	add \$15
908: rack flange kit	add \$10
909: rack flange/front handle kit	add \$20
910: additional instrument manual (includes binder and system description)	add \$15
15400A: blank panel, quarter mainframe width	\$30
15401A: blank panel, eighth mainframe width	\$20
15402A: Feedthru panel (6 $\times$ BNC) eighth mainframe width	\$25

8080A Mainframe

\$820

# PULSE GENERATORS

8080 System: 300 MHz/1 GHz output amplifiers

Models 8083A & 8093A

- 800 or 300 ps transition times
- 8083A—2 V amplitude,  $\pm 1$  V offset
- 8093A—1.2 V amplitude,  $\pm 1.2$  V offset

- Norm/compl, pos./neg. outputs available
- Selectable, preset ECL outputs
- Low reactance 50 ohm source impedance

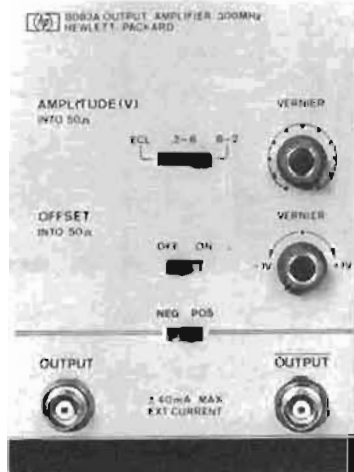

8083A



8093A

## 8083A and 8093A Descriptions

Models 8083A and 8093A are the output amplifiers of the 8080 series. They apply amplitude and output format parameters to the generated signals, and supply precision fast rise time pulses to the tested device or system.

Model 8083A is a quarter-width module that covers repetition rates up to 300 MHz with fixed transition times of less than 800 ps. Pulse amplitude is variable up to 2 V, can be set to positive or negative polarity, and can be offset from ground by  $\pm 1$  V. Simultaneous normal and complement outputs simplify tests of balanced input devices and systems.

Model 8093A is an eighth-width module that extends performance to 1 GHz repetition rate. The 300 ps pulse transition times provided by this module enable parametric testing of even the fastest logic families. Other applications include bandwidth determination, switching transistor and circuit evaluation, and driving high speed data multiplexers and modulators. The amplifier delivers positive or negative pulses with up to 1.2 V amplitude and  $\pm 1.2$  V offset. The output format can be set to deliver normal or complementary pulses.

An additional amplitude setting on both modules provides fixed ECL-compatible output levels. Levels can be adjusted internally.

Connection to the circuit or system under test is simplified by the low-reactance 50 ohm source impedances of the two modules. These outputs will deliver clean pulses into 50 ohm systems and preserve pulse shapes by absorbing reflections from external loads.

## 8083A Specifications

**Output channels** Simultaneous normal and complement outputs provided

**Source impedance:** 50 ohms  $\pm 5\%$ .

**Polarity:** neg./pos. selectable.

**Output pulse**

**Amplitude (into 50 ohm load):** 0.2 V to 2 V in two ranges continuously adjustable, plus ECL range ( $-0.8$  V to  $-1.6$  V adjustable).  
**Maximum levels:**  $\pm 4$  V.

**Offset (into 50 ohm load):**  $\pm 1$  V common to both channels.

**Transition time (10% to 90%):**  $\leq 800$  ps.

**Duty cycle (with drive input duty cycle of 50%):** 50%  $\pm 10\%$ .

**Prehoot, overshoot, and ringing:**  $\leq 10\%$

**Output protection:** max applied ext. voltage  $\pm 2$  V in pos. mode and 0 V to  $-4$  V in neg. mode, or max ext. current  $\pm 40$  mA.

**Drive Input (Impedance 50 ohms typical)**

**Input frequency:** 0-300 MHz.

**High signal level:** more positive than  $-100$  mV.

**Low signal level:** more negative than  $-500$  mV.

**Min. amplitude:**  $\geq 500$  mVpp.

**Transition times (10%—90%):**  $\leq 3$  ns.

**Max. external voltage:**  $\pm 1$  V.

**Propagation delay time:** 4.8 ns  $\pm 500$  ps.

**General**

**Size:** quarter mainframe width.

## 8093A Specifications

**Output channel**

**Format:** normal or complement selectable.

**Source impedance:** 50 ohms  $\pm 5\%$ .

**Polarity:** neg./pos. selectable.

**Output pulse**

**Amplitude (into 50 ohm load):**  $\leq 0.6$  V to 1.2 V continuously adjustable, plus ECL range ( $-0.8$  V to  $-1.6$  V adjustable).

**Maximum levels:**  $\pm 4$  V.

**Offset (into 50 ohm load):**  $\pm 1.2$  V.

**Transition time (10% to 90%):**  $\leq 300$  ps.

**Duty cycle (with drive input duty cycle of 50%):** 50%  $\pm 10\%$ .

**Prehoot, overshoot, ringing:**  $\leq 10\%$  to 500 MHz,  $\leq 15\%$   $> 500$  MHz.

**Output protection:** max applied ext. voltage:  $\pm 2$  V.

**Drive input A (impedance 50 ohms typical)**

**Input frequency:** 1 GHz.

**High signal level:** more positive than  $-100$  mV.

**Low signal level:** more negative than  $-500$  mV.

**Min. amplitude:**  $\geq 500$  mVpp.

**Transition times (10%—90%):**  $\leq 350$  ps.

**Max. external voltage:**  $\pm 1$  V.

**Propagation delay times:** 5 ns  $\pm 200$  ps.

**Schmitt trigger input B (impedance 50 ohms typical)**

**Signal levels, amplitude, ext. voltage as for input A.**

**Input frequency:** 0-300 MHz.

**Transition times (10%—90%):**  $\leq 10$  ns.

**Propagation delay:** 7.8 ns  $\pm 300$  ps.

**General**

**Size:** eighth mainframe width.

**8083A and 8093A Option**

910: additional operating and service manual

**Price**  
add \$7.50

**Ordering information**

8083A 300 MHz Output Amplifier module

\$795

8093A 1 GHz Output Amplifier module

\$1525

# PULSE GENERATORS

## 8080 System: word generator

### Model 8084A



- 300 bit word generation
- 16, 32 or 64 bit word lengths

- RZ/NRZ formats
- Selectable auto/single/gated cycle mode

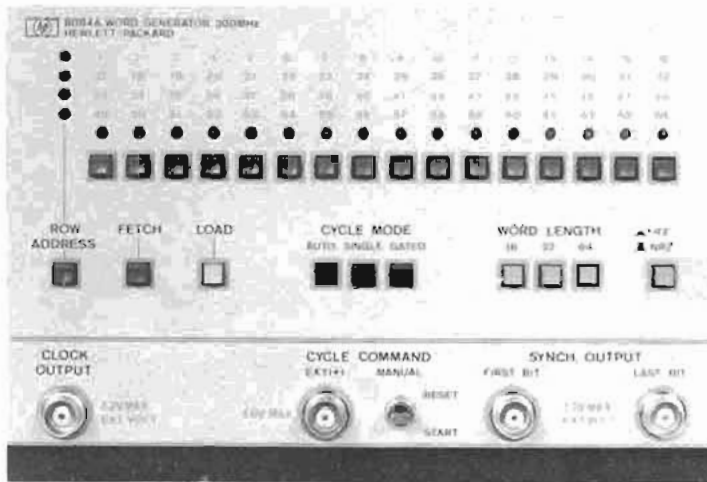

8084A

### 8084A Description

The Model 8084A word generator module provides high speed data streams for testing integrated circuits, memories, and data transmission lines and systems.

The 8084A with complementary rate generator and output amplifier modules, forms a serial data generator system with pulse parameters tailored to your measurement requirements.

The 8084A module generates a serial digital word in RZ or NRZ mode at repetition rates up to 300 MHz. Word length of 16, 32 or 64 bits is selectable via front panel pushbuttons. Data is fetched from and loaded into the 64-bit memory in 16-bit segments using the Fetch and Load pushbuttons. The 16-bit segments are selected using a Row Address pushbutton with four LED indicators, and the data content is loaded and displayed using a row of 16 data pushbuttons and adjacent LEDs.

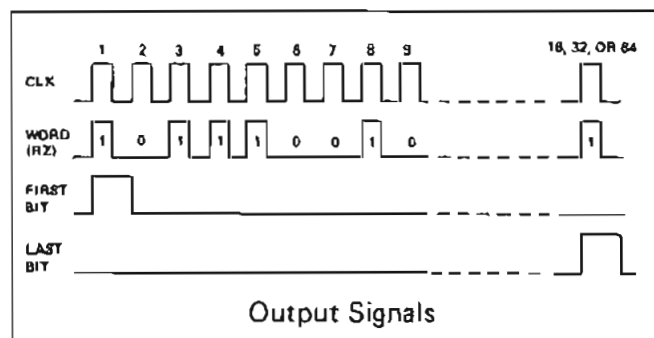

Output Signals

The 8084A operates in Auto, Single or Gated cycle modes. In Auto mode the output is continuous and the word is recycled automatically. In Single cycle mode one word is produced for each cycle command pulse. In Gated cycle mode data is continuously generated as long as the cycle command input is held high, and the last word is always completed.

Synchronizing the 8084A to test instruments or circuits is achieved only when parallel connecting 8084A modules in separate mainframes.

8084A option 001 replaces the internal Clock input and Gate and Word outputs with front panel BNC connectors and should be ordered only when parallel connecting 8084A modules in separate mainframes.

### Specifications

#### Data capacity

**Number of data channels:** 1 x 16, 32 or 64 bits selectable.

**Cycle command input (impedance 50 ohms  $\pm$  10%, 600 ohms  $\pm$  10%)**

**Amplitude:**  $\geq$  +0.8 V. Max. input:  $\pm$ 6 V. Width:  $\geq$ 3 ns.

**Period between cycle comms:** word length + 2x clock periods + 100 ns.

#### Clock input (internal)

**Repetition rate:** 0-300 MHz. Impedance: 50 ohms typical.

**High signal level:** more positive than -100 mV.

**Low signal level:** more negative than -500m V.

**Min. amplitude:**  $\geq$ 500 mVpp. Max. input voltage  $\pm$ 3 V.

**Transition times (10%–90%):**  $\leq$ 3 ns.

**Width:**  $\geq$ 3 ns at  $\leq$ 100 MHz, 50%  $\pm$  10% at  $>$  100 MHz.

**Slope:** low to high transition generates bit.

#### Internal outputs (Word, Word, Clock, Gate)

**Fan-out:** drives one 8080 system module.

**Gate function:** high level starts/low level stops rate generator.

**Word, Word format:** RZ or NRZ, switch selectable.

**Clock:** inverted output simultaneous with Clock output.

**High signal level:** more positive than -100 mV.

**Low signal level:** more negative than -500 mV.

**Min. amplitude:**  $\geq$ 500 mVpp. Source impedances: 50 ohms  $\pm$  5%.

**Transition times (10%–90%):** Word  $\leq$ 1.2 ns, Gate  $\leq$ 1.5 ns.

**RZ duty cycle (with 50% duty cycle drive input):** 50%  $\pm$  10%.

#### External outputs (Clock, First Bit, Last Bit)

**Clock:** delivers one pulse per bit. RZ format.

**First Bit (FB):** coincident with first bit of word. NRZ format.

**Last Bit (LB):** coincident with last bit of word. NRZ format.

**High/low signal levels:** more pos. than -100 mV/more neg than -500 mV or  $>$  +500 mV/  $<$  +100 mV, switch selectable.

**Min. amplitude:**  $>$  500 mVpp. Source impedances: 50 ohms  $\pm$  5%.

**Transition times (10%–90%):** FB and LB  $\leq$ 1.5 ns, Clock  $\leq$ 1.2 ns.

**RZ duty cycle (with 50% duty cycle drive input):** 50%  $\pm$  10%.

#### General

**Size:** half mainframe width.

**Weight:** net 1.7 kg (3.7 lb); shipping 3.9 kg (8.6 lb).

#### Options

**001:** brings int. clock input, cycle comm. and word outputs to front panel in multimainframe systems

**083 & 093:** should be ordered when 8084A is connected to an 8083A (Opt 083) or 8093A (Opt 093) in same mainframe. For other combinations, contact HP

**910:** additional operating and service manual

**8084A 300 MHz Word Generator module**

**Price**  
add \$65

N/C

add \$7.50

**\$2510**



# PULSE GENERATORS

## 8080 System: 1 GHz delay generator/freq. divider

### Model 8092A

- 9.9 ns channel separation
- Digital delay/advance in 100 ps steps
- LED display of delay or advance interval
- Selectable half frequency operation

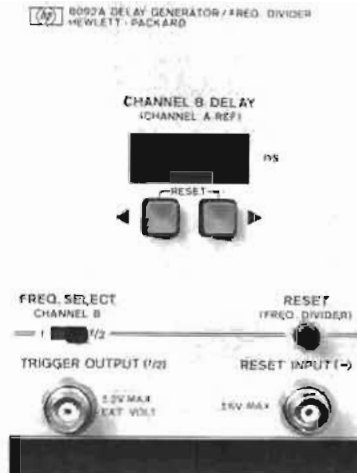

### 8092A Description

The Model 8092A is a delay generator/frequency divider for use in functional and parametric testing of subnanosecond digital logic circuits. The 8092A has two output channels which can be delayed or advanced with respect to each other in 100 ps steps over  $\pm 9.9$  ns range. The selected delay is digitally displayed on numeric LEDs.

The 8092A delay is obtained by delay lines, which offers jitter free delay, that can be set to greater than one clock period. An added advantage of the delay line is that you can easily repeat delay settings if required in a later test.

Another feature of the 8092A is the capability of dividing the channel B frequency by 2. In this operating mode, the two 8092A output channels carry  $f$  and  $f/2$  with variable interchannel delay.

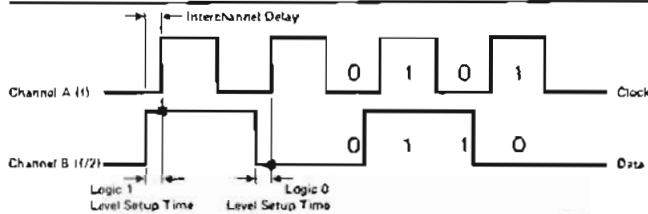

Frequency Division for FLIP FLOP and Gate Testing

These waveforms are ideal for high speed flip-flop testing. The full frequency signal drives the clock input and the half frequency signal the data input. You can then use the channel separation to check device setup and hold times. The  $f$  and  $f/2$  waveforms also contain all of the four combinations of two bits (00, 01, 10 and 11) so that you can test dual input gates. Both of these tests normally require two pulse generators to perform them.

The advance and delay pushbuttons have a built-in rapid count facility. If you hold down either pushbutton for more than one second, the channel separation increments at a greatly increased rate. This enables you to step through large time intervals very quickly. If you press both pushbuttons together, the delay immediately resets to zero.

A half-frequency trigger output is provided for triggering test equipment when the frequency divider is used. A reset control is also provided to enable you to reset the frequency divider flip-flop to the logic 0 state before the start of a pulse burst in gated mode. You can reset the flip-flop either electrically or with a pushbutton.

### 8092A Specifications

Channel B delay/advance (channel A reference)

Range:  $\pm 9.9$  ns.

Step size: 100 ps.

Frequency division Channel B output frequency is selectable by front panel switch

Frequencies available:  $f$  (channel A) or  $1/2f$  (channel A).

Internal outputs (Impedance 50 ohms typical)

Number of channels: 2 (channels A and B).

Fan-out: 1 for each output.

High signal level: more positive than  $-100$  mV.

Low signal level: more negative than  $-500$  mV.

Min. amplitude:  $\geq 500$  mVpp.

Transition times (10%–90%):  $\leq 500$  ps.

Duty cycle (with drive input duty cycle of 50%): 50%  $\pm 10\%$ .

Max. external voltage:  $\pm 2$  V.

Trigger output ( $f/2$ ) The trigger output is present only in  $f/2$  mode

Signal levels, amplitude & ext. voltage as for internal outputs.

Transition times (10%–90%):  $< 1$  ns.

Internal drive Input (Impedance 50 ohms typical)

Signal levels, amplitude & ext. voltage as for internal outputs.

Input frequency: 0–1000 MHz.

Transition times (10%–90%):  $\leq 350$  ps.

Pulse width:  $\geq 0.5$  ns.

Reset Input (Impedance 1 Kohms typical)

Negative-going transition resets ch. B to low level in  $f/2$  mode

Signal levels & amplitude as for internal outputs.

Input frequency: 0–2 MHz.

Reset time:  $\geq 0.5$   $\mu$ s.

Maximum external voltage:  $\pm 6$  V.

Transition times (10%–90%):  $\leq 10$  ns.

Manual pushbutton: resets ch. B to low level in  $f/2$  mode.

### General

Size: quarter mainframe width.

Weight: net 1 kg (2.2 lb), shipping 2.7 kg (5.9 lb).

Options  
910: additional operating and service manual  
8092A Delay Generator/Frequency Divider

Price  
add \$7.50  
\$2600

# PULSE GENERATORS

## 8080 System: repetition rate generators

### Models 8081A & 8091A



- 300 MHz/1 GHz repetition rate
- High resolution rate controls

- External gate and trigger
- Trigger slope and level controls



8081A



8091A

### 8081A and 8091A Descriptions

Models 8081A and 8091A are quarter-width rate generator modules in the 8080 system. The 8081A produces pulses at rates up to 300 MHz, and the 8091A up to 1 GHz. An 8-position frequency range switch and 3-turn vernier potentiometer enable rapid, precise setting of the pulse repetition rate.

Both rate generators include an external trigger which enables you to synchronize the system to an external source. In this mode you can use the rate generators as pulse shapers and amplifiers.

Gating capability is also included in both modules to enable you to synchronously start the repetition rate oscillator to produce a burst of pulses.

### 8081A Specifications

#### Timing

**Repetition rate:** 10 Hz - 300 MHz.

**Period jitter:**  $\leq 0.1\% \pm 50$  ps.

#### External inputs (Impedance 50 ohms typical)

**Trigger mode:** 0-300 MHz repetition rate,  $\geq 1.7$  ns pulse width.

**Gate on/off time:**  $> 1$  period/ $> 1$  period + 10 ns.

**Trigger level and slope:** -1 V to +1 V, pos. or neg. edge selectable.

**Sensitivity:** 200 mVpp.

**Maximum input voltage:**  $\pm 6$  V.

#### Internal gate input (Impedance 50 ohms typical)

**Gate on/off time:**  $> 10$  ns/ $> 20$  ns.

**High signal level:** 0V  $\pm 100$  mV.

**Low signal level:** more negative than -500 mV.

**Min. amplitude:**  $\geq 500$  mVpp.

**Max. input voltage:**  $\pm 1$  V.

#### External trigger output (Impedance 50 ohms typical)

**High signal level:** more positive than -100 mV.

**Low signal level:** more negative than -500 mV.

**Min. amplitude:**  $\geq 500$  mVpp.

**Transition times (10%-90%):**  $\leq 1.2$  ns.

**Duty cycle:** 50%  $\pm 10\%$ .

**Max. external voltage:**  $\pm 2$  V.

#### Internal output (Impedance 50 ohms typical)

**Fan-out:** drives one 8080 system module.

Other specs as for external trigger output.

### 8091A Specifications

#### Timing

**Repetition rate:** 100 Hz - 1 GHz.

**Period jitter:**  $\leq 0.1\% \pm 20$  ps.

**External inputs (Impedance 50 ohms typical)**

**Trigger mode:** 0 - 1 GHz rep. rate,  $\geq 0.5$  ns pulse width.

**Gate on/off time:**  $> 1$  period/ $> 1$  period + 10 ns.

**Trigger level and slope:** -1 V to +1 V, pos. or neg. edge selectable.

**Sensitivity:**  $> 300$  MHz: pulse/sine 600 mVpp.

$\leq 300$  MHz: pulse 200 mVpp; sine 1 Vpp.

**Max. input voltage:**  $\pm 6$  V.

#### Internal gate input (Impedance 50 ohms typical)

**Gate on/off time:**  $> 10$  ns/ $> 20$  ns.

**High signal level:** 0V  $\pm 50$  mV.

**Low signal level:** more negative than -500 mV.

**Min. amplitude:**  $\geq 500$  mVpp.

**Max. input voltage:**  $\pm 1$  V.

#### External trigger output (Impedance 50 ohms typical)

**High signal level:** more positive than -100 mV.

**Low signal level:** more negative than -500 mV.

**Min. amplitude:**  $\geq 600$  mVpp.

**Transition times (10%-90%):**  $\leq 500$  ps.

**Duty cycle:** 50%  $\pm 10\%$ .

**Max. external voltage:**  $\pm 2$  V.

#### Internal output (Impedance 50 ohms typical)

**Fan-out:** drives one 8080 system module.

Other specs as for external trigger output.

### 8081A and 8091A Operating modes

**Norm:** repetition rate is determined by front panel controls.

**External trigger:** outputs are shaped version of ext. input.

**External gate:** gate signal starts rate generator synchronously.

**Internal gate:** ext. input disconnected. Generator gated internally.

**Manual:** all functions can be triggered manually by pushbutton.

### General

#### 8081A and 8091A

**Size:** quarter mainframe width.

**Weight:** (8081A) net 0.6kg (1.3lb); shipping 2.2kg (4.8lb).

(8091A) net 1.2kg (2.6lb); shipping 2.8kg (6.2lb).

#### 8081A and 8091A option

**910:** additional operating and service manual

#### Ordering Information

**8081A 300 MHz Rep. Rate Generator module**

**8091A 1 GHz Rep. Rate Generator module**

**Price**  
add \$7.50

\$795  
\$3145

# PULSE GENERATORS

Economical 16 V output, pulse burst option

Model 8011A

- Repetition rate 0.1 Hz to 20 MHz
- Designed for easy operation
- Positive/negative/symmetrical output
- Normal/complement switch
- Switchable 50 ohm source
- Square wave mode for rapid pulse set-up



## Introduction

The 8011A is a versatile, reliable, low cost pulse generator. This compact instrument features an uncomplicated design using high quality components to ensure long, dependable service. Ease of operation is a natural result of the logical and simple front panel layout. These qualities, and the variety of pulse formats available, make the model 8011A a very cost-effective solution to pulse problems encountered in a variety of situations.

## Pulse burst option

For anyone working with counters, shift registers, memories or logic in general, 8011A option 001 offers a new approach to driving, troubleshooting or analyzing logic designs. With this original option, the 8011A can generate precisely any number of pulses from 1 to 9999, independent of pulse rate. The number of pulses required in the burst is set on thumbwheel switches. All other pulse parameters are set on the front panel as normal.

The burst can be started either by external electrical trigger or by pressing the single burst pushbutton. Synchronous trigger pulses occur for the duration of each burst. At the end of a burst, extra pulses can be generated individually by pressing the single pulse button. Thus, circuits can be clocked to a desired state at their operational clock rate and then analysed under static conditions.

## Applications

The 8011A proves itself with its wide range of amplitudes to cover CMOS and the commonly used logic families as well as linear circuits. Students and engineers alike will find the clear and uncluttered front panel layout makes this a very easy pulse generator to use. With the pulse burst option, model 8011A is a powerful tool in the problems of logic design and troubleshooting. This compact instrument features a simple design with adjustments reduced to a minimum so that routine recalibration is a quick and easy operation. Reliability is assured by the high quality components mounted on a gold plated printed circuit board and a short circuit proof output prevents accidental damage. Also, rigorous testing in hostile conditions (such as 95% relative humidity at 40°C) has proved that model 8011A will meet specifications when operated at temperatures between 0°C and 55°C.

## Specifications

### Pulse characteristics

(50 ohm source and load impedances)

Transition times: <10 ns fixed.

Overshoot, ringing and prehoot:  $\leq \pm 5\%$  of pulse amplitude. May increase to 10% at counter-clockwise positions of amplitude vernier. Pulse width: 25 ns to 100 ms in four ranges. Vernier provides continuous adjustment within each range.

Width jitter:  $<0.1\% + 50$  ps of any width setting.

Maximum duty cycle:  $>50\%$  (100% using pulse complement).

Maximum output: 16 V, with internal 50 ohms and external high impedance or with internal high impedance and external 50 ohms, 8 V with 50 ohms source and load impedances.

Attenuator: three step attenuator provides the ranges 0.25 V-1 V-4 V-16 V. Vernier provides continuous adjustment within each range.

Source impedance: 0.25 V-1 V-4 V ranges, 50 ohms  $\pm 10\%$  shunted by 30 pF. 4 V-16 V range, 50 ohms  $\pm 10\%$  or high impedance, switch selectable.

Polarity: positive, negative or symmetrical switch selectable.

Format: normal or complement switch selectable.

### Repetition rate and trigger

Repetition rate: 0.1 Hz to 20 MHz in 5 ranges. Vernier provides continuous adjustment within each range.

Period jitter:  $<0.1\% + 50$  ps of any period setting.

Square wave: 0.05 Hz to 10 MHz.

Trigger output: dc coupled 50 ohm (typ) source delivering  $\geq +1$  V across 50 ohm load (can increase to +5 V).

Trigger pulse width: 20 ns  $\pm 10$  ns.

### Externally controlled operation

#### External Input

Input impedance: 50 ohms  $\pm 10\%$ .

Maximum Input:  $\pm 5$  V.

Trigger polarity: positive.

Sensitivity: 1 V.

Manual: front panel pushbutton for generating single pulse.

#### External triggering

Repetition rate: 0 to 20 MHz. In square wave, output frequency is half input frequency.

Trigger source: manual or external signal. Min external signal width 10 ns.

Pulse burst mode (option 001): preselected number of pulses generated on receipt of trigger.

Burst trigger source: external signal or manual. Min external signal width 25 ns.

### General

Operating temperature range: 0°C to 55°C.

Power: 100 V, 120 V, 220 V, or 240 V,  $\pm 5\%$ , -10%, 48 Hz to 440 Hz, 70 VA max.

Weight: net, 4 kg (9 lb). Shipping, 6.5 kg (14.6 lb).

Dimensions: 126 H  $\times$  200 W  $\times$  280 mm D (5"  $\times$  7.9"  $\times$  11").

### Options & Accessories

Opt 001: Pulse Burst

Opt 910: extra operating and service manual

15179A Adapter frame. Rack mount for two units

Price

add \$300

add \$10.50

\$85

8011A Pulse Generator

\$600

# PULSE GENERATORS

Extremely flexible 50 MHz sources  
Models 8012B & 8013B



- Variable transition times down to 5 ns
- $\pm 10$  V amplitude; selectable source impedance
- Ideal for testing TTL

- Fixed 3.5 ns transition times
- 10 V amplitude; selectable source impedance
- 2 outputs



8012B



8013B

The 8012B and 8013B are at the top of their class for versatility, ease of operation and wide range of application. They provide the ideal solution to almost all digital logic testing problems with fixed 3.5 ns transition times on the 8013B and variable transition times down to 5 ns on the 8012B. The well-composed layout of the front panel controls (horizontal controls for horizontal parameters, vertical controls for vertical parameters) enables output pulses to be set up quickly and accurately with minimum risk of incompatible settings. Both models feature normal and complement outputs and a switchable internal 50 ohm source.

## Specifications

### Pulse characteristics

Parameter	8012B		8013B	
	Int. load IN	Int. load OUT	Int. load IN	Int. load OUT
Transition times	5 ns—0.5 $\mu$ s 4 ranges, Verniers provide separate control of both edges within ranges up to max. ratios of 100:1 or 1:100.	6 ns—0.5 $\mu$ s	3.5 ns fixed	5 ns fixed
Source impedance	50 ohms $\pm$ 10% shunted by typically 20 pF	>50 ohms	50 ohms $\pm$ 3% shunted by typically 20 pF	>50 ohms

Parameter	8012B/8013B	
	Internal load IN	Internal load OUT
Overshoot, ringing	$\leq \pm 5\%$ of pulse amplitude	May increase to $\pm 10\%$ when amplitude is between 0.4 V—4 V
Maximum output	5 V across 50 ohms, 10 V across open circuit. Short ckt. protection.	10 V across 50 ohms, Short ckt. protection.
Attenuator DC offset	4-step, reduces output to 0.2 V $\pm$ 2.5 V across 50 ohms. Independent of amplitude settings.	4-step, reduces output to 0.4 V. DC offset switched off.

**Linearity (8012B):** for transition times  $> 30$  ns, maximum straight line deviation is 5% of pulse amplitude.

**Preshoot:**  $\leq \pm 5\%$  of pulse amplitude.

**Pulse width:**  $< 10$  ns to 1 s in four ranges. Vernier provides continuous adjustment within ranges.

**Width jitter:**  $< 0.1\% + 50$  ps on any width setting.

**Maximum duty cycle:**  $> 75\%$  from 1 Hz to 10 MHz, decreasing to  $\geq 40\%$  at 50 MHz. Up to 100% in COMPL mode.

**Polarity:** 8012B; positive or negative selectable, NORM/COMPL/SYM selectable; 8013B, one positive + one negative channel, NORM/COMPL selectable.

**Pulse delay:**  $< 35$  ns to 1 s (with respect to trigger output) in four ranges; vernier provides continuous adjustment within ranges.

**Delay jitter:**  $< 0.1\% + 50$  ps on any delay setting.

### Repetition rate and trigger

1 Hz to 50 MHz in four ranges, continuous adjustment within ranges.

**Period jitter:**  $< 0.1\% + 50$  ps on any rate setting.

**Square wave:** 0.5 Hz to 25 MHz in four ranges. Duty cycle 50%  $\pm 5\%$  up to 1 MHz, tolerance increases to  $\pm 15\%$  at 25 MHz.

**Trigger output:**  $> +1$  V across 50 $\Omega$ , 16 ns  $\pm 10$  ns wide.

### External triggering

0 to 50 MHz; for square wave output, frequency divided by factor 2.

**Trigger input:** sine waves 1.5 V p-p (about zero) or pulses  $> 0.8$  V either polarity,  $> 7$  ns wide. Maximum input  $\pm 7$  V.

**Impedance:** 50 $\Omega$   $\pm 10\%$ , dc coupled.

**Delay:** 25 ns  $\pm 8$  ns leading edge trig. input to trig. output.

**Manual:** pushbutton for single pulse.

### Gating

**Synchronous gating:** gating signal turns generator "on". Last pulse is completed even if the gate ends during pulse.

**Gate input:** dc-coupled; voltage at open connector approx. +1.8 V. Shorting current  $\leq 12$  mA. Input impedance approx. 160 $\Omega$

**Gate input signal:** voltage  $> +1.5$  V or resistor  $> 1$  k $\Omega$  to ground enables rep. rate generator. Voltage  $< +0.8$  V or resistor  $< 160\Omega$  disables rep. rate generator. Input TTL compatible. max.  $\pm 5$  V.

### External width and RZ

**External width:** output pulse width determined by width of drive input signal. Amplitude, transition times selectable. Trigger output independent of external width input signal.

**RZ mode:** external drive input switched to delay generator. Period determined by period of drive input signal. Delay, amplitude and width selectable.

**Input signal:**  $> +1$  V,  $> 7$  ns wide. Max.  $\pm 5$  V. 50 $\Omega$  dc coupled.

### General

**Operating temperature range:** 0 $^{\circ}$ C to 55 $^{\circ}$ C.

**Power:** 100/120/220/240 V  $\pm 5\%$ ,  $-10\%$ , 48 to 400 Hz, 100 VA max.

**Weight:** net, 4 kg (8.8 lb). Shipping, 6.5 kg (14.6 lb).

**Size:** 126 H  $\times$  200 W  $\times$  280 mm D (5  $\times$  7.9  $\times$  11 in.)

### Options and accessories

15179A Adapter frame. Rack mounting for two units

Opt 910: extra operating and service manual

### Price

\$85

add \$10

### Ordering information

8012B Pulse Generator

8013B Pulse Generator

\$1050

\$895

# PULSE GENERATORS

Versatile source, unique level controls

Model 8015A

- 50 MHz repetition rate
- 2 output channels
- 16 V amplitude and offset
- Counted burst option, 0-9999 pulses
- Ideal for MOS, TTL and analog applications
- Each control ergonomically designed



The 8015A is a 50 MHz dual channel pulse generator with variable transition times, designed for optimum flexibility in the control of any pulse parameter. Each of the two independent output amplifiers can generate  $\pm 16$  V. A unique way of avoiding the usual offset and amplitude adjustment problems is provided by two independent pulse level sliders; with the aid of a calibrated scale the slider positions determine the pulse "high" and "low" levels.

In addition to control of pulse timing and amplitude parameters, it is possible to delay the pulse from channel B with respect to the pulse from channel A. For analyzing critical timing conditions or generating 2-phase clocks this B Delay mode offers continuous pulse delay between the two channels.

It is also possible to parallel both output amplifiers using A + B mode, which doubles the output current and enables a maximum output swing of 30 V (within a  $\pm 16$  V window). The combination of A + B mode and B Delay mode together with variable transition times and individual selection of Normal/Complement format for each output permits complex waveforms to be generated: waveforms such as three-level signals, special codes or simulated biomedical signals.

A range of options extends the 8015A's usefulness and offers new solutions to applications problems. Generation of an exact number of pulses, for example, is difficult to achieve by the usual techniques. With the pulse burst option (002), however, it is possible to generate an exact number of pulses (predetermined by thumbwheel switches) at rep. rates up to 50 MHz. This is achieved by means of a built-in preset counter. A pulse burst can be initiated by an external signal or pushbutton control thus enabling continuous, multiple or single burst operation.

Direct access to the linear output amplifiers (option 004) permits any TTL or even low level analog signal to be converted to MOS/CMOS levels. While one output delivers the normal pulse generator signal, the other can be used to amplify a PRBS/word generator output signal forming a test set for full parametric testing of MOS/CMOS shift registers, memories etc.

A safe and simple way to drive TTL devices is to use a separate TTL output with fixed levels, while all other parameters remain variable coincident with channel A output. This TTL output, available as option 005, requires no external termination because the internal 50 ohm source impedance ensures pulse fidelity when connected to the test circuit.

A particular problem with CMOS devices is that the input clock/data amplitudes must never exceed the power supply voltage or the CMOS circuit will be destroyed. This means that if the supply voltage is varied as part of a parametric test, the clock/data levels must be adjusted first. An option that completely eliminates this problem is the 8015A upper output level tracking option (006). This option enables the CMOS clock/data signals to track the CMOS power supply voltage. Thus when carrying out CMOS parametric tests at varying supply voltages, the signal upper levels automatically track the supply voltage and device safety and proper input levels are ensured. The test circuit is safe even if the power supply is switched off.

The 8015A can be used as part of an automatic test system using the remote control option (003). This option enables the range and vernier settings for the pulse period, delay, width, transition times and output levels to be remotely controlled. Range control is achieved by contact closure to ground using TTL compatible levels. Vernier control is achieved by voltage or current or resistor. Remote or local control of each parameter is selected using the appropriate front panel range switch. Both upper and lower signal levels of each output channel can be controlled independently.

## Specifications

### Pulse characteristics

**Transition times:** 6 ns to 0.5 s in four ranges (see table). Common for leading and trailing edges within each range up to maximum ratios of 100:1 or 1:100.

**Non-linearity:** transitions  $> 30$  ns:  $< 5\%$  of pulse amplitude.

**Overshoot and ringing:**  $\pm 5\%$  of pulse amplitude, possibly increasing  $< \pm 10\%$  at minimum amplitude.

**Prehoot, droop:**  $< 5\%$  of pulse amplitude.

**Pulse width:**  $< 10$  ns to 1 s in four ranges.

**Width jitter:**  $< 0.1\% + 50$  ps for any width setting.

**Maximum output:**  $\pm 16$  V.

**Maximum duty cycle:**  $> 75\%$  from 1 Hz to 1 MHz, decreasing to  $\geq 50\%$  at 50 MHz. Square wave:  $50\% \pm 5\%$  from 1 Hz to 1 MHz,  $\pm 15\%$  at 25 MHz.

**Pulse delay:** 20 ns ( $+25$  ns fixed) to 1 s, in four ranges.

**Delay jitter:**  $< 0.1\% + 50$  ps for any delay setting.



Mode	Source/Load Impedance	Transition Times	Upper Level Voltage (V <sub>UL</sub> )	Lower Level Voltage (V <sub>LL</sub> )	Upper Level Current (I <sub>UL</sub> )	Lower Level Current (I <sub>LL</sub> )	V <sub>UL</sub> -V <sub>LL</sub> Max Min	I <sub>UL</sub> -I <sub>LL</sub> Max Min	Max. Rep. Rate
AsepB	50Ω/50Ω 50Ω/1 kΩ or 1 kΩ/50Ω	*6 ns-0.5 s 8 ns-0.5 s	+8 V to -7 V +16 V to -14 V	+7 V to -8 V +14 V to -16 V	+320 mA to -280 mA	+280 mA to -320 mA	8V 1 V 16 V 2 V	320 mA 40 mA	50 MHz 40 MHz
A-B	50Ω/50Ω 50Ω/1 kΩ or 1 kΩ/50Ω	15 ns-0.5 s 15 ns-0.5 s	-16 V to -14 V +16 V to -12 V	+14 V to -16 V +12 V to -16 V	+640 mA to -560 mA	+560 mA to -640 mA	16 V 2 V 30 V 4 V	640 mA 80 mA	20 MHz 20 MHz

\*6 ns at 8 V, may increase to 6.5 ns at 4 V.

### Repetition rate and trigger

**Repetition rate:** 1 Hz to 50 MHz in four ranges (see table).

**Period jitter:** <0.1% +50 ps for any rep. rate setting.

**Square wave:** 0.5 Hz to 25 MHz.

**Double pulse:** 25 MHz max. (simulates 50 MHz).

**B Delay:** 20 MHz max. Channel B pulse delayed on channel A pulse by amount set on delay controls.

**Trigger output:** dc coupled, 50Ω (typ.) source impedance, delivering ≥1 V across 50Ω load. 9 ns ± 5 ns width.

### Externally controlled operation

**External input:** 50Ω ±10% or 500Ω ±10%, dc coupled.

**Maximum input:** ±7 V (50Ω input), ±25 V (500Ω input).

**Trigger polarity:** positive or negative slope selectable.

**Threshold level:** +1 V to -1 V (50Ω input impedance) or +10 V to -10 V (500Ω input impedance).

**Sensitivity:** 50Ω input impedance, sinewaves 1 V p-p, pulses ±0.5 V; 500Ω input impedance, sinewaves 10 V p-p, pulses ±5 V.

**Minimum pulse width:** 5 ns in Ext. Trig., 20 ns in Burst mode.

**Delay:** <50 ns between trigger input and trigger output.

**Manual button:** push to activate input.

**External width:** output pulse width and rate determined by width and rate of drive signal.

**Synchronous gating:** gating signal turns on repetition rate. Last pulse completed even if gate ends during pulse. Max. repetition rate: 40 MHz.

### Options

#### Opt 002 pulse burst

**Number of pulses:** 1-9999.

**Burst trigger source:** external signal or manual.

**Repetition rate:** 0 to 40 MHz.

**Minimum time between bursts:** 200 ns.

**Trigger:** all specifications as for EXT INPUT except minimum width: ≥20 ns.

#### Opt 003 remote control

**Timing ranges:**

pulse period } contact closure to ground or TTL compatible  
 pulse delay } signals. One line for each range  
 pulse width }  
 transition time }  
 Threshold voltages: logic 0 = 0.4 V, logic 1 = 2.4 V

#### Timing verniers:

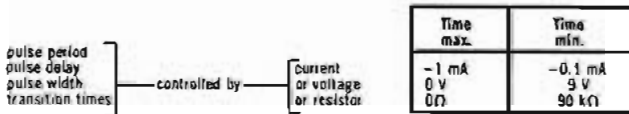

**Absolute maximum input current limits:** 0 mA to -1.1 mA.

**Absolute maximum input voltage limits:** +10 V to -0.1 V.

#### Output levels

Input control voltage	Output level
Upper level control set to max. (+8 V)	+8 V
0 (0 V)	0 V
max. (-7 V)	-7 V
Lower level control set to max. (+7 V)	+7 V
0 (0 V)	0 V
max. (-8 V)	-8 V

\*50 ohm into 50 ohm

**Minimum difference between upper level and lower level control voltage:** 1 V (for 1 V output swing).

**Absolute maximum input voltage limits:** ±20 V.

**Pulse burst:** 4 decades (1-9999), 4 lines per decade (1248 BCD format). Contact closure to gnd. or TTL compatible levels. Threshold voltages are logic 0 = 0.4 V, logic 1 = 2.4 V. Note: Opt 003 includes Opt 006. To use pulse burst, Opt 002 must be ordered with 003.

#### Opt 004 direct output amplifier access

**Input impedance:** 50 ohms ±5%.

**Operation:** asymmetrical.

**Input voltage for max. output:** 2.5 V p-p (baseline 0 V, top +2.5 V).

**Absolute maximum input voltage:** ±5 V.

**Gain:** continuously variable between 0.8 and 6.4 by level controls (Z<sub>s</sub> = 50 ohms, no load).

**Frequency response (-3 dB):** Z<sub>s</sub> = 50 ohms, no load—

0 to 50 MHz

Z<sub>s</sub> = 50 ohms, 50 ohm load—

0 to 80 MHz

**Polarity:** inverting for NORM, non-inverting for COMPL.

Note: B DELAY mode cannot be used with this option.

#### Opt 005 extra TTL output

**Logic 1 level:** 4.5 V min.

**Logic 0 level:** 0.2 V max. (20 mA sink current).

**Source impedance:** 50 ohms.

**Pulse delay:** zero, coincident with channel A.

**Pulse output:** normal/complement as selected by channel A.

#### Opt 006 upper output level tracking

**Input voltage:** +2 V to +16 V.

**Absolute max. input voltage:** +20 V.

**Absolute min. input voltage:** 0 V.

**Input impedance:** 10 kΩ ±5%.

**Upper level accuracy:** ±5% of control voltage.

**Lower level accuracy:** 0 V ±250 mV.

**Settling time to ±5% of final value:** 400 μs.

### General

**Operating temperature range:** 0°C to 55°C.

**Power:** 100 V, 120 V, 220 V, or 240 V, +5%, -10%, 48 to 440 Hz, 180 VA maximum.

**Weight:** net, 11 kg (24.26 lb). Shipping, 14.7 kg (32.4 lb).

**Size:** 133 H × 426 W × 346 mm D (5.2" × 16.75" × 13.6").

#### Options and accessories

	Price
002: pulse burst	add \$450
003: remote control	add \$895
004: direct output amplifier access	add \$215
005: extra TTL output	add \$190
006: upper output level tracking	add \$110
907: Front Handle Kit	add \$20
908: Rack Flange Kit	add \$15
909: Rack Flange/Front Handle Kit	add \$30
910: Additional Operating and Service Manual	add \$18
<b>8015A Pulse Generator</b>	<b>\$2700</b>

# PULSE GENERATORS

Very fast & variable transitions, 1 ns to 0.5 ms

Model 8082A

- < 1 ns variable transition times
- 250 MHz repetition rate
- Ultra-clean 50 ohm source
- Switch-selectable ECL levels
- $\pm 5$  V outputs



The 8082A is Hewlett-Packard's fastest pulse generator with all pulse parameters variable. With repetition rates to 250 MHz, transition times down to 1 ns and amplitudes to 5 V, the 8082A is ideally suited for state-of-the-art TTL and ECL logic designs. Using the 8082A, you can rapidly test logic circuits under all operating conditions by simply varying pulse parameters. Although a highly sophisticated instrument, the 8082A is still easy to operate because of its logical front panel layout and switch-selectable ECL output levels. Another feature that contributes to ease of operation is the square wave mode. You can, for example, carry out toggle rate tests in this mode up to 250 MHz without having to worry about pulse duty cycle.

Hybrid ICs, manufactured by Hewlett-Packard, are used extensively in the design of the 8082A. These ICs eliminate the need for fans, reduce power consumption and enable a low reactance 50 ohm source impedance to be used. This source impedance absorbs 98% of reflections from signals up to 4 V amplitude.

## Specifications

### Pulse characteristics (50 $\Omega$ source and load impedance)

**Transition times:** < 1 ns – 0.5 ms (10% to 90%) in 6 ranges. < 750 ps (20% to 80%). Leading/trailing edges controlled separately on fastest range, independently variable over 1:10 ratio on other ranges.

**Overshoot and ringing:**  $\leq \pm 5\%$  of pulse amplitude may increase to  $\pm 10\%$  with amplitude vernier CCW.

**Prehoot:**  $\leq \pm 5\%$  of pulse amplitude.

**Linearity:** linearity aberration for both slopes  $\leq 5\%$  for transition times > 5 ns.

**Output:** maximum amplitude is 5 V from 50  $\Omega$  into 50  $\Omega$ . Maximum output voltage is  $\pm 5$  V (amplitude + offset).

**Offset:**  $\pm 2$  V, into 50  $\Omega$ .

**DC-source impedance:** 50  $\Omega \pm 5\%$ .

**Reflection coefficient:** reflection is 2% typical for steps with 1 ns rise time applied to output connector on all amplitude ranges except 5 V range. On the 5 V range, the reflection may be 15%.

**Output protection:** cannot be damaged by open or short circuits or application of ext.  $\leq \pm 6$  V or  $\sim 200$  mA independent of control settings.

**Attenuator:** two separate three step-attenuators reduce the outputs to 1 V. Vernier is common for both outputs and reduces the output to 0.4 V minimum. A further position provides ECL-compatible outputs ( $-0.9$  V to  $-1.7$  V typ. open circuit).

### Timing

**Repetition rate:** 250 MHz to 1 kHz in 6 ranges.

**Period jitter:** < 0.1% of setting + 50 ps.

**Delay:** 2 ns – 0.5 ms in 6 ranges plus typ. 17 ns fxd. with respect to trigger output. Duty cycle > 50%.

**Delay jitter:** < 0.1% of setting + 50 ps.

**Double pulse:** up to 125 MHz max. (simulates 250 MHz).

**Pulse width:** < 2 ns – 0.5 ms in 6 ranges.

**Width jitter:**

< 0.1% of setting + 50 ps.

**Width duty cycle:** > 50%.

**Square wave:** delay and double pulse are disabled, max. Rep. Rate 250 MHz. Duty cycle is 50%  $\pm 10\%$  up to 100 MHz, 50%  $\pm 15\%$  for > 100 MHz.

**Trigger output:** negative going Square Wave (50% duty cycle typ.) > 500 mV from 50  $\Omega$  into 50  $\Omega$ . Internal 50  $\Omega$  can be switched off by slide-switch on PC-board. Amplitude up to 1 V into 50  $\Omega$  up to 200 MHz.

**Trigger output protection:** cannot be damaged by short circuit or application of external  $\pm 200$  mA.

### Externally controlled operation

#### External input

**Input impedance:** 50  $\Omega \pm 10\%$ . DC coupled.

**Maximum input:**  $\pm 6$  V.

**Trigger level:** adjustable  $-1.5$  V to  $+1.5$  V.

**Slope control:** positive, negative or manual selectable. In the manual position all ext. functions can be controlled by push button. Button pushed in simulates an "on-signal."

**Sensitivity:** sine-wave > 200 mV p-p pulses > 200 mV.

**Repetition rate:** 0 to 250 MHz.

### External-controlled modes

**External trigger:** there is approximately 7 ns delay between the external input and the trigger output. Rep. rate is externally controlled (is triggered by external signal). Trigger output provides the pulse-shaped input signal. Square wave mode is disabled.

**Synchronous gating:** gating signal turns rep. rate generator on. Last pulse normal width even if gate ends during pulse.

**External width:** output pulse width determined by width of drive input. Rep. rate and delay are disabled. Trigger output provides shaped input signal.

### General

**Operating temperature:** 0°C to 55°C.

**Power requirements:** 100 V, 120 V, 220 V, 240 V (+5%, -10%) 48-440 Hz. Power consumption 85 VA max.

**Weight:** net, 7.9 kg (17.44 lb). Shipping 8.9 kg (19.63 lb).

**Dimensions:** 133 mm H  $\times$  426 W  $\times$  345 mm D (5.2"  $\times$  16.75"  $\times$  13.6").

### Options

907: Front Handle Kit

908: Rack Flange Kit

909: Rack Flange & Front Handle Combination

910: Additional Operating and Service Manual

8082A Pulse Generator

Price

add \$20

add \$15

add \$30

add \$12

\$ 3675

# PULSE GENERATORS

Clean waveshape, all parameters variable

Model 8007B



- 100 MHz repetition rate
- Variable transition times down to 2 ns.

- Extremely linear slopes
- Designed to drive TTL-S and commonly used ECL

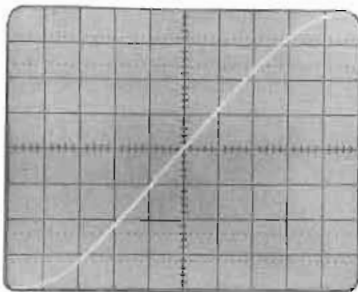
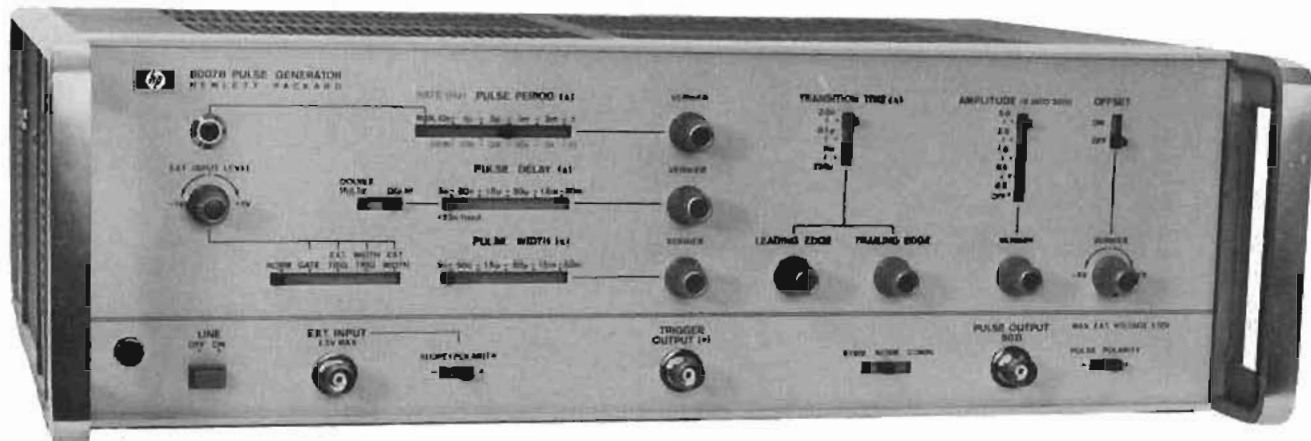

1 ns/cm  
0.5 V/cm  
1 GHz bandwidth

The 8007B is a high speed pulse generator that is well suited for STTL and ECL applications.

The output can be set to positive or negative polarity, complement or symmetrical to ground. A high dc-offset of up to  $\pm 4$  V is also included.

External triggering and synchronous gating are provided. The trigger level is adjustable for all externally controlled modes with the slope polarity selectable. This is very useful for avoiding malfunctions caused by noise and ringing on the external trigger signal.

In "External Width" mode the external input and pulse output have equal width. Transition times and amplitude of the output pulse can be set by the front panel controls. This mode is useful for shaping NRZ signals, as the width information is passed on to the output pulse unchanged.

The "Width Trigger" mode is suitable for RZ signal shaping. Delay, width, transition times and amplitude are determined by the front panel controls.

## Specifications

### Pulse characteristics (50 $\Omega$ source and load impedance)

**Transition times:** <2 ns to 250  $\mu$ s, three ranges (common for both transition times). Independent verniers for adjusting leading and trailing edge within each range up to maximum ratios of 1:50 or 50:1.  
**Linearity:** maximum deviation from a straight line between 10% and 90% points  $\leq 5\%$  of pulse amplitude.

**Prehoot, overshoot, ringing:**  $< \pm 5\%$  of pulse amplitude.

**Pulse width:** <5 ns to 50 ns in five ranges. Vernier provides continuous adjustment within ranges.

**Width jitter:** <0.1% on any width setting.

**Maximum duty cycle:** normal >50%; complement approx. 100%.

**Amplitude:** 5 V max (10 V across open circuit) to 0.2 V in four ranges; vernier adjustment within ranges. Pulse can be switched off.

**Pulse output:** + or - polarity selectable; normal, complement, or symmetrical to ground.

**Source impedance:** 50 $\Omega \pm 4\Omega$  shunted by typ. 10 pF.

**DC-offset:**  $\pm 4$  V across 50 $\Omega$  load. Independent of amplitude setting, can be switched off.

**Pulse delay:** <30 ns to 50 ms with respect to trigger output. Five ranges, with continuous adjustment within ranges.

**Delay jitter:** <0.1% on any delay setting.

### Repetition rate and trigger

10 Hz to 100 MHz in 5 ranges. Continuous adjustment within ranges.

**Period jitter:** <0.1%.

**Double pulse:** available only up to pulse rate setting of 50 MHz, representing an output pulse rate of 100 MHz.

**Trigger output:** >+1 V across 50  $\Omega$ , 4 ns  $\pm$  2 ns wide.

### External triggering (0 to 100 MHz)

**Delay:** approx. 15 ns between trig. input and trig. output.

**Manual:** front panel pushbutton for single pulse.

### External width and width trigger

**External width:** output pulse width determined by width of drive input.

**Width trigger:** external drive input switched to the width generator. Pulse width determined by front panel width setting.

**Rate generator:** provides trigger pulses independent of drive input.

### Synchronous gating

Gating signal turns generator "on." Last pulse is completed even if gate ends during pulse.

### External input

**Impedance:** 50 $\Omega$ , dc-coupled. Max input  $\pm 5$  V.

**Level:** adjustable from +1 V to -1 V. Polarity: + or -.

**Sensitivity:** sine waves 1 V p-p; pulses 1 V.

### General

**Operating temperature range:** 0°C to +55°C.

**Power requirements:** 115 or 230 V  $\pm 10\%$ , -15%, 48 to 440 Hz, 100 VA (maximum).

**Weight:** net, 8 kg (17.6 lb). Shipping, 9 kg (19.8 lb).

**Dimensions:** 128 mm H  $\times$  426 mm W  $\times$  345 mm D (5"  $\times$  16.8"  $\times$  13.6").

### Options

908: Rack Flange Kit

910: Additional Operating and Service Manual

8007B Pulse Generator

Price  
add \$10  
add \$11  
\$2600

# PULSE GENERATORS

High pulse power: 100 V, 200 W output

Model 214A

- Wide amplitude range; 0.08 V to 100 V
- 15 ns transition times
- 1 MHz repetition rate
- Double pulse mode

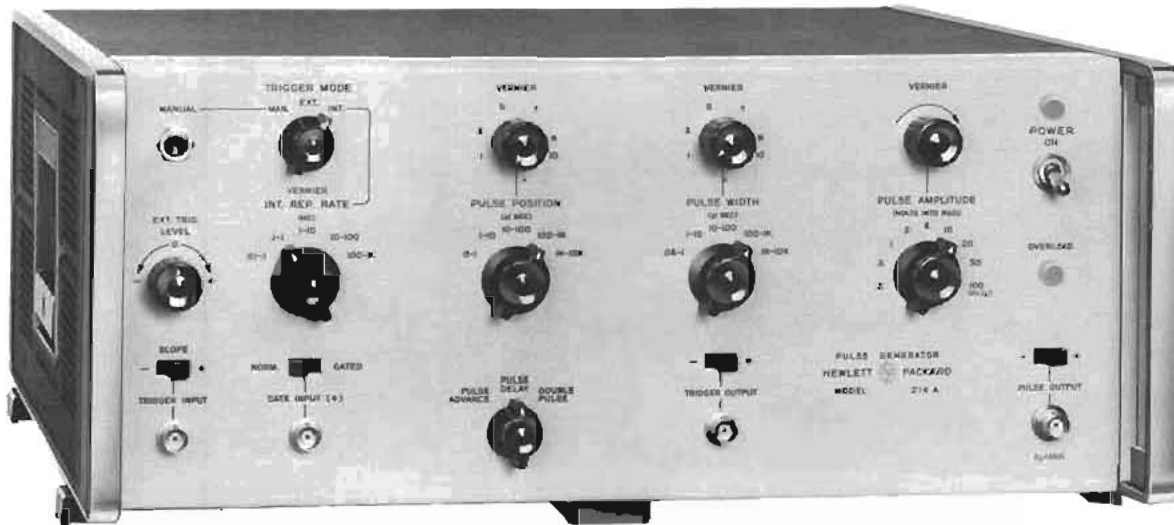

The 214A is a well-proven pulse generator with a very wide range of applications. The high 200 watts of pulse power (2 amp peak,  $\pm 100$  volts into 50 ohms) and fast rise time of 15 ns are particularly suited for testing current-driven devices such as magnetic cores, as well as high-power modulators. The fast rise and fall times combined with high power output pulses facilitate checking switching time of high power semiconductors. The positive or negative pulse output, with identical characteristics, provides a simple means of checking either npn or pnp type transistors. By gating the Model 214A output, a burst of pulses may be obtained for making computer logic measurements. The double pulse feature may also be used for pulse resolution tests of amplifiers and memory cores. Because of its ability to provide a 100 V amplitude output pulse, the 214A is ideally suited as a trigger source in high power applications where a poor signal-to-noise ratio is present.

Source impedance is 50 ohms on all but the highest (100-volt) range, to minimize errors caused by re-reflections when operating into unmatched loads. At lower output levels (down to 80 mV), the rise time is less than 13 ns (typically less than 10 ns). Carefully controlled pulse shape, pulse rate and width, and minimum pulse jitter ensure accurate and dependable test results. All characteristics of the pulse waveform, including overshoot, preshoot, pulse droop, and pulse top variations, are completely specified, and pulse irregularities are kept to a minimum.

An external trigger source of dc to 1 MHz can be used instead of the internal rate generator to produce the output pulses. Positive or negative trigger signals of 0.5 volts peak may be used and trigger slope and level may be selected to determine the triggering point on the waveform. A single pulse may be obtained from an internal circuit each time a manual button is pushed. Gating of pulses is easily achieved by applying an external signal and an output occurs only when the gating signal reaches a positive 8 volt level. Three modes of pulse operation allow: (1) setting of the output pulse to occur from 0 to 10 ms before (advance) the trigger output, (2) setting of the output pulse to occur from 0 to 10 ms after (delay) the trigger output, or (3) a double pulse output with variable spacing between the two pulses.

## Specifications

### Pulse characteristics

**Source impedance:** 50 ohms on 50 V and lower ranges; approx. 1500 ohms on the 100 V range.

**Transition times:** <13 ns on 20 V and lower ranges and the -50 V range, <15 ns on the +50 V range; typically <10 ns with the vernier set for maximum attenuation and typically 15 ns on the 100 V range.

**Pulse amplitude:** 100 V into 50 ohms. Attenuator provides 0.2 to

100 V in 1, 2, 5, 10 sequence (9 ranges); vernier reduces output of 0.2 V setting to 80 mV and provides continuous adjustment within ranges.

**Polarity:** positive or negative.

**Overshoot:** <5%, both edges (measured on a 50 MHz oscilloscope).

**Pulse top variation:** <5%.

**Droop:** <6%.

**Preshoot:** <2%.

**Pulse widths:** 50 ns to 10 ms in 5 decade ranges; continuously adjustable vernier.

**Width jitter:** <0.05% of pulse width + 1 ns.

**Maximum duty cycle:** 10% on 100 V and 50 V ranges; 25% on 20 V range; 50% on 10 V and lower ranges.

### Repetition rate and trigger

#### Internal

**Repetition rate:** 10 Hz to 1 MHz (5 ranges), continuously adjustable vernier. Rate jitter: <0.5% of the period.

**Manual:** pushbutton single pulse, 2 Hz maximum rate.

#### External

**Repetition rate:** dc to 1 MHz.

**Sensitivity:** <0.5 V peak.

**Slope:** positive or negative.

**Level:** adjustable from -40 V to +40 V.

**Delay:** delay between input trigger and leading edge of pulse is approximately 250 ns in Pulse Advance mode (approx. 420 ns minimum in Pulse Delay mode).

**External gating:** +8 V input threshold. Maximum input 40 V peak.

#### Double pulse

**Minimum spacing:** 1  $\mu$ s on the 0.05 to 1  $\mu$ s pulse width range and 25% of upper limit of width range for all other ranges.

#### Trigger output

**Amplitude:** >10 volts open circuit.

**Source impedance:** approximately 50 ohms.

**Width:** 0.05  $\mu$ s nominal.

**Polarity:** positive or negative.

#### General

**Power:** 115 or 230 V  $\pm 10\%$ , 48 to 66 Hz, approx. 325 VA.

**Size:** 172 mmH  $\times$  426 mmW  $\times$  416 mmD (6.8"  $\times$  16.8"  $\times$  16.4").

**Weight:** net, 15.8 kg (35 lb). Shipping, 18.5 kg (41 lb).

#### Options

**OPT 808:** Rack Flange Kit

**OPT 910:** Additional Operating and Service Manual

214A Pulse Generator

Price  
add \$10

add \$7.50

\$1900

- 2 independent pulse generators in one
- Simulation of complex analog signals
- Independent timing for driving digital ICs

**8010A**

The 8010A is a very versatile pulse generator because it is actually two pulse generators in one. All pulse parameters except repetition rate are generated separately for each channel. The two outputs can be used separately for digital logic applications or can be combined at the output amplifiers to provide extremely complex waveforms for analog applications. The repetition rate can be triggered separately for each channel thus enabling one channel to be controlled by the repetition rate generator while the other is triggered externally.

### Specifications

**Pulse characteristics (with 50 ohms load impedance)**  
**Transition times:** separate outputs, <10 ns to 1 s. In A + B mode, <12 ns to 1 s. With 10 V output, <20 ns to 1 s.  
**Non-linearity:** for transition times >30 ns, <4% of pulse amplitude.  
**Overshoot and ringing:** <5% of pulse amplitude.  
**Pulse width (A and B):** <20 ns to 1 s.  
**Jitter:** <0.1% of setting.  
**Max. duty cycle:** >80% (1 Hz-1 MHz), >50% (1-10 MHz).  
**Output amplitude:** 0.02 V to 5 V sep., up to 10 V combined (channel B).  
**DC offset:**  $\pm 2$  V across 50 ohm load. Can be switched off.  
**Pulse delay:** (A and B) 50 ns to 1 s related to trig output in 8 ranges.  
**Jitter:** <0.1% of setting.  
**Repetition rate and trigger**  
**Free running:** 1 Hz-10 MHz in 7 ranges.  
**Jitter:** <0.1% of setting.  
**Square wave:** 1 Hz-10 MHz symmetrical to ground.  
**Double pulse:** channel A and B independently selectable.  
**External triggering (Input impedance 1 K ohms)**  
**Rep. rate:** 0-10 MHz,  $\pm 2$  for square wave output.  
**Trigger input:** sine waves 1 Vp-p. Pulses 0.5 V, 20 ns wide.  
**Delay:** approximately 30 ns trig. input to trig. output.  
**Manual:** pushbutton for single pulse.  
**Sep. trig. for both channels:** +2 V amp., >50 ns wide, 50 $\Omega$  impedance.

#### Trigger output (50 ohms impedance)

**Amplitude:** +2 V across 50 ohms. 15 ns  $\pm$  10 ns wide.

#### Gating

**Synchronous:** -2 V to -10 V signal turns rate generator on.  
**Asynchronous:** -2 V to -10 V signal turns the output pulse on.

#### General

**Power:** 115 V or 230 V + 10% - 15%, 48 to 440 Hz, 200 VA max.  
**Operating temperature range:** 0°C to 55°C.  
**Weight:** net 10.6 kg (23.4 lb).  
**Size:** 177 H x 426 W x 422 mm D (7" x 16.8" x 16.6").

- Dual outputs, +10 V and -10 V
- TTL output
- Gating, square wave, double pulse modes

**8005B**

The 8005B is a general purpose, triple output pulse generator. This versatile instrument has all parameters variable and produces simultaneous pos. and neg. pulses. It also has a TTL output which has all parameters variable except amplitude. This feature, together with the normal/complement facility, greatly improves the ease of operation.

### Specifications

#### Pulse characteristics

**Transition times:**  $\leq 10$  ns to 2 s. Edges independently variable.  
**Non-linearity:** for transition times >30 ns, <4% of pulse amplitude.  
**Preshoot, overshoot, ringing:** <5% of pulse amplitude.  
**Pulse width:** <25 ns to 3 s in 5 ranges. **Jitter:** <0.1% of setting.  
**Max. duty cycle:** >80% (0.3 Hz-1 MHz), >50% (1-20 MHz).  
**Square wave:** 0.15 Hz-10 MHz.  
**Pulse delay:** <100 ns to 3 s. **Jitter:** <0.1% of setting.  
**Pulse outputs:** simultaneous pos., neg. and TTL compatible outputs.  
**Pulse amplitude:** 300 mV to 10 V.  
**Output protection:** max. external voltage  $\pm 10$  V.  
**Source impedance:** 50 ohms  $\pm 10\%$  or high impedance, selectable.  
**TTL compatible output:** +4.6 V norm or comp. 50 ohms impedance.  
**Repetition rate and trigger**  
**Repetition rate:** 0.3 Hz to 20 MHz in 5 ranges. **Jitter:** <0.1%.  
**Double pulse:** 10 MHz max. Simulates 20 MHz.  
**Trigger output:** >+2 V amp. across 50 ohms. **Width:** >6 ns.

#### Externally controlled operation

##### External triggering (dc to 20 MHz)

**Delay:** approx. 35 ns trig. input to trig. output.

##### Trigger Input

**Maximum input:**  $\pm 10$  V.  
**Impedance:** approx. 1 K ohms dc-coupled.  
**Sensitivity:** sine 2 Vpp.  
**Pulses:**  $\pm 1$  V peak.  
**Width:**  $\geq 10$  ns.

##### Gating

**Synchronous:** gate signal turns on repetition rate. Last pulse is always completed.

**Asynchronous:** gate signal controls output of rate generator.

##### Gate input (Impedance 1 K ohms dc coupled)

**Amplitude:** 2 V to 20 V (max.). **Polarity:** negative.

##### General

**Operating temperature range:** 0°C to 55°C.

**Power:** 115 V or 230 V + 10%-15%, 48 to 440 Hz, 180 VA max.

**Weight:** net 7 kg (15.5 lb). Shipping 9 kg (20 lb).

**Size:** 130 H x 426 W x 290 mm D (5.1" x 16.8" x 11.4").

##### Options and accessories

**Opt 908:** Rack Flange Kit

**8010A-910:** additional Operating and Service Manual

**8005B-910:** additional Operating and Service Manual

##### Ordering information

**8010A Pulse Generator**

**8005B Pulse Generator**

**Price:**

add \$10

add \$17.50

add \$7

\$3600

\$1750

# PULSE GENERATORS

Model 1900 Plug-in pulse generator system

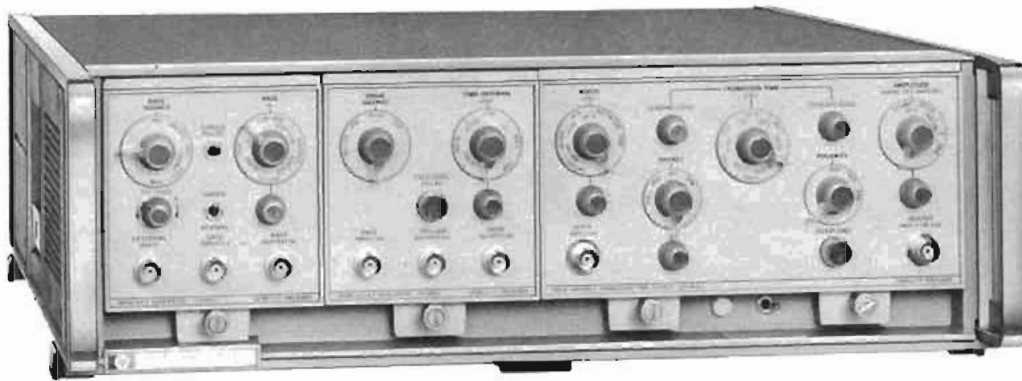

## 1900 System Introduction

The Hewlett-Packard 1900 system with its modular construction offers the maximum possible flexibility and versatility in a pulse generator. It makes available an extremely wide range of facilities which could otherwise only be implemented by several conventional instruments.

The 1900 system comprises a series of fully compatible plug-in units with a maximum repetition rate of 25 MHz.

Rate	Data/Timing	Output
1905A	1907A 1925A 1930A	1915A 1917A 1920A

## Applications

Because of its flexibility the 1900 system covers a very wide range of applications. The following applications areas, described in terms of plug-in capabilities, are typical.

The 1917A, the general-purpose output amplifier of the 1900 system, produces 0.2 V to 10 V pulses from 50 ohms into 50 ohms (14 V into Hi-Z) with transition times down to 7 ns. It covers a wide range of digital applications including logic design testing of TTL, ECL and MOS circuits.

The 1915A produces a  $\pm 2.5$  V to 50 V output at 1 A into a 50 ohm load and transition times down to 7 ns. The H51 special enables the 1915A to handle single pulses or low duty cycles of  $<0.2\%$ . Thus the 1915A is ideally suited for testing CMOS logic or as a modulator in radar, microwave or plasma experiments, or any high voltage, high current application. An overload circuit and indicator lamp are provided to prevent output amplifier damage.

The 1920A provides pulses with 350 ps rise times and 400 ps fall times. These very fast transition times suit the 1920A to rise time, propagation delay, bandwidth and storage time testing of high speed transistors and logic families such as ECLIII. The zero pulse width facility is useful for impulse testing. The H02-1920A special enables the 1920A to be used in fiber optics applications. This special modifies the 1920A to deliver pulses with  $\leq 300$  ps transition times and 10 V fixed amplitude into 50 ohms for driving LEDs and laser diodes.

The 1925A and 1930A plug-ins bring word generation and PRBS

capabilities to the 1900 system. The 1925A can generate words of 2-16 bits in length at up to 50 MHz and PRBS of 32 767 bits for testing communications channels.

The 1930A can generate a variable length PRBS of 7 to 1 048 575 bits at rates up to 40 MHz, and also includes a bit-error-detection facility.

## Programmability

Remote programming is available for the 1900 system which enables it to be built into systems for automatic testing of components or systems. With analog programming, pulse parameter ranges are controlled by external contact closure and verniers by analog current or resistance. For digital programming the 1900 system is interfaced to a computer via the 6940B Multiprogrammer.

## 1900A Mainframe

The 1900A mainframe provides housing, power supplies and RFI shielding for all 1900 system plug-ins. Plug-ins in the mainframe can be connected either internally or externally.

## 1900A Mainframe specifications

### General

**Size:** 133 H  $\times$  426 W  $\times$  492 mmD (5.3"  $\times$  16.7"  $\times$  19.4").

**Weight:** net 16 kg (35 lb). Shipping 21 kg (46 lb).

**Power:** 115 V or 230 V  $\pm 10\%$ . 48 to 66 Hz, 300 watts max.

### Accessories

**Analog programming kit:** P/N 01900-69502 for Opt 001.

**Blank plug-ins:** 10481A - quarter size, 10482A - half size.

**Plug-in extender:** 10484A for half and quarter size plug-ins.

### Options

**001:** cables for remote programming facility

**002:** chassis slides

**007:** rear panel inputs and outputs

**908:** rack flange kit

**910:** extra operating and service manual

**1900A Mainframe**

**Price**

add \$225

add \$95

add \$80

add \$10

add \$7

**\$1250**

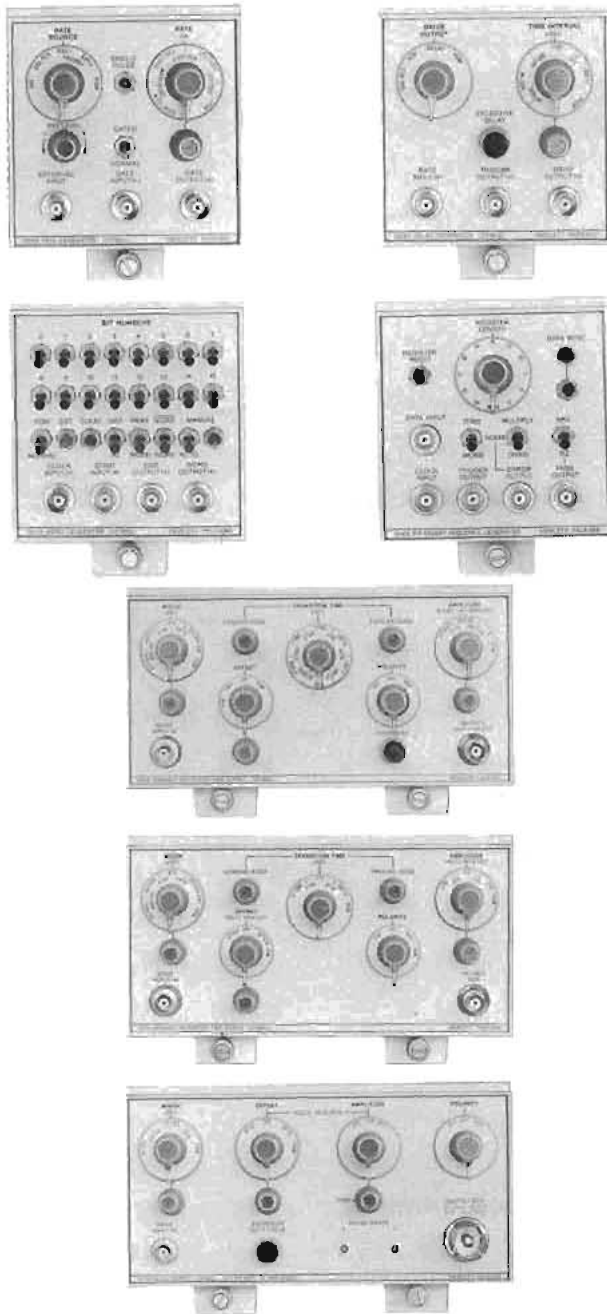

### 1905A 25 MHz rate generator specifications

**Frequency:** 25 Hz-25 MHz (int.), 0-25 MHz (ext.).  
**Period jitter:** <0.1%.  
**External trigger:** amplitude 0.5 V to 5 Vpp. Slope pos. or neg.  
**Input impedance:** 50 ohms dc coupled.  
**Synch gating:** -2 V gates generator on, -5 V max. 50 ohms impedance.  
**Output pulse:** amp. >1.5 V (50 Ω/50 Ω).  
**Risetime:** <5 ns. Width: <10 ns.  
**Width:** <10 ns.

### 1908A 25 MHz delay generator specifications

**Delay range:** 15 ns to 10 ms.  
**Jitter:** <0.1% of setting.  
**Rate Input:** 0-25 MHz.  
**Amplitude:** 1 V p-p min, 5 V p-p max.  
**Trigger and drive outputs**  
**Amplitude:** >1.5 V (50 Ω/50 Ω).  
**Risetime:** <5 ns.  
**Width:** <10 ns.  
**Impedance:** 50 ohms.

### 1925A PRBS/word generator specifications

**Function:** word length 2-16 bits. PRBS 32,767 bits.  
**Clock Input (impedance 50 ohms)**  
**Repetition rate:** 0-50 MHz (15-35°C), 0-45 MHz (0-50°C).  
**Amplitude:** +1 Vmin, +5 Vmax.  
**Width:** >4 ns, <18 ns at +0.6 V.  
**Start Input (impedance 50 ohms dc coupled)**  
**Period:** >(word length plus 30 ns).  
**Amplitude:** +1 Vmin, +5 Vmax.  
**Width:** >5 ns.

### 1930A PRBS generator specifications

**Function:** PRBS 7 to 1 048 575 bits variable.  
**Clock Input (impedance 50 ohms dc coupled)**  
**Repetition rate:** 0-40 MHz.  
**Amplitude:** = 1 V to ±5 V.  
**Width:** >4 ns <15 ns.  
**Data Input (impedance 50 ohms dc coupled)**  
**Rep. rate:** 0-40 MHz.  
**Amplitude:** '1' level +1 Vmin, '0' level 0 V. Max. ±5 V.  
**Trigger output (impedance 50 ohms)**  
**Amplitude:** 1 V (open circuit).  
**Width:** 1 clock period.

### Error and PRBS outputs (unterminated current sources)

**Amplitude:** >2 V into 50 Ω.  
**Width:** >10 ns, <50% of period in RZ mode.

### 1915A Output Amplifier specifications

**Source impedance:** 50 ohms or 4 K ohms.  
**Amplitude:** ±1.25 V to ±25 V (50 Ω/50 Ω), ±2.5 V to ±50 V (Hi-Z/50 Ω).  
**Transition times:** 7 ns (10 ns with Hi-Z source) to 1 ms.  
**Baseline offset:** ±1.5 V (50 Ω source), ±3 V (Hi-Z source).  
**Internal width:** 15 ns-40 ms.  
**Jitter:** <0.5%.

**External width:** determined by drive input width.

### 1917A Output Amplifier specifications

**Source impedance:** 50 ohms or 3 K ohms, 45 pF shunt.  
**Amplitude:** ±0.2 V to ±10 V into 50 ohms, 0 V to ±14 V into 3 K ohms.  
**Transition times:** 7 ns to 500 μs. Separate rise and fall controls.  
**Baseline offset:** ±2.5 V (50 ohms into 50 ohms).  
**Internal width:** 15 ns to 40 ms.  
**Jitter:** <0.25%.

**External width:** determined by drive input width.

### 1920A Output Amplifier specifications

**Source impedance:** 50 ohms ±5%.  
**Amplitude:** ±0.5 V to ±5 V into 50 Ω.  
**Offset:** 0 V to ±2 V into 50 Ω.  
**Transition times:** leading edge <350 ps; trailing edge <400 ps.  
**Width:** 0 to 10 μs.  
**Jitter:** <20 ps or 0.1% whichever is greater.  
**Duty cycle:** 0 to >25% (0-20 MHz), 0 to 10% (>20 MHz).

### Options

Options	Price
001: analog programming - 1905A, 1908A	add \$125
001: analog programming - 1915A, 1920A	add \$300
001: analog programming - 1917A	add \$325
Programming kit: HP 01908-69 for Opt 001	\$145
002 (1915A only): positive output	less \$225
003 (1915A only): negative output	less \$225
004 (1915A only): voltage calibration	add \$ 25
005: digital programming - 1905A, 1908A	add \$550
005: digital programming - 1925A, 1930A	add \$310
005: digital programming - 1915A, 1917A	add \$2995, \$2295
007 (1915A, 1917A): rear panel outputs	add \$ 25
910: extra manual - all except 1915A, 1917A	add \$ 5
910: extra manual - 1915A, 1917A	add \$ 10

### Ordering information

1905A 25 MHz Rate Generator plug-in	add \$350
1908A Delay Generator plug-in	add \$350
1925A PRBS/Word Generator plug-in	add \$1300
1930A PRBS Generator plug-in	add \$1400
1915A Output Amplifier plug-in	add \$2300
1917A Output Amplifier plug-in	add \$1100
1920A Output Amplifier plug-in	add \$2900



# PULSE GENERATORS

## 1900 System: programming information

- Full control of all parameters
- Both analog and digital control available

- Occupies only one controller I/O slot
- System can be easily expanded

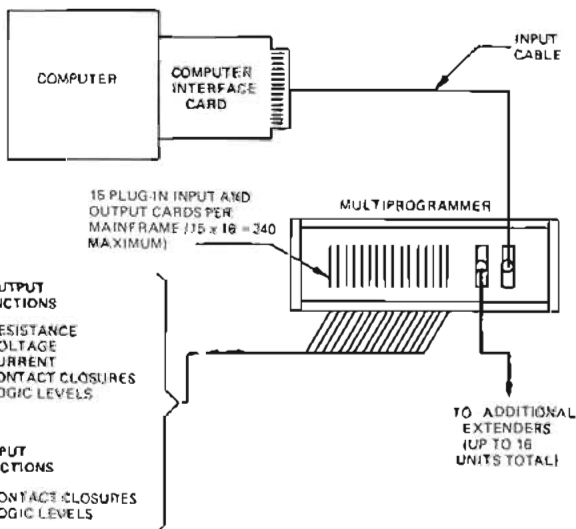
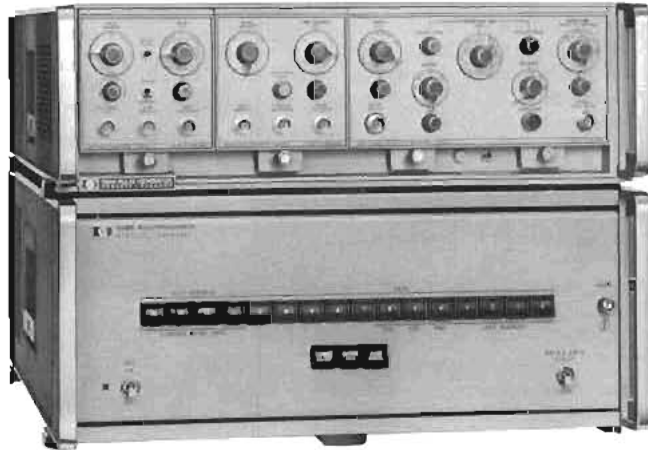

### Introduction

Programmable pulse generators can be incorporated into automatic test systems. Programming adds flexibility which is invaluable for applications that require several different but repeatable pulse waveforms. This capability is available in a number of the components of the 1900 system.

### Analog control

Analog control is particularly suitable for simple applications where only partial control is needed or when only a few pulse waveforms are required repeatedly. Available in the 1900 series are four plug-ins which feature analog programming as an option. They are:

1905A	001	1915A	001	Programming of these modules requires an option 001 1900A mainframe.
1908A	001	1920A	001	

Programming is by contact closure for ranges and by resistor or analog current for vernier functions.

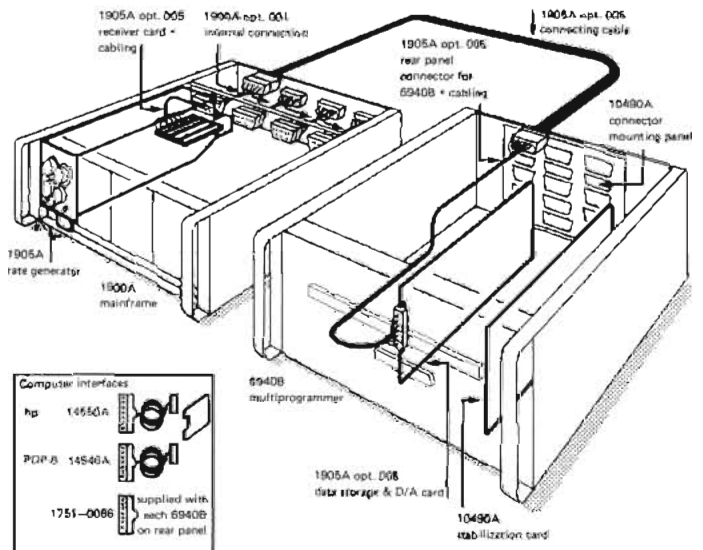

### Digital programming

For flexible control of a pulse generator, digital programming is the answer and Hewlett-Packard's contribution is the 1900/6940B programmable pulse generator.

The plug-in 1900 system and the 6940B Multiprogrammer allow reliable and efficient control of a large number of functions by a microcomputer, using only a single 16 bit I/O slot. Up to fifteen 6941 B Extenders may be added to provide control of up to 240 separate functions still using only one computer I/O slot. A 10490A connector mounting panel and stabilization card are necessary when using the 6940B with a 1900 system.

Available in the 1900 series are six plug-ins which feature digital programming as an option. They are:

1905A	005	1917A	005	Programming of these modules requires an Option 001 1900A mainframe.
1908A	005	1925A	005	
1915A	005	1930A	005	

Only the functions with parameters to be varied need be programmable. For the others, standard plug-ins may be used or part of the programming hardware can be omitted. For example: if only the width of an output stage and not offset, amplitude, etc. is to be programmed, then the cards in the 6940/6941B which would be required to control these non-varying parameters can be omitted.

The 1900/6940B works with any digital computer, however, for Hewlett-Packard digital computers, software in FORTRAN and BASIC is available.



# WORD GENERATORS

## 2 × 16 bit word & PRBS generator

### Model 8006A



- 10 MHz repetition rate
- Selectable PRBS and word length
- Selectable formats RZ/NRZ, normal/complement
- TTL compatible output
- Bit pattern programmable
- Single and continuous cycling

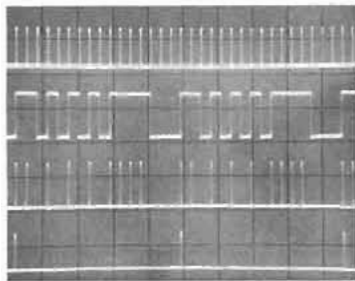

External clock  
NRZ Output (16 bit continuous word recycling)  
RZ Output signal  
First bit synch pulse

The 8006A generates serial digital words of variable length at clock rates up to 10 MHz. An easy selection of two 16 bit words is available. These two words can be serialized to produce a 32 bit word at each output. Selectable operating modes include positive return-to-zero (RZ) format, positive and negative non-return-to-zero (NRZ) format, manual or automatic word cycling, complementary output signals, and remote programming of the data content. The remote programming feature allows conversion of parallel words to serial words. Two outputs provide trigger pulses coincident with the first and the last bit.

Additionally, a pseudo-random binary sequence variable from 7 to 65535 bits can be obtained from channel A output, with the inverted sequence available at channel B.

## Specifications

### Word generation

One 4 to 32 bit word (even numbers only) or two 2 to 16 bit words. No clock period between words.

**Word content:** independently set for both words by front panel switches or remote programming (parallel data input). Complement of each word selectable by front panel switches. WORD A—WORD A, WORD B—WORD B.

**Word cycling:** continuous or by cycle command (external trigger or manual).

**Bit rate:** internal, 10 Hz to 10 MHz, four ranges, continuous adjustment within ranges. Manual or external clock 0 to 10 MHz.

**Reset:** manual reset of word outputs to bit 1 in AUTO CYCLE mode and to word pause in SINGLE CYCLE mode.

**Word format:** RZ/ NRZ/-NRZ selectable for each word output. Positive outputs have current sink capability to drive integrated circuits (TTL/DTL).

**Sync outputs:** trigger pulses corresponding to the first bit (leading edge) and last bit (trailing edge).

**Pseudo-random sequence generation PRN:** provides a linear shift register sequence at channel A output and the inverted sequence at channel B output. Maximum bit rate is 9 MHz.

**Sequence length:** variable from 7 to 65535 bits.

**Trigger pulse:** selectable for each bit in sequence.

### Interface

#### Clock input

**Repetition rate:** 0 to 10 MHz, amplitude  $\geq \pm 2$  V,  $\leq \pm 10$  V.  
**Width:**  $> 15$  ns at +1 V. Input impedance:  $> 500\Omega$ .

#### Cycle command input

**Minimum period:** word length plus 100 ns. Amplitude  $> +2$  V,  $< +10$  V.

**Width:**  $> 15$  ns at +1 V. Input impedance:  $> 500\Omega$ .

#### External data inputs no storage capability for programmed data

**Low state:** contact closure, TTL low, or voltage source  $> 0$  V,  $< +0.8$  V.

**High state:** open, TTL high or voltage source  $> +2.4$  V,  $< +5$  V.

#### Sync outputs

**Amplitude:**  $> +2$  V across  $50\Omega$ .

**Width:** approx. 40 ns. Output impedance:  $50\Omega$ .

#### Clock output (rear panel)

**Amplitude:** 2 V across  $50\Omega$ .

**Source impedance:** approximately  $50\Omega$ .

**Pulse width:** approximately 30 ns.

#### Word outputs

**Positive NRZ, RZ:** high:  $+2.5$  V across  $50\Omega$ , source impedance  $50\Omega$ . Low:  $\geq -0.3$  V,  $\leq +0.3$  V, source impedance approx.  $0\Omega$ . Current sink capability 80 mA maximum.

**RZ pulse width:** approx. 45 ns.

**Negative NRZ:** high: 0 V, low:  $-5$  V across  $50\Omega$ , source impedance  $50\Omega$ .

**Transition times:**  $< 10$  ns.

### General

**Operating temperature:**  $0^\circ\text{C}$  to  $50^\circ\text{C}$ .

**Power:** 115 V or 230 V,  $\pm 10\%$ ,  $-15\%$ , 48 Hz to 440 Hz, 59 VA.

**Weight:** net, 6 kg (13 1/4 lb).

**Dimensions:** 86 mm H  $\times$  426 mm W  $\times$  335 mm D (3.4"  $\times$  16.8"  $\times$  13.2").

### Options

906: Rack Flange Kit

910: additional Operating and Service Manual

8006A 2  $\times$  16 bit Word and PRBS Generator

Price

add \$10

add \$14

\$1975

# WORD GENERATORS

## 50 MHz serial data/PRBS generator

Model 8018A

- 2048 bit, dual channel memory
- Variable word and pattern length
- TTL, ECL, CMOS compatible

- PRBS generation
- HP-IB interface
- Mixed PRBS/word output for serial data links

HP-IB

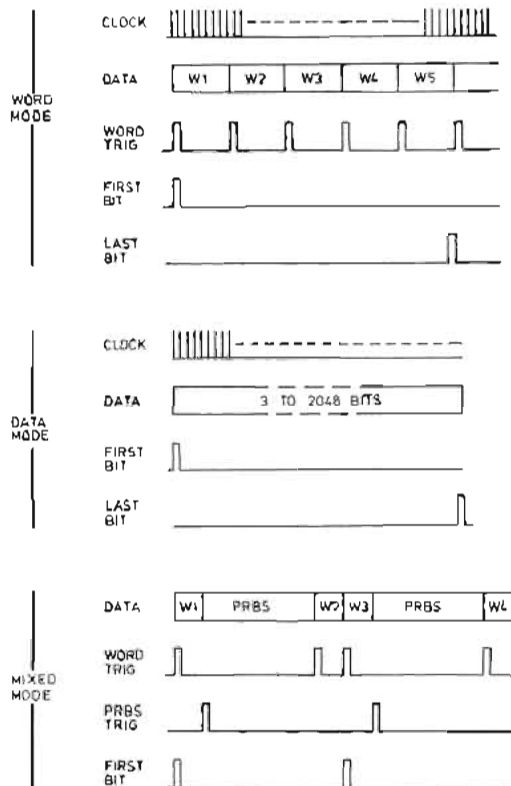
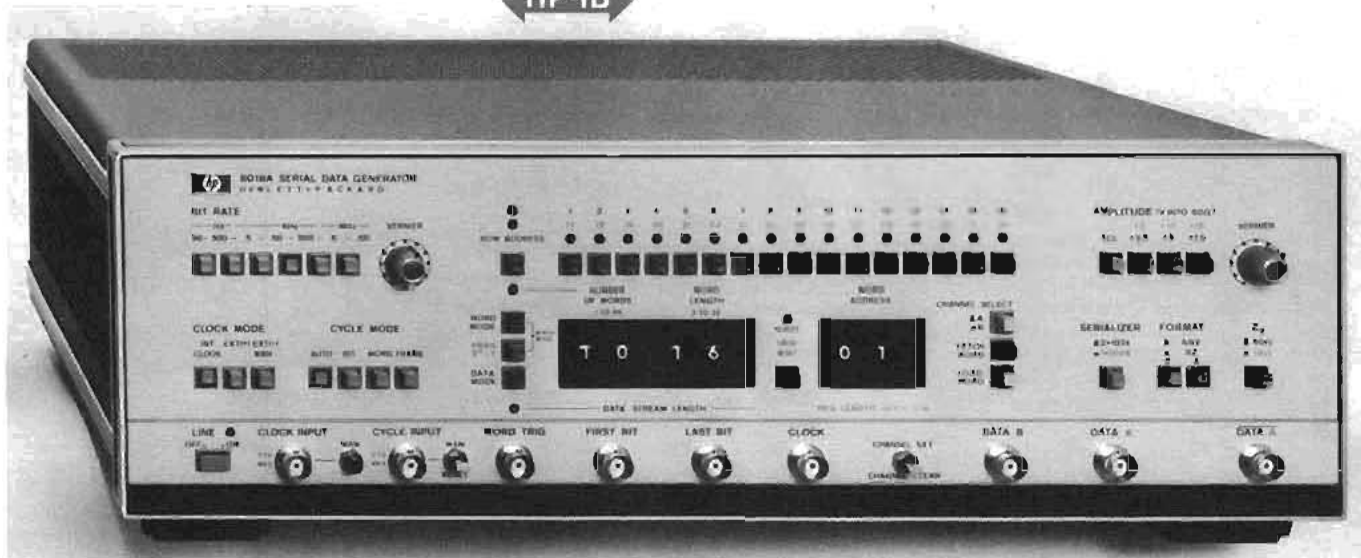

The Hewlett-Packard model 8018A is a high performance data generator designed to meet all of your requirements for serial stimulus up to 50 Mbits/s. Its dual channel memory, for example, contains 2048 individually programmable serial bits, sufficient capacity for the most complex data pattern requirements. Both word and data stream length are variable so you can configure data streams that exactly match your testing applications.

Pattern generating capability is enhanced by a Pseudo-Random Binary Sequence (PRBS) generator. PRBS is a convenient means of generating "worst-case" test patterns and extends pattern length to over 1 million bits. An innovative new technique even lets you mix

PRBS and programmable data words in a single stream, perfect for simulating preamble-data-postamble patterns in serial data link applications.

A high performance output amplifier adds to the 8018A's wide applicability. It delivers clean, 6 ns pulses with repetition rates from dc to 50 Mbits/s. Output amplitude is variable up to 15 volts into 50  $\Omega$ . This enables you to directly drive logic circuits ranging from TTL to CMOS. Output levels for emitter-coupled-logic (ECL) are also provided.

This wide range of operating modes has been designed to shorten and simplify troubleshooting tasks whenever a serial data source is required. In aerospace, telecommunications, integrated circuits, and in computer and peripheral interfacing, the 8018A provides the stimulus you need for digital design and testing.

For production and other systems environments an HP-IB programming interface (option 001) provides remote control of data generating functions. The interface controller can be anything from a large computer system to a simple card reader. The 15263A card reader (option 002) is especially suited to this purpose. Cards can be marked with instructions or data for rapid and error free memory loading. A 4-channel adaptor (HP15450A) and 4-channel TTL-CMOS translator (15451A) are also available as accessories for the 8018A (see page 331).

## Specifications

### Word and data generation

**Number of channels:** 2.

**Channel length:** 1024 bits (2048 bit total memory capacity).

**Word length (M):** 3 to 32 bits (to 2048 bits in Data mode).

**Number of words (N):** variable from 1 to 99.

**Channel serialization:** channels may be cascaded to extend Channel A length to 2048 bits.

**Data content:** each bit is individually programmable using front panel switches, or remotely via optional HP-IB interface.

**Data formatting:** RZ and NRZ formats independently selectable for both output channels. Width in RZ format approximates width of clock output pulse.

### Data generation modes

**Word mode:** data frame consists of N words of length M bits/word.

**Data mode:** data frame consists of a continuous pattern of length between 3 and 2048 bits. Frame length is determined by 4-digit number set into thumbwheel switches.

**PRBS mode:** Pseudo-Random Binary Sequence of length  $2^n - 1$  bits is produced;  $n = 9, 10, 15, 20$ .

**Mixed mode:** Same as WORD mode except with PRBS sequence inserted after every odd number word. Simulates preamble, data message, postamble.

**Frame length:** 1 to 99 words (WORD mode) or 3 to 2048 bits (DATA mode).

**Channel set/clear:** fills selected data channel with ones or zeros.

#### Data outputs

##### DATA A, DATA A

Output Attenuator Positions	RS	RL	Maximum Amplitude	Minimum Amplitude	t <sub>r</sub> /t <sub>d</sub> (10%-90%)	Maximum Repetition Rate
2.5 V	50 Ω	50 Ω	7.5 V	1.3 V	6 ns	50 MHz
5 V	1 K Ω	50 Ω	15 V	2.5 V	8 ns	40 MHz
7.5 V	50 Ω	1 K Ω	15 V	2.5 V	8 ns	40 MHz
ECL	50 Ω	50 Ω	1.0 V	0.5 V	5 ns	50 MHz

**Pulse amplitude:** variable in three ranges from 1.3 V to 15 V plus fixed ECL position. See table.

**Output format:** simultaneous Data and Data waveforms are provided. Data output is positive-going with 0V baseline. Data is inverted with identical upper and lower level voltages.

**ECL position:** positive-going pulse with 0.6 to 1.0 V amplitude, and +0.5 to -1.6 V offset. Amplitude and offset internally adjustable. 5 ns maximum transition time. Levels preset for standard ECL. (50 Ω source and load resistance).

**Maximum transition times (10-90%):** 6 ns. See table.

**Maximum preshoot, overshoot, pulse top/baseline distortion:** 10% of amplitude. 15% in ECL position.

**Source resistance:** selectable 50 Ω or 1 K Ω.

**Relation to clock pulse:** leading edge of Channel B output coincides with leading edge of clock output  $\pm 3$  ns.

**Overload protection:** cannot be damaged by externally applied voltages between 0 and 16 volts. Protected against open and short circuits.

##### DATA B

**Pulse amplitude:** 2.4 V min. into 50 Ω, 4.8 V min. into open circuit.

**Polarity:** positive.

**Source resistance:** 50 Ω.

**Relation to clock pulse:** leading edge of Channel B output coincides with leading edge of clock output  $\pm 3$  ns.

**Overload protection:** cannot be damaged by externally applied voltages between +5 and -2 volts. Additionally protected against voltages between 0 and 16 volts when current limited to 20 mA. Protected against open circuit and shorts to ground.

#### Synchronizing outputs

**Clock:** RZ pulse, occurs with each data bit.

**First bit:** RZ pulse, identifies first bit of data pattern.

**Last bit:** RZ pulse, identifies last bit of data pattern.

**Word trigger:** RZ pulse, identifies first bit of each word.

**PRBS trigger:** NRZ pulse, identifies beginning of each PRBS pattern

#### Amplitude

**Clock:** 2.4 V min. into 50 Ω, 4.8 V min. into open circuit.

**FB, LB, WT, PRBS TRIG:** 1.2 V min. into 50 Ω, 2.4 V min. into open circuit.

**Source resistance:** 50 Ω.

#### Width:

**Clock, FB, LB, WT:** 50%  $\pm$  20% of period in internal clock mode. Approximates width of externally applied clock pulse in external clock mode.

**PRBS trigger:** 3 clock cycles.

**Overload protection:** cannot be damaged by externally applied voltages between +5 and -2 volts. Additionally protected against voltages between 0 and 16 volts when current limited to 20 mA. Protected against open circuits and shorts to ground.

#### Clocking

##### Internal

**Bit rate:** 50 Hz to 50 MHz (40 MHz max. in MIXED mode).

**Jitter:** 0.2% + 50 ps.

**Controls:** 5 ranges and 3 turn potentiometer for fine adjust.

#### External clock Input

**Bit rate:** DC to 50 MHz (40 MHz max. in MIXED mode).

**Nominal trigger level:** 0.5 V (EXT+), -1.2 V (EXT-).

**Minimum pulse amplitude:** 1.0 V (EXT+), 0.8 V (EXT-).

**Trigger slope:** positive.

**Minimum pulse width:** 10 ns.

**Input resistance:** 50 Ω to ground.

**Overload protection:**  $\pm 7$  V, 0-16 V when current limited to 20 mA. By means of an internal switch, the CLOCK input may be switched to a high impedance mode. The following specifications then apply.

**Input resistance:** 1 LS-TTL load in series with 300 Ω.

**Bit rate:** DC to 40 MHz.

**Trigger pulse:** TTL levels. Amplitude may be increased to 16 volts when current limited to 20 mA.

**Minimum pulse width:** 15 ns.

**Manual:** pushbutton switch enables single bit output.

#### Cycle modes

**Auto:** data frame recycles continuously.

**Bit:** single bits are triggered by pulses at the CYCLE INPUT. If the input is held high, data bits are continuously generated. Data generation ceases when the input goes low and continues from where it stopped when the input is returned to the high state.

**Word:** single words are triggered by pulses at the CYCLE INPUT. If the input is held high, words are continuously generated. When the input goes low, data generation ceases after completion of the current word. Data generation continues with the next word when the CYCLE INPUT is returned to the high state.

**Frame:** single data frames are generated by pulses at the cycle input. If the input is held high, frames are continuously generated. When the input goes low, the current frame is completed and data generation ceases.

#### Cycle Input

**Nominal trigger level:** 0.5 V.

**Trigger slope:** positive.

**Minimum pulse amplitude:** 1.0 V.

**Minimum pulse width:** 10 ns.

**Input resistance:** 50 Ω to ground.

**Overload protection:**  $\pm 7$  V, 0-16 V when current limited to 20 mA. By means of an internal switch, the CYCLE INPUT can be set to high impedance. The following specifications apply.

**Input impedance:** 1 LS-TTL load in series with 300 Ω.

**Trigger pulse:** TTL levels.

**Minimum pulse width:** 15 ns.

**Manual:** Switch enables outputting single bits, words, or frames.

**Reset:** Returns generator to bit 1.

#### General

**Power requirements:** 100 V, 120 V, 220 V, or 240 V; +5 to -10%, 48 to 440 Hz, 230 VA max.

**Environmental:** 0 to 50°C, and with relative humidity to 95% at 40°C.

**Weight:** net 12 kg (26.5 lbs). Shipping 16 kg (35.3 lbs).

**Size:** 133 H x 426 W x 422 mm D (5.2" x 16.8" x 16.6").

#### Options

**Opt 001:** HP-IB Interface. Permits loading the 8018A memory, word length, and number of words from any HP-IB compatible controller. Starting and stopping of data generation is also remotely controllable.

**Opt 002:** 15263A Card Reader. Provides fast loading of 8018A. Data stored on punched or marked cards is loaded into the 8018A via its HP-IB interface. Requires Opt 001

**Opt 907:** Front Handle Kit

**Opt 908:** Rack Mounting Kit

**Opt 909:** Combined Front Handle and Rack Mounting Kit

**Opt 910:** Extra Operating and Service manual

**8018A Serial Data Generator**

#### Price

add \$425

add \$600

add \$20

add \$15

add \$30

add \$20

\$3475

# WORD GENERATORS

Highly flexible word generator,  $9 \times 32$  bit

Model 8016A

- DC to 50 MHz repetition rate
- 2 complementary outputs per channel, RZ/NRZ formats
- Variable RZ width, 4 delay channels
- Channel serializer
- TTL/ECL output levels selectable
- Optional HP-IB programming of Bit pattern

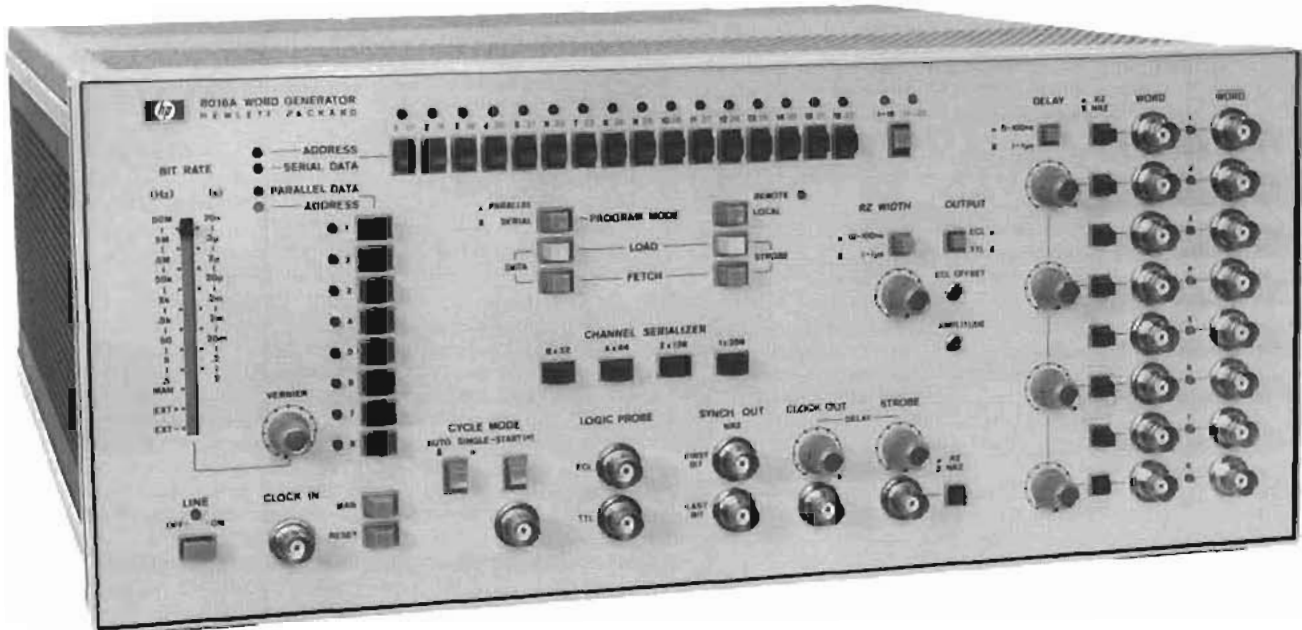

8016A

The 8016A is a parallel and serial data generator that provides digital stimulus for a very wide range of applications. For the digital designer the 8016A is a natural companion to multichannel data display devices such as logic analyzers. It forms an ideal system component for large test systems because it can provide the combination of digital patterns plus adjustable timing parameters necessary for testing IC's and circuit boards. It is also a quite useful time saver for design and test of complex communications systems.

The large memory size and ease with which bit patterns are programmed produce a flexibility of signal output, both in content and in format. Data loading and output can be in either a parallel or serial format. In parallel mode, data is input and output as 32 sequential bytes, each 8 bits wide. In serial mode data is handled as 32 bit serial words, and 8 independent words are available. A built-in channel serializer also permits cascading the channels to produce a word length of up to 256 bits. Maximum use of the memory is thus retained when fewer channels are required.

A strobe output provides additional data formatting capability. The strobe can function either as a ninth data channel 32 bits long, or as a floating 32 bit trigger word assignable to any or all of the 32 bit sections of a serialized data frame. The strobe is thus perfect as a word framing pulse or as a qualifier signal to label address and data information contained in the same data stream. Additional synchronizing signals are provided by the first and last bit outputs and the clock output.

The 8016A's front panel control scheme provides simple control of all of the 8016A's complex waveform generation capabilities. The data entry controls are optimized to a "row of 16, column of 8" arrangement. Each pushbutton and adjacent LED form one bit of a buffer switch register whose states are displayed on the LED's. Data is loaded either into the row pushbuttons as serial words or into the column pushbuttons as 8 bit parallel bytes. A single press of the load data switch then transfers the data to the high speed memory. If data needs to be edited, a "fetch" facility returns data to the

buffer register, where it is again displayed on the LED's. Bit patterns may also be more rapidly loaded into the 8016A via an optional card reader. The entire memory may thus be loaded in less than 2 seconds.

Complete testing of digital circuits and systems requires not only digital patterns but control of the analog parameters of the pulses as well. Pulse widths, levels, and interchannel delays must all be adjustable both for proper functional testing and, in addition, to measure such dynamic parameters as setup and hold times, clock pulse width sensitivities, and the system sensitivity to propagation delay variations. To meet these testing requirements the 8016A first includes 6 independent delay circuits. Two selectable delay ranges, 0-100 ns or 0.1-1  $\mu$ s are provided. Output levels of the 8016A's 50  $\Omega$  output amplifiers may also be adjusted to meet either ECL or TTL test specifications. Transition times of <3 ns for TTL and <2.5 ns for ECL pulses are also in line with testing requirements. In addition a choice of RZ or NRZ formats with variable RZ pulse width is provided. This combination of pattern and pulse parameter control means the 8016A can often provide problem solutions which would otherwise require a setup of separate pulse and word generators.

Its simple but very flexible bit pattern programmability combined with its short cycle time (50 MHz clock) make the 8016A especially effective in simulating worst case conditions in IC testing, e.g. high speed testing of critical areas of memory. Similarly, the 8016A is a time saver in component evaluation environments because test setups can be rapidly built and reconfigured to meet the demands of testing small quantities of a wide variety of IC types. In addition the 8016A is very useful in feeding controlled bit patterns into data buses, data communications systems, and telemetry systems, both for testing and for simulation purposes.

Model 15450A four-channel adapter and model 15451A TTL-CMOS translator can both be used as accessories for the 8016A (see page 331).

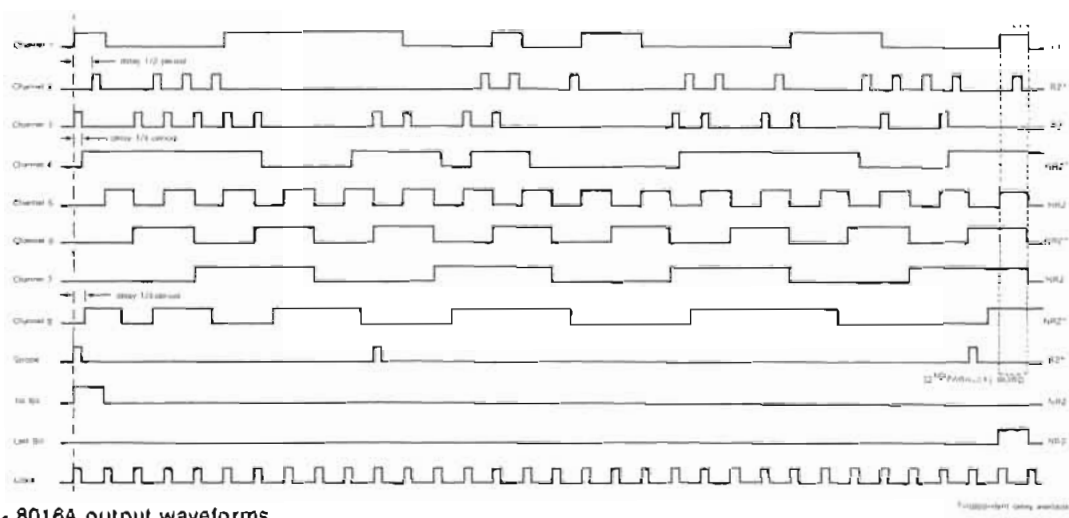

Figure 1 - 8016A output waveforms

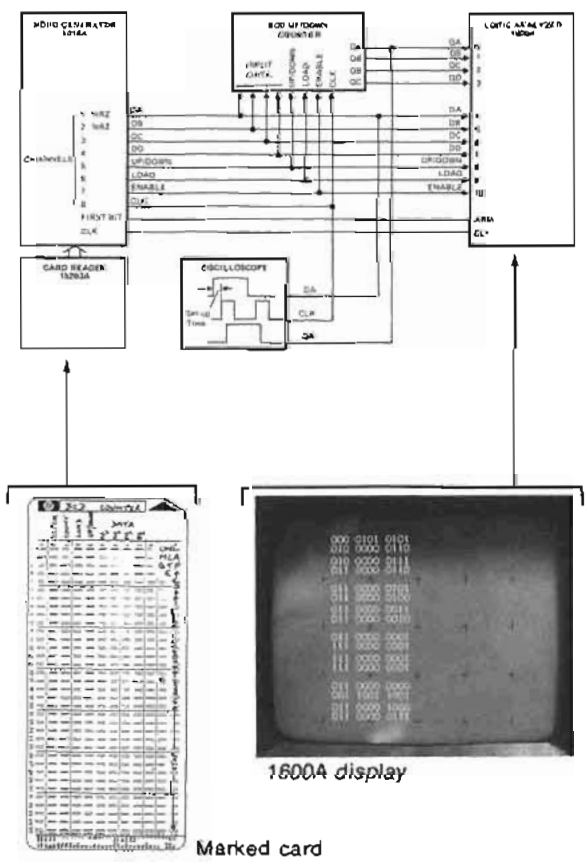

Figure 2 - BCD counter test set-up

**8016A applications**

Applications are the yardstick of a test instrument's capabilities and the 8016A's main applications are in the fast growing world of digital technology. IC testing, telecommunications equipment, parallel interface design and automatic test systems all involve complex digital circuitry and all are applications areas for the 8016A.

Taking one area as an example, complete functional and parametric testing of complex ICs, such as those found in microprocessors, was a difficult and time-consuming task requiring complicated test set-ups . . . until the 8016A came along. Not only can the 8016A be used to perform a complete functional check on the device, but because of its variable pulse parameter features it can also carry out full parametric testing. This is very important in circuit design because it is not enough to know that the circuit works, you must also know under what conditions it works. This means you have to be able to run tests at full operating speeds, with all necessary data patterns, and be able to vary pulse parameters to operating limits. You only need one 8016A to do all this.

It is also necessary, of course, to have some means of displaying your resulting data patterns and pulse waveforms. For this purpose you can use a Hewlett-Packard 1600A Logic State Analyzer; the ideal receiver for the 8016A. Pulse waveforms can be displayed on an oscilloscope such as the Hewlett-Packard 1740A.

In the following example the 8016A is used as the signal source to carry out functional and parametric checks on a BCD counter. The eight output channels can be programmed to supply signal stimuli for functional tests. Pulse widths, inter-channel delay and clock rate are separately adjustable for parametric testing.

A typical test set-up, with the BCD counter as device-under-test (DUT) is shown in figure 2. The 8016A is used as signal source and the 1600A is used to verify device functional response. A Hewlett-Packard 15263A Card Reader is also included in the set-up. This card reader is custom-built for fast and easy memory loading of the 8016A via the 8016A's HP-IB interface. An oscilloscope is also used to provide a timing display for parameter measurements.

The truth table for the BCD counter provides the data input for the functional test. The truth table inputs are simply marked on a card; the pencil marks (or punched holes) indicating binary "1". The 8016A is loaded and the timing margins are set to well within tolerance. The counter's responses and the associated commands are then displayed in binary format on the 1600A display. By comparing this display to the counter truth table, device function can be verified. Dynamic tests are then performed by adjusting the appropriate 8016A controls until the parametric values, calculated from the oscilloscope display, cause breakdown of the counter's operation (indicated on the 1600A).



# WORD GENERATORS

Highly flexible word generator, 9 × 32 bit  
Model 8016A (cont.)

## Specifications

### Data capacity

Data can be loaded in parallel or serial form depending on the position of the PROGRAM MODE switch. The data is loaded via a single row and single column of pushbuttons, each pushbutton controlling a one-bit buffer register.

**Number of channels:** 8 data channels plus 1 strobe channel.

**Number of bits per channel:** 32 (fixed).

**Total bit capacity:** 288.

### Serial capacity

One word consists of 32 bits in serial. A front panel switch serializes words to form a frame.

### Serial formats:

9 words on 9 channels, including strobe word, each 32 bits long.

4 frames on 4 channels, each consisting of 2 words or 64 bits.

2 frames on 2 channels, each consisting of 4 words or 128 bits.

1 frame on 1 channel consisting of 8 words or 256 bits.

### Parallel capacity

**Parallel format:** 32 words with up to 9 bits in parallel-strobe channel included—will be generated. The number of bits per word depends on the number of output channels serialized.

### Data outputs

Two separate outputs per channel, one for normal and one for complement.

**Amplitude:** TTL or ECL voltage levels, variable by front panel control.

**Source impedance:** 50 ohms

**Delay:** four channels can be separately delayed between 0 ns and 1  $\mu$  sec with reference to the channels 1, 3, 5 or 7.

**Two ranges:** 0 ns - 100 ns

0.1  $\mu$ s - 1  $\mu$ s

Ranges are common to all delayable channels. Channels have individual vernier controls.

**Delay jitter:**  $\leq 0.1\% + 5$  ps.

**Skewtime:** Skewtime of undelayable channels (3, 5, 7) in reference to channel one:  $\pm 1$  ns.

**Format:** RZ or NRZ separately selectable for each data channel and strobe channel.

**RZ Width:** 10 nsec to 1  $\mu$ sec in two ranges. Vernier provides continuous adjustment within ranges. Range switch and vernier common to all channels.

**Width jitter:**  $\pm 0.2\% + 50$  ps.

### Auxiliary outputs

**First bit:** corresponds with parallel word one or with the first bit of the serial word. Format is NRZ.

**Last bit:** corresponds with the last parallel word or with the last bit of the last word of a frame. Format is NRZ.

**Clock:** delivers one pulse per bit. Format is RZ.

**Clock pulse width:** controlled by RZ-Width control. Clock pulse may be delayed between 0 ns and 1  $\mu$ s in reference to channels 1, 3, 5 or 7.

**Strobe word:** separate LOAD and FETCH pushbuttons and length 32 bits (can be extended to 256 bits by repetition). The strobe word may be delayed between 0 ns and 1  $\mu$ sec in reference to channels 1, 3, 5 or 7.

**Amplitude of aux. outputs:** TTL or ECL voltage levels variable by front panel control.

**Source impedance:** 50 ohms.

### Probe power

ECL: -5.2 V dc  $\pm 10\%$ ; 80 mA.

TTL: +5 V dc  $\pm 10\%$ ; 100 mA.

### Bit rate

**Internal:** 0.5 Hz to 50 MHz in eight ranges. Vernier provides continuous adjustment within ranges.

**External:** dc up to 50 MHz or manual triggering.

### Clock Input

**Repetition rate:** 0 to 50 MHz.

**Trigger pulse width:**  $\geq 10$  nsec.

**Trigger amplitude:** selectable by internal switches on Bit Rate board A5. Max. Amplitude:  $\pm 7$  V at 100% duty cycle.

**Ext + (TTL):** amplitude  $\geq +2$  V, input impedance  $\geq 1$  k to GND.

**Ext +:** amplitude  $\geq +1$  V, input impedance 50 ohms to GND.

**Ext -(ECL):** amplitude  $\leq -1.6$  V, input impedance 50 ohms to -2 V.

**Ext -:** Trigger level adjustable at Potentiometer A5R114 from +1 V to -1 V.

**Input Impedance:** 50 ohms to GND.

### Recycling

**Auto mode:** data is recycled continuously.

**Single cycle (2 modes):** a) one word generated for each cycle command. b) words generated as long as the cycle command is active. Last word always completed. If channels are serialized, the serialized word (64 bits, 128 bits, 256 bits) is always completed.

**Period between cycle commands:** Byte (frame) length plus 200 ns.

**Amplitude:**  $> +2$  V,  $\leq +10$  V.

**Width:**  $\geq 12$  ns.

**Input Impedance:** 1 k $\Omega$ .

### Manual reset

**Auto cycle:** all channel outputs are set to "0". The next clock pulse after RESET generates byte number one.

**Single cycle:** all channel outputs are reset to word pause. Word pause can either be "ZERO" or "LAST BYTE", controlled by a rear panel switch.

### Pulse characteristics

The level of all output signals is controlled by a TTL/ECL switch. Adjusts for amplitude and offset. Source Impedance is 50 ohms.

**TTL (across 50 ohms):** HIGH LEVEL variable from 2.5 V to 1 V. LOW LEVEL  $\leq 0.2$  V.

**Transition times:**  $\leq 3.0$  ns (First/Last Bit Trigger  $< 4.0$  ns).

**ECL (across 50 ohms):** HIGH LEVEL OFFSET variable from -0.9 to +1.1 V. Amplitude variable from 0.3 V to 1.0 V.

**Transition times:**  $\leq 2.5$  ns (First/Last Bit Trigger  $< 4.0$  ns).

### General

**Operating temperature range:** 0°C to +50°C.

**Power requirements:** 100 V/120 V/220 V or 240 V  $\pm 5\%$ , -10%, 48 Hz to 66 Hz, 200 VA (maximum).

**Weight:** net, 14.5 kg (31.96 lb). Shipping, 16 kg (35.27 lb).

**Size:** 177 H  $\times$  426 W  $\times$  422 mm D (7"  $\times$  16.8"  $\times$  16.6").

### Options and accessories

**001: remote programming.** Bit pattern can be programmed by any controller that is compatible with the HP Interface Bus (HP-IB)

**002: Card Reader.** This option enables rapid loading of the data and strobe channel bit patterns. The card reader accepts marked or punched cards (HP Part Number 9320-0595) and transmits the data/control information to the 8016A via the HP-IB (Option 001 required)

**907: Front Handle Kit**

**908: Rack Flange Kit**

**909: Rack Flange & Front Handle Combination Kit**

**910: Additional Operating and Service Manual**

**15450A: four-channel adapter**

**15451A: four-channel TTL-CMOS translator**

### Price

add \$550

add \$600

add \$30

add \$20

add \$45

add \$20

add \$140

add \$250

8016A 9  $\times$  32 Bit Word Generator

\$6800

# WORD GENERATORS

## Accessories for logic signal sources

Models 15263A, 15450A & 15451A



- 15263A card reader for rapid data loading
- 15450A adapter for easy circuit connections
- 15451A translator gives CMOS output levels

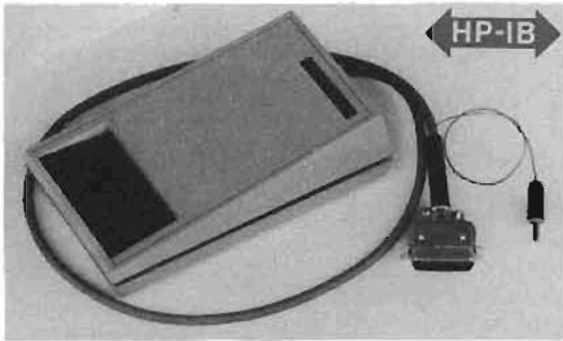

15263A

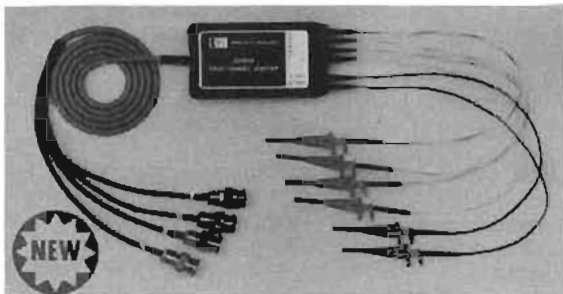

15450A

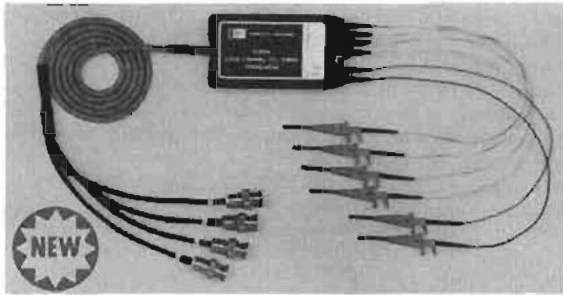

15451A

### 15263A card reader

#### Description

The 15263A is a convenient and easy-to-use remote programming device. It provides parallel instructions or data and is especially suited for the HP 8016A Parallel Word Generator or HP 8018A Serial Data Generator; both provide the power supply voltage necessary for driving the card reader. Rapid and error free memory loading of either generator is obtained. Any bit pattern can easily be programmed by marking cards accordingly. A card is typically read in 1.5 seconds and makes data re-loading or modification a fast and uncomplicated operation.

#### Specifications

**Logic levels (TTL neg. true):** HI (0) +2.5 V to +5 V, LO (1) 0 V to +0.4 V.

#### General

**Operating temperature range:** 0°C to 55°C.  
**Power:** +5 V, 550 mW.  
**Weight:** 0.6 kg (1.31 lb.) Shipping 1.6 kg (3.5 lb.)  
**Size:** 57 × 115 × 195 mm (2.2" × 4.5" × 7.6").

**Accessories supplied:** 50 cards, part number 9320-0595.

### 15450A four-channel adapter

#### Description

The Model 15450A Four-Channel Adapter facilitates easy connection from a pulse or data generator to the circuit-under-test, and helps to avoid the distortion problems often encountered in impro-

vised connections. These advantages are of particular significance where multi-channel data and pulse stimulus is required; in such instances, the Adapter is an ideal companion for the HP 8016A Word Generator.

Inputs to the Adapter are carried by a cable assembly. This consists of four 50 Ohm cables with BNC connectors which plug directly to the signal source. The outputs from the Adapter are carried by 4 short, removable, connecting leads with small hook-type probes which connect easily to the circuit-under-test; even DIP's can be connected reliably. With probes removed, the connecting leads will plug onto back plane pins.

To minimize distortion due to reflections from the circuit-under-test, each channel is terminated by a passive load inside the Adapter body. Two parallel ground leads (also with hook-type probes) are provided to ensure good grounding to the device-under-test.

#### Specifications

**AC/DC characteristics:** dependent on signal source.

**Internal load:** 47.5 ohms in series with 33 pF.

#### General

**Operating temperature:** 0°C to 50°C.

**Size:** body size 95 mm × 54 mm × 22 mm (3.7" × 2.1" × 0.9"). Total length including cable 152 cm (60 in).

### 15451A four-channel TTL-CMOS translator

#### Description

The model 15451A is a four channel active signal translator which amplifies TTL signals to CMOS levels. Its capabilities are perfect for adding CMOS compatibility to pulse and word generators with 5 volt outputs such as HP's Model 8016A Word Generator. The 15451A's four inputs conveniently connect to the signal source with BNC connectors. Its four outputs are easily interfaced to the test circuits via small probes which directly attach to circuit nodes. Even adjacent pins of dual-in-line IC packages are reliably and simply contacted using these small hook-type probes. With probes removed, the connecting leads will plug onto back plane pins.

The 15451A is normally powered from the  $V_{DD}$  supply of the circuit-under-test and accepts supplies in the range of 5 to 18 volts. The applied power supply voltage is also used to determine the output signal amplitude. This level-tracking capability means that pulse amplitudes need not be reset when the CMOS power-supply voltage is adjusted. It further guarantees that pulse amplitudes never exceed the  $V_{DD}$  supply voltage - even when the power supply is switched off (pulse amplitude greater than  $V_{DD}$  is a forbidden condition with CMOS logic, violation of which can cause rapid destruction of the tested IC).

#### Specifications

##### Inputs

**Number of channels:** 4. Fan-in: 2 standard LS TTL loads.

**Max. input frequency/transition time:** 10 MHz/1  $\mu$ s.

**Input signal levels:** low 0V to +0.8 V, high +2 V to +5 V.

**Max./min. input voltage:** +7 V - 1 V.

**Outputs (source impedance 220 ohms)** Following specs. relate to 5 MHz square wave input signal with  $V_{DD} = 15$  V and load capacitance = 50 pF per channel.

**Output signal level:** high ( $V_{DD} - 1$  V) typ., low +100 mV typ.

**Transition times (20%-80%):** LO to HI 23 ns typ., HI to LO 16 ns typ.

**Propagation delay:** LO to HI 45 ns typ., HI to LO 35 ns typ.

**Interchannel skew:** 2 ns typ.

#### General

**Operating temperature:** 0°C to 50°C.

**Power:** +5 V to +18 V at 250 mA

**Size:** body size 95 × 54 × 22 mm (3.7" × 0.9" × 2.1").

Total length including cable 152 cm (60").

#### Options

**15263A:** opt. 910 extra operating and service manual \$6.38

**15450A & 15451A:** opt 910 extra operating note \$1.40

#### Ordering information

**15263A** Card Reader \$600

**15450A** four-channel adapter \$140

**15451A** four-channel TTL-CMOS translator \$250

# WORD GENERATORS

## PRBS and WORD generation up to 150 Mb/s

### Model 3760A

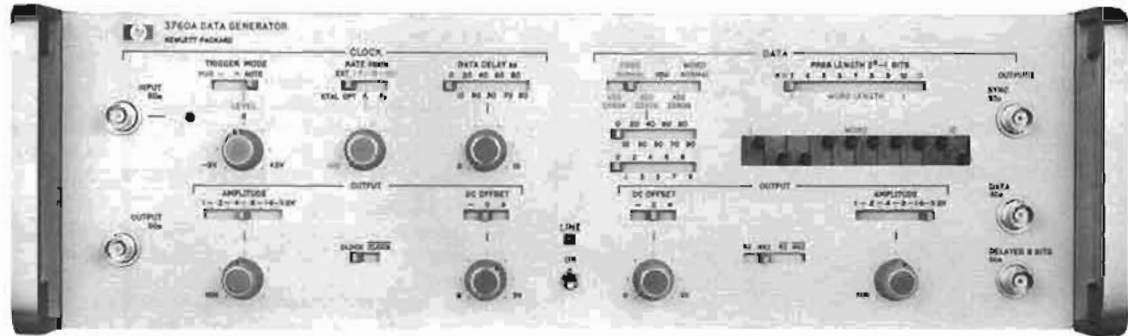

The 3760A Data Generator is a fast, versatile PRBS and WORD generator intended for both factory and field use, with many features which make it especially attractive for applications in high frequency digital communications.

The generator can be manually or automatically triggered from an external clock in the frequency range 1 kHz-150 MHz. Alternatively the clock can be derived from an optional internal clock source which can be variable or crystal controlled in the frequency range 1.5-150 MHz. A clock output is always provided in normal or complemented form, which is variable in amplitude and dc offset.

The pseudo-random binary sequence, PRBS, is variable in length from  $2^3-1$  to  $2^{10}-1$  bits, with an additional long sequence of  $2^{15}-1$  bits. A sync pulse occurs once per PRBS and may be varied in position relative to the sequence. As the 3760A generator is often used in conjunction with the 3761A Error Detector, two errors can be inserted once per 4000 sequences to check the accuracy of the 3760A/3761A system.

The length of the binary WORD is variable from 3 to 10 bits and its content is selected on the front panel. A sync pulse is generated once per WORD. Alternatively, a repetitive 1010 pattern can be selected.

The sync pulse can be used to initiate a block of 1 to 99 zeros which can be added to the data stream and used to examine re-generator clock extraction and threshold circuits in PCM/TDM systems.

The data output which can be PRBS, WORD or the fixed pattern 1010, is available in normal or complemented form. Either RZ or NRZ formats may be selected and the data output can be delayed by up to 100 ns with respect to the clock. As with the clock, the data output can be varied in amplitude and dc offset. A second data output, which is synchronously delayed by 8 bits from the normal data output, is also available as an option. This feature makes the generator ideally suited for driving digital radio systems employing four phase modulation.

## Specifications

### Modes of operation

**PRBS normal:** generates a repetitive  $2^n-1$  bit maximal length PRBS where  $n = 3$  to 10 and 15.

**PRBS add zeros:** addition of a block of 1 to 99 zeros with PRBS normal, occurring after the sync pulse.

**PRBS add error:** introduction of two errors per 4000 sequences.

**1010:** generates a preset repetitive word, content 1010.

**WORD normal:** generates a continuous 3 to 10 bit word with selectable content.

**WORD add zeros:** addition of a block of 1 to 99 zeros into WORD normal, occurring between words.

### Clock Input

**Rate:** 1 kHz to 150 MHz.

**Impedance:** 50 ohms  $\pm 5\%$  dc coupled (75 ohms optional).

**Trigger:** manual with level range  $-3$  V to  $+3$  V, +ve or -ve slope. Auto with input mark:space ratio range 10:1 to 1:10.

**Sensitivity:** better than 500 mV pk-pk.

**Amplitude:** 5 V pk-pk maximum. Limits  $\pm 5$  V.

**Pulse width:** 3 ns minimum at 50% pulse amplitude.

**Indicator:** lamp showing clock present and triggering correctly.

### Internal clock (optional)

**Variable:** range 1.5 to 150 MHz.

**Crystal:** two rates in the range 1.5 to 150 MHz, stability  $\pm 20$  ppm.

**Jitter:**  $< 0.5\%$  of period  $+0.05$  ns pk-pk.

### Clock output

**Outputs:** CLOCK or  $\overline{\text{CLOCK}}$ .

**Impedance:** source impedance 50 ohms  $\pm 5\%$  (75 ohms optional).

**Amplitude:** continuously variable in 5 ranges from 0.1 to 3.2 V symmetrical about offset level.

**DC offset:** Zero,  $< 2\%$  of pulse amplitude.

Variable, continuous 0 to  $\pm 3$  V.

**Transition times:**  $< 1.4$  ns into 50 ohms.

$< 1.6$  ns into 75 ohms.

**Overshoot:**  $< 10\%$  of pulse amplitude.

### Data output

**Outputs:** DATA or  $\overline{\text{DATA}}$ .

**Format:** NRZ or RZ (up to 130 Mb/s).

**Delay:** data (and sync) delayed with respect to clock continuously in 10 ranges from 0 to 100 ns.

Other specifications as for clock output.

### Delayed data output (optional)

**Outputs:** DATA or  $\overline{\text{DATA}}$  ganged with normal Data output.

**Delay:** synchronous 8 bits with respect to normal Data output. Other specifications as for normal Data output with ganged amplitude and dc offset controls.

### Sync output

**Rate:** once per PRBS or WORD cycle.

**Amplitude:**  $+1$  V into 50 ohms.

### General

**Power:** 115 V  $\pm 10\%$  or 230 V  $\pm 10\%$ , 40 to 400 Hz, consumption 90 W.

**Weight:** 13.5 kg. (30 lb).

**Size:** 140 H, 425 W, 467 mm D ( $5\frac{1}{2}$ "  $\times$   $16\frac{3}{4}$ "  $\times$   $18\frac{3}{4}$ ".)

3760A Data Generator



## Oscillators, function generators

Signal sources have been described by various names—oscillators, test oscillators, audio signal generators, function generators, etc. Different names are applied, depending on design and intended use of the source. The name "test oscillator" has been used to describe an oscillator having a calibrated attenuator and output monitor. The term "signal generator" is reserved for an oscillator with modulation capability.

A function generator is a signal generator that delivers a choice of different waveforms with frequencies adjustable over a wide range. Function generators produce sine, triangle, square wave, saw-tooth waves, pulses, sweep, and modulation. Hewlett-Packard's function generators extend from a low frequency of 0.0005 Hz (HP 3310A) up to a high frequency of 50 MHz (HP 8165A).

### Basic requirements

In selecting an oscillator or function generator, the user will be most interested in its frequency coverage. The question to be answered here is, "Will the instrument supply both the lowest and highest frequencies of interest for anticipated tests?" As shown in Table 1, Hewlett-Packard manufactures a broad range of oscillators and function generators covering the frequency spectrum from 0.0005 Hz to 50 MHz.

The user's next concern will be with available output power or voltage. Some tests require large amounts of power, while others merely require sufficient voltage output. For almost any application, there is a Hewlett-Packard oscillator capable of delivering desired voltage output into a high-impedance load or of supplying desired power into lower impedance loads.

Besides frequency range and power output, the user will be interested in instrument stability, its dial resolution, and the amount of harmonic distortion, hum and noise in the output signal, and functions available. See Table 1 for a comparison of Hewlett-Packard oscillators and function generators.

### Frequency stability

Frequency stability of an oscillator determines the ability of the instrument to maintain a selected frequency over a period of time. Component aging, power-supply variations and temperature changes all affect stability. Carefully chosen components, such as precision resistors and variable capacitors in the frequency-determining networks, contribute to long-term stability.

### Amplitude stability

Amplitude stability is important in certain

FUNCTIONS ~ □ ▲ ▽ ▽ ▽	FREQUENCY RANGE													POWER OUTPUT	INST.	PAGE
	0.1 mHz	1 mHz	.01 Hz	0.1 Hz	1 Hz	10 Hz	100 Hz	1 kHz	10 kHz	100 kHz	1 MHz	10 MHz	50 MHz			
●														3 W	201C	334
●														560 mW	3310A/B	339
●														250 mW	3312A*	338
●														20 mW	3311A	337
●														200 mW	6518/652A 654A	342
●														160 mW	200C0	334
●														160 mW	4204A	336
●														40 mW	209A	335
●														20 mW	653A	--
●														10 mW	236A	537
●														10 mW	204C	335
●														1.4 mW	8165A	340

\*Two Generators, AM, FM, Sweep, Trigger/Gate \*\*See data sheet

Table 1. Functions, frequency range and power output of Hewlett-Packard oscillators and function generators.

oscillator applications. Amplitude stability is inherent in the Hewlett-Packard RC oscillator circuit because of large negative feedback factor and amplitude stabilizing techniques. "Frequency response," or amplitude variation as frequency is changed, is of special interest when the oscillator is used for response measurements throughout a wide range of frequencies.

### Distortion

Distortion in the oscillator's output signal is a measure of the purity of the oscillator's waveform.

Oscillator distortion can be undesirable for harmonic distortion testing of amplifiers, for example. If the amount of distortion contributed by the oscillator is more than 20 dB below the distortion contributed by the amplifier, an error in the harmonic distortion measurement will be less than 10 percent.

### Hum and noise

Hum and noise can be introduced at a variety of points in oscillator circuits; but when the circuit operates at a relatively high level, the amount of hum and noise introduced into the device under test is usually negligible. Hum and noise introduced by a

power amplifier usually remain constant as output signal amplitude is diminished. Hence, even though hum and noise power may be quite small compared to rated output, these spurious signals sometimes become a significant portion of low-level output signals. To overcome such a limitation, many Hewlett-Packard oscillators have their amplitude control on the output side of the power amplifier so that hum and noise are reduced proportionally with the signal when low-level signals are desired for test purposes.

### Function generators

The function generator is a versatile multiwaveform signal source capable of very wide frequency coverage. Available functions range from modulation (3310A/B, 3312A). The function generator is an indispensable general purpose signal source for production testing, instrument repair, and the electronics laboratory. Diverse fields of applications in which the function generator is being used include medical research, education, chemical, communications, geophysics, industrial control, military, and aerospace.

# OSCILLATORS & FUNCTION GENERATORS

5 Hz to 600 kHz audio oscillators

Models 200CD, 200CD Opt: H20, & 201C



200CD



201C

## Description

These Hewlett-Packard oscillators have high stability and accurate, easily resettable tuning circuits. Low-impedance operating levels, together with superior insulation, guarantee peak performance throughout years of trouble-free service. The instruments have a wide frequency range and long dial lengths and feature an improved vernier frequency control.

## Accessories available

11000A Cable Assembly	\$17
11001A Cable Assembly	\$17
11004A Line Matching Transformer	\$81
11005A Line Matching Transformer	\$125

## Price

## Specifications

	200CD	201C
Frequency Range	5 Hz to 600 kHz	20 Hz to 20 kHz
Number of Ranges	5 overlapping	3 overlapping
Dial Accuracy	$\pm 2\%$	$\pm 1\%$
Frequency Response	$\pm 1$ dB (1 kHz ref)	$\pm 1$ dB (1 kHz ref)
Output (into 600 $\Omega$ load)	> 160 mW (1.0 V) Opt. H20: 93 mW (7.5 V)	3 W (42.5 V)
Output Impedance	600 $\Omega$	600 $\Omega \pm 10\%$ , 20, 30 and 40 dB settings <600 $\Omega$ , 0 dB and 10 dB settings
Output Balance	Balance and floating better than 0.1% at lower frequencies and approx. 1% at higher frequencies	One terminal at ground potential
Distortion	0.2%, 20 Hz to 200 kHz 0.5%, 5 Hz to 20 Hz and 200 kHz to 600 kHz Opt. H20: 0.06%, 60 Hz to 50 kHz 0.1%, 20 Hz to 60 Hz and 50 kHz to 400 kHz 0.5%, 5 Hz to 20 Hz and 400 kHz to 600 kHz	<0.5%, 50 Hz to 20 kHz at 1 W <1%, 20 Hz to 20 kHz at 3 W
Hum and Noise	<0.1% of rated output	<0.03% of rated output
Attenuator	Bridged "T"	0 to 40 dB steps, coarse and fine controls
Input Power	115 or 230 V, 50 to 1000 Hz, 90 VA	115 or 230 V, 50 to 400 Hz, 75 VA
Weight kg (lb)	Net: 9.9 kg (22 lb) Shipping: 10.8 kg (24 lb)	Net: 7.2 kg (16 lb) Shipping: 8.6 (19 lb)
W x H x D Dimensions	187 mm x 292 mm x 365 mm (7 $\frac{3}{8}$ " x 11 $\frac{1}{2}$ " x 14 $\frac{3}{8}$ ")	191 mm x 292 mm x 318 mm (7 $\frac{1}{2}$ " x 11 $\frac{1}{2}$ " x 12 $\frac{1}{2}$ ")
Price	200CD: \$600, Opt. H20: add \$75.	201C: \$600

# OSCILLATORS & FUNCTION GENERATORS

4 Hz to 2 MHz sine, square wave oscillators

Models 209A, 204C & 204D



209A



204C



204D

## Description

The HP 209A is a small, lightweight, sine/square oscillator. Stable, accurate signals can be synchronized with an external source over a frequency range from 4 Hz to 2 MHz. Separately adjustable sine/square outputs are located on the front panel. Distortion and flatness can be minimized at low frequencies by a rear panel low distortion mode switch.

The HP 204C is a small, lightweight capacitive-tuned oscillator. Interchangeable power packs, line, rechargeable batteries or mercury batteries make this instrument ideal for both field and laboratory use.

The HP 204D Oscillator is identical to the 204C with the addition of an 80 dB attenuator and vernier. The attenuator with the vernier provides excellent output amplitude settable

## 209A Specifications

**Frequency:** 4 Hz to 2 MHz in 6 ranges.

**Dial accuracy:**  $\pm 3\%$  of frequency setting.

**Flatness** at maximum output into 600 $\Omega$  load, 1 kHz reference

Low distortion mode	+1%	$\pm 0.5\%$	$\pm 1\%$	$\pm 5\%$
Normal mode	+5%, -1%	$\pm 0.5\%$	$\pm 1\%$	$\pm 5\%$
	4	100	300 k	1 M 2 M (Hz)

**Distortion:** 200 Hz to 200 kHz, 0.1% (-60 dB); 4 Hz to 200 Hz, <0.2% (-54 dB); 200 kHz-2 MHz, <1% (-40 dB).

**Hum and noise:** <0.01% of input.

### Output characteristics sine wave

**Output voltage:** 5 V rms (40 mW) into 600 $\Omega$ ; 10 V open circuit.

**Output impedance:** 600 $\Omega$ .

**Output control:** >26 dB range continuously adjustable.

**Output balance:** 140 dB below 20 kHz. Output can be floated up to  $\pm 500$  V peak between output and chassis ground.

### Output characteristics square wave

**Output voltage:** 20 V p-p open circuit symmetrical about 0 V. Output can be floated up to  $\pm 500$  Vp.

**Rise and fall time:** <50 ns into 600 $\Omega$ . Symmetry:  $\pm 5\%$ .

**Output impedance:** 600 $\Omega$ .

### Synchronization

**Sync output:** sine wave in phase with output; 1.7 V rms open circuit (high end affected by capacitive loads); impedance 10 k $\Omega$ .

**Sync input:** same as 204C.

## 204C Specifications

**Frequency:** 5 Hz to 1.2 MHz in 6 overlapping ranges.

**Dial accuracy:**  $\pm 3\%$  of frequency setting.

**Flatness** at maximum output into 600 $\Omega$  load, 1 kHz reference

Low distortion mode	$\pm 1\%$	$\pm 0.5\%$	$\pm 1\%$
Normal mode	+5%, -1%	$\pm 0.5\%$	$\pm 1\%$
	6	100	300 k 1.2 M (Hz)

**Distortion:** 30 Hz to 100 kHz, 0.1% (-60 dB); 5 Hz to 30 Hz, <0.6% (-44 dB); 100 kHz-1.2 MHz, linearly derated to <1%.

**Hum and noise:** <0.01% of output.

### Output characteristics

**Output voltage:** >2.5 V rms (10 mW or +10 dBm) into 600 $\Omega$ ; >5 V rms open circuit.

**Output impedance:** 600 $\Omega$ .

**Output control:** >40 dB range; continuously adjustable.

**Output balance:** >40 dB below 20 kHz. Can be floated up to  $\pm 500$  V peak between output and chassis ground.

### Synchronization

**Sync output:** sine wave in phase with output; >100 mV rms into <100 pF over entire range; impedance 10 k $\Omega$ .

**Sync input:** oscillator can be synchronized to external signal. Sync range, the difference between sync frequency and set frequency, is a linear function of sync voltage.  $\pm 1\%/V$  rms for sine wave with a maximum input of  $\pm 7$  V peak ( $\pm 5$  V rms).

## 204D Specifications

(Identical to 204C except "output control" is replaced by the following):

### Output attenuator

**Range:** 80 dB in 10 dB steps.

**Overall accuracy:**  $\pm 0.3$  dB, +10 dB through -60 dB ranges;  $\pm 0.5$  dB on -70 dB range.

**Output vernier:** >10 dB range, continuously adjustable.

### General

**Operating temperature:** specifications are met from 0°C to 55°C.

**Power:** standard: ac-line 115 V or 230 V  $\pm 10\%$ , 48 Hz to 66 Hz, <7 VA max. Opt. 001: mercury batteries 300 hours operation. Opt. 002: line/rechargeable batteries 115 V or 230V  $\pm 10\%$ , 48 Hz to 66 Hz, <7 VA max. 35 hours operation per recharge.

**Dimensions:** 155 mm H (without removable feet)  $\times$  130 mm W  $\times$  203 mm D (6<sup>1</sup>/<sub>2</sub>"  $\times$  5<sup>1</sup>/<sub>8</sub>"  $\times$  8").

**Weight:** net 2.7 kg (6 lb). Shipping, 3.6 kg (8 lb).

### Options and accessories

Option 001, 204C/D (for mercury batteries)

Price

add \$85

Option 002, 204C/D (for rechargeable batt/ac line)

add \$95

11137A Rechargeable battery/AC power pack for 204C/D

\$140

11075A Instrument case

\$115

5060-8762 Rack adapter frame

\$55

### Ordering Information

209A Sine, square wave oscillator

\$495

204C Sine wave oscillator

\$415

204D Sine wave oscillator

\$475

# OSCILLATORS & FUNCTION GENERATORS

## 10 Hz to 1 MHz digital oscillator

Model 4204A

- 0.2% frequency accuracy
- Accurate 80 dB output attenuator
- 0.01% frequency repeatability
- Excellent stability
- Flat frequency response



### Description

Hewlett-Packard's 4204A Digital Oscillator provides accurate, stable test signals for both laboratory and production work. This one instrument does the job of an audio oscillator, an ac voltmeter, and an electronic counter when an accurate frequency source of known amplitude is required.

Any frequency between 10.0 Hz and 999.9 kHz can be digitally selected with an in-line rotary switch, to four significant figures. As many as 36,900 discrete frequencies are available. Infinite resolution is provided by one vernier control, which also extends the upper frequency limit to 1 MHz. Frequency accuracy is better than  $\pm 0.2\%$  and repeatability is typically better than  $\pm 0.01\%$ .

A built-in high impedance voltmeter measures output. The meter is calibrated to read volts or dBm into a matched 600 ohm load. (0 dBm = 1 mW into 600 ohms.) The output attenuator has an 80 dB range, adjustable in 10 dB steps with a 20 dB vernier. Maximum output power can be increased to 10 volts (22 dBm) into 600 ohms or 20 volts open circuit.

Frequency response is flat with less than  $\pm 3\%$  variation over the entire frequency range at any attenuator setting. Frequency stability is better than 10 parts in  $10^9$  per minute.

### Specifications

**Frequency range:** 10 Hz to 1 MHz, 4 ranges

**Frequency accuracy:**  $\pm 0.2\%$  or  $\pm 0.1$  Hz (at 25°C).

**Frequency stability**

$\pm 10\%$  line voltage variation: less than  $\pm 0.01\%$ .

**Change of frequency with temperature:**  $< \pm 100$  ppm/°C.

**Drift:**  $< 10$  ppm/minute.

**Frequency response:** flat within  $\pm 3\%$ , 9.999 kHz ref. (25°C  $\pm 5^\circ$ C).

**Output:** 10 V (22 dBm) into 600 ohms (160 mW), 20 V open circuit.

**Output attenuator:** 80 dB in 10 dB steps.  $\leq \pm 0.5$  dB error.

**Output monitor:** voltmeter monitors level at input of attenuator in volts or dB.

**Accuracy:**  $\pm 2\%$  of full scale.

**Flatness:**  $\pm 1\%$  at full scale, 10 Hz to 500 kHz;  $\pm 2\%$  at full scale, 500 kHz to 1 MHz.

**Distortion:** less than 0.3%, 30 Hz to 100 kHz. Less than 1%, 10 Hz to 600 kHz. Less than 1.2%, 10 Hz to 1 MHz.

**Hum and noise:** less than 0.05% of output.

**Temperature range:** 0°C to +50°C.

**Power:** 115 V/230 V switch,  $\pm 10\%$ , 10 VA, 50 to 60 Hz.

**Weight:** net, 8.5 kg (19 lb). Shipping, 11 kg (28 lb).

**Dimensions:** 141 mm H  $\times$  426 mm W  $\times$  336 mm D (5 $\frac{1}{2}$ "  $\times$  16 $\frac{3}{4}$ "  $\times$  13 $\frac{1}{4}$ ").

### Accessories available

11000A Cable: dual banana plugs

**Price**

\$17

11001A Cable: banana plug to BNC male connector

\$17

11004A Line Matching Transformer has a frequency response of 5 kHz to 600 kHz providing fully balanced outputs for 135 or 600 ohms

\$81

11005A Line Matching Transformer has a frequency response of 20 Hz to 45 kHz providing full balanced output into 600 ohms.

\$125

16252A Matching Transformer has a frequency response of 10 kHz to 1 MHz providing unbalanced 75 ohm output, terminated in UG-657/U female BNC connector

\$89

### Options

001: 4204A Output Monitor top scale calibrated in dBm/600 $\Omega$ . Bottom scale calibrated in volts

add \$25

908: Rack Flange Kit

add \$10

910: Extra Manual

add \$9

4204A Digital Oscillator

\$1500

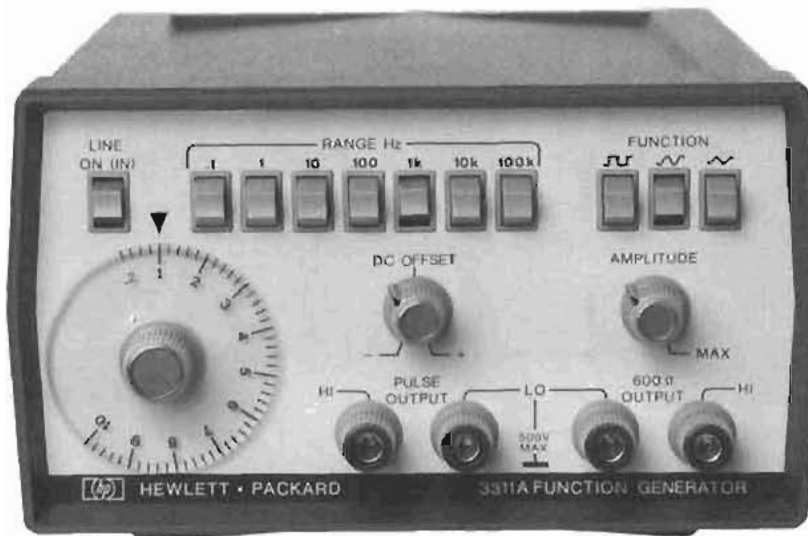

## Description

The 3311A Function Generator offers wide functional capability at a modest price. This compact unit has seven decades of range from 0.1 Hz to 1 MHz. Pushbutton range and function selection add convenience to versatility. Added features normally not found on function generators in this price range are 10:1 voltage control and a separate pulse output suitable for synchronization or driving TTL logic circuits.

### Output

Ten V p-p into 600Ω (20 V p-p O.C.). This output may be attenuated by >30 dB by a variable attenuator and offset by ±5 V. The dc offset allows the sine, square, and triangle functions to be positioned to the most desired level. This feature adds to the usefulness of all three functions.

### VCO

The dc coupled voltage control allows the use of an external source to sweep the 3311A >10:1 in frequency.

### Pulse output

A separate TTL compatible pulse output provides current sinking for up to 20 TTL loads. The pulse has a 15/85 aspect ratio with a <25 ns rise time.

## Specifications

**Waveforms:** sinusoid, square, triangle, and positive pulse.

**Frequency range:** 0.1 Hz to 1 MHz in seven decade ranges.

**Dial accuracy:** ±5% of full scale.

**Isolation:** using an external supply, outputs may be floated up to ±500 V relative to the instrument case (earth ground).

### 600 Ohm output

**Maximum output amplitude:** 20 V p-p open circuit; 10 V p-p into 600 Ω.

**Amplitude control:** continuously variable, >30 dB range. DC offset: up to ±10 V open circuit, ±5 V into 600Ω, continuously

adjustable and independent of amplitude control. Maximum  $V_{pk} + V_{dc}$  offset without clipping is ±10 V open circuit, ±5 V into 600Ω.

**Output impedance:** 600Ω ±10%.

**Sine wave amplitude flatness:** within ±3% of 10 kHz reference (maximum output amplitude) to 100 kHz, ±6% to 1 MHz.

**Sine wave total harmonic distortion:** <3% (maximum output amplitude).

**Triangle linearity:** deviation <1% from best straight line at 100 Hz (maximum output amplitude).

**Square wave transition time:** rise time: <100 ns; fall time: <100 ns.

**Square wave time axis symmetry error:** ±2% maximum to 100 kHz.

### Pulse output

**Output amplitude:** >3 V positive (open circuit) TTL compatible.

**Duty cycle:** 13.5% to 16.5% of the total period.

**Transition times:** <25 ns.

### External frequency control

**VCO range:** >10:1 on any frequency range.

**Input requirement:** with frequency dial set to 1.0, a linear ramp of 0.0 V to -10 V ±2 V will linearly increase frequency >10:1

**Input impedance:** 10 kΩ ±10% in parallel with <60 pFd.

### General

**Operating temperature:** 0°C to 55°C; specifications apply from +15°C to +35°C.

**Storage temperature:** -40°C to +75°C.

**Power:** 100/120/220/240 V -10%, +5% switchable; 48 Hz to 66 Hz; ≤12 VA.

**Dimensions:** 89 mm H × 159 mm W × 248 mm D (3 1/2" × 6 1/4" × 9 3/4").

**Weight:** net, 1.5 kg (3 1/2 lb); shipping, 2.5 kg (5 1/2 lb).

**Rack Mount Kits:** 10851A for one 3311A, 10852A for two.

# OSCILLATORS & FUNCTION GENERATORS

## Function generator

Model 3312A

- AM, FM, sweep, trigger, gate and burst



### Description

Hewlett-Packard's 3312A Function Generator combines two separate, independent function generators with a modulator section in one compact instrument.

The main generator can—via pushbutton control—be triggered by the modulation generator to provide sweep functions, AM, FM or tone burst.

Ten V p-p into 50Ω provides adequate power for most applications. The output attenuator has a range of more than 10,000:1 so clean low-level signals from 10 V to 1 mV p-p into 50Ω can be obtained.

The main generator includes dc offset up to 10 volts p-p into 50Ω.

Hewlett-Packard's 3312A is an effective low cost solution for generating a multitude of functions.

### 3312A Specifications

**Output waveforms:** sine, square, triangle,  $\pm$  ramp, pulse, AM, FM, sweep, trigger and gate.

#### Frequency characteristics

**Range:** 0.1 Hz to 13 MHz in 8 decade ranges.

**Dial accuracy:**  $\pm 5\%$  of full scale.

**Square wave rise or fall time (10% to 90%):** < 18 nsec.

**Aberrations:** < 10%.

**Triangle linearity error:** < 1% at 100 Hz.

**Variable symmetry:** 80:20:80 to 1 MHz.

**Sine wave distortion:** < 0.5% THD from 10 Hz to 50 kHz. > 30 dB below fundamental from 50 kHz to 13 MHz.

#### Output characteristics

**Impedance:** 50Ω  $\pm 10\%$ .

**Level:** 20 V p-p into open circuit, 10 V p-p into 50Ω.

**Level flatness (sine wave):** <  $\pm 3\%$  from 10 Hz to 100 kHz at full rated output (1 kHz reference). <  $\pm 10\%$  from 100 kHz to 10 MHz.

**Attenuator:** 1:1, 10:1, 100:1, 1000:1 and > 10:1 continuous control.

**Attenuator error:** < 5%.

**Sync output:** impedance: 50Ω  $\pm 10\%$ . > 1 V p-p square wave into open circuit. Duty cycle varies with symmetry control.

**DC offset:**  $\pm 10$  volts, continuously adjustable, independent of variable attenuator setting. Instantaneous ac voltage + Vdc offset must be between  $\pm 10$  V (not terminated) or  $\pm 5$  V (terminated with 50Ω) in the 1:1 attenuator position.

#### Modulation characteristics

**Types:** internal AM, FM, sweep, trigger, gate or burst; external AM, FM, sweep, trigger, gate or burst.

**Waveforms:** sine, square, triangle, ramp or pulse variable symmetry.

**Frequency range:** 0.01 Hz to 10 kHz.

**Output level:** > 1.0 V p-p into 10 kΩ.

#### Amplitude modulation

**Depth:** 0 to 100%.

**Modulation frequency:** 0.01 Hz to 10 kHz (internal). DC to > 1 MHz (external)

**Carrier 3 dB bandwidth:** < 100 Hz to > 5 MHz.

**Carrier envelope distortion:** < 2% at 70% sine wave modulation with  $f_c = 1$  MHz,  $f_m = 1$  kHz.

**External sensitivity:** < 10 V p-p for 100% modulation.

#### Frequency modulation

**Deviation:** 0 to  $\pm 5\%$  (internal).

**Modulation frequency:** internal: 0.01 Hz to 10 kHz; external: DC to > 50 kHz.

**Distortion:** < -35 dB at  $f_c = 10$  MHz,  $f_m = 1$  kHz, 10% modulation.

#### Sweep characteristics

**Sweep width:** > 100:1 on any range.

**Sweep rate:** 0.01 Hz to 100 Hz, 90:10 ramp, and 0 Hz (provides manual setting of "Sweep Start" without modulation generator oscillating).

**Sweep mode:** repetitive linear sweep between start and stop frequency settings. Retrace time can be increased with symmetry control.

**Ramp output:** 0 to > -4 p-p into 5 kΩ.

**Gate characteristics:** start/stop phase range: +90° to -80°.

**Frequency range:** 0.1 Hz to 1 MHz (useful to 10 MHz).

**Gating signal frequency range (external):** DC to 1 MHz, TTL compatible.

#### External frequency control

**Range:** 1000:1 on any range.

**Input requirement:** with dial set at 10, 0 to -2 V  $\pm 20\%$  will linearly decrease frequency > 1000:1. An ac voltage will FM the frequency about a dial setting within the limits  $(0.1 < f < 10) \times$  range setting. **Linearity:** the frequency versus voltage curve will be linear within 0.5% over a 100:1 frequency range.

**Input impedance:** 2.8 kΩ  $\pm 5\%$ .

#### General

**Operating temperature:** 0°C to +55°C; specifications apply from 0°C to 40°C.

**Storage temperature:** -40°C to +75°C.

**Power:** 100 V, 120 V, 220 V, 240 V +5%, -10%, switchable; 48 Hz to 440 Hz;  $\leq 25$  VA.

**Size:** 102 H  $\times$  213 W  $\times$  377 mm D (4"  $\times$  8 $\frac{3}{8}$ "  $\times$  14 $\frac{13}{16}$ ").

**Weight:** net, 3.8 kg (8 lbs, 6 oz). Shipping, 5.9 kg (13 lbs).

3312A Function Generator

\$900

# OSCILLATORS & FUNCTION GENERATORS

0.0005 Hz to 5 MHz function generators

Model 3310A/B

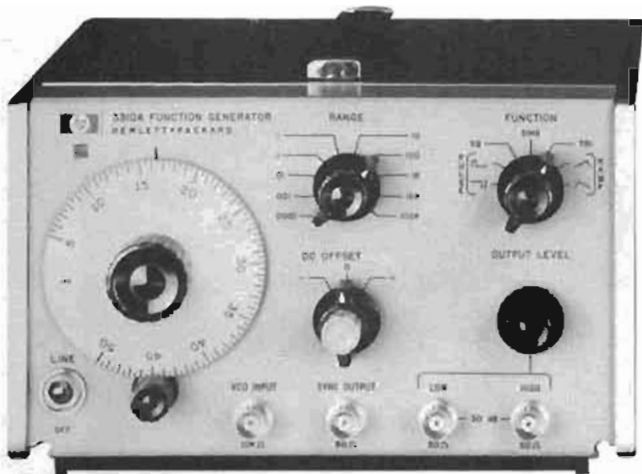

3310A

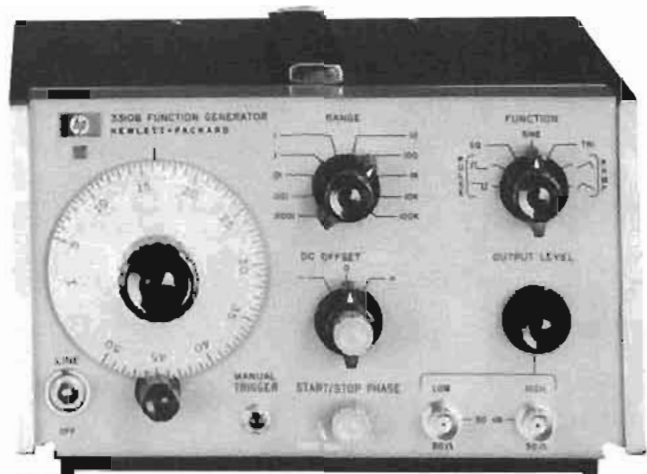

3310B

## Description

The 3310A Function Generator is a compact voltage-controlled generator with 10 decades of range. Ramp and pulse functions are available in addition to sine, square and triangle. DC offset and external voltage control provide wide versatility. A fast rise time sync output is provided. Aspect ratio of nonsymmetrical function is 15%/85%.

The 3310B has all the features of the standard 3310A plus single and multiple cycle output capability.

## 3310A Specifications

**Output waveforms:** sinusoidal, square, triangle, positive pulse, negative pulse, positive ramp and negative ramp. Pulses and ramps have a fixed 15% or 85% duty cycle.

**Frequency range:** 0.0005 Hz to 5 MHz in 10 decade ranges

**Sine wave frequency response**

0.0005 Hz to 50 kHz:  $\pm 1\%$ ; 50 kHz to 5 MHz:  $\pm 4\%$ . Reference, 1 kHz at full amplitude into 50 $\Omega$ .

**Dial accuracy**

0.0005 Hz to 500 kHz all functions:  $\pm(1\%$  of setting + 1% of full scale).

500 kHz to 5 MHz sine, square and triangle:  $\pm(3\%$  of setting + 3% of full scale).

500 kHz to 5 MHz pulse and ramps:  $\pm(10\%$  of setting + 1% of full scale).

**Maximum output on high:**  $>30$  V p-p open circuit,  $>15$  V p-p into 50 $\Omega$  (except for pulses at frequency  $>2$  MHz).

**Pulse (frequency  $>2$  MHz):**  $>24$  V p-p open circuit;  $>12$  V p-p into 50 $\Omega$ .

**Minimum output on low:**  $<30$  mV p-p open circuit;  $<15$  mV p-p into 50 $\Omega$ .

**Output level control:** range  $>30$  dB. High and low outputs overlap for a total range of  $>60$  dB; low output is 30 dB down from high output.

**Sine wave distortion**

0.0005 Hz to 10 Hz;  $>40$  dB (1%).

10 Hz to 50 kHz (on 1 k range):  $>46$  dB (0.5%).

50 kHz to 500 kHz:  $>40$  dB (1%).

500 kHz to 5 MHz:  $>30$  dB (3%).

**Square wave and pulse response:**  $<30$  ns rise and fall times at full output.

**Triangle and ramp linearity:** 0.0005 Hz to 50 kHz,  $<1\%$ .

**Impedance:** 50 $\Omega$ .

**Sync**

**Amplitude:**  $>4$  V p-p open circuit,  $>2$  V p-p into 50 $\Omega$ .

**DC offset**

**Amplitude:**  $\pm 10$  V open circuit,  $\pm 5$  V into 50 $\Omega$  (adjustable).

**Note:** max V ac p + V dc offset is  $\pm 15$  V open circuit,  $\pm 7.5$  V into 50 $\Omega$ .

**External frequency control:** 50:1 on any range.

**Input requirement:** with dial set to low end mark, a positive ramp of 0 to  $+10$  V  $\pm 1$  V will linearly increase frequency 50:1. With dial set at 50, a linear negative ramp of 0 to  $-10$  V  $\pm 1$  V will linearly decrease frequency 50:1. An ac voltage will FM the frequency about a dial setting within the limits  $(1 < f < 50) \times$  range setting.

**Linearity:** ratio of output frequency to input voltage ( $\Delta F/\Delta V$ ) will be linear within 0.5%.

**Sensitivity:** approximately 100 mV/minor division.

**Input impedance:** 10 k $\Omega$ .

**General**

**Power:** 115 V or 230 V  $\pm 10\%$ , 48 Hz to 440 Hz,  $<20$  VA max.

**Dimensions:** 114 mm H (without removable feet), 197 mm W,

203 mm D ( $4\frac{1}{2}'' \times 7\frac{3}{4}'' \times 8''$ ).

**Weight:** net, 2.7 kg (6 lb); shipping, 4.5 kg (10 lb).

**Accessories available**

HP Part No. 3060-8540 filler strip for use with HP 1051A Combining Case or HP 3060-8762 Rack Adapter Frame.

## 3310B Specifications

Same as 3310A with the following additions:

**Modes of operation:** free run, single cycle, multiple cycle.

**Frequency range:** 0.0005 Hz to 50 kHz (usable to 5 MHz).

**Single cycle\*\*:** ext trigger (ac coupled) requires a positive-going square wave or pulse from 1 V p-p to 10 V p-p. The triggering signal can be dc offset, but  $(V_{ac} \text{ peak} + V_{dc}) \leq \pm 10$  V ext gate (dc coupled) will trigger a single cycle on any positive waveform  $\geq 1$  V but  $\leq 10$  V which has a period greater than the period of the 3310B output, and a duty cycle less than the period of the 3310B output. The gate signal cannot exceed 10 V.

**Multiple cycle\*\*:** manual trigger will cause the 3310B to free run when depressed. When the trigger button is released, the waveform will stop on the same phase as it started. Ext gate will cause the 3310B to free run when the gate is held at between  $+1$  and  $+10$  V. When the gate signal goes to zero, the 3310B will stop on the same phase as it started.

**Start-stop phase:** the start-stop phase can be adjusted over a range of approximately  $\pm 90^\circ$ .

**Ordering information**

3310A Function Generator

3310B Function Generator

\*\*This specification applies to the X 0001 to X1 k range only.

**Price**

\$800

\$900



# OSCILLATORS & FUNCTION GENERATORS

## 50 MHz programmable signal source

### Model 8165A

- 1 mHz to 50 MHz
- sine, ramp and pulse waveforms
- counted burst
- 20 Vpp amplitude
- Fully programmable
- Storage of operating parameters

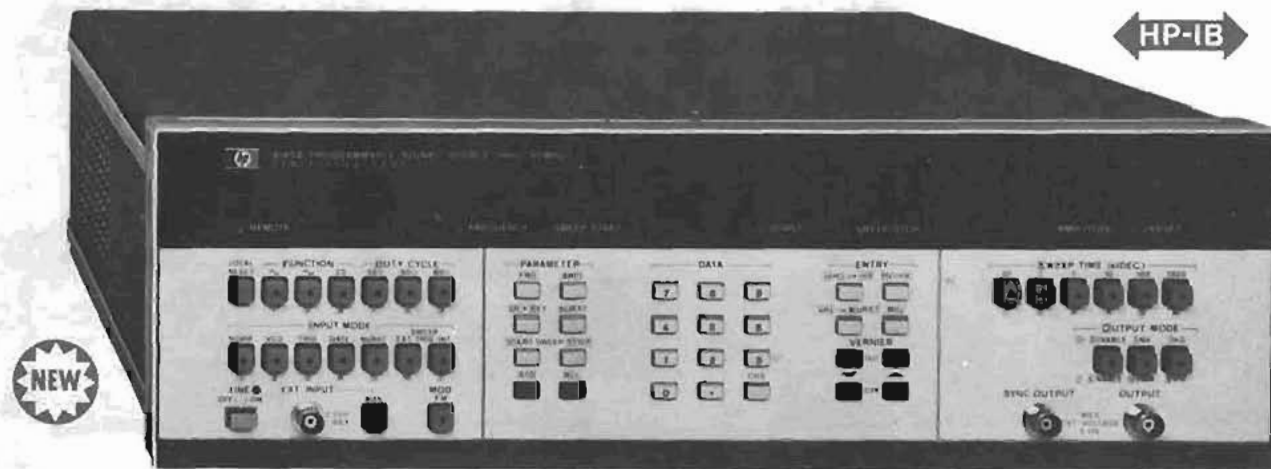

8165A with Sweep Opt 001

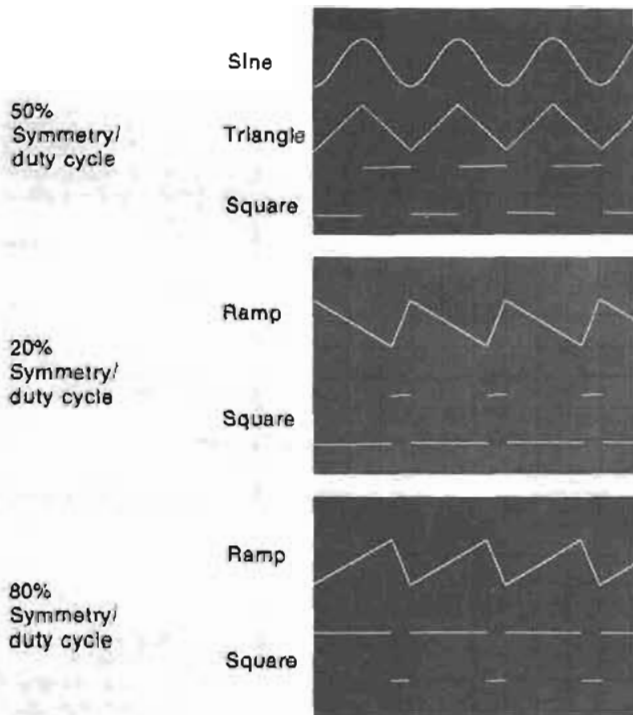

#### Introduction

The 8165A Programmable Signal Source generates sinewaves, triangles, ramps, square waves and pulses over a frequency range of 1 mHz to 50 MHz. The pushbutton front panel controls and the LED parameter display enable rapid and accurate setting of parameters with no repeatability problems. When you include other features such as microprocessor control, remote programmability of all parameters, and seven operating modes, you have a versatile signal source in just a single instrument that can be used in a wide range of applications.

#### Microprocessor control

The 8165A contains a microprocessor-controlled interface and keyboard designed to simplify operating and programming. Whether operating the instrument from its keyboard or from a controller via the HP-IB, the microprocessor simplifies parameter and data entry.

It also checks for illegal operations, incompatible settings, and sets up front panel displays. The microprocessor greatly simplifies front panel operation by enabling any parameter to be changed using only 3 steps: a **PARAMETER** key, **DATA** keys, and an **ENTRY** key.

#### Operating set storage

Up to 10 complete operating sets (functions and parameters) can be stored in the built-in memory. Subsequently you can recall any of the 10 sets instantaneously by pressing only two keys or using one program statement. And you don't have to worry about losing operating sets if the 8165A is accidentally switched off or if the power fails. Internal batteries preserve the current and stored operating sets for up to four weeks.

#### Stability, accuracy and resolution

The use of phase lock loop techniques, plus a 10 MHz internal or external crystal reference, ensures very stable output frequencies with an accuracy of  $\pm 1 \times 10^{-9}$  deviation from programmed value. Resolution is four digits over the frequency range of 1 mHz to 50 MHz. For example, in the frequency range 1-9.999 mHz, this is equivalent to a resolution of 1  $\mu$ Hz.

#### Multiple waveform generation

The multiple waveforms that can be generated by the 8165A suit it to a wide range of digital and analog applications. Sine, triangle or square waves can be generated at frequencies up to 50 MHz. Ramps and rectangular pulses with 20% or 80% duty cycle/symmetry can be generated at frequencies up to 19.99 MHz.

#### Operating modes

The 8165A can be operated in any of seven different modes: normal, trigger, gate, voltage controlled oscillator (VCO), sweep, counted burst, and frequency modulation (FM). This wide range of modes enables the 8165A to be used in any operating environment.

#### Output capability

The 8165A has been designed to fulfil the requirements of analog and digital testing. The source impedance can be set to 50 ohms or 1 k ohms for best termination, i.e. minimum distortion and reflection in each application. The 8165A can also be used as a current source, or supply a variable dc level.

#### HP-IB programming

The use of a microprocessor makes the 8165A very easy to program across the HP-IB, and ideal in automatic test systems. All operating parameters and functions can be programmed and in learn mode the 8165A can report its status and its current or stored operating sets. Programming is further simplified by the codes on the instrument front panel. The framed mnemonics are the ASCII characters required for programming.



## Specifications

### Waveforms

Sine, square/pulse (20, 50, 80% duty cycle), triangle/ramp (20, 50, 80% symmetry)

### Frequency characteristics

**Range:** 1.000 MHz to 50.00 Mhz (1.000 MHz to 19.99 MHz for 20 and 80% duty cycle/symmetry).

### Output characteristics

**Range:** amplitude and offset independently variable within  $\pm 10$  V.  
**Source impedance:** selectable 50  $\Omega$   $\pm 1\%$  or 1 k $\Omega$   $\pm 10\%$ , in parallel with 50 pF.

**Amplitude:** 10.0 mV<sub>pp</sub> to 10.0 V<sub>pp</sub> (50  $\Omega$  into 50  $\Omega$ )  
 2.00 V<sub>pp</sub> to 20.0 V<sub>pp</sub> (1 k $\Omega$  into 50  $\Omega$ )

### Accuracy

Frequency	Sine	Square	Triangle (80%)	Triangle (20%, 80%)	Pulse (20%, 80%)
1 kHz	$\pm 2\%$	$\pm 2\%$	$\pm 2\%$	$\pm 2\%$	$\pm 2\%$
1 kHz-5 MHz	$\pm 2\%$	$\pm 2\%$	$\pm 2\%$	$\pm 5\%$	$\pm 2\%$
5 MHz-20 MHz	$\pm 5\%$	$\pm 5\%$	$\pm 5\%$	$\pm 5\%$	$\pm 5\%$
20 MHz-50 MHz	$\pm 5\%$	$\pm 5\%$	-5% to -20%	—	—

**Resolution:** 3 digits.

**Offset:** 0  $\pm 10$  mV to  $\pm 5.00$  V (50  $\Omega$  into 50  $\Omega$ ),  
 0  $\pm 20$  mV to  $\pm 10.0$  V (1 k $\Omega$  into 50  $\Omega$ ).

**Accuracy:**  $\pm 1\%$  programmed value  $\pm 1\%$  signal V<sub>pp</sub>  $\pm 20$  mV.

**Resolution:** 2 digits (10 to 99 mV), 3 digits ( $\geq 100$  mV).

### Sine characteristics

**Distortion:** total harmonic distortion (THD) for fundamental up to 1 MHz:  $\leq 1\%$ .

**Harmonic signals (fundamental 1-10 MHz):**  $\leq -36$  dB.

**Harmonic signals (fundamental above 10 MHz):**  $\leq -30$  dB.

**Non-harmonic:**  $\leq -40$  dB.

### Square/pulse characteristics

**Duty cycle:** 20, 50, 80% selectable.

**Transition times (10% to 90%):**  $< 5$  ns (50  $\Omega$  into 50  $\Omega$ ),  $< 7$  ns (1 k $\Omega$  into 50  $\Omega$ ).

**Overshoot/ringing:**  $\leq 5\%$  (50  $\Omega$  into 50  $\Omega$ ),  $\leq 10\%$  (1 k $\Omega$  into 50  $\Omega$ ).

**Prehoot:**  $\leq 5\%$  (50  $\Omega$  into 50  $\Omega$ ),  $\leq 10\%$  (1 k $\Omega$  into 50  $\Omega$ ).

### Triangle/ramp characteristics

**Symmetry:** 20, 50, 80% selectable.

**Linearity: (10% to 90%):**

$\leq 1\%$  (up to 5 MHz),  $\leq 5\%$  (above 5 MHz).

### Operating modes

**Norm:** continuous waveform is generated, phase locked to an internal 10 MHz crystal reference.

**VCO:** external voltage V<sub>in</sub> (f<sub>max</sub> = 100 kHz) sweeps output frequency over a band. The band is determined by the frequency setting, and the frequency shift by the amplitude of V<sub>in</sub>.

**Trig:** each trigger input cycle or manual command generates one output cycle, min trigger pulse width: 10 ns.

**Gate:** external signal enables oscillator when more positive than threshold. First and last output cycles are always complete, min. pulse width: 10 ns.

**Burst:** a preprogrammed number of output cycles is generated on receipt of an input trigger signal or manual command, min. time between bursts: 50 ns. Burst length: 1 to 9999 cycles. Min. trigger pulse width: 10 ns.

**Frequency modulation:** output is frequency modulated by an external voltage applied to a rear panel BNC. 0 to  $\pm 1$  V modulates 0 to  $\pm 1\%$  deviation.

**Modulating frequency:** 100 Hz to 20 kHz (Norm mode), dc to 20 kHz (Gate mode with carrier frequency  $\geq 1$  kHz).

### Auxiliary inputs and outputs

**Ext. Input:** common front panel BNC for external signals used in VCO, Trig, Gate, Burst and (Option 001) Sweep ext./trig.

**Signal threshold:** +250 mV (upper), 0 V (lower).

**Max input:**  $\pm 20$  V.

**Input impedance:** 10 k $\Omega$   $\pm 10\%$ .

**Sync output:** front panel BNC provides one trigger cycle per main output cycle.

**Amplitude:** 0.8 V<sub>pp</sub> into 50  $\Omega$  (low level zero V, high +0.8 V).

**Duty cycle:** as main output.

**Ext. 10 MHz Ref:** rear panel BNC for connection of 10 MHz, TTL, system clock, selected by rear panel switch.

### HP-IB programming (IEEE Std 488)

#### Settling times

**Frequency:**  $< 200$  ms to settle to final value.

**Other functions:** 20 ms.

### Memory

10 addressable locations plus one for current operating state.

**Capacity:** each location can store a complete set of operating parameters and modes.

**Access time:** 20 ms each location.

**Storage time:** internal battery provides memory retention for approx 4 weeks at room temperature.

### Options

**001 Sweep:** provides logarithmic frequency sweep between limits set in on the 8165A. Rear panel BNC provides triangular sweep voltage (V<sub>sweep</sub>), 0 to 2.99 V amplitude.

**Sweep rate:** 0.01, 0.1, 1, 10, 100, 1000 seconds per decade selectable.

**Trigger:** internal for continuous sweep, external produces one up-down sweep per trigger pulse.

### General

**Power requirements:** 100 V, 120 V, 220 V or 240 V; +5 to -10%, 48 to 66 Hz, 200 VA max.

**Environmental:** operates to specifications from 0 to 50°C, and with relative humidity to 95% at 40°C.

**Storage:** -20 to +70°C.

**Weight:** net 12 kg (26.5 lbs). Shipping 16 kg (35.3 lbs).

**Size:** 133 mm H x 426 mm W x 422 mm D (5.2" x 16.8" x 16.6").

### Accessories available

The following cables for interconnecting HP-IB instruments to the bus are available:

10631A 1 m (3.28 ft), 10631B 2 m (6.56 ft)  
 10631C 4 m (13.1 ft), 10631D 0.5 m (1.64 ft)

### Options

001: Sweep

907: Front Handle Kit

908: Rack Mounting Kit

908: Combined Front Handle and Rack Mounting Kit

910: additional Operating and Service Manual

### Price

add \$350

add \$20

add \$15

add \$30

add \$22

# OSCILLATORS AND FUNCTION GENERATORS

## 10 Hz to 10 MHz test oscillators

### Models 651B, 652A, 654A

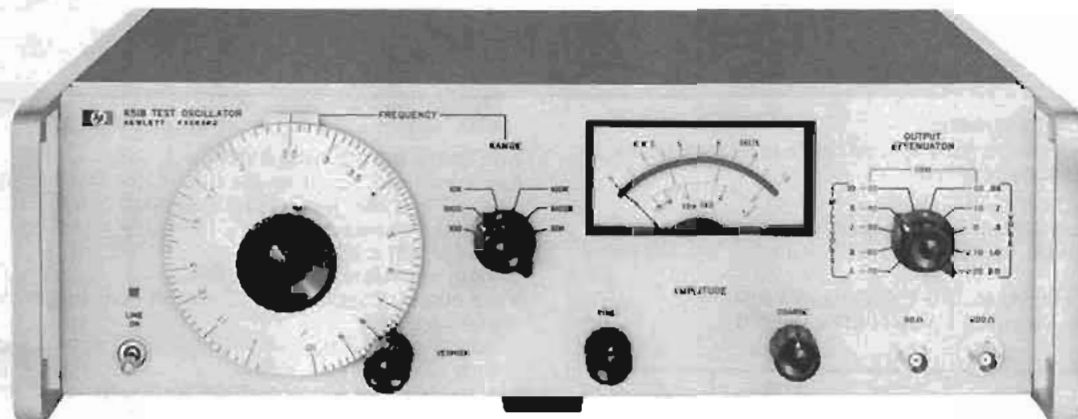

651B

## Specifications

MODEL NO.	651B	652A	654A
Description	Amplitude and frequency stability of this solid state capacitance-tuned test oscillator provides high quality signals for general purpose lab or production measurements.	Same as Model 651B, HP's Model 652A offers an expandable output monitor for amplitude control to 0.25% across its entire frequency band for greater output and resetability.	Similar to the 651B Test Oscillator, HP's Model 654A has balanced outputs of 135Ω, 150Ω, and 600Ω. Automatic leveling over entire frequency range and expanded meter.
Frequency Range	10 Hz to 10 MHz, 6 bands.		
Frequency Accuracy	±2%, 100 Hz to 1 MHz; ±3%, 10 Hz to 100 Hz and 1 MHz to 10 MHz.		±2% 100 Hz to 5 MHz; ±3% 10 Hz to 100 Hz; ±4% 5 MHz to 10 MHz.
Frequency Response (Flatness)	±2%, 100 Hz to 3 MHz; ±3%, 10 Hz to 100 Hz; ±4%, 1 MHz to 10 MHz (applies only at 50Ω or 75Ω output and amplitude readjusted to a reference on the output monitor.)	±0.25%, 3 V and 1 V range; ±0.75%, 0.3 V to 0.3 mV range; ±1.75%, 0.1 mV range. (Amplitude readjusted using expanded scale on output monitor.)	(±10 dBm and 9 dBm) ±0.5% from 10 Hz to 10 MHz for unbalanced outputs and 10 Hz to 5 MHz for 135Ω and 150Ω outputs, and 10 Hz to 1 MHz for 600Ω output.
Distortion	<1%, 10 Hz to 2 MHz; <2%, 2 MHz to 5 MHz; <4%, 5 MHz to 10 MHz.		10 Hz to 1 MHz, >40 dB below fundamental; 1 MHz to 10 MHz, >34 dB below fundamental.
Output	3.16 V into 50Ω or 600Ω; 6.32 V open circuit, 0.1 mV to 3.16 V full scale, 10 steps in 1, 2, 10 sequence; -70 dBm to +23 dBm (50Ω output) full scale, 10 dBm per step; 20 dB coarse and fine adjustable amplitude control.		+11 dBm to -90 dBm, 10 dB and 1 dB steps with adjustable ±1 dB meter range, calibrated for each impedance of 10Ω and 75Ω unbalanced and 135Ω, 150Ω and 600Ω balanced.
Output Monitor (Monitor's level at input of attenuator)	Top scale calibrated in mV, bottom scale in dB. Accuracy ±2% of full scale.	Same as 651B plus Expand Scale which expands reference voltage of the normal scale from 0.9 to 1.0 or 2.8 to 3.2.	±1 dBm with full scale with 0.02 dB resolution. Accuracy ±0.05 dB.
Output Connectors	BNC connectors.		
Attenuator	90 dB range in 10 dB steps; ±0.075 dB, -63 dBm to +20 dBm; ±0.2 dB, -70 dBm to -50 dBm.		99 dB range in 10 dB and 1 dB steps; ±1.5% 0.15 dB; except ±10% (1 dB) at output levels below 60 dBm at frequencies >300 kHz.
Temperature Range	0°C to +55°C (32°F to 130°F)		
Power	115 V or 230 V ±10%, 48 Hz to 66 Hz, 30 VA max.		115 V or 230 V ±10%, 50 Hz to 66 Hz, 35 VA max.
Weight	Net, 7.6 kg (17 lb). Shipping, 9.90 kg (22 lb).		Net, 9.4 kg (21 lb). Shipping, 11.8 kg (26 lb).
Dimensions	133 mm H × 425 mm W × 286 mm D (5.21" × 16.75" × 11.25")		
PRICE	\$945	\$1,100	\$1,600

\*Maximum dc voltage that can be applied to output: <=3 V p.

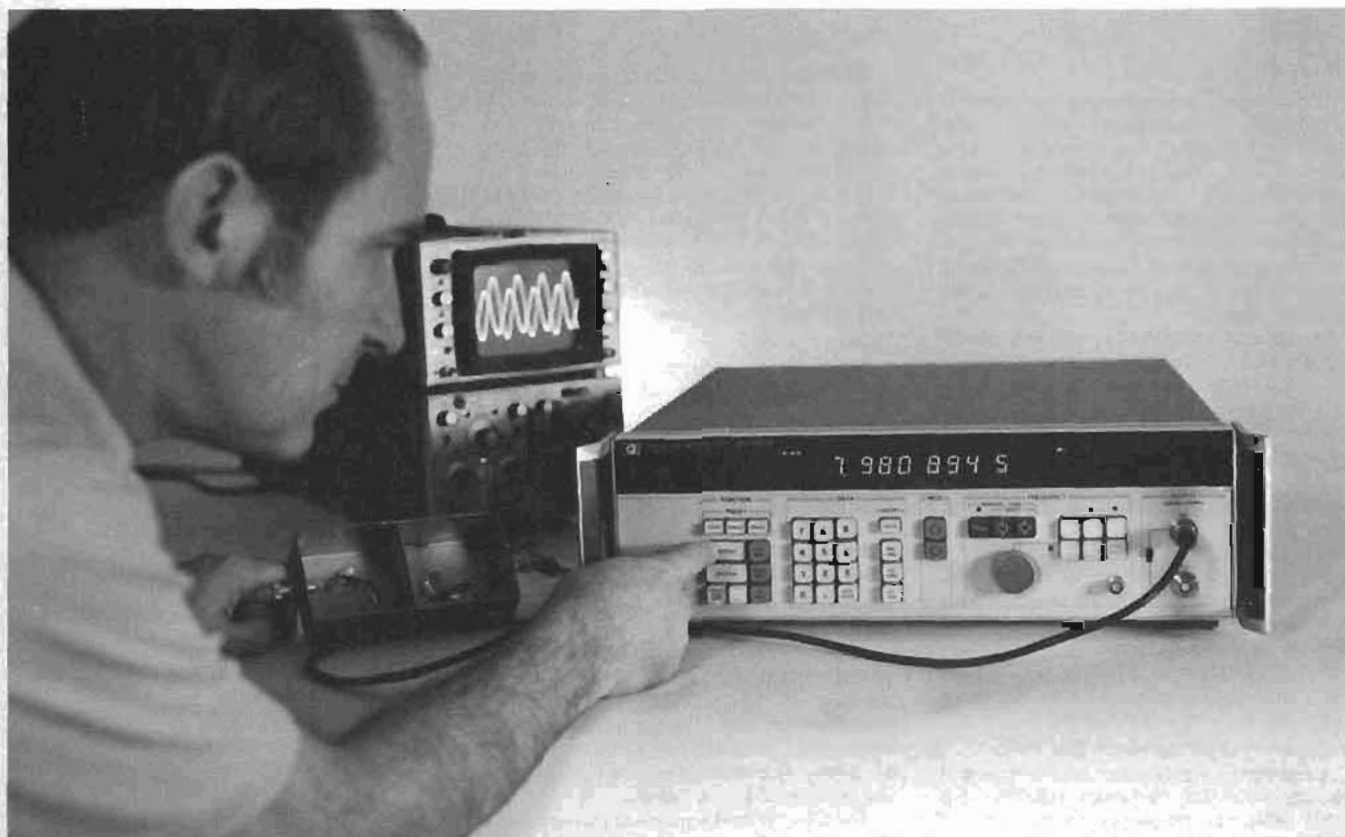

Hewlett-Packard frequency synthesizers translate the stable frequency of a precision frequency standard to one of thousands or even billions of frequencies over a broad spectrum that extends from dc to 2600 MHz. The table below highlights HP's complete line of frequency synthesizers.

HP Model	Frequency Range	Frequency Resolution	Frequency Stability	Level Range dBm - 50Ω	Level Resolution	Remote Control	Other Features*
3320A (Pg. 348)	DC - 13 MHz 5 ranges	0.01 Hz to 10 kHz (4 digits)	10 <sup>-7</sup> /day	0 to +13	1/2 turn Vernier	Freq.	1
3320B (Pg. 348)	DC - 13 MHz 5 ranges	0.01 Hz to 10 kHz (4 digits)	10 <sup>-7</sup> /day	-73 to +27	0.05 dB (4 digits)	Freq. & Ampl.	1, 8
3320C (Pg. 550)	10 kHz to 17 MHz	10 kHz (20 Hz with Vernier)	10 <sup>-7</sup> /day	-73 to +10 +15, 90	0.01 dB (4 digits)	—	1
3330B (Pg. 350)	DC - 13 MHz	0.1 Hz (3 digits)	10 <sup>-7</sup> /day	-87 to +13	0.05 dB (4 digits)	Freq. & Ampl.	2, 3, 4, 6, 8
3335A (Pg. 345)	200 Hz - 80 MHz	.001 Hz	10 <sup>-7</sup> /day	-87 to +13	0.01 dB (4 digits)	Freq. & Ampl.	2, 3, 8
8660A/C** (Pg. 358)	101 kHz to 2600 MHz (3 plug-ins)	1 Hz or 2 Hz (10 digits)	3 × 10 <sup>-7</sup> /day	-146 to +13	3 dB steps plus vernier	Freq., Ampl. & Modulation	A/C, 5, 7, 8 C, 3
8671A (Pg. 354)	2 to 6.2 GHz	1 kHz	5 × 10 <sup>-7</sup> /day	> 8	—	Freq., FM Modulation	8, 9
8672A** (Pg. 352)	2 to 76 GHz	1, 2, 3 kHz	5 × 10 <sup>-7</sup> /day	-120 to +3	3 dB steps plus vernier	Freq., Ampl. & Modulation	8, 10

\* Other features: (1) 10<sup>-7</sup>/day freq. stability optional, (2) 5 × 10<sup>-7</sup>/day, (3) digital true, sweep, (4) digital ampl. sweep, (5) internal AM/FM, (6) external AM/FM, (7) 5 × 10<sup>-7</sup>/day stability opt., (8) HP-IB, (9) External FM, (10) External AM & FM.

\*\* The 8660A/C and 8672A are synthesized signal generators. They are discussed in detail in the section labeled "Signal Generators."

### General information

Today's measurement needs are placing increasingly stringent requirements on signal sources for greater frequency resolution and stability. Radio astronomy, secure communications, narrowband component testing, satellite and terrestrial communications, local oscillator and automatic test systems are only a few of the many applications that continually require better and better signal sources.

Increased amplitude accuracy and resolution are also must requirements in many applications. The telecommunication industry's Frequency Division Multiplex (FDM) systems require high amplitude accuracy and resolution (0.01 dB) as well as high frequency resolution and stability. These amplitude capabilities are also finding their place in many R&D and production test situations.

The answer to these requirements has been the frequency synthesizer. With technology producing continuing cost reductions in synthesis techniques, the synthesizer is finding use as a precision oscillator and signal generator as well as the more traditional uses as a synthesizer.

### Frequency synthesizer definition

A frequency synthesizer is an instrument that translates the frequency stability of a single reference frequency to any one of many other desired frequencies. This definition of a synthesizer distinguishes it from the oscillator or signal generator which derives its frequency from a tuned circuit or resonant cavity. The desired output frequency of these types of sources is produced directly by adjusting the values of oscillator components. The stability and resolution of these sources are limited by these components. However, the synthesizer's output frequency is synthesized or created by some type of arithmetic operation on the basic frequency reference as shown in the synthesizer model below.

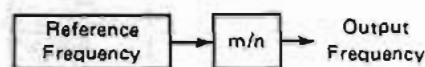

As the model above shows, any desired frequency can be obtained by selecting the appropriate values for  $m$  and  $n$ . The frequency reference in the above model is in many cases an internal crystal, either ambient temperature or oven stabilized, while in other cases the reference is an external standard such as a crystal, rubidium gas cell or cesium beam.

### Frequency generation

Synthesizers employ two general methods of generating the output frequency — direct and indirect synthesis. In the direct synthesis method, a series of arithmetic operations (multiplying, dividing, mixing) is performed on the reference to achieve the desired output frequency. High switching speed (microseconds) is the primary advantage of direct synthesizers.

Hewlett Packard synthesizers use the indirect synthesis method which derives its output frequency from one or more voltage tuned oscillators (VTO). The stability of the synthesizer comes from phase-locking the VTOs to the reference frequency or a harmonic of the reference via a phase-lock loop (PLL). The VTO outputs are then combined to achieve the desired output frequency. The primary advantage of the indirect method is lower cost.

### Signal quality

The common specifications which describe signal sources include frequency range and resolution, amplitude range and resolution, distortion and stability. These, plus several additional parameters must be considered when comparing synthesizers. The two primary additional specifications pertinent to the synthesizer are phase noise and spurious content.

**Phase noise:** Phase noise describes the short term frequency stability of a signal source. Internal short-term frequency fluctuations inherent in the signal source will produce phase modulation sidebands about the nominal frequency. Phase noise is a measure of the magnitude of these sidebands. There are two common methods of specifying phase noise — a sideband plot and integrated phase noise.

The first method expresses phase noise as the ratio of the power in one phase noise sideband per hertz of bandwidth to the total signal power. A sideband plot of the phase noise graphically displays the magnitude and frequency components (spectral density) of the phase noise.

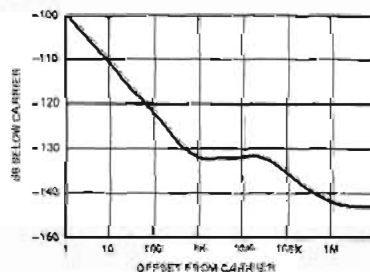

Typical single-sideband phase noise measured at output of Model 3335B Automatic Synthesizer in 1-Hz bandwidth with instrument operating at 10 MHz.

The second method, integrated phase noise, is the ratio of the rms value of the total phase noise sidebands in a 30 kHz bandwidth around the carrier (excluding  $\pm 1$  Hz) to the power of the carrier.

For a detailed treatment of the subject of phase noise and practical methods of measuring it, refer to Application Note #207.

**Spurious signals:** Spurious signals are discrete non-harmonically related signals appearing in the output. The spurious output specification is the maximum level, in dB below the carrier, of any spurious signal.

### Hewlett-Packard synthesizers

Hewlett-Packard offers a wide range of high quality frequency synthesizers covering the frequency range of DC to 18 GHz. In addition to being high performance synthesizers, they incorporate many additional features which allow them to fulfill the needs for either bench or programmable precision signal sources or as versatile programmable signal generators.

### Precise level control

Precision amplitude capability consisting of 100 dB amplitude range, 0.05 dB flatness, and 0.01 dB resolution allow the 3320B/C, 3330B and 3335A to perform as precision level generators as well as synthesizers. Precise level control using a True-RMS leveling loop eliminates the need for external leveling and level monitoring.

### Level control

The 8660A/C uses several interchangeable plug-ins to provide output flexibility including a wide range attenuator and exceptionally flat frequency response across the full 2 to 18 GHz range.

### Synthesized signal generator

The HP 8660A/C and 8672A synthesized signal generators cover the range of 10 kHz to 18 GHz. These instruments combine synthesizer accuracy and stability and HP-IB programmability along with the precise modulation and output level calibration of a high quality signal generator. For complete details on these and other signal generators, please refer to the "Signal Generators" section.

### Synthesized level generator

The HP 3335A is a synthesized level generator covering the range of 200 Hz to 80 MHz. Balanced outputs, telecommunication output impedances and special connectors make this instrument ideal for the telecommunications industry as a stand-alone generator with synthesizer stability or as a companion generator for the HP 3745A/B SLMS. For detailed information on this generator, refer to the "Telecommunications" section.

### Digital sweep

The 3330B, 3335A, and 8660C are among the most linear sweepers ever built. Keyboard control of the built-in microprocessor gives both instruments digital sweep (a point-by-point sweep with frequency synthesizer accuracy).

The 3330B also offers digital amplitude sweeps. Amplitude can be swept in increments as small as 0.01 dB to test level-sensitive circuits like voltage-controlled oscillators and automatic gain control loops.

### Programmability (HP-IB)

The 3320B, 3330B, 3335A, 8660A/C, 8671A, and 8672A are programmable via the Hewlett-Packard Interface Bus (HP-IB), Hewlett-Packard's implementation of IEEE STD 488-1975. Multiple signal sources interfaced to the same interface bus each may be independently programmed for different functions or frequencies.

# FREQUENCY SYNTHESIZERS

200 Hz to 80 MHz automatic synthesizer  
Model 3335A



## Description

Covering a frequency range of 200 Hz - 80 MHz, the 3335A Synthesizer/Level Generator has performance characteristics that make it ideally suited for the telecommunications industry, as well as for traditional synthesizer applications. The 3335A's broad frequency range allows testing of all classes of Frequency Division Multiplex (FDM) equipment as well as R & D and production testing of communications systems or components. It features precision level control, milliHertz resolution across its entire frequency range, high spectral purity, optional frequency stability of  $\pm 5 \times 10^{-10}$ /day, internal frequency sweep and numerous user conveniences. The 3335A offers full programmability (IEEE Std. 488-1975) as a standard feature for use in automatic test systems.

### Microprocessor Power

The 3335A uses a microprocessor which performs the overall control within the instrument. In addition, the microprocessor greatly simplifies operation and provides additional powerful instrument features to include:

- Four modes of internal frequency sweep for precision sweep applications.
- Automatic correction of the output amplitude display for different impedances.
- Internal memory which will store 10 complete instrument front panel settings for rapid recall in repetitive tests.
- Out-of-limits warning for improper parameter entries.
- Arbitrary increment values for digitally stepping the output frequency, amplitude and phase.
- Selection of minimum output amplitude when instrument is turned on to prevent possible damage to the circuit under test.

### Internal Storage

Characterizing a device under test often requires a selected number of spot frequencies and amplitudes. For manual testing, this generally means resetting all of the front panel settings every time a

change is desired. Not so with the 3335A. Up to 10 different front panel settings (frequency, level,  $\theta$  incr, etc.) can be stored in internal memory registers. Once stored, the contents of each register can be recalled to reset all front panel controls to the preprogrammed condition, or if desired, only one parameter may be altered. The DISPLAY key allows viewing of register contents without altering the synthesizer output.

### Precision Amplitude

Increasing channel capacity of Frequency Division Multiplex (FDM) systems is continually placing more stringent requirements on the testing of transmission parameters. This, in turn, places further demands on test equipment used to design and maintain FDM systems. One such area where new standards of performance are being required is amplitude control. To meet these performance standards, the 3335A incorporates a state-of-the-art attenuator resulting in attenuator accuracies of up to  $\pm 0.03$  dB over the 80 MHz frequency range. To achieve these accuracies, the attenuator uses thin-film tantalum nitride resistor pads in a coaxial transmission line structure. A true rms leveling loop provides  $\pm 0.15$  dB flatness over the entire frequency range. For limited frequency applications, the flatness is specified at  $\pm 0.07$  dB from 1 kHz to 25 MHz. For even greater flatness control or for leveling at the output of a cable, an external leveling input is provided so the output can be leveled with an external DC signal.

### Programmability

The 3335A is fully programmable via the Hewlett-Packard Interface Bus (HP-IB), HP's implementation of IEEE Standard 488-1975. This industry-standard interface eliminates mechanical and electrical interface problems and greatly simplifies software development. With the ease of interface, automatic test systems are economically justifiable for limited-volume applications or even one-time tests. Most Hewlett-Packard 9800 Series Programmable Calculators as well as Models 21 MX and 2100 series minicomputers are easily interfaced to the HP-IB.

# FREQUENCY SYNTHESIZERS

## 200 Hz to 80 MHz automatic synthesizer

### Model 3335A (cont.)

#### Manual Tuning with Digital Precision

For applications which require manual frequency tuning, the 3335A with its Rotary Pulse Generator (RPG) provides the optimal solution. This shaft encoder uses a dual optical sensor to digitally increment (or decrement) the output frequency. Fine or coarse tuning is accomplished simply by selecting the digit to be tuned. The benefit of this type of tuning is that the "analog feel" is preserved while fully realizing the accuracy advantage of precision digital frequency generation.

#### Frequency Stability

The 3335A synthesizes its output frequency from an internal temperature-controlled crystal oscillator which provides  $\pm 1 \times 10^{-8}$ /day frequency stability. For even more exacting requirements, an optional high stability crystal with a 24-hour stability of  $\pm 5 \times 10^{-10}$  is available. For instant turn-on, the STANDBY position on the power switch leaves power applied to the crystal oven whenever the line cord is plugged in. Also, the 3335A can be phase-locked to any external frequency standard which is a subharmonic of 40 MHz from 1 MHz to 40 MHz.

#### Automatic Frequency Sweep

The 3335A combines the precision frequency accuracy and stability of a synthesizer with the time-saving convenience of a sweeper. Digital sweeping under the control of the microprocessor overcomes the major drawbacks of analog or ramp sweeping where the noise, non-linearity and inaccuracy of the analog signal is directly translated to the output signal of the sweeper.

#### Signal Quality

The 3335A features very high spectral purity. Harmonics are specified at greater than 45 dB below the carrier from 200 Hz to 10 MHz, and at 40 dB down for frequencies up to 80 MHz. Non-harmonically related spurious components are specified at greater than 75 dB below the carrier. Integrated phase noise is also better than -70 dB depending on output frequency.

#### SLMS - Tracking Generator

The 3335A operates as a tracking generator with the HP 3745A/B Selective Level Measuring Set (SLMS) for automatic or semi-automatic testing of FDM systems. For closed-loop tracking where the 3335A and 3745A/B are in the same location, the frequency of the generator is controlled by the microprocessor in the SLMS. The 3745A/B and 3335A can sweep through any selectable frequency spectrum or cycle through the channels of a multiplex system by calling up the channel frequencies from the FDM plans stored in the memory of the SLMS. The 3335A and 3745A/B can also operate in an open loop tracking mode where they are separated by the system under test. For even more measurement power, the 3335A and 3745A/B can easily be interfaced via the HP-IB.

## Specifications

#### Frequency

**Range:** 200 Hz-80,999,999,999 MHz.

**Resolution:** 0.001 Hz.

**Display:** 11 digit LED display in MHz, kHz, or Hz.

**Stability (higher stability available with Opt 001):**  $\pm 1 \times 10^{-8}$ /day;  $\pm 1 \times 10^{-10}$ /month

**External frequency reference:** the 3335A may be phase-locked with a 100 mV to 1.25 V rms signal that is any subharmonic of 40 MHz from 1 MHz through 40 MHz.

**Frequency switching and settling time:** <20 ms to within 90° of final phase.

#### Spectral purity

**Harmonic components (relative to fundamental, full output):**

200 Hz - 10 MHz: -45 dB.

10 MHz - 80 MHz: -40 dB.

**Spurious:** all non-harmonically related outputs will be greater than 75 dB below the carrier or -125 dBm, whichever is greater.

**Phase noise (30 kHz band, excluding  $\pm 1$  Hz, centered on the carrier):** 9.9 MHz: -63 dB; 20 MHz: -70 dB; 40 MHz: -64 dB; 80 MHz: -58 dB.

#### Amplitude

##### Range

50  $\Omega$ : +13.01 dBm to -86.98 dBm; 75  $\Omega$ : +11.25 dBm to -88.74 dBm.

**Resolution:** 0.01 dB.

**Display:** 4 digit LED display, automatically corrected for output impedance.

**Absolute accuracy (full amplitude at 100 kHz, 10°C to 35°C):**  $\pm 0.05$  dB.

**Note:** To determine absolute accuracy tolerances at other frequencies or amplitudes, the flatness and attenuator specifications must be added to the above accuracy specification.

**Flatness (relative to 100 kHz, full amplitude):** 1 kHz - 25 MHz:  $\pm 0.07$  dB; 200 Hz - 80 MHz:  $\pm 0.15$  dB.

##### Attenuator

**Range:** 98 dB in 2 dB steps.

**Accuracy (1 year)**

Z <sub>o</sub>	ATTENUATION (dB)	FREQUENCY		
		200 Hz	25 MHz	80 MHz
50 $\Omega$ 75 $\Omega$	0 to 18	$\pm 0.03$ dB $\pm 0.04$ dB	$\pm 0.15$ dB	
50 $\Omega$ 75 $\Omega$	20 to 58	$\pm 0.07$ dB $\pm 0.09$ dB	$\pm 0.25$ dB	
50 $\Omega$ 75 $\Omega$	60 to 98	$\pm 0.2$ dB $\pm 0.2$ dB	$\pm 0.50$ dB	

**Amplitude switching time:** <500 ms to within  $\pm 0.02$  dB of final value.

#### Sweep characteristics

##### Sweep Modes:

**Single 10 sec:** 10 second single sweep from min. to max. frequency.

**Single 50 sec:** 50 second single sweep from min. to max. frequency.

**Manual:** bidirectional sweep, rate and direction controlled by the frequency tuning knob (RPG).

**Auto:** repetitive sweep from min. to max. frequency at a nominal rate of 125 ms per sweep.

**Center frequency:** may be set to any frequency from 200 Hz - 80 MHz.

**Sweep width:** may be set to any width from 1 Hz to 80 MHz provided the resultant sweep does not exceed the 200 Hz - 80 MHz instrument frequency range.

**Number of steps:** 10 sec., 50 sec., MANUAL: 1000 steps; AUTO (125 ms): 100 steps.

**Phase discontinuities:** there will be no significant phase discontinuities provided the following breakpoints are not crossed:

200 Hz - <10 MHz: 1 MHz points, e.g. 1 MHz, 2 MHz, etc.

10 MHz - <20 MHz: 250 kHz points, e.g. 10.25 MHz, 10.5 MHz, etc.

20 MHz - <40 MHz: 500 kHz points.

40 MHz-80 MHz: 1 MHz points.

#### Opt 001 (high stability frequency reference)

**Aging rate:**  $\pm 5 \times 10^{-10}$ /day;  $\pm 2 \times 10^{-9}$ /month;  $\pm 1 \times 10^{-7}$ /year.

**Temperature coefficient:**  $<7 \times 10^{-9}$  frequency change (0 to 50°C range).

**Warm up:** reference will be within  $5 \times 10^{-9}$  of final value 20 minutes after turn-on at 25°C (final value is defined as the frequency 24 hours after turn-on).

### Opt 002/004

For specifications not listed below, refer to standard instrument specifications.

#### Frequency

**Range:** 75 Ω: 200 Hz - 80,999,999,999 MHz; 124 Ω: 10 kHz - 10 MHz; 135 Ω: 10 kHz - 2 MHz.

**Resolution:** .001 Hz.

#### Spectral purity

**Harmonic components [relative to fundamental, full output (75 Ω), 0 dBm (124 Ω/135 Ω)]:** 200 Hz-10 MHz: -45 dB; 10 MHz-80 MHz: -40 dB.

#### Nonharmonic spurious signals (25°C ± 10°C):

75 Ω: 75 dB below the carrier or -125 dBm, whichever is greater.

124 Ω: 75 dB below the carrier or -97 dBm, whichever is greater.

135 Ω: 75 dB below the carrier or -100 dBm, whichever is greater.

#### Amplitude

**Range:** +11.25 dBm to -88.74 dBm.

**Resolution:** 0.01 dB.

#### Flatness (relative to 100 kHz at full amplitude):

75 Ω: 1 kHz - 25 MHz: ±0.07 dB; 200 Hz - 80 MHz: ±0.15 dB

124 Ω: 50 kHz - 10 MHz: ±0.15 dB; 10 kHz - 10 MHz: ±0.40 dB

135 Ω: 10 kHz - 2 MHz: ±0.18 dB

**Accuracy at full output (100 kHz, 10°C to 35°C):** 75 Ω: ±0.05 dB;

124 Ω/135 Ω: ±0.10 dB

**Amplitude accuracy (includes the effects of flatness and attenuator)**

75 Ω	200 Hz	1 kHz	25 MHz	80 MHz
+ 11.25				
- 8.74	± 0.25 dB	± 0.15 dB	± 0.35 dB	
-48.74	± 0.30 dB	± 0.20 dB	± 0.45 dB	
-88.74	± 0.40 dB	± 0.30 dB	± 0.70 dB	

124 Ω	10 kHz	50 kHz	10 MHz
+ 11.25			
- 8.74	± 0.60 dB	± 0.35 dB	
-48.74	± 0.65 dB	± 0.40 dB	
-70.0*	± 1.1 dB	± 0.85 dB	

135 Ω	10 kHz	2 MHz
+ 11.25		
- 8.74	± 0.35 dB	
-48.74	± 0.40 dB	
-70.0*	± 0.85 dB	

\*Levels down to -88.74 dBm can be selected, however, accuracies are unspecified due to spurious noise floor of -100 dBm.

#### Outputs

**Output Impedances:** 75 Ω unbalanced, 124 Ω balanced, 135 Ω balanced

**Signal Balance (100 kHz):** >60 dB.

#### Opt 002

75 Ω: commercial equivalent of WECO type 477B (accepts WECO plug 358A).

124 Ω: commercial equivalent of WECO type 477B at 16 mm (0.625") spacings (accepts WECO plug 372A)

135 Ω: commercial equivalent of WECO type 223A at 16 mm (0.625") spacings (accepts WECO plug 241A).

#### Opt 004

75 Ω: commercial equivalent of WECO type 560A (accepts WECO plug 439A or 440A).

124 Ω: commercial equivalent of WECO type 560A at 12.7 mm (0.5") spacings (accepts WECO plug 443A).

135 Ω: commercial equivalent of WECO type 223A at 16 mm (0.625") spacings (accepts WECO plug 241A).

### Opt 003

#### Frequency

**Range:** 75 Ω: 200 Hz - 80,999,999,999 MHz; 150 Ω: 10 kHz - 2 MHz.

**Resolution:** .001 Hz.

#### Spectral purity

**Harmonic components [relative to fundamental full output (75 Ω), 0 dBm (150 Ω)]:** 200 Hz-10 MHz: -45 dB; 10 MHz-80 MHz: -40 dB.

#### Nonharmonic spurious signals

75 Ω: 75 dB below the carrier or -125 dBm, whichever is greater.

150 Ω: 75 dB below the carrier or -100 dBm, whichever is greater.

#### Amplitude

**Range:** +11.25 to -88.74 dBm.

**Resolution:** 0.01 dB.

**Flatness (relative to 100 kHz at full amplitude):** 75 Ω: 1 kHz-25 MHz: ±0.07 dB, 200 Hz-80 MHz: ±0.15 dB; 150 Ω: 10 kHz-2 MHz: ±0.18 dB.

**Accuracy at full output (100 kHz, 10°C to 35°C):** 75 Ω: ±0.05 dB; 150 Ω: ±0.10 dB.

**Amplitude accuracy (includes the effects of flatness and attenuator)**

75 Ω	200 Hz	1 kHz	25 MHz	80 MHz
+ 11.25				
- 8.75	± 0.25 dB	± 0.15 dB	± 0.35 dB	
-48.74	± 0.30 dB	± 0.20 dB	± 0.45 dB	
-88.74	± 0.40 dB	± 0.30 dB	± 0.70 dB	

150 Ω	10 kHz	2 MHz
+ 11.25		
- 8.74	± 0.35 dB	
-48.74	± 0.40 dB	
-70.0*	± 0.85 dB	

\*Levels down to -88.74 dBm can be selected, however accuracies are unspecified due to spurious noise floor of -100 dBm.

#### Outputs

##### Output Impedances

75 Ω Unbalanced, 150 Ω Balanced

**Signal Balance (100 kHz):** >60 dB

##### Connectors

75 Ω: BNC; 150 Ω: Pair of BNC's at 20 mm (0.8") spacings

#### General

##### Warm-up Time

**Standby to "ON":** <20 s to full frequency specifications, <30 min. to full amplitude specifications.

**Application of power to "ON":** <30 min. to meet amplitude specifications and to be within  $1 \times 10^{-5}$  of final frequency. (final value is defined as the frequency 24 hours after turn-on).

##### Operating environment

**Temperature:** 0°C to 55°C.

**R.H.:** <95% . 0°C to +40°C.

**Storage temperature:** -40°C to +75°C.

**Power:** 100/120/220/240 V, +5%, -10%; 48 to 66 Hz; 195 VA.

**Weight:** net: 18.2 kg (40 lbs). Shipping: 26.8 kg (59 lbs).

**Size:** 132.6 H x 425.5 W x 497.8 mm D (5 1/8" x 16 3/4" x 19 3/8").

##### Ordering Information

J335A

Opt 001

Opt 002

Opt 003

Opt 004

Prices effective in U.S. only

Price
\$7000
add \$580
add \$300
add \$200
add \$300

# FREQUENCY SYNTHESIZERS

.01 Hz to 13 MHz frequency synthesizer

Models 3320A & 3320B

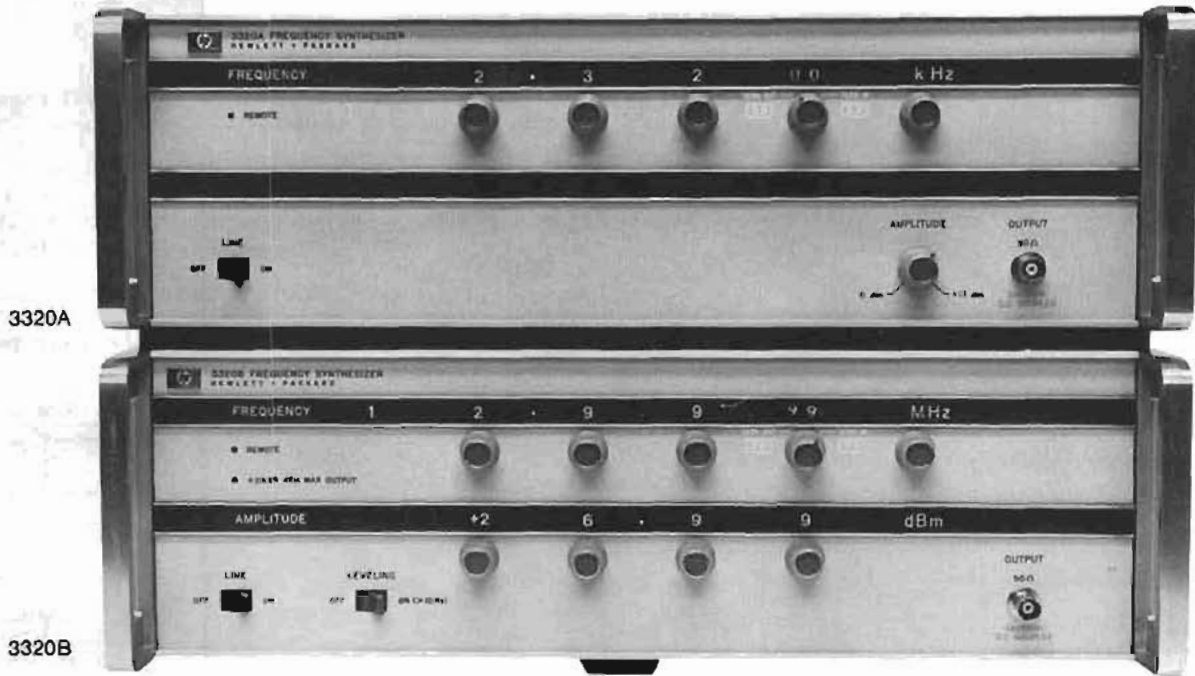

## Description

The 3320A/B Frequency Synthesizer has the frequency accuracy, stability, and resolution demanded by many of today's exacting applications. The ease and flexibility of adding greater stability means the 3320A/B can be tailored to your needs as they emerge. Spectral purity and low signal-to-phase noise complement the frequency qualities of the 3320A/B.

The 3320B is more than a synthesizer. It offers precise level control, superior frequency response, low harmonic distortion and high power output.

Two choices of digital remote control afford great flexibility for today's system applications. High precision in both frequency and amplitude means that expensive system monitoring is unnecessary.

## Frequency

The 3320A/B Frequency Synthesizer has a broad frequency range of 0.01 Hz to 13 MHz in seven frequency ranges.

Three digits plus a ten-turn two-digit continuous vernier, plus 30% overrange capability, gives the 3320A/B one part in  $10^6$  frequency resolution across its total frequency range.

## Amplitude

The 3320A has a maximum one volt rms into 50 ohms output (+13 dBm) with a continuous +13 dBm to 0 dBm amplitude vernier.

The 3320B features a four-digit leveling loop with a 0.01 dB level

resolution of a calibrated output from +26.99 dBm to -69.99 dBm (-73.00 dBm under remote control).

Frequency response of  $\pm 0.05$  dB over the range of 10 Hz to 13 MHz, and level accuracy of  $\pm 0.05$  dBm absolute at 10 kHz, complement the level capability of the 3320B.

## Programmability/remote control

The 3320A/B is a programmable signal source. Digital remote control capability may be purchased installed in the instrument, or may be added later if the need arises.

The 3320A, with its Option 003, allows parallel BCD remote control of frequency only. The first digit of the frequency vernier, the frequency range, and the main frequency digits may be controlled remotely.

The 3320B has two remote control options. Both options allow full control of all functions except the last vernier digit and the line switch. Option 004 is parallel BCD remote control capability. Option 007 (HP-IB) is a unique bit-parallel/word serial programming option. The Hewlett Packard Interface Bus (HP-IB) provides a low-cost versatile way to interconnect instruments digitally.

## Specifications

**Frequency range:** 0.01 Hz to 13 MHz in 7 ranges.

**Frequency ranges:** 10 MHz, 1000 kHz, 100 kHz, 10 kHz, 1000 Hz, 100 Hz and 10 Hz (optional), 30% overrange on all ranges.



**Frequency resolution**

Range	Vernier Out (local or remote)	Vernier In (local)	Vernier In (remote)
10 MHz	10 kHz	10 Hz	1 kHz
1000 kHz	1 kHz	1 Hz	100 Hz
100 kHz	100 Hz	0.1 Hz	10 Hz
10 kHz	10 Hz	0.01 Hz	1 Hz
1000 Hz	1 Hz	1 mHz	0.1 Hz
100 Hz	0.1 Hz	0.1 mHz	0.01 Hz
10 Hz	0.01 Hz	0.01 mHz	0.001 Hz

**Frequency accuracy**

**Vernier out:** ±0.001% of setting for 6 mo, 0°C to 55°C.

**Vernier in:** ±0.01% of range for 6 mo, 0°C to 55°C.

**Frequency stability**

**Long term:** ±10 parts in 10<sup>6</sup> of setting per year (vernier out) with ambient temperature reference. Optional high stability crystal reference oven available (Option 002).

**Signal-to-phase noise (integrated):** >40 dB down in 30 kHz band, excluding ±1 Hz, centered on carrier. 10 MHz range, vernier out. Improves on lower frequency ranges.

**Harmonic distortion:** with output frequencies >0.1% of range at full output amplitude, any harmonically related signal will be less than the following levels: -60 dB with output from 5 Hz to 100 kHz; -50 dB with output from 100 kHz to 1 MHz; -40 dB with output from 1 MHz to 13 MHz.

**Spurious:** >60 dB down.

**Internal frequency standard:** 20 MHz crystal.

**Phase locking:** the 3320A/B may be phase locked with a 200 mV to 2 V rms signal that is any subharmonic of 20 MHz.

**Rear panel output:** front or rear panel output is standard.

**Auxiliary outputs**

**Tracking outputs:** 20 MHz to 33 MHz offset signal. >100 mV rms/50Ω.

**1 MHz reference output:** 220 mV rms/50Ω (>0 dBm/50Ω).

**Low level output:** same frequency as main output but remains between 50 mV rms and 158 mV rms (into 50Ω) depending on main output level setting.

**3320A Amplitude section**

**Amplitude:** maximum 1 V rms ±10% into 50Ω.

**Amplitude range:** 0 dBm to +13 dBm range through ¼ turn front panel control (not programmable).

**Frequency response:** ±2 dB over total range.

**Output impedance:** 50Ω (75Ω, Opt 001).

**3320B Amplitude section**

**Amplitude range:** +26.99 dBm (½ watt) to -69.99 dBm (-73.00 dBm under remote control) into 50Ω. (+26.99 dBm = 5 V rms into 50Ω).

**Amplitude resolution:** 0.01 dB.

**Frequency response (10 kHz reference):**

dc	10 Hz	12 MHz
±0.5 dB	±0.05 dB	-26.99 dBm
	±0.1 dB	-3.00 dBm
	±0.2 dB	-23.00 dBm
	±0.4 dB	-53.00 dBm
		-73.00 dBm

**Amplitude accuracy (absolute):** +26.99 dBm, ±0.05 dB at 10 kHz and (20°C to 30°C).

**Output impedance:** 50Ω (75Ω Option 001).

**Options**

**001 (3320A/B) 75 ohm:** amplitude range (3320B only) +24.99 dBm to -69.99 dBm (-75.00 dBm under remote control) into 75Ω.

**002 (3320A/B) crystal oven\*:** 5 MHz crystal in temperature stabilized oven. Long term stability: ±1 part in 10<sup>6</sup>/day; ±1 part in 10<sup>7</sup>/mo. Frequency accuracy: ±1 part in 10<sup>7</sup> of setting per mo. For field installation order accessory kit HP 11237A.

**003 (3320A only) BCD remote control\*:** allows digital remote control of frequency only on 3320A. The most significant digit of the vernier may be programmed, thus giving four digits, plus 30% over-range, control of frequency in seven ranges (two are optional). Frequency switching and settling time: ±0.1% of range, 15 ms, ±0.001% of range, 60 ms. For field installation order accessory kit HP 11238A.

**004 (3320B only) BCD remote control\*:** allows digital remote control of frequency and amplitude. \*\*Four digits of frequency, over-range, frequency range, Vernier In/Out, four digits of amplitude, and leveling loop response times are all controlled digitally. Frequency switching and settling time is ±0.01% of range, 15 ms; ±0.001% of range, 60 ms. Amplitude switching and setting time: <1.5 s to rated accuracy. For field installation, order accessory kit HP 11238C.

**006 (3320A/B) 100 Hz, 10 Hz Ranges\*:** adds two lower frequency ranges, 100.0 Hz and 10.00 Hz, yielding greater resolution for low frequency outputs (see resolution section of specifications). These two ranges are fully programmable if digital remote options are installed. For field installation, order Accessory Kit HP 11240A.

**007\* (3320B only) HP-IB remote control:** allows bit-parallel word-serial remote control of all functions. \*\*This fully-isolated option allows the 3320B to be interconnected with up to 14 additional HP-IB compatible instruments on a common interface bus. Using a unique addressing scheme, the 3320B can be singled out to receive its individual programming instructions on the bus. This permits several 3320B's to be interconnected to the same interface bus, each programmed to different frequencies and amplitudes. All front panel controls are disabled when in remote control. For field installation, order Accessory Kit, HP 11239C.

Logic Level Requirements for all Digital Remote Control Options.

State	Requirements
"Low" (logical "1")	0 V to 0.4 V (5 mA max.) or contact closure to ground through <80 ohms.
"High" (logical "0")	+2.4 V to +5 V or removal of contact closure to ground.

**General**

**Operating temperature:** 0°C to 55°C.

**Storage temperature:** -40°C to +70°C.

**Power requirements:** 115 V or 230 V ±10%, 48 Hz to 63 Hz, 110 VA max.

**Weight**

**3320A:** net. 14.4 kg (32 lb). Shipping, 18.1 kg (40 lb).

**3320B:** net. 15.9 kg (35 lb). Shipping, 19.5 kg (43 lb).

**Size:** 132.6 H, 425 W, 542.9 mm D (5<sup>7</sup>/<sub>16</sub>" × 16<sup>1</sup>/<sub>4</sub>" × 21<sup>9</sup>/<sub>16</sub>").

**Options and accessories**

3320A/B Opt 001: 75Ω output	N/C
3320A/B Opt 002: Crystal Oven	\$500
3320A Opt 003: BCD remote control	\$355
3320B Opt 004: BCD remote control	\$425
3320A/B Opt 008: 100 Hz/10 Hz ranges	\$238
3320B Opt 007: HP-IB remote control	\$765
11048C: 50Ω feedthrough termination	\$17
11094B: 75Ω feedthrough termination	\$17
11473-76A: Balancing Transformers. (see page 517.)	\$290

**Ordering information**

3320A Frequency Synthesizer	\$2600
3320B Frequency Synthesizer	\$3665

\*Field installable.

\*\*Except last vernier digit and line switch.

# FREQUENCY SYNTHESIZERS

## 0.1 Hz to 13 MHz automatic synthesizer

### Model 3330B

- HP-IB
- Digital sweeping of frequency and amplitude

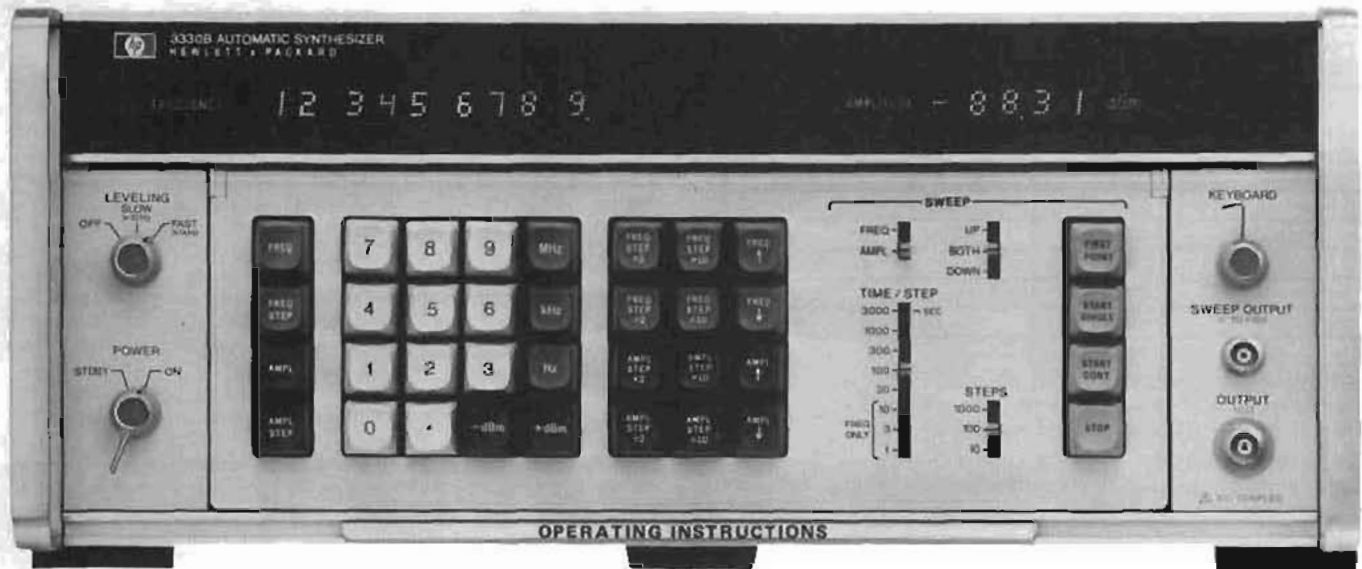

### Description

The fully programmable (HP-IB) 3330B Frequency Synthesizer has a frequency stability of  $\pm 1 \times 10^{-8}$  per day,  $-50$  dB signal-to-phase noise, with a constant resolution of 0.1 Hz up to 13 MHz. Amplitude can be controlled to a resolution of 0.01 dB over a 100 dB range.

Solid-state displays show frequency and amplitude. Nine digits of frequency and four digits of amplitude are displayed on the Model 3330B.

Spectral purity, not normally associated with frequency synthesizers, is a unique feature of the 3330B. Spurious is  $>70$  dB below the carrier and harmonics are  $>60$  dB to 40 dB below the carrier, depending upon the frequency setting. As a sweeper, the 3330B uses digital sweeping for linearity. Either single or continuous sweeps may be set up. Parameters such as center frequency, frequency step, time per step, and the number of steps go into the memory, then are executed by pressing a single button. The ROM operates the sweep as set up until told to stop. Many of the sweep parameters can be changed while the instrument is sweeping. The instrument sweeps amplitude in steps as small as 0.01 dB. The amplitude can be stepped at the end of each frequency sweep cycle to produce a family of curves.

### Specifications

**Frequency range:** 0.1 Hz to 13,000,999.9 Hz.

**Frequency resolution:** 0.1 Hz (8 digits + overrange).

**Frequency stability**

**Long term:**  $\pm 1 \times 10^{-8}$  of frequency per day,  $\pm 1 \times 10^{-7}$  of frequency per month.

**Temperature:**  $\pm 1 \times 10^{-8}$  of frequency at  $25^\circ\text{C} \pm 10^\circ\text{C}$ ,  $\pm 1 \times 10^{-7}$  of frequency at  $0^\circ\text{C}$  to  $55^\circ\text{C}$ .

**Signal to phase noise (Integrated):** 50 dB down in a 30 kHz band, excluding  $\pm 1$  Hz, centered on carrier.

**Harmonic distortion:** with full output amplitude, any harmonically related signal will be less than the following specified levels.

5 Hz to 100 kHz:  $-60$  dB.

100 kHz to 1 MHz:  $-50$  dB.

1 MHz to 13 MHz:  $-40$  dB.

**Spurious**

All nonharmonically related spurious signals will be greater than 70 dB below selected output level or  $\leq 110$  dBm/50 $\Omega$ , whichever is greater.

**Frequency switching and settling time:** the time required for frequency switching and settling is a function of the largest frequency digit affected by the frequency change in question.

Largest digit changed	0.1 Hz or 1 Hz	10 Hz or 100 Hz	1 kHz or 10 kHz	100 kHz, 1 MHz or 10 MHz
Switching and settling time	$< 1$ ms to within 500 $\mu\text{Hz}$	$< 1$ ms to within 0.05 Hz	$< 1$ ms to within 5 Hz $< 50$ ms to within 0.01 Hz	$< 1$ ms to within 500 Hz; $< 50$ ms to within 1 Hz

**Internal frequency reference:** 5 MHz crystal oscillator in temperature stabilized oven.

**Frequency adjustments**

**Coarse:** internal adjustment adequate for five years of aging.

**Fine:** one turn pot or  $\pm 5$  V dc for  $1.2$  to  $2.5 \times 10^{-7}$  max control with internal reference or  $3 \times 10^{-8}$  max control with rear panel switch in ext. ref. position without an external reference applied.

**External frequency reference:** the 3330B may be phase locked with a 200 mV to 2 V rms signal that is any subharmonic of 20 MHz from 1 MHz through 10 MHz.

**Rear panel output:** front or rear panel output is standard.

**Auxiliary outputs**

**20 - 33 MHz tracking output:**  $> 100$  mV rms/50 $\Omega$ .

**1 MHz reference output:**  $> 220$  mV rms/50 $\Omega$  (0 dBm/50 $\Omega$ ).

**Synthesized search or tune:** a frequency step (0.1 Hz min) may be entered. This step may be added to or subtracted from the synthesized output signal. Rate of search or tune is selected by the time per step control.

**Digital sweeping of frequency:** accomplished by entering and setting the center frequency, a frequency step, number of steps, time per step, and sweep direction.

**Sweep width:** the product of the step size and number of steps.

**Step size:** continuously adjustable in 0.1 Hz increments.

**Step accuracy:**  $\pm 1 \times 10^{-8}$  per day for standard reference crystal.

**Number of steps:** 10, 100, or 1000.

**Time per step:** 1 ms, 3 ms, 10 ms, 30 ms, 100 ms, 300 ms, 1000 ms, and 3000 ms.

**Direction of sweep:** up, both, down.

**Single sweep:** initiated by momentary pushbutton.  
**Continuous sweep:** initiated by momentary pushbutton.  
**Manual sweep:** accomplished by holding down the freq ↑ or freq ↓ keys. Display will follow output.  
**Sweep output:** stepped dc voltage proportional to sweep position, 0 to +10V.  
**Accuracy:** ±0.2% of full scale.  
**Linearity:** ±0.1% of full scale.

#### Digital outputs

**Step count:** 0 to 1000 count on 12 BCD (1-2-4-8) lines to indicate sweep position.  
**Sweep status:** line to indicate when instrument is sweeping.  
**Step ready:** indicates instrument has spent the selected time per step and is ready to go to the next step.  
**Sweep modification (continuous):** during a continuous sweep, the step size, center frequency, sweep direction, and time per step may be changed without stopping the sweep.  
**Center frequency modification:** accomplished by pressing freq ↑ or freq ↓.  
**Frequency step:** to widen or narrow the sweep width, the frequency step size may be expanded or contracted by factors of 2 or 10. The keys labeled freq step ×2, freq step ÷2, freq step ×10 and freq step ÷10 may be pressed.  
**Sweep modification (single):** during a single sweep, the time per step and direction sweep may be changed without stopping the sweep.

#### Amplitude section

**Amplitude:** maximum 2.1 V rms into open circuit; maximum 1.05 V rms into 50Ω.  
**Amplitude range:** +13.44 dBm to -86.55 dBm into 50Ω.  
**Amplitude resolution:** 0.01 dB.  
**Output impedance:** 50Ω (75Ω Opt 001).  
**Display:** four digit readout in dBm with reference to 50Ω.  
**Leveled frequency response:** (10 kHz reference) 10 Hz-13 MHz.\*  
 +13.44 dBm to -16.55 dBm: ±0.05 dB.  
 -16.55 dBm to -36.55 dBm: ±0.1 dB.  
 -36.55 dBm to -66.55 dBm: ±0.2 dB.  
 -66.55 dBm to -86.55 dBm: ±0.4 dB.

**Amplitude attenuator accuracy:** ±0.02 dB/10 dB step (at 10 kHz) of attenuation down from maximum output.  
**Amplitude accuracy (absolute):** ±0.05 dB at 10 kHz and +13.44 dBm (15°C ±5°C). (For absolute accuracy at other frequencies and amplitudes, add 0.05 dB to the leveled frequency response specification, plus the attenuator accuracy specification.)

**Amplitude modulation:** requires external modulation source. Rear panel BNC. ALC switch must be in slow position.

**Modulating signal:** 100 Hz to 100 kHz.

**Modulation depth:** 0.95 V rms modulating signal for 95% modulation depth.

**Digital sweeping of amplitude:** accomplished by entering and setting the center amplitude, an amplitude step, number of steps, time per step and sweep direction.

**Type:** linear and symmetrical about the center amplitude.

**Sweep width:** product of the step size and number of steps.

**Step size:** 0.01 dB to 99.99 dB in 0.01 dB increments.

**Number of steps:** 10, 100, or 1000.

**Time per step:** 30 ms, 100 ms, 300 ms, 1000 ms, 3000 ms.

**Direction of sweep:** up, both, down.

**Single sweep:** momentary pushbutton. Display follows output.

**Continuous sweep:** momentary pushbutton. Display of center amplitude or step.

**Manual sweep:** accomplished by holding down the ampl ↑ or ampl ↓ keys. Display will follow output. Sweep output, digital outputs,

\*Add ±0.5 dB for leveling off.

sweep modification (continuous), sweep modification (single), all the same as with frequency sweep.

#### Digital remote control

Remote control of the 3330B is accomplished via the Hewlett-Packard Interface Bus (HP-IB) which is a standard feature of the instrument. Both the standard nonisolated HP-IB version and an optional isolated HP-IB version (Opt. 004) allow full programming of all frequency, amplitude and sweep functions.

The HP-IB interface allows the 3330B to be interconnected with up to 14 additional HP-IB compatible instruments on a common interface bus. Using an industry-standard addressing scheme, the 3330B can be singled out to receive its individual programming instructions. This permits multiple 3330B's, or other HP-IB sources, to be connected to the same interface bus, each programmed to different frequencies and amplitudes.

Connection of instruments to a system controller is vastly simplified since all HP-IB instruments are interfaced with a common I/O card and driver, Hewlett-Packard Models 9815A, 9825A, 9830A and 9831A Calculators, and Models 21MX and 2100 Series computers are all compatible with HP-IB.

#### Options

**001:** 75 ohms-1 V rms (factory installation only). Attenuation and output referenced to 75Ω.

**Amplitude range:** +11.25 dBm to -88.74 dBm.

**002:** High Stability Crystal Oven.

**Long term frequency stability:** ±1 × 10<sup>-9</sup> per day, +2 × 10<sup>-8</sup> per month.

**Long term temperature:** ±1 × 10<sup>-9</sup> total frequency at 25°C, ±10°C, ±1 × 10<sup>-8</sup> total of frequency at 25°C, 0°C to +55°C.

**Frequency adjustments:** same as standard instrument.

**003:** deletion of Crystal Oven. 20 MHz ambient temperature crystal reference oscillator.

**Frequency stability:** ±10 parts in 10<sup>8</sup>/yr.

**Frequency adjustments:** rear panel I turn pot or rear panel voltage control input for 30 × 10<sup>-6</sup> maximum control.

**004:** isolated Digital Input (factory installation only). With this option, the digital input lines are electrically isolated from the signal ground. (HP-IB)

**DC isolation:** ±250 V.

**AC isolation:** >30 dB, 0 to 1 MHz.

**005:** 5 V rms-50 ohm output. This option gives the 3330B a ½ watt output.

**Amplitude range:** +26.99 dBm to -73 dBm into 50 ohms.

#### General

**Operating temperature:** 0°C to +55°C.

**Storage temperature:** -40°C to +70°C.

**Turn on time:** application of power to "On": 20 min to within ±1 × 10<sup>-7</sup> of the final frequency.

"Standby" to "On": 15 s to full specifications.

**Power requirements:** 115 V or 230 V ±10%, 48 Hz to 63 Hz, 20 W standby, 200 W on.

**Weight:** net, 22.6 kg (53 lb). Shipping, 26.8 kg (63 lb).

**Dimensions:** 177 mm H × 426 mm W × 547 mm D (7" × 16<sup>3</sup>/<sub>4</sub>" × 21<sup>1</sup>/<sub>2</sub>").

#### Options

**001:** 75Ω-1 V output

**002:** crystal oven

**003:** deletion of oven

**004:** isolated HP-IB

**005:** 5 V-50Ω output

#### Price

N/C

add \$580

less \$150

add \$440

add \$295



Hewlett-Packard calibration instruments provide accurate and precise dc and ac stimulus for your calibration needs. Accurate dc voltage measurements capability to 1000 volts is also available for testing dc power supplies and other precision dc sources. See Table 1 for a list of instrument features.

**Table 1.**

FUNCTION	RANGE	RESOLUTION	MODEL NO.	PAGE
AC volts	1 mV—1000 V*	1 ppm	745A	354
AC volts DC volts AC amps DC amps	0.01 V—1000 V	3 digits	6920B	353

\*X10 Amplifier for 745A

- Calibrate/test DC ammeters up to 4 amps
- Calibrate/test average-reading AC ammeters up to 5 amps

- Calibrate/test DC voltmeters up to 1000 volts
- Calibrate/test average-reading AC voltmeters up to 1000 volts



## Specifications

### Output voltage ranges

- 0.01-1 V: current capability 0-5 A.
- 0.1-10 V: current capability 0-1 A.
- 1-100 V: current capability 0-100 mA.
- 10-1000 V: current capability 0-10 mA.

Above output voltage ranges and maximum current capabilities for each range apply for either dc or ac operation.

### Output current ranges (5 A maximum output)

- 1-100  $\mu$ A: voltage capability 0-500 V (uncalibrated in AC).
- 0.01-1 mA: voltage capability 0-500 V.
- 0.1-10 mA: voltage capability 0-500 V.
- 1-100 mA: voltage capability 0-50 V.
- 0.1-10 A: voltage capability 0-5 V.

0.1-10 A: (5 A max. output) voltage capability 0-0.5 V. Above output current ranges and maximum voltage capabilities for each range apply for either dc, 50 Hz or 60 Hz operation.

**Output accuracy:** DC—0.2% of set value plus 1 digit. AC—0.4% of set value plus 1 digit (when used with average-reading meters). Above accuracy applicable over a temperature range from 15°C to 35°C, over full input voltage range, and after 1-hour warmup.

### Controls

**Function switch:** 3-positions: OFF, AC, and DC. In the OFF position the ac power input is disconnected from the unit. In the AC position the meter calibrator produces an ac output, and in the DC position the calibrator produces a dc output.

**Range switch:** 10 positions, one for each voltage and current range.

**Calibrated output control:** digital potentiometer readout control (3 significant digits) determines exact value of output.

**Output switch:** switch described at left.

**Output terminals:** two front panel terminals are provided; these are the output terminals for both ac and dc operation. In voltage ranges, the negative terminal is grounded.

**Ripple:** in dc operation the output ripple is typically less than 1.0% rms/5% p-p of the output range switch setting.

**Input:** 115 V ac  $\pm$  10%, single-phase, 58-62 Hz, 0.7 A, 65 W max. (See Options 005 and 028 for 50 Hz and 230 V ac operation).

**Operating temperature range:** 0°C-50°C; convection cooled.

**Size:** 172 H  $\times$  198 W  $\times$  279 mm D (6 $\frac{7}{8}$ "  $\times$  7 $\frac{7}{8}$ "  $\times$  11").

**Weight:** net, 6.8 kg (15 lb). Shipping 7.71 kg (17 lb)

### Options

- 005: 50 Hz output regulation realignment
- 028: 230 V ac  $\pm$  10%, single phase input

Price  
N/C  
N/C

### Accessories

5060-8762 Rack kit for mounting one or two 6920B's in a 19" rack

\$55

5060-8760 Filler panel to block unused half of rack adapter

\$11

**6920B Meter calibrator**

**\$895**

## Description

Model 6920B is a versatile ac/dc meter calibrator, capable of both constant-voltage and constant-current output. Its absolute accuracy makes it suitable for laboratory or production testing of panel meters, multimeters, and other meters having accuracy on the order of 1.0% or higher. This calibrator has been designed for convenience, and combines in one instrument all the outputs needed to test the most commonly used meters.

### Output switch

The output switch has two ON positions. The ON TEST position has a momentary contact and output is obtained only while the switch is held ON. This is convenient when several full scale readings are being checked successively and the meter and calibrator are being switched through their ranges. The ON HOLD position is used when continuous output is desired.

### AC output waveshape

When the function switch is set on AC, the output wave-shape is sinusoidal (to a first approximation) and has the same frequency as the input line power applied to the instrument (except when an external ac reference is used). The feedback loop, which controls and regulates this ac, is actually monitoring the average value of the ac output although the front panel controls are calibrated in terms of rms. Thus, this calibrator is suitable for use with average-reading ac voltmeters scaled in rms. In addition, the calibrator can be used with true-rms meters, provided allowance is made for the total output distortion. This distortion is approximately equal to the line input waveshape distortion (or distortion of the external ac reference) plus 3%.

# CALIBRATORS

AC calibrator, high voltage amplifier

Models 745A & 746A

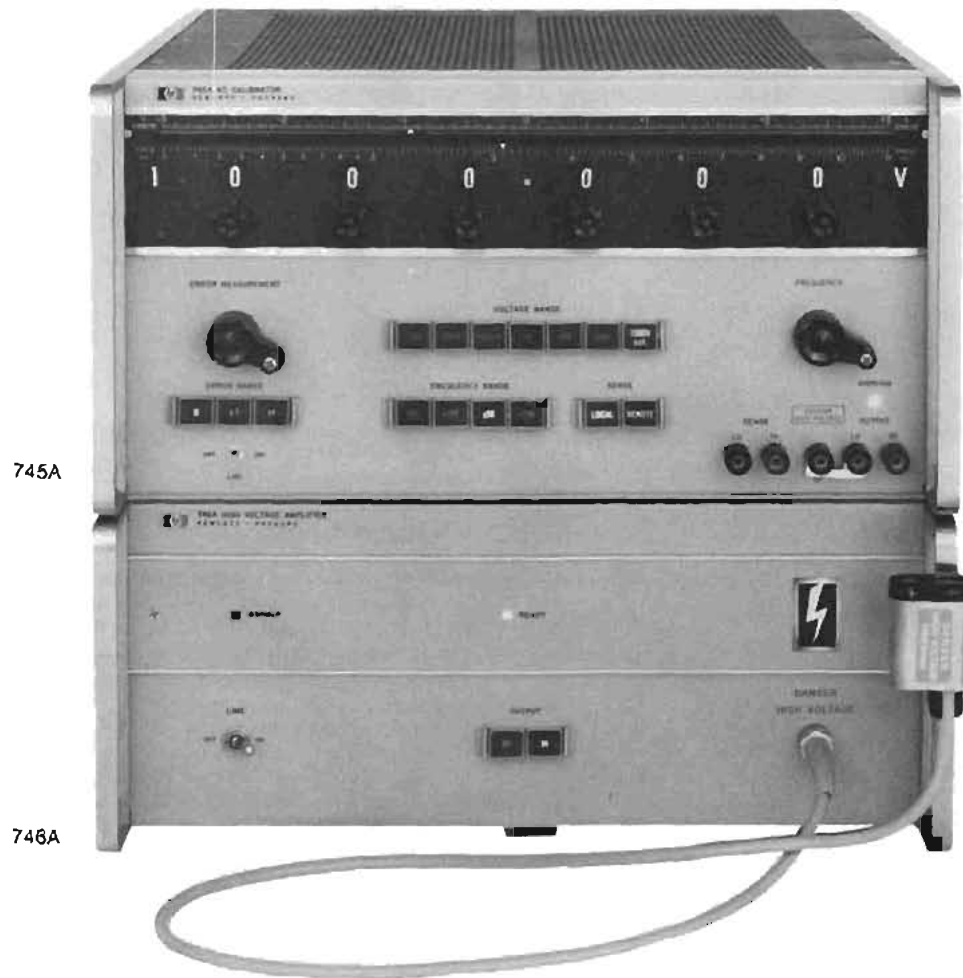

745A

746A

## Description

Hewlett-Packard's Model 745A AC Calibrator combined with Model 746A High Voltage Amplifier is a compact, calibrated AC source with continuously adjustable frequency output from 10 Hz to 110 kHz. Output voltage can be varied from 0.1 mV to 1099.999 V in steps as small as 1 ppm of range over the entire frequency range.

HP's 745A provides the first six voltage ranges, 0.1 mV to 109.9999 V, while the combination of the 745A and 746A permits expansion to 1099.999 V as a seventh range. Model 746A can only be used with the 745A.

## Specifications

### Ranges

**Output voltage ranges:** seven ranges with 10% overrange as follows:

Range	Settability and resolution
1 mV	0.100000 mV to 1.099999 mV in 1 nV steps
10 mV	1.00000 mV to 10.99999 mV in 10 nV steps
100 mV	10.0000 mV to 109.9999 mV in 100 nV steps
1 V	0.100000 V to 1.099999 V in 1 $\mu$ V steps
10 V	1.00000 V to 10.99999 V in 10 $\mu$ V steps
100 V	10.0000 V to 109.9999 V in 100 $\mu$ V steps
1000 V	100.000 V to 1099.999 V in 1 mV steps

Output voltage from 100  $\mu$ V to 110 V are available from 745A output terminals; voltages from 100 V to 1100 V are available from the 746A output cable.

**Output frequency ranges:** continuously adjustable from 10 Hz to 110 kHz in four decade ranges with 10% overlap.

**Error measurement:** two ranges with zero center dial;  $\pm 0.3\%$ ,  $\pm 3\%$ . A zero range is provided to easily switch out the effects of the error measurement system.

### Performance rating

**Accuracy:** accuracy holds for a 90-day period and is met after a one-hour warm-up period at 25°C  $\pm 5^\circ$ C with <95% RH. This applies only to the 745A. Warm-up time required for HP's 746A is approximately 30 s.

**Voltage:** specifications are absolute, traceable to National Bureau of Standards.

### 1 mV to 100 V ranges

Frequency	Accuracy
50 Hz to 20 kHz	$\pm (0.02\%$ of setting $+ 0.002\%$ of range $+ 10 \mu$ V)
20 Hz to 50 Hz 20 kHz to 110 kHz	$\pm (0.05\%$ of setting $+ 0.005\%$ of range $+ 50 \mu$ V)
10 Hz to 20 Hz	$\pm (0.2\%$ of setting $+ 0.005\%$ of range $+ 50 \mu$ V)

**1000 V range**

Frequency	Accuracy
50 Hz to 20 kHz	±0.04% of setting
20 Hz to 50 Hz 20 kHz to 50 kHz	±0.08% of setting
50 kHz to 110 kHz	±0.15% of setting
10 Hz to 20 Hz	±(0.2% of setting +0.005% of range)

**Frequency:** ±(2% of setting +0.2% of end scale).  
**Error measurement:** ±(0.5% of setting +0.5% of range).

**Temperature coefficient**

**Voltage:** 1 mV to 100 V ranges: ±0.0003% of setting per °C, 0°C to 55°C. 1000 V range: ±0.0005% of setting per °C, 0°C to 55°C.

**Frequency:** ±0.05% of end scale per °C, 0°C to 55°C. Derate accuracy specification by this temperature coefficient for operation in temperature range of 0°C to 20°C and 30°C to 50°C.

**Voltage stability:** stability met after one-hour warm-up period at constant temperature with <95% RH. 1 mV to 100 V ranges:

- Long-term:** ±0.01% of setting for six months.
- Short-term:** ±0.005% of setting for 24 hours.

**1000 V range**

- Long-term:** 50 Hz to 20 kHz: ±0.01% of setting for six months; 10 Hz to 50 Hz and 20 kHz to 110 kHz: ±0.02% of setting for six months.
- Short-term:** ±0.005% of setting for 24 hours.

**Output characteristics**

**Total distortion and noise:** 0.05% of setting + 10 µV over 100 kHz bandwidth on all ranges.

**Total distortion, cycle-to-cycle instability and noise:** will cause <±0.005% of error when used to calibrate an average-responding or true rms-responding instrument from 1 mV to 1100 V.

**Load regulation (no load to full load)**

**Output impedance:** <1Ω on 1 mV, 10 mV, 100 mV ranges. On the 1 V, 10 V, 100 V and 1000 V ranges for output current equal to or less than that shown in the diagram below, error is included in the accuracy specification.

**Load capability:** 1000 pF or 50 mA on 1 mV to 100 V ranges (50 mA allows 800 pF at 100 V, 100 kHz); 1000 pF or 63 mA on 1000 V range (63 mA allows 100 pF at 1000 V, 100 kHz).

**Line regulation:** ±0.001% of setting change in output voltage for a 10% change in line voltage (included in accuracy specs).

**Output terminals:** high and low output terminals can be floated ±500 V dc above chassis ground.

**Counter output:** frequency counter output on 745A rear panel, 2.2 V ±50%, protected against short circuits.

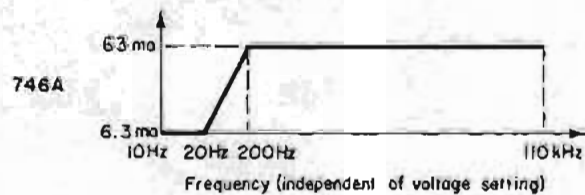
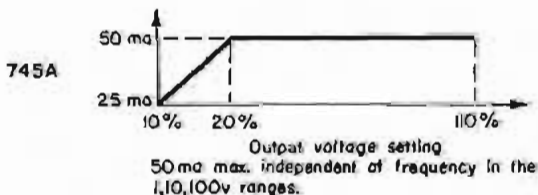

**Remote programming**

Voltage range, frequency range, error range, and senses	Requirements
Contact closure	Less than 400Ω to ground
NPW transistor	Open circuit voltage 5 V Short circuit current 2 mA Maximum voltage on programming line at closure 0.8 V.
Read switch through diode	
NPW transistor through diode	Minimum to maximum of range
Frequency vernier	
Analog voltage	+3 V to +10 V DC
Resistance to ground	500Ω—10 kΩ

**General**

**Operating temperature:** 0°C to 55°C.

**Storage temperature:** -40°C to +75°C.

**RFI:** meets MIL-1-61811D when using shielded output connectors.

**Power**

**745A:** 115 V or 230 V ±10%, 50 Hz to 66 Hz, 100 VA max.

**746A:** 115 V or 230 V ±10%, 50 Hz to 60 Hz, 850 VA max.

**746A** aux power rated at 120 VA max.

**Weight**

**745A:** net, 29.3 kg (65 lb). Shipping, 36.3 kg (80 lb).

**746A:** net, 34 kg (75 lb). Shipping, 38.5 kg (85 lb).

**Dimensions**

**745A:** 221 mm H × 425 mm W × 467 mm D (8.75" × 16.75" × 18.37").

**746A:** 177 mm H × 425 mm W × 464 mm D (7" × 16.75" × 18.25").

**745A Accessories furnished**

Rack mount kit.

HP Part No. 5060-0630, 22-pin printed circuit board extender.

HP Part No. 5060-0043, 15-pin printed circuit board extender.

HP Part No. 5060-0031, 10-pin printed circuit board extender.

HP Part No. 1251-0084 remote programming plug.

**746A Accessories furnished**

Rack mount kit.

HP Part No. 1251-0485, remote right angle connector.

HP Part No. 1450-0356, incandescent lamp.

HP Part No. 4040-0427, extractor.

HP Part No. 5060-0404, probe holder.

HP Part No. 5060-0216, joining kit bracket.

HP Part No. 5060-0630, 22-pin printed circuit board extender.

HP Part No. 00746-0270, foam filter.

**Ordering information**

- 745A AC Calibrator
- 746A High Voltage Amplifier

**Price**  
 \$5500  
 \$3500



## Signal generators

Hewlett-Packard offers a complete line of easy to use HF, VHF, UHF, and SHF signal generators covering frequencies between 10 kHz and 40 GHz. This line includes synthesized signal generators and solid-state generators as well as a complete line of performance-proven vacuum tube signal generators. Each includes the following features: 1) accurate, easy-to-read frequencies, calibrated and variable; 2) accurately calibrated variable output level; 3) wide modulation capability.

Beside these basic features, HP signal generator characteristics ensure the utmost convenience and accuracy for all kinds of measurements and signal simulations, including receiver sensitivity, selectivity or rejection, signal-to-noise ratio, gain bandwidth characteristics, conversion gain, antenna gain, and transmission line characteristics, as well as power to drive bridges, slotted lines, filter networks, etc.

### 2 to 18 GHz microwave synthesized signal generator

HP's newest signal generator, Model 8672A, provides AM/FM capability and calibrated output usually associated only with signal generators, along with the resolution, spectral purity, stability and programmability of a high quality synthesizer. The HP 8672A covers 2 to 18 GHz with output from +3 to -120 dBm.

A companion unit, the HP 8671A, is a synthesizer only, with a minimum of +8

dBm from 2 to 6.2 GHz and FM only. Both units are programmable via the HP Interface Bus.

The HP 8672A will find application in several important areas: 1) As a programmable signal simulator in automatic test systems; 2) For satellite receiver testing requiring highly stable ( $5 \times 10^{-10}$ /day) signals; 3) General purpose lab use where its multi-band capability can replace a benchful of separate band generators; and, 4) Production use where short runs require different frequency ranges from run to run.

The 8671A will serve in local oscillator applications requiring up-conversion or multiplication for satellite communications or radio astronomy. SSB noise is -89 dB/Hz below the carrier at a 10 kHz offset. Non-harmonic spurious is -70 dB.

### 10 kHz to 2600 MHz synthesized generator

The HP 8660A/C is a particularly versatile synthesized generator family. Two mainframes are available. The 8660A utilizes thumbwheel switches for frequency selection. The 8660C mainframe has a more versatile keyboard control featuring synthesized digital sweep and frequency-step capability. Programming options for both BCD and HP-IB interfaces are available.

Three plug-in RF sections provide three separate ranges: 10 kHz to 110 MHz, 1 MHz to 1300 MHz, and 1 MHz to 2600 MHz. Output levels are calibrated over >140 dB of range. A wide range of modula-

tions can be configured with plug-in sections. AM, FM, and phase modulation as well as external pulse modulation are available in various combinations.

### Solid-state, high performance generators

This group of signal generators offers all the advantages of solid-state design, such as increased portability, ruggedness, and reliability, while still retaining the outstanding signal quality characteristics of Hewlett-Packard's older vacuum tube signal generators. In addition these generators offer many features not found on the older generators such as digital frequency readout (8640B, 8660C), ability to count external signals (8640B), field portability (8654A/B) and complete remote programming (8660A, 8660C).

### HF to UHF

The performance leader of the solid-state family is the 8640 signal generator covering 450 kHz to 550 MHz. Frequency coverage can be extended to 1100 MHz with an internal doubler (Opt 002) and an optional builtin audio oscillator extends the CW output range down to 20 Hz (Opt 001). This generator is available in three models: the 8640A with mechanical slide rule frequency dial; the 8640B featuring a built-in 550 MHz counter; and the 8640M for ruggedized applications.

The 8640B with built-in counter includes two significant new features not previously found on Hewlett-Packard signal generators:



1) the ability to count external signals at frequencies up to 550 MHz and 2) a front panel pushbutton to phase-lock the generator's RF output to the counter time base for frequency stability of better than  $5 \times 10^{-9}$ /hour.

Internally, the heart of the 8640 is a mechanically tuned high-Q cavity oscillator that operates over the range of 230 to 550 MHz. This oscillator has very good inherent stability and exceptionally low noise characteristics. Nine lower frequency ranges are obtained by dividing down the basic oscillator frequency and filtering out the unwanted harmonics. Frequency range from 10 kHz to 10 MHz can be obtained using the 11710B Down Converter with the 8640 & 8654.

The 8640M is a ruggedized version of the 8640B featuring phase-locked stability, digital read-out, built-in thermal cutoff and reverse power protection. The 'M' with its aluminum carrying case has been type-tested to withstand shock, vibration and humidity extremes, and is specified to operate over a temperature range of  $-40^{\circ}\text{C}$  to  $+55^{\circ}\text{C}$  for field and flight-line measurements.

#### Compact, field portable

Compact, portable signal generators form another part of the solid-state family. The 8654 covering 10 to 520 MHz features calibrated output level with a full range attenuator and both AM and FM modulation capability. Small size and light weight make

it well suited for field maintenance and operational readiness checks in addition to general purpose signal generator applications. The 8654A is an AM generator with uncalibrated FM capability, while the 8654B has full calibrated and metered FM and AM.

The 8655A Synchronizer/Counter combines with the 8654A and B to phase lock the generator's RF output to the counter time base for frequency stability of better than 0.1 ppm/hour. In addition the 8655A is an RFI-proof counter with the capability to count external signals up to 520 MHz.

### Performance-proven vacuum tube signal generators

#### HF to UHF

The HP 606B, 608E, and 612A signal generators collectively cover frequencies from 50 kHz to 1.23 GHz. All feature extremely low drift and incidental frequency modulation, and may be amplitude (sine, square, pulse) modulated.

#### UHF to SHF

A complete line of Hewlett-Packard microwave signal generators provides coverage from 800 MHz to 21 GHz. The 618C, 620B, 626A, and 628A incorporate cavity-tuned klystron oscillators with very low drift and residual FM. They may be pulse, square-wave and frequency modulated, making them useful for microwave receiver

testing as well as SWR and transmission line measurements.

The HP 8614A and 8616A signal generators covering 0.8 to 2.4 GHz and 1.8 to 4.5 GHz feature built-in PIN diode modulators. These modulators allow internal or external output power leveling as well as a wide range of pulse and amplitude modulation.

HP 938A and 940A Frequency Doubler Sets provide low-cost signal generator capability in the 18 to 40 GHz range by doubling the frequency of signal sources in the 9 to 20 GHz range.

#### Special signal generators/accessories

For Avionics navigation and communications applications, the 8640B option 004 combines the digital readout, phase lock features with a demodulated output and special AM circuitry. Combined with suitable external modulation sources the 8640B provides for testing and calibration of aircraft VOR/ILS and Marker Beacon receivers.

A variety of accessories are available to enhance the operation of HP signal generators. The list includes a spectrum generator, frequency doublers, output terminations, a fuse holder, balanced mixers, filters and a series of PIN modulators to increase the modulation capability of microwave signal sources. Also available is the new HP 11720A Pulse Modulator providing high performance pulse modulation capability over the range of 2 to 18 GHz.

## Signal generator summary

Model	Frequency range	Characteristics	Page
8671A Synthesizer	2 to 6.2 GHz	1 kHz frequency resolution, $5 \times 10^{-10}$ /day stability. $\approx 8$ dBm minimum output, completely HP-IB programmable. EXT FM	364
8672A Synthesized Generator	2 to 18.6 GHz	1 to 3 kHz frequency resolution, $5 \times 10^{-10}$ /day stability. Calibrated output from $-3$ to $-120$ dBm. Completely HP-IB programmable, metered, external AM and FM	362
8660A/C Synthesized Generator	0.01 to 110 MHz 1 to 1300 MHz 1 to 2600 MHz	1 Hz frequency resolution, $3 \times 10^{-9}$ /day stability. Calibrated output from $-13$ to $-146$ dBm. Completely TTL programmable. Plug-ins determine frequency range and modulation capability	358
606B Signal Generator	50 kHz to 65 MHz	output 3 V to 0.1 $\mu\text{V}$ , mod. BW dc to 20 kHz, low drift and noise, low incidental FM, low distortion, auxiliary RF output	372
8640A/B/M Signal Generator	0.5–1024 MHz	output $+19$ to $-145$ dBm into 50 $\Omega$ ; AM, FM, and ext. pulse modulation, direct calibration, leveled output. 8640B has built-in counter and phase-lock capability. All solid state	365, 369
8640B Opt. 004 Avionics Generator	0.5 to 512 MHz	same as 8640B with phase shift $<0.01^{\circ}$ at 30 Hz, demodulated AM output, 1 dB step attenuator, for use with external VOR/ILS Audio Generators	368
608E Signal Generator	10 to 480 MHz	output 1 V to 0.1 $\mu\text{V}$ , into 50-ohm load; AM, pulse modulation, direct calibration, leveled power output, aux RF output	373
3200B Oscillator	10–1000 MHz	1 V to 1 $\mu\text{V}$ output into 50 $\Omega$ , 120 dB attenuator range 0.002% stability, compact, portable, weight, 15 lb. Doubler extends frequency to 1000 MHz	378
8654A/B Signal Generator	10–520 MHz	output 0 to $-120$ dBm into 50 $\Omega$ , direct calibration, leveled output, amplitude and frequency modulation, solid-state, compact, weight 16 lb	370
8655A Synchronizer/Counter	10–520 MHz	phase lock frequency stabilizer for 8654A and B. 6-digit LED display lock resolution, 500 Hz. Low RFI, external count capability to 520 MHz	371
612A Signal Generator	450 to 1230 MHz	output 0.5 V to 0.1 $\mu\text{V}$ into 50-ohm load; pulse or square-wave modulation, direct calibration	374
8614A, 8616A Signal Generator	0.8 to 2.4 GHz 1.8 to 4.5 GHz	output $+10$ (8616: $+3$ dBm above 3 GHz) to $-127$ dBm into 50 ohms, leveled below 0 dBm; internal square-wave; external pulse, AM and FM, auxiliary RF output	375
618C, 620B Signal Generators	3.8 to 7.6 GHz 7 to 11 GHz	output 1 mW to $-127$ dBm (0.1 $\mu\text{V}$ ) into 50 ohms, pulse, frequency or square-wave modulation, direct calibration, ext FM and pulse modulation, auxiliary RF output	376
626A, 628A Signal Generators	10 to 15.5 GHz 15 to 21 GHz	output $+10$ dBm to $-90$ dBm; pulse, frequency or square-wave modulation, direct calibration	377
938A, 940A Frequency Doublers	18 to 26.5 GHz 26.5 to 40 GHz	driven by 9 to 13.25 GHz source, 13.25 to 20 GHz source, HP 626A, 628A, 8690 or 8620 series sweepers or klystrons, 100 dB precision attenuator	377

# SIGNAL GENERATORS

## Synthesized Signal Generators

Model 8660A and 8660C

- 10 kHz to 2600 MHz
- Synthesizer stability and accuracy
- 1 Hz resolution (2 Hz above 1300 MHz)
- Calibrated output over >140 dB range
- AM, FM,  $\Phi$ M, or pulse modulation
- Fully TTL programmable



8660C



### System Concept

The 8660A/C family is a modular solid-state plug-in system. Each system includes: 1) a programmable synthesized signal generator mainframe, 2) at least one RF section plug-in, and 3) at least one modulation section. This modular plug-in construction allows an 8660 system to be configured for any specific application while minimizing the added expense of unnecessary features.

As its name implies, the 8660 is a true frequency synthesizer. Yet it is finding even broader appeal as a high performance signal generator. And being completely programmable, the 8660 is the perfect choice for most automated receiver or component testing situations.

### Mainframes

There are two different synthesized signal generator mainframes to choose from. Both feature complete TTL programming of frequency, output levels, and most modulation functions. The standard programming interface is BCD and an optional HP-IB interface is available. Both mainframes can operate from an internal crystal reference or external frequency standard.

The 8660 A mainframe uses thumbwheel switches to select CW output frequencies. Frequencies up to 1300 MHz can be entered directly with 1 Hz resolution. (For applications requiring frequencies above 1300 MHz the 8660A must be used with the 86603A Option 003. The frequency selection process involves selecting one-half of the desired RF output frequency and activating the 86603A Option 003 front panel doubler switch).

The 8660C keyboard mainframe provides direct keyboard entry of CW frequencies up to 2600 MHz. Added capabilities of the 8660C include digital sweep, frequency stepping, synthesized search, and a ten-digit numerical display.

Swept testing of very narrowband devices such as crystal filters is made possible by the 8660C's digital sweep. Since the RF output consists of discrete synthesized steps, the result is a very linear sweep with extremely low residual FM. A 0-8 V horizontal sweep output is provided for driving XY plotters, oscilloscopes, etc.

For applications which require frequency to be changed in uniform increments, a frequency stepping capability is provided on the

8660C. For example, if a receiver with 50 kHz channel spacing is being tested, a 50 kHz step size can be entered and the frequency stepped to the next higher or lower channel with a single key-stroke.

Synthesized search provides the dial tuning convenience of a signal generator while maintaining synthesizer signal quality. As the dial is turned the output frequency is tuned up or down in discrete synthesized steps which may be chosen as small as 1 Hz.

### Plug-In RF Sections

There are three RF sections to choose from. The 86601A covers the 10 kHz to 110 MHz frequency range with calibrated output of +13 to -146 dBm. The 86602B (used with the 11661B Frequency Extension Module) covers 1 MHz to 1300 MHz with output of +10 to -146 dBm. The 86603A (also used with the 11661B) covers 1 MHz to 2600 MHz with output of +7 to -136 dBm. All RF sections have 1 Hz frequency resolution except for 2 Hz above 1300 MHz with the 86603A. In the remote mode output level can be programmed in 1 dB steps over the full operating range.

### Plug-In Modulation Sections

There are five modulation sections to choose from. The 86632B and 86633B are both AM/FM modulation sections. An accurate modulation meter indicates % AM or FM peak deviation. The 86633B differs from the 86632B in that the carrier is phase locked while FM modulating at rates and deviations up to 100 kHz. The 86632B utilizes a free running VCO during FM but allows rates and deviations up to 1 MHz. Any drift can be removed by depressing the FM CF CAL button.

The 86634A offers only analog phase modulation at rates to 10 MHz and metered deviations to 100° below 1300 MHz and 200° above 1300 MHz. The 86635A  $\Phi$ M/FM Modulation Section is similar in performance to the 86634A except rates are limited to 1 MHz and FM capability is also included. (The 86634A and 86635A must be used with Option 002 RF sections).

The 86631B Auxiliary Section provides both external AM and pulse modulation. The 86631B Auxiliary Section must be used when another modulation section is not installed.

All modulation functions of the 86632B, 86633B, and 86635A are fully programmable.

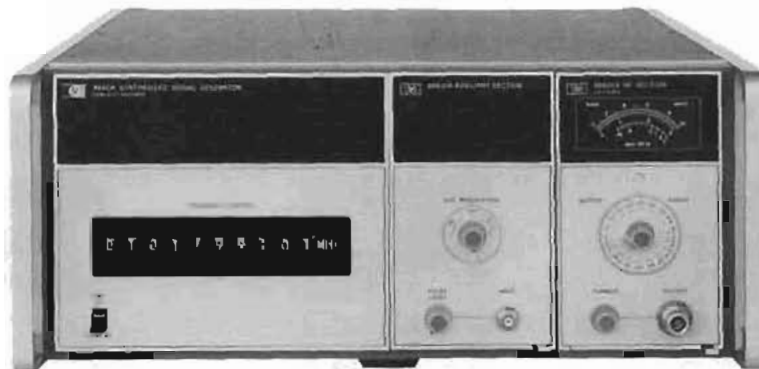

8660A

### 8660A/C mainframe specifications

**Frequency accuracy and stability:** CW frequency accuracy and long term stability are determined by reference oscillator in 8660A/C mainframe ( $3 \times 10^{-8}$ /day) or by external reference, if used.

#### Reference oscillator

**Internal:** 10 MHz quartz oscillator. Aging rate less than  $\pm 3$  parts in  $10^6$  per 24 hours after 72 hours warm-up. ( $\pm 3$  parts in  $10^6$  per 24 hours, Option 001).

**External:** rear panel switch allows operation from 5 MHz or 10 MHz frequency standard at a level between 0.5V and 2.5V rms into 170 ohms.

**Reference output:** rear panel BNC connector provides output of reference signal selected at level of at least 0.5 V rms into 170 ohms.

**Digital sweep (8660C):** auto, single or manual. Selectable speeds 0.1, 1, or 50 seconds.

#### Remote programming

##### Functions

**8660A:** all front panel frequency and output level, and most modulation functions are programmable.

**8660C:** CW frequency, frequency stepping (STEP $\uparrow$ , STEP $\downarrow$ ), and output level, and most modulation functions are programmable. Note: digital sweep is NOT programmable.

##### Programming input

**Connector type:** 36-pin Cinch type 57 (mating connector supplied). [Optional HP-IB interface: 24-pin Cinch type 57 (mating connector NOT supplied)].

**Logic:** TTL compatible (negative true).

**Switching time:** less than 5 ms to be within 100 Hz of any new frequency selected. (Less than 100 ms to be within 5 Hz).

### General

**Operating temperature range:** 0° to +55°C.

**Power:** 100, 120, 220, or 240 volts +5%, -10%, 48-66 Hz. Approximately 350 watts.

**Weight:** [Mainframe only] net, 23.8 kg (53 lb). Shipping, 29.6 kg (65 lb).

#### Options for 8660A/C

**001:**  $\pm 3 \times 10^{-8}$ /day internal reference oscillator.

**002:** no internal reference oscillator.

**003:** operation from 50 to 400 Hz line.

**004:** 100 Hz frequency resolution (200 Hz above 1300 MHz CF).

**005:** HP-IB programming interface.

**100:** 11661B factory installed.

**009:** (8660A only): front panel LED display indicates selected frequency in 1-2-4-8 BCD code.

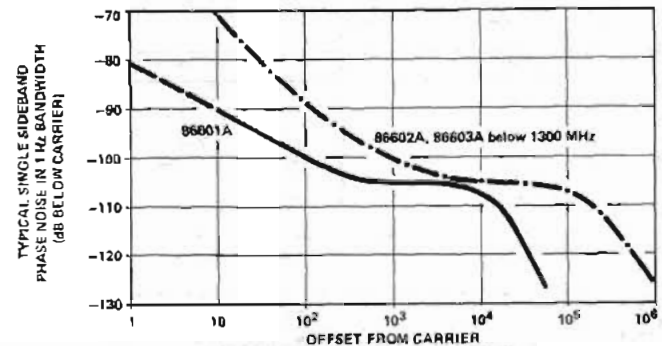

### RF section specifications (Installed in 8660A or 8660C mainframe)

		86601A	86602B (with 11661B)	86603A (with 11661B)
FREQUENCY CHARACTERISTICS	Frequency Range	0.01-110 MHz (109.999999 MHz)	1-1300 MHz (1299.999999 MHz)	1-2600 MHz (2599.999998 MHz)
	Frequency Resolution		1 Hz	2 Hz
	Harmonics	<-40 dB	<-30 dB (<-25 dB above +3 dBm)	<-20 dB <sup>1</sup>
	Spurious: Non Harmonically Related	-80 dB	-80 dB below 700 MHz -80 dB above 700 MHz within 45 MHz of carrier -70 dB above 700 MHz >45 MHz from carrier -50 dB on +10 dBm range <-70 dB	-74 dB within 45 MHz of carrier <sup>1</sup> -64 dB >45 MHz from carrier <-64 dB
	Power Line Related (CW, AM, FM only) <sup>2</sup>	-70 dB		
	Signal To Phase Noise Ratio (CW, AM, FM only) <sup>2</sup>	>50 dB	>45 dB	>39 dB

<sup>1</sup>For output levels +3 dBm and below, slightly higher from +3 to +7 dBm.

<sup>2</sup>Measured in a 30 kHz band centered on the carrier excluding a 1 Hz band centered on the carrier.

# SIGNAL GENERATORS

8660A & 8660C (cont.)

• 10 kHz to 110 MHz

• 1 MHz to 1300 MHz

• 1 MHz to 2600 MHz



86601A



86602B



86603A

RF Sections specifications (cont.)

		86601A	86602B (with 11651B)	86603A (with 11651B)		
		0.01—110 MHz	1—1300 MHz	1—1300 MHz	1300—2600 MHz	
OUTPUT CHARACTERISTICS	Output Level (into 50Ω)	-13 dBm to -146 dBm	+10 to -146 dBm	+10 to -136 dBm	+7 to -136 dBm <sup>3</sup>	
	Output Accuracy (local and remote)	±1 dB, +13 to -66 dBm ±2 dB, -66 to -146 dBm	±1.5 to -76 dBm ±2.0 to -146 dBm	±2.5 dB, to -76 dBm <sup>3</sup> ±3.5 dB, to -136 dBm		
	Flatness (output level variation with frequency)	≤±0.5 dB	≤±1.0 dB	±2.0 dB (1—2600 MHz)		
	Impedance	50Ω				
MODULATION CHARACTERISTICS	AM	AM Modulation Depth	0 to 95%	0 to 90% <sup>4</sup>		
		3 dB Bandwidth	200 Hz, CF < 0.4 MHz 10 kHz, 0.4 ≤ CF < 4 MHz 100 kHz, CF ≥ 4 MHz	10 kHz, CF < 10 MHz 10 kHz, CF ≥ 10 MHz	10 kHz	
		0—70%	1.25 Hz, CF < 0.4 MHz 6 kHz, 0.4 ≤ CF < 4 MHz 60 kHz, CF ≥ 4 MHz	6 kHz, CF < 30 MHz 60 kHz, CF ≥ 10 MHz	N/A	
		0—90%	200 Hz, CF < 0.4 MHz 5 kHz, 0.4 ≤ CF < 4 MHz 50 kHz, CF ≥ 4 MHz	5 kHz, CF < 10 MHz 50 kHz, CF ≥ 10 MHz	N/A	
	Distortion, THD at 30% AM at 70% AM at 90% AM	< 1%, 0.4—110 MHz < 3%, 0.4—130 MHz < 5%, 0.4—110 MHz	< 1% < 3% < 5%	< 5% N/A N/A		
	FM	FM Rate	DC to 1 MHz with 86632B 20 Hz to 100 kHz with 86633B	DC to 200 kHz with 86632B and 86635A 20 Hz to 100 kHz with 86633B		
		Maximum Deviation (peak)	1 MHz with 86632B 100 kHz with 86633B	200 kHz with 86632B and 86635A 100 kHz with 86633B	400 kHz w/86632B, 35A 200 kHz w/86633B	
		Distortion, THD (at rates up to 20 kHz)	< 1% up to 200 kHz dev. < 3% up to 1 MHz dev.	< 1% up to 200 kHz dev.		< 1% up to 400 kHz dev.
	PULSE	Pulse Rise/Fall Time	200 ns	50 ns		
		ON/OFF Ratio (with pulse level control at max.)	*50 dB	*40 dB		*60 dB
ΦM	ΦM Rate	N/A	DC to 1 MHz with 86635A DC to 1 MHz for CF > 100 MHz DC to 10 MHz for CF > 100 MHz } with 8634A			
	Maximum Peak Deviation	N/A	0 to 100 degrees		0 to 200 degrees	
	Distortion, THD	N/A	< 5% up to 1 MHz rates < 7% up to 5 MHz rates < 15% up to 10 MHz rates			
GENERAL	Weight	Net 5 kg (11 lb) Shipping 6.4 kg (14 lb)	Net 4.1 kg (9 lb) Shipping 5.5 kg (12 lb)	Net 5 kg (11 lb) Shipping 6.4 kg (14 lb)		
		11651B: Net 2.3 kg (5 lb), Shipping 2.7 kg (6 lb)				

3. For +3 to +7 dBm output levels, output accuracy and flatness will be slightly degraded (above 1300 MHz only).  
4. For RF output level meter readings from -3 dB to -6 dB and only at +3 dBm and below.

5. Applies only at 400 Hz and 1 kHz rates with output meter set at 0 to -3 dB. At -6 dB meter setting the distortion approximately doubles.  
6. Phase modulation is only possible with Option 002 RF Section.

## • Pulse/AM



86631B

## • AM/FM



86632B

## • AM/FM



86633B

 •  $\phi$ M

86634A

 •  $\phi$ M/FM

86635A

**Modulation section specifications**

		86631B	86632B	86633B	86634A	86635A
AM	Functions	Ext. Only	Int. and Ext.	Int. and Ext.	—	—
	Indicated Accuracy (at 400 and 1000 Hz rates)	—	$\pm 5\%$ of full scale With 86601A RF Section: $\pm 7\%$ , center frequency $\geq 100$ MHz With 86603A RF Section: $\pm 10\%$ , center frequency $\geq 1300$ MHz		—	—
FM	Functions	—	Int. and Ext., FM CF CAL	Int. and Ext.	—	Int. and Ext., FM CF CAL
	Center Frequency Long Term Stability	—	Typically less than 200 Hz/hr.	Same as in CW Mode ( $3 \times 10^{-6}$ /day)	—	Typically less than 200 Hz/hr.
	Indicated Accuracy (up to 20 kHz rates)	—	$\pm 5\%$ of full scale		—	$\pm 5\%$ of full scale
PULSE	Functions	Ext. Only	—	—	—	—
$\phi$ M	Functions	—	—	—	Int. and Ext.	Int. and Ext.
	Indicated Accuracy (15°C to 35°C)	—	—	—	$\pm 5\%$ of full scale up to 100 kHz rates $\pm 8\%$ of full scale up to 2 MHz rates $\pm 15\%$ of full scale up to 10 MHz rates	
Meter		—	0—100% AM 0—10, 100, 1000 kHz FM Pk. Dev. (0—20, 200, 2000 kHz FM for CF $\geq 1300$ MHz)	0—100% AM 0—10, 100 kHz FM Pk. dev. (0—20, 200 kHz FM for CF $\geq 1300$ MHz)	0—100° Peak $\phi$ M, (0—200° for CF $\geq 1300$ MHz)	0—10, 100, 1000 kHz FM, 0—100° Pk $\phi$ M (0—20, 200, 2000 kHz FM, 0—200° Pk. $\phi$ M for CF $\geq 1300$ MHz)
Internal Modulation Source Output		None	400 Hz and 1 kHz $\pm 5\%$ 200 mV minimum into 10 k $\Omega$ . Available on front panel BNC connector			
Input Impedance		50 $\Omega$ Pulse 600 $\Omega$ AM	600 $\Omega$	600 $\Omega$	50 $\Omega$	600 $\Omega$
Weight		Net, 1.4 kg (3 lb) Shipping, 2.3 kg (5 lb)	Net, 2.7 kg (6 lb) Shipping, 4.1 kg (9 lb)	Net, 2.7 kg (6 lb) Shipping, 4.1 kg (9 lb)	Net, 1.8 kg (4 lb) Shipping, 3.2 kg (7 lb)	Net, 2.7 kg (6 lb) Shipping, 4.1 kg (9 lb)

**Ordering information**

8660A Synthesized Signal Generator Mainframe	Price	\$6900
8660C Synthesized Signal Generator Mainframe		\$9150
Opt 001: $\pm 3 \times 10^{-6}$ /day internal reference oscillator	add	\$210
Opt 002: no internal reference oscillator	less	\$300
Opt 003: operation from 50 to 400 Hz line	add	\$155
Opt 004: 100 Hz frequency resolution (200 Hz above 1300 MHz)	less	\$350
Opt 005: HP-IB programming interface		\$250
Opt 009: (8660A only) LED display indicates selected frequency in 1-2-4-8 BCD code	add	\$210
Opt 100: 11661B factory installed inside mainframe	add	\$3600
86601A RF Section		\$3600

86602B RF Section	\$4600
86603A RF Section	\$6750
Opt 001: no RF output attenuator (all RF Sections)	less \$600
Opt 002: adds phase modulation capability (86602B, 86603A only)	add \$1650
Opt 003: allows operation of 86603A with 8660A mainframe	add \$250
11661B Frequency Extension Module	\$3600
86631B Auxiliary Section	\$300
86632B AM/FM Modulation Section	\$2050
86633B AM/FM Modulation Section	\$2050
86634A $\phi$ M Modulation Section	\$1650
86635A $\phi$ M/FM Modulation Section	\$2350

# SIGNAL GENERATORS

## Synthesized signal generators

### Model 8672A

- 2 to 18 GHz frequency range
- 1 to 3 kHz frequency resolution
- Low spurious and phase noise

- +3 to -120 dBm calibrated output
- $<5 \times 10^{-10}$ /day stability
- Metered AM/FM

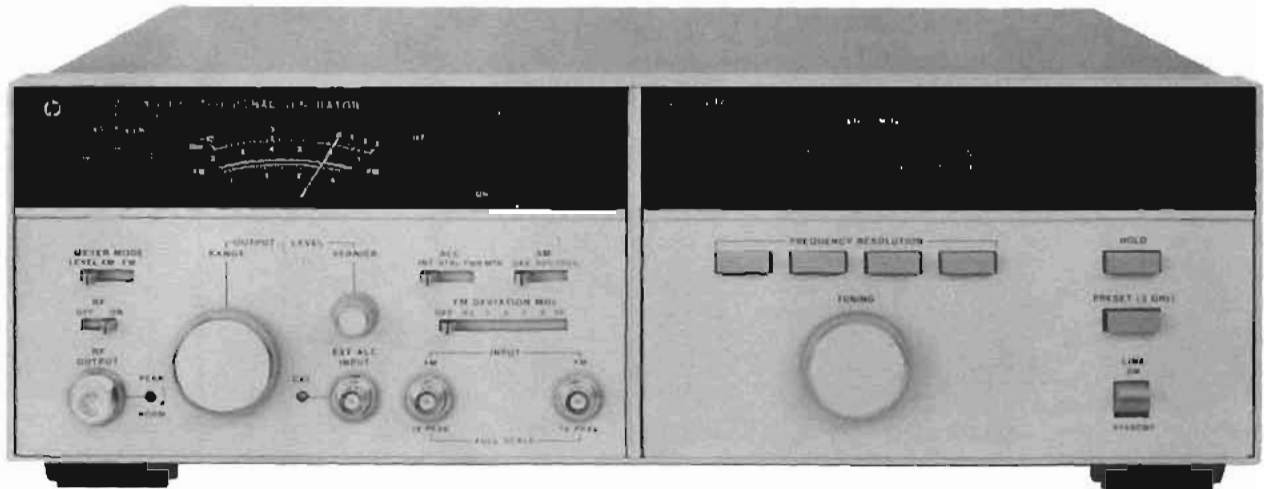

8672A



The 8672A synthesized signal generator covers the entire 2.0 to 18.0 GHz frequency range in one compact solid-state package (133 mm, 5.25 in. high) while providing calibrated output and complete AM/FM modulation capability. The 8672A can replace two, three, or even four instruments in many applications.

#### Advanced thin film technology

An indirect synthesis approach is used to phase lock a wideband 2.0 to 6.2 GHz YIG-tuned transistor oscillator (YTO) to the internal (or ext.) time base. The output of the YTO drives a YIG tuned multiplier (YTM), a product made possible by HP's advanced microcircuit technology, to achieve the 2 to 18 GHz coverage. This YTM produces spectrally pure harmonics of the input frequency and selects the proper harmonic automatically.

#### Excellent spectral purity

The 8672A has been designed for very low single sideband phase noise (see figure 2). This characteristic is very important for L.O. applications and many tests on communication and radar systems. Non-harmonic spurious are also controlled to prevent undesired responses. Such signals are -70 dB from 2 to 6.2 GHz and -60 dB from 12.4 to 18 GHz, excluding power line related frequencies.

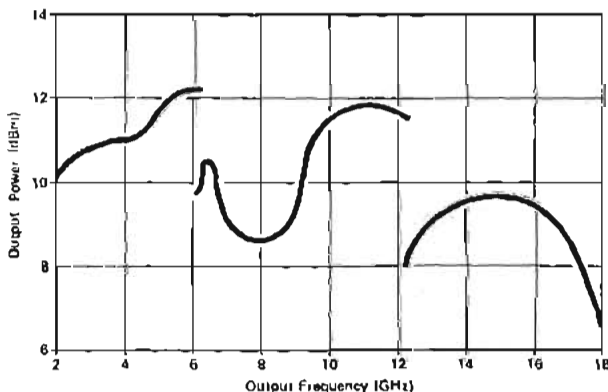

Figure 1. Maximum power typically available on "+10" attenuator setting (Overrange) at 25°C.

#### Wide dynamic output range

For broadband component and receiver testing applications the 8672A incorporates an exceptionally flat frequency response across the full 2 to 18 GHz range. The addition of a calibrated 110 dB RF step attenuator on the output results in accurate output control from +3 to -120 dBm, enabling very sensitive receiver tests to be made. For LO applications an "overrange" position provides additional power at most frequencies across the full 2 to 18 GHz band. See figure 1.

#### Calibrated AM/FM modulation

To expand the versatility of the 8672A for accurate receiver testing, AM/FM capability is provided (with externally applied modulation signals). AM depth at rates up to 100 kHz can be accurately set using the front panel meter. FM is allowed up to 10 MHz rates and peak deviations. The meter can also be used to monitor peak deviations on any of six selectable ranges. Both AM depth and FM deviation are linearly controlled by varying the input voltage up to 1 volt maximum. The 8672A remains phase locked in both the AM and FM modes.

#### Front panel status indicators

For unambiguous operation, a series of annunciators is conveniently located on the front panel to indicate the operational "status" of the instrument. These include:

1. AM/FM modes and selected ranges
2. Output level "overrange" selection
3. RF ON/OFF
4. "Not phase locked" indication
5. Uneveled condition
6. Remote operation.

#### All functions fully programmable

The 8672A provides full programmability of all its front panel functions: frequency, output level (in 1 dB steps) and modulation selection. The 8672A has an HP-IB interface (standard on all units) and can be used with any HP 9800 series calculator or minicomputer for automatic systems application.

#### Fast pulse capability available

High performance pulse modulation of the 8672A is available by the addition of the accessory I1720A Broadband Pulse Modulator. (See page 378). This new Pulse Modulator provides >80 dB ON/OFF ratios with 5 nanosecond (typical) rise and fall times over the 2 to 18 GHz range of the 8672A.

## 8672A specifications

(See technical data sheet for complete specifications)

### Frequency characteristics

**Frequency range:** 2.0-18.0 GHz (with overrange to 18.599997 GHz).

**Frequency resolution:** 1 kHz to 6.2 GHz, 2 kHz to 12.4 GHz, 3 kHz to 18.0 GHz.

**Time base:** internal 10 MHz ( $<5 \times 10^{-10}$ /day aging rate) or external 5 or 10 MHz.

**Frequency switching time:**  $<15$  ms to be within 1 kHz, 2-6.2 GHz; 2 kHz, 6.2-12.4 GHz; 3 kHz, 12.4-18 GHz.

### Spectral purity

**Harmonics, subharmonics and multiples ( $\leq 18$  GHz):**  $<-25$  dB.

**Single-sideband phase noise (1 Hz BW, CW mode):**

Offset from $f_c$	10 Hz	100 Hz	1 kHz	10 kHz	100 kHz
2.0-6.2 GHz	-58 dB	-68 dB	-78 dB	-89 dB	-109 dB
2-12.4 GHz	-52 dB	-62 dB	-72 dB	-83 dB	-103 dB
12.4-18.0 GHz	-48 dB	-58 dB	-68 dB	-79 dB	-99 dB

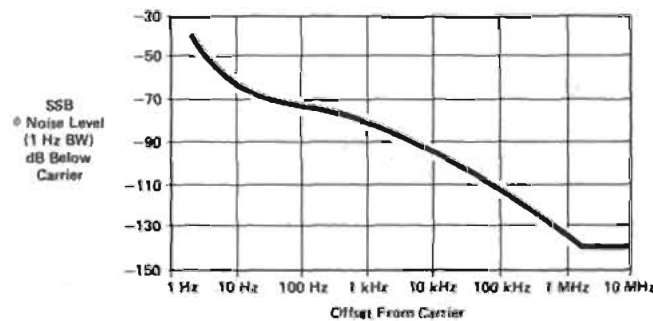

Figure 2. Typical 8672A single-sideband phase noise performance using the internal standard, 2.0-6.2 GHz.

### Spurious (CW and AM modes)

#### Non-harmonically related:

$<-70$  dB, 2.0-6.2 GHz.

$<-64$  dB, 6.2-12.4 GHz.

$<-60$  dB, 12.4-18.0 GHz.

#### Power line related (CW mode, and within 5 Hz below line frequency, and multiples):

Offset from $f_c$	300 Hz	300 Hz to 1 kHz	$>1$ kHz
2.0-6.2 GHz	-50 dB	-60 dB	-65 dB
6.2-12.4 GHz	-54 dB	-54 dB	-59 dB
12.4-18.0 GHz	-40 dB	-50 dB	-55 dB

### Output characteristics

**Output level (+15°C to +35°C):** +3 to -120 dBm.

**Total indicated meter accuracy (+15°C to +35°C):**

Frequency Range	Output Level Range			
	0 dBm	-10 dBm	-20 dBm	-30 dBm and below
2.0-6.2 GHz	$\pm 1.75$ dB	$\pm 2.25$ dB	$\pm 2.45$ dB	$\pm 1.75$ dB $\pm 0.3$ dB/ 10 dB step below 0 dBm range
6.2-12.4 GHz	$\pm 2.0$ dB	$\pm 2.5$ dB	$\pm 2.7$ dB	$\pm 2.0$ dB $\pm 0.3$ dB/ 10 dB step below 0 dBm range
12.4-18.0 GHz	$\pm 2.25$ dB	$\pm 2.85$ dB	$\pm 3.05$ dB	$\pm 2.25$ dB $\pm 0.4$ dB/ 10 dB step below 0 dBm range

**Remote programming accuracy:** 0.75 dB better than indicated meter accuracy.

**Flatness (+15°C to +35°C):**  $\pm 0.75$  dB, 2.0-6.2 GHz;  $\pm 1.00$  dB, 2.0-12.4 GHz;  $\pm 1.25$  dB, 2.0-18.0 GHz.

**Output level switching time:**  $<20$  ms.

**Source impedance:** 50  $\Omega$ .

### Amplitude modulation

**AM depth (for RF output meter readings  $\leq 0$  dB, +15°C to +35°C):**

0-75%, 2.0-6.2 GHz.

0-60%, 6.2-12.4 GHz.

0-50%, 12.4-18.0 GHz.

**Sensitivity:** 30%/V, 100%/V ranges. Max input 1 V peak into 600  $\Omega$ .

**Rates (3 dB BW):** 10 Hz-100 kHz.

**Indicated AM meter accuracy (100 Hz - 10 kHz rates):**  $\pm 5\%$  of range.

**Distortion (rates  $\leq 10$  kHz, RF output  $\leq 0$  dB, +15°C to +35°C):**  $<1\%$  at 30% depth.

### Frequency modulation

**Peak deviation (max):** the smaller of

10 MHz or  $f_{mod} \times 5$ , 2.0-6.2 GHz.

10 MHz or  $f_{mod} \times 10$ , 6.2-12.4 GHz.

10 MHz or  $f_{mod} \times 15$ , 12.4-18.0 GHz.

**Sensitivity:** 30, 100, 300 kHz/V and 1, 3, 10 MHz/V ranges. Max input 1 volt peak into 50  $\Omega$ .

**Rates (3 dB BW typical):** 30, 100 kHz/V ranges: 50 Hz to 10 MHz; 300 kHz/V and 1, 3, 10 MHz/V ranges: 1 kHz to 10 MHz.

**Distortion:**  $<12\%$  for rates  $<3$  kHz decreasing linearly with frequency to 5% at 20 kHz;  $<5\%$  for 20 kHz to 100 kHz rates.

**Indicated FM meter accuracy (100 kHz rate, +15°C to 35°C):**  $\pm 10\%$  of full scale.

**Residual FM in FM and CW modes (2-6.2 GHz, residual FM doubles for 6.2-12.4 GHz, triples for 12.4-18 GHz):**

Range	Post Detection BW	
	20 Hz - 1 kHz	20 Hz - 3 kHz
CW, $\pm 30, 100, 300$ kHz/V, and $\pm 1, 3, 10$ MHz/V	6 Hz rms	12 Hz rms
10 MHz/V	10 Hz rms	20 Hz rms

### Remote programming capability

**Frequency:** programmable over full range with same resolution as in manual mode.

**Output level:** programmable over full range in 1 dB steps.

**AM modulation:** OFF, 30%/V, and 100%/V ranges.

**FM modulation:** OFF, 30, 100, 300 kHz/V and 1, 3, 10 MHz/V ranges.

**Other:** RF ON/OFF, ALC INT./EXT. (crystal or power meter).

**Programming format:** HP-IB (Hewlett-Packard Interface Bus).

### General

**Operating temperature range:** 0 to +55°C.

**Power:** 100, 120, 220, 240 V +5, -10%, 40-66 Hz, 300 VA max.

**Weight:** net, 27 kg (60 lb). Shipping, 32.5 kg (72 lb).

**Dimensions:** 133 mm H  $\times$  425 mm W  $\times$  603 mm D (5.25"  $\times$  16.75"  $\times$  23.75").

### Options

**001:** No RF output attenuator

**002:** No internal reference oscillator

**003:** Operation at 400 Hz line only

**004:** Rear panel RF output

**006:** Rear panel RF output without RF attenuator

**008:** Chassis slide kit

### Price

less \$600

less \$550

add \$250

add \$ 75

less \$525

add \$ 45

# SIGNAL GENERATORS

## Microwave frequency synthesizer

### Model 8671A

- 2–6.2 GHz frequency range
- 1 kHz frequency resolution
- $<5 \times 10^{-10}$ /day stability

- Low spurious and phase noise
- +8 dBm minimum output power
- HP-IB programmability

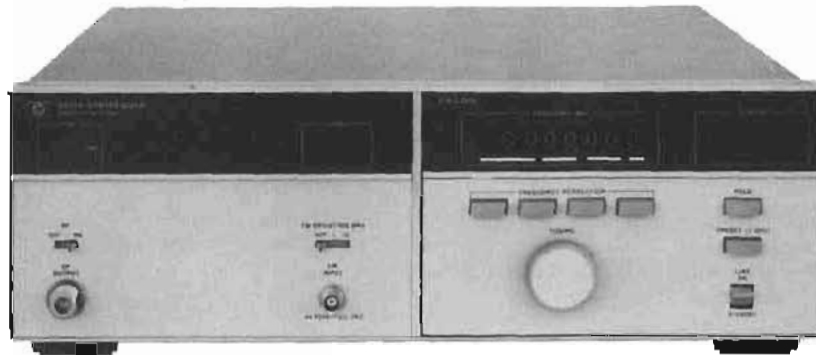

8671A



### Description

The 8671A microwave frequency synthesizer covers the frequency range 2.0 to 6.2 GHz in 1 kHz steps with excellent stability and spectral purity. It is well suited for most LO applications that require state-of-the-art performance as well as broadband capability.

### Spectral purity

Spurious responses (except power line related) are greater than -70 dB below the carrier across the full frequency band. And phase noise, a critical parameter in many applications, is low enough to permit extremely sensitive measurements.

### Output power

The 8671A has a guaranteed output of +8 dBm at all frequencies. This is well within the operating range of most commercial mixers. However, for the few applications requiring greater power the 8671A produces clean outputs as high as +10 dBm at many frequencies.

### Wideband FM

The 8671A also has frequency modulation capability at rates up to 10 MHz and peak deviations up to 10 MHz (with externally applied signals). Carrier phase-lock is maintained in the FM mode.

### HP-IB programmability

The standard programming interface offered with the 8671A is directly compatible with the Hewlett-Packard Interface Bus. Programmable functions include frequency, FM, and RF ON/OFF.

### Specifications

(See technical data sheet for complete specifications.)

#### Frequency characteristics

**Frequency range:** 2.0–6.2 GHz (6.199999 GHz).

**Frequency resolution:** 1 kHz.

**Time base:** internal 10 MHz ( $<5 \times 10^{-10}$ /day aging rate) or external 5 or 10 MHz.

**Switching time:**  $<15$  ns to be within 1 kHz.

**Harmonics:**  $<-15$  dB.

#### Single-sideband phase noise (1 Hz BW, CW mode)

Offset from $F_c$	10 Hz	100 Hz	1 kHz	10kHz	100 kHz
SSB level	-58 dB	-68 dB	-78 dB	-89 dB	-109 dB

#### Spurious

**Non-harmonically related:**  $<-70$  dB.

**Power line related (CW mode, and within 5 Hz below any line related frequency)**

Offset from $F_c$	$<300$ Hz	300 Hz to 1 kHz	$>1$ kHz
2.0–6.2 GHz	-50 dB	-60 dB	-65 dB

### Output characteristics

**Power (unleveled):** +8 dBm (min.), +15 to 35°C.

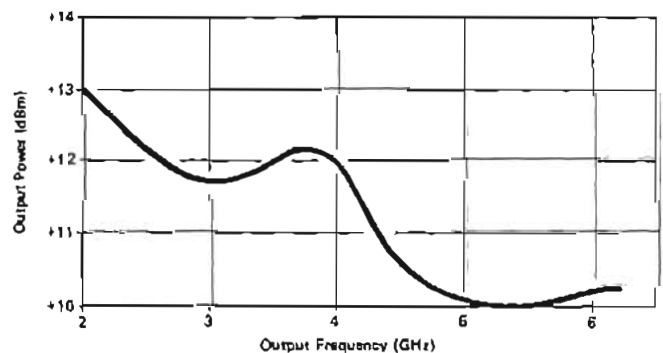

Figure 1. Typical output power available.

**Flatness:**  $<6$  dB total variation across full frequency band.

**Source impedance:** 50  $\Omega$

#### Frequency modulation

**Peak deviation (max):** 10 MHz or  $f_{mod} \times 5$ , whichever is smaller.

**Sensitivity:** 50 kHz/V and 5 MHz/V ranges. Max input 2V peak.

**Rates (3 dB BW):** 50 Hz to 10 MHz typical.

#### Remote programming

**Frequency:** programmable over full range with 1 kHz resolution.

**FM modulation:** OFF, 50 kHz/V, and 5 MHz/V ranges.

**Other:** RF, ON/OFF.

**Programming format:** HP-IB (Hewlett-Packard Interface Bus).

#### General

**Operating temperature range:** 0 to 55°C.

**Power:** 100, 120, 220, or 240 V +5, -10%, 48–66 Hz, 300 VA max.

**Weight:** net, 24 kg (58 lb); shipping, 29.5 kg (65 lb).

**Size:** 133 H  $\times$  425 W  $\times$  603 mm D (5.25"  $\times$  16.75"  $\times$  23.75").

#### Options

002: No internal reference

003: Operation at 400 Hz line only

005: Rear panel RF output

006: Chassis slide kit

#### Price

less \$550

add \$250

add \$ 75

add \$ 45



# SIGNAL GENERATORS

Precision, high stability, AM-FM, 0.5 to 1024 MHz  
Models 8640A, 8640B



- Wide frequency and power range
- Low broadband and close-in noise
- Calibrated, metered AM and FM

- The 8640B also features:  
internal phase lock synchronizer  
external counter to 550 MHz

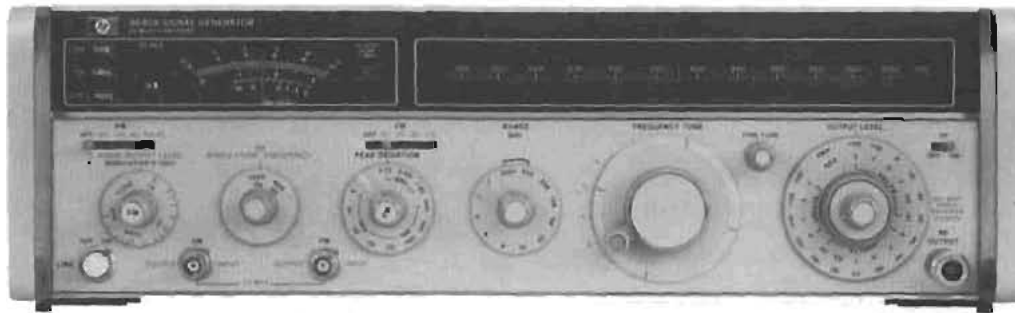

8640A



8640B

## Description

The 8640 Signal Generator covers the frequency range 500 kHz to 512 MHz (450 kHz to 550 MHz with band overrange) and can be extended to 1100 MHz with an internal doubler (Opt 002). Using the 11710B Down Converter, the 8640 frequency range can be extended down to 10 kHz. An optional audio oscillator is also available with a frequency range of 20 Hz to 600 kHz. This broad coverage, together with calibrated output and modulation, provides for complete RF and IF performance tests on virtually any type of HF, VHF, and UHF receivers.

Both solid state generators 8640A and B have an output level range of +19 to -145 dBm (2 V to 0.013  $\mu$ V) which is calibrated, metered, and leveled to within  $\pm 0.5$  dB across the full frequency range of the instrument.

The 8640A/B generators provide AM, FM, and pulse modulation for a wide range of receiver test applications. This modulation is calibrated and metered for direct readout under all operating conditions.

A reverse power protection option (Opt 003) is available to eliminate instrument damage due to accidental transmitter keying. This module protects against up to 50 watts of applied power and automatically resets upon removal of the excessive signal.

### Spectrally pure output signals

Noise performance of the 8640 is state-of-the-art for a solid-state generator. The high-Q cavity oscillator has been optimized with use of a low-noise microwave transistor for spectrally pure output signals.

At 20 kHz offsets from 230 to 450 MHz, SSB phase noise is >130 dB/Hz below the carrier level and rises to 122 dB/Hz at 550 MHz. This signal-to-noise ratio increases by approximately 6 dB for each division of the output frequency down to the broadband noise floor of better than 140 dB/Hz. This exceptional noise performance is also preserved during FM modulation and in the phase-locked mode of the 8640B.

### Mechanical dial or built-in counter

There are two versions of the 8640 Signal Generators. One, the 8640A, has an easy-to-read slide rule dial with scales for each of the 10 output frequency ranges. There is an additional scale to provide direct readout of the output frequency even in the INTERNAL DOUBLER band, 512-1024 MHz.

The 8640B has the same performance features as the 8640A, but incorporates a built-in 550 MHz frequency counter and phase lock synchronizer.

The built-in 6 digit counter displays the output frequency and can also be used to count external input signals from 20 Hz to 550 MHz. This eliminates the need for a separate frequency counter in many measurement systems.

### Internal pushbutton synchronizer

At the push of a button, the 8640B built-in phase lock synchronizer locks the RF output frequency to the crystal time base used in the counter. In this locked mode, the output stability is better than  $5 \times 10^{-9}/h$  and the spectral purity and FM capability of the unlocked mode are preserved. For higher stability, it is possible to lock to an externally applied 5 MHz standard. Two 8640B's can also be locked together for various 2-tone measurements.

In the phase locked mode, increased resolution is available by using the  $\frac{1}{2}$  digit increment button. For example, 500 Hz resolution is possible for frequencies between 100 and 1000 MHz.

### FM while phase locked

When phase locked, full FM capability is preserved down to modulation rates of 50 Hz. The narrow bandwidth of the phase lock loop (<5 Hz) provides for FM modulation up to 250 kHz rates and assures no degradation in noise from the unlocked mode. This crystal stability, coupled with the precision modulation and low noise, makes the 8640B ideal for testing narrowband FM or crystal-controlled receivers.

# SIGNAL GENERATORS

Precision, high stability, AM-FM, 0.5 to 1024 MHz

Models 8640A, 8640B (cont.)

## 8640A/B specifications

(See technical data sheet for complete specifications). All specifications apply over the nominal Frequency ranges and over the top 10 dB of the output level vernier range unless otherwise specified.

### Frequency characteristics

**Range:** 500 kHz to 512 MHz in 10 octave ranges (to 1024 MHz with option 002 internal frequency doubler).

**Ranges and range overlap:** ranges extend 10% below and 7% above the nominal frequency ranges shown below.

Frequency ranges (MHz)		
0.5-1	8-16	128-256
1-2	16-32	256-512
2-4	32-64	512-1024
4-8	64-128	(opt. 002)

### Fine tuning

**8640A and 8640B unlocked:** > 1000 ppm total range.

**8640B locked mode:** > ±20 ppm by varying internal time base vernier.

### Internal counter resolution (8640B unlocked)

Frequency Ranges (MHz)	Normal Mode	Expand X10	Expand X100
0.5-1	10 Hz	1 Hz	0.1 Hz
1-16	100 Hz	10 Hz	1 Hz
16-128	1 kHz	100 Hz	10 Hz
128-1024	10 kHz	1 kHz	100 Hz

### Optimum counter resolution when phase-locked (8640B)

Frequency Ranges (MHz)	With 6 Digits	+1/2 Digit
0.5-0.9999995	1 Hz	0.5 Hz
1.0-9.999995	10 Hz	5 Hz
10.0-99.99995	100 Hz	50 Hz
100.0-999.9995	1 kHz	500 Hz
1000-1024	10 kHz	5 kHz

### Accuracy

**8640A:** mechanical dial; accuracy better than ±1.0%, resettability better than 0.1%.

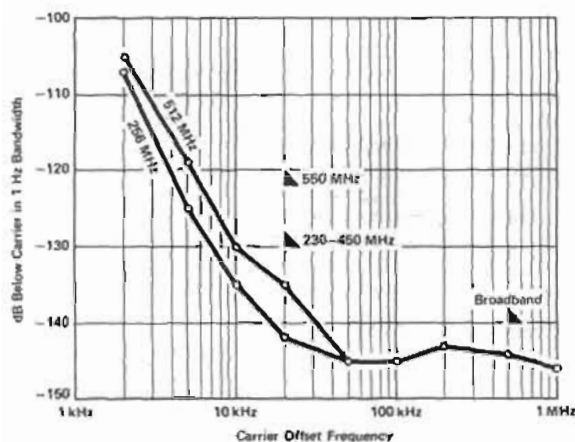

Measured SSB Noise vs. Offset from carrier. Markers indicate specified limits.

**8640B:** 6½ digit LED display with X10 and X100 expand; accuracy depends on internal or external reference used.

### Stability (after 2 hour warmup)

**Normal:** < 10 ppm/10 min.

**Locked (8640B):** < 0.05 ppm/hr.

### Restabilization time after frequency change

**Normal:** < 15 min.

**Locked (8640B):** < 1 min. after relocking to be within 0.1 ppm of steady state frequency.

### Output characteristics

**Range:** 10 dB steps and 18 dB vernier provide the following output power settings into 50Ω.

Frequency Range (MHz)	8640A/B	With Option(s)		
		002	003	002/003
0.5 to 512	+19 to -145 dBm	+18.5 to -145 dBm	+18.5 to -145 dBm	+18 to -145 dBm
512 to 1024 (Option 002)	—	+13 to -145 dBm	—	+12 to -145 dBm

**Level flatness (referred to output at 50 MHz and applies to 1 V range and for top 10 dB of vernier range)**

Frequency Range (MHz)	8640A/B	With Option(s)		
		002	003	002-003
0.5 to 64	±0.5 dB	±0.5 dB	+0.75 dB -1.25 dB	+1.0 dB -2.0 dB
64 to 512	—	±1.0 dB	—	—
512 to 1024 (Option 002)	—	±1.5 dB	—	±2.0 dB

**Level accuracy:** (worst case as indicated on level meter) ±1.5 dB to ±4.5 dB depending on level, frequency, and options installed

### Spectral purity

**Harmonics (at 1 volt, +10 dBm output range and below):**

> 30 dB below fundamental, 0.5 to 512 MHz.

> 12 dB below fundamental, 512 to 1024 MHz.

**Spurious output signals (excluding frequencies within 15 kHz of the signal whose effects are specified in residual AM and FM)**

Frequency Range (MHz)	Subharmonically Related		Non-harmonically Related	
	8640A	8640B	8640A	8640B
0.5 to 512	none detectable	> 100 dBc	none detectable	> 100 dBc
512 to 1024 (Option 002)	> 20 dBc <sup>1</sup>		—	—

**Residual AM (averaged rms):** 0.3 to 3 kHz post-detection noise bandwidth > 85 dBc.

**Residual FM (averaged rms):** 0.3 to 3 kHz post-detection noise bandwidth. (CW and up to 1/3 maximum allowable peak deviation.)

0.5 to 512 MHz < 5 Hz.

512 to 1024 MHz < 10 Hz.

<sup>1</sup>dBc = dB below the carrier.

## Modulation characteristics

### General

**Types:** Internal AM and FM; External AM, FM and PULSE; simultaneous AM and FM or PULSE and FM.

**Internal modulation sources:** (independently adjustable output is available at front panel).

**Standard:** 8640A or 8640B.

**Frequency:** fixed 400 Hz and 1 kHz,  $\pm 3\%$ .

**Output level:** 1 mV to 1 V rms into 600 $\Omega$ .

**Optional:** (internal variable audio oscillator Option 001, 8640A or 8640B).

**Frequency:** variable 20 Hz to 600 kHz,  $\pm 1.5\%$  plus fixed 400 Hz and 1 kHz  $\pm 3\%$ .

**Output level:** 1 mV to 3 V rms into 600 $\Omega$ .

### Amplitude modulation

#### Depth

**0.5 to 2 MHz:** 0 to 100% for output level range from +13 dBm and below.

**512 to 1024 MHz:** 0 to 100% for output levels of +7 dBm and below and for 6 dB to 16 dB down on output vernier range.

**AM Rates:** INT and EXT ac; 20 Hz to AM 3 dB bandwidth. EXT dc; dc to AM 3 dB bandwidth.

#### AM 3 dB bandwidth:

Frequency Ranges	0 to 50% AM	50 to 90% AM
0.5 to 2 MHz	20 kHz	12.5 MHz
2 to 8 MHz	40 kHz	25 kHz
8 to 512 MHz	60 kHz	50 kHz
512 to 1024 MHz	60 kHz	50 kHz

#### AM distortion (at 400 Hz and 1 kHz rates):

Frequency Ranges	0 to 30% AM	30 to 50% AM	50 to 80% AM
0.5 to 512 MHz	<1%		<3%
512 to 1024 MHz	<10%		<20%

#### External AM sensitivity (400 Hz and 1 kHz rates)

**0.5 to 512 MHz:** (0.1  $\pm$  0.005)% AM per mV peak into 600 $\Omega$  with AM vernier at full CW position.

**512 to 1024 MHz:** nominal 0.1% AM per mV peak into 600 $\Omega$  with AM vernier at full CW position.

#### Indicated AM accuracy (400 Hz and 1 kHz rates using internal meter)

**0.5 to 512 MHz:**  $\pm 5.5\%$  of reading  $\pm 1.5\%$  of full scale from 0 to 50°C.

**512 to 1024 MHz:** not specified; each generator can be individually calibrated using operating manual procedure.

#### Peak incidental phase modulation (at 30% AM)

**0.5 to 128 MHz:** <0.15 radians.

**128 to 512 MHz:** <0.3 radians.

**512 to 1024 MHz:** <0.6 radians.

**Peak incidental frequency deviation:** equals peak incidental phase modulation  $\times$  modulation rate.

### Pulse modulation

Frequency Ranges (MHz)	0.5-1	1-2	2-8	8-32	32-512	512-1024
Rise and Fall Times	<9 $\mu$ s	<4 $\mu$ s	<2 $\mu$ s	<1 $\mu$ s		<1 $\mu$ s typical
Pulse Repetition Rate	50 Hz to 50 kHz	50 Hz to 100 kHz	50 Hz to 250 kHz	50 Hz to 250 kHz		
Pulse Width Minimum <sup>1</sup>	10 $\mu$ s	5 $\mu$ s	2 $\mu$ s			
Pulse ON/OFF ratio at max. vernier	>40 dB				>50 dB	
Peak Input Required	Nominally +0.5 V (5 V max). Sinewave or Pulse return to zero into 50 $\Omega$ .					

<sup>1</sup>For level accuracy within 1 dB of CW level accuracy specification (< 0.1% duty cycle).

### Frequency modulation

**Deviation:** maximum allowable deviation equals 1% of lowest frequency in each nominal output frequency range.

Frequency Range (MHz)	Maximum Peak Deviation (kHz)
0.5-1	5
1-2	10
2-4	20
4-8	40
8-16	80
16-32	160
32-64	320
64-128	640
128-256	1280
256-512	2560
512-1024	5120

**FM 3 dB bandwidth:** internal and external ac; 20 Hz to 250 kHz External dc; dc to 250 kHz. (8640B locked mode: FM above 50 Hz only.)

#### FM distortion (at 400 Hz and 1 kHz rates)

<1% for deviations up to  $\frac{1}{2}$  maximum allowable.

<3% up to maximum allowable deviation.

**External FM sensitivity:** 1 volt peak yields maximum deviation indicated on PEAK DEVIATION switch with FM vernier at full CW position.

**Indicated FM accuracy:** (400 Hz and 1 kHz rates using internal meter)  $\pm$  (7% of reading + 1.5% of full scale).

#### Incidental AM (at 400 Hz and 1 kHz rates)

**0.5 to 512 MHz:** <0.5% AM for FM up to  $\frac{1}{2}$  max allowable deviation. <1% AM for FM at maximum allowable deviation.

**512 to 1024 MHz (Opt 002):** <1% AM for FM up to  $\frac{1}{2}$  max allowable deviation.

## Counter characteristics (8640B)

### External RF input

**Frequency range:** 1 Hz to 550 MHz.

**Sensitivity:**  $\geq 100$  mV rms into 50 $\Omega$ , ac only.

**Resolution:** 6-digit LED DISPLAY.

Mode	Normal	Expand X10	Expand X100
0-10 MHz	100 Hz	10 Hz	1 Hz
10-550 MHz	10 kHz	1 kHz	100 Hz

**External reference input:** 5 MHz, nominally  $>0.5$  V p-p (5 V max) into 1 k $\Omega$ .

### Internal reference characteristics (after 2-hr warmup).

**Temperature drift:** (after calibration at 25°C)

< $\pm 2$  ppm for 15° to 35°C.

< $\pm 10$  ppm for 0° to 55°C.

**Aging rate:** (constant temperature and line voltage) <0.05 ppm per hour; <2 ppm per 90 days.

**Frequency tuning:**  $\geq 20$  ppm using internal time base vernier.

**Rear output:**  $>0.5$  V p-p into 500 $\Omega$ . This will drive another 8640B.

### General characteristics

**Operating temperature range:** 0 to 55°C.

**Power requirements:** 100, 120, 220, and 240 volts, +5%, -10%, 48 to 440 Hz; 175 VA maximum. (Option 002, 190 VA max.)

**Weight:** 8640A and 8640B: net, 20.8 kg (46 lb). Shipping, 24.1 kg (53 lb).

**Dimensions:** 140 mm H  $\times$  425 mm W  $\times$  476 mm D (5.5"  $\times$  16.75"  $\times$  18.75").

### Options

**001:** (internal variable audio oscillator, 20 Hz to 600 kHz) add \$275

**002:** (internal doubler 512-1024 MHz) add \$850

**003:** (reverse power protection) add \$300

**004:** (avionics option) 8640B only add \$800

### Ordering information

**8640A** Signal Generator

**8640B** Signal Generator

### Price

\$5200

\$6600

# SIGNAL GENERATORS

Avionics option  
Model 8640B Opt 004

- Demodulated output from RF detector, AC and DC
- Phase shift; less than  $0.01^\circ$  at 30 Hz
- External Count Capability: 1 Hz to 550 MHz



8640B Opt 004

The Hewlett-Packard Model 8640B Option 004 NAV/COM Signal Generator is an 8640B AM/FM Signal Generator specially adapted for testing ILS (Marker Beacon, Localizer and Glide Slope), VOR and VHF communications receivers used throughout the Aviation industry. VOR, LOCALIZER and VHF communications frequencies (108 to 136 MHz) are available on one frequency band for rapid channel selection. GLIDE SLOPE (329 to 335 MHz) and MARKER BEACON (75 MHz) frequencies are also easily set using the 6-digit LED display.

The 8640B Option 004 provides highly stable, spectrally pure RF signals for testing narrow-channel, crystal controlled receivers. For avionics testing, external audio generators are required to provide the composite modulation. Designed with versatile AM and FM modulation, Option 004 features low distortion modulation when used with suitable, external VOR/ILS Audio Generators.

Operation and specifications of the 8640B Option 004 are the same as the Standard 8640B AM/FM Signal Generator with the following additions.

### Demodulated output

One front panel BNC connector provides demodulated output from the RF peak detector for precise AM settings. A choice of combined AC/DC at 1 V rms or AC only at 5 V rms is provided.

### Output level setting

To ensure the best possible demodulated output linearity, Option 004 combines a 1 dB step attenuator and a vernier with a 10 dB step attenuator. This provides output levels from +15 dBm to -142 dBm (1.3 V to 0.018  $\mu$ V). The output level can be read directly from the attenuator dial in dBm or from the front panel meter in dBm or volts.

### External AM Input Impedance

External AM input impedance of 2 k $\Omega$  allows compatible operation with old and new generations of external audio generators.

### Low distortion modulation

The 8640B Option 004 provides flat AM response and minimum phase shift at 30 Hz and 9960 Hz as well as constant group delay between 9 kHz and 11 kHz for accurate VOR and ILS testing.

## Specifications

(These specifications apply to 8640B Option 004 in addition to standard 8640B specifications. See 8640B AM/FM Signal Generator Data Sheet for complete specifications.)

### Spectral purity

**Noise:** SSB Broadband noise floor: greater than 1 MHz offset from carrier, >130 dB down.

### Output characteristics

**Range:** +15 dBm to -142 dBm (1.3 V to 0.018  $\mu$ V)

**Attenuators:** a 10 dB step attenuator plus a 1 dB step attenuator with vernier allow selection of any output level over the full output level range.

**Vernier:** 2 dB continuously variable from a CAL detent position.

**Level flatness:**  $\leq \pm 0.75$  dB from 0.5 to 512 MHz referred to output at 190 MHz.  $< \pm 0.5$  dB from 108 to 336 MHz referred to output at 190 MHz. (Flatness applies to +10 to -10 dBm.)

### Level accuracy

Output Level (dBm)	+15 to -10	-10 to -50	-50 to -142	With Option 003
Total Accuracy as Indicated on Level Meter	$\pm 1.5$ dB	$\pm 2.0$ dB	$\pm 2.5$ dB	Add $\pm 0.5$ dB except from 108 to 336 MHz

### Modulation characteristics

**Demodulated output (Output vernier in CAL position) (108 to 118 and 329 to 338 MHz):** an internal selector switch allows selection of AC only or AC and DC at the demodulated output.

**AC only output:** directly proportional to AM depth. (90 to 150 Hz modulation frequency).

**%AM equals:** (20  $\pm$  0.6)% per V rms, 0 to 55°C; (20  $\pm$  0.4)% per V rms, 20 to 30°C; (20  $\pm$  0.2)% per V rms (using calibration sheet provided by factory).

**AC and DC output:** AC output voltage is directly proportional to AM depth (90 to 150 Hz modulation frequency).

**%AM equals:** (100  $\pm$  3)% per V rms, 0 to 55°C; (100  $\pm$  2)% per V rms, 20 to 30°C; (100  $\pm$  1)% per V rms (using calibration sheet provided by factory).

DC output equals (1.414  $\pm$  0.010) V dc with vernier in CAL position.

**Amplitude modulation characteristics (+10 dBm output and below)**

**External Input Impedance:** nominally 2 k $\Omega$ .

**Frequency response:**  $\pm 0.05$  dB from 90 Hz through 150 Hz (108 to 118 and 329 to 335 MHz);  $\pm 0.05$  dB from 9 kHz through 11 kHz (108 to 118 MHz);  $\pm 3$  dB (0 to 70% AM) from dc through 50 kHz (8 to 512 MHz);  $\pm 3$  dB (0 to 90% AM) from dc through 35 kHz (8 to 512 MHz).

**Phase shift from audio input to demodulated output (108 to 118 MHz) (AM EXT DC mode):**

30 Hz  $\leq \pm 0.01^\circ$

30 Hz to 10 kHz  $\leq \pm 3^\circ$

9 kHz to 11 kHz  $\leq \pm 2^\circ$  difference.

8640B Avionics Opt 004

\$7400

# SIGNAL GENERATORS



## Ruggedized signal generator, down converter

Models 8640M, 11710B

- 500 kHz to 512 MHz
- $-40^{\circ}\text{C}$  to  $+55^{\circ}\text{C}$  operating temperature
- Phase lock stability, external count



8640M

### 8640M Signal generator

The 8640M is a highly ruggedized version of the 8640B signal generator which adds field useability and retains the excellent stability and signal purity of the 8640B. Six-digit display, phase-lock and external count capability similar to the 8640B are standard on the 8640M. Internal Pulse modulation capability and 50 W reverse power protection are also standard.

The waterproof combination case, constructed to the requirements of Mil-T-21200J, provides a protective outer shell and cushioned mounts to assure tolerance to the shock and vibration rigors of off-road transportation. All controls on the front panel are drip-proof, and the air ducts are louvered to allow operation in wind, rain, or snow.

Reliability testing to Mil-Std-781 allows prediction of MTBF's in excess of 2200 hours. The testing included vibration,  $-40^{\circ}\text{C}$  to  $+55^{\circ}\text{C}$  temperature cycling, and power cycling. Maintainability testing to Mil-Std-471 has verified that the mean time to repair the 8640M is less than 2 hours.

### 8640M Specifications

#### Frequency characteristics

**Range:** 500 kHz to 512 MHz in 10 Octave ranges (to 1024 w/hz with External Frequency Doubler).

**Internal counter resolution:** same as 8640B (except no Expand X100 range; no extra  $\frac{1}{2}$  digit).

**External counter resolution:** from 0 to 10 MHz: 10 Hz; from 10 to 550 MHz: 1 kHz.

#### Stability

	Normal (Typical)	Locked
Time (after 3-hr. warm-up)	$<15 \text{ ppm}/20 \text{ min}$	$<2 \text{ ppm}/20 \text{ min}$
Temperature	$<50 \text{ ppm}/^{\circ}\text{C}$	$<1 \text{ ppm}/^{\circ}\text{C}$

#### Output range and accuracy

Output (dBm) Range	Using Top 10 dB of Vernier Range			Using Full Vernier Range
	+13 to -7	-7 to -47	-47 to -137	+18 to -145
Total Accuracy as Indicated on Level Meter	2.0 dB	2.5 dB	3.0 dB	Add $\pm 0.5 \text{ dB}$

#### Modulation

**Types:** internal AM, FM, and PULSE.  
external AM, FM and PULSE.

#### Environmental performance

**Temperature:** MIL-STD-810B, Method 501, 502 Proc. 1.

**Operating:** continuous operation allowed between  $-40^{\circ}\text{C}$  ( $-40^{\circ}\text{F}$ ) and  $+55^{\circ}\text{C}$  ( $131^{\circ}\text{F}$ ). Intermittent operation ( $<20 \text{ min.}$ ) allowed up to  $+71^{\circ}\text{C}$  ( $160^{\circ}\text{F}$ ).

**Non-Operating:** storage allowed between  $-60^{\circ}\text{C}$  ( $-76^{\circ}\text{F}$ ) and  $+85^{\circ}\text{C}$  ( $185^{\circ}\text{F}$ ).

- Extends frequency range down to 10 kHz on all 8640 and 8654 series generators
- Preserves calibrated output level and modulation



11710B



**Humidity:** MIL-STD-810B, Method 507 Proc. 1, 10-day test.

**Operating:**  $-40^{\circ}\text{C}$  ( $-40^{\circ}\text{F}$ ) to  $+40^{\circ}\text{C}$  ( $104^{\circ}\text{F}$ ) at up to 95% R.H.

**Non-Operating:** storage allowed between  $-60^{\circ}\text{C}$  ( $-76^{\circ}\text{F}$ ) and  $+60^{\circ}\text{C}$  ( $140^{\circ}\text{F}$ ) up to 95% R.H. Condensation allowed.

**Shock:** MIL-T-21200J Class II. When mounted in its combination case, the 8640M will withstand 20 g's shock in any of 3 planes without damage.

**Vibration:** MIL-T-21200J Class II.

**Rain:** MIL-STD-810B Method 506 Proc. 1. Simulated rain and wind conditions up to 12 in./hour rainfall and up to 40 mph wind. Instrument was in normal operating configuration.

**Explosive Atmosphere:** MIL-STD-810B Method 511 Proc. 1. Type testing verified successful operation in potentially explosive atmosphere laden with avionic fuel vapor.

**Salt Fog:** MIL-STD-810B Method 509 Proc. 1. A mechanical mock-up was tested to verify the non-corrosive nature of parts, materials, and processes.

**Fungus:** non-fungus nutrient material used.

**EMI:** MIL-STD-461A, Class C1, Test Methods CE 03 and RE 02.

### 11710B Down converter

The 11710B Down Converter is an accessory for the 8640 and 8654 series signal generators. Frequency inputs from 50.01 to 61 MHz are down converted to the 10 kHz to 11 MHz range respectively. The output level and modulation functions of the 8640 and 8654 remain calibrated. A straight through selection allows the input to pass through unchanged and switch thus minimizes the necessity to move cables when testing.

### 11710B Specifications

#### Input characteristics

**Down-conversion mode:** 50.01 to 61.00 MHz at  $\leq 0 \text{ dBm}$ .

**Straight-through mode:** 0.01 to 1100 MHz.

#### Down-converted output characteristics

**Frequency range:** 10 kHz to 11 MHz.

**Level range:** 0 to  $-107 \text{ dBm}$ .

**Level flatness (referred to 4.0 MHz):**  $\pm 0.5 \text{ dB}$ .

**Level accuracy:**  $\pm 1 \text{ dB}$  plus input level accuracy.

**Harmonics:**  $>35 \text{ dB}$  below the carrier (dBc).

**Intermixing spurious:**  $>60 \text{ dBc}$ .

**Local oscillator feed-through (50 MHz):**  $< -80 \text{ dBm}$ .

#### Internal reference characteristics

**Time base output:** 1 MHz or 5 MHz selectable, nominally  $>0.5 \text{ V p-p}$  into 500  $\Omega$ . This will drive an 8640B or 8655A External Time Base Input.

**Typical overall accuracy:** (within 3 mo. of calibration and from  $15^{\circ}\text{C}$  to  $35^{\circ}\text{C}$ ):  $\pm 2 \text{ ppm}$ .

#### General characteristics

**Operating temperature range:** 0 to  $55^{\circ}\text{C}$ .

**Power requirements:** 100, 120, 220, 240 V ( $\pm 5\%$ ,  $\sim 10\%$ ), 48 to 440 Hz; 12.5 VA.

**Weight:** net, 2.2 kg (4 lb 13 oz). Shipping 3 kg (6 lb 8 oz).

**Dimensions:** 102 mm H  $\times$  266 mm W  $\times$  290 mm D ( $4'' \times 10.5'' \times 11.4375''$ ).

#### Ordering information

8640M Signal generator

11710B Down converter

#### Price

\$8400

\$1000

# SIGNAL GENERATORS

Rugged solid-state generator 10 to 520 MHz; synchronizer/counter

Models 8654A, 8654B, 8655A

- Calibrated output power
- Calibrated AM, FM; internal, external, independent
- 25 Watt reverse power protection (optional)



8654A



8654B

## 8654A/B Signal generators

The HP 8654A/B Signal Generators are portable, low-cost solid-state generators providing calibrated output and versatile modulation capabilities over the 10 to 520 MHz frequency range. The 8654 provides clean RF signals with harmonics >20 dBc (below carrier) and subharmonics and spurious >100 dBc for testing receivers, amplifiers, antennas, and filter networks. The 8654B has calibrated AM and FM while the 8654A has uncalibrated FM.

Its compactness and small size allow the 8654 to fit easily into production, mobile, airborne, and shipboard test locations. Its rugged, lightweight construction is also suitable for field maintenance and service applications.

Internal oscillators provide both amplitude modulation and frequency modulation at 400 Hz and 1000 Hz, or external modulation can be accomplished using standard audio oscillators.

A front-panel meter accurately indicates amplitude modulation depth from 0 to 90% when the meter mode switch is in the AM position. Additionally, the 8654B provides calibrated and metered FM over four deviation ranges: 0 to 3 kHz, 0 to 10 kHz, 0 to 30 kHz, and 0 to 100 kHz.

Reverse power protection is available (Option 003) to protect against accidental triggering of transceivers of up to 25 watts into the signal generator.

Effective RF shielding and output range permit receiver sensitivity measurements to be made down to power levels of 0.1  $\mu$ V.

## 8654A/B specifications

Specifications apply from 10 to 520 MHz for output power  $\leq$  +10 dBm and over the top 10 dB of output level vernier range unless otherwise specified.

### Frequency characteristics

**Range:** 10 to 520 MHz in 6 ranges:

**8654A ranges (MHz):** 10 to 18.6, 18.6 to 35, 35 to 66, 66 to 130, 130 to 250, 250 to 520.

**8654B ranges (MHz):** 10 to 19, 19 to 35, 35 to 66, 66 to 130, 130 to 270, 270 to 520.

**Accuracy:**  $\pm 3\%$  after 2-hour warm-up.

**Settability:** settable to within 5 ppm of the desired frequency with an external indicator after 1-hour warm-up.

**Stability (after 2-hour warm-up and 15 min. after frequency change):** <(1 kHz plus 20 ppm)/5 min.

### Spectral purity

**Harmonic distortion (output power  $\leq$  +3 dBm):** >20 dBc; with option 003, >15 dBc.

**Subharmonics and non-harmonic spurious (excluding line related):** >100 dBc.

**Residual AM (average rma):** >55 dBc in a 50 Hz to 15 kHz post-detection noise bandwidth.

**Residual FM on CW (averaged rma deviation):** <0.3 ppm in  $\pm$  0.3 to 3 kHz post-detection noise bandwidth, <0.5 ppm in a 50 Hz to 15 kHz post-detection noise bandwidth.

### Output characteristics

**Range:** 10 dB steps and a 13 dB vernier provide power settings from +10 dBm to -130 dBm (0.7 V to 0.07  $\mu$ V) into 50 $\Omega$ . With Option 003, maximum output power is +8 dBm (0.56 V).

**Impedance:** 50 $\Omega$  ac coupled. SWR <1.3 on 0.1 V range or lower. With Option 003, SWR <1.5 on 0.1 V range or lower.

**Level accuracy (total as indicated on level meter):** +10 to -7 dBm,  $\pm 1.5$  dB; -7 to -57 dBm,  $\pm 2.0$  dB; -57 to -97 dBm,  $\pm 2.5$  dB; -97 to -127 dBm,  $\pm 3$  dB.

**Level flatness:**  $\pm 1$  dB referenced to the output at 250 MHz for output levels >-7 dBm.

**Auxiliary RF output:**  $\geq -7$  dBm (100 mV) into 50 $\Omega$ .

**Leakage (with all RF outputs terminated properly):** leakage limits are below those specified in MIL-I-6181D. Furthermore, with an output level <0.01 V, less than 0.5  $\mu$ V is induced in a 2-turn, 25 mm diameter loop 25 mm away from any surface and measured into a 50 $\Omega$  receiver.

**Reverse power protection (Option 003):** protects signal generator from accidental applications of up to 25 w (+44 dBm) of RF power (between 10 and 520 MHz) into generator output.

### Modulation characteristics

**Amplitude modulation:** specifications apply for output power  $\leq$  +3 dBm.<sup>1</sup>

**Depth:** 0 to 90%.

**Modulation rate:** internal, 400 and 1000 Hz  $\pm 10\%$ ; external 3 dB bandwidth, dc coupled to >20 kHz.

**External AM sensitivity:<sup>2</sup>** (0.1  $\pm$  0.01)% AM/mV pk into 600 $\Omega$ .

**Indicated AM accuracy:<sup>2</sup>**  $\pm$  (5% of reading + 5% of full scale).

**Peak incidental frequency deviation (30% AM):<sup>2</sup>** less than 200 Hz.

**Envelope distortion:<sup>2</sup>** <3%, 0 to 70% modulation; <5%, 70 to 90% modulation.

### Frequency modulation

**8654B:** fully calibrated.

**Peak deviation:** 0 to 30 kHz from 10 to 520 MHz.

0 to 100 kHz from 80 to 520 MHz.

**Deviation ranges:** 0 to 3 kHz, 0 to 10 kHz, 0 to 30 kHz, 0 to 100 kHz.

**Modulation rate:** internal, 400 and 1000 Hz  $\pm 10\%$ . External 3 dB bandwidth, dc coupled to >25 kHz.

**FM distortion:<sup>2</sup>** <2% for deviations up to 30 kHz, <3% for deviations up to 100 kHz.

<sup>1</sup>AM is possible above +3 dBm as long as the combination of the AM depth plus carrier output does not exceed +9 dBm.

<sup>2</sup>400 and 1000 Hz modulation rates.

- Synchronize 8654A/B, stability 0.1 ppm/hr.
- 500 Hz lock resolution
- Low RFI counter to 520 MHz

**External FM sensitivity:**<sup>2</sup> 1 volt peak yields maximum deviation indicated on peak deviation meter with FM LEVEL vernier at fully clockwise position.

**Sensitivity accuracy:**<sup>2</sup> = 12%.

**Indicated FM accuracy (15° to 35°C):**<sup>2</sup> = (12% of reading + 3% of full scale). For 100 kHz deviation above 130 MHz, add 3% of reading.

**Incidental AM:**<sup>2</sup> < 1% AM at 30 kHz deviation.

**Frequency modulation, 8654A:** uncalibrated.

**Deviation:** > 0.1% of carrier frequency, maximum.

**Modulation rate:** internal, 400 & 1000 Hz ± 10%. External 3 dB bandwidth, dc-coupled to > 25 kHz driven from 600 Ω or less.

**External FM sensitivity:** 10 V<sub>pk</sub> into 600 Ω yields > 0.1% deviation (= 15 volts max).

**General characteristics**

**Power:** 100, 120, 220, or 240 volts +5%, -10%, 48 to 440 Hz; 25 VA maximum. 2.3 m (7.5 ft.) power cable furnished with mains plugs to match destination requirements.

**Weight:** net, 7.9 kg (17.4 lb). Shipping, 9.5 kg (21 lb).

**Size:** 178 H × 267 W × 306 mm D (7" × 10.5" × 12").

### 8655A Synchronizer/Counter

The HP 8655A Synchronizer/Counter is a phase-lock frequency stabilizer that provides the HP 8654A and 8654B Signal Generators with crystal-oscillator frequency stability. It is also a frequency counter with very low RFI leakage. When used with an 8654 Signal Generator, the frequency can be phase-locked at any frequency from 10 to 520 MHz. In the locked mode the spectral purity and FM capability of the unlocked 8654 are preserved. This performance allows testing of new state-of-the-art crystal controlled receivers.

Phase locking the 8654 is simple with the 8655A Synchronizer. A push of the LOCK button establishes lock at the frequency shown on the LED display. Maximum lock resolution is 500 Hz. If lock is broken, the LED display flashes. Lock can be re-established by retuning and again pushing the LOCK button.

The 8655A can also be used to count external input signals from 1 kHz to 520 MHz. Input sensitivity is better than 100 mV into 50 ohms. Using the EXPAND button it is possible to achieve a resolution of 1 Hz in the 1 kHz—10 MHz EXT COUNT mode or 100 Hz in both the 10—520 MHz EXT COUNT and SYNCHRONIZE COUNT modes.

RF leakage from an 8654B/8655A system is < 1.5 μV in a 2-turn, 25 mm diameter loop 25 mm away from any surface and measured into a 50 ohm receiver.

### 8655A Specifications

**Counter characteristics**

**Range:** 1 kHz to 520 MHz.

**Sensitivity:** < 100 mV rms (-7 dBm), ac coupled into 50 ohms. (Typically < -20 dBm, 10 kHz to 200 MHz.)

**Maximum input:** AC: 707 mV (+10 dBm) for accurate count. DC: ± 25 V on EXTERNAL COUNT INPUT, 0 V dc (ac only) on rear panel SYNCHRONIZE COUNT INPUT. Both inputs are protected with common fuse.

**Count resolution:** 6-digit LED display:

Mode	Normal	X10 EXPAND <sup>3</sup>
1 kHz to 10 MHz (EXTERNAL)	10 Hz	1 Hz
10 MHz to 520 MHz (EXTERNAL & SYNCHRONIZE COUNT)	1 kHz	100 Hz

**Accuracy:** ± 1 count ± time base accuracy.

<sup>3</sup>Will continue to accurately count from 1 to 10 MHz and 100 to 520 MHz with loss of most significant digit (indicated by overflow light). Phase lock is not allowed.



8655A

### Time base characteristics

**Frequency:** 1 MHz temperature-compensated crystal oscillator.  
**Aging:** (constant ambient temperature) < 0.1 ppm/hr. < 2 ppm/90 days.

**Temperature:** ± 5 ppm from 0° to 50°C. (Referenced to 25°C.)

**Typical overall accuracy (after 2 hour warm-up and within 3 months of calibration):** better than ± 2 ppm from 15° to 35°C. (Optional higher stability time base available.)

**Rear output:** 1 MHz, nominally > 0.5 V peak-to-peak into 500 ohms.

**External reference input:** 1 MHz, nominally > 0.5 V peak-to-peak into 1000 ohms. (Not available with optional high stability time base.)

### 8654A/B-8655A Synchronization characteristics

**Frequency range:** 10—520 MHz.

**Frequency count resolution:** 1 kHz, or 100 Hz in X10 EXPAND.

**Frequency lock resolution:** 1 kHz. Depressing LOCK +500 Hz button allows a locked resolution of 500 Hz.

**Frequency accuracy:** same as time base accuracy.

**Lock time duration (after 5 minute warm-up, constant ambient):** 45 min, typical.

**FM rate while synchronized:** 50 Hz to > 25 kHz, (with 8654B only).

**FM accuracy (with 8654B only):**

$$\left[ \begin{array}{l} \text{Total FM} \\ \text{Accuracy} \end{array} \right] \approx \left[ \begin{array}{l} \text{8654B FM} \\ \text{Accuracy} \end{array} \right] \pm \left[ \begin{array}{l} \text{Frequency} \\ \text{Correction Error} \end{array} \right]$$

Frequency correction error<sup>4</sup> is typically < ± 4%.

### General

**RF leakage (when operated with 8654B using furnished interface cables):** less than 1.5 μV in a 2-turn, 25 mm diameter loop 25 mm away from any surface and measured into a 50 ohm receiver.

**Power:** 100, 120, 220, or 240 volts +5%, -10%, 48 to 400 Hz, 100 VA maximum. 2.3 m (7.5 ft.) power cable.

**Weight:** net, 6 kg (13.2 lb). Shipping 6.5 kg (14.25 lb).

**Size:** 102 H × 267 W × 318 mm D (4" × 10.5" × 12.5").

<sup>4</sup>Frequency correction error is a function of the unlocked 8654B frequency drift. For optimum FM accuracy, this error may be eliminated by unlocking, returning to the desired frequency, and relocking.

### Ordering information

8654A AM signal generator

8654B AM/FM signal generator

Opt 003: Reverse power protection (for 8654A/B)

8655A Synchronizer/Counter

Opt 001: High stability time base (for 8655A)

### Price

\$2100

\$2600

add \$300

\$2075

add \$450

# SIGNAL GENERATORS

HF signal generator  
MODEL 606B

- 50 kHz to 65 MHz



606B

The Hewlett-Packard 606B Signal Generator provides you with high quality, versatile performance with distinctive ease of operation in the important and widely used 50 kHz to 65 MHz frequency range. Output signals are stable and accurately known, output amplitude can be precisely established over a very wide dynamic range, and versatile modulation capabilities are incorporated to satisfy virtually all measurement requirements. Convenient size and shape, together with a simple, straightforward control panel layout, make the 606B well suited for production line use as well as laboratory or field applications.

## Design

The 606B is a master oscillator-power amplifier (MOPA) design with a broadband buffer amplifier stage between the oscillator and power amplifier circuits for isolation. The MOPA design permits optimization of the oscillator circuit for highest stability including low drift, minimum residual FM, low harmonics, etc., without restricting the modulation characteristics. Modulation is applied to the power amplifier circuit with negligible effect on the oscillator frequency (because of the buffer stage). Very fine frequency settability is achieved through incorporation of a  $\Delta F$  control which provides better than 10 ppm resolution.

## 606B Specifications

(All specifications apply over top 10 dB of output vernier range.)

### Frequency and output characteristics

**Range:** 50 kHz to 65 MHz in 6 bands; accuracy:  $\pm 1\%$ .  
**Drift:** (1 V output and below) less than 50 ppm (or 5 Hz, whichever is greater) per 10 min period after 2-hr warmup; less than 10 min to restabilize after changing frequency.  
 **$\Delta F$  control:** better than 10 ppm settability; range of  $\Delta F$  control approximately 0.1%.  
**Resettability:** better than 0.15% after warmup.  
**Crystal calibrator:** provides frequency checkpoints every 100 kHz and 1 MHz; jack provided for audio frequency output; crystal frequency accuracy better than 0.01% from 0° to -50°C.  
**Residual FM:** less than  $\pm 1$  ppm or  $\pm 20$  Hz peak, whichever is greater.  
**Output level:** continuously adjustable from 0.1  $\mu V$  to 3 V into 50-ohm resistive load, calibrated in voltage and dBm.

**Frequency response and output accuracy:** at output below 1 V, output level variation with frequency is less than 2 dB; output accuracy is better than  $\pm 1$  dB at any frequency.

**Impedance:** 50 ohms, SWR less than 1.2 on 0.3 V attenuator range and below.

**RFI:** meets all conditions specified in MIL-I-6181D; permits receiver sensitivity measurements down to at least 0.1  $\mu V$ .

**Harmonic output:** at least 25 dB below the carrier.

**Spurious AM:** hum and noise sidebands are 70 dB below carrier down to the thermal level of 50-ohm output system.

**Auxiliary RF output:** (fixed level CW) on front panel; minimum output: 100 mV rms into 50 ohms from 50 kHz to 19.2 MHz, 200 mV rms from 19 to 65 MHz.

## Modulation characteristics

### Internal AM

**Frequency:** 400 and 1000 Hz,  $\pm 5\%$ .

**Modulation level:** 0 to 95% on 1 V attenuator range and below; 0 to at least 30% on 3 V range.

**Incidental FM (attenuator on 1 V range and below, 30% modulation):** less than  $5 \times 10^{-6}$  + 100 Hz peak.

**Carrier envelope distortion:** <1% at 30% AM, <3% at 70% AM (attenuator on 1 V range and below).

### External AM

**Frequency:** dc to 20 kHz maximum, dependent on carrier frequency ( $F_c$ ) and percent modulation as tabulated.

### Maximum modulation frequency:

30% Mod.	70% Mod.	Square wave Mod.
$0.06 f_c$	$0.02 f_c$	$0.003 f_c$ (3 kHz max.)

**Modulation level:** 0 to 95% on 1 V attenuator range and below, 0 to at least 30% on 3 V range.

**Input required:** 4.5 V peak produces 95% modulation (maximum input 50 V peak); input impedance 1000 ohms.

**Carrier envelope distortion:** <3% at 70% AM ( $\leq 1$  V output).

**Modulation meter accuracy:**  $\pm(5\%$  of full scale + 5% of reading) from 0 to 90% for rates to 10 kHz;  $\pm 10\%$  of full scale for rates to 20 kHz.

**Modulation level constancy (Internal or external AM; attenuator on 1 V range and below):** modulation level of 70% or less stays constant within  $\pm 0.5$  dB regardless of carrier frequency and output level changes.

### General

**Power:** 115 or 230 V  $\pm 10\%$ , 50 to 400 Hz, 135 VA.

**Dimensions:** cabinet, 318 mm H  $\times$  527 mm W  $\times$  375 mm D (12.5"  $\times$  20.75"  $\times$  14.75"); rack 265.9 mm H  $\times$  483 mm W  $\times$  371 mm D behind panel, (10.5"  $\times$  19"  $\times$  14.61").

**Weight:** cabinet, net, 25 kg (55 lb). Shipping 30 kg (66 lb); rack, net, 22.7 kg (50 lb). Shipping 29.5 kg (65 lb).

### Accessories available:

11507A Output Termination, provides 3 positions: 50 ohms, 5 ohms and IEEE Standard Dummy Antenna.

11509A 1 userholder, protection for 606B transceiver tests.

10534A Mixer, for use as a nanosecond pulse modulator.

### Ordering Information

606B HF Signal Generator (cabinet)

606BR HF Signal Generator (rack)

### Price

\$3750

\$3750



- Versatility and value, 10-480 MHz

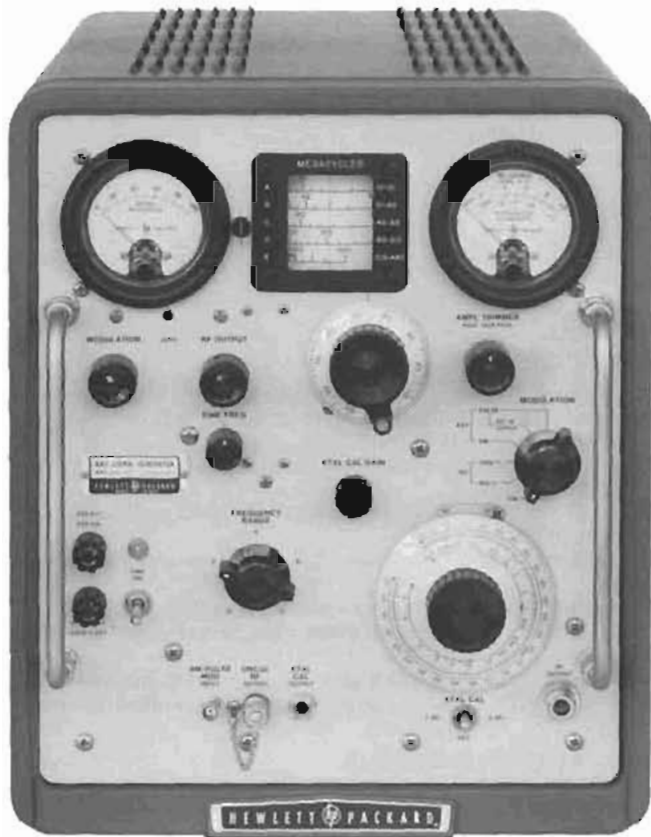

608E

Model 608E provides high-quality, versatile performance with distinctive ease of operation. The 608E provides an output of up to 1 volt over the range from 10 to 480 MHz.

The 608E is an improved version of the popular and time-proven HP 608C/D Signal Generators. The instrument is a master oscillator-power amplifier (MOPA) type with a broadband buffer amplifier stage between the oscillator and power amplifier circuits for isolation. The MOPA design permits optimization of the oscillator stage for high stability of 0.005% per 10 minutes, minimum residual FM, and low harmonics without restricting the modulation characteristics. Modulation is applied to the power amplifier stage with negligible effect on the oscillator frequency.

### 608E specifications

#### Frequency characteristics

**Range:** 10-480 MHz in five bands.

**Accuracy:**  $\pm 0.5\%$  with cursor adjustment.

**Drift:** less than  $50 \times 10^{-6}/10$  min after one hr. warmup.

**Resetability:** better than  $\pm 0.1\%$  after initial warmup; fine-frequency-adjust provides approximately 25 kHz settability at 480 MHz.

**Crystal calibrator:** provides frequency check points every 1 MHz up to 270 MHz or every 5 MHz over total range; jack provided for audio frequency output; crystal frequency accuracy better than 0.01% at room temperatures.

**Residual FM:** less than  $\pm 5$  parts in  $10^7$  in a 10 kHz post-detection bandwidth.

**Harmonic output:** at least 35 dB below the carrier for harmonic frequencies below 500 MHz.

#### Output characteristics

**Output level:** continuously adjustable from 0.1  $\mu$ V to 1.0 V into a 50-ohm resistive load; output calibrated in volts and dBm.

**Accuracy:** within  $\pm 1$  dB of attenuator dial reading at any frequency when RF output meter indicates "ATTENUATOR CALIBRATED."

**Impedance:** 50  $\Omega$  with a maximum SWR of 1.2 for attenuator setting below  $-7$  dBm

**RFI:** meets all conditions specified in MIL-I-6181D; permits receiver sensitivity measurements down to at least 0.1  $\mu$ V.

**Auxiliary RF output:** at least 180 mV rms into 50  $\Omega$  provided at front panel.

#### Modulation characteristics

##### Internal AM

**Frequency:** 400 and 1000 Hz,  $\pm 10\%$ .

**Modulation level:** 0 to 95% modulation at carrier levels 0.5 V and below.

**Carrier envelope distortion:** less than 2% at 30% AM, less than 5% at 70% AM.

##### External AM

**Frequency:** 20 Hz to 20 kHz.

**Modulation level:** 0 to 95% modulation at carrier levels of 0.5 V and below; continuously adjustable from front panel MOD LEVEL control; input required, 1-10 V rms (1000  $\Omega$  input impedance).

**Carrier envelope distortion:** less than 2% at 30% AM, less than 5% at 70% AM (modulation source distortion less than 0.5%).

**Modulation meter accuracy:**  $\pm 5\%$  of full scale 0 to 80%,  $\pm 10\%$  from 80% to 95% (for INT AM or 20 Hz to 20 kHz EXT AM).

**Incidental FM (at 400 and 1000 Hz modulation):** less than 1000 Hz peak at 50% AM for frequencies above 100 MHz; below 100 MHz; less than 0.001% at 30% AM.

#### External pulse modulation

**Rise and decay time:** from 40 MHz to 220 MHz, combined rise and decay  $< 4 \mu$ s; above 220 MHz, combined rise and decay time  $< 2.5 \mu$ s.

**On-off ratio:** at least 20 dB for pulsed carrier levels of 0.5 and above.

**Input required:** positive pulse, 10-50 V peak, input impedance 2 k $\Omega$ .

#### General

**Power:** 115 or 230 V  $\pm 10\%$ , 50 to 400 Hz; approx. 220 W.

**Size:** cabinet, 416 H  $\times$  337 W  $\times$  533 mm D (16.38"  $\times$  13.25"  $\times$  21"); rack mount: 355.6 H  $\times$  483 W  $\times$  467 mm D behind panel (14"  $\times$  19"  $\times$  18.4").

**Weight:** cabinet mount: net, 28 kg (63 lb); shipping 33.4 kg (74 lb); rack mount: net, 28 kg (62 lb); shipping, 37.4 kg (83 lb).

#### Accessories available:

11508A Output Cable for high impedance circuits.

11509A Fuse Holder - protection for transceiver tests.

10514A Mixer for use as nanosecond pulse modulator.

#### Ordering information

608E VHF Signal Generator (cabinet)

608ER VHF Signal Generator (rack)

**Price**

\$4800

\$4800

# SIGNAL GENERATORS

## UHF signal generator

### Model 612A

- 450 to 1230 MHz



Here is an all-purpose, precision signal generator particularly designed for utmost convenience and applicability throughout the important UHF-TV frequency band. It is ideally suited for measurements in UHF-television broadcasting, studio-transmitter links, citizen's radio and public service communications systems. The HP 612A also covers the important frequencies used in aircraft navigation aids such as DME, TACAN and airborne transponders. Accessory modulators, available from many of the manufacturers of these navigational aids, enable the 612A to provide the complex modulation patterns required for testing and aligning these systems. In the laboratory, the 612A is a convenient power source for driving bridges, slotted lines, antennas and filter networks. In addition, the HP 8731 PIN Modulators can be used with the 612A to obtain RF pulses with 30 ns rise time and 0.1  $\mu$ s minimum duration—with on-off ratios approaching 80 dB.

### MOPA circuit

The master oscillator-power amplifier circuit in the HP 612A provides 0.5 volt into 50 ohms over the full frequency range of 450 to 1230 MHz. There is very low incidental FM (less than 0.002% at 30% AM) and excellent amplitude modulation capabilities by all frequencies from 20 Hz to 5 MHz. The degree of modulation is easily read from the large percent modulation meter. The instrument can be amplitude-modulated (either internally or externally), and provision is made for external pulse modulation as well. Pulse modulation can be applied to the amplifier or directly to the oscillator when high on-off signal ratios are required (signal may be completely cut off between pulses). Modulation can be up or down from a preset level to simulate TV modulation characteristics accurately.

### Cavity oscillator

The oscillator-amplifier circuit in the 612A employs high frequency pencil triodes in a cavity-tuned circuit for precise tracking over the entire band. Noncontacting cavity plungers are die-cast to precise tolerances, then injection-molded with a plastic filler for optimum Q. The frequency drive is a direct screw-operated mechanism, free from backlash. A waveguide-beyond-cutoff piston attenuator and crystal monitor circuit are used to ensure accurate, reliable output down to 0.1  $\mu$ V. The attenuator is calibrated over a range of 131 dB and has been carefully designed to provide a constant impedance-versus-frequency characteristic. The SWR of the 50-ohm output system is less than 1.2 over the complete frequency range.

### Specifications

#### Frequency and output characteristics

**Frequency range:** 450 to 1230 MHz in one band; scale length approximately 381 mm (15").

**Calibration accuracy:** within  $\pm 1\%$ , resettability better than 5 MHz at high frequencies.

**Output voltage:** 0.1  $\mu$ V to 0.5 V into 50-ohm load; calibrated in V and dBm (0 dBm = 1 mW).

**Output accuracy:**  $\pm 1$  dB, 0 to -127 dBm over entire frequency range.

**Output impedance:** 50 ohms; maximum reflection coefficient, 0.091 (1.2 SWR, 20.8 dB return loss) for attenuator settings of 0 dBm and below.

**RFI:** conducted and radiated leakage limits are below those specified in MIL-I-6181D; permits receiver sensitivity measurements down to 1  $\mu$ V.

#### Modulation characteristics

**Amplitude modulation:** above 470 MHz, 0 to 90% at audio frequencies, indicated by panel meter; accuracy  $\pm 10\%$  of full scale, 30 to 90% modulation.

**Incidental FM:** less than 0.002% for 30% AM.

**Internal modulation:** 400 and 1000 Hz  $\pm 10\%$ ; envelope distortion less than 3% at 30% modulation.

**External modulation:** 20 Hz to 5 MHz; above 470 MHz, 2 V rms produces 85% AM at modulating frequencies up to 500 kHz, at least 40% AM at 5 MHz; modulation may be up or down from the carrier level or symmetrical about the carrier level; positive or negative pulses may be applied to increase or decrease RF output from the carrier level.

#### Pulse Modulation

**Pulse 1 (pulse applied to amplifier):** positive or negative pulses, 4 to 40 V peak produce an RF on-off ratio of at least 20 dB; minimum RF output pulse length, 1.0  $\mu$ s.

**Pulse 2 (pulse applied to oscillator):** positive or negative pulses, 4 to 40 V peak; no RF output during off time; minimum RF output pulse length, 1.0  $\mu$ s.

#### General

**Power:** 115 or 230 volts  $\pm 10\%$ , 48 to 440 Hz, 360 VA.

**Dimensions:** cabinet: 419 mm H  $\times$  343 mm W  $\times$  584 mm D (16.5"  $\times$  13.5"  $\times$  23"); rack mount: 355 mm H  $\times$  483 mm W  $\times$  552 mm D behind panel (14"  $\times$  19"  $\times$  21.7").

**Weight:** net, 25.2 kg (56 lb). Shipping, 30.6 kg (68 lb), (cabinet); net, 25.2 kg (56 lb). Shipping, 34.6 kg (77 lb) (rack mount).

**Accessories available:** 11500A RF Cable Assembly; 360B Low-Pass Filter (may be used where harmonic output must be reduced to a minimum, as in slotted line measurements).

#### Ordering information

612A UHF Signal Generator (cabinet)

612AR UHF Signal Generator (rack)

#### Price

\$4100

\$4100

# SIGNAL GENERATORS

## UHF Signal generators

### Models 8614A & 8616A



- Stable, easy to use, 800–4500 MHz



### HP 8614A, 8616A Signal generators

The HP 8614A and 8616A Signal Generators provide stable, accurate signals from 800 to 2400 MHz (8614A) and from 1800 to 4500 MHz (8616A). Both frequency and attenuation are set on direct-reading digital dials, while selectable functions include CW, leveled output, square-wave modulation, and external AM, FM and pulse modulation. Modulation can be accomplished simultaneously with or without leveling.

Two RF power outputs are simultaneously available from separate front-panel connectors. One provides at least 10 mW (2 mW above 3000 MHz) or a leveled output from 0 to -127 dBm. The other is at least 0.5 mW across the band. This signal can be used for phase-locking the signal generators for extreme stability, or it can be monitored with a frequency counter for extreme frequency resolution without adversely affecting the primary output.

A unique PIN diode modulator permits amplitude modulation from dc to 1 MHz or RF pulses with a 2  $\mu$ s rise time. This broad modulation bandwidth permits remote control of output level or precise leveling using external equipment. The internal leveling is also obtained by using a PIN modulator.

The 8614A and 8616A can also be used with companion modulators, HP 8403A modulators and HP 8730-series PIN modulators to provide 80 dB pulse on/off ratio (see page 379). In addition, TWT amplifiers can be used with these generators to provide high power levels.

### Specifications

#### 8614A

**Frequency range:** direct reading within 2 MHz 800 to 2400 MHz.

**Variation:**  $\Delta F$  control has a minimum range of 1.0 MHz for fine tuning.

**Frequency calibration accuracy (0 dBm & below):**  $\pm 5$  MHz.

**Frequency stability:** approximately 50 ppm/ $^{\circ}$ C change in ambient temperature, less than 2500 Hz peak residual FM, negligible incidental FM in pulse and AM operation below -10 dBm, 30 ppm change for line voltage variation of  $\pm 10\%$ .

**RF output power:** +10 dBm (0.707 V) into 50  $\Omega$  load. Output attenuation dial directly calibrated in dBm from 0 to -127 dBm. A second uncalibrated output (approximately -3 dBm) is provided on front panel.

**RF output power accuracy (with respect to attenuation dial):**  $\pm 0.75$  dB + attenuator accuracy (0 to -127 dBm) including leveled output variations.

**Attenuator accuracy:** +0, -3 dB from 0 to -10 dBm;  $\pm 0.2$  dB  $\pm 0.06$  dB/10 dB from -10 to -127 dBm; direct reading dial, 0.2 dB increments.

**Output impedance:** 50  $\Omega$ ; SWR < 2.0.

**Modulation:** on-off ratio at least 20 dB for square wave, pulse.

**Internal square wave:** 950 to 1050 Hz. Square wave can be synchronized with a +1 to +10 V signal at PULSE input.

**External pulse:** 50 Hz to 50 kHz; 2  $\mu$ s rise time, +20 to +100 V peak input.

**External AM:** DC to 1 MHz.

**External FM:** a) front panel connector capacity-coupled to repeller of klystron; b) four-terminal rear panel connector (Cinch-Jones type S304AB) is dc-coupled to repeller of klystron.

**Power source:** 115 or 230 V  $\pm 10\%$ , 50 to 60 Hz, approximately 125 W.

**Size:** 141 H  $\times$  425 W  $\times$  467 mm D (5.5"  $\times$  16.75"  $\times$  18.4"); rack mount 133 H  $\times$  416 W  $\times$  483 mm D (5.2"  $\times$  16.4"  $\times$  19").

**Weight:** net, 19.5 kg (43 lb). Shipping, 22.3 kg (49 lb).

**Option 001:** external modulation input connectors on rear panel in parallel with front-panel connectors; RF connectors on rear panel only.

#### 8616A

**Frequency range:** direct reading within 2 MHz 1800 to 4500 MHz.

**Variation:**  $\Delta F$  control has a range of approximately 1.0 MHz for fine tuning.

**Frequency calibration accuracy (0 dBm & below):**  $\pm 10$  MHz.

**Frequency stability:** approximately 50 ppm/ $^{\circ}$ C change in ambient temperature, less than 2500 Hz peak residual FM, negligible incidental FM in pulse and AM operation for attenuator settings below -10 dBm, 30 ppm change for line voltage variation of  $\pm 10\%$ .

**RF output power:** +10 dBm (0.707 V) to -127 dBm into 50  $\Omega$  load, 1800 to 3000 MHz; +3 dBm to -127 dBm from 3000 to 4500 MHz into a 50  $\Omega$  load. Output attenuation dial directly calibrated in dBm from 0 to -127 dBm. A second uncalibrated output (approximately -3 dBm) is provided on the front panel.

**RF output power accuracy (with respect to attenuation dial):**  $\pm 1.0$  dB + attenuator accuracy (0 to -127 dBm).

**Attenuator accuracy:** +1, -2 dB from 0 to 10 dBm, ( $\pm 0.2$  dB + 0.06 dB/10 dB) from -10 to -127 dBm.

**Output impedance:** 50  $\Omega$ ; SWR less than 2.0.

**Modulation:** on-off ratio at least 20 dB for square wave, pulse.

**Internal square wave:** 950 to 1050 Hz. Other frequencies available on special order.

**External pulse:** 50 Hz to 50 kHz; 2  $\mu$ s rise time, +20 to +100 V peak input.

**External AM:** DC to 1 MHz.

**External FM:** a) front panel connector capacity-coupled to repeller of klystron; b) four-terminal rear panel connector (Cinch-Jones type S304AB) is DC-coupled to repeller of klystron.

**Dimensions:** 141 mm H  $\times$  425 mm W  $\times$  467 mm D (5.5"  $\times$  16.75"  $\times$  18.4"); rack mount 133 mm H  $\times$  416 mm W  $\times$  483 mm D (5.2"  $\times$  16.4"  $\times$  19").

**Weight:** net, 19.5 kg (43 lb). Shipping, 22.3 kg (49 lb).

#### Options

**001:** external modulation input connectors on rear panel in parallel with front-panel connectors; RF connectors on rear panel only.

**008:** Rack Flange Kit

**Price**  
add \$25

add \$10

#### Ordering Information

8614A Signal Generator (800–2400 MHz)  
8616A Signal Generator (1800–4500 MHz)

\$4500  
\$4500

# SIGNAL GENERATORS

## SHF Signal generators

Models 618C, 620B

- Multiple-purpose instruments, 3.8 to 11 GHz



The Models 618C and 620B SHF Signal Generators provide versatility, accuracy, and stability in the range from 3.8 to 11 GHz. Frequency is set on a large, direct-reading dial. A  $\Delta F$  vernier control provides ultra-fine tuning capability. There is also a provision for remote fine tuning.

A calibrated output from 0 to  $-127$  dBm (0.224 volts to 0.1 microvolt) is also set on a large, direct-reading dial. The dial is calibrated in both dBm and volts. An auxiliary output of at least 0.3 milliwatt is available and is independent of attenuator setting. Thus, it can be used for phase-locking the signal generator when crystal-oscillator stability is required, or it can be monitored with a frequency counter for extreme frequency resolution.

The 618C and 620B Generators both feature oscillators of the reflex klystron type, with external resonant cavity. Oscillator frequency is determined by a movable plunger which varies the length of the cavity. Oscillator output is monitored by a temperature-compensated detector circuit. This circuit operates virtually unaffected by ambient temperature conditions.

Modulation includes internal pulse, square wave, and frequency modulation plus external pulse and frequency modulation.

### 618C and 620B specifications

#### Output

##### Frequency range

**618C:** 3.8 to 7.6 GHz covered in a single band.

**620B:** 7 to 11 GHz covered in a single band; repeller voltage automatically tracked and proper mode automatically selected.

**Calibration:** direct reading; frequency calibration accuracy better than  $\pm 1\%$ .

**Frequency stability:** with temperature: less than 60 ppm/°C change in ambient temperature; with line voltage less than 200 ppm change for line voltage variation of  $\pm 10\%$ ; residual FM:  $< 15$  kHz peak.

**Output range:** 1 milliwatt or 0.224 volt to 0.1 microvolt ( $-127$  dBm) to  $-127$  dBm into 50 ohms; directly calibrated in dBm and volts; coaxial type N connector.

**Output accuracy:** within  $\pm 2$  dB from  $-7$  to  $-127$  dBm, within  $\pm 3$  dB from 0 to  $-7$  dBm, terminated in 50-ohm load.

**Source Impedance:** 50 ohms nominal; SWR  $< 2.0$ .

#### Modulation

**Internal pulse modulation:** repetition rate variable from 40 to 4,000 pps, pulse width variable  $\frac{1}{2}$  to 10 microseconds.

**Sync out signals:** simultaneous with RF pulse, positive, in advance of RF pulse, positive, variable 3 to 300 microseconds (better than 1 microsecond rise time and 25 to 100 volts amplitude into 1,000-ohm load).

**External synchronization:** sine wave: 40 to 4,000 Hz, 5 to 50 V rms, pulse: 40 to 4,000 pps, 5 to 50 V peak, positive or negative, 0.5 to 5  $\mu$ s wide, 0.1 to 1  $\mu$ s rise time.

**Internal square-wave modulation:** variable 40 to 4,000 Hz.

**Internal FM:** sawtooth sweep rate adjustable 40 to 4,000 Hz; frequency deviation to 5 MHz peak-to-peak over most of the frequency range.

**External pulse modulation:** pulse requirements: amplitude from 20 to 70 volts positive or negative, width 0.5 to 2,500 microseconds.

**External FM:** frequency deviation approximately 5 MHz peak-to-peak over most of the band; sensitivity approximately 20 V/MHz at front-panel connector, approximately 10 V/MHz at rear-panel connector (mating connector supplied); front-panel connector is capacitively coupled to klystron repeller; rear-panel connector is decoupled to klystron repeller and is suitable for phase-lock control input.

#### General

**RFI:** conducted and radiated leakage limits are below those specified in MIL-I-6181D.

**Power source:** 115 or 230 volts  $\pm 10\%$ , 50 to 60 Hz 230 W.

**Dimensions:** cabinet, 353 mm H  $\times$  445 mm W  $\times$  518 mm D (13.9"  $\times$  17.5"  $\times$  20.4"); rack mount 355 mm  $\times$  483 mm  $\times$  483 mm (14"  $\times$  19"  $\times$  19").

**Weight:** net, 31.1 kg (69 lb), Shipping, 35.5 (77 lb).

**Accessory furnished:** JLSM0A Cable Assembly, 1830 mm (6 ft) of RG-214A/U 50-ohm coax, terminated on each end by type N male connectors.

#### Ordering information

618C or 620B SHF Signal Generator (cabinet mount)

618CR or 620BR SHF Signal Generator (rack mount)

#### Price

\$5400

\$5400

# SIGNAL GENERATORS

SHF generators/doublers

Models 626A, 628A, 938A, 940A



- Generate stable signals, 10 to 40 GHz

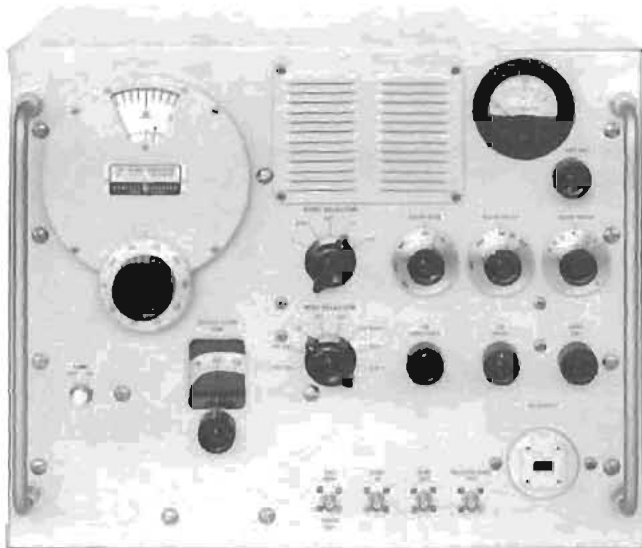

626A



938A

## Description

The 626A covers frequencies 10 to 15.5 GHz, and the 628A covers frequencies 15 to 21 GHz. In design and operation, the instruments are similar to Hewlett-Packard generators for lower frequency ranges. Carrier frequency is set and read directly on the large tuning dial. No voltage adjustment is necessary during tuning because repeller voltage is tracked with frequency changes automatically. Oscillator output is also set and read directly, and no frequency correction is necessary throughout operating range. A frequency logging scale permits frequency to be reset within 0.1%.

Both the 626A and 628A offer internal pulse, squarewave and frequency modulation, plus external pulse and frequency modulation. The pulse generators may be synchronized with an external sine wave and positive or negative pulse signals.

The high power output of these signal generators makes them ideally suited for driving HP 938A and 940A Frequency Doubler sets. These doubler sets retain the modulation and stability of the driving source and have accurate power monitors and attenuators.

## 626A, 628A specifications

**Frequency range:** 626A, 10 to 15.5 GHz; 628A, 15 to 21 GHz.  
**Frequency calibration:** dial direct-reading in GHz, accuracy better than  $\pm 1\%$ .  
**Output range:** 10 mW to 1 pW (+10 dBm to -90 dBm, 0 dBm = 1 mW); attenuator dial calibrated in output dBm.  
**Source SWR:** <2.5 at +10 dBm; <1.35 at 0 dBm and below.  
**Output monitor accuracy:** better than  $\pm 1$  dB; temperature-compensated thermistor bridge circuit monitors RF oscillator power level.  
**Output connector:** 626A: WR75 waveguide, flat cover flange; 21.6  $\times$  12.0 mm (0.85  $\times$  0.475 in.). 628A: WR51 waveguide, flat cover flange; 15.0  $\times$  8.5 mm (0.59  $\times$  0.335 in.).  
**Output attenuator accuracy:** better than  $\pm 2\%$  of attenuation in dB introduced by output attenuator.  
**Modulation:** internal pulse, FM, or square wave; external pulse and FM.

**Internal pulse modulation:** repetition rate variable from 40 to 4000 pps; pulse width variable 0.5 to 10  $\mu$ s.

**Internal square-wave modulation:** variable 40 to 4000 Hz controlled by "pulse rate" control.

**Internal frequency modulation:** power line frequency, deviation up to  $\pm 5$  MHz.

**External pulse modulation:** pulse requirements: amplitude 15 to 70 volts peak positive or negative; width 1 to 2500  $\mu$ s.

**External frequency modulation:** provided by capacitive coupling to the klystron repeller; maximum deviation approximately  $\pm 5$  MHz.

**Sync out signals:** positive 20 to 100 V peak into 1000-ohm load; better than 1  $\mu$ s rise time; 1) simultaneous with RF pulse, positive; 2) in advance of RF pulse, positive, variable 5 to 300  $\mu$ s.

**External synchronization:** 1) sine wave, 40 to 4000 Hz, amplitude 5 to 50 V rms; 2) pulse signals 40 to 4000 pps, 5 to 50 V amplitude, positive or negative; pulse width 0.5 to 5  $\mu$ s; rise time 0.1 to 1  $\mu$ s.

**Power:** 115 or 230 volts  $\pm 10\%$ , 50 to 60 Hz, approx. 200 watts.

**Dimensions:** cabinet: 356 mm H  $\times$  432 mm W  $\times$  381 mm D (14"  $\times$  17"  $\times$  15"); rack mount: 356 mm H  $\times$  483 mm W  $\times$  313 mm D (14"  $\times$  19"  $\times$  12.8").

**Weight:** net, 26.8 kg (59 lb). Shipping, 29.8 kg (66 lb).

**Accessories furnished:** 626A, MX 292B and MP 292B Waveguide Adapters; 628A, NP 292A and NK 292A Waveguide Adapters.

**Accessories available:** M362A low-pass filter.

## Frequency doubler sets

Model 938A supplies power from 18 to 26.5 GHz and Model 940A from 26.5 to 40 GHz when driven by 9 to 13.25 GHz and 13.25 to 20 GHz sources respectively. For a swept output, use a swept-frequency source such as Model 8690B or Model 8620A/B series with appropriate RF units.

## 938A, 940A specifications

**Frequency range:** 938A, 18 to 26.5 GHz; 940A, 26.5 to 40 GHz.  
**Conversion loss:** less than 18 dB at 10 mW input.  
**Output power:** approximately 0.5-1 mW when used with typical 626A, 628A signal generators; input power: 100 mW maximum.  
**Output attenuator:** accuracy,  $\pm 2\%$  of reading or  $\pm 0.2$  dB, whichever is greater; range, 100 dB.  
**Output reflection coefficient:** approx. 0.33 at full output; less than 0.2 with attenuator set to 10 dB or greater.  
**Output flange:** 938A K-band flat cover flange for WR-42 waveguide; 940A R-band flat flange for WR-28 waveguide.  
**Dimensions:** 137 mm H  $\times$  489 mm W  $\times$  457 mm D (5.4"  $\times$  19.25"  $\times$  18").  
**Weight:** net, 9 kg (20 lb). Shipping, 11.8 kg (26 lb).

## Ordering Information

626A or 628A SHF signal generator (cabinet)  
626AR or 628AR SHF signal generator (rack)  
938A or 940A frequency doubler

**Price**  
\$8200  
\$8200  
\$5300



## SIGNAL GENERATORS

VHF oscillator, frequency doubler probe, pulse modulator

Models 3200B, 13515A, 11720A

- 10 to 500 MHz
- to 1000 MHz with doubler probe

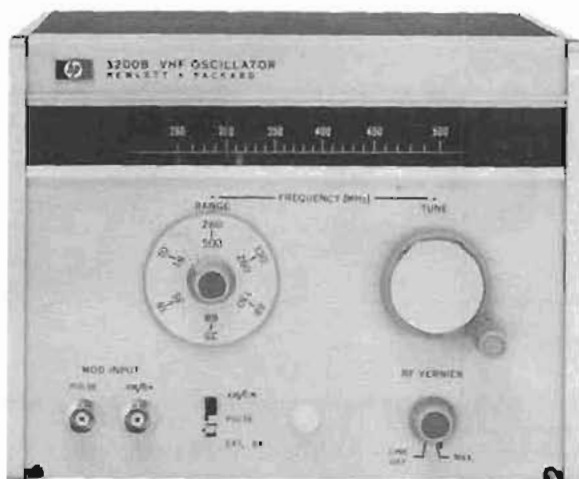

3200B

### 3200B VHF oscillator

The VHF oscillator, model 3200B, provides low cost, stable, 10 to 500 MHz RF for testing receivers and amplifiers, and driving bridges, slotted lines, antennas, and filter networks. Good pulse modulation sensitivity allows standard audio oscillators to be used to provide usable square wave modulation; a 2.5-volt sine wave will provide adequate drive for this type application. An optional accessory frequency doubler probe, model 13515A, provides additional frequency coverage from 500 to 1000 MHz.

The 3200B is well suited for bench use and may be adapted for standard 483 mm (19 in.) rack mounting.

#### Specifications

**Frequency range:** 10–500 MHz in six bands: 10–18.8 MHz; 18.5–35 MHz; 35–68 MHz; 68–130 MHz; 130–260 MHz; 260–500 MHz.

**Frequency accuracy:** within  $\pm 2\%$  after  $\frac{1}{2}$  hour warmup.

**Frequency calibration:** increments of less than 4%.

**Frequency stability (after 4 hour warm-up under 0.2 mW load):** short term (5 min)  $\pm 20$  ppm; long-term (1 hour)  $\pm 200$  ppm; line voltage (5 V change)  $\pm 10$  ppm.

#### RF output

**Maximum power (across 50 ohm external load):** 200 mW (10–130 MHz);  $>150$  mW (130–260 MHz);  $>25$  mW (260–500 MHz).

**Range:** 0 to  $>120$  dB attenuation from maximum output.

**Load impedance:** 50 ohms nominal.

**RF leakage:** sufficiently low to permit measurements at  $1 \mu\text{V}$ .

**RFI:** meets requirements of MIL-I-6181D.

**Amplitude modulation:** externally modulated.

**Range:** 0 to 30%.

**Distortion:**  $<1\%$  at 30% AM.

**External requirements:** approximately 32 volts rms into 600 ohms for 30% AM, 200 Hz to 100 kHz.

**Pulse modulation:** externally modulated.

**External requirements:** 2.5 volt negative pulse into 2000 ohms.

**Power:** 105 to 125 V or 210 to 250 V, 50 to 400 Hz, 30 VA.

**Dimensions:** 167 mm H  $\times$  194 mm W  $\times$  333 mm D (6.6"  $\times$  7.6"  $\times$  13.1").

**Weight:** net, 6.8 kg (15 lb); shipping, 7.7 kg (17 lb).

**Accessories available:** 13515A frequency doubler probe; 00502-60002 patching cable.

### 13515A Frequency doubler probe

**Frequency range:** 500 to 1000 MHz with the 3200B operating 250 to 260 MHz (130 to 260 MHz range) or 260 to 500 MHz.

**RF output:** more than 4 mW across external 50 ohm load.

- 2 to 18 GHz
- $<10$  ns rise and fall times
- $>80$  dB ON/OFF ratio



11720A

### 11720A Pulse modulator

The 11720A Pulse Modulator is a high performance state-of-the-art microwave pulse modulator covering the range of 2 to 18 GHz. Because of this wide frequency coverage it can be used to increase the modulation capabilities of many microwave sources (sweepers or Signal Generators) and eliminates the need for several individual modulators in broadband applications.

In addition to wide frequency coverage, the 11720A features extremely short rise and fall times ( $<10$  ns) and a high ON/OFF ratio ( $>80$  dB) making it suitable for almost any pulsed RF application.

Internally the modulator used in the 11720A is a unique series-shunt PIN diode switch offering superior performance to a simple shunt-diode switch which reflects the input power back to the source in the "off" state. In the 11720A the series components reduce this reflection without significantly increasing the insertion loss.

The 11720A contains all the necessary modulator drive circuitry to achieve specified performance so that a standard pulse generator, or any source that can deliver  $>3$  V peak into 50 ohms, can supply the input. In addition a normal/complement function is provided to adapt the 11720A to positive-true or negative-true logic inputs.

#### Specifications

**Frequency range:** 2 to 18 GHz.

**ON/OFF ratio:**  $>80$  dB.

**Rise and fall times:**  $<10$  ns.

**Insertion loss:**  $<6$  dB, 2 to 12.4 GHz;  $<10$  dB, 2 to 18 GHz.

**Maximum RF input power:**  $+20$  dBm.

**Maximum repetition rate:**  $>5$  MHz.

**Minimum RF pulse width:**  $<50$  ns.

#### Pulse Input

**Normal mode:**  $>3$  V (on),  $<0.5$  V (off).

**Complement mode:**  $<0.5$  V (on),  $>3$  V (off).

**Impedance:** 50  $\Omega$  nominal.

#### General

**Operating temperature:**  $0^\circ\text{C}$  to  $55^\circ\text{C}$ .

**Power:** 100, 120, 220, 240 V  $\pm 5\%$ ,  $-10\%$ , 48–400 Hz; 50 VA max.

**Weight:** net, 2.6 kg (5 lb 12 oz); shipping, 3.6 kg (8 lb).

**Size:** 101 H  $\times$  222 W  $\times$  290 mm D (4.0"  $\times$  8.4"  $\times$  11.4").

#### Ordering Information

3200B VHF oscillator  
13515A Frequency doubler probe  
11720A Pulse modulator

#### Price

\$1225  
\$150  
\$2500

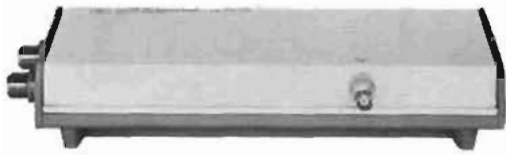

8730B

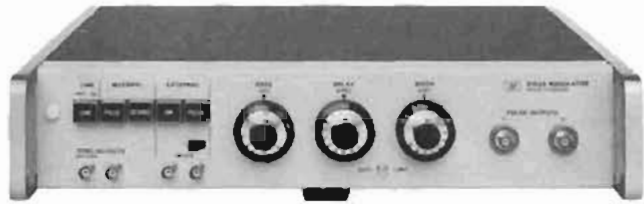

8403A

### 8730 Series PIN modulators

With HP 8730 series PIN Modulators, signal sources, including klystrons, can be pulse-modulated, leveled or amplitude-modulated with sinusoidal and complex waveforms. Fast-rise times, low incidental FM and a nearly constant impedance match to source and load are typical of these absorption-type modulators.

### 8403A Modulator

The Model 8403A provides complete control of the PIN modulators, supplying the appropriate modulation wave shapes and bias levels for fast rise times, rated on/off ratios and amplitude modulation. An internal square-wave and pulse modulator with PRF or 50 Hz to 50 kHz and adjustable pulse width and delay also provide square wave and pulses for general pulse applications. For applications requiring an absorption-type modulator plus controls in a single unit, a PIN modulator can be installed in the Model 8403A.

### 8403A specifications

**Output characteristics** (available separately at front panel).

**For driving 8730 PIN modulators:** AM and pulse output, pulse output specially shaped for optimum RF rise and decay times.

**For general pulse applications:** positive dc-coupled pulse 25 to 30 volt in amplitude, approximately symmetrical about 0 volt; no AM signal.

#### Modulation

##### Internal square wave

**Frequency:** variable from 50 Hz to 50 kHz.

**Symmetry:** better than 45/55%.

##### Internal pulse

**Repetition rate:** variable from 50 Hz to 50 kHz.

**Delay:** variable from 0.1  $\mu$ s to 100  $\mu$ s, between sync out pulse and RF output pulse.

**Width:** variable from 0.1  $\mu$ s to 100  $\mu$ s.

##### External sync

**Signal:** 5 to 20 volts peak, + or -, pulse or sine wave.

**Input impedance:** approximately 2000 ohms, dc-coupled.

#### Trigger out

**Sync out:** simultaneous with or 0.1 to 100  $\mu$ s in advance of RF pulse, as set by delay control.

**Delayed sync out:** simultaneous with output pulse.

**Amplitude:** approximately -2 volts.

**Source impedance:** approximately 330 ohms.

#### External pulse

**Amplitude and polarity:** 5 volts to 20 volts peak, + or -.

**Repetition rate:** maximum average PRF, 500 kHz/sec.

**Input impedance:** approximately 2000 ohms, dc-coupled.

**Width:** minimum 0.1  $\mu$ s; maximum 1/PRF-0.4  $\mu$ s.

#### Amplitude modulation (with 8730 series)

**Frequency response:** dc to approximately 10 MHz (3 dB).

**Sensitivity:** approximately 10 dB/volt with HP 8730A series; approximately 20 dB/volt with HP 8730B series.

**Input impedance:** approximately 100 ohms.

#### General

**Power:** 115 or 230 volts  $\pm$  10%, 50 to 400 Hz, approximately 10 watts.

**Size:** 96 H  $\times$  425 W  $\times$  467 mm D (3.75"  $\times$  3.75"  $\times$  18.4"); hardware furnished for rack mount 89 H  $\times$  483 W  $\times$  416 mm D (3.5"  $\times$  19"  $\times$  16.4").

**Weight:** net, 7.4 kg (16.5 lb). Shipping, 9 kg (20 lb).

#### Options

PIN Modulators installed in 8403A:

001: 8731A

002: 8731B

003: 8732A

004: 8732B

005: 8733A

006: 8733B

007: 8734A

008: 8734B

009: Input and Output Connectors on rear panel

8403A Modulator

#### Price

add \$830

add \$1025

add \$830

add \$1120

add \$885

add \$1415

add \$1000

add \$1285

add \$25

\$1600

### 8730 Series specifications

HP Model	8731A	8731B	8732A	8732B	8733A	8733B	8734A	8734B	8735A	8735B	H16-8731B <sup>4</sup>
Frequency range (GHz)	0.8-2.4	0.8-2.4	1.8-4.5	1.8-4.5	3.7-8.3	3.7-8.3	7.0-12.4	7.0-12.4	8.2-12.4	8.2-12.4	0.4-1.2
Dynamic range (dB)	35	80	35	80	35	80	35	80	35	80	35
Max. residual atten. (dB) <sup>1</sup>	<1.5	<2.0	<2.0	<3.5 <sup>2</sup>	<2.0	<3.0	<4.0	<5.0	<4.0	<5.0	<2.0
Typical rise time (ns) <sup>3</sup>	40	30	40	30	30	30	30	30	30	30	40
Typical decay time (ns) <sup>3</sup>	30	20	30	20	20	20	20	20	20	20	30
SWR, min. attenuation	1.5	1.6	1.5	1.6 <sup>4</sup>	1.8	2.0	1.8	2.0	1.7	2.0	1.5 <sup>7</sup>
SWR, max. attenuation	1.8	2.0	1.8	2.0	2.0	2.2	2.0	2.2	2.0	2.2	2.0 <sup>7</sup>
Forward bias input resistance (ohms)	300	100	300	100	300	100	300	100	300	100	300
RF connector type	N(f)	N(f)	N(f)	N(f)	N(f)	N(f)	N(f)	N(f)	W/G <sup>5</sup>	W/G <sup>5</sup>	N(f)
Weight, net kg (lb)	1.4 (3)	2.5 (5.5)	1.4 (3)	2.5 (5.5)	1.1 (2.5)	1.6 (3.5)	1.1 (2.5)	1.6 (3.5)	1.1 (2.5)	1.6 (3.5)	2.5 (5.5)
Weight, shipping kg (lb)	1.6 (4)	4.1 (9)	1.6 (4)	4.1 (9)	1.6 (4)	2.3 (5)	1.6 (4)	2.3 (5)	1.6 (4)	2.3 (5)	4.1 (9)
Dimensions											
Height, mm (in)	57 (2.25)	57 (2.25)	57 (2.25)	57 (2.25)	57 (2.25)	57 (2.25)	57 (2.25)	57 (2.25)	57 (2.25)	57 (2.25)	57 (2.25)
Width, mm (in)	83 (3.25)	124 (4.9)	83 (3.25)	124 (4.9)	83 (3.25)	83 (3.25)	83 (3.25)	83 (3.25)	83 (3.25)	83 (3.25)	124 (4.9)
Depth, mm (in)	283 (11.1)	289 (11.4)	283 (11.1)	289 (11.4)	213 (8.4)	311 (12.3)	213 (8.4)	311 (12.3)	171 (6.75)	267 (10.5)	289 (11.4)
Price	\$725	\$1025	\$725	\$1025	\$775	\$1300	\$890	\$1170	\$810	\$1280	\$1025

Maximum ratings: maximum input power, peak or CW, 1 W, bias limits: +20 V, -10 V.  
Bias polarity: negative voltage increases attenuation.  
RFI: radiated leakage limits are below those specified in MIL-I-6181D at input levels <1 mW, at all input levels radiated interference is sufficiently low to obtain rated attenuation.

1. With +5 V bias.  
2. 4 dB, 4 to 4.5 GHz.  
3. Driven by HP 8403A Modulator.  
4. 2.0 SWR, 4 to 4.5 GHz.

5. Fits 1  $\times$  1/2 in. (WR 90) waveguide.  
6. External high-pass filters required.  
7. Excluding high-pass filters.



# SIGNAL GENERATORS

## Accessories

Models 10511A, 10514A, 10534A, 11507A, 11508A, 11509A, 11687A, 11690A, 11697A/B/C

- Additional Capabilities for Signal Generators

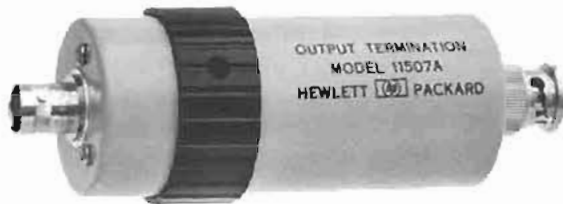

11507A



11509A



11687A

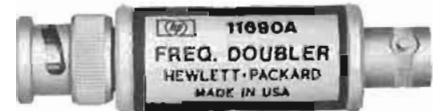

11690A



11697A

### 10511A Spectrum generator

Extends the useful frequency range of signal generators, sources and frequency synthesizers by providing a spectrum of harmonics up to 1 GHz from sine-wave inputs between 10 and 75 MHz. A 50 $\Omega$  bandpass filter can then be cascaded with the 10511A to extract the desired harmonic. The harmonic power available is at least -19 dBm for harmonics 1 through 10.

**Input requirements:** 1 to 3 volts rms into 50 $\Omega$ , 10 to 75 MHz.

### 10514A, 10534A Double balanced mixers

Used with signal generators in a variety of mixing as well as AM, pulse and square-wave modulation applications. The careful balancing of the hot carrier diodes in the 10514 and 10534 Mixers provides excellent suppression of the local oscillator and input frequencies at the output port. Frequency range of the 10514 is 0.2-500 MHz and the 10534 is 0.05-150 MHz.

### 11507A Output termination

A multi-purpose termination which enhances the usefulness of the 606A or 606B by providing the following:

1. A matched 50-ohm termination to permit use into high impedance circuits.
2. A 20-dB (10:1) terminated voltage divider which reduces the source impedance to 5 ohms.
3. A dummy antenna having the IEEE standard characteristics for receiver measurements (driven from 10:1 divider)

**Frequency range:** 50 kHz to 65 MHz on 0 to 20 dB positions. 540 kHz to 23 MHz on dummy antenna.

### 11508A Output cable

Provides 50 $\Omega$  termination and standard binding posts at the end of a 610 mm (24-inch) length of cable. Allows direct connection of the signal generator to high impedance circuits.

### 11509A Fuseholder

Prevents accidental burnout of attenuators in HP 8640, HP 606 and 608 Signal Generators during transceiver testing by introducing a fuse element between the signal generator and the transceiver. Several watts of RF power could otherwise be applied to the signal generator attenuator should the transceiver accidentally be switched to "Transmit." While the fuseholder provides protection, it in no way limits the usable output from the signal generators.

**Accessories furnished:** 10 extra fuses.

### 11687A 50-75 $\Omega$ Adapter

This 50-75 $\Omega$  Adapter with Type N connectors is recommended for use with the 8640A/B for measurements in 75 $\Omega$  systems. The voltage calibration on the output level meter is unaffected by use of the adapter, but a correction of 1.76 dB must be made when using the dB scale.

### 11690A Frequency doubler

The HP 11690A Frequency Doubler is designed to extend the 8640A or 8640B frequency range by doubling the 256-512 MHz Frequency Band up to 1024 MHz (to 1100 MHz with band overrange). Its recommended input level for optimum performance with AM modulation is +10 dBm.

The 8640A has a dial scale for the 512 to 1024 MHz external doubler band to indicate the correct doubled output frequency. The 8640B also displays the correct doubled output frequency when the 512 to 1024 range is selected. For FM in the doubled range, an additional position on the PEAK DEVIATION RANGE switch allows peak deviation up to 3.12 MHz.

The following specifications describe the 11690A when used with the 8640A or 8640B:

**Input required:** +10 to +19 dBm (0.707 V to 2 V).

**Conversion loss:** <13 dB.

**Level flatness:** 4 dB total variation. Suppression of 1st and 3rd harmonic of input typically >20 dB.

### 11697A/B/C Bandpass filters

The 8640A/B Option 002 Internal Doubler covers several communication bands including UHF-TV, Mobile Radio and some ATC/DME. External bandpass filters should be used to improve the generator spurious and harmonic performance in any of these bands. Three such filters are available. 11697A (512 to 674 MHz), 11697B (674 to 890 MHz), and 11697C (800 to 1100 MHz).

**Pass band SWR:**  $\leq 1.4$ .

**Pass band attenuation:**  $\leq 1.1$  dB.

**Midband attenuation:**  $\leq 0.6$  dB.

**Rejection band attenuation**

Model	Below Passband		Above Passband	
	Frequency (MHz)	Attenuation	Frequency (MHz)	Attenuation
11697A	$\approx 337$	-20 dB	768-3000	-20 dB
11697B	$\approx 445$	-20 dB	1011-3000	-20 dB
11697C	$\approx 550$	-20 dB	1333-3000	-20 dB

### Ordering information

	Price
10511A Spectrum Generator	\$300
10514A Double Balanced Mixer (0.2-500 MHz)	\$139
10534A Double Balanced Mixer (0.05-150 MHz)	\$104
11507A Output Termination	\$175
11508A Output Cable	\$50
11509A Fuseholder	\$80
11687A 50 $\Omega$ -75 $\Omega$ Adapter	\$115
11690A Frequency Doubler	\$180
11697A Bandpass Filter (512-674 MHz)	\$270
11697B Bandpass Filter (674-890 MHz)	\$270
11697C Bandpass Filter (800-1100 MHz)	\$270





### Sweep oscillators

Swept frequency oscillators are used in applications where the characteristics of a device must be determined over a wide, continuous range of frequencies. Combined with a broadband detector and display test set, sweep oscillators provide many benefits compared to CW frequency sources. A swept measurement provides a dynamic display of the data. The results of any adjustments to the unknown test device are seen immediately (real time) on the display. By replacing laborious point-by-point techniques swept measurements increase the speed and convenience of broadband testing. The continuous frequency characterization of the unknown device also eliminates the chance of missing important information between frequency points. Swept techniques are applicable in all phases of design, manufacture and maintenance.

#### Hewlett-Packard sweep oscillators

Hewlett-Packard sweepers cover the entire frequency spectrum from dc to 50 GHz. Self-contained, multi-octave sweepers cover the frequency range to 110 MHz. The 8690 series of backward wave and solid state oscillators features plug-ins from 400 kHz to 50 GHz. The 8620 family of solid state oscil-

lators provide a versatile choice of configurations—single band, multiband, or very wide band plug-ins from 10 MHz to 22 GHz. A chart of the individual frequency bands available appears on page 383.

#### Sweep oscillator features

##### Sweep flexibility

Every HP sweeper has several different sweep modes available for setting the frequency limits of the instrument. A full band or independently adjustable start/stop frequency sweep can be selected. Alternatively, a marker sweep or a symmetrical  $\Delta F$  sweep about the desired center frequency can be chosen. Switching from one sweep mode to another is a simple pushbutton operation. In the auto mode the sweep retriggers automatically. Sweep times of 0.01 to more than 100 seconds can be selected. A manual sweep is also available as a front panel control, a real convenience for calibrating displays such as X-Y recorders. An external trigger is provided as well for applications where the sweeper must be synched to other instrumentation or remotely controlled.

On all sweeps a linear voltage proportional to frequency is available on an external connector which is useful for driving the

horizontal of the display. Blanking and pen lift signals are also provided at rear output connectors during flyback time when the RF is off.

The 8620 solid state family also features a self-contained multi-band capability in one compact instrument. Different octave range oscillators (up to three in one drawer) can be selected by simply pressing one band select lever. This results in performance, cost, and size benefits compared to externally multiplexed sweeper systems.

##### Power output and leveling

Power output is continuously adjustable at the front panel over approximately a 10 dB range. Built-in attenuators are also available for greater power control. Internal or external leveling is employed to obtain (1) a constant power output and (2) a good source match (low VSWR). This ensures high accuracy when making sweep measurements.

##### Modulation

Modulation capabilities further extend the sweeper's usefulness both as a sweeper and a signal generator for signal simulations. Wide AM and FM bandwidths are useful for a variety of tests on communication receivers. The flexible FM capability allows remote analog frequency programming which is important for many applications.

# SWEEP OSCILLATORS

## General information

### MLA compatibility

In communications applications where up-converter simulation is required in conjunction with the HP Microwave Link Analyzer, the 86200 series of plug-ins provides this capability as an option in frequency ranges from 500 MHz to 18 GHz. Group delay of less than 1 nanosecond and linearity of better than 0.5% across 30 MHz across most of the frequency range permit very accurate RF to RF, RF to IF and RF to BB distortion measurements.

### Programming

The 8620C solid state sweeper mainframe provides optional BCD or HP-IB programming capability. More than ten thousand frequency points per band permit very fine frequency control. In addition, band selection, sweep mode, RF attenuator, and remote-local can be controlled remotely. This allows the sweeper to be used in a wide variety of automatic systems and sophisticated signal simulation applications.

For example, a 1 MHz to 18.6 GHz frequency synthesizer can be configured using the calculator, the 86290B/8620C 2-18.6 GHz sweep oscillator, and the 8660 UHF synthesizer. (See Figure 1). Harmonics of the 8660 are used to phase lock the sweeper to the accuracy and stability of the synthe-

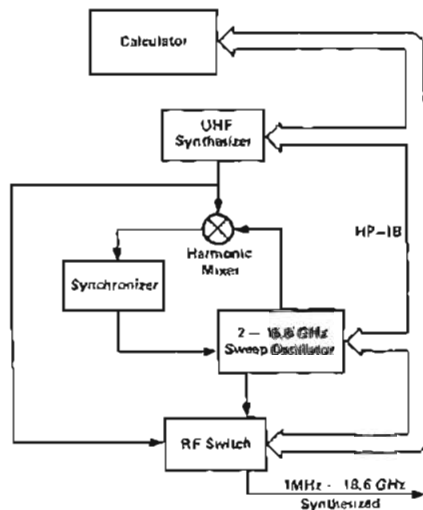

Figure 1.

sizer. The calculator is then used to control the sweeper, the UHF synthesizer, and RF switches to allow keyboard control of a CW signal or to step the source across a band of interest. Of course, the calculator can also be used to assimilate data gathered at each point.

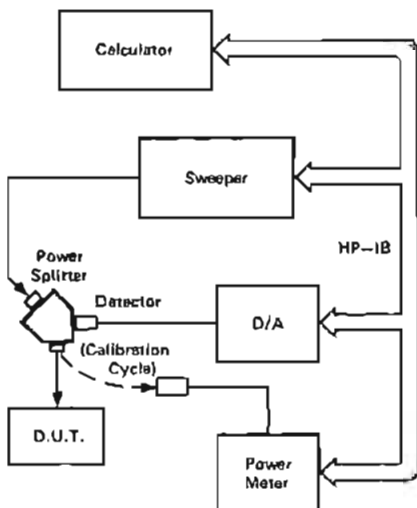

Figure 2.

Precision power level control of the sweeper can be obtained by using the calculator to drive the sweeper's EXT AM input through a Digital-to-Analog Converter. A calibration array previously stored in the calculator would control the D-A voltage producing power level accuracy similar to that of the 436A power meter used in the calibration. (See Figure 2). Level control of the sweeper is important in measuring gain compression and when ratio measurements are not practical. If greater than 10 dB of control range is required, a programmable attenuator with as much as 110 dB of range may be used.

### Digital sweeping synthesizers

The 8660C and 3330B combine the precision frequency accuracy and stability of a synthesizer with the time saving convenience of a sweeper. Parameters such as center frequency, frequency step, time per step, and sweep width are entered and executed through a convenient keyboard or remote programming connector. An additional feature on the 3330B is amplitude sweeping in steps as small as 0.01 dB. The combina-

tion of frequency and amplitude sweeping can be used to produce a comprehensive family of curves.

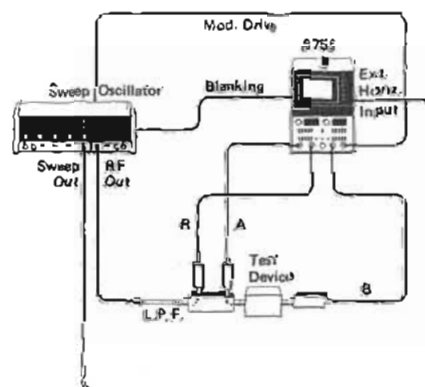

Figure 3.

### Sweeper applications

Sweepers are used extensively with swept frequency test sets to characterize the amplitude response of broadband devices or with network analyzers when the phase characteristics of the device (or S-parameters) are needed as well. Two RF measurements—transmission and reflection—are basic to both types of analyzer. Hewlett-Packard offers a complete line of directional couplers, power splitters, and other transducers which together with the analyzers and sweep oscillators provide a total swept measurement solution. Figure 3 shows a complete swept system that can be used to simultaneously characterize the scalar transmission and reflection properties of devices from 10 MHz to 18 GHz. This system has a sensitivity of better than -50 dBm.

For measurements requiring more sensitivity and/or phase information, sweepers may be used with network analyzers. Now with the HP 8620 family of solid state sweepers and the HP 8410B, these measurements can easily be made across many octaves of frequency. Previously the 8410 had to be retuned every octave. Now, for example, with the 8622A/B and the 8410B, phase-magnitude transmission or reflection coefficients can be measured across the full, 0.11-2.4 GHz range in one continuous sweep at full sweep speed. Since the 8410 is a tuned receiver this means a spurious-free sensitivity of -78 dBm.

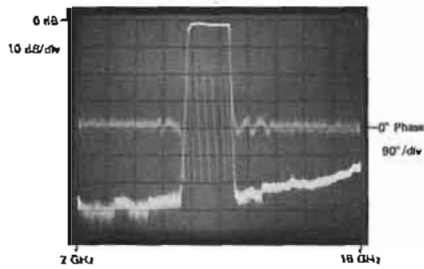

Figure 4

Figure 4 is a CRT photo of simultaneous phase and magnitude transmission characteristics of an 8 to 10 GHz bandpass filter across 2 to 18 GHz using the 86290 Sweep Oscillator Plug-in.

For high power applications such as RFI-susceptibility tests and high attenuation measurements, Hewlett-Packard offers TWT amplifiers which provide better than 1 watt from 1 to 18 GHz.

Synthesizer accuracy and stability can be obtained by phase-locking the Hewlett-Packard sweep oscillators to a harmonic of a

very stable source. This high stability is important in many applications including microwave spectroscopy and high-Q swept frequency measurements.

Two-tone swept testing of devices such as mixers and receiver front ends requires two signals offset from each other by the 1F. This is accomplished by phase-locking the difference frequency of two sweep oscillators to a very stable source. The sweepers may then be swept across the band of interest.

The modulation and built-in attenuator features of Hewlett-Packard sweep oscillator make them useful in many traditional CW signal generator applications.

In addition, accuracy, linearity, and flatness of the broadband 86222A/B and 86290A/B plug-ins make them more than adequate in many applications requiring a general purpose CW generator.

For wideband applications the 86290A/B, 2-18 GHz plug-in and the 86222A/B 0.01-2.4 GHz plug-ins feature performance that rivals octave band oscillators in the area of frequency purity and accuracy, harmonics, and flatness.

For a complete discussion of swept frequency measurements the following application notes and others are available from your local Hewlett-Packard sales office.

AN 117-1 "Microwave Network Analysis Applications"

AN 117-2 "Stripline Component Measurements"

AN 155-1 "Active Device Measurements with the 8755 . . ."

AN 155-2 "100 dB Dynamic Range Measurements, using the 8755 Frequency Response Test Set"

AN 183 "High Frequency Swept Measurements"

AN 187-2 "Configuration of A 2-18 GHz Synthesized Frequency Source using the 8620C Sweep Oscillator"

AN 187-3 "Three HP-1B Configurations for Making Microwave Scalar Measurements"

AN 187-4 "Configuration of a Two-Tone Sweeping Generator"

AN 187-5 "Calculator Control of the 8620C Sweep Oscillator using the HP-1B"

AN 221 "Semi-Automatic Measurements using the 8410B Microwave Network Analyzer and the 9825A Desk-Top Computer"

## Sweep Oscillator—summary chart

Frequency Range*	Model Number		Sweep Range												
	8620 Series	8690 Series	Other Sweepers	100 kHz	1 MHz	10 MHz	100 MHz	1 GHz	2 GHz	4 GHz	8 GHz	12 GHz	16 GHz	26 GHz	40 GHz
0.1-13 MHz 10 MHz-2600 MHz			3330B 8660A/C	—	—	—	—	—	—	—	—	—	—	—	—
100 kHz-110 MHz 400 kHz-110 MHz 10-1300 MHz 10-2400 MHz	86220A 86222A/B	8698B	8601A	—	—	—	—	—	—	—	—	—	—	—	—
100 MHz-4 GHz 1.0-2.0 GHz 1.4-2.5 GHz 1.7-4.2 GHz	86331C/86320B	8699B 8691A/B 8691A Opt 200 8692B Opt 100		—	—	—	—	—	—	—	—	—	—	—	—
1.7-4.3 GHz 2-4 GHz 2-8 GHz 3.5-8.5 GHz 2-18 GHz 2-16.5 GHz	86235A or 86331C  86240A/B 86240C 86290A 86290B	8692A/B		—	—	—	—	—	—	—	—	—	—	—	—
3.2-6.5 GHz 3.5-6.75 GHz 3.7-8.3 GHz 4-8 GHz	86241A or 86341C	8693A Opt 200 8693B Opt 100 8693A/B		—	—	—	—	—	—	—	—	—	—	—	—
5.9-9.0 GHz 5.9-12.4 GHz 7-111 GHz 8-12.4 GHz 8-18 GHz	86242D or 86342C 86245A 86250D Opt H08 86250D or 86350C	8694A/B Opt 200 8694A/B 8694A/B Opt 300		—	—	—	—	—	—	—	—	—	—	—	—
10-15 GHz 12.4-36 GHz 17-32 GHz 1.8-36.5 GHz 26.5-40 GHz 3-30 GHz	86260A Opt H04 86260A 86260A Opt H22	8695A Opt 100 8695A/B  8696A 8697A 8697A Opt H50		—	—	—	—	—	—	—	—	—	—	—	—

\*Other Special Frequency Ranges Can Be Provided Upon Request.

## SWEEP OSCILLATORS

Digital marker & generator/sweeper  
Models 8600A & 8601A



8601A

Covering 100 kHz to 110 MHz, the Model 8601A Generator/Sweeper combines the high linearity and flatness of a precision sweeper with a signal generator's frequency accuracy and wide range of calibrated power levels. Though it's small and lightweight, it does the work of two instruments easily and conveniently.

### 8601A Specifications

**Frequency range:** low range, 0.1–11 MHz; high range, 1–110 MHz.

**Frequency accuracy:** approximately  $\pm 1\%$  of frequency.

**Power output:** +20 to -110 dBm; 10-dB steps and 13-dB vernier provide continuous settings over entire range. Meter monitors output in dBm and rms volts into 50 $\Omega$ .

**Power accuracy:**  $\pm 1$  dB accuracy for any output level from +13 dBm to -110 dBm.

**Flatness:**  $\pm 0.25$  dB over full range,  $\pm 0.1$  dB over any 10 MHz portion (+10 dBm step or below).

**Impedance:** 50 $\Omega$ , SWR <1.2 on 0 dBm step and below.

**Harmonics and spurious signals:** (CW above 250 kHz, output levels below +10 dBm) harmonics at least 35 dB below carrier. Spurious at least 40 dB below carrier.

**Residual FM noise** in a 20 kHz bandwidth including line related components (dominant component of residual FM is noise)

CW: <50 Hz rms, low range; <500 Hz rms high range.

SYM 0, sweep: <100 Hz rms, low range; <1 kHz rms, high range.

**Residual AM:** AM noise modulation index (rms, 10 kHz bandwidth) is <-50 dB; (typically -60 dB at 25°C).

**Crystal calibrator:** internal 5 MHz crystal allows frequency calibration to  $\pm 0.01\%$  at any multiple of 5 MHz.

**Sweep modes:** full, video, and symmetrical.

**Internal AM:** fixed 30%  $\pm 5\%$  at 1 kHz.

**External AM:** 0 to 50%, dc to 400 Hz; 0 to 30%, up to 1 kHz.

**Internal FM:** 1 kHz rate, fixed 75 kHz  $\pm 5\%$ , deviation, high range; 7.5 kHz  $\pm 5\%$ , deviation, low range; <3% distortion.

**External FM:** sensitivity, 5 MHz per volt  $\pm 5\%$ , high range, 0.5 MHz per volt  $\pm 5\%$ , low range; negative polarity; FM rates to 10 kHz.

**Weight:** net, 9.5 kg (21 lb). Shipping, 12.3 kg (27 lb).

**Dimensions:** 155 mm H  $\times$  190 mm W  $\times$  416 mm D (6 $\frac{1}{2}$ "  $\times$  7 $\frac{5}{8}$ "  $\times$  16 $\frac{3}{8}$ ").

The Model 8600A Digital Marker provides five independent, continuously variable frequency markers over the range 0.1–110 MHz when used with the HP 8601A or 8690B/8698B Generator Sweeper.

The high resolution controls and 6-digit readout permit 0.05% frequency settability. The frequency of any marker may be read while sweeping, simply by pushing a button within the marker control. The marker selected is brighter than the others and points in the opposite direction, ensuring positive marker identification.

### 8600A Specifications

**Marker accuracy:** any marker may be placed at a desired frequency  $\pm (0.05\%$  of sweep width + sweeper stability).

**Weight:** net, 5.9 kg (13 lb); shipping 8.2 kg (18 lb).

**Dimensions:** 99 mm H  $\times$  413 mm W  $\times$  337 mm L (3 $\frac{7}{8}$ "  $\times$  16 $\frac{3}{4}$ "  $\times$  13 $\frac{1}{4}$ ").

### Ordering Information

8600A Digital Marker

Opt 001: Modification kit for 8690B/8698B

8601A Generator/Sweeper

Opt 008: 75  $\Omega$  BNC output

Price

\$1500

N/C

\$3000

add \$50

# SWEEP OSCILLATORS

Solid state sweeper family, 10 MHz to 22 GHz  
Model 8620 System



- Single-band, multi-band, and wide band plug-ins
- >10 mW to 22 GHz



## 8620 System

The Hewlett-Packard 8620 solid state sweeper system offers the flexibility of the 8620C mainframe in addition to a choice of single-band, multiband, and the wide band plug-ins. The 8620 system also offers high output with solid state reliability—greater than 10 mW leveled to 22 GHz.

The fundamental oscillators used in the plug-ins and modules are YIG tuned transistor or bulk effect circuits. YIG tuning results in exceptional tuning linearity, low noise, and low spurious content; it also allows frequency modulation at high rates and wide deviations with low distortion.

## Typical unlevelled power output

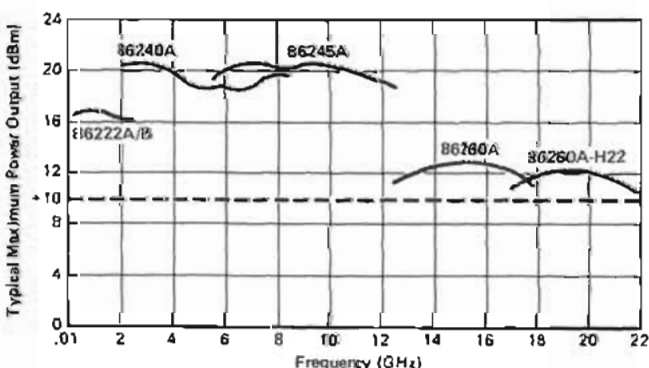

## 8620C Sweeper mainframe

The 8620C has many features which are highly useful in stringent applications. With convenient functionally grouped controls and lighted pushbutton indicators the mainframe offers extreme ease of operation and flexibility. In addition, it can be a completely programmable source, either HP-IB or BCD, an indispensable feature for automatic systems and signal simulation applications.

## 86222A/B and 86290A/B wide band plug-ins

Now the 10 MHz to 18.6 GHz frequency range can be covered with just two plug-ins—the 86222A/B and 86290A/B. Besides their broad frequency range these plug-ins offer many special features including unique crystal markers in the 86222B and better than  $\pm 20$  MHz frequency accuracy in a 86290A/B even at 18 GHz.

## New 86240A/B multi-octave plug-ins

Covering more than two octaves of frequency the 86240A and B span 2–8.4 GHz with major advances in power output and signal purity. The 86240A offers more than 40 mW leveled output across the full band. The 86240B specifies harmonics of >50 dBc which can be very important when making measurements across more than one octave.

## 86200 Series single-band plug-ins

The 86200 series of plug-ins covers both ends of the frequency spectrum from 10 MHz to 22 GHz with a choice of more than nine plug-ins.

## 8621B and 86300 Series multiband plug-ins

The 8621B drawer provides capability for up to two fundamental oscillator modules (86300 series) plus a heterodyne module (86320B). Selecting the band is as simple as pressing a front panel lever.

# SWEEP OSCILLATORS

## 8620 Family: mainframe

### Model 8620C

- Optional BCD or HP-IB Programming
- 3 Markers
- 100%  $\Delta F$  Capability, fully calibrated

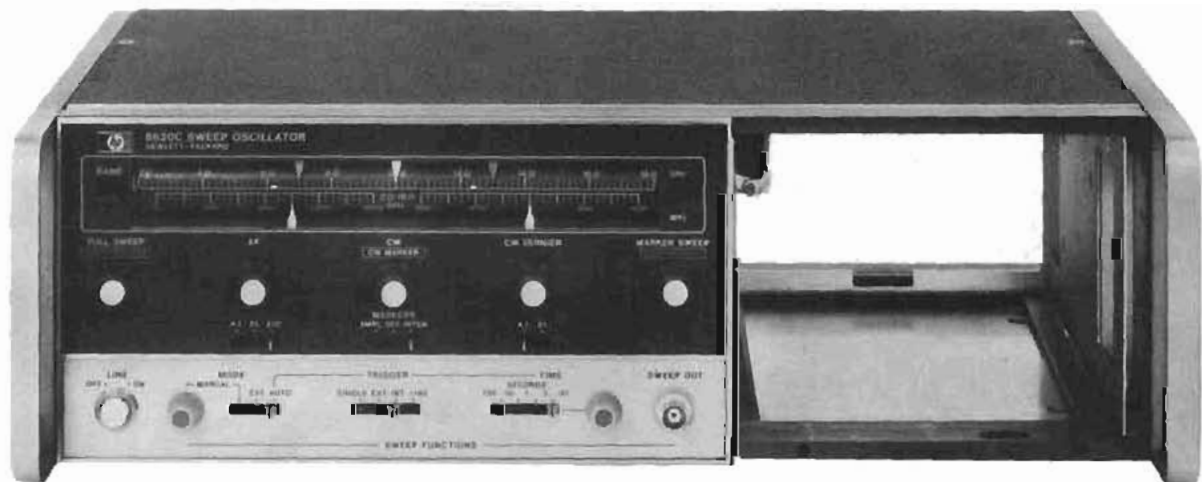

HP-IB

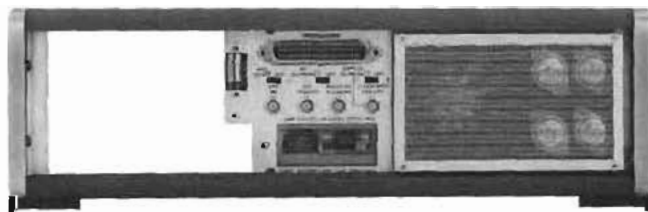

The 8620C offers many features as standard equipment. For example, up to four separate bands and their respective frequency scales can be selected with a touch of the band select lever just to the left of the dial scale. This represents a truly convenient wide-band capacity, one which doesn't necessitate changing plug-ins or the addition of costly, bulky, additional instruments to make wide-band swept measurements. Pushbuttons, concentrically located in the frequency control knobs, light when actuated to indicate the sweep function in use. For example, depressing the FULL SWEEP pushbutton results in a sweep of the total range selected by the band select lever. In this mode three markers are available, controlled by the START MARKER, STOP MARKER, and CW MARKER knobs. The MARKER SWEEP function causes a sweep between START and STOP MARKERS. In MARKER SWEEP, the CW MARKER is still available for further flexibility in identifying specific frequencies.

The 8620C is fully and continuously calibrated for any  $\Delta F$  sweep width. Having chosen an optimum width, one can read the total sweep width from the calibrated  $\Delta F$  dial scale. The sweep is symmetrical about the CW MARKER setting and in this function the START and STOP MARKERS are available. Three continuously variable  $\Delta F$  ranges are available by using the range switch below the  $\Delta F$  knob. This allows calibrated sweep widths of up to 1%, 10% or 100% of full band at the user's choice.

The CW function is selected by depressing the CW push button. It is possible to also engage the CW VERNIER knob to achieve very accurate setability. With the main dial scale cursor placed on any convenient mark, it is possible to interpolate accurately between dial scale markers by utilizing the CW VERNIER. This vernier makes the effective length of the dial scale  $7\frac{1}{2}$  meters (300 inches) and contributes to the increased setability.

Another feature is the capability to fully program the sweeper. The standard 8620C includes inputs for band selection, attenuator setting (with 8621B Opt 010 installed), sweep function selection, and analog frequency control. Option 011 provides, in addition, the capability to digitally program the sweeper with the HP-Interface Bus (HP-IB). With this option, the user can place the sweeper into any sweep function ( $\Delta F$ , FULL SWEEP, etc.) and it will sweep according to the front panel frequency settings. In this mode a programmable digital marker is available. In addition, an extremely flexible digital frequency programming capability is included with this option. Resolution of 10,000 points per band or 10,000 points across the frequency range set by the front panel controls permit extremely high resolution limited only by the Residual FM of the sweeper. Option 001 BCD programming provides the same capabilities as the HP-IB option with the exception that no digital marker is available in the programmed sweep modes.

## 8620C Specifications

### Frequency

**Frequency range:** determined by band select lever and RF unit.

**Frequency linearity:** refer to RF unit specifications.

### Sweep functions

**FULL sweep:** sweeps the full band as determined by the plug-in and the band select lever.

**MARKER sweep:** sweeps from START MARKER to STOP MARKER frequency settings.

**Range:** both independent settings are fully calibrated and continuously adjustable over the entire frequency range; can be set to sweep either up or down in frequency.

**End-point accuracy:** refer to RF unit specifications, same as frequency accuracy.

**ΔF Sweep:** sweeps symmetrically upward in frequency, centered on CW setting, CW vernier can be activated for fine control of center frequency.

**Width:** continuously adjustable and calibrated from zero to 1%, zero to 10%, or zero to 100% of usable frequency band as selected with front panel switch. Dial scale calibrated directly in MHz.

**Width accuracy:**  $\pm 1\%$  of maximum  $\Delta F$  plus  $\pm 2\%$  of  $\Delta F$  being swept.

**Center-frequency accuracy:** refer to RF unit specifications, same as frequency accuracy.

**CW operations:** single-frequency RF output controlled by CW MARKER knob selected by depressing pushbutton in CW MARKER control.

**Preset frequencies:** START MARKER, STOP MARKER, and  $\Delta F$  end points in manual sweep mode and CW MARKER frequency can be used as preset CW frequencies.

**CW vernier:** calibrated directly in MHz about CW setting. CW vernier activated by pushbutton in CW vernier control. Zero to  $\pm 0.5\%$  or zero to  $\pm 5\%$  of full bandwidth, selectable with front panel switch.

**Accuracy:** refer to RF unit specifications, same as frequency accuracy.

**Frequency markers:** three constant width frequency markers are fully calibrated and independently adjustable over the entire range in FULL Sweep function, controlled by START MARKER, STOP MARKER, and CW MARKER controls. In  $\Delta F$  sweep START and STOP MARKERS are available, and in MARKER SWEEP the CW MARKER is available. Front panel switch provides for the selection of either amplitude or intensity markers (amplitude modulating the RF output or Z-axis modulating the CRT display).

**Resolution:** better than 0.25% of RF unit bandwidth.

**Marker output:** rectangular pulse, typically -5 volts peak available from Z-axis BNC connector on rear panel. Source impedance, approximately 1000 ohms

**Accuracy:** refer to RF unit specifications, same as frequency accuracy.

### Sweep modes

**Auto:** sweep recurs automatically

**Line:** sweep can be synchronized with the ac power line.

**External trigger:** sweep is actuated by external trigger signal.

**Sweep time:** continuously adjustable in four decade ranges typically 0.01 to 100 seconds.

**Single sweep:** activated by front panel switch.

**Manual sweep:** front panel control provides continuous manual adjustment of frequency between end frequencies set in any of the above sweep functions.

**External sweep:** sweep is controlled by external signal applied to programming connector. Zero volts for start of sweep increasing linearly to approximately -10 volts for end of sweep.

**Sweep output:** direct-coupled sawtooth, zero to approximately

+10 volts, at front panel BNC connector, concurrent with swept RF output. Zero at start of sweep, approximately +10 volts at end of sweep regardless of sweep width or direction. In CW mode, dc output is proportional to frequency.

### Modulation

**Internal AM:** square-wave modulation continuously adjustable from 950 to 1050 Hz on all sweep times. On/Off ratio, refer to RF unit specifications.

**External AM:** refer to RF unit specifications.

**External FM:** refer to RF unit specifications.

**Phase-lock:** refer to RF unit specifications.

### Remote control

**Remote band select:** frequency range can be controlled remotely by three binary contact closure lines available at rear panel connector.

**Remote attenuation select:** 0 to 70 dB attenuation in 10 dB steps can be controlled by 4 binary contact closure lines when used with 8621B Option 010.

### Remote frequency programming, Opt 001 (BCD) and 011 (HP-IB)

#### Functions

**Band:** manual enable or remote control of four bands.

**Mode:** seven modes, including digital frequency control in three modes, with a resolution of 10,000 points across FULL band, between START MARKER and STOP MARKER as set by front panel controls, or across  $\Delta F$  as set by front panel  $\Delta F$  and CW controls; or selection of any of four analog sweep functions:  $\Delta F$  or MARKER Sweep with end points set by appropriate front panel controls, CW as set by CW MARKER control, or FULL sweep of band selected.

**Marker:** with analog sweeps (FULL,  $\Delta F$ , or MARKER SWEEP), a programmable marker is available (Opt 011 only), in either amplitude or intensity as selected with front panel switch.

### General

#### Blanking

**RF:** with blanking switch enabled, RF automatically turns off during retrace, and remains off until start of next sweep. On automatic sweeps, RF is on long enough before sweep starts to stabilize external circuits and equipment whose response is compatible with the selected sweep rate.

**Display (Z-axis/MKR/Pen Lift Output):** direct-coupled rectangular pulse approximately +5.0 volts coincident in time with RF blanking is on rear panel.

**Negative (Negative blanking output):** direct-coupled rectangular pulse approximately -5.0 volts coincident in time with RF blanking, fully compatible with 8410A/B network analyzer.

**Pen lift:** for use with X-Y recorders having positive power supplies. Transistor-switch signal is available on Z-axis/MKR/Pen lift connector. This signal is also available on the programming connector.

**Furnished:** 2.29 m (7 1/2-foot) power cable with NEMA plug; 2 spare 3 amp fuses; extender board for servicing; and calibration scale.

**Power:** 100, 120, 220, or 240 volts  $\pm 5 - 10\%$ , 50 to 400 Hz. Approximately 140 watts.

**Weight** (not including RF unit): Net, 11.1 kg (24 lb). Shipping 13.4 kg (30 lb).

**Dimensions:** 132.6 mm H  $\times$  425 mm W  $\times$  337 mm D (5 1/2"  $\times$  16 1/2"  $\times$  13 3/4").

### Ordering information

Opt 001: BCD Frequency Programming  
 Opt 011: HP-IB Frequency Programming  
 Opt 908: Rack Flange Kit

Price  
 add \$650  
 add \$950  
 add \$10

8620C Sweep Oscillator Mainframe

\$2150

# SWEEP OSCILLATORS

## 8620 Family: broadband plug-ins

Models 86290A/B

- +10 dBm 2 to 18.6 GHz with 86290B
- +7 dBm 2 to 18 GHz with 86290A
- Advanced technology provides outstanding performance
- Extended capability for network analysis



86290B



The 86290A and 86290B broadband plug-ins set new standards in wideband sweeper value with versatile frequency coverage and excellent performance characteristics at an attractive size and price. For broadband testing, a continuous sweep from 2 to 18.6 GHz (18 GHz with the 86290A) is provided. In addition, higher frequency resolution is achieved by covering the 2 to 18.6 GHz range in three individual bands of 2 to 6.2 GHz, 6 to 12.4 GHz, and 12 to 18.6 GHz (or 18 GHz). Individual bands and corresponding dial scales are selected using the band select lever on the 8620C mainframe. Front panel lights indicate the frequency range selected. In each frequency band, all sweeper mainframe controls are operable.

The 86290A/B plug-ins offer outstanding electrical performance along with small size and simplicity of operation. The key microelectronic elements of the 86290B are a 2 to 6.2 GHz fundamental oscillator, 250 mW GaAs FET amplifier, and high-efficiency multiplier integrated with a tracking YIG filter, which combine to produce >10 mW swept output over the 2 to 18.6 GHz range. This output is low in harmonic and spurious content and has excellent frequency linearity. On wideband sweeps, the 6.2 GHz and 12.4 GHz switch points can be Z-axis blanked as well as RF blanked, resulting in a spurious-free, clean continuous trace on any display.

The 86290A/B plug-ins have unique advantages as the source for network measurements. For 2 to 18 GHz scalar measurements, the 86290 accepts 27.8 kHz square wave AM modulation directly from the HP 8755 Frequency Response Test Set. Thus the need for an external modulator is eliminated providing convenience and cost savings, and more important, making full sweeper power available at the test device. Phase/amplitude network analysis over the continuous 2 to 18 GHz range becomes a reality using the 86290 and the HP 8410B Network Analyzer. Interfacing between the 8410B and the sweeper permits the 8410B to automatically phase-lock over multi-octave sweeps. Together, the 86290 and the 8410B now make possible phase and amplitude measurements from 2 to 18 GHz in one continuous sweep.

### HP 86290B Typical Levelled Power Output

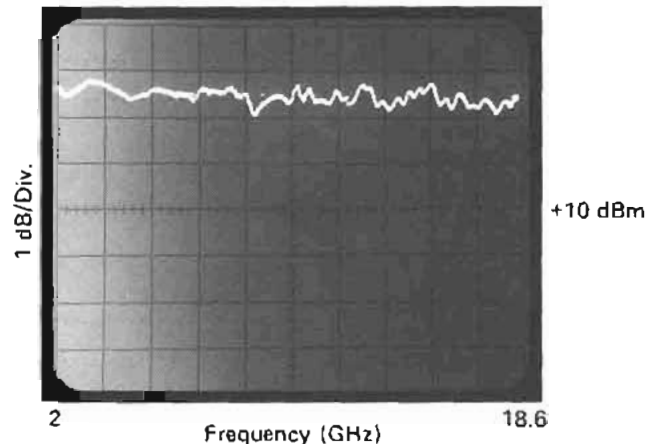

As a stand-alone sweeper, the 8620C and 86290 plug-in provide still more features for ease in swept testing. Even at 18 GHz, frequency can be set with  $\pm 20$  MHz accuracy. Sweep linearity is 0.05% which means frequencies in the swept mode can be identified to accuracies comparable with wavemeters. Internal leveling is standard. External crystal and power meter leveling circuitry is also provided. A SLOPE control permits the frequency-dependent losses of a test setup to be compensated. The 2 to 6.2 GHz fundamental oscillator signal is always available through a rear output connector. Phase-locking from 2 to 18.6 GHz is accomplished using only 6.2 GHz hardware via this output. Accurate frequency readout is possible by connecting a DVM to the calibrated 1 volt/GHz output located on the rear panel.

With the plug-in flexibility and these exceptional features, the 8620C/86290 sweeper is the ideal source for broadband sweep testing of components, transmission lines, antenna systems and ECM equipment.

#### General specifications

**Switch points:** broadband switch points are at 6.2 and 12.4 GHz. Frequency overlap is typically 0 to 20 MHz at switch points.

**Auxiliary output:** rear panel 2 to 6.2 GHz fundamental oscillator output, nominally—10 dBm.

**Slope control:** front panel control allowing compensation for frequency dependent losses of a test setup by attenuating power at lower frequencies.

**Peak control:** front panel control for peaking power over desired frequency range.

**Frequency reference output:** nom. 1 v/GHz (2—18.6 volts) rear panel BNC output. CW frequency accuracy typically  $\pm 35$  MHz.

**Mainframe compatibility:** the 86290B will operate properly only with the 8620C mainframe. The 86290A will operate directly with 8620A mainframes with serial number prefixes of 1332A and above and with all 8620C mainframes. To use the 86290A with other 8620A mainframes order 86290A Option 060 which includes a mainframe modification kit.

**Weight:** net, 4.4 kg (9.6 lb). Shipping, 5.9 kg (13 lb).



### 86290A and New 86290B Broadband plug-ins

Specifications with plug-in installed in an 8620C mainframe	BAND 1	BAND 2	BAND 3	BAND 4
<b>Frequency range: (GHz)</b> 86290A 86290B	2-6.2 2-6.2	6-12.4 6-12.4	12-18 12-18.6	2-18 2-18.6
<b>Frequency accuracy (25 °C)</b> CW mode (or > 100 ms sweep time with FM switch in FM/PL): (MHz) All sweep modes: (MHz) Marker: (MHz) Frequency linearity (correlation between frequency and sweep out voltage) typically: (MHz)	±20 ±30 ±30 ±8	±20 ±30 ±30 ±8	±20 ±30 ±30 ±8	±80 ±80 ±80 ±30
<b>Frequency stability</b> With temperature: (MHz/°C) With 10% line voltage change: (kHz) With 10 dB power level change: (kHz) With 3:1 load VSWR, all phases: (kHz) Frequency drift (in 10 minute period after 30 minute warm-up): typically (kHz) Residual FM (10 kHz bandwidth; FM switch in norm) CW mode: (kHz peak)	±0.5 ±100 ±200 ±100 ±300 <10	±1.0 ±100 ±400 ±200 ±600 <20	±1.5 ±100 ±600 ±300 ±900 <30	±2.0 ±100 ±600 ±300 ±900 <30
<b>Maximum leveled power (25 °C): (dBm)</b> 86290A 86290B Power level control range: (dB)	>+7 >+10 >10	>+7 >+10 >10	>+7 >+10 >10	>+7 >+10 >10
<b>Power variation</b> Internally leveled: (dB) External leveled (excluding coupler and detector variation) Crystal detector: Power meter: With temperature (typically): (dB/°C)	±0.7 ±0.15 ±0.15 ±0.1	±0.7 ±0.15 ±0.15 ±0.1	±0.8 ±0.15 ±0.15 ±0.1	±0.9 ±0.15 ±0.15 ±0.1
<b>Spurious signals (below fundamental at specified maximum power)</b> Harmonic related signals: (dB) Nonharmonics: (dB)	>25 >50	>25 >50	>25 >50	>25 >50
<b>Residual AM in 100 kHz bandwidth (below fundamental at specified maximum power): (dB)</b>	>55	>55	>55	>55
<b>Source VSWR Internally leveled, 50Ω nominal impedance</b>	<1.9	<1.9	<1.9	<1.9
<b>External FM</b> Maximum deviations for modulation frequencies. DC to 100 Hz: (MHz) 100 Hz to 2 MHz: (MHz) <b>Sensitivity (typically)</b> FM mode: (MHz/volt) Phase-lock mode: (MHz/volt)	±75 ±5 -20 -6	±75 ±5 -20 -6	±75 ±5 -20 -6	±75 ±5 -20 -6
<b>AM (At specified maximum power)</b> Specific requirements guaranteeing HP 8755 with ±6 V, 27.8 kHz square wave MOD DRIVE connected to EXT AM input. On/Off ratio: (dB) Symmetry: Attenuation for +5 volt input: (dB) Internal 1 kHz square wave On/Off ratio: (dB) RF blanking (selected by mainframe switch) On/off ratio: (dB)	>30 40/60 >30 25 >30	>30 40/60 >30 >25 >30	>30 40/60 >30 >25 >30	>30 40/60 >30 >25 >30
<b>Minimum sweep time typically: (ms)</b>	10	10	10	60
<b>CW remote programming setting time</b> typical time to settle into CW frequency accuracy specification, 8620C Opt. 001 or 011; FM switch in FM/PL: (ms)	5	5	5	10

**Ordering Information**

86290A 2 to 18 GHz +7 dBm (5 mW) plug-in (internal leveling standard)  
 86290B 2 to 18.6 GHz +10 dBm (10 mW) plug-in (internal leveling standard)

**Price**

\$13,250  
 \$15,250

**Opt 004: rear panel RF output:**

(See Data Sheet for specifications)

**Opt 005: APC-7 RF output connector:**

**Opt 080:** 86290A only, kit included for modifying 8620A mainframes with serial prefix 1332A and below. 86290B can only be used with the 8620C:

add \$80

add \$40

add \$300

# SWEEP OSCILLATORS

## 8620 Family: straddle band plug-ins

Models 86240A, 86240B, and 86240C



86240B

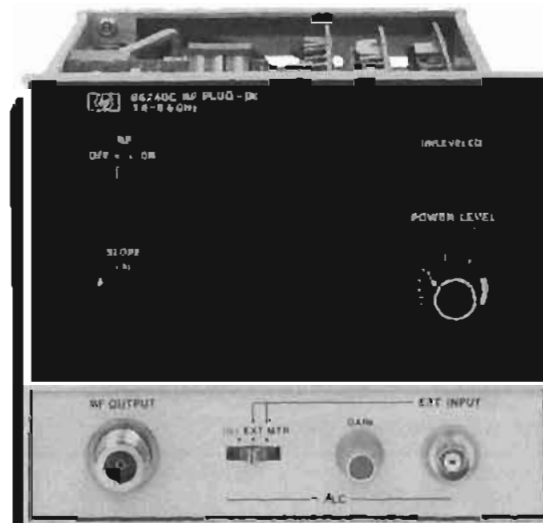

86240C



### New 86240B Low Harmonic Distortion: 2–8.4 GHz

The dynamic range of a swept measurement is often limited by source harmonics. Low pass filtering, either internal or external to the plug-in, is practical only over sweep widths less than an octave. However you can now get narrowband 50 dBc harmonic performance with the convenience of a multi-octave sweep in the 86240B. The dynamic range advantage of the low harmonics when measuring filter rejection, amplifier or mixer distortion is further enhanced by the 86240B's 20 mW of calibrated output power. Internal leveling to  $\pm 0.5$  dB is standard as well as a slope control for optimizing the total measurement system flatness. A step attenuator is optionally available if calibrated power control over an 80 dB range is desired.

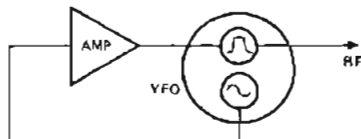

Key to the 50 dBc harmonic performance of the 86240B is the HP designed YIG-FILTER-OSCILLATOR (YFO). The YFO includes two YIG spheres in the same magnet housing. Changing the DC magnetic field strength tunes the resonant frequency of both YIG spheres simultaneously. One YIG tunes the oscillator circuit whose output is amplified by a 100 mW GaAs FET amplifier. This signal is then coupled through the second YIG which filters harmonics down to a level  $>50$  dB below the carrier over the entire 2 to 8.4 GHz range. Fast rise time pulses are made possible by pulsing the gate bias of a GaAs FET in the amplifier.

### New 86240A High Output Power: 2–8.4 GHz

The use of fixed attenuators to reduce mismatch errors in a swept measurement requires additional source power to maintain the same dynamic range. Similarly, if one wants to take advantage of the excellent flatness and source match of a resistive power splitter, additional power is needed, especially if the test device is a mixer or amplifier with a 10 dBm drive level specification. The 86240A, which contains a non-filtered version of the YFO described above, was designed to meet these needs. It features up to 40 mW of output power, competitive harmonics, at an attractive price. With the internal leveling option, the 86240A also provides calibrated output power and slope control. For radar simulation applications, the 86240A can be externally amplitude modulated with 20 ns rise time pulses.

### New 86240C RF Distortion Analysis of MW Links: 1.6–18.6 GHz

Distortion analysis of microwave radio links frequency requires MLA Upconverter Simulation. The 86240C is designed to fill this need over the important 4, 6, and 8 GHz commercial and military communication bands. The FM circuitry is modified to accept the sweep and test tone signals from the MLA. The oscillator is optimized for group delay of less than 1 ns peak-to-peak over 30 MHz and linearity better than 0.5%. The 86240C is also a very good 40 mW sweeper. It has a 10 MHz FM bandwidth, flat to  $\pm 1.5$  dB for noise loading applications plus all the optional leveling and power control features found on the 86240A. Thus, it is two products in one—both general and special purpose—ideal for communications systems applications.

## 86240A/B/C Plug-Ins

### Specifications with plug-in installed in 8620C mainframe

**Frequency linearity:** typically  $\pm 1\%$ .

**RF power leveling:** internal dc-coupled leveling amplifier provided.

**Internal, Opt 001:** selected by front panel switch; refer to RF plug-in specifications (standard on 86240B).

**External**

**Crystal Input:** approximately  $-10$  to  $-200$  mV for specified leveling at rated output; for use with negative polarity detectors such as 780 Series Directional Detectors, 423A/B and 424 Series Crystal Detectors.

**Power meter Input:** switch selects proper compensation for HP models 432 A/B/C.

**Indicator:** front panel indicator lights when RF power level is set too high to permit leveling over entire selected sweep range or when operating in unlevelled mode.

**Reference output DC-coupled voltage** proportional to RF frequency, voltage approximately 1 V/GHz, output impedance, approximately 1000 ohms.

**External AM**

**Frequency response:** typically dc to 100 kHz unlevelled, dc to 50 kHz levelled (at maximum levelled power).

**Input impedance** approximately 5000 ohms.

**Square wave response:** guarantees HP 8755 Frequency Response Test Set operation with 8755 Modulator Drive connected to PULSE input.

**ON/OFF ratio:**  $> 30$  dB.

**Symmetry:** 40/60.

**Attenuation for +5 V Input:**  $> 30$  dB.

**Internal AM**

**1 kHz square-wave On/Off ratio:**  $> 40$  dB.

**External pulse modulation**

**Rise/Fall Time:** typically 20 ns.

**Minimum pulse width:** typically 1  $\mu$ s.

**Residual AM in 100 kHz BW:**  $> 50$  dB below carrier at maximum power.

**Size:** 127 H  $\times$  152 W  $\times$  295 mm D (5"  $\times$  6"  $\times$  11 $\frac{3}{8}$ ").

**Weight:** 2.3 kg (5 lb). Shipping 3.2 kg (7 lb).

**RF output:** type N Female.

**Option**

**004:** Rear Panel RF Output

**Price**  
add \$80

	86240A	86240B	86240C
<b>FREQUENCY</b> Frequency Range	2.0-8.4 GHz	2.0-8.4 GHz	3.6-8.8 GHz
<b>Frequency Accuracy (25°C)</b> CW Mode All Sweep Modes (for sweep time $> 100$ ms)	$\pm 20$ MHz $\pm 30$ MHz	$\pm 20$ MHz $\pm 30$ MHz	$\pm 20$ MHz $\pm 30$ MHz
<b>Frequency Stability:</b> With Temperature With 10% Line Voltage Change With 10 dB Power Level Change Residual FM: (in 10 kHz bandwidth, CW Mode)	$\pm 500$ kHz/°C $\pm 40$ kHz $\pm 1.0$ MHz $< 9$ KHz peak	$\pm 500$ kHz/°C $\pm 40$ kHz $\pm 1.0$ MHz $< 9$ KHz peak	$\pm 500$ kHz/°C $\pm 40$ kHz $\pm 1.0$ MHz $< 9$ KHz peak
<b>POWER OUTPUT</b> Maximum Levelled Power (25°C)	$> 40$ mW	$> 20$ mW	$> 40$ mW
<b>Power Variation:</b> Unlevelled Internally Levelled (Opt 001); Externally Levelled (Excluding Coupler and Detector Variation) Crystal Detector and Power Meter:	$< \pm 2$ dB $< \pm 1$ dB $< \pm 0.1$ dB	$< \pm 0.5$ dB $< \pm 0.1$ dB	$< \pm 2$ dB $< \pm 0.8$ dB $< \pm 0.1$ dB
<b>Spurious Signals:</b> (below fundamental at specified maximum power); Harmonics Nonharmonics	$> 20$ dB (20 mW) $> 16$ dB (40 mW) $> 60$ dB	$> 50$ dB (10 mW) $> 45$ dB (20 mW) $> 60$ dB	$> 20$ dB (20 mW) $> 16$ dB (40 mW) $> 60$ dB
<b>Source VSWR:</b> 50 $\Omega$ nominal impedance Internally Levelled (Opt 001) Unlevelled: Typically	$< 1.6$ 4	$< 1.6$ 4	$< 1.6$ 4
<b>MODULATION</b> <b>External FM</b> Maximum Deviations for Modulation Frequencies: DC to 100 Hz DC to 1 MHz 90 kHz to 10 MHz Sensitivity: Nominal <b>FM Mode</b> Phase Lock Mode Upconverter Mode	$\pm 75$ MHz $\pm 5$ MHz $- 20$ MHz/V $- 6$ MHz/V	$\pm 75$ MHz $\pm 5$ MHz $- 20$ MHz/V $- 6$ MHz/V	$\pm 150$ MHz $\pm 1.5$ MHz $+ 20$ MHz/V $- 6$ MHz/V $+ 20$ MHz/V
<b>Upconverter Stimulation (86240C Only):</b> Across 30 MHz Sweep Width Linearity at 277 kHz Group Delay at 277 kHz Differential Gain at 2.4 MHz Differential Phase at 2.4 MHz	N/A	N/A	$\leq 0.5\%$ $\leq 1$ ns $\leq 0.5\%$ $\leq 1^\circ$
<b>PRICE</b> <b>Plug-In:</b> Opt 001 (Internal Leveling) Opt 002 (70 dB Step Attenuator)	\$3750 add \$650 add \$400	\$5200 Included add \$400	\$4700 add \$650 N/A



## SWEEP OSCILLATORS

8620 Family: 10 MHz to 2.4 GHz Plug-ins

Models 86222A and 86222B

- 10 MHz to 2.4 GHz in ONE, CONTINUOUS sweep
- Internally leveled FLATNESS  $\pm 0.25$  dB over full range

- 1, 10, and 50 MHz crystal marker combs with 86222B
- Marker accuracy even in CW with 86222B



86222A

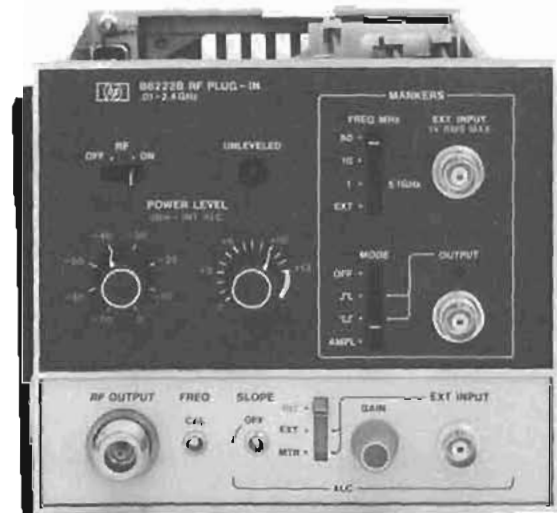

86222B

The HP 86222A/B sweeper provides uncompromising 10 MHz to 2.4 GHz frequency coverage. The entire range can be swept continuously—no need to break up your measurement into two or more sweeps. Yet narrowband resolution is not sacrificed. This precision is complemented by the 86222's good stability and frequency accuracy to make narrowband measurements truly practical. Both narrowband and wideband linearity is excellent (2 MHz over full band). The RF output characteristics of the 86222 feature similar high performance. Power output is calibrated 0 to +13 dBm in 1 dB increments. The output is internally leveled to  $\pm 0.25$  dB flatness over the entire 0.01 to 2.4 GHz range!

For applications demanding precise frequency identification, the 86222B offers an advanced digitally processed birdie marker system which provides the accuracy associated with standard birdie markers without their normal liabilities. The 86222B marker system internally generates a typical birdie marker, then processes it to produce a digital pulse. This pulse can then be used to produce an intensity dot on the CRT which corresponds to a precise frequency. This opens the applications of 86222B "birdie" markers to a wide variety of network analyzers and displays, such as the 8410B and 8755, where previously it was impossible to inject them on either the detected dc or RF signals. Alternately, an amplitude marker, derived from the birdie, can be selected which produces a dip in RF power at each marker frequency. This type of marker is useful for X-Y recordings. In addition, when the output frequency is coincident with a 10, 100, or 1 MHz comb of the internal crystal oscillator, a front-panel LED lights. Thus, independent of the display, an operator can accurately identify a CW frequency of the 86222B—within 75 kHz at 1 GHz! Provision is also made for injection of an external marker for identification of specific frequencies between 1 MHz markers.

Continuous multi-octave vector measurements to 2.4 GHz are now possible using the HP 86222 together with the HP 8410B Network Analyzer. Previously, measurements could be made only one octave at a time because manual range switching of the HP 8410 was necessary. Now, the HP 86222/86220C combination automatically range switches the network analyzer for one continuous display, even from 0.1 to 2.4 GHz. In addition, with the 86222B crystal marker system the important third dimension, frequency, can be added to the polar display of the HP 8410B.

Increased dynamic range scalar measurements can be made using the HP 86222A/B together with the HP 8755 Swept Frequency Response Test Set. Heterodyne plug-ins in the range of 0.01–2 GHz will typically have a broadband noise output only 45 to 50 dB below the fundamental output signal. This noise is due to the high gain output amplifier used in heterodyne approaches. The noise level will be higher than most broadband detectors' noise level and significantly higher than the noise of the Schottky diode used in the HP 8755. This will limit the dynamic range of measurements such as the transmission loss of high pass, low pass, and notch filters, or return loss of bandpass filters when broadband detectors are used. The HP 8755, which is a 27.8 kHz receiver does not exhibit this problem when used with the HP 86222A/B. By designing in integral modulator in the sweeper, and an ALC loop which will handle the 27.8 kHz, the fundamental oscillator output can be modulated at 27.8 kHz without modulating the noise of the output amplifier. The HP 8755 will therefore not respond to the noise. The typical result is a 10 to 15 dB dynamic range improvement over other heterodyne sweepers and dc diode detection systems.

## Specifications with plug-in installed in an 8620C mainframe

### Frequency characteristics

Range: 10 MHz to 2.4 GHz.

#### Accuracy (25°C)

CW mode:  $\pm 10$  MHz.

Using programming Input (8620C Option 001 or 011): typically  $\pm 6$  MHz.

All sweep modes:  $\pm 15$  MHz ( $< 0.1$  sec sweep time). Accuracy of 86222B may be enhanced to better than  $\pm 200$  kHz through use of crystal markers.

Linearity (correlation between frequency and SWEEP OUT Voltage): typically  $\pm 2$  MHz.

Frequency reference output: nominally 1 V/GHz  $\pm 0.01$  V.

Frequency cal control: permits fine frequency calibration.

#### Stability

With temperature:  $\pm 500$  kHz/°C.

With 10% line voltage change:  $\pm 20$  kHz.

With 3:1 load SWR, all phases:  $\pm 10$  kHz.

With 10 dB power level change:  $\pm 20$  kHz.

With time (after 1-hour warm-up): typically  $\pm 100$  kHz/10 min.

Residual FM: (10 kHz bandwidth; FM switch in NORM; CW Mode):  $< 5$  kHz peak.

### Output characteristics

Maximum leveled power (25±):  $> +13$  dBm (20 mW); typically  $> +15$  dBm.

Power level accuracy (Internal leveling only):  $\pm 1$  dB (includes frequency response).

Attenuator Opt 002: add  $\pm 0.2$  dB/10 dB step.

#### Power Variation

##### Internally leveled

0.01 to 2.4 GHz:  $\pm 0.25$  dB.

Across any 50 MHz (0.03 to 2.3 GHz): typically  $\pm 0.05$  dB.

Stability with temperature: typically  $\pm 0.02$  dB/°C.

##### Externally leveled (excluding coupler and detector variation)

Crystal detector: ( $-10$  to  $-100$  mV at rated output):  $\pm 0.1$  dB.

Power meter (with HP 432A/B/C Series power meters):  $\pm 0.1$  dB.

Unleveled Indicator: lights when RF power level is set too high to permit leveling over sweep range selected.

Residual AM in 100 kHz BW:  $> 50$  dB below carrier at maximum power.

Spurious signals: below fundamental.

Harmonics:  $> 25$  dB at  $+13$  dBm; typically  $> 30$  dB at  $+10$  dBm.

#### Non-Harmonics

0.01 to 2.3 GHz:  $> 30$  dB at  $+13$  dBm; typically  $> 40$  dB at  $+10$  dBm.

2.3 to 2.4 GHz:  $> 25$  dB at  $+13$  dBm; typically  $> 35$  dB at  $+10$  dBm.

Broadband noise in 100 kHz bandwidth: typically  $< -70$  dBm.

Impedance: 50Ω nominal.

SWR:  $< 1.5$ .

Slope control: allows variable compensation for frequency dependent losses in test set-up.

Output connector: type N female.

### Modulation characteristics

#### External FM

Input impedance: approximately 10 kΩ.

Frequency response: typically 150 kHz.

#### External AM

Square wave response: guarantees HP 8755 Frequency Response Test Set operation with 8755 Modulator Drive connected to EXT AM input.

ON/OFF ratio:  $> 30$  dB.

Symmetry: 40/60 at  $\geq 10$  dBm output power.

Attenuation for +5 V Input:  $> 30$  dB.

#### Internal AM

1 kHz square-wave On/Off ratio:  $> 30$  dB.

RF blanking On/Off ratio:  $> 30$  dB.

#### External FM

Maximum deviations for modulation frequencies

DC to 100 Hz:  $\pm 75$  MHz

100 Hz to 1 MHz:  $\pm 5$  MHz.

1 MHz to 2 MHz:  $\pm 2$  MHz.

#### Sensitivity (typically)

FM mode:  $-20$  MHz/V.

Phase-lock mode:  $-6$  MHz/V.

### Crystal marker capabilities (86222B Only)

Internal crystal markers: harmonic markers of 10 and 50 MHz usable over full 0.01 to 2.4 GHz range and 1 MHz markers usable 0.01 to 1 GHz. Positive ( $\square$ ) or negative ( $\sqcup$ ) voltage output pulses can be selected to Z-axis intensify a scope trace; or RF amplitude pips can be selected (at maximum sweep speed pulse width optimized for approximately 10 markers/sweep).

Accuracy of center frequencies (25°C):  $\pm 5 \times 10^{-4}$ .

Typical marker width around center frequency

1 MHz markers:  $\pm 75$  kHz.

10 MHz markers:  $\pm 200$  kHz.

50 MHz markers:  $\pm 300$  kHz.

Temperature stability: typically  $\pm 2 \times 10^{-4}$ /°C.

Marker output  $\square$  mode: nominally  $> 3$  V.

$\sqcup$  mode: nominally  $-4$  to  $-9$  V, internally adjustable.

Amplitude mode: typically 0.5 dB.

External marker input: generates amplitude or Z-axis marker when sweep frequency equals external input frequency.

Frequency range: 0.01 to 2.4 GHz.

Marker width: typically  $\pm 300$  kHz.

Marker Indicator light: green LED lights coincident with crystal or external marker for accurate CW calibration.

### General

#### Improved Network Measurements Capability

8410B Network Analyzer: interfacing through 8620C rear panel connector allows the 8410B to maintain phase lock over multi-octave sweeps at all sweep speeds.

8755 Frequency Response Test Set: direct connection of 8755 mod drive signal to external AM input of the 8620C eliminates the need for an external modulator.

### Ordering Information

86222A 0.01–2.4 GHz RF Plug-In (Internal Leveling Standard)

### Price

\$3500

86222B 0.01–2.4 GHz RF Plug-In with Crystal and External Markers (Internal Leveling Standard)

\$4100

Opt 002: 70 dB Step Attenuator (10 dB steps)

add \$295

Opt 004: Rear Panel RF Output

add \$80

# SWEEP OSCILLATORS

## 8620 Family: single band-plug-ins

### 86200 Series

- 10 MHz to 22 GHz coverage
- >50 mW from 5.9 to 12.4 GHz



86245A



86260A

## Specifications

### 86200 Series

The 86200 series plug-ins feature a wide choice of bandwidths and power specifications for covering the 10 MHz to 22 GHz frequency range. The 86222 10 MHz to 2400 MHz unit and the 86290 2 GHz to 18.6 GHz plug-in both cover multi-octave frequency ranges with exceptional frequency precision and RF output characteristics. See preceding pages for specifications on these plug-ins. For octave band applications, smaller range plug-ins covering, for instance, 5.9 GHz to 12.4 GHz are available with optional capability to operate as upconverters for MLA measurements.

**Frequency linearity:** typically  $\pm 1\%$ .

**Frequency reference output:** typically 1 V/GHz DC-coupled voltage is available for referencing or phase-locking external equipment to the plug-in or for multi-octave operation with an 8410B.

**RF power leveling:** internal dc-coupled leveling amplifier and PIN modulator provided.

**Internal, Opt 001:** selected by front panel switch; refer to RF plug-in specifications (standard on 86220A).

#### External

**Crystal input:** approximately -20 to 250 mV for specified leveling at rated output; for use with negative polarity detectors such as 780 Series Directional Detectors, 423A/B and 8470 Series Crystal Detectors.

**Power meter input:** leveling amplifier with compensation for HP 432A power meter included internally in all plug-ins except the 86230B and 86241A which require the use of an 8404A Leveling Amplifier and the EXT AM input on the 8620 Mainframe.

**Indicator:** front panel indicator lights when RF power level is set too high to permit leveling over entire selected sweep range or when operating in unleveled mode.

**Residual AM in 100 kHz bandwidth:** >50 dB below fundamental at specified maximum power.

#### External AM

**Frequency response:** typically dc to 100 kHz unleveled, dc to 50 kHz leveled (at maximum leveled power).

**Input impedance:** approximately 5000 ohms.

**RF output connector:** type N Female.

**Size:** 127 H x 152 W x 295 mm D (5" x 6" x 11 7/8").

**Weight:** net, 2.3 kg (5 lb). Shipping, 3.2 kg (7 lb).

#### Options

**001:** Internal leveling. Refer to RF plug-in specifications.

**002:** 70 dB attenuator in 10 dB steps, available in 86220A and 86235A

**004:** rear panel RF output

**005:** APC-7 RF output connector available on 86260A

#### Price

See model number  
add \$275  
add \$400  
add \$80  
add \$40

**Upconverter simulation options:** options are available which guarantee compatibility with the HP Microwave Link Analyzers. For further information on these plug-ins refer to the Telecommunications Test Equipment Section beginning on page 557.

### Single band plug-ins

Refer also to broadband models 86222A/B (0.01-2.4 GHz), 86240A/B/C (2-8.6 GHz), and 86290A/B (2-8.6 GHz)

Specifications with plug-in installed in 8620C	86220A	86230B	NEW 86235A	86241A	NEW 86242D	NEW 86245A	NEW 86250D	86260A	NEW 86280A Opt H22
<b>Frequency range<sup>1</sup> (GHz):</b>	0.01-1.3	1.8-4.2	1.7-4.3	3.2-6.5	5.9-9.0	5.9-12.4	8.0-12.4	12.4-18.0	17.0-22.0
<b>Frequency accuracy</b> CW mode (MHz):	±10	±15	±20	±30	±35	±40	±40	±50	±50
All sweep modes (sweep time >100 ms)(MHz):	±15	±20	±30	±33	±40	±50	±50	±70	±70
<b>Residual FM (10 kHz BW)</b> CW mode (kHz) peak:	<5	<7	<7	<7	<15	<15	<15	<25	<25
<b>Maximum leveled power<sup>1</sup></b> (mW):	10	>10	>40	>6.3	>10	>50	>10	>10	>10
<b>Power variation:</b> Internally leveled (dB):	≤0.5 internal leveling cal'd output std.	≤±1.2	≤±0.8	≤±0.8	≤±0.5	≤±0.6	≤±0.5	≤±0.7	
Externally leveled (dB) (excluding coupler & detector variation):	N/A	≤±0.1	≤±0.1	≤±0.1	≤±0.1	≤±0.1	≤±0.1	≤±0.1	≤±0.1
<b>Spurious signals:</b> (dB below fund, at specified max power) Harmonics:	>25	>20	>20	>16(3.2-3.8 GHz) >20(3.8-6.5 GHz) >60	>30	>17(5.9-7 GHz) >30(7-12.4 GHz) >60	>30	>25	>25
Nonharmonics:	>50	>60	>60	>60	>60	>60	>60	>50	>50
<b>Source VSWR:</b> (50Ω nom, internally leveled)	<1.3	<1.6	<1.6	<1.6	<1.6	<1.6	<1.6	<1.6	
<b>External FM:</b> Max deviations (MHz) for modulation frequencies: DC-100 Hz:	±15	±25	±75	±25	±150	±150	±150	±75	±75
DC-1 MHz:	±0.5	±2	±5	±2	±7	±7	±7	±5(OC-200 kHz)	±5(OC-200 kHz)
Sensitivity (nom, MHz/V):	+3.5	-4	-20/-6	-6	-20/-6	-20/-6	-20/-6	-20/-6	-20/-6
<b>AM: Internal square wave on/off ratio &amp; Ext AM sensitivity</b> To -10 V (dB):	>35	>25	>30	>25	>40	>40	>40	>25	>25
EXT AM: Response compatible with 8755 Mod drive signal:	No	No	Yes	No	Yes	Yes	Yes	No	No
<b>Price:</b> Plug-in: Opt Q01 (int. lev):	\$2500 Included	\$2600 +\$390	\$3300 +\$550	\$2500 +\$390	\$2600 +\$450	\$4200 +\$500	\$2900 +\$450	\$3200 +\$550	\$5250

<sup>1</sup> Special frequency bands and higher power outputs available on request.

# SWEEP OSCILLATORS

## 8620 Family: multiband plug-ins

### Models 8621B, 86300 series

- Modular construction
- >40 mW in S-band



8621B

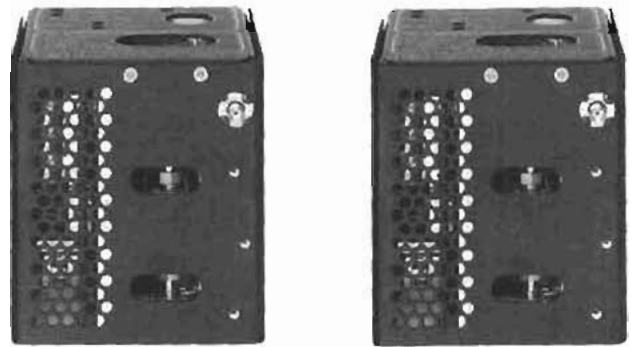

86300 Series

The 8621B RF Drawer houses the 86300 series RF Modules. The standard drawer will accept one fundamental oscillator module. In addition, with the 1.7 to 4.3 GHz fundamental oscillator module, the standard drawer also accepts the 0.1 to 2 GHz heterodyne module to give 0.1 to 4.3 GHz coverage. The 8621B Option 100 will accept two fundamental oscillator modules and the heterodyne module. This will allow, for example, 0.1 to 6.5 GHz coverage in one plug-in.

## Specifications

### 8621B

#### 70 dB step attenuator, opt 010

**Range:** 70 dB in 10 dB steps set by front panel switch.

**Insertion loss:** <2.0 dB.

**Accuracy:** (including frequency response).

**For 10 dB:**  $\leq \pm 0.6$  dB.

**For >10 dB:**  $\leq \pm 5\%$  of attenuation.

**Remote control capability:** 4-line binary logic, open or contact closure to ground (8620A/C Mainframe only, input available at rear panel connector.).

**Weight:** net, 0.9 kg (2 lb).

**RF power leveling:** internal dc-coupled leveling amplifier provided.

**Internal:** selected by front panel switch; refer to RF module specifications.

**External:**

**Crystal input:** approximately  $\pm 20$  to  $\pm 250$  mV for specified leveling at rated output; for use with positive or negative polarity detectors such as 780 Series Directional Detectors, 423A/B and 424 Series Crystal Detectors; polarity switch provided in RF drawer.

**Power meter input:** switch in RF drawer selects proper compensation for Models 431B/C or 432A/B/C power meters.

**Indicator:** front panel indicator lights when RF power level is set too high to permit leveling over entire selected sweep range or when operating in unlevelled mode.

**Frequency reference output:** DC-coupled voltage nominally 1 V/GHz is available for referencing or phase locking external equipment to the sweeper or for multi-octave operation with the 8410B.

**RF output connector:** type N Female.

**Size:** 127 H  $\times$  152 W  $\times$  295 mm D (5"  $\times$  6"  $\times$  11 $\frac{3}{8}$ ").

**Weight:** net, 1.4 kg (3 lb). Shipping, 2.3 kg (5 lb).

## Common specifications

### 86300 series

**Frequency linearity:** typically  $\pm 1\%$ .

**Residual AM in 100 kHz bandwidth:** >50 dB below fundamental at maximum power.

**External AM**

**Frequency response:** typically dc to 100 kHz unlevelled, dc to 50 kHz leveled (at maximum leveled power).

**Input impedance:** approximately 5000 ohms.

**Internal leveling:** standard on all modules. Refer to RF module specifications.

**Size:** 103 H  $\times$  92 W  $\times$  92 mm D (4"  $\times$  3 $\frac{3}{8}$ "  $\times$  3 $\frac{3}{4}$ ").

**Weight:** net, 1.4 kg (3 lb). Shipping, 1.8 kg (4 lb). Option 010 add .9 kg (2 lb).

## Ordering information

### 8621B RF Drawer

Opt 004: Rear panel RF output

Opt 010: 70 dB Attenuator

Opt 100: Multiband capability

## Price

\$750

add \$80

add \$950

add \$500



### Multiband plug-ins

Specifications with unit Installed in 8621B and 8620C	86320B <sup>1</sup>	86331C	86341C	86342C	86350C
Frequency range (GHz):	0.1-2.0	1.7-4.3	3.2-6.5	5.9-9.0	8.0-12.4
Frequency Accuracy: CW mode (MHz): All sweep modes (sweeptimes > 100 ms) MHz:	$\pm 15$ $\pm 20$	$\pm 20$ $\pm 25$	$\pm 30$ $\pm 33$	$\pm 35$ $\pm 40$	$\pm 40$ $\pm 50$
Residual FM (10 kHz BW) CW mode (kHz Peak):	<15	<7	<7	<15	<15
Maximum leveled power (dBm):	>+13	>+16	>+10	>+7	>+6
Power variation: Internally leveled Externally leveled (dB) (Excluding coupler-detector or thermistor variation):	$\pm 0.7$ $\leq -0.1$	$\leq \pm 0.8$ $\leq \pm 0.1$	$\leq \pm 1$ $\leq -0.1$	$\pm 1$ $\leq -0.1$	$\pm 1$ $\leq -0.1$
Spurious signals: (dB below fund. at specified max power) Harmonics: Nonharmonics:	$>30$ @ 10 dBm $>24$ @ 13 dBm $>30$ @ 10 dBm $>24$ @ 13 dBm	$>20$ $>60$	$>14$ (3.2-3.8 GHz) $>25$ (3.8-6.5 GHz) $>60$	$>30$ $>60$	$>30$ $>60$
Source VSWR: (50 $\Omega$ nom, internally leveled)	<1.6	<1.6	<1.6	<1.5	<1.5
External FM: Max deviations (MHz) for Modulation frequencies: DC-100 Hz: DC-1 MHz: DC-2 MHz: Sensitivity: nominal FM mode (MHz/V): Phase lock mode (MHz/V):	$\pm 75$ $\pm 5$ $\pm 2$ -20 -6	$\pm 75$ $\pm 5$ $\pm 2$ -20 -6	$\pm 75$ $\pm 5$ $\pm 2$ -20 -6	$\pm 75$ $\pm 3$ $\pm 2$ -20 -6	$\pm 75$ $\pm 5$ $\pm 2$ -20 -6
AM: Internal square wave on/off ratio and Ext. AM sensitivity To -10 V (dB)	>15	>40	>25	>40	>40
Price	\$2200	\$2630	\$2480	\$2730	\$2730

1. 86320B is a reference unit which must be used with 86331C.

# SWEEP OSCILLATORS

8690 Sweeper family, 400 kHz to 50 GHz

Model 8690 System

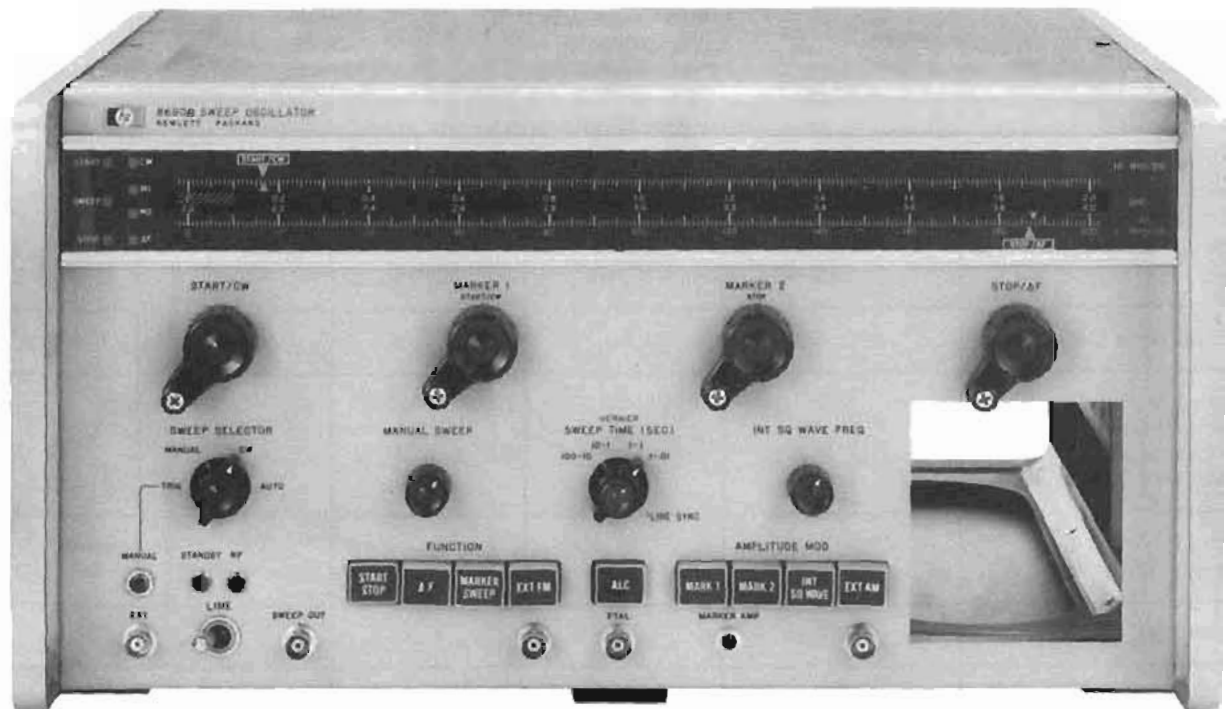

## 8690 System

The familiar 8690 BWO sweeper family offers exceptional value in performance, operation and versatility. With the ability to accept both BWO and solid state plug-ins, the 8690 mainframe allows BWO coverage where necessary, and more reliable, high performance solid state coverage at lower frequencies.

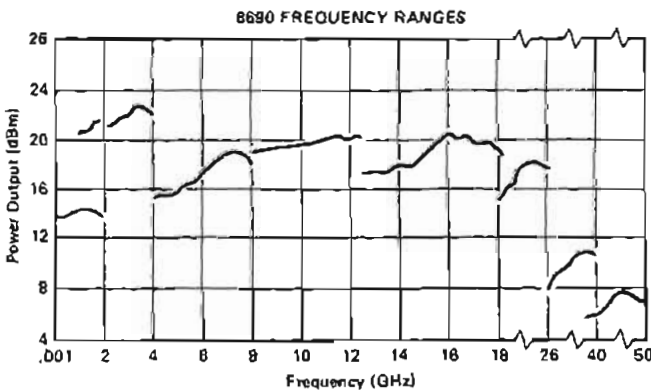

## 8690B Mainframe specifications

### Sweep functions

**START/STOP sweep:** sweeps from "start" to "stop" frequency setting. Both settings continuously adjustable over entire frequency range.

**MARKER sweep:** sweeps from "Marker 1" to "Marker 2" frequency setting. Both settings continuously adjustable over entire frequency range and accurate to 1% of full scale for all RF units.

**$\Delta F$  sweep:** sweeps upward in frequency, centered on CW setting. Width is continuously adjustable from zero to 10% of the frequency band and is calibrated in MHz. Accuracy is  $\pm 1\%$  of maximum  $\Delta F$  plus  $\pm 10\%$  of  $\Delta F$  being swept.

**CW operation:** single-frequency RF output selected by START/CW or MARKER 1 control, depending on sweep function selected.

### Sweep modes

Auto, manual, and triggered sweep modes; sweep indicator lights during each sweep.

**Sweep time:** continuously adjustable in four decade ranges, 0.01 to 100 seconds.

**Sweep output:** direct-coupled sawtooth, zero to approximately +15 V, concurrent with swept RF output, regardless of sweep width or direction

### General

**Frequency markers:** two markers independently adjustable over entire frequency range accurate to 1% of full scale. Amplitude is adjustable from front panel. A -5 V (triangular pulse) is available as an intensity marker on the rear panel.

**Internal AM:** square wave modulation continuously adjustable from 950 to 1050 Hz.

**External AM:** frequency response dc to 350 kHz unlevelled, dc to 50 kHz levelled.

**Blanking:** both negative (-4 V) and RF blanking available along with pen lift output.

**Weight:** net, 23.9 kg (53 lb). Shipping, 32 kg (71 lb).

**Size:** 222 mm H  $\times$  425 mm W  $\times$  467 mm D (8 $\frac{3}{4}$ "  $\times$  16 $\frac{3}{4}$ "  $\times$  18 $\frac{3}{8}$ ").

8690B Sweeper mainframe

\$2800

- Solid state plug-ins
- Both pin and grid leveled BWO plug-ins
- Frequency coverage to 50 GHz

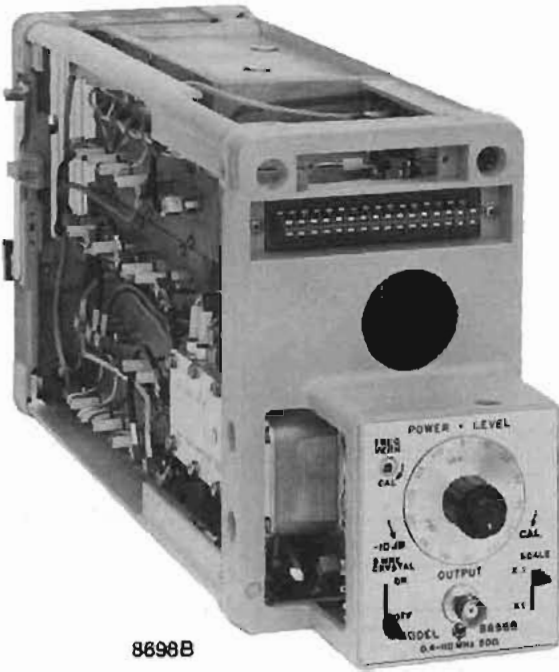

8698B



8693B

### Solid state and BWO plug-ins

Solid state plug-ins from 400 kHz to 4 GHz are available for the 8690 mainframe. BWO replacement is both expensive and inconvenient. Solid state plug-ins not only offer high reliability, but also provide low residual FM and good spectral purity. This capability allows one mainframe to cover high frequency, high power BWO applications, yet facilitate high performance, longer life solid state coverage of lower frequencies. There are two solid state plug-ins. The 8698B covers 400 kHz to 110 MHz while the 8699B plug-in has a 100 MHz to 4 GHz range.

Both grid leveled and pin leveled BWO plug-ins are available covering 1 to 50 GHz. Grid leveled BWO oscillators achieve power and leveling control by varying bias on the BWO grid. Although some degradation in frequency performance specifications is seen by this method, grid leveling provides an economical means of power control and delivers higher power output since there are no components (pin modulators) between BWO and front panel output.

PIN leveled BWO plug-ins offer superior frequency stability characteristics. As in all solid state plug-ins, leveling is accomplished through use of a pin diode modulator between oscillator and output. Use of the pin allows the oscillator to work at constant bias and into a constant impedance load, resulting in very low residual FM and very little frequency pulling. Pin leveling also results in a better source impedance match.

### Common specifications: BWO plug-ins

**Warranty:** all BWO's are unconditionally warranted for one year.

**Spurious signals:** harmonics, >20 dB below CW output, nonharmonics, >40 dB below CW output.

**Residual AM:** >40 dB below CW output.

**Magnetic shielding:** all plug-ins except the 8691A/B have shielded BWO's.

**Reference output:** dc voltage proportional to frequency output  $\approx 40$  V/octave.

**Leveling indicator:** front panel light indicates unlevelled operation.

#### Power variation

**Unleveled:** <10 dB over full band.

**Externally leveled:**  $\pm 0.2$  dB for A units.

$\pm 0.1$  dB for B units.

**Frequency stability with temperature:**  $\pm 0.01\%/^{\circ}\text{C}$ .

#### Weight

8691-8692: net, 7.7 kg (17 lb). Shipping, 11.3 kg (25 lb).

8693-8697: net, 5.4 kg (12 lb). Shipping, 9 kg (20 lb).

8698-8699: net, 5.0 kg (11 lb). Shipping, 8.6 kg (19 lb).

## 8690 Sweeper family (cont.)

## Pin leveled solid state plug-ins

Frequency Range	Model Number	Maximum Leveled Power	Frequency Accuracy	Frequency Stability With		Residual FM <sup>2</sup>	Int. Leveling Power Variation	Connector	Price
				Temperature	10 dB Power Level Change				
0.4—11 MHz	8698B	>20 mW	±1% ±50 kHz	±0.05%/°C	—	<300 Hz rms	±0.3 dB	BNC <sup>1</sup>	\$2200
11—110 MHz		>20 mW	±1% ±500 kHz	±0.05%/°C	—	<500 Hz rms	±0.3 dB		
0.1—2 GHz	8699B	>20 mW	±10 MHz	±750 kHz/°C	<100 kHz	<3 kHz rms	—	Type N	\$4850
2—4 GHz		>6 mW	±10 MHz	±750 kHz/°C	<500 kHz	<3 kHz rms	—		

1 8698B Opt 001: 75Ω BNC output.

2 Residual FM measured with 10 kHz bandwidth.

Add \$55.

## Grid and pin leveled BWO plug-ins

Frequency	Model Number	Power Control	Maximum Leveled Power	Frequency Accuracy	Freq. Stability With Power Level Change <sup>1</sup>	Residual FM Peak <sup>2</sup>	Option 001 Int. Leveling Power Variation	Connector	Price <sup>1</sup>	Option 001 Int. Leveling Price-Add
1.0—2.0 GHz	8691A	GRID	>100 mW	±1%	<20 MHz	<30 kHz	±0.4 dB	Type N	\$3400	\$360
	8691B	PIN	>70 mW	±10 MHz	±500 kHz	<10 kHz	—	Type N	\$3750	—
1.4—2.5 GHz	8691A Opt. 200	GRID	>100 mW	±1%	<30 MHz	<30 kHz	—	Type N	\$3880	—
1.7—4.2 GHz	8692B Opt. 100	PIN	>15 mW	±75 MHz	±4 MHz	<20 kHz	—	Type N	\$4230	—
2.0—4.0 GHz	8692A	GRID	>70 mW	±1%	±40 MHz	<30 kHz	±0.4 dB	Type N	\$3200	\$360
	8692B	PIN	>40 mW	±20 MHz	±4 MHz	<15 kHz	—	Type N	\$3800	—
3.5—8.75 GHz	8693A Opt. 200	GRID	>40 mW	±1%	<80 MHz	<50 kHz	—	Type N	\$2500	—
3.7—8.3 GHz	8693B Opt. 100	PIN	>5 mW	±45 MHz	±1 MHz	<20 kHz	±0.4 dB	Type N	\$3450	\$190
	8693A	GRID	>30 mW	±1%	<80 MHz	50 kHz	±0.5 dB	Type N	\$2700	\$390
4.0—8 MHz	8693B Opt. 200	PIN	>15 mW	±40 MHz	±1 MHz	<15 kHz	±0.4 dB	Type N	\$3100	\$390
	8693A Opt. 200	GRID	>25 mW	±1%	<160 MHz	<60 kHz	±0.75 dB	Type N	\$3055	\$490
7.0—11.0 GHz	8694B Opt. 200	PIN	>15 mW	±40 MHz	±1 MHz	<20 kHz	±0.75 dB	Type N	\$3705	\$490
	8694A Opt. 100	GRID	>25 mW	±1%	<160 MHz	<60 kHz	±0.75 dB	Type N	\$3380	\$490
7.0—12.4 GHz	8694B Opt. 100	PIN	>15 mW	±50 MHz	±1 MHz	<20 kHz	±0.75 dB	Type N	\$4210	\$490
	8694A	GRID	>50 mW	±1%	±160 MHz	<60 kHz	±0.75 dB	Type N	\$3000	\$490
8.0—12.4 GHz	8694B	PIN	>30 mW	±40 MHz	±1 MHz	<15 kHz	±0.75 dB	Type N	\$3850	\$490
	8694A Opt. 300	GRID	>10 mW	±1%	±150 MHz	<150 kHz	—	Type N	\$2150	—
8.0—18.0 GHz	8694B Opt. 300	PIN	>5 mW	±1%	±1 MHz	<50 kHz	—	Type N	\$6350	—
	8695A Opt. 100	GRID	>25 mW	±1%	±0.25 GHz	<150 kHz	—	Flange flange for WR-75WG	\$4050	—
12.4—18.0 GHz	8695A	GRID	>40 mW	±1%	±0.25 GHz	<150 kHz	—	UG-419/U	\$3200	—
	8695B	PIN	>15 mW	±56 MHz	±1 MHz	<25 kHz	—	UG-419/U	\$3600	—
18.0—26.5 GHz	8696A	GRID	>10 mW	±1%	<0.36 GHz	<200 kHz	—	UG-595/U	\$3350	—
26.5—40 GHz	8697A	GRID	>5 mW	±1%	±0.53 GHz	<350 kHz	—	UG-599/U	\$5400	—
33—50 GHz	8697A Opt. 400	GRID	>1 mW	±1%	±0.66 GHz	<450 kHz	—	UG-383/U	\$11,400	—

1. Power level change specification for B units typically 10 dB, A units 6 dB.

2. Residual FM measured with 10 kHz bandwidth.

Opt 004: rear output 8691-8694, 8698-8699

Opt 004: rear output 8695-8697

Opt J54: phase lock input

add \$80

add \$155

add \$350

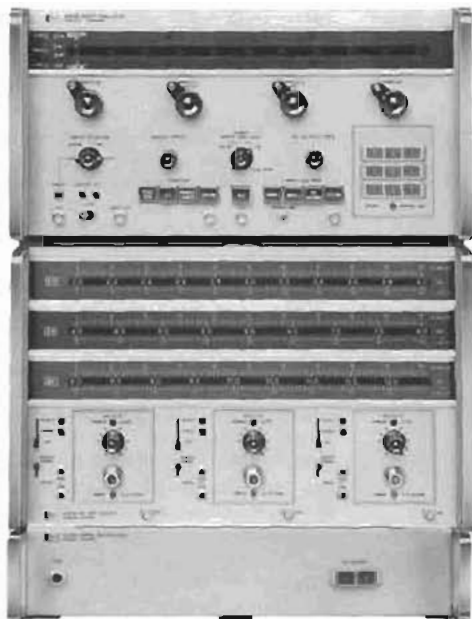

8690B/8706A, 8707A, 8705A



8709A



8404A



11531A

### 8705A, 8706A, 8707A Multiband system

Multiband systems 400 kHz to 50 GHz are available using the 8706A control unit plug-in and the 8707A RF unit holder. The 8706A allows pushbutton control of RF plug-ins installed in the 8707A. The 8705A multiplexer switches RF signals up to 12.4 GHz from three RF units and provides an ALC signal for the 8690B leveling circuits.

#### Specifications

##### 8705A Multiplexer

**Frequency range:** dc to 12.4 GHz. Output port SWR  $\leq 1.67$ . Input port SWR  $\leq 1.35$ .

**Insertion loss:** 3 dB.

**Weight:** net, 7.8 kg (17 lb). Shipping, 10 kg (22 lb).

##### 8706A Control plug-in

**Compatibility:** the 8706A controls up to three 8707A RF unit holders; Option H26 for remote band switching of the 8699B.

**Weight:** net, 7.3 kg (16 lb). Shipping, 11.4 kg (25 lb).

##### 8707A RF Unit Holder

**Capability:** accepts up to three 8690 plug-ins.

##### Sweep functions

**Normal:** permits all 8690B sweep functions.

**Preset:** allows screwdriver setting of individual start/stop points.

**Weight:** net, 13.6 kg (30 lb). Shipping, 16.8 kg (37 lb).

### 8709A Phase lock synchronizer

The 8709A synchronizer is a phase comparator designed to stabilize the frequency of both HP BWO and solid state sources by phase locking to a reference oscillator. Under these conditions system stability is determined primarily by the stability of the reference oscillator. Phase lock capability is standard on solid state plug-ins from 0.01 to 18 GHz. Order Option J54 for BWO plug-ins. Information on complete phase-locked systems available on request.

#### Specifications

**Input frequency:** the locking frequency of the 8709A is 20 MHz. This signal is obtained by multiplying and mixing the reference oscillator with the microwave signal.

**Sensitivity:** -65 dBm.

**Minimum output voltage:** high level  $\pm 12.0$  V dc; low level  $\pm 8.0$  V dc.

**Modulation sensitivity:** 8690 BWO Option J54 plug-ins, 0.5 to 6.0 MHz/V. 8620 solid state plug-ins 6.0 MHz/V.

**Weight:** net, 4.5 kg (10 lb). Shipping, 5.3 kg (11.6 lb).

### 8404A Power meter leveling amplifier

The 8404A leveling amplifier permits the 431B/C or 432A/B/C power meter to level both the 8620 and 8690 sweeper plug-ins. RF output is leveled to  $\pm 0.5$  dB or less when connected to the AM input of the sweeper.

### 11531A Mainframe test plug-in

The 11531A test unit plug-in allows complete calibration of the 8690 mainframe, including sweep modes, markers and BWO. All voltages are selected from a front panel switch.

#### Ordering Information

8404A Power Meter Leveling Amplifier

Price

\$550

Opt 001: 4 line BCD level control

add \$210

8705A Signal Multiplexer dc-12.4 GHz

\$3100

8706A Control Unit Plug-in

\$1200

8707A RF Unit Holder

\$2650

8709A Phase-Lock Synchronizer

\$1500

11531A Mainframe Test Unit Plug-in

\$550

# POWER & NOISE FIGURE METERS

Power and noise measurements

## Average power measurements

At microwave frequencies, power is the best measure of signal amplitude because, unlike voltage and current, power remains constant along a lossless transmission line. For this reason, power meters are almost indispensable for microwave measurement. Typical applications include monitoring transmitter power levels, calibrating signal generators, leveling signal sources, and measuring transmission characteristics of unknown devices.

To satisfy the requirements of this broad range of applications, Hewlett-Packard has developed a family of general purpose microwave power meters. These power meters use either a diode, thermocouple, or thermistor as the power sensing element, and it is important to understand the merits of each of these sensors before choosing a particular power meter.

## Power meters & sensors

Hewlett-Packard makes four average-reading power meters, the 436A, 435A, 432A, and 432B. The 435A and 436A are analog and digital meters, respectively, which are designed to operate with HP's line of thermocouple and diode power sensors. The 432A and 432B are analog and digital meters, respectively, which are designed to operate with HP's line of thermistor power sensors.

Thermocouple power sensors use the latest technology and are generally preferred for measuring power because they exhibit lower SWR and wider dynamic range than previously used thermistor elements. Low SWR is directly responsible for superior accuracy since mismatch errors are lower.

HP thermocouple sensors (8481, 8482, 8483) are available from 100 kHz to 18 GHz and range from -30 dBm to +33 dBm. The model 8484A diode sensor operates with the same meters and extends the input level down to -70 dBm. This sensor uses a Lower-Barrier Schottky diode to achieve exceptional 100 pW (-70 dBm) sensitivity, and low noise and drift. Because the diode is always operated in its square law region (voltage out  $\propto$  power in), the 8484A can be used to measure the true power of complex as well as CW waveforms.

Thermistor power sensors (478A, 486A series) operate with the 432A and 432B power meters. They are used whenever a direct DC-substitution technique is required since these power meters are based on balanced bridge principles. In addition, a full line of waveguide thermistor mounts are available from 2.6 to 40 GHz.

## Applications

Information on virtually all aspects of microwave power measurement is contained in a comprehensive new application note. The AN 64 series is intended as the definitive publication for general theory, product orientated how-to descriptions, and a complete treatment of new, innovative automatic systems.

AN 64-1, *Fundamentals of RF & Microwave Power Measurements*, deals with the general theory of microwave power measurements. It covers information which

does not change rapidly such as basic principles, calibration and traceability, etc. Future notes will treat more equipment-related aspects and mini-system-oriented applications.

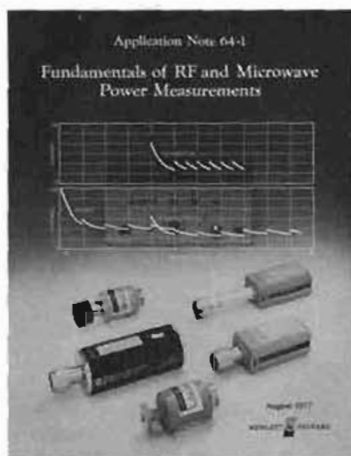

AN 196, *Automated Measurements Using the 436A Power Meter*, describes 5 systems built around the HP-Interface Bus and the programmable 436A digital power meter. The 5 typical applications are power data logging, measuring 50 dB dynamic power range, signal generator calibration, gain and attenuation measurement, and power sensor calibration; all under computer control. Figure 1 shows a sensor calibration setup.

All of these application notes and the 1977-78 Coaxial & Waveguide Catalog are available without charge by simply using the request card at the back of this catalog.

## Peak power measurement

A frequent requirement in microwave work is the measurement of peak power in a periodic pulse. This may be done by various indirect techniques using thermocouples or thermistors. Hewlett-Packard also produces a versatile instrument that conveniently

measures peak power directly in the 50 MHz to 2 GHz frequency range. Model 8900B utilizes a video comparator technique to bring a known dc voltage, supplied by the instrument, in a known impedance, to a level which is equal to the pulse being measured. This allows simple measurement of peak pulse power with a basic accuracy of 1.5 dB even when the waveform is not rectangular. A custom calibration chart increases accuracy to 0.6 dB for critical applications.

## Noise figure measurements

In RF microwave communications, radar, etc., the weakest signal that can be detected is usually determined by the amount of noise added by the receiving system. From a performance standpoint, providing an increase in the receiver signal-to-noise ratio by reducing the amount of added noise is more economical than increasing the power of the transmitter.

The quality of a receiver or amplifier is expressed as a figure of merit, or noise figure. Noise figure is the ratio, expressed in dB, of the actual output noise power of the device compared to the noise power which would be available if the device were perfect and merely amplified the thermal noise of the input termination rather than contributing any noise of its own.

The Hewlett-Packard system of automatic noise figure measurement depends upon the periodic insertion of a known excess noise power at the input of the device under test. Subsequent detection of noise power results in a pulse train of two power levels. The power ratio of these two levels contains the desired noise figure information. Hewlett-Packard noise figure meters automatically measure and present this ratio directly in dB of noise figure.

Noise figure is discussed in detail in Hewlett-Packard AN 57. Use the enclosed request card. Application Note 57, *Noise Figure Primer*, derives noise figures formulas, describes general noise figure measurements, and discusses accuracy considerations.

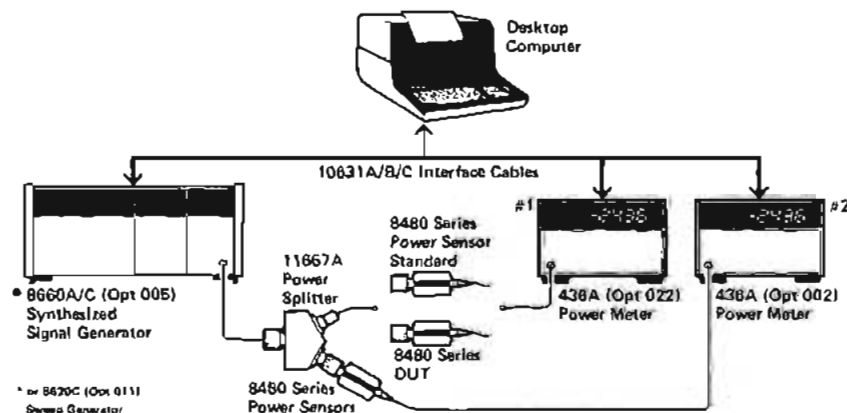
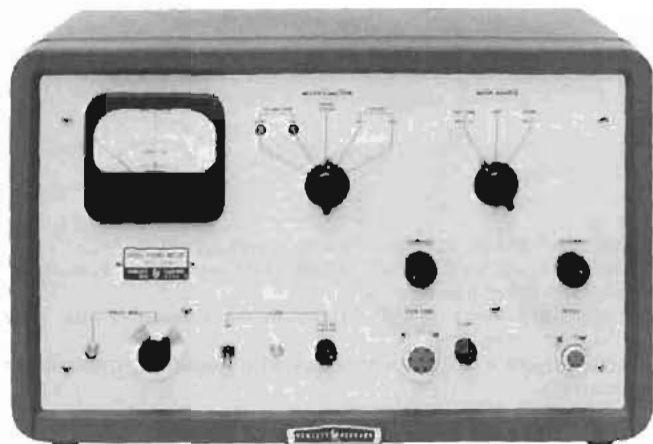

Figure 1. System for transferring calibration factor from one 8480 series power sensor to another.



340B

### Noise figure meters and noise sources

Model 340B Noise Figure Meter, when used with the appropriate HP noise source, automatically measures and continuously displays noise figure for equipment with IF frequencies of 30 and 60 MHz. Model 342A is similar, and operates on frequencies of 30, 60, 70, 105 and 200 MHz.

HP noise sources provide calibrated noise for measurements on various equipment from IF amplifiers to complete radar systems. Model 343A VHF source operates from 10 to 600 MHz with 50 ohm impedance. 345B IF source is tuned for 30 or 60 MHz with 50, 100, 200, or 400 ohm outputs.

The 347A waveguide sources are argon gas discharge tubes carefully mounted in waveguide sections for frequencies from 3.95 to 18 GHz. Model 349A also uses an argon tube in a coaxial configuration for frequencies from 400 to 4000 MHz.

#### 340B and 342A specifications

**Noise figure range:** with a 5.2 dB noise source, 0 to 15 dB, indication to infinity; with a 15.2 dB noise source, 3 to 30 dB, indication to infinity.

**Accuracy (excluding source accuracy):** noise diode scale:  $\pm 0.5$  dB, 0 to 15 dB; gas tube scale:  $\pm 0.5$  dB, 10 to 25 dB;  $\pm 1$  dB, 3 to 10 dB and 25 to 30 dB.

**Input frequency:** 340B: 30 or 60 MHz, selected by switch; 342A: 30, 60, 70, 105, and 200 MHz, selected by switch. Other frequencies available; prices and details on request.

**Bandwidth:** 1 MHz minimum.

**Input requirements:** -60 to -10 dBm (noise source on); corresponds to gain between noise source and input of approximately 50 to 100 dB for 5.2 dB noise source and 40 to 90 dB for 15.2 dB noise source.

**Input impedance:** 50 ohms nominal.

**AGC output:** nominal 0 to -6 V from rear binding posts.

**Recorder output:** 1 mA maximum into 2000 ohms maximum.

**Power input:** 115 or 230 volts  $\pm 10\%$ , 50 to 60 Hz, 185 to 435 watts, depending on noise source and line voltage.

**Power output:** sufficient to operate 343A, 345B, 347A or 349A Noise Sources.

**Dimensions:** cabinet: 324 mm H, 527 mm W, 368 mm D; (12.8"  $\times$  20.3"  $\times$  14.5"); rack mount: 266 mm H, 483 mm W, 353 mm D behind panel (10.5"  $\times$  19"  $\times$  13.9").

**Weights:** net 19.4 kg (43 lb), shipping 23.9 kg (53 lb) (cabinet); net 16.2 kg (36 lb), shipping 22.5 kg (50 lb) (rack mount).

**Accessory furnished:** one 340A-16A Cable Assembly, connects noise figure meter to 347A or 349A Noise Source.

#### 343A specifications

**Frequency range:** 10 to 600 MHz.

**Excess noise ratio:** 10 to 30 MHz, 5.20 dB  $\pm 0.20$  dB; 100 MHz, 5.50 dB  $\pm 0.25$  dB; 200 MHz, 5.80 dB  $\pm 0.30$  dB; 300 MHz, 6.05 dB  $\pm 0.30$  dB; 400 MHz, 6.30 dB  $\pm 0.50$  dB; 500 MHz, 6.50 dB  $\pm 0.50$  dB; 600 MHz, 6.60 dB  $\pm 0.50$  dB.



349A



343A



345B



X347A

**Source impedance:** 50 ohms nominal.

**Reflection coefficient:**  $< 0.091$  (1.2 SWR), 10 to 400 MHz;  $< 0.13$  (1.3 SWR), 400 to 600 MHz.

**Noise generator:** temperature-limited diode.

**Dimensions:** 63 mm H, 70 mm W, 127 mm D (2.5"  $\times$  2.75"  $\times$  5").

**Weight:** net 0.34 kg (¾ lb); shipping 0.9 kg (2 lb).

#### 345B specifications

**Spectrum center:** 30 or 60 MHz, selected by switch.

**Excess noise ratio:** 5.2 dB.

**Source impedance:** 50, 100, 200 or 400 ohms,  $\pm 4\%$ , as selected by switch; less than 1 pF shunt capacitance.

**Noise generator:** temperature-limited diode.

**Dimensions and weight:** same as 343A.

#### 347A specifications

HP Model	Freq. Range (GHz)	Excess Noise Ratio dB	W/O WR	Eqiv. Flange UG-( )/D	Price
G347A	3.95-5.85	15.2 $\pm 0.5$	187	407	\$775
J347A	5.30-8.20	15.2 $\pm 0.5$	137	441	\$850
H347A	7.05-10.0	15.6 $\pm 0.5$	112	138	\$825
X347A	8.20-12.4	15.7 $\pm 0.4$	90	39	\$700
P347A	12.4-18.0	15.8 $\pm 0.5$	62	419	\$750

Reflection coefficient for all models, fired or unfired,  $< 0.091$  (SWR 1.2) max.

#### 349A specifications

**Frequency range:** 400 to 4000 MHz, wider with correction.

**Excess noise ratio:** 15.6 dB  $\pm 0.6$  dB, 400 to 1000 MHz; 15.7 dB  $\pm 0.5$  dB, 1000 to 4000 MHz.

**Source impedance:** 50 ohms nominal.

**SWR:**  $< 1.35$  (fired),  $< 1.55$  (unfired) up to 2600 MHz;  $< 1.55$  (fired or unfired), 2600 to 3000 MHz;  $< 2.0$  (fired),  $< 3.0$  (unfired) 3000 to 4000 MHz.

**Dimensions:** 51 mm H, 76 mm W, 381 mm L (2"  $\times$  3"  $\times$  15").

**Weight:** net 1.4 kg (3.25 lb). Shipping 2.7 kg (6 lb).

#### Ordering Information

340B Noise Figure Meter (cabinet)	\$1875
340BR Noise Figure Meter (rack mount)	\$1855
342A Noise Figure Meter (cabinet)	\$2000
342AR Noise Figure Meter (rack mount)	\$1985
343A Noise Source	\$ 265
345B Noise Source	\$ 425
349A Noise Source	\$ 500

#### Price

# POWER & NOISE FIGURE METERS

## Thermocouple power meter

### Model 436A



436A



### 436A Power Meter

The HP Model 436A Power Meter is a general purpose digital power meter intended for manual and automatic RF and microwave power measurements. It is compatible with the entire series of 8480 power sensors. Depending on which power sensor is used, the 436A can measure power from  $-70$  dBm (100 pW) to  $+35$  dBm (+3 W) at frequencies up to 18 GHz.

The logically organized and uncluttered front panel, and the convenience of push-button operation and digital display make the 436A both easy to interpret and easy to use in any application. The auto ranging capability allows for "hands-off" operation.

The 436A measures either absolute or relative power. It displays absolute power in either watts or dBm, while relative power is displayed in dB.

The 436A Power Meter also features optional programmability; both Hewlett-Packard Interface Bus (HP-IB) and BCD interfaces are available. These interfaces allow full remote control of all power meter functions (CAL function can be programmed to either 100 percent or the CAL factor which has been manually set on the front panel). These options may be added by the user at a later time.

### Specifications

**Frequency range:** 100 kHz to 18 GHz (depending on Power Sensor used).

#### Power range

**With 8481A, 8482A or 8483A sensors:** 50 dB with 5 full scale ranges of 10 and 100  $\mu$ W; 1, 10 and 100 mW. The display is also calibrated in dBm and dB from  $-20$  dBm to  $+20$  dBm full scale in 10-dB steps.

**With 8481H or 8482H sensors:** 45 dB with 5 full-scale ranges of 1, 10 and 100 mW; 1 and 3 watts. The display is also calibrated in dBm and dB from 0 dBm to  $+30$  dBm full scale in 10-dB steps, and a 5-dB step from  $+30$  dBm to  $+35$  dBm.

**With 8484A sensor:** 50 dB with 5 full scale ranges of 1, 10, 100 nW; 1, 10  $\mu$ W. The display is also calibrated in dBm and dB from  $-60$  dBm to  $-20$  dBm full scale in 10 dB steps.

#### Accuracy

##### Instrumentation

**Watt mode:**  $\pm 0.5\%$  in ranges 1 through 4;  $\pm 1.0\%$  in range 5.

**dBm mode:**  $\pm 0.02$  dB  $\pm 0.001$  dB/ $^{\circ}$ C in range 1 through 4;  $\pm 0.04$  dB  $\pm 0.001$  dB/ $^{\circ}$ C in range 5.

**dB (REL) mode:**  $\pm 0.02$  dB  $\pm 0.001$  dB/ $^{\circ}$ C in ranges 1 through 4;  $\pm 0.04$  dB  $\pm 0.001$  dB/ $^{\circ}$ C in range 5.

**Zero:** automatic, operated by a front-panel switch.

**Zero set:**  $\pm 0.5\%$  of full scale on most sensitive range, typical.  $\pm 1$  count on other ranges.

**Zero carry over:**  $\pm 0.2\%$  of full scale when zeroed on the most sensitive range.

**Noise (typical at constant temperature over any one-minute interval):**

With 8484A Sensor: 20 pW peak.

With 8481A, 8482A, 8483A Sensors: 40 nW peak.

With 8481H, 8482H Sensors: 4  $\mu$ W peak.

#### General

**Zero drift:**  $\pm 2\%$  of full scale on most sensitive range (1 hour, typical at constant temperature).

**Response time: (0 to 99% of reading):**

Range 1 < 10 seconds (most sensitive range)

Range 2 < 1 second

Ranges 3 through 5 < 100 msec

(Typical, measured at recorder output).

**Power reference:** internal 50 MHz oscillator with Type N female connector on front panel or rear panel (Option 003 only).

**Power output:** 1.0 mW. Factory set to  $\pm 0.7\%$  traceable to the National Bureau of Standards.

**Accuracy:**  $\pm 1.2\%$  worst case ( $\pm 0.9\%$  rms) for one year ( $0^{\circ}$ C to  $55^{\circ}$ C).

**Cal factor:** 16-position switch normalizes meter reading to account for calibration factor. Range 85% to 100% in 1% steps.

**Cal adjustment:** front-panel adjustment provides capability to adjust gain in meter to match power sensor in use.

**Recorder output:** proportional to indicated power with 1 volt corresponding to full scale and 0.316 volts to  $-5$  dB; 1 k $\Omega$  output impedance, BNC connector.

**RF blanking:** open collector TTL; low corresponds to blanking when auto-zero mode is engaged.

**Display:** digital display with four digits, 20% over-range capability on all ranges. Analog meter: uncalibrated peaking meter to see fast changes.

**Power consumption:** 100, 120, 220, or 240 V  $\pm 5\%$ ,  $-10\%$ , 48 to 440 Hz, less than 20 watts (less than 23 with Option 022 or 024).

**Weight:** net, 4.5 kg (10 lb). Shipping, 5.5 kg (12 lb).

**Size:** 134 H, 213 W, 279 mm D (5 $\frac{1}{4}$ "  $\times$  8 $\frac{3}{8}$ "  $\times$  11").

**Accessories furnished:** 1.5 m (5 ft) cable for power sensor; 2.3 m (7.5 ft) power cable. Main plug shipped to match destination requirements.

#### Accessories available

To rack mount one 436A by itself order:

5061-0057 Rack Mount Adapter Kit and accessories

#### Options

002: input connector placed on rear panel in parallel with front

003: input connector and reference oscillator output on rear panel only

009: 3 m (10 ft) cable for power sensor

010: 6.1 m (20 ft) cable for power sensor

011: 15.2 m (50 ft) cable for power sensor

012: 30.5 m (100 ft) cable for power sensor

013: 61 m (200 ft) cable for power sensor

022: digital input/output, fully compatible with HP Interface Bus (HP-IB)

024: digital input/output BCD Interface

5061-0057 Rack Mount Kit

436A Power Meter

Price

add \$25

add \$10

add \$30

add \$55

add \$105

add \$155

add \$260

add \$400

add \$300

\$15

\$1975



# POWER & NOISE FIGURE METERS

Thermocouple power meter, range calibrator

Model 435A, 11683A



435A



11683A

## 435A Power meter

The 435A Power Meter is an analog power meter, compatible with the entire series of 8480 power sensors. Depending on which sensor is used, the 435A can measure power from -65 dBm to +35 dBm, full scale, at frequencies from 100 kHz to 18 GHz. This versatile instrument also features <1% instrumentation uncertainty, low noise and drift, auto-zero, recorder output, optional battery operation, and long cable options (up to 200 ft).

## 11683A Range calibrator

The 11683A calibrator is specifically designed for use with the 435A and 436A power meters. It allows verification of full-scale meter readings on all ranges, as well as meter tracking. Simply connect the cable between the power meter and calibrator. The CAL. ADJ control on the power meter is used to set the meter to full scale on the 1 mW range. The calibrator and meter are then stepped through the other ranges verifying accuracy within  $\pm 1\%$  plus noise and drift. The 11683A also has a polarity switch which tests the Auto-Zero circuit.

## Specifications:

### 435A power meter

**Frequency range:** 100 kHz to 18 GHz (depending on power sensor used).

**Power range:** (435A calibrated in watts and dB in 5 dB steps).

With 8481A, 8482A, or 8483A: -25 dBm (3  $\mu$ W) to +20 dBm (100 mW) full scale.

With 8481H or 8482H: -5 dBm (0.3 mW) to +35 dBm (3 W) full scale.

With 8484A: -65 dBm (300 pW) to -20 dBm (100 W) full scale.

**Instrumentation uncertainty:**  $\pm 1\%$  of full scale on all ranges (0° to 55°C).

**Zero:** automatic, operated by front panel switch.

**Zero carryover:**  $\pm 0.5\%$  of full scale when zeroed on the most sensitive range.

**Power reference:** internal 50 MHz oscillator with Type N female connector on front panel (Option 003 only).

**Power output:** 1.0 mW. Factory set to  $\pm 0.7\%$  traceable to the National Bureau of Standards.

**Accuracy:**  $\pm 1.2\%$  worst case ( $\pm 0.9\%$  rms) for one year (0°C to 55°C).

**Noise and drift:** (% of full scale peak on most sensitive range; typical, at constant temperature).

8481A, 8482A, 8483A: <1.5%; less on higher ranges.

8481H, 8482H: <1.5%; <2% of full scale on top range; less on other ranges.

8484A: <5%; less on higher ranges.

**Response time:** (0 to 99% of reading, five time constants).

Range 1 (most sensitive range) 0.0 seconds

Range 2 3.8 seconds

Range 3 1.3 seconds

Ranges 4 to 10 500 milliseconds

(Typical, measured at recorder output)

**Cal factor:** 16-Position switch normalizes meter reading to account for calibration factor or effective efficiency. Range 85% to 100% in 1% steps.

**Recorder output:** proportional to indicated power with 1 volt corresponding to full scale; 1 k $\Omega$  output impedance, BNC connector.

**RF blanking output:** provides a contact closure to ground when auto-zero mode is engaged.

**Cal adj:** front panel adjustment provides capability to adjust gain of meter to match power sensor in use.

**Power consumption:** 100, 120, 220 or 240 V  $\pm 5\%$ ,  $\sim 10\%$ , 48 to 440 Hz, less than 4 watts (less than 10 watts for option 001 when recharging battery).

**Weight:** net, 2.6 kg (5 lb, 12 oz). Shipping, 4.2 kg (9 lb, 3 oz).

**Size:** 155 H  $\times$  130 W  $\times$  279 mm D (6 $\frac{3}{32}$ "  $\times$  5 $\frac{1}{8}$ "  $\times$  11").

**Accessories furnished:** 1.52 m (5 ft) cable for the power sensor; 2.29 m (7 $\frac{1}{2}$  ft) power cable. Mains plug shipped to match destination requirements.

### Accessories available

11076A: carrying case.

5060-8762: rack adapter frame (holds three instruments the size of the 435A).

### Combining cases

1051A: 286 mm (11 $\frac{1}{4}$ " deep).

1052A: 416 mm (16 $\frac{3}{8}$ " deep).

The combining cases accept the  $\frac{1}{2}$ -module Hewlett-Packard instruments for bench use or rack mounting. See 1051A data sheet for details.

### 11683A Range calibrator

**Calibration functions:** outputs corresponding to meter readings of 3, 10, 30, 100 and 300  $\mu$ W; 1, 3, 10, 30, and 100 mW.

**Calibration uncertainty:**  $\pm 0.25\%$  in all ranges.

**Power:** 115 or 230 V  $\pm 10\%$ ; 50-400 Hz, less than 2 W.

**Weight:** net, 1.13 kg (2 lb 8 oz). Shipping, 1.9 kg (4 lb 3 oz).

**Size:** 88.9 H  $\times$  133.35 W  $\times$  215.9 mm D (3 $\frac{1}{2}$ "  $\times$  5 $\frac{1}{4}$ "  $\times$  8 $\frac{1}{4}$ ").

### Options

001: rechargeable battery installed, provides up to 16 hours of continuous operation

002: input connector placed on rear panel in parallel with front

003: input connector and reference oscillator output on rear panel only

009: 3.05 m (10-foot) cable for power sensor

010: 6.10 m (20-foot) cable for power sensor

011: 15.24 m (50-foot) cable for power sensor

012: 30.48 m (100-foot) cable for power sensor

013: 60.96 m (200-foot) cable for power sensor

### Ordering Information

11683A Range calibrator

### Price

add \$100

add \$25

add \$10

add \$30

add \$55

add \$105

add \$155

add \$260

435A Power meter

\$550

\$950

# POWER & NOISE FIGURE METERS

## Power sensors

Models 8481A, 8481H, 8482A, 8482H, 8483A, 8484A



8481A



8481H



8482A



8482H



8483A



11708A



8484A

### 8480 Series power sensors

The 8480 Series sensors are designed for use with the 435A or 436A power meters. They cover a frequency range of 100 kHz to 18 GHz and a power range of  $-70$  dBm to  $+35$  dBm. These sensors feature *very low* SWR which results in a significant reduction in measurement uncertainty due to mismatch. Each sensor is individually calibrated for CAL FACTOR to allow compensation for power sensor efficiency and mismatch due to sensor SWR. The new model 8484A high sensitivity power sensor offers an extended range capability down to  $-70$  dBm with exceptional temperature stability. Models 8481H and 8482H have an internal attenuator to allow measurements to 3 W.

### 8481A Power sensor

#### Wide frequency and amplitude range

Measure power from  $0.3 \mu\text{W}$  to  $100 \text{ mW}$ , full scale, over a frequency range from 10 MHz to 18 GHz with a single power sensor.

#### Low SWR reduces measurement uncertainty

A silicon monolithic thermocouple is used as the sensing element and its small physical size allows reduction of SWR to  $<1.10$  over the range of 50 MHz to 2 GHz;  $<1.18$  up to 12.4 GHz; and  $<1.28$  to 18 GHz. This assures low mismatch uncertainty, usually the largest single source of error in power measurement.

#### Individually calibrated

Each sensor is individually calibrated, traceable to the National Bureau of Standards, and a Cal Factor control on the meter compensates for power sensor efficiency at any frequency. In addition, a precise Automatic Network Analyzer printout at 17 frequencies for Cal Factor and reflection coefficient in magnitude and phase is supplied. This means you can eliminate mismatch uncertainty by calculating the mismatch error.

### 8481H Power sensor

#### Higher power version of the 8481A power sensor

Measure power from  $30 \mu\text{W}$  to 3 W, full scale, over a frequency range from 10 MHz to 18 GHz with a single power sensor.

### 8482A Power sensor

#### RF sensor (similar to the 8481A power sensor)

Measure power from  $0.3 \mu\text{W}$  to  $100 \text{ mW}$ , full scale, over a frequency range from 100 kHz to 4.2 GHz with a SWR  $<1.20$  over the range of 300 kHz to 1 MHz;  $<1.10$  between 1 MHz and 2 GHz; and  $<1.30$  to 4 GHz.

### 8482H Power sensor

#### Higher power version of the 8482A power sensor

Measure power from  $30 \mu\text{W}$  to 3 W, full scale, over a frequency range from 100 kHz to 4.2 GHz with a single power sensor.

### 8483A Power sensor

#### 75 ohm RF sensor (similar to the 8482A power sensor)

Measure  $75 \Omega$  source power from  $0.3 \mu\text{W}$  to  $100 \text{ mW}$ , full scale, over a frequency range from 100 kHz to 2 GHz with a SWR  $<1.18$  over the range of 100 kHz to 2 GHz.

### 8484A Power sensor

#### High sensitivity sensor

Measure power from  $100 \text{ pW}$  to  $10 \mu\text{W}$  over a frequency range of 10 MHz to 18 GHz with a single power sensor. Furnished with 11708A 50 MHz Reference Attenuator for precise calibration with 1 mW Power Meter Reference Oscillator.

#### Low noise and drift

Noise and drift have been reduced to a minimum in this sensor, thus making readings at low power levels reliable and accurate. Noise and drift when used with the 435A power meter are typically less than 5% of full scale on the  $300 \text{ pW}$  range — only  $15 \text{ pW}$ . Noise and drift are even less with the 436A power meter.

## 8480 Series specifications

Model	Frequency Range (GHz)	Nominal Impedance	SWR Maximum (Reflection Coefficient)	Power Range	Maximum Power	Dimensions mm (in.)	Shipping Weight kg (lb)	Rf Connector	Price
8481A	10 MHz–18 GHz	50Ω	1.1 (0.048), 50 MHz–2 GHz 1.18 (0.082) 30 MHz–50 MHz 2–12.4 GHz 1.28 (0.123) 12.4–18 GHz	0.3 μW to 100 mW	300 mW Av, 15 W Peak 30 W μs (per pulse)	30 × 38 × 105 (1 1/16 × 1 1/2 × 4 1/8)	0.5 (1)	N(m)	\$425
Option 001									APC-7
8481H*	10 MHz–18 GHz	50Ω	1.2 (0.091), 10 MHz–8 GHz 1.3 (0.13), 8–12.4 GHz 1.5 (0.20), 12.4–18 GHz	30 μW to 3 W	3.5 W Av, 100 W Peak 100 W μs (per pulse)	30 × 38 × 149 (1 3/16 × 1 1/2 × 5 7/16)	0.5 (1)	N(m)	\$550
8482A	100 kHz–4.2 GHz	50Ω	1.1 (0.048), 1 MHz–2 GHz 1.2 (0.091), 300 kHz–1 MHz 1.3 (0.13), 2–4.2 GHz 1.6 (0.231), 100–300 Hz	0.3 μW to 100 mW	300 mW Av, 15 W Peak 30 W μs (per pulse)	30 × 38 × 105 (1 3/16 × 1 1/2 × 4 1/8)	0.5 (1)	N(m)	\$425
8482*	100 kHz–4.2 GHz	50Ω	1.2 (0.091), 100 kHz–4.2 GHz	30 μW to 3 W	3.5 W Av, 100 W Peak 100 W μs (per pulse)	30 × 38 × 149 (1 3/16 × 1 1/2 × 5 7/16)	0.5 (1)	N(m)	\$550
8483A	100 kHz–2 GHz	75Ω	1.18 (0.082), 600 kHz–2 GHz 1.8 (0.286), 100–600 Hz	0.3 μW to 100 mW	300 mW Av, 10 W Peak 30 W μs (per pulse)	30 × 38 × 105 (1 3/16 × 1 1/2 × 4 1/8)	0.5 (1)	N(m), 75Ω	\$425
8484A	10 MHz–18 GHz	50Ω	1.15 (0.070), 30 MHz–8 GHz 1.2 (0.091), 4 GHz–10 GHz 1.3 (0.13), 10 GHz–18 GHz 1.4 (0.17), 10 MHz–30 MHz	0.1 nW to 10 μW	200 mW Av, 200 mW Peak	40 × 50 × 170 (1 3/16 × 2 × 6 1/16)	0.5 (1)	N(m)	\$575

\*Only specifications listed in this table apply to 8481H and 8482H. No other specifications are implied.

### Uncertainty of calibration factor data for 8482A and 8483A

Frequency (MHz)	Sum of Uncertainties (%) <sup>1</sup>		Probable Uncertainties (%) <sup>2</sup>	
	8482A	8483A	8482A	8483A
0.1	1.85	3.05	1.33	1.79
0.3	1.85	3.05	1.33	1.79
1.0	1.85	3.05	1.33	1.79
3.0	1.85	3.05	1.33	1.79
10.0	1.85	3.05	1.33	1.79
30.0	1.85	3.05	1.33	1.79
50.0	1.45	1.75	1.03	1.07
100.0	2.95	3.25	1.58	1.81
300.0	2.95	3.25	1.58	1.61
1000.0	2.95	3.25	1.58	1.61
2000.0	3.45	3.75	1.92	1.94
4000.0	2.95	—	1.58	—

### Uncertainty of calibration factor data for 8481A and 8484A

Frequency (GHz)	Sum of Uncertainties (%) <sup>1</sup>		Probable Uncertainties (%) <sup>2</sup>	
	8481A	8484A	8481A	8484A
1.0	2.95	—	1.58	—
2.0	3.45	4.70	1.92	2.25
4.0	2.95	4.35	1.58	1.97
6.0	2.95	4.55	1.58	2.00
8.2	2.85	4.47	1.46	1.91
10.0	2.85	4.42	1.46	1.89
12.4	2.85	4.71	1.46	1.98
14.0	5.05	7.00	2.95	3.24
16.0	5.45	7.62	3.07	3.40
18.0	5.45	7.15	3.07	3.30

1. Includes uncertainty of reference standard and transfer uncertainty. Directly traceable to NBS.  
2. Square root of sum of the individual uncertainties squared (RSS).

# POWER & NOISE FIGURE METERS

## Thermistor power meters

Models 432A and 432B

- High accuracy
- Automatic zero
- Long cable options
- Analog recorder outputs
- BCD digital output (432B)



432A

432B

### 432A and 432B Power meters

**DC bridge circuit:** Using dc instead of the conventional 10 kHz bias current results in three benefits: 1) No signal emission from the mount to disturb sensitive circuits, 2) meter zeroing is independent of the impedance connected to the RF input of the thermistor mount, 3) the instrument is not affected by capacitance changes caused by movement of the thermistor mount cable.

**High accuracy—no thermoelectric error:** high accuracy over a wide temperature range is featured on the 432 Power Meters. By measuring the output voltage of the thermistor bridges, and computing the corresponding power, even higher accuracy of  $\pm 0.2\% \pm 0.5 \mu\text{W}$  can be obtained.

Accuracy is maintained on even the most sensitive range because the error due to thermoelectric effect is reduced to a negligible level. **Calibrated mounts:** each thermistor mount is furnished with data stating the Calibration Factor\* and Effective Efficiency\* at various frequencies across the operating range. For easy and accurate power measurements, the front panel of the 432 contains a calibration factor control, calibrated in 1% steps from 88% to 100%, that compensates for losses in the mount and eliminates the need for calculation.

\*"Calibration Factor" and "Effective Efficiency" are figures of merit expressing the ratio of the substituted signal measured by the power meter to the microwave power incident on and absorbed by the mount, respectively.

**Instrument type:** automatic, self-balancing power meter for use with temperature-compensated thermistor mount.

#### Specifications

##### Power range

**432A:** seven ranges with full scale readings of 10, 30, 100, and 300  $\mu\text{W}$ , 1, 3, and 10 mW; also calibrated in dBm from -20 dBm to +10 dBm full scale in 5 dB steps.

**432B:** four ranges with full scale readings of 10 and 100  $\mu\text{W}$ , and 1 and 10 mW.

**Noise:** less than 0.25% of full scale peak.

**Response time:** at recorder output, 35 ms time constants (typical).

**Fine zero:** automatic, operated by front panel switch.

**Zero carryover:** less than 0.50% of full scale when zeroed on most sensitive range.

**RFI:** meets all conditions specified in MIL-1-6181D.

##### Meter

**432A:** taut-band suspension, individually calibrated, mirror-backed scales. Milliwatt scale more than 108 mm (4 1/4") long.

**432B:** three digits with one digit overrange. 20% overrange capability on all ranges.

**Calibration factor control:** 13-position switch normalizes meter reading to account for the thermistor mount calibration factor. Range 100% to 88% in 1% steps.

**Thermistor mount:** external temperature-compensated thermistor mounts required for operation (HP 478, 8478B, and 486 Series; mount resistance 100 or 200 ohms).

**Recorder output:** proportional to indicated power with 1 volt corresponding to fullscale. 1 k $\Omega$  output impedance.

**BCD output (8, 4, 2, 1 code):** "1" positive. TTL compatible logic. Operates with HP 5055A Digital Recorder. "Print." and "Inhibit" lines available. (432B only.)

**Bridge outputs (V<sub>RP</sub> and V<sub>COMP</sub>):** direct connections to the thermistor bridges; used in instrument calibration and precision power measurements.

##### Power consumption

**432A:** 115 or 230 V ac  $\pm 10\%$ , 50 to 400 Hz, 2 1/2 watts. Optional rechargeable battery provides up to 24 hours continuous operation. Automatic battery recharge.

**432B:** 115 or 230 V ac  $\pm 10\%$ , 50 to 400 Hz, 10 watts.

##### Weight

**432A:** net, 3.1 kg (6 lb 14 oz). Shipping, 4.7 kg (10 lb 5 oz).

**432B:** net, 3.1 kg (6 lb 14 oz). Shipping, 4.7 kg (10 lb 5 oz).

**Size:** 155 H x 130 W x 279 mm D (6.1" x 5.1" x 11").

**Accessories furnished:** 1.52 m (5 ft), cable for Hewlett-Packard temperature-compensated thermistor mounts; 2.29 m (7.5 ft) power cable. Mains plug shipped to match destination requirements.

##### Options

**001:** rechargeable battery installed, provides up to 24 hours continuous operation (432A only)

**002:** input connector placed on rear panel in parallel with front

**003:** input connector on rear panel only

Note: thermistor mount cable impedance is part of the 432 input bridge circuit. For cables over 10 feet long, the bridge is matched to specific cable options, so the various cables should not be interchanged.)

**009:** 3.05 m (10 ft) cable for 100-ohm or 200-ohm mount

**010:** 6 m (20 ft) cable for 100-ohm or 200-ohm mount

**011:** 15 m (50 ft) cable for 100-ohm or 200-ohm mount

**012:** 30 m (100 ft) cable for 100-ohm or 200-ohm mount

**013:** 61 m (200 ft) cable for 100-ohm or 200-ohm mount

##### Ordering information

432A Power meter

432B Power meter

##### Price

add \$105

add \$25

add \$10

add \$30

add \$55

add \$105

add \$155

add \$260

\$800

\$1400

# POWER & NOISE FIGURE METERS

Thermistor mounts, Peak power calibrator & power meter calibrator  
Models 478A, 8478B, 486 Series, and Models 8900B & 8477A



## Temperature compensated thermistor mounts

High efficiency and good RF match are characteristic of the HP 478A and 8478B Coaxial and 486A-Series Waveguide Thermistor mounts which, in conjunction with the 432 Power Meter, provide you with high accuracy even in routine power measurements. These thermistor mounts are temperature-compensated for low drift, even in the presence of thermal shocks, permitting measurement of microwave power as low as one microwatt. Each mount contains data showing Calibration Factor and Effective Efficiency at six frequencies, directly traceable to the National Bureau of Standards at those frequencies where NBS provides calibration service.

## Specifications

HP Model	Frequency range, GHz	Maximum SWR	Operating resistance (ohms)	Price
478A	10 MHz to 10 GHz	1.75, 10 to 25 MHz 1.3, 25 MHz to 7 GHz 1.5, 7 to 10 GHz	200	\$225
8478B*	10 MHz to 18 GHz	1.75, 10 to 30 MHz 1.35, 30 to 100 MHz 1.1, 0.1 to 1 GHz 1.35, 1 to 12.4 GHz 1.6, 12.4 to 18 GHz	200	\$380
0486A	3.95 to 5.85	1.5	100	\$400
J486A	5.30 to 8.20	1.5	100	\$400
H486A	7.05 to 10.0	1.5	100	\$480
X486A	8.20 to 12.4	1.5	100	\$295
M486A	10.0 to 15.0	1.5	100	\$400
P486A	12.4 to 18.0	1.5	100	\$315
K486A*	18.0 to 26.5	2.0	200	\$430
R486A*	26.5 to 40.0	2.0	200	\$450

\*Option 011, furnished with APC-7 RF connector

\*Circular flange adapters:

K-band (UG-425/U) HP 11515A

R-band (UG-381/U) HP 11516A

add \$25

\$110

\$110

## 8900B Peak power calibrator

The HP 8900B peak power calibrator provides a convenient means for measuring the peak RF power of pulses in the range from 50 to 2000 MHz. The power level is read out directly on the panel meter and is completely independent of repetition rate and pulse width (>0.25  $\mu$ sec).

## Specifications

### Radio frequency measurement characteristics

Frequency range: 50 to 2000 MHz.

RF power range: 10-200 mW peak full scale (may be readily increased through use of external attenuators or directional couplers).

RF power accuracy:  $\pm 1.5$  dB ( $\pm 0.6$  dB) with custom calibration curve furnished with instrument).

RF power precision: 0.1 dB.

RF pulse width: >0.25  $\mu$ s.

RF repetition rate: 1.5 MHz maximum.

RF Impedance: 50 ohms.

RF VSWR: <1.25.

### Monitor output

Level: >0.2 volt for 20 mW input (nominal).

Impedance: 150 ohms nominal.

Bandwidth: >7 MHz.

### Physical characteristics

Size: 156 H, 197 W, 279 mm D (6.1"  $\times$  7.75"  $\times$  11").

Weight: net, 4.5 kg (10 lb). Shipping, 5.9 kg (13 lb).

Power consumption: 105 to 125 or 210 to 250 volts, 50 to 60 Hz.

## 8477A Power meter calibrator

The 8477A Calibrator is specifically designed for use with the 432 Power Meter. It allows you to verify full-scale meter readings on all ranges, and meter tracking. Simply connect three cables between the power meter and calibrator; no charts or additional instruments are required.

## Specifications

Calibration points: outputs corresponding to meter readings of: 0.01, 0.03, 0.1, 0.3, 1.0, 2.0, 3.0, and 10 mW (for mount resistance switch settings of both 100 and 200 ohms).

Calibration uncertainty:  $\pm 0.2\%$  on the top five ranges, and  $\pm 0.5\%$  on the 0.01 and 0.03 mW ranges from +20° to +30°C.

RFI: meets all conditions specified in MIL-I-6181D.

Power: 115 or 230 V  $\pm 10\%$ , 50-400 Hz, approximately 2 W.

Weight: net, 2.0 kg (4.5 lb). Shipping, 2.9 kg (6.25 lb).

Size: 155 H, 130 W, 203 mm D (6.1"  $\times$  5.1"  $\times$  8").

## Ordering information

8900B Peak power calibrator

8477A Power meter calibrator

Price

\$950

\$550

# MICROWAVE TEST EQUIPMENT

Microwave measurements and products



## Microwave test equipment product line

Hewlett-Packard offers a complete line of microwave coaxial and waveguide measur-

ing equipment. Measuring systems can be assembled from this equipment to make accurate reflection and transmission measurements on other components such as filters, mixers, cables, etc.

The bulk of microwave measurements made in production test, maintenance, and calibration require amplitude information only. These are sometimes referred to as scalar measurements.

The tables to the left summarize HP capabilities in scalar microwave measurements. More detailed information is available in the following publications:

AN 183 Microwave Swept Measurement  
AN 196 Automated Measurements (436A)  
1977-78 Coaxial and Waveguide Catalog

Complimentary copies are available from HP offices or you can use the request card in the back of this catalog.

### HP impedance/SWR measuring techniques and capabilities

Measurement Technique	Coaxial Freq. Range	Waveguide Freq. Range	Typical Range	Remarks/Cost/Accuracy/Speed
Manual Slotted Line	500-4000 MHz 1-18 GHz	3.95-40 GHz (6 Bands)	30-35 dB	Lowest cost, high accuracy, slow, point-by-point
Swept Slotted Line	1.8-18 GHz	—	34 dB	Moderate cost, high accuracy, good speed, comprehensive
Reflectometer Square-Law	100-4000 MHz 2-18 GHz	3.95-40 GHz (6 Bands)	35-40 dB	Moderate cost, moderate accuracy, fast, comprehensive
Reflectometer RF-Substitution	100-4000 MHz 2-18 GHz	3.95-40 GHz (6 Bands)	50 dB	Moderate cost, high accuracy, fast, requires display storage
Bridge	1-110 MHz 40 MHz-18 GHz	—	40 dB	Multi-octave, good for coax, best for low SWR, 9 dB insertion loss
Computer network analyzed system	500 KHz-130 MHz 100 MHz-18 GHz	—	50-60 dB	Very expensive, highest accuracy, corrects for system errors

### HP insertion loss measuring techniques and capabilities

Measurement Technique	Coaxial Freq. Range	Waveguide Freq. Range	Typical Range	Remarks/Cost/Accuracy/Speed
Square-Law	10 MHz-18 GHz	2.6-40 GHz (7 Bands)	50 dB	Low cost, moderate accuracy, simple, fast
RF Substitution	10 MHz-18 GHz	2.6-40 GHz (7 Bands)	50-80 dB	Moderate cost, high accuracy, fast, requires display storage
IF Substitution	10 MHz-18 GHz	2.6-18 GHz (5 Bands)	30-120 dB	High cost, very high accuracy, best range, moderate speed
Desktop computer mini-system	100 MHz-4 GHz 10 MHz-18 GHz	—	40 dB	Moderate cost, very high accuracy, automated
Computer network analyzer system	50 KHz-1300 MHz 100 MHz-18 GHz	—	110 dB	Very expensive, highest accuracy, corrects for system errors



# MICROWAVE TEST EQUIPMENT



## Coaxial fixed attenuators

Models 8491A/B, 8492A, 8493A/B, 11581/2/3A

- Flat frequency response
- Low SWR
- Specifications traceable to NBS



8492A Opt 003



8491A Opt 003



8493A Opt 010



8491B Opt 010  
Calibration points



11581A

### 11581A, 11582A, 11583A attenuator sets

A set of four Hewlett-Packard attenuators, 3, 6, 10 and 20 dB are furnished in a handsome walnut accessory case. The 11581A set consists of 8491A attenuators. A set of 8491B attenuators is contained in the 11582A, while the 11583A is comprised of 8492A attenuators. In addition to the calibration stamping on the bodies of the attenuators, the set includes a calibration report. The calibration report is certified traceable to the National Bureau of Standards, and includes accuracy of both the attenuation and the reflection coefficients at selected frequencies.

These sets are ideal for calibration labs or where precise knowledge of attenuation and SWR is desired.

### 1977-78 Coaxial & Waveguide Catalog

And Microwave Measurement Handbook. 84 pages with over 350 measurement accessories. Use request card at back of this catalog.

### Ordering information

11581A 3, 6, 10, 20 dB 8491A set  
11582A 3, 6, 10, 20 dB 8491B set  
11583A 3, 6, 10, 20 dB 8492A set

Price  
\$290  
\$400  
\$710

### 8491A/B, 8492A, 8493A/B fixed attenuators

Hewlett-Packard coaxial fixed attenuators provide precision attenuation, flat frequency response, and low SWR over broad frequency ranges at low prices. Attenuators are available in nominal attenuations of 3-dB and 6-dB and also 10-dB increments from 10 dB to 60 dB. These attenuators are swept-frequency tested to insure meeting specifications at all frequencies. Calibration points are provided on a nameplate chart attached to each unit.

#### Ordering example:

When ordering, the connectors, frequency range, and attenuation value must be specified as shown in the example below.

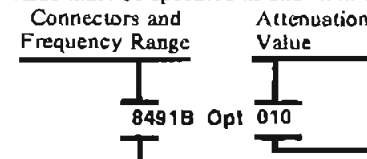

- 003: 3 dB
  - 006: 6 dB
  - 010: 10 dB
  - 020: 20 dB
  - 030: 30 dB
  - 040: 40 dB\*
  - 050: 50 dB\*
  - 060: 60 dB\*
- \*Not available for 8493A/B

- 1A: Type N (m,f), dc-12.4 GHz
- 1B: Type N (m,f), dc-18 GHz
- 2A: APC-7, dc-18 GHz
- 3A: SMA (m,f), dc-12.4 GHz
- 3B: SMA (m,f), dc-18 GHz

### 8491A/B, 8492A, 8493A/B specifications

Model	Frequency Range GHz	SWR Maximum	Maximum Input Power	Attenuation Accuracy								Connector	Price (Specify option)
				3 dB (Option 003)	6 dB (Option 006)	10 dB (Option 010)	20 dB (Option 020)	30 dB (Option 030)	40 dB (Option 040)	50 dB (Option 050)	60 dB (Option 060)		
8491A 3-30 dB	dc-12.4	1.2: dc-8 GHz 1.3: 8-12.4 GHz	2 W Av. 100 W Peak	±0.3 dB	±0.3 dB	±0.5 dB	±0.5 dB	±1 dB	—	—	—	N(m,f)	\$70
				—	—	—	—	—	±1.5 dB	±1.5 dB	±2 dB		\$95
8491B 3-30 dB	dc-18	1.2: dc-8 GHz 1.3: 8-12.4 GHz 1.5: 12.4-18 GHz	2 W Av. 100 W Peak	±0.3 dB	±0.3 dB ±0.4 dB: 12.4-18 GHz	±0.5 dB	±0.5 dB ±1.0 dB: 12.4-18 GHz	±1 dB	—	—	—	N(m,f)	\$80
				—	—	—	—	—	±1.5 dB	±1.5 dB	±2 dB		\$130
8492A 3-30 dB	dc-18	1.15: dc-8 GHz 1.25: dc-12.4 GHz 1.35: 12.4-18 GHz	2 W Av. 100 W Peak	±0.3 dB	±0.3 dB ±0.4 dB: 12.4-18 GHz	±0.5 dB	±0.5 dB ±1.0 dB: 12.4-18 GHz	±1 dB	—	—	—	APC-7	\$105
				—	—	—	—	—	±1.5 dB	±1.5 dB	±2 dB		\$200
8493A 3-20 dB	dc-12.4	1.2: dc-8 GHz 1.3: 8-12.4 GHz	2 W Av. 100 W Peak	±0.3 dB	±0.3 dB	±0.5 dB	±0.5 dB	—	—	—	—	SMA (m,f)	\$75
				—	—	—	—	±1 dB	—	—	—		\$80
8493B 3-20 dB	dc-18	1.2: dc-8 GHz 1.3: 8-12.4 GHz 1.5: 12.4-18 GHz	2 W Av. 100 W Peak	±0.3 dB	±0.3 dB ±0.4 dB: 12.4-18 GHz	±0.5 dB	±0.5 dB ±1.0 dB: 12.4-18 GHz	—	—	—	—	SMA (m,f)	\$90
				—	—	—	—	±1 dB	—	—	—		\$95

# MICROWAVE TEST EQUIPMENT

## Coaxial step attenuators

Models 355 series, 8494/5/6 series

- Flat frequency response
- Small, compact
- Manual and programmable



355C



355F



8495K



8495D

### 355C/D/E/F Manual and programmable step attenuators, dc to 1000 MHz

Precision attenuation from dc to 1000 MHz is available with these Hewlett-Packard attenuators. Models 355C/E provide 0 to 12 dB in 1-dB steps and models 355D/F provide 0 to 120 dB in 10-dB steps. All standard models are equipped with BNC connectors.

The attenuator sections are inserted and removed by cam actuated microswitches which keep lead lengths short. This novel system minimizes stray capacitances and inductances and extends the frequency limit of the 355 attenuators to 1000 MHz. In addition, the phase shift is kept at a minimum. The electrical length for the 355C/D is approximately 60 cm at 0 dB (no sections engaged). For each section engaged the electrical length decreases by approximately 2 cm.

For the 355E and 355F models, attenuation programming is done through a 7-pin connector. To insure protection of the user's transistor drivers against transients associated with the switching process, a protective diode is placed between each solenoid and the driver (Option 007).

### 8494A/B/G/H, 8495A/B/D/G/H/K, 8496A/B/G/H Manual and programmable step attenuators, dc to 26.5 GHz

This family of precision, microwave coaxial step attenuators represents the state-of-the-art in attenuator design. They offer outstanding performance at attractive prices. Three attenuation ranges are available: 0 to 11 dB in 1-dB steps (Model 8494), 0 to 70 dB in 10-dB steps (Model 8495) and 0 to 110 dB in 10-dB steps (Model 8496). There is a choice of three connectors Type N (f), SMA (f), and APC-7 (APC-3.5 on 8495D/K only). Manual and programmable versions are available as well as coverage of three frequency ranges (dc—4 GHz, dc—18 GHz, and dc—26.5 GHz).

Each attenuator consists of three or four attenuation sections connected in cascade. Each section uses a precision thin-film card with 10, 20, or 40 dB of attenuation (1, 2 or 4 dB for the 8494, a lossless transmission line, and a ganged pair of SPDT switches that connect the input and output to either the attenuation element or the lossless line.

Attenuator sections are inserted and removed by low-torque cam-actuated contacts. These contacts are gold-plated leaf-springs that ensure long life (over a million steps) and high repeatability (typically 0.03 dB). The G, H, & K programmable models offer the same high performance as the manual models with the addition of fast switching solenoids.

The 20 millisecond maximum switching time is a significant advantage for automatic testing and other applications where speed is of prime importance. Once switched, the solenoids are held in place by strong, permanent magnets able to withstand shocks over 10 G's.

Attenuation programming is done through a 12-pin connector. For ease of connection to the driving circuit, each attenuator is provided with a five-foot cable assembly that includes the mating connector. By using the HP 59306A Relay Actuator and a power supply as the driver mechanism, the attenuators are easily integrated into a Hewlett-Packard Interface Bus (HP-IB) automated system.

Equivalent versions of these attenuators, for incorporation in equipment (i.e., "OEM") are available under HP model numbers 33320, 33321, and 33322. See following page.

#### How to order the 8494/5/6 Series attenuators

To order, basic model number, suffix letter, and connector option must be specified:

#### Ordering example:

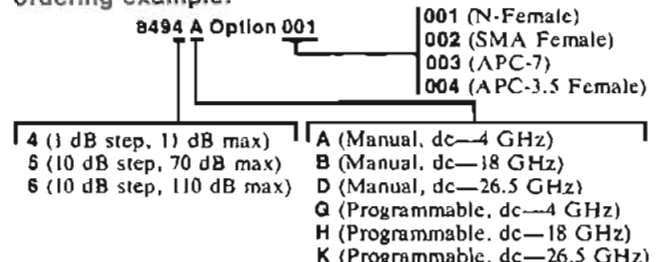

#### 1977-78 Coaxial & Waveguide Catalog

And Microwave Measurement Handbook, 84 pages with over 350 measurement accessories. Use request card at back of this catalog.



### 355 Series, 8494/5/6 series specifications

Model and (Switching Mode)	Frequency Range (GHz)	Incremental Attenuation (dB)	SWR Maximum (50 Ω Nominal)	Insertion Loss (0 dB Setting)	Attenuation Accuracy	Power Rating, Minimum LHA	Solenoid Voltage Speed Power	Dimensions, Shipping Weight	Connector Options Available	Price
355C (Manual)	dc—1	0—12 1 dB steps	1.2: dc—0.25 GHz 1.3: dc—0.5 GHz 1.5: dc—1.0 GHz	0.11 dB + 1.39 dB/GHz	±0.1 dB @ 1000 Hz ±0.25 dB: dc—0.5 GHz ±0.35 dB: dc—1.0 GHz	0.5 W avg 350 W peak 0.6 million steps	— 15—18 V ≤65 ms 3.0 W	152 × 76 × 67 mm (6 × 2.75 × 2.6 in) 1.4 kg (3 lb)	BNC (f) See Note 1	\$225 \$380
355E (Programmable)										
355D (Manual)	dc—1	0—120 10 dB steps	1.2: dc—0.25 GHz 1.3: dc—0.5 GHz 1.5: dc—1.0 GHz	0.11 dB + 1.39 dB/GHz	±0.3 dB @ 1000 Hz ±1.5 dB to 90 dB, and ±3 dB to 120 dB @ 1 GHz	0.5 W avg 350 W peak 0.6 million steps	— 15—18 V ≤65 ms 3.0 W	152 × 70 × 67 mm (6 × 2.75 × 2.6 in) 1.4 kg (3 lb)	BNC (f) See Note 1	\$225 \$380
355F (Programmable)										
8494A (Manual)	dc—4	0—11 1 dB Steps	1.5	0.6 dB + 0.09 dB/GHz	±0.2 dB: 1—2 dB ±0.3 dB: 3—6 dB ±0.4 dB: 7—10 dB ±0.5 dB: 11 dB	1 W avg 100 W peak 10 μs max. 1 million steps	— 20—30 V ≤20 ms 2.7 W	159 × 73 × 43 mm (6.2 × 2.9 × 1.7 in) 0.9 kg (2 lb)	001 002 003 See Note 2	\$450 \$715
8494C (Programmable)										
8494B (Manual)	dc—18	0—11 1 dB steps	1.5: dc—8 GHz 1.6: dc—12.4 GHz 1.9: dc—18 GHz	0.6 dB + 0.09 dB/GHz	dc—12.4 GHz ±0.3 dB: 1—2 dB ±0.4 dB: 3—4 dB ±0.5 dB: 5—6 dB ±0.6 dB: 7—10 dB ±0.7 dB: 11 dB dc—18 GHz ±0.7 dB: 1—5 dB ±0.8 dB: 6—9 dB ±0.9 dB: 10—11 dB	1 W avg 100 W peak 10 μs max. 1 million steps	— 20—30 V ≤20 ms 2.7 W	159 × 73 × 43 mm (6.2 × 2.9 × 1.7 in) 0.9 kg (2 lb)	001 002 003 See Note 2	\$595 \$835
8494H (Programmable)										
8495A (Manual)	dc—4	0—70 10 dB steps	1.3	0.4 dB + 0.07 dB/GHz	±1.6% % in dB from Atten. Setting	1 W avg 100 W peak 10 μs max. 1 million steps	— 20—30 V ≤20 ms 2.7 W	130 × 73 × 43 mm (5.1 × 2.9 × 1.7 in) 0.9 kg (2 lb)	001 002 003 See Note 2	\$325 \$580
8495C (Programmable)										
8495B (Manual)	dc—18	0—70 10 dB steps	1.35: dc—8 GHz 1.5: dc—12.4 GHz 1.7: dc—18 GHz	0.4 dB + 0.07 dB/GHz	±3%: dc—12.4 GHz ±4%: dc—18 GHz % in dB from Atten. Setting	1 W avg 100 W peak 10 μs max. 1 million steps	— 20—30 V ≤20 ms 2.7 W	130 × 73 × 43 mm (5.1 × 2.9 × 1.7 in) 0.9 kg (2 lb)	001 002 003 See Note 2	\$450 \$690
8495H (Programmable)										
8495D (Manual)	dc—26.5	0—70 10 dB steps	1.6: dc—12.4 GHz 1.9: 12.4—18 GHz 2.2: 18—26.5 GHz	0.5 dB + 0.13 dB/GHz	±3%: dc—12.4 GHz ±4%: dc—18 GHz ±7%: dc—26.5 GHz % in dB from Atten. Setting	1 W avg 100 W peak 10 μs max. 1 million steps	— 20—30 V ≤20 ms 2.7 W	159 × 52 × 43 mm (6.2 × 2.1 × 1.7 in) 0.9 kg (2 lb)	004 APC-3, 5 See Note 2	\$700 \$1080
8495K (Programmable)										
8496A (Manual)	dc—4	0—110 10 dB steps	1.5	0.5 dB + 0.09 dB/GHz	±1.6% % in dB from Atten. Setting	1 W avg 100 W peak 10 μs max. 1 million steps	— 20—30 V ≤20 ms 2.7 W	159 × 73 × 43 mm (6.2 × 2.9 × 1.7 in) 0.9 kg (2 lb)	001 002 003 See Note 2	\$450 \$715
8496C (Programmable)										
8496B (Manual)	dc—18	0—110 10 dB steps	1.5: dc—8 GHz 1.6: dc—12.4 GHz 1.9: dc—18 GHz	0.6 dB + 0.09 dB/GHz	±3%: dc—12.4 GHz ±4%: dc—18 GHz % in dB from Atten. Setting	1 W avg 100 W peak 10 μs max. 1 million steps	— 20—30 V ≤20 ms 2.7 W	159 × 73 × 43 mm (6.2 × 2.9 × 1.7 in) 0.9 kg (2 lb)	001 002 003 See Note 2	\$595 \$835
8496H (Programmable)										

Note 1: 355C/D/E/F connector options (BNC (f) standard)  
 Option 001 (N) add \$25  
 Option 005 (TNC(f)) add \$10  
 Option 007 Transistor protection add \$50

Note 2: 8494/5/6 models must specify connector option. See ordering example on adjacent page.  
 Option 001 (N) N/C  
 Option 002 (MAT) N/C  
 Option 003 (APC-7) add \$50  
 Option 004 APC-3 5 (8495D/K only) N/C

# MICROWAVE TEST EQUIPMENT

## Variable attenuators and OEM step attenuators

### Models 375 series, 382 series, 393A, 394A, 33300 series, 33320 series

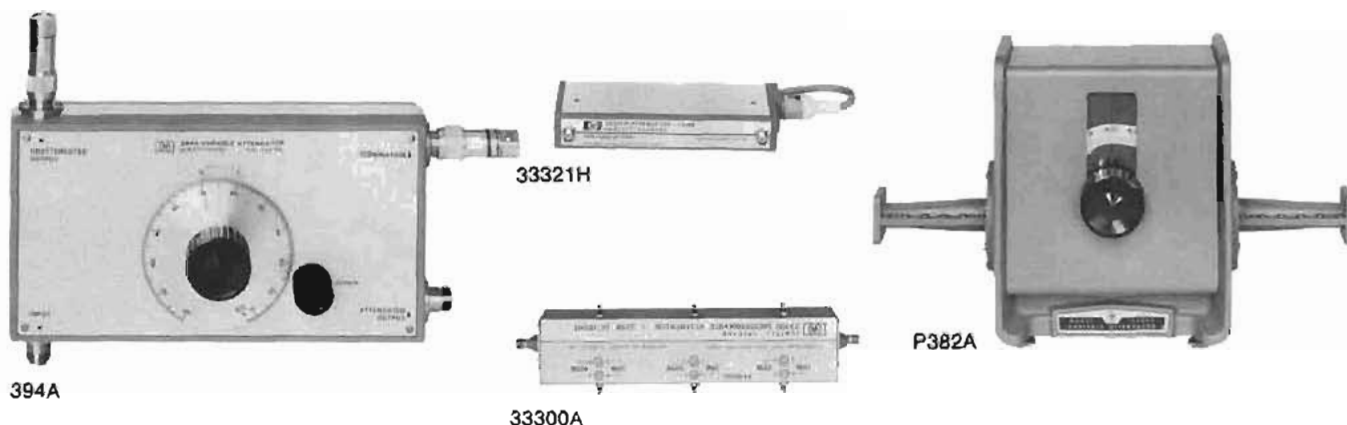

### 393A, 394A Coaxial variable attenuator 33300 series, 33320 series OEM step attenuators

Models 393A and 394A are high power, variable coaxial attenuators for the 0.5 to 2 GHz range. They use the principle of a variable directional coupler to achieve up to 120 dB range with 200 watt power handling capability.

33300 series step attenuators provide wideband programmable signal level control. Magnetic latching solenoids switch individual attenuating elements into and out of contact with a 50-ohm transmission line. C/D models have separate "indicator contacts" and A/B models have "no indicator contacts." Three digit connector options (0XY) must be specified. X is the input connector, Y is output connector, first digit is always 0. See table for option numbers.

33320 series step attenuators are compact versions of the 8494/5/6 bench attenuators on the previous page and are configured for de-

signing into microwave systems and instruments. Manual or electrically-activated versions are available. The manual models take less than 1.5 square inches of panel space. OEM quantity discounts are available for 33300 and 33320 series.

### 375 Series, 382 series waveguide attenuators

Operation of these 382 series rotary-vane, continuously variable attenuators depends on a mathematical law, rather than on the resistivity of the attenuator card. They are direct-reading and provide accurate attenuation from 0 to 50 dB (60 dB for S382C) regardless of temperature and humidity.

375A series variable flap attenuators consist of a short slotted section of waveguide in which a matched resistive strip is inserted.

1977-78 Coaxial and Waveguide Catalog  
And Microwave measurement handbook. 84 pages with over 350 measurement accessories. Use request card at back of this catalog.

### 393A, 394A, 33300 series, 33320 series specifications

Model	Freq Range (GHz)	Mode	Range	Remarks	Price
393A	0.5-1	Manual	5-120 dB Variable	200 W average	\$1320
394A	1-2	Manual	6-120 dB Variable	200 W average	\$1250
33300 A/B C/D	DC-18	Prog.	0-70 dB 10 dB steps	A/B models 12-15 V	\$ 825 \$ 860
33301 A/B C/D	DC-18	Prog.	0-42 dB 6 dB steps	B/D models 24-30 V	\$ 825 \$ 860
33304 A/B C/D	DC-18	Prog.	0-11 dB 1 dB steps	Connector options available:	\$1100 \$1140
33305 A/B C/D	DC-18	Prog.	0-110 dB 10 dB steps	0: N(f), 1: Nm 2: 7mm(f), 3: 7mm(m) 5: SMA(f), 6: SMA(m)	\$1100 \$1140
33320A B	DC-4 DC-18	Manual	1-11 dB 1 dB steps	Specifications identical to 8495 series previous page	\$ 440 \$ 585
33320G H	DC-4 DC-18	Prog.		SMA(f) connectors	\$ 705 \$ 825
33321A B D	DC-4 DC-18 DC-26.5	Manual	0-70 dB 10 dB steps	Specifications identical to 8495 series previous page.	\$ 315 \$ 440 \$ 680
33321G H K	DC-4 DC-18 DC-26.5	Prog.		SMA (f) connectors (APC-3.5 on 38K)	\$ 580 \$ 680 \$1050
33322A B	DC-4 DC-18	Manual	0-110 dB 10 dB steps	Specifications identical to 8496 series previous page	\$ 440 \$ 585
33322G H	DC-4 DC-18	Prog.		SMA (f) connectors	\$ 705 \$ 825

### 375A Series 382 series specifications

Model	Frequency Range (GHz)	Accuracy	Attenuation Range (dB)	Waveguide & Equivalent Flange	Price
S382C	2.5-3.85	$\pm 1\%$ of reading or 0.1 dB whichever greater $\pm 2\%$ above 50 dB	0-60	WR 284 UG-584/U	\$2600
G382A	3.95-5.85	$\pm 2\%$ of reading or 0.1 dB whichever greater	0-50	WR 187 UG-407/U	\$1000
J382A	5.3-8.2	$\pm 2\%$ of reading or 0.1 dB whichever greater	0-50	WR 137 UG-441/U	\$1550
H382A	7.05-10.0	$\pm 2\%$ of reading or 0.1 dB whichever greater	0-50	WR 112 UG-138/U	\$1550
X382A	8.2-12.4	$\pm 2\%$ of reading or 0.1 dB whichever greater	0-50	WR 90 UG-135/U	\$ 845
P382A	12.4-18.0	$\pm 2\%$ of reading or 0.1 dB whichever greater	0-50	WR 62 UG-119/U	\$ 850
K382A	18.0-26.5	$\pm 2\%$ of reading or 0.1 dB whichever greater	0-50	WR 42 UG-597/U	\$1950
R382A	26.5-40.0	$\pm 2\%$ of reading or 0.1 dB whichever greater	0-50	WR 28 UG-599/U	\$1500
X375A	8.2-12.4	$\pm 1$ dB, $\pm 2$ dB	0-20	WR 90 UG-39/U	\$ 395
P375A	12.4-18.0	$\pm 1$ dB, $\pm 2$ dB	0-20	WR 62 UG-419/U	\$ 680

- Precision reflection measurements 0.5 to 18 GHz

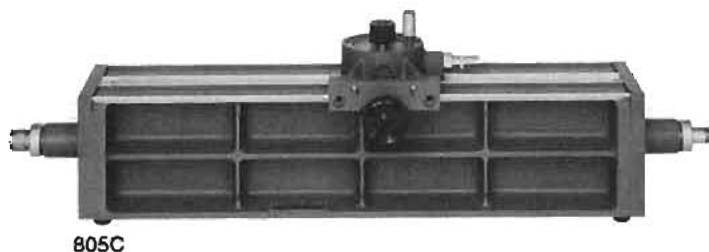

805C



442B

447B

448B

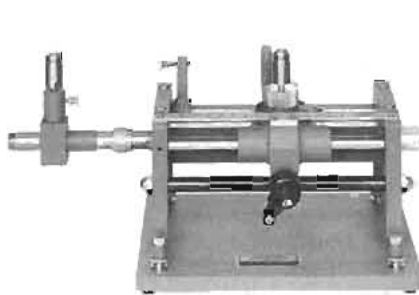

817B

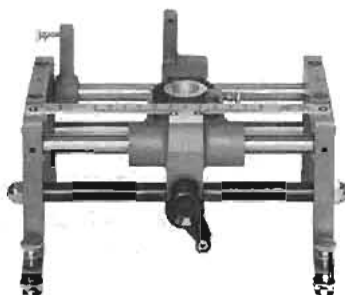

809C



X810B



816A

### 805C Coaxial slotted line system, 0.5 to 4 GHz

Model 805C is a complete slotted line system, employing 2 parallel ground planes and a rigid center conductor. This configuration has negligible slot radiation and is less sensitive to probe depth. The probe is tunable from 500 to 4000 MHz.

### 817B coaxial swept slotted line system, 1.8 to 18 GHz

817B fully tested system provides comprehensive swept frequency reflection data with the accuracy inherent in slotted lines. 817B consists of the 816A line, 809C carriage, and the 448B sweep adapter for use with model 11664A detectors and the 8755 frequency response test set.

#### 805C, 817B specifications

Model	Frequency Range (GHz)	SWR Residual	Connectors	Remarks	Price
805C	0.5-4.0	1.04	N(m) N(f)	21512A N(m) short, 11511A N(f) short furnished	\$1650
817B	1.8-18.0	1.06	APC-7 N(f)	11512A N(m) short, 11565A APC-7 short furnished	\$1675
817B Options	001: APC-7 connectors on 448B probes				add \$55
	022: N(m) and N(f) connectors on 816A slotted section				less \$15

#### 810B Series, 816A specifications

Model	Frequency Range (GHz)	SWR Residual	W/G—Coax Flange/Conn.	Remarks	Price
J810B	5.3-8.2	1.01	WR 137 UG-441/U	Use with 809C Carriage, 444A or 442B + 440A Probes	\$575
H810B	7.05-10.0	1.01	WR 112 UG-138/U		\$425
X810B	8.2-12.4	1.01	WR 90 UG-135/U		\$550
P810B	12.4-18.0	1.01	WR 62 UG-419/U	809C carriage 444A Probe	\$425
816A	1.8-18.0	1.02-1.04	Coaxial APC-7 N(f)	809C Carriage 447B Probe or 448B Sweep Adapter	\$600
Opt 011			Both APC-7		add \$25
Opt 022			N(m), N(f)		11512A N(m) Short 1156A APC-7 Short furnished

### 440A, 442B, 444A, 447B, 448B Probes/adapters

440A is a tunable mount (1N21 crystal not supplied) for 2.4-12.4 GHz, to be used on the 442 broadband probe. 442B fits the 809C carriage and provides sampled RF on a Type N jack.

444A is an untuned probe for 2.6-18 GHz for use with the 809C carriage or other 3/4 inch (19 mm) mounting hole and the 810B waveguide sections. 447B is similarly used with the 809C and the 816A coaxial section for 1.8 to 18 GHz.

448B sweep adapter probe has Type N outputs for use with the 11664A detectors of the 8755 test set.

#### 1977-78 Coaxial & Waveguide Catalog

And Microwave Measurement Handbook. 84 pages with over 350 measurement accessories. Use request card at back of this catalog.

#### Ordering information

440A Detector mount	\$225
442B RF probe	\$150
444A Untuned probe	\$140
447B Detector probe	\$215
448B Slotted line sweep adapter probes 1.8-18 GHz	\$475
809C Slotted line carriage	\$600

### 809C Slotted line carriage

The 809C Carriage operates with the 816A Coaxial slotted section and four 810B Waveguide slotted sections. It is compatible with the 442B, 444A, 447B, and 448B coaxial probes. The carriage has a centimeter scale with a vernier reading to 0.1 mm, and provision is made also for mounting a dial gauge if more accurate probe position reading is required.

### 810B Series, 816A slotted sections

810B waveguide and 816A coaxial slotted sections are used with the 809C carriage. 810B waveguide sections accept the 444A untuned probe or the 442B probe plus 440A tuned detector. 816A coaxial line accepts the 447B probe or the 448B adapter sets.

# MICROWAVE TEST EQUIPMENT

## Coaxial single and dual-directional couplers

Models 770 series, 790 series, 11691D, 11692D

- Broadband coverage
- High directivity
- Close tracking



11692D

### 779D Directional coupler

The HP 779D spans more than two octaves from 1.7 to 12.4 GHz with excellent directivity. With increased coupling factor (typically 24 dB), the 779D is useful down to 500 MHz. Upper frequency usefulness extends to 18 GHz with directivity reduced to about 15 dB. Various connector options are available.

### 790 Series directional couplers (octave bands)

The 790 directional couplers are ultra-flat, high directivity couplers which are ideal for power-monitoring applications in coaxial systems. Output coupling (ratio of output power from main and auxiliary arms) is specified rather than coupling factor. Thus, no correction factor is required to account for insertion losses in the main arm.

### 11691D Directional coupler

The 11691D is an ultra-wide-band single-directional coupler covering 2 to 18 GHz with high directivity. It is useful as a power monitoring or leveling coupler or used for making reflection measurements. Couplers are preferred over broadband bridges in reflectometer applications in situations where the power level of the source is limited, or where simultaneous measurement of return loss and insertion loss is desired.

### 779D, 790 Series, 11691D specifications

Model	Frequency Range (GHz)	Mean Output Coupling (dB)	Output Coupling Variation (dB)	Minimum Directivity (dB)	Equivalent <sup>1</sup> Source Match	Price
779D	1.7-12.4	20 ± 0.5	±0.75	1.7-4 GHz: 30 4-12.4 GHz: 26	1.2	\$650
796D	0.96-2.11	20 ± 0.5	±0.2	30	1.13	\$375
797D	1.9-4.1	20 ± 0.5	±0.2	26	1.16	\$375
798C	3.7-8.3	10 ± 0.3	±0.3	20	1.25	\$470
11691D	2-18	22 Nominal	±1.0	2-8 GHz: 30 dB 8-18 GHz: 26 dB	1.2	\$925
<b>796D-798C Standard connectors</b> Primary line: N(f), N(m) Auxiliary Arm: N(f)						
<b>779D Standard connectors</b> Primary Line: N(f) input, N(f) output, Auxiliary Arm: N(f) Option 010: Primary Line N(f) input, N(m) output Other Options: APC-7 on any or all ports N/C Contact HP						
<b>11691D Standard connectors</b> Primary line: APC-7, APC-7, Auxiliary Arm: N(f) Opt 001: All N(f) Opt 005: All APC-7 less \$50 add \$25						
<sup>1</sup> Apparent SWR at the output port of a coupler when used in a closed-loop leveling system.						



11691D



774D

### 774D-777D Dual-directional couplers (octave bands)

The economical 774D-777D couplers cover frequency spreads of more than two-to-one, each centered on one of the important VHF/UHF bands. With their high directivity, and a mean coupling accuracy of ±0.5 dB these couplers are ideal for reflectometer applications. Furthermore, the close tracking of the auxiliary arms makes these couplers particularly useful for reflectometers driven by externally leveled sweep oscillators such as the HP 8690B and 8620A/B. Power ratings are 50 W average, 500 W peak.

### 778D, 11692D Dual-directional couplers (multi-octave bands)

These extra wide frequency couplers are ideal for swept-frequency reflectometer testing of broadband coaxial components. 778D covers 100 MHz to 2 GHz and 11692D covers 2 to 18 GHz. High directivity and close tracking of the auxiliary arms are featured. Various connector options are available as shown. Both couplers handle 50 W average power. Peak power; 778D, 500W; 11692D, 250 W.

### 774D, 775D, 776D, 777D, 778D, 11692D Specifications

Model	Frequency Range (GHz)	Nominal Coupling (dB)	Maximum Coupling Variation (dB)	Minimum Directivity (dB)	SWR Primary Line Maximum (50 W Nom.)	Price
774D	0.215-0.450	20	±1	40	1.15	\$498
775D <sup>1</sup>	0.450-0.940	20	±1	40	1.15	\$515
776D <sup>1</sup>	0.940-1.90	20	±1	40	1.15	\$485
777D	1.90-4.0	20	±0.4	30	1.2	\$575
778D	0.10-2.0	20	±1	0.1-1 GHz: 36 <sup>2</sup> 1-2 GHz: 32	1.1	\$590
11692D	2.0-18.0	22	±1 Incident to test port	2-8 GHz: 30 8-18 GHz: 26 <sup>2</sup>	2-12.4 GHz: 1.3 12.4-18 GHz: 1.4	\$1600
<b>774D-777D Standard connectors</b> Primary Line: N(m), N(f) Auxiliary Arm: N(f), N(f)						
<b>778D Standard connectors</b> Primary Line: N(m), N(f); Auxiliary Arms: N(f), N(f) Option 011: Primary Line, APC-7, N(f) add \$25 Option 012: Primary Line, N(m), N(f) N/C						
<b>11692D Standard connectors</b> Primary line: N(f), APC-7; Auxiliary Arms: N(f), N(f) Opt 001: Primary Line, N(f), N(f) less \$15 Opt 002: Primary Line, N(f), N(m) less \$15						
<sup>1</sup> Maximum auxiliary arm tracking: 0.3 dB for 776D; 0.5 dB for 777D <sup>2</sup> ±30 dB, 0.1 to 2 GHz, input port. <sup>3</sup> ±24 dB with Type N connector on the test port						

# MICROWAVE TEST EQUIPMENT

## Coaxial directional detectors and waveguide directional couplers

Models 780 series, 752 series



- Flat frequency response
- Low equivalent source match
- High directivity to >40 dB

- Low SWR
- Coverage to 40 GHz



786D

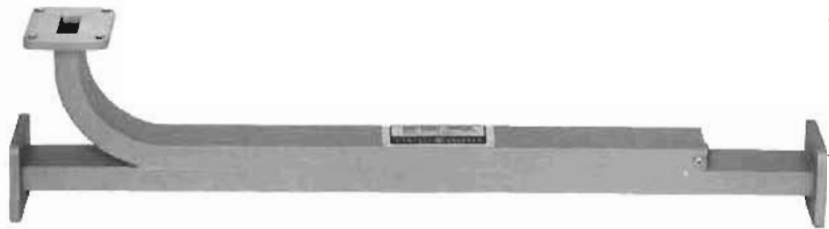

X752A

### 780 Series directional detectors

The 780 series detectors are directional couplers with built-in crystal detectors. The couplers have flat frequency response and good directivity, while the detectors have good frequency response plus high sensitivity. The configuration of the directional detector reduces the number of ambiguities over the standard system of separate coupler and detector and makes possible tighter correlation between main-arm power and detected signal. The directional detector is well suited for sweep oscillator leveling and can also be used to monitor power with a voltmeter or oscilloscope.

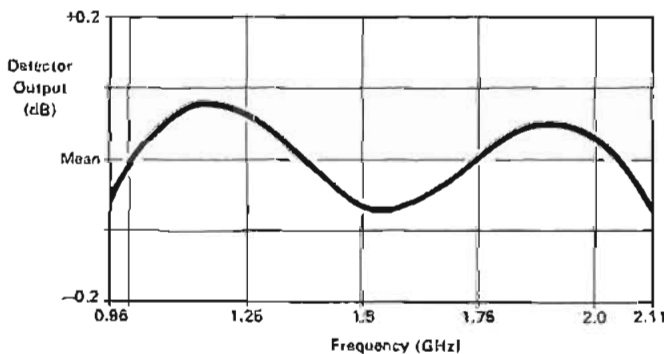

Figure 1. Typical 786D Frequency Response.

### 780 Series specifications

Model	Frequency Range (GHz)	Frequency Response <sup>1</sup>	Equivalent <sup>2</sup> Source Match	Price
786D	0.96-2.11	±0.2	1.13	\$480
787D	1.9-4.1	±0.3	1.16	\$480
788C	3.7-8.3	±0.3	1.25	\$805
789C	8-12.4	±0.5	1.25	\$725

<sup>1</sup> Includes coupler and detector variation with frequency as read on a meter calibrated for square-law detectors (e.g., HP 415E).

<sup>2</sup> Apparent SWR at the output port of the directional detector when used in a closed-loop leveling system.

### Standard connectors

Output: All N (f)

Input: 786D-788C, N (m), 789, N (f)

### 752 Series waveguide directional couplers

The HP 752 Series couplers are specified to meet a wide variety of microwave applications. Every coupler has a minimum directivity of 40 dB over its entire frequency range. Each coupler is swept-frequency tested to ensure that the main guide SWR and directivity specifications are accurate. Performance characteristics are unaffected by humidity, temperature, and time, making these units especially useful in microwave "standards" measurements.

The 752 couplers are an essential part of many waveguide measurement systems. Attenuation measurements, reflectometer setups, power measurements, source leveling and network analysis are just a few areas in which these couplers are used.

### 752 Series specifications

Model	Frequency Range (GHz)	Nominal Coupling (dB)	Mean Coupling Accuracy (dB)	Maximum Coupling Variation (dB)	Minimum Directivity (dB)	Waveguide & Flange	Price
J752A	5.85-8.2	3	±0.4	±0.5	40	WR137 UG-441/U	\$760
J752C	5.85-8.2	10	±0.4	±0.5	40		\$760
J752D	5.85-8.2	20	±0.4	±0.5	40		\$760
H752A	7.05-10.0	3	±0.4	±0.5	40	WR112 UG-138/U	\$520
H752C	7.05-10.0	10	±0.4	±0.5	40		\$520
H752D	7.05-10.0	20	±0.4	±0.5	40		\$520
X752A	8.2-12.4	3	±0.4	±0.5	40	WR90 UG-135/U	\$380
X752C	8.2-12.4	10	±0.4	±0.5	40		\$390
X752D	8.2-12.4	20	±0.4	±0.5	40		\$390
F752A	12.4-18.0	3	±0.4	±0.5	40	WR62 UG-419/U	\$350
P752C	12.4-18.0	10	±0.4	±0.5	40		\$350
P752D	12.4-18.0	20	±0.4	±0.5	40		\$350
K752A	18.0-26.5	3	±0.7	±0.5	40	WR42 UG-595/U	\$470
K752C	18.0-26.5	10	±0.7	±0.5	40		\$470
K752D	18.0-26.5	20	±0.7	±0.5	40		\$470
R752A	26.5-40.0	3	±0.7	±0.5	40	WR28 UG-599/U	\$600
R752C	26.5-40.0	10	±0.7	±0.5	40		\$500
R752D	26.5-40.0	20	±0.7	±0.6	40		\$500

# MICROWAVE TEST EQUIPMENT

## Coaxial crystal detectors

Models 423A/B, 8470A/B, 8471A, 8472A, 8473B/C, 33330B/C

- Flat frequency response
- High burnout protection

- Low SWR
- Field replaceable detector elements



33330B



8470B Opt 012



423A



8470A



423B



8470B



8472A



8471A

### 423B, 8470B, 8473B/C, 33330B/C Low Barrier Schottky (LBS) Detectors

The low-barrier Schottky (LBS) detectors are a state-of-the-art addition to the HP family of high performance detectors. Various models provide coverage to 12.4, 18, and 26.5 GHz and input connectors are Type N, APC-7, or APC-3.5 depending on frequency range. Output connector is BNC (f) except for the 33330B/C (SMC).

Matched pairs (Opt 001), square law load (Opt 002), and positive polarity output (Opt 003) are available for most models.

### 423A, 8470A, 8471A, 8472A point-contact detectors

These point-contact detectors have been widely used for many years and provide high performance at an economical price. The 8470A, 8470A Opt 012, and 8472A provide APC-7, Type N, and SMA connector versions to 18 GHz. Matched pairs are available for applications requiring close detector tracking, and all but the 8472A can be supplied with video loads for optimum conformance to square law.

1977-78 Coaxial & Waveguide Catalog

And Microwave Measurement Handbook, 84 pages with over 350 measurement accessories. Use request card at back of this catalog.

### Coaxial crystal detector specifications

Model	Frequency Range (GHz)	Frequency Response (dB)	SWR Maximum (50Ω Nom.)	Low Level Sensitivity	Maximum Input (Peak or Average)	Short-Term Maximum Input (< 1 min.)	Opt 001 Matched Pair (order 2 units for each pair)	Options Available	Input Connector	Price
423B	0.01-12.4 LBS	±0.2/octave to 8 GHz ±0.3 overall	<1.15 to 4 GHz <1.3 to 12.4 GHz	>0.5 mV/ μW	200 mW	1 watt	±0.2 dB to 12.4 GHz	001 002 003	N (m)	\$190
423A	0.01-12.4 Point Contact	±0.2/octave to 8 GHz ±0.5 overall	<1.2 to 4.5 GHz <1.35 to 7 GHz 1.5 to 12.4 GHz	>0.4 mV/ μW	100 mW	0.1 watt	±0.2 dB to 8 GHz ±0.3 dB to 12.4 GHz	001 002 003	N (m)	\$155
8470B	0.01-18.0 LBS	±0.2/octave to 8 GHz ±0.3 to 12.4 GHz ±0.6 to 18 GHz	<1.15 to 4 GHz <1.3 to 15 GHz <1.4 to 18 GHz	>0.5 mV/ μW	200 mW	1 watt	±0.2 dB to 12.4 GHz ±0.3 dB to 18 GHz	001 002 003	APC-7	\$230
8470B Opt 012									N (m)	\$215
8470A	0.01-18.0 Point Contact	±0.2/octave to 8 GHz ±0.5 to 12.4 GHz ±1.0 to 18 GHz	<1.2 to 4.5 GHz <1.35 to 7 GHz <1.5 to 12.4 GHz <1.7 to 18 GHz	>0.4 mV/ μW	100 mW	0.1 watt	±0.2 dB to 8 GHz ±0.3 dB to 12.4 GHz ±0.6 dB to 18 GHz	001 002 003	APC-7	\$195
8470A Opt 012									N (m)	\$180
8473B	0.01-18.0 LBS	±0.2 dB/octave to 8 GHz ±0.3 dB to 12.4 GHz ±0.6 dB to 18 GHz	<1.2 to 12.4 GHz <1.5 to 18 GHz	>0.5 mV/ μW	200 mW	1 watt	±0.2 dB to 12.4 GHz ±0.3 dB to 18 GHz ±0.5 dB to 26.5 GHz	001 003	APC-3.5 (m)	\$235
8473C	0.01-26.5 LBS	±0.6 dB to 20 GHz ±1.5 dB w/a ±3.5 dB slope, 20 to 26.5 GHz	<1.2 to 4 GHz <1.5 to 18 GHz <2.2 to 26.5 GHz	>0.5 mV/μW to 18 GHz >0.18 mV/μW to 26.5 GHz	200 mW	1 watt	±0.2 dB to 12.4 GHz ±0.3 dB to 18 GHz ±0.5 dB to 26.5 GHz	001 003	APC-3.5 (m)	\$275
8472A	0.01-18.0 Point Contact	±0.2/octave to 8 GHz ±0.5 to 12.4 GHz ±1.0 to 18 GHz	<1.2 to 4.5 GHz <1.35 to 7 GHz <1.5 to 12.4 GHz <1.7 to 18 GHz	>0.4 mV/ μW	100 mW	0.1 watt	±0.2 dB to 8 GHz ±0.3 dB to 12.4 GHz ±0.6 dB to 18 GHz	001 003	SMA (m)	\$180
33330B	0.01-18.0 LBS	±0.6 dB	<1.5	>0.5 mV/ μW	200 mW	1 watt	±0.3 dB	001 003	APC-3.5 (m)	\$205
33330C	0.1-26.5 LBS	±0.6 dB to 20 GHz ±1.5 dB with ±3.5 dB slope 20 to 26.5 GHz	<1.5 to 18 GHz <2.2 to 26.5 GHz	>0.5 mV/μW to 18 GHz Degrades to 0.18 mV/μW at 26.5 GHz	200 mW	1 watt	±0.3 dB to 18 GHz ±0.5 dB to 26.5 GHz	001 003	APC-3.5 (m)	\$200
8471A	100 kHz-1.2 GHz Point Contact	±0.6 dB (typical) ±0.1/100 MHz	1.3 (typical) 50Ω	>0.35 mV/ μW	3 V rms	3 V rms	No	004 005 006	BNC (m)	\$70

#### Options

All applicable models:

001: matched pair

002: square law load

Models 423A/B, 8470A/B, 8472A

003: positive output

#### Price

add \$20/unit

add \$20/unit

N/C

Models 8473B/C, 33330B/C

003: positive output

Model 8471A

004: positive output

005: 75 ohm negative output

006: 75 ohm positive output

add \$30

N/C

add \$10

add \$10



K422A



J424A



H532A



537A

### 422 Series, 424 series crystal detectors

The 422A and 424A family of crystal detectors combine high sensitivity with flat frequency response and low SWR to provide waveguide band coverage from 3.95 to 40 GHz. They deliver between 0.3 and 0.4 mV/ $\mu$ W output at low level and handle 100 mW peak input. SWR ranges from 1.35 at S-band to 3 at R-band.

For reflectometer applications in which both flat frequency response and square-law characteristics are important, these models can be supplied as matched pairs (Option 001) and also with an optimum square-law load (Option 002).

### 532 Series, 536A, 537A frequency meters

These direct-reading frequency meters measure frequencies from 5.30 to 40 GHz in waveguide and from 960 MHz to 12.4 GHz in coax quickly and accurately. Their long scale length and numerous calibration marks provide high resolution which is particularly useful when measuring frequency differences or small frequency changes. Frequency is read directly in GHz so interpolation or charts are not required.

The instruments comprise a special transmission section with a high-Q resonant cavity which is turned by a choke plunger. A 1-dB or greater dip in output indicates resonance; virtually full power is transmitted off resonance. Overall accuracy of each frequency meter includes allowance for 0 to 100 percent relative humidity and temperature variation from 13 to 33°C. Except for the J532A, there are no spurious modes or resonances.

### 422 Series, 424 series waveguide crystal detector specifications

Model	Frequency Range (GHz)	Frequency Response (dB)	Option 001 Matched Pair Tracking (dB)	Option 003 Positive Output	Waveguide & Equivalent Flange	Price
G424A	3.95-3.75	$\pm 0.2$	$\pm 0.2$ dB	Yes	WR187 UG-407/U	\$250
J424A	5.2-8.2	$\pm 0.2$	$\pm 0.2$ dB	Yes	WR137 UG-441/U	\$250
H424A	7.05-10.0	$\pm 0.2$	$\pm 0.2$ dB	Yes	WR112 UG-138/U	\$350
X424A	8.2-12.4	$\pm 0.3$	$\pm 0.3$ dB	Yes	WR90 UG-135/U	\$180
M424A	30.0-15.0	$\pm 0.5$	$\pm 0.5$ dB	Yes	WR75 Cover	\$300
P424A	12.4-18.0	$\pm 0.5$	$\pm 0.5$ dB	Yes	WR62 UG-419/U	\$220
K422A	18.0-26.5	$\pm 2$	$\pm 1$ dB	No	WR42 UG-595/U	\$875
R422A	26.5-40.0	$\pm 2$	$\pm 1$ dB	No	WR28 UG-599/U	\$580
All Models—Option 001 Matched Pair						Add \$20/Unit
All Models—Option 002 Optimum Square-Law Load						Add \$20/Unit
Not All Models—Option 003 Positive Output						N/C

### 1977-78 Coaxial & Waveguide Catalog

And Microwave Measurement Handbook. 84 pages with over 350 measurement accessories. Use request card at back of this catalog.

### 532 Series, 536A and 537A specifications

Model	Frequency Range (GHz)	Overall Accuracy (%)	Calibration Increment (MHz)	W/S-Coax Equivalent Flange (Connector)	Price
536A	0.96-4.20	0.22-0.96 to 1 GHz 0.17-1 to 4.2 GHz	2	Coax (Type N (f))	\$350
537A	3.7-12.4	0.170	10	Coax (Type N (f))	\$690
J532A	5.30-8.20	0.065	2	WR137 UG-441/U	\$1250
H532A	7.05-10.0	0.075	2	WR112 UG-138/U	\$1250
X532B	8.20-12.4	0.080	5	WR90 UG-135/U	\$645
P532A	12.4-18.0	0.100	5	WR62 UG-419/U	\$625
K532A	18.0-26.5	0.110	10	WR42 UG-595/U	\$875
R532A	26.5-40.0	0.120	10	WR28 UG-599/U	\$850

# MICROWAVE TEST EQUIPMENT

## Coaxial and waveguide terminations

Models 905, 907-911, 914, 920, 930

- Precision loads and shorts for measurements to 40 GHz
- New 26.5 GHz coaxial sliding load



### 905A, 907A, 911A, 911C Coaxial sliding loads

The 905A, 907A and 911A are movable, low reflection 50Ω, loads for precision measurements. The 905A and 907A are supplied with three interchangeable connectors, N-male, N-female and APC-7. The 911A is supplied with SMA male and female.

The 911C is a new sliding load designed for 3.5 mm coaxial transmission lines and uses the new APC-3.5 connector. This permits mode-free operation to 26.5 GHz. The 911C is furnished with interchangeable male and female connectors in a carrying case.

### 908A, 909A Coaxial fixed terminations

The 908A and 909A terminations are low-reflection loads for terminating 50Ω coaxial systems in their characteristic impedance.

### 905A, 907A, 911A, 911C specifications

HP Model	Frequency range (GHz)	Load SWR	Power rating	Length in. (mm)	Shipping weight	Price
905A	1.8-18	1.05	1 W avg. 5 kW pk	17.25 (440)	3 lb (1.4 kg)	\$385
907A	1-18	1.1, 1-1.5 GHz; 1.05, 1.5-18 GHz	1 W avg. 5 kW pk	30.62 (778)	9 lb (4.1 kg)	\$750
911A	2-18	1.1, 2-4 GHz; 1.05, 4-18 GHz	1 W avg. 5 kW pk	14.87 (380)	3 lb (1.4 kg)	\$385
911C	2-26.5	1.21, 2-10 GHz; 1.07, 10-26.5 GHz	1 W avg. 5 kW pk	10.5 (266)	3.6 lb (1.7 kg)	\$720

### 908A, 909A specifications

HP Model	Frequency Range (GHz)	Impedance	SWR	Power Rating	Connector	Price
908A	dc-4	50 ohms	1.05	1/2 W avg. 1 kW pk	N male	\$50
909A	dc-18	50 ohms	1.05, 0-4 GHz; 1.1, 4-12.4 GHz; 1.25, 12.4-18 GHz	2 W avg. 300 W pk	APC-7	\$105
909A Option 012 and Option 013	dc-18	50 ohms	1.05, 0-4 GHz; 1.11, 4-12.4 GHz; 1.3, 12.4-18 GHz	2 W avg. 300 W pk	Opt. 012 N male Opt. 013 N female	Subtract \$15

### 11511A, 11512A, 11565A Coaxial shorts

These shorts are used for establishing measurement planes for known reflection phase and magnitude in 50Ω and 75Ω coaxial systems for various connectors.

### 1977-78 Coaxial & Waveguide Catalog

And Microwave Measurement Handbook. 84 pages with over 350 measurement accessories. Use request card at back of this catalog.

### Ordering Information

11511A N-female short (50 ohm)	\$20
1250-1531 N-female short (75 ohm)	\$15
11512A N-male short (50 ohm)	\$15
1250-1530 N-male short (75 ohm)	\$20
11565A APC-7 short (50 ohm)	\$50
0960-0054 SMA-female short (50 ohm)	\$10
0960-0055 SMA-male short (50 ohm)	\$10

### 910A/B, 914A Waveguide fixed and movable terminations

The 910A/B are fixed terminations for waveguide systems. The 914A/B are similar to the 910A/B, except that its absorptive element is movable and a lockable plunger controls the position of the element.

### 910A/B, 914A/B specifications

Model	Frequency Range (GHz)	SWR	Power Rating	Type	Waveguide Size (EIA)	Price
J910A	5.3-8.2	1.02	1 watt	fixed	WR137	\$185
H910A	7.05-10.0	1.02	1 watt	fixed	WR112	\$125
X910B	8.2-12.4	1.015	1 watt	fixed	WR90	\$135
P910A	12.4-18	1.02	1 watt	fixed	WR62	\$110
J914A	5.3-8.2	1.01	2 watt	sliding	WR137	\$415
H914A	7.05-10.0	1.01	1 watt	sliding	WR112	\$375
X914B	8.2-12.4	1.01	1 watt	sliding	WR90	\$275
P914A	12.4-18	1.01	1/2 watt	sliding	WR62	\$275
K914B	18-26.5	1.01	1/2 watt	sliding	WR42	\$450
R914B	26.5-40	1.01	1/2 watt	sliding	WR28	\$415

### 920A/B, X923A, X930A Waveguide shorts

The 920A/B are movable shorts, adjustable through at least half a wavelength at the low end of the band. The X923A is also a movable short, but is adjustable through about two wavelengths at 8.2 GHz. The X930A is a shorting switch. SWR is less than 1.02 in "open," greater than 125 in "short."

### 920A/B, X923A, X930A specifications

Model	Frequency Range (GHz)	Waveguide Size EIA	Price
J920A	5.3-8.2	WR137	\$240
H920A	7.05-10.0	WR112	\$330
X923A	8.2-12.4	WR90	\$300
P920B	12.4-18	WR62	\$330
K920B	18.0-26.5	WR42	\$450
R920B	26.5-40.0	WR28	\$425
X930A	8.2-12.4	WR90	\$440



# MICROWAVE TEST EQUIPMENT

Filters, mixers, and tuners

Models 360 series, 362 series, 870A, P932A, 934A



- Effective elimination of undesirable signals
- Low insertion loss through passband

- Correct waveguide discontinuities
- Measure microwave frequencies



X362A



P932A



360D



X870A



934A

## 360 Series coaxial low pass filters, 362 Series waveguide low pass filters

These Hewlett-Packard low-pass filters facilitate microwave measurements by eliminating undesirable signals (such as harmonics) from the measurement system. Suppression of such signals is particularly important in applications such as broadband reflection and transmission measurements or slotted line measurements, where harmonics generated by the signal source could otherwise impair measurement accuracy.

## X870A, P870A Waveguide slide-screw tuners

Waveguide slide-screw tuners are used primarily for correcting discontinuities or for "matching" waveguide systems. X870A covers 8.2–12.4 GHz in WR 90 waveguide and P870A likewise covers 12.4–18.0 GHz in WR 62 waveguide. Both can correct an SWR of 20 to a value of 1.02, with a maximum loss of 2 dB.

## 934A, P932A Harmonic mixers

These mixers can be used for frequency measurements and phase lock applications from 2 to 18 GHz. Both accept stable VHF signals from 100 to 1000 MHz and provide broadband, high sensitivity mixing with microwave signals. 934A handles coaxial inputs from 2 to 12.4 GHz while P932A mixes signals from 12.4 to 18 GHz in WR 62 waveguide. With 0 dBm input signal 934A provides 1.4 mV p-p output and P932A 0.4 mV p-p.

## 1977-78 Coaxial and Waveguide Catalog

And Microwave Measurement Handbook. 84 pages with over 350 measurement accessories. Use request card at back of this catalog.

## Ordering information

X870A Waveguide tuner  
P870A Waveguide tuner  
P932A Waveguide harmonic mixer  
934A Coaxial harmonic mixer

Price  
\$490  
\$510  
\$525  
\$340

## 360 Series coaxial filter specifications

Model	Cut-off Frequency MHz	Insertion Loss	Rejection	Impedance	VSWR Maximum	Connectors	Overall Length mm (in)	Shipping Weight kg (lb)	Price
360A	700	Less than 1 dB below 0.9 times cut-off frequency	Greater than 50 dB at 1.25 times cut-off frequency	50Ω	< 1.6 to within 100 MHz of cut-off	N (m, f)	276 (10 <sup>9</sup> / <sub>16</sub> )	0.9 (2)	\$260
360B	1200			50Ω		N (m, f)	183 (7 <sup>1</sup> / <sub>32</sub> )	0.9 (2)	\$228
360C	2200			50Ω	< 1.6 to within 200 MHz of cut-off	N (m, f)	274 (10 <sup>7</sup> / <sub>32</sub> )	0.9 (2)	\$160
360D	4100			50Ω	< 1.6 to within 300 MHz of cut-off	N (m, f)	187 (7 <sup>3</sup> / <sub>16</sub> )	0.45 (1)	\$160

## 362 Series waveguide low pass filter specifications

Model	Passband GHz	Stopband GHz	Passband Insertion Loss	Stopband Rejection	SWR Maximum	Waveguide Size	Equivalent Flange	Length mm (in)	Shipping Weight kg (lb)	Price
X362A	8.2–12.4	16–37.5	< 1 dB	At least 40 dB	1.5	WR 90	UG-39/U	136 (5 <sup>1</sup> / <sub>2</sub> )	0.9 (2)	\$700
M362A	10.0–15.5	19–47			1.5	WR 75	Cover	114 (4 <sup>1</sup> / <sub>2</sub> )	0.9 (2)	\$600
P362A	12.4–18.0	23–54			1.5	WR 62	UG-419/U	94 (3 <sup>1</sup> / <sub>4</sub> )	0.37 (13 oz)	\$720
K362A <sup>1</sup>	18.0–26.5	31–80			1.5	WR 42	UG-595/U	64 (2 <sup>1</sup> / <sub>2</sub> )	0.15 (5.3 oz)	\$595
R362A <sup>1</sup>	26.5–40.0	47–120	< 2 dB	> 35 dB	1.8	WR 28	UG-599/U	42 (1 <sup>7</sup> / <sub>32</sub> )	0.11 (4 oz)	\$525
										\$120

<sup>1</sup>Circular Flange Adapters available. For X-Band, Specify 11515A (UG-425/U). For R-Band, Specify 11516A (UG-381/U).

# MICROWAVE TEST EQUIPMENT

## Coaxial switches

Models 8761A/B, 33311B/C

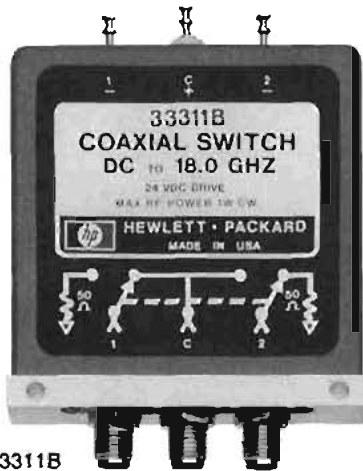

33311B



8761A Opt 001

### 33311B/C Coaxial switch

The 33311B/C are high isolation, single pole, double-throw coaxial switches with excellent characteristics. They are designed for use in 50 ohm systems and the un gated port is automatically terminated internally with 50 ohms, thus eliminating the need for three-switch trees. This feature makes them particularly useful in systems which require low SWR on their lines at all times. The switches are controlled by latching solenoids and switching current is automatically cut off when switching is completed. The 33311C utilizes the new APC-3.5 connector which is SMA compatible and extends the operating frequency range to 26.5 GHz.

#### 33311B/C Specifications

##### Frequency Range:

**33311B:** dc to 18 GHz.

**33311C:** dc to 26.5 GHz.

##### SWR (50 ohm characteristic impedance)

**33311B:** <1.25, dc to 12.4 GHz; 1.5, 12.4 to 18 GHz.

**33311C:** <1.3, dc to 10 GHz; <1.5, 10 to 16 GHz; <2.3, 16 to 26.5 GHz.

##### Insertion Loss

**33311B:** <0.25 dB, dc to 2 GHz; <0.5 dB, 2 to 18 GHz.

**33311C:** <0.25 dB, dc to 2 GHz; <0.5 dB, 2 to 10 GHz; <0.8 dB, 10 to 16 GHz; <1.4 dB, 16 to 26.5 GHz.

##### Isolation

**33311B:** >90 dB, dc to 18 GHz.

**33311C:** >90 dB to 12.4 GHz; >85 dB, 12.4 to 18 GHz; >50 dB, 18 to 26.5 GHz.

##### RF Connectors

**33311B:** (3) SMA female.

**33311C:** (3) APC-3.5 female (SMA compatible).

**Power:** 1 W average, 100 W peak (10  $\mu$ sec duration).

**Solenoid voltage (dc or pulsed):** 24 volts. Diode protected to reduce voltage transients.

**Switching speed:** <30 ms (including settling time).

**Life:** >1,000,000 switchings.

**Size:** 54" x 53" x 14 mm D (2.13" x 2.13" x 0.56") excluding connectors and solenoid terminals.

**Weight:** net, 88 gm (3.1 oz). Shipping, 220 gm (8 oz).

**Options:** 011, 5-volt solenoid voltage (only on 33311B).

### 8761A/B Coaxial switch

The 8761 is a single-pole, double-throw coaxial switch with low standing-wave ratio, low insertion loss, and excellent isolation from dc to 18 GHz. Mechanically, the switch is a break-before-make type controlled by a latching solenoid. Any of seven coaxial connectors, or a 50-ohm termination, may be specified for each port.

#### 8761A/B Specifications

**Characteristic impedance:** 50 ohms.

**Frequency range:** dc to 18 GHz.

#### Standing-wave ratio

Frequency	SWR		
	7-mm	N	SMA
dc-12.4 GHz	1.15 (1.20)	1.20 (1.25)	1.30 (1.30)
dc-18 GHz	1.20 (1.25)	1.25 (1.30)	1.35 (1.35)

SWR in parentheses applies to switch with built-in termination.

**Insertion loss:** <0.5 dB, dc to 12.4 GHz; <0.8 dB, dc to 18 GHz.  
**Isolation:** >50 dB, dc to 12.4 GHz; >45 dB, dc to 18 GHz.  
**Power:** 10 W average, 5 kW peak; built-in termination rated at 2 W average, 100 W peak.

**Switching energy:** 1.5 W for 20 ms (permanent magnet latching).  
**Solenoid voltages (dc or pulsed):** 12 to 15 V, 8761A; 24 to 30 V, 8761B.

**Switching speed:** 35 to 50 ms (including settling time).

**Life:** >1,000,000 switchings.

**Dimensions:** 41 x 38 x 38 mm (1.6 x 1.5 x 1.5 in.) excluding connectors and solenoid terminals.

**Weight:** net, 140 to 220 gm (5 to 8 oz). Shipping, 220 to 300 gm (8 to 11 oz).

#### How to order 8761A/B switches

Specify solenoid voltage and connectors (including built-in 50-ohm termination) by the alphabetic suffix on the switch model number and the appropriate three-digit option number.

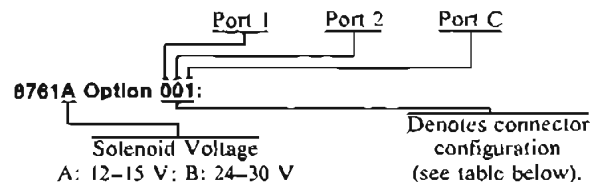

Option Code	Connector Type	Option Code	Connector Type
0	N (f)	4	APC-7 for UT-250 Coax
1	N (m)	5	SMA (f)
2	APC-7 w/threaded sleeve	6	SMA (m)
3	APC-7 w/Coupling nut	7	50 $\Omega$ Termination

#### Ordering Information

8761A/B order must include option number

8761A/B Coaxial Switch (quantity 1-9)	\$195
8761A/B Coaxial Switch (quantity 10-24)	\$185
8761A/B Coaxial Switch with 50-ohm termination	add \$35
33311B Coaxial Switch (quantity 1-9)	\$395
33311B Coaxial Switch (quantity 10-24)	\$365
33311C Coaxial Switch (quantity 1-9)	\$525
33311C Coaxial Switch (quantity 10-24)	\$485

Price

# MICROWAVE TEST EQUIPMENT

Frequency response test sets, 10 MHz to 26.5 GHz  
Model 8755 System

- 10 MHz to 26.5 GHz frequency range
- Absolute & ratio measurement capability



- 60 dB dynamic measuring range for each detector
- Excellent stability with time and temperature

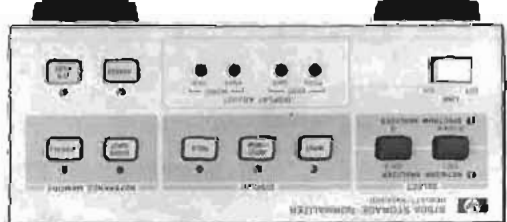

8750A Storage-Normalizer

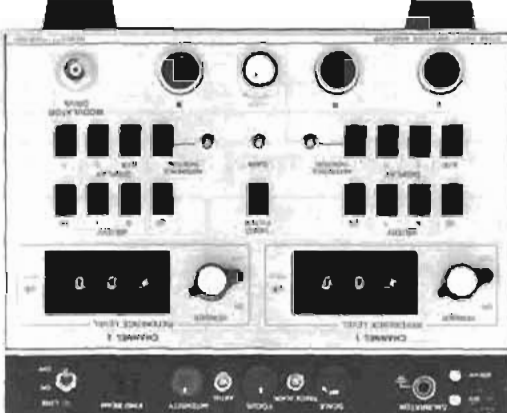
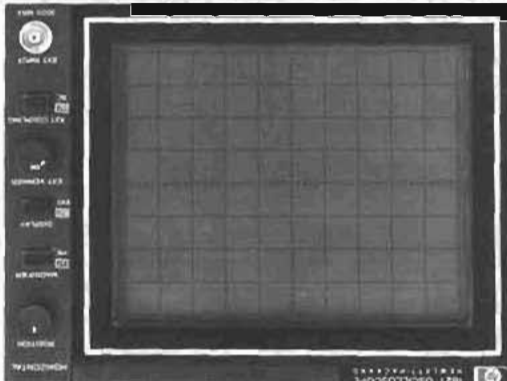

182T Display/8755B Plug-in  
11664A Detectors

8755S SYSTEM

The 8755B has two independent channels and three detector inputs allowing simultaneous ratio measurement capability. The detectors have a +10 dBm to -50 dBm dynamic range, are interchangeable, and require no calibration. For each channel a resolution of 10, 5, 1, or .25 dB per division is available (also combinations of these, e.g., 15 dB/division) as well as a calibrated offset of  $\pm 99$  dB in .25 dB increments. The 8750A Storage-Normalizer connects directly to the 8755B/182T by a single cable to provide digital normalization and storage capability for both channels.

Common measurements made with the 8755 are simultaneous insertion and return loss, amplifier gain and gain compression, and mixer conversion loss and return loss, all on a swept frequency basis. The 8755S system has many features that improve both the accuracy and the versatility compared with other scalar measurement systems.

The 8755B uses an AC detection system which can reject undesired RF signals such as local oscillator feedthrough in mixer measurements and broadband noise in amplifier measurements. The 8755B provides the 27 kHz squarewave drive to AM modulate the RF sweeper output, either directly (most HP 8620 RF sweeper plugs are directly compatible with the 8755) or by using the 11665B external modulator.

In addition to making absolute or relative power measurements with a single detector, the 8755 will also measure the logarithmic difference in power between two detectors, i.e., ratio measurements. Ratio measurement techniques improve accuracy by providing better equivalent source match and immunity to source power variations. A ratio technique can also allow dynamic range expansion up to 100 dB.

The 8750A Storage-Normalizer improves both the accuracy and convenience of swept frequency measurements. System frequency response error is eliminated by subtracting a digitally stored calibration trace from the measurement trace using the 8750 input minus memory mode. The input minus memory mode also facilitates comparison measurements by providing a single trace display of the difference between two devices. The 8750A has digital storage or flicker-free display so that a complete trace is seen independent of the RF sweep rate. This is a real benefit when device constants require a slow sweep rate as when making narrow band filter or stepped CW measurements. The 8750A also makes x-y plotting much more convenient by automatically outputting the x, y and penult signals from digital memory at the push of a single button.

A number of accessories are available for use with the 8755S system to meet most signal separation and filtering requirements. These include the HP 11664A Reflection Bridge, the HP 11677A Power Splitter, and the HP 11678 Filter Kits. The HP 11679A and B Extension Cables are also available for use with the 11664 Detectors or the 11666A Bridge to make remote measurements without performance degradation.

### Typical applications

#### Simultaneous insertion and return loss

One common setup for making simultaneous insertion loss and return loss measurements is shown in the diagram above. The R detector in the 11666A measures the incident power while the A detector measures reflected power. The ratio A/R then provides return loss information while the B/R trace displays insertion gain/return loss simultaneously. A display of a bandpass filter measurement using this setup is shown in the photo. The ability to monitor the effects of adjustments on both parameters is especially advantageous. System frequency response error is eliminated using the 8750A input minus memory mode. The difference between the measurement and calibration traces is displayed directly, eliminating the frequency response common to both traces. In addition, both the input minus memory and the input modes of the 8750 provide a flicker-free display independent of the RF sweep rate allowing the complete frequency response to be seen even at very slow sweep rates.

The 8755S is an economy network measurement system designed to make absolute power and power ratio measurements over the 10 MHz to 26.5 GHz frequency range. It is a versatile system capable of solving the majority of scalar (amplitude only) impedance and transmission measurement requirements. The 8755S system consists of the following separate instruments: (1) 8755B Swept Amplitude Analyzer, (1) 182T display unit, (1) 8750A Storage Normalizer, (3) 11664A Schottky diode detectors.

# MICROWAVE TEST EQUIPMENT

## Adapters, waveguide stands, air lines

Models 281A/B, 292A/B, 11515/6/A, 11524/5/A, 11533/4/A, 11566/7/A, 11588A, 11606A



11540A



11515A

11542A-11548A

### 281A/B Specifications

HP Model	SWR	Frequency Range (GHz)	Waveguide Size	Coaxial Connector	W/B Flange	Price
S281A	1.25	2.60-3.95	WR284	N Female	53	\$115
G281A	1.25	3.95-5.85	WR187	N Female	169A	\$115
J281A	1.25	5.30-8.20	WR137	N Female	34A	\$85
H281A	1.25	7.05-10.0	WR112	N Female	51	\$85
X281A	1.25	8.20-12.4	WR90	N Female	39	\$75
X281B	1.25	8.20-12.4	WR90	APC-7	39	\$105
P281B	1.25	12.4-18.0	WR62	APC-7	418	\$145

1. 3 from 5.3 to 5.5 GHz  
2. Option 012 furnished with stainless steel N-female connector.  
W/B: 5/8"

### 292A/B, 11515A, 11516A Specifications

HP Model	SWR	Frequency Range (GHz)	W/B Size	Flange	Price
HX292B	1.05	8.2-10.0	1.05	WR 112 UG-51/U	\$105
MX292B	1.05	10.0-12.4	1.05	WR 75 UG-39/U	\$150
MP292B	1.05	12.4-15.0	1.05	WR 75 UG-19/U	\$115
MP292A	1.05	15.0-18.0	1.05	WR 51 UG-41/U	\$105
NK292A	1.05	18.0-22.0	1.05	WR 51 UG-59/U	\$175
11515A	—	18.0-26.5	—	WR 42 UG-425/U	\$110
11516A	—	26.5-40.0	—	WR 28 UG-59/U	\$110

### 11524A, 11525A, 11533A, 11534A Specifications

HP Model	Description	Shipping Weight	Price
11524A	APC-7 to N female	110 g (4 oz)	\$95
11525A	APC-7 to N male	140 g (5 oz)	\$105
11533A	APC-7 to SMA male	140 g (5 oz)	\$135
11534A	APC-7 to SMA female	140 g (5 oz)	\$135

### 11588A, 11606A Specifications

HP Model	Frequency Range (GHz)	SWR	Connectors	Dimensions (mm)	Shipping Weight (kg (lb))	Price
11588A	DC-12.4	1.11	7 mm, male	42 x 59 x 30	0.28 (0.07)	\$320
11606A	DC-12.4	1.1	7 mm, female	100 x 19	0.45 (1 lb)	\$250

### Ordering Information

- 11566A Air line extension
- 11567A Air line extension
- 11540A Waveguide stand
- 11542A G-Band
- 11543A J-Band
- 11544A H-Band
- 11545A X-Band
- 11546A P-Band
- 11547A K-Band
- 11548A R-Band

### Price

- \$170
- \$195
- \$30
- \$25
- \$15
- \$15
- \$15
- \$15
- \$15
- \$15

• Increase versatility of microwave measurements

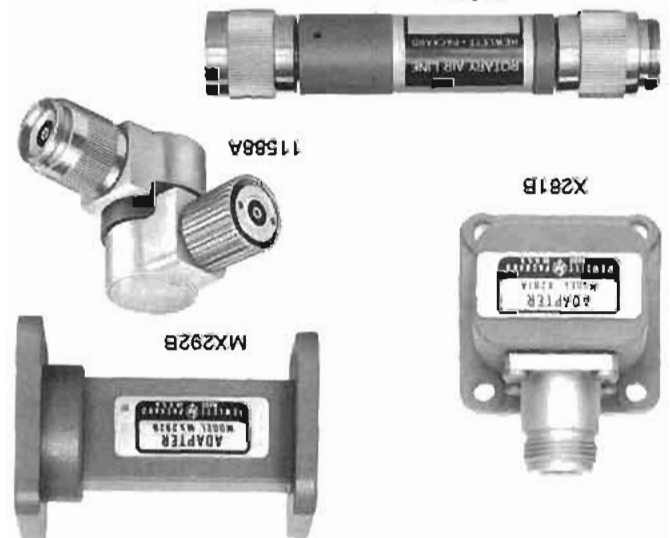

### 281A/B Coax to waveguide adapters

HP 281A/B adapters transform waveguide transmission line into 50-ohm coaxial line. Power can be transmitted in either direction, and each adapter covers the full frequency range of its waveguide band with SWR less than 1.25.

### 292A/B, 11515A, 11516A Waveguide to waveguide adapters

Models 292A/B waveguide-to-waveguide adapters connect two different waveguide sizes with overlapping frequency ranges. The 292A consists of a short tapered section of waveguide. The 292B is a square to circular flange adapter for K-band. The 11515A is a square to circular flange adapter for K-band. The 11516A is a square to circular flange adapter for R-band (UG-599 to UG-381).

### 11524A, 11525A, 11533A, 11534A Coax to coax adapters

These coaxial adapters permit easy interconnection of 50-ohm precision 7-mm (APC-7) connectors and 50-ohm Type N or SMA (3-mm type) connectors.

### 11588A Swivel adapter, 11606A rotary air line

The 11606A rotary air line and the 11588A swivel adapter are capable of a full 360° of rotation. A combination of the air line and the adapter permits rigid coax movement in three dimensions. Even the most awkwardly shaped devices can be easily connected or disconnected in a coax system with the aid of these components. Insertion loss is <0.5 dB and uncertainty due to rotation is -57 dB.

### 11566A, 11567A Air line extension

Impedance: 50 ohms  
Frequency: dc-18 GHz  
Reflection coefficient: 0.018 + 0.001 (frequency in GHz)  
Connector: APC-7  
Length: 11566A: 10.25 cm 11567A: 20.25 cm  
Weight: 0.45 kg (1 lb) net.

### 11540 Series waveguide stand, waveguide holders

The 11540A waveguide stand locks HP waveguide holders at any height from 70 to 133 mm (2.75" to 5.25"). The stand is 64 mm (2.25") high, and the base measures 121 mm (4.75") in diameter. The waveguide holders are offered in seven sizes to hold waveguide covering frequencies from 3.95 to 40 GHz.

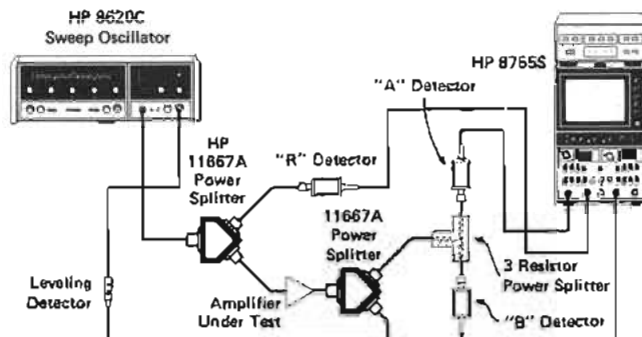
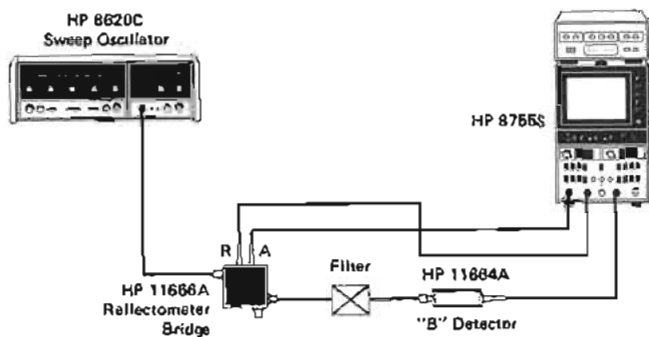
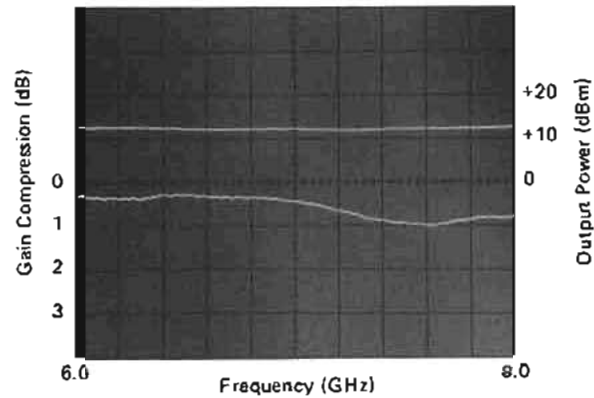
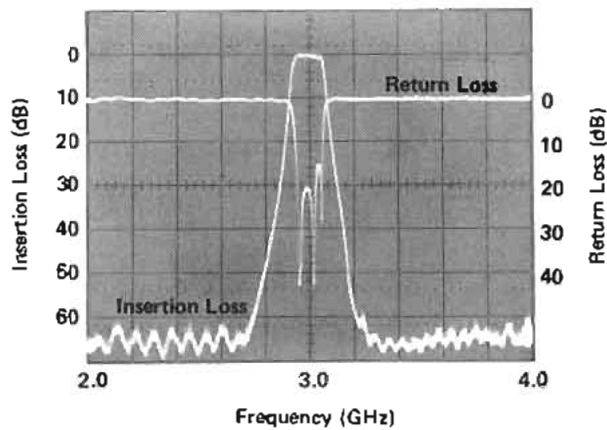

### Amplifier gain compression

The ability to make absolute power measurements along with normalized ratio measurements is very useful for amplifier characterization. The top right setup can measure amplifier gain, gain flatness, output power, and gain compression, all on a swept frequency basis. The photo displays the amplifier gain compression and output power over the 6–8 GHz range of the amplifier. The 8750A *input minus memory* mode provides the important ability to compare differences between the small signal gain response with successively compressed gain responses. Once the gain is compressed 1 dB at any frequency the output power indicated by the B detector is the output power for 1 dB gain compression.

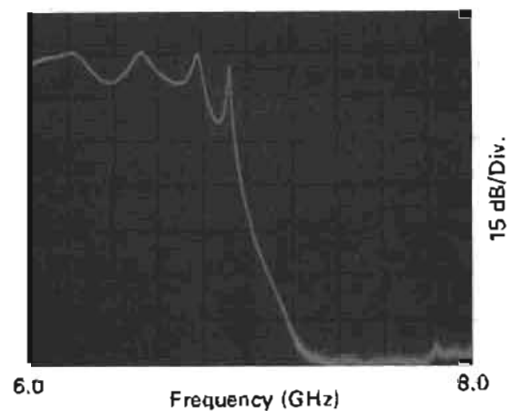

### Expanded dynamic range

Each detector channel of the 8755 has a 60 dB dynamic range. By using the lower right setup, the dynamic range for each channel is added together to make a 100 dB dynamic range measurement on a lowpass filter. The AC processing system of the 8755 allows the detector to reject the broadband noise from the amplifier providing up to 30 dB more dynamic range than would be possible with a DC type detection system. In addition, the full 100 dB dynamic range can be viewed on the CRT display by selecting the 5 and 10 dB per division resolution buttons together, giving 15 dB/division. The amplifier gain variations enter into the measurement as frequency response common to both calibration and measurement traces. The 8750A Storage-Normalizer *input minus memory* mode displays the difference between the calibration and measurement traces thus eliminating the effects of frequency response.

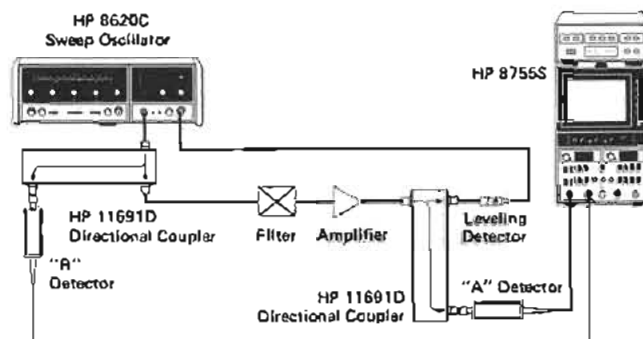



11666A



11665B



11667A

### 11666A Reflectometer Bridge

Reflection measurements covering from 40 MHz to 18 GHz with one coupling device can be made with the Model 11666A Reflectometer Bridge. Operation of this type of coupling device is based on principles of the resistive Wheatstone Bridge extended to microwave frequencies. When three bridge arms are 50Ω, the voltage across corners of the bridge is directly proportional to the reflection coefficient of the device connected in the fourth arm. Equivalent directivity is then a measure of how well the bridge circuit is balanced with a 50Ω termination connected. (Ideally this would create a voltage null representing infinite return loss.) The high equivalent directivity achievable over wide bandwidths makes the bridge configuration attractive.

The 11666A is completely dedicated to the 8755; two Schottky diode detectors (which sample the incident and reflected signals for ratioing by the 8755) are incorporated as an integral part of the bridge unit. The effective external leveling achieved by ratioing thus isolates the measurement port from source/bridge input mismatch. With the addition of an external 11664A detector, two simultaneous ratio measurements of insertion and return loss can be made. Small size combined with its wide frequency range and high directivity make the 11666A ideal for production use.

Specifications 11666A (connected to the 8755B Analyzer)

Frequency Range: 40 MHz to 18 GHz.

Frequency Range	Equivalent Directivity	Equivalent Output SWR
40 to 100 MHz	30 dB	1.25
0.1 to 1 GHz	38 dB	1.25
1 to 2 GHz	36 dB	1.25
2 to 4 GHz	33 dB	1.25
4 to 8 GHz	29 dB	1.25
8 to 12 GHz	27 dB	1.27
12 to 18 GHz	26 dB	1.52

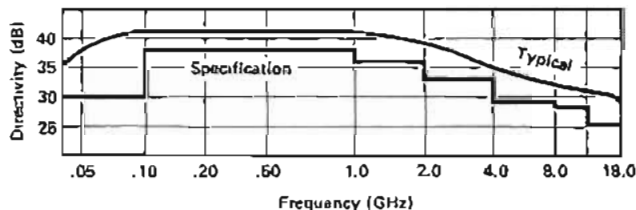

### Frequency tracking

(between incident and reflected arms):  $\pm 1.6$  dB  
(between incident and test port, including  $\pm 0.5$  dB from 11664A Detector):  $\pm 2.1$  dB

Nominal coupling: 6-dB incident arm, 9-dB reflected arm, 9-dB transmission loss.

Input SWR: 1.8.

Maximum Input power: +15 dBm.

Connectors: Type N-Female on input and output. APC-7 Optional.

Dimensions: 69.9 mmH  $\times$  69.9 mmW  $\times$  46.6 mmD (2.75"  $\times$  2.75"  $\times$  1.83"). Cable length, 1219 mm (48").

Weight: net, 0.7 kg (1.5 lb). Shipping, 2.26 kg (5.13 lb).

Accessories furnished: 11512A short, Type N-Male (11565A short, APC-7 with Opt 002 and 003).

### 11667A Power splitter

The 11667A Power Splitter is recommended when making wide-band transmission measurements using the 8755 Test Set. This two-resistor type splitter provides excellent output SWR at the auxiliary arm when used for source leveling or ratio measurement applications. The 0.25 dB tracking between output arms over a frequency range from dc to 18 GHz allows wideband measurements to be made with a minimum of uncertainty.

Frequency range: dc to 18 GHz.

Impedance: 50Ω.

	dc-4 GHz	dc-8 GHz	dc-18 GHz
Input SWR:	$\leq 1.15$	$\leq 1.25$	$\leq 1.45$
Equivalent output SWR: leveling or ratio measurement	1.10	1.20	1.33
Output tracking: (between output arms)	0.15	0.20	0.25

Insertion loss: 6 dB nominal (input to either output).

Maximum Input power: +27 dBm.

Connectors: Type N female on all ports.

Size: 46 H  $\times$  50 W  $\times$  19 mm D (1<sup>13</sup>/<sub>16</sub>"  $\times$  2"  $\times$  3/4").

Weight: net, 0.06 kg (2 oz). Shipping 0.22 kg (8 oz).

### Other signal separation devices

Many other signal separation devices are available from HP for use with the 8755. Coaxial couplers from .1 to 18 GHz are available with the 770 series, the 790 series, the 11692. Higher directivity 752 series waveguide couplers can also be used with the 8755S with the addition of appropriate 281 series waveguide to coax adaptors.

### 11665B Modulator

Function: absorptive on-off modulator designed for and powered by the 8755B plug-in.

Frequency Range	Return Loss On and Off		Insertion Loss On Off	
	$\geq$	$\leq$	$\leq$	$\geq$
15-40 MHz	$\geq 10$ dB	$\leq 7.0$ dB	$\geq 35$ dB	
40 MHz-4 GHz	$\geq 15$ dB	$\leq 3.2$ dB	$\geq 35$ dB	
4-8 GHz	$\geq 12$ dB	$\leq 3.8$ dB	$\geq 40$ dB	
8-12.4 GHz	$\geq 8$ dB	$\leq 4.3$ dB	$\geq 45$ dB	
12.4-18 GHz	$\geq 6$ dB	$\leq 5.0$ dB	$\geq 45$ dB	

Modulator drive feedthrough:  $\leq 8$  mV (peak) at 27.8 kHz at either port when powered by the 8755B. Reduced to  $\leq 1$  mV (peak) using the 11668A. (See 11668A High Pass Filter).

Drive current: nominally +50 mA in ON condition. -50 mA Off condition.

Weight: net, 0.17 kg (6 oz). Shipping, 0.9 kg (2 lb).

Individual Instrument Specifications

8755B Plug-in

Function: swept amplitude analyzer for 180 series displays. Has inputs for three 1166A Detectors and supplies 27.8 kHz drive for 1165B Modulator.

Weight: net, 2.8 kg (6.3 lb). Shipping, 4.5 kg (10 lb).

Display units

The 8755B can be used with any 180 series display. However, the 180 "T" series displays are recommended. These mainframes provide medium persistence P39 phosphor which reduces flicker on slow sweeps, negative z-access blanking input, and zero DC offset recorder outputs.

1166A Detectors

Function: Schottky diode detects envelope of the modulated microwave signal. 10 MHz to 18 GHz.

Frequency response

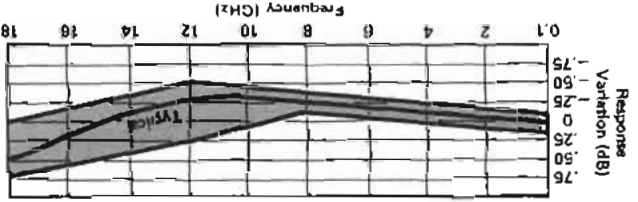

Detector return loss

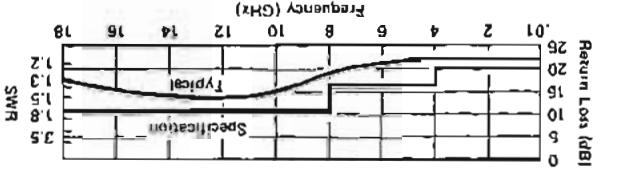

Weight: net, 0.17 kg (6 oz). Shipping, 0.9 kg (2 lb).

New 11664B 26.5 GHz Detectors

The 11664B and 11664B Opt 001 (female) detectors utilize the new APC 3.5 connectors which extend the frequency range to 26.5 GHz. All specifications from 10 MHz to 18 GHz are similar to the 11664A. The return loss from 18 GHz to 26.5 GHz is greater than 8.5 dB.

New 8750A Storage-Normalizer

Function: Provides digital storage display and digital normalization for the 8755. The 8750A connects directly to the 8755B/182T via a single cable. Older 182 mainframes and 8755A plug-ins can be retrofitted to accept the 8750A. See page 459 for details.

8755S Options

001: rack mount version of the 8755S system. Deletes 182T large screen display and adds 180TR standard screen rack display.

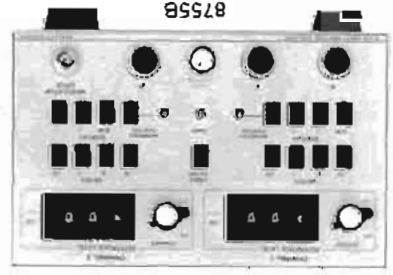
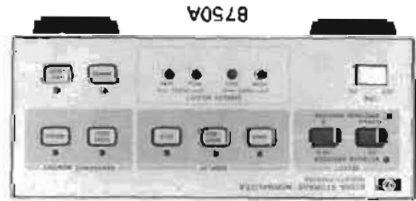

- 002: complete test set for making simultaneous return loss and insertion measurement from 40 MHz to 18 GHz. Deletes 2 11664A dc detectors for monitoring the forward and reflected power.
  - 003: adds the 1165B modulator to provide external 27 kHz square wave modulation capability. The 1165B is used with sources that cannot be directly modulated or for modulating after the device under test.
  - 004: deletes 8750A Storage-Normalizer.
  - 006: deletes 8750A Storage-Normalizer.
- Ordering information**  
The 8755S system and its options are configured of separate instruments and components solely for ordering convenience. If a different display or optional connectors are desired, each part of the system should be listed separately.

- 8755S Complete Test Set \$5650
- Opt 001: Rack mount version no charge
- Opt 002: deletes (2) 11664 detectors, adds \$1600
- 11666A Reflector Bridge \$300
- Opt 003: adds 1165B modulator \$1800
- Opt 004: deletes 8750A Storage-Normalizer less \$1450
- 8755B Test Set Plug-in only \$1800
- 11665B 15 MHz 18 GHz modulator \$500
- Opt 013: Input N-female, output APC-7 add \$25
- Opt 021: Input N-female, output N-female N/C
- 11664A 10 MHz 18 GHz detector \$250
- Opt 001: APC-7 connector add \$25
- 11664B APC 3.5 10 MHz to 26.5 GHz Detector \$250
- Opt 001: APC 3.5 female connector \$250

- Both 11664B Detectors extend the frequency range to 26.5 GHz)
- 182T Large screen cabinet scope display \$1650
- 180TR Standard screen rack display \$1650
- 181T Storage, cabinet display \$2400
- 181TR Storage, rack display \$2500
- 11666A Reflector Bridge \$2100
- Opt 001: Input N-female, Output N-female N/C
- Opt 002: Input N-female, Output APC-7 add \$50
- 11679A 25 ft detector extension cable add \$75
- 11679B 200 ft detector extension cable \$55
- 11668A 50 MHz high pass filter \$195
- Opt 001: APC-7 input and output \$225
- Opt 002: Type N female input and output add \$55
- Opt 001: Type N female input, type N female output N/C
- 11667A DC 18 GHz power splitter \$525
- Opt 001: Type N male input, type N female outputs N/C
- Opt 002: Type N female input, APC-7 outputs add \$75
- 11678A Low pass filter kit \$600
- Individual filters: specify model number \$120



11679A



11668A



11678A

**11678A Low Pass Filter Kit**  
 The 11678A Low Pass Filter Kit contains five filters conveniently matched to HP 8620 sweeper bands. These filters have <math>< 1.1\text{ dB}</math> insertion loss at .95 fc with >40 dB rejection at 1.25 fc. Filter use is recommended to reduce undesirable harmonics causing errors in broadband detector measurements.

**Frequency range:** low pass filters, cutoff frequency fc: 11688A, 2.8 GHz; 11689A, 4.4 GHz; 11684A, 6.8 GHz; 11685A, 9.5 GHz;

**Connectors:** N-Male, N-Female.

**Weight:** net 0.44 kg (1 lb). Shipping 1.2 kg (2.9 lb).

**11668A High Pass Filter**

The 11668A High Pass Filter accessory is recommended when making measurements on active devices which have gain below 50 MHz. Use of the 11668A, placed after the 11665B, reduces the modulator drive feedthrough from 8 mV to 1 mV and prevents possible amplifier saturation. Use of the 11668A filter is not necessary for passive measurements since the feedthrough from the 11665B is -65 dBm and causes no degradation in system performance.

**Frequency range:** 50 MHz to 18 GHz.

**Insertion Loss**

50 - 100 MHz	$\leq 2.5$ dB	$\leq 12$ dB
100 MHz - 8 GHz	$\leq 1.0$ dB	$\leq 16$ dB
8 - 12 GHz	$\leq 1.0$ dB	$\leq 14$ dB
12 - 18 GHz	$\leq 1.5$ dB	$\leq 14$ dB

**Specifications**

**87555 System**

**Frequency range:** 10 MHz to 18 GHz.

**Measurement range**

**Single channel:** +10 dBm to -50 dBm (noise level).

**Ratio of two channels:** 60 dB (up to 120 dB using expanded dynamic range setup on page 425).

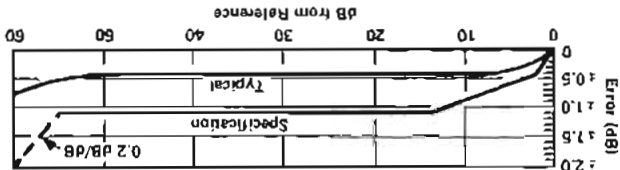

Curve does not include mismatch or coupler ambiguities. Ratio measurement accuracy.

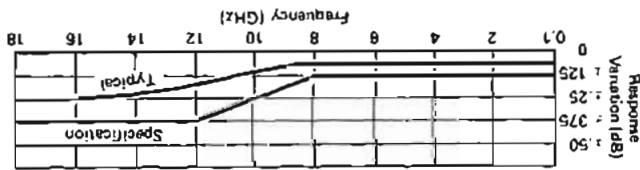

Frequency response (ratio measurement)

Accuracy curve shows system uncertainty for a relative measurement with +10 dBm incident at the test detector when the 0-dB reference is set. Accuracy when calibration levels below +10 dBm are used remains the same, except the additional 0.2 dB/dB uncertainty should be added for measurements below -45 dBm. This curve includes system noise, offset uncertainty, and crossstalk, and assumes the reference detector power remains fixed between calibration and test. System frequency response is specified separately.

**Impedance:** 50 $\Omega$ .  
**Resolution:** each channel independent, 10, 5, 1 or .25 dB per division. Combinations of these can be obtained by depressing multiple buttons.

**Offset:** each channel independent,  $\pm 99$  dB in 1 dB steps.  
**Recorder output:** 0.5 volt/division; zero dc offset.  
**Marker and blinking inputs:** accepts both positive and negative marker and blinking inputs.

**Temperature range:** operation, 0 to 55°C; storage -40°C to 75°C. Temperature drift typically 0.01 dB/°C from 5° to 55°C.  
**Standard connectors**  
 11664A detectors: Type N-male.

**Size**  
 87555 (182T display): 440 H  $\times$  202 W  $\times$  499 mm D (17 $\frac{1}{2}$ "  $\times$  5 $\frac{1}{2}$ "  $\times$  21 $\frac{1}{2}$ ").

87555 Option 001 (1807R display): 235 H  $\times$  425 W  $\times$  543 mm D (9 $\frac{1}{2}$ "  $\times$  16 $\frac{1}{2}$ "  $\times$  21 $\frac{1}{2}$ ").

**Weight**  
 87555: net 18.2 kg (40.3 lb). Shipping 28 kg (63 lb).  
 87555 Opt 001: net 17.2 kg (37.8 lb). Shipping 27 kg (61 lb).





415E

The Hewlett-Packard Model 415E SWR meter is a low noise, tuned amplifier-voltmeter calibrated in dB and SWR for use with square law detectors. It is an extremely useful instrument for measuring SWR, attenuation, and gain directly from metered scales, or as a tuned amplifier for driving an X-Y recorder when making RF substitution measurements. The 415E responds to a standard tuned frequency of 1000 Hz. This frequency is front panel adjustable over a range of 7% for exact matching to the internal 1 kHz modulation of the signal source being used. Amplifier bandwidth is also adjustable from 15 to 130 Hz. The narrow bandwidth allows maximum sensitivity at CW frequencies while the wider bandwidths enable swept tests to be displayed on an oscilloscope or X-Y recorder.

A precision 60 dB attenuator with an accuracy of 0.05 dB/10 dB assures high accuracy in making substitution measurements. An expand-offset feature allows any 2 dB range to be expanded to full scale for maximum resolution. Linearity is  $\pm 0.02$  dB on expanded ranges and is limited only by meter resolution on normal scales. This performance, together with the inherently low noise figure, allows maximum measurement range with exceptional resolution and linearity.

The Model 415E operates with either crystal or bolometer detectors. Both high and low-impedance inputs are available for crystal detectors. Precise bias currents of 4.5 and 8.7 mA (200 $\Omega$ ) are available for operation with bolometers as selected at the front panel. This bias is peak limited for positive bolometer protection.

Both ac and dc outputs located on the rear panel allow use of the 415E as a high-gain tuned amplifier or for X-Y recorder operation. In addition, the 415E can be operated with an internally mounted battery pack (option 001) for completely portable use.

### Specifications

**Sensitivity:** 0.15  $\mu$ V rms for full-scale deflection at maximum bandwidth (1  $\mu$ V rms on high impedance crystal input).

**Noise:** at least 7.5 dB below full scale at rated sensitivity and 130 Hz bandwidth with input terminated in 100 or 5000 $\Omega$ ; noise figure less than 4 dB.

**Range:** 70 dB in 10 and 2-dB steps.

**Accuracy:**  $\pm 0.05$  dB/10 dB step; maximum cumulative error be-

tween any two 10 dB steps,  $\pm 0.10$  dB; maximum cumulative error between any two 2 dB steps,  $\pm 0.05$  dB; linearity,  $\pm 0.02$  dB on expand scales, determined by inherent meter resolution on normal scales.

**Input:** unbiased low and high impedance crystal (50-200 and 2500-10,000 $\Omega$  optimum source impedance respectively for low noise); biased crystal (1 V into 1 k $\Omega$ ); low and high current bolometer (4.5 and 8.7 mA  $\pm 3\%$  into 200 $\Omega$ ), positive bolometer protection; input connector, BNC female.

**Input frequency:** 1000 Hz adjustable 7%; other frequencies between 400 and 2500 Hz available on special order.

**Bandwidth:** variable, 15-130 Hz; typically less than 0.5 dB change in gain from minimum to maximum bandwidth.

**Recorder output:** 0-1 V dc into an open circuit from 1000 $\Omega$  source impedance for ungrounded recorders; output connector, BNC female.

**Amplifier output:** 0-0.3 V rms (Norm), 0-0.8 V rms (Expand) into at least 10,000 $\Omega$  for ungrounded equipment; output connector, dual banana jacks.

**Meter scales:** calibrated for square-law detectors; SWR: 1 — 4, 3.2 — 10 (Norm); 1 — 1.25 (Expand); dB: 0 — 10 (Norm); 0 — 2.0 (Expand); battery: charge state.

**Meter movement:** taut-band suspension, individually calibrated mirror-backed scales; expanded dB and SWR scales greater than 108 mm (4 $\frac{1}{4}$ " long).

**RFI:** conducted and radiated leakage limits are below those specified in MIL-I-6181D.

**Power:** 115-230 V  $\pm 10\%$ , 50-400 Hz, 1 W; optional rechargeable battery provides up to 36 hr continuous operation.

**Size:** 115 H, 190 W, 279 mm D, (6 $\frac{3}{32}$ "  $\times$  7 $\frac{5}{16}$ "  $\times$  11").

**Weight:** net 4 kg (9 lb). Shipping 5.8 kg (13 lb).

### Ordering Information

415E SWR meter

Opt 001: rechargeable battery installed

Opt 002: rear panel input connector in parallel with front panel connector

### Price

3800

add \$103

add \$23

# NETWORK ANALYZERS

Complete characterization of linear networks



## Why network analysis?

Characterizing the behavior of linear networks that will be stimulated by arbitrary signals and interfaced with a variety of other networks is a fundamental problem in both synthesis and test processes. For example, the engineer designing a multicomponent network must predict with some certainty the final network performance from his knowledge of the individual components. Similarly, a production manager must know allowable tolerances on the products he manufactures and whether the final products meet the specified tolerances. Network analysis offers a solution to these problems through complete description of linear network behavior in the frequency domain.

Network analysis accomplishes the description of both active and passive network by creating a data model of such component parameters as impedances and transfer functions. However, these parameters not only vary as a function of frequency but are also complex variables in that they have both magnitude and phase. Until the advent of the modern network analyzer, phase was difficult to measure at CW frequencies and often involved laborious calculations; these measurements were accomplished by conventional oscilloscopes at lower frequencies and slotted lines at microwave frequencies. However, swept network analyzers now measure amplitude and phase (the total complex quantity) as a function of frequency with less difficulty than conventional CW measurements. Impedance and transfer functions can then be conveniently displayed on a swept CRT, X-Y recorder, or computer controlled peripherals such as a

printer and/or a plotter. HP computers also combine with network analyzers to give new levels of speed and accuracy in swept measurement that could only be attained previously by long calculations at CW frequencies.

Thus, network analysis satisfies the engineering need to characterize the behavior of linear networks quickly, accurately, and completely over broad frequency ranges. In design situations, this minimizes the time required to test new designs and components, allowing more time to be spent on the design itself. Likewise, production test times may be minimized while reducing the uncertainties surrounding the test.

## What is network analysis?

Network analysis is the process of creating a data model of transfer and/or impedance characteristics of a linear network through sine wave testing over the frequency range of interest. All network analyzers in the HP product line operate according to this definition.

Creating a data model is important in that actual circuit performance often varies considerably from the performance predicted by calculations. This occurs because the perfect circuit element doesn't exist and because some of the electrical characteristics of a circuit may vary with frequency.

At frequencies above 1 MHz lumped elements actually become "circuits" consisting of the basic elements plus parasitics like stray capacitance, lead inductance, and unknown absorptive losses. Since parasitics depend on the individual device and its construction they are almost impossible to pre-

dict. Above 1 GHz component geometries are comparable to a signal wavelength, intensifying the variance in circuit behavior due to device construction. Further, lumped-element circuit theory is useless at these frequencies and distributed-element (or transmission-line) parameters are required to completely characterize a circuit.

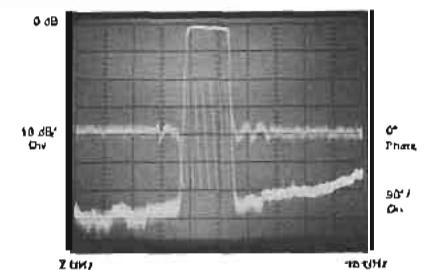

Figure 1. 2 GHz to 18 GHz measurement of magnitude and phase in a single sweep

Data models of both transfer and impedance functions must be obtained to completely describe the linear behavior of a circuit under test. At lower frequencies,  $h$ ,  $y$ , and  $z$ -parameters are examples of transfer and/or impedance functions used in network description; at higher frequencies,  $S$ -parameters are used to characterize input-output impedances and transfer functions. Therefore, a network analyzer must measure some form of a circuit's transfer and impedance functions to achieve its objective of complete network characterization.

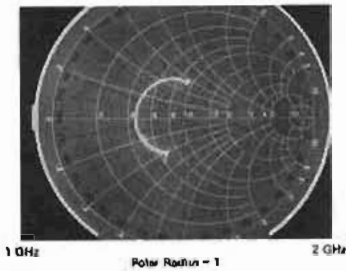

Figure 2. Input impedance of microcircuit amplifier is read directly with Smith Chart Overlay for Polar Display

Network analysis is limited to the definition of linear networks. Since linearity constrains networks stimulated by a sine wave to produce a sine wave output, sine wave testing is an ideal method for characterizing linear network's amplitude and phase responses as a function of frequency. In nonlinear measurements phase is often meaningless and amplitude has to be defined with respect to individual frequency components. For nonlinear measurements see sections on spectrum analyzers and wave analyzers.

### Network analyzers

Hewlett Packard Network Analyzers are instruments that measure transfer and/or impedance functions of linear networks through sine wave testing. A network analyzer system accomplishes these measurements by configuring its various components around the device under test. The first requirement of the measurement system is a sine wave signal source to stimulate the device under test. Since transfer and impedance functions are ratios of various voltages and currents, a means of separating the appropriate signals from the measurement ports of the device under test is required. Finally, the network analyzer itself must detect the separated signals, form the desired signal ratios, and display the results.

#### Signal sources and signal separation

In the general case, any sine wave source meeting the network analyzer's specifications can be used to stimulate the device under test. For CW measurements a simple oscillator may suffice; for greater CW frequency accuracy a signal generator or synthesizer may also be desirable. If the analyzer is capable of swept measurements, great economies in time can be achieved by stimulating the device under test with a sweep oscillator or sweeping synthesizer. This allows quick and easy characterization of devices over broad frequency ranges. Some network analyzers will operate only with a companion source which both stimulates the device under test and acts as the analyzer's internal oscillator.

At low frequencies it is not particularly difficult to separate the appropriate voltages and currents required for transfer and impedance function measurements. Signal separation is merely the process of establishing the proper shorts, opens, and connections at the measurement ports of the device

under test. As frequencies increase, the problem of signal separation usually involves traveling waves on transmission lines and becomes correspondingly more difficult. Hewlett Packard manufactures test sets (often called "transducers") applicable for separating the appropriate traveling waves in a variety of high frequency measurements.

### Broadband and narrowband detection

After the desired signals have been obtained from the test set (or transducer) they must be detected by the network analyzer: HP network analyzers can use one of two detection methods. Broadband detection accepts the full frequency spectrum of the input signal while narrowband detection involves tuned receivers which convert CW or swept RF signals to a constant IF signal. There are certain advantages to each detection scheme.

Broadband detection reduces instrument cost by eliminating the IF section required by narrowband analyzers but sacrifices noise and harmonic rejection. However, noise is not a factor in many applications, and careful measurement techniques, using filters, can eliminate harmonic signals that would otherwise preclude accurate measurements. Broadband systems are generally source independent while some narrowband systems require companion tracking sources. Finally, broadband systems can make measurements where the input and output signals are not of the same frequency, as in the measurement of the insertion loss of mixers and frequency doublers. Narrowband systems cannot make these measurements.

Active low noise detection of the constant IF possible. This allows increased accuracy and dynamic range for frequency selective measurements (as compared to broadband systems) and high resolution through IF substitution using precision IF attenuators. Source dependent narrowband systems utilize a companion tracking source not only to stimulate the device under test but also to produce a signal offset from the RF by a fixed frequency for tuning the analyzer's constant IF.

### Signal processing and display

Once the RF has been detected, the network analyzer must process the detected signals and display the measured quantities. All HP network analyzers are multichannel receivers utilizing a reference channel and at least one test channel; absolute signal levels in the channels, relative signal levels (ratios) between the channels, or relative phase difference between channels can be measured depending on the analyzer. Using these measured quantities, it is possible to either display directly or compute the amplitude and phase of transfer or impedance functions.

Amplitude measurements fall into two categories, relative and absolute; absolute measurements involve the exact signal level

in each channel while relative measurements involve the ratios of the two signal channels. Absolute measurements are usually expressed in voltage (dBV) or in power (dBm). The units dBV are derived by taking the log ratio of an unknown signal in volts to a one volt reference. Similarly, dBm is the log ratio of unknown signal power to a one milliwatt reference.

Relative ratio measurements are usually made in dB which is the log ratio of an unknown signal (Test Channel) with a chosen reference signal (Reference Channel). This allows the full dynamic range of the instrumentation to be used in measuring variations of both high and low level circuit responses. For example, 0 dB implies the two signal levels have a ratio of unity while  $\pm 20$  dB implies a 10:1 voltage ratio between two signals.

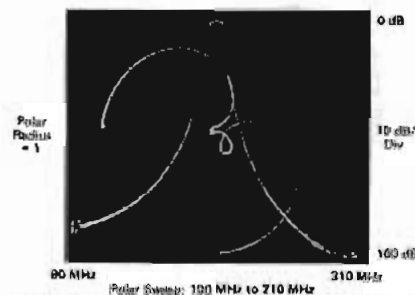

Figure 3. Simultaneous measurement of transmission response and passband reflection coefficient

All network analyzer phase measurements are relative measurements with the reference channel signal considered to have zero phase. The analyzer then measures the phase difference of the test channel with respect to the reference channel.

Measurement results at CW frequencies may be displayed on analog meters, LEDs or computer controlled printers. Swept frequency measurements of amplitude and phase may be displayed versus frequency on CRTs or X-Y plotters. The addition of digital storage and normalization to network analyzer CRT's assures flicker-free traces and removal of frequency response errors for fast, real-time displays of test device responses versus frequency.

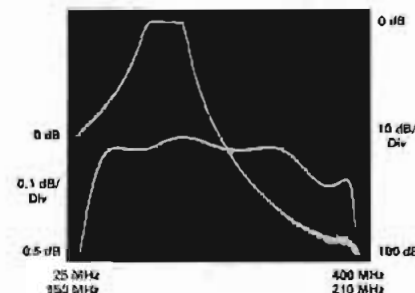

Figure 4. Automatic alternate sweep for coincident measurement filter passband and skirts

### Low frequency network analysis

Networks operating at frequencies below 10 MHz are generally characterized by measuring the gain and phase changes through the network and the associated input and output impedance; h, y, and z-parameters as well as other lumped-component models are typical analytical and computational tools used to represent these measurements. The first derivative of phase with respect to frequency, group delay, is an important measurement of distortion in communication systems. Hewlett-Packard produces a broad line of instrumentation capable of measuring all of these parameters.

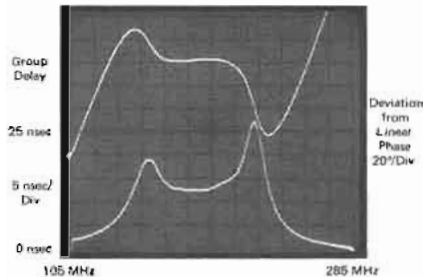

Figure 5. Two independent techniques for measuring filter phase distortion

Phase information complements amplitude data in the measurement of low frequency parameters because it is more sensitive to network behavior and because it is a required component of complex impedance and transfer functions. For instance, phase is more sensitive than amplitude in determining the frequency of network resonances (poles) and anti-resonances (zeros). This is because the phase shift of a network transfer function is exactly zero at the frequency of resonance. Phase information is also vital in circuit design, particularly loop design, where phase margins are critical.

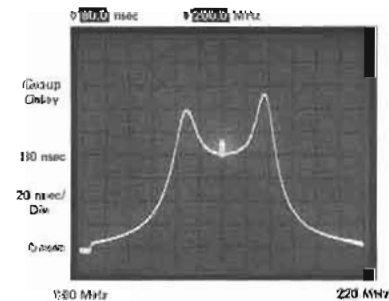

Figure 6. Direct Measurement of Group Delay with digital readout at marker

Phase data are also required to measure delay distortion or group delay of networks. Delay distortion occurs when different frequency components of a complex waveform experience nonlinear phase shifts as they are transmitted through a network. Group delay is a measure of this distortion and is defined as:

$$T_g = \frac{d\theta}{d\omega}$$

There are several techniques for measuring group delay; the most common techniques are phase slope, amplitude modulation, frequency modulation, and frequency deviation. Most HP network analyzers can make measurements with at least one of these techniques while several analyzers measure and display group delay directly. Choice of a group delay measurement technique is dependent on the particular device under test and the resolution required.

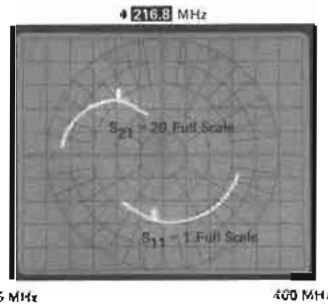

Figure 7. Simultaneous measurement of transistor S-parameters

An alternative method for measuring phase distortion is deviation from linear phase or differential phase. Deviations from linear phase can be measured by introducing enough electrical length in the network analyzer's reference channel to linearize a device's phase shift. Once this has been accomplished it is possible to observe any variations in phase shift linearity at high resolution. Since group delay is the derivative of phase ( $d\theta/d\omega$ ), nonlinearities in phase shift correspond directly to changes in a device's group delay. Introduction of electrical length in the measurement channel may be accomplished by physically adding cable, or it may be accomplished electronically on some network analyzers.

### High frequency network analysis

Total voltage and current along a transmission line begin to vary periodically with distance as frequency increases. Consequently, it becomes difficult to establish the required shorts and opens in the correct measurement plane to determine low frequency parameters. Transmission-line theory explains the variations in total voltage and current at high frequencies through forward and reverse traveling waves. Thus, traveling waves are the logical variables to measure at higher frequencies.

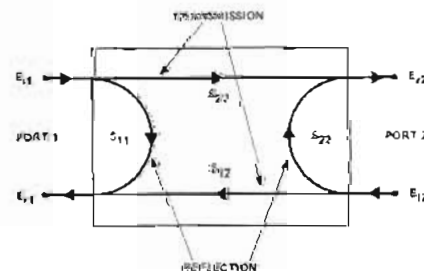

Figure 8. S-parameter model for a two-port linear network

Scattering parameters or S-parameters were developed to characterize linear networks at high frequencies. S-parameters define the ratios of reflected and transmitted traveling waves measured at the network ports.  $S_{11}$  is the complex reflection coefficient at port 1 and is the ratio of  $E_{r1}/E_{i1}$ , if  $E_{i2} = 0$  (port 2 terminated in its characteristic impedance).  $S_{21}$  is the complex transmission coefficient from port 1 to port 2.  $E_{r2}/E_{i1}$ , if  $E_{i2} = 0$ ,  $E_{i1}$ , and  $E_{r2}$  are normalized voltages (voltage divided by the square root of the characteristic impedance) and represent the amplitude and phase of the traveling waves. By reversing the ports and terminating port 1 in its characteristic impedance,  $S_{22}$  and  $S_{12}$  can be similarly defined. From these definitions, the following equations can be derived:

$$E_{r1} = S_{11}E_{i1} + S_{12}E_{i2}$$

$$E_{r2} = S_{21}E_{i1} + S_{22}E_{i2}$$

where incident signals act as independent variables determining the signals leaving the network. The definition of an S-parameter can be easily extended to multiport networks; measurement is also easily accomplished by terminating additional ports in their characteristic impedances. Thus, S-parameters completely describe linear network behavior in the same manner as low frequency parameters.

S-parameters offer numerous advantages to the microwave engineer because they are both easy to use and easy to measure. They are easy to measure because the device is terminated in its characteristic impedance which is accurate at high frequencies, allows swept broadband frequency measurement without tuning, enhances the stability of active devices, and permits a test set up to be used for different devices. The design process is simplified because S-parameters are directly applicable to flow graph analysis. HP network analyzers and the appropriate test sets will measure and directly display  $S_{21}$  or  $S_{12}$  as gain or attenuation and  $S_{11}$  or  $S_{22}$  as reflection coefficient, return loss or impedance. Also, S-parameters may be directly related to h, y, and z-parameters through algebraic transformations.

With the increased utilization of microwave frequencies in a broad spectrum of applications, S-parameter measurements have become more important and more generally used in designing both active and passive networks. Hewlett-Packard has developed a series of tutorials for measurement and design with S-parameters: Application Notes 117-1, 117-2, 154, video tapes #800586 and #800600 deal with general S-parameter techniques. Further aids include special S-parameter design seminars and a set of calculator programs "Microwave Circuit Design PAC" for computationally aided design.

### Additional capabilities

The computational capabilities of a digital computer can complement the network analyzer's versatility through simplifying and speeding measurements, data processing, and accuracy enhancement. Hewlett-Packard has integrated network analyzers

into computer systems and now offers some analyzers that may be easily interfaced with HP desktop computers through the Hewlett-Packard Interface Bus.

Precision design work and important manufacturing tolerances demand highly accurate measurements, but more errors in network measurements are complex quantities that vary as a function of frequency, making manual error correction prohibitive. However, the computer can make great contributions to measurement confidence by quickly and easily performing the complex mathematics for sophisticated error correction.

Aside from new levels of accuracy, computer controlled network analyzers can be programmed to set up and make many measurements automatically. The measurement process is further accelerated by the computer's ability to store, transform, summarize, and output data in a variety of formats on a number of peripherals. These capabilities make the computer controlled network analyzer ideal for both computationally aided design or automatic production testing.

#### Network Analyzer Product Line

Hewlett-Packard offers a complete line of network analyzers capable of measurements through the 1 Hz to 40 GHz frequency range. Further information and detailed specifications on individual network analyzers are available on the following pages (see matrix for specific page numbers).

#### 3575A

The 3575A measures Phase and Amplitude or Gain. With the 3575A, the complete response picture is available at a reasonable cost from a single instrument, over an 80 dB range, from 1 Hz to 13 MHz. The 3575A uses a broadband measurement technique, which is attractive because the measurement is not constrained by internal tracking source or dedicated external device. The 3575A is not dependent on the wave shape, thus measurements can be made on a variety of waveforms such as triangle and square waves.

#### 3040A/3042A

The 3040A is a network analysis system capable of measuring amplitude and phase to 13 MHz. Group delay is an optional capability. The system consists of a synthesizer signal source and a two-channel tracking detector. Measurement applications include filter design and production, amplifier testing, delay measurements on communication devices, and measurements on any linear two-port device.

The 3042A is a fully automatic system which uses the HP 9825A Desktop Computer as a computing controller. The memory, computational power and decision-making power of the computing controller extend the measurement solutions to complex networks in the lab or rapid production line testing. Accuracy can be improved by subtracting system errors from the measurements by using the memory and algebraic powers of the computer and supplied software.

#### 8407A

The 8407A network analyzer tracks the 8601A generator/sweeper (or the 8690B/8698B sweeper) from 100 kHz to 110 MHz. Measurement capabilities include:

- 1) Transmission (gain, loss, phase shift) and reflection (return loss, impedance) measured quickly and easily in either 50Ω or 75Ω by sweeping over the frequency range of interest.
- 2) Complex impedance [Z],  $\theta$ , or  $R=jX$  over the wide impedance range 0.1Ω to >10 kΩ.
- 3) Voltage and current transfer functions.
- 4) High impedance in-circuit probing.

A rectangular and polar display and various CRT overlays permit direct readings of parameters of interest as frequency is swept. Applications are detailed in Application Notes 121-1, 121-2. A videotape "8407 Network Analyzer System," #800475, is also available.

#### 8405

The 8405A vector voltmeter is a dual-channel RF millivoltmeter and phasemeter. It reads the absolute voltages on either of two channels and simultaneously determines the phase relationship between them. CW measurements can be made over the frequency range 1 MHz to 1 GHz.

Besides its use as a voltmeter, applications of the 8405A include:

- 1) Transmission measurements (gain, loss, phase shift and return loss) in 50Ω systems.
- 2) Group delay and amplitude modulation index.
- 3) In-circuit probing.
- 4) S-parameters in 50Ω systems.

Application Notes 77-1, 77-3, 77-4, and 91 are available for more detail on the above measurements.

#### 8505A/8507A

The 8505A Network Analyzer provides measurement capability from 500 kHz to 1.3 GHz. Three RF input ports, each with 100 dB of dynamic range, make possible simultaneous network measurements of reflection and transmission parameters. Two independent yet identical display channels are each capable of displaying magnitude, phase, deviation from linear phase and group delay of either the transmission or reflection characteristics of an RF Network. These parameters can be displayed in rectangular, in polar coordinates or both formats at the same time. The Swept Source, which is an integral part of the analyzer, offers extreme frequency flexibility through seven different modes of operation.

The 8507A/B is an Automatic Network Analyzer using the 8505A with HP-IB interface and either the HP 9825A or HP 9830B Desktop Computer as a controller. The "Learn" mode of operation extends the traditional automatic operation to a new level of operator convenience. Accuracy

enhancement, formatting of data, and the speed and ease with which data can be accumulated and summarized are all network measurement contributions made by the 8507A/B.

#### 8410B/8409A

The 8410B network analyzer system measures the transmission and reflection characteristics of linear networks in the form of gain, attenuation phase shift, reflection coefficient, normalized impedance and S-parameters in the frequency range of 110 MHz to 40 GHz.

Harmonic frequency conversion of the RF to a constant 1F is accomplished by the 8411A Harmonic Frequency Converter from 110 MHz to 12.4 GHz; the 8411A Options D18 operates from 110 MHz to 18 GHz. In the frequency ranges 18–26.5 GHz (K-band) and 26.5–40 GHz (R-band), the K8747A and R8747A Reflection/Transmission Test units use crystal mixers and a local oscillator to heterodyne the signals down into the range of the 8410B/8411A. In this manner, waveguide components can be measured from 18 to 40 GHz.

The 8410B is a ratiometer using both reference and test signal inputs; consequently, the sweeper output must be divided into channels. This is accomplished by a "Test Set" whose other major function can be to provide the switching required for making transmission and reflection measurements with minimum or no changes in the measurement setup. Hewlett-Packard offers a total of twelve different test sets covering various frequency ranges and switching functions.

Another major instrument required in the 8410 measurement system is a unit for the detection and display of the 1F amplitude and phase. Three plug-in displays (for the 8410B mainframe) are available for this purpose: a phase-gain indicator with meter readouts for CW measurements; a phase-gain display for displaying log amplitude and phase versus frequency; and a polar display for displaying amplitude and phase in polar coordinates.

The 8410B is capable of swept measurements over multi-octave bands through 18 GHz. Between 18 GHz and 40 GHz, 2 GHz windows may be viewed. Measurements of more than 60 dB of attenuation and 40 dB of gain are possible.

The HP 8409A Semi-Automatic Network Analyzer System is a practical solution to the need for automatic error-corrected RF and microwave network measurements using a simple and economical configuration. It is a complete measurement system, consisting of the programmable 8620C Sweeper, the 8410B Network Analyzer System, and the 9825A Desktop Computer. It brings the major advantages in accuracy, speed, data collection, and operating convenience at a modest cost increase over the manual network analyzer system. Further information is available in Application Notes 117-1, 117-2, 221 and in videotape #800473.



# NETWORK ANALYZERS

Complete characterization of linear networks (cont.)

## 8540 Series

The 8540 series system (100 MHz to 18 GHz) couples the network analyzers' ability to completely characterize a linear network with the computer's ability to completely setup a measurement, store data, and solve complex mathematics. As a result, the au-

tomated system offers these advantages: increased speed of measurement; increased accuracy through sophisticated error-correction techniques; ease of operation; and a variable data output format (alphanumeric or graphic with hardcopy, cassette or CRT presentations).

Data can also be made readily accessible to computer aided design programs to assist designer in evaluating overall network performance based on component measurement data.

## NETWORK ANALYZER PRODUCT LINE SUMMARY

Model	Frequency Range	Source	Measurement Capabilities
3575A Gain Phase Meter Page 438	1 Hz-13 MHz	None	Gain Phase and Amplitude Low Frequency Analysis
3040A Manual Network Analyzer Page 435	50 Hz-13MHz	3320A/B or 3330A/B	Amplitude and Phase Option Group Delay Gain or Loss Linear Frequency Sweep
3042A Automatic Network Analyzer Page 436	50 Hz-13MHz	3330B Synthesizer	9825A or 9830B Desktop Computer Control Complex Network Analysis Decision Making Ability Computation Capability
8407A Network Analyzer Page 448	100 kHz-110MHz	8601A Generator/Sweeper 8690B/8698B Sweep Oscillator	Transfer functions, impedance in 50Ω, 75Ω Systems Complex Impedance 0.1Ω to >10 kΩ High Impedance In-Circuit Probing S-parameters in 50Ω, 75Ω systems
8405A Vector Voltmeter Page 450	1 MHz-1GHz (CW)	3200B Oscillator, VHF Signal Generators, 608E (VHF), 612A (UHF), 8654 (UHF), and 8640 A/B	Voltmeter Transfer Functions, Impedance in 50Ω systems Group Delay, Amplitude Modulation Index S-parameters in 50Ω systems
8505A RF Network Analyzer Page 440	500 kHz-1.3GHz	Swept Source Included	Complex Transfer functions—Gain/Loss or S-parameters Complex Impedance—Γ, Return Loss, R± jX Distortion—Group Delay, Deviation from Linear Phase Digital Readout of Data while sweeping Frequency Counter included HP-IB with Learn Mode
8507A/B Automatic RF Network Analyzer Page 448	500 kHz-1.3GHz	Swept Source Included	9830B or 9825A Desktop Computer with 8505A HP-IB with Learn Mode Automatic Measurements with Data Formatting Accuracy Improved Measurements
8410B Network Analyzer Page 451	110 MHz-40GHz	8620 or 8690 Series Sweep Oscillators	Transmission/Reflection Characteristics, S-Parameters 50Ω Coax Measurements 110 MHz to 18 GHz Waveguide Measurements 8.2 GHz to 40 GHz Continuous Multioctave Measurements with 8620 Series Sweepers DC Bias for Semiconductor Measurements
8409A Semi-Automatic Network Analyzer Page 458	110 MHz-18GHz	8620C Series Sweep Oscillators	Semi-Automatic Transmission/Reflection Measurements Full Error Correction in Reflection Measurements 8410B Network Analyzer System 9825A Desktop Computer
8542B Automatic Network Analyzer Page 577	100 MHz-18GHz	8620 or 8690 Series Sweep Oscillators	Automatic Measurements of Transmission/Reflection Characteristics Full Error Correction Virtually No Programming Required Versatile Output: 28 Parameter Alphanumeric or Graphic; Hardcopy Cassette or Cathode-Ray Tube

# NETWORK ANALYZERS

Network analysis from 50 Hz to 13 MHz  
Model 3040A



- High resolution digital amplitude and phase measurements
- 100 dB dynamic range
- Precision digital sweep capability

- Narrow band analysis
- Optional group delay and limit test
- Full digital control via HP-IB

3040A Network Analyzer



3330B Synthesizer



## Description

The 3040A Network Analyzer is designed to meet the demand for precise and fast characterization of both active and passive linear two-port devices. The Network Analyzer is a new, powerful bench system that makes digital amplitude, phase and group delay response measurements over a 50 Hz to 13 MHz frequency range. It uses the 3330B Automatic Synthesizer with leveled output and digital sweep capability to generate the local oscillator signal for the 3570A Tracking Receiver and to provide the stimulus to the device under test.

This system effectively combines the wide dynamic range and the high accuracy of the 3570A Tracking Receiver with the high resolution, and stability of the 3330B Synthesizer, giving the design, production and Q.A. engineers working at audio, video and RF frequencies the precision, convenience and high information content of swept-frequency response measurements, but with the point by point accuracy of synthesized incremental frequency sweeps.

Residual FM, often a serious limitation to the frequency resolution of swept frequency measurements, is very low ( $\ll 1$  Hz) in the 3040A System, allowing accurate narrow band sweeps.

The 3570A Analyzer (Tracking Receiver) has two identical channels for fast, high accuracy "B-A" measurements of gain or insertion loss of two-port devices and to measure the phase shift between input and output ports. It can also function as a limit comparator to determine how closely the gain and phase response of a device matches that of a reference.

Both the passband and the stopband of a device can be examined in detail because the 3570A Analyzer has both a wide amplitude range of 120 dB (1  $\mu$ V to 1 V) and a high resolution display (0.01 dB increments). The digital readout also displays phase readings with 0.01° resolution.

Beyond the basic amplitude and phase measurements, the 3040A offers several automatic features not found in more conventional network analyzers.

One is Digital Offset: Values of amplitude and/or phase measured on a reference device are stored in the instrument's memory at the push of a button. Future measurements can then be displayed relative to the stored values. This could be used, for example, to quickly find the -3 dB passband limits of a filter or amplifier.

Another feature is Group Delay: As the synthesizer is stepped in frequency, the analyzer's internal digital processor calculates group delay from two phase shift measurements as  $T_d = \Delta\phi/360\Delta f$  sec.

A third one is Limit Test: High and low limits can be entered as digital words from an external controller, for example, a paper tape. The analyzer can be set to stop or output a marker when a limit is reached. This capability is useful for example to precisely find the center frequency of a resonant circuit by stopping at the 0° phase reading.

The 3040A Network Analyzer introduces precision, convenience and built-in "intelligence" to the problem of characterizing the behavior of linear networks on the bench.

# NETWORK ANALYZERS

Automatic network analysis from 50 Hz to 13 MHz

Model 3042A



3042A Automatic Network Analyzer



## Description

The 3042A Automatic Network Analyzer is a highly powerful, fully automatic computer controlled system that is designed to meet the demand for precision, speed, automation, simple operation and low cost in the area of fully characterizing active or passive linear two-port devices.

The 3042A system uniquely integrates the

- wide dynamic range and high resolution of the 3570A Network Analyzer (tracking receiver)
- accuracy and high stability of the 3330B Synthesizer and
- The power computation, data processing and smart peripheral control capabilities of the 9825A Computing Controller

into a superior systems performance that results in a unique set of contributions to solve the problem of characterizing the behavior of linear two-port over the wide frequency range of 50 Hz to 13 MHz:

- Amplitude, phase and group delay measurement
- Wide amplitude range and high resolution
- Speed and precision in measurements
- Simplicity and flexibility in operation
- Data analysis and presentation of results
- Simple programming and powerful output
- Accuracy enhancement and decision making
- Full automation and substantial reduction in costs

- Full automation and low cost
- Speed and precision in measurements
- Accuracy enhancement
- Data analysis and presentation of results
- Simplicity and flexibility in operation
- HP-IB systems interfacing
- 9825A Computing Controller

The 3042A is a fully automatic two-channel Network Analyzer System that provides digital amplitude, phase and group delay measurements, on line data analysis, data reduction and decision making capability plus formatted graphic or tabular representation of results or data storage for further processing at a later time.

Environments such as production, quality assurance and the laboratory are now provided with the capability of extending precision network analysis to applications that were previously impractical because of the length of time it took to make the necessary measurements.

### Production applications

In production applications the 3042A substantially reduces the time and cost of making a range of simple or complicated tests on all types of components, for example, crystals, amplifiers, filters and other analog devices. The system can run through a long series of tests on a device, checking performance at all specified points and deliver a simple pass/fail answer.

However, automatically compiled test data provides excellent production statistics for improved production control, more precise scheduling and accurate production cost analysis.

Testing programs with built-in operator instructions minimize the requirements for highly trained technicians as well as training costs. Furthermore, uniform test procedures may easily be established. The 3042's impact in the production environment can be directly traced to a substantial increase in total production throughput while at the same time increasing the number of test parameters, resulting in greater product confidence and lower production cost.

### Quality assurance applications

In quality assurance applications the 3042A not only significantly reduces the cost of test equipment necessary to assure a comprehensive product testing job, but the system's inherent flexible HP-IB interface structure allows the system configuration to be easily changed by either simple software modifications or hardware additions. Adapting the 3042A System to an application, which may require a programmable power supply or contact closure to drive the device under test, becomes as simple as connecting the additional instruments via the standard HP-IB connector, loading a different program from the computing controller's cassette and running it. Skilled technicians may be relieved from repetitive yet demanding tasks and placed in positions that maximize the use of their knowledge and skills. The 3042A provides reliable and repeatable results. Various parameters may be tested in greater detail and in less time, resulting in greater product confidence and quality but lower warranty costs.

Automatically compiled test data provides excellent quality assurance statistics which can easily be presented in any formatted graphic or tabular form by an optional plotter or line printer.

### Laboratory applications

In laboratory applications, engineers gain greater insight into their circuit design due to the speed and ease with which data can be accumulated and summarized with the 3042A. The easy-to-use calculator programming format allows easy-to-write, customized programs which solve specialized measurement problems in a fraction of the time required to manually perform and evaluate the same measurements or to write a corresponding computer program. In addition the accuracy enhancement software furnished with the 3042A System significantly increases the accuracy of the system seven times over that of a single channel measurement (three times over a "B-A" measurement), by judiciously combining the capabilities of the instruments and the controller.



**System control and interface**

The 3042A Automatic Network Analyzer incorporates the new 9825A Computing Controller as systems controller, operator interface and data processor. The 9825A offers the power and speed of much larger computers but features a high level programming language and editing capabilities that allow nearly instant use of the system with minimal effort.

System-operator interface is greatly simplified through the 9825A's alphanumeric display and typewriter-like keyboard.

Easy programmability which requires minimal training, versatile editing capability for reducing programming time, immediate feedback on errors made due to improper instructions, availability of large user memory for lengthy program or data storage, cartridge convenience for permanent storage of programs or data and flexibility for input and output functions are features offered by the 9825A controller.

**Summary**

The 3042A Automatic Network Analyzer provides a complete solution to production, quality assurance and laboratory applications at audio, video and RF frequencies with accurate, reliable, repeatable and fast results plus the high information content that automatic gain-phase-delay measurements can give.

**Specifications 3040A and 3042A systems**

**Sources** (Channel A & B outputs are isolated and electrically identical)

**Frequency**

**Range:** 0.1 to 13,000,999.9 Hz.

**Resolution:** 0.1 Hz (9 digits).

**Amplitude**

**Range:** +13.44 to -86.55 dBm (50Ω).

+11.68 to -88.31 dBm (75Ω option).

**Resolution:** 0.01 dB.

**Accuracy**

**Leveled frequency response (10 kHz reference)\***

10 Hz	13 MHz	-13.44 dBm
±0.05 dB		-16.55 dBm
±0.1 dB		-36.55 dBm
±0.2 dB		-66.55 dBm
±0.4 dB		-86.55 dBm

\*Add 0.5 dB for leveling switch in off position.

**Attenuator:** (10 kHz reference, 25°C ±5°C) ±0.2 dB/10 dB step of attenuation down from maximum output.

**Absolute:** (10 kHz, maximum output, 25°C ±5°C) ±0.45 dB.

**Stability:** (24 hr., 25°C ±1°C): ±0.01 dB.

**Impedance:** 50 or 75Ω (optional) ±2%.

**Receivers** (Channel A & B inputs are electrically identical and both tuned precisely to the signal source's frequency)

**Frequency**

**Range:** 50 Hz to 13 MHz.

**Resolution:** 0.1 Hz.

**Selectivity:** 10 Hz, 100 Hz and 3 kHz bandwidths (60 dB/3 dB bandwidths, 20:1).

**Amplitude:** (Output is in dB relative to 1 V, 0 dBm or 0.1 V, corresponding to the position of the "Max/Ref Input Voltage" switch.)

**Measurement range:** 1 V rms to 1 μV rms.

**Dynamic range:** 0 to -100 dB (using A or B amplitude function), -100 dB to +100 dB (using B-A amplitude function).

**Resolution:** 0.01 dB.

**Accuracy:** (25°C ±5°C): Accuracy of the 3042A is enhanced with software supplied with the system over the 50 Hz to 10 MHz and over the top 20 dB of the dynamic range as shown below.

**Frequency response:** A or B "Amplitude Function" ±0.5 dB; B-A "Amplitude Function" ±0.1 dB; using Accuracy Enhancement Software ±0.03 dB furnished with 3042 system.

**Linearity:** (A or B amplitude function)

0 to -20 dB	$\left\{ \begin{array}{l} \pm 0.2 \text{ dB} \\ \pm 0.06 \text{ dB with Accuracy Enhancement} \end{array} \right.$
-20 to -80 dB	
-80 to -100 dB	±1.5 dB

**Stability (8 hr., 25°C ±1°C after 3 hr. warmup)**

100 Hz & 3 kHz BW	±0.05 dB	±0.08 dB	Not specified	Temp. Coefficient (20°C - 30°C)	
10 Hz BW	±0.08 dB	±0.15 dB	Not specified		
	0 dB	-20 dB	-80 dB	-100 dB	±0.02 dB/°C
					±0.05 dB/°C

**Phase (Phase reference is channel A)**

**Range:** -179.5° to 179.5° (display recycles).

**Resolution:** 0.01°.

**Accuracy:** (25°C ±5°C).

**Frequency response (Channel at 0 dB)**

50 Hz	100 Hz	1 MHz	13 MHz
±0.8°	±0.2°	±1°	

**Amplitude response Channel B within 6 dB of Channel A**

0 dB	-20 dB	-70 dB	-80 dB	100 dB
±0.4°	±0.6°	±1°	No Spec	

For channels at different levels (specification determination by lowest input).

0 dB	-20 dB	-60 dB	-80 dB	-100 dB
±1.3°	±1.5°	±3.5°	No Spec	

\*Only specified to -70 dB for frequencies from 50 Hz to 100 kHz.

**Linearity:** ±0.2° (Channel B within 6 dB of Channel A).

**Input Impedance:** 1 MΩ ±2% shunted by <30 pF.

**General**

**Programmability:** all controls, except power switches are programmable using the HP-IB format.

**Ultra-high accuracy:** the 3040/42A systems can be coupled with an external device such as a calibrated attenuator to provide relative measurements whose amplitude accuracy is limited to the amplitude stability of the receiver and source and the accuracy of the external device.

**3040A Options**

The basic 3040A system options are listed below. For more information refer to the 3040/3042A data sheet.

(Order Opt 110 or 111 and Opt 120 or 121)	
110: Standard 50Ω 3570A	\$6890
111: Standard 75Ω 3570A	\$6890
112: Delay/Limit Test/Offset (Hardware)	\$470
113: Cable and Load Kit	\$87
120: Standard 50Ω 3330B	\$7455
121: Standard 75Ω 3330B	\$7455

**3042A Options**

The basic 3042A system options are listed below. For more information refer to the 3040/3042A data sheet.

200: 50Ω System	N/C
201: 75Ω System	N/C
204: 1201B Oscilloscope	\$2670

The 3042A system is fully integrated, tested, verified and specified as a system. It is supplied with complete software and documentation.

**3042A Automatic Network Analyzer \$24,775**

Consisting of: 3330B Synthesizer, 3570A Network Analyzer, 9825A Calculator, 6.8k bytes memory, ROMs, Interface and documentation, 56" Rack.

# NETWORK ANALYZERS

## Gain/phase meter

### Model 3575A

- dBV, dB ratio and degrees from 1 Hz to 13 MHz



3575A Option 001 dual panel meters

## Description

The HP 3575A Gain-Phase Meter is a versatile two-channel analyzer which can measure and display the absolute amplitude level or amplitude ratio of signals present at the inputs. In addition, the 3575A can measure the phase relationship of the two signals. This analyzer is a broadband detector which is easy to use because no frequency tuning is required.

Since a dedicated tracking source is not required to operate with the 3575A, a wide selection of stimuli is possible. This flexibility coupled with a variety of possible amplitude, gain and phase outputs (LED display, analog outputs, and optional BCD) give you a wide choice of cost/results tradeoffs. For example, you may wish to manually plot your network response data on a Bode diagram in which case a low cost sine wave oscillator stimulus may be used. For easier, quicker results you may select a sweeping oscillator and an x-y plotter and let the instruments plot your response. You may use a calculator or computer to control a programmable stimulus source and the 3575A to provide automatic measurements. Here you have a wide range of computation and output possibilities.

### Phase

The phase relationship of two signals is indicated over a range of  $\pm 192$  degrees with 0.1 degree resolution. A unique logic circuit (patent) design allows the 3575A to make stable phase measurements in the presence of noise. This feature minimizes the error to less than two degrees for a signal-to-noise ratio of 30 dB. One of three band limiting filters may be selected to get further noise rejection.

The 3575A is also capable of measuring the phase relationship of a variety of waveforms such as square waves and triangle waves. Even harmonic and in-phase odd harmonic components of these signals cause no phase measurement error. For out-of-phase odd harmonic signal-to-harmonic ratios of 40 dB, measurement errors are less than 0.6 degree as shown in Figure 1.

### Amplitude

The amplitude of either channel or the ratio of the two can be measured over an 80 dB dynamic range and 100 dB measurement range. Resolution is 0.1 dB. Results are displayed in dBV for channel amplitude and dB for ratio measurements. Digit blanking and channel overload annunciators will turn on if the maximum allowable signal level at either channel input is exceeded.

### Readout

The standard three-digit LED display may be selected by the operator to indicate the amplitude of channel A or B or gain or phase. A second three-digit LED display is optionally available for simultaneous display of amplitude and phase readings. Lighted annunciators identify the measurement function, units and remote status.

### Programmable

Two programmable options both offer full control of front panel functions and BCD output of information (amplitude, ratio or phase) contained in both digital displays. The two options give the user a choice of **negative** true or **positive** true outputs.

### Applications

The 3575A can solve network analysis problems in the 1 Hz to 13 MHz frequency range where complex measurements (gain or phase or both) are required. A few of the many measurements it can make are: **gain** and **phase** response of feedback systems, envelope delay and **return loss** of transmission lines, complex impedance of components, and **insertion loss** of mixers and frequency doublers. Bode plots and Nichols charts are useful graphical tools for analyzing many of these response data.

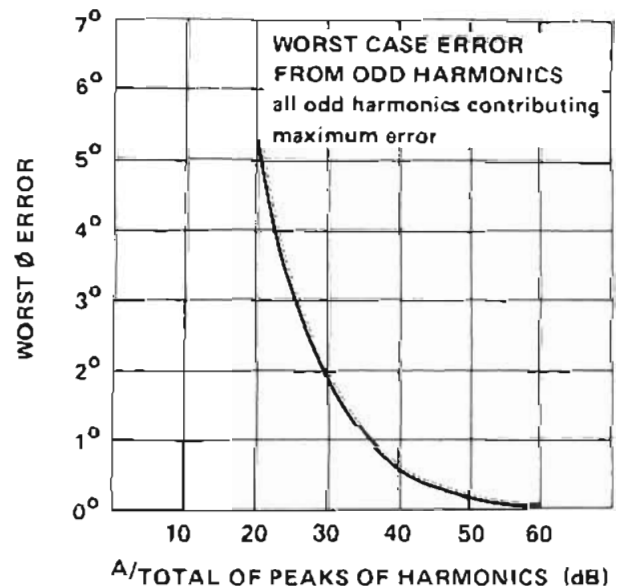
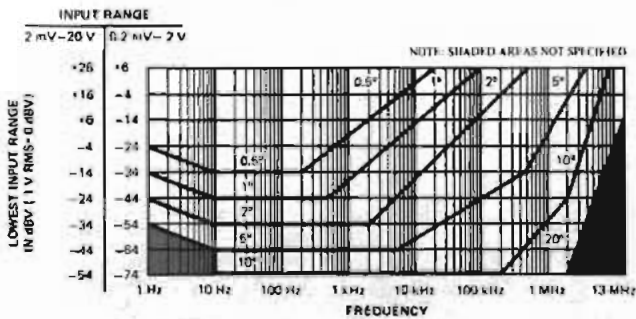

Figure 1. Worst case error from odd harmonics.

## Specifications

### Phase accuracy\*



\*Conditions: Temperature: 25°C ± 10°C; frequency range switch on lowest applicable range; Analog Output accuracy (rear panel).

Input signal range: 200 μV rms to 20 V rms.

### Harmonic rejection

**Even harmonics:** no error.

**Odd harmonics:** (in phase) no error.

**Odd harmonics:** (out of phase) 0.57° worst case error when total odd harmonic distortion is 40 dB below the fundamental.

**Noise tolerance:** 2° error for a 10 kHz, 1 V sine wave on one channel. One volt sine wave added to Gaussian noise (limited to a 1 MHz bandwidth and 30 dB S/N ratio) on the other channel. The 100 Hz to 1 MHz frequency range was used.

### Display

**Range:** ± 180° with 12° of overrange.

**Resolution:** 0.1°.

**Panel meter accuracy:** ± 3 counts (0.3 degrees, 0.3 dB/dBV). The panel meter error must be added to the phase and amplitude errors to obtain the display error.

### Inputs

**Impedance:** 1 MΩ 30 pF.

**Protection:** ± 50 V dc, 25 V rms.

**Response time to achieve 90% of final reading**

Frequency Range	Time
1 Hz to 1 kHz	20 s
10 Hz to 100 kHz	2 s
100 Hz to 1 MHz	0.2 s
1 kHz to 13 MHz	20 ms

Rear terminal inputs are available as a special (3575A-C09). Digital (Opt. 002). 0, +5 ground true. Twelve lines to fully program all functions.

### Outputs

#### Analog

**Phase:** 10 mV/degree.

**Amplitude:** 10 mV/dB or dBV.

**Output impedance:** 1 kΩ

**Digital (Opt 002):** 0, +5 V ground true. 31 output lines (1-2-4-8 BCD).

**Digital readout:** 3½ digits with sign and annunciators. Four readings per second, fixed.

### Amplitude accuracy\*

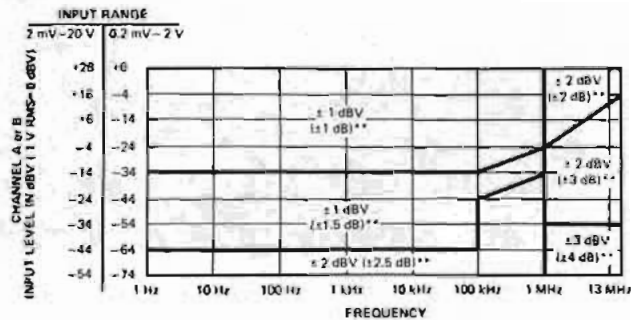

\*Conditions: Temperature: 25°C ± 10°C; accuracy applies to dBV and ratio measurements with the same frequency on both channels; for ratio measurements, the lowest level channel determines accuracy; analog output accuracy (rear panel).

**Amplitude functions:** A dBV, B dBV or B/A dB.

**Amplitude reference:** (A dBV, B dBV) 1 V rms = 0 dBV.

### Display

**Range:** A dBV, B dBV: -74 dBV to +26 dB (in two ranges).

B/A dB: -100 to +100 dB. (Both input signals must be within the range of 0.2 mV rms to 20 V rms).

**Resolution:** 0.1 dBV, 0.1 dB.

### Options

**001 Dual panel meters:** HP's 3575A Opt 001 is equipped with two digital readouts and two analog outputs for simultaneous amplitude and phase readings. This option has no additional measurement capability over the standard instrument.

**Dual analog outputs:** rear panel BNC connectors provide dc output voltages that correspond to the respective panel meter readings.

**002/003 Programmable:** 3575A Opt 002 and Opt 003 are equipped with dual panel meters and dual analog outputs (same as Opt 001) plus BCD outputs and complete remote control capability. Opt 002 has negative true output levels and Opt 003 has positive true output levels. BCD information from the 3575A (Opt 002) can be read by the 9800 series HP Calculators with appropriate interfacing.

**908:** Rack Flange Kit.

### General

**Power:** 115 V/230 V ± 10%, 48 Hz to 60 Hz, 40 VA.

**Weight:** net, 8.3 kg (18.4 lb). Shipping, 11.3 kg (25.8 lb).

**Size:** 88 H × 425 W × 337 mm D (3½/₃₂" × 16¾/₈" × 13¼/₈").

**Accessories furnished:** extender boards, line cable and 50-pin connector (Opt 002 and 003 only).

### Options

**001:** Dual Readout

**002:** Programmable (negative true output levels)

**003:** Programmable (positive true output levels)

**908:** Rack Flange Kit

**910:** Extra Product Manual

### Price

add \$525

add \$930

add \$930

add \$10

add \$23

3575A Gain/Phase Meter

\$3050

# NETWORK ANALYZERS

## RF network analyzer, 500 kHz to 1.3 GHz

### Model 8505A

- 100 dB of dynamic range
- Digital readout of data with analog display
- Direct group delay and deviation from linear phase
- High performance sweep oscillator
- Complete family of 50 $\Omega$  and 75 $\Omega$  test sets
- Digital storage and normalization

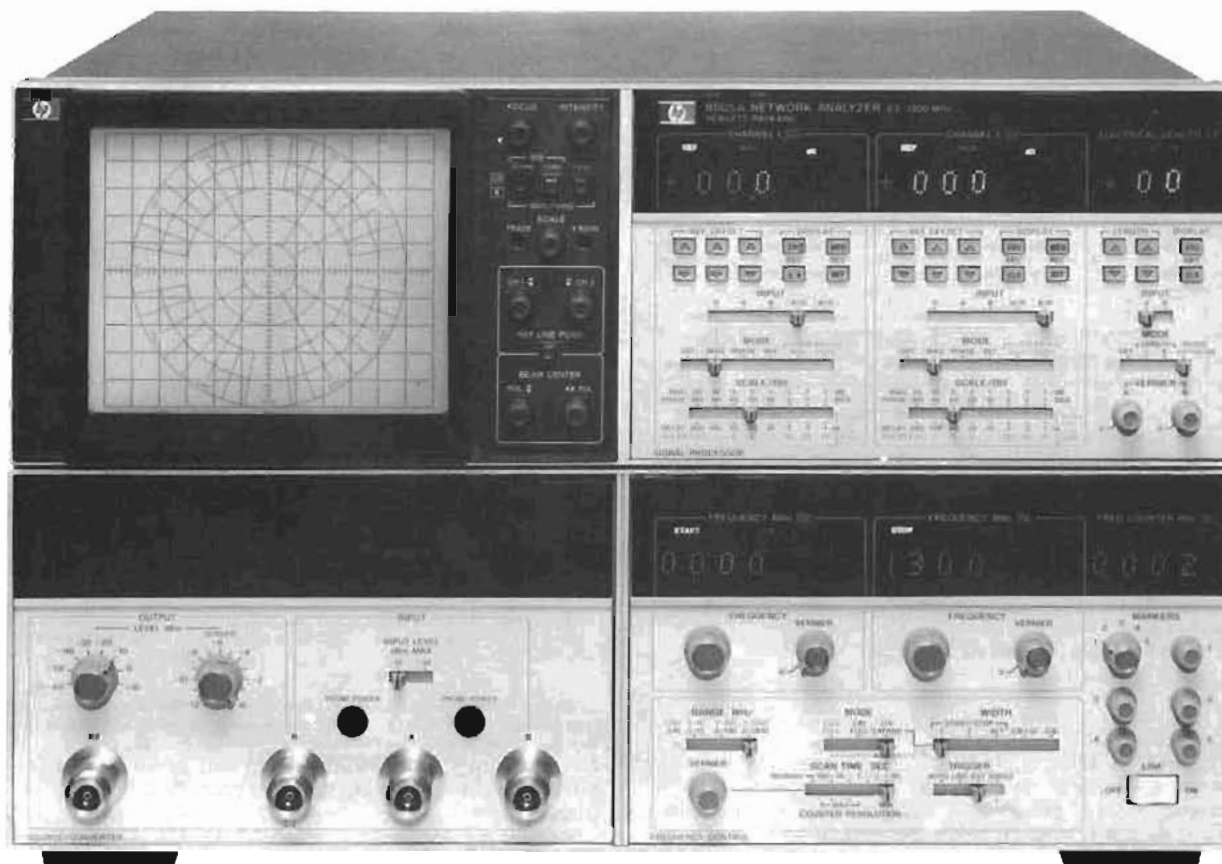

8505A

HP-IB

The HP 8505A is a high performance RF network analyzer operating over the 500 kHz to 1.3 GHz frequency range. It accurately and easily measures complex impedance, transfer functions and group delay of coaxial components and semiconductors. Because both magnitude and phase are measured, it is possible to completely characterize the linear behavior of either active or passive networks.

Since magnitude and phase can be measured and displayed over 100 dB of dynamic range (-10 to +110 dBm), it is a simple process for the 8505A to measure transmission loss of high rejection devices such as filters or gain and return loss of small signal devices like amplifiers. Distortion parameters like group delay, deviation from linear phase, and deviation from constant amplitude are measured in an equally straight-forward manner. Group delay is measured and displayed directly to resolutions of 1 ns per major division using a new linear FM measurement technique. A unique new electrical line stretcher compensates for the linear phase shift of the device under test so that phase non-linearities may be examined at high resolution (1° per major division). Amplitude deviations with frequency can be similarly observed to resolutions 0.1 dB per major division with clear, crisp trace stability. In addition, it is possible to read out amplitude, phase and delay digitally while sweeping at any one of five continuously variable markers with resolutions of 0.01 dB, 0.1°, and 0.1 ns respectively.

Many of the 8505A's high performance features and operating conveniences are derived from the fact that it is a completely integrated system including both the sweep oscillator and receiver. The basic instrument also includes a built-in frequency counter, polar and rectangular displays on the same CRT, the new electronic line stretcher, group delay measurement, and frequency selective digital readings of amplitude, phase and delay while sweeping. The frequency counter with resolutions up to 100 Hz adds further precision to the measurements by allowing frequency as well as amplitude, phase and delay to be read out at any of the five markers. The 8505A is fully programmable in a straight-forward fashion using the Hewlett-Packard Interface Bus (Opt 001). Two fully configured calculator-based automatic network analyzers systems, the 8507A and 8507B are offered (see page 446).

Companion instruments include the 11850A Three Way Power Splitter for high resolution transmission and transmission comparison measurements, the 8502A Transmission/Reflection Bridge for simultaneous transmission and reflection measurements, and the 8503A S-parameter Test Set for complete characterization of two port devices in a single test set-up. The 8501A Storage Normalizer adds digital storage, normalization, signal averaging and graphics to 8505A measurements.

## 8505A Specifications

### Source

#### Frequency characteristics

**Frequency range:** 500 kHz to 1.3 GHz in three ranges: 500 kHz to 13 MHz, 500 kHz to 130 MHz and 500 kHz to 1.3 GHz.

**Swept frequency accuracy:**  $\pm 1\%$  of range for linear sweep.

**CW frequency accuracy:**  $\pm 2$  counts  $\pm$  time-base accuracy.

**Frequency stability:** better than  $\pm 0.01\%$  of reading  $\pm 0.01\%$  of frequency range over 10 minutes after warm-up.

**Frequency counter characteristics:** frequency counter measurements are made at any one of five continuously variable marker positions without interrupting the swept RF signal.

#### Resolution (least significant digit)

Frequency Range (MHz)	0.5 to 13	0.5 to 130	0.5 to 1300
10 ms Sweep time	10 kHz	100 kHz	1 MHz
100 ms Sweep time	1 kHz	10 kHz	100 kHz
1 second Sweep time	100 Hz	1 kHz	10 kHz

**Counter accuracy:**  $\pm 2$  counts  $\pm$  time-base accuracy.

**Marker frequency accuracy:**  $\pm 0.002\%$  of scan width = counter accuracy.

**Time base accuracy:**  $\pm 5$  ppm = 1 ppm/ $^{\circ}$ C  $\pm 3$  ppm/90 days

#### Output characteristics

**Output power range:** +10 dBm to -72 dBm.

**Attenuator accuracy:**  $\pm 1.5$  dB over 70 dB range.

**Vernier accuracy:**  $\pm 1$  dB

**Leveling:**  $\pm 0.5$  dB from 500 kHz to 1.3 GHz

**Impedance:** 50 $\Omega$ ;  $\geq 16$  dB return loss at -10 dBm output level (<1.38 SWR).

#### Residual FM

Frequency Range (MHz)	0.5 to 13	0.5 to 130	0.5 to 1300
Residual FM	20 Hz rms	200 Hz rms	2 kHz rms
Bandwidth	20 Hz—1 kHz	20 Hz—1 kHz	20 Hz—10 kHz

**Harmonics:** >25 dB below main signal at +10 dBm output level.

**Sub-harmonics and spurious signals:** below -50 dBm at +10 dBm output level.

#### General characteristics

**Sweep modes:** Linear Full, Log Full, Start/Stop 1, Start/Stop 2, Alternate, CW  $\pm$   $\Delta$ F, and CW.

**Sweep times:** 10 ms to 100 s in decade ranges.

**Trigger modes:** auto, line sync, single scan or external sync.

**RF Output connector:** Type N Female

#### Receiver

**Frequency range:** 500 kHz to 1.3 GHz

#### Input characteristics

**Input channels:** three channels (R, A, and B) with 100 dB dynamic range.

**Damage level:** +20 dBm or  $\geq 50$  V dc.

**Noise (10 kHz BW):** -110 dBm from 10 to 1300 MHz; -100 dBm from 0.5 to 10 MHz.

**Impedance:** 50 $\Omega$ ;  $\geq 20$  dB return loss (<1.22 SWR). Typically >26 dB return loss (<1.11 SWR).

#### Magnitude characteristics

**Absolute frequency response (A, B, R):**  $\pm 1.5$  dB

**Ratio frequency response (A/R, B/R):**  $\pm 0.3$  dB from 0.5 MHz to 1.3 GHz.

**Dynamic accuracy:**  $\pm 0.01$  dB/dB from -20 to -40 dBm;  $\pm 0.2$  dB from -10 to -50 dBm;  $\pm 0.5$  dB from -50 to -70 dBm;  $\pm 1.0$  dB from -70 to -90 dBm;  $\pm 2.0$  dB from -90 to -100 dBm;  $\pm 4.0$  dB from -100 to -110 dBm.

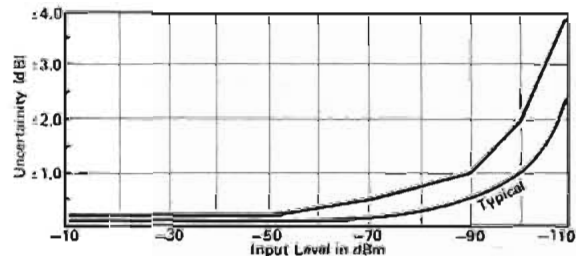

**Crosstalk error limits:** >100 dB isolation between inputs.

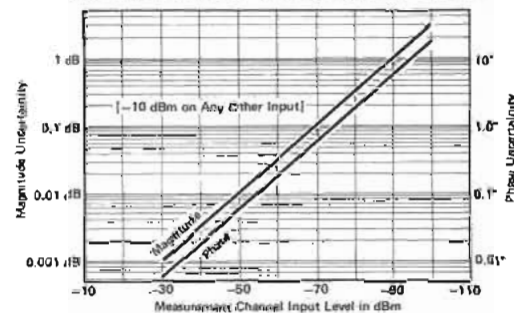

**Reference offset accuracy:**  $\pm 0.02$  dB  $\pm 0.003$  dB/dB of offset

**Marker measurement resolution:** 0.01 dB over any <10 dB range; 0.1 dB over any  $\geq 10$  dB range.

**CRT Display resolution:** 0.1 dB to 20 dB/division in 1, 2, 5 sequence.

#### Phase characteristics

**Frequency response:**  $\pm 3^{\circ}$  from 500 kHz to 750 MHz;  $\pm 5^{\circ}$  from 750 MHz to 1.3 GHz.

**Range:**  $\pm 180^{\circ}$ .

**Accuracy:**  $\pm 0.01^{\circ}$ /degree for  $\pm 170^{\circ}$ ;  $\pm 0.01^{\circ}$ /degree  $\pm 0.5^{\circ}$  for  $\pm 180^{\circ}$ .

**Dynamic accuracy (in 10 kHz Bandwidth):**  $\pm 0.02^{\circ}$ /dB from -20 to -40 dBm;  $\pm 0.5^{\circ}$  from -10 to -50 dBm;  $\pm 1^{\circ}$  from -50 to -70 dBm;  $\pm 3^{\circ}$  from -70 to -90 dBm.

**Crosstalk:** see amplitude crosstalk specification.

**Reference offset accuracy:**  $\pm 0.5\%$  of offset.

**Marker measurement resolution:** 0.1 $^{\circ}$  over <100 $^{\circ}$  range and 1 $^{\circ}$  for  $\geq 100^{\circ}$  range.

**CRT display resolution:** 1 $^{\circ}$  to 180 $^{\circ}$  per division in 8 steps.

**Polar characteristics:** Frequency, Response, Dynamic Response, Reference Offset and Marker Measurement specifications are the same as magnitude and phase characteristics.

**CRT display accuracy:** actual value is within less than 3 mm circle of the displayed value.

**Tracking between dB offset controls and polar full switch positions:**  $\leq 0.2$  dB.

**Full scale magnitude range:** 1 to 0.01 in a 1, 0.5, 0.2 sequence.

#### Delay characteristics

**Frequency response:**  $\pm 1$  ns from 500 kHz to 1.3 GHz.

**Delay accuracy:**  $\pm 3\%$  of reading  $\pm 3$  units (Units = 1 ns for 0.5 to 1300 MHz range, 10 ns for 0.5 to 130 MHz range, and 100 ns for 0.5 to 13 MHz range.)

$\pm 3$  units may be calibrated out with thru connection

## Range resolution and aperture

Frequency Range (MHz)	0.5 to 13	0.5 to 130	0.5 to 1300
Range	0 to 80 $\mu$ s	0 to 8 $\mu$ s	0 to 800 ns
Resolution CRT: Marker: Marker over limited Range:	100 ns 100 ns 10 ns ( $< 1 \mu$ s)	10 ns 10 ns 1 ns ( $\leq 100$ ns)	1 ns 1 ns 0.1 ns ( $< 10$ ns)
Aperture <sup>1</sup>	7 kHz	20 kHz	200 kHz

Reference offset accuracy:  $\pm 0.2$  units  $\pm 0.3\%$  of offset.  
Electrical length/ref. plane extension characteristics  
Calibrated electrical length range and resolution:<sup>2</sup>

Frequency Range (MHz)	0.5 to 13	0.5 to 130	0.5 to 1300
Range X1	$\pm 19.9$ m	$\pm 1.99$ m	$\pm 19.9$ cm
X10	$\pm 100$ m	$\pm 10$ m	$\pm 1$ m
Resolution X1	10 cm	1 cm	0.1 cm
X10	1 m	10 cm	1 cm

Calibrated electrical length accuracy:  $\pm 3\%$  of reading  $\pm 1\%$  of range.

Linear phase substitution (degrees/scan) Range:  $\pm 1700^\circ$  per scan with  $0^\circ$  offset.

$$\frac{\pm 1.4 \text{ km}}{\text{scan width (MHz)}} \text{ or } \frac{\pm 4.7 \mu\text{s}}{\text{scan width (MHz)}}$$

Linear phase substitution resolution:  $10^\circ$

Linear phase substitution accuracy:  $\pm 3\%$  of reading  $\pm 10^\circ$  per scan

Phase compensation linearity:  $< 0.2\%$  of phase slope inserted.

## General Characteristics

RF Input connectors: type N Female

Display bandwidth: selectable IF bandwidths of 10 kHz and 1 kHz. A video filter position is also provided.

CRT overlays: Smith Charts (3.16, 1, 0.5, 0.2, 0.1 full scale), Log Charts (10 MHz), 100 MHz and 1000 MHz).

CRT photography: HP 197A Opt 006 camera or HP 197A with 10375A Bezel Adapter required to fit 8505A display. A CRT illumination control is provided.

## Auxiliary outputs

Channel 1 and 2 outputs: 0.25 V/display division.

Sweep output: 0.25 V/display division.

Pen lift: DC coupled, 200 mA current sink

## Programming

Opt 001 of the 8505A provides a remote programming interface using the Hewlett-Packard Interface Bus with Learn Mode.

Power: selection of 100, 120, 200 or 240 V  $\pm 5\%$  -10%. 50 to 60 Hz approximately 275 watts.

Size: 279 H  $\times$  426 W  $\times$  553 mm D (11"  $\times$  16 $\frac{3}{4}$ "  $\times$  21 $\frac{3}{4}$ ").

## 8505A Opt 005 Specifications (Phase-Lock Operation)

## Source

## Frequency characteristics

Modes (8505A): CW and CW  $\pm \Delta F$  only.

Range and Resolution (8505A and 8660C/86602B/86632B): the total frequency range is 1 to 1300 MHz with a CW resolution of 1 Hz (set on the 8660C). The maximum  $\pm \Delta F$  and  $\pm \Delta F$  resolution is 1.3 kHz and 1 Hz from .5 to 13 MHz, 13 kHz and 10 Hz from .5 to 130 MHz, and 130 kHz and 100 Hz from .5 to 1300 MHz.

Range and Resolution (8505A and 8640B Opt 002): (Total Frequency Range: 0.5 to 1024 MHz).

	8640 Frequency Range (MHz)	8505A Frequency Range (MHz)		
		0.5-13	0.5-130	0.5-1300
CW Resolution (Set on 8640B)	0.5-1 1-13 16-128 128-1024	0.1 Hz 1 Hz	10 Hz	10 Hz 100 Hz
$\pm \Delta F$ Resolution (Set on 8505A)	All freq. Ranges	1 Hz	10 Hz	100 Hz
Max $\pm \Delta F$	0.5-8 8-16 16-1024	1.3 kHz 1.3 kHz	13 kHz 13 kHz	130 kHz

Typical system residual FM: the Residual FM of a phase-locked 8505A approaches that of the 8660C/86602B/86632B or 8640B.

## Output characteristics

Power output, harmonics, spurious outputs, RF phase noise, etc. are determined by the 8660C with 86602B and 86632B or the 8640B.

## Receiver

Magnitude and phase characteristics are unchanged with the exception of the dynamic range specification.

## Delay characteristics

Accuracy:  $\pm 3\%$  of reading  $\pm 3$  units. One unit is equal to the maximum resolution per major division for the frequency range of measurement.

Range, resolution and aperture: (8660C/86602B/86632B or 86640B)

(8505A indicated units  $\times$  1000)

	8505 Frequency Range (MHz)		
	0.5-13	0.5-130	0.5-1300
Range	0-80 ms	0-8 ms	0-800 $\mu$ s
Resolution: CRT & Digital Marker Digital Marker with Delay Switch Setting	100 $\mu$ s 10 $\mu$ s $< 1$ ns	10 $\mu$ s 1 $\mu$ s $< 100 \mu$ s	1 $\mu$ s 100 ns $< 10 \mu$ s
Aperture <sup>1</sup>	1.5 kHz	2.0 kHz	4.0 kHz

## Electrical length characteristics

Accuracy:  $\pm 3\%$  of reading  $\pm 3\%$  of range.

Calibrated electrical length, range, and resolution: (8660C/86602B/86632B or 8640): (8505A digital readouts  $\times$  1000) give electrical length 1000 times larger and resolution divided by 1000.

## General characteristics

## RF Inputs

L.O. drive input level: 10 dBm  $\pm 2$  dB (Rear panel BNC).

RF drive input level: 0 dBm  $\pm 2$  dB (Rear panel BNC).

Tunable FM output:  $\pm 1.3$  V maximum (rear panel BNC with output level controlled by  $\pm \Delta F$  control on front panel of 8505A).  $\pm 1.3$  V output is obtained independent of the frequency range switch setting.

Capture range of phase-lock loop: 100 kHz (0.5-13 MHz Range); 400 kHz (0.5-130 MHz Range); 4 MHz (0.5-1300 MHz Range).

Standard/phase-lock operation: rear panel switch can disable all phase-lock circuitry when using the instrument in its standard (non phase-lock operating mode).

<sup>1</sup>Typical measurement Aperture using linear FM modulation technique.

<sup>2</sup>Vendor provides continuous adjustment of electrical length. Calibrated Electrical Length Linearity:  $\Delta \phi = 0.7\% \times 1.21 \text{ (MHz)} \cdot 1 \text{ (metres)}$ .

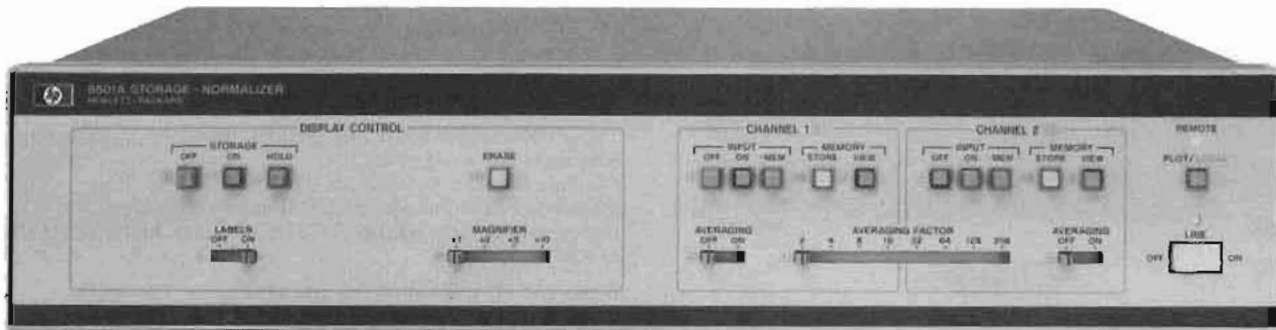

8501A



## Description

The 8501A high performance Storage-Normalizer is a dedicated accessory that extends the measurement capability of your HP 8505A RF Network Analyzer (500 kHz to 1.3 GHz). Flicker free displays with digital storage and CRT annotation of major control settings provide convenient easy documentation. Using normalization, frequency response errors are simply removed. In addition the 8501A can average signals to dramatically improve signal-to-noise ratios and magnify the display for high accuracy measurements. With a desktop computing controller, computer graphics capability is added to the 8505A for displaying corrected data, operator messages, or computer programs.

## 8501A Specifications

### Display

#### Rectangular displays

**Horizontal memory resolution:** two display channels, 500 points per channel (0.2% of full scale, 0.24 mm).

**Vertical Memory Resolution:** 500 points displayed full scale (0.2% of full scale) plus a 50% overrange (250 points) both above and below full screen.

#### Polar displays

**Resolution:** two display channels, 250 points per polar display (0.2% of full scale, 0.2 mm in X and Y).

**Display tracking:** visual offsets between direct 8505A and stored displays are approximately  $\pm 1/2$  CRT minor division ( $\pm 1$  mm).

**Horizontal Input sweep times:** 100 sec max/10 ms min.

**Conversion time:** 10 ms max for 500  $\pm 2$  data points (20  $\mu$ s per point).

**Display refresh time:** nominally 20 ms depending upon information displayed.

**Line generator:** a line generation technique is used to connect points on a CRT display, yielding a smooth continuous trace.

**Markers:** all five markers are also available in the digital display mode.

### Output

**Auxiliary outputs XYZ:** (BNC female connectors on rear panel).

X—1 V full screen, 83 mV/div (12 div).

Y—1 V full screen, 100 mV/div (10 div).

Z—1 volt blanks display, +2 volt unblanks display. (Signal compatible for all HP CRT displays such as 1332, 1304, or 1310).

**Offsets:** The X, Y, and polar display offsets can be adjusted over a  $\pm 10\%$  range of screen by means of potentiometers on the rear panel of the 8501A.

**Labeling Interface:** all major control settings of the 8505A and 8503A and phase-lock indication are displayed on the CRT.

## HP-IB Interface

### HP-IB Interface capabilities

#### Remote programming

**Learn mode:** this feature provides the ability to output the current instrument state to a computing controller.

**Input data:** data for graphics or other purposes can be sent to the 8501A at a rate of:

**ASCII mode:** 600 points per second.

**Binary mode:** 10000 points per second.

**Output data:** data can be read from the 8501A at a rate of:

**ASCII mode:** 800 points per second.

**Binary mode:** 9000 points per second.

**Graphics:** data for graphics can be read into the 8501A and viewed in two types of displays:

**Text displays:** 22 lines of text with 54 characters per line can be displayed on the CRT.

**Vector displays:** lines can be drawn on the display between any two points with a resolution of 432 points in x and 360 points in y (nominal).

### General

#### Display controls

**Storage Off:** the 8501A is bypassed so the display returns to normal analog operation.

**Storage On:** turns on digitally stored display.

**Storage Hold:** the current display is not updated and is frozen for CRT photography or further analysis.

**Erase:** display and memory are erased.

**Labels:** switches all display labeling on or off.

**Magnifier:** expands the display by a factor of 1, 2, 5, or 10.

#### Processing functions (Channel 1 and 2)

**Input Off:** display of channel 1 (2) is blanked.

**Input On:** channel 1 (2) measurement is displayed.

**Input Mem:** the difference between the channel 1 (2) measurement and the stored memory content is displayed (normalization).

**Memory Store:** the current measurement is stored in memory.

**Memory View:** the stored memory content is displayed.

**Averaging:** the data averaging function for channel 1 (2) is switched on or off.

**Averaging Factor:** the degree of averaging is selectable from 2, 4, 8 . . . to 256. The current averaged trace is always displayed and updated at the sweep rate.

**Local:** returns the 8501A control to the front panel from remote HP-IB control.

**Includes:** HP-IB cable and the processor interconnect cable.

**Accessories:** the 11864A Accessory Kit provides the labeling interface boards and connectors for the 8505A. 8505A Opt 007 has these boards and connectors installed.

**Power:** selection of 100, 120, 220, or 240 V  $\pm 5\%$ -10%, 50 to 60 Hz and  $< 140$  VA ( $< 140$  watts).

**Size:** 90 H  $\times$  426 W  $\times$  534 mm D (3 1/2"  $\times$  16 3/4"  $\times$  21").

**Weight:** net, 12.25 kg (27 lb). Shipping, 14 kg (31 lb).



# NETWORK ANALYZERS

RF network analyzer, 500 kHz to 1.3 GHz (cont.)



8503A



8502A



11850A



11851A

## 8502A 50Ω Transmission/Reflection Test Set

## 8502B 75Ω Transmission/Reflection Test Set

**Frequency range:** 500 kHz to 1.3 GHz.

**Impedance:** 8502A, 50Ω; 8502B 75Ω.

**Directivity:** ≥40 dB.

### Frequency response

**Transmission:** ≤±0.8 dB and ≤±8°.

**Reflection:** ≤±1.5 dB and ≤±15° from 0.5–1300 MHz; ≤±10° from 2–1300 MHz.

### Port match

**Test port:** ≥26 dB return loss from 2–1300 MHz (≥24 dB for 8502B); ≥20 dB return loss from 0.5–2 MHz (≥18 dB for 8502B).

**Test port open/short ratio:** ±0.75 dB and ±6° from 2–1000 MHz (±0.9 dB and ±7.5° for 8502B); ±0.9 dB and ±7.5° from 1000–1300 MHz; ±1.25 dB and ±10° from 0.5–2 MHz.

**Reference and reflection ports:** ≥25 dB return loss from 2–1000 MHz; ≥23 dB return loss from 0.5–1300 MHz.

**Input port:** ≥23 dB return loss.

### Nominal Insertion loss:

**Input to Test Port:** 13 dB (8502A), 19 dB (8502B).

**Input to Reference Port:** 19 dB (8502A), 19 dB (8502B).

**Input to Reflection Port:** 19 dB (8502A), 31 dB (8502B).

**Maximum operating level:** +20 dBm.

**Damage level:** 1 watt CW.

**RF Attenuator range:** 0 to 70 dB in 10-dB steps.

**Connectors test port:** 50Ω Type N Female for 8502A and 75Ω

Type N Female for 8502B; all other RF ports 50Ω Type N Female; Bias input, BNC Female.

**DC Bias Input:** ±30 V dc and ±200 mA.

**Includes:** 8502B includes 50Ω/75Ω minimum loss pad.

**Recommended accessory:** 11851A RF Cable Kit for either 8502A or 8502B.

**Size:** 61.5 H × 101 W × 204 mm D (2<sup>3</sup>/<sub>16</sub>" × 7<sup>1</sup>/<sub>2</sub>" × 8").

**Weight:** net, 1.7 kg (3<sup>1</sup>/<sub>4</sub> lb). Shipping, 3.1 kg (7 lb).

## 8503A 50Ω S-Parameter Test Set

## 8503B 75Ω S-Parameter Test Set

**Frequency range:** 500 kHz to 1.3 GHz.

**Impedance:** 8503A, 50Ω; 8503B, 75Ω.

**Directivity:** ≥40 dB.

### Frequency response

**Transmission (S<sub>12</sub>, S<sub>21</sub>):** ±1 dB, ±12° from 0.5–1300 MHz.

**Reflection (S<sub>11</sub>, S<sub>22</sub>):** ±2 dB, ±20° from 0.5–1300 MHz; ±15° from 2–1300 MHz.

### Port match

**Test ports 1 and 2:** ≥26 dB return loss from 2–1300 MHz (≥24 dB for 8503B), ≥20 dB return loss from 0.5–2 MHz (≥18 dB for 8503B).

**Test port 1 and 2 Open/Short Ratio:** ≤±0.75 dB and ±6° from 2–1000 MHz (±0.9 dB and ±7.5° for 8503B); ≤±0.9 dB and ±7.5° from 1000–1300 MHz; ±1.25 dB and ±10° from 0.5–2 MHz.

**Reference and return ports:** ≥23 dB return loss from 2–1000 MHz; ≥20 dB return loss from 0.5–2 MHz and 1000–1300 MHz.

**RF Input port:** 20 dB return loss from 0.5–1300 MHz.

**Maximum operating level:** +20 dBm.

**Damage level:** 1 watt CW.

**Connectors:** test ports, 50Ω APC-7 for 8503A and 75Ω Type-N Female for 8503B; all other RF connectors, 50Ω Type-N Female; Bias inputs BNC Female.

**DC Bias Input:** ±30 V dc, ±200 mA.

**Includes:** four 19 cm (7.5") cables for connection to 8505A.

**Recommended accessory:** 11857A 50Ω Test Port Extension Cables or 11857B/C 75Ω Test Port Extension Cables.

**Programming:** Opt 001 allows programming via HP-IB.

**Power:** 100, 120, 220, or 240 V ±5%–10%, 50 or 60 Hz. Approx. 10 watts (15 watts for 8503B).

**Dimensions:** 90 H × 432 W × 495 mm D (3<sup>1</sup>/<sub>2</sub>" × 17" × 19<sup>1</sup>/<sub>2</sub>").

**Weight:** net, 9.1 kg (20 lb). Shipping, 11.3 kg (25 lb).

### Accessories

#### 11850A 50Ω Power Splitter

#### 11850B 75Ω Power Splitter

**Frequency range:** DC to 1.3 GHz.

**Impedance:** 11850A, 50Ω; 11850B, 75Ω.

**Tracking between any two output ports:** ≤0.1 dB and ≤1.5°.

**Equivalent source match (ratio or leveling):** ≥32 dB return loss (≤1.05 SWR).

**Input port match:** ≥20 dB return loss.

**Nominal insertion loss:** 9.54 dB for 11850A; 7.78 dB for 11850B.

**Frequency response absolute:** Input to Output ≤0.2 dB.

**Maximum operating level:** +20 dBm.

**Burn-out level:** ≥1 watt CW.

**Connectors:** 11850A, 50Ω Type N female; 11850B, three outputs 75Ω Type N female, RF input 50Ω Type N female.

**Recommended accessory:** 11851A RF Cable Kit.

**Includes:** 11850B includes three (3) 50Ω/75Ω Minimum Loss Pads

**Size:** 46 H × 67 W × 67 mm D (1<sup>7</sup>/<sub>8</sub>" × 2<sup>3</sup>/<sub>8</sub>" × 2<sup>3</sup>/<sub>8</sub>").

**Weight:** net, 1.8 kg (4 lb). Shipping, 3.1 kg (7 lb).

#### 11851A RF Cable Kit

**General:** four 61 cm (24 in.) shielded 50Ω cables, phase matched to 4° at 1.3 GHz. Connectors are Type N Male. Recommended for use with 8502A/B Transmission/Reflection Test Set and 11850A/B Power Splitter.



**Weight:** net, 0.91 kg (2 lb). Shipping, 1.36 kg (3 lb).

**11852A 50Ω/75Ω Minimum Loss Pad**

**General:** the 11852A is a low SWR minimum loss pad required for transmission measurements on 75Ω devices with 8505A receiver (50Ω).

**Frequency range:** DC to 1.3 GHz.

**Insertion loss:** 5.7 dB.

**Return loss:** ≥30 dB (≤1.06 SWR).

**Flatness:** ≤0.1 dB from DC to 1.3 GHz.

**Maximum input power:** 250 mW (+24 dBm).

**Connectors:** 50Ω Type N female and 75Ω Type N male.

**Size:** 14 D × 70 mm L (9/16" × 2 3/4").

**Weight:** net, 0.11 kg (4 oz). Shipping, 0.26 kg (9 oz).

**11853A 50Ω Type N Accessory Kit**

**General:** the 11853A furnishes the RF components required for measurement of devices with 50 Type N Connectors using the 11850A, 8502A or 8503A (8503A also requires the 85032A). Kit contains a Type N Female short, a Type N Male short, two Type N Male barrels, two Type N Female barrels and storage case.

**Weight:** net, 0.91 kg (2 lb). Shipping, 1.36 kg (3 lb).

**11854A 50Ω BNC Accessory Kit**

**General:** the 11854A furnishes the RF components required for measurement of devices with 50Ω Type N Connectors using the 11850A, 8502A, or 8503A (8503A also requires the 85032A). Kit contains two Type N Male to BNC Female adapters, two Type N Male to BNC Male adapters, two Type N Female to BNC Female adapters, two Type N Female to BNC Male adapters, a BNC Male short and storage case.

**Weight:** net, 1.13 kg (2 1/2 lb). Shipping, 1.59 kg (3 1/2 lb).

**11855A 75Ω Type N Accessory Kit**

**General:** the 11855A provides the RF connecting hardware generally required for measurement of devices with 75Ω Type N connectors using the 8502B, 11850B or 8503B. Kit contains two 75Ω Type N Male barrels, two 75Ω Type N Female barrels, a 75Ω Type N Male short, a 75Ω Type N Female short, a 75Ω Type N Male termination, and storage case.

**Weight:** net, 0.91 kg (2 lb). Shipping, 1.36 kg (3 lb).

**11856A 75Ω BNC Accessory Kit**

**General:** the 11856A provides the RF connecting hardware generally required for measurement of devices with 75Ω BNC connectors using the 8502B, 11850B or 8503B. Kit contains two Type N Male to BNC Female adapters, two Type N Male to BNC Male adapters, two Type N Female to BNC Female adapters, two Type N Female to BNC Male adapters, a BNC Male short, a 75Ω BNC Male termination, and storage case.

**Weight:** net, 0.91 kg (2 lb). Shipping, 1.36 kg (3 lb).

**11857A 50Ω APC-7 Test Port Extension Cables**

**General:** two precision 61 cm (24 in.) cables, phase matched to 4° at 1.3 GHz for use with 8503A S-parameter test set. Connectors are 50Ω APC-7.

**Weight:** net, 0.91 kg (2 lb). Shipping, 1.36 kg (3 lb).

**11857B 75Ω Type N Test Port Extension Cables**

**General:** two precision 61 cm (24 in.) cables, phase matched to 4° at 1.3 GHz for use with 8503B S-parameter test set. One cable has 75Ω Type N Male connectors on both ends; the other has one Type N

Male and one Type N Female connector.

**Weight:** net, 0.91 kg (2 lb). Shipping, 1.36 kg (3 lb).

**11857C 75Ω GR 900 Test Port Extension Cables**

**General:** two precision 61 cm (24 in.) cables, phase matched to 4° at 1.3 GHz for use with 8503B S-parameter test set. Connectors are 75Ω Type N Male and 75Ω GR 900.

**Weight:** net, 0.91 kg (2 lb). Shipping, 1.36 kg (3 lb).

**11858A Transistor fixture adapter**

**General:** the 11858A adapts the 11600B and 11602B transistor Fixtures (vertical test port configuration) to the 8503A S-parameter test set. Connectors are APC-7.

**Weight:** net, 0.91 kg (2 lb). Shipping, 1.36 kg (3 lb).

**Ordering Information**

	<b>Price</b>
8505A RF Network Analyzer	\$24,500
Opt 001: HP-1B	\$2,950
Opt 005: Phase Lock	\$1,000
Opt 007: Labeling Interface	\$600
Opt 907: Front Handle Kit	\$40
Opt 908: Rack Flange Kit	\$30
Opt 909: Rack Flange/Front Handle Kit	\$60
Opt 910: Extra Manual	\$50
8503A 50Ω S-Parameter Test Set	\$4,000
Opt 001: HP-1B	\$400
Opt 907: Front Handle Kit	\$20
Opt 908: Rack Flange Kit	\$15
Opt 909: Rack Mount Flange/Front Handle Kit	\$20
Opt 910: Extra Manuals	\$10
8503B 75Ω S-parameter Test Set	\$4,000
Opt 001: HP-1B	\$400
Opt 907: Front Handle Kit	\$20
Opt 908: Rack Flange Kit	\$15
Opt 909: Rack Mount Flange/Front Handle Kit	\$20
Opt 910: Extra Manual	\$10
8501A Storage Normalizer	\$5,300
Opt 907: Front Handle Kit	\$20
Opt 908: Rack Mounting Kit	\$15
Opt 909: Rack Mounting/Front Handle Kit	\$20
8502A 50Ω Transmission/Reflection Test Set	\$1,850
Opt 910: Extra Manual	\$6
8502B 75Ω Transmission/Reflection Test Set	\$1,850
Opt 910: Extra Manual	\$6
11850A 50Ω Power Splitter	\$475
11850B 75Ω Power Splitter	\$475
11851A RF Cable Kit	\$350
11852A 50Ω to 75Ω Minimum Loss Pad	\$85
11853A 50Ω Type N Accessory Kit	\$135
11854A 50Ω BNC Accessory Kit	\$135
11855A 75Ω Type N Accessory Kit	\$155
11856A 75Ω BNC Accessory Kit	\$210
11857A 50Ω APC-7 Test Port Extension Cables	\$550
11857B 75Ω Type N Test Port Extension Cables	\$550
11857C 75Ω GR 900 Test Port Extension Cables	\$650
11858A Transistor Fixture Adapter	\$450
11864A Labeling Interface Kit	\$600

# NETWORK ANALYZERS

Automatic network analyzer, 500 kHz to 1.3 GHz

Models 8507A/B

- Improve productivity in lab and factory
- Accuracy enhancement
- Ease of operation via HP-IB
- 9830B or 9825A Desktop Computer
- New learn mode

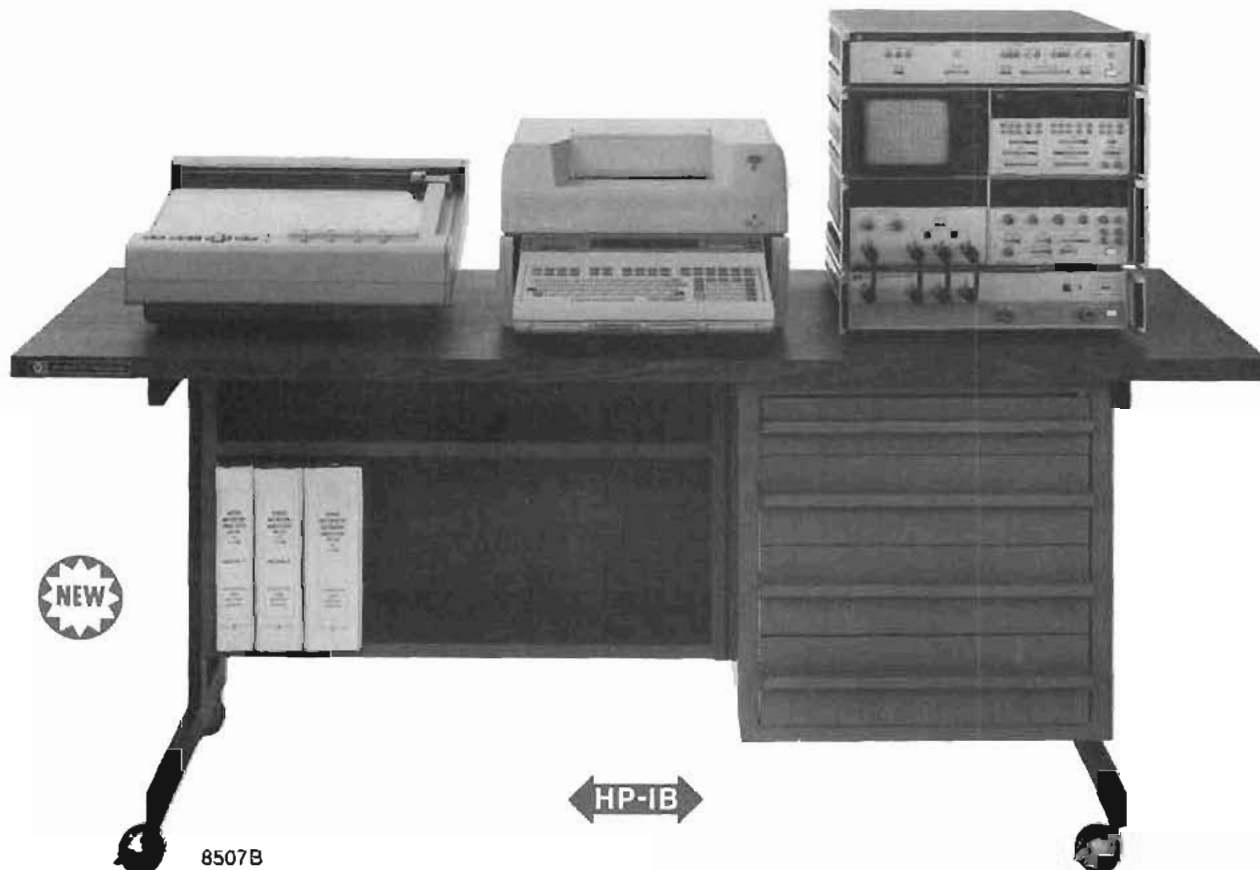

## Description

The 8507A/B is a desktop computer system based on the 8505A RF Network Analyzer. The 8507A utilizes the 9830B BASIC language desktop computer while the 8507B system uses the faster 9825A. The synergism of these easy-to-use desktop computers with the "most programmable network analyzer yet designed" provides a powerful RF network measurement tool for both lab and production uses.

### Cost effective solutions

In laboratory applications, engineers gain greater circuit insight due to the speed and ease with which data can be accumulated and summarized with the 8507 A/B. With just a few hours training, engineers with no previous programming experience have been able to write customized programs which solve specialized measurement problems. In production applications, the 8507A/B dramatically reduces the time and cost of making complicated limit tests on all types of components. Testing programs with built-in operator instructions can minimize training cost and assure uniform test procedures.

### Simplicity and flexibility of HP-IB

Configuration of the standard 8507A/B or your own customized system is a simple matter since it is programmed via the Hewlett-Packard Interface Bus (HP-IB). For instance, your RF measurement application may require a programmable power supply for transistor biasing or a digital voltmeter. Merely choose an instrument from the already large but still growing list of HP-IB interfaceable instruments and add it to your 8507A/B using universal HP-IB cables.

Getting started making measurements is equally easy since the 8507A/B comes complete with programs for system verification, accuracy enhancement and measurement applications. The system verification programs provide you with a fast operational check of the network analyzer, the desktop computer, and all system interfaces. However, one of the major contributions of the 8507A/B is its ease of operation and programming using the HP-IB with Learn Mode.

### Learn mode operation

The "Learn" mode of operation extends traditional automatic operation to a new level of operator convenience. A single key stroke can cause the desktop computer to accept (learn) a data string from the network analyzer which defines all of the manually set front panel control settings. Once stored in the desktop computer (or permanently recorded) this data string can then be used to automatically return the network analyzer to its exact original test conditions...all without the operator ever writing a single program line!

### Programmability features

1) Unique "marker mode" operation provides a real time swept display at the same time data (frequency or displayed parameters) is being logged.

So you can store data at a limited number of frequencies and still be sure you haven't missed a glitch.

2) Human-engineered HP-IB coding does away with complex code tables. To program a function, just type its name (shortened to first letter if you like) and switch position number (numbered 1 to N left to right).

### New 85036A 75Ω Type N Calibration Kit

For use with the 8507A/B Opt E75 75Ω Automatic Network Analyzer. Contains 1 Type N Male Termination, 1 Type N Female Termination, 1 Type N Male Short, 1 Type N Female Short, 1 Type N Male Barrel, and 1 Type N Female Barrel.

### Accuracy enhancement

Each 8507A/B system is supplied with a program that permits frequency tracking, mismatch, and directivity errors to be characterized by applying known standards. These stored system errors are then removed from the measurement of the unknown to provide a degree of accuracy exceeding that possible with the standard 8505A.

### An example

The plots on the left show the result of software accuracy enhancement. Curve A depicts raw measurements on a 50 dB return loss termination at the end of a six-foot RG 214 cable—a typical application problem in testing in temperature chambers. Curve B shows the results after calibrating at the end of the cable—a 25 dB improvement.

### Data in the form you need

With these desktop computers, it is a simple matter to obtain customized printed or plotted outputs. Or you may want to store data on tape for later analysis. Data can be analyzed or statistically summarized directly, bypassing the laborious and error-prone task of manually recording and re-entering data. Data reformatting such as converting return loss to SWR or s-parameters to y-parameters is easily done.

## 8507A/B Automatic Network Analyzer

### General includes:

- 8505A Network Analyzer with HP-IB interface
- 8503A S-Parameter Test Set with HP-IB interface
- APC-7 Calibration Kit (85031A), Systems Table, & Cables
- System Assembly and checkout

### 8507A also includes:

- 9830B Desktop Computer (16K byte memory and String Variables ROM) with 9866A Printer, Cradle, and HP-IB interface including extended I/O ROM.
- 85030A Applications Pac—three cassette programs for system verification, accuracy enhancement and basic measurements.

### 8507B also includes:

- 9825A Desktop Computer (23K byte memory) with String-Advanced Programming and Plotter-General I/O—Extended I/O ROMS and 9866B Printer, cradle and interface, and HP-IB interface.
- 85030B Applications Pac—cartridge with three programs for system verification, accuracy enhancement and basic measurements.

**Power:** 115 or 230V 50-60 Hz, 750 VA.

**Weight:** net 227 kg (500 lb). Shipping, 272 kg (600 lb).

### Ordering Information

	<b>Price</b>
8507A Automatic Network Analyzer	\$47,805
Opt 002: Delete Systems Table	less \$600
Opt 003: Delete 9830B Calculator	less \$12,745
Opt 004: 30 K byte memory	add \$3,200
Opt 005: Phase lock	add \$1,000
85010A Basic Measurements Program PAC for 8501A and 9830A/B	\$50
85030A Applications Pac software 8507A	\$250
8507B Automatic Network Analyzer	\$49,875
Opt 002: Delete Systems Table	less \$600
Opt 003: Delete 9825A Calculator	less \$14,815
Opt 005: Phase lock	add \$1,000
Opt 006: 8501A Normalizer and 85010B Basic Measurements Program PAC.	add \$5,900
85010B Basic Measurements Program PAC for 8501A and 9825A	\$50
85030B Applications Pac software 8507B	\$250
85031A Verification/APC-7 Calibration Kit	\$600
85032A N Calibration Kit	\$775
85033A SMA Calibration Kit	\$400
85036A 75Ω Type N Calibration Kit	\$400

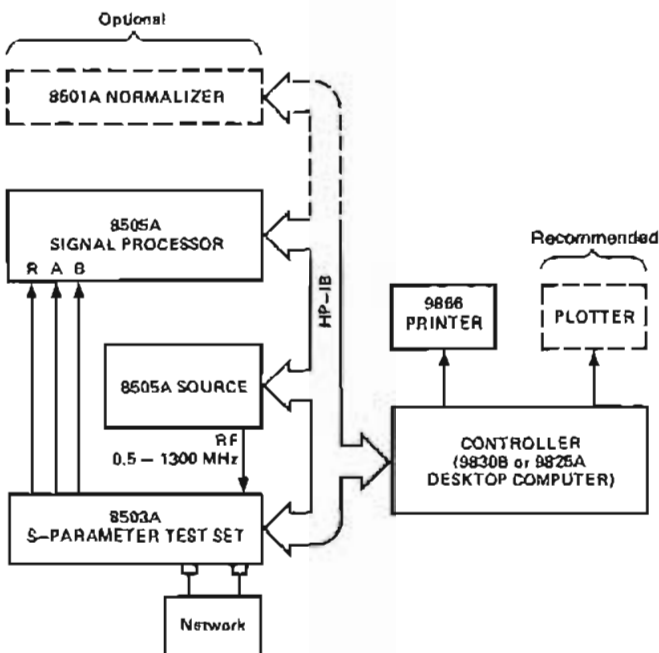
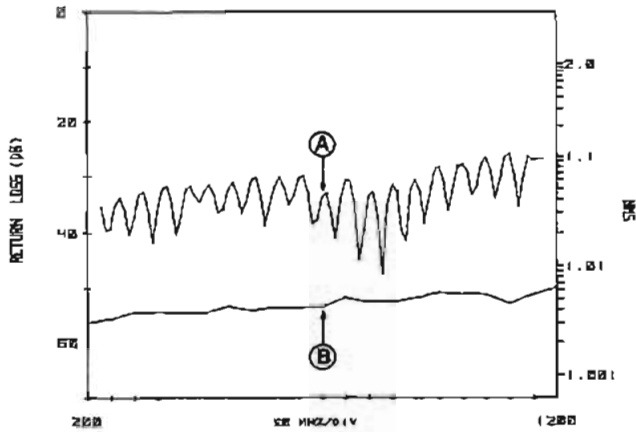

## 8507A/B Calibration Kits

### 85031A Verification and APC-7 Calibration Kit

Included with 8507A/B. Contains Precision APC-7 Load, APC-7 Short, and two verification standards.

### 85032A Type N Calibration Kit

For use with 8507A/B. Contains 2 APC-7 to N-Male Adapters, 2 APC-7 to N-Female Adapters, 1 N-Male Load, 1 N-Female Load, 1 N-Female Short, and 1 N-Male Short.

### 85033A SMA Calibration Kit

For use with 8507A/B. Contains 2 APC-7 to SMA-Male Adapters, 2 APC-7 to SMA-Female Adapters, 1 SMA-Male Load, 1 SMA-Female Load, 1 SMA-Female Short, and 1 SMA-Male Short.



## NETWORK ANALYZERS

RF network analyzer system, 100 kHz to 110 MHz

Model 8407 system

- Complete swept characterization of linear networks
- Modular system flexibility
- 50Ω and 75Ω measurements
- Digital storage



Swept measurements for either designing or testing are made with ease by HP's versatile 8407 Network Analyzer System. Since phase as well as magnitude is measured by a Network Analyzer, the behavior of both active and passive linear networks can be completely characterized from 100 kHz to 110 MHz by swept measurement.

Measurements of gain, loss, phase shift (compute group delay), return loss, and complex reflection coefficient are all possible in either 50Ω or 75Ω systems. These measurements allow the linear behavior of the networks under test to be completely characterized by their complex S-Parameters. Swept complex impedance  $|Z|$  and  $\theta$  (for  $|Z|$  from 0.1Ω to >10 kΩ) as well as voltage and current transfer functions are also measured quickly and easily by the 8407 system. Typical linear networks designed and tested with the 8407 are filters, amplifiers, attenuators, antennas, detectors, cables, and recording heads.

Much of the 8407's versatility stems from its modular construction which allows the system to perform a variety of measurements or be economically tailored to one application. The basic instruments of the 8407 system are: The HP 8407A Network Analyzer, one of two REQUIRED sources (HP 8601A Sweeper/Generator or HP 8690B/8698B Sweep Oscillator), choice of two plug-in displays (HP 8412A Phase-Magnitude Display or HP 8414A Polar Display), an optional digital marker (HP 8600A), and one of four transducers (HP 11652A, 11654A, 11655A, or 1121A) depending on the measurement. Because the 8407A is a tracking receiver, the HP 8601A and HP 8690B/8698B are the only sources providing the VTO output required to operate the network analyzer. Thus, an operating system must be configured with one of the required sources, the network analyzer, a display and one or more of the transducers depending on the device under test and the network parameters desired.

### Specifications

#### 8407A

**General:** 8407A is a two input tracking receiver, using both inputs (reference and test channels) to form their magnitude ratio and phase difference before routing to display.

**Frequency range:** 0.1 - 110 MHz.

**Impedance:** 50Ω, Option 008: 75Ω, VSWR < 1.08.

**Dynamic range:** 80 dB.

**Test Input:** DIRECT -10 to -90 dBm signal range. ATTENUATED, +20 to -50 dBm signal range. Damage level +26 dBm/50 V dc.

**Reference Input:** DIRECT level required, -10 to -60 dBm ATTENUATED level required +20 to -20 dBm. Damage level +26 dBm/50 V dc.

**Amplitude accuracy:** FREQUENCY RESPONSE  $\pm 0.2$  dB for DIRECT input (test input > -60 dBm), 0.1-110 MHz;  $\pm 0.05$  dB over any 10 MHz portion; may be calibrated out. Typically  $\pm 0.05$  dB for DIRECT inputs (REFERENCE level of -10 dBm). DISPLAY REFERENCE, < 0.05 dB/1 dB step, total error  $\leq 0.1$  dB; < 0.1 dB/dB step, total error  $\leq 0.25$  dB. ATTENUATED INPUTS, 40 dB  $\pm 0.5$  dB. REFERENCE CHANNEL GAIN CONTROL, 20 dB and 40 dB steps  $\pm 0.5$  dB/step. CROSSTALK, > 0.03 dB when test/ref = -40 dB to < 4 dB when test/ref = -80 dB.

**Phase accuracy:** FREQUENCY RESPONSE,  $\pm 5^\circ$  for DIRECT input (test input > -60 dBm), 0.1 to 110 MHz;  $\pm 2^\circ$  over any 20 MHz portion, may be calibrated out. Typically  $\pm 2^\circ$  from 1 - 110 MHz for DIRECT inputs (REFERENCE level of -10 dBm). DISPLAY REFERENCE, < 0.5°/10 dB step; total error < 3°. ATTENUATED inputs,  $\pm 2^\circ$  from DIRECT inputs. REFERENCE CHANNEL GAIN CONTROL,  $\pm 2^\circ$ /step. CROSSTALK, < 0.3° when test/ref = -40° to < 11° when test/ref = -80 dB.

**Power:** 65 watts, 50-60 Hz, 115/230  $\pm 10\%$  V ac.

**Weight:** net, 14.6 kg (32 lb). Shipping, 17.8 kg (39 lb).

#### 8412A

**General:** plug-in PHASE-MAGNITUDE CRT Display. Displays magnitude and/or phase vs. frequency.

**Amplitude accuracy:** display, 0.08 dB/dB from midscreen. Rear output: 0.03 dB/dB variation from 0 volt output.

**Phase Accuracy:** DISPLAY, 0.065°/degree from midscreen. PHASE OFFSET, 0.3°/20° step,  $\leq 3^\circ$  for 360° change, positive or negative direction. VS. DISPLAYED AMPLITUDE, < 1°/10 dB; total < 6° over 80 dB range.

**Rear panel inputs:** sweeping,  $\leq 15$  V dc. Blanking, -4 V dc blanks CRT. Z axis (marker), 5 V dc intensifies and +5 V dc blanks trace.

**Power:** 23 watts, supplied by 8407A.

**Weight:** net, 7.8 kg (17 lb). Shipping, 10 kg (22 lb).

Detailed specifications on page 454.

#### New 8750A

**General:** the 8750A Storage-Normalizer provides digitally stored and normalized CRT displays when used with the 8412A Phase-Magnitude Display. Measurements are faster, easier, and more accurate when the 8750A is employed because the CRT is flicker-free and frequency response errors are eliminated. The 8750A is not compatible with the 8414A Polar Display.

**Power:** selection of 100, 120, 220, or 240 V +5% -10%, 48 to 440 Hz and  $\leq 20$  VA ( $\leq 20$  watts).

**Weight:** net, 2.72 kg (6 lbs). Shipping, 5.0 kg (11 lbs). Detailed Specifications on Page 450.

#### 8414A

**General:** normalized POLAR coordinate display with magnitude calibration in 0.2 of full scale gradations. Full scale is determined by DISPLAY REFERENCE on 8407A; phase calibration is in 10° increments over 360° range. Smith Chart overlays available.

**Accuracy:** all errors in amplitude and phase due to display are contained within a circle of 3mm about measurement point.

**Rear panel inputs:** blanking, -4 to -10 V dc blanks CRT. Marker, intensified trace with -4 to -10 V dc.

**Rear panel outputs:** horizontal and vertical both  $\pm 2.5$  V for full scale deflection.

**Power:** 35 watts, supplied by 8407A

**Weight:** net, 5.9 kg (13 lb) Shipping, 8.0 kg (18 lb).

Detailed specifications on page 454.

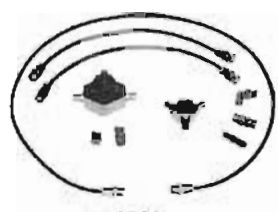

11652A



11654A



1121A

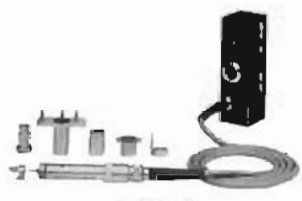

11655A



11658A



85428B

**8601A**

**General:** GENERATOR/SWEEPER operating in either CW or SWEPT modes. Sweep modes are full, variable stop frequency, and symmetrical (up to 10 MHz). Features very low residual FM, spurious, harmonics, and drift. 8601A provides the VTO signal required to operate the 8407A.

**Frequency:** 0.1–110 MHz in two sweep ranges, 0.1–11 MHz and 1–110 MHz.

**Impedance:** 50Ω, Option 008: 75Ω. VSWR < 1.2.

**Accuracy:** 1% of frequency, 0.5% linearity, and 2% of sweep width.

**Calibrated output:** ±0.25 dB flatness over full range, output accuracy ±1 dBm from +10 to –110 dBm.

**Auxiliary output:** sweep out, blanking (for 8412 and 8414), VTO (required by 8407A), and auxiliary output (0.1–11 MHz both ranges) for 8600 counter/digital marker.

Detailed specifications on page 384.

**8600A**

**General:** DIGITAL MARKER used with 8601A generator/sweeper to provide five continuously variable markers on a display while reading out the frequency of any one marker. Six digit display.

**Markers/accuracy:** 5 markers accurate at desired frequency ± (0.05% sweep width + sweep stability).

**Counter frequency range:** 0.1–15 MHz (automatically scales up by ten when 8601A on 0.1–110 MHz range).

Detailed specifications on page 384.

**11652A**

**General:** REFLECTION-TRANSMISSION KIT containing power splitter, 8721A DIRECTIONAL BRIDGE, precision termination, calibrating short, three BNC adapters, and four matched, low-leakage cables for both transmission and reflection measurements. All 50Ω BNC connectors, Option 008: 75Ω.

**Directional bridge:** 8721A: 6dB insertion loss and 6dB coupled to auxiliary arm. Frequency response ±0.5 dB (0.1–110 MHz). Directivity >40 dB (1 to 110 MHz). Load port return loss >30 dB ( $\rho < 0.03$ ). Max input power +20 dBm. 50Ω, Option 008: 75Ω.

**Power splitter:** 6 dB through each arm. Max input power +20 dBm. 50Ω.

**50Ω termination:** return loss >43 dB.

**Weight:** net, 0.7 kg (1.5 lb). Shipping, 1.2 kg (2.5 lb).

**11654A**

**General:** passive probe kit for measuring current and voltage transfer functions and accurate complex impedance below 11 MHz con-

tains a pair each of six resistive divider probes (1:1, 5:1, 10:1, 20:1, 50:1, 100:1), current probes and a variety of adapters.

**Weight:** net, 0.9 kg (2 lb). Shipping, 1.4 kg (3 lb).

**11655A**

**General:** swept or CW impedance probe mounting directly to 8407A. Mount contains internal calibrator, 100Ω ±0.5% and 0° ±2°; parasitic capacitances are calibrated out; and simple charts are available for calculating out residual resistances. Contains component adapter, probe to BNC adapter, probe to type N adapter, and various ground assemblies.

**Frequency:** 0.5–110 MHz (usable to 0.1 MHz).

**Measurement range:** amplitude, 0.1Ω to >10 kΩ; phase, 0° ±90°.

**CW accuracy:** amplitude ±5%; ±5° for  $|Z| > 3.16Ω$ .

**Swept accuracy:** typically ±5% in amplitude (3–110 MHz), ±5° in phase (5–110 MHz); accuracy decreases below 3 MHz. Note all accuracy specs valid only for proper input levels and calibration.

**Max external voltage to probe:** 50 Vdc, 5 V rms.

**Weight:** net, 0.9 kg (2 lb). Shipping, 2.7 kg (6 lb).

**11658A**

**General:** 50Ω to 75Ω matching resistor for matching the 50Ω of the 8407A to a 75Ω environment. Two 11658A's are very useful for frequent 50Ω to 75Ω changes. The 11658A's mount directly on the front pane, of 8407A. **FREQUENCY,** 0.1–110 MHz. **INSERTION LOSS,** 3.5 dB. **RETURN LOSS,** >40 dB. **CONNECTORS,** 50Ω BNC male and 75Ω BNC female.

**Net weight:** 28 g (1 oz).

**1121A**

**General:** 1:1 active probe for making measurements without disturbing circuitry and measuring voltage transfer functions in systems different from 50Ω, 10:1 and 100:1 dividers and BNC adapter also furnished.

**Frequency response:** ±0.5 dB and ±2% from 0.1–110 MHz with a bandwidth (3 dB) of 1 kHz to >500 MHz and gain 0 dB ±1 dB.

**Input Impedance:** 100 kΩ, shunt capacitance of 3 PF at 100 MHz. With 10:1 or 100:1 divider, 1 MΩ, shunt capacitance 1 PF at 100 MHz.

**Output Impedance:** 50Ω nominal.

**Maximum Input:** 300 mV rms, ±80 V dc; with 10:1 divider, 3 V rms, ±350 V dc; with 100:1 divider, 30 V rms, ±350 V dc.

**Power:** supplied by 8407A through PROBE PWR jacks.

**Weight:** net, 0.7 kg (1.5 lb). Shipping, 1.2 kg (2.5 lb).

**85426A**

**General:** bias insertion network providing DC biasing to devices under test on RF (transmission lines). Operating frequency range is 0.1–500 MHz with insertion loss <0.4 dB and return loss >28 dB. Max biasing current of 750 mA and max biasing voltage of 70 V. Connectors are BNC for DC biasing and APC-7 for RF.

**Weight:** net, 0.5 kg (1 lb). Shipping, 0.8 kg (1.7 lb).

**85428B**

**General:** 50Ω to 75Ω minimum loss pad. Pad operates from 0.1–110 MHz with an insertion loss of 5.7 dB and VSWR < 1.05. Connectors are 50Ω BNC male and 75Ω BNC female.

**Weight:** net, 0.1 kg (2 oz). Shipping, 0.2 kg (6 oz).

**Ordering information**

	<b>Price</b>
8407A Network Analyzer	\$4500
Opt 008: 75Ω input	add \$115
8412A Phase Magnitude Display	\$2200
8750A Storage-Normalizer	\$1450
8414A Polar Display	\$2000
8601A Sweeper/Generator	\$3000
Opt 008: 75Ω output	add \$50
8600A Digital Marker	\$1500
11652A Reflection/Transmission Kit (50Ω)	\$475
Opt 008: 75Ω	add \$60
11654A Passive Probe Kit	\$550
11655A Impedance Probe Kit	\$1500
11658A Matching Resistor	\$40
1121A AC Probe Kit	\$595
85426A Bias Insertion Network	\$550
85428B Minimum Loss Pad	\$175
8721A Directional Bridge (50Ω)	\$200
Opt 008: 75Ω	add \$20

# NETWORK ANALYZERS

## Vector voltmeter

Model 8405A

- Accurate voltage and phase measurement
- 1 to 1000 MHz

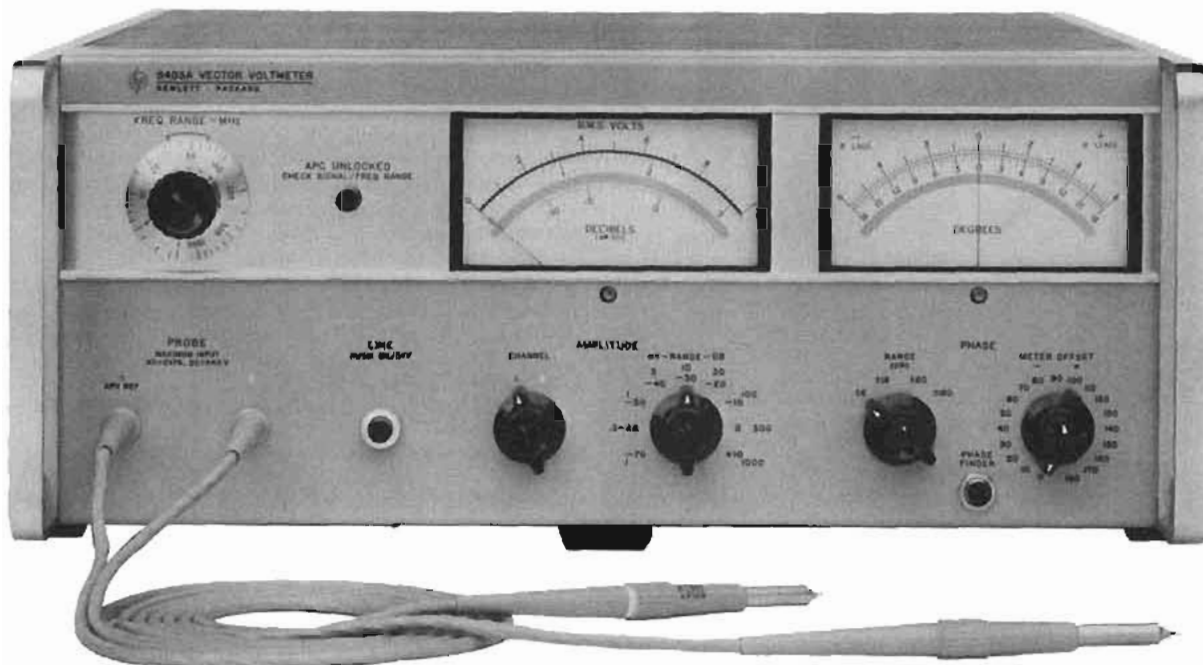

The 8405A Vector Voltmeter measures voltage vectors described by both magnitude and phase. This capability makes the 8405A a unique instrument for about any design and test application in the frequency range 1 to 1000 MHz.

In addition to absolute voltage measurements, capabilities include insertion loss and group delay of passband-filters and other transmission devices, gain and phase margin of amplifiers, complex impedance of mixers, antennas, matching the electrical lengths of cables, s-parameters of transistors, amplitude modulation index, RF distortion measurements and in-circuit probing.

The 8405A achieves this measurement versatility through its two-channel capability enabling voltage magnitude measurements in either channel, thus allowing ratio measurements, and phase difference measurements between the two channels. Gain or loss in excess of 90 dB and phase measurements with 0.1° resolution over a 360° phase range are possible.

Accuracy is achieved through the 1 kHz bandwidth entailing response only to the fundamental frequency of the input signal. Also, phase-locked coherent sampling to translate 1 to 1000 MHz RF signals to 20 kHz IF signals enables accurate detection of voltage magnitude and phase. Automatic phase-locked tuning makes it possible to select the one of 21 overlapping octave ranges which contains the input signal frequency by simply rotating a switch.

### Specifications

**Frequency range:** 1 MHz to 1 GHz in 21 overlapping octave bands; tuning automatic within each band.

**Isolation between channels:** 1 to 300 MHz, > 100 dB; 300 to 1,000 MHz > 80 dB.

**Maximum input:** ac, 2 V peak; dc,  $\pm 50$  V.

**Input impedance (nominal):** 0.1 M $\Omega$  shunted by 2.5 pF; 1 M $\Omega$  shunted by 2 pF when 11576A 10:1 Divider is used; 0.1 M $\Omega$  shunted by 5 pF when 10216A Isolator is used. AC coupled.

### Voltage range (rms)

Channel	1 - 10 MHz	10 - 500 MHz	500 - 1000 MHz
A	1.5 mV - 1.0 V	300 $\mu$ V - 1.0 V	500 $\mu$ V - 1.0 V
B	<20 $\mu$ V - 1.0 V	<20 $\mu$ V - 1.0 V	<20 $\mu$ V - 1.0 V

**Voltmeter ranges:** 100  $\mu$ V to 1 V rms full scale in 10 dB steps.

**Voltage ratio accuracy:** 1-200 MHz, 0.2 dB for -60 to 0 dB ranges and 0.5 dB for -70 dB to +10 dB ranges; 200-1000 MHz, 0.2 dB for -60 to -10 dB ranges, 0.5 dB for -70 dB to 0 dB ranges and 1.5 dB for +10 dB range.

**Phase range:** 360° indicated on zero-center meter with end-scale ranges of  $\pm 180^\circ$ ,  $\pm 60^\circ$ ,  $\pm 18^\circ$ , and  $\pm 6^\circ$ .

**Phase resolution:** 0.1° at any phase angle.

**Phase meter offset:**  $\pm 180^\circ$  in 10° steps.

**Phase accuracy:**  $\pm 1.5^\circ$  (equal voltage Channel A and B).

**Accessories furnished:** two 11576A 10:1 Dividers, two 10216A Isolators, two 10218A BNC Adapters, six ground clips for 11576A or 10216A; six replacement probe tips.

**Bandwidth:** 1 kHz.

**Power:** 115 or 230 V  $\pm 10\%$ , 50 to 400 Hz, 35 W.

**Weight:** net, 13.9 kg (31 lb). Shipping, 16.3 kg (36 lb).

**Size:** 177 H  $\times$  425 W  $\times$  467 mm D (7"  $\times$  16 $\frac{3}{4}$ "  $\times$  18 $\frac{3}{8}$ ").

### 11570A Accessory kit

**50 $\Omega$  TEE:** 11535A: for monitoring signals on 50 $\Omega$  transmission lines without terminating line. Kit contains two with type N RF fittings.

**50 $\Omega$  Power splitter:** 11549A: all connectors Type N female.

**50 $\Omega$  termination:** 908A: for terminating 50 $\Omega$  coaxial systems in their characteristic impedance.

**Shorting plug:** 11512A: Shorting Plug, Type N male.

### Ordering Information

8405A Vector Voltmeter

Opt 002: linear dB scale

11570A Accessory Kit (measurement in 50 $\Omega$  systems only)

Price

\$3750

add \$25

3365

# NETWORK ANALYZERS

Microwave network analyzer, 110 MHz to 40 GHz  
Model 8410S systems



- Complete microwave measurement systems
- Measures all network parameters
- Multioctave swept frequency measurements
- System accuracy fully specified

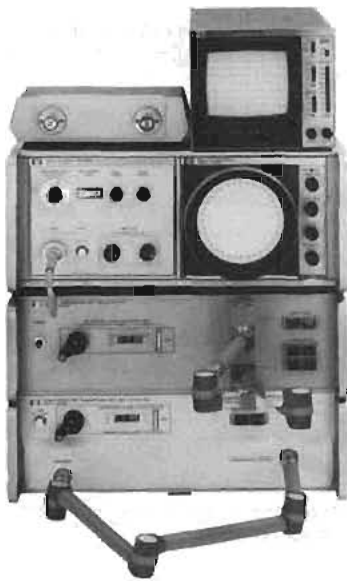

8410S Opt 310

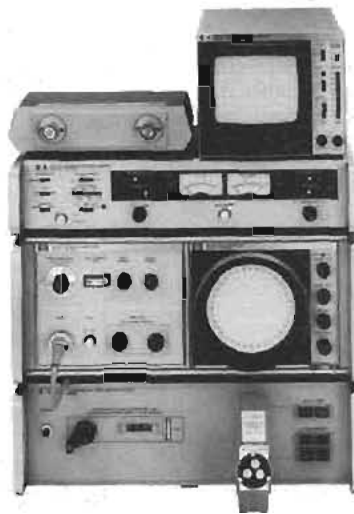

8410S Opt 400

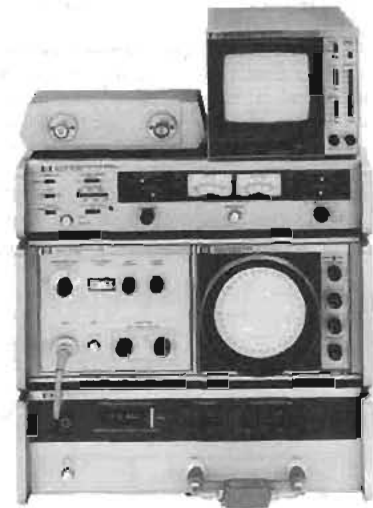

8410S Opt 500

All 8410S Systems measure transmission and reflection parameters of coaxial or semiconductor components in the form of gain, attenuation, phase, reflection coefficient or impedance. Each option has been configured and fully specified for making general measurements within a frequency range or for pushbutton S-parameter measurements on semiconductor devices in a variety of package styles. The 8410S Systems enable the operator to view a real time CRT display over octave or multioctave bands with a dynamic range of 60 dB amplitude and 360° phase. Multioctave, continuous net-

work measurements over the frequency range of 2 to 18 GHz are possible when the 8410B is used with the HP 8620/86290 Swept Oscillator.

The 8410S Systems' upper frequency limit for coaxial and semiconductor measurements is 12.4 GHz; however, individual instruments may be ordered that will expand coaxial measurement capability to 18 GHz (option 018 instruments) and waveguide measurements from 8.2 GHz to 40 GHz (8747A series).

8410S Network Analyzer Systems Table

GENERAL PURPOSE MEASUREMENTS			All 8410S Systems include the Following Instrument Model Numbers: 8410B, 8411A, 8412A*, 8414A and 11609A										Price
Frequency Range	Option No.	Measurement Port Configuration	8743A	8745A	8746A	8717B	11600B	11602B	11608A	11604A	11605A	11650	
0.11 to 2 GHz	110*	Coaxial (APC-7)		X						X		X	\$18,685
0.11 to 12 GHz	310*	Coaxial (APC-7)	X	X						X	X	X	\$24,295
2 to 12.4 GHz	210*	Coaxial (APC-7)	X								X	X	\$17,645
SEMICONDUCTOR CHARACTERIZATION													
0.11 to 2 GHz	400	FD1B/T072 Packages		X		X	X						\$19,765
0.11 to 2 GHz	401	T05/T032 Packages		X		X		X					\$19,765
0.5 to 12.4 GHz	500	T051 Package			X	X			X				\$22,415
0.5 to 12.4 GHz	501	HPAC-200 Package			X	X			X				\$22,415

\*Options 100, 200 and 300 are identical to 110, 210 and 310 respectively except for the 8412A which is replaced by the 8413A.

## Model 8410S Systems (cont.)

## Specifications

## 8410S Common Performance Specifications

**Function:** all systems measure transmission and reflection parameters on a swept-frequency or CW basis with readout of attenuation, gain, phase shift, reflection coefficient, return loss, impedance, depending on display unit.

**Transmission measurement (using 8412A):** accuracy curves show overall system uncertainty as a function of the amplitude and phase value. Sources of error included are IF gain control, display accuracy, phase offset, system noise and cross-talk. System frequency responses is specified separately and is not included in accuracy curves.

**Amplitude accuracy (60 dB dynamic range)**

IF gain control: 69 dB in 10 dB and 1 dB steps.

$\pm 0.1$  dB/10 dB  
 $\pm 0.05$  dB/1 dB

$\pm 0.2$  dB maximum cumulative

Display: 0.08 dB/dB from midscreen.

**Phase accuracy**

Phase offset:  $0.3^\circ/20^\circ$  step; maximum  $3^\circ$  for  $360^\circ$  change.

Display:  $0.065^\circ/\text{degree}$  from midscreen.

**Connectors:** RF Input, Type N female stainless steel; Measurement Ports, APC-7 precision 7-mm connectors.

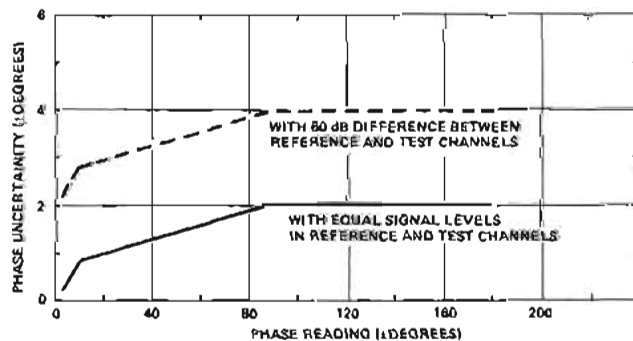
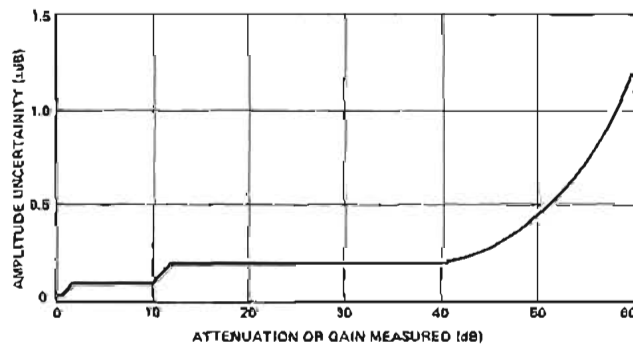

## 8410S Opt 100/110 specifications

**Function:** the 8410S option 100/110 measurement systems give all four S-parameters for a two-port network with pushbutton ease over the frequency range of 110 MHz to 2 GHz. A choice in log display units is made by selecting Option 100 (8413A display) or Option 110 (8412A display).

**Frequency range:** 0.11 to 2.0 GHz.

**RF Input:** 20 dB range between  $-21$  dBm and  $+7$  dBm.

**Source reflection coefficient:**  $\leq 0.09$ , 0.11–2.0 GHz.

**Termination reflection coefficient:**  $\leq 0.11$ , 100–200 MHz;  $\leq 0.09$ , 200–2000 MHz.

**Directivity:**  $> 36$  dB 0.11–1.0 GHz;  $> 32$  dB 1.0–2.0 GHz.

**Insertion loss, RF Input to test port:** 4 dB nominal.

**Frequency response**

**Transmission:** typically  $< \pm 0.35$  dB amplitude and  $< \pm 3^\circ$  phase.

**Reflection:** typically  $< \pm 0.09$  magnitude and  $\pm 5^\circ$  phase with a short on the test port.

**Transmission measurement accuracy:** (see Common Performance Specifications).

**Reflection measurement accuracy (using 8414A):** sources of error included in the accuracy equations are directivity, source match, and polar display accuracy.

**Magnitude accuracy:**

$\rho_u = \pm(0.015 + 0.03 \rho_L + 0.06 \rho_i \cdot \rho_L^2)$  0.11–1.0 GHz.

$\rho_u = \pm(0.025 + 0.03 \rho_L + 0.06 \rho_i \cdot \rho_L^2)$  1.0–2.0 GHz.

$\rho_u$  = magnitude uncertainty.

$\rho_L$  = measured reflection coefficient magnitude.

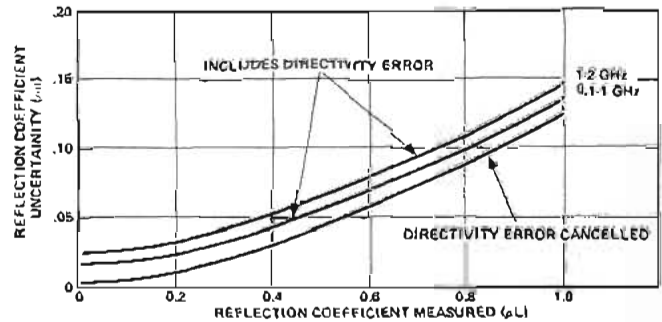
**Phase accuracy:**

$\Phi_u = \sin^{-1} \rho_u / \rho_L$ , for  $\Phi_u < 90^\circ$ .

$\Phi_u$  = phase uncertainty.

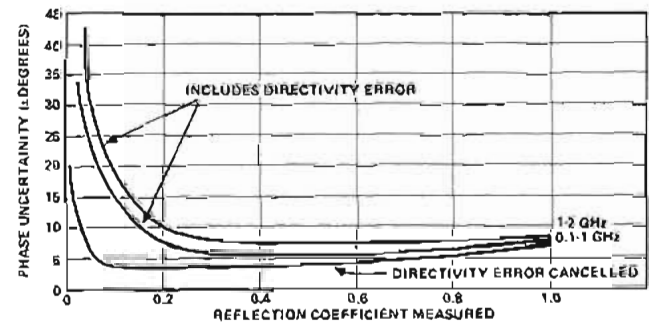

See 8410S Network Analyzer Systems Table for price and instrument breakdown.

## 8410S Opt 200/210 specifications

**Function:** The 8410S Option 200/210 measurement systems cover a frequency range of 2 to 12.4 GHz. With just one simple setup and calibration both transmission and reflection measurements are easily made by pushing a button. A choice in log display units is made by selecting Option 200 (8413A display) or Option 210 (8412A display).

**Frequency range:** 2.0 to 12.4 GHz.

**RF Input:** 20 dB range between  $-14$  dBm and  $+14$  dBm.

**Source reflection coefficient:**  $\leq 0.09$ , 2–8 GHz;  $\leq 0.13$ , 8–12.4 GHz.

**Termination reflection coefficient:**  $\leq 0.09$ , 2–8 GHz;  $\leq 0.13$ , 8–12.4 GHz.

**Directivity:**  $\geq 30$  dB, 2–12.4 GHz.

**Insertion loss, RF Input to test port:** 20 dB nominal.

**Frequency response**

**Transmission:** typically  $< \pm 0.5$  dB amplitude and  $< \pm 5^\circ$  phase.

**Reflection:** typically  $< \pm 0.09$  magnitude and  $< \pm 6^\circ$  phase, with a short on the unknown port.



**Transmission measurement accuracy:** (see Common Performance Specifications).

**Reflection measurement accuracy (using 8414A):** sources of error included in the accuracy equations are directivity, source match, and polar display accuracy.

**Magnitude accuracy:**

$$\rho_u = \pm(0.0316 + 0.03 \rho_L + 0.09 \rho_L^2) \text{ 2-8 GHz.}$$

$$\rho_u = \pm(0.0316 + 0.03 \rho_L + 0.13 \rho_L^2) \text{ 8-12.4 GHz.}$$

$\rho_u$  = magnitude uncertainty.  
 $\rho_L$  = measured reflection coefficient magnitude.

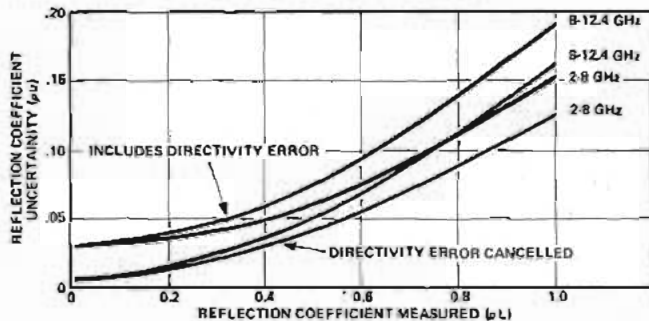

**Phase accuracy:**

$$\Phi_u = \sin^{-1} \rho_u / \rho_L \text{ for } \Phi_u < 90^\circ.$$

$\Phi_u$  = phase uncertainty.

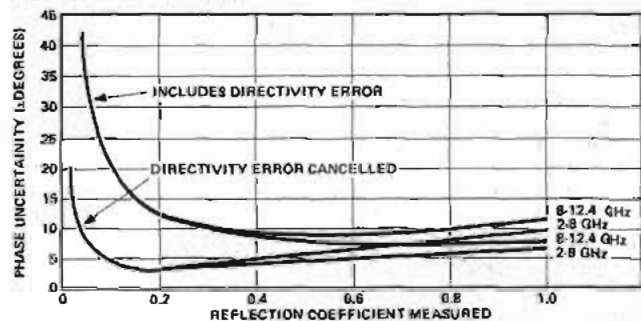

See 8410S Network Analyzer Systems Table for price and instrument breakdown.

**8410S Opt 300/310 specifications**

**Function:** The 8410S Option 300/310 measurement systems encompass both the 8410S Option 110 and 210 system specifications and flexibility. The two RF transducer units cover the frequency range of 110 MHz to 12.4 GHz and both offer calibrated line stretchers for extending the reference plane. Coaxial rotary joints and air-lines mounted on the front of the transducer units allow easy connections to the test device. A choice in log display units is made by selecting either Option 300 (8413A display) or Option 310 (8412A display).

See 8410S Network Analyzer System Table for price and instrument breakdown.

**8410S Opt 400/401 specifications**

**Function:** The 8410S Option 400/410 S-parameter measurement system provides two port S-parameters for semiconductors in TO-18/TO-72 (Option 400) or TO-5/TO-12 (Option 401) packages. A short circuit Termination and a 50 ohm through section are included with each type fixture for reference plane calibration.

**Frequency range:** 0.11 to 2.0 GHz.

**Transistor dc bias selection:** front panel slide switches establish proper dc biasing for both Bi-polar and FET transistors. The voltage and current controls operate independently and are continuously adjustable over a current range of 0 to 500 mA and a voltage range of 0 to 30 Vdc.

**RF Input:** 20 dB range between -21 dBm to +7 dBm.

**Incident power at device under test:** +3 dBm to -25 dBm.

**Source reflection coefficient**

- Opt 400: typically -0.062.
- Opt 401: typically -0.067.

**Termination reflection coefficient**

- Opt 400: typically <0.11, 100 to 200 MHz.  
<0.09, 0.2 to 2.0 GHz.
- Opt 401: typically <0.14, 100 to 200 MHz.  
<0.10, 0.2 to 2.0 GHz.

**Directivity**

- Opt 400: typically <31 dB, 0.11 to 1.0 GHz.  
<29 dB, 1.0 to 2.0 GHz.
- Opt 401: typically <28 dB, 0.11 to 1.0 GHz.  
<27 dB, 1.0 to 2.0 GHz.

**Frequency response**

- Transmission: typically  $\leq \pm 0.35$  dB,  $\pm 3^\circ$ .
- Reflection: typically  $\leq \pm 0.5$  dB,  $\pm 5^\circ$ .

**Transmission measurement accuracy:** (see Common Performance Specifications).

**Reflection measurement accuracy (using 8414A):** sources of error included in the accuracy equations are directivity and source match.

**Magnitude accuracy**

- Opt 400:
    - $\rho_u = \pm(0.029 + 0.048 \rho_L + 0.06 \rho_L^2)$  0.11 to 1 GHz.
    - $\rho_u = \pm(0.035 + 0.051 \rho_L + 0.062 \rho_L^2)$  1.0 to 2.0 GHz.
  - Opt 401:
    - $\rho_u = \pm(0.038 + 0.054 \rho_L + 0.067 \rho_L^2)$  1.0 to 2.0 GHz.
- $\rho_u$  = magnitude uncertainty.  
 $\rho_L$  = measured reflection coefficient magnitude.

**Phase accuracy:**

$$\Phi_u = \sin^{-1} \rho_u / \rho_L \text{ for } \Phi_u < 90^\circ.$$

$\Phi_u$  = phase uncertainty.

See 8410S Network Analyzer Systems Table for price and instrument breakdown.

**8410S Opt 500/501 specifications**

**Function:** The 8410S Option 500/501 S-parameter measurement systems provide the capability of biasing and measuring all four S-parameters of strip-line transistors in the TO-51 (Option 500), HPAC-200 (Option 501) packages. A short circuit termination and a 50-ohm through section are included with each fixture for reference plane calibration.

**Frequency range:** 0.5 to 12.4 GHz.

**Transistor dc bias selection:** front panel slide switches establish proper dc biasing for both Bi-polar and FET transistors. The voltage and current controls operate independently and are continuously adjustable over a current range of 0 to 500 mA and a range of 0 to 30 Vdc.

**RF Input:** 20 dB range between -7 and +13 dBm.

**Incident power at device under test:** -27 dBm to -7 dBm with INCIDENT ATTENUATION set to 0 dB.

**Incident attenuation range:** 0 to 70 dB in 10 dB steps.

**Source reflection coefficient:** (typically) <0.13, 0.5 to 8.0 GHz;  $\pm 0.14$ , 8.0 to 12.4 GHz.

**Termination reflection coefficient:** (typically) <0.13, 0.5 to 8.0 GHz;  $\pm 0.14$ , 8.0 to 12.4 GHz.

**Directivity:** >28 dB, 0.5 to 4.0 GHz; >23 dB, 4 to 12.4 GHz.

**Frequency response:** (typically) <1.0 dB,  $\pm 5$  degrees, 0.05 to 4.0 GHz; <1.5 dB,  $\pm 5$  degrees, 4.0 to 8.0 GHz; <2.5 dB,  $\pm 5$  degrees, 8.0 to 12.4 GHz.

**Transmission measurement accuracy:** (see Common Performance Specifications).

**Reflection measurement accuracy:** sources of error included in the accuracy equation are directivity and source match.

**Magnitude accuracy:**

- $\rho_u = \pm(0.04 + 0.08 \rho_L + 0.13 \rho_L^2)$  0.5 to 4.0 GHz.
  - $\rho_u = \pm(0.07 + 0.09 \rho_L + 0.135 \rho_L^2)$  4.0 to 8.0 GHz.
  - $\rho_u = \pm(0.074 + 0.098 \rho_L + 0.14 \rho_L^2)$  8.0 to 12.4 GHz.
- $\rho_u$  = magnitude uncertainty.  
 $\rho_L$  = measured reflection coefficient magnitude.

**Phase accuracy:**

$$\Phi_u = \sin^{-1} \rho_u / \rho_L \text{ for } \Phi_u < 90^\circ.$$

$\Phi_u$  = phase uncertainty.

See 8410S Network Analyzer Systems Table for price and instrument breakdown.



# NETWORK ANALYZERS

## Individual Instruments

### 8410 family

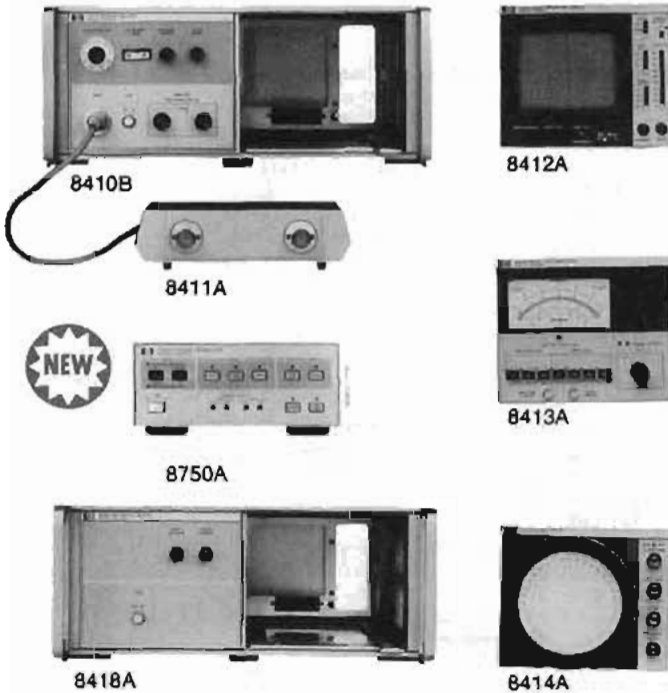

## Specifications

### 8410B/8411A Network Analyzer

**Function:** 8411A converts RF signals to IF signals for processing in 8410B mainframe. 8410B is the mainframe for display plug-in units. Mainframe includes tuning circuits (octave bands or multioctave bands when used with HP 8620/86290 sweep oscillator), IF amplifiers and precision IF attenuator.

**8410B frequency range:** 0.11 to 18 GHz.

**8411A frequency range:** 0.11 to 12.4 GHz.

**Opt 018:** 0.11 to 18 GHz.

**8411A Input Impedance:** 50 ohms nominal. SWR <1.5, 0.11 to 8.0 GHz; <2.0, 8.0 to 12.4 GHz; typically increases to a 10:1 SWR, 12.4 to 18 GHz.

**Channel Isolation:** >65 dB, 0.1 to 6 GHz; >60 dB, 6 to 12.4 GHz; >50 dB, 12.4 to 18 GHz.

#### Amplitude

**Reference channel:** -16 to -26 dBm, 0.11 to 18 GHz; -16 to -36 dBm, 0.11 to 12.4 GHz.

**Test channel:** -10 to -78 dBm from 0.11 to 12.4 GHz; -10 to -68 dBm from 12.4 to 18 GHz.

**Maximum RF input to either channel:** 50 mW.

**IF gain control:** 69 dB range in 10 dB and 1 dB steps with a maximum cumulative error of  $\pm 0.2$  dB.

#### Phase

**Phase range:** 0 to 360°.

**Control:** vernier control  $\leq 90^\circ$ .

**Connectors (8411A):** APC-7.

**Power:** 115 or 230 V ac  $\pm 10\%$ , 50-60 Hz, 70 watts (includes 8411A).

#### Weight

**8410B:** net, 14.9 kg (33 lb). Shipping, 18.5 kg (41 lb).

**8411A:** net, 3.2 kg (7 lb). Shipping, 4.5 kg (10 lb).

#### Size

**8410B:** 191 H  $\times$  425 W  $\times$  467 mm D (7 $\frac{1}{2}$ "  $\times$  16 $\frac{3}{4}$ "  $\times$  18 $\frac{3}{8}$ ").

**8411A:** 67  $\times$  228 W  $\times$  143 mm D (2 $\frac{3}{8}$ "  $\times$  9"  $\times$  5 $\frac{5}{8}$ ") exclusive of connectors and cable.

### 8412A Phase-Magnitude Display

**Function:** plug in CRT display unit for 8410B. Displays relative amplitude in dB and/or relative phase in degrees between reference and test channel inputs versus frequency.

#### Amplitude

**Range:** 80 dB display range with selectable resolutions of 10, 2.5, 1 and 0.25 dB/division.

**Accuracy:** 0.08 dB/dB from midscreen.

#### Phase

**Range:**  $\pm 180^\circ$  display range with selectable resolutions of 90, 45, 10, and 1°/division.

**Accuracy:** 0.065°/degree from midscreen.

**Phase offset:** 0.3°/20° step cumulative  $< 3^\circ$ .

**Power:** 23 watts supplied by mainframe.

**Weight:** net, 7.8 kg (17 lb). Shipping, 10 kg (22 lb).

**Dimensions:** 152 H  $\times$  186 W  $\times$  395 mm D (6"  $\times$  7 $\frac{3}{32}$ "  $\times$  15 $\frac{1}{16}$ ") excluding front panel knobs.

### New 8750A Storage-Normalizer

**General:** the 8750A Storage-Normalizer provides digitally stored and normalized CRT displays when used with the 8412A Phase Magnitude Display. Measurements are faster, easier and more accurate when the 8750A is employed because the CRT is flicker-free and frequency response errors are eliminated. The 8750A is not compatible with the 8414A Polar Display.

**Power:** selection of 100, 120, 220, or 240 V  $\pm 5\%$  - 10%. 48 to 440 Hz and  $\leq 20$  VA  $\leq 20$  watts).

**Weight:** net, 2.72 kg (6 lbs). Shipping, 5.0 kg (11 lbs).

Detailed specifications on page 459.

### 8413A Phase-Gain Indicator

**Function:** plug-in meter display unit for 8410B. Displays relative amplitude in dB between reference and test channel inputs or relative phase in degrees. Pushbutton selection of meter function and range.

#### Amplitude

**Range:**  $\pm 30$ ,  $\pm 10$ , and  $\pm 3$  dB full scale.

**Accuracy:**  $\pm 3\%$  of end scale.

**Log output:** 50 millivolts per dB up to 60 dB total.

#### Phase

**Range:**  $\pm 180$ ,  $\pm 60$ ,  $\pm 6$  degrees full scale.

**Accuracy:**  $\pm 2\%$  of end scale.

**Output:** 10 millivolts per degree.

**Phase offset:**  $\pm 180$  degrees in 10-degree steps.

**Accuracy:**  $\pm 0.2^\circ + 0.3^\circ/10^\circ$  step, cumulative  $< 2^\circ$ .

**Power:** additional 15 watts supplied by 8410B.

**Weight:** net, 4.9 kg (11 lb). Shipping, 6.7 kg (15 lb).

**Size:** 152 H  $\times$  186 W  $\times$  395 mm D (6"  $\times$  7 $\frac{3}{32}$ "  $\times$  15 $\frac{1}{16}$ ").

### 8414A Polar Display

**Function:** plug-in CRT display unit for 8410B. Displays amplitude and phase data in polar coordinates on  $\phi$ -in. cathode ray tube.

**Range:** normalized polar coordinate display; magnitude calibration 20% of full scale per division. Scale factor is a function of IF setting on 8410B. Phase calibrated in 10-degree increments over 360-degree range.

**Accuracy:** error circle on CRT  $\pm 3$  mm.

**Power:** additional 35 watts supplied by 8410B.

**Weight:** net, 5.8 kg (13 lb). Shipping, 8.1 kg (18 lb).

**Size:** 152 H  $\times$  186 W  $\times$  395 mm D (6"  $\times$  7 $\frac{3}{32}$ "  $\times$  15 $\frac{1}{16}$ ") excluding front panel knobs.

### 8418A Auxiliary Power Supply

**Function:** the 8418A power supply unit provides power for operating of the 8412A, 8413A or the 8414A display units. Used in conjunction with the 8410B Network Analyzer, it provides the capability of viewing amplitude and phase readout in both rectangular and polar coordinates simultaneously. Option H01 adds a remotely programmable 0-70 dB IF attenuator required for autoranging in semi-automatic applications.

**Weight:** net, 11.2 kg (25 lb). Shipping, 19.7 kg (44 lb).

**Size:** 177 H  $\times$  483 W  $\times$  450 mm D (6 $\frac{3}{16}$ "  $\times$  19"  $\times$  17 $\frac{1}{8}$ ").

## Ordering Information

8410B mainframe

Opt 908: Rack Flange Kit

8411A Frequency Converter

Opt 018: 0.11 to 18 GHz

8412A Phase-Magnitude Display

8413A Phase-Gain Display

8414A Polar Display

8418A Auxiliary Power Supply

Opt H01: Programmable 0-70 dB IF Attenuator

8750A Storage-Normalizer

## Price

\$3750

add \$10

\$3100

add \$500

\$2200

\$1750

\$2000

\$1600

add \$2000

\$1450



8745A



11604A



11602B



11600B



8743A

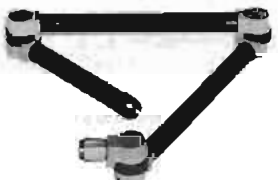

11605A

### 8745A S-Parameter Test Set

**Function:** wideband RF power splitter and reflectometer with calibrated line stretcher. Pushbutton operated for either transmission or reflection measurements with network analyzer.

**Frequency range:** 100 MHz to 2 GHz.

**Impedance:** 50 ohms nominal.

**Source reflection coefficient:**  $\leq 0.057$ , 0.11 to 2.0 GHz.

**Termination reflection coefficient:**  $< 0.10$ , 100 to 200 MHz;  $< 0.063$ , 200 MHz to 2.0 GHz.

**Directivity:**  $\geq 36$  dB, below 1 GHz;  $\geq 32$  dB, 1 to 2 GHz.

**Reference plane extension:** 0 to 15 cm for reflection; 0 to 30 cm for transmission.

**Maximum RF power:** 2 watts.

**Connectors:** RF input, type N female; all other connectors APC-7.

**Rear panel programming and bias inputs**

**Opt 001:** output connectors type N female.

**Power:** 115 or 120 V ac  $\pm 10\%$ , 50 to 400 Hz, 40 watts.

**Weight:** net, 15.4 kg (34 1/2 lb). Shipping, 18.0 kg (40 lb).

**Size:** 140 H  $\times$  425 W  $\times$  654 mm D (5 1/2"  $\times$  16 3/4"  $\times$  25 3/4").

### 11604A Universal Extension

**Function:** mounts on front of 8745A; connects to device under test. Rotary air-lines and rotary joints connect to any two port geometry.

**Frequency range:** dc to 2 GHz.

**Impedance:** 50 ohms nominal.

**Reflection coefficient:** 0.035.

**Acc. Included:** semi-rigid coax. cable, HP Part #11604-20021.

**Weight:** net, 1.8 kg (4 lb). Shipping, 2.2 kg (5 lb).

**Size:** 127 H  $\times$  32 W  $\times$  267 mm D (5"  $\times$  1 1/4"  $\times$  10 1/2").

### 11600B/11602B Transistor Fixtures

**Function:** mounts on front of 8745A S-parameter test set; holds devices for S-parameter measurements in a 50-ohm, coax circuit. Both fixtures provide bias for bipolar transistors and FETs. Other devices also fit the fixture (tunnel diodes, etc.).

**Transistor base patterns**

**Model 11600B:** accepts TO-18/TO-72 packages.

**Model 11602B:** accepts TO-5/TO-12 packages.

**Calibration references:** short circuit termination and a 50-ohm through-section.

**Frequency ranges:** dc to 2 GHz.

**Impedance:** 50 ohm nominal.

**Reflection coefficient:**  $< 0.05$ , 100 MHz to 1.0 GHz;  $< 0.09$ , 1.0 to 2 GHz.

**Connectors:** hybrid APC-7; Option 001, type N female.

**Weight:** net 1.1 kg (2 3/8 lb). Shipping, 1.8 kg (4 lb).

**Size:** 152 H  $\times$  44 W  $\times$  229 mm D (6"  $\times$  1 3/4"  $\times$  9").

### 8743A Reflection/Transmission Test Unit

**Function:** wideband RF power splitter and reflectometer with calibrated line stretcher. Pushbutton operated for either transmission or reflection measurement with network analyzer.

**Frequency range:** 2 to 12.4 GHz, (Opt 018: 2 to 18 GHz).

**Impedance:** 50 ohms nominal.

**Source reflection coefficient:**  $\leq 0.09$ , 2.0 to 8.0 GHz;  $\leq 0.13$ , 8.0 to 12.4 GHz;  $< 0.2$ , 12.4 to 18 GHz.

**Termination reflection coefficient:**  $\leq 0.13$  in reflection mode, 2.0 to 12.4 GHz;  $\leq 0.2$  in transmission mode, 2.0 to 12.4 GHz; typically  $< 0.2$ , 12.4 to 18 GHz.

**Directivity:**  $\geq 30$  dB, 2.0 to 12.4 GHz;  $\geq 18$  dB, 12.4 to 18 GHz.

**Reference plane extension:** 0 to 15 cm for reflection; 0 to 30 cm for transmission.

**Connectors:** RF input, type N female; all other connectors APC-7.

**Power:** 115 or 230 V ac  $\pm 10\%$ , 50-400 Hz, 15 W.

**Weight:** net, 12.1 kg (29 lb). Shipping, 15.3 kg (34 lb).

**Size:** 140 H  $\times$  425 W  $\times$  467 mm D (5 1/2"  $\times$  16 3/4"  $\times$  18 3/4").

### 11605 Flexible Arm

**Function:** Mounts on front of 8743A; connects to device under test. Rotary air-lines and rotary joints connect to any (two-port geometry).

**Frequency range:** dc to 12.4 GHz. (Opt 018, 2 to 18 GHz).

**Impedance:** 50 ohms nominal. Reflection coefficient of ports:  $\leq 0.11$ , dc to 12.4.

**Opt 018:**  $\leq 0.23$ , 2.0 to 12.4 GHz;  $\leq 0.31$ , 12.4 to 18 GHz.

**Connectors:** APC-7.

**Weight:** net, 1.8 kg (4 lb). Shipping, 2.7 kg (6 lb).

**Length:** 257 mm (10 1/8") closed; 648 mm (25 1/2") extended.

### Ordering Information

	Price
8745A Test Set	\$5000
Opt 001: Type N Test Port Connectors	N/C
Opt 908: Rack Flange Kit	add \$10
11604A Universal Arm	\$1450
11600B/11602B Transistor Fixtures	\$850
Opt 001: Type N Female Connectors	less \$30
8743A Reflection/Transmission Test Unit	\$4500
Opt 018: 0.11 to 18 GHz	add \$800
Opt 908: Rack Flange Kit	add \$10
11605A Flexible Arm	\$1100
Opt 018: 0.11 to 18 GHz	add \$525

## 8410 family (cont.)



8746B



11608A

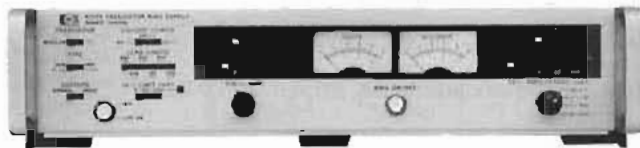

8717B



8740A



8741A



8742A

**8746B S-Parameter Test Set**

**Function:** wideband RF power divider and reflectometer with calibrated stretcher and a selectable 0–70 dB incident signal attenuator. Provides internal bias tests for completely characterizing two port active devices.

**Frequency range:** 0.5 to 12.4 GHz.

**Source and termination reflection coefficient:**  $\leq 0.13$ .

**Directivity:**  $\geq 30$  dB, 0.5 to 4.0 GHz;  $\geq 26$  dB, 4.0 to 12.4 GHz.

**Incident attenuation:** 0–70 dB in 10 dB steps  $\pm 5\%$ .

**Reference plane extension:** adds 0–15 cm (30 cm in transmission path).

**Remote programming:** ground closure to 36 Pin connector.

**Transistor biasing:** via 36 Pin connector.

**Connectors:** input type N female, test ports APC-7.

**Opt 001:** provides 10 dB higher power level at the test port.

**Power:** 115 or 230 V  $\pm 10\%$ , 48 to 440 Hz, 110 VA max.

**Weight:** net, 16.1 kg (35 lb). Shipping, 19.1 kg (42 lb).

**Size:** 140 H  $\times$  425 W  $\times$  467 mm D (5 $\frac{1}{2}$ "  $\times$  16 $\frac{3}{4}$ "  $\times$  18 $\frac{3}{8}$ ").

**11608A Transistor Fixture**

**Function:** provides the capability of completely characterizing strip-line transistors in either the TO-51 or HPAC-200 package styles. For special package styles, a through-line microstrip and bolt-in grounding structure machinable by customer is available.

**Frequency range:** dc to 12.4 GHz.

**Reflection coefficient:**  $< 0.05$ , dc to 4 GHz;  $< 0.07$ , 4.0 to 8.0 GHz;  $< 0.11$ , 8 to 12.4 GHz.

**Package styles**

**Opt 001:** Customer machineable.

**Opt 002:** TO-51 (0.250" dia.).

**Opt 003:** HPAC-200 (0.205" dia.).

**Calibration references:** options 002 and 003 only, short circuit termination and a 50-ohm through-section.

**Connectors:** APC-7 Hybrid (Option 100 type N female).

**Weight:** net, 0.9 kg (2 lb), Shipping, 1.4 kg (3 lb).

**Size:** 25 H  $\times$  143 W  $\times$  89 mm D (1"  $\times$  5 $\frac{3}{8}$ "  $\times$  3 $\frac{1}{2}$ ").

**8717B Transistor Bias Supply**

**Function:** for manual or programmable transistor testing. It is particularly useful with the 11600B, 11602B, and 11608A Transistor Fixtures. The 8717B has two meters for independently monitoring current and voltage on any of the three leads of a transistor under test. Bias connections are conveniently selected for all transistor configurations with a front panel switch. Special circuitry protects sensitive devices from excessive current transients which commonly occur in less sophisticated supplies.

**Voltage ranges:** 1, 3, 10, 30, 100 V.

**Current ranges:** 0.1, 0.3, 1, 3, 10, 30, 100, 300, 1000 mA.

**Accuracy:** 4% of full scale for both current and voltage.

**Option 001:** programmable D/A converter.

**Weight:** net, 9.0 kg (20 lb). Shipping, 11.0 kg (25 lb).

**Size:** 86 H  $\times$  425 W  $\times$  336 mm D (3 $\frac{3}{8}$ "  $\times$  16 $\frac{3}{4}$ "  $\times$  13 $\frac{1}{2}$ ").

**8740A Transmission Test Unit**

**Function:** RF power splitter and calibrated line stretcher for transmission measurement with network analyzer.

**Frequency range:** dc to 12.4 GHz.

**Output reflection coefficient:**  $< 0.07$ , dc to 7 GHz;  $< 0.11$ , 7.0 to 12.4 GHz.

**Connectors:** RF input, type N female; output, APC-7 (Opt 001 type N female).

**Reference plane extension:** electrical, 0 to 10 cm; mechanical 1–10 cm.

**Weight:** net, 7.1 kg (16 lb). Shipping, 9.4 kg (21 lb).

**Size:** 152 H  $\times$  186 W  $\times$  410 mm D (6"  $\times$  7 $\frac{3}{32}$ "  $\times$  16 $\frac{3}{16}$ ").

**Recommended accessory:** 11587A accessory kit.

**8741A and 8742A Reflection Test Units**

**Function:** wideband reflectometer, phase-balanced for swept or single frequency impedance tests with 8410B. Calibrated adjustable reference plane.

**Frequency range:** 0.11–2.0 GHz (8741A); 2.0–12.4 GHz (8742A).

**Directivity:**  $\geq 36$  dB 0.11–1 GHz,  $\geq 32$  dB 1–2 GHz (8741A);  $\geq 30$  dB 2–12.4 GHz (8742A).

**Connectors:** RF input, type N female; all others APC-7.

**Reference plane extension:** 0–15 cm.

**Accessories furnished:** 11565A, APC-7 short.

**Weight:** net, 6.7 kg (15 lb). Shipping, 8.9 kg (20 lb).

**Size:** 152 H  $\times$  186 W  $\times$  410 mm D (6"  $\times$  7 $\frac{3}{32}$ "  $\times$  16 $\frac{3}{16}$ ").

**Recommended accessory:** 11587A Accessory Kit

**Ordering Information**

	Price
8746B Test Unit	\$7700
Opt 001: Type N Test Port Connectors	N/C
Opt 908: Rack Flange Kit	add \$10
11608A Transistor Fixture (must specify Option 001, 002, or 003)	
Opt 001: Customer Machineable	\$750
Opt 002: TO-51	\$800
Opt 003: HPAC-200	\$800
Opt 100: Type N Female Connectors	less \$30
8717B Transistor Bias Supply	\$2750
Opt 001: Programmable D/A Converter	add \$670
Opt 908: Rack Flange Kit	add \$10
8740A Transmission Test Set	\$3300
8741A Reflection Test Set	\$2500
8742A Reflection Test Set	\$3300



X8747A and P8747A

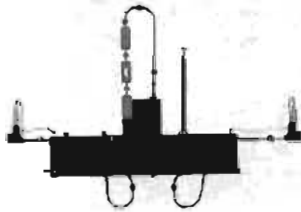

K8747A and R8747A



11587A



11650A



11609A



11589A and 11590A



11599A



11607A

#### X, P 8747A Reflection/Transmission Test Units

**Function:** waveguide setup for measuring reflection and transmission parameters of waveguide devices with the network analyzer.  
**Frequency range:** X8747A: 8.2–12.4 GHz; P8747A: 12.4–18 GHz.

#### K, R 8747A Reflection/Transmission Test Units

**Function:** waveguide setup for measuring reflection and transmission parameters of waveguide devices with the network analyzer; down-converts with built-in mixers to the frequency range of the 8411A.  
**Frequency range:** K8747A: 18–26.5 GHz; R8747A: 26.5–40 GHz.

#### 11587A Accessory Kit

**Function:** accessories normally used for transmission and reflection tests with the 8740A, 8741A, and 8742A.  
**Weight:** net, 1.34 kg (3 lb). Shipping, 2.23 kg (5 lb).

#### 11650A Accessory Kit

**Function:** accessories normally used for transmission and reflection tests with the 8745A and 8743A.  
**Weight:** net, 1.34 kg (3 lb). Shipping, 2.23 kg (5 lb).

#### 11609A Cable Kit

**Function:** interconnecting cables normally required for network measurements using the 8410 network analyzer.  
**Weight:** net, 0.9 kg (2 lb). Shipping, 1.36 kg (3 lb).

#### 11589A and 11590A Bias Networks

**Function:** auxiliary units for use with the 11600B, 11602B and 11608A transistor fixtures. These bias networks provide dc bias to the center conductor of a coaxial line while blocking the dc bias from the input RF circuit.

**Frequency range:** 11589A—0.1 to 3.0 GHz; 11590A—1.0 to 12.4 GHz.

**Connectors:** BNC for dc biasing; type N female for RF (Option 001: APC-7).

**Weight:** net, 0.3 kg (9 oz). Shipping, 0.5 kg (1 lb).

**Dimensions:** 29 H × 76 W × 114 mm D (1<sup>3</sup>/<sub>8</sub>" × 3" × 4<sup>1</sup>/<sub>2</sub>").

#### 11599A Quick Connect Adapter

**Function:** quickly connects and disconnects the 8745A and the transistor fixtures or 11604A universal extension.

**Weight:** net, 397 gm (14 oz). Shipping, 652 gm (2 lb).

**Dimensions:** 127 H × 76 W × 108 mm D (5" × 3" × 4<sup>1</sup>/<sub>2</sub>").

#### 11607A Small Signal Adapter

**Function:** used with the 8745A S-parameter test set. The incident signal levels to the test device are reduced to the -20 to -40 dBm range.

**Weight:** net, 4.1 kg (4<sup>5</sup>/<sub>8</sub> lb). Shipping, 4.5 kg (10 lb).

**Dimensions:** 60 H × 413 W × 244 mm D (2<sup>3</sup>/<sub>8</sub>" × 16<sup>1</sup>/<sub>4</sub>" × 9<sup>5</sup>/<sub>8</sub>").

#### Ordering information

	Price
X8747A Waveguide Test Set	\$3100
P8747A Waveguide Test Set	\$3250
K8747A Waveguide Test Set	\$9000
R8747A Waveguide Test Set	\$9500
11587A Accessory Kit	\$1140
11650A Accessory Kit	\$880
11609A Cable Kit	\$115
11589A Bias Network	\$350
Opt 001: APC-7 Connectors	add \$30
11590A Bias Network	\$400
Opt 001: APC-7 Connectors	add \$30
11599A Quick Connect Adapter	\$175
11607A Small Signal Adapter	\$800

# NETWORK ANALYZERS

Semi-automatic network analyzer, 110 MHz to 18 GHz

Model 8409A

- Economical automated microwave measurement
- Accuracy enhancement
- 9825A desktop computer



HP-IB

## Description

The HP 8409A Network Analyzer system is a practical solution to the need for automated error-corrected RF and microwave network measurements using a simple and economical configuration. It's a complete measurement system, comprised of a programmable source, network analyzer, and computing controller. The 8409A brings major advantages in accuracy, speed, and operating convenience at a modest cost increase compared to a manual network analyzer.

The 8409A consists of standard HP instruments and is delivered with accuracy enhancement software, calibration standards, and all necessary cables for hook-up and immediate use. Transmission and reflection characteristics are measured in two ranges, 0.11 to 2 GHz using the 8745A S-Parameter Test Set and 86222B sweeper plug-in, and 2 to 18 GHz using the 8743A Reflection/Transmission Test Unit and 86290B sweeper plug-in. Switching between the two frequency ranges is easily accomplished by changing both the test set and sweeper plug-in.

Accuracy enhancement software extends measurement capability to tests not possible or extremely difficult and time consuming using a manual system. Vector error terms are measured and stored using a precision sliding load, a short, a shielded open, and a through connection to quantify directivity, source match, and tracking errors at each frequency. These systematic errors are removed during the measurement sequence as the analyzer tunes back to each calibration frequency, measures the device response, and performs the error correction computation.

## 8409A Automatic Network Analyzer system components

Basic configuration includes:

Network analyzer

8410B Network Analyzer

8411A Opt 018 Harmonic Frequency Converter

8412A Phase-Magnitude Display

8418A Opt H01 Auxiliary Power Supply

8414A Polar Display

Test sets

8745A S-Parameter Test Set (0.11 to 2 GHz)

11857A Test Port Extension Cables

8743A Opt 018 Reflection/Transmission Test Set (2 to 18 GHz)

11605A Opt 018 Flexible Arm (2 to 18 GHz)

Source

8620C Opt 011 Sweep Oscillator Mainframe with HP-1B Interface

86222B (.01 to 2.4 GHz)

86290B (2 to 18.6 GHz)

HP-1B accessories

59313A Analog-to-Digital Converter

59306A Relay Actuator

Controller

9825A Opt 002 Desk Top Computer (with 23K bytes

memory) with String-Advanced Programming ROM.

9872A Plotter—General and Extended I/O ROM and HP-1B Interface.

9866B Thermal Printer with cradle

9872A Digital Plotter

Type N to SMA calibration accessories, software, system cables and integration

Ordering Information

8409A Automatic Network Analyzer

Opt 001: (2 to 18 GHz) deletes .11 to 2 GHz test set and sweeper plug-in.

- Digital storage and normalization
- Simple CRT photos and x-y recordings
- Use with HP network and spectrum analyzers

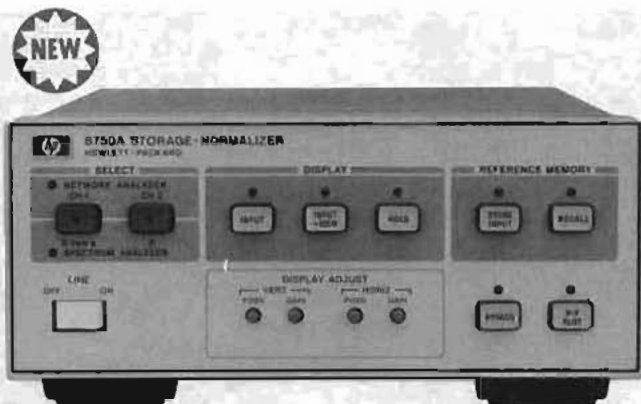

With HP's versatile 8750A Storage-Normalizer, you can make your network analyzer or spectrum analyzer measurements faster, easier, and more accurately through the simple addition of digital storage and normalization. This useful instrument accessory is directly compatible via a single interface cable with the following recently produced or appropriately modified Hewlett-Packard instruments: the 8755 Frequency Response Test Set, the 8407A/8412A, the 8410/8412A, and the 8505A Network Analyzers, and 8557A, 8558B, and the 8565A Spectrum Analyzers. A special I/O Adapter (opt 001 or opt 002) is available for interfacing instruments (like 140 Series Spectrum Analyzers) that are not directly compatible with the 8750A. An external oscilloscope can then be used for digitally stored and normalized displays. (The 8750A is not compatible with the 8414A Polar Display or the polar mode of 8505A.)

In network analyzer applications, digital storage always yields a flicker-free display of the complete device response, facilitating easy adjustment of test devices under slow sweep conditions. Measurement accuracy is also improved since frequency response errors can be automatically removed through digital normalization. This effectively eliminates the need to manually record calibration traces on a CRT or x-y recorder and allows high resolution measurements of attenuator, amplifier, or filter passband flatness.

In spectrum analyzer applications, the 8750A's digital storage feature simplifies many difficult tests requiring slow scan times such as high resolution modulation measurements. Drift test are also easy since two traces, a stored reference and the current input, can be displayed simultaneously.

Hard copy documentation can be obtained quickly and easily since data can be frozen on the CRT for straight forward CRT photography or outputted to an x-y recorder at a constant 30 second sweep rate.

## Specifications

### Display

**Horizontal memory resolution:** two display channels, 256 points per channel (0.4% of full scale, 8 bit word).

**Vertical Memory Resolution:** 512 points displayed full scale (0.2% of full scale, 10 bit word) plus a 50% overrange (256 points) both above and below full screen.

**Horizontal input sweep rates:** 100 sec max./10 ms min.

**Display refresh rate:** 6 ms.

### Video detection

**Network analyzer:** Average Detection (20 kHz).

**Spectrum analyzer:** Peak Detection.

### Input/output

#### A/D Horizontal Input

**Network analyzer:** 0 to 10 V nominal. Offset  $\pm 0.5$  V and Gain Adjust 6 to 15 V.

**Spectrum analyzers:**  $\pm 5$  V nominal. Offset  $\pm 0.5$  V and Gain Adjust  $\pm 4.45$  to  $\pm 5.5$  V.

#### A/D Vertical Input

**Network analyzer:**  $\pm 0.8$  V min. and  $\pm 2.25$  V max. with continuous gain adjustment. Offset  $\pm 0.3$  V.

**Spectrum analyzer:** 0 to 0.8 V or 0 to  $-0.8$  V. Offset  $\pm 0.1$  V and Gain Adjust  $\pm 10\%$ .

#### D/A Horizontal output

**Network analyzer:** gain adjustment from 1 to 3 V peak. Offset adjustment allows  $\pm 1.5$  V or 0 to 3 V sweep output.

**Spectrum analyzer:** 0 to 3 V nominal. Offset  $\pm 5$  V and Gain Adjustment from 0.7 to 3.5 V.

#### D/A Vertical output

**Network analyzer:** same as Vertical Input with  $\pm 10\%$  adjustment range.

**Spectrum analyzer:** same as Vertical Input with  $\pm 10\%$  adjustment range.

#### X-Y Recorder outputs

**Horizontal range and accuracy:** 0  $\pm 20$  mV to 1 V nominal, settable within  $\pm 3\%$  of full scale. BNC female output (rear panel).

**Vertical range and accuracy:**  $\pm 4$  V  $\pm 3\%$  BNC female output (rear panel).

**Sweep time:** 30 sec per displayed trace.

**Penlift voltage:** 20 V maximum.

**Penlift sinking current:** 50 mA maximum.

**Penlift output:** BNC female (rear panel with open collector driver.)

### Controls

**Select:** LED display indicates Network or Spectrum Analyzer operation depending on the plug-in interface card. Two rear panel plug-in interface cards are provided to accommodate the different network and spectrum analyzer performance requirements. Internal storage is provided for the interface card that is not in use.

**Network analyzer:** two keys activate front panel controls for adjustment of either channel 1 or 2 displays.

**Spectrum analyzer:** two keys allow the storing, viewing, and manipulation of up to two display traces (A and B).

### Display

**Input:** initiates digital storage.

**Input-Mem (Input minus Mem):** Stored Reference trace is subtracted from input data (normalization) and the difference displayed directly.

**Hold:** freezes display for CRT photos or further analysis.

### Reference memory

**Store Input:** current input trace is stored as Reference for future normalization (Input-Mem).

**Recall:** displays stored Reference trace.

**Bypass:** bypasses 8750A so display is returned to conventional analog operation.

**X-Y Plot:** initiates X-Y plots. Data and pen lift are outputted through rear panel BNC connectors.

**Display adjust:** Gain and Position potentiometers for adjustment of D/A outputs to CRT display requirements (see D/A Outputs).

### General

**Power:** selection 100, 120, 220, or 240 V  $\pm 5\%$   $-10\%$ . 48 to 440 Hz and  $< 20$  VA ( $< 20$  watts).

**Size:** 102 H  $\times$  212 W  $\times$  280 mm D (4"  $\times$  8.4"  $\times$  11.2").

**Weight:** net, 2.72 kg (61 lbs). Shipping, 5.0 kg (11 lbs).

### Ordering information

8750A Storage-Normalizer

**Opt 001:** BNC Interface Adapter (Deletes direct interface cable)

**Opt 002:** BNC Interface Adapter (Retains direct interface cable)

Price

\$1450

N/C

\$125

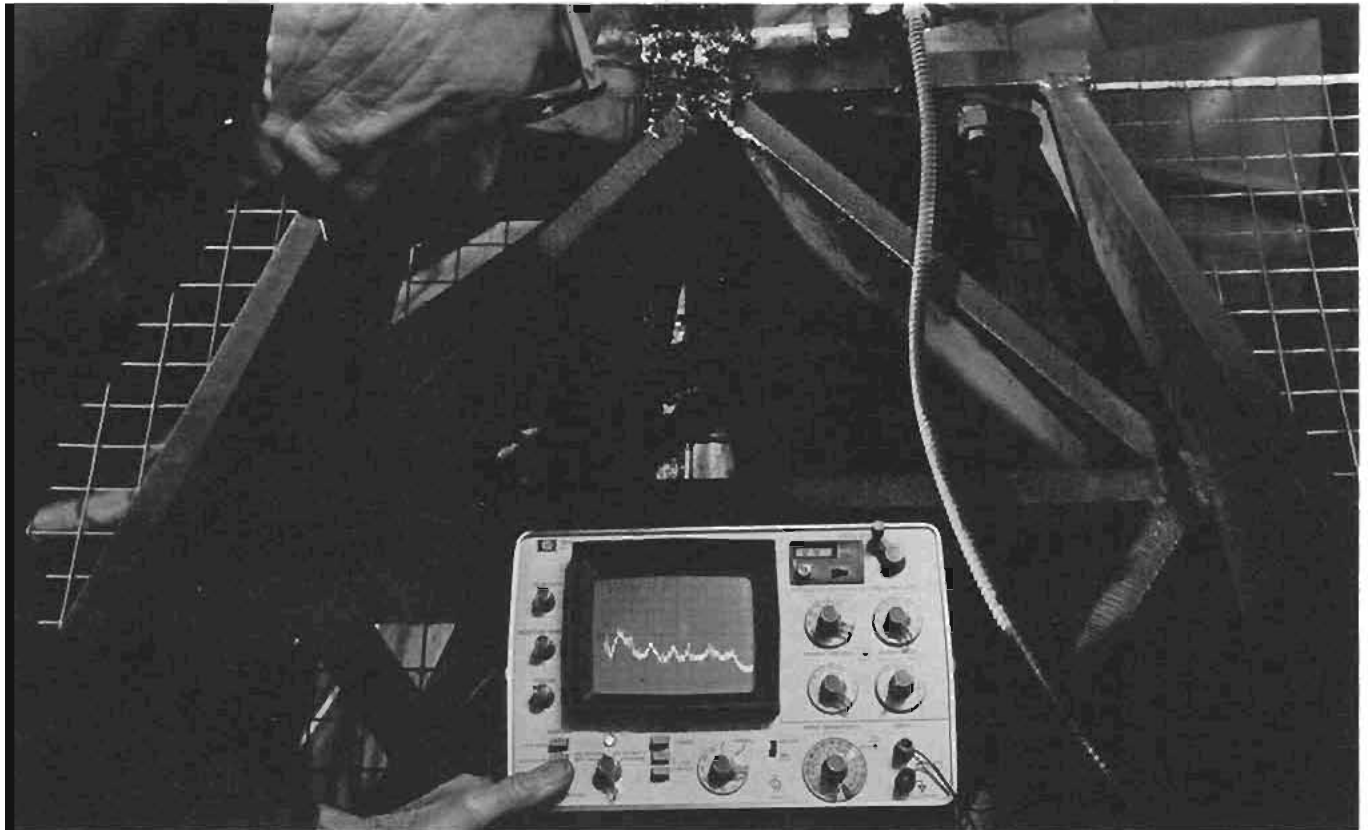

Analysis of signals in the frequency domain is an important measurement concept which is widely used for providing electrical and physical system performance information. Several examples will illustrate some important applications where signal analyzers are useful.

The vibrational patterns of structures (aircraft, automobiles, bridges, etc.) must be known to predict behavior in dynamic operating environments. Noise and vibration levels are of vital concern to the manufacturers and users of rotating machinery and automobile and aircraft engines. Resonant modes and many other parameters may be measured with the HP Fourier Analyzer.

A need for signal analysis in fluid flow signature identification applications has emerged in recent years. Particles carried in a flowing fluid may be identified and quantified by observing its spectral response to ultrasonic stimulation.

In the fields of telecommunications, the spectrum and wave analyzers provide vital operational performance verification of multiplex systems. Unwanted signals such as carrier leak signals, out-of-band noise, and cross modulated signals must be identified. System gain, loss, and pilot tone measurements must also be made. These measurements are discussed in more detail in the Telecommunications Test Equipment sec-

tion of this catalog.

Doppler Radar ranging systems require pure, stable CW signals for accurate determination of vehicle distance and movement. The phase noise of these CW signals limits the distance, accuracy, and resolution measuring capabilities of the system. Phase noise is an important parameter the spectrum analyzer can effectively display.

Finally, in the general field of electronics, there are three primary uses for the signal analyzer. First, the analyzer is used to identify and measure signals which result from non-linear effects in the process of amplification, filtering, and mixing. Second, the purity of signal sources is commonly observed. Third, the signal analyzer with a companion tracking generator is used as a network analyzer for frequency response measurements of filters, amplifiers, and many other types of networks.

This section discusses the definition and use of four type of instruments for frequency response signal analysis: spectrum analyzers, digital Fourier analyzers, wave analyzers, and distortion analyzers.

Each of these instruments measures the magnitude of CW signals through a specific bandwidth, just the same as a tuned voltmeter. But each measurement technique is different. The spectrum analyzer is a swept receiver that provides a visual display of

amplitude versus frequency. It shows on a single display how energy is distributed as a function of frequency, displaying the absolute value of Fourier components of a given waveform. The Fourier analyzer uses digital sampling and transformation techniques to form a Fourier spectrum display that has phase as well as amplitude information. The wave analyzer is the true tuned voltmeter, showing on a meter the real time amplitude of the energy in a specific frequency window which is tunable over a specific frequency range. The distortion analyzer performs an almost reciprocal function to that of the wave analyzer. It collectively measures the energy outside a specific bandwidth, tuning out the fundamental signal and displaying the energy of the harmonics and other distortion products on a meter.

Figure 1 shows a graphical representation of the way the three analyzers view a simple CW signal and one harmonic. The time domain scan of the CW signal is presented in 1.a.  $A(t)$  is the complex voltage waveform as it would be viewed on an oscilloscope. The dashed lines represent the vector components of the signal:  $A(t)$ , the fundamental and  $A(t)$ , the second harmonic. In 1.b. the spectrum analyzer displays the frequency spectrum showing both vector components and their amplitude relationship. Spectrum analysis is useful from 5 Hz to over 40 GHz.



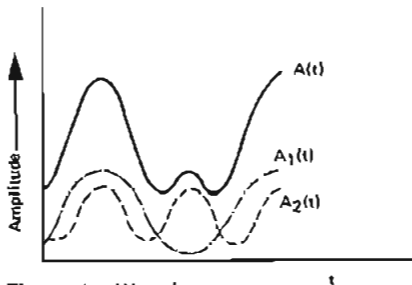

Figure 1a. Waveform

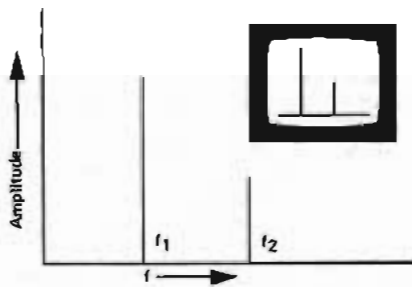

Figure 1b. Spectrum and Fourier analyzers

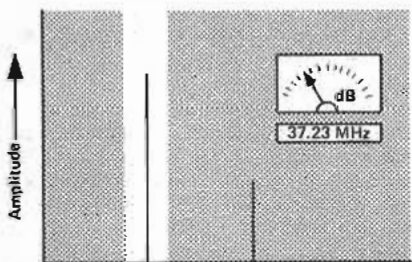

Figure 1c. Wave analyzer

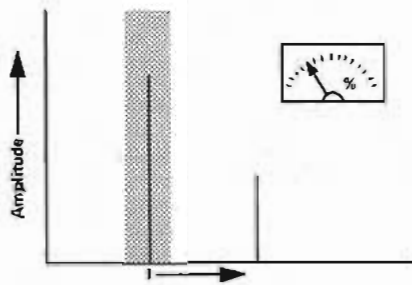

Figure 1d. Distortion analyzer

The Fourier Analyzer displays both the amplitude and phase components of each frequency so that accurate amplitude and phase relationships can be observed. Because the Fourier Analyzer uses digital techniques to extract frequency information rather than swept filter techniques, it can display the complete spectrum of a signal in just the time it takes to analyze the lowest frequency component. Hewlett-Packard Fourier Analysis is presently practical in the range of DC to 100 kHz. The wave analyzer in Figure 1.c. measures the amplitude and frequency of the signal in the frequency window to which it is tuned. This window can be moved to measure the amplitude of the second harmonic, thereby making a precise comparison with the fundamental. This

technique is practical from 10 Hz to above 18 MHz.

The distortion analyzer as pictured in Figure 1.d. rejects the fundamental to which it has been tuned and measures the energy everywhere else within the instrument's frequency spectrum. Distortion—as a percentage or in dB down from the fundamental—is displayed directly on a meter. Hewlett-Packard distortion analyzers cover 5 Hz to 600 kHz.

The following section considers each instrument technique, showing the particular strength and flexibility of each.

**Spectrum analyzer**

To display useful information about a frequency scan, a spectrum analyzer must be sensitive, frequency stable, free of spurious responses over a wide band, and have calibrated accuracy in the CRT display. The examples which follow best demonstrate the wide variety of information which can be measured on the spectrum analyzer.

**Measurements with the spectrum analyzer**

**CW signal:** the most basic spectrum analysis measurement is the single CW signal.

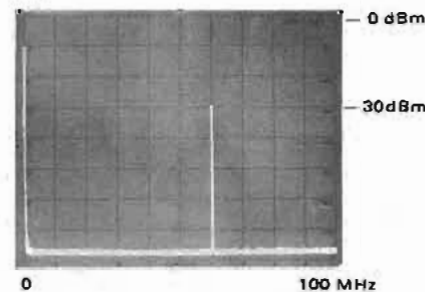

Pictured is a -30 dBm signal at 60 MHz. The zero frequency indicator is at the far left graticule.

**Spectral purity of a CW signal:** one very important oscillator signal measurement is spectral purity. This 70 Mz carrier has power line related sidebands ( $\pm 60$  Hz) which are 65 dB down.

Such sidebands may result from power supply ripple. The 50 Hz/division spectrum analyzer scan and the 10 Hz analyzer bandwidth provide the high degree of resolution required to see these sidebands.

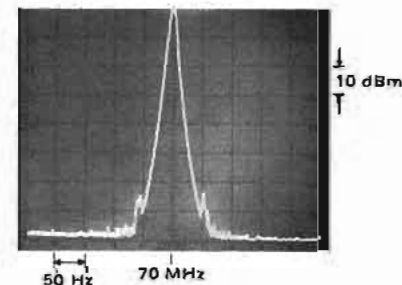

**Frequency conversion products:** the spectrum analyzer is well suited for frequency conversion measurements such as the output of a balanced mixer as shown.

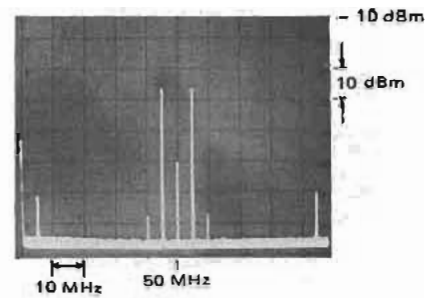

With the 50 MHz local oscillator input at 0 dBm and a 5 MHz, -30 dBm mixer signal, two sidebands at 45 MHz and 55 MHz result. The sidebands are -36 dBm, giving the mixer a 6 dB conversion loss. Other information easily extracted from this spectrum analyzer display is the 60 dB local oscillator isolation and the 5 MHz signal has 41 dB isolation. Second order distortion products at 40 and 60 MHz are 40 dB below the desired mixer outputs.

**Amplitude modulation; percent amplitude modulation** is often more easily measured

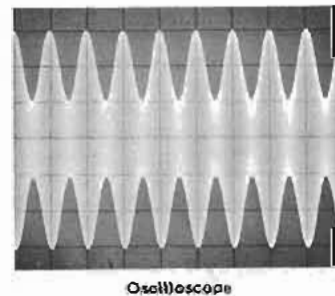

Oscilloscope

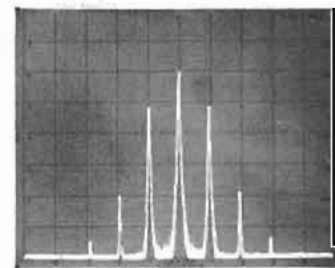

Spectrum Analyzer

with the spectrum analyzer than it is with the oscilloscope. This is especially true for low level modulation.

With the oscilloscope time display, percent modulation,  $M$ , is measured as a ratio of the signal's dimensions:  $M = 100 \cdot (6-2)/(6+2) = 50\%$ . In the spectrum analyzer display, whose vertical calibration is 10 dB/division, the carrier and sidebands differ by 12 dB, the voltages in the sidebands are  $1/2$  that of the carrier and again,  $M = 50\%$ . At the same time the second and third harmonic distortion of the sidebands can be measured at 28 and 44 dB respectively.

**Frequency modulation:** information transmitted by FM can be thoroughly characterized by the spectrum analyzer.

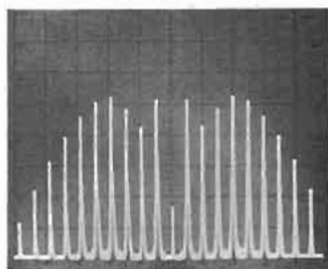

20 kHz Low Deviation FM

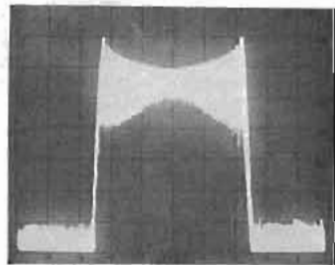

0.5 MHz High Deviation FM

Low deviation FM is applied to a 60 MHz carrier in the first photo. The deviation has been adjusted for the second carrier null ( $M = 5.52$ ). The sidebands spacing is 10 kHz, the modulation frequency; therefore,  $\Delta f$  peak =  $5.52 \times 10 \text{ kHz} = 55.2 \text{ kHz}$ .

The second photo is an example of high deviation FM. The transmission bandwidth is 2.5 MHz.

**Pulsed CW power:** by viewing the spectra of a repetitive RF pulse on the spectrum analyzer, pulse width average and peak power, occupied bandwidth, and duty cycle can be determined.

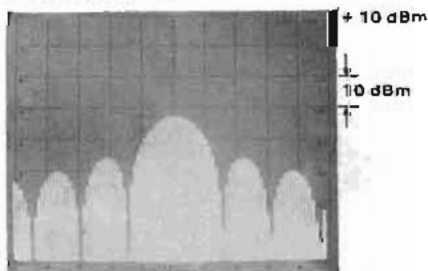

0.5 MHz 6.3 GHz

From the spectral output shown the pulse's complete characteristics are determined: 6.3 GHz RF at 0 dBm, pulsed at 50 kHz rate. The pulse width is 1.3  $\mu$ s.

**Noise:** spectrum analysis is effective in measuring impulse noise, random noise, carrier to noise ratio, and amplifier noise figure.

**Phase noise:** the short term frequency fluctuations of a sine wave source can be measured directly as phase modulation sidebands. Hewlett-Packard spectrum analyzers with narrow resolution and synthesized internal frequency sources can make many phase noise measurements directly. Bandwidth corrections, analyzer corrections, data averaging and setup calibration factors can be accounted for by Hewlett-Packard Automatic Spectrum Analyzers. All instrument control, data

transfer and data reduction can be handled by easy-to-write software.

**Frequency response:** using a tracking signal source and a spectrum analyzer the frequency response of filters can be displayed with ease.

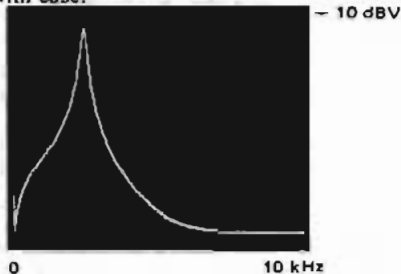

In this case, an audio filter used in a communications system is being measured. Since the input reference level to the filter is -13 dBV, the insertion loss at 2.4 kHz is 4 dB. Extremely high Q devices can be measured with this system.

#### Spectrum analyzer capabilities

To be useful in making measurements in the frequency domain, the analyzer must be capable of making quantitative measurements. Specifically, an analyzer must:

1. make absolute frequency measurements
2. make absolute amplitude measurements
3. operate over a large amplitude dynamic range
4. have high resolution of frequency and amplitude
5. have high sensitivity
6. provide means of observing, preserving, and recording its output in a convenient and rapid manner by using variable persistence, digital storage and adaptive sweep.

Hewlett-Packard spectrum analyzers excel in these six measures of performance.

Let us consider each of these performance standards in greater detail.

#### Absolute frequency measurements:

Frequency readout accuracy depends upon the tuning and readout techniques employed, as well as the stability of the spectrum analyzer's frequency reference. The absolute frequency accuracy read off the slide-rule type of frequency dial is approximately 1% of full scale. Synthesized local oscillators allow accuracies to +4 Hz at 1500 MHz in narrow frequency spans. When the spectrum analyzer is used in conjunction with a tracking generator (a source whose frequency is the same as the analyzer tuning frequency) accuracy much better than 1% can be achieved by counting the generator output.

**Absolute amplitude measurements:** All Hewlett-Packard spectrum analyzers are absolutely calibrated for amplitude measurements. This means the spectrum analyzer indicates to the user what the log/reference level or linear sensitivity is regardless of control settings. Either a warning light or CRT message indicates an uncalibrated condition, making operation of the analyzer easy and foolproof.

**Dynamic range:** the dynamic range of a spectrum analyzer is defined as the difference between the input signal level and the

average noise level or distortion products whichever is greater. Hence, dynamic range can be either distortion limited, noise limited or display limited.

**Frequency and amplitude resolution:** frequency resolution is the ability of the analyzer to separate signals closely spaced in frequency. The frequency resolution of an analyzer is a function of three factors: 1) minimum IF bandwidth, 2) IF filter shape factor, 3) spectrum analyzer stability.

The minimum IF bandwidth ranges down to 1 Hz on Hewlett-Packard spectrum analyzers.

One way to define IF filter shape factor is the ratio of 60 dB bandwidth to 3 dB bandwidth. Filter shape factor specifies the selectivity of the IF filter. Hewlett-Packard spectrum analyzers have IF filter shape factors as low as 11:1.

Analyzer frequency stability also limits resolution. The residual FM (short term stability) should be less than the narrowest IF bandwidth. If not, the signal would drift in and out of the IF pass band. Hewlett-Packard analyzers have excellent stability. The residual FM ranges from <1 Hz at low frequency, to <100 Hz at microwave frequencies, enabling the measurement of noise sidebands. The stabilization circuitry is completely automatic and foolproof. No signal recentering, phase-lock loop, manual search, or checking is required.

Amplitude resolution is a function of the vertical scale calibration. Hewlett-Packard analyzers offer both log calibration for observing large amplitude variations (10, 2 and 1 dB/div) and linear calibration for observing small amplitude variations.

**Sensitivity:** sensitivity is a measure of an analyzer's ability to detect small signals, and is often defined as the point where the signal level is equal to the noise level or  $(S + N)/N = 2$ . Since noise level decreases as the bandwidth is decreased, sensitivity is a function of bandwidth. The maximum attainable sensitivity ranges from -150 dBm to -125 dBm with Hewlett-Packard analyzers.

**Variable persistence, digital storage, and adaptive sweep:** high resolution and sensitivity both require narrow bandwidths and consequently slow sweep rates. Because of these slow sweeps, variable persistence is virtually indispensable in providing a bright, steady, flicker-free trace. (In effect, variable persistence allows one to vary the length of time a trace remains on the CRT.)

The digital storage feature on Hewlett-Packard analyzers covering audio to microwave frequency ranges make measurements and CRT photography simple. It gives the CRT displays a dot matrix connected by line generators for an unbroken and uniform intensity scan.

On low frequency analyzers, adaptive sweep speeds measurement times. On the very slow sweep times required when using the 1 Hz bandwidth adaptive sweep allows the scan to sweep rapidly when no signals occur. At signals above a preset level the sweep is slowed for an accurate measurement. The measurement time savings can be greater than 20:1.

**Tracking preselector**

The only way to simultaneously avoid spurious, multiple, harmonic and image responses, is to filter the RF signal through a tracking preselector. This is an electronically tuned bandpass filter that automatically tracks the analyzer's tuning. A preselector improves the spurious-free range of the analyzer from less than 70 dB to 100 dB.

**Tracking generator**

A tracking generator expands the measurement capability of the spectrum analyzer by providing a signal source which tracks the tuning frequency of the analyzer. The source/receiver combination can be used to measure insertion loss, frequency response, return loss and precision frequency count.

It helps make these additional measurements with increased distortion-free dynamic range, sensitivity and selectivity. The tracking generator is also an excellent stable sweeping generator. The residual FM ranges from  $\pm 1$  Hz for low frequency tracking generators to  $\pm 400$  Hz for microwave tracking generators.

**Frequency stability analysis**

Frequency stability and spectral purity are important parameters when characterizing precision frequency sources. Long term stability or frequency drift due to aging or temperature effects is generally measured with a precision frequency counter such as the HP 5345A; random fluctuations in frequency or phase stability can be measured in the time domain with an electronic counter and the Allan Variance technique. Measurement dimensions for this method are rms Fractional Frequency Deviation in parts per million for various averaging (gate) times.

Another technique for estimating random fluctuations is by measuring phase spectral density in the frequency domain. The most commonly used dimensions for this measurement is the single sideband signal-to-phase noise ratio expressed in dBc (dB below the carrier) at various offset frequencies from the carrier. The most common method of making this measurement is to mix two signals together and feed the output into lower frequency wave analyzer or spectrum analyzer. The technique works well for offset frequencies far away enough from the carrier to be compatible with the bandwidths of the analyzer.

For offset frequencies close to the carrier, (eg. below 100 Hz) the bandwidths of analog analyzer become large in comparison to the frequencies being measured. As 1 Hz is approached, measurements become extremely difficult.

An automatic system for making phase noise measurements very close to the carrier is the HP 5390A Frequency Stability Analyzer which is based upon a high performance electronic counter and a programmable calculator. The counter is ideally suited to make measurements in the time domain, and the calculator can transform the data into the frequency domain. This technique allows measurements to be made

from 0.01 Hz away from the carrier out to 10 kHz. Sensitivities greater than  $-150$  dBc can typically be obtained at a 1 Hz offset on carriers ranging from 500 kHz to 18 GHz. For a more complete description of this automated technique refer to the 5390A Frequency Stability Analyzer on page 502.

**Automatic spectrum analyzers**

The measurement capability of a spectrum analyzer can be greatly enhanced by allowing a desktop computer to control instrument functions and record frequency and amplitude information. Data can be gathered and processed into a variety of formats at a very rapid rate. Through comprehensive self-calibration, automatic spectrum analysis offers amplitude accuracy of up to  $\pm 0.2$  dB with 0.02 dB resolution. User cost savings are realized through faster measurements, lower operator skill requirements, and unattended operation capability.

Further discussion of computer, based automatic spectrum analysis can be found on page 483 and 577.

**Fourier analyzers**

Fourier analysis is one of a variety of digital signal analysis techniques that allow analysis of signals that cannot be adequately measured by "traditional" instrumentation. Among these are: Random signals or signals obscured by noise, joint properties or relationships of two or more signals, statistical properties of signals, or very low-frequency signals (below 20 Hz).

The basis for Fourier analysis lies in the fact that time domain signals may be represented as a number of individual frequency components in the frequency domain. The Fourier transform calculates the amplitude and phase coefficients of each component frequency.

The fundamental steps involved are shown in Figure 2. One or more analog inputs are first sampled at regular intervals,  $\Delta t$ , then digitized and stored in memory. The desired function (i.e., power spectrum, transfer function, etc.) is then computed by the processing unit and stored in memory. The contents of memory can then be viewed on a CRT display, plotted, or processed further—based on the user's specific requirements.

**Advantages**

The digital nature of Fourier analysis insures high accuracy, stability and essentially

no low-frequency limits. Since the transform provides all frequency lines from DC to some maximum frequency at the same time, a great time savings is obtained over analog swept techniques.

This is especially advantageous when analyzing low-frequency signals which require long time periods or when extremely high resolution is desired.

One technique used by the Fourier Analyzer to obtain very high resolution is Band Selectable Fourier Analysis (BSFA). Using BSFA, a 100 Hz band centered about 25 kHz can be analyzed with 0.2 Hz resolution.

The Fourier Analyzer accepts multiple inputs. With simultaneous sampling, the relationship between two or more signals may be calculated, such as the input and output of a mechanical, electrical, or acoustic system. This flexibility, as well as the ability to compute many different statistical functions and output the data in a variety of formats, result in an extremely cost effective, general-purpose analyzer.

Equally important, the Fourier Analyzer is easy to use. It can be operated without special programming and contains a built-in calibrated CRT display for easy interpretation of results.

These advantages have opened up several new applications for Fourier analysis, many of them in fields which are not traditional users of digital instrumentation.

**Applications**

The versatility and performance of the Fourier Analyzer make it an ideal tool for a variety of applications. Mechanical engineers, electrical engineers, geophysicists and bio-medical researchers are applying its advanced digital analysis capability to a broad spectrum of problems. Power spectrum analysis, ensemble averaging, cross spectrum measurements, transfer function measurements, and correlation are fundamental measurement techniques. Although the use or source of the data may differ, these analyses form the basis for understanding and solving complex dynamic problems.

Applications for Fourier analysis cover a broad range of areas. Rotating machinery analysis, structural dynamics, vibration control, electromechanical systems analysis, and acoustic studies, are just a few of the areas where these advanced techniques are being applied.

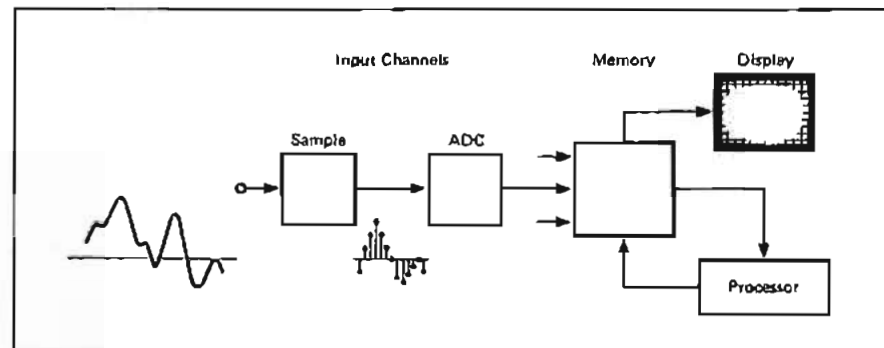

Figure 2. Basic Fourier Analyzer

### Correlator, spectrum display

Correlation analysis may be thought of as the time domain equivalent of spectrum analysis. It is particularly useful for the recovery of periodic signals buried in noise (without requiring a synchronizing signal), the measurement delays in signal transmission path, and the identification of the time response of linear systems.

Correlation is the product of two signals expressed as a function of a time delay between them. In computing the cross correlation between two signals, one signal is delayed relative to the other by a known variable amount. For each value of relative delay the signals are multiplied together and the average product represents the correlation, or similarity for the particular delay. A peak value in a cross correlation of random signals indicates that for that delay value there is a high degree of similarity between the signals. Such information can be useful in determining propagation times of random phenomena.

Autocorrelation is a special case in which a signal is delayed relative to itself. At zero delay, a signal is of course identical to itself and the correlation value is merely a measure of the mean square voltage of the signal. At increasing values of delay the autocorrelation function can reveal the existence of small periodic components in a large random signal. Such a measurement finds application in acoustics, infrasound analysis, radio astronomy, and many other fields.

Since the correlation function and the power spectrum are Fourier transform pairs, the addition of a spectrum display turns a correlator into a powerful frequency and time domain measuring instrument. An autocorrelation function measured by the correlator can be transformed by the spectrum display into the auto power spectrum of the input signal. Similarly, a crosscorrelation function may be transformed into the corresponding cross power spectrum.

The simultaneous display of time domain functions and their corresponding spectra, coupled with the features of digital signal analysis mentioned above give the correlator and spectrum display some unique advantages as an economical signal analyzer.

### Wave analyzer

Wave analyzers are known by several different names: frequency selective voltmeter, carrier frequency voltmeter, and selective level meter. These names describe the instrument's function rather well.

As mentioned in the introduction to this section a wave analyzer can be thought of as a finite bandwidth window filter which can be tuned throughout a particular frequency range.

Signals will be selectively measured as they are framed by the frequency window. Thus, for a particular signal, the wave analyzer can indicate its frequency (window position) and amplitude. Amplitude is read on an analog meter; frequency is read on either a mechanical or electronic readout.

The uses of wave analyzers can be

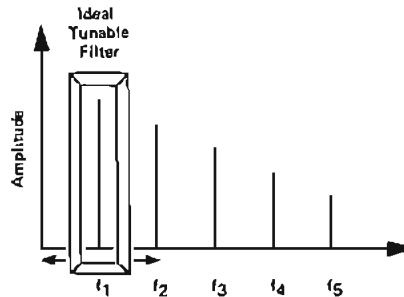

Figure 3. Wave analyzer tunable filter

categorized into three broad areas: 1) amplitude measurement of a single component of a complex frequency system, 2) amplitude measurement in the presence of noise and interfering signals and, 3) measurement of signal energy appearing in a specified, well defined bandwidth.

### Wave analyzer considerations

#### Frequency characteristics

**Range:** should be selected with the future in mind as well as present requirements.

**Accuracy and resolution:** should be consistent with available bandwidths. Narrow bandwidths require frequency dial accuracy to place the narrow window in the proper position for measurement. Accuracy of instruments with selectable bandwidths is determined by the basic center frequency accuracy of the IF bandwidth filters in addition to the local oscillator frequency accuracy. Accuracy is usually specified as a fixed frequency error at any point on the dial, thus meaning poorer percentage accuracy at the low frequency settings.

**Readout:** usually a frequency dial but newer instruments use a frequency counter whose accuracy and ease of use outweighs the increased cost.

**Stability:** frequency stability is important when using narrow bandwidths and for long term signal monitoring. Stability is best achieved with automatic frequency control (AFC). AFC locks the local oscillator to the incoming signal and eliminates any relative drift between the two. It serves as a tuning aid to pull the signal within the passband, eliminating peaking the frequency control. The AFC always tunes within the passband, improving accuracy on repetitive measurements.

**Sweep:** some instruments are equipped with sweep to allow use as a spectrum analyzer. Readout is a CRT or X-Y recorder.

#### Amplitude characteristics

**Range:** the amplitude range is determined by the input attenuator and the internal noise of the instrument. Sensitivity is defined as the lowest measurable signal equal to the noise level for a unity signal-to-noise ratio (often called tangential sensitivity).

Sensitivity will vary with bandwidth and input impedance.

**Dynamic range:** defined as the dB ratio of the largest and smallest signals that can be simultaneously accommodated without causing an error in the measurement.

**Attenuators:** the amplitude range switch is an attenuator in the input and IF stages. Intermodulation distortion is lowest when the input amplifier has the minimum signal applied and the IF gain is greatest. Conversely the internal noise, important when making sensitive measurements, is lowest with maximum input signal and lowest IF gain. The two attenuator instruments allow this transfer of gain between input and IF to be accomplished easily.

**Accuracy:** amplitude accuracy is a function of frequency, input attenuator response, IF attenuator performance, calibration oscillator stability and accuracy, and meter tracking. Often specifications are expanded to separately describe each contributor.

**Readout:** amplitude readout is usually a meter calibrated in dB and/or volts. Linear voltage meters are used to allow the user to see down into the noise at the bottom of the scale. Digital readouts are not used because of their slow response and the difficulty of deriving rate-of-change information from a sequence of numbers. This is important since the readout is used as a tuning indicator to show presence of a signal in the passband and when it has reached a peak. Expanded scale meters allowing expansion of any 1 or 2 dB portion of the scale into a full scale presentation allow resolution of input level changes of a few hundredths of a dB. This is useful when the wave analyzer is used as a sensitive indicator in bridge or comparison measurements. The expanded scale meter is included in some instruments and is an optional accessory on others.

#### Input characteristics

**Impedance:** may be high impedance bridging input or terminating impedance to match standard transmission lines. High frequency measurements require matched systems to avoid error-producing standing waves on interconnecting cables. The measure of impedance accuracy is usually return loss or reflection coefficient ( $RL = 20 \log \rho$ ). In low frequency instruments, percent accuracy is used. High input impedance instruments are usually poorer in frequency and noise performance and are usually low frequency instruments. High impedance at high frequencies is accomplished by using a bridging probe to place the impedance at the point of measurement. The probe may be active with unity gain or passive with 20-30 dB insertion loss.

**Input arrangement:** input may be balanced to ground or unbalanced. Communications system usage typically requires balanced input. Standard 600 and 135/150Ω balanced inputs are limited in frequency to less than 1 MHz and 124Ω balanced to less than 10 MHz in most instruments. The impedance may be balanced to ground with the center point grounded or may be completely isolated from ground. Unbalanced inputs do not have frequency range limitations.

### Network analysis application

**Frequency response testing:** with its BFO output, the wave analyzer is particularly useful for measuring filter and amplifier frequency responses. If a notch filter is being measured, for example, a narrow band measurement like that provided by a wave analyzer is essential for obtaining acceptable accuracy. A broadband technique will lead to some misleading results. For example, a notch filter may be driven with a flat oscillator and the response measured with a broadband voltmeter. The notch filter will reject the oscillator's fundamental tone, but pass its harmonics which are in the volt-

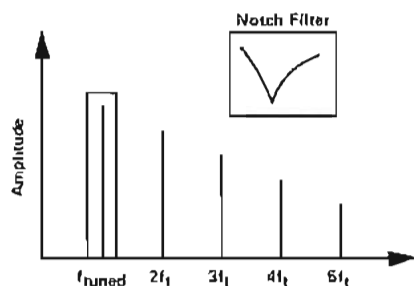

Figure 4. Only signal detected by wave analyzer. For example, the notch of a filter can be accurately measured to its full depth.

meter's measurement range. Thus, an error results. If the voltmeter were frequency selective, like a wave analyzer, the harmonics would be rejected and the true level of the notch would be measured. Accurate and fast measurements can be made because Hewlett-Packard wave analyzers track and detect only the BFO frequency.

### Distortion analyzers

Harmonic distortion is one of many types of distortion created in communications equipment and audio and ultrasonic sound systems. Nonlinear elements in amplifiers cause harmonic related frequencies from a pure tone stimulus to be created at the output. Hence, to a listener, a poor reproduction quality becomes apparent. The total of these frequency components present in a signal, in addition to the fundamental frequency can be measured quickly and easily with Hewlett-Packard distortion analyzers.

The ratio of these frequency components to the amplitude of the fundamental is the total harmonic distortion (THD) as defined by the following equation (1):

$$THD = \frac{\sqrt{\sum(\text{harmonics})^2}}{\text{fundamental}}$$

The Hewlett-Packard distortion analyzer consists of a narrow band rejection filter and broadband detector. Before the fundamental is rejected, the analyzer first measures the

amplitude of the fundamental, all the harmonic components, and noise. Then the rejection filter is employed to remove the fundamental. The ratio of the two measurements is an approximation of equation (1) above and is defined by the following equation (2):

$$THD = \frac{\sqrt{\sum[(\text{harmonics})^2 + (\text{noise})^2]}}{\sqrt{\sum[(\text{fundamental})^2 + (\text{harmonics})^2 + (\text{noise})^2]}}$$

An approximation error of 1/2% can be expected for true THD levels of 10%. However, distortion levels as high as 10% are seldom encountered in most measurement situations. The harmonic content of the stimulus source must not be more than a third of the distortion expected to be caused by the system under test.

### True harmonic distortion measurements

The Hewlett-Packard calculator controlled automatic spectrum analyzer provides the user a rapid means of measuring true harmonic distortion levels. The fundamental and its harmonic components are rapidly measured one at a time and the distortion is computed by applying equation (1). In production test situations, distortion calculations can be stored on tape for future reference and/or plotted for hard copy needs. Also, limit testing can be applied.

## Signal analyzers selection guide

### Spectrum analyzers

Frequency Range	Amplitude Calibration Range	Bandwidths		Model Description	Companion Instruments	Page
		Min	Max			
5 Hz-50 kHz	-150 to +30 dBm	1 Hz	300 Hz	3580A Spectrum Analyzer		476
20 Hz-300 kHz	-130 to +10 dBm	10 Hz	10 kHz	8556A Tuning Section Plug-In (See Note 1)		492
10 Hz-13 kHz	-140 to 0 dBm	3 Hz	10 kHz	3044A/45A Spectrum Analyzer		473
1 kHz-110 MHz	-130 to +10 dBm	10 Hz	300 kHz	8553B Tuning Section Plug-In (See Note 1)	8443A Tracking Generator (100 kHz-110 MHz)/Counter	491
10 kHz-350 MHz	-120 to +20 dBm	1 kHz	3 MHz	8557A Spectrum Analyzer Plug-In (See Note 2)	8750A Storage-Normalizer	486
100 kHz-1250 MHz	-122 to +10 dBm	100 Hz	300 kHz	2554B Tuning Section Plug-In (See Note 1)	8444A Tracking Generator (500 kHz-1250 MHz)	494
100 kHz-1500 MHz	-115 to +30 dBm	1 kHz	3 MHz	3558B Spectrum Analyzer Plug-In (See Note 2)	8750A Storage-Normalizer 8444A Opt. USB Tracking Generator (500 kHz-1300 MHz)	488
100 Hz-1500 MHz	-137 dBm to +30 dBm	10 Hz	3 MHz	8568A Spectrum Analyzer and 8581A Automatic Spectrum Analyzer	8444A Opt. H59 Tracking Generator (500 kHz-1500 MHz)	478 483
10 MHz-40 GHz	124 dBm to +30 dBm	100 Hz	3 MHz	8565A Spectrum Analyzer	8750A Storage-Normalizer 8444A Opt. USB Tracking Generator (10-1300 MHz)	484
10 MHz-40 GHz	-130 to +10 dBm	100 Hz	300 kHz	8555A Tuning Section Plug-In (See Note 1)	8444A Tracking Generator (10 MHz-1300 MHz) 8445B Automatic Presetector (10 MHz-18 GHz)	498
0.01 Hz-10 kHz offset from carrier 500 kHz-18 GHz carrier range	-150 dBc min.	<100 μHz	10 kHz	5390A Frequency Stability Analyzer	59309A Digital Clock	502

NOTE 1. For use in oscilloscope mainframes 1401 and 1411 with B section plug-ins 8552A or 8552B (page 498).

NOTE 2. For use in oscilloscope mainframes 180TR, 1811TR and 182T.



# SIGNAL ANALYZER

Wave, distortion, spectrum and Fourier analyzers (cont.)

## Digital Signal Analyzers

Frequency Range	Amplitude Calibration Range	Resolution Points		Model Description	Functions Available	Page
		Min	Max			
DC-100 kHz (See Note 1)	7 steps from ±0.125 to ±8 V	32	2048	5451 Fourier Analyzer	Power spectrum Transfer function Coherence Convolution	504
DC-25 kHz	7 Steps from ±0.1 to ±10 V	256	32,000 (See Note 2)	5420A Digital Signal Analyzer	Time Average Linear Spectrum Auto Spectrum Transfer Function Coherence Function Histogram Correlation Impulse Response	505
0.1-25 kHz	7 steps from ±0.125 to ±8 V	256 PS 128 TF	1024 PS 512 TF	5425A Digital Vibration Control System (Analysis Mode)	Power Spectrum (PS) Transfer Function (TF) Transient Capture Shock Response Spectrum	504
DC-250 kHz	40 mV to 4 V rms	100	100	3721A Correlator	Correlation (Auto and Cross) Probability Density Probability Integral	506
0.005-250 kHz	40 mV to 4 V rms	100	100	Spectrum Display	Real and Complex Fourier Transform of 3721A data	506

NOTE 1: Standard range is DC to 50 kHz, expandable with options to 100 kHz.

NOTE 2: Equivalent number of points using Band Selectable Analysis.

## Distortion analyzer

Frequency Range	Auto Nulling	Hi-Pass Filter	Lo-Pass Filter	AM Detector	Gear Reduction Tuning	Model No.	Page
5 Hz to 300 kHz					•	331A	468
				•	•	332A	468
			•	•	•	332A Opt H05	468
	•	•				333A	468
	•	•			•	334A	468
10 Hz to 100 kHz	•	•	•	•		334A Opt H05	468
						4333A	487

## Wave analyzers

Frequency Range	Selective Bandpass	Dynamic Range		Freq. Readouts	Type of Inputs	Type of Outputs	Modes of Operation	Model Number	Page
		Absolute	Relative						
15 Hz to 50 kHz	3 Hz 10 Hz 30 Hz 100 Hz 300 Hz	0.1 µV-300 V full scale	>85 dB	5-place digital	Banana jacks	rec: 5 V dc full scale, with pen lift BFO, Local Oscillator, tuning loudspeaker, and headphone jack	AFC, normal, BFO	3581A/ 3581C	472 532
1 kHz to 18 MHz 18 ranges	50 Hz or Optional 150 Hz 2800 Hz 3100 Hz	-120 to +23 dBm	>72 dB	7-place decade counter	75Ω accepts WECO 358A 124Ω accepts WECO 408A 135Ω accepts WECO 305A External frequency standard	Recorder: 1 V dc full scale 1 kHz source aux: 1 MHz (1 V p-p) 30 MHz (40-70 mV) rms LO: (30-48 MHz) 60 to 90 mV rms Audio: +13 dBm into 600Ω	AM, beat LSB, USB	312D/ 3320C	550
1 kHz to 18 MHz 18 ranges or 1 kHz to 22 MHz 18 ranges*	200 Hz 1000 Hz 3100 Hz	200 mV-3.2 V full scale or -120 to +23 dBm -130 to +13 dBm (600Ω only)	>72 dB	7-place decade counter	BNC & probe 11530A bridged/ terminated balanced or unbalanced  or WE-477B input unbalanced*  or BNC input 50Ω unbalanced*	rec: 1 V dc full scale 1 kHz source aux: 1 MHz (1 V p-p) 30 MHz (40-70 mV) rms LO: (30-48 MHz) 60 to 90 mV rms audio: >0.5 into 10 kΩ 313A: Track or tuned 75Ω unbalanced, -99.9 to +10 dBm (Opt 001, 50Ω unbalanced output)	AFC, AM, beat LSB, USB	312B 313A	470

\*312B/313A Opt H01 (WE477B input unbalanced); 312B/313A Opt H05 (BNC Input 50Ω unbalanced).

- Ultra low distortion: 0.01% full scale
- Frequency range: 10 Hz to 100 kHz
- Automatic tuning

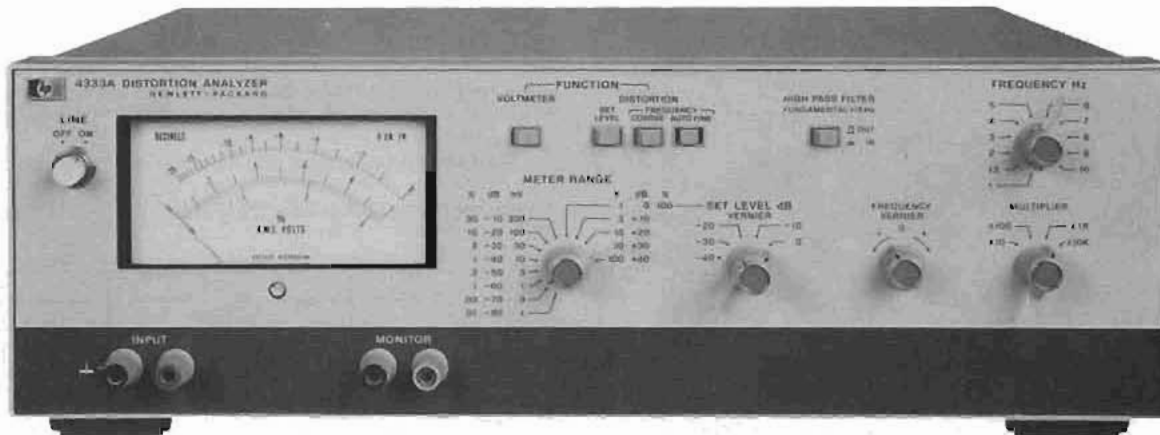

## Description

Hewlett-Packard Model 4333A Distortion Analyzer measures total harmonic distortion down to 0.01% full scale at 41 spot frequencies between 10 Hz and 100 kHz; harmonics are indicated up to 600 kHz.

Automatic fundamental nulling reduces critical manual nulling operations where only coarse tuning of the frequency vernier ( $\pm 8\%$  of spot frequency) to less than 3% of set level reference is required.

A 1 kHz high-pass filter which may be activated by a front panel switch is available for reducing the effects of hum components below 400 Hz.

A high sensitivity voltmeter mode offers 13 ranges in 10 dB steps; range is from 100  $\mu\text{V}$  to 100 V rms full scale. The bandwidth is 10 Hz to 600 kHz for the 300  $\mu\text{V}$  to 100 V ranges and 10 Hz to 200 kHz for the 100  $\mu\text{V}$  range. Meter indication is proportional to the average value of the sine wave and calibrated in rms volts/%; dB scale is calibrated dBV.

## Specifications, Model 4333A

**Distortion measurement ranges:** nine ranges, 0.01% to 100% full scale.

**Frequency range for distortion measurement:** frequency vernier and multiplier controls 41 spot frequencies (not including overlapping points) for choosing between 10 Hz through 100 kHz in a 1, 1.5, 2, 3, 4, 5, 6, 7, 8, 9, 10 sequence. Any set frequency is variable up to  $\pm 8\%$  with frequency vernier.

### Distortion measurement accuracy

#### Harmonic measurement accuracy (full scale)

Range/Accuracy	$\pm 3\%$	$\pm 6\%$
100%–0.03%	10 Hz–400 kHz	10 Hz–600 kHz
0.01%	10 Hz–100 kHz	10 Hz–200 kHz

### Elimination characteristics

#### Fundamental rejection:

- >100 dB, 10 Hz to 10 kHz (multiplier X10, X100, X1 K).
- >95 dB, 10 kHz to 100 kHz (multiplier X10 K).

**Second harmonic accuracy:** better than +0, -0.6 dB, 10 Hz to 100 kHz.

**Distortion introduced by instrument:**  $< -95$  dB (0.0018%) from 10 Hz to 10 kHz (multiplier X10, X100, X1 K).

- $< -90$  dB (0.0032%) from 10 kHz to 30 kHz (multiplier X10 K).
- $< -85$  dB (0.0056%) from 40 kHz to 100 kHz (multiplier X10 K).

### Input

**Impedance:** 100 k $\Omega$   $\pm 5\%$  shunted by  $< 80$  pF.

Single ended, low side chassis ground.

**Input level for distortion measurement:** for 100% (0 dB) set level 1.0 V rms to 130 V rms. Minimum input for auto nulling is 0.1 V rms.

**Voltmeter range:** 100  $\mu\text{V}$  to 100 V rms full scale (13 ranges) 10 dB per range.

### Frequency range for voltage measurement

10 Hz to 600 kHz: (300  $\mu\text{V}$ –100 V range).

10 Hz to 200 kHz: (100  $\mu\text{V}$  range).

### Voltmeter accuracy

Range/Accuracy	$\pm 2\%$	$\pm 5\%$
100 $\mu\text{V}$	20 Hz to 50 kHz	10 Hz to 200 kHz
300 $\mu\text{V}$ to 100 V	20 Hz to 300 kHz	10 Hz to 600 kHz

### Voltmeter residual noise (600 $\Omega$ termination)

300  $\mu\text{V}$  range:  $< 25$   $\mu\text{V}$  rms.

100  $\mu\text{V}$  range:  $< 10$   $\mu\text{V}$  rms.

**Monitor output:** 0.1 V rms  $\pm 0.01$  V rms open circuit for full scale meter indication. 2 k $\Omega$   $\pm 10\%$  output impedance.

**High-pass filter:** 3 dB point at 400 Hz with 18 dB per octave rolloff. Normally used only with fundamental frequencies greater than 1 kHz.

### General

**Power supply:** 100, 120, 220, 240 V  $\pm 10\%$ , 48 to 66 Hz, approximately 11 VA. Rear terminals are provided for external battery supply. Positive and negative voltages between 22 V and 40 V are required. Current drain from each supply is approximately 150 mA.

**Weight:** net, 7.5 kg (16 $\frac{3}{4}$  lb). Shipping, 9.9 kg (22 lb).

**Dimensions:** 132.6 mm H  $\times$  425.5 mm W  $\times$  349.3 mm D (5.25"  $\times$  16.75"  $\times$  13.75").

### Options

907: Front Handle Kit

908: Rack Flange Kit

909: Rack Flange & Front Handle Combination Kit

910: Extra Manual

### Price

add \$15

add \$10

add \$20

add \$9

4333A Distortion Analyzer

\$1885

# SIGNAL ANALYZERS

## Distortion analyzers

### Models 331A, 332A, 333A, 334A



333A

## Description

Hewlett-Packard's models 331A, 332A, 333A and 334A Distortion Analyzers measure total distortion down to 0.1% full scale at any frequency between 5 Hz to 600 kHz; harmonics are indicated up to 3 MHz. These instruments measure noise as low as 50 microvolts and measure voltages over a wide range of level and frequency. Refer to table below for available models and features.

Model No.	Auto Nulling	Hi-Pass Filter	Lo-Pass Filter	AM Detector
331A				
332A				X
332A Opt. H05			X	X
333A	X	X		
334A	X	X		X
334A Opt. H05	X		X	X

Option 001, for each model, features VU meter characteristics conforming to FCC requirements.

## 331A Specifications

**Distortion measurement range:** any fundamental frequency, 5 Hz to 600 kHz. Distortion levels of 0.1%–100% are measured full scale in 7 ranges.

### Distortion measurement accuracy

#### Harmonic measurement accuracy (full scale)

Fundamental Input Less Than 30 V			
Range	±3%	±6%	±12%
100%–0.3%	10 Hz–1 MHz	10 Hz–3 MHz	
0.1%	30 Hz–300 kHz	20 Hz–500 kHz	10 Hz–1.2 MHz

Fundamental Input Greater Than 30 V			
Range	±3%	±6%	±12%
100%–0.3%	10 Hz–300 kHz	10 Hz–500 kHz	10 Hz–3 MHz
0.1%	30 Hz–300 kHz	20 Hz–500 kHz	10 Hz–1.2 MHz

**Elimination characteristics:** fundamental rejection >80 dB. Second harmonic accuracy for a fundamental of 5 to 20 Hz: better than +1 dB; 20 Hz to 20 kHz: better than ±0.6 dB; 20 kHz to 100 kHz: better than –1 dB; 100 kHz to 300 kHz: better than –2 dB; 300 kHz to 600 kHz: better than –3 dB.

**Distortion introduced by instrument:** >–70 dB (0.03%) from 5 Hz to 200 kHz. >–64 dB (0.06%) from 200 kHz to 600 kHz. Meter indication is proportional to average value of a sine wave.

**Frequency calibration accuracy:** better than ±5% from 5 Hz to 300 kHz. Better than ±10% from 300 to 600 kHz.

**Input impedance:** distortion mode; 1 MΩ ±5% shunted by <70 pF (10 MΩ shunted by <10 pF with HP 10001A 10:1 divider probe).

**Voltmeter mode:** 1 MΩ ±5% shunted by <35 pF 1 to 300 V rms; 1 MΩ ±5% shunted by <70 pF, 300 μV to 0.3 V rms.

**Input level for distortion measurements:** 0.3 V rms for 100% set level or 0.245 V for 0 dB set level (up to 300 V may be attenuated to set level reference).

**DC isolation:** signal ground may be ±400 V dc from external chassis.

**Voltmeter range:** 300 μV to 300 V rms full scale (13 ranges) 10 dB per range.

**Voltmeter accuracy:** (using front panel input terminals)

Range	±2%	±5%
300 μV	30 Hz–300 kHz	20 Hz–500 kHz
1 mV–30 V	10 Hz–1 MHz	5 Hz–3 MHz
100 V–300 V	10 Hz–300 kHz	5 Hz–500 kHz

**Noise measurements:** voltmeter residual noise on the 300 μV range: <25 μV rms, when terminated in 600 (shielded) ohms, <30 μV rms terminated with a shielded 100 kΩ resistor.

**Output:** 0.1 ±0.01 V rms open circuit and 0.05 ±0.005 V rms into 2 kΩ for full scale meter deflection.

**Output impedance:** 2 kΩ.

**Power supply:** 115 or 230 V ±10%, 50 to 66 Hz, approximately 4 VA.

## 332A Specifications

Same as Model 331A except as indicated below:

**AM detector:** high impedance DC restoring peak detector with semi-conductor diode operates from 550 kHz to greater than 65 MHz. Broadband input, no tuning is required.

**Maximum input:** 40 V p-p AC or 40 V peak transient.

**Distortion introduced by detector:** carrier frequency: 550 kHz–1.6 MHz: <50 dB (0.3%) for 3–8 V rms carriers modulated 30%. 1.6 MHz–65 MHz: <40 dB (1%) for 3–8 V rms carriers modulated 30%. Note: Distortion introduced at carrier levels as low as 1 Volt is normally <40 dB (1%) 550 kHz to 65 MHz for carriers modulated 30%.

## 333A Specifications

Same as Model 331A except as indicated below:

**Automatic nulling mode:** set level: at least 0.2 V rms

**Frequency ranges:** X1, manual null tuned to less than 3% of set level; total frequency hold-in ±0.5% about true manual null. X10 through X10 k, manual null tuned to less than 10% of set level; total frequency hold-in ±1% about true manual null.

**Automatic null accuracy:** 5 Hz to 100 Hz: meter reading within 0 to +3 dB of manual null. 100 Hz to 600 kHz: meter reading within 0 to +1.5 dB of manual null.

**High-pass filter:** 3 dB point at 400 Hz with 18 dB per octave roll off. 60 Hz rejection 40 dB. Normally used with fundamental frequencies greater than 1 kHz.

**Power supply:** same as Model 331A.

## 334A Specifications

Same as Model 333A except includes AM Detector described under Model 332A:

### General

**Dimensions:** 426 mm W × 126 mm H × 337 mm D (16.75" × 5" × 13.25").

**Weight:** net, 7.98 kg (17.75 lb). Shipping, 10.35 kg (23 lb).

### Ordering instructions

Option 001, indicating meter has VU characteristics conforming to FCC requirements for AM/FM and TV broadcasting

H05-332A (meets FCC requirements)

H05-334A (meets FCC requirements)

331A Distortion Analyzer

332A Distortion Analyzer

333A Distortion Analyzer

334A Distortion Analyzer

### Price

add \$23

add \$129

add \$105

\$1100

\$1150

\$1250

\$1300



- Ultra low distortion measurements
- Built-in low distortion oscillator

- Automatic
- True RMS detection

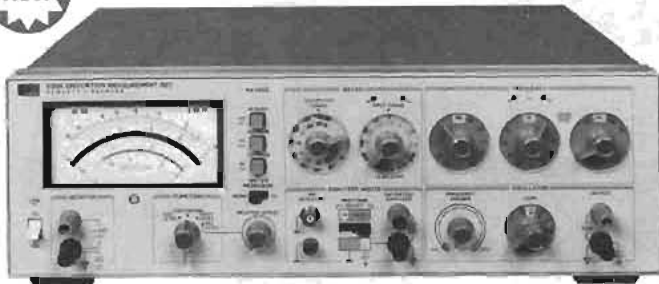

339A

### Description

Hewlett-Packard's new Model 339A Distortion Measurement Set is an ultra low distortion measuring system complete with total harmonic distortion (THD) analyzer, true-rms voltmeter, and sine-wave oscillator. This small, lightweight bench measurement set allows you to make THD distortion measurements as low as 0.0018% over a 10 Hz to 110 kHz frequency band including harmonics to 330 kHz.

#### Fast and easy THD measurements

For fast and easy THD measurements the built-in tracking oscillator in HP's 339A saves test time because you tune one instrument instead of two. Frequency and level measurements are easy to do with HP's 339A's voltmeter, which offers you a 1 mV to 300 V dynamic range. The Relative Level mode has been included to further simplify frequency response measurements. Just set a 0 dBm reference at any frequency from 10 Hz to 110 kHz. Gain measurements can be read directly from the easy-to-read meter.

#### Operation simplicity

Automatic frequency tuning and set-level features allows you to make rapid, error free THD measurements. The 339A's built-in tracking oscillator eliminates the need to find the fundamental frequency and tune the analyzer for a null. Just select your oscillator frequency and the rest is automatic. Automatic set-level saves time by automatically setting 0 dB (100%) reference in the distortion measuring mode. Front panel directional indicators light when the input range setting is improper insuring accurate and repeatable measurements. Automatic set-level also greatly simplifies measurements where distortion as a function of level (SINAD, for example) is desired. Without this feature, measurements are very time consuming and tedious.

When an external stimulus is used, analyzer tuning is simplified by directional indicator lights for reaching the fundamental null quickly and easily.

#### FCC requirements

The FCC required features for broadcast testing are included in the 339A. They include an AM detector, 30 kHz low pass filter, and switchable VU meter ballistics.

#### Other features

Hum and noise filters, a high level monitor output for further harmonic analysis, and floating input are standard features on the model 339A.

1. Method for measuring receiver sensitivity performance.

### Tentative Specifications

#### Distortion mode

**Fundamental frequency range:** 10 Hz–110 kHz.

**Distortion measurement range:** 0.01% full scale to 100% full scale (–80 dB to 0 dB) in 9 ranges.

**Detection and meter indication:** true rms detection for waveforms with crest factor  $\leq 3$ .

**Fundamental rejection:** 10 Hz to 20 kHz: >100 dB; 20 kHz to 50 kHz: >90 dB; 50 kHz to 110 kHz: >86 dB.

**Distortion introduced by instrument:** (input  $\leq 1$  V rms): 10 Hz to 20 kHz: <–95 dB; 20 kHz to 30 kHz: <–90 dB; 30 kHz to 50 kHz: <–85 dB; 50 kHz to 110 kHz: <–70 dB.

**Residual noise:** (fundamental frequency setting < 20 kHz, 80 kHz filter in, source resistance  $\leq 1$  K $\Omega$  shielded): –92 dB referenced to 1 V.

**Input level:** 30 mV to 300 V rms (100 mV range minimum).

**Input impedance:** 100 k $\Omega$   $\pm 1\%$  shunted by <100 pF input High to Low.

**DC Isolation:** input low may be floated 30 V dc.

**Auto set level:** 10 dB capture range.

**Auto null:** internal oscillator: fully automatic; external sine wave source: pull range > one least significant digit.

#### Voltmeter mode

**Voltmeter range:** 1 mV rms full scale to 300 V rms full scale.

**Frequency range:** 10 Hz to 110 kHz.

**Accuracy (% of range setting):** 20 Hz to 20 kHz:  $\pm 2\%$ ; 10 Hz to 110 kHz:  $\pm 4\%$ .

**Relative input level:** voltage range, frequency range, accuracy specifications, are the same as in Voltmeter Mode.

#### Oscillator

**Frequency range:** 10 Hz to 110 kHz.

**Output level:** variable from <1 mV to >3 V rms into 600 $\Omega$  load with 10 dB/step LEVEL control and 10 dB VERNIER adjustment.

**Frequency accuracy:**  $\pm 2\%$  of selected frequency (with FREQUENCY VERNIER in CAL position).

**Level flatness:** 20 Hz to 20 kHz:  $\leq \pm 0.1$  dB; 10 Hz to 110 kHz:  $\leq \pm 0.2$  dB.

**Distortion ( $\geq 600\Omega$  load,  $\leq 3$  V output):** 10 Hz to 20 kHz: <–95 dB (0.0018%) THD; 20 kHz to 30 kHz: <–85 dB (0.0056%) THD; 30 kHz to 50 kHz: <–80 dB (0.01%) THD; 50 kHz to 110 kHz: <–70 dB (0.032%) THD.

**Output resistance:** 600 $\Omega$   $\pm 5\%$ .

**Input filters:** Low Pass Filters: 30 kHz –3 dB point at 30 kHz with 60 dB/decade rolloff; 80 kHz –3 dB point at 80 kHz with 60 dB/decade rolloff; High Pass Filter: 400 Hz –3 dB point at 400 Hz with 60 dB/decade rolloff.

#### AM detector

##### Frequency range

**Carrier frequencies:** 550 kHz to 1.6 MHz.

**Modulation frequencies:** 20 Hz to 20 kHz.

##### Input level

**Maximum:** 60 V peak.

**Modulation signal level:** 2 V rms minimum, 10 V rms maximum.

#### General

**Power:** 100/120/220/240 V  $\pm 5\%$ , –10% 48 Hz to 66 Hz line operation, 200 mA maximum.

**Size:** 146 H  $\times$  426 W  $\times$  442 mm D (5.75"  $\times$  16.75"  $\times$  17.4").

**Weight:** net 8.2 kg (18 lbs), Shipping 11.3 kg (25 lbs).

339A Distortion Measurement Set

\$1900

# SIGNAL ANALYZERS

1 kHz to 18 MHz selective voltmeter/tracking oscillator

Models 312B & 313A



312B (top), 313A

## Description

Hewlett-Packard Model 312B/313A is a frequency selective voltmeter/tracking oscillator operating in the frequency range of commercially available carrier and radio systems. The set is capable of making transmission and noise measurements. A 312D is available with special features for telecommunications applications. See page 500.

HP's 312B uses a frequency synthesizer for tuning that is automatically phase locked in 1 MHz steps. Tuning between lock points is indicated on a 7-place digital readout with 10 Hz plus time-base accuracy. Coupled with this digital indication of unambiguous frequency is an automatic tuning aid known as automatic frequency control (AFC). The AFC will automatically fine tune frequency to the center of the set's passband, and automatically correct any relative frequency drift between the set and the signal being measured. Long term monitoring of signals is possible without periodic readjustment. High frequency accuracy coupled with AFC gives clear, instantaneous tuning and eliminates the need to search for signals.

Input and IF attenuators allow a maximum of dynamic range without concern for overloading the set. Attenuators can be easily set for minimum distortion or noise performance. Attenuator settings are indicated clearly on a lighted annunciator which, when

added to meter indication, gives a fast indication of input level. An accessory expanded scale meter allows 0.02 dB resolution of input level for high resolution readings.

The instrument is equipped with both balanced and unbalanced inputs to fit measuring situations without the need for external accessory transformers. A wide selection of input impedances, either bridging or terminated, is provided along with provisions for an accessory high impedance, balanced bridging probe to reduce measurement errors. The set always indicates directly in dBm or volts at any impedance, eliminating time consuming calculations or conversion charts.

Three selectable bandwidths are provided for all measurement situations. A narrow 200 Hz bandwidth is used for highly selective measurements, a 1000 Hz bandwidth for general measurements, and a 3100 Hz bandwidth for noise measurements.

Demodulation of upper or lower sideband channels with an audio output is provided for monitoring noise, traffic, or tones in any channel. The accurate digital frequency readout requires only a quick reference to the system frequency charts to determine frequency for perfect demodulation. In this respect, Model 312B can be thought of as a single-channel, tuneable, multiplex, receive terminal.

erence to the system frequency charts to determine frequency for perfect demodulation. In this respect, Model 312B can be thought of as a single-channel, tuneable, multiplex, receive terminal.

HP's Model 313A Tracking Oscillator provides an accurate, flat output at the frequency to which the 312B is tuned for frequency response measurements. Output frequency is quickly and easily set by the digital tuning indicator on the selective voltmeter.

Output level is easily set by a 3-digit presentation with 0.1 dB resolution. Output level is also easily read and remains constant with changes in frequency requiring no time consuming resetting of level at each new frequency.

A built-in meter provides an expanded scale display of the 312B's meter indication with 0.02 dB resolution of input level.

### 312B Specifications

#### Tuning characteristics

**Frequency range:** 1 kHz to 18 MHz in 18 overlapping bands. 200 kHz overlap between bands.

**Frequency accuracy:**  $\pm 10$  Hz + time base accuracy. Frequency indicated on in-line digital readout with  $\pm 10$  Hz resolution.

#### Selectivity

Bandwidth Hz	3 dB BW	60 dB BW
200 Hz	200 Hz $\pm 10\%$	426 Hz $\pm 10\%$
1000 Hz	1 kHz $\pm 10\%$	2135 Hz $\pm 10\%$
3100 Hz	3100 Hz $\pm 10\%$	6200 Hz $\pm 10\%$

#### Amplitude characteristics

##### Amplitude measurement range

50  $\Omega$  to 150  $\Omega$ : -120 dBm to +23 dBm.

600  $\Omega$ : -130 dBm to +13 dBm.

**Voltage:** 200 mV full scale to 3.2 V (50  $\Omega$  reference).

##### Amplitude accuracy

**Frequency response** (bridging input with external termination of 50  $\Omega \pm 1\%$ ).

1 kHz to 10 kHz:  $\pm 0.5$  dB (5% of reading).

10 kHz to 10 MHz:  $\pm 0.2$  dB (2% of reading).

10 MHz to 18 MHz:  $\pm 0.5$  dB (5% of reading).

**Matching impedance:** 50  $\Omega$ , 60  $\Omega$ , 75  $\Omega$ , 124  $\Omega$ , 135  $\Omega$ , 150  $\Omega$  or 600  $\Omega$ , balanced or unbalanced on 312B.

##### Distortion

**Harmonically related, 1 kHz to 1 MHz:** >55 dB below zero reference. 1 MHz to 18 MHz: >65 dB below zero reference. Residual response.

**Noise floor:** < -120 dBm in 1 kHz bandwidth and 75  $\Omega$  input.

#### Receiver characteristics

##### Receiver mode outputs

**AM:** diode-demodulated audio.

**Beat:** beat frequency audio centered at  $f_0$ .

**LSB:** product-demodulated audio, carrier reinserted at  $f_0 + 1.8$  kHz.

**USB:** product-demodulated audio, carrier reinserted at  $f_0 - 1.8$  kHz.

**Audio output level:** >0.5 V rms into 10 k $\Omega$  with full-scale meter deflection.

**Recorder output level:** 1 V  $\pm 0.1$  V with full-scale meter deflection across open circuit.

**Power:** 115 V or 230 V  $\pm 10\%$ , 48 Hz to 66 Hz, <100 VA.

**Size:** 266 H  $\times$  425 W  $\times$  467 mm D (10<sup>13</sup>/<sub>32</sub>"  $\times$  16<sup>3</sup>/<sub>4</sub>"  $\times$  18<sup>3</sup>/<sub>4</sub>").

**Weight:** net, 20.7 kg (46 lb).

### 313A Specifications

#### Frequency range

**As tracking oscillator:** 10 kHz to 18 MHz.

**As signal source:** 10 kHz to 18 MHz in one band, continuous tuning.

#### Frequency accuracy

**As tracking oscillator:** 35 Hz  $\pm 4$  Hz above 312B tuning.

#### As signal source

10 kHz to 2 MHz:  $\pm 1\%$  of max dial setting.

2 MHz to 8 MHz:  $\pm 3\%$  of max dial setting.

8 MHz to 22 MHz:  $\pm 5\%$  of max dial setting.

#### Frequency stability

**As signal source:** short-term (5 min) drift <1 kHz in stable environment after warmup.

**Frequency response:**  $\pm 0.1$  dB, 10 kHz to 18 MHz.

**Amplitude stability:**  $\pm 0.1$  dB for 90 days (0° to 55°C).

**Maximum output:** 0 dBm or +10 dBm  $\pm 0.1$  dB, selectable at front panel.

**Output attenuator:** 3-section attenuator provides 0 dB to 99.9 dB attenuation in 0.1 dB steps.

#### Attenuator accuracy

0.9 dB section (0.1 dB steps):  $\pm 0.02$  dB.

9 dB section (1 dB steps):  $\pm 0.1$  dB.

90 dB section (10 dB steps):  $\pm 0.1$  dB to 50 dB,  $\pm 0.2$  dB to 90 dB.

**Output impedance:** 75  $\Omega$  unbalanced, (50  $\Omega$  option:01)

**Harmonic distortion:** more than 34 dB below fundamental.

**Recorder output:**  $\pm 0.3$  V for full-scale deflection. Output impedance 1 k $\Omega$ , BNC female connector.

**Power:** 115 V or 230 V  $\pm 10\%$ , 48 Hz to 66 Hz, <35 VA.

**Size:** 132.6 H  $\times$  425 W  $\times$  467 mm D (5<sup>2</sup>/<sub>16</sub>"  $\times$  16<sup>3</sup>/<sub>4</sub>"  $\times$  18<sup>3</sup>/<sub>4</sub>").

**Weight:** net, 11.3 kg (25 lb).

#### 312B Options

**001:** carrier rejection notches inserted at  $f_0 \pm 2$  kHz

**H01:** Frequency range 1 kHz to 22 MHz in 22 overlapping bands

**Meter calibration:** dBm only (75  $\Omega$  reference).

**Input impedance:** 75  $\Omega$  or bridging (10 k $\Omega$ ).

**Input connector:** equivalent to WECO-477B.

**H10:** same as H01-312B except uses BNC connectors

**H05:** same as H01-312B except uses 50  $\Omega$  reference and BNC connectors. Calibrated in volts and dBm

**H55:** -50 Hz bandwidth substituted for 200 Hz bandwidth; -313 also modified so that the offset frequency is 15 Hz  $\pm 2$  Hz

**H16:** speaker included so operator can hear restored audio output

**Price**

add \$134

add \$320

add \$350

add \$320

add \$200

add \$295

add \$295

#### 312B Accessories

**11530A Probe:** provides a high impedance input at the end of a flexible four-foot cable

\$295

#### 11530A Specifications

**Amplitude range:** <1  $\mu$ V to 3 V

**Amplitude accuracy:** (probe and divider only):  $\pm 0.5$  dB

**Furnished:** 1:1, 10:1, 100:1 divider heads

#### Ordering information

312B Selective Voltmeter

\$5300

313A Tracking Oscillator

\$2145

# SIGNAL ANALYZERS

## 15 Hz to 50 kHz wave analyzer

### Model 3581A



### Description

Hewlett-Packard's 3581A Wave Analyzer resolves and measures the amplitude and frequency of spectral components. This instrument offers accurate amplitude and good frequency resolution in the form of a portable, easy to use measuring tool. Since not all signals originate from a stable frequency source, the 3581A incorporates an AFC circuit which locks to a drifting signal for stable, accurate measurements.

HP's 3581A has other important features that are necessary when making measurements of small voltages from transducers and harmonic signals. Its 30 nV sensitivity becomes important for these measurements. Battery operation or balanced input option can be used to reduce the line related interference common in low level measurements so only the real spectrum is measured.

Digital readout of tuned frequency is located above the analog meter. It has been grouped with the meter for ease of reading. Resolution of the digital readout is 1 Hz for any frequency between 15 Hz and 50 kHz. Readout is updated five times per second so delay between tuning and reading is minimized.

Four meter scales are used to provide a wide range of displays. Two scales are used for linear voltage readings. Two log scales provide either a 90 dB or 10 dB display. In any case, the large meter with its mirror backing can present readings in dBV or dBm or volts. A meter was specifically chosen for amplitude display rather than digital readout because it is easier to peak a meter reading and because it's much easier to get a feel for noise or other amplitude variations by watching the meter. The same voltage used to drive the meter is also available on the rear panel for driving X-Y recorders.

### Specifications\*

#### Frequency characteristics

**Range:** 15 Hz to 50 kHz.

**Display:** 5 digit LED readout.

**Resolution:** 1 Hz.

**Accuracy:**  $\pm 3$  Hz.

**Typical stability:**  $\pm 10$  Hz/hr after 1 hour and  $\pm 5$  Hz/ $^{\circ}$ C.

**Automatic frequency control (AFC) hold-in range:**  $\pm 800$  Hz.

#### Amplitude characteristics

##### Instrument range

**Linear:** 30 V to 100 nV full scale.

**Log:** +30 dBm or dBV to -150 dBm or dBV.

**Amplitude accuracy:**

	Log	Linear
Frequency response, 15 Hz-50 kHz	$\pm 0.4$ dB	$\pm 4\%$

**Dynamic range:**  $>80$  dB.

**Noise sidebands:** greater than 70 dB below CW signal. 10 bandwidths away from signal.

**Spurious responses:**  $>80$  dB below input reference level.

#### Sweep characteristics

**Scan width:** 50 Hz to 50 kHz. These scans can be adjusted to cover a group of frequencies within the overall instrument range.

**Sweep error light:** this LED indicates a sweep that is too fast to capture full response. When the light is on, response will be lower than it should be.

**External trigger:** a short to ground stops the normal sweep. Opening the short then enables a sweep.

#### Input characteristics

**Impedance:** 1 M $\Omega$ , 30 pF.

**Maximum input level:** 100 V rms,  $\pm 100$  V dc.

#### Output characteristics

**Tracking generator output:** (also known as BFO or tracking oscillator output).

**Range:** 0 to 2 V rms.

**Frequency response:**  $\pm 3\%$  15 Hz to 50 kHz.

#### X-Y recorder analog outputs

**Vertical:** 0 to +5 V  $\pm 2.5\%$ .

**Horizontal:** 0 to +5 V  $\pm 2.5\%$ .

**Impedance:** 1 k $\Omega$ .

**Pen lift:** contact closure to ground during sweep.

**Restored output:** acts as a narrow band amplifier.

#### General

**Power requirements:** 100 V, 120 V, 220 V, or 240 V +5% -10%, 48 Hz to 440 Hz, 10 VA typical.

**Dimensions:** 412.8 mm H  $\times$  203.2 mm W  $\times$  285.8 mm D (16 1/4"  $\times$  8"  $\times$  11 1/4").

**Weight:** 11.5 kg (23 lb). Opt 001: 13.5 kg (30 lb).

#### Options

**001:** Internal battery 12 hours from full charge. Internal battery is protected from deep discharge by an automatic turnoff. Useful life of this battery is over 100 cycles.

**910:** Extra set manuals

#### Price

add \$385

add \$20

#### 3581A Wave Analyzer

\$3325

\*Note: for complete specifications, refer to page 532 (HP 3581C selective voltmeter) which is a dedicated telecommunication version of the HP 3581A wave analyzer.

### 3044A

- High accuracy and resolution digital amplitude measurements
- Synthesizer frequency accuracy and stability
- Wide amplitude range of 150 dB
- Narrow band analysis
- Full digital control via HP-IB

### 3045A

- Full automation and low cost
- Speed and precision in measurements
- Data analysis and presentation of results
- Simplicity and flexibility in operation
- HP-IB systems interfacing flexibility
- 9825A Computing Controller

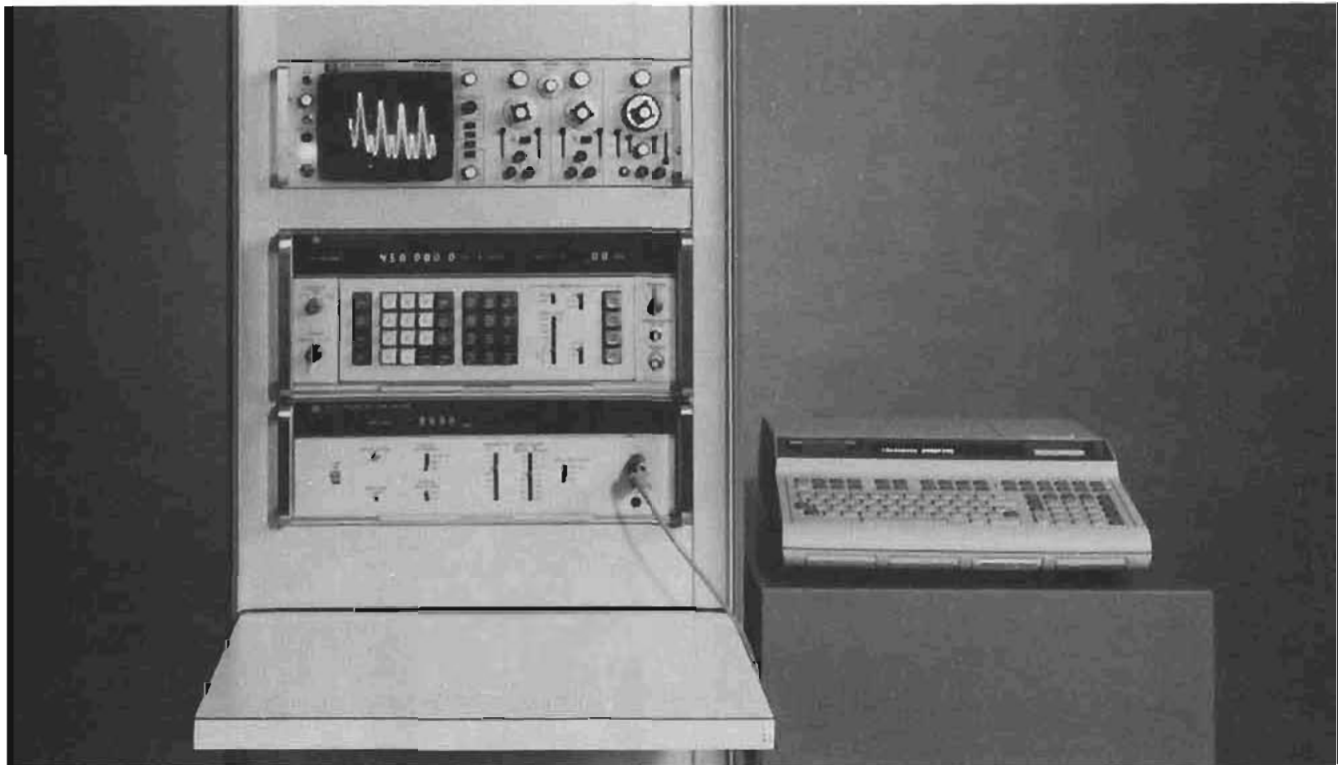

3045 System with Option 204 (HP Model 1201B Oscilloscope)



## Description

### 3044A Spectrum analyzer

Meeting the demand for precise frequency and amplitude measurements in the 10 Hz to 13 MHz region, the 3044A is a spectrum analyzer with tracking generator. This system uses a synthesizer with leveled output and sweep capability to generate the local oscillator signal for the analyzer and the tracking generator output. This allows fast, extremely accurate "tuning" with the use of frequency up-down keys or keyboard entry of center frequency. The input impedance is front-panel switch selectable to 50Ω, 75Ω, and 1 MΩ. The units of the digital display are also front-panel selectable to dBm, dBV and dB relative to a user-entered offset. Digital display of amplitude and frequency gives an unambiguous, high-resolution readout commensurate with the wide dynamic range and high accuracy of this analyzer.

### 3045A Automatic spectrum analyzer

While the 3044A is an excellent stand-alone spectrum analyzer, the capabilities are greatly improved with the addition of the 9825A Controller, which forms the 3045A system.

The 9825A Controller allows program and data storage on its fast tape cassette. The tape cassette, short calculation times and buf-

fered input/output speed allow repeated, automated tests which can greatly reduce production and quality-assurance test times. Also the scope of possible measurements greatly increase with the 3045A System. Logarithmic sweeps and limit tests are only two examples. The calculator also allows data manipulation and presentation in units familiar to the system operator in graphic or tabular form. (A plotter and line printer are system's options.)

Because the user may not be familiar with HPL (the language of the 9825A Controller) or even with programming, a compiler is furnished with the 3045A System. The compiler allows the calculator to converse in terms understood by the test engineer, like start and stop frequencies, plot results, and compare with limits. It also accepts and outputs in units of Hz, kHz, MHz, dBm and dBV. The compiler enables the execution of sophisticated tests, like intermodulation distortion measurements, with only a few minutes of initial "programming" time. It can also record the test parameters, which can then be used repeatedly, as in a production environment. The compiler's versatility and ease of use make the full power of the 3045A Spectrum Analyzer readily available to the user.

The 3045A Automatic Spectrum Analyzer system is fully integrated, tested, verified and specified as a system. It is supplied with complete software and documentation.

## Applications

### Sideband analysis

This is a more traditional spectrum analysis problem using HP's 3044A and 1201B Oscilloscope. Figure 3 is a picture of the spectrum. The carrier frequency was supposed to be at 10.7 MHz. Therefore, the synthesizer was set up with a 10.7 MHz center frequency and a  $\pm 500$  Hz sweep about the center frequency. From the picture, it is apparent that the carrier frequency is about where it should be. It is possible to move the center frequency in 0.1 Hz steps with the step buttons and look for the peak responses to more accurately identify the carrier frequency.

Using the 3 Hz resolution bandwidth, 60 Hz spurious responses are revealed. Noise products also appear very close to the carrier. Here the wide dynamic range of the system exposes the responses that are more than 70 dB below the carrier.

### Distortion measurements

The spectrum analyzer system can be very powerful for characterizing the complete response of amplifiers. Gain, noise, spurious distortion and frequency response can all be done with one setup. This example of distortion measurement is one part of the total characterization that can be done.

Distortion of audio frequencies as they pass through amplifiers is measured by several methods. Total harmonic distortion is found by measuring the harmonic output assuming a pure sinewave input. Here again the 3045A offers benefits through calculation power. After the user enters the fundamental frequency, the calculator takes over and makes measurements at the appropriate frequencies and calculates the percentage distortion. Figure 2 shows the type of user-oriented printout that is possible using the 9825A Controller and the 9866A Printer. The other calculators have built-in printers which could give the same type of printout.

Intermodulation distortion can similarly be measured as part of the same system provided the sources are available.

### Modulation measurements

Both AM and FM modulation show up very well in the frequency domain. Figure 4 shows a typical wide band FM signal. This measurement could be made with the same setup as Figure 2. A more sophisticated measurement was made using the 3045A. The calculator is used to program the instruments for measurements at the carrier and sideband frequencies. From the data, the modulation index was calculated to be 1.53 with a calculator Bessel algorithm. This is a good example of using the 3045A to make measurements that are not easy with a simple spectrum analyzer.

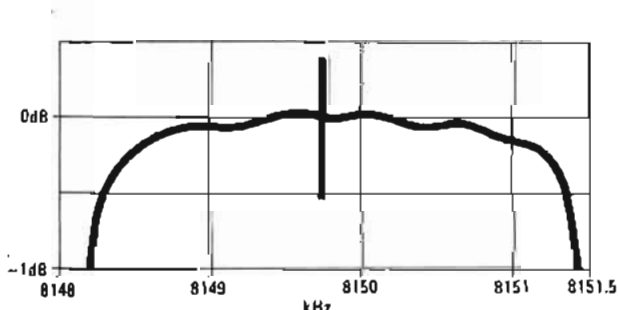

Figure 1. This bandpass filter was characterized using a 3044A system and an x-y recorder. By expanding the Y-axis so only 5 dB are covered, the ripple and 3 dB points are very easy to identify.

TOTAL HARMONIC DISTORTION TEST			
FUNDAMENTAL FREQUENCY	ABSOLUTE LEVEL		
1231.0	0.7 DBV		
HARMONIC FREQUENCY	RELATIVE LEVEL		
2	2462.0	-44.20	DB
3	3693.0	-49.20	DB
4	4924.0	-56.70	DB
5	6155.0	-60.40	DB
6	7386.0	-77.50	DB
TOTAL HARMONIC DISTORTION EQUALS -42.05 DB			
OR 0.72 PERCENT			

Figure 2. Using a 3045A system, an amplifier can be completely characterized for total harmonic distortion as well as intermodulation distortion, noise, spurious, frequency response and gain.

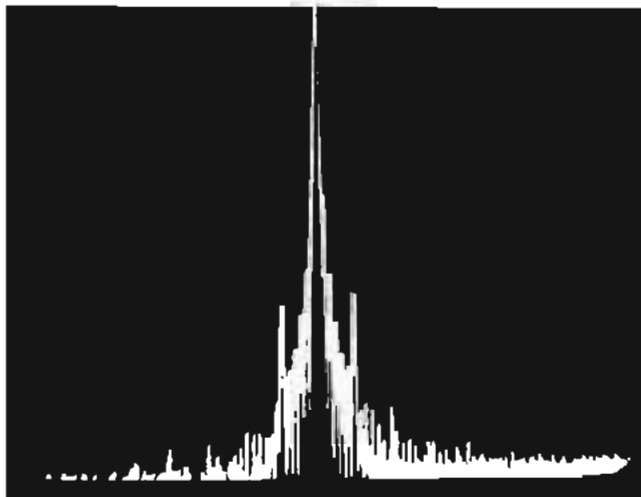

Figure 3. A 3044A was used to analyze close in spurious and noise of a 10.7 MHz carrier. The sweep covers 1 kHz around the carrier.

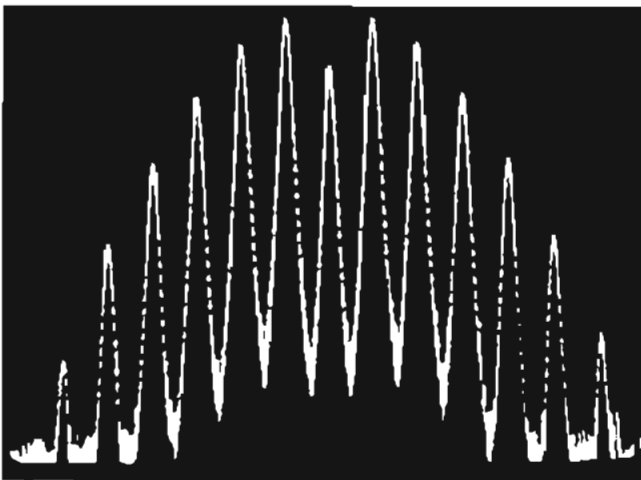

Figure 4. Wideband FM modulation with a 5.3 MHz carrier.

## Telemetry

One of the most powerful applications for the spectrum analyzer is in monitoring frequency multiplexed telemetry or alarm systems.

The operating system may have many channels at different levels. When spurious signals appear or channels drop out, it is difficult to see them on a CRT. This is done by storing the spectrum of the system when it is running properly. Figure 5a shows a part of such a telemetry system. Then subsequent spectrums are subtracted from the normal spectrum. Channels that drop out or lose gain will appear as negative points as shown in Figure 5b. Spurious signals that were not present before will appear as points above the noise level. Rather than looking over the entire spectrum for problems, the system shows them graphically with enough frequency accuracy so the channel with problems can be quickly identified.



Figure 5a. This represents a portion of a frequency multiplexed system operating normally. Notice that not all channels are operating at the same level.

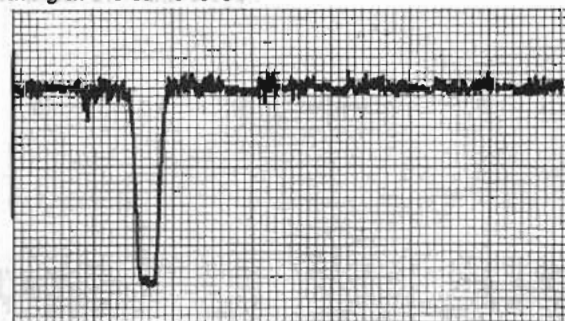

Figure 5b. The difference between a normal system and one that has problems is immediately apparent. One of the channels has dropped out.

## 3044A/3045A Specifications

### Frequency specifications

**Frequency range:** 10 Hz to 13 MHz.

**Scan width:** any desired scan is possible in 10, 100 or 1000 steps of frequency increments as small as 0.1 Hz and with 0.1 Hz resolution. The 3045A is additionally capable of taking any number of steps with direct calculator control of the sweep.

### Resolution

**Bandwidths:** 3 Hz to 10 kHz in a 1, 3, 10 sequence.

**Bandwidth selectivity:** 60 dB/3 dB bandwidth ratios  $\leq 1:1$ .

### Stability

**Long term:**  $\pm 1 \times 10^{-6}$ /day.  
 $\pm 1 \times 10^{-7}$ /month.

**Temperature:** 20° to 30°C:  $\pm 1 \times 10^{-6}$ /°C of 5°C frequency.

**Phase noise:** <50 dB below CW signal in a 30 kHz band around signal.

### Amplitude specifications

**Absolute amplitude calibration range:** -130 dBm to +20 dBm (50 or 75Ω). -140 dBV to +10 dBV.

**Digital amplitude readout:**  $\pm 199.99$  dB with 0.01 dB resolution.

### Dynamic range

**Average noise level:** -127 dBV in 1 kHz resolution bandwidth.  
**Smoothing (video filter):** provides smoothing with a bandwidth of  $1/n$ th the resolution bandwidth on all but the 3 Hz and 10 Hz bandwidths.

**Spurious responses:** >70 dB below input range setting.

**Distortion responses:** >80 dB below input signal at input range setting level.

**Power-line related responses:** 70 dB below input range on +10 dBV through -40 dBV ranges; 60 dB on -50 dBV; 50 dB on -60 dBV ranges.

### Amplitude accuracy

**Frequency response:**  $\pm 0.25$  dB (250 kHz reference).

**Input range:**  $\pm 0.05$  dB/step,  $\pm 0.15$  dB total accumulation.

**Log linearity:** 0 to -30 dB  $\pm 0.1$  dB.

-30 to -60 dB  $\pm 0.25$  dB.

-60 to -80 dB  $\pm 0.75$  dB.

**Stability:** (8 hr., 25°C  $\pm 1$ °C, after 1 hr. warmup)

10 kHz, 3 kHz, 100 Hz, 300 Hz, 10 Hz BW's	0 dB	-30 dB	-60 dB	temp. coefficient
	$\pm 0.05$ dB	$\pm 0.08$ dB		$\pm 0.02$ dB/°C
1 kHz, 300 Hz, 3 Hz BW's	0 dB	-30 dB	-60 dB	
	$\pm 0.08$ dB	$\pm 0.15$ dB		$\pm 0.04$ dB/°C

### Tracking generator (3330B output)

**Frequency range:** 0.1 to 13 000 999.9 Hz.

**Frequency resolution:** 0.1 Hz (9 digits).

**Amplitude range:** -13.44 to -86.55 dBm (50Ω).  
 +11.68 to -88.31 dBm (75Ω option).

### Amplitude accuracy

**Leveled frequency response (10 kHz reference)<sup>4</sup>**

10 Hz	13 MHz	-13.44 dBm
$\pm 0.05$ dB		-16.55 dBm
$\pm 0.1$ dB		-36.55 dBm
$\pm 0.2$ dB		-66.55 dBm
$\pm 0.4$ dB		-86.55 dBm

<sup>4</sup>Add 0.5 dB for leveling switch in off position.

**Attenuator (10 kHz reference, 25°C  $\pm 5$ °C):**  $\pm 0.02$  dB/10 dB step of attenuation from maximum output.

**Absolute accuracy:**  $\pm 0.05$  dB at 10 kHz and +13.44 dBm (25°C  $\pm 5$ °C).

**Amplitude stability (24 hr., 25°C  $\pm 1$ °C):**  $\pm 0.01$  dB.

### General

**Input impedance:** 50Ω, 75Ω >30 dB return loss.

1 MΩ  $\approx 5\%$  shunted by 30 pF.

**Maximum input level:** +20 dBm.

**Programmability:** all controls, except power switches, are programmable using the HP-IB format.

### 3044A/3045A Options

The basic 3044A and 3045A system options are listed below. For more information refer to the 3044A/3045A data sheet.

#### 3044A Options

110: Standard 3571A

120: Standard 50Ω 3330B w/Isol. HP-IB

121: Standard 75Ω 3330B w/Isol. HP-IB

122: 5 V Output

#### 3045A Options

200: 50Ω System

201: 75Ω System

204: I201B Oscilloscope

#### Price

add \$6550

add \$7455

add \$7455

add \$300

N/C

N/C

add \$2670

### Ordering information

3044A Spectrum Analyzer with Opt 110 & 120

\$14,005

3045A Automatic Spectrum Analyzer consisting of:

\$23,995

3330B Synthesizer; 3571A Spectrum Analyzer; 9825A

Calculator, 6.8 k bytes memory; ROMs, Interface.

documentation; 56" Rack.

# SIGNAL ANALYZERS

## 5 Hz to 50 kHz spectrum analyzer

### Model 3580A



### Description

Hewlett Packard's 3580A Spectrum Analyzer is a low frequency high performance analyzer. Its 1 Hz bandwidth allows the user to examine noise and extraneous signal content close in to a signal of interest.

For low frequency applications where sweep speeds can be slow and time-consuming, a special feature, adaptive sweep, allows the user to set a threshold above which only the spectra of interest is observed. In this mode, the CRT is rapidly swept. When a signal is encountered, the sweep slows down to reproduce full response. A factor of ten speed gain is possible.

Digital storage is another important feature which enhances the display for slowly swept low frequency signals. The analyzed signals are digitized and stored in memory. Trace information is then read from memory at a rate appropriate for obtaining an analog-like display.

### Digital storage for spectra comparison

Digital storage makes it possible to store one or two traces. When two are stored, both may be simultaneously displayed for easy comparison as shown below.

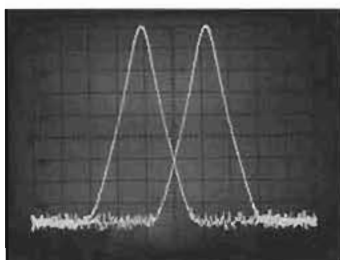

### Adaptive sweep

A tremendous savings in sweep time can be achieved by using adaptive sweep. In the left trace below over 80 dB of dynamic range is used to look at low level signals and noise. Two hundred seconds were required to make the sweep. In the right trace, the baseline is raised to give 50 dB of dynamic range. Noise and other responses are not analyzed so sweep now takes only 14 seconds.

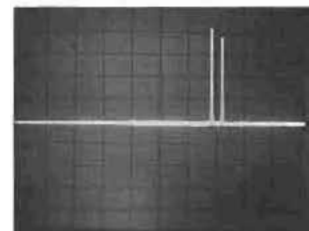
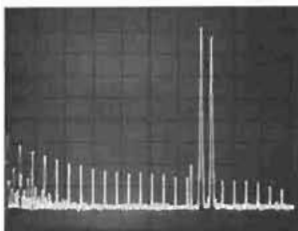

### 1 Hz bandwidth

When using a 1 Hz bandwidth 60 Hz line related spectra are clearly exposed as shown in the left trace. An analysis of the same signal with a 10 Hz bandwidth will not resolve the line related spectra as shown on the right.

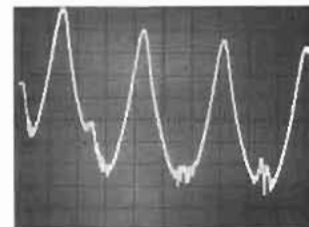
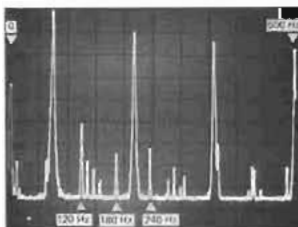





## Telecommunications application

Besides analysis of voice spectrum, HP's 3580A gives a clear picture of frequency spectrum for digital transmission. This picture shows a 1200 baud full duplex modem using double sideband suppressed carrier FSK modulation. The "answer" band covers 850 Hz to 1450 Hz while the "transmit" band covers 1950 Hz to 2550 Hz. The higher frequency band at high levels from 3150 Hz to 3750 Hz comes from 3rd order products of the answer band.

### Internal calibration signal

A 10 kHz pulse derived from a crystal can be used to compensate for internal errors. A 10 kHz calibration potentiometer is provided so the 10 kHz fundamental can be adjusted to fall on the top line of the display. With this feature, operation and calibration can be verified for most of the instrument.

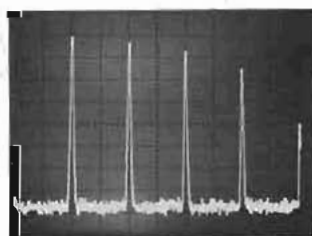

## Specifications

### Frequency characteristics

**Range:** 5 Hz to 50 kHz.

**Frequency dial accuracy:**  $\pm 100$  Hz, 20°C to 30°C;  $\pm 300$  Hz, 0°C to 55°C.

**Display accuracy:** frequency error between any two points is less than  $\pm 2\%$  of their indicated separation.

**Typical stability:**  $\pm 10$  Hz/hr after 1 hour;  $\pm 5$  Hz/°C.

**Frequency dial resolution:** 20 Hz on frequency dial.

Bandwidths,  
(accuracy  $\pm 15\%$ )

Shape factor:

1 Hz (25°C $\pm$ 5°C)	3 Hz	10 Hz	30 Hz	100 Hz	300 Hz

**Out of range blank:** if controls are set so portions of displayed signal lie below 0 Hz or above 50 kHz, the baseline is displayed.

### Amplitude specifications

#### Overall instrument range:

Linear	20 V–100 nV full scale
Log	+30 dBm or dB V; –150 dBm or dB V

Amplitude accuracy:	Log	Linear
Frequency response:		
20 Hz–20 kHz	$\pm 3$ dB	$\pm 3\%$
5 Hz–50 kHz	$\pm 5$ dB	$\pm 5\%$
Switching between bandwidths (25°C):		
3 Hz–300 Hz	$\pm 5$ dB	$\pm 5\%$
1 Hz–300 Hz	$\pm 1$ dB	$\pm 10\%$
Amplitude display	$\pm 2$ dB	$\pm 2\%$
Input attenuator	$\pm 3$ dB	$\pm 3\%$
Amplitude reference level: (1F attenuator)		
Most sensitive range	$\pm 1$ dB	$\pm 10\%$
All other ranges	$\pm 1$ dB	$\pm 3\%$

**Dynamic range:** 80 dB.

**1F feedthru:** input level  $> 10$  V,  $-60$  dB;  $< 10$  V,  $-70$  dB.

**Spurious responses:**  $> 80$  dB below input reference level.

**Smoothing:** 3 positions, rolloff is a function of bandwidth.

**Overload Indicator:** this LED indicator warns of possible input amplifier overloading. Without this indication it would be possible to introduce spurious responses without knowing it.

### Sweep characteristics

**Scan width:** 50 Hz to 50 kHz.

**Log sweep:** 20 Hz to 43 kHz  $\pm 20\%$  after 3 sweeps.

**Sweep time:** .1 sec to 2000 sec.

**Rep:** In the repetitive mode, sweep will continuously sweep specified band.

**Reset:** HP's 3580 is set to the start frequency of the sweep.

**Manual:** in combination with the concentric knob, manual sweep fully duplicates the span of the electronic sweep.

**Adaptive sweep:** when in adaptive sweep below the threshold level, scan speed is 20 to 25 times faster. Threshold is adjustable to cover 0–60% of screen. Signals greater than about 6 dB above threshold are detected and swept slowly.

**Sweep error light:** this LED indicates a sweep that is too fast to capture full response. When the light is on, response can be  $> 5\%$  lower than it should.

**Zero scan:** to look at the time varying signal at the center or start frequency within the bandwidth selected, the zero scan is used.

### Output characteristics

**Tracking generator output:** (also known as BFO or tracking oscillator output).

**Range:** 0 to 1 V rms.

**Frequency response:**  $\pm 3\%$ , 5 Hz to 50 kHz.

**Impedance:** 600  $\Omega$ .

**Total harmonic and spurious content:** 40 dB below 1 volt signal level.

### X-Y recorder analog outputs

**Vertical:** 0 to +5 V  $\pm 2.5\%$ .

**Horizontal:** 0 to +5 V  $\pm 2.5\%$ .

**Impedance:** 1 k  $\Omega$ .

**Pen lift:** contact closure to ground during sweep.

**Dimensions:** 203.2 mm H  $\times$  412.8 mm W  $\times$  285.8 mm D (8"  $\times$  16 1/4"  $\times$  11 1/4").

**Weight:** net, 12.25 kg (27 lb); 3580A Opt 001: net, 15.88 kg (35 lb).

**Temperature range:** 0°C to 55°C.

**Power:** 100 V, 120 V, 220 V, or 240 V  $\pm 5\%$ – $10\%$ , 48 to 440 Hz, 35 VA max.

**Opt 001 battery:** 5 hours from full charge, 14 hours to fully recharge. The internal battery is protected from deep discharge by an automatic turn off. Useful life of batteries is over 100 cycles.

### Ordering Information

**Opt 001:** internal rechargeable battery

**Opt 002:** balanced input

**Price**

add \$385

add \$107

**3580A Spectrum Analyzer**

**\$4485**

# SIGNAL ANALYZERS

## Spectrum Analyzer, 100 Hz to 1500 MHz

### Model 8568A

- 100 Hz to 1.5 GHz Frequency Range
- 10 Hz Resolution Bandwidth
- Frequency Counter Accuracy
- Digital Display
- Tunable Marker with Amplitude and Frequency Readout
- Store and Recall Control Settings

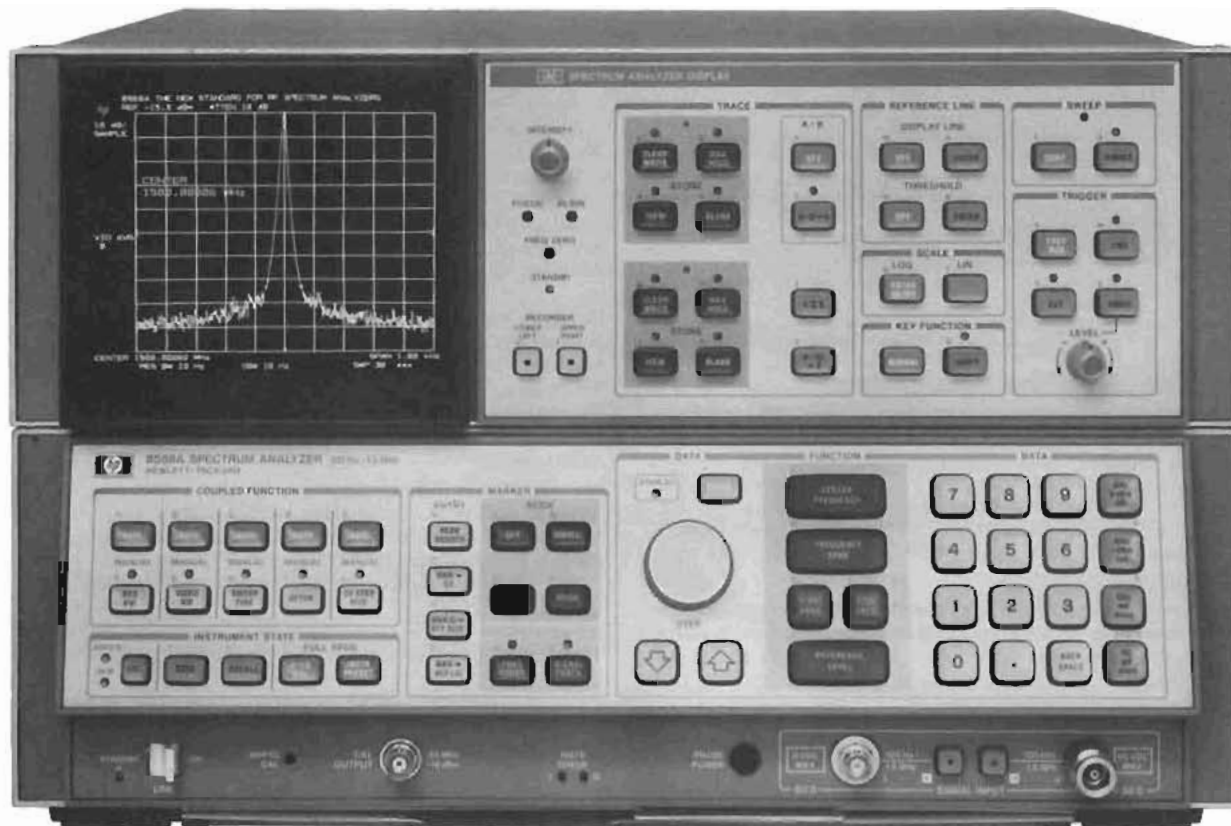

The 8568A is a high performance spectrum analyzer for bench or HP-IB systems use that operates over the 100 Hz to 1500 MHz frequency range. A sophisticated phase lock system combines "synthesizer like" tuning and frequency accuracy with superior local oscillator spectral purity to make narrow resolution bandwidths practical at RF frequencies. The analyzer is designed around its own internal bus and controlled by a microcomputer to yield significant improvements in RF measurement performance, new operational features and unparalleled flexibility under program control.

### Performance

Exceptional stability enables the use of a 10 Hz resolution bandwidth over the 100 Hz to 1500 MHz tuning range of the analyzer. Unparalleled spectral purity and narrow resolution makes it possible to resolve line related sidebands or measure clean oscillators directly at RF frequencies. 10 Hz resolution also results in  $-137$  dBm sensitivity which makes greater than 85 dB spurious free dynamic range achievable. A frequency reference error of  $1 \times 10^{-4}$  /day together with the analyzer's resolution and sensitivity allow small signals in the presence of large ones to be measured with frequency counter accuracy.

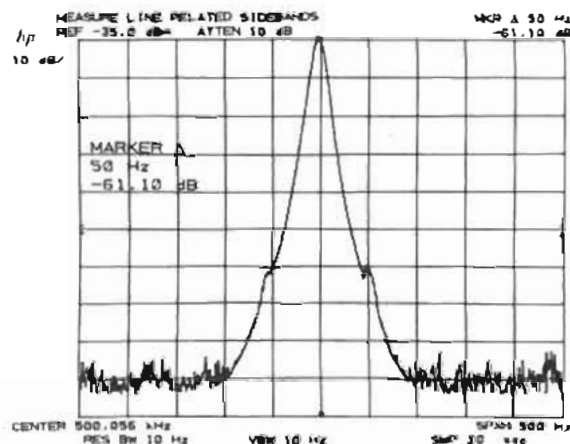

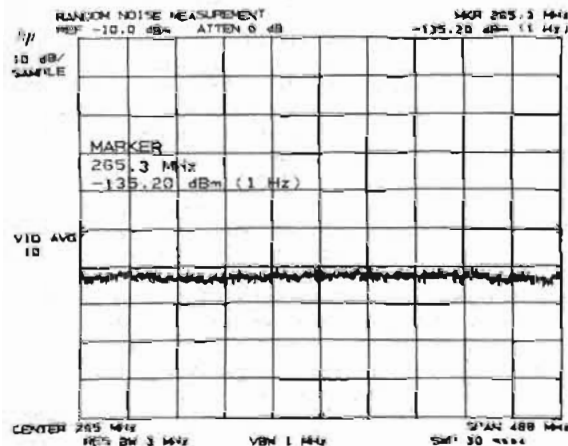
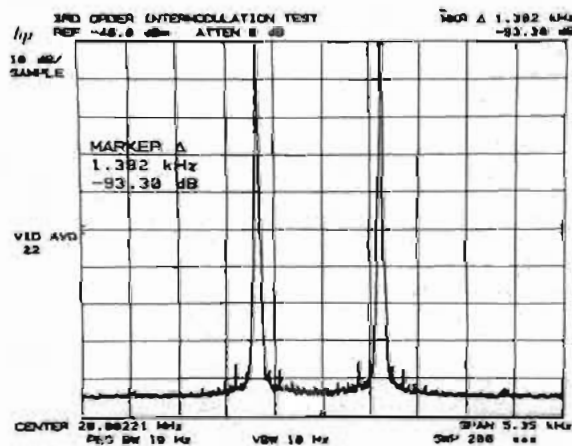
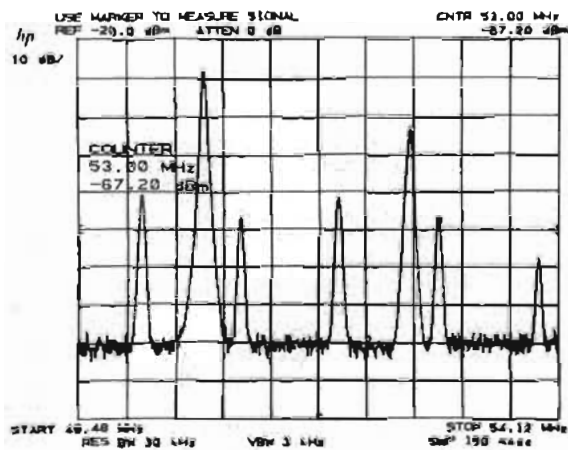
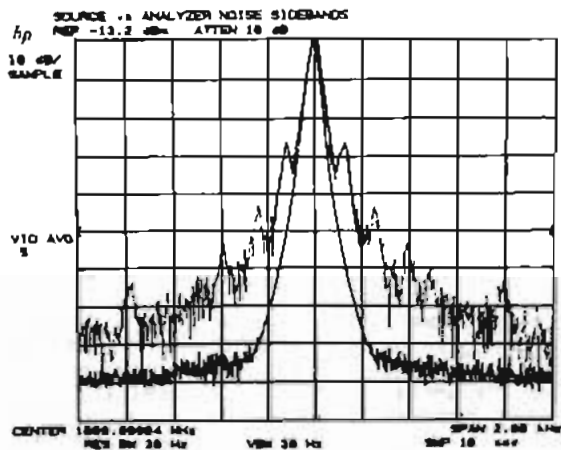

### Usability

The front panel concept of the 8568A is new in that the operator reads all the analyzer control settings off the *CRT display* and sets function values through *data controls*. To activate a function the user pushes the appropriate button; he then has the option of setting the function's value using a knob, step keys or numeric/unit keyboard.

Measurements can be made following conventional "zoom" techniques using the center frequency, frequency span and reference level functions, or with the help of certain measurement aids. A preset button sets all analyzer controls to a convenient starting point; coupled functions such as resolution bandwidth and sweep-time change automatically as frequency span is reduced to maintain a calibrated display. A tunable marker is available for directly measuring a signal or speeding the process of magnifying the portion of the spectrum to be analyzed.

With the marker set to the signal peak, the signal's *amplitude* and *frequency*, to counter accuracy, are numerically displayed on the CRT. A second marker, useful for modulation or distortion measurements, makes relative measurements by displaying the difference in amplitude and frequency between the two markers. Marker information enables the operator to step between evenly spaced portions of the frequency spectrum such as communication channels or signal harmonics; the noise level at the marker can be converted to RMS noise density normalized to a 1 Hz bandwidth. The marker may also be positioned at the peak of the largest signal on the screen and used to zoom-in on signals *automatically*.

Once the analyzer's controls have been adjusted, all settings can be *saved* and later *recalled* to repeat the measurement, even through a power failure.

All displayed information resides in a digital memory from which the CRT is refreshed at a flicker-free rate. Display titles may be added. A trace may be viewed real-time or stored; max hold displays the largest amplitude at 1001 points across the CRT over successive sweeps to aid in the measurement of residual FM or drift. Up to three traces may be observed simultaneously and arithmetic between traces or a trace and reference display line is possible for comparison or frequency response normalization.

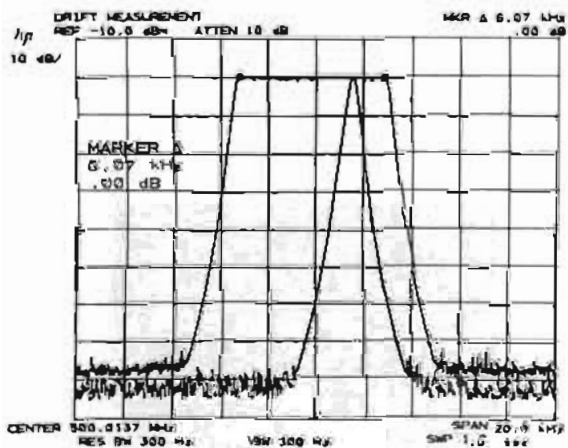

### Automatic Measurement Capability

The design of the 8568A lends itself to automatic control via the HP Interface Bus (IEEE Standard 488-1975). The analyzer can be tuned with the precision of a synthesizer while retaining analog sweep and exceptional spectral purity. Its internal architecture facilitates the remote programming of all function settings and the output of CRT trace and marker readout information; the display itself is accessible for annotation purposes.

By exploiting this architecture, a new level of interaction between a user and a measurement system becomes possible under program control. While the user's measurement programs reside in the controller, the operator need interface only with the analyzer (which functions as a "measurement terminal"). A list of these programs may be displayed on the CRT for selection through the appropriate code on the numeric keyboard. The programs themselves can lead the operator through a measurement using graphics to explain each step of the process.

Friendly analyzer codes and HP-IB commands are used to program the analyzer; for example, CF 20 MZ instructs the analyzer to set center frequency to 20 MHz. Built-in firmware features such as instrument preset, peak search and zoom further simplify writing software. Control settings may even be "programmed" from the instrument front panel using "learn" mode.

The primary advantage of computer control is the execution of complicated or time consuming measurement routines with a minimum of involvement by the operator. This capability is especially useful in production line testing or unattended measurement situations such as spectrum monitoring. An analyzer may be joined by other instruments in a distributed system, or be controlled remotely through a data communications network. External control is desirable for setting the proper analyzer function values, reading data, performing any numerical manipulation required (including error correction), analyzing the results, and providing output data in a convenient format on a printer, plotter, or the analyzer CRT. This capability is available in the form of a configured system:

8581A Automatic Spectrum Analyzer.  
Consider this measurement example:

**Electromagnetic Interference:** the analyzer begins by using the CRT to show the test set-up. Next it draws the MIL-STD 461 conducted interference test limits on the CRT, adjusting them for the current probe transfer impedance and normalizing for the analyzer impulse bandwidth. The analyzer controls (including resolution bandwidth, video bandwidth, and calibration units) are set to their proper values for the measurement and the results are presented on a log-log plot together with a printout analyzing compliance.

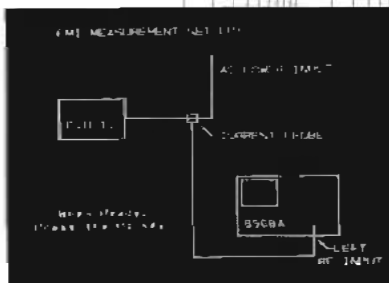
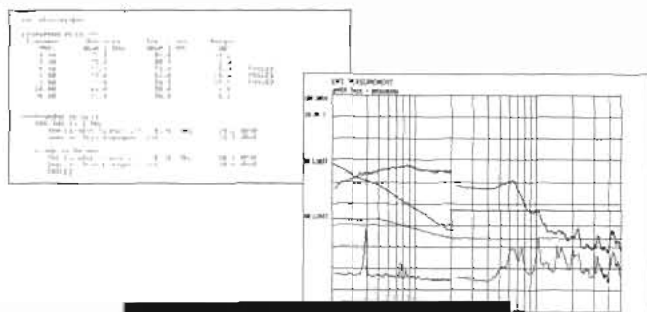

### 8568A Specifications

#### Frequency

##### Displayed range

**Frequency span:** 100 Hz to 1500 MHz over 10 division CRT horizontal axis. In zero span, the instrument is fixed tuned at the center frequency.

**Full span (0-1500 MHz):** is immediately executed with 0-1.5 GHz or INSTR PRESET keys.

**Frequency span accuracy:** for spans  $> 1$  MHz,  $\pm 2\%$  of the indicated frequency separation between two points; for spans  $\leq 1$  MHz,  $\pm 4\%$  of frequency separation.

**Center frequency:** 0 Hz to 1500 MHz. Center frequency step size may be set using the numeric keyboard or MKR/ $\Delta$   $\rightarrow$  STP SIZE key.

**Readout accuracy:**  $\pm (2\%$  of frequency span + frequency reference error  $\times$  tune frequency) in AUTO resolution bandwidth after adjusting freq zero at stabilized temperature, and using the error correction function. SHIFT W and SHIFT X.

**Start-Stop frequency:** permissible values must be consistent with those for center frequency and frequency span. SHIFT O sets the analyzer start and stop frequencies equal to the frequencies of the two  $\Delta$  markers.

**Readout accuracy:** same as center frequency.

#### Marker

**Normal:** displays the frequency at the horizontal position of the tunable marker.

**Accuracy:** same as center frequency accuracy.

PEAK SEARCH positions the marker at the center of the largest signal response present on the display to within  $\pm 10\%$  of resolution bandwidth. MKR  $\rightarrow$  CF sets the analyzer center frequency equal to the marker frequency; MKR/ $\Delta$   $\rightarrow$  STP SIZE sets the center frequency step size equal to the marker frequency.

**Freq count:** displays the frequency of the signal on whose response the marker is positioned. The marker must be positioned at least 20 dB above the noise or the intersection of the signal with an adjacent signal and more than four divisions up from the bottom of the CRT. Frequency span must be less than 500 MHz.

**Accuracy:** for span  $\leq 100$  kHz; frequency reference error  $\times$  displayed frequency  $\pm 2$  counts. For span  $> 100$  kHz but  $\leq 1$  MHz; freq. ref. error  $\times$  displayed frequency  $\pm 10$  Hz  $\pm 2$  counts. For span  $> 1$  MHz but  $\leq 500$  MHz;  $\pm 10$  kHz  $\pm 1$  count.

**Frequency reference error:** aging Rate  $< 1 \times 10^{-2}/$ Day; Temp Stability  $< 7 \times 10^{-2}$   $^{\circ}$  to  $55^{\circ}$ C.

**Signal track:** re-tunes the analyzer to place a signal identified by the marker at the center of the CRT and maintain its position. Useful when reducing frequency span to zoom-in on a signal; also keeps a drifting input signal centered.

$\Delta$ : displays the frequency difference between the stationary and tunable markers. Reference frequency need not be displayed.

**Accuracy:** same as frequency span accuracy; in the FREQ COUNT mode, twice the frequency count uncertainty plus drift during the period of the sweep (typically  $< 10$  Hz/minute). MKR/ $\Delta$   $\rightarrow$  STP SIZE sets the center frequency step size equal to the frequency difference between the markers. SHIFT O sets the analyzer start and stop frequencies equal to the frequencies of the two markers.

**Zoom:** makes it possible to reduce the frequency span about the marker (or signal in the signal track and freq count modes) using the step down key.

#### Resolution

**Resolution bandwidth:** 3 dB bandwidths of 10 Hz to 3 MHz in a 1, 3, 10 sequence. Bandwidth may be selected manually or coupled to frequency span.

**Bandwidth accuracy:** calibrated to:  $\pm 20\%$ , 3 MHz to 10 Hz;  $\pm 10\%$ , 1 MHz to 3 kHz.

**Bandwidth selectivity:** 60 dB/3 dB bandwidth ratio:  $< 15:1$ , 3 MHz to 100 kHz;  $< 13:1$ , 30 kHz to 10 kHz;  $< 11:1$ , 3 kHz to 30 Hz. 60 dB points on 10 Hz bandwidth are separated by  $< 100$  Hz.

#### Stability

**Residual FM:**  $< 3$  Hz peak-to-peak  $\leq 10$  sec; span  $< 100$  kHz, resolution bandwidth  $\leq 30$  Hz, video bandwidth  $\leq 30$  Hz.

**Drift:**  $< 10$  Hz/minute of SWEEP TIME after 1 hr. warmup at stabilized temperature, for frequency span  $\leq 100$  kHz. Spans  $> 100$  kHz but  $\leq 1$  MHz,  $< 100$  Hz/minute of SWEEP TIME;  $> 1$  MHz,  $< 5$  kHz/minute of SWEEP TIME.

### Spectral purity

**Noise sidebands:** >80 dB below the peak of a CW signal at frequency offsets  $\geq 30 \times$  resolution bandwidth setting, for resolution bandwidths  $\leq 1$  kHz.

**Line related sidebands:** >85 dB below the peak of a CW signal.

### Amplitude

**Measurement range:** -137 dBm to +30 dBm.

### Displayed range

**Scale:** Over a 10 division CRT vertical axis with the Reference Level at the top graticule line.

#### Calibration

##### Log:

10 dB/div for 90 dB display from Reference Level.

5 dB/div for 50 dB display

2 dB/div for 20 dB display

1 dB/div for 10 dB display

} expanded from Reference Level.

##### Linear:

10% of Reference Level/div when calibrated in voltage.

#### Fidelity:

##### Log: Incremental

$\pm 0.1$  dB/dB over 0 to 80 dB display

##### Cumulative

$\leq \pm 1.0$  dB max over 0 to 80 dB display, 20-30°C.

$\leq \pm 1.5$  dB max over 0 to 90 dB display.

**Linear:**  $\pm 3\%$  of Reference Level.

### Reference level

#### Range

##### Log:

+60.0<sup>1</sup> to -139.9 dBm or equivalent in dBmV, dB $\mu$ V, volts.

##### Linear:

228.6<sup>1</sup> volts to .22  $\mu$ volts full scale.

**Accuracy:** the sum of the following factors determines the accuracy of the reference level readout. Depending upon the measurement technique followed after calibration, various of these sources of uncertainty may not be applicable.

An internal error correction function calibrates and reduces the uncertainty introduced by analyzer control changes from the error calibration state (-7 dBm reference level, 1 dB/div scale, 10 dB RF attenuation, 1 MHz bandwidth) when SHIFT W is executed just prior to the signal measurement (i.e., at the same temperature) within the 20°-30° range.

**Calibrator uncertainty:**  $\pm 0.2$  dB.

**Frequency response (Flatness) uncertainty:** input #1:  $\pm 1$  dB, 100 Hz to 500 MHz; +1, -2 dB 100 Hz to 1500 MHz; input #2:  $\pm 1$  dB, 100 kHz to 1500 MHz.

**Amplitude temperature drift:** at -10 dBm reference level with 10 dB input attenuation and 1 MHz resolution bandwidth,  $\pm 0.05$  dB/°C (eliminated by recalibration).

**Input attenuation switching uncertainty:**  $\pm 0.1$  dB corrected ( $\pm 1.0$  dB uncorrected) over 10 dB to 70 dB range.

**Resolution bandwidth switching uncertainty:** (referenced to 1 MHz bandwidth)—corrected (uncorrected)

Range	20-30°C	0-55°C
3 MHz to 10 Hz	$\pm 0.1$ dB ( $\pm 1.0$ dB)	( $\pm 2.0$ dB)
1 MHz to 30 Hz	$\pm 0.1$ dB ( $\pm 0.5$ dB)	( $\pm 1.0$ dB)

**Log scale switching uncertainty:**  $\pm 0.1$  dB corrected ( $\pm 0.5$  dB uncorrected).

**IF Gain uncertainty:** corrected (uncorrected). Assuming the internal calibration signal is used to calibrate the reference level at -10 dBm and the input attenuator is fixed at 10 dB, any changes in reference level in the following ranges will contribute IF gain uncertainty:

Range	20-30°C	0-55°C
0 dBm to -59.9 dBm	NA <sup>2</sup>	
-60 dBm to -129.9 dBm	( $\pm 0.6$ dB)	( $\pm 1.0$ dB)
	$\pm 1.0$ dB <sup>3</sup>	
	( $\pm 1.0$ dB)	( $\pm 1.5$ dB)

Each 10 dB decrease (or increase) in the amount of input attenuation at the time of calibration and measurement will cause a corresponding 10 dB decrease (or increase) in the absolute reference level settings described above.

**RF Gain uncertainty (due to 2nd LO shift):**  $\pm 0.1$  dB corrected ( $\pm 0.5$  dB uncorrected).

**Error correction accuracy** (applicable when controls are changed from the error calibration state if SHIFT W and SHIFT X are used):  $\pm 0.4$  dB.

### Marker

**Normal:** displays the amplitude at the vertical position of the tunable marker.

**Accuracy:** equals the sum of calibrator uncertainty, reference level uncertainty, and scale fidelity between the reference level and marker position.  $\pi$  PEAK SEARCH positions the marker at the peak of the largest signal present on the display. MKR $\rightarrow$ REF LVL set the analyzer reference level equal to the marker amplitude. RMS noise density in a 1 Hz bandwidth is read out using SHIFT M, by sampling the displayed trace and arithmetically correcting for the analyzer envelope detector response, log shaping, and measurement bandwidth.

$\Delta$ : displays the amplitude difference between the stationary and tunable markers. Reference frequency need not be displayed.

**Accuracy:** equals the sum of scale fidelity and frequency between the two markers.

### Reference lines

**Display line:** movable horizontal line with amplitude readout.

**Threshold:** movable horizontal trace threshold with amplitude readout.

**Accuracy:** equals the sum of calibrator uncertainty, reference level uncertainty, and scale fidelity between the reference level and reference line.

### Dynamic range

**Spurious responses:** for signal levels  $\leq -40$  dBm at the input mixer of the analyzer, all image and out-of-band mixing responses, harmonic and intermodulation distortion products are  $>75$  dB below the input signal level.

**Second harmonic distortion:** for a signal -30 dBm at the mixer and  $\geq 10$  MHz, second harmonic distortion  $>70$  dB down; 60 dB down for signals  $\leq 10$  MHz.

**Third-Order intermodulation distortion:** for two signals -30 dBm at the mixer, third-order intermodulation products  $>70$  dB down (+5 dBm T.O.I. for 0 dB input attenuation).

**Residual responses (no signal at input):**  $< -105$  dBm, with 0 dB input attenuation (typically  $< -115$  dBm).

**Average noise level:** displayed  $< -137$  dBm for frequencies  $> 1$  MHz,  $< -117$  dBm for frequencies  $\leq 1$  MHz with 10 Hz resolution bandwidth (0 dB input attenuation, 1 Hz video filter). When SHIFT M is used with marker, noise measures  $< -144$  dBm/1 Hz and  $< -124$  dBm/1 Hz respectively for frequencies  $> 1$  MHz and  $\leq 1$  MHz.

**Video bandwidth:** post detection low pass filter used to average displayed noise; bandwidth variable from 1 Hz to 3 MHz in a 1, 3, 10 sequence. Video bandwidth may be selected manually or coupled to resolution bandwidth.

**Digital video averaging:** displays the sweep-to-sweep average of the trace over a specifiable number of sweeps with SHIFT G, video averaging is turned off with SHIFT H.

**Gain compression:**  $< 0.5$  dB for signal levels  $\leq -10$  dBm at the input mixer.

### Sweep

#### Trigger

**Free run:** sweep triggered by internal source.

**Line:** sweep triggered by power line frequency

**Video:** sweep triggered by detected waveform of input signal at an adjustable level; signal must be  $\geq 0.5$  div peak-to-peak.

**External:** sweep triggered by rising edge of signal input to rear panel BNC connector; trigger source must be  $> 2.4$  volt (10 volt max).

<sup>1</sup>Maximum input must not exceed  $\pm 30$  dBm damage level.

<sup>2</sup>Accounted for under Error Correction Accuracy.

<sup>3</sup>Correction only applies over the 0 dBm to -59.9 dBm range.



# SIGNAL ANALYZERS

## Spectrum Analyzer, 100 Hz to 1500 MHz (cont.)

### Continuous

Sequential sweeps initiated by the trigger; 20 msec full span to 1500 sec full span in 1, 1.5, 2, 3, 5, 7.5, 10 sequence.

**Accuracy:** sweep time  $\leq 100$  sec,  $\pm 10\%$ ;  $> 100$  sec,  $\pm 20\%$ .

**Zero frequency span:** 1  $\mu$ sec full sweep (10 divisions) to 10 msec full sweep in 1, 2, 5 sequence; 20 msec full sweep to 1500 sec full sweep in 1, 1.5, 2, 3, 5, 7.5, 10 sequence.

**Accuracy:** same as continuous.

Sweep time may be set manually or automatically for the frequency span, resolution bandwidth and video bandwidth selected.

**Single:** single sweep armed on activation and initiated by trigger (sweep  $\geq 20$  msec only).

### Display

**Trace:** A and B are two independent signal response memories each having 1001 horizontal data positions and vertical resolution of 0.1%. Memory contents are displayed on the CRT at a rate independent of the analyzer sweep time. Trace A is displayed brighter than trace B.

**Clear/Write:** clears memory contents when first activated, then writes the analyzer signal response into the memory each sweep and displays memory.

**Max hold:** retains in memory and displays the largest signal level occurring at each horizontal data position over the repetitive sweeps beginning at the time the function is activated.

**View:** stops writing into memory and displays memory without changing its contents.

**Blank:** stops writing into memory and blanks the trace while retaining the last response in memory.

### Arithmetic

**A-B  $\rightarrow$  A:** initially subtracts the stored memory contents of B from the current memory contents of A and writes the difference into A; this process continues as the A memory is updated at the sweep rate. To accomplish **A+B  $\rightarrow$  A** use SHIFT c.

**A  $\leftrightarrow$  B:** exchanges A and B display memory contents.

**B-DL  $\rightarrow$  B:** subtracts the amplitude of the display line from the memory contents of B and writes the difference into B.

A third signal response memory, C (also with a 1001 data positions), can be used for signal response storage. It is accessed indirectly by transferring memory contents between B and C.

**B  $\rightarrow$  C:** SHIFT l.

**B  $\leftrightarrow$  C:** SHIFT i.

**View C:** SHIFT j.

**Blank C:** SHIFT k.

### Annotation

**Title:** allows the user to write characters into a specified area on the CRT by pushing SHIFT E and typing the keys next to the blue front panel characters and data numbers desired. Use BACKSPACE for corrections.

**Blank:** SHIFT o blanks (SHIFT p unblanks) all CRT characters and control setting readouts. SHIFT m blanks (SHIFT n unblanks) the CRT graticule.

### Input

#### RF Inputs

The standard instrument configuration is as follows:

**Input #1:** 100 Hz to 1500 MHz, 50 $\Omega$ , BNC connector (Fused); dc coupled.

**Reflection coefficient:**  $< 0.20$  (1.5 SWR) to 500 MHz,  $< 0.33$  (2.0 SWR) 500 MHz to 1500 MHz;  $\geq 10$  dB input attenuation.

**Input #2:** 100 kHz to 1500 MHz, 50 $\Omega$ , Type N connector; ac coupled.

**Reflection coefficient:**  $< 0.20$  (1.5 SWR);  $\geq 10$  dB input attenuation.

**LO emission:** typically  $< -75$  dBm (0 dB RF Atten).

**Isolation:**  $> 90$  dB between inputs.

**Also available:** Input #1, 100 kHz to 1500 MHz, 75 $\Omega$ , BNC connector, ac coupled (Opt 001).

### Maximum Input level

**AC:** continuous power, +30 dBm (1 watt); 100 watts, 10  $\mu$ sec pulse into  $\geq 50$  dB attenuation.

**DC:** Input #1, 0 volts; Input #2,  $\pm 50$  volts.

**Input attenuator:** 70 dB range in 10 dB steps. Zero dB attenuation accessible only through numeric/unit keyboard. Attenuation may be selected manually or coupled to reference level to insure a -10 dBm input mixer drive level for full-screen signals; other mixer levels may be specified using SHIFT , and entering the desired amplitude through the keyboard.

**Accuracy:**  $\pm 0.5$  dB/10 dB step but  $\leq 1.0$  dB max.

### Output

**Calibrator:** 20 MHz  $\pm 20$  MHz  $\times$  frequency reference error ( $1 \times 10^{-9}$ /Day), -10 dBm  $\pm 0.2$  dB; 50 $\Omega$ .

**Probe Power:** +15 V, -12.6 V; 150 mA max.

### Auxiliary (rear panel; nominal values)

**Display:** X, Y and Z outputs for auxiliary CRT displays. X, Y: 1 volt full deflection; Z: 0 to 1 V intensity modulation, -1 V blank. BLANK output (TTL level  $> 2.4$  V for blanking) compatible with most oscilloscopes.

### Recorder

**Horizontal sweep output (x axis):** a voltage proportional to the horizontal sweep; 0 V for left edge to +10 V for right edge.

**Video output (y axis):** detected video output proportional to vertical deflection of CRT trace. Output increases 100 mV/div from 0 to 1 V.

**Penlift output (z axis):** 15 V blanking output during retrace.

**21.4 MHz IF:** a 50 $\Omega$ , 21.4 MHz output related to RF input to the analyzer. Output nominally -20 dBm for a signal at the reference level. Bandwidth controlled by the analyzer's resolution bandwidth setting.

**1st LO:** 2-3.7 GHz,  $> +4$  dBm; 50 $\Omega$  output impedance.

**Frequency reference:** 10,000 MHz, 0 dBm; 50 $\Omega$  output impedance.

### Instrument State Storage

Up to 6 complete sets of user-defined control settings may be stored and recalled by pressing SAVE or RECALL and the desired register number (1 to 6) from the keyboard. Instrument state information is retained in memory indefinitely in STANDBY and approximately 30 days after line power is terminated.

### Remote Operation

The standard 8568A operates on the Hewlett-Packard Interface Bus (HP-IB). All analyzer control settings (with the exception of VIDEO TRIGGER LEVEL, FOCUS, ALIGN, INTENSITY, FREQ ZERO and AMPLD CAL) are remotely programmable. Function values, marker frequency/amplitude, and A/B traces may be output; CRT labels and graphics may be input.

### General

#### Environmental

**Temperature:** operating 0 $^{\circ}$ C to 55 $^{\circ}$ C, storage -40 $^{\circ}$ C to +75 $^{\circ}$ C.

**Humidity:** operating  $< 95\%$  R.H., 0 $^{\circ}$ C to 40 $^{\circ}$ C except as noted.

**EMI:** conducted and radiated interference is within the requirements of CE03 and RE02 of MIL STD 461A, VDE 0871, and CISPR pub'n 1, 2 and 4.

**Power requirements:** 50 to 60 Hz; 100, 120, 220 or 240 volts ( $\pm 5\%$ , -10%); approximately 450 VA (40 VA in standby), 400 Hz operation is available as Opt 400.

**Weight:** total net, 45 kg (100 lb); Display/IF Section, 21 kg (47 lb); RF Section, 24 kg (53 lb). Shipping, Display/IF Section 31 kg (69 lb); RF Section 34 kg (75 lb).

### Ordering information

#### 8568A Spectrum Analyzer

**Opt 001:** 75 $\Omega$  (BNC), 100 kHz to 1500 MHz RF

**Input #1**

**Opt 400:** 400 Hz Power Line Frequency Operation

**Opt 907:** Front Handle Kit

**Opt 908:** Rack Flange Kit

**Opt 909:** Rack Flange and Front Handle Kit

**Opt 810:** Extra Manual

Price

\$27,800

\$200

\$400

\$40

\$30

\$60

\$75

# SIGNAL ANALYZERS

## Automatic Spectrum Analyzer, 100 Hz to 1500 MHz

Model 8581A



- Interactive Front Panel Under Program Control
- Friendly Programming Codes and Powerful Firmware
- 9825A Computing Controller
- Ease of Operation Via HP-IB

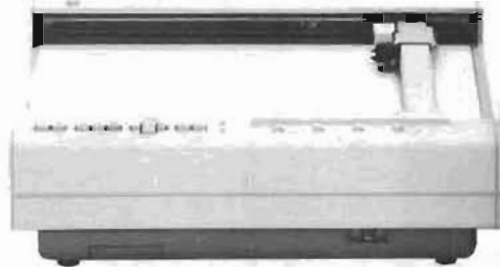

Recommended

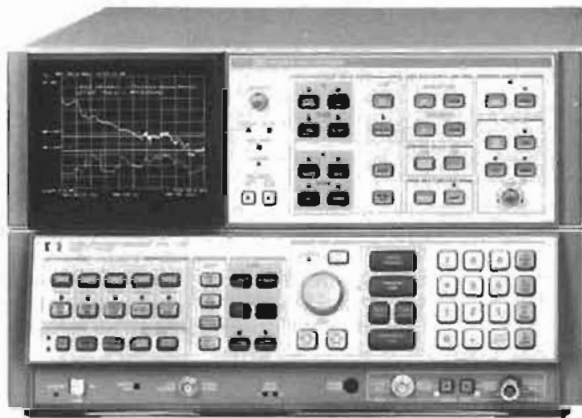

The 8581A "Automatic Spectrum Analyzer" includes 8568A Spectrum Analyzer, 9825A Desktop Computer with 23K bytes of memory and all necessary accessories, 9866B Printer with stand, and system table. A "starter"-software PAC contains programs to store and recall user defined instrument states or plot an entire CRT display together with various sample measurement programs. In the process of describing these programs, a basic set of software statements and subroutines are developed which can be incorporated by the user into his own software.

### Ordering Information

8581A Automatic Spectrum Analyzer

Price  
\$45,600

### System Components

- 8568A Spectrum Analyzer
- 9825A Desktop Computer with Option 002, 23K Bytes Memory
- 98210A String-Advanced Programming Plug-In
- 98216A Plotter-General I/O-Extended I/O Plug-In
- 9866B Printer with Option 025, 9825A Interface
- 98034A HP-IB Interface Card
- 98226A Computer Cradle
- System Table
- 85860A Starter-Software PAC for 8568A/9825A
- Factory Assembly and Checkout Prior to Shipment

### 8581A Options

- Opt 002: Delete System Table less \$600
- Opt 910: Extra Manual Set \$150
- 85860A Starter-Software Pac for 8568A/9825A: PAC includes a 9825A cartridge containing programs to store/recall instrument states, plot the CRT display and perform various sample measurements. Also included is a manual with annotated program listings. Complete compatibility requires 8568A; 9825A, Opt 002; 9866B Opt 025; 98210A; 98216A; and 98034A (plus 9872A Opt 025 and HP-IB cable for plotting). \$250

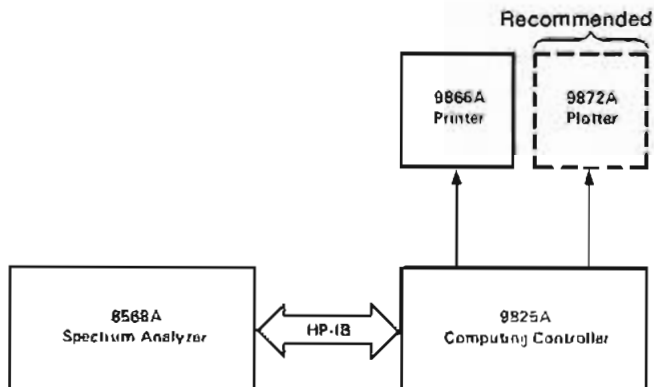

# SIGNAL ANALYZERS

## Spectrum Analyzer, 10 MHz to 40 GHz

### Model 8565A

- .01 to 22 GHz coverage with internal mixer
- Internal preselection 1.7 to 22 GHz
- Wide choice of resolution bandwidths
- Simple three knob operation
- Absolute amplitude calibration
- CRT bezel readout displays control settings

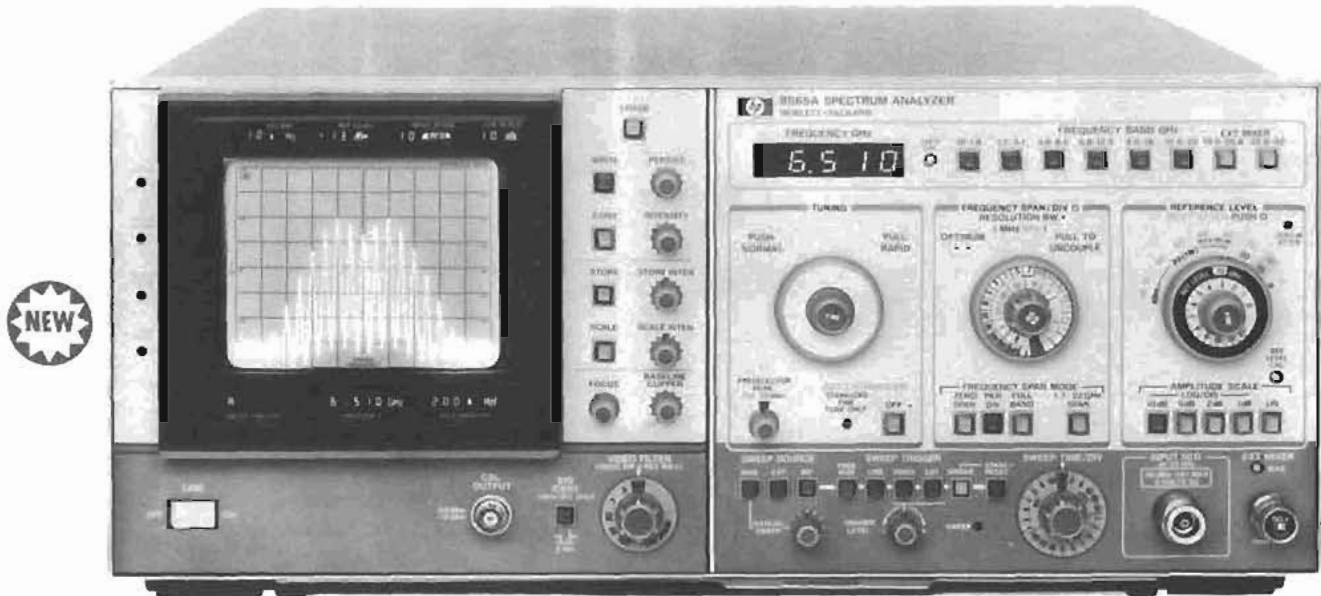

### 8565A Spectrum Analyzer

Covering from 0.01 to 22 GHz with its internal mixer, the 8565A has built-in preselection and brings accuracy plus convenience to microwave spectrum analysis. The wide range, spurious-free display, compact design and ease of use make it well suited for lab, production, or field applications requiring accurate measurement from 1F thru microwave frequencies. The 8565A can cover .01 to 22 GHz in just two spans for rapid location of signals prior to close-in analysis in one of six bands. Coverage is easily extended up to 40 GHz with the HP 11517A external mixer.

#### High Resolution

Fully automatic stabilization in narrow spans reduces residual FM and drift. Standard resolution bandwidths range from 1 kHz to 3 MHz. The 1 and 3 MHz bandwidths allow fast sweeps in wide spans and increased dynamic range for pulsed RF; narrow bandwidths for measurement of closely spaced signals. Option 100 provides additional 100 Hz and 300 Hz IF bandwidth filters, and residual FM is < 100 Hz when stabilized. This 100 Hz resolution is useable up to 12.9 GHz and the 300 Hz resolution bandwidth to 22 GHz. All resolution filters are Gaussian-shaped for repeatable measurements, faster non-distorting sweeps and best pulse response.

#### Absolute Amplitude Calibration

Absolute signal levels from -110 dBm to +30 dBm are easily measured because the HP-8565A always displays the value of the reference line with LED's in the CRT bezel and at the reference level control. Changes in RF, 1F gain and preselector loss are automatically included. In addition, flat frequency response insures accuracy for relative as well as absolute power measurements.

#### Wide Dynamic Range

Internal preselection (1.7 to 22 GHz) enables you to measure distortion products as much as 100 dB down. Even for closely spaced signals or measurements below 1.7 GHz, all distortion products are greater than 70 dB down. In either case, maximum dynamic range is assured even for 1 watt signals with the 70 dB input attenuator. An input limiter (.01 to 1.8 GHz) and the internal preselector (1.7 to 22 GHz) enable the 8565A to withstand RF signals up to +30 dBm for all input attenuator settings.

#### Designed For Convenience

Coupled controls allow you to make most measurements in 3 simple steps. Green color coded keys preset the 8565A for normal operation so a measurement only requires that you tune to a signal, select a desired span, and raise it to the reference level. Auto-

matically selected sweep times insure a calibrated display for all combinations of frequency span, resolution bandwidth and video filtering.

The CRT bezel LED's display all pertinent control settings to give you all the information needed for signal evaluations in one central location. These data are also captured in CRT photos.

### 8444A Option 058 Tracking Generator

Make swept frequency response measurements to  $\pm 1.7$  dB from 10 to 1300 MHz with greater than 90 dB of dynamic range. The output is absolutely calibrated at 0 dBm and continuously variable to < -10 dBm. The frequency of unknown signals as well as the frequency of any point on the frequency response curve can be measured from the external counter output using the low-cost HP 5300/5305B 1300 MHz Counter.

### 8750A Storage-Normalizer

The analyzer is made even easier to use with the digital storage of the 8750A because there is no need to re-adjust intensity or persistence as the sweep time changes. With the push of a button, a signal can be frozen on the CRT and then compared directly to the current input signal. Traces can also be compared arithmetically (i.e., normalized) to automatically remove frequency response variations. This is especially useful when used with the HP 8444A Opt. 058 Tracking Generator.

### 8565A Specifications

#### Frequency Specifications

**Frequency range:** 0.01 to 22 GHz with internal mixer, 14.5 to 40 GHz with HP 11517A External Mixer.

#### Tuning accuracy (digital frequency readout in any span mode)

**Internal mixing:** 0.01 to 2.5 GHz  $\leq 5$  MHz  $\pm 20\%$  of Freq.

**Span/Div:** 2.5 to 22 GHz  $\pm 0.2\%$   $\pm 20\%$  of Freq Span/Div.

**External mixing:** 14.5 to 40 GHz  $\leq 0.7\%$   $\pm 20\%$  of Freq Span/Div.

#### Frequency spans

**1.7 to 22 GHz:** multiband span from 1.7 to 22 GHz in one sweep.

**Full band:** displays spectrum of entire band selected.

**Per division:** eighteen calibrated spans from 1 kHz per div. to 500 MHz per div in a 1, 2, 5 sequence, plus a full band span, "F".

**Span width accuracy:** the frequency error for any two points on the display for spans from 500 MHz/div to 20 kHz/div (un-stabilized) is less than  $\pm 5\%$  of the indicated separation; for stabilized spans 100 kHz/div and less, the error is less than  $\pm 15\%$ .

**Zero span:** analyzer becomes a manually tuned receiver.



### Spectral resolution and stability

**Resolution bandwidths:** resolution (3 dB) bandwidths from 1 kHz to 3 MHz in 1, 3, 10 sequence. Bandwidth and span width are independently variable or may be coupled for optimum display when control markers are aligned (▶◀).

**Resolution bandwidth accuracy:** 3 dB points:  $\pm 15\%$ .

**Selectivity (80 dB/3 bandwidth ration):**  $< 15:1$ .

**Stability (fundamental mixing .01 to 4.1 GHz):** total residual FM stabilized  $< 200$  Hz p-p in 0.1 sec; unstabilized  $< 10$  kHz p-p in 0.1 sec.

**Stabilization range:** first LO automatically stabilized for frequency spans 100 kHz/div or less. First LO residual FM typically 30 Hz p-p when stabilized.

**Noise sidebands:**  $> 70$  dB down,  $> 30$  kHz from center of CW signal in a 1 kHz Res. Bandwidth and a 10 Hz (0.01) Video Filter.

### Amplitude Specifications

#### Amplitude range - internal mixer

##### Measurement range

**Total power:** +30 dBm (1 watt).

**Damage levels:** (50 $\Omega$  nominal source impedance).

**dc:** 0 V with 0 dB atten,  $\pm 7$  V with  $\geq 10$  dB input atten.

**ac:** 0 V with 0 dB input atten, 10 V peak with  $\geq 10$  dB input atten.

**RF:** (signals above 10 MHz) + 30 dBm.

**Gain compression:**  $< 1$  dB for 0 dBm input level with 0 dB attenuation.

**Average noise level:** max. avg. noise level with 1 kHz Res. Bandwidth (0 dB atten and 3 Hz video filter) is in the table below:

Frequency Band (GHz)	First IF in MHz	Harmonic Mode	Noise Level (dBm)	Frequency Response* ( $\pm$ dB MAX)
0.1-1.8	2050	1-	-112	1.2
1.7-4.1	321.4	1-	-109	1.7
3.8-8.5	321.4	2-	-100	2.5
5.8-12.9	321.4	3-	-94	2.5
8.5-18	321.4	4+	-87	3.0
10.5-22	321.4	5+	-78	4.5

\*Frequency response includes input attenuator, preselector and mixer frequency response plus mixing mode gain variation (band to band).

#### Amplitude range HP 11517A External Mixer

**Measurement range:** Maximum waveguide input: saturation (gain compression  $< 1$  dB),  $-15$  dBm. Damage level  $> 0$  dBm or 0.1 erg.

**Sensitivity (Average noise level in a 10 kHz IF bandwidth):**

14.5-18 GHz  $< -80$  dBm, 18-26.5 GHz  $< -70$  dBm, 26.5-40 GHz  $< -60$  dBm.

Typical sensitivity is 10 dB better for each band.

##### Reference Level

**Reference level range:** +70 dBm (+30 dBm max. input) to  $-102$  dBm in 10 dB steps and continuous 0 to  $-12$  dB calibrated vernier

**Reference level accuracy:** the Auto Sweep setting of the sweep time/div control insures a calibrated display within these limits:

**Callibrator output (100 MHz  $\pm 10$  kHz):**  $-10$  dBm  $\pm 0.3$  dB.

**Reference level variation (input attenuator at 0 dB):** 10 dB steps  $\pm 0.5$  dB (0 to  $-70$  dBm);  $\pm 1.0$  dB (0 to  $-90$  dBm).

**Vernier (0 to  $-12$  dB) continuous:** maximum error  $< 0.5$  dB.

**Input attenuator:** (at preselector input, 0-70 dB in 10 dB steps).

**Step size variation:**  $\leq \pm 1.0$  dB 0.01 to 18 GHz;  $\leq \pm 1.5$  dB 0.01 to 22 GHz.

**Maximum cumulative error over the 0 to 70 dB range:**  $\leq \pm 2.8$  dB 0.01 to 18 GHz;  $\leq \pm 4.0$  dB 0.01 to 22 GHz.

**Frequency response:** see table above.

**Switching between bandwidths:** 2 MHz to 1 kHz,  $\pm 1.0$  dB.

##### Calibrated display range

**Log (expanded from reference level down):** 70 dB @ 10 dB/div, 40 dB @ 5 dB/div, 16 dB @ 2 dB/div and 8 dB @ 1 dB/div.

**Linear:** full scale from 36  $\mu$ V ( $-102$  dBm in 50  $\Omega$  to 707 volts (+70 dBm) in 10 dB steps and continuous 0 to  $-12$  dB vernier.

##### Display accuracy

**Log:**  $\leq \pm 0.1$  dB/dB, but  $\leq \pm 1.5$  dB over full 70 dB display range.

**Linear:**  $\leq \pm 0.1$  division over full 8 division deflection.

**Residual responses (no signal present at input):** with 0 dB input atten, fundamental mixing (0.01 to 4.1 GHz)  $< -90$  dBm.

**Signal Identifier:** available on all bands, used in 1 MHz/div span for signal identification.

### Signal Input Characteristics

#### Input 50 $\Omega$ 0.01 to 22 GHz

**Input connector:** precision Type N female.

##### Input Impedance

Input attenuator at 0 dB: 50 ohms nominal.

**SWR:**  $< 1.5$  0.01 to 1.8 GHz;  $< 2.0$  1.7 to 22 GHz (at analyzer tuned frequency).

**Input attenuator at 10 dB or more:** 50 ohms nominal.

**SWR:**  $< 1.3$  0.01 to 1.8 GHz;  $< 2.0$  1.7 to 22 GHz.

**LO Emission (2.00 to 4.48 GHz):**  $-50$  dBm 0.01 to 1.8 GHz;  $-85$  dBm 1.7 to 22 GHz.

**Input protection (for input signals from 0.01 to 22 GHz)**

0.01 to 1.8 GHz frequency band: internal diode limiter.

1.7 to 22 GHz frequency bands: saturation of TIG filter (pre-selector) occurs at total input signal power levels below input mixer damage.

**External mixer input:** BNC female connector is a port for LO power transfer, bias current and IF return.

### Sweep Specifications

#### Sweep time

**Auto:** sweep time is automatically controlled by Frequency

Span/Div, Resolution Bandwidth and Video Filter controls to maintain an absolute amplitude calibrated display.

**Calibrated sweep times:** 21 internal sweep times from 2  $\mu$ sec/div to 10 sec/div in 1, 2, 5, 10 sequence.

### Display Characteristics

**Cathode Ray Tube (aluminized P31 phosphor, 8 x 10 div internal graticule)**

##### Persistence

**Conventional:** natural persistence of P31 phosphor.

**Write:** continuously adjustable from 0.2 sec to full storage.

**Storage time:** continuously adjustable from 1 minute (full brightness) to  $> 30$  minutes (minimum brightness).

**CRT Bezel Readout:** bezel LEDs display the following measurement data (included in CRT photographs taken with the HP 197A Opt 006 Oscilloscope Camera): Ampl. Scale Factor, Ref. Level, Input Atten., Res. Bandwidth, Sweptime/Div., Freq., Freq. Span/Div.

### General Specifications

**Temperature range:** operating 0°C to 55°C, storage  $-40^\circ$  to  $+75^\circ$ C.

**Humidity range (Operating):**  $< 95\%$  R.H. 0°C to 40°C

**EMI:** conducted and radiated interference is within the requirements of methods CE03 and RE02 of MIL STD 461A, VDE 0871 and CISPR pub'n 1, 2 and 4.

**Power requirements:** 48-66 Hz, 100, 120, 200 or 240 volts ( $\pm 10\%$  to  $\pm 5\%$ ) 220 VA max (400 Hz operation available as Opt 400).

**Size:** 188 H x 426 W x 552 mm D (7 $\frac{3}{4}$ " x 16 $\frac{3}{4}$ " x 21 $\frac{1}{4}$ ").

**Weight:** net 29.1 kg (64 lbs). Shipping 38.6 kg (85 lbs).

##### Standard options available

**Opt 100, 100 and 300 Hz Resolution Bandwidths:** adds 100 Hz and 300 Hz resolution bandwidths with 11:1 shape factor, residual FM  $< 100$  Hz when stabilized and improves sensitivity by 10 dB.

**Opt 200—Calibration in dB $\mu$ V**

**Opt 400—400 Hz Power Supply**

##### Ordering information

8565A Spectrum Analyzer Price

Opt 100: 100 Hz and 300 Hz Resolution Bandwidths \$17,850

Opt 200: Calibration in dB $\mu$ V add \$800

Opt 400: 400 Hz Power Supply add \$100

11517A External Mixer (taper section req'd) add \$250

11518A Taper Section, 12.4 to 18 GHz \$250

11519A Taper Section, 18 to 26.5 GHz \$160

11520A Taper Section, 26.5 to 40 GHz \$160

8444A Opt 058 Tracking Generator \$3,800

8750A Storage-Normalizer \$1,450

# SIGNAL ANALYZERS

## Spectrum Analyzer, 0.01 to 350 MHz

### Models 8557A/182T & 8750A

- Easy to operate
- Signal level displayed directly in dBm
- $\pm 2.25$  dB amplitude accuracy
- Resolution bandwidths 1 kHz to 3 MHz
- Optional 75 $\Omega$  input with dBm or dBmV calibration
- Digital Storage-Normalizer available

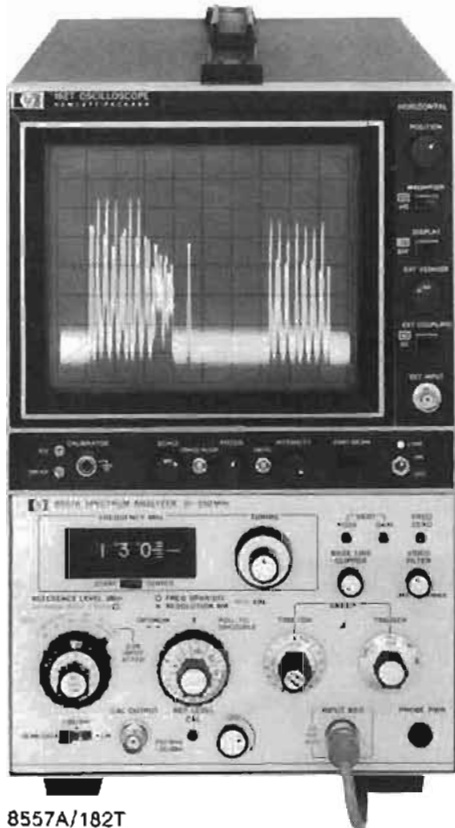

8557A/182T

### 8557A Spectrum analyzer

#### Economy plus performance

The Model 8557A is a 0.01 to 350 MHz spectrum analyzer which plugs into any model 180-series oscilloscope display. This low cost, easy-to-use analyzer provides high accuracy in both amplitude and frequency measurements.

#### Simple, 3-knob operation

Most measurements are a three step process. Center the inverted marker under the signal to be measured; its frequency is displayed on the digital readout. Zoom-in on the signal by decreasing the frequency span; bandwidth, sweep time, and video filtering are set automatically. Raise the signal to the top of the CRT; read its amplitude (in dBm) off the reference level control.

#### Absolute amplitude calibration

Signal levels can be read directly from the CRT in dBm (dBmV for Option 002) without the use of external standards or calculations. The signal level represented by the top CRT graticule line is always indicated by the reference level control, and vertical scale factors of 10 dB/div, 1 dB/div, or linear can be selected.

#### Optional 75 ohm input

Two options are available which allow measurements in 75 ohm systems: Option 001 has 75 ohms impedance and retains the dBm power calibration; Option 002 is also 75 ohms, but the amplitude is calibrated in dBmV for measurements on systems such as CATV.



### New 8750A Storage-Normalizer

The 8750A is an accessory which provides digital storage, trace comparison and normalization where data in memory is subtracted from current input and then displayed. In conjunction with the 182T display maniframe and either the 8557A or 8558B, the Storage-Normalizer provides flicker-free display of measured signals. High resolution, slow sweep time measurements are easy to observe because of the 8750A's continuous refresh whose rate is independent of the analyzer's sweep rate. Additionally, two traces can be viewed from memory for CRT photography or detailed signal comparison.

### 8557A Specifications

#### Frequency specifications

**Frequency range:** 10 kHz to 350 MHz.

**Frequency display span:** (on a 10-division CRT horizontal axis): 12 calibrated spans from 20 MHz/div to 5 kHz/div in a 1, 2, 5 sequence. In "F" or full span the analyzer displays the full 10 kHz to 350 MHz. In "0" or zero span, the analyzer is a fixed-tuned receiver.

**Accuracy:** frequency error between any two points on the display is less than  $\pm 10\%$  of the indicated frequency separation.

**Digital frequency readout:** indicates center frequency or start frequency of the frequency display span. In full span, the readout indicates center frequency or start frequency of the frequency display span. In full span, the readout indicates the frequency at the marker. Resolution 100 kHz.

**Accuracy:** (after zeroing on the LO feedthrough)  $\pm 3$  MHz + 10% of FREQUENCY SPAN PER DIVISION setting.

#### Stability

**Residual FM:** less than 1 kHz peak-to-peak for time  $\leq 0.1$  sec (video filter full clockwise, but not in detent).

**Noise sidebands:** more than 75 dB below CW signal, 50 kHz or more away from signal with a 1 kHz resolution bandwidth and full video filtering.

#### Resolution

**Bandwidth ranges:** 3 dB resolution bandwidths of 1 kHz to 3 MHz in a 1, 3, 10 sequence. Resolution bandwidth may be coupled to frequency display span at a ratio of two display spans per resolution bandwidth.

**Resolution bandwidth accuracy:** individual resolution bandwidth 3 dB points calibrated to  $\pm 20\%$ ,  $10^\circ - 40^\circ\text{C}$ .

**Resolution bandwidth selectivity:** 60 dB/3 dB resolution bandwidth ratio  $< 15:1$ .

**Video filter:** post-detection low pass filter used to average displayed noise. Bandwidth variable from approximately 3X Resolution Bandwidth to approximately 0.01X Resolution Bandwidth. In the MAX position provides a noise averaging filter with a bandwidth of approximately 1.5 Hz.

### Amplitude specifications

#### Absolute amplitude calibration range

**Log calibration range:** from -117 dBm to +20 dBm in 10 dB steps. Reference level vernier, 0 to -12 dB continuously.

**Log display ranges:** 10 dB/div on a 70 dB display and 1 dB/div on an 8 dB display.

**Linear display:** from 2.2 microvolts (-100 dBm) full-scale to 2.24 volts (+20 dBm) full-scale in 10 dB steps. Full-scale signals in linear translate to approximately full-scale signals in log.

#### Dynamic range

**Average noise level:** < -107 dBm with a 10 kHz resolution bandwidth (0 dB input attenuation), 1-350 MHz.

**Spurious responses:** for input signal level  $\leq$  Optimum Input Level setting, all image and out of band mixing responses, harmonic and inter-modulation distortion products are more than 70 dB below input signal level, 1 MHz to 350 MHz; 60 dB below, 20 kHz to 1 MHz.

**Spurious responses due to 3rd order intermodulation distortion:** for two input signals 10 dB above Optimum Input Level setting 3rd Order Intermodulation distortion products are >70 dB below the input signals, 1-350 MHz; 60 dB below, 10 kHz to 1 MHz (signal separation  $\geq$  50 kHz).

**Residual responses (no signal present at input):** < -100 dBm with 0 dB input attenuation, 0.1-350 MHz.

#### Amplitude accuracy

**Frequency response (flatness):**  $\pm 0.75$  dB.

**Switching between bandwidths** (at 10° -40°C, 90% relative humidity)

**3 MHz to 300 kHz:**  $\pm 0.5$  dB.

**3 MHz to 1 kHz:**  $\pm 1.0$  dB.

**Reference level accuracy** (at fixed center frequency, fixed resolution bandwidth):  $\pm 1.5$  dB (includes input attenuator and IF gain accuracy. May be improved using IF or RF substitution techniques).

**Amplitude log display:**  $\pm 0.1$  dB/dB but no more than  $\pm 1.5$  dB over full 70 dB display range.

#### Calibrator

**Amplitude:** -30 dBm  $\pm 1$  dB.

**Frequency:** 250 MHz  $\pm 50$  kHz, crystal controlled.

#### Input specifications

**Input connector:** Type BNC female.

**Input impedance:** 50 $\Omega$  nominal. Typical reflection coefficient < 0.27 (1.74 SWR) for all Optimum Input Level settings except -40 dBm (0 dB Input Attenuation).

**Input attenuator:** 50 dB range. Accuracy  $\pm 0.5$  dB per 10 dB step, but not more than  $\pm 1.0$  dB over full 50 dB range.

#### Maximum input levels

**AC or peak:** peak or average power +20 dBm (3.16 V ac peak or 0.1 W) incident on analyzer. (MAX input markings on front panel indicate maximum input allowable for <1 dB gain compression or attenuator overload.)

**DC:**  $\pm 30$  V dc.

#### Output characteristics

**Cal output:** -30 dBm, 250 MHz.

**Probe power:** +15 V, -12.6 V; 150 mA max. Powers 1120A, 1121A, 1123A, or 1124A high impedance probes.

**Note:** oscilloscope display rear panel outputs refer to 180T-series displays and 180-series Option 807 displays only. See below for information on modifying standard displays.

**Vertical output:** (AUX A on oscilloscope display rear panel): 0 to 0.8 V for 8-division deflection on CRT display; 50 $\Omega$  output impedance.

**Pen lift/blinking output:** (AUX B on oscilloscope display rear panel): 0 to 15 V (0 V, pen down). Approximately 10 k $\Omega$  impedance when blanked. Compatible with HP 7004B, 7034B, 7005B, and 7035B X-Y RECORDERS.

**21.4 MHz IF output:** a 21.4 MHz output linearly related to the RF input to the analyzer. Bandwidth controlled by analyzer Resolution Bandwidth setting. Amplitude controlled by input attenuator, IF gain vernier, and first six IF step gain positions (-10 through -60 dBm Ref Level with 0 dB input attenuation). Output is approximately -10 dBm for full-scale signals on the CRT. (AUX C on oscilloscope display rear panel, 50 $\Omega$  output impedance.)

**Horizontal output** (AUX D on oscilloscope display rear panel): -5.0 to +5.0 V for 10 div CRT deflection, 5 k $\Omega$  output impedance.

#### Sweep characteristics

##### Sweep time

**Auto:** sweep time is automatically controlled by Frequency Span, Resolution Bandwidth, and Video Filter.

**Manual:** sweep determined by front panel control; continuously variable across CRT in either direction.

**Calibrated sweep times:** 16 internal sweep times from 0.1 ms/div to 10 sec/div in a 1, 2, 5 sequence. For sweep times of 2 ms/div to 10 sec/div, the analyzer is operable in its normal swept-frequency mode. Faster sweeps are useful for analyzing modulation waveforms when the analyzer is being operated as a fixed-tuned receiver with 0 Display Span. Sweep times may be reduced to an effective 10  $\mu$ sec/div by using the 180-series X10 horizontal magnifier.

**Accuracy:**  $\pm 10\%$ .

##### Sweep trigger

**Internal:** sweep internally triggered by envelope of RF input signal (signal amplitude of 1.0 division peak-to-peak required on CRT display).

**Line:** sweep triggered by power line frequency.

**Free run:** sweep triggered repetitively by internally generated ramp.

**Single:** sweep triggered by front panel sweep trigger switch (spring return position).

#### Display characteristics

##### Oscilloscope display sections

**180 Series compatibility:** the 8557A is compatible with all 180A/180AR, 180C, 180D, 180F, 181A, 181AR, 182A, 184A, and 184B mainframes. It is operable with the 183A, 183B mainframes, but the display is limited to 6 divisions by the 6-division CRT. The following 180-series oscilloscope displays are recommended for use with the 8558B Spectrum Analyzer because they provide 4 nonbuffered rear panel auxiliary outputs (for unattenuated vertical, horizontal, and penlift outputs) and P39 medium-persistence CRT phosphor (except with 181T, 181TR which provide variable persistence):

180TR	P39 phosphor
181T	P31 phosphor with variable persistence
181TR	P31 phosphor with variable persistence
182T	P39 phosphor

See HP Service Notes 180A/AR-10, 180C/D-2, 181A/AR-8 and 182A/C-1 for information needed to modify standard display to provide auxiliary outputs.

##### Ordering information

	Price
8557A Spectrum Analyzer	\$3850
Opt 001: 75 ohm input (BNC), dBm calibration	add \$100
Opt 002: 75 ohm input (BNC), dBmV calibration	add \$100
182T Display	\$1650
180TR Display	\$1650
181T Display	\$2600
181TR Display	\$2700
8750A Storage-Normalizer	\$1450

## SIGNAL ANALYZERS

### Spectrum Analyzer, 0.1 to 1500 MHz

Models 8558B/182T & 8444A

- Simple, 3 knob operation
- Digital frequency readout
- Display of signal levels directly in dBm

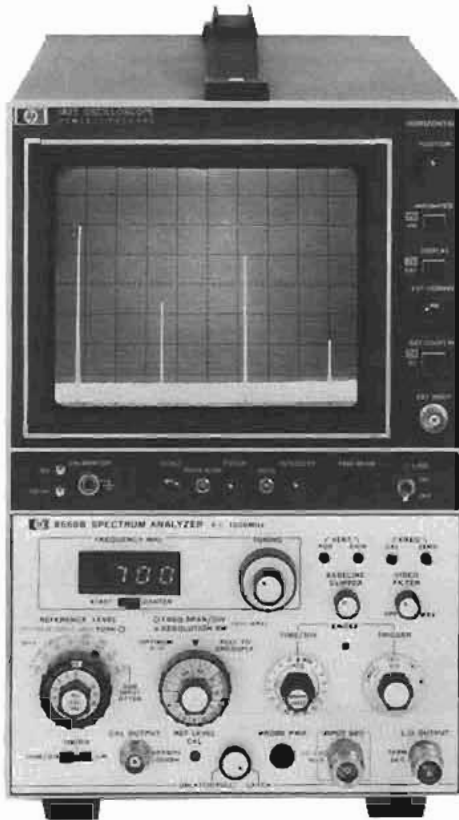

8558B/182T

### 8558B Spectrum analyzer

#### Economical, wide frequency coverage

The Model 8558B is a 0.1 to 1500 MHz spectrum analyzer which plugs into any 180-series oscilloscope display. It is fully calibrated in frequency and amplitude, easy to use, and provides an economical means for making measurements in the RF range.

#### Simple, 3-knob operation

Most measurements are a simple three step process. Tune to the signal to be measured; its frequency is displayed on the LED readout. Zoom-in on the signal by decreasing the frequency span; bandwidth, sweep time, and video filtering are set automatically. Raise the signal to the top of the CRT; read its amplitude (in dBm) off the reference level control.

#### Absolute amplitude calibration

Signal levels can be read directly from the CRT in dBm (dBmV for Option 002) without the use of external standards or calculations. The signal level represented by the top CRT graticule line is always indicated by the reference level control, and scale factors of 10 dB/div, 1 dB/div, and linear can be selected.

#### Optional 75 ohm input

Two options are available which allow measurements in 75 ohm systems: Option 001 has 75 ohms impedance and retains the dBm power calibration; Option 002 is also 75 ohms, but the amplitude is calibrated in dBmV for measurements on systems such as CATV.

- Resolution bandwidths from 1 kHz to 3 MHz
- 0.5 to 1300 MHz Tracking Generator
- Digital Storage-Normalizer available



8444A Opt 058 (Compatible with 8558B)

### 8444A Option 058 Tracking Generator (0.5—1300 MHz)

Make swept frequency response measurements to  $\pm 1.5$  dB from 0.5 to 1300 MHz with greater than 90 dB of dynamic range. The output is absolutely calibrated at 0 dBm of dynamic range. The output is absolutely calibrated at 0 dBm and continuously variable to  $-10$  dBm. The frequency of unknown signals as well as the frequency of any point on the frequency response curve can be measured using the external counter output and Model 5383A Counter up to 500 MHz or Model 5341A Opt 003 Counter to 1300 MHz.

### New 8750A Storage-Normalizer

The 8750A is an accessory which provides digital storage, trace comparison and swept response normalization. The frequency response variation of a swept measurement system, such as the 8558B and 8444A, can be removed through normalization. In addition, a "real time" signal can be compared with a stored trace or both traces can be viewed from memory for CRT photography or detailed comparison.

### 8558B Specifications

#### Frequency specifications

**Frequency range:** 100 kHz to 1500 MHz.

**Frequency display span:** (on a 10-division CRT horizontal axis): 14 calibrated spans from 100 MHz/div to 5 kHz/div in a 1, 2, 5 sequence. In "0" (zero span) the analyzer is a fixed-tuned receiver.

**Accuracy:** frequency error between any two points on the display is less than  $\pm 5\%$  of the indicated frequency separation.

**Digital frequency readout:** indicates center frequency or start frequency of the frequency display scan. Two ranges: 0 to greater than 195 MHz with 100 kHz resolution; 195 MHz to 1500 MHz with 1 MHz resolution. ZERO control allows frequency readout to be adjusted for accurate calibration anywhere in the frequency range; CAL control removes frequency hysteresis. Resolution 100 kHz.

**Accuracy:** (after zeroing on the LO feedthrough and operation of the CAL button,  $20^\circ - 40^\circ\text{C}$ ).

**0-195 MHz:**  $\pm 1$  MHz  $+20\%$  of FREQUENCY SPAN PER DIVISION setting ( $\leq 1$  MHz per division).

**195-1500 MHz:**  $\pm 5$  MHz  $+\%$  of FREQUENCY SPAN PER DIVISION setting.

#### Stability

**Residual FM:** less than 1 kHz peak-to-peak for time  $\leq 0.1$  sec.

**Noise sidebands:** more than 65 dB below CW signal, 50 kHz or more away from signal with a 1 kHz resolution bandwidth and full video filter.

#### Resolution

**Bandwidth ranges:** 3 dB resolution bandwidths of 1 kHz to 3 MHz in a 1, 3, 10 sequence. Resolution bandwidth may be coupled to frequency display span at a ratio of two display spans per resolution bandwidth.

**Resolution bandwidth accuracy:** individual resolution bandwidth 3 dB points calibrated to  $\pm 20\%$ .

**Resolution bandwidth selectivity:** 60 dB/3 dB resolution bandwidth ratio  $< 15:1$ .

**Video filter:** post-detection filter used to average displayed noise. Bandwidth variable from approximately 3X Resolution Bandwidth to approximately 0.01X Resolution Bandwidth. In the MAX position provides a noise averaging filter with a bandwidth of approximately 1.5 Hz.

#### Amplitude specifications

##### Absolute amplitude calibration range

**Log calibration range:** from -115 dBm to +30 dBm in 10 dB steps. Reference level vernier, 0 to -12 dB continuously.

**Log display ranges:** 10 dB/div on a 70 dB display, and 1 dB/div on an 8 dB display.

**Linear display:** from 2.2 microvolts (-100 dBm) full scale to 7.1 volts (+30 dBm) full-scale in 10 dB steps. Full-scale signals in linear translate to approximately full-scale signals in log.

##### Dynamic range

**Average noise level:** < -107 dBm with a 10 kHz resolution bandwidth (0 dB input attenuation).

**Spurious responses:** for input signal level  $\leq$  Optimum Input Level setting, all image and out-of-band mixing responses, harmonic and intermodulation distortion products are more than 70 dB below input signal level, 5 MHz to 1500 MHz; 60 dB below, 100 kHz to 5 MHz.

**Spurious responses due to 3rd order Intermodulation distortion:** for two input signals 10 dB above Optimum Input Level setting 3rd Order Intermodulation distortion products are >70 dB below the input signals, 5-1500 MHz; 60 dB below, 100 kHz to 5 MHz (signal separation  $\geq$  50 kHz).

**Residual responses:** (no signal present at input): < -100 dBm with 0 dB input attenuation.

##### Amplitude accuracy

**Frequency response (flatness):**  $\pm 1.0$  dB.

**Switching between bandwidths (at 10° -40°C).**

**3 MHz to 300 kHz:**  $\pm 0.5$  dB.

**3 MHz to 1 kHz:**  $\pm 1.0$  dB.

**Reference level accuracy (at fixed center frequency, fixed resolution bandwidth):**  $\pm 1.5$  dB (includes input attenuator and IF gain accuracy. May be improved using IF or RF substitution techniques).

**Amplitude log display:**  $\pm 0.1$  dB/dB but not more than  $\pm 1.5$  dB over full 70 dB display range.

##### Calibrator

**Amplitude:** -30 dBm  $\pm 1.0$  dB.

**Frequency:** 280 MHz  $\pm 50$  kHz, crystal controlled.

##### Input specifications

**Input connector:** type N female.

**Input impedance:** 50  $\Omega$  nominal. Typical reflection coefficient < 0.20 (1.5 SWR) for all Optimum Input Level settings except -40 dBm (0 dBm input attenuation).

**Input attenuator:** 70 dB range. Accuracy  $\pm 0.5$  dB per 10 dB step but not more than  $\pm 1.0$  dB over full 70 dB range.

##### Maximum

**AC or peak:** peak or average power +10 dBm (1.0 V ac peak) incident on mixer (0 dB input attenuation), +30 dBm (10 V ac peak or 1 W), incident on input attenuator. (MAX input markings on front panel indicate maximum input allowable for <1 dB gain compression or attenuator overload).

**DC:**  $\pm 50$  V dc.

##### Output characteristics

**LO output:** +10 dBm nominal, 50 ohms; 2.05-3.55 GHz.

**Cal output:** -30 dBm, 280 MHz

**Probe power:** +15 V, -12.6 V; 150 mA max. Powers 1120A, 1121A, 1123A, or 1124A high impedance probes.

**Note:** the following oscilloscope display rear panel outputs refer to 180T 180TR, 181T, 181TR displays and older 180-series displays with Option 807 only.

**Vertical output:** (AUX A on oscilloscope display rear panel.) 0 to 0.8 V for 8-division reflection on CRT display; 50  $\Omega$  output impedance.

**Pen lift/blinking output:** (AUX B on oscilloscope display rear panel): 0 to 15 V (0 V, pen down). Approximately 10 k $\Omega$  impedance when blanked. Compatible with HP 7004B, 7034B, 7005B, and 7035B X-Y RECORDERS.

**21.4 MHz IF output:** a 21.4 MHz output linearly related to the RF input to the analyzer. Bandwidth controlled by analyzer Resolution Bandwidth setting, amplitude controlled by input attenuator, IF gain vernier, and first six IF step gain positions (-10 through -60 dBm Ref Level with 0 dB input attenuation). Output is approximately -10 dBm for full-scale signals on the CRT. (AUX C on oscilloscope display rear panel, 50  $\Omega$  output impedance).

**Horizontal output (AUX D on oscilloscope display rear panel):** -5.0 to +5.0 V for 10 div CRT deflection, 5 k $\Omega$  output impedance.

##### Sweep characteristics

###### Sweep time

**Auto:** sweep time is automatically controlled by Frequency Span, Resolution bandwidth, and Video Filter.

**Manual:** sweep determined by front panel control, continuously variable across CRT in either direction.

**Calibrated sweep time:** 16 internal sweep times from 0.1 ms/div to 10 sec/div in a 1, 2, 5 sequence. For sweep times of 2 ms/div to 10 sec/div, the analyzer is operable in its normal swept frequency mode. Faster sweeps are useful for analyzing modulation waveforms when the analyzer is being operated as a fixed-tuned receiver with 0 Display Span. Sweep times may be reduced to an effective 10  $\mu$ sec/div by using the 180-series X10 horizontal magnifier.

**Accuracy:**  $\pm 10\%$ .

###### Sweep trigger

**Internal:** sweep internally triggered by envelope of RF input signal (signal amplitude of 1.0 division peak-to-peak required on CRT display).

**Line:** sweep triggered by power line frequency.

**Free run:** sweep triggered repetitively by internally generated ramp.

**Single:** sweep triggered by front panel sweep trigger switch (spring return position).

##### Display characteristics

###### Oscilloscope display sections

**180 Series compatibility:** the 8558B is compatible with all 180A, 180AR, 180C, 180D, 180F, 181A, 181AR, 182A, 184A, and 184B mainframes. It is operable with the 183A, 183B mainframes, but the display is limited to 6 divisions by the 6-division CRT. The following 180-series oscilloscope displays are recommended for use with the 8558B Spectrum Analyzer because they provide 4 non-buffered rear panel auxiliary outputs (for unattenuated vertical, horizontal, and penlift outputs) and P39 medium-persistence CRT phosphor (except with 181T, 181TR which provide variable persistence):

180TR	P39 phosphor
181T	P31 phosphor with variable persistence
181TR	P31 phosphor with variable persistence
182T	P39 phosphor

See HP Service Notes 180A/AR-10, 180C/D-2, 181A/AR-8 and 182A/C-1 for information needed to modify standard displays to provide auxiliary outputs.

##### Ordering Information

	Price
8558B Spectrum Analyzer	\$4850
Opt 001: 75 ohm input (BNC), dBm calibration	add \$100
Opt 002: 75 ohm input (BNC), dBmV calibration	add \$100
Opt 003: Internal Limiter	add \$150
182T Display	\$1650
180TR Display	\$1650
181T Display	\$2600
181TR Display	\$2700
8444A Opt 058 Tracking Generator	\$3800
8750A Storage-Normalizer	\$1450

# SIGNAL ANALYZERS

## Plug-in spectrum analyzer system, 20 Hz to 40 GHz

### Model 141T system

- 20 Hz to 40 GHz with just a tuning section change.
- Advantages of fully calibrated solid state system.
- Add measurement capability to your system as needed.
- Tracking generator expands measurement capability.
- Increase dynamic range with tracking preselector.
- Storage-normalizer adds digital storage.

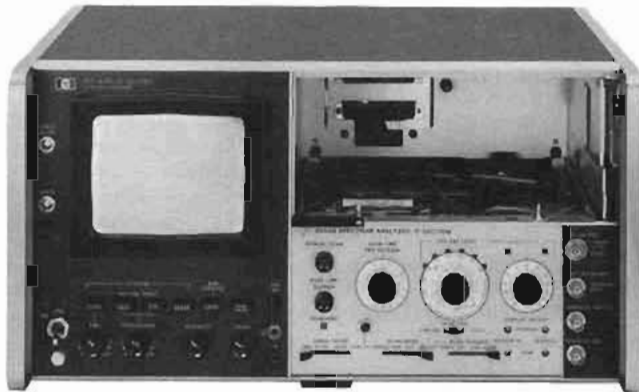

141T, 8552B



8443A



8444A



8445B Opt 002, 003

Hewlett-Packard's high performance plug-in spectrum analyzer family makes frequency domain measurements from 20 Hz to 40 GHz. Because of the system's modularity, the user need purchase only analyzer components necessary to meet immediate production or laboratory measurement requirements. Then, as broader frequency capability is required, additional tuning sections or companion instruments can be added.

The models 8553B, 8554B, 8555A, and 8556A are tuning sections which plug into a 141T display mainframe along with an 8552B IF section to form a member of the Hewlett-Packard high performance spectrum analyzer family. Each tuning section covers a frequency range convenient for equipment design or spectrum surveillance: 8556A, 20 Hz to 300 kHz; 8553B, 1 kHz to 110 MHz; 8554B, 100 kHz to 1250 MHz; and 8555A, 10 MHz to 40 GHz. The IF section plug-in which is used with each tuning section, serves to condition the measurement signal for proper display on the CRT. Two IF sections are available, the 8552B high performance model and the 8552A model for economy. The spectrum analyzer specifications included in this catalog assume the use of the 8552B.

The 8443A and 8444A are tracking generators complementing the basic spectrum analyzer function with an RF source locked to the tuning frequency. The 8445B is an automatic preselector which enhances the dynamic range of the 10 MHz to 40 GHz 8555A tuning section analyzer.

The 141T based spectrum analyzer features absolute calibration of frequency and amplitude, high resolution and sensitivity, wide dynamic range, and simple to interpret display output.

The following pages cover spectrum analyzer performance with each of the tuning sections and companion tracking generator/preselector.



8553B



8554B



8555A



8556A

### Absolute amplitude calibration

For ease and speed of measurement, full frequency band amplitude calibration allows direct interpretation of signal power or voltage from the CRT display. A choice of logarithmic or linear scaling calibrates the CRT in dBm or  $\mu$ V respectively. Front panel settings set the top horizontal graticule on the CRT as the reference power in the logarithmic mode; all other CRT measurements can be made relative to this reference. In linear scaling the CRT is calibrated in voltage per division using front panel settings. The bottom graticule is zero voltage.

When a combination of frequency scan, bandwidth, or video filter settings are chosen such that the display becomes uncalibrated, a warning light indicates the condition.

### High resolution frequency calibration

The frequency measurement capability of the spectrum analyzer is responsive to user need, making spectrum measurements simply and accurately with three frequency scan modes.

First is the FULL scan mode, which displays the entire tuning section frequency band on the 10 cm horizontal CRT graticule. This mode is effective in viewing broadband effects of circuit adjustments and refinements as they are made. In FULL scan a marker on the CRT corresponds in frequency to the position of the pointer on the tuning section frequency scale, so signals can be readily identified.

The second mode, PER DIVISION scan, centers the display about the frequency indicated by the tuning section pointer. In this mode, narrow, calibrated scan per division and automatic frequency stabilization make high resolution measurements for analysis of signal purity, sidebands, and low deviation FM.

In the third mode, ZERO scan, the analyzer becomes a receiver tuned to the frequency indicated on the scale. Modulation in an input signal at the tuned frequency is displayed on the CRT in the time domain. The scan time control provides a calibrated time base.

### High resolution

The ability to resolve close-in signal sidebands, such as line related modulation, is important in frequency domain analysis. The Hewlett-Packard 141T plug-in spectrum analyzers each have narrow bandwidths for such resolution. Up to 110 MHz, the analyzers offer 10 Hz bandwidths and to 18 GHz, 100 bandwidths. The frequency stabilization feature already mentioned ensures high resolution by maintaining a jitter free display.

### Wide dynamic range, sensitive

Confidence in signal identification is given by the analyzer's ability to measure wide amplitude differentials without distortion products and to measure very low level signals. The plug-in spectrum analyzers have typically 70 dB of distortion free dynamic range; that is, the capability of measuring 0.03% signal distortion from the CRT display. With the 8445B preselector the 8555A has a spurious free range of 100 dB. The CRT displays full dynamic range on a linear, easy to read scale.

Signals at as low a level as  $-142$  dBm (20 nanovolts, 50 ohms) can be detected by the spectrum analyzer with 10 Hz bandwidth. At high frequencies and with 100 Hz bandwidth,  $-125$  dBm signals can be measured.



have typically 70 dB of distortion free dynamic range; that is, the capability of measuring 0.03% signal distortion from the CRT display. With the 8445B preselector the 8555A has a spurious free dynamic range of 100 dB. The CRT also displays full dynamic range on a linear, easy to read scale.

Signals at as low a level as  $-142$  dBm (20 nanovolts, 50 ohms) can be detected by the spectrum analyzer with 10 Hz bandwidth. At high frequencies and with 100 Hz bandwidth,  $-125$  dBm signals can be measured.

#### A parallax free, storable display

The 141T spectrum analyzer mainframe and display features a variable persistence CRT which enables response storage for any measurement. With very narrow bandwidth measurements, extremely slow sweeps are necessary to maintain amplitude calibration (allowing band-pass filters time to respond). A recording CRT is necessary to save this response for viewing. Of course, any response can be stored for a display ready to be photographed. Another display mainframe, the 140T, is available with standard persistence.

Interpretation of response levels on the CRT is free from parallax since the graticule is etched on the inside of the display screen adjacent to the phosphor.

#### IF section adds convenience features

The high resolution 8552B or the economic 8552A IF section features video filtering, recorder outputs and an internal calibration signal to make the spectrum analyzer easier to use. Video filtering is a low-pass filter which averages out noise amplitude response for easier small signal readings. It also makes wide band noise measurements easier.

Recorder outputs, including pen lift, allow hard copy duplication of the CRT display. Manual scan allows setting up of accessories, such as X-Y recorders, adjusting signals on screen during slow scans and measuring frequencies with a counter.

The internal calibration standard is a very stable  $-30$  dBm, 30 MHz signal for quick front panel calibration.

#### Tracking generators for each frequency band

Either available internally, or as a companion instrument, are leveled signal sources designed to track the swept tuning frequency of the spectrum analyzer. Amplifiers, filters or any circuit which requires an input signal can be characterized to 1300 MHz, with typically wider dynamic range and more precise frequency accuracy than with the spectrum analyzer alone.

The 8556A low frequency tuning section has an internal tracking generator, standard with the instrument. The 8553B and 8554B/8555A use separate generators namely 8443A and 8444A, respectively.

#### New 8750A Storage-Normalizer

You can add digital storage to the 140-series spectrum analyzer with the 8750A (Opt. 001) and an external oscilloscope. Digital storage provides a flicker-free display regardless of the analyzer sweep speed and facilitates trace comparisons of two traces. If a tracking generator is employed, the normalization feature significantly reduces frequency response variations. The 8750A Storage-Normalizer is a versatile accessory which may be used directly with other HP spectrum and network analyzers. (See Page 450).

#### General specifications

##### 141T spectrum analyzer system

**Input impedance:** 50 $\Omega$  nominal. Reflection coefficient  $<0.30$  (1.85 SWR), input attenuator  $\geq 10$  dB.

**Maximum input level:** peak or average power  $+13$  dBm (1.4 V ac

peak),  $\pm 50$  V dc.

**Attenuator:** 0 to 50 dB in 10 dB steps.

**Scan time:** 16 internal scan rates from 0.1 ms/div to 10 sec/div in a 1, 2, 5 sequence, and manual scan (8552B only).

##### Scan time accuracy

0.1 ms/div to 20 ms/div:  $\pm 10\%$ .

50 ms/div to 10 s/div:  $\pm 20\%$ .

##### Scan mode

**Int:** analyzer repetitively scanned by internally generated ramp; synchronization selected by scan trigger.

**Single:** single scan with front panel reset.

**Ext:** scan determined by 0 to 18 volt external signal.

**Manual:** scan determined by front panel control.

##### Scan trigger: for internal scan mode, select between

**Auto:** scan free-runs.

**Line:** scan synchronized with power line frequency.

**Ext:** scan synchronized with  $>2$  volt (20 volt max.) signal

**Video:** scan internally synchronized to envelope of RF input.

##### Auxiliary outputs

**Vertical output:** 0 to  $-0.8$  V for full deflection.

**Scan output:** to  $+5$  V for 10 div CRT deflection.

**Pen lift output:** 0 to 14 V (0 V, pen down).

#### Display characteristics

141T, 140T

**Plug-ins:** accepts Models 8552A/B, 8553B, 8554B, 8555A and 8556A and Model 1400-series Oscilloscope plug-ins.

##### Cathode-ray tube type

**Model 141T:** post-accelerator storage tube, 9000-volt accelerating potential; aluminized P31 phosphor.

**Model 140T:** post-accelerator, 7300 volt potential medium-short persistence (P7) phosphor.

##### Cathode-ray tube graticule

**Model 141T:** 8  $\times$  10 division (approx. 7.1 cm  $\times$  8.9 cm parallax-free internal graticule).

##### Persistence, model 141T only

**Normal:** natural persistence of P31 phosphor (0.1 second).

##### Variable

**Normal writing rate mode:** continuously variable from less than 0.2 second to more than one minute.

**Maximum writing rate mode:** from 0.2 second to 15 seconds.

**Erase:** manual; erasure takes approximately 350 ms.

**Storage time model 141T only:** normal writing rate; more than 2 hours at reduced brightness (typically 4 hours).

**Fast writing speed, model 141T only:** more than 15 minutes.

**Functions used with oscilloscope plug-ins only:** intensity modulation, calibrator; beam finder.

**EMI:** conducted and radiated interference is within requirements of MIL-I-16910C and MIL-I-6181D and methods CE03, and RE02 of MIL-STD-461 (except 35 to 40 kHz) when appropriate RF tuning section and 8552A or 8552B are combined in a 140T or 141T Display Section.

**Temperature range:** operating,  $0^{\circ}\text{C}$  to  $+55^{\circ}\text{C}$ ; storage,  $-40^{\circ}\text{C}$  to  $+75^{\circ}\text{C}$ .

**Power requirements:** 100, 120, 220, or 240 V  $\pm 5\%$ ,  $-10\%$ , 50 to 60 Hz, normally less than 225 watts (includes plug-ins used).

##### Weight

**Model 8552A or 8552B IF section;** net, 4.1 kg (9 lb). Shipping 6.4 kg (14 lb).

**Model 140T display section;** net, 16.8 kg (37 lb). Shipping, 20 kg (45 lb).

**Model 141T display section;** net, 18 kg (40 lb). Shipping, 23 kg (51 lb).

**Tuning section:** see following pages.

**Size:** model 140T or 141T with plug-ins: 221 H  $\times$  425 W  $\times$  416 mm D (8 $\frac{7}{8}$ "  $\times$  16 $\frac{7}{8}$ "  $\times$  16 $\frac{3}{4}$ ").

**Special order:** chassis slides and adapter kit.

##### Ordering information

140T Normal Persistence Display

Opt 908: Rack Flange Kit

141T Variable Persistence Display

Opt 908: Rack Flange Kit

8552A Economy IF Section

8552B High Resolution IF Section

##### Price

\$1600

add \$15

\$2500

add \$15

\$3175

\$3875

# SIGNAL ANALYZERS

## 141T Spectrum Analyzer System: 20 Hz to 300 kHz

### Model 8556A

- Accurate signal level measurements ( $\pm 0.95$  dB)
- Accurate frequency measurements ( $\pm 3$  Hz)

- High sensitivity ( $-152$  dBV)
- Built-in tracking generator



8556A

### General purpose measurement flexibility

The 8556A Spectrum Analyzer covers the frequency range from 20 Hz to 300 kHz. It was designed to accommodate the variety of characteristic impedances and amplitude units used in making audio measurements. Balanced or unbalanced inputs are available, and open circuit voltages (dBV or linear) or power (dBm) in several characteristic impedances may be measured. The analyzer is capable of high resolution; frequencies can be measured very accurately. A built-in tracking generator further increases the instrument's utility.

### Frequency range

The 8556A has two frequency scales, 0–300 kHz for full coverage and 0–30 kHz for better resolution at low frequencies. The analyzer may be swept symmetrically about a tunable center frequency, swept from 0 Hz to a selectable end point, or operated as a fixed tuned receiver. 20 kHz crystal markers (accurate to 0.01%) can be generated on the CRT to make very accurate frequency measurements.

### Absolute amplitude calibration

The 8556A is calibrated for dBm in 600 $\Omega$ , dBm in 50 $\Omega$ , dBV, and volts. The very accurate reference level control ( $\pm 0.2$  dB) and vernier ( $\pm 0.25$  dB) allow the 1F substitution technique to be used to improve amplitude measurement accuracy.

### Low distortion

Careful design has decreased analyzer distortion to the point where a full 70 dB dynamic range is achieved. This allows small signals, such as harmonic or intermodulation distortion, to be measured in the presence of large ones.

### Resolution—sensitivity

Resolution bandwidths between 10 kHz and 10 Hz are available on the 8556A. Using the narrow bandwidth, 50 or 60 Hz line related sidebands can be measured. The analyzer's extremely low noise figure together with its narrow bandwidths makes the 8556A very sensitive. Signals as low as  $-152$  dBV (25 nV) can be measured in a 10 Hz bandwidth. The 8556A may be used to measure EMI, such as interference conducted along an AC power line.

### Isolated Input

The isolated input eliminates the possibility of spurious signal pickup which could be caused by line related ground currents flowing in the ground connections between the analyzer and signal source. The input impedance (1 M $\Omega$ ) is high enough so that a scope probe may be used with a minimum of loading. An optional balanced input is available which is transformer coupled for isolation and high common mode rejection. The input impedance is 15 k $\Omega$ , and the analyzer is calibrated for either dBm-135 $\Omega$  or dBm-150 $\Omega$  as well as dBm-600 $\Omega$  and dBm-900 $\Omega$ . Balance (symmetry) is 80 dB at 50 Hz and typically 50 dB at 300 kHz.

### Tracking generator

A tracking generator is built into the 8556A. If an external counter is connected to the tracking generator, frequencies can be measured to an accuracy of  $\pm 3$  Hz. Swept insertion loss or return loss measurements can be made on a device such as an amplifier or filter. A

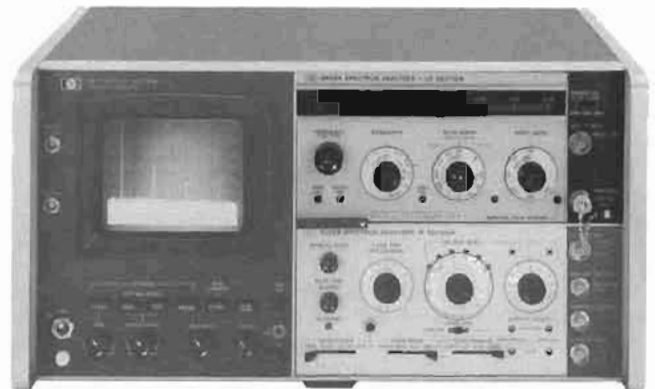

140 dB measurement range is possible using the narrowest resolution bandwidth. The tracking generator also provides a convenient signal for compensating an oscilloscope probe used with the 8556A.

### Other applications

The combination of a tracking generator and spectrum analyzer in this frequency range is valuable in applications such as receiver testing and fault location.

## Specifications—with 8552B IF Section

### Frequency specifications

**Frequency range:** 20 Hz to 300 kHz. Tuning dial ranges of 0–30 kHz and 0–300 kHz.

**Scan width:** (on a 10-division CRT horizontal axis)

**Per division:** 10 calibrated scan widths from 20 Hz/div to 20 kHz/div in a 1, 2, 5 sequence.

**0–10 f:** 10 calibrated preset scans, from 300 Hz to 200 kHz in a 1, 2, 5 sequence. Analyzer scans from zero frequency to ten times the scan width per division setting.

**Zero:** analyzer is a fixed tuned receiver.

### Frequency accuracy

**Center frequency accuracy:** 0–30 kHz Range:  $\pm 500$  Hz; 0–300 kHz Range:  $\pm 3$  kHz.

**Marker accuracy:** RF markers every 20 kHz accurate to within  $\pm 0.01\%$ . Markers controlled by front panel on/off switch.

**Scan width accuracy:** frequency error between any two points on the display is less than  $\pm 3\%$  of the indicated frequency separation.

### Stability

**Residual FM:** sidebands  $>60$  dB down 50 Hz or more from CW signal, scan time  $\geq 1$  sec/div, 10 Hz bandwidth.

**Noise sidebands:** more than 90 dB below CW signal, 3 kHz away from signal, with a 100 Hz 1F bandwidth.

**Frequency drift:** less than 200 Hz/10 min.

### Resolution

**Bandwidth ranges:** 1F bandwidths of 10 Hz to 10 kHz are provided in a 1, 3, 10 sequence.

**Bandwidth accuracy:** individual 1F bandwidth 3 dB points calibrated to  $\pm 20\%$  (10 kHz bandwidth  $\pm 5\%$ ).

**Bandwidth selectivity:** 60 dB/3 dB 1F bandwidth ratios, with 1F section:  $<11:1$  for 1F bandwidths from 10 Hz to 3 kHz;  $<20:1$  for 10 kHz bandwidth. For 10 Hz bandwidth, 60 dB points are separated by less than 100 Hz.

### Amplitude specifications

#### Absolute amplitude calibration

#### Log calibration modes

dBV	0 dBV = 1 V rms
dBm-600 $\Omega$	0 dBm = 1 mW-600 $\Omega$
dBm-50 $\Omega$	0 dBm = 1 mW-50 $\Omega$

Input impedance is 1 M $\Omega$ . dBm ranges are referenced with input properly terminated externally.



**Log calibration range:** from -150 dBm/dBV to +10 dBm/dBV.  
**Log display range:** 10 dB/div on a 70 dB display, or 2 dB/div on a 16 dB display.

**Linear sensitivity:** from 0.1 V/div in a 1, 2, 10 sequence. Linear sensitivity vernier X1 to X0.25 continuously.

#### Dynamic range

**INPUT LEVEL control:** -10 to -60 dBm/dBV in 10 dB steps. Accuracy  $\pm 0.2$  dB. Marking indicates maximum input levels for 70 dB spurious-free dynamic range.

**Average noise level** (specified with a 600 $\Omega$  or less source impedance and INPUT LEVEL at -60 dBm/dBV)

Mode	1 kHz IF Bandwidth	10 Hz IF Bandwidth
dBm — 50 $\Omega$	<-122 dBm (180 nV)	<-142 dBm (18 nV)
dBm — 600 $\Omega$	<-130 dBm (250 nV)	<-150 dBm (25 nV)
dBV	<-132 dBV (250 nV)	<-152 dBV (25 nV)
Linear	<400 nV	<40 nV

**Video filter:** averages displayed noise, bandwidth of 10 kHz, 100 Hz, and 10 Hz. Bandwidth accuracy  $\pm 20\%$ .

**Spurious responses:** input signal level  $\leq$  INPUT LEVEL setting; out of band mixing responses, harmonic and intermodulation distortion products are all more than 70 dB below the input signal level 5 kHz to 300 kHz; 60 dB, 20 Hz to 5 kHz. Third order intermodulation products are more than 70 dB below the input signal level, 5 kHz to 300 kHz with signal separation >300 Hz.

**Residual responses (no signal present at input):** With the INPUT LEVEL at -60 dBm/dBV and the input terminated with 600 $\Omega$  or less, all line related residual responses from 0 to 500 Hz are below -120 dBm/dBV. All other residual responses are below -130 dBm/dBV.

Amplitude accuracy:	Log	Linear
Frequency response	$\pm 0.2$ dB	$\pm 2.3\%$
Amplitude display	$\pm 0.25$ dB/dB but not more than $\pm 1.5$ dB over 70 dB display range	$\pm 2.8\%$ of full 8 div display

**Log reference level control:** provides 90 dB IF gain control in 10 dB steps. Accurate to  $\pm 0.2$  dB ( $\pm 2.3\%$ ).

**Log reference level vernier:** provides continuous 12 dB range. Accurate to  $\pm 0.1$  dB ( $\pm 1.2\%$ ) in 0, -6, -12 dB positions; otherwise  $\pm 0.25$  dB ( $\pm 2.8\%$ ).

**Amplitude measurement accuracy:**  $\pm 0.95$  dB with proper technique.

#### General

**Scan time:** 16 internal scan rates from 0.1 ms/div to 10 sec/div in a 1, 2, 5 sequence.

#### Scan mode

**Int:** analyzer repetitively scanned internally.

**Ext:** scan determined by 0 to +8 volt external signal.

**Single:** single scan actuated by front panel button.

**Manual:** scan determined by front panel control.

**Input level:** provides 50 dB control of input preamplification and attenuation to prevent input overload. INPUT LEVEL markings of

-60 dBm/dBV to -10 dBm/dBV indicate maximum input level for a minimum of 70 dB spurious-free dynamic range. Accuracy  $\pm 0.2$  dB (2.3%).

**Input Impedance:** 1 M $\Omega$  shunted by  $\approx 32$  pF.

**Maximum Input level:** 10 V rms,  $\pm 200$  V dc. Ground terminals of BNC input connectors are isolated from the analyzer chassis ground to minimize ground loop pickup at low frequencies.

**Maximum voltage, isolated ground to chassis ground:**  $\pm 100$  V dc.

**Isolated ground to chassis ground Impedance:** 100 k $\Omega$  shunted by approximately 0.3 F.

**Gain compression:** for input signal level 20 dB above INPUT LEVEL setting, gain compression is less than 1 dB.

#### Tracking generator specifications

**Frequency range:** tracks the analyzer tuning, 20 Hz to 300 kHz.  
**Amplitude range:** continuously variable from 100 mV rms to greater than 3 V rms into an open circuit.

**Amplitude accuracy:** with TRACKING GEN LEVEL in CAL position and 20 kHz markers off, output level at 100 kHz is 100 mV  $\pm 0.3$  dB into an open circuit.

**Frequency response:**  $\pm 0.25$  dB 50 Hz to 300 kHz.

**Output Impedance:** 600 $\Omega$ .

**Residual FM:** <1 Hz peak-to-peak.

**Power requirements:** 100, 120, 200, or 240 V  $\pm 5\%$ , -10%, 50 to 60 Hz, normally less than 225 watts.

**Weight:** Model 8556A LF section: net, 3.7 kg (8 lb). Shipping, 5.3 kg (12 lb).

**Size:** 102 H, 226 W, 344 mm D (4"  $\times$  8 $\frac{7}{8}$ "  $\times$  13 $\frac{1}{4}$ ").

#### Specifications with 8556A Options 001, 002-balanced input

##### Amplitude

**Log calibration modes-balanced (bridged) Input**

dBm — 135 $\Omega$  (Option 001) 0 dBm = 1 mW — 135 $\Omega$

dBm — 150 $\Omega$  (Option 002) 0 dBm = 1 mW — 150 $\Omega$

dBm — 600 $\Omega$  0 dBm = 1 mW — 600 $\Omega$

dBm — 900 $\Omega$  0 dBm = 1 mW — 900 $\Omega$

Input impedance is typically 15 k $\Omega$ . dBm ranges are referenced with input properly terminated externally.

##### Input

**Maximum Input levels:** normal Mode,  $\pm 20$  V rms or  $\pm 150$  V dc for normal mode (symmetrical) signals between input signal connectors; Common Mode, 200 V rms at 60 Hz or  $\pm 500$  V dc for common mode (asymmetrical) voltages between input signal connectors and GUARD or instrument chassis; Guard,  $\pm 100$  V dc from GUARD to instrument chassis. (GUARD to chassis impedance is approximately 100 k $\Omega$  shunted by 0.3  $\mu$ F.)

**Balance (Symmetry):** 0 - 30 kHz Range, greater than 80 dB, 50 Hz to 1 kHz; 1 - 300 kHz range, greater than 60 dB, 1 kHz to 20 kHz.

#### Ordering information

8556A RF section  
 Opt 001: Balanced Input  
 Opt 002: Balanced input

#### Price

\$2525  
 add \$220  
 add \$220



## SIGNAL ANALYZERS

### 141T Spectrum Analyzer System: 1 kHz to 110 MHz (cont.)

Models 8553B & 8443A

- Wide frequency range
- 10 Hz resolution bandwidth
- High sensitivity ( $-140$  dBm)



8553B



8443A

- Accurate amplitude measurements ( $\pm 1.25$  dB)
- 10 Hz frequency with tracking generator
- 130 dB swept measurement range

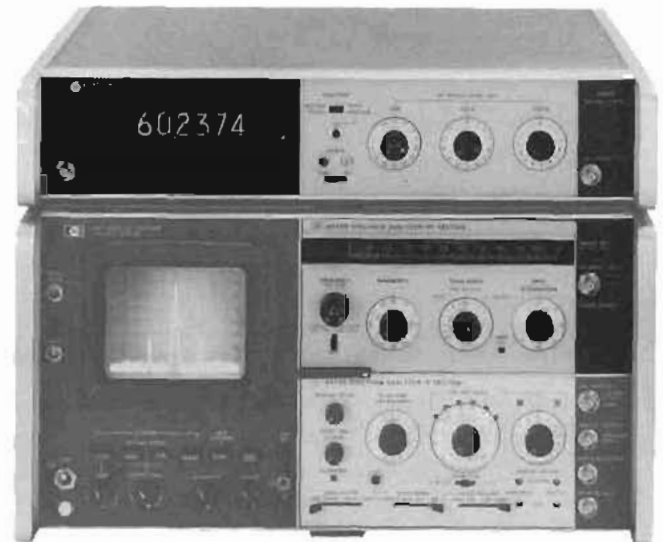

#### General purpose

The 8553B Spectrum Analyzer makes absolute amplitude and frequency measurements over the 1 kHz to 110 MHz range. This frequency span includes audio, video, navigation aids, telemetry, multiplex communication systems basebands, commercial AM, FM, TV, and land mobile communication. The analyzer features high resolution and stability, low distortion, high sensitivity, and a wide dynamic range. A tracking generator is available which improves the frequency measurement accuracy of the analyzer and can be used to make swept measurements.

#### Wide frequency range

The broad frequency range of 1 kHz to 110 MHz extends from audio through the FM broadcast band. Scan widths from 200 Hz to 100 MHz allow a user to view all or selected parts of the frequency spectrum while the zero scan mode turns the analyzer into a fixed tuned receiver and displays amplitude variations in the time domain. The analyzer has two dial scales, 0–110 MHz for full coverage and 0–11 MHz for better resolution at low frequencies.

#### Resolution—stability

The 8553B has resolution bandwidths that range from 300 kHz to 10 Hz. Wide bandwidths are necessary for making measurements on a wideband spectrum such as FM. The extremely high resolution 10 Hz bandwidth allows measurement of 50 Hz sidebands 60 dB down. Such high resolution is made possible by automatic stabilization through phase lock, which reduces residual FM to a negligible level. Good stability is required to measure oscillator residual FM and drift.

#### Absolute amplitude calibration

The 8553B Spectrum Analyzer is absolutely calibrated in both dBm and volts from  $-142$  dBm ( $.02 \mu\text{V}$ ) to  $+10$  dBm ( $.7$  V). This absolute calibration is derived from a built-in calibrator ( $-30$  dBm at 30 MHz) and extremely flat analyzer frequency response ( $\pm 0.5$  dB). A display uncal. light warns if the display becomes uncalibrated. The probe power output supplies power to a high impedance probe which can be used to make bridging measurements on circuits terminated at both ends.

#### High sensitivity

A low analyzer noise figure and narrow bandwidths give the 8553B very high sensitivity. Signal levels as low as  $-140$  dBm can be measured in 10 Hz bandwidth, and a preamplifier is available to further increase sensitivity by 16 dB. Video filtering in 10 kHz, 100 Hz and 10 Hz bandwidths will average the displayed noise. High analyzer sensitivity is required if distortion in an amplifier or oscil-

lator is to be measured as a function of output level. In EMI studies, fields strength can be measured with a calibrated antenna.

#### 70 dB dynamic range

The 8553B has a 70 dB dynamic range when the signal level is properly conditioned at the input mixer. A wide dynamic range is necessary to measure small signals in the presence of large ones, such as harmonic or intermodulation distortion or to monitor signals of widely varying amplitudes, such as in EMC, RFL, and surveillance work.

#### 8443A Tracking Generator

A tracking generator, 8443A, is available which covers the 100 kHz to 110 MHz frequency range of the 8553B. It has a built-in counter, and precision RF attenuators which are useful making substitution measurements.

#### Frequency accuracy

In conjunction with an 8443A Tracking Generator, the 8553B Spectrum Analyzer can measure frequencies to an accuracy of  $\pm 10$  Hz. When the 8443A is operated in the "track analyzer" mode, the counter will read the frequency at a tunable marker which is generated on the analyzer CRT. The "restore signal" mode is a more convenient way to measure signal frequencies in wide scans because the counter reads the signal frequency automatically without fine tuning. The 8443A Tracking Generator may also be used externally as a 120 MHz direct reading counter.

#### Swept measurements

The 8443A Tracking Generator can be used with the 8553B to make swept insertion loss and return loss measurements over the 100 kHz to 110 MHz frequency range. Because the signal source tracks the analyzer's tuning, up to 130 dB dynamic measurement range is possible (at 10 Hz bandwidth). Excellent system flatness ( $\pm 1.0$  dB) insures the accurate determination of swept response characteristics.

#### Specifications—with 8552B IF Section

##### Frequency specifications

**Frequency range:** 1 kHz–110 MHz (0–11 MHz and 0–110 MHz tuning ranges).

##### Scan width (on 10-division CRT horizontal axis)

**Per division:** 18 calibrated scan widths from 20 Hz/div to 10 MHz/div in a 1, 2, 5 sequence.

**Preset:** 0–100 MHz, automatically selects 300 kHz bandwidth IF Filter.

**Zero:** analyzer is fixed tuned receiver with selectable bandwidth.

**Frequency accuracy**

**Center frequency accuracy:** the dial indicates the display center frequency within  $\pm 1$  MHz on the 0–110 MHz tuning range;  $\pm 200$  kHz on the 0–11 MHz tuning range with FINE TUNE centered, and temperature range of 20°C to 30°C.

**Scan width accuracy:** scan widths 10 MHz/div to 2 MHz/div and 20 kHz/div to 20 Hz/div; Frequency error between two points on the display is less than  $\pm 3\%$  of the indicated frequency separation between the two points. Scan widths 1 MHz/div to 50 kHz/div; Frequency error between two points on the display is less than  $\pm 10\%$  of the indicated frequency separation.

**Resolution**

**Bandwidth:** IF bandwidths of 10 Hz to 300 kHz are provided in a 1, 3 sequence.

**Bandwidth accuracy:** individual IF bandwidths' 3 dB points calibrated  $\pm 20\%$  (10 kHz bandwidth  $\pm 5\%$ ).

**Bandwidth selectivity:** 60 dB/3 dB IF bandwidth ratios: 10 Hz to 3 kHz bandwidths,  $<11:1$ ; 10 kHz to 300 kHz bandwidths,  $<20:1$ ; 60 kHz points on 10 Hz bandwidth separated by  $<100$  Hz.

**Stability**

**Residual FM stabilized:** sidebands  $>60$  dB down 50 Hz or more from CW signal, scan time  $\geq 1$  sec/div, 10 Hz bandwidth (typically less than 1 Hz peak-to-peak).

**Residual FM unstabilized:**  $<1$  kHz peak-to-peak.

**Noise sidebands:** more than 70 dB below CW signal, 50 kHz or more away from signal, with 1 kHz IF bandwidth.

**Long term drift (after 1-hour warm-up), stabilized:** 50 Hz/min, 500 Hz/10 min; unstabilized: 5 kHz/min, 20 kHz/10 min.

**Amplitude specifications**

**Absolute amplitude calibration range**

**Log:** from  $-130$  to  $+10$  dBm, 10 dB/div on a 70 dB display or 2 dB/div on a 16 dB display.

**Linear:** from  $0.1 \mu\text{V/div}$  to  $100 \text{ mV/div}$  in a 1, 2 sequence on an 8-division display.

**Dynamic range**

**Average noise level:**  $<-110$  dBm with 10 kHz IF bandwidth. **Video filter:** averages displayed noise; 10 kHz, 100 Hz, and 10 Hz bandwidths.

**Spurious responses:** are below a  $-40$  dBm signal at the input mixer as follows: All image and out-of-band mixing responses, harmonic and intermodulation distortion less than 70 dB down, 2 MHz to 110 MHz; less than 60 dB down, 1 kHz to 2 MHz. Third order intermodulation products less than 70 dB down, 1 kHz to 110 MHz (Signal separation  $>300$  Hz).

**Residual responses (no signal present at input):** with input attenuation at 0 dB:  $<-110$  dBm (200 kHz to 110 MHz);  $<-95$  dBm (20 kHz to 200 kHz).

**Amplitude accuracy:**

Frequency response (Flatness: attenuator settings  $>10$  dB):

1 kHz to 110 MHz  
Amplitude Display

	Log	Linear
	$\pm 0.5$ dB	$\pm 5.8\%$
	$\pm 0.25$ dB/dB but not more than $\pm 1.5$ dB over the full 70 dB display range	$\pm 2.8\%$ of full 8 div deflection

**Calibrator amplitude:**  $-30$  dBm,  $\pm 0.3$  dB.

**Calibrator frequency:** 30 MHz,  $\pm 3$  kHz.

**Log reference level control:** provides 70 dB range (60 dB below 200 kHz), in 10 dB steps. Accurate to  $\pm 0.2$  dB ( $\pm 2.3\%$ , Linear Sensitivity).

**Log reference level vernier:** provides continuous 12 dB range. Accurate to  $\pm 0.1$  dB ( $\pm 1.2\%$ ) in 0,  $-6$ , and  $-12$  dB positions; otherwise  $\pm 0.25$  dB ( $\pm 2.8\%$ ).

**Amplitude measurement accuracy:**  $\pm 1.25$  dB with proper technique.

**General**

**Input impedance:** 50 $\Omega$  nominal, BNC connector. Reflection coefficient  $<0.13$  (1.3 SWR), input attenuator  $\geq 10$  dB. A special 75 $\Omega$  8553B/8552B is available.

**Maximum input level:** peak or average power  $+13$  dBm (1.4 V ac peak),  $\pm 50$  V dc, 1 dB compression point,  $-10$  dBm.

**Scan time:** 16 internal scan rates from 0.1 ms/div to 10 sec/div in a 1, 2, 5 sequence, or manual scan.

**Scan mode**

**Int:** analyzer repetitively scanned internally.

**Ext:** scan determined by 0 to  $+8$ -volt external signal.

**Manual:** scan determined by front panel control.

**Attenuator:** 0 to 50 dB, in 10 dB increments, coupled to Log Reference Level indicator; automatically maintains absolute calibration. Attenuator accuracy  $\pm 0.2$  dB.

**Power requirements:** 100, 120, 220, or 240 V  $\pm 5\%$ ,  $-10\%$ , 50 to 60 Hz, normally less than 225 watts.

**Weight:** Model 8553B RF Section: Net, 5.5 kg (12 lb). Shipping, 7.8 kg (17 lb).

**Dimensions:** 102 mm H  $\times$  226 mm W  $\times$  334 mm D (4"  $\times$  8 $\frac{1}{8}$ "  $\times$  13 $\frac{1}{2}$ ").

**Tracking generator (8443A)**

**Frequency range:** 100 kHz to 110 MHz.

**Amplitude range:**  $<-120$  dBm to  $+10$  dBm in 10 and 1 dB steps with a continuous 1.2 dB vernier.

**Amplitude accuracy**

**Frequency response (flatness):**  $\pm 0.5$  dB.

**Absolute:** 0 dBm at 30 MHz:  $\pm 0.3$  dB.

**Output impedance:** 50 $\Omega$ , BNC connector, ac coupled, reflection coefficient  $\leq 0.09$  (1.2 SWR) with output  $<0$  dBm.

**Counter**

**Display:** 7 digits with 1 digit over-range. Reads to  $\pm 10$  Hz increments.

**Resolution (gate time):** 1 kHz (1 ms), 100 Hz (10 ms), 10 Hz (100 ms).

**Accuracy:**  $\pm 1$  count  $\pm$  time base accuracy.

**Time base aging rate:**  $<3 \times 10^{-9}$ /day (0.3 Hz/day) after warm-up.

**External counter inputs:** 10 kHz to 120 MHz, 50 $\Omega$ ,  $-10$  dBm min.

**Power:** 100, 120, 220, or 240 V  $\pm 5\%$ ,  $-10\%$ , 48 to 440 Hz 75 watts.

**Net weight:** 8443A, 11.04 kg (24 lb, 5 oz). Shipping weight 14.47 kg (31 lb, 14 oz).

**Dimensions:** 88.2 mm H  $\times$  425 mm W  $\times$  332 mm D (3 $\frac{1}{2}$ "  $\times$  16 $\frac{3}{4}$ "  $\times$  13 $\frac{1}{4}$ ").

**Ordering information**  
8553B RF Section  
8443A Tracking Generator

**Price**  
\$3250  
\$4775

# SIGNAL ANALYZERS

## 141T Spectrum Analyzer System, 100 kHz to 1250 MHz

Models 8554B & 8444A

- High resolution to 100 Hz
- Flat frequency response  $\pm 1$  dB
- High sensitivity to  $-122$  dBm (180 nV)

- Variable persistence display
- Companion Tracking Generator
- External counter capability

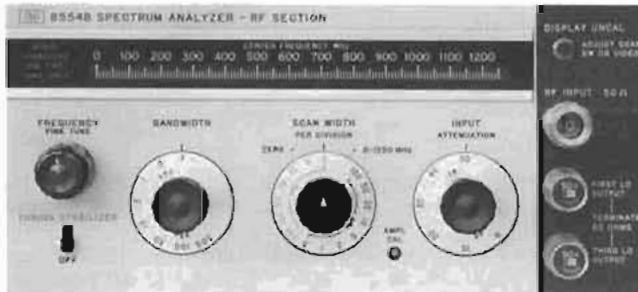

8554B



8444A



### 8554B Spectrum Analyzer

The 8554B Spectrum Analyzer RF Section covers the frequency range from 100 kHz to 1250 MHz. This broad frequency coverage allows analysis from baseband through UHF navigation bands. Absolute amplitude calibration is maintained over the entire range. Some typical applications include power and frequency measurements on modulation, distortion and spurious outputs, frequency response measurements of filters, amplifiers, modulators and mixers. The analyzer can also be used to make noise measurements and EMI and EMC measurements using a calibrated antenna or current probe.

#### Absolute amplitude calibration

Absolute amplitude measurements can be made from  $+10$  to  $-122$  dBm with  $\pm 2.8$  dB accuracy. This accuracy can be increased to  $\pm 1.75$  dB using 1F substitution. The display is calibrated in log dBm to obtain a wide display range and linear (voltage) for measurements requiring maximum resolution. The top graticule line on the CRT is a calibrated reference level which can be changed by the front panel controls from  $+10$  to  $-72$  dBm for 1F substitution measurements. Amplitude calibration is dependent upon the proper relationship between sweep width, sweep time, resolution bandwidth and video filtering. An uncal warning light is present to indicate an uncalibrated situation.

#### Flat frequency response

In broadband use, the wide bandwidths allow fast sweeping of the entire spectrum. The analyzer is extremely flat ( $\pm 1$  dB) over its entire range, allowing direct comparisons of signal amplitudes displayed on the CRT. A 0 to 50 dB input attenuator is provided to prevent overdriving the input mixer.

#### Resolution

The low residual FM ( $< 100$  Hz peak-to-peak) of the 8554B makes possible resolution bandwidths as narrow as 100 Hz. This enables resolving closely spaced signals such as 1 kHz and 400 Hz sidebands. Bandwidths range from 100 Hz to 300 kHz in a 1, 3, 10 sequence making it easy to select an optimum bandwidth to scan width ratio. The resolution bandwidths consist of synchronously tuned "gaussian" shaped filters to enable faster sweeping for any

given bandwidth. In addition, these filters have narrow shape factors making it possible to measure closely spaced signals differing greatly in amplitude.

#### Sensitivity

The high sensitivity ( $-122$  dBm in 100 Hz bandwidth) and wide spurious-free measurement range ( $> 65$  dB) of the 8554B means accurate measurements can be made on low level signals and signals varying widely in amplitude. For example, modulation as low as 0.2% can be measured. Low level harmonic and intermodulation distortion, spectrum surveillance and EMI are just a few of the measurements possible. A video filter is provided in the 1F section to average displayed noise and simplify the measurement of low level signals.

#### Automatic tuning stabilization

The 8554B Spectrum Analyzer is automatically stabilized in narrow scans. This gives the stability ( $< 100$  Hz peak-to-peak residual FM) needed for high resolution analysis. Stabilization is accomplished by phase locking the LOs (local oscillators) to a crystal reference in scan widths 10 MHz and below. No signal recentering or checking for stabilization is required because the signal remains on screen when phase locked.

### 8444A Tracking Generator

The 8444A Tracking Generator is a signal source, which, when connected to the 8554B Spectrum Analyzer, has an output whose frequency is the same as the swept frequency of the analyzer. The tracking generator is used as a signal source to measure the frequency response of a device. It can also be used for precision frequency measurements. An external counter output is provided on the 8444A and the frequency of unknown signals as well as the frequency of any point on a frequency response curve can be measured. The use of the 5300/5305B Counter is suggested for frequency measurements to 1300 MHz.

The tracking generator-spectrum analyzer system can be used to supply test signals for other devices as a sweeper. The sweep widths and sweep rates are controlled from the spectrum analyzer and the output level from the tracking generator.

## 8554B Specifications—with 8552B IF Section

### Frequency specifications

**Frequency range:** 100 kHz to 1250 MHz.

**Scan width (on 10-division CRT horizontal axis)**

**Per division:** 15 calibrated scan widths from 100 MHz/div to 2 kHz/div in a 1, 2, 5 sequence.

**Preset:** 0–1250 MHz, automatically selects 300 kHz bandwidth IF filter

**Zero:** analyzer is fixed-tuned receiver.

### Frequency accuracy

**Center frequency accuracy:** the dial indicates the display center frequency with 10 MHz.

**Scan width accuracy:** frequency error between two points on the display is less than 10% of the indicated separation.

### Resolution

**Bandwidth:** IF bandwidths of 0.1 to 300 kHz provided in a 1, 3, 10 sequence.

**Bandwidth accuracy:** individual IF bandwidths 3 dB points calibrated to  $\pm 20\%$  (10 kHz bandwidth  $\pm 5\%$ ).

**Bandwidth selectivity:** 60 dB/3 dB IF bandwidth ratio  $< 20:1$  for IF bandwidths from 10 kHz to 200 kHz. 60 dB/3 dB bandwidth ratio  $< 11:1$  for IF bandwidths 100 Hz to 3 kHz.

### Stability (residual FM)

**Stabilized:**  $< 100$  Hz peak-to-peak.

**Unstabilized:**  $< 10$  kHz peak-to-peak.

**Noise sidebands:** more than 70 dB below CW signal, 30 kHz or more away from signal, with 1 kHz IF bandwidth.

### Amplitude specifications

#### Absolute amplitude calibration range

**Log:** from  $-122$  to  $+10$  dBm. 10 dB/div on a 70 dB display, or 2 dB/div on a 16 dB display.

**Linear:** from  $0.1 \mu\text{V/div}$  to  $100 \text{ mV/div}$  in a 1, 2 sequence on an 8-division display.

#### Dynamic range

**Average noise level:**  $< -102$  dBm with 10 kHz IF bandwidth.

**Spurious responses:** all image and out-of-band mixing responses, harmonic and intermodulation distortion products are more than 65 dB below a  $-40$  dBm signal at the input mixer.

**Residual responses (no signal present at input):** with input attenuation at 0 dB:  $< -100$  dBm.

#### Amplitude accuracy

	Log	Linear
Frequency response (flatness)		
100 kHz to 1250 MHz	$\pm 1$ dB	$\pm 12\%$
Switching between bandwidths (at 20°C)	$\pm 0.5$ dB	$\pm 5.8\%$
Amplitude display	$\pm 0.25$ dB/dB but not more than $\pm 1.5$ dB over the full 70 dB display range.	2.8% of full 8 div deflection

#### Calibrator output

**Amplitude:**  $-30$  dBm,  $\pm 0.3$  dB.

**Frequency:** 30 MHz,  $\pm 3$  kHz.

**Log reference level control:** provides 70 dB range (60 dB below 200 kHz), in 10 dB steps. Accurate to  $\pm 0.2$  dB ( $\pm 2.3\%$ , Linear Sensitivity).

**Log reference level vernier:** provides continuous 12 dB range. Accurate to  $\pm 0.1$  dB ( $\pm 1.2\%$ ) in 0,  $-6$ , and  $-12$  dB positions; otherwise  $\pm 0.25$  dB ( $\pm 2.8\%$ ).

**Amplitude measurement accuracy:**  $\pm 1.75$  dB with proper technique.

#### RF input specifications

**Input impedance:** 50 $\Omega$  nominal. Typical reflection coefficient  $< 0.30$  (1.85 SWR), input attenuator  $\geq 10$  dB.

**Maximum input level:** peak or average power  $+13$  dBm (1.4 V ac peak),  $\pm 50$  V dc.

### General

**Scan time:** 16 internal scan rates from 0.1 ms/div to 10 sec/div in a 1, 2, 5 sequence, and manual scan.

#### Scan time accuracy

0.1 ms/div to 20 ms/div:  $\pm 10\%$ .

50 ms/div to 10 s/div:  $\pm 20\%$ .

#### Weight

**Model 8554B RF section:** net, 4.7 kg (10 lb, 4 oz). Shipping 7.8 kg (17 lb).

## 8444A Specifications

### Specifications for swept frequency response measurements

**Dynamic range:**  $> 90$  dB from spectrum analyzer 1 dB gain compression point to average noise level (approximately  $-10$  dBm to  $-100$  dBm). Spurious responses not displayed.

**Gain compression:** for  $-10$  dBm signal level at the input mixer, gain compression  $< 1$  dB.

#### Absolute amplitude calibration range:

**Tracking generator** (drive level to test device: 0 to  $-10$  dBm continuously variable. 0 dBm absolutely calibrated to  $\pm 0.5$  dB at 30 MHz.

**Frequency range:** 500 kHz to 1250 MHz.

**Frequency resolution:** 1 kHz.

#### Stability

**Residual FM** (peak-to-peak): stabilized,  $< 200$  Hz; unstabilized,  $< 10$  kHz.

#### Amplitude accuracy

**System frequency response:**  $\pm 1.50$  dB.

**Tracking generator calibration:** 0 dBm at 30 MHz to  $\pm 0.5$  dB.

#### Specifications for precision frequency measurements

**Frequency accuracy:** for unknown signals  $\pm 10$  kHz. (Tracking drift typically 50 kHz/10 min after 2-hour warm-up). For points on frequency response curve, counter accuracy  $\pm$  Residual FM (200 Hz).

#### Counter mode of operation

**Manual scan:** scan determined either by front panel control of 8552B IF Section or by external scan signal provided by the 8444A.

**Zero scan:** analyzer is fixed-tuned receiver. Counter reads center frequency to accuracy of tracking drift.

**Counter output level:** typically 0.1 V rms.

#### Specifications for sweep/CW generator

**Frequency:** controlled by spectrum analyzer. Range 500 kHz to 1250 MHz with 8554B. Scan widths are as enumerated on this page.

**Frequency accuracy:**  $\pm 10$  MHz using spectrum analyzer tuning dial. Can be substantially improved using external counter output. Flatness:  $\pm 0.5$  dB.

#### Spectral purity

**Residual FM** (peak-to-peak): 200 Hz.

**Harmonic distortion:** 25 dB below output level (typical).

**Nonharmonic (spurious) signals:**  $> 35$  dB below output level.

**Long term stability:** drift typically less than 30 kHz/hour when stabilized after 2-hour warm-up.

**Sweep width:** 20 kHz to 1000 MHz.

**Sweep rates:** selected by Scan Time per Division on spectrum analyzer.

### General

**Temperature range:** operation, 0°C to 55°C, storage  $-40$ °C to 75°C.

**EMI:** conducted and radiated energy is within the requirements of MIL-1-6181D.

**Power:** 115 V and 230 V, 48 to 440 Hz, 12 watts max.

**Weight:** net, 7.1 kg (15 lb, 10 oz). Shipping, 9.5 kg (21 lb).

#### Ordering information

8554B RF Section

8444A Tracking Generator

Price

\$4300

\$3500

# SIGNAL ANALYZERS

## 141T Spectrum analyzer system, 10 MHz to 40 GHz (cont.)

### Models 8555A, 8444A & 8445B

- Absolute amplitude calibration
- High sensitivity to  $-125$  dBm (2.5 nV)
- Resolve signals to 100 Hz
- Scan up to 8 GHz full screen
- 100 dB distortion free dynamic range with preselector
- Companion tracking generator to 1.3 GHz

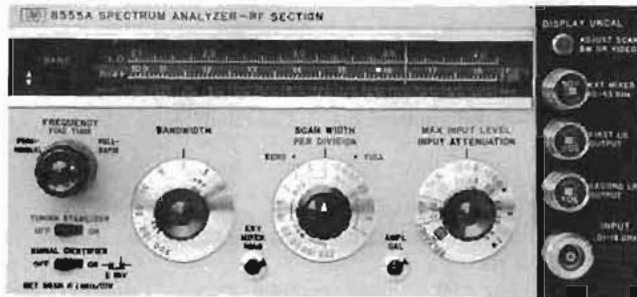

8555A



8444A



8445B Opt 002, 003



### 8555A Spectrum analyzer

The 8555A spectrum analyzer covers 10 MHz to 18 GHz with fundamental and harmonic mixing. A single external waveguide mixer can provide 12.4 GHz to 40 GHz coverage. This broad frequency range coupled with its high sensitivity and resolution bandwidth allow a variety of power measurements, frequency measurements, modulation and noise analysis on almost every type of design module: the frequency response of amplifiers, mixers, and modulators, response and alignment of filters isolators, couplers and limiters. With wide scan widths and calibrated amplitude the 8555A is ideal for spectrum surveillance and RFI/EMC field strength analysis with a calibrated antenna.

#### Absolute amplitude calibration

The 8555A offers absolute amplitude calibration from  $+10$  dBm to  $-125$  dBm over the 10 MHz to 18 GHz frequency range. This capability makes possible not only absolute signal power measurements, but also the measurement of the power differential between two signals separated by as much as 18 GHz. The parallax free CRT graticule can read as a log scale (dBm) or a linear scale (volts) with a frequency response accuracy of  $\pm 1.5$  dB to 6 GHz and  $\pm 2.0$  dB to 18 GHz. The top line of the display is established as the reference level by front panel controls. A light warns of an uncalibrated condition.

#### High sensitivity

The high sensitivity from  $-125$  dBm (fundamental mixing) to  $-100$  dBm (4th harmonic) in a 100 Hz bandwidth makes it possible to measure large values of attenuation, out of band filter and amplifier response, weak transmitted signals in surveillance work or microvolt signals in EMC applications. A post detection filter with 10 kHz, 100 Hz and 10 Hz position averages any noise and yields an extremely clean observed trace.

#### High resolution

Due to low residual FM ( $< 100$  Hz peak-to-peak) the 8555A offers outstanding 100 Hz resolution which allows the users to resolve closely spaced signals and low level sidebands resulting from a 1 kHz modulating signal. The resolution capability makes it possible to analyze spurious low frequency modulation of microwave signals. The high stability of the analyzer results in more accurate measurements of residual FM, long-term drift, phase noise and spectral purity. Furthermore, the Gaussian shape of the IF filters allow fastest sweep for a given resolution bandwidth.

#### Automatic tuning stabilization

When scanning over a relatively narrow frequency range, the frequency stability of the analyzer's internal local oscillators become important for high resolution and frequency measurements. For this reason the 8555A is equipped with a tuning stabilizer circuit which automatically phase locks the analyzer to a crystal oscillator. Display jitter and signal recentering are virtually eliminated.

#### Added input mixer protection

To prevent an inadvertent 0 dB setting of the input attenuator, a pushbutton lockout is provided on the attenuator knob.

### 8445B Tracking preselector, 10 MHz to 18 GHz

The 8445B tracking preselector is a YIG tuned filter coupled to the 8555A spectrum analyzer in order to be tuned exactly to the analyzer's reception frequency. The preselector eliminates harmonic mixing image and multiple responses from 1.8 to 18 GHz. The result is a wide measurement range and an end to signal identification. Clean, full band sweeps possible in scans of 2, 4, 6 or 8 GHz depending upon the band selected.

Below 1.8 GHz the image and multiple responses are eliminated by a low pass filter in the preselector.

An optional five digit LED display with 1 MHz resolution allows accurate measurement of either the display frequency at the display marker in full scan mode or the center frequency in per division scan.

### 8444A Tracking Generator 10 to 1300 MHz

The 8444A Tracking Generator provides a level, calibrated RF signal which is exactly the tuned frequency of the spectrum analyzer. This enables swept frequency tests such as frequency response and return loss measurements up to 1300 MHz. With an external counter the frequencies of unknown signals on points along a frequency response curve can be made.

### 8555A Specifications — with 8552B IF Section

#### Frequency specifications

**Frequency range:** 0.01 – 40 GHz.

#### Tuning range

**With internal mixer:** 0.01 – 18.0 GHz.

**With external mixer:** 12.4– 40 GHz.

#### Harmonic mixing mode

**Signal identification:** not normally required with preselector. Signal identifier provided for positive identification of all responses. Rejection of images and multiple responses with pre-selector is >70 dB.

#### Scan width

**Full scan:** the width of the scan depends on mixing mode. Scan width =  $n \times 2000$  MHz, where  $n$  is the mixing mode; e.g. for  $n = 2$ , scan width is 4 GHz. Maximum scan width full screen is 8 GHz with coaxial mixer. Preselector necessary to make wide scans usable.

**Per division:** 16 calibrated scan widths from 2 kHz/div to 200 MHz/div in a 2, 5, 10 sequence.

**Zero scan:** analyzer becomes fixed tuned receiver.

#### Frequency accuracy

**Dial accuracy:**  $n \times (\pm 15 \text{ MHz})$  where  $n$  is the mixing mode.

**Scan accuracy:** frequency error between two points on the display is less than  $\pm 10\%$  of the indicated separation.

**Stability:** residual FM stabilized <100 Hz (peak-to-peak) (fundamental mixing).

**Noise sidebands:** for fundamental mixing. More than 70 dB below CW signal 30 kHz or more away from signal, with 1 kHz IF bandwidth and 100 Hz video filter.

#### Frequency drift

**Long term drift:** at fixed center frequency after 2-hour warm-up (Typical).

**Stabilized:**  $\pm 3.0$  kHz/10 min.

**Unstabilized:**  $\pm 25$  kHz/10 min.

**Stabilization range:** first LO can be automatically stabilized to internal crystal reference for scan widths of 100 kHz/div or less.

#### Resolution

**Bandwidth range:** selectable 3 dB bandwidths from 100 Hz to 300 kHz in a 1, 3, 10 sequence.

**Bandwidth shape:** approximately gaussian.

**Bandwidth selectivity:** 11:1 to 20:1 (60 dB/3 dB).

**Bandwidth accuracy:** individual IF bandwidth 3 dB points calibrated to  $\pm 20\%$  (10 kHz bandwidth  $\pm 5\%$ ).

### Amplitude specifications

#### Measurement range

**Log reference level:** from -60 dBm to +10 dBm.

**Linear sensitivity:** from 0.1  $\mu\text{V/div}$  to 100 mV/div.

**Sensitivity and frequency response with internal coaxial mixer**

**Average noise level:** specified for 1 kHz bandwidth.

**Frequency response with 10 dB input attenuator setting:**

Frequency Range (GHz)	Mixing Mode (n)	Average Noise Level (dBm max.)	Frequency* Response (dB max.)
0.01 – 2.05	1-	-115	-1.0
1.50 – 3.55	1-	-117	$\pm 1.0$
2.07 – 6.15	2-	-108	$\pm 1.3$
2.60 – 4.65	1+	-117	$\pm 1.0$
4.11 – 6.15	1+	-115	$\pm 1.0$
4.13 – 10.25	3-	-103	$\pm 1.5$
6.17 – 10.25	2+	-105	$\pm 1.5$
6.19 – 14.35	4-	-95	-2.0
8.23 – 14.35	3+	-100	-2.0
10.29 – 18.00	4+	-90	-2.0

\*Includes mixer frequency response, RF attenuator frequency response, mixing mode gain variation, RF input VSWR.

**Sensitivity and frequency response with 11517A external waveguide mixer and appropriate waveguide tapers**

**Average noise level 10 kHz bandwidth (dBm typical):**

12.4 – 18.0	6-	-85
18.0 – 26.5	6-	-80
26.5 – 40.0	10+	-65

**Frequency response:** typically  $\pm 3$  dB over 1 GHz frequency scans.

**Residual responses:** referred to input on fundamental mixing: <-90 dBm.

#### Display range

**Log:** 70 dB, 10 dB/div and 2 dB/div log expand on a 16 dB display.

**Linear:** from 0.1  $\mu\text{V/div}$  to 100 mV/div in a 1, 2 sequence on an 8-division display.

**Spurious responses due to second harmonic distortion with preselector:**

Frequency Range	Power Incident on Input Mixer	2nd Harmonic Distortion
0.01 – 1.85 GHz	-40 dBm	-63 dB
1.85 – 18.0 GHz	0 dBm	-100 dB

**Spurious responses due to third order intermodulation distortion with preselector:**

Frequency Range	Signal Separation	Power Incident on Input Mixer	Third Order Intermodulation Distortion
0.01 – 18.0 GHz	> 1 MHz < 20 MHz	-30 dBm	-70 dB
0.01 – 1.85 GHz	> 70 MHz	-30 dBm	-70 dB
1.85 – 18.0 GHz	> 70 MHz	0 dBm	-100 dB

**Video filter:** post detection filter used to average displayed noise. Nominal bandwidths: 10 kHz, 100 Hz, and 10 Hz.

**Gain compression:** for internal mixer gain compression <1 dB for -10 dBm peak or average signal level to input mixer, 11517A External Mixer (12.4–40 GHz) gain compression <1 dB for -15 dBm peak or average signal level to input mixer.

#### Amplitude accuracy

**IF gain variation with different bandwidth settings:** (at 20°C.)



# SIGNAL ANALYZERS

## 141T Spectrum analyzer system, 10 MHz to 40 GHz

Models 8555A, 8444A & 8445B (cont.)

**Log:**  $\pm 0.5$  dB.

**Linear:**  $\pm 5.8\%$ .

### Amplitude display

**Log:**  $\pm 0.25$  dB/dB, but not more than  $\pm 1.5$  dB over the full 70 dB display range.

**Linear:**  $\pm 2.8\%$  of full 8-division deflection.

**Log reference level:** accurate to  $\pm 0.2$  dB ( $\pm 2.3\%$  linear sensitivity).

**Log reference level vernier:** accurate to  $\pm 0.1$  dB (1.2%) in 0, -6, and -12 dB positions; otherwise,  $\pm 0.25$  dB ( $\pm 2.8\%$ ).

**Input attenuator range:** 0 - 50 dB in 10 dB steps, manual safety lockout for 0 dB position.

**Frequency response:** typically  $\pm 0.6$  dB from 10 MHz to 18 GHz.

**Calibrator output:** amplitude -30 dBm,  $\pm 0.3$  dB. Frequency 30 MHz  $\pm 3$  kHz.

**Absolute calibration accuracy:** overall accuracy is a function of measurement technique. With the appropriate technique, absolute accuracy of  $\pm 1.6$  dB (fundamental mixing) and  $\pm 2.6$  dB (4th harmonic mixing) is achievable.

### Input characteristics

**Input impedance:** 50 ohms nominal (0.01 - 18 GHz).

**Reflection coefficient:**  $< 0.130$  (1.30 SWR) for input RF attenuator settings  $\geq 10$  dB.

**Maximum input level:** peak or average power +13 dBm (1.0 V ac rms) incident on mixer (+30 dBm with Opt 002), +33 dBm incident on input attenuator.

**RF input connector:** type N female.

**LO emission:** -10 dBm without preselector, -80 dBm with preselector over recommended operating ranges (10 dB input attenuator setting).

**Specifications with option 002; internal limiter installed**

All specifications are the same as for the standard unit except the following:

### Maximum input level

**Continuous:** 1 W (+30 dBm).

**Pulse:** 75 watts peak, pulse width  $\leq 1$   $\mu$ s, 0.001 duty cycle.

**Reflection coefficient:**  $< 0.33$  (2.0 SWR).

**Frequency response (flatness):**  $\pm 0.5$  dB degradation in response, 0.1 - 12.4 GHz.

### General

**Scan time:** 16 internal scan rates from 0.1 ms/div to 10 sec/div in a 1, 2, 5 sequence.

**Power requirements:** 100, 120, 220, 240 V +5% - 10%, 50 - 60 Hz, normally less than 225 watts (varies with plug-in units used).

**Size:** 102 H  $\times$  226 W  $\times$  344 mm D (4.0"  $\times$  8 $\frac{7}{8}$ "  $\times$  13.5").

**Weight:** net, 16.8 kg (14 lb, 15 oz). Shipping, 8.7 kg (19 lb).

## 8445B Tracking Preselector

### Frequency specifications

**Frequency range:** DC - 1.8 GHz low-pass filter, 1.8 - 18 GHz tracking filter.

**Tracking filter 3 dB bandwidth:** typically 20 - 45 MHz.

**Tracking filter skirt roll-off:** characteristics of a three-pole filter. (Nominal: 18 dB/octave.)

### Insertion loss

	Frequency	Insertion Loss (Except Opt. 004)	Insertion Loss (Opt. 004)
Low-Pass Filter	DC - 1.8 GHz @ 2.05 GHz	$< 2.5$ dB $> 50$ dB	*
Tracking Filter	1.8 - 12 GHz 12 - 18 GHz	$< 8$ dB $< 10$ dB	$< 7$ dB $< 8$ dB

\*Low-Pass Filter deleted with Opt 004.

Typical preselector minimum insertion loss at 25°C.

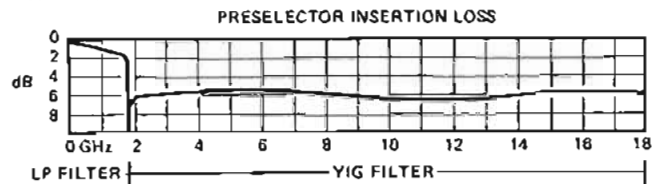

**Out-of-band rejection:** for YIG filter 1 GHz from center of passband  $> 70$  dB.

### Digital frequency readout (Option 003):

**Function:**

**Full scan mode:** displays frequency at inverted marker.

**Per division scan:** displays center frequency.

**Manual or remote operation of preselector:** displays tuned frequency of filter.

**Resolution:** 1 MHz.

**Accuracy:** 0.01 - 1.0 GHz:  $\pm 6$  MHz.

1.0 - 4.0 GHz:  $\pm 8$  MHz.

4.0 - 18 GHz:  $\pm 0.2\%$ .

### Input specifications

**Input connector:** precision Type N female.

**Input VSWR:** typically  $< 2.0$  (1.8 - 18 GHz).

**Limiting level:** (maximum input level for  $< 1$  dB signal compression)  $> +5$  dBm.

**Damage level:**  $> +20$  dBm.

### General

**Remote function:** YIG filter frequency can be set by externally supplied voltage.

**Power requirements:** 100, 120, 220 or 240 V + 5% - 10%, 48 to 440 Hz, less than 110 watts.

**Size:** 88.2 H  $\times$  425 W  $\times$  467 mm D (3 $\frac{5}{16}$ "  $\times$  16 $\frac{3}{4}$ "  $\times$  18 $\frac{3}{8}$ ").

**Weight:** net, 8.8 kg (19 lb 8 oz). Shipping, 11.9 kg (26 lb).

## 8444A Tracking Generator

**Frequency range:** 10 MHz to 1300 MHz.

**Frequency resolution:** 1 kHz.

**Residual FM (peak-to-peak):** 200 Hz (stabilized).

### Amplitude range

**Spectrum analyzer display:** from -130 dBm to +10 dBm, 10 dB/div on a 70 dB display or 2 dB/div on a 16 dB display (8552B only).

**Tracking generator (drive level to test device):** 0 to -10 dBm continuously variable.

### Amplitude accuracy

**System frequency response:**  $\pm 1.50$  dB.

**Tracking generator calibration:** 0 dBm at 30 MHz to  $\pm 0.5$  dB.

**Dynamic range:**  $> 90$  dB.

**Counter output:** typically 0.1 V rms.

### General

**Power:** 115 V and 230 V, 48 to 440 Hz, 12 watts max.

**Size:** 85.2 H  $\times$  425 W  $\times$  467 mm D (3 $\frac{5}{16}$ "  $\times$  16 $\frac{3}{4}$ "  $\times$  18 $\frac{3}{8}$ ").

**Weight:** net, 7.1 kg (15 lb, 10 oz). Shipping, 9.5 kg (21 lb).

### Ordering Information

	Price
8555A Tuning Section	\$7900
Opt 001: APC-7 connectors	add \$40
Opt 002: Internal limiter	add \$210
Opt 005: Video tape	add \$105

### 8445B Tracking Preselector, dc-18GHz

	\$3050
Opt 001: APC-7 connectors	add \$15.5
Opt 002: Add manual controls	add \$80
Opt 003: Add digital frequency readout	add \$670
Opt 004: Delete low-pass filter	less \$42.5
Opt 005: Delete interconnect rigid coax	less \$50

8444A Tracking Generator, 10 MHz-1300 MHz \$3500

11517A External Mixer (tape section req'd) \$250

11518A Tape Section, 12.4 to 18 GHz \$160

11519A Tape Section, 18 to 26.5 GHz \$160

11520A Tape Section, 26.5 to 40 GHz \$160



# SIGNAL ANALYZERS

Spectrum analyzer accessories

Models 8447 Series, 11694A, 1121A



11694A



1121A



11517A



11693A

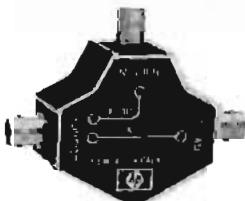

8721A



8406A



197A



8750A



8447 Series

## 8750A Storage-Normalizer

The 8750A's digital storage allows the user to maintain a flicker-free display, even at slow sweep speeds. Trace comparisons are simplified with the dual memory by simultaneously displaying two traces. When used with a tracking generator, system frequency response variations may be stored in memory and automatically removed from the measurement (normalization).

The 8750A is directly compatible with the HP 8557A, 8558B, and 8565A spectrum analyzers, as well as most HP network analyzers, and requires a conventional low-frequency oscilloscope to be used with the 140 series analyzers. (See page 450.)

## 8447 Series amplifiers (0.1-1300 MHz)

The 8447 Series amplifiers feature low noise and wide bandwidth. This makes them ideal for improving spectrum analyzer sensitivity and noise figure while providing input isolation. Accurate measurements over a wide frequency range are assured due to the broad frequency coverage, flat frequency response and low distortion of these amplifiers. (See page 31).

## 11694A 75 Ohm Matching transformer (3-500 MHz)

Allows measurement in 75-ohm systems while retaining amplitude calibration. VSWR is less than 1.2, and insertion loss is less than 0.75 dB. Note: Also see Options 001 and 002 for 75 Ohm versions of 8557A and 8558B.

## 1121A Active probe (0.1-500 MHz)

Provides high impedance (>100 k Ohm shunted by <3 pF) input to spectrum analyzer for measurements on sensitive circuits. Probe power is supplied by most HP Spectrum Analyzers and flat response with unity gain assures accurate, convenient measurements. (See page 449).

## 11517A External mixer

To extend the frequency range of the 8555A and 8565A analyzers to 40 GHz. Taper sections for 12.4-18 GHz (11518A), 18-26.5 GHz (11519A) or 26.5-40 GHz (11520A) bands are required.

## 11693A Limiter (0.1-12.4 GHz)

The Model 11693A Limiter provides input protection for a variety of instruments in general applications (usable from 0.01 to 18 GHz). For example, the input circuits of spectrum analyzers, samplers, or amplifiers may be protected for inputs up to 75 watts peak or 1 watt average power. Also, signal generators can be protected from application of reverse power.

## 8721A Directional bridge

For making return loss measurements from 100 kHz to 110 MHz. (See page 449 under "11652A: Directional bridge".)

## 8406A Frequency comb generator

Produces frequency markers at 1, 10, and 100 MHz increments accurate to  $\pm 0.01\%$ . External oscillator can be used to generate precision interpolation sidebands. Comb is usable to beyond 5 GHz.

## 197A Oscilloscope camera

For a permanent record of your measurements. The 10367A Adapter is required to use the camera with 182-series displays. (See page 175).

## Ordering Information

	Price
11694A 75 Ohm Matching Transformer	\$75
11517A External Mixer (Mixer only)	\$250
11518A/11519A/11520A Waveguide Taper Sections	\$160
11693A Limiter	\$235
8406A Frequency Comb Generator	\$875
8750A Storage-Normalizer	\$1450

# SIGNAL ANALYZERS

## Frequency stability analyzer

### Model 5390A

- Phase Noise Measurements Close to Carrier
- Fractional Frequency Deviation With Low Dead Time
- Wide Input Frequency Range 500 KHz to 18 GHz
- Automatic Operation
- Complete Application Programs
- Fully Integrated and Tested



5390A Frequency Stability Analyzer

### General Description

The 5390A Frequency Stability Analyzer is a powerful, fully automatic calculator controlled system designed to meet the demand for measuring the frequency instabilities of various types of oscillators and signal sources. Two different measures of frequency instabilities can be performed by the system: one, a time domain measure, is the two sample variance of fractional frequency fluctuations (fractional frequency deviation), the other, a frequency domain measure is the spectral density of phase fluctuations (phase noise,  $s\phi(f)$ ).

The 5390A uniquely integrates the:

- high resolution (2 nsec) time measuring capability of 5345A Electronic Counter
  - high speed measurements and extended gate time control of the 5358A Measurement Storage Plug-In
  - low noise heterodyne down conversion of input signals of the 10830A Mixer/IF Analyzer
  - the powerful and friendly capabilities of the 9825 Computing Controller
  - system Self test and verification capability provided by the 10831A Test Tone Generator
  - interactive application programs
- into a system that provides exceptional capabilities to measure two of the most common measures of the frequency instabilities of oscillators.

The system offers a multitude of capabilities and is truly many instruments in one. Primarily it is a special purpose instrument for measuring either fractional frequency deviation or close-in phase noise. In addition it is a general purpose HP-IB system featuring the 5345A Counter under the control of the powerful 9825A Calculator able to perform a large variety of automatic measurements (see application note series 174).

#### Frequency stability measurements

The 5390A is a complete tool for measuring either fractional frequency deviation or close in phase noise including complete signal processing provided by the 10830A Mixer/IF Amplifier. The input signals from the test and reference oscillators are heterodyne down converted to an audio range beat note between 1 Hz and 100 KHz. This technique greatly improves the system resolution. The 10830A can accommodate a wide range of input frequencies from 500 KHz to 18 GHz in three bands with provision for external mixers.

The software package supplied facilitates the making of both these measurements. The programs are easy to use due to the interactive mode of operation. The special function keys of the calculator are used to select the desired mode of operation much like the controls

of an ordinary instrument. A typical measurement sequence involves connecting the test and reference oscillators, specifying the measurement parameters (which can be saved and retrieved from a data cartridge) and initiating the measurements. Once started the system is automatic and runs to the completion of the specified measurements unattended.

System performance verification is built in, being supplied by the 10831A Test Tone Generator. Used with either of the application programs, the system's noise floor can be verified at a 10 KHz beat frequency and a good functional test of the system's operation performed. Diagnostic programs are also supplied for 9825, 5345A/5358A combination, and the optional 59309A. These can be used to isolate problems to the individual instrument level and aid the trouble shooting of each. Functional verification of each component of the system is achieved to a very high confidence level.

Both programs feature convenient output of results on the 9871A Printer/Plotter. All the measurement parameters are printed out including the date and time (automatic when the clock option is included) along with the results in numerical form. The results can then be output in graphical form to the 9871A and plotted. The user has complete control over plot parameters so the data can be arranged in the most convenient form. Measurement results can also be saved on a data cartridge providing a means to plot several sets of data on the same graph.

#### Fractional frequency deviation measurement capabilities

This widely recognized time domain specification of frequency stability is fast, simple, and easy to measure with the 5390A. Control of the measurement is accomplished by the operator specifying measurement parameters at the keyboard of the 9825A. The Tau values, number of samples to be averaged, carrier frequency, measurement bandwidth can all be specified. To make the system even more versatile, the Tau values can be generated by specifying each point or by setting-up a sweep which may be either log or linear by specifying the end points and step size. Tau values can be specified over a wide range from 10  $\mu$ sec to more than 10,000 sec with a resolution 0.1% or 1 cycle of the beat frequency whichever is greater. The number of Tau's that can be measured at one time is limited by only the calculator's memory. With this high resolution and number of points it is easy to identify the various noise process exhibited by the oscillator under test.

The 5390A provides excellent performance characteristics for measuring even the most stable oscillators achieving high sensitivity and low dead time. The maximum sensitivity, a function of the beat frequency and ultimately limited by the noise floor of the 10830A, is given by



5390A Instrument Cluster (shown with Digital Clock Opt 004)



$$L(f)_{\min} = 173 + 20 \log \nu_b - 10 \log f \text{ db/Hz}$$

where the  $\nu_b$  = beat frequency

$f$  = offset frequency from carrier

The offset frequency resolution is a function of the beat frequency and is given by:

$$f = \frac{\nu_b}{6i} \text{ where } i = 1, 2, 3 \dots$$

$$\sigma_y^2(\tau)_{\min} = \frac{1.155 \times 10^{-14}}{\tau} \cdot \frac{\nu_b}{\nu_o} \text{ for } \nu_b \geq 900 \text{ Hz}$$

$$= \frac{1 \times 10^{-7}}{\tau} \cdot \frac{1}{\nu_o} \text{ for } \nu_b < 900 \text{ Hz}$$

where  $\nu_b$  = beat frequency  
 $\nu_o$  = carrier  
 $\tau$  = measurement time

The dead time is limited by the 5358A can be as low as 17  $\mu$ s or 1 cycle of the beat frequency which ever is greater, thus reducing the bias function correction necessary for small Tau values.

**Close-In phase noise measurement capabilities**

Traditional phase noise measuring techniques are limited as to how close in to the carrier measurements can be made, about 10 Hz usually is as close as can be achieved. The 5390A provides the means to get closer than this limitation plus the ability to cover an overlap region up to 10 KHz. The measurement technique is an N sample variance (sometimes referred to as the Hadamard Variance) which is a variance of N time domain measurements which can be related to the phase spectral density. The sampling function produces an equivalent digital filter which can be made to have an arbitrarily narrow bandwidth, thus the ability to get close to the carrier.

Measurements are easily made by first specifying several measurement parameters, thereafter the system completes the measurements unattended. The user can specify the offset frequencies, filter bandwidth, averaging parameters, number of sweeps, correction coefficient. The offset frequencies can be specified by one of three ways: at specific frequencies or by a log or linear sweep where the end points and step size are specified. Bandwidth can be specified as a particular value for each offset frequency, or as a percentage or as a constant value. The set of offset frequencies can be measured any number of specified times. The results of each "sweep" are printed out and when all are complete statistics on the mean, sigma, minimum and maximum are printed providing information about the variability of the noise processes.

The sensitivity floor is a function of the beat frequency and is limited by the time resolution of the 5345A as given by:

**Systems options (see data sheet for complete listing)**

- 001:** adds memory to the 5358A Plug-in in 2k byte increments. Up to three opt. 001's may be added add \$300
- 004:** adds 59309A Digital Clock and one 10631A cable to system. add \$1085
- 101:** expands 9825A memory from 6k to 14k bytes add \$1600
- 102:** expands 9825A memory from 6k to 24k bytes add \$3200
- 162:** adds 9862A XY Plotter and interface for 9825 Calculator. Replaces 98214A ROM. add \$3445
- 166:** adds 9866B Thermal Printer and interface for 9825A Calculator add \$3750
- 325:** deletes 9825A Calculator. Appropriate if system is to be used with an existing 9825A Calculator. less \$7550
- 371:** deletes 9871A Printer/Plotter. Appropriate if system is to be used with an existing 9871A or 9862A Plotter. less \$3400

**Ordering Information**

- 5370A Basic system includes:**
- 5345A Opt 011 Electronic Counter
  - 5358A Measurement Storage Plug-In
  - 10830A Mixer/IF Amplifier
  - 10831A Test Tone Generator
  - 9825A Calculator
  - 98210A Adv. Program/String Variab. ROM
  - 98213A Gen. Purpose/Ext. I/O ROM
  - 98034A HP-IB Interface
  - 9871A Opt 011 Printer/Plotter
  - System Software Cartridge
  - System, Application and Instrument Manuals
  - System Cabinet and Cables
  - Factory Assembly and Integration
  - 90 day calculator on-site warranty
  - 1 year instrument bench repair warranty

**Price**

5390A Basic System \$25,500

# SIGNAL ANALYZERS

## Digital Fourier Analyzer, Vibration Test Control

Models 5451, 5427A



The 5427A provides closed-loop control of environmental and/or developmental random vibration test stimuli. Sine and transient test control may be added optionally and inexpensively.

The basic system consists of: 5478C 2-channel (expandable to 4) analog-to-digital converter for processing feed-back information; 54427A fast, microcoded digital processor; 1335A Persistence CRT Display; 2640B operator's terminal; 5477A pushbutton control unit, 9885M flexible disc storage unit; cabinet and programs for random control and a set of analysis routines designed for easy operation by laboratory personnel.

### System operation

Random, sine and transient control follow the same logical operational phases. First, the appropriate disc is loaded and the test program or setup (envelope, alarm and abort limits, test time, calibrations, etc.) is loaded from disc storage in response to one of 25 search codes or names. If a new program or modifications are desired, a friendly question-and-answer sequence is used. Once a new setup has been generated or changes made, it can be assigned a new name and stored for later use.

After a satisfactory setup is obtained, the operate phase allows control of the actual test via pushbuttons on the central control panel. Removable snap-on overlay panels clearly label buttons for the type of test desired. Choices of on-line displays and a 'save' button allows saving of up to 110 displays for later plotting, including auxiliary PSD measurements during random control.

After the test, results and all saved data are available for review or documentation. The digital plotter option provides fully labeled, report-quality plots of test results.

### Specification summary

#### Random control

**Resolution:** 64, 128, 256, 512 lines (1024 lines optional).

**Loop Time:**  $\leq 1.0$  second with 2500 Hz bandwidth, 256 lines.

**Bandwidth:**  $\Delta f$  to 5000 Hz.

**Dynamic Range:**  $\geq 65$  dB.

**Reference Spectrum:** programmable, 40 breakpoints.

**5427A BASE PRICE**

**\$43,000**

#### Model 5427A

- Digital Accuracy and Repeatability
- Pushbutton Operation, Eliminates Programming
- Easily Expanded to Sine and Transient Control

#### Model 5451

- Multi-Channel Operation DC to 50 kHz
- Keyboard-Controlled Data Acquisition and Analysis
- 80 dB Dynamic Range
- Dedicated Modal and Signature Analysis Packages

The 5451 Fourier Analyzer provides digital frequency domain analysis of complex time signals in the frequency range of DC to 50 kHz (100 kHz optional). It is a fully calibrated, multi-purpose digital system for data acquisition, data storage, and data analysis. The primary analysis functions which are controlled from the system keyboard include: Forward and inverse Fourier transform, auto and cross power spectrum, transfer and coherence function and time or frequency domain averaging.

The ability to measure these functions quickly and accurately and with large dynamic range makes the Fourier Analyzer a powerful tool for stimulus-response measurements, system identification, vibration control, modal analysis, signature analysis, underwater sound, acoustics, communications, and more.

### Band Selectable Fourier Analysis

5451 Band Selectable Fourier Analysis (BSFA) allows the digital analyzer user to perform digital spectrum analysis over a frequency band whose center frequency and bandwidth are independently selectable by the operator. This frees the user from the DC to  $F_{max}$  restrictions of conventional baseband digital analysis. With BSFA the frequency resolution of a measurement can be increased by a factor of 400:1 without a corresponding increase in the amount of computer data space required. With BSFA, the full dynamic range of the analyzer (80 dB) can be applied to the band of interest without interference from outside frequencies.

### Modal Analysis Option

Hewlett-Packard offers a comprehensive modal analysis system designed to meet the requirements of a wide range of modal testing applications. The Hewlett-Packard Modal System operates on measured transfer function data to determine modal properties. In addition, an animated isometric display of the structure under test is generated to aid the engineer to better understand its dynamic characteristics. This system offers significant time savings over traditional swept sine analog techniques because it operates on transfer function data. The system provides random, pseudo-random, transient, or periodic random excitation for transfer function measurements.

### Signature analysis

Noise, vibration, and failure problems in rotating machinery are quickly analyzed using Hewlett-Packard's powerful Signature Analysis Package. It combines key rotating machinery measurements into a dedicated user-oriented system that's used for preventive maintenance, production quality control, design analysis, and noise and vibration studies.

Six measurements are pushbutton selectable from the operator's control panel: RPM and TIME Spectral Maps, Power Spectrum Analysis, Composite Power Spectrum, Order Ratio, and Order Tracking. This complete range of measurement and analysis features helps the user quickly gain insight into the overall dynamic characteristics of the device, eliminating time-consuming trial-and-error procedures.

**5451 SYSTEM PRICE**  
(Depends on Configuration)

**\$60,000 to \$100,000**

# SIGNAL ANALYZERS

## Digital Signal Analyzer

### Model 5420A



- Dual-Channel Transfer Function
- Band Selectable Analysis
- Fully Calibrated Annotated Display

- Powerful Post-Measurement Processing
- Digital Data Storage
- Random Noise Generator

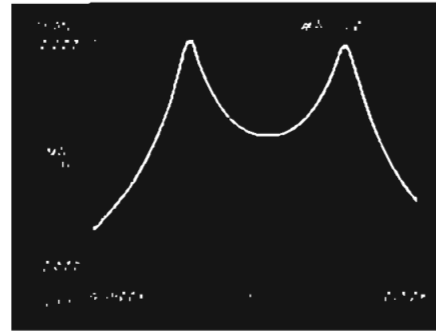

Band Selectable Transfer Function Display



The 5420A Digital Signal Analyzer makes a wide variety of time and frequency domain measurements in the range of dc to 25 kHz. Capable of both stimulus-response and response-only analysis, its measurement repertoire includes:

- Transfer Function
- Coherence Function
- Impulse Response
- Auto/Cross Spectrum
- Linear Spectrum
- Time Average
- Amplitude Histogram
- Auto/Cross Correlation

Included are powerful features such as a fully annotated and calibrated dual-trace display, digital storage for measurement results, extensive post-processing, and a random noise generator. The 5420A is well suited to studies of structural noise and vibration and the measurement of electronic systems and signals.

#### Operation

Operation of a digital signal analyzer has never been easier. A novel "menu" concept replaces the rotary and toggle switches commonly used to control an instrument's operation. The entire set-up state, including measurement type, bandwidth, voltage ranges, etc., is displayed at the push of a key. Changes are made by selection from displayed lists (menus) or by direct numerical input from the control keyboard. Up to 50 different setups may be stored on the digital cartridge for rapid recall.

Once set up, measurements are easily executed. Results are always fully calibrated and annotated. Up to 120 measurement results may be stored on the digital cartridge.

#### Cursors

The 5420A includes flexible X and Y axis cursors to provide data readout in full format, display expansion and measurement control. Cursors may be swept or set explicitly to desired locations. Data values may be read absolutely or relatively on each axis. Any area of the display may be expanded to full screen. Harmonic markers are provided. The X-axis cursors may be used to set the desired center frequency and bandwidth of the measurement, concentrating the resolution of the 5420A into an area of interest.

#### Post-processing

Data may be processed in a variety of ways. Quantities such as power, power in a band, harmonic power, resonant frequency, and percent critical damping are available at the stroke of a key. Time domain differentiation and integration of a frequency domain function are also provided. The four-function "waveform calculator," with real and complex constants, allows calculations such as mechanical impedance, coherent output power, signal-to-noise ratio, open-loop gain, and more.

#### HP-IB

The Hewlett-Packard Interface Bus accessory, 10920A, interfaces the 5420A with other HP-IB compatible instruments and computing controllers to yield custom system solutions to specific measurement problems. With this option, a computing controller can "push" all of the keys on the 5420A's front panel. The computing controller can also take data from the instrument for further processing and send data back to the 5420A for display.

#### Digital plotting

When equipped with the 10920A, the 5420A will produce four color annotated plots on the HP 9872A Plotter. A hard copy record of instrument set-up states can also be obtained from the plotter. Finally, the 9872A provides output of measured data in tabular form.

#### And more . . .

There is a lot more to the 5420A than can be described here. Local Hewlett-Packard field representatives can provide detailed information.

**5420A Digital Signal Analyzer**  
10920A: HP-IB Interface

**\$29,900**  
**\$2200**

# SIGNAL ANALYZERS

Correlator and spectrum display  
Models 3721A, 3720A

## 3721A Correlator

The Model 3721A Correlator is a digital statistical signal analyzer covering the range dc to 250 kHz. It computes autocorrelation, cross-correlation, and amplitude probability functions. In addition, a signal recovery facility uses signal averaging to improve the signal-to-noise ratio of a repetitive signal buried in noise. The resultant functions are displayed on a built-in CRT.

The versatile analysis and averaging capabilities combined with portability, automatic calibration, built-in CRT and real-time operation make the 3721A an ideal analyzer for both laboratory and field use.

## Major Specifications

**Input signal bandwidth:** dc to 250 kHz.

**Input range:** 40 mV rms to 4 V rms.

**Functions:** Autocorrelation, Crosscorrelation, Probability (Density and Integral), Signal Recovery.

**Number of points:** 100 points computed and displayed for each function.

**Sampling interval:** 1 s to 1  $\mu$ s (1 Hz to 1 MHz sampling rates). External clock facility allows any interval  $\geq 1 \mu$ s to be selected. In Correlation and Signal Recovery the time between displayed points is equal to the sampling interval.

**Averaging** (two modes are provided)

**Summation:** computation automatically stopped after a fixed number of samples has been taken. Number of samples selectable from 128 to  $128 \times 1024$ .

**Exponential:** continuous averaging with time constant selectable from 36 ms to over  $10^7$  seconds.

**Calibration:** vertical calibration is automatically displayed on an illuminated panel (except Probability).

**Outputs:** all computed functions are displayed on the built-in CRT. Analog outputs are provided for use with X-Y recorder and external oscilloscope. Digital outputs allow the transfer of computed data to any HP digital computer or HP paper tape punch (2895A or 8100A). Extra plug-in assemblies are required, type depending on the peripheral used.

## 3720A Spectrum display

The 3720A Spectrum Display is a unique add-on unit for the Correlator, to complement and extend its capability by Fourier transforming any time display on the 3721A and presenting its equivalent frequency function on a built-in display.

The 3720A performs the Real and/or Complex transformation of autocorrelation and crosscorrelation functions to produce the Power and Cross Spectral Density functions respectively, and converts signal recovered data into frequency information.

Together the 3721A Correlator and 3720A Spectrum Display, each with its own CRT display, form an analysis system giving both time and frequency information simultaneously.

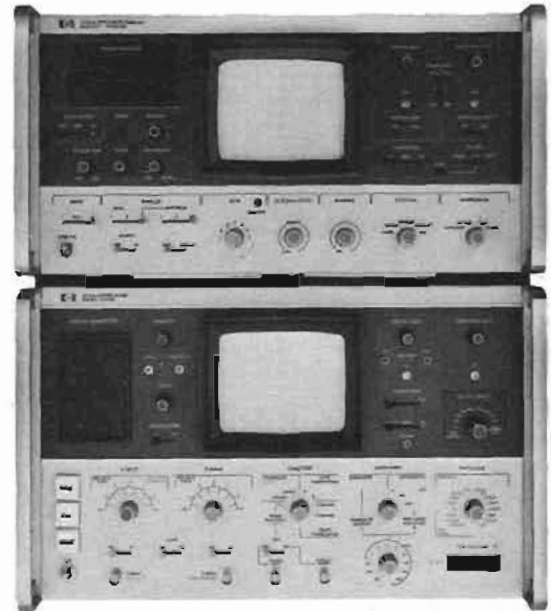

Models 3721A, 3720A

## Major Specifications

**Input data:** digital data is transferred from the Correlator and held in either of two stores, labeled 1 and 2.

**Computed transforms:** either the Real or Complex transform can be computed of the contents of store 1, the contents of store 2, or the contents of stores 1 and 2 together.

**Frequency range:** 0.005 Hz to 250 kHz using internal 3721A clock. Extendable down to dc with external clock.

**Displayed frequency range:** two decades of frequency are displayed, the highest frequency being  $\frac{1}{2} \Delta t$  Hz ( $\Delta t$  is the 3721A Timescale setting).

**Dynamic range:** ratio of full scale signal to noise level, for fixed integrator gain, is better than 50 dB.

**Gain:** continuously variable over a 2-decade, 40 dB, range in seven discrete steps, with intermediate vernier.

**Window:** two choices are available.

**OFF:** natural window, nominal bandwidth  $\frac{1}{2} \Delta t$ .

**ON:** triangular window, nominal bandwidth  $\frac{1}{100} \Delta t$ .

**Interpolation:** (two modes available).

**MANUAL:** computes and displays 100 frequency points. Frequencies of all 100 points can be simultaneously and equally varied over a frequency interval,  $\frac{1}{2} \Delta t$ .

**AUTO:** automates the manual interpolation, calculating 10 equispaced points across each frequency interval.

**Transform presentation:** all combinations of the following axes are available for display.

**Vertical axis:** Phase, Log Mod, Modulus, Imaginary, Real.

**Horizontal axis:** Frequency, Log Frequency, Real, Phase.

**CRT display:** built-in variable persistence CRT with storage facility.

**X-Y recorder:** separate horizontal and vertical analog outputs corresponding to the CRT display.

## Ordering information

3720A Spectrum Display

3721A Correlator

Price

\$7 265

\$10 125

# SIGNAL ANALYZERS

Calibrated noise for system stimulation  
Model 3722A

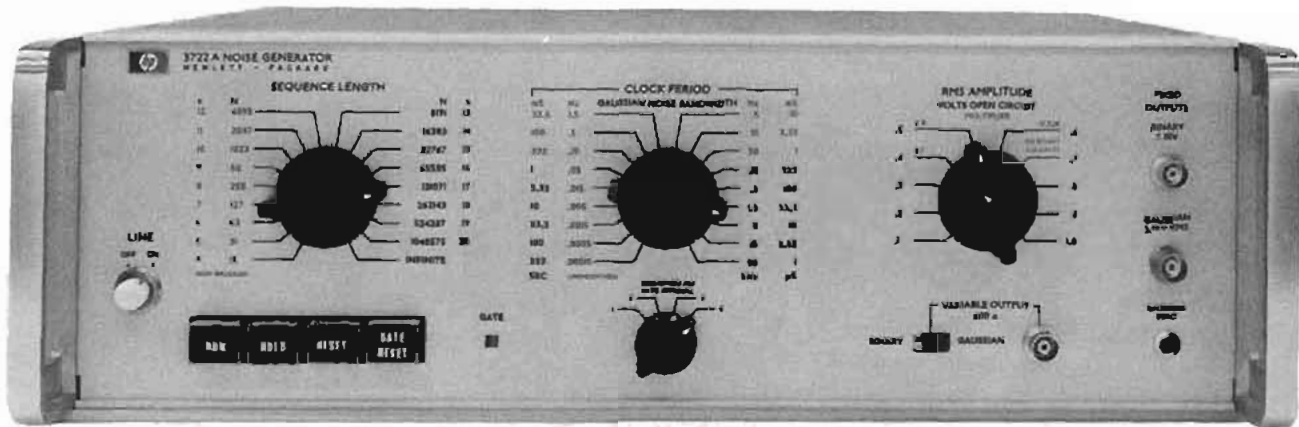

## 3722A

The Model 3722A Noise Generator uses digital techniques to synthesize binary and Gaussian noise patterns. These 'pseudo-random' patterns, which are of known content and duration, are repeated over and over without interruption. Since one pattern is identical with the next, each pattern has the same effect on the system under test. For this reason, pseudo-random noise signals cause no statistical variance in test results. The Model 3722A also generates truly random binary and Gaussian noise.

The basis of the Model 3722A is a binary waveform generator. The binary output has a  $(\sin x/x)^2$  shaped spectrum and the Gaussian output, which is derived from the binary signal by precision low-pass filtering, has an almost rectangular spectrum. Both binary and Gaussian outputs are controllable in bandwidth, but the output power remains constant regardless of selected bandwidth. The frequency of the first null in the binary spectrum is selectable from 0.003 Hz to 1 MHz, and the bandwidth (at -3 dB point) of the Gaussian noise is selectable from 0.00015 Hz to 50 kHz.

### Opt H01

Model 3722A Option H01 is a standard Model 3722A Noise Generator modified to provide a second binary output which can be delayed by a selectable number of clock periods with respect to the main binary output. The delayed binary output is available only when the instrument is in the pseudo-random mode. The delay introduced between the two binary outputs is selected by three decade switches on the front panel. These switches are set according to a conversion table supplied with the instrument.

## Specifications

### Binary output (fixed amplitude)

**Amplitude:**  $\pm 10$  V.  
**Output impedance:**  $< 10 \Omega$ .  
**Load impedance:** 1 k $\Omega$  minimum.  
**Rise time:**  $< 100$  ns.  
**Power density:** approximately equal to (clock period  $\times$  200) V<sup>2</sup>/Hz at low frequency end of spectrum.  
**Power spectrum:**  $((\sin x/x)^2$  form) first null) occurs at clock frequency, and -3 dB point occurs at  $0.45 \times$  clock frequency.

### Gaussian output (fixed amplitude)

**Amplitude:** 3.16 V rms.  
**Output impedance:**  $< 1 \Omega$ .  
**Load impedance:** 600  $\Omega$  minimum.  
**Zero drift:**  $< 5$  mV change in zero level in any 10°C range from 0° to +55°C.  
**Power density:** approximately equal to (clock period  $\times$  200) V<sup>2</sup>/Hz at low frequency end of spectrum.  
**Power spectrum:** rectangular, low-pass: nominal upper frequency  $f_0$  (-3 dB point) equal to  $1/20$ th of clock frequency. Spectrum is flat within  $\pm 0.3$  dB up to  $1/2$   $f_0$ , and more than 25 dB down at 2  $f_0$ .  
**Crest factor:** up to 3.75, dependent on sequence length.

### Variable output (binary or gaussian) Amplitude (open circuit)

**Binary:** 4 ranges:  $\pm 1$  V,  $\pm 3$  V,  $\pm 3.16$  V, and  $\pm 10$  V, with ten steps in each range, from X0.1 to X1.0.

**Gaussian:** 3 ranges: 1 V rms, 3 V rms, and 3.16 V rms, with ten steps in each range, from X0.1 to X1.0.

**Output impedance:** 600  $\Omega \pm 1\%$ .

### Main controls

**Sequence length switch:** first 17 positions select different pseudo-random sequence lengths; final position selects random mode of operation (INFINITE sequence length).  $N = 2^n - 1$ , where  $n$  is the range 4 through 20.

**Clock period switch:** selects 18 frequencies from internal clock.

### Internal clock

**Crystal frequency:** 3 MHz nominal.  
**Frequency stability:**  $< \pm 25$  ppm over ambient temperature range 0° to +55°C.  
**Output:** +12.5 V rectangular wave, period as selected by CLOCK PERIOD switch.

### External clock

**Input frequency:** useable BINARY output (pseudo-random only) with external clock frequencies up to 1 MHz.  
**Input level:** negative-going signal from +5 V to +3 V initiates clock pulse.  
**Maximum input:**  $\pm 20$  V.

### Remote control

**Control inputs:** remote control inputs for RUN, HOLD, RESET, and GATE RESET functions are connected to 36-way receptacle on rear panel.

**Sequence length indication:** 18 pins plus one common pin on the 36-way receptacle are used for remote signaling of selected sequence lengths (contact closure between common pin and any one of the 18 pins).

### Delayed binary output (Opt H01)

**Typical performance figures for the delayed output are:**

**Amplitude:** switches between +1.5 V and +12 V.

**Maximum sink current at 1.5 V level:** 10 mA.

**Impedance:** 50  $\Omega$  (+1.5 V) and 600  $\Omega$  (+12 V).

**Rise time:**  $< 50$  ns.

**Fall time:**  $< 20$  ns.\*

\*Measured with  $\div$  probe shunted by 10 pF.

### General

**Dimensions:** 132.6 mm H  $\times$  425 mm W  $\times$  416 mm D (5<sup>17</sup>/<sub>32</sub>"  $\times$  16<sup>3</sup>/<sub>16</sub>"  $\times$  16<sup>3</sup>/<sub>16</sub>").

**Weight:** net, 10.5 kg (23 lb). Shipping 13.5 kg (30 lb).

### 3722A Noise Generator

Opt H01: Delayed Output

\$3615  
+add \$340

# CABINETS & MEASUREMENT ACCESSORIES

Modular enclosure system for individual HP products  
System-II

- Truly modular, fits standard heights and widths
- Broad range of accessories for bench or rack use
- Strong frame, yet easy service access to interior

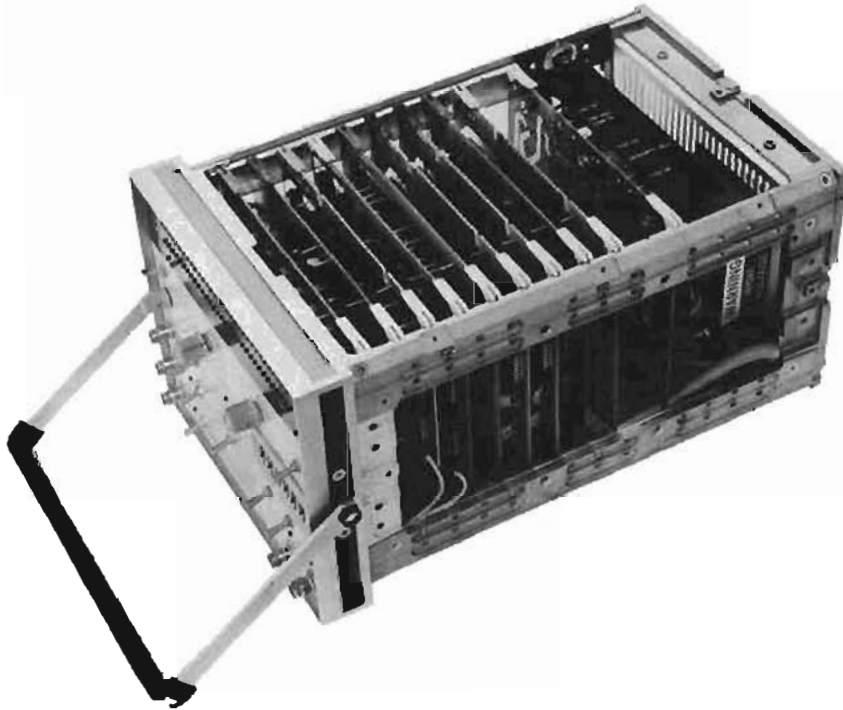

Look inside newer HP instruments housed in System-II cabinets, and you will find an extremely strong frame allowing maximum use of interior space. Yet, there's excellent service access from top, bottom and sides. (Optional ball handle is shown on this particular instrument.)

In 1961, Hewlett-Packard introduced a new universal enclosure system for instruments. That system (called "System I" within HP) made it practical to stack instruments neatly for bench use, while at the same time providing a convenient means for mounting the instruments directly in a rack. It was also esthetically more appealing than the simple boxes of various sizes that had been the norm—and it provided more convenient access to internal parts and more efficient use of space than the conventional chassis-slipped-into-a-box approach commonly in use at that time.

### Need for a new enclosure system

Continuing changes in the nature of electronic instrumentation have created new needs in enclosure systems. Foremost among these is the need for even better accessibility to internal parts, as circuits become more densely packed. Ideally, this not only means access from top and bottom, as provided by the 1961 system, but also from the sides, front and back as well.

Today's miniaturized circuits also lead to two other types of problems. First, the enclosures tend to be smaller than in the past—meaning that costly combining cases or space-consuming rack adapter frames are often required for grouping smaller products together on the bench or in the rack. Sec-

ond, there's the need to optimize utilization of smaller front panel areas—and it becomes increasingly difficult to arrange displays, nomenclature and the growing number of controls for convenient user operation.

Radiated electrical interference can also be a significant problem, as transition times of digital signals shorten to the nanosecond region. This means that instruments tend to radiate a greater amount of high-frequency energy, thereby creating potential problems for users operating sensitive devices in close proximity.

### New standard enclosure: System-II

With the above in mind, Hewlett-Packard has developed a new enclosure system for HP products, using an "inside-out" design approach. That is, design priorities first concentrated on all servicing, manufacturing, electrical, mechanical, and thermal needs before turning to the esthetic considerations. The resulting enclosure has greater strength but is lighter in weight than the earlier design. Also, it provides better accessibility for servicing, has more versatility in bench/rack configurations, and it inherently provides significant attenuation of unwanted RF energy.

This new enclosure is called "System II", and it is now the standard package in which new HP cabinet-enclosed products are being introduced.

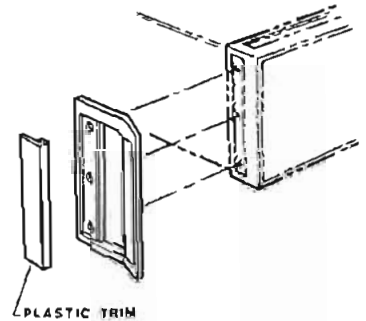

PLASTIC TRIM

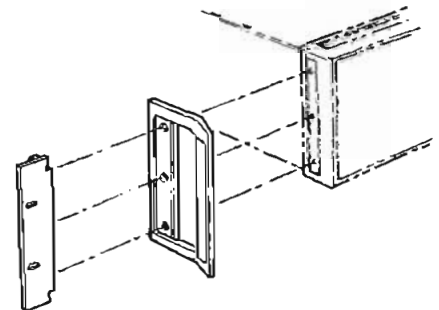
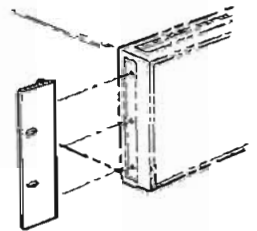

Three front handle and/or rack flange kits are available as standard options on full-width instruments—or, the kits may be purchased separately.

Compatibility with current System-I products has been carefully considered. Cabinet and panel colors for both systems are the same, and the new System-II instruments will conveniently stack on the older System-I enclosures (and vice-versa).

The basic System-II frame consists of six die-cast aluminum parts: a front panel frame, a rear panel frame, and four connecting side struts. It is rigid by itself and does not depend upon internal decking, front or rear panels, or covers for strength. The resulting open design makes maximum use of available space, and allows easy access inside.

The sturdy front panel frame is the heart of the design. It has integral pads for the side struts, mounting holes for fastening the front panel, recesses for front handles and rack flanges or for links that lock adjacent enclosures together, slots for plug-in latches, and narrow channels for holding top, side, and bottom covers.



## Heights

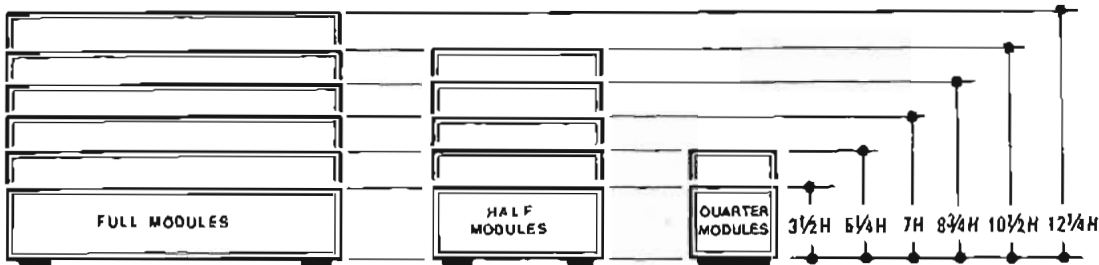

## Widths

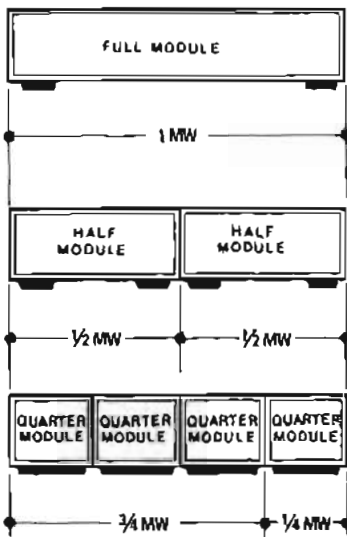

The narrow U-shaped channels serve as wave traps that reduce the radiation of (or susceptibility to) unwanted RF energy. As a further precaution, small ridges aligned in the direction of cover insertion provide high-pressure points for establishing good electrical contact. Only RF energy at wavelengths much shorter than those of concern can move between these contact points. Trim detail on the side covers provide the same kind of RF seal along the sides, as does a similar arrangement under the lip of the covers at the rear. The covers, however, are each retained by a single captive screw, enabling quick removal for servicing.

The sizes of holes such as those needed for mounting cabinet feet have been reduced to practical minimums.

### Maximized panel area

Unlike the earlier design, the System-II front panel frame uses all the available area in full multiples of vertical EIA/JEC increments. Also, the front panel frame overhangs lower side members, completely filling the allotted rack space while still allowing room for the optional use of System-II rack support shelves.

The front panel mounts to the framework with screws accessible from the outside, and because it does not serve as a structural member, there is an increase in the amount of usable panel space. This reduces the crowding of controls so instruments become easier to operate.

All screws used in cabinet assembly are of the self-locking type with an inserted plastic patch on the threads, preventing the screws from working loose when subject to vibration.

### Easier carrying

Front-panel handles (now optional) have been designed with an outward tilt. The angled handle is comfortable for the hand, while presenting a minimal visual obstruction of controls located along the edges of the front panel. (Optional rack-mounting flanges may be installed with or without the front handles in place.)

## Summary of System-II dimension descriptors

Dimension Descriptor	Equivalent to: "U"	mm	
		mm	Inches
Height	2U	88.1	3.469
	3U	132.6	5.219
	4U	177.0	6.969
	5U	221.5	8.719
	6U	265.9	10.469
	7U	310.4	12.219
Width	1/4 MW	105.7	4.160
	1/2 MW	212.3	8.360
	3/4 MW	318.9	12.550
	1 MW	425.5	16.750
Depth*	11D	268.2	10.600
	14D	345.4	13.600
	17D	421.6	16.600
	20D	497.8	19.600
	23D	574.0	22.600

\*See ANSI C83.9-1972 or IEC 297-1975.

<sup>1</sup> HP products are not available in S-II cabinets 3/4 MW, but this is useful dimension to indicate filler panel widths.

<sup>2</sup> Adding S-II rack flanges extends the 1 MW dimension for mounting in standard 482.6 mm (19.000 inch) rack.

<sup>4</sup> Depth dimension includes basic cabinet only; does not include protrusions such as controls, front handles, etc.

## Depths

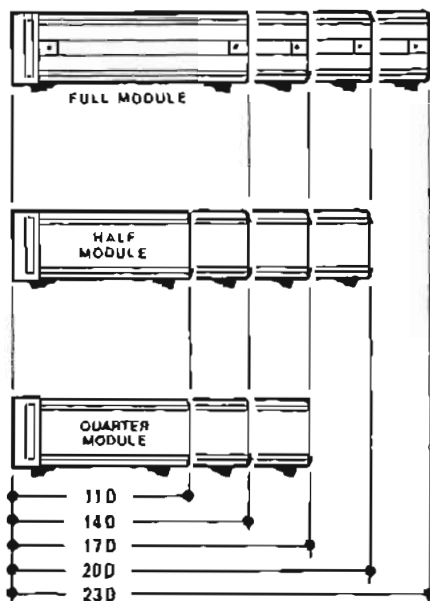

Full-width products have a handle on each side. Each side handle is in the form of a long strap, which provides more freedom in finding a balance point. The strap handle recess in each side panel also provides a place for mounting rack slides.

An optional front bail handle is available for smaller products, and some products are equipped with a strap handle on top.

### Modular small enclosures

The smaller enclosures in System-II are dimensioned to be exact submultiples of the standard rack width design. Rack mounting frames are therefore not required; a simple extender to reach full rack width is all that is needed.

It is easy to group instruments together horizontally or vertically by using simple lock links. The links can be installed by using threaded holes already provided in the framework, allowing quick assembly and separation of instruments.

# CABINETS & MEASUREMENT ACCESSORIES

Modular enclosure system for individual HP products

System-II general accessories and parts

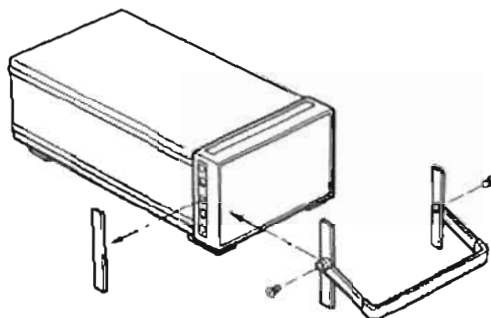

Bail-type carrying handles are available for 1/2 MW products having heights of 3 1/2 H, 5 1/4 H or 7 H.

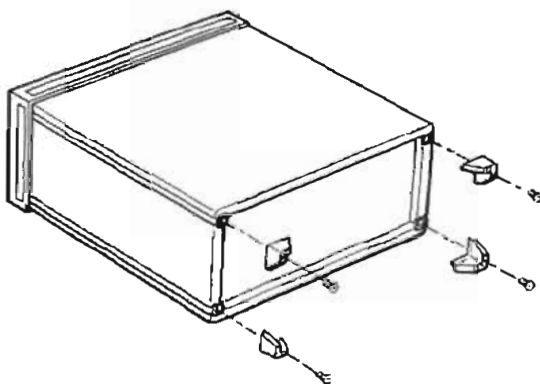

Standoff feet in Kit 5061-2009 provide rear panel protection for instruments operated, transported or stored vertically.

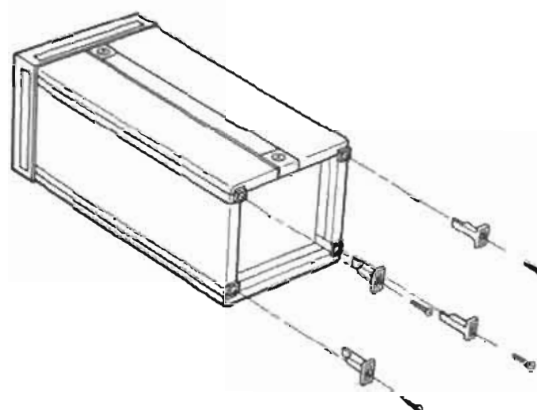

Kit 5061-0095 provides flanged cord wrap posts as a convenient way to keep power cords and signal cables with an instrument.

## Locking cabinets together

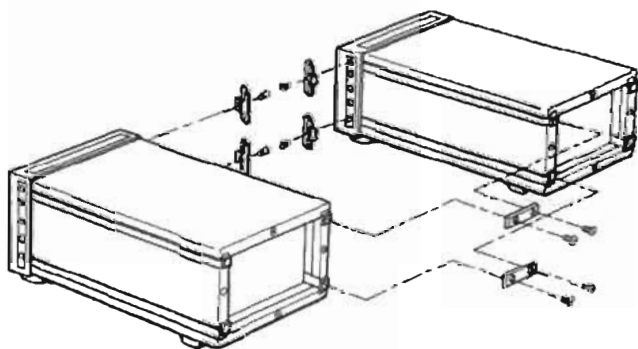

Sub-module cabinets (1/4 MW & 1/2 MW) of equal depths lock side-by-side, using horizontal lock links from Kit 5061-0094.

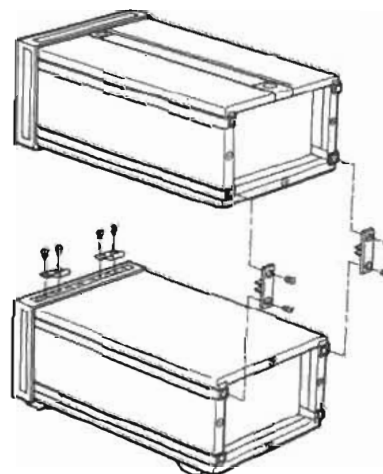

Cabinets of equal depths can be stacked and locked together securely, using vertical lock links from Kit 5061-0094.

**General accessories and parts for System-II cabinets**

Item <sup>1</sup>	Fits these System-II Cabinets	Description	Part Number	Price
<b>Front handle kit</b> (Will be shipped with instrument, if ordered as Option 907 at same time. Otherwise available separately per Part Numbers listed at right.)	All cabinets—but principle use is on 1 MW (Full Module) cabinets, or on sub-Module cabinets (locked together to form width of 1 MW.	Includes two front handles: fit on each side	3½ H 5061-0088	\$20
		of front panel frames, for cabinets this high:	5¼ H 5061-0089	\$20
			7 H 5061-0090	\$30
			8¾ H 5061-0091	\$30
			10½ H 5061-0092	\$45
		12¼ H 5061-0093	\$45	
<b>Ball handle kit</b>	½ MW (Half Module)	Convenient carrying handle for lightweight	3½ H 5061-2001	\$15
		cabinets this high:	5¼ H 5061-2002	\$20
			7 H 5061-2003	\$25
<b>Cabinet lock-together kit</b>	All cabinets, provided they are of equal depth.	Kit of lock link hardware and screws for joining instrument cabinets in several different configurations. Enough horizontal links (12 front, 6 rear) to form three side-by-side joints (up to 4 instruments), and enough vertical links (4 front, 4 rear) to form two over-under joints (up to 3 instruments). <sup>2</sup>	5061-0094	\$15
<b>Cabinet feet</b>	1 MW (Full Module) and ½ MW (Half Module)	<b>Standard foot (1):</b> fits bottom of 1 MW and ½ MW cabinets (requires 2 front, 2 rear).	5040-7201	\$2 ea.
		<b>Tilt stand (1):</b> fits onto standard foot and is used in pairs (front or rear).	1460-1345	\$2 ea.
		<b>Non-skid foot (1):</b> used (in pairs) in lieu of standard rear or front foot, to minimize bench-top creeping instrument. (Some lighter-weight products are supplied with this type foot on rear.)	5040-7222	\$3 ea.
	¼ MW (Quarter Module)	<b>Standard foot (1):</b> fits bottom of ¼ MW cabinet (requires 1 in front, 1 in rear).	5040-7205	\$2.50 ea.
		<b>Tilt stand (1):</b> fits onto ¼ MW standard foot (only 1 used, for front or rear).	1460-1369	\$2.50 ea.
<b>Feet, rear panel standoff</b>	All cabinets—except does not normally fit cabinets which are ¼ MW and 3½ H.	Kit of four special feet which provide 25.4 mm (1 in.) standoff protection to rear panel. Used when instrument is operated in vertical position, or when it is transported/stored on its rear panel.	5061-2009	\$3 ea.
<b>Cord-wrap kit, rear panel</b>	Recommended for products only ¼ MW and ½ MW weighing less than 111 kg (24 lbs.)	Kit of four flanged posts around which power cords or signal cables may be wrapped for transport/storage. (not designed for heavy duty support; use kit 5061-2009 for such applications.)	5061-0095	\$5

<sup>1</sup> All kits and rear panel standoff feet are supplied with appropriate mounting screws.

<sup>2</sup> Locking cabinets together horizontally in a configuration wider than 1 MW (full Module) is not recommended.

# CABINETS & MEASUREMENT ACCESSORIES

Modular enclosure system for individual HP products

System-II rack mounting accessories

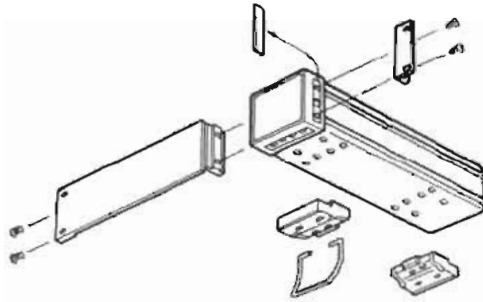

Cabinets 1/4 MW utilize one broad foot each at front and rear (either accept tilt stand). Note how rack mounting adapter and rack flange fit onto front frame, after trim strip is removed.

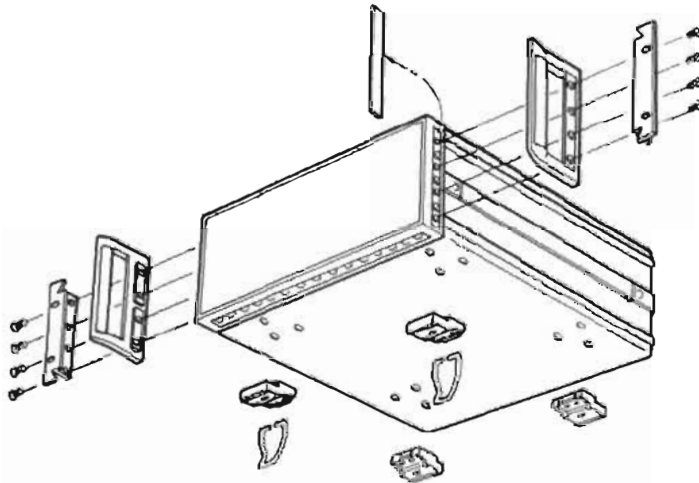

Cabinets 1/2 MW and 1 MW utilize two feet each at both front and rear (all accept tilt stand). Note how front handle and/or rack flange fit onto front frame.

Sub-module cabinets (1/4 MW & 1/2 MW) may be extended to full rack width, by using rack mounting adapters as shown above.

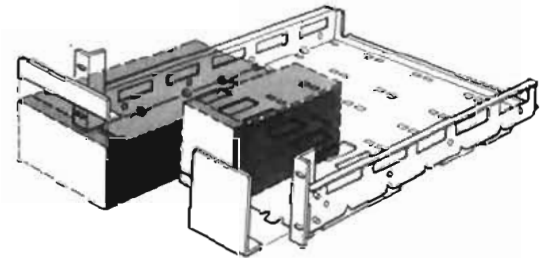
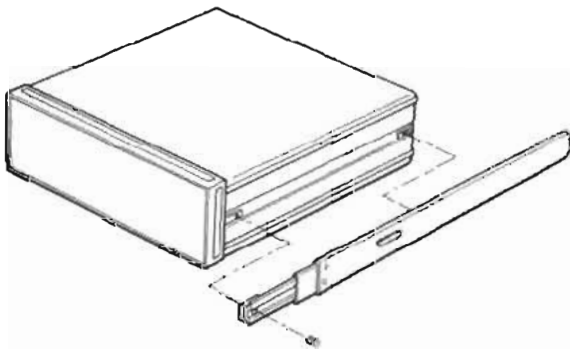

Sub-module cabinets (1/4 MW & 1/2 MW) of any height and depth may be rack mounted by using the support shelf and optional filler panels.

Standard slides fit full module cabinets (1 MW) for installation in HP rack enclosures. Adapter brackets for using slides in non-HP rack enclosures are also available.

### Rack mounting accessories for System-II cabinets

S-II Cabinet Width	Item <sup>1</sup>	Description		Part Number	Price
1 MW (Full Module)	Rack flange kit (Will be shipped with instrument, if ordered as Option 908 at same time. Otherwise available separately per Part Numbers listed at right.)	Includes two rack flanges; fit on each side of front panel frames, for cabinets this high.	3½ H	5061-0076	\$15
			5¼ H	5061-0077	\$15
			7 H	5061-0078	\$20
			8¾ H	5061-0079	\$20
			10½ H	5061-0080	\$25
			12¾ H	5061-0081	\$25
Rack flange & front handle combination kit (Will be shipped with instrument, if ordered as Option 909 at same time. Otherwise available separately per Part Numbers listed at right.)	Includes two rack flange/front handle combinations; fit one each side of front panel frame, for cabinets this high.	3½ H	5061-0082	\$20	
		5¼ H	5061-0083	\$30	
		7 H	5061-0084	\$45	
		8¾ H	5061-0085	\$45	
		10½ H	5061-0086	\$60	
		12¾ H	5061-0087	\$60	
Standard slide kit for HP rack enclosures	Includes two standard slides for installing instrument weighing no more than 38.6 kg (85 lb.) into HP rack enclosures. Fit side handle recess on S-II cabinets this deep.	140 & 170	1494-0018	\$45	
		200 & 230	1494-0017	\$45	
		140 & 170	1494-0025	\$85	
		200 & 230	1494-0026	\$85	
			1494-0023	\$20	
Slide adapter bracket kit	Includes brackets for adapting the standard slides above for use in non-HP rack system enclosures of adequate depth.			\$20	
				\$20	
Heavy-duty slide kit for HP rack enclosures	Includes two heavy-duty slides for installing instrument weighing no more than 79.6 kg (175 lb.) into HP rack enclosures. Fit S-II cabinets this deep.	200 & 230	1494-0016	\$115	
				\$115	
¼ MW (Quarter Module) and ½ MW (Half Module)	Rack mounting adapter kit <sup>2</sup>	Includes one rack flange and one extension adapter ¼ MW. For mounting one S-II cabinet ¼ MW, having a height 3½ H.		5061-0053	\$25
			3½ H	5061-0054	\$25
			5¼ H	5061-0057	\$25
			7 H	5061-0060	\$35
	Rack flange kit <sup>2</sup>	Includes one rack flange and one extension adapter ½ MW. For mounting one S-II cabinet ½ MW or two cabinets ¼ MW, having these heights.	10½ H	5061-0066	\$45
				5061-0055 <sup>2</sup>	\$25
	Rack flange & front handle combination kit <sup>2</sup>	Includes one rack flange and one extension adapter ¼ MW. For mounting one S-II cabinet ¼ MW together with one cabinet ¼ MW, or for mounting three cabinets ¼ MW together, having a height of 3½ H.			
	Support shelf	May be used whenever S-II cabinets ¼ MW and/or ½ MW are combined to a full width of 1 MW (Full Module).		See 1 MW above	
			See 1 MW above		
Slide kit for support shelf	May be used whenever S-II cabinets ¼ MW and/or ½ MW are combined a full width of 1 MW (Full Module).	For mounting one or more S-II cabinets which are ½ MW or ¼ MW, and up to 200. Cabinet depths need not be equal, but heights must match support shelf height, except where top filler panels are used. Maximum shelf projection behind front mounting panel is 534 mm (21 in.).	3½ H	5061-0056	\$100
			5¼ H	5061-0057	\$110
			7 H	5061-0058	\$125
Front filler panels for support shelf	Includes two slides for slide-mounting any of the above three support shelves in HP rack enclosures.		1494-0015	\$45	
		For 3½ H support shelf partially filled with S-II instruments, and having the following front panel space to fill:	¼ MW to fill	5061-2021	\$15
			½ MW to fill	5061-2022	\$20
			¾ MW to fill	5061-2023	\$25
Top filler panels for support shelf	For 5½ H support shelf, and having the following front panel space to fill:	¼ MW to fill	5061-2024	\$20	
		½ MW to fill	5061-2025	\$25	
		¾ MW to fill	5061-2026	\$30	
Top filler panels for support shelf	For 7 H support shelf, and having ½ MW front panel space to fill.		5061-2027	\$25	
Top filler panels for support shelf	For ¼ MW and having the following vertical space to fill:	1¾ H	5061-2035	\$10	
		3½ H	5061-2036	\$15	
Top filler panels for support shelf	For ½ MW and having the following vertical space to fill:	1¼ H	5061-2037	\$15	
		3¼ H	5061-2038	\$20	

<sup>1</sup> All kits and support shelf items are supplied with appropriate mounting screws and hardware.

<sup>2</sup> Cabinet lock-together kit (5061-0094) is also required whenever two, three or four sub-modules (¼ MW and/or ½ MW) are to be joined in a configuration using Rack mounting adapters or Rack

flanges. Also, submodules/adapters must be of equal depth.

<sup>3</sup> Requires two 5061-0055 kits if the cabinet ¼ MW is to be center-mounted.

# CABINETS AND MEASUREMENT ACCESSORIES

## Instrument accessories

### Cables, adapters, connectors

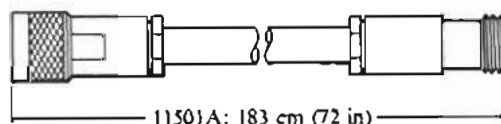
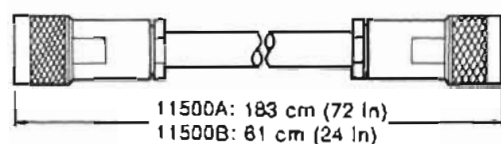
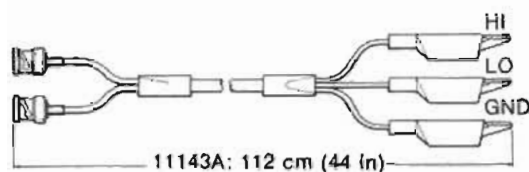
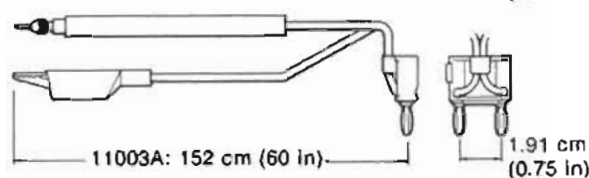
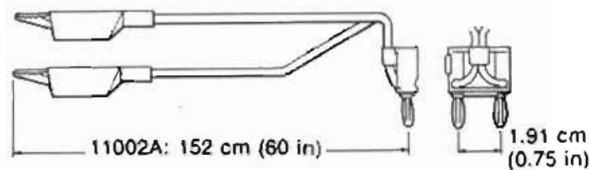
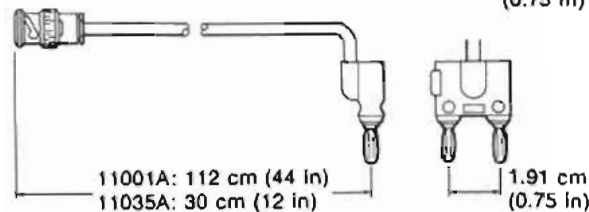
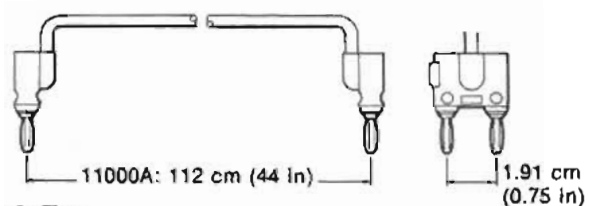
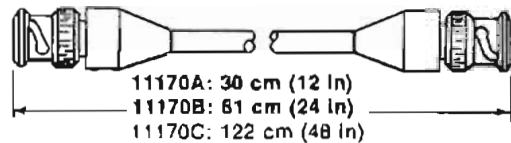

## Cable assemblies

### 11170A Cable assembly

30 cm (12 in.) of 50-ohm coaxial cable terminated on both ends with BNC (m) connectors.

Price

\$17

### 11170B Cable assembly

61 cm (24 in.) of 50-ohm coaxial cable terminated on both ends with BNC (m) connectors.

\$17

### 11170C Cable assembly

122 cm (48 in.) of 50-ohm coaxial cable terminated on both ends with BNC (m) connectors.

\$17

### 11000A Cable assembly

112 cm (44") of 50-ohm coaxial cable terminated on both ends with a dual banana plug, for  $\frac{3}{4}$ " binding posts.

\$17

### 11001A Cable assembly

112 cm (44 in.) of 50-ohm coaxial cable terminated on one end with a dual banana plug and on the other end with a UG-88C/U BNC (m) connector.

\$17

### 11002A Test leads

152 cm (60 in.) test leads alligator clips to dual banana plug.

\$12

### 11003A Test leads

152 cm (60 in.) test leads, probe and alligator clip to dual banana plug.

\$12

### 11035A Cable assembly

30 cm (12 in.) of 50-ohm coaxial cable terminated on one end with a dual banana plug and on the other end with a UG-88C/U BNC (m) connector.

\$17

### 11143A Cable assembly

112 cm (44 in.) test leads, dual BNC to alligator clips.

\$39

### 11500A Cable assembly

183 cm (72 in.) of 50-ohm coaxial cable terminated on both ends with UG-21D/U Type N (m) connectors.

\$45

### 11500B Cable assembly

Identical with 11500A except 61 cm (24 in.) long.

\$40

### 11501A Cable assembly

183 cm (72 in.) of 50-ohm coaxial cable terminated with UG-21D/U Type N (m) and UG-23D Type N (f) connectors.

\$50



1250-0076  
1250-1288

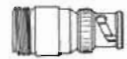

1250-0077  
1250-1534  
1250-1477

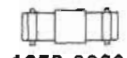

1250-0080  
1250-1287

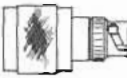

1250-0082  
1250-1533  
1250-1473



1250-0176



1250-0216  
1250-1288



1250-0559



1250-0777  
1250-1529  
1250-1472

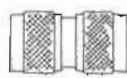

1250-0778  
1250-1528  
1250-1472

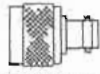

1250-0780  
1250-1535  
1250-1476



1250-0781



1250-0846



1250-1158

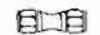

1250-1159

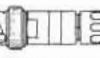

1250-1263

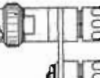

1250-1264



1250-1474

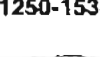

1250-1536

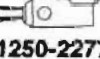

1250-2277

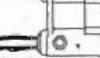

1251-2816

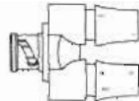

10110A

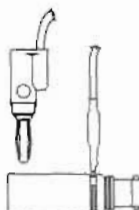

10111A



10113A

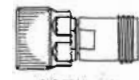

11524A



11525A

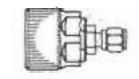

11533A

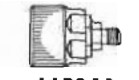

11534A

#### Adapters type N, Standard 50Ω

Part no.	Price
1250-0077 N (f) to BNC (m)	\$7.90
1250-0082 N (m) to BNC (m)	\$14
1250-0176 N (m) to Type N (f) right angle	\$8.75
1250-0559 N tee, (m) (f) (f)	\$21
1250-0777 N (f) to Type N (f)	\$6.50
1250-0778 N (m) to Type N (m)	\$10
1250-0780 N (m) to BNC (f)	\$5
1250-0846 N tee (f) (f) (f)	\$11

#### Adapters type N, Precision<sup>1</sup> 50Ω

Part no.	Price
1250-1472 N (f) to N (f)	\$20.50
1250-1473 N (m) to BNC (m)	\$20.50
1250-1474 N (f) to BNC (f)	\$16
1250-1475 N (m) to N (m)	\$26
1250-1476 N (m) to BNC (f)	\$20
1250-1477 N (f) to BNC (m)	\$17.50

#### Adapters type N, Standard 75 Ω<sup>2</sup>

Part no.	Price
1250-1528 N (m) to N (m)	\$25
1250-1529 N (f) to N (f)	\$25
1250-1533 N (m) to BNC (m)	\$40
1250-1534 N (f) to BNC (m)	\$35
1250-1535 N (m) to BNC (f)	\$40
1250-1536 N (f) to BNC (f)	\$30

#### Adapters SMA

Part no.	Price
1250-1158 SMA (f) to SMA (f)	\$8
1250-1159 SMA (m) to SMA (m)	\$11

#### Adapters APC-7

Part no.	Price
11524A APC-7 to Type N (f)	\$95
11525A APC-7 to Type N (m)	\$85
11533A APC-7 to SMA (m)	\$135
11534A APC-7 to SMA (f)	\$135

#### Adapter banana plug

Part no.	Price
1251-2816 Dual Banana plug	\$2.35

#### Adapters BNC, Standard 50 Ω

Part no.	Price
1250-0076 Right angle BNC (UG-306/D)	\$4.90
1250-0080 BNC (f) to BNC (f) (UG-914/U)	\$4.90
1250-0216 BNC (m) to BNC (m)	\$5.25
1250-0781 BNC Tee (m) (f) (f)	\$6.20
1250-1263 BNC (m) to single banana plug	\$9.30
1250-1264 BNC (m) to dual banana plug	\$16
1251-2277 BNC (f) to dual banana plug	\$10
10110A BNC (m) to dual banana plug	\$25
10111A BNC (f) to shielded banana plug	\$17
10113A Dual BNC (f) to triple banana plug	\$17

#### Adapters BNC, Standard 75 Ω

Part no.	Price
1250-1286 Right Angle BNC	\$12
1250-1287 BNC (f) to BNC (f)	\$10.50
1250-1288 BNC (m) to BNC (m)	\$11.50

<sup>1</sup>Precision<sup>1</sup>: typically >36 dB Return Loss to 1.3 GHz.  
<sup>2</sup>Type N outer conductor, center pin sized for 75 Ω characteristic.

# CABINETS & MEASUREMENT ACCESSORIES

Instrument accessories  
Probes, voltage dividers



10007B



11021A



11036A



11040A



11045A



11047A

### 10007B, 10008B Probe

The 10007B and 10008B are straight-thru BNC probes with a retractable hook tip, and 20 cm (8 in.) ground lead with alligator tip included

Price

\$32

	Peak Voltage	Shunt Capacitance	Length
10007B	600 V	40 pF	1.1m (3.5 ft.)
10008B	600 V	60 pF	1.8m (6 ft.)

### 11021A Divider probe

1000:1 divider probe increases range of HP 425A DC Microvolt-Ammeter to 1000 volts

\$135

### 11028A Current divider

100:1 divider for extended range measurements for 456A AC Current Probe

\$85

### 11036A AC probe

Peak responding for use with 410C

\$150

### 11040A Capacitive voltage divider

For 410 series voltmeters. Increases range so transmitter voltages can be measured quickly and easily. Accuracy  $\pm 1\%$ . Division ratio 100:1. Input capacity approximately 2 pF. Maximum voltage 2000 V at 50 MHz, decreasing to 100 V at 400 MHz. Frequency range 10 kHz to 400 MHz

\$110

### 11045A DC voltage divider

For 410C voltmeter. Gives maximum safety and conveniences for measuring high voltages as in television receivers, etc. Accuracy  $\pm 5\%$ . Division ratio 100:1. Input impedance 1 G $\Omega$ . Maximum voltage 30 kV. Maximum current drain 2.5  $\mu$ A

\$100

### 11047A Output voltage divider

Input 600 $\Omega$ . Output 600 $\Omega \pm 1\%$ . 6 $\Omega \pm 1\%$ . Voltage rating 1/2 watt

\$30





456A (with ac VM)



11473A

## 456A Description

Conventional voltmeters or oscilloscopes can measure current quickly and dependably—without direct connection to the circuit under test or any appreciable loading to test circuit. HP's 456A AC Current Probe clamps around the current-carrying wire, and provides a voltage output read on a voltmeter or scope. Model 456A's 1 mA to 1 mV conversion permits direct reading up to 1 A rms.

## 456A Specifications

**Sensitivity:** 1 mV/mA  $\pm 1\%$  at 1 kHz.  
**Frequency response:**  $\pm 2\%$ , 100 Hz to 3 MHz;  $\pm 5\%$ , 60 Hz to 4 MHz;  $-3$  dB at  $< 25$  Hz and  $> 20$  MHz.  
**Pulse response:** rise time is  $< 20$  ns, sag  $< 16\%$ /ms.  
**Maximum input:** 1 A rms, 1.5 A peak; 100 mA above 5 MHz.  
**Effect of dc current:** no appreciable effect on sensitivity and distortion from dc current up to 0.5 A.  
**Input impedance:** (impedance added in series with measured wire by probe)  $< 50$  m $\Omega$  in series with 0.05  $\mu$ H (this is approximately the inductance of 1 1/2 in. of hookup wire).  
**Probe aperture:** 4 mm (3/16") diameter.  
**Probe shunt capacity:** approx. 4 pF added from wire to ground.  
**Distortion at 1 kHz:** for 0.5 A input at least 50 dB down; for 10 mA input at least 70 dB down.  
**Equivalent input noise:**  $< 50$   $\mu$ A rms (100  $\mu$ A when ac powered).  
**Output impedance:** 220 $\Omega$  at 1 kHz; approximately +1 V dc component; should work into load of not less than 100,000 $\Omega$  shunted by approximately 25 pF.  
**Power:** battery life (two), approximately 400 hours; ac power supply: Option 001, 115 or 230 V  $\pm 10\%$ , 50 to 1000 Hz approx. 1 W.

## 11473A-11476A Description

New balancing transformers provide a balanced output from a single-ended input, or a single-ended output from a balanced input. Impedances available are 75 ohms unbalanced to 124 $\Omega$ , 135 $\Omega$ , 150 $\Omega$ , and 600 $\Omega$  balanced. Frequency response is  $\pm 0.5$  dB.

(Each module contains two transformers with the following specifications)

Model No.		11473A	11473B	11474A	11475A	11476A
Impedance*	Unbal	75 $\Omega$	75 $\Omega$	75 $\Omega$	75 $\Omega$	75 $\Omega$
	Bal	600 $\Omega$	600 $\Omega$	135 $\Omega$	150 $\Omega$	124 $\Omega$
Mating connectors	Unbal	BNC	BNC	BNC	BNC	BNC
	Bal	WECO 310	Siemens 9 REL STP-6AC	WECO 241	Siemens 4 IHL STP-6AC	WECO 408A
Frequency range:		20 Hz—50 kHz	20 Hz—50 kHz	2 kHz—2 MHz	2 kHz—2 MHz	5 kHz—5 MHz
Frequency response:		$\pm 0.5$ dB	$\pm 0.5$ dB	$\pm 0.5$ dB	$\pm 0.5$ dB	$\pm 0.5$ dB
Insertion loss:		$< 0.75$ dB at 1 kHz	$< 0.75$ dB at 1 kHz	$< 0.75$ dB at 50 kHz	$< 0.25$ dB at 50 kHz	$< 0.25$ dB at 50 kHz
Longitudinal balance:		$> 40$ dB	$> 40$ dB	$> 40$ dB	$> 40$ dB	$> 35$ dB
Max input power:		+13 dBm	+13 dBm	+27 dBm	+27 dBm	+27 dBm

\*50 $\Omega$  unbalanced to balanced transformer available on special basis. Above specifications apply

Ordering Instructions  
 456A AC Current Probe  
 Opt 001: AC Power Supply  
 11473A Balancing Transformer

Price  
 \$425  
 add \$45  
 \$290

11473B Balancing Transformer  
 11474A Balancing Transformer  
 11475A Balancing Transformer  
 11476A Balancing Transformer

\$290  
 \$290  
 \$310  
 \$290

# CABINETS AND MEASUREMENT ACCESSORIES

Combining cases, rack adapters, panel covers, carrying cases

1051A, 1052A, 11046A, 11075A, 5060 Series

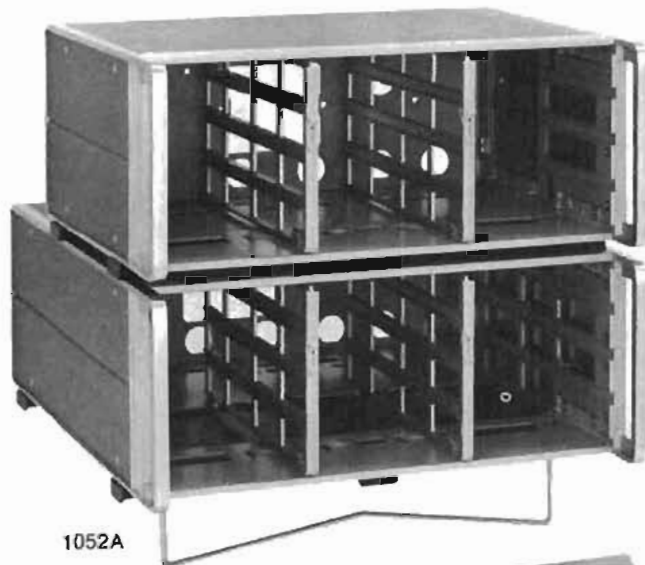

1051A

1052A

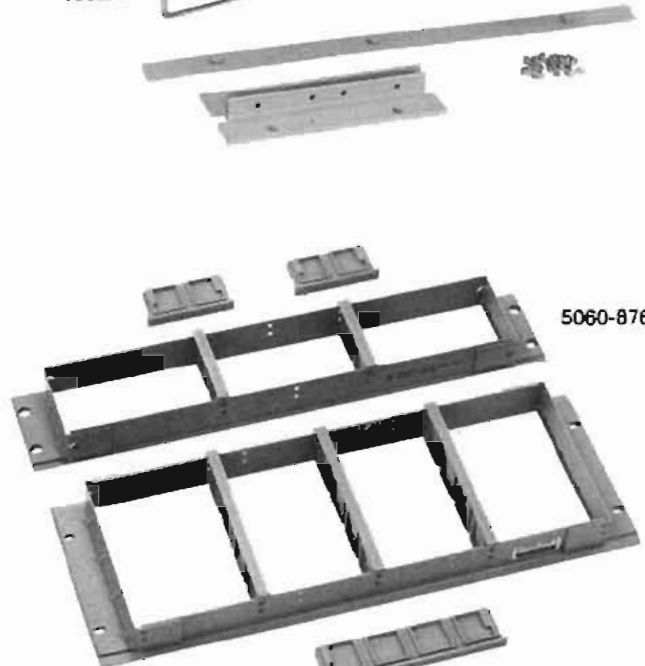

5060-8764

5080-8762

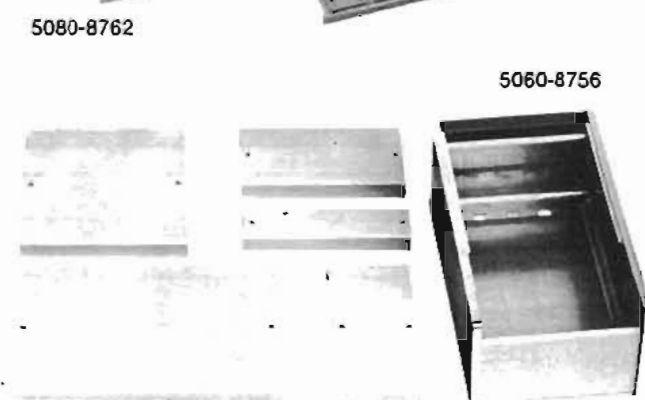

5060-8756

5060-8757 to 5060-8761

## 1051A, 1052A Combining cases

Models 1051A and 1052A combining cases conveniently rack or bench mount combinations of small modular Hewlett-Packard instruments. In addition, these cases can be stacked on each other or on any full module instrument. Both cases accept  $\frac{1}{2}$  or  $\frac{1}{4}$  instrument modules, 130 mm or 198 mm wide ( $5\frac{1}{8}$  or  $7\frac{7}{32}$  inches). The basic difference is that the 1052A is 130 mm ( $5\frac{1}{8}$  inches) deeper, and will accept modules up to 416 mm deep ( $16\frac{3}{8}$  inches). The extra length provides more space in the rear for wiring. The 1051A accepts instruments up to 286 mm deep ( $11\frac{1}{4}$  inches). Each case is furnished with two dividers.

## 1051A, 1052A Specifications

### Price

### Dimensions

1051A: 178 H  $\times$  482.6 W  $\times$  337 mm D ( $7'' \times 19'' \times 13\frac{1}{4}''$ ).

1052A: 178 H  $\times$  482.6 W  $\times$  467 mm D ( $7'' \times 19'' \times 18\frac{3}{4}''$ ).

### Weight

1051A: net, 4.5 kg (10 lb). Shipping, 6.7 kg (15 lb) \$300

1052A: net, 5.4 kg (12 lb). Shipping, 8.1 kg (18 lb) \$325

Opt 910: extra manual add \$1

## Rack adapter frames 5060-8762, 5060-8764

These frames can be used to hold combinations of  $\frac{1}{2}$  and  $\frac{1}{4}$  width module HP instruments. Each frame is furnished with mounting hardware and divider panels. Two models are available for different instrument heights. Adapter frames are for permanent or semipermanent rack mounting. Where quick removal and reinstallation of instruments is desirable, the 1051A and 1052A combining cases should be used.

5060-8762: equivalent to IEC 4U (7" H), accepts instrument heights of 38, 77, or 155 mm ( $1\frac{1}{2}''$ ,  $3\frac{1}{32}''$ , or  $6\frac{1}{32}''$ ) \$60

5060-8764: accepts only instrument heights of 38 or 77 mm ( $1\frac{1}{2}''$  or  $3\frac{1}{32}''$ ) \$55

## Filler panels, 5060-8757 to 5060-8761

Filler panels can be used to close off any leftover space after instruments are mounted in combining cases or adapter frames. Panels are made in a variety of widths and heights. Available widths are  $\frac{1}{4}$ ,  $\frac{1}{2}$ , and  $\frac{1}{2}$  modules; heights are  $\frac{1}{4}$ ,  $\frac{1}{2}$  and the full 155 mm ( $6\frac{1}{32}''$ ).

## Specifications, filler panels

Part No.	Module Case Height $\times$ Width	Dimensions		Price
		mm	in	
5060-8757	$\frac{1}{4} \times \frac{1}{2}$	38 $\times$ 130	$1\frac{1}{2} \times 5\frac{1}{8}$	\$12
5060-8758	$\frac{1}{2} \times \frac{1}{2}$	77 $\times$ 130	$3\frac{1}{32} \times 5\frac{1}{8}$	\$15
5060-8759	full $\times$ $\frac{1}{2}$	155 $\times$ 130	$6\frac{1}{32} \times 5\frac{1}{8}$	\$15
5060-8760	full $\times$ $\frac{1}{2}$	155 $\times$ 198	$6\frac{1}{32} \times 7\frac{7}{32}$	\$16
5060-8761	full $\times$ $\frac{1}{4}$	155 $\times$ 63	$6\frac{1}{32} \times 2\frac{31}{64}$	\$12

## Accessory drawer 5060-8756

\$85

The accessory drawer can be used in place of a filler panel to finish off unused space in the combining cases. The drawer is  $\frac{1}{4}$  width and  $\frac{1}{2}$  height.

Dimensions: 77 H  $\times$  130.2 W  $\times$  279.4 mm D ( $3\frac{1}{32}'' \times 5\frac{1}{8}'' \times 11''$ )

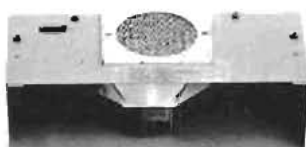

5060-0789

**Cooling kits, 5060-0789 and 5060-0796**

These cooling kits are designed to be easily installed in the 1052A combining case. They can be installed in the 1051A, at the factory upon special request, but installation in the shorter case limits the depth of instruments the case can accept, and makes it impossible to use the accessory drawer.

5060-0789: 115 V, 50 to 60 Hz

\$200

5060-0796: 230 V, 50 to 60 Hz

\$200

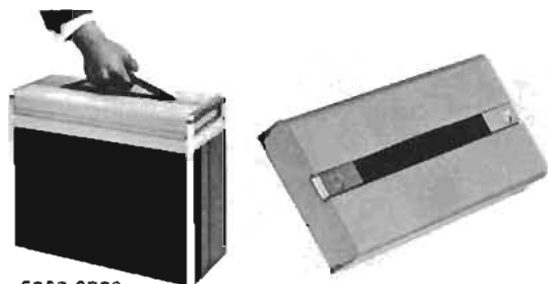

5060-8768

**Control panel covers, 5060-8766 to 5060-8771**

A series of control panel covers equipped with carrying handles are available for full rack width instruments. These covers protect instrument front panels and make rack mounted instruments tamper-proof.

One of these covers, the 5060-8768, fits either the 1051A or 1052A. Other covers are available to fit the six modular enclosures with front panel heights ranging from 88.1 to 310.4 mm (3 1/2 to 12 1/4").

5060-8766: 88.1 mm (3 1/2") EIA panel height

\$80

5060-8767: 132.6 mm (5 1/4") EIA panel height

\$85

5060-8768: 177 mm (7") EIA panel height

\$90

5060-8769: 221.5 mm (8 3/4") EIA panel height

\$95

5060-8770: 265.9 mm (10 1/2") EIA panel height

\$100

5060-8771: 310.4 mm (12 1/4") EIA panel height

\$110



11046A

**11046A Carrying case**

This rugged, splashproof carrying case accepts 1/3 width module instruments (maximum depth 203.2 mm or 8"). The case includes a shoulder carrying strap. Weight 5.4 kg (12 lb).

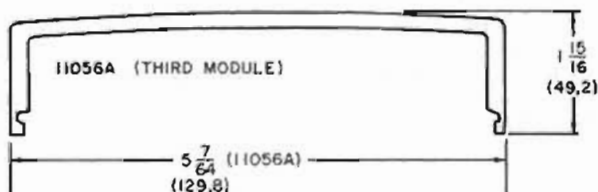

11056A

**11056A Handle kit**

A handle for carrying HP instrument modules of 1/3 width. \$15



11075A

**11075A, 11076A Module instrument case**

A rugged, high impact plastic instrument case for HP 1/3 module instruments. Instruments can be operated, stored or carried in this splashproof case. Storage compartment for power cord in rear of case is accessible through a removable hatch. Front lid contains adequate storage space for cables, test leads, etc. The dual purpose tilt stand also serves as a carrying handle. 11075A is 203 mm D (8"); 11076A is 279 mm (11") D.

11075A: Module Instrument Case

\$115

11076A: Module Instrument Case

\$135

# CABINETS & MEASUREMENT ACCESSORIES

Rugged protection for Instruments  
System-II modular instrument transit cases

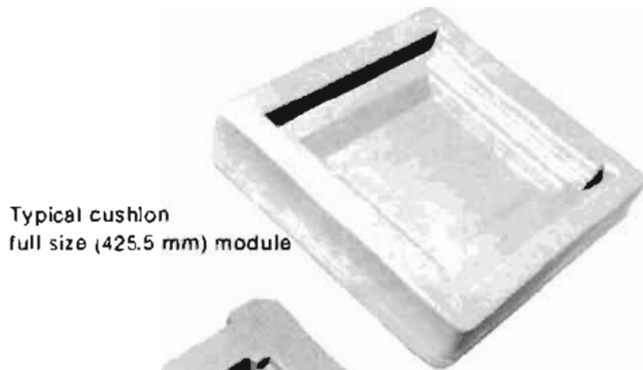

Typical cushion  
full size (425.5 mm) module

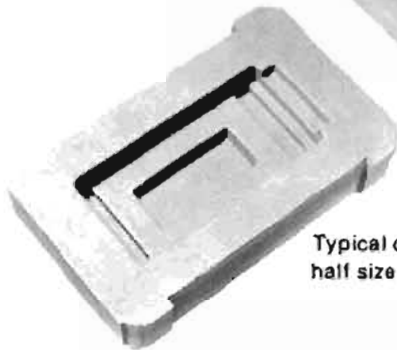

Typical cushion  
half size module (197.6 mm wide)



Typical transit case



V= Valise Style



S= Split Style

## Transit Case Styles

The HP transit cases are rugged protective outer shells for use when instruments must be frequently transported and used away from laboratory conditions. They are molded of strong fiberglass-reinforced plastic. All are sealed tightly with O-ring gaskets and clamping latches. They are rainproof under the test conditions of MIL-STD-108. Carrying handles are conveniently placed, fold flat when not in use.

Transit cases are typically provided with foam cushions, custom formed to fit the standard HP modular cabinets. This arrangement provides maximum protection against damage from handling, dropping, or crushing. A selection of case sizes is available to accommodate nearly any instrument and combination of accessories.

## Transit cases

Instrument Size (inches)			Instrument Size (mm)			Case Size* (inches) Not including hardware			Case size (mm) Not including hardware			Style	Shipping Weight		HP Part Number	Price
H	W	D	H	W	D	L	W	D	L	W	D		lbs.	kg		
3 1/2	16 3/4	13 1/4	88.1	425.5	336.6	20 1/2	17 1/2	9	520.7	444.5	228.6	V	15	68	9211-1288	\$185
5 1/2	16 3/4	13 1/4	132.6	425.5	336.6	20 1/2	17 1/2	10 3/4	520.7	444.5	273.1	V	16	73	9211-1289	\$185
7	16 3/4	13 1/4	177.0	425.5	336.6	20 1/2	17 1/2	12 1/2	520.7	444.5	317.5	V	17	77	9211-1290	\$185
8 3/4	16 3/4	13 1/4	221.5	425.5	336.6	20 1/2	17 1/2	14 1/4	520.7	444.5	362.0	S	18	82	9211-1291	\$205
3 1/2	18 3/4	18 3/4	88.1	425.5	466.7	23	21	9	584.2	533.4	228.6	V	18	82	9211-1292	\$220
5 1/4	18 3/4	18 3/4	132.6	425.5	466.7	23	21	10 3/4	584.2	533.4	273.1	V	19	86	9211-1293	\$230
7	18 3/4	18 3/4	177.0	425.5	466.7	23	21	12 1/2	584.2	533.4	317.5	V	20	91	9211-1294	\$230
8 3/4	18 3/4	18 3/4	221.5	425.5	466.7	23	21	14 1/4	584.2	533.4	362.0	V	21	95	9211-1295	\$220
10 1/2	18 3/4	18 3/4	265.9	425.5	466.7	23	21	16	584.2	533.4	406.4	S	22	100	9211-1296	\$220
12 1/4	18 3/4	18 3/4	310.4	425.5	466.7	23	21	17 3/4	584.2	533.4	450.9	S	22	100	9211-1297	\$225
5 1/4	16 3/4	21 3/4	132.6	425.5	542.9	25 1/2	23 1/2	10 3/4	647.7	596.9	273.1	V	24	110	9211-1318	\$290
7	16 3/4	21 3/4	177.0	425.5	542.9	25 1/2	23 1/2	12 1/2	647.7	596.9	317.5	V	24	110	9211-1319	\$300
12 1/4	16 3/4	24 3/4	310.4	425.5	542.9	24	19	29 3/4	609.6	482.6	755.7	S	32	150	9211-1297	\$410
6 1/2	5 1/8	8	165.1	130.2	203.2	14 1/4	9	13 1/4	362.0	228.6	285.8	V	8	36	9211-1317	\$110
6 1/2	5 1/8	11	165.1	130.2	279.4	16 3/8	10 3/8	11 1/4	428.6	263.5	285.8	V	11	50	9211-1318	\$125
6 1/2	7 3/8	8	165.1	196.9	203.2	16 3/8	10 3/8	12 3/4	428.6	263.5	285.8	V	11	50	9211-1319	\$135
6 1/2	7 3/8	11	165.1	196.9	279.4	16 3/8	10 3/8	11 1/4	428.6	263.5	285.8	V	11	50	9211-1315	\$125
6 1/2	7 3/8	16	165.1	196.9	406.4	20 1/2	12 1/2	11 1/4	520.7	317.5	285.8	V	15	68	9211-1314	\$185
6 1/2	10 1/2	11	165.1	266.7	279.4	16 3/8	14 1/2	8 3/4	419.1	368.3	215.9	V	12	55	9211-1315	\$155

### Full-module width instruments

Appropriate Front Handle Kit (HP Part Number 5061-0088 to -0093) must be installed on instruments for adequate protection.

#### Dimensions in inches and mm

Instrument size						Case size* (not including hardware)						Style	HP Part Number	Price
H		W		D		L		W		D				
in	mm	in	mm	in	mm	in	mm	in	mm	in	mm			
3 1/2	88.1	16 3/4	425.5	13 3/4	349.3	23	584.2	21	533.4	8 3/4	222.3	V	9211-2642	\$230
5 1/4	132.6	16 3/4	425.5	13 3/4	349.3	23	584.2	21	533.4	10 1/2	266.7	V	9211-2643	\$230
7	177.0	16 3/4	425.5	13 3/4	349.3	23	584.2	21	533.4	12 1/4	311.2	V	9211-2644	\$230
8 3/4	221.5	16 3/4	425.5	13 3/4	349.3	23	584.2	21	533.4	14	355.6	V	9211-2645	\$230
10 1/2	265.9	16 3/4	425.5	13 3/4	349.3	23	584.2	21	533.4	15 3/4	400.1	S	9211-2646	\$230
12 1/4	310.4	16 3/4	425.5	13 3/4	349.3	23	584.2	21	533.4	17 1/2	444.5	S	9211-2647	\$230
3 1/2	88.1	16 3/4	425.5	16 3/4	425.5	24 1/2	622.3	24 1/2	622.3	8 3/4	222.3	V	9211-2648	\$245
5 1/4	132.6	16 3/4	425.5	16 3/4	425.5	24 1/2	622.3	24 1/2	622.3	10 1/2	266.7	V	9211-2649	\$245
7	177.0	16 3/4	425.5	16 3/4	425.5	24 1/2	622.3	24 1/2	622.3	12 1/4	311.2	V	9211-2650	\$245
8 3/4	221.5	16 3/4	425.5	16 3/4	425.5	24 1/2	622.3	24 1/2	622.3	14	355.6	S	9211-2651	\$245
10 1/2	265.9	16 3/4	425.5	16 3/4	425.5	24 1/2	622.3	24 1/2	622.3	15 3/4	400.1	S	9211-2652	\$245
12 1/4	310.4	16 3/4	425.5	16 3/4	425.5	28	711.2	24	609.6	17 1/2	444.5	S	9211-2653	\$250
3 1/2	88.1	16 3/4	425.5	19 3/4	501.7	28	711.2	24	609.6	8 3/4	222.3	V	9211-2654	\$250
5 1/4	132.6	16 3/4	425.5	19 3/4	501.7	28	711.2	24	609.6	10 1/2	266.7	V	9211-2655	\$250
7	177.0	16 3/4	425.5	19 3/4	501.7	28	711.2	24	609.6	12 1/4	311.2	V	9211-2656	\$250
8 3/4	221.5	16 3/4	425.5	19 3/4	501.7	28	711.2	24	609.6	14	355.6	S	9211-2657	\$250
10 1/2	265.9	16 3/4	425.5	19 3/4	501.7	28	711.2	24	609.6	15 3/4	400.1	S	9211-2658	\$250
12 1/4	310.4	16 3/4	425.5	19 3/4	501.7	28	711.2	24	609.6	17 1/2	444.5	S	9211-2659	\$250
3 1/2	88.1	16 3/4	425.5	22 3/4	577.9	30 1/2	774.7	24 1/2	622.3	8 3/4	222.3	V	9211-2660	\$250
5 1/4	132.6	16 3/4	425.5	22 3/4	577.9	30 1/2	774.7	24 1/2	622.3	10 1/2	266.7	V	9211-2661	\$250
7	177.0	16 3/4	425.5	22 3/4	577.9	30 1/2	774.7	24 1/2	622.3	12 1/4	311.2	V	9211-2662	\$250
8 3/4	221.5	16 3/4	425.5	22 3/4	577.9	30 1/2	774.7	26 1/4	666.8	14	355.6	S	9211-2663	\$260
10 1/2	265.9	16 3/4	425.5	22 3/4	577.9	30 1/2	774.7	26 1/4	666.8	15 3/4	400.1	S	9211-2664	\$260
12 1/4	310.4	16 3/4	425.5	22 3/4	577.9	30 1/2	774.7	26 1/4	666.8	17 1/2	444.5	S	9211-2665	\$260

\*For overpack size to hold case add 1 1/4", 31.8 mm, to L & W and 1/4", 6.4 mm to D.

### Half-and quarter-module width instruments

#### Dimensions in inches and mm

Instrument size						Case size* (not including hardware)						Style	HP Part Number	Price
H		W		D		L		W		D				
in	mm	in	mm	in	mm	in	mm	in	mm	in	mm			
3 1/2	88.1	8 3/4	204.2	10 3/4	273.1	14 7/8	377.8	13 3/4	349.3	7 1/2	190.5	V	9211-2666	\$155
5 1/4	132.6	8 3/4	204.2	10 3/4	273.1	14 7/8	377.8	13 3/4	349.3	9 1/4	235.0	V	9211-2667	\$155
7	177.0	8 3/4	204.2	10 3/4	273.1	14 7/8	377.8	13 3/4	349.3	11	279.4	V	9211-2668	\$155
8 3/4	221.5	8 3/4	204.2	10 3/4	273.1	14 7/8	377.8	13 3/4	349.3	12 3/4	323.9	V	9211-2669	\$155
10 1/2	265.9	8 3/4	204.2	10 3/4	273.1	14 7/8	377.8	13 3/4	349.3	14 1/2	368.3	V	9211-2670	\$155
3 1/2	88.1	8 3/4	204.2	13 3/4	349.3	20	508.0	13 3/2	342.9	7 1/2	190.5	V	9211-2671	\$165
5 1/4	132.6	8 3/4	204.2	13 3/4	349.3	20	508.0	13 3/2	342.9	9 1/4	235.0	V	9211-2672	\$165
7	177.0	8 3/4	204.2	13 3/4	349.3	20	508.0	13 3/2	342.9	9 3/4	235.0	V	9211-2673	\$165
8 3/4	221.5	8 3/4	204.2	13 3/4	349.3	20	508.0	13 3/2	342.9	12 3/4	323.9	V	9211-2674	\$165
10 1/2	265.9	8 3/4	204.2	13 3/4	349.3	20	508.0	13 3/2	342.9	14 1/2	368.3	V	9211-2675	\$165
3 1/2	88.1	8 3/4	204.2	16 3/4	425.5	20	508.0	13 3/2	342.9	7 1/2	190.5	V	9211-2676	\$165
5 1/4	132.6	8 3/4	204.2	16 3/4	425.5	20	508.0	13 3/2	342.9	9 1/4	235.0	V	9211-2677	\$165
7	177.0	8 3/4	204.2	16 3/4	425.5	20	508.0	13 3/2	342.9	11	279.4	V	9211-2678	\$165
8 3/4	221.5	8 3/4	204.2	16 3/4	425.5	20	508.0	13 3/2	342.9	12 3/4	323.9	V	9211-2679	\$165
10 1/2	265.9	8 3/4	204.2	16 3/4	425.5	20	508.0	13 3/2	342.9	14 1/2	368.3	V	9211-2680	\$165
3 1/2	88.1	8 3/4	204.2	19 3/4	501.7	24 1/4	616.0	13	330.2	7 1/2	190.5	V	9211-2681	\$175
5 1/4	132.6	8 3/4	204.2	19 3/4	501.7	24 1/4	616.0	13	330.2	9 1/4	235.0	V	9211-2682	\$175
7	177.0	8 3/4	204.2	19 3/4	501.7	24 1/4	616.0	13	330.2	11	279.4	V	9211-2683	\$175
8 3/4	221.5	8 3/4	204.2	19 3/4	501.7	24 1/4	616.0	13	330.2	12 3/4	323.9	V	9211-2684	\$175
10 1/2	265.9	8 3/4	204.2	19 3/4	501.7	24 1/4	616.0	13	330.2	14 1/2	368.3	V	9211-2685	\$175
3 1/2	88.1	4 1/2	104.8	10 3/4	273.1	14	355.6	10	254.0	6 1/2	165.1	V	9211-2686	\$145
5 1/4	132.6	4 1/2	104.8	10 3/4	273.1	14	355.6	10	254.0	8 3/4	209.6	V	9211-2687	\$145
7	177.0	4 1/2	104.8	10 3/4	273.1	14	355.6	10	254.0	10	254.0	V	9211-2688	\$145
3 1/2	88.1	4 1/2	104.8	13 3/4	349.3	16 7/8	428.6	10 1/2	266.7	6 1/2	165.1	V	9211-2689	\$155
5 1/4	132.6	4 1/2	104.8	13 3/4	349.3	16 7/8	428.6	10 1/2	266.7	8 3/4	209.6	V	9211-2690	\$155
7	177.0	4 1/2	104.8	13 3/4	349.3	16 7/8	428.6	10 1/2	266.7	10	254.0	V	9211-2691	\$155
3 1/2	88.1	4 1/2	104.8	16 3/4	425.5	20 1/4	514.4	11 3/4	298.5	8 3/2	165.1	V	9211-2692	\$160
5 1/4	132.6	4 1/2	104.8	16 3/4	425.5	20 1/4	514.4	11 3/4	298.5	10	254.0	V	9211-2693	\$160
7	177.0	4 1/2	104.8	16 3/4	425.5	20 1/4	514.4	11 3/4	298.5	10	254.0	V	9211-2694	\$160

\*For overpack size to hold case add 1 1/4", 31.8 mm, to L & W and 1/4", 6.4 mm to D.



Cases for other size instruments or special applications are available through HP Service Center



Caster kit 1490-0913 can be field installed to provide (4) 3 1/4" diameter swivel casters mounted with quarter turn fasteners

# CABINETS & MEASUREMENT ACCESSORIES

Operating Cases: rugged protection for instruments



Operating Case with instrument and drawer.

HP cases are rugged protective outer shells for use when instruments must be frequently transported and used away from laboratory conditions. They are molded of strong fiberglass and have conveniently placed carrying handles that fold flat when not in use. All are sealed tightly with O-ring gaskets and clamping latches and are rainproof under the test conditions of MIL-STD-108.

Operating cases are equipped internally with shock-mounted frames that accept any standard 19-inch rack-mounting instruments up to the maximum height of the frames. This arrangement offers the convenience of operation without removing the instrument from its carrying case. At the same time, environmental protection is afforded.

More than one instrument may be combined in a single operating case for convenience in setting up and operating. Patch-cable interconnections may then be left in place within the case, so that when the unit has been transported to its place of use the covers are removed and the instruments inside are ready to put into use with a minimum of delay.

Drawers are available in three different heights so that small accessories, tools, etc., can be kept inside the case with the instruments. Fitted foam cushions can be made up to accommodate nearly any shape articles.



A caster kit is available to fit the operating case allowing it to become a mobile rack. Once the kit is installed, the casters themselves may be attached or removed in seconds. With casters removed, the attaching hardware adds nothing to the overall dimensions of the case.



Fitted foam drawer cushions to accommodate various HP accessory combinations are available.

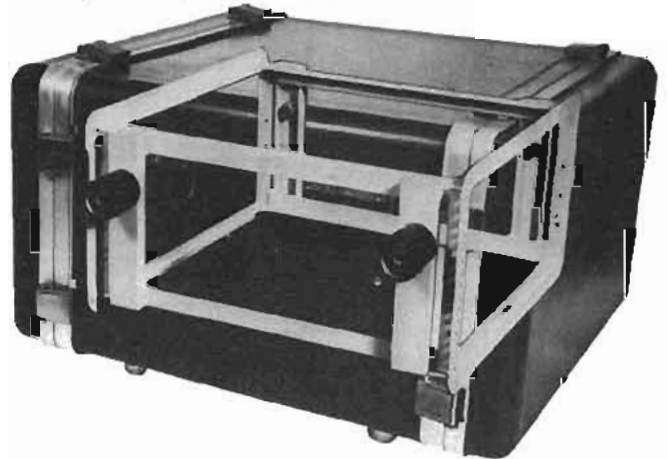

Equipped with elastomeric shock mounts, these enclosures provide outstanding shock and vibration attenuation. A set of standard shock mounts can be provided for any equipment weight and fragility.



Operating Case showing T-Bars Installed



Nominal rack ht. in	ISO	Instrument Weight				Case Size (inches) Not including hardware			Case Size (mm) Not including hardware			Weight				HP Part Number	Price
		Maximum lb	kg	Minimum lb	kg	W	H	D	W	H	D	Case lb	kg	Shipping lb	kg		
5 1/4	3U	75	34.0	20	9.1	24.0	10.8	28.5	609.6	274.3	723.9	40	18.1	50	28.7	9211-1302	\$725
8 1/4	5U	75	34.0	20	9.1	24.0	15.0	27.0	609.6	381.0	685.8	46	20.9	56	25.4	9211-1303	\$800
10 1/4	6U	130	59.0	30	13.6	24.0	17.0	28.5	609.6	431.8	723.9	53	24.0	64	29.0	9211-2635	\$825
12 1/4	7U	100	45.4	25	11.3	24.0	18.9	28.5	609.6	480.1	723.9	55	24.9	65	29.5	9211-1163*	\$850
14	8U	130	59.0	30	13.6	24.0	20.6	28.5	609.6	523.2	723.9	57	25.9	70	37.8	9211-1241	\$1100
15 3/4	9U	130	59.0	30	13.6	24.0	22.4	28.5	609.6	569.0	723.9	60	27.2	75	34.0	9211-1242	\$1100
17 1/2	10U	130	59.0	30	13.6	24.0	24.1	28.5	609.6	612.1	723.9	64	29.0	80	36.3	9211-1243	\$1100
19 1/4	11U	130	59.0	30	13.6	24.0	25.9	28.5	609.6	657.9	723.9	69	31.3	85	38.6	9211-1244	\$1150
21	13U	250	113.4	50	22.7	24.0	28.0	28.5	609.6	711.2	723.9	75	34.0	90	40.8	9211-1245	\$1150
22 3/4	14U	250	113.4	50	22.7	24.0	29.5	28.5	609.6	749.3	723.9	77	34.9	95	43.1	9211-2636	\$1300
24 1/4	15U	250	113.4	50	22.7	24.0	31.0	28.5	609.6	787.4	723.9	80	36.3	100	45.4	9211-1911	\$1300
26 1/4	16U	250	113.4	50	22.7	24.0	30.8	28.5	609.6	782.3	723.9	83	37.6	105	47.6	9211-2637	\$1300
28	17U	250	113.4	50	22.7	24.0	34.5	28.5	609.6	876.3	723.9	87	39.5	110	49.9	9211-2638	\$1300
29 3/4	18U	250	113.4	50	22.7	24.0	36.4	28.5	609.6	924.6	723.9	90	40.8	115	52.2	9211-2639	\$1350
31 1/4	19U	250	113.4	50	22.7	24.0	38.0	28.6	609.6	965.2	723.9	94	42.6	120	54.4	9211-2640	\$1350
33 1/4	20U	250	113.4	50	22.7	24.0	39.9	28.5	609.6	995.7	723.9	97	44.0	125	56.7	9211-1713*	\$1350
47 1/4	21U	320	145.2	70	31.8	24.0	53.9	28.5	609.6	1369.1	723.9	140	63.5	175	79.4	9211-2641	\$2100

1. Each Operating Case is supplied with one T-bar set for supporting sides of instruments.
2. Has interlocking feet for stacking.
3. For rack mounts no deeper than 533.4 mm (21 in.); uses 431.8 mm (17 in.) T-bar sets.

**Standard & special order features**

- Inner rack frame with provision for infinitely adjustable T-bar instrument support brackets. Supplied
- Inner rack frame with RETMA hold pattern drilled in rear rails. Supplied
- Mating feet for stacking one case on top of another. Supplied
- Special color other than tan. Please specify. N/C
- Modified inner rack frame depth. Standard depth 20" from front panel mounting surface to rear surface of frame. This option includes an appropriate change in the overall depth of the enclosure. Please specify desired inner frame depth. Maximum 23", minimum 12". \$60
- Chassis trak C-300 instrument slide pair to mount on either side of inner frame using RETMA hole pattern drilled in front and rear rails. \$20
- Special shock mounts for unusual instrument weights. Please specify weights. \$10
- Increased front cover depth. Maximum depth 6". Please specify. \$40
- Increased rear cover depth. Maximum depth 6". Please specify. \$40
- Latches recessed into the surface of the case. \$75
- Handles recessed into the surface of the case. \$20
- Hermetically sealed case tested by the hot water method. \$35
- MIL-C-4150 certification with the exception of design and preproduction testing. Case will have increased wall thickness, hardware anodized to military

- specification, and will be hermetically tested using the hot water method. \$70
- Addition of an automatic pressure relief valve. \$20
- Addition of a manual pressure relief valve. \$10
- Addition of four permanently mounted, 3 1/2" diameter swivel casters. \$40
- Addition of four removable, 3 1/2" diameter swivel casters. Also available in kit form P/N 1490-0913. \$55
- Addition of two aluminum hat-suction skids to the case bottom. \$30
- Addition of lift rings to either side of the case. \$15
- Accessories**
- 9211-1184 3 1/2" H (88.1 mm) Drawer with ball bearing slides. \$170
- 9211-1165 5 1/2" H (132.6 mm) Drawer with ball bearing slides. \$180
- 9211-1166 7" H (177 mm) Drawer with ball bearing slides. \$196
- 0950-0122 AC power receptacle strip with four outlets mounted on bottom rear of inner rack frame. Power cord 1 m (3.3') long, NEMA connectors. \$22.50
- 9211-1173 Pair T-Bar instrument support brackets. \$25
- 1490-0913 Caster kit, four removable 3 1/2" (88.9 mm) swivel casters. \$55
- On special order, complete transportable field instrument groups can be assembled to suit individual requirements. On request, cases can be fabricated that meet the environmental requirements of Military Specifications.

# TRANSCEIVER TEST EQUIPMENT

Automatic transceiver test system

Model 8950B

- Designed for AM, FM and  $\emptyset$ M transceivers from 2 to 1000 MHz



- Ideal for testing citizens' band, aircraft communication, practical and FM mobile radios.
- Measures up to 100 watts transmitting power



The HP 8950B Transceiver Test System will automatically test AM and FM communications transceivers over the frequency range of 2 to 1000 MHz. It is nearly ideal for production line testing, R&D evaluation, quality assurance testing, incoming inspection, and user maintenance of many transceivers. An HP 9825A Calculator controls the stimulus and measurement capabilities of the system via the HP Interface Bus (HP-IB).

Several new instruments have been incorporated in the 8950B to offer improved performance. A new multimeter with rms detector and increased speed has reduced transceiver test time typically by 20%. A new counter provides direct count to 1300 MHz and a new power supply provides current or voltage programmability. These changes demonstrate the ease of system improvement offered thru HP-IB as new and better equipment becomes available.

### Speed

Using the 8950B system, transceiver test time can typically be reduced by a factor of 10 or more, resulting in greatly increased productivity. For example, the system can perform a typical set of tests on a mobile radio in about 2 minutes, while a manually operated setup would require about 20 minutes.

### Accuracy

Operation of the 8950B under calculator can offer better accuracy than a manual system. By automatically applying previously measured calibrations factors, repeatable system errors such as frequency response and insertion loss can be virtually eliminated.

### Data presentation

The 9825A calculator includes a small thermal printer adequate for writing software or for short message printouts. Both the 9871A Character Impact Printer (Option 001) and the 9866B Thermal Printer are systems compatible to provide more sophisticated printouts.

### A flexible HP-IB system

HP-IB interconnection insures that your 8950B will not become obsolete in the near future: as new and more advanced instrumentation is offered, your system can easily be updated to include added measurement capability. The 8950B employs general purpose, off-the-shelf instruments except for the 8951B System Interface. This means you may already be using nearly identical instruments in your measurements; therefore, test results will be directly comparable and operation and maintenance will be simplified.



### 8951B System interface

The 8951B System Interface contains all the signal switching and conditioning needed to route signals to and from the proper instruments and the radio under test. All radio connections are made at a single working panel and no manual switching or cable reconnection is necessary during a typical series of tests.

In addition to switches, the 8951B includes a 100 watt RF attenuator, a high quality FM discriminator, and a diode detector for AM measurements. Three band-reject filters with provision for an external filter are used for distortion and SINAD measurements.

The 8951B has added several additional capabilities. Positive and negative peak detectors provide improve measurement accuracy of distorted FM signals found in modulation limiting testing. Buffer amplifiers have been added to reduce internal settling times and increase testing speed. Extra switching has been provided to allow system expansion to include spectrum analysis, floating transmitter keying and supply voltage measurement.

### 9825A Computer controller

The flexible and powerful 9825A is an almost ideal controller for this system. It uses a high-level programming language called HPL which offers power and efficiency for handling equations and controlling instruments, yet is easy to learn and use. The calculator and HPL allow easy storage and review of programs and data on a built-in, high speed, 250,000 byte tape cartridge.

### System software

The 8950B is furnished with a tape cartridge containing a comprehensive library of system programs: 1) the verification program is a short system self-test to assure the user that the system is operation, 2) the calibration program generates calibration factors to correct repeatable errors in the system, 3) the measurement subroutines allow complex measurements to be made by writing only a single statement, 4) and the instrument drivers facilitate information transfer between the calculator and the instruments.

### Writing programs

To perform a series of tests on a transceiver, a program must be written which accesses the appropriate measurement and instrument driver subroutines. Additional program statements will provide a printed copy of the results which can include the chosen test limits or a Pass-Fail indication of total test performance. Because of the software flexibility, special tests can easily be written using the instrument drivers provided with the system.

### Typical system tests

<b>Receiver:</b> SINAD sensitivity Quieting sensitivity Squelch threshold Audio power Audio distortion Audio response Hum and noise AGC response Modulation acceptance bandwidth Power supply sensitivity Current drain DC and AC voltage	<b>Transmitter:</b> Carrier power Carrier frequency and stability AM depth FM deviation Audio distortion Audio response Audio sensitivity Squelch tone frequency Limited spurious measurement Power supply sensitivity Current drain  <b>Module and Subassembly:</b> Resistance AC volts Frequency DC volts
---	--

## 8950B System specifications (includes software calibration)

### General

**System frequency range:** 1-1000 MHz.

**System power range:** 0.5-100 watts.

**Calculator controlled power supply voltages:** 0 to 50 V, 50 mV resolution.

**Current drain measurement range:** 50 mA to 10 A.

### Transmitter tests

**Power measurement range (Antenna port):** 1 mW to 100 watts.

**Power measurement range (AUX RF Input):** 10  $\mu$ W to 1 watt.

**Power measurement accuracy (Antenna port):** expected  $\pm 0.14$  dB ( $\pm 3.3\%$ ).

**Frequency measurement range:** 0 to 1300 MHz.

### AM measurement

**Frequency range:** 2-400 MHz.

**AM depth range:** 0.2-90%.

**AM accuracy (1 kHz rate 10% to 80%):**  $F_c < 200$  MHz:  $\pm 2\%$   $\pm 3\%$  of full scale;  $F_c \geq 200$  MHz:  $\pm 2\%$   $\pm 5\%$  of reading.

**AM rate range (3 dB):** 50 Hz-25 kHz.

**AM residual distortion (at 30% AM):**  $\leq 2.0\%$ .

### FM measurement (positive and negative peak detection)

**Frequency range:** 4-1000 MHz.

**Peak deviation range:** 300 Hz-20 kHz.

**System residual:**  $< 10$  Hz in 1 kHz BW.

**FM accuracy (1 kHz rate):**  $\pm 3\% \pm 20$  Hz.

**FM rate range:** 50 Hz-20 kHz.

**FM residual distortion (at  $\geq 3$  kHz peak deviation):**  $\leq 1.0\%$ .

### FM measurement

**Frequency range:** 4-1000 MHz.

**Deviation:**  $\Delta\phi_{max} = 20/\text{mod. rate (kHz)}$ .

**FM rate range:** 50 Hz-20 kHz.

**FM accuracy (1 kHz rate):**  $\pm 3\%$ .

**Spurious measurements ( $> 1$  MHz away from carrier):** 0 to -40 dBc.

### Receiver tests

**Minimum measurable sensitivity (typical):** 0.2  $\mu$ V.

**Output level range (Antenna port, into 50 ohms):** -146 to -19 dBm (0.02  $\mu$ V to 25 mV).

**Output level accuracy (1 to 1000 MHz, at Antenna port):**  $\pm 1.5$  dB.

**Audio power measurement accuracy:** 0.5%  $\pm$  speaker load tolerance.

**Audio distortion measurement:** At 400, 1000, and 3000 Hz rates.

**Residual distortion:** RF generator distortion +0.3%.

### Audio frequency range:

**AM:** 50 Hz to 50 kHz (RF freq  $> 10$  MHz)

**FM:** 50 Hz to 100 kHz.

**Modulation acceptance bandwidth measurement range:** 1 to 100 kHz.

### General characteristics

**Operating temperature range:** 15° to 35°C.

**Power requirements:** 115 volts  $\pm 10\%$ , 60 Hz.

**Net weight (less calculator):** 216.8 kg (478 lb).

### Options

**002:** Additional Power Supply capability (Substitute 6268B, # 026, J80 and S9501A for 6002A)

**003:** Reduced frequency (110 MHz)

**004:** 230 V, 50 Hz operation

**005:** Delete 9825A Calculator and Access

### Price

add \$650

less \$4,300

N/C

less \$10,750

**8950B Transceiver Test System**  
(including a calculator and programs)

**\$63,000**

### Data and voice testing

There are a wide variety of tests which can be made on a data communications system. Depending on the point in the system at which the tests are made, quite different philosophies and techniques apply. These group conveniently into three areas; data domain, time domain and frequency domain. Data domain tests are concerned with the flow of digital information within the data communications systems. Time domain

change with time. Intermittent problems are very difficult and time consuming to troubleshoot in any system. The size and complexity of a data communication system aggravates the problems.

Even private leased lines are in a constant state of flux. When a trunk goes down for testing or repair, a new trunk will be patched in with different parameters. This constant change requires more frequent testing.

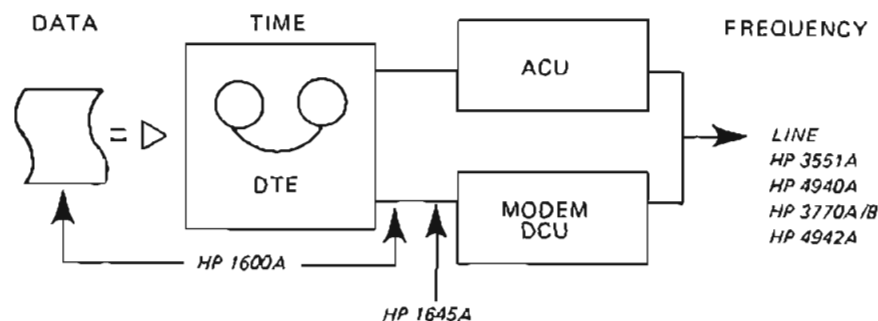

Figure 1. The three domains of data communication instrumentation.

includes common digital tests, such as Bit Error Rate. Frequency domain tests are made on the analog transmission line, for example, group delay response.

Data communications troubleshooting involves some unique testing problems that are different from the testing done on traditional equipment. The individual tests and parameters are simple because of the low bandwidths (about 3 kHz) and modest signal-to-noise ratios (about 24 dB). The difficulty comes from the complex interrelationships of these simple parameters. For example, how does envelope delay distortion of the line (Figure 2) affect the digital error rate of a modem (Figure 3), and how does that affect the throughput of the computing system? The mathematical relationship between these simple parameters is very difficult to understand for terrestrial data links. And, it is only one of many relationships that have to be understood when troubleshooting a data communication system.

Data communication systems require extensive handshaking between machines and across the different domains. Handshake problems are difficult to locate because they are transient and because each machine alone will usually test good. It is very difficult to isolate the handshake problem to one interface.

The geographic size and multitude of subsystems in a telecommunication system make it vulnerable to intermittent and transient impairments as well as degradation and

### Data domain

Logic State Analyzers are capable of trapping and displaying both serial and parallel digital data in their natural binary forms. They are useful for monitoring serial data out of the modem, parallel data on the information bus, and both serial and parallel data within the Data Terminal Equipment.

The logic analyzer can trigger on the sync word of the serial bit stream and display the subsequent bytes of data. The instrument can delay from the sync point and display data far removed from the sync character. Digital memory allows easy examination of transient messages common in data communications.

Parallel data analysis can be used to examine data on the RS232/V24 bus between the data terminal equipment and the modem. The trigger word can be used to start the display on important signals (e.g. request-to-send or received-line-signal-detect). The display can be used to monitor, simultaneously, activity on the other lines of the bus.

Before a link can pass data, the subsystems must "handshake" with each other to establish a continuous synchronized link. The data terminal equipment turns on the modem transmit carrier by raising request-to-send. The modem will allow time for training sequences, echoes and receiver squelches before replying with a clear-to-send to the computer. The 10235A Interface cover is designed to monitor both standard and new handshake sequences on the terminal interface.

### Digital measurements—time domain

Data Error Analyzers are used to monitor the quality of both the modem and transmission facility. They provide more information about the modem and transmission line than Logic State Analyzers, but no information about the Data Terminal Equipment which they replace.

The overall quality of the link is indicated by its Bit Error Rate. A good link will have an error rate better than  $1 \times 10^{-5}$  errors per bit. This measurement will include the effect of both transmission line impairments and the modem's ability to overcome them. Modems vary widely in their sensitivity to line impairments. Low speed (less than 300 bps) and adaptively equalized modems are less sensitive than high speed (more than 4800 bps) and nonadaptively equalized modems.

Since data communication systems transmit data and control errors in blocks, these instruments also measure Block Error Rate. Bit Error Rate and Block Error Rate can be used together to examine the statistics of the error mechanism. If the Bit Error Rate and Block Error Rate are both high, the impairment is random and probably due to noise. If the Bit Error Rate is high but the Block Error Rate is low, the impairment is more sporadic. This happens when lines are switched, sync is temporarily lost or impulse noise is too high.

Error rates are qualitative checks of the data communication system which can be made in a few minutes. If the system is bad, diagnostic measurements are provided to help isolate the problem. Dropouts, clock slips, error skew, jitter and total peak distortion indicate some of the problems that can occur on a link. These measurements are made simultaneously with the error rate measurements and can be printed on in automatic, unattended mode if desired.

These instruments are available in programmable versions for fully automatic system maintenance and checkout.

Catastrophic failures can usually be found with self tests and loop back switches built into the Data Terminal Equipment and Modem. A Transmission Test Set can find catastrophic failures of the transmission line. Logic Analyzers and Data Error Analyzers can find catastrophic failures that are not illuminated by internal self tests.

Degradations of the modem or transmission line are more difficult to find and require more extensive test equipment. The most common degradation is an excessive error rate due to line impairments or a faulty modem.

The transmission line will have a set of steady state impairments (e.g., amplitude distortion, envelope delay distortion, non-linear distortion, and frequency offset which smear the modem's symbols and make them harder to separate in the modem receiver). The line will also have random impairments (e.g., message circuit noise, impulse noise, phase jitter, phase and gain hits which can temporarily push the symbols into the wrong slot, causing a digital error).

**Line impairments—frequency domain**

Transmission Line Analyzers and Transmission Impairment Measuring Sets (TIMS) are used to measure the transmission distortion parameters that cause the modems to have a high bit error rate. These distortion parameters fall into two main types: steady-state and transient. These transmission parameter measurements are made on the telephone plant facilities. Because they are frequency domain measurements, they do not provide information about the data or time domain. In most cases, these transmission parameter measurements conform to CCITT or Bell standards . . . both in their results and in the methods used.

Typically, a telephone line is conditioned for a given data rate, thereby limiting the distortion allowed. The total line capability can be assessed if three line characteristics are established:

- (a) effective channel bandwidth as given by the attenuation and delay distortion
- (b) net-circuit loss
- (c) noise

The attenuation and delay distortions impose an upper limit to data transmission speed and reduce the noise margin to errors generated. The net circuit loss and noise affect the signal-to-noise margin. Noise includes both steady-state background noise and transient noise which includes impulse noise, gain and phase hits and drop-outs.

**Measurements**

There is a major difference in testing above and below 2000 bps. Below 2000 bps, modems are asynchronous and usually frequency shift keyed (FSK). These modems are not as sensitive to line impairments and can be maintained most of the time with simple test equipment like HP 3551A and 3555B. The digital measurements can all be made by the HP 1645A which is capable of either asynchronous or synchronous testing.

Data rates higher than 2000 bps are accomplished by transmitting more bits per symbol. This requires a synchronous modem of more sophisticated design. These modems, especially at 7200 and 9600 bps, are sensitive to channel impairments. Bell modems usually are phase shift keying (PSK) or quadrature amplitude modulation (QAM). Also used are pulse amplitude modulation (PAM) and AM single sideband (SSB) modems.

Only the Logic State Analyzers are capable of on-line testing with data traffic. The Data Error Analyzers and Transmission Test Sets generally require that the line be taken out of service and tested at each end with a compatible test set. These test sets require a known stimulus for all measurements except signal level and message circuit noise.

The majority of data networks are duplex

(two way) because of the necessity for error control schemes that require a reply (ACK or NAK) from the nominal receiver. Because of this, the testing must be done near to far and far to near to verify that both directions of the line are working.

There usually must be an identical or equivalent test set on each end of the line (4940/4940 or 1645/1645) and a technician to operate the set in each direction. The 4942A and 3770B use a microprocessor to achieve master-slave operation so that only one technician is required.

Sometimes lines can be looped around at the far end to eliminate the extra technician and test set. In the laboratory, this is always true for half duplex testing of experimental equipment. In the field, however, the loop around causes twice the length of line to be tested, so the parameters are relative . . . not absolute, and not tariffed. Some modems are capable of gain restoration in loop around to avoid an unrealistic extra 16 dB loss. Digital loop around can be accomplished at the terminal interface or in software in the DTE.

The 4940A is capable of measuring all the tariffed impairments in the U.S. The 3770B measures in one combined unit all of the maintenance parameters laid down in CCITT recommendation M, 1060, P53A, and V55. The 1645A is capable of synchronous measurements according to both Bell and CCITT specifications. There is some overlapping of the frequency domain measurements. A 3551A might be used to make simple measurements on a synchronous circuit and a 4940A might be used to investigate difficult problems on a low speed asynchronous circuit.

The choice between digital and frequency measurements depends on the application. A telephone company may not have access to or responsibility for the digital side of the modem, so frequency measurements would be best. A data communication end-user interested in go/no-go testing can make them fastest with a digital measurement of bit error rate or data characters. Since malfunctions know no boundaries, it is important that the test equipment fit the problem.

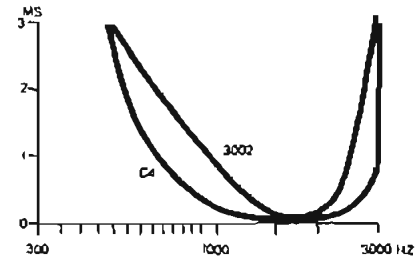

Figure 2. Advanced test sets like the 4940A, 4942A, and 3770A/B can measure envelope delay distortion.

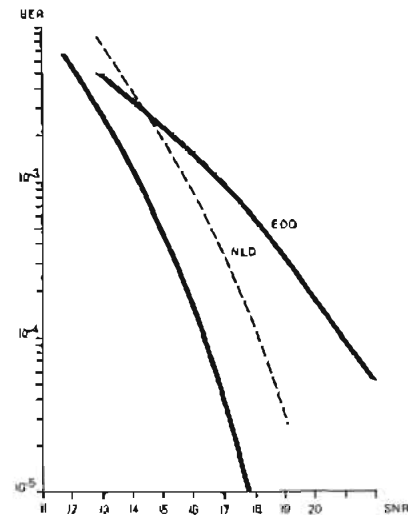

Figure 3. This classical performance characteristic of a modem shows where three types of equipment can contribute. Data error analyzers, like the 1645A, can measure bit-error-rate (BER) in the time domain. Simple transmission test sets, like the 3551A, can measure signal-to-noise ratio in the frequency domain. Advanced test sets like the 3770A/B, 4940A, and 4942A can measure important envelope delay distortion (EDD). Further the 4940A measures non-linear distortion (NLD).

MODEM TYPE	FREQUENCY		TIME	DATA
	US	CCITT		
ASYNCH < 2000 bps	3551A	3552A	1645A	1600A 10254A
SYNCH > 2000 bps	4940A 4942A	3770A 3770B		
DDS				

Figure 4. Where to use the various HP Instruments in a data communication system.

# TELECOMMUNICATIONS TEST EQUIPMENT

## Six simultaneous, automatic data measurements

Models 1645A & 10235A

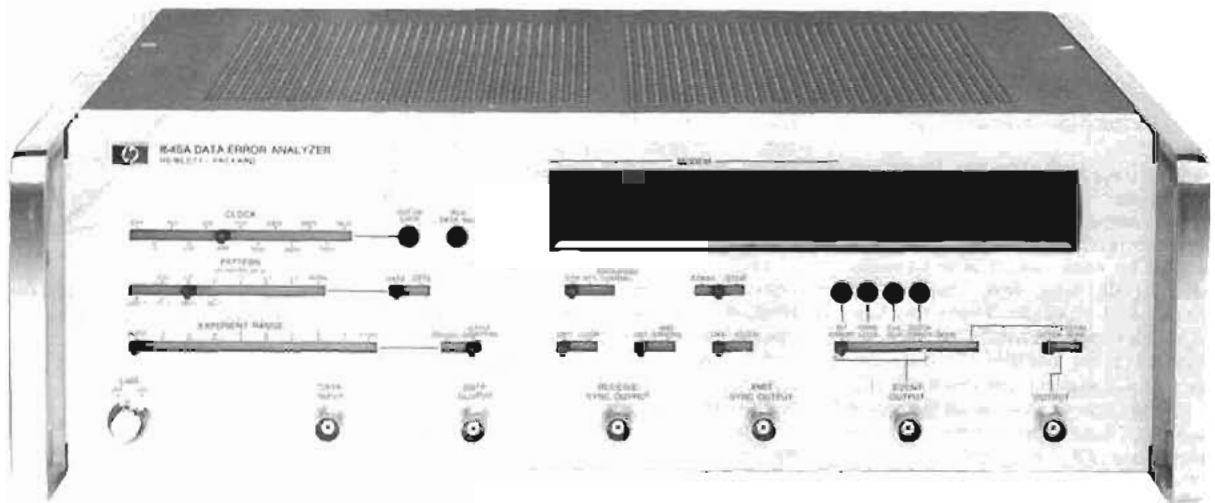

1645A



Direct reading, autoranged indications are displayed on an LED readout. Handshake signals conforming to CCITT convention are included for operation through any modem system.

### 1645A Description

Hewlett-Packard's Model 1645A Data Error Analyzer quickly isolates data communications link problems through six simultaneous measurements. During tests, the 1645A can be left totally unattended because it automatically maintains synchronization even in the presence of dropouts. And for added convenience, the 1645A can be equipped with a printer for hard-copy, permanent recordings of long tests.

Bit-error and block-error rate tests are autoranged and displayed directly on an LED readout; there is no need to perform any calculation. Additionally, the 1645A measures jitter or total peak distortion (the sum effect of jitter and bias), counts the number of times carrier loss or dropouts occur, measures data-error skew and counts the number of clock slips resulting from phase hits on the link or modem sync problems.

With all these measurements made during the same test interval, you'll know precisely what is causing your problems in modems, data channels, complete communications systems.

### 10235A Interface cover

The 10235A Interface Cover is designed for troubleshooting problems on the RS-232C interface bus. The most common problems such as wrong voltages and excessive turnaround times, which most commonly occur during installation, are easily pinpointed with the measurement capability of the interface cover.

Measurements include time interval, voltage measurements, audio monitoring, data set control signal monitoring, and the ability to send control signals to the data sets. This measurement capability can be easily patched through the 25 x 25 pin matrix to every pin of the RS232C interface for complete testing.

The programmable matrix has the 25 pins of the RS-232C interface (modem and business machine) connected to the columns along with most of the RS-232C conductors from the 1645A to the modem. Several important signals, send data, receive data, transmit clock and receive clock, are separated and applied to the matrix rows for manual manipulation by the technician.

The most important row outputs are TP1 and TP2 which are connected to the time interval circuits for measuring the interval between signals occurring on two different leads in the matrix. The interval timer measures the time while a visual indication of which lead changed state first is supplied by LED's connected to TP1 and TP2. This permits accurate timing measurements of important signals such as turnaround time between Request to Send and Clear to Send responses. Test points 1 and 2 may also be monitored with the built-in loudspeaker. For maximum flexibility the voltmeter can be connected through jumper leads to TP1, TP2, or TP3 of the matrix to any of the 25 input leads. The external inputs also allow external voltage measurements such as telephone line signal levels.

Control information can also be exchanged between the 10235A and the data set by using any of the eight data set control switches. In addition control signals from the data set can be monitored through the matrix on the eight control signal indicators.

### Interfaces

For versatility in design and troubleshooting, both CCITT V24 (RS-232C) levels and TTL levels are available in the 1645A. TTL levels are through front panel BNC connectors. Interfacing with standard RS-232C systems is through a rear panel 25 pin connector. The system interface, including connector, is contained on one circuit card which is easily replaced for other interfaces. The Model 10388A interface card and cable is for modems conforming to CCITT V35 (W.E. Type 306) high speed modems. The Model 10387A interface is for type 303 wideband modems. Interfacing with modems conforming to MIL-188C standards is available on special order. A breakout box, Model 10389A for RS-232C systems, is available as a convenient method of opening interconnecting lines. Test points on each side of the switch permits monitoring of signal levels, or with jumper leads offer a convenient method of matching different system installations.

For communications companies that need to test both low and high speed systems the 1645S offers a complete data transmission test set. The test set includes a 1645A Data Error Analyzer with RS-232C interface; 10235A Interface Cover; CCITT V 35 and Type 303 interface with matching cables; Model 10389A RS-232C breakout box with cable; and two accessory pouches. The 1645A in this system incorporates a wider phase lock loop capture range which allows receiver lock-on to PRBS signals of other units that do not have crystal controlled transmitters for end-to-end testing. The 1645S includes two diode and two resistor pins for the 10235A matrix. This complete test system offers eight basic data communication measurements plus audio which is capable of detecting malfunctions ranging from crossed wires to intersymbol interference in a wide range of data communications systems.

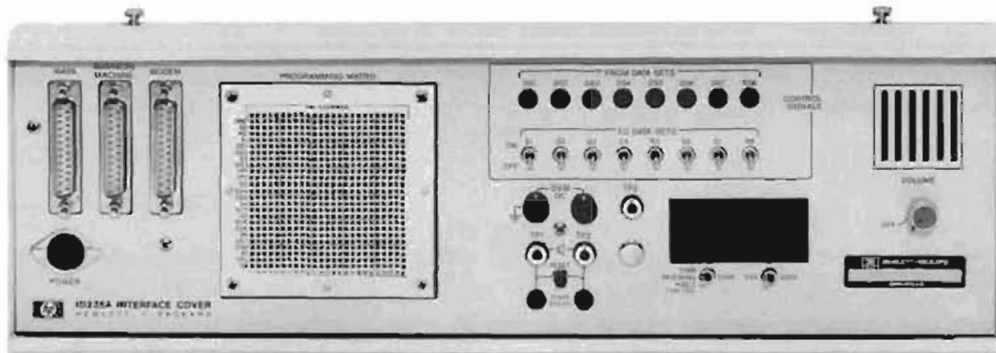

10235A

### 1645A Specifications

#### Bit rate Internal

**Transmitter bits per second:** selectable 75, 150, 200, 300, 600, 1200, 1800, 2400, 3600, 4800, 7200, 9600.

**Crystal frequency:** 5.75 MHz  $\pm 0.03\%$ ,  $< 0.01\%$  jitter.

**Receiver with bit synchronizer:** same as internal transmitter.

**External:** transmitter and receiver, to 5 MHz.

#### Data outputs/Inputs

##### Front panel

**Input:** data input requires TTL levels; max input 5.5 V.

**Outputs:** receiver sync, transmitter sync, and event at TTL levels; data output is  $> 2$  V into 50 ohms; jitter/total peak is 1 V p-p for each 10% of p-p distortion from waveform causing distortion.

##### Rear panel

**Inputs:** backward channel data, external transmitter and receiver clock require TTL levels; max input 5.5 V.

**Outputs:** bits lost at TTL levels; internal transmitter clock is  $> 2$  V into 50 ohms.

**Multipin connectors:** 25 pin female connector for interfacing with standard RS-232C communications systems. 36 pin female printer output at TTL levels in BCD 8421 code.

#### General

**Power:** 115 or 230 V ac, 48 to 440 Hz, 150 VA max.

**Operating environment:** temperature, 0 to  $+55^{\circ}\text{C}$  ( $+32^{\circ}\text{F}$  to  $+130^{\circ}\text{F}$ ); humidity, to 95% relative humidity at  $+40^{\circ}\text{C}$  ( $+104^{\circ}\text{F}$ ); altitude, to 4600 m (15 000 ft); vibration, vibrated in three planes for 15 min, each with 0.254 mm (0.010 in.) excursion, 10 to 55 Hz.

**Dimensions:** 133 H  $\times$  425 W  $\times$  286 mm D ( $5\frac{1}{4}$ "  $\times$   $16\frac{3}{4}$ "  $\times$   $11\frac{1}{4}$ ").

**Weight:** net, 8.2 kg (18 lb). Shipping, 10.9 kg (24 lb).

**Accessories supplied:** one 3 m (10 ft) RS-232C interconnecting cable to connect the 1645A to the modem, connects to 10235A when used in the 1645S configuration (HP P/N 01645-61605), one 2.3 m (7.5 ft) 3 wire power cord (HP P/N 8120-1378); one Operating and Service Manual.

### 1645A Indicators and controls

#### Indicators

Out of lock; received data inverted; bit error; carrier loss; clock slip; block error; data set ready (DSR); clear to send (CTS); loss of data; test on.

#### Selector switches

Clock; pattern; data/data; exponent range; single/cycle (printer); DTR/RTS/backward channel; start/stop; off/loop; off/xmit errors; off/filter; event, bit error, carrier loss, clock slip, block error, skew, jitter/total peak.

### 10235A Specifications

#### Time interval

**Range:** 999 ms full scale.

**Resolution:** 1 ms.

**Accuracy:**  $\pm 2\%$  of measured interval  $\pm 1$  count.

**Start-Stop:** TPI & TP2 input, LED indicates event start at TPI or TP2.

**Trigger slope:** positive edge.

**Trigger amplitude:**  $\pm 3$  V.

**Input resistance:** approx. 4 k $\Omega$ .

#### DC digital voltmeter

**Ranges:** 19.99 V, 199.9 V full scale.

**Accuracy:**  $\pm 1\%$  of reading,  $\pm 1$  count.

**Digital units:**  $3\frac{1}{2}$  digits.

**Input resistance:** 1 M $\Omega$ .

**Overload protection:** to 1000 V.

#### General

**Interface connectors:** three 25 pin female connectors for connecting the 10235A to the 1645A, modem, and business machine. Interface conforms to RS-232C standard.

**Power requirements:** +15 V to 25 V and -15 V to -25 V supplied by the 1645A.

**Dimensions:** 132 H  $\times$  399 W  $\times$  48 mm D ( $5.2$ "  $\times$   $15.7$ "  $\times$   $1.9$ ").

**Weight:** net, 1.8 kg (4 lb). Shipping, 3.2 kg (7 lb).

**Accessories supplied:** one 46 cm (18") RS-232C interconnecting cable connects 10235A to 1645A (HP P/N 10235-61606); one 46 cm (18") power cable connects to 1645A (HP P/N 10235-61602); one accessory pouch, attaches to side of 1645A (HP P/N 1540-0385); one Operating Note.

#### Indicator and control functions

**Indicators:** eight light emitting diodes (LED) provide logic HI or LO indications for corresponding patch pins in the programming matrix, +3 V lights LED.

**Audio:** built-in loudspeaker and volume control.

**Control switches:** eight switches supply control signals through the program matrix to business machine/modem connectors. On is +5 V, OFF is -5 V.

#### Interfaces

Model 10387A for Type 303 modems (with cable)

Model 10388A for CCITT V.35 (with cable)

Model 10389A Breakout Box (RS-232C) (with cable)

MIL-STD-188C and other interfaces available on special order. Contact HP Field Engineer.

#### Price

\$390

\$290

\$165

#### Accessories

**Printer interconnecting cable:** Model 10233A cable connects the 1645A to HP Model 5055A or 5150A printers; 36 pin male connector on one end and 50 pin male connector on the other \$50

**Front panel cover:** protects 1645A front panel during transit and provides convenient carrying handle (HP P/N 5060-8767). This cover is not needed when a 10235A Interface Cover is ordered with a 1645A, or with a 1645S Data Transmission Test Set. \$80

#### Ordering information

1645A Data Error Analyzer \$2300

Opt 908: includes rack mounting kit add \$10

Opt 910: additional set of manuals add \$15.50

10235A Interface Cover \$1000

1645S Data Communications Test Set\* \$4100

Opt 910: additional set of manuals add \$25

\*Includes 10387A, 10388A, 10389A, and interconnecting cables.

# TELECOMMUNICATIONS TEST EQUIPMENT

## Amplitude/delay distortion analyzer; Telephone line analyzer

### Models 3770A, 3770B

3770A & 3770B

- Delay and Attenuation Distortion measurements
- Compatible with CCITT Recommendation 0.81
- Rugged, portable, and really easy to use



3770A

3770B only

- Makes all the maintenance measurements listed in CCITT Recommendation M.1060
- Optional slaving facilities

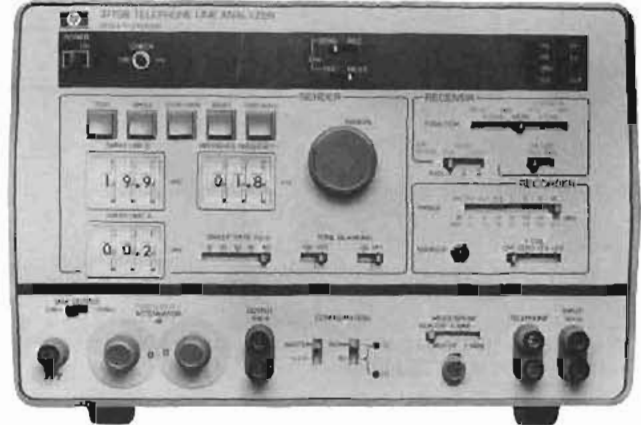

3770B

### Description

The HP 3770A and 3770B are designed for audio data line characterization to CCITT standards. The 3770A measures the basic parameters affecting data lines. The 3770B makes, in one combined unit, all of the routine maintenance measurements listed in CCITT Recommendation M.1060 for high speed data lines. This includes the measurements performed by the 3770A.

The 3770A measures group delay, attenuation distortion, and absolute level in the frequency range 200 Hz to 20 kHz. It has automatic ranging, zeroing, and synchronization, with simultaneous LED readout of measurement result and frequency. The sender and receiver are combined in a single, rugged, portable unit.

The 3770B, in addition, measures weighted noise, noise-with-tone, and impulse noise. Further, an optional slave facility for group delay and attenuation distortion measurements allows the measurement results for both directions of transmission on a 4-wire circuit to be displayed at one end of the circuit. Also, the measurements in both directions can be controlled from one end of the circuit, leaving the slave unit unattended.

The 3770A and 3770B both have X-Y recorder outputs to enable a permanent swept record of the measurements to be made. A suitable portable X-Y recorder can be supplied as an option. Pre-printed graph paper showing CCITT limits for group delay and attenuation distortion measurements can also be supplied.

Both instruments also have a built-in telephone facility to allow voice communication in a 2- or 4-wire mode over the line or lines under test. An integral loudspeaker allows the operator to monitor either the receiver input or sender output.

### Measurement principles

For group delay and attenuation distortion measurements, the operation of the 3770A and 3770B is compatible with CCITT Recommendation 0.81. With this method, the sender generates a carrier signal which switches between the reference and measuring frequencies at a rate of 4.166 Hz. The composite signal is amplitude modulated by a 41.66 Hz sinewave and transmitted through the channel to be analyzed. The relative group delay of the channel at the two frequencies is measured by comparing the delay of the envelope recovered during the measuring period with that recovered during the reference period. The relative attenuation measurement is made by comparing the amplitude of the two envelopes.

The receiver can measure the absolute level of either the measuring or reference carrier within the range -50 to +10 dBm. As the

sender output is calibrated in dBm, this measurement allows the absolute loss of the transmission path to be calculated. In addition to normal operation, absolute level measurements can be made using a pure tone.

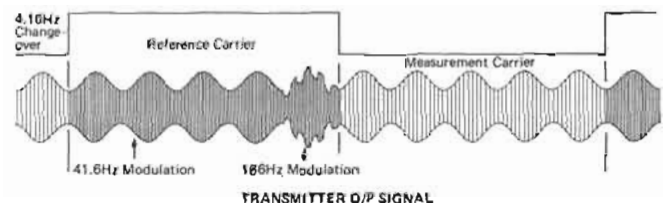

Background noise can be measured in two ways with the 3770B: weighted noise measurements, and weighted noise-with-tone measurements. Weighted noise measurements are made in accordance with CCITT Recommendation P.53A. The input is applied to a psophometric (or telephone) weighting filter and then the power is measured using a true rms detector. The filter simulates the combined characteristics of a telephone handset and a human ear, and is used to make the noise reading correspond to the subjective effect of the noise on the human ear. Also available with the 3770B is a 3 kHz flat filter which gives the noise power in the channel without psophometric weighting. In the weighted noise-with-tone mode, the 3770B measures the background noise while a 1004 Hz tone is applied to the channel. This is particularly important with, for example, PCM channels where the noise measurement would be inaccurate unless the channel is loaded. At the receiver, the 1004 Hz tone is filtered out before the noise power is measured.

The impulse noise measurement is compatible with CCITT Recommendation V.55. Impulsed noise can be caused by switching, lightning, etc., and is characterized by large spikes exceeding the normal background noise level. It is measured by counting the number of spikes which exceed a given threshold level. In the 3770B, the threshold level is adjustable in 1 dB steps over the range 0 to -49 dB, where 0 dB corresponds to 1.1 V (the peak voltage of a 0 dBm sinewave into 600Ω is 1.1 V). Pulses exceeding the threshold and of greater than 50μs duration are counted; pulses of less than 20 μs duration are not. Also, there is a dead time of approximately 125 ms during which further impulses are not counted.

The specifications which follow apply to both the 3770A and 3770B, unless otherwise stated.

## Specifications

### Sender

Reference carrier: 0.4 to 19.9 kHz in 100 Hz steps.  
 Measuring carrier: 0.20 to 20.00 kHz in 10 Hz steps.  
 Modulation envelope frequency: 41.66 Hz (Mod. Index 0.4 ±0.05).  
 Identification-burst frequency: 166 Hz\* (Mod. Index 0.2 ±0.05).  
 Carrier changeover frequency: 4.166 Hz.\*  
 Accuracy of above frequencies: ±0.1%.

\*Locked to envelope frequency

Measuring frequency sweep rates: 10, 20, 40, 80, 160 Hz/s, nominal.

Measuring frequency sweep limits: settable in range 0.2 to 19.9 kHz (100 Hz steps). Accuracy as for measurement frequency.

Carrier level: 0 to -49 dBm in 1 dB steps.  
 Carrier harmonic distortion: <1% (40 dB) total.

### Receiver

Operating level range: <-50 dBm to >+10 dBm.  
 Frequency measurement accuracy: 0.1% (with sender other than 3770A/B: 0.1% ±5 Hz).

### Recorder

X-axis output: 0 to +5 V for 0 to 20 kHz or 0 to 5 kHz.  
 Y-axis output: ±5 V for ±FS of the recorder range selected; available for group delay, attenuation distortion, noise and noise-with-tone measurements.

### Output/input circuits

Impedance: 600Ω balanced.  
 Return loss: >40 dB.  
 Degree of balance: >50 dB. (Receiver 200 Hz to 6 kHz: >60 dB).  
 Maximum operating common mode voltage (having regard to balance): 10 V ac rms, 100 V dc.  
 Maximum safe common mode voltage: 150 V ac rms, 50 Hz to 20 kHz, or 100 V dc.

### Combined sender and receiver

Frequency range: 0.2 to 20 kHz.

### Group delay distortion

Delay range: 0 to ±10 ms.  
 Inherent group delay error of sender (rms): 0.2 to 0.4 kHz, <5 μs, 0.4 to 0.6 kHz, <2 μs; 0.6 to 20 kHz, <1 μs.  
 Receiver measuring accuracy (rms): (5°C to 40°C) 0.2 to 0.4 kHz, <15 μs ±1% of reading; 0.4 to 0.6 kHz, <8 μs ±1% of reading; 0.6 to 20 kHz, <5 μs ±1% of reading. For 0°C to 50°C, ±1% of reading becomes ±2%. For additional group delay specifications, see Data Sheet.

### Attenuation distortion

Receive Level Range within which both Measurement and Reference carrier levels are contained	Receiver Maximum Error of Attenuation in the range 0 to -40 dB		Sender Max. Error
	5 to 40°C	0 to 50°C	
-5 to -5 dBm	0.15 dB ± 1%	0.15 dB ± 1%	0.1 dB
-5 to -20 dBm	0.15 dB ± 1%	0.15 dB ± 1.5%	0.1 dB
+10 to -30 dBm	0.2 dB ± 1%	0.2 dB ± 2%	0.1 dB
+10 to -40 dBm	0.2 dB ± 1.5%	0.3 dB ± 2.5%	0.1 dB
+10 to -50 dBm	0.5 dB ± 2.5%	0.7 dB ± 3%	0.1 dB

### Level measurement (without changeover and unmodulated)

Receive range: +10 dBm to -50 dBm.

### Accuracy

	5 to 40°C		0 to 50°C	
	Sender	Receiver	Sender	Receiver
+10 to -20 dBm	±0.2 dB	±0.2 dB	-0.2 dB	±0.3 dB
-20 to -30 dBm	±0.2 dB	±0.4 dB	±0.3 dB	±0.5 dB
-30 to -40 dBm	±0.3 dB	±0.7 dB	±0.4 dB	±0.8 dB
-40 to -50 dBm	±0.5 dB	±1.2 dB	±0.5 dB	±1.6 dB

Level measurements can also be made with modulation and changeover.

### Weighted noise (3770B only)

Measurement range: 0 to -85 dBm.  
 Detector type: true rms.  
 Weighting filters: CCITT telephone, and 3 kHz flat.  
 Method: compatible with CCITT Recommendation P.53A.

Noise-with-tone (3770B only) as for weighted noise, except:

Measurement range: 0 to -80 dBm.  
 Tone frequency: 1004 Hz.  
 Impulse noise (3770B only)  
 Threshold: single level, adjustable in 1 dB steps from 0 to -49 dB (0 dB is equivalent to 1.1 V).  
 Dead time: 125 ± 25 ms.  
 Method: compatible with CCITT Recommendation V.55.  
 Slave facility (optional—3770B only)  
 Modes: remote control, and remote retransmission. Slaving applies to group delay and attenuation distortion measurements only.  
 Remote control: the master unit controls the measurement and reference frequencies of the slave unit.  
 Remote retransmission: the slave returns the group delay and attenuation distortion information to the master for display and recording.

### General

Size: 200 H × 330 W × 560 mm D (7<sup>7</sup>/<sub>16</sub>" × 13" × 22").  
 Weight: 3770A, 12 kg (26.5 lb); 3770B, 14 kg (30.9 lb).  
 Temperature ranges: operating: 0°C to 50°C unless otherwise specified; storage: -40°C to 75°C.  
 Supply voltages: 115 V ac +10 -22% or 230 V ac +10 -18%; 48 to 66 Hz.  
 Power consumption: 3770A, 75 VA; 3770B, 100 VA.

### 3770A Options

Opt 001: send level range extended to -49 to +10 dBm.  
 Opt 002: loop holding provided for sender output and receiver input.  
 Maximum dc loop holding current: 100 mA.  
 Voltage drop at maximum current: approximately 12 V.  
 Dynamic output impedance: approximately 50 kΩ.  
 Opt 005: tone blanking.  
 Range: two bands in the range 0.2 to 9.9 kHz.  
 Range limits: any multiple of 100 Hz.  
 Frequency range blanked (kHz): Option number specifies range.

kHz	Opt	kHz	Opt	kHz	Opt
0.4 to 0.6	117	2.0 to 2.4	104	2.8 to 3.2	110
0.5 to 0.7	101	2.1 to 2.5	105	3.0 to 3.4	111
0.6 to 0.9	102	2.2 to 2.6	106	3.2 to 3.6	112
0.8 to 1.2	115	2.3 to 2.7	107	3.4 to 3.8	113
1.4 to 1.8	116	2.4 to 2.8	108	3.6 to 4.0	114
1.9 to 2.2	103	2.6 to 3.0	109		

Other ranges available on request. Quote Option 100 instead of the above numbers, and specify the required frequency ranges.

In-lid operating instructions: English—std; German—Option 031; French—Option 032; Italian—Option 033; Spanish—Option 034.

Opt 040: suitable portable X-Y Recorder in carrying case. Pre-printed graph paper showing CCITT limits also available—Amplitude Distortion (9280-0403), Delay Distortion (9280-0402).

Opt 061: rack mount version.

Opt 010: additional set of manuals.

### 3770B Options

When ordering a 3770B, select ONE option from the table below (i.e. select the standard instrument OR one option). This completely specifies the measurements selected. Note that group delay, attenuation distortion and absolute level measurement facilities are provided with ALL instruments.

Measurement facilities	Option										
	010	001	002	003	004	005	006	007	008	009	010
Noise	•	•	•	•	•	•	•	•	•	•	•
Slaving		•	•								
+10 dBm output						•	•				
Tone blanking								•	•	•	•

Opt 012: loop holding—see 3770A Options for specifications.

Tone Blanking: ranges and range limits as for 3770A. Other options (In-lid instructions, X-Y recorder, rack mount version, and additional manuals) as for 3770A.

### Ordering Information

3770A Amplitude/Delay Distortion Analyzer  
 3770B Telephone Line Analyzer

Price  
 \$6500  
 \$7445

# TELECOMMUNICATIONS TEST EQUIPMENT

## 15 Hz to 50 kHz selective voltmeter

### Model 3581C

- Voice grade testing
- Wideband data circuit testing
- Single frequency interference
- Spectrum analysis



### Description

The 3581C Selective Voltmeter has found wide application in testing special service circuits in both inside and outside plant maintenance. The 3581C is used to do spectrum analysis, measure non-linear distortion (harmonic distortion) and to locate and measure unwanted spurious and induced tones. The unit can be operated from ac line or from optional internal batteries.

### Specifications

**Frequency range:** 15 Hz to 50 kHz.

**Display:** 5 digit LED readout. Resolution: 1 Hz. Accuracy:  $\pm 3$  Hz.

**Typical stability:**  $\pm 10$  Hz/hr. after 1 hour.  $\pm 5$  Hz/ $^{\circ}$ C.

**Automatic frequency control (AFC), hold-in range:**  $\pm 800$  Hz.

**Pull-in range:**  $> 5 \times$  bandwidth for 3 Hz to 100 Hz bandwidth;  $> 800$  Hz for 300 Hz bandwidth for full-scale signal.

**Lock frequency:** center of passband  $\pm 1$  Hz.

#### Amplitude

##### Instrument range

**Linear:** 30 V to 100 nV full scale.

**Log:** +30 dBm or dBV to -150 dBm or dBV.

##### Amplitude accuracy:

15 Hz-50 kHz, frequency response

Switching between bandwidths

Amplitude display

Input attenuator

Amplitude reference level

(IF Attenuator)

Most sensitive range

All other ranges

Log Linear

$\pm 0.4$  dB  $\pm 4\%$

$\pm 0.5$  dB  $\pm 5\%$

$\pm 2$  dB  $\pm 2\%$

$\pm 0.3$  dB  $\pm 3\%$

$\pm 1$  dB  $\pm 10\%$

$\pm 1$  dB  $\pm 3\%$

\*Note: These specifications cover the full temperature, frequency and amplitude range and represent worst case. Accuracy is significantly better for measurements not at the extremes.

### Dynamic range >80 dB

### Noise level

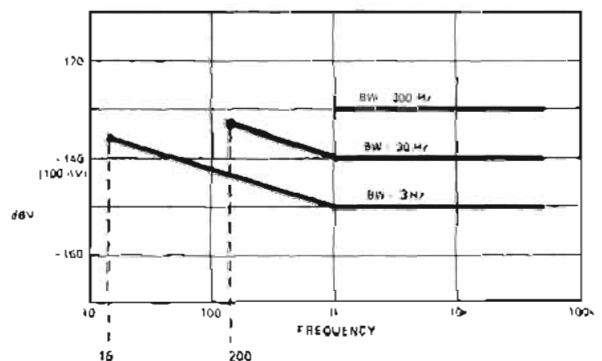

**Noise sidebands:** greater than 70 dB below CW signal, 10 bandwidths away from signal.

**IF feedthrough:** input level  $> 10$  V: -60 dB; input level:  $< 10$  V: -70 dB.

**Spurious responses:**  $> 80$  dB below input reference level.

**Line related spurious:**  $> 80$  dB below input reference level or -140 dBV (0.1  $\mu$ V) or -90 dBm on 3581C in balanced terminated mode.

**Zero beat response:**  $> 30$  dB below full scale at 25 $^{\circ}$ C  $\pm$  5 $^{\circ}$ C.  $> 15$  dB for 0 $^{\circ}$ C to 55 $^{\circ}$ C.

**Smoothing:** 3 position, rolloff is a function of BW.

**Overload indicator:** this LED warns of possible input amplifier overloading.



**Uncal indicator:** the variable input attenuator may be set to positions between steps. This is useful for scaling signals. When this feature is being used, the Uncal indicator clearly shows the instrument is not on a standard setting.

**Meter scales taut band with mirror backing:**

- 0 dB to -90 dB      Log
- 0 dB to -10 dB
- 0 to 1                      Linear
- 0 to 3.2

**Calibrator:** the 10 kHz fundamental of the calibrator may be used along with the 10 kHz cal adjustment to set the meter to full scale. This calibrates the circuitry that follows the input attenuator to an accuracy of  $\pm 1.5\%$  at full scale, 10 kHz and same bandwidth.

**Sweep**

**Scan width:** 50 Hz to 50 kHz. These scans can be adjusted to cover a group of frequencies within the overall instrument range.

**Sweep time:** 0.1 s to 2000 s.

**REP:** in the repetitive mode, sweep will continuously sweep the specified band.

**Single scan:** after triggering a single sweep, HP's 3581C will remain at upper end of sweep. A sweep may also be triggered externally through a BNC connector on the rear panel labeled "external trigger." Grounding inhibits internal trigger.

**Reset:** HP's 3581C is set to the start frequency of sweep.

**Manual:** in combination with concentric knob, manual sweep fully duplicates span of electronic sweep.

**Off:** sweep circuits and associated controls are turned off.

**Sweep error light:** this LED indicates a sweep that is too fast to capture full response. When the light is on, response will be lower than it should.

**Zero scan:** to look at the time varying signal at center or start frequency within bandwidth selected.

**External trigger:** a short to ground stops normal sweep. Opening the short then enables a sweep.

**Input**

**Unbalanced (UNBAL)**

**Impedance:** 1 M $\Omega$ /40 pF.

**Max. Input level:** 35 V rms or  $\pm 100$  V dc.

**+30 dBm to -10 dBm sensitivity:** 100 V rms or  $\pm 100$  V dc.

**-20 dBm to -70 dBm sensitivity:** 50 V rms or  $\pm 100$  V dc.

**Balanced/bridged (BRDQ)**

**Impedance:** 10 k $\Omega$ .

**Max. Input level:** 35 V rms or  $\pm 100$  dc.

**Frequency response:** 40 Hz-20 kHz,  $\pm 0.5$  dBm for signals < 20 dBm.

**Dynamic range:** 80 dB for signals < 0 dBm and > 100 Hz.

**Common mode rejection:** > 70 dB at 60 Hz.

**Balanced/terminated (TERM)**

**Impedance:** 600 $\Omega$ /900 $\Omega$  balanced.

**Max. Input level:** +27 dBm -0 V dc.

**Frequency response:** same as balanced/bridging.

**Dynamic range:** same as balanced/bridging

**Common mode rejection:** > 64 dB at 60 Hz.

**Input connector:** accepts WECO 310 plug—input is transformer coupled.

**Output**

Tracking generator output (also known as BFO or tracking oscillator output).

**Restored output**

**Range:** 0 to 2 V rms.

**Frequency response:**  $\pm 3\%$  15 Hz to 50 kHz.

**Frequency accuracy:**  $\pm 1$  Hz relative to center of filter.

**Impedance:** 600 $\Omega$

**Total harmonic and spurious content:** (for tracking generator output) > 40 dB below 1 V rms signal level.

**LO output:** 100 mV signal from 1 MHz to 1.5 MHz as input is tuned from 0 to 50 kHz.

**Output connector:** WECO 310, for connection to tracking generator output or restored output. In addition to monitoring restored output with headphones, an internal speaker also provides an audio indication of signal content.

**Restored and tracking generator**

**Output impedance:** 600 $\Omega$  balanced.

**Frequency response:**  $\pm 0.5$  dB 100 Hz to 20 kHz.

**X-Y recorder analog outputs**

**Vertical:** 0 to +5 V  $\pm 2.5\%$ .

**Horizontal:** 0 to +5 V  $\pm 2.5\%$ .

**Impedance:** 1 k $\Omega$ .

**Pen lift:** contact closure to ground during sweep.

**General**

**Operating temperature range:** 0°C to 55°C.

**Humidity:** 95% relative, maximum at 40°C.

**Power requirements:** 100 V, 120 V, 220 V, 240 V +5% - 10%, 10 VA typical, 48 Hz to 66 Hz.

**Size:** 412.8 H  $\times$  203.2 W  $\times$  285.8 mm D (16 1/4"  $\times$  8"  $\times$  11 1/4").

**Weight:** 11.5 kg (23 lb); Option 001, 13.5 kg (30 lb).

**Accessory available:** 7035B Option 20, X-Y recorder.

**Option 001 battery:** used to make floating measurements or to break ground loops; 12 hours from full charge; 12 hours to fully charge. The internal battery is protected from deep discharge by an automatic turn-off.

**Ordering Information**

3581C Selective Voltmeter

Opt 001: Battery Pack

7035B Opt 020: X-Y Recorder

**Price**

\$3500

add \$385

add \$1770

Meter Scale Buttons	Terminated	Bridging	Unbalanced
Volts 900 $\Omega$ dBm/LIN	Input impedance 900 $\Omega$ . Reads volts on volt scales of meter. 1 V rms input gives 1 V rms on meter.	Input impedance 10 k $\Omega$ . Reads volts on volt scales of meter. 1 V rms input gives 1 V rms on meter.	Input impedance 1 M $\Omega$ . Reads volts on volt scales of meter. 1 V rms input gives 1 V rms on meter.
dB 900 $\Omega$ dBm/LIN	Input impedance 900 $\Omega$ . Reads dBm 900 $\Omega$ on dB scales of meter. 0.949 V rms input gives 0 dB reading on meter.	Input impedance 10 k $\Omega$ . 900 $\Omega$ termination necessary to be calibrated with a source that has 900 $\Omega$ output impedance. 0.949 V rms input gives 0 dB reading on meter.	Input impedance 1 M $\Omega$ . 900 $\Omega$ termination necessary to be calibrated with a source that has 900 $\Omega$ output impedance. 0.949 V rms input gives 0 dB reading on meter.
Volts 600 $\Omega$ /dBm		Not a valid combination.	
dB 600 $\Omega$ /dBm	Input impedance 600 $\Omega$ . Reads dBm 600 $\Omega$ on dB scales of meter. 0.775 V rms input gives 0 dB reading on meter.	Input impedance 10 k $\Omega$ . Termination necessary to be calibrated with a source that has 600 $\Omega$ output impedance. 0.775 V rms input gives 0 dB reading on meter.	Input impedance 1 M $\Omega$ . Termination necessary to be calibrated with a source that has 600 $\Omega$ output impedance. 0.775 V rms input gives 0 dB reading on meter.

# TELECOMMUNICATIONS TEST EQUIPMENT

## Transmission test sets

Models 3551A & 3552A

- Voice grade testing
- Data circuit testing



3551A  
(North American)



3552A  
(CCITT)

### Description

Hewlett-Packard's 3551A (North American Measurement Standard) and 3552A (CCITT) Transmission Test Sets are rugged, portable and ideally suited for measurements on voice, program and data circuits up to 50 kb/s.

These four-function test sets are capable of measuring tone level, noise level, and frequency, while simultaneously sending tone. Both level and frequency are fully autoranging.

A normal sampling of 10/second in tone level and frequency allows a "direct feel" between an adjustment and the ensuing reading. In addition, a damped sample rate of 2/second is useful when reading noisy signals. The digital LED (Light Emitting Diode) readout displays either the level or frequency of the input or output regardless of terminal function selected.

Appropriate resolution, time constant and sample rate are automatically provided to simplify operation for the user.

These test sets can measure both two-wire and four-wire balanced circuits. Impedances of 135, 600, and 900 ohms can be selected on the 3551A; impedances of 150, 600, and 900 ohms are available on the 3552A. In addition, the receiver may be either terminated or bridged.

The test sets may be powered by either ac line or internal rechargeable batteries and are suited for both inside and outside plant maintenance.

A full wave average detector is used for tone level measurements. Automatic ranging eliminates the need to set attenuators and thus reduces the possibility of errors due to faulty calculations. Direct

digital readout gives a 0.1 dB resolution over the entire 85 dB dynamic range.

For frequency measurements, a four-digit autoranging frequency counter is provided. The readout is calibrated in kHz and features 1 Hz resolution from 40 Hz to 10 kHz and 10 Hz resolution from 10 kHz to 60 kHz. The decimal point is automatically positioned to avoid the possibility of errors due to overflow of the four digits.

Noise measurements are made with a QUASI RMS detector and displayed in dBm on the 3551A and dBm on the 3552A, with 1.0 dB resolution. Display rate is slowed to 2 per second to provide analog feel of slowly changing noise levels. Both test sets have the capability of measuring noise-with-tone, message circuit noise, and noise-to-ground. Four switch selectable weighting networks are provided; C-message, Program, 3 kHz, and 15 kHz Flat in the 3551A; and Telephone (Psophometric), Programme, 3 kHz Flat and 15 kHz Flat in the 3552A. In the noise-with-tone position, a notch is inserted before the selected weighting network.

Send oscillator covers a frequency range of 40 Hz to 60 kHz in three bands; 40 Hz to 1 kHz, 200 Hz to 6 kHz and 2 kHz to 60 kHz. The output level is continuously variable from +10 dBm to -60 dBm.

In addition, a fixed position is provided to be used as the holding tone when making a noise-with-tone measurement.

A convenient set of clip-on dial terminals for connecting a lineman's handset is provided. This allows a line connection to be dialed up and then held in an off-hook (busy) condition while making either receive or send measurements on a two-wire wet line.

## Specifications, Model 3551A & 3552A

### Receiver

#### Level Measurements

**Frequency range:** 40 Hz to 60 kHz.  
**Dynamic range:** +15 dBm to -70 dBm.  
**Resolution:** 0.1 dB.  
**Sample rate:** 10/second normal, 2/second damped.  
**Detector type:** average responding.  
**Accuracy:** at 25°C ± 10°C, temperature coefficient: ±0.005 dB/°C beyond this range.

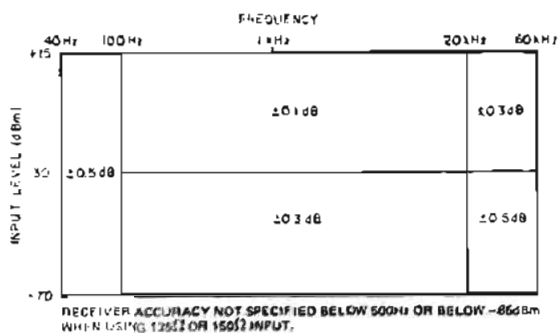

#### Frequency measurements

**Frequency range:** 40 Hz to 60 kHz.  
**Dynamic range:** +15 dBm to -70 dBm.  
**Resolution:** 1 Hz (40 Hz to 10 kHz), 10 Hz (10 kHz to 60 kHz).  
**Sample rate:** 10 second normal, 2/second damped.  
**Accuracy:** ±1 count.

#### Transmitter 3551A & 3552A

**Frequency range:** 40 Hz to 60 kHz.  
**Ranges:** 40 Hz to 1 kHz, 200 Hz to 6 kHz, 2 kHz to 60 kHz, 800 Hz fixed. (Other frequencies available 3552A.) 1004 Hz fixed, 3551A.  
**Resolution:** 1 Hz (40 Hz to 10 kHz), 10 Hz (10 kHz to 60 kHz).  
**Sample rate:** 10/second.  
**Harmonic distortion:** < -50 dB (THD 100 Hz to 4 kHz); < -40 dB (THD 40 Hz to 100 Hz and 4 kHz to 20 kHz); < -30 dB (THD 20 kHz to 60 kHz); < -55 dB (all harmonics 100 Hz to 4 kHz); < -60 dB (THD 1004 Hz fixed).  
**Accuracy:** ±1 count.  
**Level range:** +10 dBm to -60 dBm (40 Hz to 60 kHz), +6 dBm to -60 dBm, (1004 Hz fixed—3551A; 800 Hz fixed—3552A).  
**Resolution:** 0.1 dB.  
**Sample rate:** 10/second.  
**Accuracy:** at 25°C ± 10°C, temperature coefficient: ±0.005 dB/°C beyond this range.

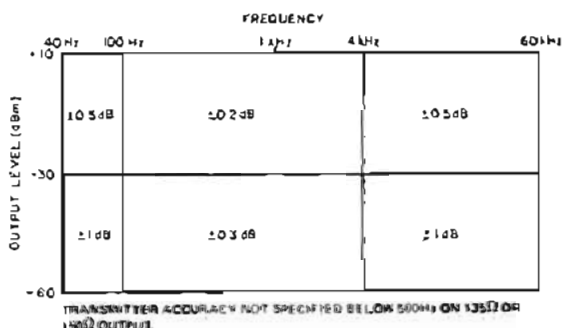

### 3551A Noise measurements

**Dynamic range**  
**Message circuit noise:** 0 dBm to +85 dBm.  
**Noise-with-tone:** 10 dBm to +85 dBm.  
**Noise-to-ground:** 40 dBm to +125 dBm.  
**Resolution:** 1 dB.  
**Sample rate:** 2/second.  
**Detector type:** Quasi-RMS responding.

**Accuracy**  
**Message circuit noise:** ±1 dB (+20 dBm to +85 dBm), ±2 dB (0 dBm to +20 dBm).  
**Noise-with-tone:** ±1 dB (+20 dBm to +85 dBm), ±2 dB (+10 dBm to +20 dBm).  
**Noise-to-ground:** ±1 dB (+60 dBm to +125 dBm), ±2 dB (+40 dBm to +60 dBm).  
**Weighting filters:** C-message, 3 kHz flat, 15 kHz flat, program.

### 3552A Noise measurements

**Dynamic range**  
**Message circuit noise:** -90 dBm to -5 dBm.  
**Noise-with-tone:** -80 dBm to -5 dBm.  
**Noise-to-ground:** -50 dBm to +35 dBm.  
**Resolution:** 1 dB.  
**Sample rate:** 2/second.  
**Detector type:** Quasi-RMS responding

**Accuracy**  
**Message circuit noise:** ±1 dB (-70 dBm to -5 dBm), ±2 dB (-90 dBm to -70 dBm).  
**Noise-with-tone:** ±1 dB (-70 dBm to -5 dBm), ±2 dB (-80 dBm to -70 dBm).  
**Noise-to-ground:** ±1 dB (-30 dBm to +35 dBm), ±2 dB (-50 dBm to -30 dBm).  
**Weighting filters:** Telephone (CCITT Psophometric), 3 kHz flat, 15 kHz flat, Programme.

### General

**Monitor:** built-in speaker, monitors received or transmitted signal.  
**Balanced impedances:** 135Ω, 600Ω, 900Ω (3551A).  
**Balanced impedances:** 150Ω, 600Ω, 900Ω (3552A).  
**Bridging loss:** < 0.2 dB.  
**Return loss:** > 30 dB.  
**Longitudinal balance:** > 60 dB at 6 kHz, > 126 dB at 50 Hz.  
**Hold circuit:** 20 milliamps constant current, < 0.2 dB holding loss, resistive fuse protection.  
**Input/output protection:** blocks 300 V dc.  
**Maximum longitudinal voltage:** 200 V rms.  
**Battery supply:** > 4 hours continuous operation on internal rechargeable batteries at 25°C. Battery drain is automatically turned off when discharged below proper operating level. Complete recharge in 12 hours.  
**Power requirements:** 100 V, 120 V, 220 V, 240 V ± 10%; 48 Hz to 440 Hz; 4 VA.  
**Temperature range:** 0°C to 55°C, operating; -20°C to +66°C storage.  
**Relative humidity:** 0 to 95% (< 40°C).  
**Dimensions:** 133 mm H × 343 mm W × 254 mm D (5 1/8" × 13 1/2" × 10").  
**Weight:** net, 6.6 kg (13 lb), Shipping, 7.3 kg (16 lb).

<b>Options</b>	<b>Price:</b>
C01-3551A, C01-3552A: 19 inch rack mount, ac power only (no batteries)	add \$75
H10-3551A: Extends frequency range to 85 kHz	add \$300
<b>Ordering Information</b>	
3551A Transmission test set	\$2000
3552A Transmission set (CCITT)	\$2345

# TELECOMMUNICATIONS TEST EQUIPMENT

## Transmission & noise measuring set

Models 3555B & 3556A

- Voice and carrier testing



### Description

Hewlett-Packard's 3555B Transmission and Noise Measuring Set is designed especially for telephone plant maintenance. It measures attenuation, distortion, cross-talk coupling and noise. Weighting networks comply with Bell System Technical Reference Publication number 41009, and include C-message, 3 kHz, 15 kHz flat and program.

HP's 3556A performs the same tasks as the 3555B. It also has built-in weighting networks that comply with 1960 CCITT requirements, which include telephone (psophometric) 3 kHz flat, and 15 kHz flat, Programme (P53) weighting filters.

Operating instructions printed in the protective cover are available in different languages at no extra charge.

Complementary equipment for the 3555B is HP 236A Telephone Test Oscillator (236A Opt. H10 for the 3556A). When used together, they make a complete transmission test set for accurate, convenient voice and carrier measurements.



### Specifications

	3555B (North American Standards)	3556A (CCITT Standards)
<b>VOICE FREQUENCY LEVEL MEASUREMENTS: 20 Hz to 20 kHz</b>		
dB/volt range	-91 dBm to +31 dBm	-78 dBm to +32 dBm/0.1 mV to 20 V F.S.
Level accuracy**	±0.5 dB, ±0.2 dB, 40 Hz to 15 kHz, level >60 dBm	100 Hz to 5 kHz: ±0.2 dB; 20 Hz to 20 kHz: ±0.5 dB
Input	Terminated or bridged 600Ω or 900Ω balanced. Bridging loss: <0.3 dB at 1 kHz. Balance: >80 dB at 60 Hz, >70 dB at 6 kHz, >50 dB to 20 kHz. Return loss: 30 dB min (50 Hz to 20 kHz)	Terminated, 600Ω symmetrical. Non-terminated, 10 kΩ symmetrical. Non-terminated error: <0.4 dB at 800 Hz. Symmetry: >80 dB at 50 Hz, >70 dB at 6 kHz, >50 dB to 20 kHz. Return loss: 30 dB min (50 Hz to 20 kHz)
Winding circuit	700Ω dc resistance, 60 mA max. loop line current at 300 Hz. With holding circuit in, above specs apply from 300 Hz to 4 kHz	
<b>NOISE MEASUREMENTS</b>		
dB/volt range	-1 dBm to +121 dBm	-78 dBm to +32 dBm/0.1 mV to 20 V F.S.
Weighting filters	3 & 15 kHz flat, C-message, and program (Bell system technical reference pub #47089)	3 & 15 kHz flat, telephone and Programme (P53, CCITT)
Input	Same as for voice frequency measurements	
<b>CARRIER FREQUENCY LEVEL MEASUREMENTS:</b>		
dB/volt range	-61 dBm to +11 dBm	-48 dBm to +12 dBm/3 mV to 3 V F.S.
Level accuracy	600Ω balanced (symmetrical): 1 kHz to 150 kHz, ±0.5 dB; 10 kHz to 100 kHz, ±0.2 dB. 150Ω balanced (or 150Ω unbalanced), 1 MHz to 600 kHz, ±0.5 dB; 10 kHz to 300 kHz, ±0.2 dB. 75Ω unbalanced (asymmetrical): 100 Hz to 600 kHz, ±0.2 dB; 30 Hz to 1 MHz, ±0.5 dB; 1 MHz to 3 MHz, ±0.5 dB ±10% of meter reading	
Input	Terminated or bridged 1350Ω or 600Ω balanced (symmetrical) and 75Ω unbalanced (asymmetrical)	
Return loss	600Ω, 26 dB min.; 3 kHz to 150 kHz, 1350Ω; 26 dB min.; 1 kHz to 300 kHz, 75Ω; 30 dB min. to 3 MHz	
Balance symmetry	>70 dB to 10 kHz, >60 dB to 100 kHz, >40 dB to 600 kHz	
<b>GENERAL:</b>		
Meter	Linear dB scale	Linear dBm scale
External battery	24 V or 48 V office battery, <15 mA	
Internal battery	Single NEDA 202, 45 V "B" battery Option H03 uses rechargeable batteries and similar to 3556A	4 rechargeable batteries (25 V total) or power line from 90 V to 250 V ac, 48 Hz to 440 Hz, <10 VA. Option 001 uses same battery as 3555B
AC	125 or 230 V (specify for 3555B) (switch for 3556A) 48 Hz to 440 Hz, <10 VA	
Dimensions	299 mm H x 197 mm W x 207 mm D (11 7/8" x 7 3/4" x 8 1/8" x 1)	
Weight	Net, 6.8 kg (15 lb). Shipping, 7.5 kg (17 lb).	
Jacks	Will accept Western Electric 241, 309, 310, 358, 289 and 347 plugs; 1011B hand-set or 52 type headset	Will accept Siemens 9 REL KL1-64, 4 mm diameter banana plugs or 3-prong Siemens 9 REL STP-6AC connector
**For levels >1 dBm accuracy spec applies only for freq. above 100 Hz. ±0.5 dB for 3556A.		

### Ordering information

HP 236A Telephone Test Oscillator (complementary equipment for 3555B) see page 537

HP 236A, Opt H10 Telephone Test Oscillator (complementary equipment for 3556A) see page 537  
 3555B Transmission and Noise Measuring Set  
 3556A Psophometer

Price

\$1150  
 \$1205

# TELECOMMUNICATIONS TEST EQUIPMENT



## Telephone test oscillators

Model 236A (Bell) Model 236A Opt H10 (CCITT)

- Voice and carrier testing

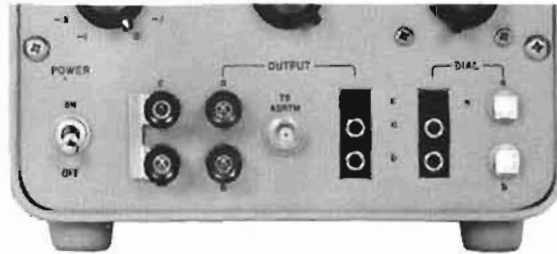

### General

Hewlett-Packard's Models 236A and 236A Option H10/H20 Telephone Test Oscillators are particularly useful for lineup and maintenance of telephone voice and carrier systems when used with their companion instruments 3555B and 3556A Transmission Noise METERS. CCITT requirements are met with the HP 236A Option H10 and HP 3556A when used together.

### Ordering Information

HP 236A Option H10, CCITT (ac line and dry battery)	add \$235
HP 236A Option H20, CCITT (ac line and rechargeable batteries)	add \$340
HP 236A Telephone Oscillator (North American)	\$780

### Specifications

	236A (Bell)	236A Option H10 (CCITT)
Frequency range	50 Hz to 560 kHz	
Frequency dial accuracy	± 3% of setting	
Frequency response		
600Ω output	± 0.3 dB from 50 Hz to 20 kHz	
900Ω output	± 0.3 dB from 50 Hz to 20 kHz	
135Ω output	± 0.5 dB from 5 kHz to 560 kHz	
150 and 75Ω outputs	± 0.5 dB from 5 kHz to 560 kHz	
Output level/accuracy	-31 to +10 dBm in 0.1 dBm steps/± 0.2 dBm from -31 to +10 dBm (1 kHz ref., Opt H10, 800 Hz ref.).	
Noise	At least 65 dB below total output or -90 dBm—whichever noise is greater. 3 kHz bandwidth	
Distortion	At least 40 dB below fundamental output.	
Output circuit	Balanced (symmetrical) and floating. Can be operated up to ±500 V dc above (earth) ground.	
Output impedance	600 and 900Ω ± 5% from 50 Hz to 20 kHz 135Ω ± 10% from 5 kHz to 560 kHz	600 and 150Ω symmetrical 75Ω asymmetrical
Output balance (output symmetry)	600 and 900Ω outputs: 70 dB at 100 Hz, 55 dB at 3 kHz 135 and 150Ω outputs: 50 dB at 5 kHz, 30 dB at 560 kHz	
Output jacks	Accepts Western Electric 241, 309, and 310 plugs.  Blinding posts accept banana plugs, spade lugs, phone tips or bare wires.	Accepts 3-prong Siemens 9 REL, STP 6 AC or 4 mm diameter banana plugs.
Dial jacks	Accepts Western Electric 309 and 310 plugs. Clip posts accept Western Electric 1011B lineman's hand-set clips.	Accepts 3-prong Siemens 9 REL, STP 6 AC or 4 mm diameter plugs. Clip posts accept lineman's hand-set clips as alligator clips.
OC holding coil	600 and 900Ω outputs only, 700Ω ± 10% dc resistance; 60 mA maximum loop current at 100 Hz.	
Power requirements	Line: 115 or 230 V (switch) ± 10% ac, 48 Hz to 440 Hz, < 2 VA. Internal battery: single NEDA 202 45 V "B" battery 236A Option H20: (same as 236A Option H10 except) five 6.25 V rechargeable batteries: 90 V ac-250 V ac, 48 Hz-440 Hz, < 10 VA during battery charge.	
Weight	Net, 6.1 kg (13.5 lb). Shipping, 7.7 kg (17 lb)	
Complementary equipment	HP 3555B Transmission and Noise Measuring Set	HP 3556A Psophometer

# TELECOMMUNICATIONS TEST EQUIPMENT

## Transmission impairment measuring set (TIMS)

Models 4940A and 4942A



4940A

### TIMS—Transmission impairment measuring set

Most of the important analog parameters can be measured by a combined assortment of analog test sets which measure only a few parameters. However, TIMS are "stand alone" combination test sets that measure 7 to 15 parameters depending on the model and options selected. Thus TIMS can replace a large number of analog test sets. The major advantages of TIMS are that they cost significantly less and are more compact and more portable than a combination of test sets required to do the same measurements.

In addition to its cost savings and portability, TIMS are easy to operate. The switches on the front panel are logically arranged in functional groups. Simple straight-forward operating procedures allow the craftsman or engineer to quickly and easily analyze voice channel-transmission lines.

#### 4940A TIMS—complete analog testing

The HP 4940A measures all the necessary parameters to completely describe the ability of a voiceband channel to carry medium and high speed data. The 4940A is the ideal tool for analyzing and troubleshooting T-channel and D1 conditions transmission lines.

With the HP 4940A it is possible to simultaneously observe all of the transients that cause data errors. By counting phase hits, gain hits, dropouts and three levels of impulse noise at the same time, a more accurate analysis can be made of error causes and channel quality. All of these transients are totalled by TIMS during the selected count time and stored in memory. The pushbutton-selectable count times are 5, 15 minutes and continuous. During the test and at the end of the count time, either the impulse noise totals or the hits and drop-out totals may be displayed from memory.

#### 4940A Specifications

For detailed specifications ask your local HP sales office for a 4940A TIMS data brochure.

##### General

**Power:** 105 volts to 129 volts AC, 60 Hz, 130 watts.

**Dimensions:** 46.4 cm H x 47.0 cm W x 32.4 cm D (18 1/4" x 18 1/2" x 12 3/4").

**Weight:** net, 18 kg (39 lb). Shipping, 25 kg (54 lb).

##### Options

001: adds P/AR measurement

002: adds nonlinear distortion measurement

003: adds P/AR and nonlinear distortion measurements

010: Field carrying case

4940A Transmission Impairment Measuring Set \$9000

Price

add \$300

add \$800

add \$975

add \$300

- Compatible with North American Standard
- Complete analog testing of the voice/data channel in communication systems



4942A

Measures level and frequency, message circuit noise (C-message and 3 kHz flat weighted), noise-with-tone, 3 level impulse noise, hits and dropouts, phase jitter, envelope delay, noise-to-ground.

#### HP 4942A simple operation plus portability

The HP 4942A features speed and ease of testing. At 26 pounds the 4942A is easily portable.

The MASTER SLAVE Control feature makes transmission impairment testing faster and easier. A 4942A operating in the SLAVE mode at far-end of the transmission line is controlled automatically from a 4942A operating in the MASTER mode at the operator end. One operator can control testing of all parameters in both directions of a full duplex (4-wire) circuit. All test results for each direction of test are displayed at the MASTER unit for ease of logging test data.

With the addition of HP-IB (Opt 010) the HP 4942A can be remotely controlled by a calculator or computer and can output data for printing, plotting and further analysis.

#### 4942A Specifications

For detailed specifications ask your local HP sales office for a 4942A TIMS data brochure.

##### General

**Power:** 117 V ac  $\pm 10\%$ , 50/60 Hz, 45 watts.

**Dimensions:** 196 mm H x 338 mm W x 533 mm D (7 7/16" x 13 3/16" x 21").

**Weight:** net, 11.8 kg (26 lb). Shipping 205 kg (45 lb).

##### Options and accessories

010: Adds HP-IB Interface

019: 19" rack mount adapter

910: Additional Set of Manuals

Accessories for Model 4942A (To be used with Option 010 HP-IB Interface)

Model 10631A ASCII Interface Cable 1 m (3.3')

Model 10631B ASCII Interface Cable 2 m (6.6')

Model 10631C ASCII Interface Cable 4 m (13.2')

Price

add \$500

add \$150

add \$50

\$66

\$65

\$75

#### 4942A Transmission Impairment Measuring Set \$5800

Measures level and frequency, C-message circuit noise, noise-with-tone, channel signal-to-noise ratio, 1 level impulse noise, envelope delay. With MASTER-SLAVE control and portable mainframe.

# TELECOMMUNICATIONS TEST EQUIPMENT

Transmission impairment measuring set (TIMS)

Models 4943A and 4944A



4943A



4944A



## 4943A TIMS

**Gives you a permanent record of your measurements**

The new analog output circuit allows you to display the measured signal on a CRT display or record it on an X-Y recorder or strip chart recorder. Built-in storage and internally generated graticule lines allow you to use non-storage oscilloscopes or uncalibrated CRT display.

### 4943A Specifications

For detailed specifications ask your local HP Sales Office for a 4943A TIMS Data Brochure.

#### General

Power: 100, 120, 220, 240 V ac 48 to 66 Hz.

Size: 196 H x 338 W x 591 mm D (7.7" x 13.3" x 23.3").

Weight: 12.2 kg (27 lb).

#### Options

010: HP-IB Interface

015: 18055A Transit Case

019: 10491B 19" Rack Mount

910: extra set manuals

#### Price

add \$500

add \$300

add \$100

add \$50

**4943A Transmission Impairment Measuring Set \$7400**

Measures Level and Frequency, message circuit noise (C-message and 3 KHz Flat weighted), 1 level impulse noise, signal-to-noise ratio, envelope delay, phase jitter. Analog outputs with internal storage and internally generated graticules, MASTER-SLAVE feature, two holding coils, and portable mainframe.

## 4944A TIMS

**Key analog parameters of voiceband channels**

Non-linear distortion is measured using the four tone intermodulation distortion technique. This technique is licensed under Hekimiam Laboratories, Inc. USA Patent No. 3862380. The 4944A TIMS computes the 2nd and 3rd order products and automatically corrects the readings for noise.

### 4944A Specifications

For detailed specifications ask your local HP Sales Office for a 4944A TIMS Data Brochure.

#### General

Power: 120 V or 240 V/50 Hz/60 Hz Power Operation

Size: 196 H x 338 W x 591 mm D (7.7" x 13.3" x 23.3").

Weight: 12.2 kg (27 lb).

#### Options

010: HP-IB Interface

015: 18055A Transit Case

019: 10491B 19" Rack Mount

910: Extra set of manuals

#### Price

add \$500

add \$300

add \$100

add \$50

**4944A Transmission Impairment Measuring Set \$7200**

Measures Level and Frequency, message circuit noise (C-message and 3 KHz Flat weighted), signal-to-noise ratio, 1 level impulse noise, envelope delay, non-linear distortion, two holding coils, MASTER-SLAVE feature, and portable mainframe.

## TELECOMMUNICATIONS TEST EQUIPMENT

Portable test set  
Model 3550B

- Voice and carrier measurements



### Description

Hewlett-Packard's Model 3550B Portable Test Set is designed specifically to measure transmission line and system characteristics such as continuity and attenuation distortion. It is particularly useful for lineup and maintenance of multi-channel communication systems. Model 3550B contains a wide range oscillator, a voltmeter, and a patch panel to match both oscillator and voltmeter to 135, 600, and 900 ohm lines. These instruments are mounted in a combining case that is equipped with a splash-proof cover. In addition, the oscillator, voltmeter, and patch panel may be used separately whether they are in or removed from the combining case.

Both the oscillator and voltmeter are transistorized and operate from their internal rechargeable batteries or from the ac line. Batteries provide 40 hours of operation between charges and are recharged automatically during operation from the ac line.

### Specifications

Oscillator HP 204C Opt H20  
(Refer to Page 335)

Voltmeter, HP 403B Opt 001  
(Refer to Page 39)

Patch panel, HP 353A

(Specifications apply with oscillator and voltmeter).

#### Input (receiver)

**Frequency range:** 50 Hz to 560 kHz.

**Frequency response:**

$\pm 0.5$  dB, 50 Hz to 560 kHz.

**Impedance:** 135 $\Omega$ , 600 $\Omega$ , and 900 $\Omega$  and bridging (10 k $\Omega$  center tapped).

**Balance:** better than 70 dB at 60 Hz for 600 $\Omega$  and 900 $\Omega$ ; better than 60 dB at 1 kHz for 600 $\Omega$  and 900 $\Omega$ ; better than 40 dB over entire frequency range for 135 $\Omega$ , 600 $\Omega$ , and 900 $\Omega$ .

**Insertion loss:** less than 0.75 dB at 1 kHz.

**Maximum level:** +22 dBm (10 V rms at 600 ohms).

#### Output (send)

**Frequency range:** 50 Hz to 560 kHz.

**Frequency response:**  $\pm 0.5$  dB, 50 Hz to 560 kHz

**Impedance:** 135 $\Omega$ , 600 $\Omega$ , and 900 $\Omega$  center tapped.

**Balance:** better than 70 dB at 60 Hz for 600 $\Omega$  and 900 $\Omega$ ; better than 60 dB at 1 kHz for 600 $\Omega$  and 900 $\Omega$ ; better than 40 dB over entire frequency range for 135 $\Omega$ , 600 $\Omega$ , and 900 $\Omega$ .

**Insertion loss:** less than 0.75 dB at 1 kHz.

**Distortion:** less than 1%, 50 Hz to 560 kHz.

**Maximum level:** +22 dBm (10 V rms into 600 ohms).

**Attenuation:** 110 dB in 10 and 1 dB steps.

**Accuracy, 10 dB section:** error is less than  $\pm 0.25$  dB at any step.

**Accuracy, 100 dB section:** error is less than  $\pm 0.5$  dB at any step.

**Connectors:** two 3-terminal binding posts for external circuit connection and two BNC female connectors for oscillator and voltmeter connection.

Patch panel, Opt H02-353A

(Same as Model 353A except as indicated below).

**Attenuator:** 23 dB  $\pm 0.5$  dB (1-step slide switch).

#### Hold circuit (rec terminals)

**\*Frequency response:** 300 Hz to 3 kHz  $\pm 0.5$  dB, 1 kHz reference.

**DC resistance:** 240 ohms nominal.

**Maximum DC current:** 100 mA.

**Maximum DC voltage:** 350 volts.

**Attenuation:** 23 dB  $\pm 0.5$  dB (1-step slide switch).

#### Hold circuit (send terminals)

**\*Frequency response:** 300 Hz to 3 kHz  $\pm 0.5$  dB, 1 kHz reference.

**DC resistance:** 240 ohms nominal.

**Maximum DC current:** 100 mA.

**Maximum DC voltage:** 150 volts.

**Connectors:** special telephone jacks to accept Western Electric No. 309 and 310 plugs. Sleeve jack is connected to sleeve of jacks 309 and 310. Two 3-terminal binding posts for external circuit connection.

Two terminals (Tel Set) connector for Hand Set, two BNC female connectors for oscillator and voltmeter connection.

Patch panel, Opt H03-353A

(Same as Model 353A except as indicated below).

#### Hold circuit (rec terminals)

**\*Frequency response:** 300 Hz to 3 kHz  $\pm 0.5$  dB, 1 kHz reference.

**DC resistance:** 240 ohms nominal.

**Maximum DC current:** 100 mA.

**Maximum DC voltage:** 150 volts.

**Attenuation:** 23 dB  $\pm 0.5$  dB (1-step slide switch).

#### Hold circuit (send terminals)

**\*Frequency response:** 300 Hz to 3 kHz  $\pm 0.5$  dB, 1 kHz reference.

**DC resistance:** 240 ohms nominal.

**Maximum DC current:** 100 mA.

**Maximum DC voltage:** 150 volts.

**Connectors:** special telephone jacks to accept Western Electric No. 309, 310 and 241 at send and rec terminals. Sleeve jack is connected to sleeve of jacks 309 and 310.

Two terminal (Tel Set) connector available for Hand Set. Two BNC female connectors for oscillator and voltmeter connection.

#### General

**Size:** 489 H  $\times$  213 W  $\times$  337 mm D (19 1/4"  $\times$  8 3/8"  $\times$  13 1/4") with cover installed.

**Weight:** net, 13.5 kg (30 1/2 lb). Shipping, 18 kg (40 lb).

#### Ordering information

3550B Portable Test Set (with 353A Patch Panel)

Price

\$1750

H02-3550B (with H02-353A substituted for standard 353A)

add \$150

H03-3550B (with H03-353A substituted for standard 353A)

add \$150

\*This is the frequency response with the holding coil across the line. Refer to Model 353A Specifications for response in "non-holding" condition.





## Analysis—The Key to Success

Trying to locate a short, ground, cross, (short between to conductors) and open in buried plant means you are literally working blind. Analysis provides the clues to help you visualize what's going on in the cable and, therefore, a pretty good idea of what caused the fault.

To locate a fault in buried plant the first problem we must solve is to locate the cable. With the Hewlett-Packard Cable Fault Locator Model 4904A this problem is easily solved. The 4904A is a tone set that has a very stable transmitter output signal, and a sharply tuned receiver unit to allow you to locate cable path and depth under the most adverse conditions. This instrument is designed to reject the normal noise interference from 60 Hz power lines. As the cable path is being located the depth of the cable can be measured and sheath damage can be pinpointed.

Now that the path and depth of the cable are known the exact location of the fault may be determined. If the fault is resistive,

(short, cross, grounded conductor, battery cross) we will use the Hewlett-Packard Model 4930A Conductor Fault Locator. In plastic insulated conductor (PIC) cable the resistive faults can range in severity from a few ohms to many thousands of ohms. The 4930A will locate the exact distance (in feet or meters) to the fault regardless of the fault resistance. The operator need only follow the easy to understand diagrams and instruction in the lid of the instrument to locate the most complex resistive fault.

The third instrument required for fault locating is the Hewlett-Packard Model 4910G Open and Split Locator. The open conductor is located as quickly and easily as the resistive faults using the 4910G. The instrument uses the latest in electronic technology, which allows you to make very accurate measurements without the need of repetitive operation. This microprocessor based instrument performs several measurements automatically and displays the distant to the open digitally. In many cases an open conductor is not open but split with

another pair. The 4910G will locate the split to within one manhole. The 4904A Cable Fault Locator can now be used to verify the split location before the splice case is removed. As you can see the 4910G Open and Split Locator will save you many hours in locating both opens and splits.

In order to be able to effectively and efficiently find faults in multi-pair cable the craftsman must be equipped with a Cable Fault Locator (4904A), Conductor Fault Locator (4930A), and the Open/Split Locator (4910G). With this family of instruments all cable faults can be located quickly. This will therefore keep down time, and customer complaints to a minimum.

When several pair have high resistance faults in the same cable, water in the cable is a good possibility. With the ease of operation and speed at which the operator can determine the fault locations, the size and location of the wet section of cable can be quickly measured and the decision to repair or replace that section can be made with confidence.

# TELECOMMUNICATIONS TEST EQUIPMENT

## Telephone outside plant instruments

Models 4980 A, 4961A, 4910G, 4930A, 4904A, 4905A, 18043A

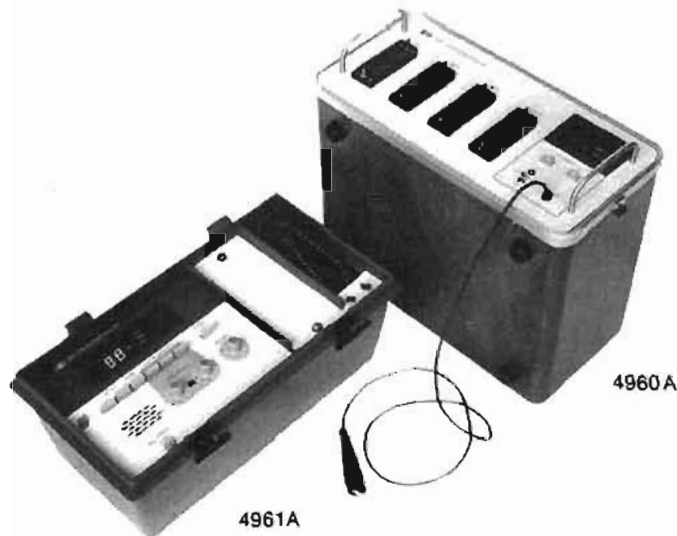

4960A

4961A



4930A



4910G

### Telephone cable construction

Telephone cable construction involves installing, splicing and then testing new cables as well as rearranging and testing old cables. Such telephone cables, containing many hundreds of conductor pairs, provide the most effective method of transmitting voice band information signals from a distribution point to the communications terminal at the subscriber's location. Most of the larger cables use noncolor-coded paper and pulp insulation for the pairs. Prior to termination in the field, the new pairs must be identified by pair number. Traditional methods of pair identification were time consuming and later semi-automatic methods often proved unreliable. An increasing need to rearrange telephone cables and pairs as well as a higher labor content associated with such activities has resulted in a need for fast, reliable pair identification equipment.

#### New 4960A/4961A automatic pair identifier system

The 4960A/4961A System reliably identifies and tests working and nonworking telephone cable pairs in loaded or nonloaded telephone cables up to 40,000 feet in length. The system has two parts . . . the 4960A Office Unit and the 4961A Field Unit. The Office Unit operates unmanned once it is connected to the switching office mainframe using standard test connectors (shoes). The Field Unit is operated by the craftsman at the field location. A pushbutton starts the operation of testing, identifying and determining the status of each pair.

There are four operating modes: Self Check, Shoe Check, Scan Mode and Select Mode. Self Check tests the operation of the units. Shoe Check determines if all the pairs in the shoe are making good contact to the mainframe. Scan Mode determines the pair number of a randomly chosen pair within the hundred pair count. Select Mode instructs the Office Unit to apply an audible tone to any selected pair in the count. The Select Mode is useful for identifying pairs that do not identify in the Scan Mode and for determining the problem on a faulted pair.

The system is noninterfering to voice and most data circuits. No control pair is required for communication between the Office and Field Units. Other features include bad, busy and reversed pair indications as well as large, lighted digital displays.

### Cable fault locating

Of prime interest in telephone cable maintenance is the location of physical damage to the cables. Telephone cable fault location has become an especially acute problem in recent years as more cable is placed underground. Although better protected from the environment, the cable is subject to new dangers and the telephone craftsman is faced with locating damage hidden by several feet of earth. In addition, higher traffic density on cables and demands for higher quality transmission have placed more emphasis on cable reliability and quality.

#### Direct reading fault locators

Field instruments that provide a direct distance-to-fault reading in feet (or metres) have the benefit of relieving the craftsman of the drudgery of performing manual calculations. Locating faults becomes faster, requires less training and is less error prone than with manual bridge techniques.

#### 4930A conductor fault locator

The 4930A is an automatic, digital, direct reading test set operating on the Wheatstone Bridge principle. It is designed to locate extremely high resistance shorts, crosses and grounds, such as might occur from minute amounts of moisture in plastic insulated cable (PIC). The 4930A is connected to the cable pairs at an access point and the far-end of the cable is strapped to form a bridge configuration. Two nulling operations are performed and then either the distance to the fault, distance strap to fault or the distance to the far-end is obtained on the autoranging digital display. The 4930A includes pushbutton checks of the fault resistance, the condition of the strap as well as of its 12 V battery. A self check circuit is built into the set. The 4930A is housed in a rugged polycarbonate case.



#### New 4910G open and split fault locator

The 4910G is designed to provide direct distance readings to both opens and splits. An open is a discontinuity in one or both of the wires of a cable pair. Opens can be the result of bad splices as well as the result of damage caused by shotgun pellets, squirrels, gophers or shovels. A split is a splicing error in which one side of a pair is inadvertently cross-connected with one side of a second pair while the remaining sides are spliced correctly. The split is the only cable fault that is virtually always man-made. The 4910G operates on a capacitance charge sampling principle which relates the charge placed on a length of wire to its capacitance and hence its length. A built-in microprocessor performs automatically the measurements and calculations necessary to locate opens and splits. The test set averages out the effect of noise on the line by automatically taking several readings on the pair prior to displaying the fault distance on its autoranging digital display. The 4910G is set automatically for standard .083mf/mile exchange cable but can be reset to other types of cable by means of the D Factor control.

#### Tone type fault locators

The tone type locator, such as the Model 4904A, places a pulsed tone on the faulted circuit which is traced by an inductive pick-up coil and a sensitive tuned receiver. At the point of the fault, the signal drops in level, thereby pinpointing the exact physical location of the fault. The tone locator also has the advantage of being able to precisely trace the path of the cable and, by triangulation, determine its depth at any point. This information is necessary for use in accurately locating the fault. It is also necessary for accurately marking the cable location to protect it from construction and excavation work being performed in the vicinity of the cable. The tone locator system is designed so that only the transmitted signal is detected, and interfering signals (such as power line harmonics) do not interfere with the measurement. Output power of the transmitter is kept low to prevent interference with other working circuits in the cable and to prevent "carry-by" of the signal beyond the fault.

#### 4904A cable fault locator

The 4904A is a pulsed tone system for locating shorts, crosses and grounds in direct buried, underground (ducted) and aerial utilities cable. It also accurately locates path and depth of buried cables and pipes. The sensitive narrow bandwidth receiver rejects ac hum and permits locating high resistance faults. It produces a pulsed 990 Hz tone for burial cable fault locating and a pulsed 150 Hz tone for aerial cable. The tone transmitters unit also has a built-in ohmmeter for analyzing faults. The accessory earth contact frame is especially useful for locating high resistance pinhole faults in the cable sheathing. It comes complete with transmitter, receiver, search wand, earth contact frame, cables and ground rod.

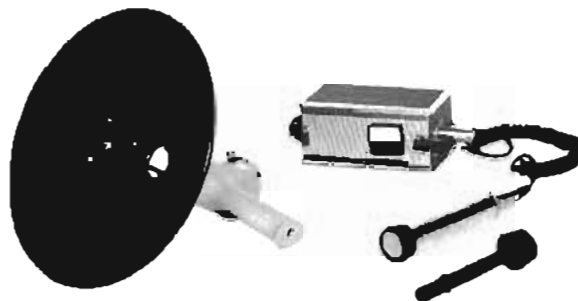

#### 4901A cable fault locator

The 4901A is an economically priced cable fault locator functionally similar to the 4904A. It produces only the pulsed 990 Hz and is limited to locating path, depth and low resistance faults. It has a built-in ohmmeter.

#### 4900A cable fault locator

The 4900A is identical to the Model 4910A except without the ohm-meter feature. The earth contact frame is optional.

#### Ultrasonic leak detection

As pressurized gas escapes through an aperture, it creates considerable noise in the ultrasonic region of 36 to 44 kHz. The HP Ultrasonic Translator Detectors (such as Model 4905A) detect this characteristic sound with a sensitive, directional Barium Titanate microphone and translates the signal to audio by mixing it with a 40 kHz local oscillator signal. The audio signal is then amplified and monitored on a speaker and level meter.

The most common causes of pressure leaks in cable plant are corrosion (particularly in coastal areas), electrolysis, squirrels, boring beetles, abrasion from wind and weather, hunters, and outside workmen. Abrasion (during installation) and corrosion are the most frequent causes of cable sheath trouble in cable installed underground in ducted passages.

To detect leaks in aerial cables, the craftsman merely scans the cable from the ground with the flashlight-size microphone, listening for the characteristic hissing sounds of a leak. By simultaneously observing the level meter, he can "peak in" on the leak and determine its exact location. Pole mounted accessories are available for closer scanning of the cable and the 18043A Ultrasonic Reflector accessory is a parabolic type dish allowing exact aerial leak localizing from ground level.

Leaks in ducted underground systems are located with a unique "Duct Probe" accessory.

#### 4905A ultrasonic translator detector

The 4905A is a lightweight, portable ultrasonic detector which includes a directional probe, a 6-ft. coil cord and a leather utility case. It has a self-contained speaker, a logging meter, and provision for headphones.

#### More information on telephone plant instruments

U.S.A. Customers: HP Delcon products are sold directly to the customer from the manufacturing division. Please direct all orders and inquiries to:

HEWLETT-PACKARD COMPANY  
 Delcon Division  
 690 E. Middlefield Road  
 Mountain View, CA 94042  
 Telephone (415) 969-0880

Customers outside the U.S.A.: Orders should be directed to your local Hewlett-Packard distributor or representative.

### Carrier testing (FDM)

FDM carriers are used to transmit large numbers of communications channels simultaneously over a single transmission medium. The channels are stacked in the frequency spectrum.

Microwave Radio systems typically carry up to 1800 channels on each RF carrier and coaxial cable systems carry up to 3600 channels on each coaxial "tube". In high density situations as many as 10,000 channels can be packed into the 60 MHz bandwidth of a single tube of a coaxial cable.

### Measurements on FDM carriers

In the design, manufacture, installation and maintenance of FDM carrier systems several types of measurements are necessary.

HP offers a variety of selective level meters, level generators, broadband power meters, atomic standards and pulse echo test sets to satisfy your FDM measurement needs. Of the many FDM measurements made, the more common are:

Measurement	Test Set
Channel and Inter-channel Noise	Selective Level Meter (SLM)
Carrier Leak	SLM
Line Pilots	SLM
Reference Pilots	SLM
Spectrum Search	SLM
Channel Power	SLM
Frequency Response	SLM and Generator
Return Loss	SLM, Generator and Hybrid
Crosstalk	SLM and Generator
Delay Distortion	Delay Distortion Test Set
Intermodulation Noise	White Noise Test Set
System Power	Broadband Power Meter
Frequency Accuracy	Atomic Standard
Impedance Regularity	Pulse Echo Test Set

### The ideal selective level meter

A loaded FDM carrier system presents several measurement challenges to the Selective Level Meter (SLM).

When measuring single tones, the SLM should have enough frequency accuracy, stability and resolution to measure a carrier leak which is just 80 Hz away from the group pilot.

When measuring channel noise, the SLM should satisfy a number of requirements:

1. It should provide a noise measuring filter which has 'C' message or Psophometric weighting. Flat weighting (i.e. 3.1 kHz flat) is also a useful feature.
2. The noise measuring filter should be accurately centered over the noise, which is contained from 300 Hz to 3400 Hz, in the voice channel.
3. An rms detector should be used.
4. To aid in noise identification a demodulated output should be provided with good listening fidelity. For ease of use, the SLM should measure noise and provide the demodulated output simultaneously.
5. The SLM should be capable of measuring channel noise as low as  $-125$  dBm.
6. Level accuracy requirements vary from a few dB to better than a tenth of a dB. Noise measurement accuracy varies from a few dB to a few tenths of a dB.

Finally, the SLM must be easy to use, reliable and ideally be adaptable for use in a system. Cost is also an important factor.

### Selective level meters

There are several alternative approaches to the design areas of SLM's, balancing cost and performance.

1. Frequency accuracy: The ideal SLM provides accurate and stable tuning to the signal(s) to be measured. This is achieved by using a synthesizer as a local oscillator, or phase-locking the oscillator to a suitable external reference.

Cost savings can be made using the alternative approach of a free-running local oscillator, with reduced stability and resolution. This approach needs manual searching in the region of the signal to, for example, peak the meter on the pilot or carrier.

2. Sensitivity: To measure channel noise at the very low level test points, which sometimes occur, can require sensitivities in the order of  $-125$  dBm. To achieve the very low noise floor required to make measurements at this level is extremely difficult, if compromises are not to be made in the ability to measure high level signals accurately. The practical approach is to cover the majority of situations, with an SLM noise floor of  $-115$  dBm and, for the very low level test points, provide external low noise amplifiers.

3. Noise measurement filters: Traditionally 1.74 kHz effective noise bandwidth filters have been used in SLM's to approximate the measurement made with true psophometric and 'C' message weighted filters. The advantages realized are in cost

savings and, in the ability to disregard the fact that a channel can be erect or inverted, since the filters are symmetrical.

The ideal solution is to use a flat-topped 3.1 kHz channel filter over which a true psophometric filter or 'C' message filter can be superimposed. The benefits which follow are a measurement of all signals in the 3.1 kHz voice channel bandwidth including, for example, signals at the band edge with no assumption about the type of noise, when used in conjunction with a true RMS detector. Additionally, a demodulated output from the flat-topped 3.1 kHz channel filter can be used for accurate further analyses with standard audio test gear.

4. RMS versus Average Detector: The majority of SLM's in use today contain average responding detectors which respond faster and cost less than rms responding detectors.

The average responding detector is a trade-off for single tone measurements, but noise measurements are a problem. Unless the noise under measurement is pure gaussian, it must be summed in an rms fashion (the way the human ear sums noise) to ensure an accurate result. The average detector's error can be offset, however, by assuming the noise is white noise and by widening the noise measuring filter so that the answers obtained with the average detector are the same as answers obtained with an rms detector. For CCITT weighting the correct bandwidth to use with an average detector is 2300 Hz. For 'C' message weighting, use 2650 Hz.

### Manual testing

The 312B and 313A tracking generator is widely used in all FDM applications from R&D to system maintenance. These units provide a relatively low cost solution when an SLM and tracking source is required.

312D and 3320C stand alone generators are specially designed for FDM system installation and maintenance. The SLM and level generator are among the lowest priced units designed for this application.

Model 3040A Network Analyzer is used in R&D and manufacturing. It can be used on FDM carriers up to 2700 channels. It is a stimulus-response test set only (no selective level capability).

It is used to characterize two-port linear devices like amplifiers and filters. The test set has 0.1 Hz frequency resolution, 0.01 dB amplitude resolution, 0.01 degree phase resolution and 1 nanosecond delay sensitivity.

The 3040A can also be automated by adding HP-IB control hardware and a system controller like the 9825A Programmable Calculator.

The 3044A provides a precise tracking generator and selective level meter. This test set features 0.1 Hz frequency resolution and 0.01 dB level resolution plus digital readout and keyboard control. It can easily be automated by adding HP-IB control hardware and a system controller like the 9825A Programmable Calculator.

The 3745A & B Selective Level Measuring Sets are designed to be as close to the ideal SLM as possible.

For ease of use under manual control, the 3745A/B is the first SLM to offer keyboard entry of an FDM channel by FDM nomenclature (e.g., MG 6, SG 4, Group 12). FDM plans are stored internally in memory. When an FDM channel is entered, the 3745A/B goes to the correct frequency automatically. The 3745A/B also features automatic pilot scans, broadband group power measurements, plus phase jitter measurement. It offers considerable time savings for routine tests such as carrier leak, pilot level, noise monitoring.

The 3745A is tailored for CCITT use and the 3745B for AT & T. Both SLM's can be automated by adding a system controller such as the 9830A Programmable Calculator.

### Automatic testing

Hewlett-Packard manufactures a wide line of HP-IB automatic system components. These make the implementation of automatic system ideas relatively straight forward from both the hardware and software standpoints. HP-IB systems make automatic testing more economically justifiable.

The 3042A Network Analyzer offers automatic stimulus response testing of level, phase and group delay. It is used in the design and manufacture of FDM carriers up to 2700 channels.

The 3042A is widely used in the design and manufacture of linear, two-port FDM devices like amplifiers and filters. The basic system consists of a precision source and tracking detector under the control of a programmable desk-top calculator. Many other programmable test instruments are offered as complements to the 3042A so that a system can be specially tailored to your application.

FDM manufacturers have found that automatic testing with the 3042A can result in much faster testing. . . . up to 20 times faster than previous manual testing. Also, the 3042A provides state-of-the-art accuracy and repeatability.

The 3045A is used primarily in FDM design and manufacture. The system consists of a precision source and tracking detector under the control of a programmable desktop calculator.

The 3045A can be used for stimulus response testing as well as for level and noise measurements. Also, you can build a system for your particular application by adding other HP-IB controllable test instruments to the 3045A.

Manufacturers of FDM equipment have found that the 3045A has helped reduce test time on radio equipment by a factor of 10. Equally important is that manufacturers have found that 3045A programming can be handled inhouse without needing software specialists.

All the capabilities of the 3745A/B can be remotely controlled through the HP-IB, to permit the building of completely automatic selective level measuring systems, controlled from either simple desk-top controllers or computers. Also available is an automatic switching capability to access test points within the equipment. The 3754A Access Switch achieves this task. The Access Switches are controlled from the 3755A Switch Controller. The 3755A is controllable manually, from a front panel keyboard, or remotely, via the HP-IB.

Such systems are already making significant contributions in the maintenance and surveillance of Frequency Division Multiplex systems throughout the world.

### Manual Selective Level Meters

	312B/313A	312D/3320C	3044A	3745A/ 3320C Opt M02	3745B/3320C
<b>MEASUREMENTS</b>					
Channel & interchannel noise	Yes (flat)	Yes (flat)	Yes (round-topped filter)	Yes (psoph or flat)	Yes (C-message or flat)
Carrier leaks & pilots	Yes	Yes	Yes	Yes (auto scan)	Yes
frequency response	Yes	Yes	Yes	Yes	Yes
Spectrum scan	Manual	Manual	Auto	Auto	Auto
Phase jitter	with external meter	with external meter	No	internal	internal
Group Power	No	No	No	Yes	Yes
<b>TEST SET CHARACTERISTICS</b>					
frequency range	1 kHz-18 MHz	1 kHz-18 MHz	10 Hz-13 MHz	1 kHz-25 MHz rms	1kHz-25MHz rms
Noise measurements	Average 2300/3100 flat	Average 2300/3100 flat	Average 3 kHz round topped	3100 flat and C-message or psophometric	3100 flat and C-message or psophometric
SLM noise floor	-117 dBm	-117 dBm	-110 dBm	-115 dBm	-115 dBm
Tone measuring bandwidth	200 Hz	50 Hz	3 Hz, 10 Hz, 30 Hz, 300 Hz	22 Hz	22 Hz
frequency accuracy	50 Hz	50 Hz	5 Hz	5 Hz	5 Hz
Price	\$7,445	\$10,000	\$14,005	\$22,085	\$21,600

# TELECOMMUNICATIONS TEST EQUIPMENT

## 25 MHz and 90 MHz Selective Level Measuring Sets

Models 3745A, 3745B and 3747A, 3747B

- Frequency range 1 kHz to 25 MHz (3745A/B)  
10 kHz to 90 MHz (3747A/B)
- Selective filters for pilot, channel and group power measurements
- Autoranging attenuators and automatic tuning to stored frequency plans
- Out-of-limit alarm with hardcopy record on separate printer
- Automatic routines for unattended measurements
- HP-IB compatible

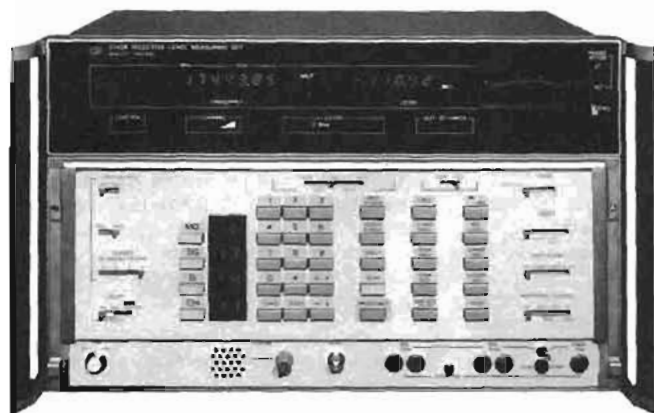

HP-IB

### Description

The 3745A & B and 3747A & B Selective Level Measuring Sets (SLMS's) are designed to make fast, accurate selective level measurements. A built-in frequency synthesizer gives accurate, stable tuning to the precise frequency at which the measurement is to be made. This simplifies the tuning of the SLMS. The 3745A/B and 3747A/B can be tuned over their frequency ranges (1 kHz to 25 MHz and 10 kHz to 90 MHz respectively) with a resolution of 10 Hz.

The SLMS's measure true rms power between +15 dBm and -115 dBm with 0.1 dB or 0.01 dB resolution. Fully autoranging attenuators and amplifiers simplify operation further by eliminating the need to set attenuators and add meter readings. Measurement results are automatically displayed to the selected resolution, in dBm or dB relative terms, on an LED display. The absolute accuracy of the measurements over wide level and temperature ranges is  $\leq \pm 0.25$  dB and flatness is typically  $\leq \pm 0.1$  dB.

Many benefits are derived from the purpose-designed filters contained in the SLMS's. The pilot filter has a flat-top, necessary for automatic tuning, and achieves high out-of-band rejection so that, for example, carrier leak and adjacent pilots can be measured on active systems. The channel filter is a flat-topped 3.1 kHz filter which measures all signals in the voice-channel with high out-of-band rejection—ensuring that pilots, residual carriers, signalling tones, etc., do not interfere with measurements. Optional weighted filters are available to make either true 'C'-message or CCITT psophometrically weighted noise measurements. With these options, phase jitter on a voice-channel can be accurately measured. A 48 kHz filter for group power measurements is also provided, to facilitate fast location of high level signals on a multiplex.

The SLMS is internally-controlled by a microprocessor which provides several ease-of-use and time-saving features. As well as tuning exactly to an entered frequency, the SLMS can refer to BELL or CCITT multiplex frequency plans in its memory and automatically tune to the correct frequency at any level in the multiplex. Other frequency plans can be installed to special order. This eliminates the need for FDM Plan Charts and Tables. The SLMS's can automatically step through pilots, channels, group powers, carrier leaks, etc., across the baseband of a multiplex—comparing levels with pre-determined alarm limits and providing a print-out of out-of-limit signals on a separate Thermal Printer. 250 pilot measurements can be made in about 2 minutes or, 2700 channel powers or carrier leaks can be measured in about 15 minutes. Spectrum analysis measurements of a voice-channel, group, supergroup

or even the whole baseband can also be made. Measurements can be made unattended, for example, overnight.

The SLMS's are fully programmable via the Hewlett-Packard Interface Bus (HP-IB) and so can form the basis of a powerful, fully-automatic surveillance system.

**Specifications** (Unless otherwise stated, all specifications are for 0°C to 55°C after 30 minute warm-up)

#### Frequency range

##### 75Ω Unbalanced Input

(3745A/B): 1 kHz to 25 MHz.

(3747A/B): 10 kHz to 90 MHz.

124Ω Balanced Input (3745B/3747B): 10 kHz to 10 MHz.

135Ω Balanced Input (3745B/3747B): 10 kHz to 10 MHz.

150Ω Balanced Input (3745A/3747A): 10 kHz to 10 MHz.

Minimum frequency step size: 10 Hz.

#### Frequency tuning accuracy

##### With INTERNAL REFERENCE OSCILLATOR

Initial settling accuracy:  $\leq \pm 2 \times 10^{-8}$  parts,  $\pm 1$  Hz

Ageing rate:  $\leq \pm 1.5 \times 10^{-8}$  parts/month,  $\pm 1$  Hz.

#### Measurement ranges

##### 75Ω Unbalanced Input

Filter	Range (dBm)	Noise floor (dBm) (with open-circuit input)	
		50 kHz to 300 kHz	300 kHz to 25 MHz (3745A/B) 300 kHz to 90 MHz (3747A/B)
22 kHz—Pilot	+15 to -120	$\leq -110$	$\leq -115$
3.1 kHz—Channel	-15 to -115	3745 $\leq -100$	3747 95
48 kHz—Group	-15 to -75	—	$\leq -100$
Input Power— Broadband	+15 to -35 (3745A/B) +15 to -95 (3747A/B)	—	—

### Input circuits

Impedance: 75Ω.

Return loss: >32 dB (50 kHz to 25 MHz—3745A/B).  
 >30 dB (50 kHz to 70 MHz—3747A/B).  
 >22 dB (70 MHz to 90 MHz—3747A/B).

Maximum ac input power: +25 dBm.

Spurious emissions from input (in-band): <-120 dBm (up to 25 MHz—3745A/B; up to 90 MHz—3747A/B).

### Measurement accuracy

#### 75Ω Unbalanced Input—selective measurement

Frequency Range	Level Accuracy (dB) over the temperature range 10°C to 35°C, for the other range—see Note 1 (after autocalibration—see Note 2)	
	+15 to -60 dBm	-60 to -80 dBm
1 kHz to 10 kHz (3745A/B)	<±1.0 (nominal)	—
10 kHz to 50 kHz (3745A/B & 3747A/B)	<±0.35	<±1.0 (nominal)
50 kHz to 20 MHz (3745A/B) 50 kHz to 70 MHz (3747A/B)	<±0.25	<±0.35
20 MHz to 25 MHz (3745A/B) 70 MHz to 90 MHz (3747A/B)	<±0.35	<±0.45

#### 75Ω Unbalanced Input—broadband measurement

Frequency Range	Level Accuracy (dB) over the temperature range 0°C to 55°C (after autocalibration—see Note 2)	
	+15 dBm to -35 dBm	+15 dBm to -55 dBm
10 kHz to 25 MHz (3745A/B)	<±1.0 (+15 dBm to -35 dBm)	
50 kHz to 70 MHz (3747A/B)	<±1.0 (+15 dBm to -55 dBm)	
70 MHz to 90 MHz (3747A/B)	<±1.5 (nominal) (+15 dBm to -55 dBm)	

Note 1: For all selective measurements in the frequency range 10 kHz to 90 MHz, to extend the temperature range to 0°C to 55°C, add 0.1 dB.

Note 2: The following errors are eliminated by autocalibration.  
 Temperature Coefficient: 0.01 dB/°C.  
 Stability: 0.1 dB/24 hours (at constant temperature).

### Measurement display

#### Long averaging

Resolution: 0.01 dB.

#### Normal averaging

Resolution: 0.1 dB.

### Filters

#### Pilot filter—22 Hz

Ripple over 22 Hz bandwidth: <0.1 dB pk-pk.

3 dB bandwidth: 38 Hz, ±10%.

Adjacent pilot rejection (± 60 Hz): >38 dB.

Rejection at >±110 Hz: >60 dB.

#### Channel filter—3.1 kHz

Ripple over 2.6 kHz bandwidth: <0.5 dB pk-pk.

3 dB bandwidth: 3.1 kHz, ±10%.

Virtual carrier rejection at ±1.85 kHz: >55 dB

Adjacent channel rejection (±4 kHz): >70 dB (3745A/B).

>65 dB (300 kHz to 70 MHz) (3747A/B).

>63 dB (70 MHz to 90 MHz) (3747A/B).

Equivalent noise bandwidth: 3.1 kHz (nominal)

#### Group filter—48 kHz

3 dB bandwidth: 48 kHz, ±15%.

Adjacent group rejection (±48 kHz): >25 dB.

Rejection at >±80 kHz: >40 dB.

### Intermodulation and spurious products

Intermodulation rejection: >70 dB.

Spurious products (non-harmonically related): -80 dB with respect to input signal.

IF and image rejection: >70 dB.

### Typical measurement times

Pilot filter: 450 ms (for pilots in a typical multiplex system).

Channel filter: 300 ms (for channels in a typical multiplex system).

Group filter: 260 ms (for groups in a typical multiplex system).

### Additional output

#### Audio output

Frequency response: ±1 dB (600 Hz to 3.1 kHz).

#### General

Size: (excluding feet, handles, controls and connectors): 268 H × 425 W × 505 mm D (10.6" × 16.8" × 19.9").

Weight: net, 40 kg (88 lb); shipping, 54 kg (120 lb).

#### Power:

Voltagess: 100/120/220/240 V (±10%), 48 to 66 Hz.

Consumption: 200 VA.

#### Options

Connectors: A range of connector options is available (see Data Sheet for information).

Opt 021: phase jitter + psophometric weighted filter

#### Phase jitter

Ranges: 3° and 30° FSD.

Residual phase jitter: <0.5°.

Accuracy: ±15% of reading + residual phase jitter.

Bandwidth: 20 to 300 Hz.

Measurements are made on a tone after the input signal has been demodulated. The demodulated test-tone must be within the range 950 Hz to 1050 Hz.

#### Weighting filter

Weighting curve: CCITT recommendation P.53 superimposed on 3.1 kHz channel filter, as specified.

Opt 022: phase jitter + 'C'-message weighted filter

#### Phase jitter

Ranges: 3° and 30° FSD.

Residual phase jitter: <0.5°.

Accuracy: ±15% of reading + residual phase jitter.

Bandwidth: 20 to 300 Hz.

Measurements are made on a tone after the input signal has been demodulated. The demodulated test-tone must be within the range 950 Hz to 1050 Hz.

#### Weighting filter

Weighting curve: 'C'-message weighting superimposed on 3.1 kHz channel filter, as specified.

#### Options

Opt 023: 800 Hz notch filter (3747A/B)

Allows the SLMS to make notched psophometric weighted measurements (to CCITT standard).

Opt 024: 1010 Hz notch filter (3747B)

Allows the SLMS to make notched 'C'-message weighted measurements (to BELL standard).

Opt 025: 2.5 kHz channel filter (3747A/B)

Ripple over 2.3 kHz bandwidth: >0.8 dB

30 dB bandwidth: 25 kHz

Adjacent channel rejection (±3 kHz): >60 dB

Equivalent noise bandwidth: 2.5 kHz

Opt 040: X-Y recorder/X-Y display driver

Allows SLMS to drive an X-Y recorder or X-Y display

#### Miscellaneous options

910: extra set manuals

Price

add \$220

add \$220

add \$515

add \$50

### Ordering information

3745A/B Selective Level Measuring Set

\$17 600

Opt 021: phase jitter + psophometric weighted filter

add \$220

Opt 022: phase jitter + 'C'-message weighted filter

add \$220

Opt 040: X-Y output

add \$1145

3747A/B Selective Level Measuring Set

\$21 385

Opt 021: phase jitter + psophometric weighted filter

add \$255

Opt 022: phase jitter + 'C'-message weighted filter

add \$255

Opt 040: X-Y output

add \$570

# TELECOMMUNICATIONS TEST EQUIPMENT

## Access switch and controller (10 kHz to 25 MHz)

Models 3754A, 3755A

- Frequency range, 10 kHz to 25 MHz
- Insertion loss  $< \pm 0.1$  dB from 50 kHz to 20 MHz
- Selects 1 from a possible 10 RF inputs
- Cascaded switches allow selection from 1000 inputs
- Local or remote input selection using HP-IB
- Single 3755A can control 111 switches



3755A



3754A



### Description

The Model 3754A Access Switch is an ac-coupled, unidirectional, ten-input switch with a frequency range from 10 kHz to 25 MHz. The input selection technique employs relays which switch between true-ground and input to a virtual-ground amplifier. Several important benefits are obtained by including a virtual-ground amplifier in the switching path. These benefits include minimizing the effects of stray capacitance, the ability to compensate for flatness variations across a wide frequency range and preset gain to compensate for losses in the interconnecting cables.

Incorporating a virtual-ground amplifier in the signal path gives an insertion loss of less than  $\pm 0.1$  dB from 50 kHz to 20 MHz. In addition, pre-set gains of 1, 2 and 3 dB are internally selectable to compensate for additional cable loss. Switching between virtual ground and true-ground ensures that voltage swings at the switch contacts are small, and the effects of stray capacitance are negligible. This means that high levels of isolation are achieved across the whole frequency range. The isolation between any unselected input and the output is greater than 85 dB and the isolation between any two inputs is greater than 90 dB.

The Model 3755A Switch Controller has a small, easy-to-operate keyboard with a 3-digit LED display to denote the input selected. Each Access Switch input is given a 1-digit code, therefore selection from 1000 inputs requires a 3-digit code (000 to 999) where each digit represents the input of the appropriate Access Switch at each of the 3 levels.

The 3755A Controller can be remotely controlled over the Hewlett-Packard Interface Bus (HP-IB) by a desktop computing controller or computer. Selection of the RF input to be accessed is achieved using the 3-digit code that defines the particular input required. Since it is the 3755A which is controlled via the HP-IB, only one bus address is used for up to 111 Access Switches.

Using a separate Switch and Controller format, it is possible to locate the Access Switches remotely from the Controller. The control signal can be transmitted over the same cable as the RF signal, which eliminates the need for separate control cables and makes interconnection changes easier. The control signal is a switched dc level which is only present between the Controller and Switch, or between Switches, during selection of a Switch input. This control signal has no effect on the RF signal source.

The control signals can also be sent along a separate two-wire path. This is necessary when the continuous dc path between the Switches and the Controller is interrupted, for example, by an

equalizer inserted into the line to compensate line frequency response.

A combination of both methods of interconnection can be incorporated into the same Access Switch system.

### Specifications

#### Access Switch

**Frequency range:** 10 kHz to 25 MHz.

**Insertion loss:**  $< \pm 0.1$  dB (50 kHz to 20 MHz).  
 $< \pm 0.7$  dB (10 kHz to 25 MHz).

**Isolation:**  $> 85$  dB (input/output).  
 $> 90$  dB (any two inputs).

**Return loss:**  $> 30$  dB (selected input).  
 $> 23$  dB (unselected input).  
 $> 30$  dB (output).

**Noise power ratio:**  $> 70$  dB.

**Overload level:** 0 dBm (data along signal path).  
+10 dBm (data along separate path).  
+8 dBm (50 $\Omega$  version).

**Maximum ac input power:** +25 dBm.

#### Switch Controller

**Frequency range:** 10 kHz to 25 MHz.

**Insertion loss:**  $< 0.1$  dB (input/output on rear panel).  
 $< 0.2$  dB (input/output on front panel).

**Return loss:**  $> 30$  dB.

**Noise power ratio:**  $> 70$  dB.

#### General

**Power:** 100/120/220/240 V ( $\pm 10\%$ ), 48 to 66 Hz.

**Consumption:**  $< 20$  VA.

**3754A only:**  $\pm 15$  V dc ( $\pm 2\%$ ).

**Dimensions:** 89 mm H  $\times$  425 mm W  $\times$  350 mm D (3 $\frac{1}{2}$ "  $\times$  16 $\frac{3}{4}$ "  $\times$  14").

#### Options\*

**907:** Front handle kit

**908:** Rack flange kit

**909:** Front handle/rack flange kit

\*For other options, refer to Data Sheet

#### Price

add \$10

add \$15

add \$20

#### Ordering Information

3754A Access Switch

3755A Switch Controller

\$1805

\$1245



# TELECOMMUNICATIONS TEST EQUIPMENT

## FDM system testing

Models 3745A/B, 3747A/B, 3754A, 3755A, 3335A, 9825A

### Introduction

The 3745A/B or 3747A/B can be incorporated in automatic test systems which have been specifically tailored to FDM measurement requirements.

Possible configurations include: 1) fully-automated systems for FDM surveillance, 2) for testing in a production or commissioning Fully-automated system for FDM surveillance

environment. In both cases, remote control of all, or part, of the system can be provided, using a standard telephone circuit.

A desktop computing controller (such as the Model 9825A) or a computer (such as one of the 21 MX Series) can be used to control the system.

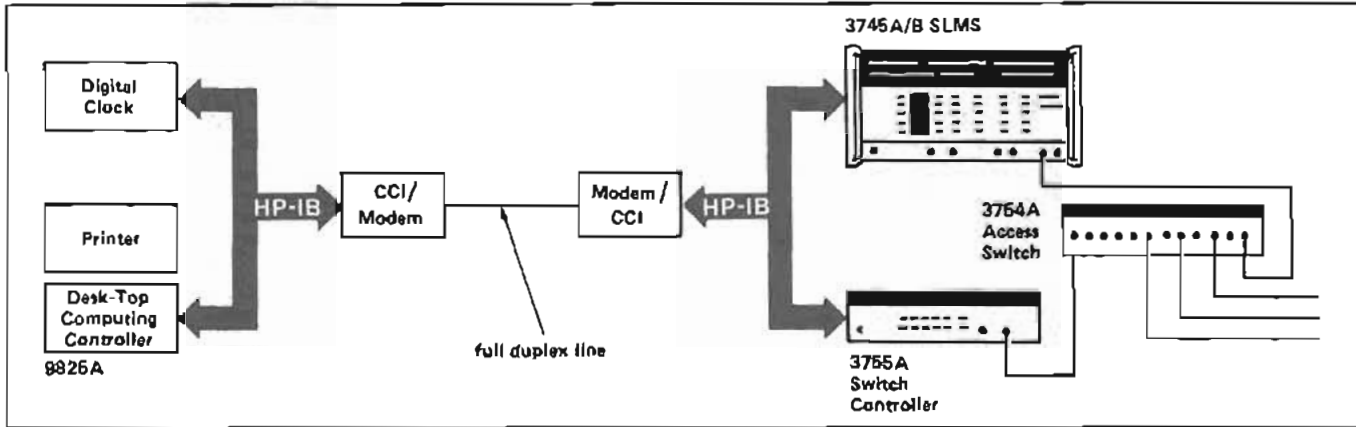

For FDM System surveillance, the 3754A Access Switch can be used to access a number of baseband test points in a station and the SLMS is used to perform routine checks of:

- 1) Pilots
- 2) Carrier leaks
- 3) Channel powers
- 4) Inter-supergroup noise slots, etc.

Control can be exercised locally, or remotely, using a pair of Common Carrier Interface (CCI) Units (Models 59403A) with a conventional modem/telephone circuit configuration.

An SLMS system of this type can be used to provide continuous monitoring of FDM System performance with print-out of fault conditions (and system alarm if necessary). It can provide: 1) an analysis of trends in FDM System levels, for early fault detection, and 2) records of system performance.

### Testing for production/commissioning

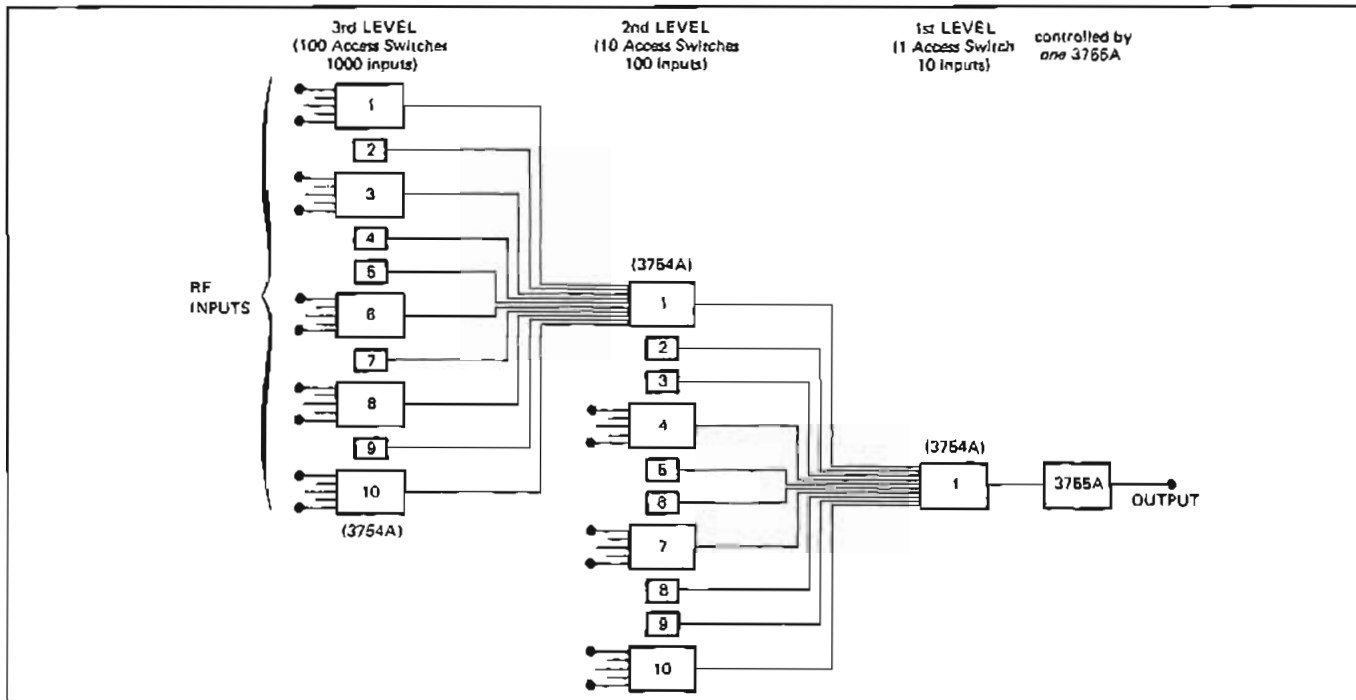

The 3745A/B and 3747A/B SLMS can be used with the 3335A Generator for end-to-end testing of FDM Systems or for testing system components during production. The 3754A Access Switch provides programmable section of test components. Applications include the testing of cables, filters and mixers. The system can be

used for many measurements including:

- 1) Flatness
- 2) Return loss (with 15582A Accessory)
- 3) Crosstalk between cable pairs
- 4) Mixer spurious products

# TELECOMMUNICATIONS TEST EQUIPMENT

## Selective level meter/generator

### Models 312D & 3320C

- Multiplex carrier testing

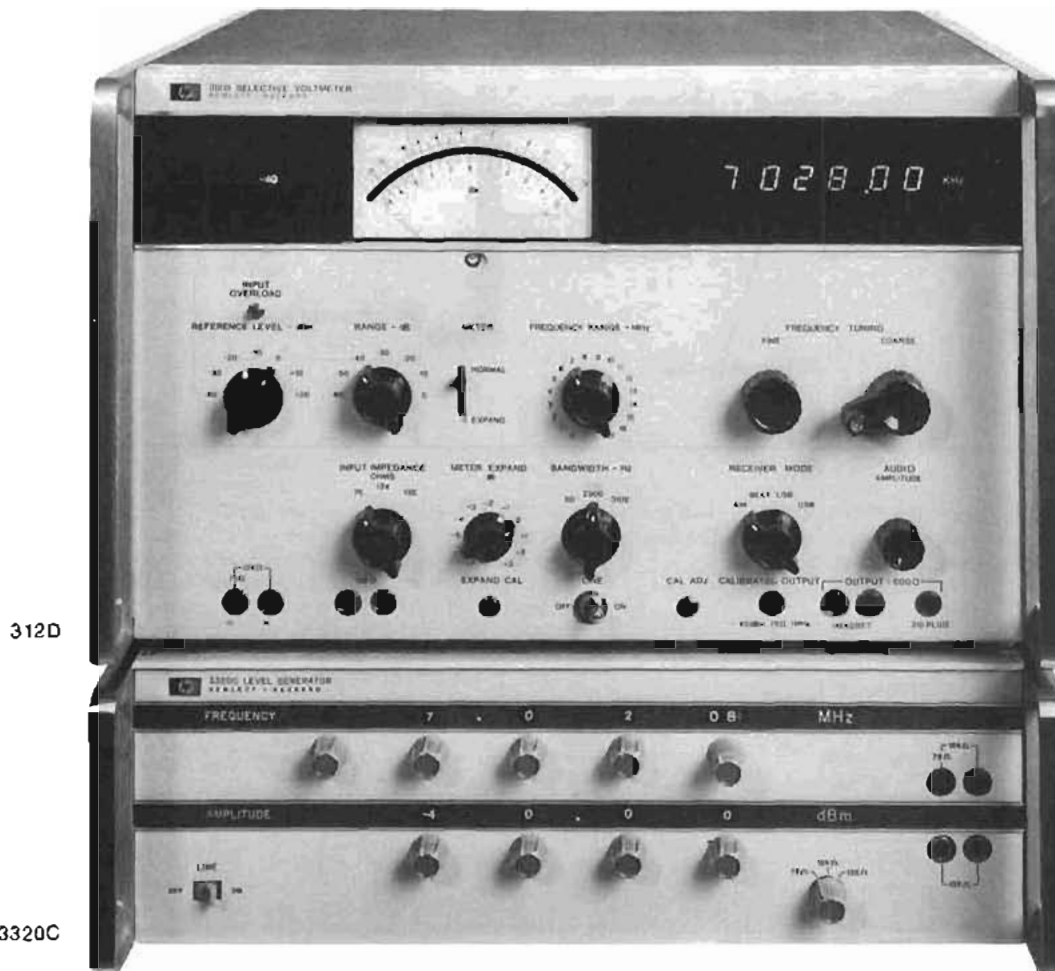

312D

3320C

## Description

### General

Hewlett-Packard Model 312D Selective Level Meter and companion Model 3320C Level Generator provide an accurate, easy-to-use transmission measuring set in the 1 kHz to 18 MHz frequency range ideally suited for maintenance and operations requirements. It provides proper input and output connectors and impedances to interface directly into most FDM carrier multiplex equipment.

HP's 312D has a noise equivalent bandwidth that provides a direct reading of C-message or psophometric noise. The instrument has sufficient fidelity to act as an invisible channel bank to down-convert any 4 kHz voice channel and make typical measurements such as phase jitter and impulse noise. It also features 10 Hz frequency resolution, 0.02 dB level resolution on the meter expand scale, and an input overload lamp to assure valid measurements.

HP 3320C companion generator is a frequency synthesizer that provides signals with an amplitude resolution of 0.01 dB over a frequency range of 10 kHz to 17 MHz with 20 Hz resolution.

## 312D Specifications

### Frequency

**Range:** 1 kHz to 18 MHz; 18 bands; 200 kHz overlap; coarse and fine tuning.

**Accuracy:**  $\pm 10$  Hz plus time base stability.

### Stability

**Aging rate:**  $\pm 20$  ppm/year.

**Temperature (25°C  $\pm 10^\circ$ C):** 20 ppm.

**Line voltage ( $\pm 10\%$ ):** 0.1 ppm.

**Resolution:** 10 Hz read on a seven digit LED display.

### Amplitude level

**Range:** -120 dBm to +23 dBm, annunciator displays each 10 dB selected input level regardless of switch combinations.

**Attenuator accuracy:**  $\pm 0.1$  dB (0 through -50 dB range);  $\pm 0.2$  dB (-60 dB range).

**Flatness (75  $\Omega$  matched load; 0 dBm max. level):**  $\pm 0.5$  dB, 1 kHz to 10 kHz;  $\pm 0.2$  dB, 10 kHz to 10 MHz;  $\pm 0.5$  dB, 10 MHz to 18 MHz.

**Stability:** 0.1 dB, 90 days.

**Overload:** lamp indicates incorrect range selection.

**Selectivity:** the exact midband of the selected filter is identified by a 3 Hz rejection notch.

Bandwidth	3 dB Rejection	60 dB Rejection
-50 Hz	50 Hz $\pm 10\%$	106 $\pm 10\%$
-150 Hz	150 Hz $\pm 10\%$	320 $\pm 10\%$
**1740/2300 Hz	2300 Hz $\pm 10\%$	4800 $\pm 10\%$
**3100 Hz	3100 Hz $\pm 10\%$	6200 $\pm 10\%$

\* Select one bandwidth only: 50 Hz standard, 150 Hz Opt 001.

\*\* Carrier notches inserted at  $f_c \pm 2$  kHz. Notch filter down  $>55$  dB at  $f = 2$  kHz, down  $>45$  dB at  $\pm 7.5$  Hz from center of rejection notch.

**Passband flatness:**  $<0.2$  dB.

**Meter range:** (backlighted scale shows whether normal or expand mode is selected).

**Normal:**  $-20$  dB to  $+3$  dB.

**Expand:**  $-1$  dB to  $+1$  dB.

The expand meter will expand any two dB portions of the meter from  $-7$  dB to  $+3$  dB in 1 dB steps.

**Tracking:**  $\pm 0.05$  dB expand;  $\pm 0.1$  dB normal (to  $-10$  dB indication).

**Input impedance:**  $75\Omega$  unbalanced, accepts WECO 358A plug;  $124\Omega$  balanced, accepts WECO 408A plug;  $135\Omega$  balanced; accepts WECO 241A plug.

**Receiver**

**Modes**

**AM:** average responding diode demodulated audio.

**Beat:** beat frequency, carrier reinserted at  $f_c$ .

**LSB:** product demodulated audio, carrier reinserted at  $f_c + 1.8$  kHz.

**USB:** product demodulated audio, carrier reinserted at  $f_c - 1.8$  kHz.

**Distortion**

**1 kHz to 1 MHz:**  $>55$  dB below zero reference.

**1 MHz to 18 MHz:**  $>65$  dB below zero reference.

**Residual response:** 72 dB below zero reference with no input.

**Noise level:**  $<-117$  dB in 2300 Hz bandwidth.

**Internal calibrator output:** 1 MHz square wave;  $-40$  dBm  $\pm 0.1$  dB into  $75\Omega$  termination; accepts WECO 358A plug.

**Common mode rejection:**  $>40$  dB, 1 kHz to 5 MHz;  $>30$  dB, 5 MHz to 18 MHz.

**Output level (front panel):**

$+14$  dBm into  $600\Omega$  with full scale meter deflection.

Accepts WECO 464A plug for operator head set.

Accepts WECO 310A plug for  $600\Omega$  output.

Speaker is normally in the output circuit unless a plug is inserted, then speaker is disconnected.

**Auxiliary outputs (rear panel)**

**1 MHz:**  $>0.5$  volt p-p sine wave into 1 k $\Omega$ , BNC female.

**30 MHz:** 40 mV to 70 mV rms into  $50\Omega$ , BNC female.

**Local oscillator:** 30 MHz to 48 MHz, 60 mV to 90 mV rms into  $50\Omega$ , BNC female.

**Auxiliary input (rear panel)**

**External reference frequency:** 1 MHz, 0 dBm  $\pm 10$  dBm into  $50\Omega$ .

**General**

**Size:** 266 H  $\times$  425 W  $\times$  467 mm D (10<sup>13/32</sup>"  $\times$  16<sup>9/16</sup>"  $\times$  18<sup>7/8</sup>").

**Weight:** net, 20.7 kg (46 lb). Shipping 26.6 kg (59 lb).

**Power:** 115 or 230 V  $\pm 10\%$ , 48 to 66 Hz,  $<100$  VA.

## Specifications, 3320C

**Frequency**

**Range:** 10 kHz to 17 MHz in one range (75 $\Omega$ ).

**Resolution**

**Vernier out:** 10 kHz.

**Vernier in:** 20 Hz.

The frequency counter in the 312D can be used to count the output frequency of the 3320C to within 10 Hz.

**Accuracy**

**Vernier out:**  $\pm 10$  ppm of setting.

**Vernier in:** 10 kHz to 12.5 MHz;  $\pm 600$  Hz.

12.5 MHz to 17 MHz;  $\pm 750$  Hz.

**Stability:**  $\pm 10$  ppm/year.

**TC:** 20°C to 30°C:  $\pm 5$  ppm.

**Line variations of 10%:** 0.1 ppm.

High stability crystal reference oven available (Option 001).

**Phase noise:**  $<-40$  dB in to 30 kHz band, excluding  $\pm 1$  Hz.

**Harmonics and spurious:**  $>50$  dB down.

**Internal frequency standard:** 20 MHz.

**Amplitude level**

**Range:**  $+11.99$  dBm to  $-79.99$  dBm.

**Resolution:** 0.01 dB.

**Accuracy:**  $+11.99$  dBm to  $-60$  dBm:  $\pm 0.25$  dB.  $-60$  dBm to  $-79.99$  dBm;  $\pm 0.4$  dB.

**Output impedance (front panel switch selectable)**

$75\Omega$  unbalanced: accepts WECO 358A Plugs.

$124\Omega$  balanced: accepts WECO 408A Plugs.

$135\Omega$  balanced: accepts WECO 241A Plugs.

**Auxiliary outputs (rear panel)**

**—Tracking output:** Tracks main output with 20 MHz offset.

$>100$  mV rms into  $50\Omega$ , Female BNC.

**—Low level output:** same frequency as main output but remains between 50 mV rms and 158 mV rms into  $50\Omega$  Female BNC.

**—1 MHz output:** Reference output, 0 dBm  $\pm 10$  dBm into  $50\Omega$ , Female BNC.

Can be used as external frequency source for the 312B or 312D.

**Auxiliary input (rear panel)**

**External frequency reference input:** may be phase locked with an external signal which is within 200 mV rms and 2 V rms and which is any subharmonic of 20 MHz from 1 MHz through 10 MHz (e.g., 1 MHz, 2 MHz, 2.5 MHz, 5 MHz, 10 MHz), Female BNC.

**High stability crystal oven (Option 001)**

5 MHz reference in temperature stabilized oven.

**Stability:**  $\pm 1$  part in 10<sup>6</sup>/day or 1 part in 10<sup>7</sup>/month.

**Accuracy:**  $\pm 1$  part in 10<sup>7</sup> of setting/month.

For field installation order Accessory Kit 11237A.

**General**

**Operating temperature:** 25°C  $\pm 5^\circ$

**Power:** 115 V or 230 V  $\pm 10\%$ , 48 Hz to 66 Hz, 110 VA.

**Weight:** net, 15.4 kg (34 lb). Shipping, 22.2 kg (49 lb).

**312D Selective Level Meter**

**Opt 001:** 150 Hz bandwidth

**Opt 908:** Rack Flange Kit

**Opt H03:** CCITT Version

**3320C Level Generator**

**Opt 001:** Crystal Oven

**Opt 908:** Rack Flange Kit

**Opt H02:** CCITT Version

**\$6000**

N/C

add \$15

add \$400

**\$4000**

add \$500

add \$10

add \$485

# TELECOMMUNICATIONS TEST EQUIPMENT

## Selective voltmeter, 20 Hz to 620 kHz

### Models 3591A/3594A

- Voice grade testing
- FDM testing



### Description

Hewlett-Packard's 3591A Mainframe and 3594A Plug-in combine to form a general purpose 20 Hz to 620 kHz frequency selective level meter. The 3591A/3594A features automatic level ranging, wide dynamic range, log and linear x-y outputs as well as several input impedances and AM/SSB demodulation capability.

The 3591A/3594A has found wide acceptance in communications laboratories, manufacturing and field maintenance.

### Specifications

**Frequency range:** 20 Hz to 620 kHz.

**Amplitude ranges:** 3  $\mu$ V to 30 V full scale in 15 ranges.

**Amplitude accuracy with input terminated**

**Meter switch in normal position:** overall accuracy:  $\pm 0.43$  dB to  $\pm 0.67$  dB of reading depending on frequency, including

**Frequency response flatness, total deviation:** 600  $\Omega$ : 20 Hz to 100 Hz  $\pm 0.53$  dB ( $\pm 5\%$ ); 100 Hz to 620 kHz  $\pm 0.26$  dB ( $\pm 3\%$ ).

**All other terminations:** 5 kHz to 620 kHz  $\pm 0.26$  dB ( $\pm 3\%$ ).

**Meter tracking:**  $\pm 0.1$  dB or  $\pm 1\%$  of reading, 0 dB to  $-10$  dB.

**Meter switch in linear dB position:** overall accuracy:  $\pm 1$  dB.

**Internal calibrator:** frequency, 100 kHz  $\pm 10$  Hz; amplitude, full scale on 0 dB range in CAL mode: accuracy,  $\pm 0.1$  dB.

**Dynamic range:** (1M and harmonic distortion products)  $>85$  dB below zero dB reference level when absolute measurements are being made ( $>70$  dB 20 Hz to 50 Hz),  $>80$  dB below zero dB reference level when relative adjustment is used ( $>70$  dB for 20 Hz to 50 Hz).

### Residual responses

$>80$  dB below zero reference ( $>70$  dB for 20 Hz to 50 Hz).

**Return loss:** 100 Hz to 620 kHz, 600  $\Omega$   $>30$  dB; 5 kHz to 620 kHz, 150  $\Omega$ , 135  $\Omega$ , 75  $\Omega$ ,  $>35$  dB.

### Noise level

Bandwidths	Input noise level (600 $\Omega$ input impedance)
10 Hz and 100 Hz 1 kHz and 3.1 kHz	$\leq -125$ dBm or 0.44 $\mu$ V $\leq -115$ dBm or 1.38 $\mu$ V

### Selectivity

Rejection	10 Hz	100 Hz	Bandwidths 1 kHz	3.1 kHz
3 dB	10 Hz	100 Hz	1 kHz	3.1 kHz
60 dB	35 Hz	320 Hz	3.1 kHz	9.6 kHz

(frequency accuracy  $\pm 10\%$ )

**Inputs:** balanced or single-ended, not floating, terminating, or bridging.

**Automatic frequency control**

**Capture threshold:** 75 dB below 0 dB reference.

**Dynamic hold-in range:**  $>3$  bandwidths. Tracking rate proportional to bandwidth.

### Input functions

**dBm:** levels calibrated in dBm for impedances selected.

**Abs Vm:** level calibrated in volts.

**Rel:** input level can be set arbitrarily to 0 dB Ref. (10 dB set level range).

### Input Impedances\*

**Resistances:** 75  $\Omega$ , 135  $\Omega$ , 150  $\Omega$ , 600  $\Omega$  terminated; 50 k $\Omega$  (single ended bridging) and 100 k $\Omega$  (balanced bridging).

**Capacitance (each terminal to ground):** 10 mV, 30 mV ranges  $<55$  pF; 100 mV to 30 V ranges  $<40$  pF.

**Common mode rejection:** 20 Hz to 620 kHz,  $>40$  dB.

**Automatic ranging:** 8 ranges, 0 dB to  $-70$  dB. Ranging rate proportional to bandwidth.

**Output:** amplitude: adjustable 0 to 1 V rms open circuit.

**BFO frequency response flatness:**  $\pm 0.2$  dB or  $\pm 2\%$ .

**Resistance:** 600  $\Omega$ .

**L.O. output:** frequency, 1.28 MHz to 1.90 MHz (1.28 MHz + tuned frequency); amplitude, 0.65 V rms  $\pm 20\%$  open circuit; resistance, 250  $\Omega$ .

### Recorder outputs

X-axis	Plug-in frequency ranges	
	62 kHz	620 kHz
X-axis linear output: (1 k $\Omega$ source resistance)	0 to $-12.4$ V (200 mV/kHz = 5%)	0 to $-12.4$ V (20 mV/kHz = 5%)
X-axis log output: (1 k $\Omega$ source resistance)	5 V/decade $\pm 5\%$ (50 Hz—62 kHz)	5 V/decade $\pm 5\%$ (500 Hz—620 kHz)

### Y-Axis

**Linear Y axis output:**  $+10$  V dc  $\pm 2\%$  for full scale meter indication, 1 k $\Omega$  source resistance.

**Log Y axis output:**  $+1$  V to  $+10$  V dc, proportional to linear dB meter indication ( $-90$  to 0 dB, 0.1 V/dB) 1k  $\Omega$  source resistance.

**Power:** 115 V or 230 V  $\pm 10\%$ , 50 Hz to 400 Hz,  $<70$  VA.

**Size:** 221 H  $\times$  425 W  $\times$  467 mm D (8 $^{3/4}$ "  $\times$  16 $^{3/4}$ "  $\times$  18 $^{3/4}$ ").

**Weight:** net, 17.2 kg (38 lb). Shipping, 24.9 kg (55 lb).

**Accessories furnished:** rack mounting kit for 19" rack.

### Options

908: Rack Flange Kit

Price

add \$15

3591A Selective Voltmeter and 3594A sweeping local oscillator plug-in

\$7900

\*Other terminations available on special order.

In many countries the main communication system consists of a network of FM microwave radio links. Typically, these links can carry up to 1800 FDM telephone channels, using a 70 MHz IF carrier and an RF band in the range 600 MHz to 18 GHz. However, some countries are now installing 140 MHz IF microwave links which can carry up to 2700 FDM telephony channels.

All information signals (speech, television, or data) carried by these links have a common objective—to convey the information with maximum fidelity. Failure to keep distortion in a link within specified limits results in an unacceptably high level of intermodulation noise. This prevents the link from carrying the designated channel capacity and the link operator incurs a severe financial penalty due to loss of revenue-earning channels. The qualitative tests shown in Table 1 are particularly relevant as indicators of overall system performance.

The use of noise-loading measurements to establish the intermodulation performance of FDM telephony links is well known and

they provide 'go/no-go' criteria for the transmission quality of a system between baseband (BB) terminals. Although such measurements can separate the basic and intermodulation noise components, they do not localize the noise sources.

The main contributors to distortion in FM microwave radio links are the modulators, demodulators and carrier circuits at IF such as amplifiers, and carrier circuits at RF such as non-linear amplifiers. The distortion parameters of these circuits can be measured in terms of nonlinearity, amplitude variations and group delay variations. To do this, test equipment must interface with the links at BB, IF and RF. Commissioning microwave link equipment involves minimizing these circuit distortion parameters by adjustment or equalization.

On lower capacity systems, these adjustments are normally enough to reduce intermodulation distortion to an acceptable level. With increased traffic capacity, the tolerances imposed on the circuit parameters become more and more strict and normal

commissioning methods often do not produce satisfactory results. Consequently, relating the circuit parameters to the intermodulation noise (measured by a noise-loading test set) becomes increasingly more difficult.

The main source of discrepancy is the result of amplitude modulation to phase modulation (AM/PM) conversion in the transmission carrier path. This AM/PM conversion occurring in non-linear networks introduces additional intermodulation from the signal deviations arising in preceding networks. These 'coupled' responses can be assessed only by differential gain/differential phase (DG/DP) measurements with high-frequency test tones.

DG/DP measurements have the advantage of characterizing a link more completely and they yield valuable diagnostic information. Furthermore, these two measurements are mathematically related to the BB measurement of noise power ratio. This information allows microwave link manufacturers to design link parameters with much more certainty and it allows microwave link operators to optimize performance in a more cost effective way. HP Application Note AN 175-1 'Differential Phase and Gain at Work' covers this subject in considerable detail.

HP microwave link analyzers (MLA's), at 70 MHz IF and 140 MHz IF, were developed specifically for the purpose of measuring various forms of distortion on terrestrial and satellite microwave radio links. The measurement capabilities of HP link analyzers were established in close cooperation with the telecommunications industry. Table 2.

A valuable extension of the MLA measurement capability can be obtained using RF up and down converters. The circuit distortions at RF have identical effects to the IF circuit distortions when the carrier signal is eventually demodulated. Hence, the RF distortions can be analyzed using an MLA, provided a transparent RF to IF interface is available. A down converter provides such an interface and allows independent measurements on microwave transmitters. A so-called 'up-converter' in fact provides a transparent BB to RF interface, allowing independent measurements on microwave receivers. Both converters used with an MLA provide an RF to RF measurement capability.

**Table 1. Qualitative tests to verify radio system performance**

Test	FDM	Video	Digital
1. Insertion Gain	•	•	•
2. Frequency Response	•	•	•
3. Envelope Delay Distortion		•	•
4. Spurious Interference Tones	•	•	•
5. Thermal Noise	•	•	•
6. White Noise Loading	•		
7. Video Waveform Tests		•	
8. Video System Program Channel (Subcarrier) Tests		•	
9. Bit Error Rate Tests			•

**Table 2. Diagnostic tests to maintain radio system performance**

Measurement	BB	IF	RF
1. Module Power Levels, Gains and Losses	•	•	•
2. Modem Centre Frequencies		•	•
3. TX and RX Local Oscillator Frequencies			•
4. Transmitter RF Output Frequency			•
5. Spurious Tones	•	•	•
6. FM Mod + Demod Deviation Sensitivity	•	•	•
7. FM Mod + Demod Linearity	•	•	•
8. Return Loss	•	•	•
9. Amplitude Flatness	•	•	•
10. Group Delay		•	•
11. Differential Gain and Phase		•	•

# TELECOMMUNICATIONS TEST EQUIPMENT

## Microwave Link Analyzers

Models 3710A and 3790A MLA systems

- Isolate and characterize causes of intermodulation distortion in wideband microwave radios
- Baseband and IF interfaces
- 70 MHz or 140 MHz IF capability
- Test analog and digital radios



3710A  
70 MHz IF  
MLA System

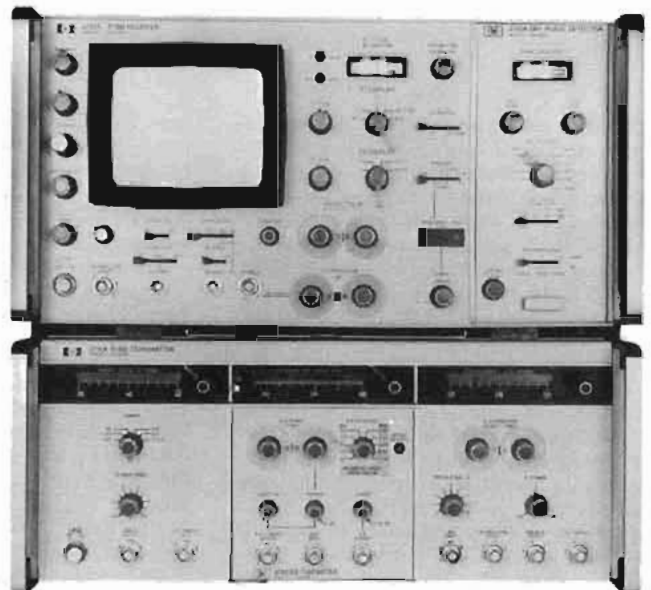

3790A  
140 MHz IF  
MLA System

### Description

The 3710A and 3790A Microwave Link Analyzer (MLA) Systems are diagnostic instruments. They isolate and characterize causes of intermodulation distortion in wideband microwave radios. The MLA's have applications in both analog and digital radio systems. Both MLA's have baseband and IF interface capabilities. The 3710A MLA system interfaces with 70 MHz IF radios and the 3790A MLA system interfaces with 140 MHz IF radios.

Primary measurements provided by the HP MLA systems are:

- baseband power, gain and loss.
- IF power, gain and loss.
- IF centre frequency.
- modulator/demodulator deviation sensitivity.
- modulator/demodulator linearity.
- modulator/demodulator group delay.
- swept IF amplitude response.
- swept IF group delay.
- swept IF return loss.
- baseband and IF differential gain (HF linearity).
- baseband and IF differential phase (HF group delay).
- baseband return loss.

When used with the 8620C/86200 Series RF Sweeper system (equipped with the MLA interface option) and the 3730A RF Down Converter, the swept measurements of the basic MLA can be extended to RF. Pages 554 and 555 give further details about this RF

instrumentation (3730A and 8620C).

Because HP MLA's have low inherent distortions they provide extremely accurate and rapid radio measurements. The specifications of HP MLA's are conservatively defined to assure adequate performance over wide operating ranges and long-time periods. The system specifications and oscillograms on the following page illustrate performance capabilities of HP MLA's.

A series of options are also provided with the MLA's. The options include:

- test-tone frequencies.
- connectors.
- balanced 124Ω baseband impedance.
- sweep frequencies.
- variable phase output of sweep signal.

Detailed information and specifications are provided in the 3710A MLA and 3790A MLA data sheets.

With this performance capability and range of options, a highly-accurate and flexible measurement system is available from HP. Therefore, the HP MLA's provide for improved design, production, commissioning and maintenance of wideband analog and digital Microwave Radio Systems.

### Ordering information

3710A Microwave Link Analyzer  
3790A Microwave Link Analyzer

Price  
\$6115  
\$7530

**MLA IF-IF System specifications**  
**3710A 70 MHz IF MLA System**

Measurement Capability	IF Range (MHz)	Range	Maximum Sensitivity	Maximum Inherent Slope	Maximum Inherent Noise (rms)	
					BB Frequency	IF - IF
IF Response	45 to 95	0 to $\pm 3$ dB	0.1dB/cm	$\pm 0.05$ dB at -5dBm $\pm 0.1$ dB from +5 to +21dBm	—	
BB Linearity & Differential Gain	50 to 90 45 to 95	0 to 50%	0.25%/cm	0.2% 0.4%	—	
Group Delay	55 to 85 50 to 90 45 to 95	200 ns	0.25ns/cm	0.4ns 0.6ns 1.0ns	83.333kHz 250kHz 500kHz	0.6ns with 200kHz 0.2ns rms dev. 0.1ns
Differential Phase	55 to 85 50 to 90 45 to 95	18° or 31.4% rad.	0.5°/cm	0.4° at 2.4 MHz 0.4° at 4.43 MHz 0.6° at 5.6 MHz 0.8° at 8.2 MHz	2.4MHz 4.43MHz 5.6MHz 8.2MHz	0.1° with 500kHz 0.1° rms. dev. —
IF Return Loss	45 to 95	10 to 49dB (accuracy depends on Hybrid used)	1dB/cm	1dB	—	

**3790A 140 MHz IF MLA System**

Measurement Capability	IF Range (MHz)	Range	Maximum Sensitivity	Maximum Inherent Slope	Maximum Inherent Noise (rms)	
					BB Frequency	IF-IF
IF Response	115 to 165	0 to $\pm 3$ dB	0.025dB/cm	$\pm 0.05$ dB at +5dBm $\pm 0.1$ dB from +5 to +10dBm at input to 3792A.	—	
BB Linearity & Differential Gain	125 to 155 115 to 165	0 to 50%	0.25%/cm	0.2% 0.4%	—	
Group Delay	125 to 155 115 to 165	200ns	0.25ns/cm	0.2ns 0.5ns	83.333kHz 250kHz 500kHz	0.6ns 200kHz 0.2ns rms dev. 0.1ns
Differential Gain	125 to 155 115 to 165	18° or 31.4% rad.	0.5°/cm	0.2° 0.5°	2.4MHz 4.43MHz 5.6MHz 8.2MHz 12.39MHz	0.1° 500kHz 0.1° rms dev. 0.1° — —
IF Return Loss	115 to 165	10 to 49dB (Accuracy depends on hybrid used)	1dB/cm	1dB	—	

**Typical HP MLA Performance**



**3710A MLA system: Amplitude flatness performance at 0 dBm input level.**

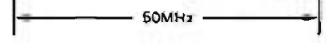

**3710A MLA system: Group delay (mask includes inherent noise slope and inherent noise specifications).**

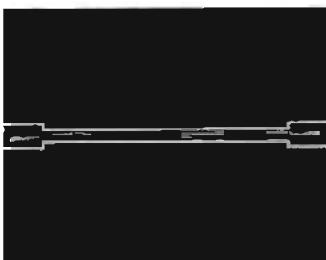

**3710A MLA system: Differential gain.**

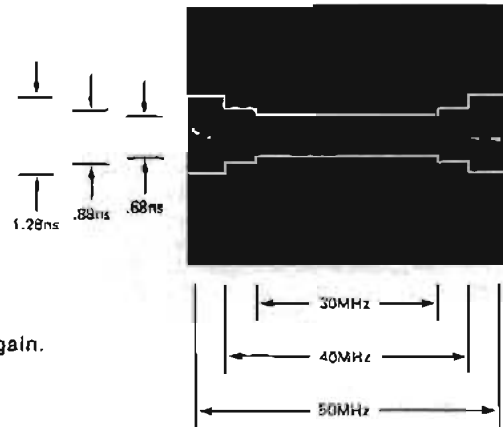

# TELECOMMUNICATIONS TEST EQUIPMENT

## RF Down Converter

Model 3730A

- RF to IF frequency conversion
- 1 to 12 GHz frequency range
- Extends test capability of microwave link analyzers to RF

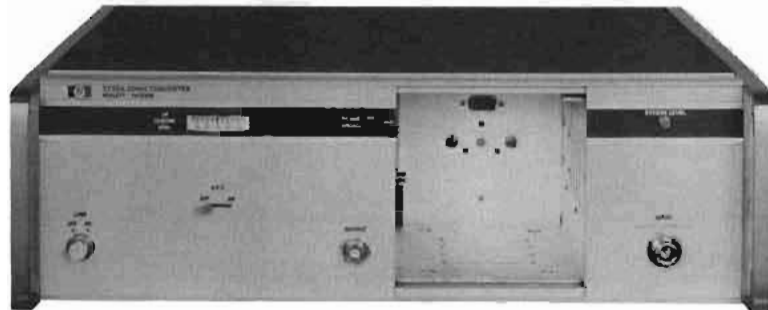

3730A  
RF Down Converter  
Mainframe



3736A  
Plug-in  
1.7 to 4.2 GHz



3737A  
Plug-in  
3.3 to 6.5 GHz



3738A  
Plug-in  
6.3 to 8.5 GHz



3739A  
Plug-in  
10.7 to 11.7 GHz



37301A  
Dummy  
Plug-in

### Description

The 3730A RF Down Converter and plug-ins provide RF to IF conversion and RF test capabilities for Microwave Link Analyzers (MLA's). The RF range (1 to 12 GHz) is accommodated by a series of local-oscillator plug-ins, allowing easy tuning to the desired operating frequency and convenient change of RF operating bands. A dummy plug-in (37301A) allows the user to connect his own local-oscillator source to the Down Converter mainframe.

The Down Converter mainframe features an IF centre frequency meter (to facilitate RF tuning), an AFC (to maintain centre frequency), an input-overload warning light and an optional 1 dB step variable gain control. Special options are available to extend the RF range up to 18 GHz and down to 0.5 GHz. A special 140 MHz IF output is also available. (Contact your local HP representative for details on these options).

Using the 3730A RF Down Converter, RF Transmitter performance can be verified and the performance adjusted locally in-station. This minimizes the amount of compensation required in the Receiver for Transmitter distortion. Thus it provides a more rapid System trouble-shooting/alignment procedure and improves System performance by minimizing Transmitter distortions at their source. The 3730A can also be used at the RF Receiver pre-selector output to isolate path/antenna/feeder problems.

### Specifications

#### 3730A RF Down converter mainframe

**Frequency range:** 1.0 GHz to 12.0 GHz (0.5 GHz to 12.0 GHz and 1.0 GHz to 18.0 GHz are available as special options\*).

**RF Input level range:** 0 to -16 dBm (standard) (0 to -40 dBm with 25 dB/1 dB step variable gain control—Opt 010).

**Maximum Input level:** 0 dBm.

**RF Input Impedance:** 50Ω.

**RF Input VSWR:** <1.4.

**IF Output frequency:** 70 MHz ±25 MHz (140 MHz ±25 MHz available as special option\*).

**IF Output impedance:** 75Ω.

**IF Output return loss:** >28 dB.

**†RF-IF Amplitude flatness:** <0.5 dB over any 50 MHz band (<0.7 dB over any 50 MHz band with Opt 010).

**†RF-IF Group delay:** <1.0 ns over any 50 MHz band

\*Contact your HP representative for details on special options.

†These specifications include 3710A system residuals. (Refer to MLA Data Sheet for detailed specifications.)

3730A RF Down Converter

\$4055



# TELECOMMUNICATIONS TEST EQUIPMENT

## RF Sweeper (MLA UP Converter Simulator)

Models 8620C, 86200 Series RF plug-ins



- Swept RF source
- MLA RF source (with proper MLA interface option)
- CW RF source
- Source for RF return loss/antenna-waveguide fault location measurements

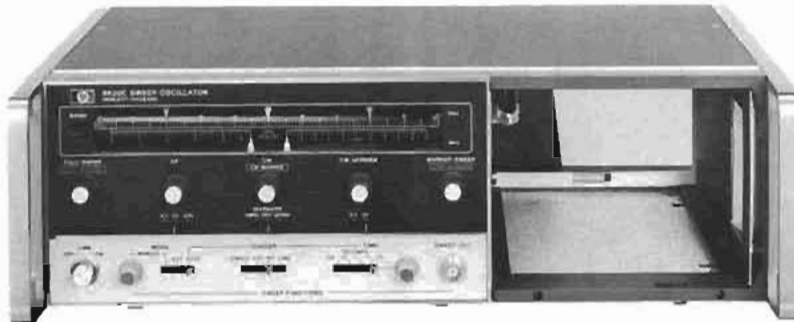

8620C  
RF Sweeper  
Mainframe



86235A (Opt 008)  
Plug-in  
1.7 to 4.3 GHz



86240C  
Plug-in  
3.6 to 8.6 GHz



86242D (Opt 008)  
Plug-in  
5.9 to 9.0 GHz



86250D (Opt 008)  
Plug-in  
8.0 to 12.4 GHz

Also available are: 86222A/B Opt H80 (0.5 to 2.4 GHz), 86245A Opt 008 (5.9 to 12.4 GHz) and 86260A Opt H82 (12.0 to 18.0 GHz)

### Description

The 8620C RF Sweeper and plug-ins provide a high-performance, solid-state RF source for Microwave Radio testing. The 8620C/86200 Series system provides a swept RF source, CW RF source and MLA RF source.

The 8620C/86200 Series system provides the RF stimulus for:

- Swept amplitude flatness measurements.
- RF Receiver AGC calibration.
- Antenna/waveguide return loss and fault location.
- MLA test signal generation (when fitted with MLA interface option).

When the 8620C RF Sweeper is used in conjunction with the 3730A RF Down Converter, Microwave Radio component testing can be performed at RF-to-RF. This provides the facility to make group delay, differential gain, amplitude flatness measurements etc. on RF devices and components.

### RF Sweeper Specifications

Refer to pages 386 to 397 for detailed specifications and information on the basic RF Sweeper system.

### MLA Specifications

MLA performance of the 8620C/86200 Series system over any 30 MHz band, is shown below.

**Amplitude flatness:** +0.1 dB (with 784D Directional Detector and 11675B Leveling Cable Assembly).

### Accessories

The 784B Directional Detector and 11675B Levelling Cable Assembly are required to properly interface the 8620C/86200 Series system to the item under test.

784B Directional Detector (1.6-12.4 GHz) \$800  
11675B Leveling Cable Assembly for 784B \$350

Model	MLA Option	RF Sweeper Frequency Range (GHz)	Linearity (%)	Group Delay (ns)	Differential Gain (%)	Differential Phase (°)	Frequency Sensitivity (MHz/V)	Price with MLA Option
86222A/B	H80	0.5 — 2.4	<2.5	<3	<2.5	<3	not specified	\$4400/\$5400
86235A	008	1.7 — 4.3	<2.0	<2	<2.0	<2	+20	\$5050
86240C	—	3.6 — 8.6	<0.5	<1	<0.5	<1	+20	\$4700
86242D	008	5.9 — 9.0	<0.5	<1	<0.5	<1	+20	\$3350
86245A	008	5.9 — 12.4	<0.5	<1	<0.5	<1	+20	\$4850
86250D	008	8.0 — 12.4	<0.5	<1	<0.5	<1	+20	\$3450
86260A	H82	12.0 — 18.0	<2.5	<3	<2.5	<3	not specified	\$4200

Test-tone frequencies Linearity and Group Delay: 277.778 kHz Differential Gain and Phase: 2.4 MHz

The options shown after each plug-in provide the special MLA interface capability. Refer to pages 388 to 395 for details on other RF Sweeper plug-in specifications and options.

## TELECOMMUNICATIONS TEST EQUIPMENT

## MLA Accessories

3743A, 3744A, 3750A



3743A IF Amplifier

## 3743A IF Amplifier

- Improve MLA IF input sensitivity to  $-40$  dBm.
- Frequency range, 45 to 95 MHz.
- Group delay,  $<0.3$  ns.
- Amplitude flatness,  $<0.2$  dB.
- Return loss,  $>26$  dB ( $75\Omega$ ).
- Noise figure,  $\leq 8$  dB.

## 3744A BB Sweeper

- Operates with 70 MHz or 140 MHz IF MLA's to provide swept baseband stimulus and amplitude detection.
- Frequency range, 100 kHz to 15 MHz.
- Flatness,  $<0.1$  dB (from 100 kHz to 8.5 MHz).

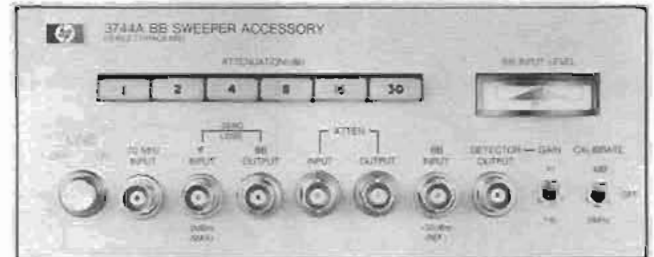

3744A BB Sweeper

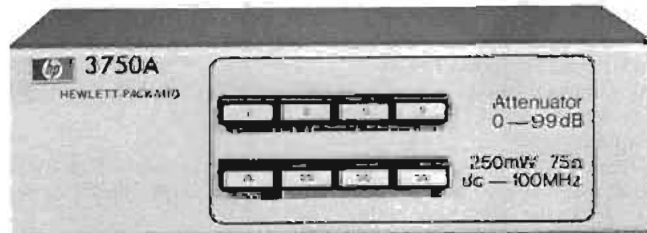

3750A Attenuator

## 3750A Attenuator

- Impedance,  $75\Omega$ .
- Attenuation range, 0 to 99 dB in 1 dB steps.
- Frequency range, dc to 100 MHz.

For detailed performance specifications on the 3743A, 3744A and 3750A, refer to the appropriate data sheet.

For details on additional MLA accessories, refer to the MLA data sheets. These additional accessories include:

- $75\Omega$  cables.
- Test hybrids, loads and calibrated mismatch.
- Transit cases.

For accessories which support the 3730A RF Down Converter and 8620C RF Sweeper, refer to the appropriate data sheets and sections of this catalog.

## Ordering Information

3743A IF Amplifier  
3744A BB Sweeper  
3750A Attenuator

## Price

\$670  
\$1690  
\$365

### PCM/TDM transmission testing

#### Transmission testing

Measurements on digital transmission systems (including the higher level TDM multiplexes) are aimed at establishing data transparency (i.e. how truthfully the data is transmitted).

The principal measure of quality is bit error rate (BER), which is defined as the total number of errors in the received signal divided by the total number of transmitted bits. As such, it represents the probability of any received bit being in error. The standard technique of measuring BER is to stimulate the transmission system with a pseudo-random binary data stream. The sequence length should be chosen to simulate a normal traffic signal and vary sufficiently in pattern to adequately test pattern-sensitive parts of the equipment (e.g. clock recovery circuits). At the transmission system output, the data stream is synchronized with a locally generated, error-free pattern and then a bit-by-bit comparison carried out. Any differences are bit errors, and if counted over a known number of clock bits, can be displayed as BER.

BER measurements are made under a number of differing conditions, including:

- normal conditions of bit rate, signal level, noise, and crosstalk.
- tests with added timing jitter (phase variations of the clock timing instants).
- tests with the data bit rate offset from the normal clock rate.

d) tests with noise added to the data signal.

BER measurements are made on the unipolar data stream (i.e. after any interface code has been removed). This is especially important for systems where the interface code is not transmitted through the system (e.g. digital multiplex and digital radio systems). However, binary access is not always available and it is necessary for test equipment to supply and accept both unipolar and bipolar patterns. It is also useful to measure code violation errors on cable transmission systems where the line code is the same as the interface code. Detection of code errors is relatively simple and can be done without taking the system out of service. For AMI line coding, two consecutive "ones" having the same polarity constitute a code error known as "bipolar violation." For HDB3, B6ZS, and B3ZS, combinations of "ones" and "zeros", including bipolar violations which do not obey the coding rule, constitute code errors.

#### Test equipment

The measurement needs of development, manufacturing and field applications are quite different. Test instruments have been developed that address the specific problems of each area. For R & D use, the 3760A Data Generator and 3761A Error Detector provide flexible capability with a wide range of bit rates, patterns, and variable binary interfaces. For production test, installation, and maintenance the 3780A

provides binary and code error measurement up to 50 Mb/s. Standard bit rate generation, standard interface levels and data formats, clock recovery, and automatic pattern recognition are provided, with a selection of error detector outputs for error analysis. Frequency offset generation and measurement are also included. The 3762A Data Generator and 3763A Error Detector comprise a dedicated error rate measurement system for evaluating higher speed digital transmission equipment up to 150 Mb/s. Some of these systems use a new interface code called Coded Mark Inversion (CMI) and this is available in the 3762A/3763A. Also provided is BER measurement on patterns with zero substitution. This is useful for checking the pattern dependence of a system, or for testing the effectiveness of scramblers. The 3762A/3763A have also been designed to operate in burst mode for TDMA satellite applications.

Testing multi voice channel PCM (or FDM) systems in production, installation and maintenance using automatic testing can now be made easier with the 3777A Channel Selector. This instrument has two identical banks of relays: each bank comprises up to 30 balanced, bi-directional, two-pole changeover switches. To provide a "quiet" termination for telecommunications equipment, all unselected channels are terminated in 600Ω. Control of the 3777A is via the HP-IB with independent selection of Tx and Rx channels.

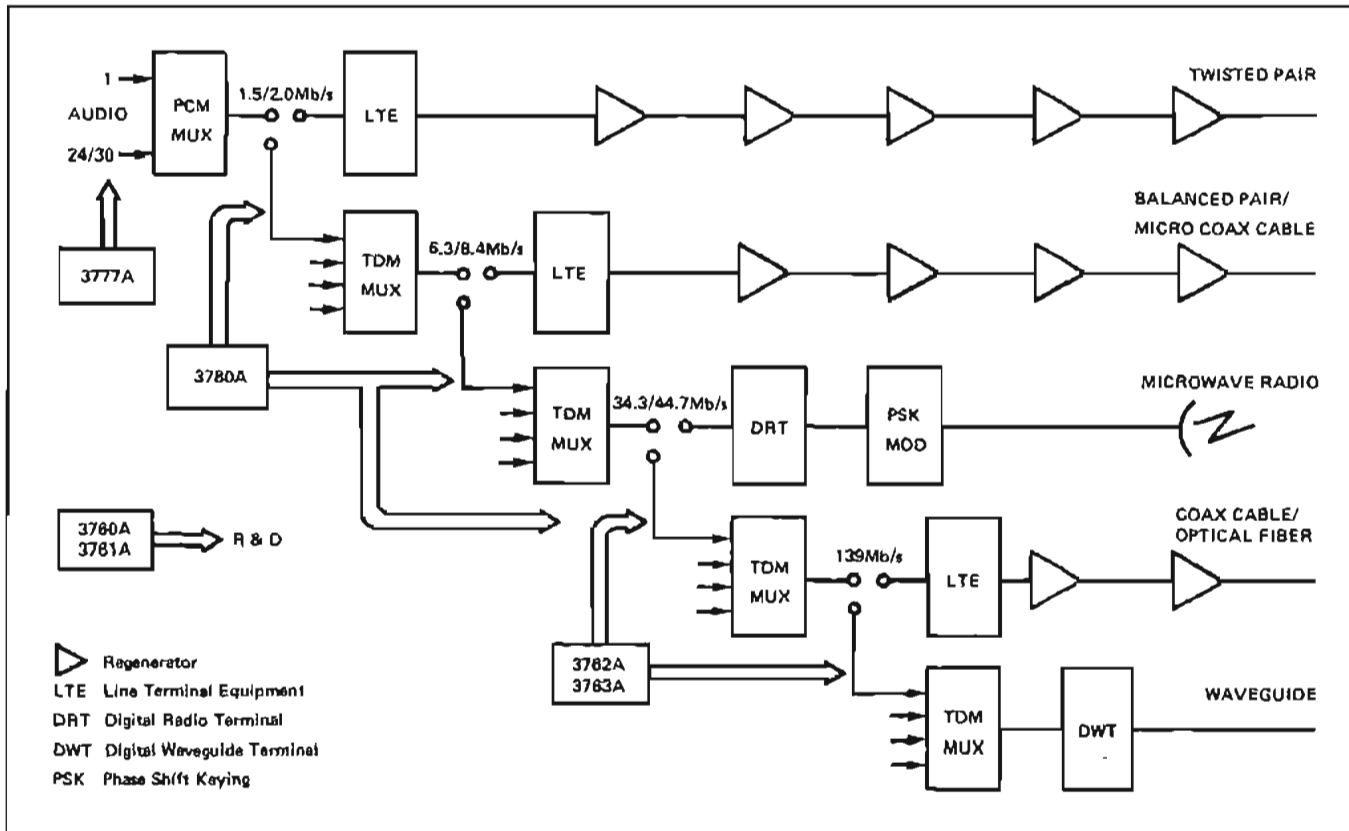

# TELECOMMUNICATIONS TEST EQUIPMENT

## 150 Mb/s PCM/TDM error measuring set for general use

Models 3760A & 3761A

- Internal variable or crystal clocks
- Wide range of test patterns
- Variable binary interfaces with optional delayed data output
- Clock/data phasing
- Automatic, manual, or external synchronization
- Bit-by-bit error detection
- Wide choice of error count period
- BCD printer output

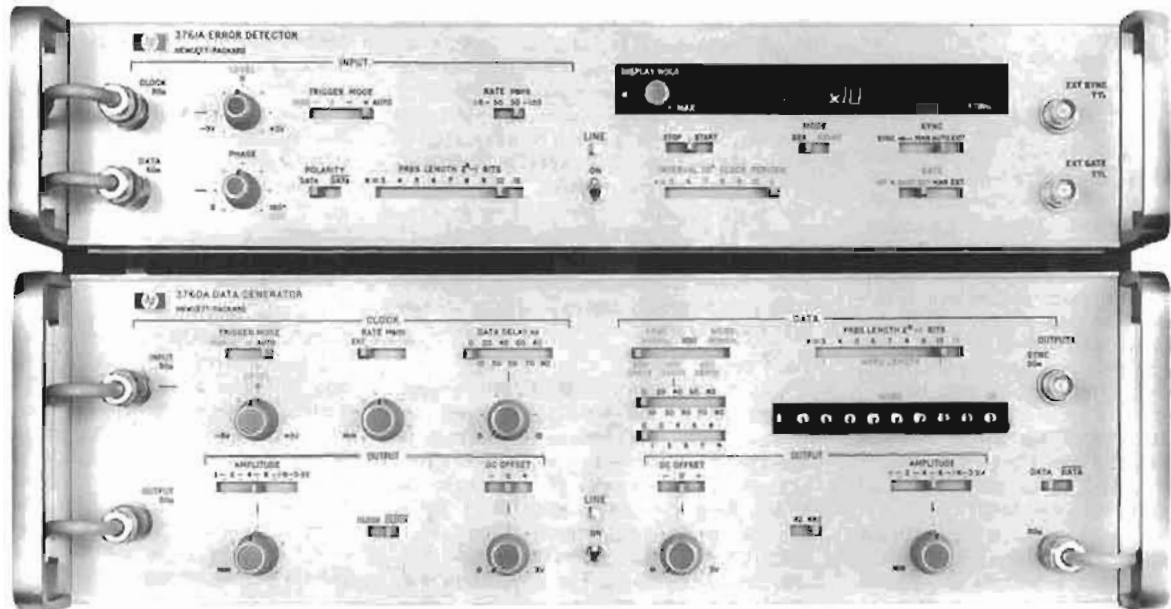

The 3760A/3761A Error Rate measurement system has been designed for general use in the evaluation of digital systems operating in the frequency range 1 kb/s–150 Mb/s. It has particular applications in the design and development of PCM/TDM systems.

The measurement system comprises the 3760A Data Generator, which provides a variable length PRBS to the item or system under test, and the 3761A Error Detector which has been specifically designed for operation with the pseudo random sequences produced by the Data Generator. Error detection is accomplished by comparing the output from the item under test, bit-by-bit, with an independent, closed loop, reference sequence in the 3761A Error Detector. This technique ensures detection of every error, random or systematic, and avoids the problems associated with open loop reference sequence generation. Errors may be counted and directly displayed in the 3761A either as Bit Error Rate (BER) or Total Error Count (COUNT).

The 3760A Data Generator is a versatile PRBS and WORD generator and can supply many of the test sequences required for the development and evaluation of digital transmission equipment. For a fuller description of the 3760A's features and facilities, refer to the entry in the Pulse and Word Generators section of this catalog.

The 3761A Error Detector requires both clock and data inputs. The inputs accept continuous or burst signals in the frequency range 1 kHz to 150 MHz. Synchronization to the incoming data can be accomplished automatically, manually or externally.

The BER measurement is computed from more than 100 errors and the results displayed directly in the form  $A.B \times 10^{-n}$  giving a range  $0.1 \times 10^{-9}$  to  $9.9 \times 10^{-1}$ . The COUNT measurement totalizes errors over a gating period, which may be controlled internally, manually, or externally, and the result is displayed as a four digit

number with leading zeros blanked. The internal gating period can be selected within the range  $10^3$  to  $10^{11}$  clock periods and can be single shot or repetitive in operation. When a count of 9999 is exceeded an "overflow" flag is lit.

In both BER and COUNT modes, the display is continually updated at a rate which may be set by the operator.

A BCD printer output of the current display is available from a rear panel socket. This output is in 8421 format and includes the sync loss and overflow flag indications. An output of one transition per error is also available at the rear panel for further analysis.

## Specifications

### Measurements

#### Bit error rate (BER)

Range:  $0.1 \times 10^{-9}$  to  $9.9 \times 10^{-1}$ , automatically scaled.

Gating: automatic.

Accuracy: computation based on at least 100 errors.

#### Total error count (COUNT)

Range: 0 to 9999.

Gating: internal, single shot or repetitive, manual or external.

Internal:  $10^3$  to  $10^{11}$  clock periods.

Manual: front panel switch.

External: TTL logic levels.

### Patterns

PRBS: maximal length  $2^n - 1$  where  $n = 3$  to 10 and 15.

Frequency range: 1 kHz to 150 MHz.

### Ordering information

3760A Data Generator

3761A Error Detector

Price

\$6525

\$5630

# TELECOMMUNICATIONS TEST EQUIPMENT

1 kb/s–50 Mb/s PCM/TDM error measuring set for field use

Model 3780A



- Binary and code error measurements
- Internal crystal clocks and clock recovery at standard bit rates
- Clock frequency offset generation and measurement capability
- Ternary coded and binary interfaces
- PRBS and WORD pattern generation and detection
- Automatic receiver synchronization
- Printer and recorder outputs

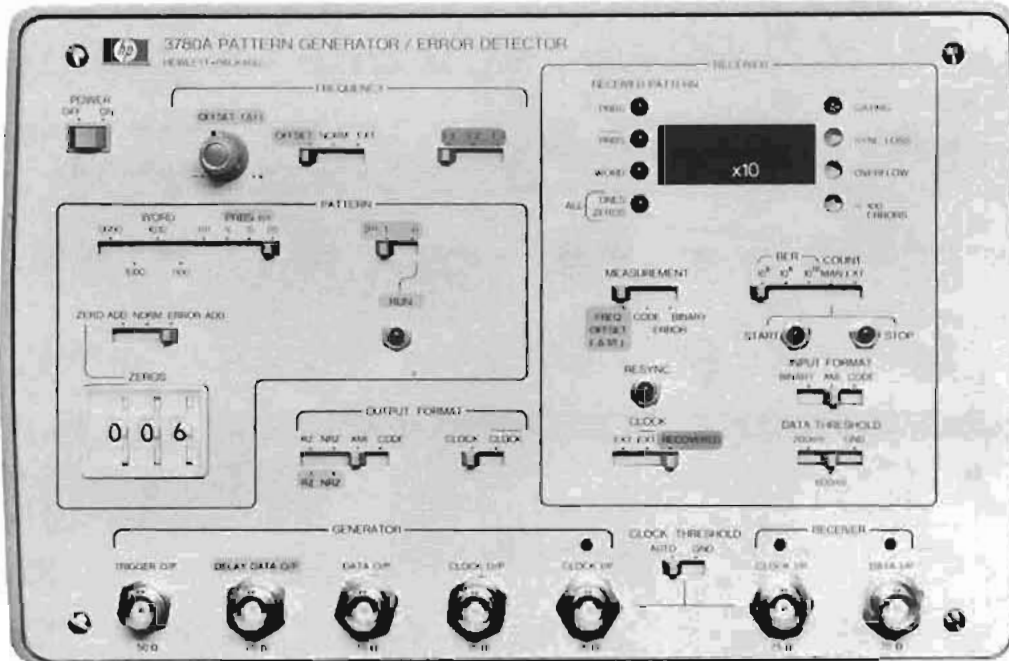

The 3780A Pattern Generator—Error Detector is a comprehensive error measuring set in one portable package. The instrument measures Binary Errors and Code Errors in digital transmission equipment operating at bit rates between 1 kb/s and 50 Mb/s. Frequency offset generation and measurement are also provided at the standard bit rates used in PCM/TDM transmission.

Binary errors are detected by stimulating the system with a test pattern and comparing the output bit-by-bit with a separate internally generated, error-free pattern. Code errors on interface or line coded information are detected during decoding into binary data. The errors can be counted over a chosen gating period and displayed directly as bit error rate (BER) or total error count (COUNT).

Error measurements can be made with PRBS or WORD patterns and the receiver has automatic pattern recognition and synchronization. Zero add facilities allow investigation of regenerator clock recovery performance. This capability can be extended by the optional addition of programmable word and alternating word generation.

The clock frequency in the pattern generator can be offset and measured in the receiver. The offset is displayed as a fraction of the nominal crystal centre frequency. In addition, the offset of external clocks applied to the generator can be measured provided that the frequency is within 25 kHz of one of the installed crystal frequencies.

BER or COUNT results can be displayed directly by LED's on the front panel or monitored via a BCD printer and strip chart recorder. This makes the 3780A ideally suited for unattended long-term measurements.

The 3780A has been designed principally for use in field trials, commissioning, and maintenance of digital transmission terminal and link equipment. It is particularly suited for testing digital multiplex, radio, and line systems but will also find application in development of more advanced systems such as optical fibre transmission and time division switching.

## Specifications

### Measurements

**Binary errors:** closed loop bit-by-bit detection on any pattern produced by generator, excluding added zeroes or alternating words.  
**Code errors:** violations of coding rule detected on any pattern with AMI, HDB3, or HDB2 coding (optionally AMI, B6ZS, or B3ZS).  
**Frequency offset:** measurement of fractional offset of generator clock output from installed crystal rates.

### Options

#### Word/connector options

001: all words replaced by a 16-bit front panel programmable word	add \$215
002: Siemens 1.6 mm connectors	add \$55
003: combination of 001 and 002	add \$270

#### Frequency offset option

099: frequency offset capability—measurement only, generation facility deleted	less \$370
--	------------

#### Frequency/codec options

100: internal clock frequencies of 2048, 8448, and 34368 kHz; HDB3/HDB2 codec.	N/C
101: internal clock frequencies of 1544, 6312, and 44736 kHz; B6ZS/B3ZS codec.	N/C
102: internal clock frequencies of 1544, 6312, and 3152 kHz; B6ZS/B3ZS codec.	N/C

Model 3780A Pattern Generator—Error Detector \$6050

# TELECOMMUNICATIONS TEST EQUIPMENT

## Dedicated 150 Mb/s PCM/TDM error detection system

### Models 3762A & 3763A

- Crystal clocks and clock recovery
- Frequency offset facilities
- Burst mode operation
- Binary and interface codes
- Input equalization
- Error detection on PRBS + Zeros
- Built-in interval timer
- Recorder and printer outputs



3762A

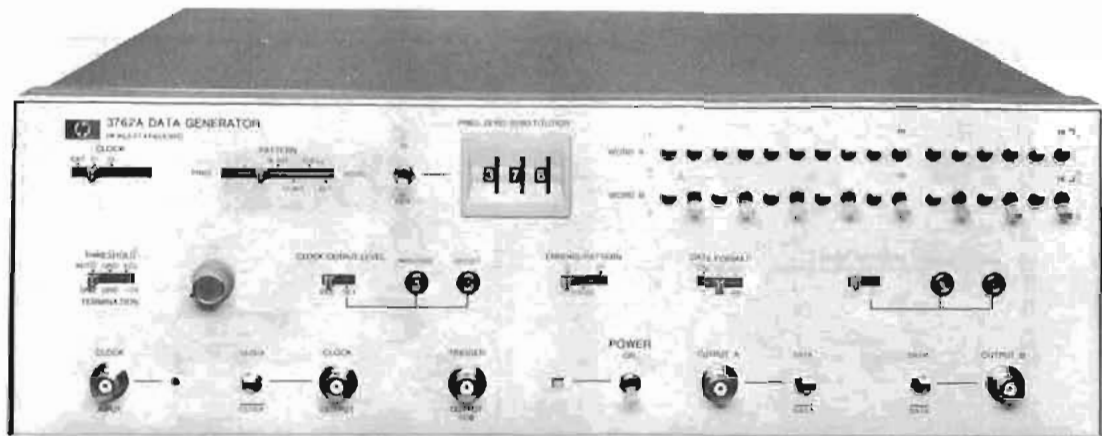

3763A

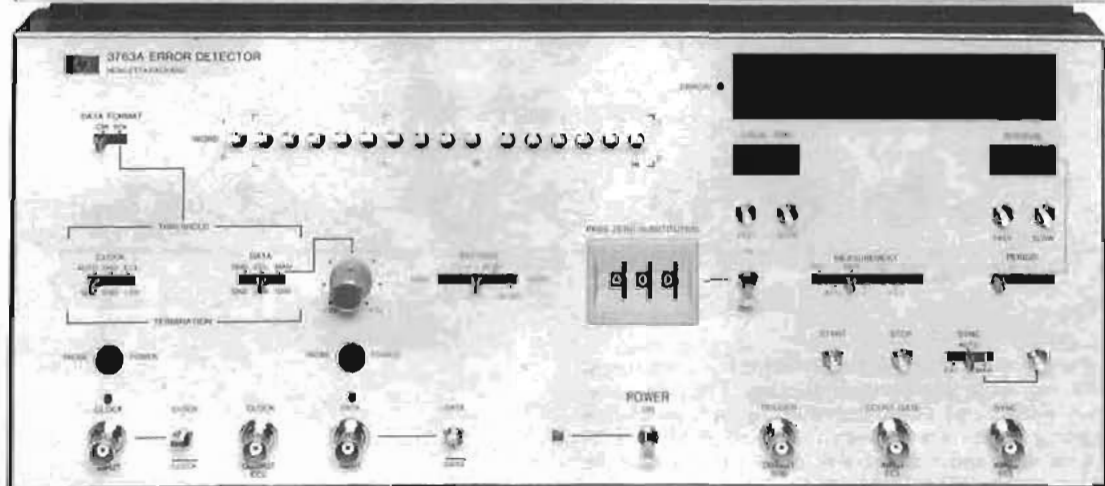

The 3762A Data Generator and 3763A Error Detector comprise a dedicated error rate measurement system for evaluating high-speed digital transmission equipment. Basically, there are two versions of the system available. One features CMI and binary data formats and is specifically intended for use in field commissioning and maintenance of digital radio (terrestrial microwave, TDMA satellite, and waveguide) systems. The other version, with CMI and ternary (HDB3 and B3ZS) data formats, is designed for digital multiplex and digital cable systems. Although optical fiber systems are still undefined, the 3762A and 3763A have sufficient built-in capability and flexibility to cover applications in this rapidly developing area of telecommunications.

The 3762A is a dual channel generator with the data on one channel delayed relative to that of the other. The patterns available are  $2^{10}-1$ ,  $2^{15}-1$ , and  $2^{23}-1$  bit PRBS, two 10- or 16-bit programmable words, two 1010 . . . repetitive patterns, and two 8-bit words alternated by an external signal. The  $2^{10}-1$  bit PRBS is as specified by CCITT. The  $2^{23}-1$  bit pattern conforms to the sequence currently proposed by many administrations for 140 Mb/s terrestrial systems and by Intelsat for TDMA satellite systems. The coded data outputs from the 3762A are at standard levels and impedances for direct connection to the equipment under test. The binary interfaces have variable amplitude and offset to suit different logic families. Two internal crystal clocks are provided at standard PCM/TDM hierarchy rates, in the range 30 to 150 Mb/s. These can be offset by up to  $\pm 60$  ppm from nominal.

In the 3763A, the output from the system under test is compared bit-by-bit with an independent, error-free reference pattern. Synchronization can be under automatic, manual, or external control. Errors are displayed in BER (bit error rate) or COUNT formats. In BER mode, a reading is given after 10 or 100 errors are counted. In COUNT, the gating period can be selected internally, externally, or manually; using the interval timer, the gating period can be set from 1 minute up to 24 hours. Clock recovery from interface coded data is provided at the rates of the installed crystal clocks with equalization to compensate for up to 12 dB of loss in installation cabling between the system and the equipment under test. Also, frequency offset can be measured in the 3763A.

For long term error measurements and more detailed studies of error distribution etc, error, printer, and recorder outputs are provided, together with a time-of-day clock and an interval timer. With this, results can be printed out at the end of every gating period, or at selected intervals, together with the time of day.

Blocks of zeros may be substituted into PRBS patterns to test scramblers/descramblers, clock recovery, and regenerator circuits. The position of the zero block within the sequence can be selected via a trigger word. Clock gating inputs allow burst mode gating control of pattern generation and error detection. In addition, a second gating input in the detector allows examination of the errors occurring in a window within the burst.

### Specifications

#### 3762A Data Generator

**Internal clock:** two crystal clocks in the range 30 to 150 MHz; crystals fitted in standard unit are 139.264 and 141.040 MHz; offset continuously variable up to  $\pm 60$  ppm.

**External clock input:** 1 kHz to 150 MHz; 75 $\Omega$ ; 300 mV pk-pk sensitivity, with choice of input termination and trigger level.

**Burst gating input (rear panel):** disables clock for burst mode operation; 50 $\Omega$ ; ECL levels.

**Clock output:** CLOCK or  $\overline{\text{CLOCK}}$ ; 75 $\Omega$ ; preset amplitude and offset or fixed ECL levels.

**Patterns:**  $2^{10} - 1$ ,  $2^{15} - 1$ , and  $2^{23} - 1$  PRBS; two 10- or 16-bit programmable words; two 1010 . . . repetitive patterns; two 8-bit words alternated by an external signal; PRBS patterns can be gated off for 1 to 999 clock periods after trigger pulse (zero substitution); error add facilities.

**Alternating word control input (rear panel):** dc to 100 kHz; 250 mV pk-pk sensitivity.

**Data output A:** PRBS or WORD A; DATA or  $\overline{\text{DATA}}$ , in CMI, NRZ or RZ format; 75 $\Omega$ ; preset amplitude and offset or fixed ECL levels.

**Data output B:** PRBS delayed, or WORD B, in NRZ or RZ format; other specifications as for Data output A.

**Trigger output:** one pulse every sequence or word; variable in position, selected by word switches; two clock periods wide, but stretched in zero substitution mode; 50 $\Omega$ ; 1 V.

**Auxiliary outputs (rear panel):** clock and data (both A and B) outputs in binary ECL levels.

#### 3763A Error Detector

**Data input:** CMI, NRZ, or RZ formats; 75 $\Omega$ ; DATA or  $\overline{\text{DATA}}$ ; 300 mV pk-pk sensitivity on binary inputs, with choice of termination and trigger level; 12 dB fixed equalization at 70 MHz on CMI inputs with clock recovery.

**External clock:** as 3762A.

**Burst gating input (rear panel):** as 3762A.

**Clock output:** monitor output; 50 $\Omega$ ; ECL levels.

**Patterns:** all the patterns of the 3762A, including zero substitution, but excluding alternating words.

**Synchronization:** automatic, manual, or external (ECL); sync loss > 10000 errors in 90000 bits; resync time typically < 800 bits.

**Trigger output:** as 3762A.

**Error measurements:** closed loop bit-by-bit comparison at the binary level with an independent, error-free local reference.

**BER:** looks for 10 or 100 errors and takes reciprocal of clock counter; result displayed on LED's as X,  $Y \times 10^{-n}$  where  $n = 1$  to 9, with automatic scaling.

**COUNT:** totalizes errors over a selected gating period; internal period can be  $10^6$ ,  $10^8$ ,  $10^{10}$  clock periods or 1 min to 24 h, repeti-

tive or single shot; manual start/stop or external (ECL) control; result displayed on LED's as ABCD.

**Measurement gating input:** gates error and clock inputs to error counter, providing a measurement "window"; 50 $\Omega$ ; ECL levels.

**Frequency offset measurement:** measures deviation of received bit rate from nominal rate; result displayed on LED's as  $\pm \text{BCD} \times 10^{-6}$ .

**Flags:** gating; errors; overflow; sync loss.

**24 hour clock:** provides local time of result on printer output.

**Interval timer:** controls gating period in COUNT and print rate when periodic printing of results is required.

**Printer output (rear panel):** 8-4-2-1 BCD, 10-column output of result, plus local time, if required, and flags; TTL print command pulse.

**Recorder output (rear panel):** constant current drive output of BER or COUNT result, with flags.

**Display output (rear panel):** overflow digits of error count available; 50 $\Omega$ ; 1 V.

**Error output (rear panel):** one transition per error; or one pulse per error below 75 Mb/s; 50 $\Omega$ ; 1 V.

**Counter gate output:** error counter gating period brought out to enable simultaneous gating of external counter; TTL levels.

#### General (3762A & 3763A)

**Size:** 3762A: 133 H  $\times$  425 W  $\times$  440 mm D ( $5\frac{1}{4}$ "  $\times$   $16\frac{3}{4}$ "  $\times$   $17\frac{7}{16}$ " (14"). 3763A: 178 H  $\times$  425 W  $\times$  440 mm D (7"  $\times$   $16\frac{3}{4}$ "  $\times$   $17\frac{7}{16}$ ").

**Weight:** 3762A: 12 kg (26.5 lb). 3763A: 14 kg (31 lb).

**Power supply:** 115 V  $\pm$  10%–22% or 230 V  $\pm$  10%–18%; ac, 48 to 66 Hz; power consumption approx 12 VA, each.

#### Options (3762A/3763A)

**105:** 75 $\Omega$  interfaces changed to 50 $\Omega$ . Frequencies are 60.032 and 30.016 MHz.

**201:** Data output B not delayed; HDB3/B3ZS/AMI; 75 $\Omega$ ;  $\pm 1$  V. Second data input (B) on 3763A; 75 $\Omega$ ; HDB3/ B3ZS/AMI; automatic equalization for up to 12 dB cable loss at  $\frac{1}{2}$  bit rate relative to a  $\pm 1$  V signal; clock recovery at installed crystal frequencies. Channel B cannot be used simultaneously with A. Frequencies are 139.264 and 120.000 MHz.

**202:** as for Option 201 except frequencies are 139.264 and 34.368 MHz.

**330:** as for Option 201 except frequencies are 131.088 and 44.736 MHz. In addition, clock and binary data interfaces changed to 50 $\Omega$ .

**801:** front cover.

	Price
	--\$70/--\$70
	--\$210/+\$300
	+\$228/+\$250
	--\$261/+\$180
	+\$38/+\$48

#### Ordering information

3762A Data Generator	Price \$7095
3763A Error Detector	\$7770

## TELECOMMUNICATIONS TEST EQUIPMENT

## PCM accessories

Models 15507A, 15508B, and 15509A



15507A



The 15507A Isolator is a passive unit which provides isolation from longitudinal voltages appearing on connections to digital transmission equipment.

**Specifications**

**Insertion loss:**  $0 \pm 2$  dB, from 0.1 to 150 MHz.

**Return loss:**  $>20$  dB against  $75\Omega$ , from 0.5 to 150 MHz.

**Longitudinal attenuation:**  $>40$  dB at 50 Hz.

$>35$  dB at 100 Hz.

$>20$  dB at 1 kHz.

**Connectors:**  $75\Omega$  BNC.

**Case dimensions:** 22 mm dia  $\times$  86 mm long (0.88"  $\times$  3.38").



15508B



The 15508B Converter is a 1 to 10 MHz balanced interface providing  $75\Omega$  unbalanced/ $110\Omega$  balanced impedance conversion. It has been designed as a passive converter for use in applications where the interface to the digital equipment requires a balanced signal.

**Specifications**

**Frequency range:** 1 to 10 MHz.

**Turns ratio ( $75\Omega/110\Omega$ ):** 1/1.2, nominal.

**Connectors:**  $75\Omega$  UNBAL—BNC.

$110\Omega$  BAL—accepts WECO 310 Jack Plug.

**Case dimensions:** 22 mm dia  $\times$  86 mm long (0.88"  $\times$  3.38").



15509A



The 15509A Amplifier provides sufficient gain on a digital signal appearing at a standard digital equipment monitor point to trigger the 3780A or 3763A error detector input. It can be used with the 3780A to monitor, for example, a traffic signal for code violations.

**Specifications**

**Gain:**  $25 \pm 2$  dB at 0.1 MHz.

$21 \pm 2$  dB at 45 MHz.

$18 \pm 2$  dB at 75 MHz.

**Input impedance:**  $75\Omega$ , typically; return loss  $>20$  dB 1 to 70 MHz,  $>15$  dB, 70 to 150 MHz.

**Required load impedance:**  $75\Omega$ .

**Maximum safe input:** ac, 3 V peak; dc,  $\pm 20$  V.

**Maximum safe dc applied to output:**  $\pm 10$  V.

**Power supply:** +15 V, 0 V, -12.6 V; consumption 1 VA.

**Case size:** 19 mm D  $\times$  163 mm L (0.75"  $\times$  6.4").

**Ordering information**

15507A Isolator  
15508B Converter  
15509A Amplifier

**Price**

\$70  
\$95  
\$130



# TELECOMMUNICATIONS TEST EQUIPMENT

HP-IB controlled Channel Selector

Model 3777A



- DC to 110 kHz
- 2-wire/4-wire balanced switching
- Modular construction
- Up to 30 4-wire channels

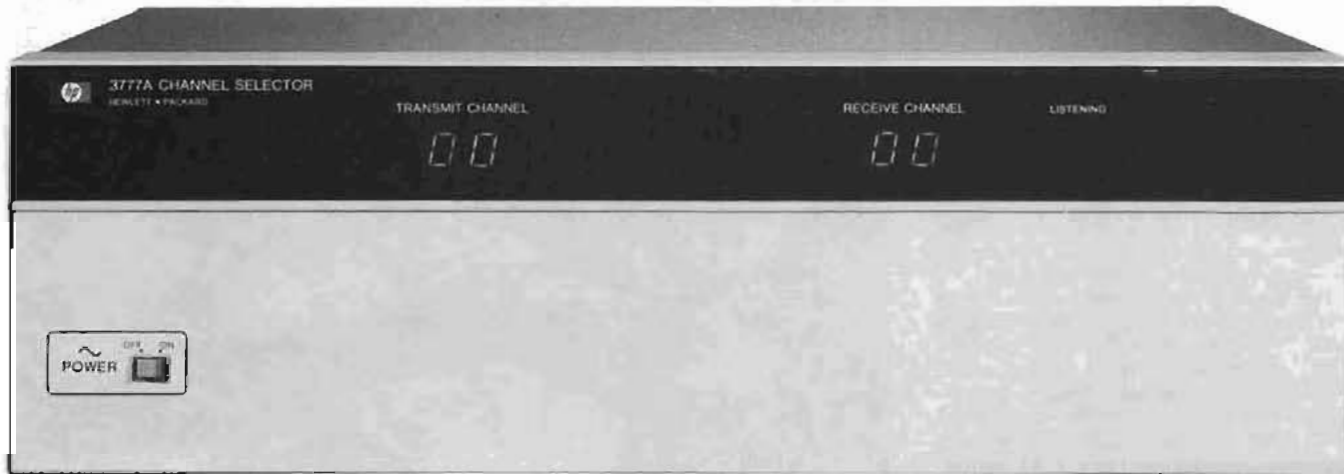

The 3777A is an HP-IB controlled Channel Selector. It provides test point access for maintenance and production testing of PCM and FDM telecommunications systems.

The instrument contains two identical banks of relays, termed "Transmit" and "Receive." Each bank comprises up to 30 balanced, bi-directional, two-pole changeover switches. The Transmit bank enables switching of a single source to any one of up to 30 outputs. In the Receive bank, any one of up to 30 inputs can be switched to a common output. To provide a quiet termination for telecommunications equipment, all unselected channels are terminated in 600Ω.

The two switch banks are controlled independently via the HP-IB from a computer or a programmable calculator. For automatic test systems, the 3777A can scan, under external program control, through a number of channels in any desired sequence.

Construction of the 3777A is modular, with the 30 channels in both Transmit and Receive banks arranged in 5 blocks, each block having 6 Transmit and 6 Receive channels. 12 and 24 channel versions with only 2 or 4 blocks are available as options.

Principal applications are in testing telecommunications equipment where the 3777A may be used to switch PCM primary multiplex channels, FDM voice channels or groups, and voice frequency telegraph circuits, for measurements during production, installation, or maintenance. The high quality relays employed in the 3777A also make it suitable for many other general purpose applications requiring an HP-IB controlled channel selector.

## Specifications

**Insertion loss:** <0.05 dB at 110 kHz.

**Resistance of through path:** <500 mΩ each leg.

**Return loss of terminated port:** >20 dB against 600Ω (800 Hz to 110 kHz).

### Crosstalk (Isolation)

- Transmit I/P to receive O/P: >105 dB (dc to 4 kHz).
- >85 dB (dc to 40 kHz).
- >75 dB (dc to 110 kHz).

- Tx I/P to unselected Tx O/P: >100 dB (dc to 4 kHz).
- Unselected Rx I/P to Rx O/P: >80 dB (dc to 40 kHz).
- Any Rx I/P to any Tx O/P: >70 dB (dc to 110 kHz).

**Changeover time:** <20 ms (including bounce).

**DC isolation to ground:** 130 V max.

**Max DC differential voltage:** 60 V.

**AC proof voltage to ground:** 184 V peak.

**Max AC differential proof voltage:** 84 V pk.

**Max DC current capability**

DC (Through): 120 mA.

AC(Terminated): 20 mA rms.

**Connectors:** Siemens audio connectors for transmit I/P and receive O/P. A 37-way D-type connector is associated with each group of 6 receive I/P's and transmit O/P's.

### General

**Weight:** 7 kg (15.4 lb)

**Dimensions:** 145 mm H × 425 mm W × 350 mm D (16.8" × 3.5" × 13.9").

**Power supply:** 100/120/220/240 V, +6 -13%; ac, 48 to 66 Hz; consumption 10 VA.

### Options

**001:** 24 channels in transmit and receive banks. WECO 310 connectors used for transmit I/P and receive O/P. Price less \$285

**002:** 12 channels in transmit and receive banks. Siemens audio connectors used for transmit I/P and receive O/P. Price less \$850

**003:** 12 channels in transmit and receive banks. WECO 310 connectors used for transmit I/P and receive O/P. Price less \$850

Model 3777A Channel Selector

\$3270

## PERSONAL CALCULATORS

### Pocket and Personal Printing Calculators

#### General Information

Hewlett-Packard introduced the world's first pocket scientific calculator in 1972. Since then, Hewlett-Packard has introduced several pocket and personal printing calculators with technologically advanced features; each with different capabilities for different levels of problem sophistication. To properly select a calculator, you must consider not only the problems you're facing today, but those you're likely to face tomorrow.

#### Personal Calculators

If your problems are fairly straightforward but still include coordinate conversions, log and trig functions, the HP-21 may be just perfect for you. The HP-21 is the lowest priced scientific pocket calculator Hewlett-Packard offers, yet it has all the functions and features you'd expect to find in a quality scientific pocket calculator.

For repetitive or iterative problems, two HP calculators are practically "custom made" for you—the HP-25 and the HP-25C. These two calculators have identical programming power and identical preprogrammed functions including conditional tests, full editing, eight addressable memories, and a great many mathematical and statistical functions. But the HP-25C also has a continuous memory that retains your programs and saves your data even when you turn the calculator off.

To bridge the gap between scientific and business calculations, you should consider the HP-27 Financial/Statistical/Scientific, which gives you every scientific function we've ever offered in a preprogrammed calculator—plus the added power of statistics and finance. The HP-27 will be extremely valuable to any scientist, businessman or engineer whose responsibilities extend into targeting, budgets, cost analysis, and other financial and forecasting considerations.

If your problems are more business oriented, take a look at the HP-22 or the new HP-10. The HP-22 Business Management Pocket Calculator provides a desirable combination of financial, mathematical, and statistical capabilities often used in modern business. For the person requiring the performance of a desktop machine in a light weight, pocket-sized model, the new HP-10 may be the answer. And the whisper-quiet thermal printer gives you a valuable printed record of your calculations.

For the businessman that must evaluate large numbers of investment alternatives, the new HP-92 provides solutions quickly, easily, and accurately. The thermal printing feature gives you an indispensable record of time and money solutions.

For the ultimate problem solving power in any field, Hewlett-Packard offers you two compatible, fully programmable calculators—the HP-67 Pocket Calculator and the HP-97 Printing Calculator. The HP-97 combines exceptional programming power—plus a battery-operated printer—all in one self-contained unit. The HP-67 pro-

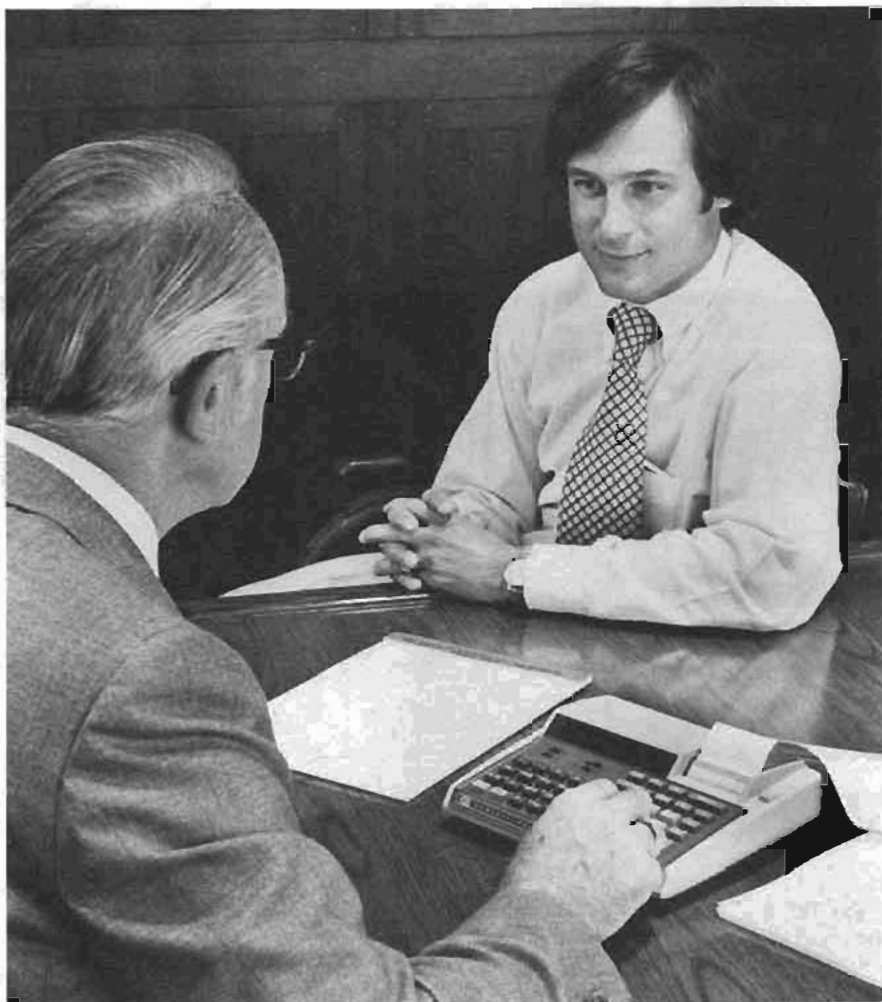

vides the identical power of the HP-97 in the classic pocket size. Used separately—or together—these compatible, fully programmable calculators do the job faster and with less chance for error.

To increase the versatility of your fully programmable HP calculator, HP has an extensive library of "Application Pacs." By using these Application Pacs, you'll discover that the solutions you require may already exist. Each program in a pac is fully documented with commented program listing allowing the adoption of programming techniques useful to each application area. The Application Pacs greatly extend the capabilities of the fully programmable models and significantly increase problem solving potential. Application Pac topic areas include:

- Stat Pac
- Math Pac
- EE Pac
- Business Decisions Pac
- Clinical Lab and Nuclear Medicine
- ME Pac
- Surveying Pac
- Games Pac
- Civil Engineering
- Navigation

To compliment the Library Application Pacs, HP has a full line of personal calculator accessories to keep your HP calculator safe and sound. To protect against a "mysterious disappearance" of your HP calculator, there is a ruggedly-designed, key-operated security cradle available to protect your investment. The cradle does not interfere with normal operations of the calculator and may be secured via four different methods (hardware included with cradle). For desktop models, a six-foot security cable is available. For outdoor calculator operations, HP has a hard leather case to guard against normal environment conditions encountered in the field.

To keep your HP calculator operating at peak efficiency, several different models of rechargeable battery packs are available to counter untimely power losses. Simply slip the battery pack into the holder, plug the holder into the recharger/AC adapter supplied with your calculator, and in six-to-eight hours you have a fully charged battery. (HP-67 recharging time, 14-17 hours.)

Whichever HP calculator or accessory you select, you can be assured that it is the finest in its class . . . because the Hewlett-Packard standard of quality permits nothing else.

# PERSONAL CALCULATORS

## Scientific Programmable & Scientific Calculators

Models HP-21, HP-25, HP-25C



### HP-21

The HP-21 is the lowest-priced scientific pocket calculator HP offers, yet it has all the functions and features you'd expect to find in a scientific pocket calculator. The HP-21 performs 32 preprogrammed functions and operations including logarithms, trig calculations and polar to rectangular conversions; in either radians or degrees. The RPN logic system tackles even the most complex problems efficiently and gives you continuous and immediate feedback. Combining the HP-21's capability with its low cost, you have a price/performance ratio that's simply unbeatable.

#### HP-21 Specifications

##### Pre-Programmed functions

**Trigonometric (all in degrees or radians):** Sin x; Arc Sin x; Cos x; Arc Cos x; Tan x; Arc Tan x.

**Logarithmic:** Log x; Ln x;  $e^x$ ;  $10^x$ .

**Other:**  $y^x$ ;  $\sqrt{x}$ ;  $1/x$ ;  $\pi$ ; rectangular/polar coordinate conversion; full register arithmetic.

##### General

**Memory:** one addressable register; four-register operational stack.

**Display:** Up to 10 significant digits in fixed-decimal notation; up to 8 significant digits plus two-digit exponent in scientific notation; full display formatting in either mode with selective round-off; indicators for improper operations, low battery.

**Dynamic range:**  $10^{-99}$  to  $10^{99}$  (200 decades).

**Power:** AC: 115 V,  $\pm 10\%$ , 50 to 60 Hz. Battery: 2.5 V dc nickel-cadmium rechargeable battery pack.

**Size:** 30 x 68 x 130 mm D (1.2" x 2.7" x 5.1").

HP-21 Scientific Pocket Calculator

\$80

### Continuous Memory (HP-25C only)

The continuous memory capability of the HP-25C can provide tremendous values in time-saving and convenience to any scientist, engineer or student who uses a few long programs repeatedly—for example, if 20 percent of your programs will solve most of your problems.

The HP-25C retains a program—no matter how often you switch it on and off—by means of sophisticated complementary metal oxide silicon circuitry (C-MOS). The last program you store is

saved, ready for use, until you clear it or enter a new program.

The 8 data storage registers are also continuous, allowing constants or data to be stored indefinitely, to be available as needed.

The HP-25 is identical to the HP-25C but without continuous memory.

#### HP-25/25C Specifications

##### Pre-Programmed functions

**Trigonometric (all in decimal degrees, radians, or grads):** Sin x; Arc Sin x; Cos x; Arc Cos x; Tan x; Arc Tan x.

**Logarithmic:** Log x; Ln x;  $e^x$ ;  $10^x$ .

**Statistical:** mean and standard deviation; summations giving n,  $\Sigma x$ ,  $\Sigma x^2$ ,  $\Sigma y$ ,  $\Sigma xy$ .

**Other:**  $y^x$ ;  $\sqrt{x}$ ;  $1/x$ ;  $\pi$ ;  $x^2$ ; %; conversions between decimal hours, degrees, radians, or grads and hours (degrees)/minutes/seconds; rectangular/polar coordinate conversions, integer/fraction truncation; absolute value; full register arithmetic.

##### Programming features:

49-step program memory; conditional branching based on any of eight relational tests ( $x < y$ ,  $x \geq y$ ,  $x \neq y$ ,  $x = y$ ,  $x < 0$ ,  $x \geq 0$ ,  $x \neq 0$ ,  $x = 0$ ); direct branching; ability to review or execute programs step-by-step; ability to add or modify program steps; PAUSE and NO-OPERATION program instructions.

##### General

**Memory:** eight addressable registers; four-register operational stack; last-X register.

**Display:** up to 10 significant digits in fixed-decimal notation; up to 8 significant digits plus 2-digit exponent in scientific or engineering notation (in engineering notation all exponents are displayed as multiples of  $\pm 3$ ); full display formatting in any mode with selective roundoff; indicators for improper operations, low battery; line-number/key matrix program display.

**Dynamic range:**  $10^{-99}$  to  $10^{99}$  (200 decades).

**Power:** AC: 115 V,  $\pm 10\%$ , 50 to 60 Hz. Battery: 2.5 V dc nickel-cadmium rechargeable battery pack.

**Size:** 30 H x 68 W x 130 mm D (1.2" x 2.7" x 5.1").

##### Ordering information

HP-25 Scientific Programmable Pocket Calculator

HP-25C Scientific Programmable with Continuous Memory

Price

\$125

\$160

## PERSONAL CALCULATORS

Scientific Pocket Calculators

Model HP-19C/29C



The new HP-19C and HP-29C are a pair of advanced programmable calculators with continuous memory. Continuous memory retains a user's programs or data, even with the power turned off. The HP-19C combines a full range of scientific functions, advanced programming features and RPN logic with a battery powered printer in a convenient hand-held size. The HP-29C offers the same features and functions in an even smaller "pocket size." These functionally identical calculators provide exceptional utility to professionals and students in science or engineering fields.

#### Specifications

##### Pre-Programmed Functions

**Angular:** Sin, Cos, Tan, Sin - 1, Cos - 1, Tan - 1; Hours - Minutes - Seconds Conversion to decimal hours; polar/rectangular conversion; degrees, radians, grads angular modes.

**Logarithmic:** Log,  $10^x$ , Ln,  $e^x$ .

**Statistics:** Summations  $\Sigma x$ ,  $\Sigma y$ ,  $\Sigma x^2$ ,  $\Sigma y^2$ ,  $\Sigma xy$ ; deletion of unwanted data; mean, standard deviation

**Other:** +, -,  $\times$ ,  $\div$ ,  $y^x$ ,  $x^2$ ,  $\pi$ ,  $\sqrt{x}$ ,  $1/x$ ,  $\%$ . Integer truncation; fraction truncation; absolute value.

**Programming features:** 98 steps of continuous memory (all functions merged); 16 continuous memory data storage registers; 14 volatile data storage registers; four-register stack; last-X register.  $x \neq y$ ,  $x = y$ ,  $x > y$ ,  $x < y$ ;  $x \neq 0$ ,  $x = 0$ ,  $x > 0$ ,  $x < 0$ ; Inc-

rement/decrement storage register and skip on zero.

**Label addressing:** indirect addressing of labels and data storage; relative addressing; three levels of subroutines.

**Editing:** single step execution; single step and back step inspection of a program; insert/delete editing; position the calculator at any step in program memory. Pause—review intermediate results or key in data in the middle of a program.

#### General

**Display:** fixed decimal, scientific and engineering notation.

**Print select switch:** print only when you desire; print digit entries and functions automatically; or trace an executing program.

##### HP-19C Physical specifications

**Power:** 115 Vac (or 230 Vac) 10%, 50 to 60 Hz.

**Size:** 40 H  $\times$  88 W  $\times$  165 mm D (1.6"  $\times$  3.45"  $\times$  6.5").

##### HP-29C Physical specifications

**Power:** AC 115 (or 230 V) 10%, 50 to 60 Hz.

**Size:** 30.2 H  $\times$  68.3 W  $\times$  130.2 mm D (1 11/16"  $\times$  2 11/16"  $\times$  5 1/16").

#### Ordering information

HP-19C Printing Programmable with Continuous

Memory

HP-29C Programmable with Continuous Memory

#### Price

\$345

\$195

- Exceptional programming power and ease of use for lengthy, repetitive calculations.

- "Smart" magnetic card reader frees your mind by automatically recording the display mode setting, angular mode setting, and the status of the four flags when you record your program.



HP-67 Fully-Programmable Pocket Calculator

HP-97 Fully-Programmable Printing Calculator

These are the most powerful personal calculators Hewlett-Packard has ever made. The HP-97 combines exceptional programming power-plus a battery-operated printer all in one self-contained unit. The HP-67 provides the identical programming power of the HP-97 in the classic pocket size.

The HP-67 is completely compatible with the HP-97. Programs recorded on the unit may be loaded and executed on the other — even the print commands (e.g., when the HP-67 executes a Print X command, it pauses, and displays the current result).

Used separately — or together — these compatible fully programmable calculators do the job faster and with less chance for error.

### HP-97/67 specifications

#### Pre-programmed functions

**Mathematical:** Sin, Cos, Tan, Sin<sup>-1</sup>, Cos<sup>-1</sup>, Tan<sup>-1</sup>; Degrees, radians, grads angular modes; Coordinate conversion; Degree/radian conversion; Hour/minutes/seconds addition and conversion to decimal hours; Log, 10<sup>x</sup>, Ln, e<sup>x</sup>; Integer truncation; Fraction truncation; Absolute value; Rounding; +, -, ×, ÷, y<sup>x</sup>, x<sup>2</sup>, 1/x, √x, N!, %, %CH, π.

**Statistical:** mean and standard deviations; Summations n, Σx, Σx<sup>2</sup>, Σy, Σy<sup>2</sup>, Σxy; Deletion of unwanted data.

#### Programming features

**Card Reader features:** Record/Load all data registers; Load selected data registers; Record/Load entire program memory; Merge program subsections; Angular mode, flag settings, and display status are recorded with program recording and reset with program loading; User is prompted for proper operation when loading; Card reader operations can be initiated manually or under program control (except program recording).

**Addressing:** label addressing; indirect addressing of labels and data storage; Relative addressing; 10 user-definable keys or 20 user-

definable labels; Three levels of subroutines (GSB).

**Conditionals:** x = y, x ≠ y, x > y, x ≤ y, x ≠ 0, x = 0, x < 0, x > 0;

Four flags; Increment, decrement storage registers and skip on zero.

**Editing:** single step execution; Single step and back step inspection of a program; Insert/Delete editing. Position the calculator at any step in program memory (GTO · nnn).

#### Other Programming features

PAUSE to review intermediate results, key in data or load magnetic cards.

#### General

**Memory:** 224 steps of program memory (all functions are merged and occupy only one step of program memory); 26 data registers; Four-register automatic memory stack; Last-X register.

**Display:** up to 10 significant digits with selective round-off to desired number of places in fixed decimal notation; up to 10 significant digits plus two digit exponent and appropriate signs in scientific and engineering notation (where values are displayed with exponents that are multiples of 3).

#### HP-97 Printing features

Quiet, thermal printer lets you record and level your calculations. Print mode switch selects three printing modes. In addition you can print and label the contents of the stack registers, the primary data storage registers, program memory, and the display.

**Dynamic range:** 10<sup>-99</sup> to 10<sup>99</sup> (200 decades).

**HP-97 Power:** 90-127 Vac or 200-254 Vac, 50 to 60 Hz or 5.0 V dc nickel cadmium rechargeable battery pack.

**HP-87 Power:** 86-127 Vac or 172-254 Vac, 50 to 60 Hz or 3.75 V dc nickel cadmium rechargeable battery pack.

**HP-97 Size:** 63.5 H × 228.6 W × 203.2 mm D (2.5" × 9" × 8").

**HP-87 Size:** 18 to 34 H × 81 W × 152.4 mm D (0.7" to 1.4" × 3.2" × 6").

#### Ordering information

HP-97 Fully Programmable Printing Calculator

HP-67 Fully Programmable Pocket Calculator

Price

\$750

\$450

## PERSONAL CALCULATORS

Business &amp; Scientific Pocket Calculators

HP-10, HP-22, HP-27

**HP-10**

The New HP-10 is a desktop printing calculator engineered to exacting HP standards to meet your arithmetical problem-solving requirements. Incredibly versatile, the HP-10 uses a combination of RPN and arithmetical logic to ensure fast and accurate solutions for all your business calculations—the right logic to ensure fast and accurate solutions for all your business calculations—the right logic system for your office needs. A whisper-quiet thermal printer gives you a permanent record of all your business transactions. A 10-digit display can be used alone or in conjunction with the printer. In addition to the accumulator, a memory is available to store and recall a constant—or if you prefer, to maintain a separate running total of your calculations. The HP-10 performs instant quotations, commissions/dividends, percentage for taxes. The buffered keyboard, add mode, fixes and floating point notation, and the printer separator add up to making the new HP-10 the most powerful machine in its class.

**Keyboard features:** Paper advance, add to and subtract from memory, clear entry, clear all, print data, print separator, printer and/or display selector.

**Arithmetical:** percent, multiplication and division, subtraction, addition.

**HP-10 Specifications**

**Power:** 115 V ac (or 230 V ac) ±10%, 50 to 60 Hz.

**Size:** 40 H × 88 W × 165 mm L.

**HP-10 Business Printing Calculator**

\$175

**HP-22**

The HP-22 business management pocket calculator puts an ideal combination of financial, mathematical and statistical functions at your fingertips. With it, you can handle everything from simple arithmetic to complex time-value-of-money computations. You can even handle planning forecasting and decision analysis. And, you can approach business problems in a variety of ways to arrive at intelligent decisions and recommendations based on facts.

The HP-22 automatically calculates discounted cash flows; percentages; ratios; proportions; compound interest; remaining balance; annuities; depreciation; mean and standard deviation; rate of return; amortization and more.

**HP-22 Specifications****Pre-programmed functions**

**Financial:** time-value-of-money calculations involving  $n$  (number of compounding periods),  $i$  (periodic interest rate), PMT (payment amount), PV (present value of money), FV (future value of money); simple interest; accumulated interest between payment periods of a loan; remaining balance of a loan.

**Statistical:** mean and standard deviation; linear regression; linear estimate; summations giving  $n$ ,  $\Sigma x$ ,  $\Sigma y$ ,  $\Sigma x^2$ ,  $\Sigma xy$ .

**Percent:** %,  $\Delta\%$ , percent one number is of another; percent one number is of a total; markups; discounts.

**Other:** Ln;  $e^x$ ;  $y^x$ ;  $\sqrt{x}$ ; full register arithmetic.

**General**

**Memory:** 10 addressable registers; five financial registers; four-register operational stack.

**Display:** up to 10 significant digits with selective round-off to desired number of decimal places (0 to 9) in fixed-decimal notation; 8 significant digits plus two-digit exponent and appropriate signs in scientific notation; indicators for improper operations, low battery.

**Dynamic range:** 10 to 10 (200 decades).

**Power:** AC: 115 V, ±10%, 50 to 60 Hz.

**Battery:** 2.5 V dc nickel-cadmium rechargeable battery pack.

**Size:** 30 H × 68 W × 130 mm D (1.2" × 2.7" × 5.1").

**HP-22 Business Management Pocket Calculator**

\$125

**HP-27**

The HP-27 Financial/Statistical/Scientific Calculator is the most powerful preprogrammed pocket calculator Hewlett-Packard has ever built. Its highly sophisticated design effectively integrates financial, statistical, and scientific functions—thus elim-

inating the need for separate calculators. The versatility of the HP-27 will be extremely valuable to any businessman or engineer whose responsibilities extend into such areas as: targeting, budgets, cost analysis, financial and forecasting considerations, technical calculations.

**HP-27 Specifications****Pre-programmed functions**

**Financial:** time-value-of-money calculations involving  $n$  (number of compounding periods),  $i$  (periodic interest rate), PMT (payment), PV (present value of money), FV (future value); net present value; internal rate of return; percent, percent difference, and percent of total.

**Statistical:**  $\Sigma^+$  accumulates  $x$ ,  $y$ ,  $x^2$ ,  $y^2$ ,  $xy$ , and  $n$ ,  $\Sigma^-$  deletes unwanted data; linear regression; correlation coefficient; mean and standard deviation; variance; normal distribution factorials.

**Scientific:** Sin, Cos, Tan, Sin<sup>-1</sup>, Tan<sup>-1</sup>; Degrees, radians, and grads angular modes; Ln, e, log, 10<sup>x</sup>, y<sup>x</sup>, x<sup>1/x</sup>, 1/x, π, +, -, X, ÷, → H.M.S., → H, H.M.S.±; Coordinate conversion.

**General**

**Memory:** 10 addressable registers; five financial registers; four-register automatic memory stack; and a Last-X register.

**Clearing options:** clear the display; clear the stack; clear statistical registers; clear addressable registers; clear the status of the financial registers; clear the prefix keys.

**Display:** up to 10 significant digits in fixed-decimal notation; up to 8 significant digits plus 2-digit exponent in scientific or engineering notation (values are displayed with exponents that are multiples of 3); full display formatting in any mode with selective round-off; indicators for improper operations, low battery.

**Dynamic range:** 10 to 10 (200 decades).

**Power:** AC: 115 V, ±10%, 50 to 60 Hz.

**Battery:** 2.5 V dc nickel cadmium rechargeable battery pack.

**Size:** 30.2 H × 68.3 W × 130.2 mm L (1.2" × 2.7" × 5.1").

**HP-27 Financial/Statistical/Scientific**

\$175

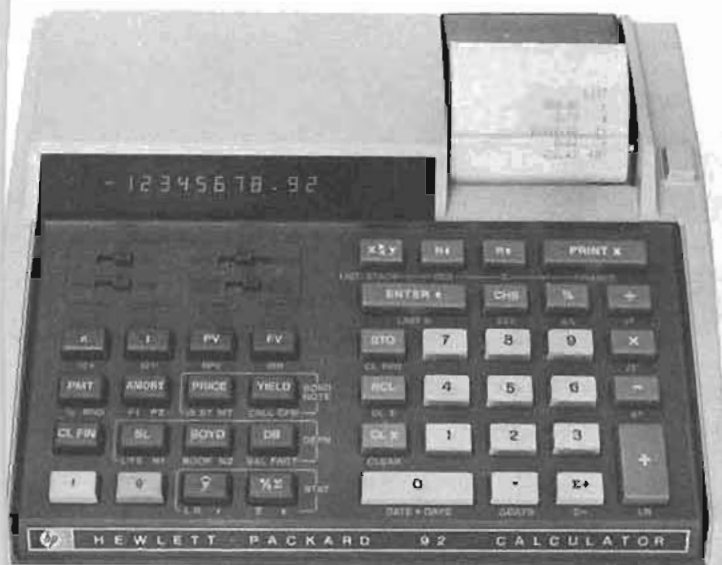

### HP-92

The new HP-92 Investor is a portable printing financial calculator for the person that must evaluate a large number of investment alternatives quickly, easily, and accurately. The HP-92 solves problems involving time and money: compound interest, balloons, discounted cash flow, bonds and notes, depreciation, net present value, internal rate of return. The flick of a switch engages the quiet thermal printer that provides an indispensable record of your calculations. 30 storage registers. Printing and clearing functions. And with all its powerful computational capability, the Investor fits into a standard-sized briefcase—an invaluable feature for the person on the go.

#### HP-92 Specifications

##### Compound Interest

- [n] — Stores or computes number of periods.
- [12X] — Converts number of periods from months to years.
- [i] — Stores or computes interest rate per compounding period.
- [12÷] — Converts interest from yearly to monthly rate.
- [PV] — Stores or computes present value (initial cash flow at the beginning of a financial problem).
- [FV] — Stores or computes future value (Final cash flow at the end of a financial problem).
- [PMT] — Stores or computes payment amount.

##### Discounted Cash Flow Analysis

- [NPV] — Computes net present value of future cash flows.
- [IRR] — Computes internal rate of return of series of up to 30 future cash flows.

##### Bonds and Notes

- [PRICE] — Stores or computes price of bond or note.
- [YIELD] — Stores or computes yield (percentage) of a bond or note.
- [IS, ST] — Stores the issue and settlement dates of bond or note for calculations.
- [MT] — Stores the maturity date of a bond or note.
- [CALL] — Stores the call price or redemption value of a bond or note.
- [CPN] — Stores the coupon amount (percentage) for bond or note calculations.

##### Depreciation

- [STL] — Calculates straight-line depreciation schedule.
- [SOYD] — Calculates sum-of-the-years' digits depreciation schedule.
- [DB] — Calculates declining balance depreciation schedule.

- [BOOK] — Stores book value of an asset.
- [LIFE] — Stores depreciable life of an asset.
- [SAL] — Stores salvage value of an asset.
- [N1] — Stores the starting year for a depreciation schedule.
- [N2] — Stores the ending year for a depreciation schedule.

##### Percentage

- [%] — Computes percent.
- [Δ%] — Computes percent of change between two numbers.
- [%Σ] — Computes percent one number is of a total.

##### Calendar

- 2000 Year Calendar — October 15, 1582 to November 25, 4046.
- [Date + Days] — Computes a future or past date from a given date and a fixed number of days.
- [Δ Days] — Computes number of days between dates.
- [g] [PRINT X] — For a given date, prints its day of the week.

##### Statistics

- [Σ+] — Automatically accumulates two variables for statistics problems:  $\Sigma x$ ,  $\Sigma y$ ,  $\Sigma x^2$ ,  $\Sigma y^2$ ,  $\Sigma xy$ , and number of terms.
- [Σ-] — Deletes statistical variables for changing or correction.
- [ $\bar{x}$ ] — Computes mean for x and y.
- [s] — Computes standard deviation for x and y.
- [L.R.] — Linear regression or trend line.
- [ŷ] — Linear estimate.
- [r] — Correlation coefficient.

##### Storage

- [STO] — Stores number in one of 30 storage registers. Performs storage register arithmetic upon 10 of the registers.
- [RCL] — Recalls number from one of 30 storage registers.

##### Printing and Clearing

- [AMORT] — Prints amortization schedule.
- LIST: — Prints all values for compound interest problems, bonds and notes.
- [PRINT X] — Prints contents of display.
- LIST: [STACK] — Prints contents of operational stack.
- LIST: [REG] — Together print contents of 30 addressable storage registers.
- [Σ] — Clears display.
- [CLX] — Clears financial functions for new problem.
- [CL FIN] — Together clear 30 addressable storage registers.
- [CLEAR] — Clears entire calculator—display, operational stack, all storage registers and financial functions.

##### Number Entry and Manipulation

- [ENTER ↑] — Separates numbers for arithmetic and other functions.
- [CHS] — Changes sign of displayed number or exponent.
- [x ↔ y] [R ↓] [R ↑] — Functions to manipulate numbers in operational stack.
- [EEX] — Enter exponent of 10.
- [RND] — Rounds actual number in display to number seen in display.
- [LAST X] — Recalls number displayed before last operation back to display.

##### Mathematics

- [y<sup>x</sup>] — Raises number to power.
- [e<sup>x</sup>] — Natural antilogarithm.
- [LN] — Natural logarithm.
- [√x] — Square root.
- [1/x] — Reciprocal.
- [+] [-] [×] [÷] — Arithmetic functions.

Power: AC: 115 or 230 V + 10%, 50 to 60 Hz.

Size: 63.5 H × 229 W × 203 mm D (2.50" × 9" × 8").

HP-92 Investor

\$625

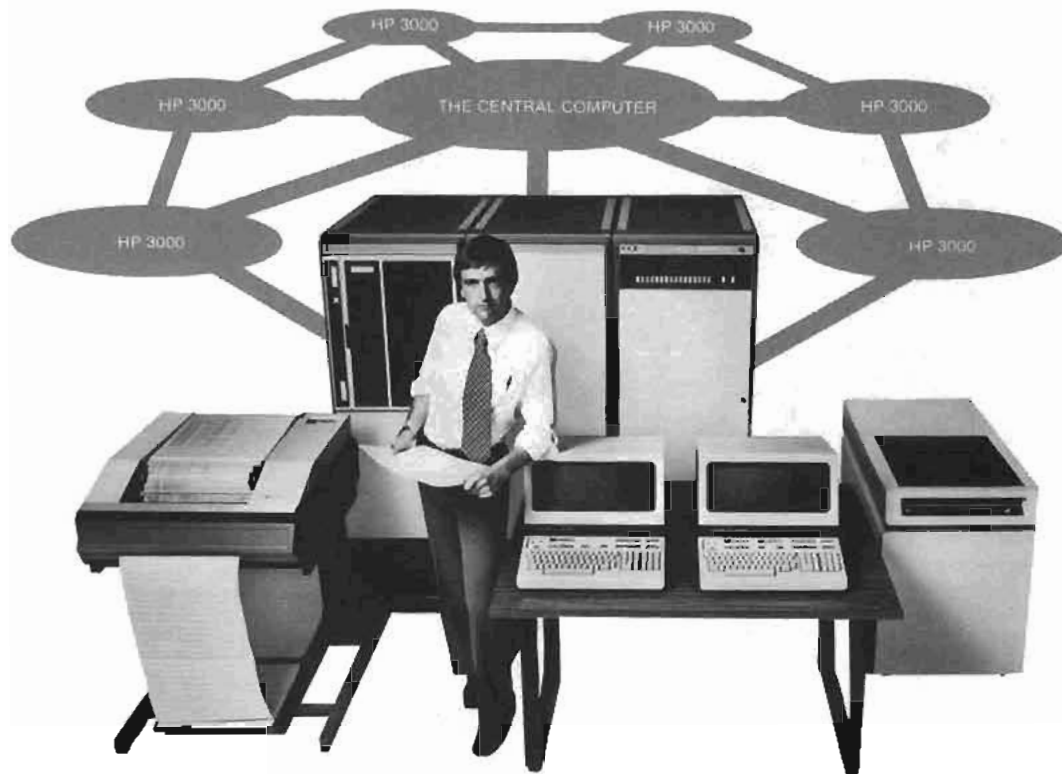

The system that makes it all seem simple: for efficient management, you should have a computer system that adapts to your EDP setup while handling those day-to-day departmental jobs you need to automate. The HP 3000 does precisely that. By forming a network of HP 3000s, each department can take care of its own workload and also share programs and data bases with the rest of the organization.

### Introduction

Hewlett-Packard has taken its place as a major supplier of computers and computer systems for companies of all sizes. The following pages contain a glimpse of these products. Equipment that lends itself readily to a catalog format, like terminals and desktop computers, is covered in more detail than larger, more sophisticated system-level products. Kindly consult your local HP sales office, or complete the enclosed reply card, for further information.

### Background

Hewlett-Packard entered the computation field by designing a minicomputer to interface with its measurement/test instruments. For the first time, customers could combine data gathering with data processing. HP computer products have since entered the business, industrial, scientific, and educational communities. Applications include computation, data management, information

retrieval, and measurement/test automation.

### HP 3000 Systems

The new HP 3000 Series II general-purpose computer system is a flexible, versatile addition to the product line. Coupled with the new Distributed System 3000 capability, HP 3000's have the ability to share data bases in a single network throughout your operation.

### HP 1000 Systems

Six different models form the HP 1000 family of upward-compatible computer systems. At their heart lie high-speed Z1MX-E processors. HP's RTE family of realtime software and IMAGE/1000 data base management software both run on HP 1000's. These systems handle tasks from scheduling to computer-aided design.

### Desktop computers

Hewlett-Packard offers another computer

advance in a line of desktop computers. Various memory sizes give you cost-effective computing power; integrated design with built-in processors and displays give convenience; and peripheral interface capability allows you to monitor production processes or quickly solve your technical or business problems.

The HP 9815A and 9825A afford stand-alone computation and system control capabilities. The new HP 9845A is a complete integrated systems with built-in cathode ray tube display and graphics capability. It also interfaces with as many as 14 peripheral devices simultaneously. It is the most powerful computer in our desktop line.

The HP 9896A Computation System is a compact, complete work station for information management. It is a viable computer system for small and medium-sized manufacturers, distributors, and service organizations, with capability to handle general accounting, payroll, statistical and engineering computations.





### CRT Display terminals

HP's computer product line is complemented by the 2640 CRT display terminal family. Speed, full editing capability, minicartridge mass storage, and high resolution display help account for their increasing popularity. The terminals appear in International as well as Domestic versions. Established as the industry standard for serviceability, these units are easily maintained because of plug-in boards and built-in self-testing circuitry.

### Customer value through product research

When purchasing HP computational equipment, you are assured of traditional value inherent in any Hewlett-Packard instrument.

To maintain this quality, the company consistently invests 10% of net income in research and development.

HP achievements include the first time-shared computer system based on a minicomputer and the first user-microprogrammable CPU from a major manufacturer. A recent innovation, the first minicomputer with all semiconductor memory from a major manufacturer, dramatically reduces CPU size, weight, power consumption, and cost, while improving speed and reliability.

### Computer value through experience

Hewlett-Packard has one of the world's largest installed customer bases. Over 20,000 HP computers are presently operating on every continent and in most countries. A world-wide network of sales and service offices support these installed bases.

### Customer value through support

Added customer support is provided by hardware and software training courses. Both maintenance and user-oriented courses are offered. And, video tape facilities successfully bring HP factory expertise to remote locations. Hewlett-Packard also supports a number of user groups with up-to-date information exchanges, periodic publications, and regional meetings.

### Customer value through quality control

For years, users in critical applications have specified Hewlett-Packard products because of respected reliability and environmental standards. This quality control can be traced partially to HP management practices. All HP quality assurance functions report directly to division management. This means that any product inadequacies receive top priority, and products that fail to meet tough standards are not shipped until they do!

## HP 3000 Systems

Applications for HP 3000 Computer Systems encompass the full range of data processing tasks. For many small-to-medium companies an HP 3000 handles the entire data processing load, from inventory control, to engineering design, sales order entry, payroll, and personnel records. Larger, multidivisional corporations tie a number of HP 3000s to a host computer and to each other to form a network and distribute computing power throughout the company.

Key features of the HP 3000 include a powerful operating system (MPE), concurrent batch and interactive processing, full data management facilities, and six programming languages, plus networking software for Series II models.

Series I systems offer the traditional HP 3000 features, except networking capabilities, at an exceptionally low cost. They have a standard 128 kb memory (non-expandable) and may be upgraded at the customer's site to a Series II. Prices start at \$75,000 for the Series I Systems.

Two standard Series II configurations are available—Models 6 and 8. The basic difference between the two models is in the size of the memory. Model 6 has a 128 kb main memory which is expandable to 256 kb. Model 8 features a 320 kb memory (expandable to 512 kb) which gives it increased performance capabilities. At any time, Model 6 may be upgraded to a Model 8 with no applications software changes required. Every HP 3000 can be augmented from a full selection of line printers, card readers, terminals, discs, interactive CRT terminals, and other peripherals. Prices start at \$110,000 for the Series II Systems.

## HP 2026 Systems

The HP 2026 is a low cost system dedicated to remote source data entry and data communications. Corporations wishing to link geographically separated divisions find the HP 2026 an outstanding system for establishing a regional, national, or worldwide communications network. With an HP 2026 at each company location, communications between them is effected over either leased or voice-grade lines. Prices for the HP 2026 start at \$38,500.

**COMPUTATION**

Dedicated real-time computer systems

HP 1000 Systems

- Computation
- Instrumentation
- Operations management



HP 1000 Model 20 Computer System with HP-IB Instruments and optional Flexible Disc

The HP 1000 family now includes two new memory-based systems, Models 20 and 21, offering efficient computation and instrument control capabilities at a lower entry-level price than the disc-based HP 1000 Model 30, 31, 80, and 81 Computer Systems.

### Computation

HP 1000 Systems use HP's powerful 21MX E-Series Computer, which delivers performance formerly achieved by computers two to three times its price. Standard instructions support floating point computations; integer multiply and divide; byte moves and scans; and word, byte, and bit manipulation. I/O transfers run at rates to 2.28 million bytes per second. Optionally, memory management instructions provide flexible access to as much as 1.7 million bytes of highly-reliable semiconductor main memory by processor and I/O channels alike. Fault control is available with standard memory to enhance its already excellent reliability 3-fold or more.

Optional high performance memory with 350 ns cycle time offers up to 30% performance increase over standard memory. Further performance increases may be achieved by microprogrammed sub-routines, such as those in HP's fast Fortran processor, which run 2 to 20 times faster than the same routines in software. In the disc-based HP 1000 Systems, the user can also develop his own performance-boosting microprogrammed routines with the aid of the optional RTE microprogramming package, test them in writable control store, and prepare tapes to burn PROMs for permanent installation in the computer. The resulting microprogrammed routines can be used in any of the HP 1000 Systems.

Through microprogramming, the user also gains access to a microprogrammable processor port, which can provide direct access by special processors to the E-Series 11.4 million byte per second internal bus.

## Instrumentation

**HP-IB Instrument Clusters** In addition to their computational capabilities, HP 1000 Systems are well-suited for control and interaction with HP-IB (Hewlett-Packard Interface Bus) instruments and devices. Up to 14 HP-IB devices can connect to the system via a single interface card, and multiple automatic test or measurement station instrument clusters can be controlled by the HP 1000 System via multiple HP-IB interfaces. Including the new 2240A Measurement and Control Processor (page 576), more than 100 different HP-IB test and measurement instruments are now available from Hewlett-Packard and 22 other manufacturers.

**Measurement and Control Stations** The HP 1000 Systems can also perform measurement and control functions via the 9611R Measurement and Control Stations, which offer medium-speed local or remote low-level and high-level analog I/O and isolated digital I/O capabilities. Simplified screw-terminal connection is available.

**Plug-in analog I/O Subsystem** For smaller analog input needs, the HP 1000 Systems can also use the 91000A Plug-In Analog-to-Digital Interface card with a capacity of 16 single-ended or 8 differential  $\pm 10.24$  V fs analog inputs.

**Digital Test Stations** For automatic digital testing, any of the disc-based HP 1000 Systems can function as the controller of up to three 9571A Digital Test Stations in a DTS-70 Digital Test System.

## Operations management

For data intensive operations management applications involving test records, order entry, inventory control, or factory data collection, the full data base management capability of IMAGE/1000 is provided in the HP 1000 Model 80 and 81 Systems, and can be added to the Model 30 and 31 Systems. This data base management system provides all necessary tools for building, maintaining, and restructuring a true data base of information required for operations management. Once established, the IMAGE/1000 data base can be accessed by multiple users with QUERY, an English-like inquiry language that simplifies information retrieval and report generation.

## Six models to choose from

**Model 20** Includes 2113B Computer with 64k bytes of main memory and a 2645A Display Station as system console, with dual mini cartridge I/O as standard input/output unit. Optional flexible disc adds full program development and file management capabilities. The system is supplied in an attractive desk-style work station. Its operations are managed by the powerful, flexible memory-based RTE-M operating system.

**Model 21** Functionally identical to the Model 20, the Model 21 is supplied in a single upright rack cabinet, which provides more space than the desk for rack mounting of additional equipment.

**Model 30** Provides same equipment as Model 20 in desk style cabinet, plus 14.7M byte cartridge disc subsystem in matching disc minirack. Its operations are managed by the disc-based, foreground-background RTE-II operating system; the multi-partition RTE-III operating system is optional.

**Model 31** Functionally identical to Model 30, but supplied in a single upright rack cabinet, which provides more space than the desk plus minirack for rack mounting of additional equipment. Offers a choice of 14.7M byte disc or lower priced 4.9M byte disc.

**Model 80** Designed for data base management applications, the Model 80 includes all equipment supplied with the Model 30, plus line printer and magnetic tape subsystems. The Model 80 comes with 128k bytes of main memory and the IMAGE/1000 data base

management system and is managed by the RTE-III operating system. A desk-style workstation is provided for the computer and the system console and a single upright cabinet houses the 14.7M byte disc and the magnetic tape drive.

**Model 81** Functionally identical to Model 80, but supplied in two upright rack cabinets that provide more space than the Model 80 for rack mounting additional equipment.

## HP 1000 Systems summary

HP 1000 Models	20	21	30	31*	80	81
Base Memory (bytes)	64k	64k	64k	64k	128k	128k
Max. Memory (bytes)	1024k	1792k	1024k	1792k	1024k	1792k
Cabinet	Desk	Rack	Desk	Rack	Desk-Rack	Rack
<b>Peripherals</b>						
System console	std	std	std	std	std	std
Add'l terminals	opt	opt	opt	opt	opt	opt
Cartridge disc			std	std	std	std
Top loading disc			opt	opt	opt	opt
Flexible disc	opt	opt	opt	opt	opt	opt
Mag tape unit	opt $\Delta$	opt $\Delta$	opt $\Delta$	opt $\Delta$	std	std
Line printer	opt	opt	opt	opt	std	std
Punched tape I/O		opt		opt		opt
Card reader	opt	opt	opt	opt	opt	opt
TV interface	opt	opt	opt	opt	opt	opt
Analog I/O	opt	opt	opt	opt	opt	opt
Digital I/O	opt	opt	opt	opt	opt	opt
Disc storage (bytes)	0.5M	0.5M	14.7M	14.7M	14.7M	14.7M
Max. storage (bytes)	2M	2M	365M	365M	365M	365M
Avail. I/O channels	12	12	11	11	8	8
Max. Av. I/O chan.	12	28	11	27	8	24
<b>Operating systems</b>						
RTE-M	std	std				
RTE-II			std	std		
RTE-III			opt	opt	std	std
<b>Program languages</b>						
BASIC	std	std	opt	opt	opt	opt
Fortran II	0	0	std	std	std	std
Fortran IV	0	0	std	std	std	std
HP Assembly	0	0	std	std	std	std
<b>Additional software</b>						
IMAGE/1000			opt	opt	std	std
Microprogram dev.	L	L	opt	opt	opt	opt

\*Model 31 can also be ordered with lower cost 4.9M byte disc, expandable with additional drives to 14.6M byte storage.

$\Delta$ Requires additional cabinet.

0=flexible disc required for program development; E=execute only; L=WCS Loader and driver are only microprogramming support in Models 20 and 21.

## Ordering information

	Price
HP 1000/20 Computer System (2173A)	\$21,000
HP 1000/21 Computer System (2174A)	\$22,000
Flexible disc for Model 20/21 (2173A/74A Opt 032)	\$ 4,500
HP 1000/30 Computer System (2172A)	\$36,500
HP 1000/31 Computer System w/4.9M byte disc (2170A)	\$31,500
HP 1000/31 Computer System w/14.7M byte disc (2171A)	\$36,500
HP 1000/80 Computer System (based on 2172A)	\$61,700
HP 1000/81 Computer System (based on 2171A)	\$62,700

## COMPUTATION

## Measurement and Control Computer Interface

Models 2240A, 9600 and 91000 Series

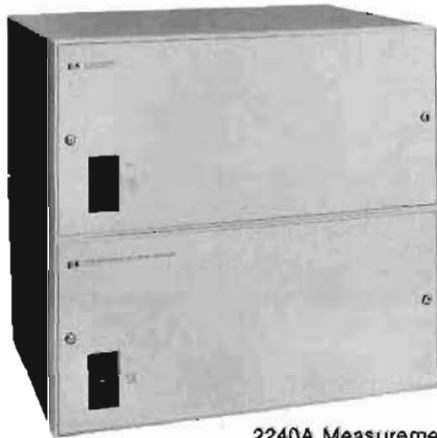

2240A Measurement and Control Processor



HP-IB

**2240/2241A Measurement and Control Processor**

The microprocessor-based HP 2240A Measurement and Control Processor provides 128 channels of both analog and digital input/output signals, with interrupt handling for complete measurement and control capability in one unit. The HP 2241A Extender adds up to 128 channels to extend the capability to a total of 256 I/O points. The microprocessor intelligence of the 2240A enables it to execute computer-independent, real-time tasks delegated from the controller. A powerful command set, tailored for measurement and control applications, is built into the 2240A to simplify and reduce programming. Programming of complete tasks can be done in BASIC, FORTRAN, HP Assembly or HPL languages via the HP-IB.

The 2240A can be used with a HP 9825A Desktop Computer for stand-alone benchtop operation or with the HP 1000 Computer System as part of a production testing or facility monitoring station. Multiple 2240A test stands can be added via the HP-IB as part of a distributed measurement and control network. You can remote the 2240A up to 1000 meters over a single twisted pair of wires, or delegate tasks over phone lines with the HP 59403A HP-IB/Common Carrier Interface and industry standard modems.

A variety of measurement and control function cards is available for the 2240A/2241A:

- **22900A Analog Input Card** \$1,600  
32 single-ended or 16 differential channels,  $\pm 10$  V, 12 bits including sign, 20 kHz sample/scan rate. Auto correction for gain and offset temperature drift.
- **22901A Analog Output Card** \$900  
4 channels, 0 to 10 V or -10 V to +10 V output, 10 bits with dual level storage. Auto readback from first level. 4-lead remote sense (Kelvin) connections.
- **22902A Digital Input Card** \$310  
32 channels, TTL or CMOS levels.
- **22903A Common Interrupt Card** \$450  
16 channels, TTL or CMOS levels, individual channel enable and transition direction, interrupt test.
- **22904A Digital Output Card** \$480  
32 channels, TTL or CMOS, open-collector output, dual level storage, auto readback, level or pulse outputs.
- **22905A Counter/Stepper Motor Card** \$800  
4 channels for event counting, frequency or period measurement, or stepper drive output. Internal self-test clock, TTL compatible.

**22920A Signal Conditioning Tray**

The HP 22920A Signal Conditioning Tray is a separate structure that provides maximum isolation for the 2240A Measurement and Control Processor from high voltage inputs and electrical noise.

Each 22920A holds one signal conditioning card, with provision for field wiring (14-22 AWG) connection to 56 screw terminal connectors. Signal conditioning cards available for the 22920A are:

- **22912A Relay Output Card** \$290  
16 channels, 2 amperes, 125 VAC/DC, 60 VA rating, Form-C (SPDT) hermetically sealed relays.
- **22913A Isolated Digital Input Card** \$430  
16 channels, 5 to 120 VDC and 16 to 230 VAC with selectable response times and overload fuses.
- **22914A General Purpose Breadboard Card** \$130  
16 channels for analog/digital, input/output signal conditioning. Pad layouts for user-installed signal conditioning components such as amplifiers, relays, filters, fuses, resistors and voltage regulators.

**9611R Remote Measurement and Control Station**

The HP 9611R is an industrial measurement and control station for computer-based measurement and control applications where digital and analog input/output lines to machine/process sources, control actuators, and indicator panels are some distance, up to 3 km (10,000 feet), from the computer. The 9611R accepts from 16 to 496 analog inputs and from 12 to 900 digital I/O signal lines, with signal conditioning options to meet a wide variety of conditions encountered in industrial measurement and control applications. The 9611R can be used with HP 2100S or HP 21MX/E computers, or HP 96MX or HP 1000 series Computer Systems, and includes a one-bay cabinet, a 91063A Digital I/O Subsystem, a 62005A 5 VDC, 2A Power Supply, and provisions for screw-terminal connection assemblies for field wiring from transducers/control actuators.

**2313B Analog I/O Subsystem**

The HP 2313B Analog I/O Subsystem consists of control, sampling, and analog-to-digital conversion modules in a mainframe designed for rack-mounted operations with HP 2100S or HP 21MX computers, or HP 96MX or HP 1000 series Computer Systems. The subsystem I/O capacity is expandable to 528 differential analog inputs or 44 analog outputs, or combinations of inputs and outputs.

**Plug-In Subassemblies**

Individual measurement and control interfaces are contained on plug-in subassembly cards for HP 2100 and HP 21MX computers:

- **91000A Analog-to-Digital Interface Subsystem** \$2,275  
A complete  $\pm 10.24$  V fs analog input subsystem, including interface and control logic, sample and hold amplifier, ADC, and input multiplexer.
- **12551B 16-Bit Relay Output Register** \$550  
Provides 16 floating contact closures for controlling 1 to 16 devices and optional readback circuitry for data verification.
- **12930A Dual-Channel Universal Interface** \$850  
16-bit input/16-bit output plus control and status data. Choice of differential or TTL logic. Up to 1 million 16-bit words.
- **12555B Digital-to-Analog Converter** \$600  
Provides two analog outputs ranging between 0 and +10 volts, 8-bit resolution.
- **12556B 40-Bit Register** \$650  
40-Bit (10 BCD digit) capacity for driving program input lines, choice of ASCII or binary output modes.
- **12604B Data Source Interface** \$875  
32-Bit (8 BCD digit) capacity, accommodates logic levels between -100 V and +100 V.

**Ordering information**

	Price
2240A Measurement and Control Processor	\$2,750
2241A Extender	\$1,500
22920A Signal Conditioning Tray	\$165
9611R Remote M&C Station	\$10,900
2313B Analog I/O Subsystem	\$6,950

**8542B Automatic Network Analyzer**

The HP 8542C Automatic Network Analyzer is a precision phase and amplitude measurement system used to measure complex of transfer functions, to 18 GHz, in order to characterize components or circuits. The 8542C achieves high accuracy by calibrating with precision standards to characterize, store, and correct for systematic errors—mismatch, directivity, crosstalk, and frequency response errors are thus removed. The 8542C is supplied with a complete set of ready-to-run Microwave Applications Programs (MAP), and with a BASIC language interpreter containing high-level microwave measurement instructions.

**8580C Automatic Spectrum Analyzer**

The HP 8580C Automatic Spectrum Analyzer measures absolute frequency and characterizes mixers, doublers, and other frequency conversion devices to 18 GHz. It is also a valuable tool for gathering spectral data on signals present in complex electronic equipment or in a geographic region.

The 8580C Option 400 is an automatic receiver system (ARS-400) that provides signal monitoring, detection, and analysis in the 100kHz to 18 GHz frequency range. The receiver system is used in a variety of applications including spectrum management, system monitoring, electronic intelligence, electromagnetic interference and site surveillance.

**DTS-70 Digital Test System**

The DTS-70 Digital Test System is designed for high throughput production testing and fast, accurate fault location of loaded digital printed circuit boards. The system is versatile in that it can be used concurrently for test program generation, multi-station production testing and manufacturing data management tasks — all on a single system computer.

The DTS-70 is comprised of three basic elements: a multiprogramming computer system, a 9571A Digital Test Station, and the 91075B TESTAID-III test generation software.

- The recommended DTS-70 System controller is the HP 1000 Computer System. It offers extremely fast processing speeds, up to 608K bytes of main memory. Real Time Executive (RTE) operating system software, and multiple terminal operation. Other HP computers, HP 2100 and 21MX series, together with a HP 7900A or 7905A Disc Memory can be used as the DTS-70 controller when configured for the RTE operating system software.
- The 9571A Digital Test Station is capable of testing TTL, CMOS, and mixed logic families. It can test large PC boards, up to 200 MSI IC's and 360 test pins, with production-oriented test fixture and test adapters for simple operation and high test pattern rates for maximum throughput. Computer assisted guided probing gives high accuracy fault isolation, and test results are automatically printed out on hard copy.
- 9107B TESTAID-III Test Generation Software is an advanced software simulator that enables comprehensive test program generation economically for large and complex digital PC boards. Modeling tools include an extensive device library (over 1000 IC's) and 15 primitive elements (ROM's RAM's shift registers, etc.). There are three methods of generating input stimulus patterns — automatic path-sensitization, pseudo-random patterns, and manual techniques.

**Switch Products For Automatic Test Systems**

New HP-IB switch products are used in HP automatic test systems and are available individually for those Automatic Test Equipment (ATE) builders who manufacture their systems in-house and other ATE users who have complex switching requirements in their automated test setups. The new switches provide a commercially available solution to one of the most important parts of an ATE system—connecting the system to the unit-under-test (UUT). Three types of switching units are available, all controlled by a



Switch Products Installed in an Automatic Test System

single 9411A Switch Controller that provides microprocessor control of up to 8 switch mainframes.

New HP-IB switch products are also available individually.

**9411A Switch Controller** \$2,350

The 9411A provides control signals and relay power for other switching units. The 9411A is controlled by the automatic test system computer via the HP-IB, and in turn provides control logic for up to eight switching units and +12.5 VDC (4A maximum) relay power for up to four switching units. Internal firmware in the 9411A enables it to perform a comprehensive self-test and fault isolation of all signal relays in the 9412A and 9414A switching units.

**9412A Modular Switch** \$10,000 to \$35,000

The 9412 provides high-density, multi-function switching of signals up to 10 MHz for automatic test equipment. A built-in 1768-pin (34 x 52 matrix) interface panel significantly improves signal performance and eliminates the "spider web" cabling found in other ATE switching configurations. The 9412A accommodates five types of switchcards in any combination up to a total of 25 cards.

**9413A VHF Switch** \$2,000 to \$7,000

The 9413A provides modular, flexible high-frequency switching of pulse and video signals up to 500 MHz for automatic test equipment. The 9413A accommodates up to 12 coaxial switch modules.

**9414A Matrix Switch** \$5,000 to \$30,000

The 9414A provides maximum flexibility in switching of signals up to 10 MHz for automatic test equipment. The unit is designed for high-density, high-performance switching in a modular package that allows any UUT pin to be switched to any instrument in the ATE system. The 16-input matrix switch can be configured in 30-pin increments (UUT pins) up to 120 pins. A distribution bus capability allows the sharing of up to four of the 16 matrix inputs with multiple measurement instruments.

**Ordering information** **Price**

8542B Automatic Network Analyzer	\$200,000
8580B Automatic Spectrum Analyzer	\$150,000-\$250,000
9571A Digital Test Station	\$24,000
91075B TESTAID-III Test Generation Software	\$15,000

## COMPUTATION

A high performance family

21MX Series

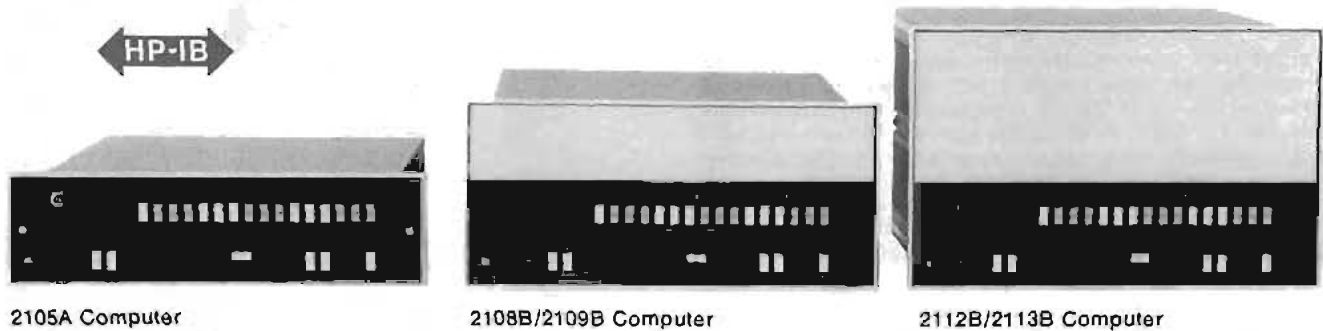

2105A Computer

2108B/2109B Computer

2112B/2113B Computer

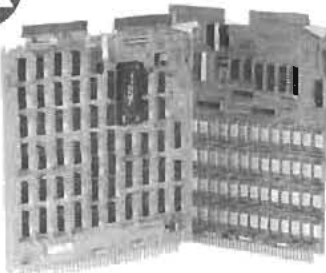

12747A 128k byte jumbo memory (right) with 2102B std performance memory controller

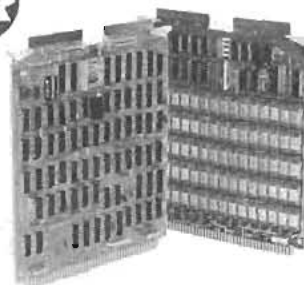

2102C Error correcting memory controller (left) and 12779A and 12780A 512k byte check bit array boards

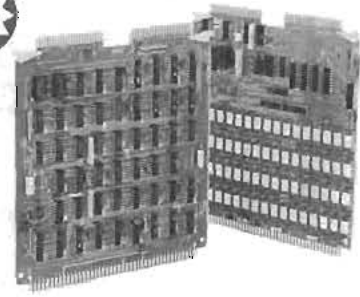

2102E High performance memory controller (left) and 12741A 350 ns 32k byte memory module

The Hewlett-Packard 21MX family of computers is based on an architecture proven successful in over 16,000 installations, and provides the flexibility and power required to satisfy a wide variety of computing needs.

The 21MX family ranges from the economical M-Series for cost-critical computer applications to the new high-performance E-Series for applications that require extremely fast processing speeds. And, for high-volume, specialized applications, there is the K-Series of computer components. Because the entire 21MX family uses the same instruction set and interfacing logic and electronics, the user can change models with minimal effect on software, peripherals, service, training, and spares provisioning.

### 21MX M-Series

Building on a successful heritage that includes the HP 2100A computer, the M-Series puts the power of the 21MX architecture in an economical package. It includes the HP 2105A, 2108B, and 2112B Computers, which offer a range of memory capacities from 64 to 2048k bytes (using the new 128k byte jumbo memory modules and a memory extender), and I/O capacity from 4 to 14 I/O channels (up to 46 I/O channels with two I/O extenders). Most of the features needed in computer systems—memory parity, extended arithmetic, floating point instructions, and a full front panel—are included at no extra cost. Memory expansion, fault control (error correcting) memory, and special processors required for more specialized uses are offered as reasonably priced accessories.

### 21MX E-Series

The 21MX E-Series combines the same powerful instruction set and I/O structure as the rest of the 21MX family with a central

processing unit nearly twice as powerful as the M-Series. In addition to variable microcycle timing and streamlined instruction set micro-routines for faster execution, microprogrammable block I/O, a microprocessor port, asynchronous memory and a much larger control store address space for the user further enhance the flexibility, power, and growth potential of the E-Series as compared with other members of the 21MX family. Asynchronous memory accommodates standard and fault control memories and the new 350 ns high-performance memory, which provides up to 30% additional improvement in performance. E-Series computers are available in two models, HP 2109B and 2113B, with a choice of maximum mainframe memory capacities from 640 to 1280 k bytes and 9 or 14 I/O channels

### Extension of memory and I/O capacities

A memory extender supports enough additional memory modules to nearly double mainframe capacity of the largest 21MX computer. I/O extenders can increase I/O capacity of any of the 21MX computers by 32 channels.

Computer model	2105A	2108B	2112B	2109B	2113B
Panel height (inches)	5.25	8.75	12.25	8.75	12.25
Series	M	M	M	E	E
Max. mainframe memory	64kb	640kb	1280kb	640kb	1280kb
Memory extender capacity	N.A.	1152kb	768kb*	1152kb	768kb*
Mainframe I/O channels	4	9	14	9	14
I/O Chan w/one extender	20	25	30	25	30
I/O Chan w/two extenders	36	41	46	41	46

\* 21MX computers with dynamic mapping can address a maximum of 2048k bytes of memory.

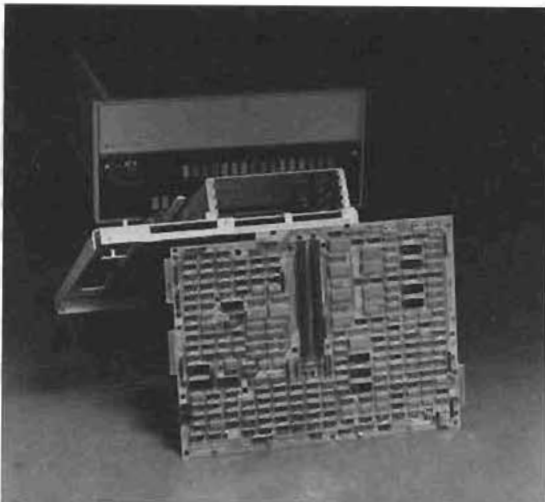

### K-Series computer components

For high-volume applications that require the processing power of a minicomputer at lower unit costs, the K-Series makes major sub-assemblies of the M-Series available in component form. The 2108K processor board, for example, is far more powerful than a micro-computer, but only slightly higher in cost. With it, the user has a high-performance 24-bit microprocessor with 211 instructions and a very fast 325 ns cycle time. Adding a 21MX instruction ROM converts the 2108K to a full "computer-on-a-board" that is fully compatible with the 21MX standard and fault control memory systems, I/O subsystems, software, and peripherals.

### Microprogramming accessories

#### Fast Fortran Processor

The fast Fortran processor provides firmware microcode for over a dozen instructions—four-word precision operations, two-and three-dimensional array processing, and other commonly-used routines previously written in Fortran—that run 2 to 20 times faster than software execution speed.

#### User Microprogramming Capabilities

Two new accessories are offered for installation of user-developed microprograms. For microprograms under development or that are swapped to and from disc during operations, there is a 1024 (24-bit) word writable control store module. There is also a 2048 (24-bit) word user control store board for user's microprograms that have been "burned" into PROMs for permanent use. These capabilities, which provide access to additional high-speed registers, are software supported by a real-time microprogram development package.

### New memory capabilities

Memory capabilities available with 21MX computers now include new 128k byte jumbo standard performance memory modules, making possible up to 1280k bytes in the mainframe of the largest 21MX computers. New fault control memory controller and check bit array boards offer an MTBF improvement of 3 times or greater over the already excellent reliability of HP's standard semiconductor memory systems. And new high-performance memory boosts E-Series computer speed up to 30%.

21MX computer series	Memory Speed	
	M	E
Standard memory	650 ns	595 ± 35 ns
Standard memory w/dynamic mapping	650 ns	665 ± 35 ns
Fault control	650 ns	630 ± 35 ns
Fault control memory w/dynamic mapping	650 ns	700 ± 35 ns
High performance memory	N.A.	350 ± 35 ns
High performance memory w/dynamic mapping	N.A.	420 ± 35 ns

### New memory expansion packages

New memory expansion packages offer various increments of standard, high performance and Fault Control (F/C) memory along with the dynamic mapping system required for expansion beyond 64k bytes at attractive package prices.

#### Ordering Information

Ordering Information	Price
2105A Computer	\$4100
2108B Computer	\$5300
2112B Computer	\$6200
2109B Computer	\$5850
2113B Computer	\$6850
12990B Memory Extender	\$3500
12979B Dual-Port I/O Extender	\$4500
2108K Microprogrammable Processor	\$1475
12977A (M-Series) Fast Fortran Processor	\$950
13306A (E-Series) Fast Fortran Processor	\$650
13197A Writable Control Store	\$2000
13047A User Ctrl Store board for user-added PROMs	\$550
2102B Standard Memory Controller	\$600
12998A 16k byte Memory Module	\$750
13187B 32 byte Memory Module	\$1600
12747A 128k byte (jumbo) Memory Module	\$6400
2102C Fault Control Memory Controller*	\$600
12779A 256k byte Check Bit Array Board	\$2750
12780A 512k byte Check Bit Array Board	\$5000
2102E High Performance Memory Controller	\$600
12741A 32k byte High Performance Memory Module	\$2100
12763A 64k byte Std Memory Exp Package (M-Series)	\$3500
12763B 128k byte Std Memory Exp Package (M-Series)	\$6400
12763C 192k byte Std Memory Exp Package (M-Series)	\$9300
12766A 64k byte Std Memory Exp Package (E-Series)	\$3500
12766B 128k byte Std Memory Exp Package (E-Series)	\$6400
12766C 192k byte Std Memory Exp Package (E-Series)	\$9300
12767A 64k byte High Perf Memory Exp. Package	\$4500
12767B 128k byte High Perf Memory Exp. Package	\$8400
12767C 192k byte High Perf Memory Exp. Package	\$12300
12782A 128k byte F/C Memory Package (M-Series)	\$9000
12782B 256k byte F/C Memory Package (M-Series)	\$15000
12782C 512k byte F/C Memory Package (M-Series)	\$29000
12782D 1024k byte F/C Memory Package (M-Series)	\$51200
12783A 128k byte F/C Memory Package (E-Series)	\$9000
12783B 256k byte F/C Memory Package (E-Series)	\$15000
12783C 512k byte F/C Memory Package (E-Series)	\$29000
12783D 1024k byte F/C Memory Package (E-Series)	\$51200

\*Fault control memory controller works with 12998A, 13187A/B, and 12747A Memory Modules, but not 12741A High Performance Memory Modules.



9815A



### 9815A

The 9815A features a built-in high speed data cartridge, a 16-character alphanumeric thermal printer, an auto-start switch, programming keys that double as Special Function keys, and two optional I/O channels. These capabilities can be used in four basic ways:

**1. Quick keystroke calculations:** 28 built-in scientific functions, the powerful Reverse Polish Notation Logic System also used by the HP pocket calculators, a buffered keyboard, large display, and readable permanent printout provide you with advanced problem solving at your fingertips.

**2. Dedicated problem solving:** Hewlett-Packard offers several software packages with a prerecorded cartridge, Special Function key overlay, and easy-to-follow instructions for each program. Set the switch to auto-start, slip in the cartridge, put the overlay in place, and turn on the 9815A. The first file will be automatically loaded and the program executed. The tedious set-up work is done for you.

**3. Programmable problem solving:** the standard 9815A has 472 program steps and ten data registers and can be expanded to 2008 steps. The memory can be allocated by you into any combination of program steps and data registers you wish. The programming language includes such sophisticated features as FOR-NEXT loops; symbolic, absolute or calculated addresses; automatic address updating during editing; descriptive error messages; and subroutines nested to seven deep. The 9815A has the programming power and memory flexibility to handle many of your most complex computational problems.

**4. Interfacing:** the 9815A has seven interface cards. The HP 98110A is an interface card for the 9872 Plotter, the HP 98131A is a 9871A Character Impact Printer Interface Card and the HP 98132A is an interface card for the 9862A Plotter. The HP 98133A BCD I/O accommodates 9-digit BCD input with high-speed mode and 8-bit parallel output. The HP 98134A General I/O is a bidirectional 8-bit parallel interface which enables the user to connect it to the 9800 Series desktop computers. The 98135A HP-IB I/O will accept up to 14 HP-IB interconnected instruments. The 9815A can be used to control the data flow to and from the instruments, gathering and processing that data simultaneously. The HP 98134A Serial I/O provides RS-232-C compatibility as well as 20 mA and 60 mA current-loop, receive-only options.



9825A



### 9825A

The 9825A Desktop Computer, designed principally for use in engineering, research and statistics, has many features previously found only on minicomputers. It is a powerful stand-alone device and is particularly suited to controller applications.

Significant contributions include two-level priority interrupt, live keyboard, direct memory access with input speeds up to 400k 16-bit words per second, high-performance bidirectional tape drive, multidimensional arrays, automatic memory record and load, and extended internal calculation range ( $\pm 10^{311}$  to  $\pm 10^{-321}$ ). Some of these are standard features and others are available in optional plug-in read-only memories (ROMs).

HPL, a high-level, formula-oriented language, is easy to learn and is designed for controller applications as well as for data processing. HPL provides for subroutine nesting and flags and allows 26 simple variables and 26 multidimensional array variables, limited only by the size of 9825A's memory. Editing of lines and characters is simple, and error locations are identified by a flashing cursor in the display. Fixed- and floating-point formats can be set from the typewriter-like keyboard.

The keyboard has twelve Special Function keys that, combined with the shift key, can handle 24 different operations. These keys help in program writing and in peripheral and instrument control. They can serve as immediate execute keys, as call keys for subroutines, and as typing aids.

With the live keyboard, never before found on a desktop computer, the user can examine and change program variables, perform complex calculations, call subroutines, and record and list programs while the 9825A is performing other operations.

Interrupt capability, available in the Extended I/O ROM, permits the 9825A to act as a controller for several instruments or peripherals requiring attention at unpredictable rates or times.

A 32-character LED display and a built-in 16-character thermal printer provide alphanumeric readout including both capital and lower-case letters. Some European and Greek characters are also available in an optional ROM.

The high-speed bidirectional data cartridge holds 250k bytes of information and has an average access time of 6 seconds to any place on the tape. Bidirectional search speed is 2286 mm/s (90 in./s), and read/write speed is 559 mm/s (22 in./s). The entire memory can be recorded on the cartridge for reloading at a later time. Verification of files is automatic on recording.

**Ordering information**  
9815A Desktop Computer  
9825A Desktop Computer

**Price**  
\$2900  
\$5900





HP-IB 9830A/B



9880B

### 9830A/B

The Hewlett-Packard 9830 is a general purpose desktop computer, designed for a wide range of applications.

The language of the 9830 is BASIC. This easy-to-use language couples simplicity with power and appeals to the new desktop computer owner as well as the experienced programmer. The 9830 automatically inherits a comprehensive range of proven software packages, including finance, mathematics, statistics, and education.

A minimum 9830A provides 3 520 8-bit bytes (1 760 words) of user read/write memory. This can be expanded to 15 808 bytes (7 904 words). In addition, the user can select from a wide range of read-only memory (ROM) plug-in blocks for increased computational capability or peripheral control, or both. The 9830A allows up to 16k bytes of add-on ROM for a total of eight plug-in blocks.

The 9830B has 15 808 8-bit bytes (7 904 words) user read/write memory, expandable to 30 144 bytes (15 072 words). Matrix operations and string variables are built in, and six additional ROM blocks are available.

A broad range of peripherals is available with either the 9830A or 9830B to allow the user maximum flexibility in putting together that specific system required to solve particular problems.

The result is a cost-effective system that can meet your data handling problems today and continue meeting them as your needs expand.

### Features

- Alphanumeric keyboard
- 32-character LED display
- Built-in tape cassette
- BASIC language
- 12 significant digits
- Full trigonometric capability
- Boolean algebraic capability
- Expandable user memory
- Add-on read-only memories (ROMs)
- Formatted output
- Broad range of peripherals available

### Programming in BASIC

The 9830 is programmed in BASIC, a formal, interactive language similar to FORTRAN. Depending on your needs, you may choose to do all your own programming. If you've already been working with BASIC, you can, with minor modifications, use your existing program. Since BASIC is a standard computer language, you will find there are many programs already written and available at nominal cost.

### 9880B Mass memory subsystem

The HP 9880B Mass Memory Subsystem supplies the HP 9830A and 9830B with the substantial data storage required for such industrial, scientific, and commercial applications as structural design, statistical analysis, payroll, account maintenance, inventory control, patient records, and credit verification.

The memory media of this peripheral are a permanently installed memory platter and an interchangeable cartridge (HP 12869A), each having a capacity of 2.4 million bytes; this is the equivalent of more than 600 000 total items of data of twelve digits each.

One of the main advantages of this system is data safety and security. Master data can be recorded on the removable cartridge, transferred into the 9830A for manipulation, stored temporarily on the fixed memory platter for further use by the program, and modified on the removable cartridge. Duplication of data files is also easily accomplished. Errors are corrected simply by repeating the operation, since the initial data still resides on the removable memory cartridge.

A 10 × 10 array can be transferred to the 9880B cartridge in about 1 second, and a typical 250-line program of 2 000 words can be transferred in less than 2 seconds.

### Ordering information

9830A Desktop Computer  
 9830B Desktop Computer  
 9880B Mass memory subsystem

Price  
 \$4900  
 \$8350  
 \$10950

## COMPUTATION

Desktop computer; multicolor plotter

9831A, 9872A



## 9831A

The HP 9831A is a desktop computer that can be used as either a stand-alone device or with peripherals in an integrated computing system for industrial, commercial and scientific applications.

One of the main features of the 9831A is its BASIC language. Because BASIC is a commonly known computer language and is similar to English, it is easy to learn. At the same time the 9831's BASIC is powerful enough to meet the demands of experienced programmers.

To facilitate programming, string variables and general input/output commands have been built into the 9831. These enable the machine to accept and manipulate alphanumeric information and also provide for basic peripheral operations. In addition there are 24 Special Function keys (12 with shift, 12 without) which can be used to represent text, functions or entire programs with keystroke simplicity.

For fast storage and retrieval, a two-track tape cartridge drive has been built into the 9831A. The storage medium, a high-density, rapid-access tape cartridge, records up to 250k bytes of information and also features automatic verification of data.

The 9831A comes standard with 7 162 bytes of read/write memory and is expandable to 31 738 bytes. Other features of the 9831 include a 32-character LED display, a typewriter-like keyboard with upper- and lower-case alphanumeric and three I/C slots and four ROM channels for extending language capability and peripheral control.

## Features

- Alphanumeric keyboard
- 32-character LED display
- Built-in tape cartridge drive
- Hard-wired BASIC language
- Add-on read-only memory (ROM)
- Expandable read/write memory
- Up to 12 significant digits
- Full trigonometric capability
- Boolean algebraic capability
- 12-24 Special Function keys (shift included)
- Broad range of peripherals

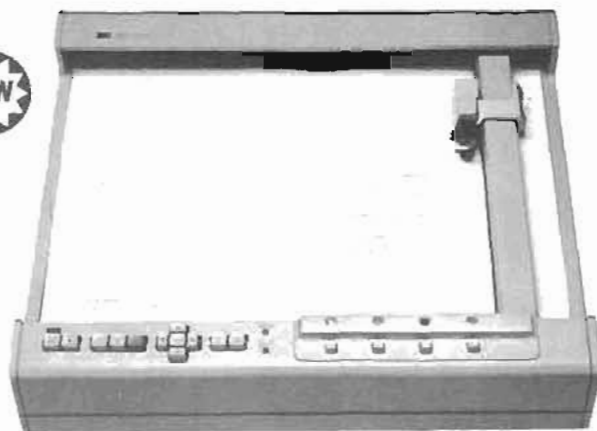

HP-IB

## 9872A

Interfaced with the 9825A, 9831A or 9845A Desktop Computer, Hewlett-Packard's 9872A Plotter will provide permanent four-color (blue, green, red and black) graphic output that's easy to read and is immediately ready for camera reproduction.

This microprocessor-based plotter (A3 size) provides automatic or manual pen selection and gives high-resolution line and character quality via addressable moves in lengths as small as 0.025 mm (0.001 in.). Seven different dashed-line fonts are also available for trace differentiation and easy interpretation.

In program mode, pen speed may be adjusted to any of 36 rates from 10 mm/s to 360 mm/s in 10-mm increments. This precision velocity control helps you produce high-quality graphics not only on paper but on other media such as mylar or acetate as well.

Window plotting, another significant feature, provides the 9872A with the ability to handle offscale data. The 9872A graphs to the point where offscale data is encountered and continues graphing at the point where onscale data is again encountered with no loss in accuracy. Point digitizing is used to determine coordinates and transmit them to the controller. By combining point digitizing and window plotting, you can magnify sections of an original graph for detailed analysis.

For more user flexibility in 9872 has five built-in character sets including Spanish, Scandinavian and French/German. You can also change character size, slant and direction or even design your own characters.

A two-letter graphics code drives the 9872A via the HP-IB. To further simplify use of the plotter mnemonics, these read-only memories (ROMs) are recommended:

- 98215A Plotter-General I/O or 98216A Plotter-General I/O-Extended I/O ROM for use with the 9825A Desktop Computer.
- 98223B Matrix Plotter ROM for use with the 9831A Desktop Computer.
- 98437A Graphics ROM for use with the 9845A Desktop Computer.

## Features

- Programmable selection of four pens
- Selectable pen speed
- Point digitizing
- Electrostatic hold down
- Five character sets
- User-defined characters
- Dashed-line fonts
- Built-in self test
- Error-free offscale data handling
- Symbol mode plotting
- Window plotting
- HP-IB compatibility

Ordering Information  
9831A Desktop Computer  
9872A Plotter

Price  
\$7200  
\$4200



Series 9800 System 45

### Series 9800 System 45

This Hewlett-Packard integrated desktop computer is a powerful, convenient system for such applications as mathematical modeling, design analysis, production test control, text processing and linear programming.

Distinctive System 45 features include a CRT display, an optional built-in thermal line printer, an enhanced BASIC language, and a tape cartridge (two drives optional).

The 310-mm (12.1 in.) diagonal CRT, an integral part of the System 45, lets you view data, list programs, and display keyboard inputs, messages and system commands. The CRT's alpha mode provides 1920 characters in a split-screen area with 24 lines. Twenty lines are reserved for data program listings and editing, while the remaining four lines provide an interactive display for prompts or user instructions, data inputs, error messages and calculation results. Special highlighting features—underlining, blinking, and inverse video—are provided for visual impact.

The CRT also has an optional graphics mode containing a 256k bit read/write memory for image refresh and a read-only memory (ROM) module for language enhancements. This allows high-speed interactive plotting within a 560 x 455 dot matrix, presenting clear, well-defined lines and curves. By giving the DUMP GRAPHICS command, you can also transfer on-screen graphics to the optional built-in thermal printer for precise hard-copy output.

The optional thermal printer also prints up to 80 characters per line at as much as 480 lines per minute, and draws strip-chart-like plots at about 25.4 mm/s (1"/s). The printer offers two means of emphasizing sections of hard copy. You can either indicate oversized characters which are 50% higher than standard or specify underlining the desired characters.

Thermal paper for the printer comes in both black-print and blue-print types, with both available in English and metric widths. The perforated black-print paper is useful for reports and permanent records requiring page control. The more economical blue-print paper in continuous rolls can be used for more routine daily activities.

System 45's enhanced BASIC language provides for matrix and string manipulation, flexible tracing, error trapping, multi-character variables and subprogramming capability. It provides 15 levels of programmable priority interrupt capability. It also provides for mass storage operations. Whichever storage device you choose, you use the same set of statements to address the media, which are the HP 9885 M/S Flexible Disk Drive, the HP 7905 and 7920 disc drives and the built-in 217k-byte tape cartridges. The language consistency saves you time and money by eliminating the need for program changes when addressing different storage devices.

A second tape cartridge drive available as an option adds 217k bytes of storage and also furnishes high-speed tape duplication capability and flexibility for program/data separation.

For handling large amounts of data, the System 45 has a standard read/write memory of 13 472 bytes. This memory can be expanded optionally to 62 624 bytes.

Should your applications require more computational capability and peripheral/instrument control, the System 45 is designed to handle these using appropriate ROMs and interfaces. Interface types include BCD, bit-parallel, bit-serial (Specification RS-232-C), and HP-IB (IEEE Specification 488-1975).

#### Features

##### Computer

- Enhanced BASIC language
- Two built-in tape cartridges (one standard, one optional)
- Overlapped processing of I/O and computation routines
- Built-in, unified mass storage operations
- Typewriter-like alphanumeric keyboard with language options
- Read/write memory of 13k bytes expandable to 62k bytes
- Interface capability

##### CRT Display

- Graphics package (optional)
- Quality alphanumeric and graphics display
- Highlighting capabilities
- Special editing characteristics
- Off-screen storage with scrolling capability
- Reduced screen glare
- Adjustable screen brightness
- Unified graphics language

##### Thermal Printer

- Fast printing/plotting
- Low cost
- Quiet operation
- Easy-to-read hard copy
- Fast transfer of graphics from CRT (graphics option required)
- Character generation flexibility
- Optional character sets in English, German, Spanish and French

#### Ordering information

- 9845A Desk Top Computer
- 9845S Desk Top Computer System

Price  
 \$11 500  
 \$30 000



9869A

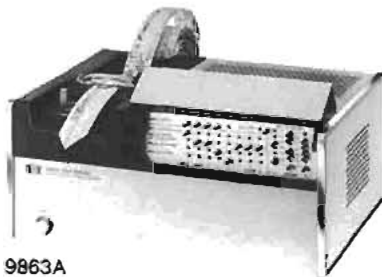

9863A



9865A



9864A

### Desktop computer peripherals

Desktop computer peripherals are the input/output devices that let you tailor your desktop computer to your specific computing requirement.

#### High speed tape reader subsystem

The 9883A uses the HP 2748B Photo Reader to increase the speed of the 9863A Tape Reader. The 9883A reads tapes optically at 300 char/s.

#### Tape punch subsystem

The 9884A provides a fast and reliable method of directly transferring output onto punched tape at 75 char/s.

#### Card readers

The high-speed 9869A Hopper Card Reader handles 80-column punched cards as well as mark-sense cards.

#### Tape cassette

The high-speed 9865A Tape Cassette lets you easily store, update, and retrieve data and programs. A fast, bidirectional search feature lets you find any file on the tape without rewinding. The 9865A has a minimum capacity of 48k bytes.

Interfaced with the 9825A or the 9831A, the 9877A External Tape Memory provides an inexpensive method of storing up to 1 M bytes of information. In addition, it offers fast duplication of up to four tapes in less than 60 min. The 9877 uses the same type of tape cartridge as that designated for the 9825A and 9831A desktop computers.

#### Paper tape reader

Data from analytical instruments, machine tools and computer terminals goes directly into your desktop computer. The 9863A reads a wide variety of formats at 20 char/s.

#### I/O expanders

The 9868A I/O Expander allows you to plug up to 13 peripherals or test instruments into your 9810A, 9820A, 9821A and 9830A/B. The 9878A provides six additional I/O slots for the 9825A and 9831A.

#### Digitizer

The 9864A Digitizer reads a curve or any irregular shape as a series of discrete points. Your HP desktop computer then prints out the dimensions of the line and the area of the contained shape.

#### Ordering information

	Price
9863A Paper Tape Reader	\$1710
9864A Digitizer	\$6000
9865A Tape Cassette	\$1885
9868A I/O Expander	\$1060
9869A Hopper Card Reader	\$4075
9877A External Tape Memory	\$2340
9878A I/O Expander	\$1200
9883A High Speed Tape Reader Subsystem	\$2510
9884A Tape Punch Subsystem	\$3080

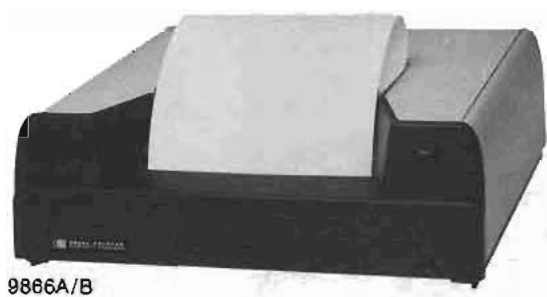

9866A/B



11285A

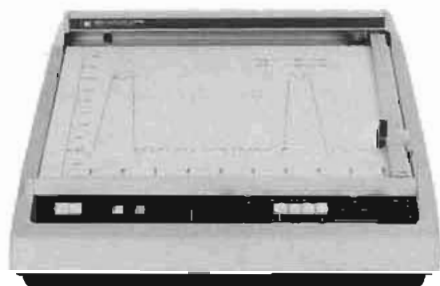

9862A

### Line printer

The 9881A Line Printer Subsystem consists of the 2607A Line Printer, which is a reliable, low-cost, 5 x 7 dot matrix printer, and the 11287A Line Printer Interface Card. Its unique print mechanism makes it quiet enough for any business environment and provides up to six consistent, clean copies. It prints at 200 lines/min regardless of the line length and has full 132-column line width.

### Thermal printers

For high-quality, hard-copy output, the 9866A/B Thermal Printers are hard to beat. The 9866A/B printers produce page-width, fully formatted, alphanumeric text, tables, or simple plots at 240 lines/min. The 9866B has upper- and lower-case characters and vertical line printer capabilities.

### X-Y plotter

The 9862A X-Y Plotter with a peripheral control function block automatically scales your data, generates words as well as numbers and sets up both axes, complete with labels and tick marks — all in your designated units.

### Interfacing

HP offers many interface cards designed for those customers who desire to build custom, desktop computer-controlled instrumentation systems. These cards are:

#### 9815A Interface cards

- 98133A BCD Interface — 8-digit BCD input with high-speed mode, 8-bit parallel output.
- 98134A General Interface — bidirectional 8-bit parallel interface.
- 98135A HP-IB Interface — general connection for HP-IB compatible instruments (in conformance with IEEE Std. 488-1975).
- 98136A RS-232-C Serial Interface — conforms to EIA RS-232-C recommended specifications.

#### 9825A, 9831A and 9845A interface cards

- 98032A 16-bit Duplex Interface — latched 16-bit input/output for bidirectional transfer of information.
- 98033A BCD Input Interface — connects the 9825A with bit-parallel, digit-parallel BCD devices.
- 98034A HP-IB Interface — allows communication with as many as 14 HP-IB compatible instruments per interface.
- 98035A Clock/Timer/Pacer Interface — adds real time reference and time-related control capabilities to the 9825A, 9831A and 9845A desktop computers.
- 98036A Serial Interface — provides bit serial communication between the desktop computers and asynchronous EIA RS-232-C devices such as data terminals and modems.

#### 9830A/B Interface cards

- 11202A I/O Interface — 8-bit parallel input/output card with TTL compatible drivers and receivers.
- 11203A BCD Input Card — 9 digits of 8421-coded BCD data, plus other functions (input from instrument to 9830A/B only).
- 11205A Serial I/O Interface — bit serial input/output card conforming to EIA RS-232-C recommended specifications.
- 59405A Hewlett-Packard Interface Bus — byte serial interface offers plug-to-plug compatibility between instruments.
- 11285A Data Communications Interface — allows communication with other 9830A/B's and computers via telephone lines and modems that meet EIA Specification RS-232-C.
- 11297B Binary Synchronous ROM — when used with 11285A allows 9830A/B to act as a remote batch terminal emulating IBM 2780.
- 11298B Interactive ROM — when used with 11285A allows 9830A/B to act as time-sharing terminal emulating ASCII Teleprinter.

### Ordering Information

	Price
9862A X-Y Plotter	\$3206
9866A Thermal Printer	\$3143
9866B Thermal Printer	\$3350
9881A Line Printer Subsystem	\$7990
98133A BCD Interface	\$600
98134A General 8-bit Parallel Interface	\$300
98135A HP-IB (IEEE Std. 488-1975) Interface	\$600
98136A RS-232-C Serial Interface	\$600
98032A 16-bit Duplex Interface	\$400
98033A BCD Input Interface	\$400
98034A HP-IB (IEEE Std. 488-1975) Interface	\$406
98035A Clock/Timer/Pacer	\$606
98036A Serial Interface	\$600
11202A 8-bit Parallel I/O Interface Card	\$225
11203A BCD Input Interface Card	\$336
11205A Serial Interface Card	\$435
11285A Data Communications Interface and ROM	\$1573
11297B Binary Synchronous ROM	\$523
11298B Interactive ROM	\$523



## 9896A

Hewlett-Packard's 9896A Computation System is a complete, flexible disk-based data processing system, suitable in both commercial and selected scientific fields. It can handle many jobs, including:

- accounting
- production planning and scheduling
- wage and salary administration
- literature and inquiry handling
- inventory control
- engineering calculations
- medical analyses
- business statistics

The standard 9896 is a system of exceptional performance configured to start solving your computational problems now. The system consists of:

- Desktop computer with integral keyboard and display for total system control
- Flexible disk drives (2) for rapid access to programs and data
- Full character impact printer to provide hard-copy printouts and graphics
- Systems desk to provide work station convenience and single power switch and printer paper storage

In short, this computational product provides a system approach to ensure total performance and quality but retains flexibility to meet your specific requirements.

For specific/industrial use, the 9896A offers on-site, quick-access data processing and computational facilities. The speed and ease with which it produces information makes it very attractive to general departments of larger organizations with data-handling requirements.

### The Desktop Computer

Controlling the entire system is the 9831A Desktop Computer which features rapid data processing and easy-to-understand BASIC language.

Valuable characteristics of this language include easy manipulation of alphabetic and numeric information, rapid sorting of rows of columns of data and efficient location of specific values in those rows or columns. These characteristics are particularly useful for searching and sorting applications such as inventory control.

Many statements and functions built into the 9831A simplify programming. For example, if you want a certain message to appear on the printout, just key in PRINT and the specific message. To find the square root of a number, you type in SQR, then the number and press the execute key. This is an advantage of BASIC—statements and function names that the 9831 knows are also easy for you to understand.

### The Printer

The system's hard-copy output device is the 30 character-per-second 9871A Full Character Impact Printer. It is controlled by the 9831 Computer.

The 96-character interchangeable disk provides the full character quality impact printout. Other character disks available are European, ASCII, Katakana, Cyrillic and APL.

The 9871A can print reports, letters, checks and invoice forms on a single sheet or continuous fan-fold, pin-feed paper with maximum width of 351 mm (15 in.). A form-feed mechanism is provided with the standard system for use with continuous paper. As many as six copies can be produced. An optional sound enclosure allows the system to be located in a quiet office environment.

Additional features of the 9871 include graphic plotting; a 335 mm (13.2 in.) writing line; a 158-character buffer — automatically fills if characters are received faster than print rate and also frees the 9831A for other operations.

Other peripherals available: The 9881A 200 line-per-minute printer; the 9866B Thermal Line Printer for rapid, quiet printouts; the 9862A or 9872A Plotter for graphics and charting, and input/output peripherals such as paper tape readers and punches, card readers and data cartridge cassette memories.

### The Mass Storage Unit

Mass storage on the 9885 provides the 9896 System random access to approximately 500,000 bytes of information per removable disk.

The standard 9896 System contains two disk drives—one master and one slave. The master drive has a built-in controller that regulates as many as three slave units. The master, in turn, is controlled by the 9831. This configuration of two drives provides a means of easy "backup" of critical information or random access to nearly 1 million bytes of data.

The 9896 System's data reliability is enhanced by the 9885 automatic write/verify feature, ensuring that the information recorded on the disk is identical to the source information in the 9831's memory.

### Software

For commercial use, business information management programs are available for accounts receivable, accounts payable, payroll, inventory control, and general ledger. All programs can be used separately or the first four can be integrated with the fifth, the general ledger program. This package of five programs comprises the Financial Information Control Software (FICS).

Ordering Information  
9896A Computation System  
FICS Package

Price  
\$18,700  
\$1,300

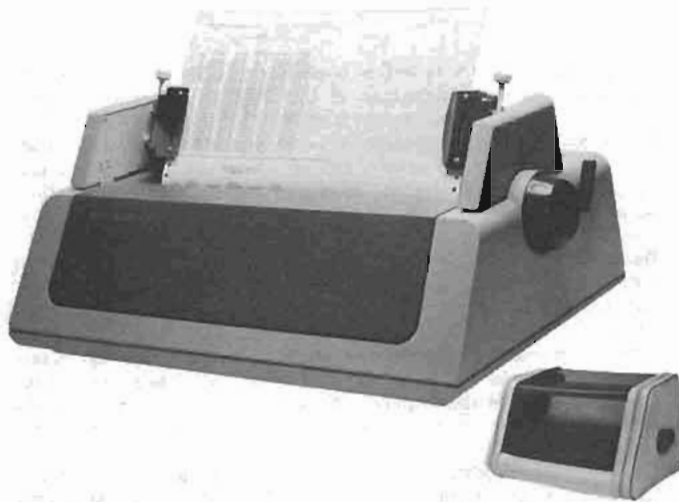

### 9871A

The HP 9871A is a full-character serial impact printer for use with 9800 Series programmable computing systems. The platen accommodates paper up to 381 mm (15 in.) wide. The 9871 prints a standard 132 columns at 10 characters/in.; however, character and line spacing can be defined to increase or decrease the number of characters per line. Any of six different interchangeable print disks (96 characters each) provides full-character quality impact printing.

#### Plotting and form filling

Bidirectional motions of the platen and print mechanism provide plotting capabilities for charts and graphs. Programmable tabulation, both horizontal and vertical, simplifies plotting and form-filling on this printer. The optional 98020A Soft Sound Enclosure allows locating the 9871 in quiet office environments. Additionally, an optional form-feed mechanism, HP 98021A, feeds continuous Z-fold paper in one direction and aids in producing clear multiple copies. The 98021A option includes a basket for stacking the paper printout.

The 9871 is fully self-contained and can be easily interfaced with any 9800 Series desktop computer for use in scientific, industrial and commercial applications.

#### Features

- Full-character quality serial impact
- Bidirectional carrier and platen
- 96-character interchangeable print disk
- 335,3 mm (13.2 in.) writing line
- User-defined character and line spacing
- Programmable page formatting
- Plotting

#### Specifications

**Speed:** average text line at 10 characters/in.; 30 characters/sec

**Paper:** single sheet; continuous feed (form-feed mechanism recommended for continuous feed); single-part or multi-part, 2 to 6 parts—0.46 mm (0.018 in.) total maximum thickness. Maximum width 381 mm (15").

#### Options and accessories

- Standard print disk
- ASCII print disk
- European print disk
- Katakana print disk
- Cyrillic print disk
- APL print disk

#### Ordering information

	Price
9871A Character Impact Printer	\$3,400
98020A Soft Sound Enclosure	\$125
98021A Form-feed Mechanism with Paper Stack Basket	\$275



### 9885M/S

Low cost, high speed, large capacity, reliability and ease of operation in data management make the HP 9885 Flexible Disk Drive a valuable addition to the desktop computer system. Mass storage on the 9885 provides random access to approximately 500,000 bytes of data per removable disk.

The flexible disk drive comes in two versions, the 9885M (master) with a built-in controller, and the 9885S (slave). Up to three slaves can connect to one master. This expandability provides a means of ensuring easy "backup" of critical information or providing random access to nearly 2 million bytes of data.

Average transfer rate between computer and disk drive is 23k bytes/s. Double-density read/write on the flexible disk further enhances access rate and increases total storage capacity. Average access time to any location on the disk is 267 ms.

#### Special features and benefits include:

- Random access
  - Store or retrieve any file(s) on the disk in less than 1/2 sec.
- Smart directory
  - Files referenced by "name"; user designates the file "name" (i.e., get "Jones").
  - Quick access to catalog (index) of stored files (available anytime). The disk directory tells the drive when and where a file exists—the drive does not waste time searching for files not on that disk.
  - Catalog update occurs "automatically" as system operations are executed.
- Dynamic size allocations
  - Provides the most efficient packing of data on the disk.
  - A deleted file will be automatically replaced by another file equal to or smaller in size than the old.
  - User may "repack" files so that all unused or available space is collected together on the disk.
- Write—verify feature
  - Ensures that the information recorded on the flexible disk is identical to the source information in the computer memory.

#### Sample Commands

get "Test 1" Loads program from the disk to the computer.

save "T Test" Stores program or specified parts of it in a specified file.

chain Loads a program from the disk to the computer, retaining variable values.

copy Duplicates contents of one file into another file or drive.

#### Ordering information

	Price
9885M Flexible Disk Drive Master and Opt 025: for operation with 9825A	\$3900
9885M Flexible Disk Drive Master and Opt 031: for operation with 9831A	\$4100
9885S Flexible Disk Drive Slave	\$2500



2648A

Hewlett-Packard has a growing family of general-purpose display terminals which include: the new 2648A Graphics Terminal, 2649A Microprogrammable Terminal, 2640B Display Terminal, the high performance 2645A Display Station, the 2640C/N/S, 2645R/S International Terminals, the 2641A APL Display Terminal and a number of accessories for filling the needs of a variety of applications. Hewlett-Packard display terminals are in wide use today in manufacturing, service organizations, government and education performing in such applications as:

- data entry
- inquiry/response
- editing text
- file updating
- transaction processing
- programming
- off-line operation
- data storage
- printing
- order entry
- batch operation
- time-sharing
- graphics

The 2648A graphics terminal is the first CRT terminal from Hewlett-Packard that was designed specifically for graphics. More importantly, it offers high performance graphics capabilities to users requiring low cost graphic terminals; capabilities normally found only in larger CPU-based systems. Being microprocessor driven, it has localized intelligence that offers users the opportunity to explore new areas and to try out new ideas in graphics not before available in a terminal.

**Raster scan technology:** the 2648A can be used in high ambient light environments since raster scan provides a bright, easy-to-read display. This helps to minimize eye fatigue when extended sessions at the terminal become necessary.

With refreshed raster scan technology, the ability to modify selected portions of a picture is a natural feature.

Modification of pictures does not require that the complete display be erased and redrawn. This helps to minimize the CPU overhead requirements and the user wait time.

**Independent alphanumeric and graphic memories:** there are 8K bytes of RAM available for display alphanumerics. This is expandable to 12K bytes maximum. Independent of the alphanumeric memory is the graphics memory, consisting of 16 each 16K RAM integrated packets providing a 360 by 720 dot resolution. Now, computer dialogue and the final picture reside in separate memories. Since either memory can be inhibited without disturbing the other, readability of the display is enhanced.

**Hardware zoom and pan:** the graphic memory of the 2648A can be magnified up to sixteen (16) times, facilitating investigations and/or modifications of dense areas of the display. Panning is available to view any area of the magnified display not in the viewing window. The complete display can be panned through without reinitializing the display data. This capability is available to the user whether on or off-line from the CPU.

Sophisticated users as well as users having little or no programming skills can take advantage of the 2648A's capability to plot column-wise tabular data automatically.

**Automatic plotting:** a simple menu is provided to lead the user through a question and answer session about the data. With a few simple keystrokes, a fully labeled plot of the specified data can then be presented on the display. This feature makes graphics friendly, easy to use, and can be done with or without a supporting CPU.

**Rubber band line:** trial graphics can be performed with or without CPU support using the Rubber Band Line mode. Quick, user-initiated picture generation and/or modification before final commitment to design is now possible.

**Pattern generation with rectangular area shading:** user-specified patterns can be generated for use in shading defined rectangular areas of the display. This enhances the shading of parts assemblies or facilitates differentiation of bar graphs where color would normally be used.

**Compatibility mode:** when in compatibility mode, the 2648A can be used with most terminals that have a 780 by 1024 dot displayable area. Data is mapped on a 1 to 1 basis into the 2648A's display space, or it may be scaled to fit in the 360 by 720 dot data space. This capability will help to minimize user conversion time and loss of the initial software investment.

Additionally, since the 2648A is a member of the 2640 Series Family of Terminals, it has many features that make it an outstanding alphanumeric terminal.

**Some of these features are:**

- Choice of Communications Environments: RS232C Asynchronous SCI; Full or Half Duplex
  - Optional 20 mA Current Loop
  - Optional Asynchronous or Synchronous (BISYNC) Multipoint/Polled
  - Wide Selection of Modems
- 8 User Definable Soft Keys
- Fully Integrated Mass Storage Option
  - Two Cartridge Tape Drives
  - 110 Kilobytes of Storage per Cartridge Tape
- Alpha/Numeric Field Checking
- Automatic Data Logging
- Character Wraparound
- Adjustable Margins
- Full Editing
  - Insert or Delete Lines or Characters
  - And much more!

#### Model 2649A microprogrammable terminal

The Hewlett-Packard Model 2649A microprogrammable terminal offers a reliable, cost effective solution to the need for an intelligent terminal in a broad range of business, industrial and research applications. The 2649A combines all of the desirable features of the 264X family of display terminals with a powerful microprocessor to produce an extremely versatile source of intelligence.

**Network or stand alone operation:** several 2649A's may be used in conjunction with a central processor to create a distributed intelligence network. In this environment, the 2649A can be programmed to preprocess data sent to the central processor and postprocess data received from the central processor. By sharing the data processing workload in this manner the throughput capability of the central processor is effectively increased and overall system performance is improved.

In applications with less demanding throughput requirements, the 2649A is capable of operating in a stand-alone mode. In this mode, where no central processor is required, the terminal may be used to process limited amounts of data and to provide control for a wide variety of external devices to which it may be interfaced.

**Modular architecture:** modular architecture allows the OEM or end user to optimize both hardware and firmware configurations to match each specific application. Thus, unnecessary hardware and firmware is avoided with a resulting cost savings to the user. Modular architecture also means greater flexibility so that as the application grows, the capability of the terminal may be enhanced by adding more memory, peripherals or firmware.





2645A

**Choice of Interface memory options:** interfacing is made easier because there is a wide selection of general purpose, peripheral and data communications interfaces to choose from. A variety of memory options, including RAM, ROM and PROM modules, is available to meet program and data storage requirements in a highly efficient manner. Memory options may be configured to support up to 60K bytes of combined RAM, ROM and PROM.

**Simplified Hardware/Firmware Development:** development of hardware and firmware is simplified by the sophisticated development tools which are available. These include a comprehensive hardware and firmware documentation package, a RAM based development terminal and a firmware support package which includes a microprocessor assembly language cross-assembler which executes on a Hewlett-Packard System 1000 Computer System.

### Model 2640B display terminal

**Easy to read display:**

the large 5 inch by 10 inch display of the 2640B presents up to 1,920 characters in a 24 line by 80 column format. A  $9 \times 15$  dot character cell allows large characters to be represented accurately. Wide character and line separation, inverse video, and optional plug-in character sets with underlining, half-bright, and blinking are enhancements designed to increase clarity and ease sessions at the terminal.

**Full editing capability:** the 2640B transmits character-by-character as an interactive terminal or is capable of operating on variable length blocks of information. Local editing allows the user to modify data before transmission to the computer. Editing and computer connect times can be significantly reduced by such standard features as:

- character or line insertion and deletion
- cursor addressability and positioning (up, down, left, right, home)
- programmable protected fields in any combination of display positions
- off-screen storage with scrolling (scroll up, scroll down, next page, previous page)
- standard horizontal tabs and protected field tabulation
- eight special function keys for user-defined routines, such as forms entry or on-line error detection
- positional memory lock

**Plug-in character sets:** there is the capacity to use up to four 128-character sets concurrently (switch selectable on a character-by-character basis): the Roman set including displayable control codes for program debugging; the line drawing set for forms drawing and limited graphics capability; the math set with frequently used math symbols and Greek characters; the large character set for enlarged character presentation; or user-defined character sets.

**Choice of communications capabilities:** the standard 2640B operates at up to 2400 baud and offers both full and half duplex asynchronous communication using an EIA RS232C interface. It is Bell 103A and 202C/D/S/T modem compatible with a choice of main channel and reverse channel protocols. Options include 20 mA DC current loop, split input/output speed and custom baud rates.

**Versatile keyboard:** the detachable, expanded ASCII keyboard is easy to use and flexible enough to fill a wide variety of applications. It contains a ten key numeric pad, cursor control, tab and page control pad, editing and special function keys.

**Multi-page display memory:** because of efficient memory allocation, the standard 2640B with its 1024 bytes of memory can display from 8 to 50 lines dependent on line length. With memory expansion to 8 k bytes, over three pages of data can be stored. Information can be viewed 24 lines at a time by scrolling forward or backward a line or a page at a time.

**Hard-copy Interface:** a wide variety of hard-copy devices can be accommodated via an optional RS232C serial interface or HP printer compatible parallel interface. Commands to print data can be initiated either locally from the terminal keyboard or remotely from a computer.

**Self-test:** every element of the 2640B has been engineered for high reliability and ease of service. For example, the Self-Test feature gives the user an instant diagnostic test that the terminal is operating properly.

**Modular architecture, microprocessor controlled:** microprocessor implementation and modular architecture produce a terminal with a wide range of capabilities; and, as needs grow, the potential for flexibly adding such features as additional display memory, printer interfaces and other character sets.

### Model 2645A display station

**All 2640B features:** the high performance 2645A Display Station offers a superset of the capabilities of the 2640B. It has the same features and benefits as the 2640B (see 2640B features description) and has the many significant additional features described below.

**High speed:** the 2645A can operate at speeds up to 9600 bits per second and, like the 2640B, transmits either character-by-character as a fully interactive terminal or can operate on variable length blocks of information.

**Choice of communications capabilities:** the standard 2645A is a teletypewriter compatible (EIA RS232C serial asynchronous, AS-C11, half or full duplex). Optional capabilities include 20 mA current loop; and either asynchronous or synchronous polling for multipoint communications networks. Polling offers the cost saving benefits of shared communications resources — modems, data lines and computer I/O channels; as well as improved transmission error checking and communications compatibility with a wide range of computer systems. The 2645A operates as a single unit or can be daisy-chained to other 2645A's on a single communication line. Synchronous multipoint (IBM Binary Synchronous Multipoint Communications, Bisync) and asynchronous multipoint (patterned after Bisync) can optionally be used for polled communications networks. Also, the 2645A can be used with a wide selection of modems over dialed or leased lines.

**User-defined soft keys:** each of 8 special function keys can be easily set to issue a user-defined string of up to 80 data characters or several control sequences stored in the 2645A. This feature allows the keyboard to be more specialized to each application, and can

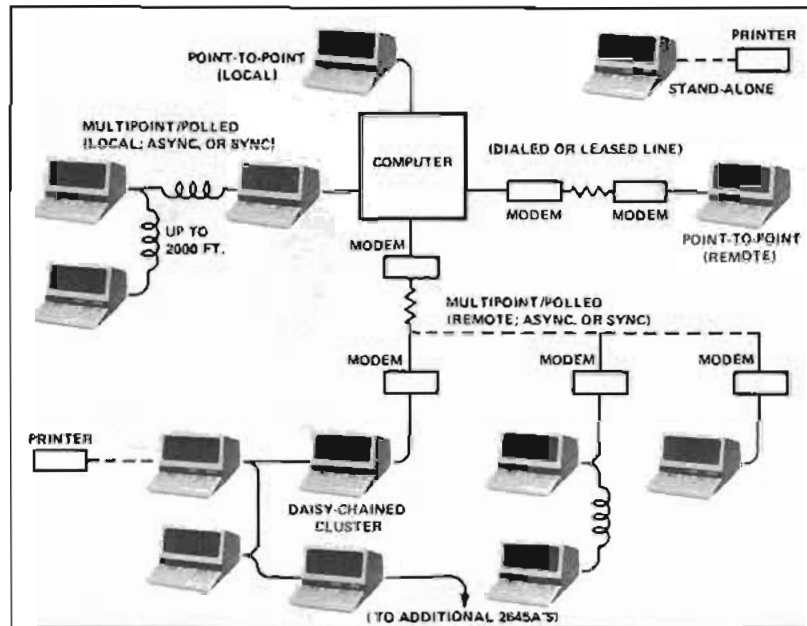

Figure 1. Data communications capabilities of the Hewlett-Packard family to terminals.

considerably simplify use of the keyboard and result in greater efficiency — each soft key performs the operations of several key sequences. For example, the soft keys can issue frequently used programming sequences; search for files; aid forms construction for data entry; dynamically configure the terminal; or issue instructions to the user, computer or both.

**Fully Integrated mass storage:** many operations normally requiring connection to a computer system can now be done off-line with the 2645A. Optional, dual cartridge tape units allow batching of information, and add extensive stand-alone capabilities which can significantly reduce user time; conserve both computer and communications resources; provide a tape backup; and very importantly, allow the terminal to keep on working even when a computer is unavailable. Single keys for the most frequently performed functions, and color-coded prefix keys to exercise the 2645A's full capabilities suit the 2645A to a wide variety of users and applications. Gold and green prefix keys provide full access to the 2645A's multiple data paths to allow information to be moved between any of the functional units of the display station—cartridge, display, keyboard, printer, and data communications interface. Also, the tapes are fully controllable from either keyboard or computer. The highly reliable, interchangeable MiniCartridge tapes each provide the capacity of 1.2 Mbytes up to 110 000 characters of storage formatted in variable length records and files. The tape units feature rapid data transfer and bi-directional high-speed search to access any file in seconds. The MiniCartridge is ideally suited for storing data, forms, programs, or text, and is an excellent substitute for paper tape.

#### Additional capabilities

- Numeric/Alpha field checking
- Display memory expandable to 12 k bytes
- Automatic data logging—stores data as it leaves the display automatically on the optional tape cartridges
- Line wraparound—when inserted text requires more than 80 columns per line.
- Adjustable margins—for variable column width/multiple columns/split screen

#### International terminals

The 2640C, 2640N, and 2640S are international versions of the 2640B Display Terminal. Each has basically the same features and benefits as the 2640B (see 2640B features description). The 2645R and 2645S are international versions of the 2645A.

**Model 2640C—Cyrillic (Russian):** the 2640C is capable of displaying the full 128-character set opt.). Cyrillic and Roman characters can be generated from a single keyboard with all keys labeled and

located in the accepted positions for Cyrillic keyboards. Pressing a single key switches between standard Roman and Cyrillic. Adjacent characters on the display can be from the Roman, Cyrillic, or optional plug-in character sets.

**2640N—Danish/Norwegian:** the 2640N is a unilingual terminal in which the Danish/Norwegian character sets are displayed and present on the keyboard

**Model 2640S/2645S—Swedish/Finnish:** the 2640S/2645S is a unilingual terminal in which the Swedish/Finnish character sets are displayed and present on the keyboard.

**Model 2645R—Arabic:** the 2645R is a dual character terminal in which Arabic and upper case Roman characters are displayed and present on the keyboard.

#### Model 2641A APL Display Station

The 2641A APL Display Station retains all features and capabilities of the 2645A. An additional APL character set, including overstrike characters, is standard. Keyboard layout conforms to industry conventions. Integrated cartridge tape storage optional.

#### Family enhancements and accessories

**13231A Display enhancement:** with the 13231A individual characters or fields of characters can be displayed in any of the sixteen possible combinations of blinking, underline, half-bright or standard inverse video. The 13231A also provides the capacity for adding up to three 128-character sets. A line drawing set, math symbol set and large character set are currently available.

**13245A Character set generation kit:** the high resolution display and  $9 \times 15$  dot character cell are available for special character set design with the 13245A. An included manual documents the steps necessary to design individual characters, assign the desired ASCII code equivalent, and generate the information to purchase Programmable Read Only Memories (PROM) which store the user-defined character sets.

**13238A Duplex register:** the 13238A provides a parallel output interface which supports the HP 9866 thermal line printer and 9871 character-serial impact printer.

**13250B Serial printer interface:** the versatile 13250B supports a wide variety of RS232C serial interface compatible printers at speeds up to 9600 bits per second. Hewlett-Packard printers that the 13250B interface supports are the HP 2762A and 2762B.

**13254A Video output interface:** the 13254A provides the capability of generating video output which can be used by compatible television monitors and video hardcopy units to duplicate whatever is being displayed by one of the Hewlett-Packard family of display terminals.



## Family specifications

### General

**Screen size:** 127 mm (5") × 254 mm (10").

**Screen capacity:** 24 lines × 80 columns (1,920 characters)

**Character generation:** 7 × 9 enhanced dot matrix; 9 × 15 dot character cell; non-interlaced raster scan.

**Character size:** 2.46 mm (0.097") × 3.175 mm (0.125").

**Character set:** 64 upper-case Roman; 128 character APL set with 2641A; 64 character Danish/Norwegian set with 2640N; 64 character Swedish/Finnish set with 2640S or 2645S; 128 character Roman/Arabic set with 2645R.

**Cursor:** blinking-underline.

**Display modes:** white on black; black on white (inverse video).

**Refresh rate:** 60 Hz (50 Hz optional).

**Tube phosphor:** P4.

**Implosion protection:** bonded implosion panel.

**Display memory:** 2640B 1 k std., 8 k max; 2645A 4 k std., 12 k max.

**Keyboard:** detachable. Full ASCII/APL keyboard for 2641A. Full ASCII code keyboard; 2640B 20 control/editing keys, 2645 8 user-defined soft keys and 16 additional control/editing keys; ten-key numeric pad; cursor pad; multi-speed auto-repeat, n-key roll-over; 1.22 m (4 ft.) cable.

### Cartridge tape:

two mechanisms, 10 ips read/write speed, 80 ips search rewind speed, 800 bpi recording, max 110 k bytes of storage per MiniCartridge. Optionally available for 2641A and 2645 series.

### Data communications

**Data rate:** 110, 150, 300, 1200, 2400 (4800 on 2641A & 2645R, 9600 also on 2645A) and external-switch selectable (110 selects two stop bits).

**Std. asynchronous communications:** EIA RS232C; compatible with Bell 103A modems; compatible with Bell 202C/D/S/T modems.

**Transmission modes:** full or half duplex, asynchronous.

### Optional communications interfaces:

Current loop, split speed, custom baud rates.

Asynchronous multipoint (2641A, 2645A/R/S).

Synchronous multipoint (2641A, 2645A/R/S).

**Operating modes:** on-line; character, block.

**Parity:** switch selectable (even/odd/none).

### Environmental conditions

#### Ambient temperature

**Non-operating:** -40° to 75°C (-40 to 167°F); -10° to 60°C (-15° to 140°F) with tape.

**Operating:** 0° to 55°C (32° to 131°F); 5° to 40°C (41° to 104°F) with tape.

**Humidity (non-condensing):** 5 to 95% (20 to 80% with tape).

**Heat dissipation:** 540 Btu/hour (158 W).

#### Altitude

**Non-operating:** sea level to 7620 metres (25 000 feet).

**Operating:** sea level to 4572 metres (15 000 feet).

**Vibration and shock** (type tested to qualify for normal shipping and handling in original shipping container).

**Vibration:** 0.25 mm (0.010") pp, 10 to 55 Hz, 3 axes.

**Shock:** 30 g, 11 ms, 1/2 sine.

### Physical specifications

**Display monitor weight:** 19.6 kg (43 lb).

**Keyboard weight:** 3.2 kg (7 lb).

**Display monitor dimensions:** 342 mm H × 444 mm W × 457 mm D (13.5" × 17.5" × 18"), 648 mm D (25.5") including keyboard).

**Keyboard dimensions:** 90 mm H × 444 mm W × 216 mm D (3.5" × 17.5" × 8.5").

### Power requirements

**Input voltage:** 115 (+10%, -23%) at 60 Hz ±0.2%.

230 (+10%, -23%) at 60 Hz ±0.2%.

**Power consumption:** 85 W to 150 W max.

### Product support

**Warranty:** 90 day on-site parts and labor warranty.

### Ordering information

2640B Interactive Display Terminal

2640C Cyrillic Display Terminal

2640N Norwegian/Danish Display Terminal

2640S Swedish/Finnish Display Terminal

2641A APL Display Terminal

2645A Display Station

with tape

2645R Arabic Display Terminal

2645S Swedish/Finnish Display Terminal

2648A Graphics Terminal

with tape

2649A Microprogrammable Terminal

Short-term lease and quantity discounts available.

### Price

\$2600

\$4250

\$2750

\$2750

\$4100

\$3500

\$5100

\$4350

\$3750

\$5500

\$7100

\$2150

## COMPUTATION

## Terminals for Real Time Applications

Models 3070A, 3071A

- Custom labels
- Prompting lights
- Special function keys
- Numeric keyboard and display 3070A

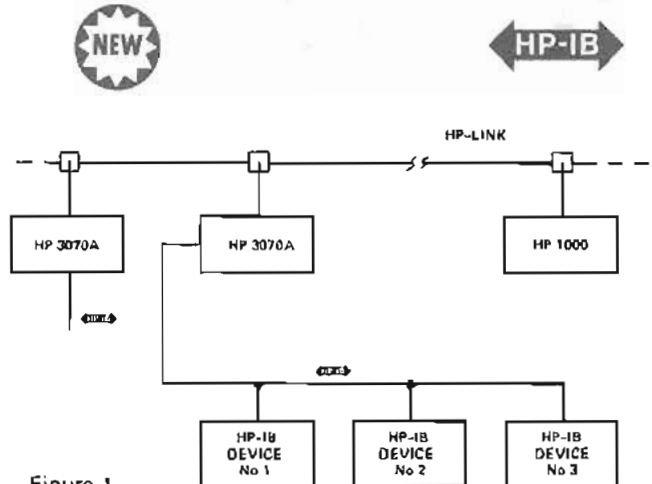

Figure 1

## Description

## General

The 3070A and 3071A Real Time Applications Terminals are compact, desk-top devices that can be tailored by the individual to suit the application. Convenient, keyboard definition labels allow one to customize special function keys and prompting lights. These keys and lights provide a fast and easy communication with a computer system. In addition to a 16-digit display the terminals contain a 10-digit buffered numeric keypad grouped together with Delete, Decimal Point, Minus and Enter keys.

## 3070A Terminal

Multiple 3070A Terminals may be connected to an HP 21MX or 2100A/S Series computer system using a unique serial link and fully supported software. The link is a single "twisted pair" cable, which connects to an HP computer interface card, and can be of length up to 4 kilometers (2.4 miles). Terminals can be connected to any point on the cable. The protocol used to link terminals to the computer includes all the necessary commands to enable them to be used to control HP-IB compatible devices. Up to 13 HP-IB devices may be connected to the standard HP-IB connector of each terminal, see Figure 1.

## 3071A Terminal

The 3071A functions with any computer system which supports its standard RS 232 asynchronous communications interface and may be used with full duplex, low-speed asynchronous modems. Use of a shift key (special function key no. 1) increases the effective number of special function keys to eighteen.

- Multidrop
- Distributed control of HP-IB devices
- Fully supported software 3071A
- RS 232C/CCITT V24 communications

## Specifications

## General

**Display:** 16 position (written left to right).  
**Display character set:** 0 through 9, decimal point, space, minus sign, letter E (e.g. Error).  
**Character generation:** seven segment, gas discharge (orange behind bronze tinted window).  
**Character size:** 6.42 mm (0.253") × 3.38 mm (0.133").  
**Prompting lights:** 15 red light emitting diodes.  
**Power-on Indicator:** green light emitting diode.  
**Keyboard ready indicator:** green light emitting diode.  
**Keyboard:** sealed contacts, buffered numeric keypad, 9 special function keys plus a gold key (used as a SHIFT key on the 3071A to provide 18 combinations). 12-key numeric pad, ENTER and DELETE keys.

## Environment

**Temperature** (free space ambient)

**Non-operating:** -40° to +70°C

**Operating:** 0° to +55°C

**Humidity:** 5% to 95% (non condensing).

**Heat dissipation:** 150BTU/hr.

**Vibration and shock:** type tested to qualify for normal shipping and handling.

## Physical

**Weight:** net, 4.7 kg (10.3 lb). Shipping 7.1 kg (15.6 lb).

**Size:** 117 H, 277 W, 400 mm D, (4.6" × 10.9" × 15.7").

## Power requirements

**Input voltage:** 100, 120, 220, 240V (-10%, +5%).

**Input frequency:** 47.5 to 66Hz.

**Power consumption:** 30W.

## Serial link communications (3070A only)

**Cable:** shielded twisted pair (HP model no. 92902A).

**Signal levels:** 5 volts, differential, isolated through optical couplers.

**Distance:** total length of link cable may be up to 4 km. Computer and terminals can be randomly connected at any point on the link providing no terminal is more than 2km from the computer.

**Transmission speeds:** link operates at 25000 bits/second, effective data transfer rate depends upon the number of terminals connected and varies between 12 transfers/second/terminal (63 terminals) to 230 transfers/second/terminal (1 terminal).

## Data communications (3071A only)

**Data rate:** 110, 150, 220, 300 baud (switch selectable). 110, 220 selects two stop bits. 150, 300 selects one stop bit.

**Parity:** odd, even, none (switch selectable). Detected parity errors cause E symbol to be displayed.

**Transmission mode:** full duplex.

**Communications interface:** EIA RS 232C/CCITT V24 (103 modem compatibility).

**U.L. approval** (listed by U.L. under the following classifications): Electronic Data Processing Equipment, Office Appliances and Business Machines.

## Subsystem for 3070A

The subsystem, under the number 92900A, consists of 40280A Computer Interface Kit, one 3070A Applications Terminal, one test cable, the corresponding software for either RTE 11 or RTE 111, and diagnostics.

## Ordering information

3070A Real Time Applications Terminal

92900A Subsystem

3071A Real Time Applications Terminal

Price

\$1470

\$2650

\$1285

## Optical mark readers for data entry and collection

Models 7260A & 7261A

- Flexible card format
- High speed operation
- Easy to interface

- OEM and quantity discounts available
- Service contracts available
- Customer service kit available



7260A

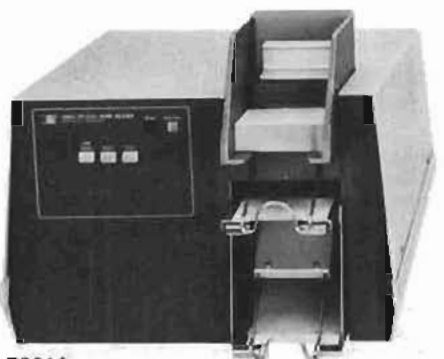

7261A

The Hewlett-Packard Models 7260A and 7261A Optical Mark Readers are desk-top data transmission instruments. The Readers optically (photo-reflectively) read standard 82.6 mm (3 1/4 in.) wide paper information processing cards. Card lengths from 187.3 mm to 282.6 mm (7 3/8 in. to 11 1/4 in.), having 40 or 80-column marked or keypunched information using on-data or after-data clocking are accepted. With Option 003, the Readers can also read cards without clock marks. They can handle 450 processing cards at a time at feed rates of up to 300 cards per minute.

### 7260A Optical Mark Reader Specifications

**Code capacity:** recognizes 128 characters Hollerith code.

**Translation:** translates to bit serial 7-level ASCII with selectable parity.

**Operational modes:** demand and continuous feed.

**Parity:** generates and transmits selectable parity.

**Data rates:** 110, 150, 300, 600, 1050, 1200, 2400 baud, switch selectable.

**Tab cards dimensions:** standard tab card size 82.6 × 187.3 mm (3 1/4 × 7 3/8 inches) or 82.6 × 282.6 mm (3 1/4 up to 11 1/4 inches).

**Hopper capacity:** 450 cards input, 450 cards output.

**Interface:** RS-232C and CCITT V24.

**Interface Connectors:** 2 Cinch/Cannon DBM-25S-rear panel.

**Invalid Code:** transmits a selectable character when data outside 128 character set is marked.

**Mute and Line — Local Operation:** allows operation with local terminal, and allows muting of terminal Printer.

**Mnemonic Control:** allows 3 letter mnemonics to control Reader when control codes would interfere with system operation.

**Image:** transmits Binary card image as two typing characters with selectable parity, activated by control codes from computer.

### 7261A Optical Mark Reader Specifications

**Card code and output codes:** the information from each card is converted by the Reader to a parallel 12-channel format. Tab cards dimensions: standard tab card size, 82.6 × 187.3 mm (3 1/4 × 7 3/8 inches) or 82.6 × 282.6 mm (3 1/4 up to 11 1/4 inches).

**Hopper capacity:** 450 cards input, 450 cards output.

**Interface connector:** 36 Pin Cinch Micro-Ribbon — rear panel.

### Common Specifications

**Dimensions:** 610 × 368 × 305 mm (24 × 14 1/2 × 12 inches).

**Weight:** net, 24.6 kg (54 lb). Shipping, 33.2 kg (73 lb).

**Environment (exclusive of tab cards)**

**Storage temperature:** -40°C to +75°C.

**Exposure power on:** -20°C to +65°C.

**Meets specifications:** 0°C to +55°C.

**Humidity:** 5%-95% at 25°C to 40°C.

**Vibration:** 10-55 Hz, 01 in. peak-to-peak excursions.

**Environment (tab cards):** from 20% to 75% RH at 23°C.

**AC Power:** (see Option 005 for 220/240 V ac operation) 100 or 120 V, ac, +5% - 10%, switch selected 47.5 Hz, 66 Hz; 300 VA.

**Line fuse:** 4 A SB.

**Transformer fuse:** 2 A SB.

**U.L. approval:** the reader has U.L. approval and meets IEC specifications.

A typical mark sense form.



### Options

002: Select Hopper

003: Encoder

004: Bell

005: 220/240 V ac +5% - 10% (line fuse 2 A SB, Transformer 1 A SB).

006: 50 Hz operation

007: Wider input hopper (+0.5 mm/0.2 inch) for use with forms of nominal standard burst from continuous line printer stationery.

300: Operating manual for 3000 series II system (7260A only)

421: DOS III B Logical Driver (7260A only)

### Price

add \$230

add \$230

add \$60

N/C

N/C

add \$70

add \$10

add \$55

### Ordering Information

7260A Optical Mark Reader

\$4295

7261A Optical Mark Reader

\$3995

12986A Optical Mark Reader Subsystem

\$4795



2635A

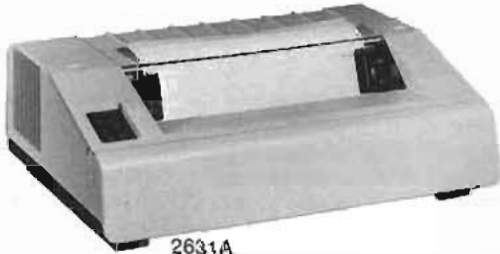

2631A

Hewlett-Packard has developed a dynamic family of hard-copy printers and terminals which set new standards in flexibility and user convenience while maintaining traditional high reliability and low cost of ownership.

The initial HP 2630 family members are the HP 2631A Printer and the HP 2635A Printing Terminal.

#### 2630 Family features

- Three Print Modes
- Auto Underline
- 128-Character Set
- Optional Secondary Character Set
- Long Life Print Head
- Easy Loading Ribbon Cartridge
- Convenient Installation
- Multiple Vertical Line Spacing
- High Throughput
- Simple Mechanical Design
- Interfacing Flexibility
- Forms Handling Variety
- Functionally Grouped Terminal Keyboard

#### Model 2631A Printer

**High Throughput:** the 2631A Printer is a smart bidirectional printer. Under microprocessor control, the printer constantly evaluates incoming data to determine the most efficient print directions based on the line length and current position of the print head. Ten or more embedded space characters are detected and cause the print head to skip these at high speed. Lines without printable characters result in a high speed paper slew to the next printable line. The result is maximum throughput for any given input.

The design limit print speed on a serial character basis is 180 characters per second. Using smart bidirectional printing, this translates to a line per minute speed in normal mode ranging from 70 lines per minute for full 136 character lines to 500 lines per minute for 10 character lines.

**128-Character set:** the standard 2631A provides a full 128-USASCII character set. The 7 x 9 dot character cell allows high resolution printing of true lower case characters and, with the display function enabled, representation of ASCII control codes. An optional secondary character set can be selected by control codes when required for the output.

**Long life print head:** the durable print head used in the 2631A is conservatively rated at 100-million characters and, to keep cost of ownership low, has been designed to be easily cleaned and, when required, replaced by the operator.

**Easy loading cartridge ribbon:** the ribbon is contained in a unique plastic cartridge and is easily removed and installed without touching the ribbon itself. Drive for the ribbon is provided by print head motion eliminating the need for a separate ribbon drive motor or electronics.

**Multiple vertical line spacing:** seven different vertical line spacings from 1 line per inch through 12 lines per inch are program selectable. Line spacing of 6 and 8 lines per inch can be selected from the control panel. Using 12 lines per inch spacing, true superscripts and subscripts can be printed.

**Interfacing flexibility:** interfaces are available for a wide range of applications. The standard interface for the 2631A is a Hewlett-Packard 8-bit differential line drive for use with the 12845B interface board in the HP 2100 family of computers.

#### Model 2635A Printing terminal

The 2635A Printing Terminal has the same features and printing capabilities of the 2631A plus additional advantages to meet the responsibilities required for full-scale terminal operations. The functionally grouped terminal keyboard is easy to use and will fill the needs of a wide range of applications.

Self test, display functions and special programming capabilities are additional convenience features of both machines.

**Interfacing flexibility:** interfaces are available for different applications. The standard interface for the HP 2635A is an EIA Standard RS232C asynchronous interface without modem control and is compatible with Bell 103 and Bell 202 type modems.

#### HP 2630 Family specifications

##### Physical

**Height:** 216 mm (8.5").

**Width:** 640 mm (25.2").

##### Depth:

**Printer:** 470.4 mm (18.5").

**Terminal:** 595.4 mm (23.4").

##### Weight

**Printer:** 23 kg (51 lb).

**Terminal:** 26 kg (57 lb).

**Stand Assembly:** 24 kg (53 lb).

##### Clearance

**Front and rear:** adequate for operator access.

**Sides:** 76 mm (3 inches).

##### Performance

**Character formation:** dot matrix (7 x 9).

**Print direction:** bidirectional (left-to-right and right-to-left).

**Printing speed:** 180 characters per second.

##### Line feed rate

**6 LPI:** 24 msec/line.

**8 LPI:** 18 msec/line.

##### Form feed rate

**6 and 8 LPI:** 176.6 mm/sec (6.96 in./sec).

**Copies:** 1-6 copies up to 0.43 mm thickness.

**Print modes:** Normal, Expanded, Compressed.

##### Forms use

The HP 2631A and HP 2635A will accommodate edge perforated forms varying in width from 400 mm (15.75 in.) edge-to-edge to 31 mm (1.22 in.) perforation to perforation, and thickness from 0.08 mm (0.003 in.) to 0.43 mm (0.017 in.). Single or multiple part forms including card stock and glued edge forms may be used interchangeably. Multiple part forms and card stock should be tried for satisfactory feeding, registration and print quality.

##### Vertical Format Control

**Number of channels:** 8 non-programmable.

##### Environmental

###### Temperature

**Non-Operating:** -55° to 75°C (-67°F to 167°F).

**Operating survival:** -20°C to 65°C (-4°F to 149°F).

**Operating:** 0°C to 55°C (32°F to 131°F).

###### Humidity

**Non-Operating:** 65°C (149°F) @ 90%.

**Operating:** 40°C (104°F) @ 5% to 95%.

**Heat dissipation:** 265 watts.

#### Ordering Information

2631A Printer

2635A Printing Terminal

#### Price

\$3150

\$3450

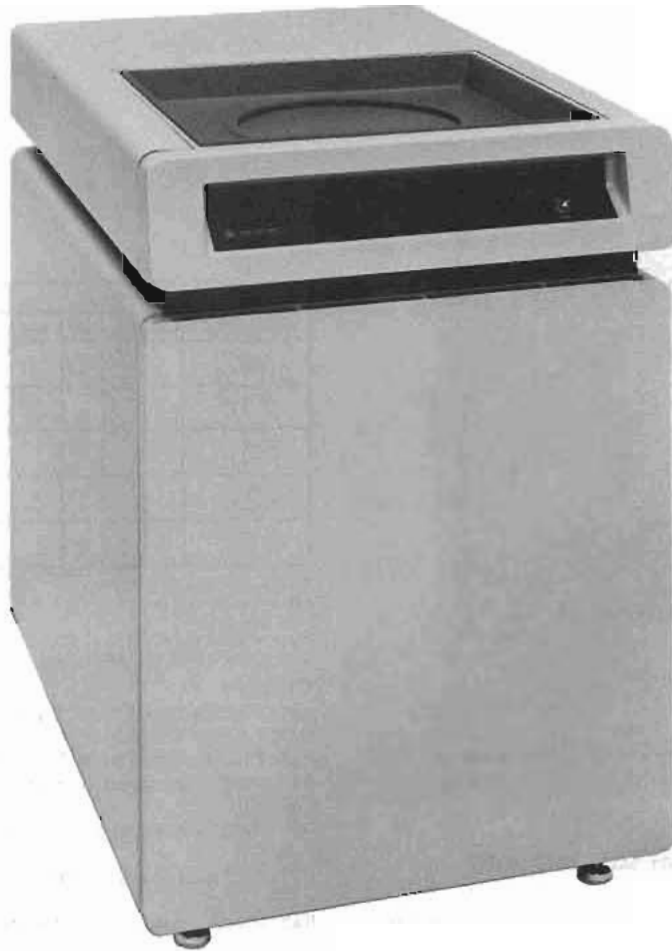

7920

## HP 7920 50 Megabyte Drive

The 7920 Disc Drive is a random access data storage device utilizing a top loading removable disc pack. This highly reliable Disc Drive utilizes track follower servo-feedback head positioning to provide exceptional performance over a wide temperature range. On the disc pack, 50M bytes of formatted data reside on 5 surfaces with one surface reserved for servo information. The operator's panel has indicators for unit select, drive ready, read only, door unlocked and drive fault. Should a fault occur, an advanced service feature identifies the fault through a group of LED indicators. The master drive includes: enclosure, 13037B controller, disc pack and cabling.

### Condensed Specifications

#### Seek Time:

Track-to-track 5 ms (max).  
Average random 25 ms (avg).  
Maximum stroke 45 ms (max).

**Data transfer rate:** 937.5 kilobytes/sec.

#### Power requirements

**AC voltages:** 100V, 120V, 220V, 240V, all  $\pm 5\%$  -10%.  
**Frequency:** single phase, 47.5 to 66 Hz.  
**Power:** 460 watts @ 120V/60 Hz.

### Environmental Specifications

**Operational:** 10°C to 40°C (50°F to 104°F), 8% to 80% Rel. Hum. non-condensing.

**Non-operational** -40°C to 75°C (-40°F to 167°F), 5% to 95% Rel. Hum. non-condensing.

**Altitude:** sea level to 15,000 ft. (operational).  
-1000 ft. to 50,000 ft. (non-operational).

**Tilt:** up to  $\pm 30^\circ$  about either horizontal axis.

**Vibration:** 1.54g's at 55 Hz.

**Controller:** same as 7906/7905.

**Interchangeability:** the 7920 allows any disc pack written on any 7920, within its operating specifications, to be read on any other 7920 operating within that range. Error performance/interchangeability can be guaranteed only if HP 13394A Disc Packs are utilized.

### Ordering information

7920M Master Drive (50 MB)  
7920S Add-on Drive (50 MB)  
13394A Disc Pack

### Price

\$17500  
\$14000  
\$700

OE prices and discount schedules available

# COMPUTATION

Compact and reliable tape subsystems

Models 7970, 12970A, 12971A, 12972A

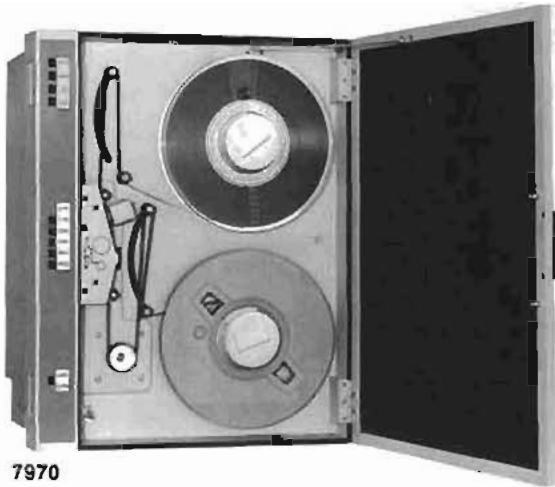

7970

Hewlett-Packard offers a wide variety of digital magnetic tape units in its 7970 Series, plus a number of fully interfaced magnetic tape subsystems.

## Magnetic tape subsystem for use with 2100/21MX based systems

**12970A Magnetic tape subsystem** \$9500  
NRZI format 7970B, 9-track tape drive subsystem. Provides 800 cpi capability at speeds of 25, 37.5, or 45 ips.

**12971A Magnetic tape subsystem** \$15,950  
NRZI format 7970B, 7-track tape drive subsystem. Provides switch selectable 200, 556, and 800 cpi capabilities at speeds of 25, 37.5, or 45 ips.

**12972A Magnetic tape subsystem** \$10,900  
Phase-encoded format 7970E, 9-track tape drive subsystem. Provides 1600 cpi capability at speeds of 25, 37.5, or 45 ips.

## 7970 Magnetic tape units

Hewlett-Packard Series 7970 Digital Magnetic Tape Units offer a compact and reliable solution to your tape system needs. Units are available in a wide range of 7-track and 9-track configurations utilizing either NRZI or phase encoded electronics. All Series 7970 Tape Units have been designed to include the same features you would expect to find in higher-priced and more complex equipment. Plus you receive complete interchangeability of data with other ANSI compatible equipment.

Reel motors provide direct drive, eliminating troublesome belts and pulleys. Tape tensioning is performed by photo-resistive controlled tension arms that eliminate the need for vacuum system components. Head assemblies consist of read stack, write stack and full width erase head. All major transport assemblies are easily accessible for servicing and/or replacement when required.

Model-Option	Density				master	slave	7-tr	9-tr	NRZI	PE	RO	RAW
	200	556	800	1600								
7970B-127 7970B-136	•	•	•		NA NA	NA NA	•	•	•			•
7970E-150 7970E-151				•	•	•	•	•	•			•
7970E-152 7970E-153				•	•	•	•	•	•			•
7970E-162 7970E-163			•	•	•	•	•	•	•			•
7970E-164 7970E-165	•	•	•	•	•	•	•	•	•			•

All above units operate at 45 ips

RAW = Read After Write

RO = Read Only

Master = Initial PE unit

Slave = additional PE unit (3 per master)

### Options

001: Change speed to 37.5 ips

002: Change speed to 25.0 ips

003: Change speed to 22.5 ips (7970E only)

007: Add front panel unit select (not available with Opt 020)

add \$155

020: Add front panel parity select (7970E-164 and 165 only)

add \$80

021: Add dual speed (7970E -162, -163, -164, and -165 only)

add \$105

048: For operation from 42 to 60 V dc source

add \$750

## Specifications, 7970 series

**Tape speed:** 22.5, 25, 37.5, or 45 ips.

**Real diameter:** up to 10.5 in. (26.7 cm).

**Tape:** computer grade.

**Width:** 0.5 in.

**Thickness:** 1.5 mils.

**Tape tension:** 8.5 ounces nominal.

**Tape format:** ANSI compatible.

**Rewind speed:** 160 ips.

**Start/Stop Travel:** Read-After-Write: 0.187 in.  $\pm$  0.020 in.

**Power requirements:** 115 or 230 ( $\pm$  10%) V ac, 48 to 60 Hz single phase. 400 VA maximum (on high line).

**Operating environment (hardware)**

**Ambient temperature:** 0 to +55°C (+32 to +131°F).

**Relative Humidity:** 20% to 80% noncondensing.

**Altitude:** 10,000 ft. (3 048 metres).

**Physical characteristics**

**Size:** 610 H x 483 W x 400 mm D (24" x 19" x 15.75"). Depth from mounting surface, 305 mm (12").

**Weight:** 63.5 kg (140 lb) maximum.

**Ordering Information**

7970B-127 Magnetic Tape Unit

\$6360

7970E-151 Magnetic Tape Unit

\$8885

For complete specifications and a list of accessories, request technical data sheets (7970B/C or 7970E). OEM prices and discount schedules are available.



Multiprogrammer: versatile I/O expander & converter  
Model 6940B

- Build Your Own Automatic System

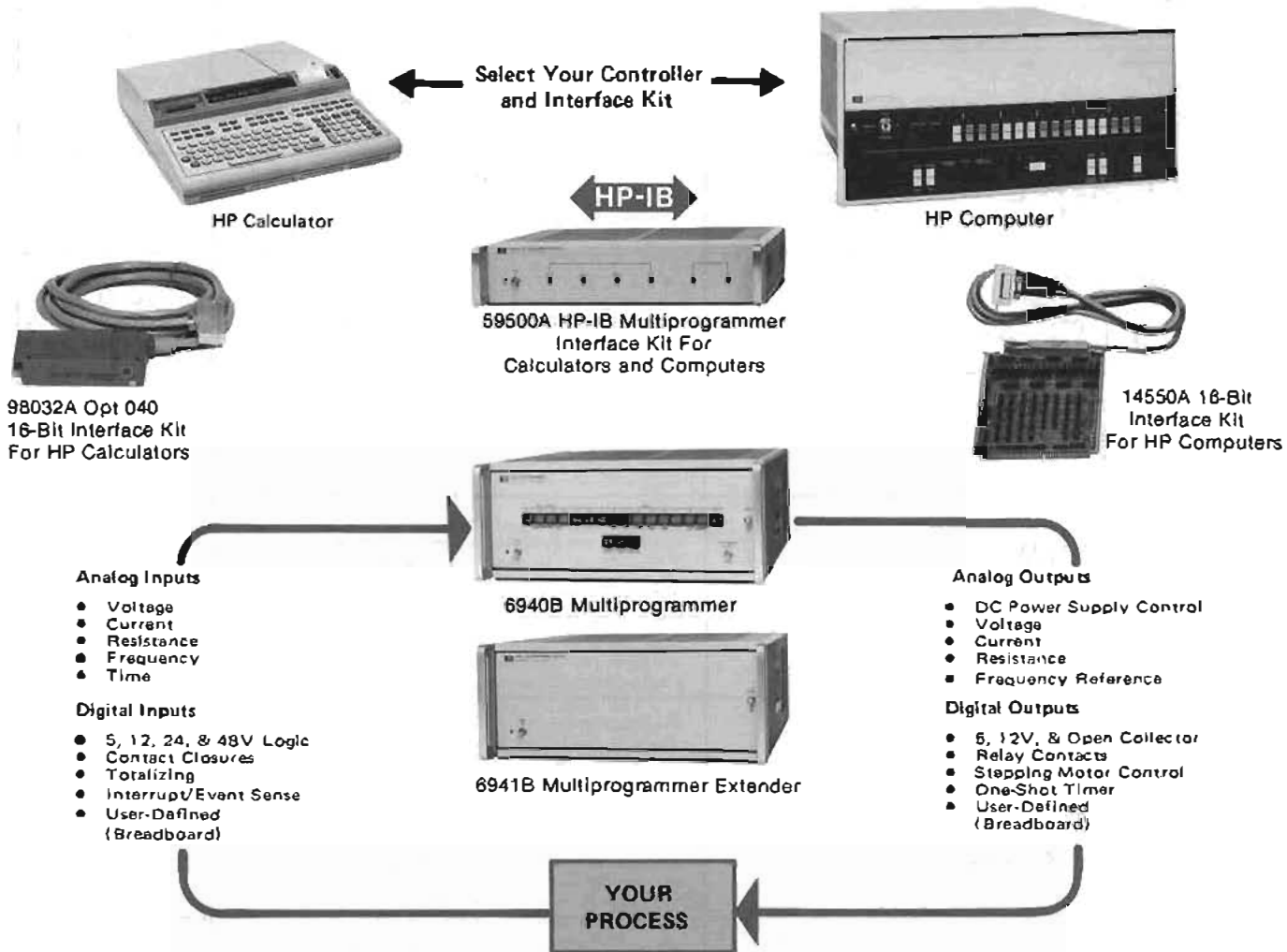

**Description**

The multiprogrammer is the vital link between a Hewlett-Packard desktop computer or minicomputer and your test or control process. As shown above, multiprogrammer products include interface kits, 6940B and 6941B mainframes, and a family of plug-in cards that provide the I/O capabilities shown above and on the next page.

Each 6940B Multiprogrammer mainframe holds up to fifteen plug-in cards. For additional I/O capability, a chain of up to fifteen 6941B Multiprogrammer Extenders may be cabled to the 6940B Multiprogrammer expanding the maximum capacity of the system to 240 plug-in cards.

Thousands of Multiprogrammers are in use now as part of user-defined-and-assembled systems for production testing and control, data acquisition, process monitoring, life testing, quality control, and component evaluation. Production Engineers find that the Multiprogrammer is a versatile and convenient instrument for industrial

measurement and control applications. Additional information for all multiprogrammer products is available in a free, 48-page brochure. Included are detailed specifications as well as applications, programming, and interfacing information. Ask your HP Sales Engineer for publication number 5952-3982, or use card at rear of catalog.

Additional information for all multiprogrammer products is available in a free, 48-page brochure. Included are detailed specifications as well as applications, programming, and interfacing information. Ask your HP Sales Engineer for publication number 5952-3982, or use the card at rear of catalog.









## COMPUTATION

## Multiprogrammer: versatile I/O expander &amp; converter

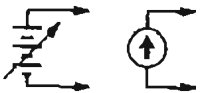
Model 6940B (cont.)

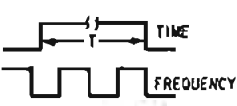
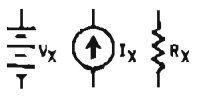
- Stimulus
- Measurement
- Control
- Data acquisition

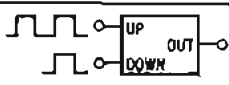
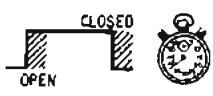
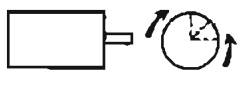
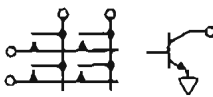
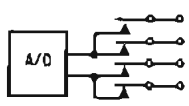
## Multiprogrammer I/O card function

	Functions	Applications	Cards Used
STIMULUS	 <p>Programmable DC Voltage and Current</p>	The output voltage (up to 100V) and current (up to 1000 A) of thirty-seven different HP power supplies can be programmed to provide bias in automatic test systems or control of electromechanical process equipment.	Resistance Output 69501A-69513A
	 <p>Digital-to-Analog Conversion</p>	Twelve bit voltage and current DAC's for strip chart, x-y, and analog tape recordings as well as control of analog programmable instruments and process control devices with 0-5 volt or 4-20 mA inputs.	Voltage DAC, 69321B, Current DAC, 69370A, Regulator 69351B
	 <p>Time and Frequency Reference</p>	One-shot timing pulses, programmable from 1 $\mu$ sec to 40 days, and crystal-controlled pulse trains in fixed frequencies of 1, 10, 100, 1 K, 10 K, and 100 kHz serve as time base references for control, measurement, and data acquisition.	Timer, 69600B; Frequency Ref. 69601B.
MEASUREMENT	 <p>Voltage, Current and Resistance Measurements</p>	Measure voltages in the presence of 100 V of common mode noise. Connecting a resistor across the input permits current measurements for 4-20 mA current loops used in process control. Combine voltage monitor and current DAC cards for resistance measurements.	Voltage Monitor, 69421A, Current DAC, 69370A, Regulator 69351B
	 <p>Frequency Measurements</p>	The pulse counter card accumulates counts over a precise time interval when a programmable timer card is connected to the enable line of the counter. The program divides the count by the time interval to measure frequencies from 200 kHz to 0.001 Hz.	Pulse Counter, 69435A, Timer, 69600B.
	 <p>Pulse Counting Preset Up/Down</p>	Counter may be preset to any value within count range of 0 to 4095. The program can examine the counter without disturbing the counting process (read on the fly).	Pulse Counter, 69435A.
	 <p>Time Interval Measurement</p>	Elapsed time between two events can be measured in the range of 10 $\mu$ sec to 1 hour by counting a known frequency over the unknown interval. The program divides the accumulated count by the known frequency to determine the interval.	Pulse Counter, 69435A; Frequency Reference, 69601B.
CONTROL	 <p>Stepping Motor Control</p>	One output word to card produces from 1 to 2047 square-wave pulses at either of two outputs (CW or CCW) to control motor translators. Output pulses are also used for pulse train update of supervisory control stations.	Stepping Motor Control, 69335A.
	 <p>Digital Output and Switching</p>	Twelve bits of data in TTL, open collector, or SPST relay-contact form provide digital control of instruments, indicators, and solid-state AC relays.	TTL, 69331A; Open Collector, 69332A, Relay Out, 69330A, Relay Out/Readback, 69434A.
ACQUISITION	 <p>Scanning and Input Multiplexing</p>	Simple single-ended switches or multi-wire scanner matrices are formed by interconnecting relays on a Relay Output or a Relay Output/Readback Card. The relay output card scanners act as input multiplexers for Voltage Monitor, Pulse Counter, and Digital Input Cards.	Relay Output, 69330A, Relay Output/Readback, 69433A.
	 <p>Event Sensing</p>	It is often necessary for a system to respond quickly to alarm conditions, operator intervention or other requests for immediate service. This service request is made via a program interrupt generated by either an event sense or a process interrupt card.	Event Sense, 69434A; Process Interrupt, 69436A.
	 <p>Digital Input</p>	Digital input cards accept 12 bits of data from digital measuring instruments, push buttons, switches, relays, and other digital devices in the form of logic levels or contact closures. Digital data sources with more than 12 bits of data use several digital input cards.	Digital Input, 69431A, Isolated Digital Input, 69430A

New Multiprogrammer plug-in cards are being developed. Ask your HP Field Sales Engineer for the latest technical data describing all Multiprogrammer products.

## Desktop Computer—Based Multiprogrammers

Unless your automatic system requires the high-speed execution of a computer, there's a good chance you can take advantage of the economy, flexibility, and ease-of-programming offered by a desktop computer-based multiprogrammer. The heart of the multiprogrammer approach to real-time system design is the HP Desktop Computing Controller.

**9825A HPL language computing controller:** a powerful programmable calculator that features a high-level language particularly suited to controller applications. Designed principally for engineering, research, and statistics use, it has many features previously found only in minicomputers.

A basic system includes an HP desktop computing controller, a 6940B Multiprogrammer, from one to fifteen plug-in I/O cards, and the interfacing accessories of your choice. Model 6941B Extender mainframes and additional I/O cards can be used to further expand the system.

### HP-IB Interfacing Accessories

For HP-IB systems, a 59500A Multiprogrammer Interface unit is required, together with the HP-IB interface card associated with your computing controller (98034A card for 9825A controllers).

### HP-IB Multiprogrammer Cabling

**Computing controller-to-59500A interface unit:** One HP-IB cable No. 10631 supplied with the controller interface card. Additional 10631 cables can be ordered separately in 1, 2, or 4 metre lengths.

**59500A-to-6940B:** Standard 18-inch (0.46 m) chaining cable No. 14541A, supplied with 59500A.

**6940B-to-6941B:** Standard 18-inch (0.46 m) chaining cable No. 14541A, purchased separately. Lengths up to 100 ft (30 m) are available on special order.

**Plug-in card-to-users device:** 14555A connector provided with most multiprogrammer plug-in cards for user to fabricate own cable.

### 16-Bit Duplex Interface

The multiprogrammer can also be interfaced directly to a 9825A computing controller using the 98032A, Option 040, controller interface card. The 98032A, Option 040 includes the basic interface card, a boot, and a cable that comes ready to connect to the 6940B mainframe.

### Documentation Package

A complete documentation package is supplied with each purchase, including a User's Guide for the selected desktop computer, a Multiprogrammer User's Guide, and Operating and Service Manuals for the various Multiprogrammer mainframes, plug-in cards, and accessories.

### Minicomputer-Based Multiprogrammers

Hewlett-Packard computers are interfaced to most Multiprogrammers with HP Interface Kit 14550A. The kit contains the HP computer-to-6940B cable, verification and driver software, and plug-in cards and cable.

### 14550A Interface Kit for HP Minicomputers

This kit provides all the equipment necessary to install, verify, and operate a Multiprogrammer with HP 2100 series computers. This kit includes:

1. A specially modified 12566B card, 16-bit duplex register card that plugs into the HP computer. Hardware manuals, a test connector and a software verification routine for the microcircuit card are provided in the kit.
2. A 14540A Multiprogrammer-to-12566B 12-ft (3 m) cable.)
3. A 69431A Digital Input Card with Option 095, 69331A Digital Output Card, 14550-60001 Slot Verification Cable, and 14910A Complete Diagnostic tape. This equipment is used to completely test the digital paths between the computer and the Microcircuit card, 14540A cable, Multiprogrammer Mainframe, 14541A Chaining Cables, 6941B Multiprogrammer Extenders and each Multiprogrammer plug-in I/O slot. The diagnostic also tests the front panel lamps and proximity switches by interfacing with the operator.
4. Binary object tapes and software operating manuals for BCS, (DOS/DOS-M), and RTE Multiprogrammer Drivers. Also included is a tape and manual for the RCS Multiprogrammer Library that allows the Multiprogrammer BCS Driver to be used with FORTRAN or ALGOL.
5. Instructions that allow you to completely test the Interface Kit and Mainframes. On-site installation by HP is not included with the kit. The kit is designed to help you become familiar with the Multiprogrammer as you install it and verify its operation.

**14540A Main input cable:** This 12-ft (3 m) cable connects the Multiprogrammer to the specially Modified Ground True 12566B Microcircuit Card. This cable is included in the 14550A Interface Kit.

### Common Accessories

The following multiprogrammer accessories are common to all types of interfaces:

**14541A chaining cable:** This cable connects 6940B to 6941B Mainframes and 6941B to other 6941B's. Cable is 18" long (.46 m).

**14533B pocket programmer:** The pocket programmer is used to check digital input/output connector J1 of the 6940B. Changes in the switch positions on the pocket programmer are visible on the front panel of the 6940B, and the outputs of the 6940B proximity switches are available at test points on the pocket programmer.

**14534A pocket programmer cable:** The pocket programmer plugs directly into the 6940B. The 3-foot extender cable allows you to operate the pocket programmer in front of the 6940B.

**14551A multiprogrammer service kit:** This kit allows rapid troubleshooting of a multiprogrammer system to the plug-in board level to minimize system downtime. The basic kit includes: spare components for 6940B/6941B mainframes and plug-in I/O cards, spare plug-in boards for mainframes, software and hardware necessary to run diagnostic tests on a desktop computer or minicomputer-based multiprogrammer, an extender card, and complete service documentation. If desired, the kit can be expanded in accordance with specific needs of the user.

## Condensed Specifications

### 6940B/6941B Common Specifications

**Input/output card positions:** Maximum of 15 plug-in input or output cards per mainframe. Hinged front panel provides access.

**Mainframe data connectors:** Two 50-contact, ribbon connectors.

**Data transfer rate:** up to 20,000 words/second.

**Maximum data resolution:** 12 bits per plug-in card.

**Accessories furnished:** Data Input Plug, PC Board Extender Card.

**Cooling:** Natural convection.

**Temperature:** 0°C to 55°C operating, -40°C to +75°C storage.

**Size:** 172.2 H × 425.4 W × 539.8 mm D (6.78" × 16.75" × 21.25").

**Power:** 100/120/220/240 V ac (selectable, 48-440 Hz, 230 watts).

**6940B Specifications**

**Front panel controls:** Power ON/OFF switch and indicator lamp, REMOTE/LOCAL switch for selecting computer or manual control, 19 proximity switches for manual data entry and control.

**Weight:** net, 15.9 kg (35 lb). Shipping, 19.5 kg (43 lb).

**6941B Specifications**

**Front panel controls:** Power ON/OFF switch and indicator lamp.

**Weight:** net, 15.2 kg (33.5 lb). Shipping, 18.3 kg (40.3 lb).

**Programmable Plug-In Cards****Output Cards**

**69500A-69506A Resistance Output Cards:** Provides a single 12-bit resistance programming channel. The programming coefficients of these models are compatible with HP programmable power supplies equipped with Option 040. Model 69500A is supplied without resistors allowing the user to install his own.

**69510A-69513A Resistance Output Cards:** Provides two 6-bit resistance programming channels; these models program the current limit of HP power supplies equipped with Option 040.

**69321B Voltage D/A Converter Card:** Provides a high speed, bipolar output voltage. Output range is from -10.240 to +10.235 V, at 0-5 mA. Conversion speed is 30  $\mu$ sec maximum to within 5 mV of final value. (69351B voltage regulator also required.)

**69330A Relay Output Card:** Provides 12 separate form A (SPST, normally open) mercury-wetted contact outputs that reflect the status of 12 programmed data bits. Includes gate/flag circuits for exchange of control signals with user's device.

**69433A Relay Output/Readback Card:** Provides 12 separate form A (SPST, normally open) mercury-wetted contact outputs. Also supplies 12 input data lines that can be read by the controller and which indicate the relay coil voltage status.

**69331A Digital Output Card:** Provides programmed microcircuit logic level outputs on 12 separate output lines. Card includes gate/flag circuits for exchange of control signals with user's device.

**69332A Open Collector Output Card:** Provides 12 open-collector driver outputs. IC buffers on the card act as switches for voltages up to 30 volts dc and currents up to 40 mA.

**69335A Stepping Motor Control Card:** Used to drive stepper motor and pulse-update type controls. Can be programmed to generate from 1 to 2047 pulse outputs to either of two terminals.

**69600B Programmable Timer Card:** Can be programmed to generate crystal controlled, one-shot timing pulses. Time increment is variable from 1  $\mu$ s to 40 days.

**69380A Breadboard Output Card:** This card allows user to design and build a custom analog or digital output card. Card includes basic address, storage and control signal buffer circuits.

**69325A-69328A Power Amplifier Control Cards:** Provides resistance outputs for controlling the voltage, current and gain of HP Model 6825A-6827A Power Supply/Amplifiers

\$1500

**69601B Frequency Reference Card:** Provides six fixed square wave outputs derived from a 1 MHz crystal at frequencies from 1 Hz to 100 kHz.

\$250

**Input Cards**

**69421A Voltage Monitor Card:** This card monitors bipolar dc voltages in the range of +10.235 to -10.240 V, and returns a 12-bit two's complement digital word to the controller to indicate the magnitude and sign of the measured voltage. Up to 150 conversions per second can be performed as commanded by the program or an external gate input.  $\pm 1$  V and  $\pm 100$  V inputs available

\$400

**69431A Digital Input Card:** This card monitors 12 bits of TTL, DTL, or contact closure data from user's device. Card includes gate/flag circuits for exchange of control signals with user's device. Return bits to controller reflect the status of 12 input bits.

\$210

**69430A Isolated Digital Input Card:** This card monitors 12 bits of input data from user's device. All input lines are isolated from one another and from the Multiprogrammer power supply. Eight options of the card are available to accommodate either ground-true or positive-true logic sense inputs and various input levels.

\$250

**69434A Event Sense Card:** This card compares the magnitude of an external 12-bit input word with a stored reference word and generates a service request for any of four conditions, depending on the placement of a jumper on the card. The four possible conditions are: In > Ref, In  $\neq$  Ref, In > Ref, In < Ref. The reference word is loaded from the controller. Both the input and reference words can be read back to the controller.

\$400

**69435A Pulse Counter Card:** This card counts pulses, up or down, in the range of 0 to 4095. A carry or borrow pulse is generated as the count goes above 4095 or below 0. These pulses allow multiple counter cards to be cascaded for greater counting capability or they can serve as alarm signals. The card can also be used as a pre-set counter

\$250

**69436A Process Interrupt Card:** This card provides TTL and open collector compatible edge detectors; one positive and one negative for each of 12 storage latches. Logic transitions lasting 100 ns or longer are detected, stored, and used to generate a service request to the controller.

\$400

**69480A Breadboard Input Card:** Allows user to design and build a custom analog or digital input card. Card includes basic address and control circuits.

\$125

**59500A Interface Unit Specifications**

\$700

Converts the serial ASCII alphanumeric of the HP-1B to the 16-bit parallel format required by the 6940B/6941B Multiprogrammer. The 59500A design is optimized for ease of programming the 6940B/6941B.

**Front panel controls:** Power ON/OFF switch and indicator. LED's indicate mode and gate/flag status between HP-1B and the Multiprogrammer for system check-out and maintenance.

**Cooling:** Natural convection.

**Temperature:** 0°C to 55°C operating; -40°C to +75°C storage.

**Size:** 82.6 H  $\times$  425.4 W  $\times$  463.6 mm D (3.25"  $\times$  16.75"  $\times$  18.25").

**Weight:** 5.4 kg (12 lb).

**Power:** 100/120/220/240 V ac (selectable) 48-440 Hz. 15 W.

\$1100

\$250-\$300

\$300

\$300

\$250

\$250

\$210

\$130

\$200

\$300

\$125

\$400



### Laser Measurement

The Hewlett-Packard 5526A Laser Calibration System utilizes a precisely-known wavelength of light to provide a portable, easily used dimensional measurement tool for such parameters as length, angle, straightness, squareness and flatness.

The 5526A Laser Calibration System is used in a wide variety of applications where very accurate physical measurements are required, such as characterizing the positioning accuracy and geometry of machine tools and measuring machines.

A wide variety of output devices are available to record the measurement data including digital printers and X-Y recorders. The Option X55 Laser/Calculator System allows the measurement data to be transferred directly from the Laser Calibration System to the 9815A Programmable Calculator and immediately processed by pre-written metrology programs. The reduced data is then presented in either printed format or plotted to provide report quality graphs of the measurements.

### Quartz Crystal Technology

Hewlett-Packard laboratories have developed quartz crystals which respond to temperature or pressure with amazing

linearity, stability, accuracy, and sensitivity. Quartz crystals resonate in electronic oscillator circuitry at a very precise frequency. Hewlett-Packard has discovered a way to produce quartz crystals whose resonate frequencies vary extremely linearly with temperature or pressure. For example, the resonate frequency of a 2804A temperature sensing crystal varies 1000 Hz (nominal) per °C. These resonate frequencies are conditioned by electronic circuitry to produce exceptionally high resolution temperature or pressure measurements.

### Digital Thermometer

HP's 2804A Quartz Thermometer provides extremely precise, reliable measurements with standard resolution of 0.0001°C over the range -80 to +250°C. The excellent sensing characteristics of the quartz thermometer are enhanced by the advantages of *direct digital readout* (no bridge balancing, or reference to resistance- or voltage-temperature tables or curves), immunity to noise and cable resistance effects, and no requirement for external equipment such as reference junction. Temperature can be measured up to 4500 feet from the 2804A with optional amplifiers.

Nearly all intermediate range digital thermometers use resistance, thermistor, or thermocouple sensors. Because of its good sensing characteristics, Hewlett-Packard uses a platinum resistance sensor in its general purpose 2802A thermometer. Platinum resistance sensors have very good accuracy, stability, linearity and reproducibility. The 2802A features two ranges: -200°C to +600°C with 0.1°C resolution and -100°C to +200°C with 0.01°C resolution. The display unit may be used with other HP snap-in modules to make a voltmeter, a multimeter as well as other instruments.

### Quartz Pressure Gauge

The Hewlett Packard 2811B Quartz Pressure Gauge can detect pressure changes as small as 0.01 psi in 10,000 psia. Precision pressure measuring capability and rugged construction make the HP 2811B Quartz Pressure Gauge (Probe and Signal Processor) ideal for applications requiring surface readout such as oil well logging, oceanographic research, and studies of subterranean hydrodynamics. The 2811B recording options can be connected directly to the pressure gauge output for direct readout, strip chart recording or digital printout of pressure data.

# PHYSICAL AND OPTICAL MEASUREMENTS

## Laser transducer for "build-in" applications

### Model 5501A

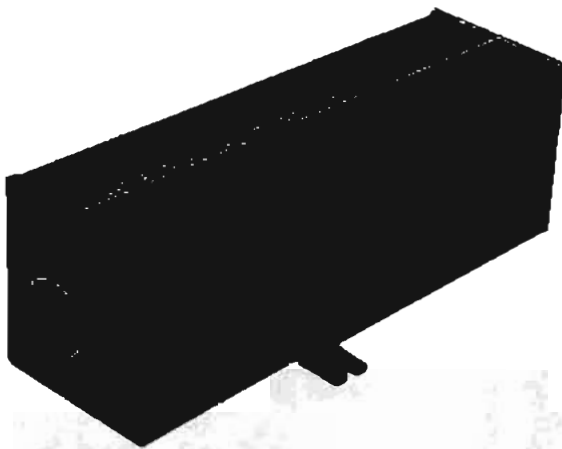

HP-IB



### Systems description

The 5501A Laser Transducer is the basis of a linear displacement measuring system which brings the many advantages of interferometry to builders and users of accurate positioning equipment at a cost comparable with conventional devices. Using a single laser source, up to 6 axes of motion may be monitored simultaneously. This feature plus numerous other design innovations, significantly lowers the cost of laser interferometer feedback. A range of output devices offers the choice of feedback control or digital display. Although the Laser Transducer is designed for original equipment manufacturers (OEM), simple installation techniques make it attractive for retrofit by end-users as well.



### Optional accessories

A wide variety of Interferometers, Retroreflectors, Beam Splitters, and Beam Benders allow application of the 5501A Laser Transducer to the most complex measurement problems.

**Linear Interferometer:** most economical and widely used for linear displacement measurements.

**Plane mirror Interferometer:** used for precision measurement and control of X-Y stage motion.

**Single beam Interferometer:** extremely small linear measurement interferometer for applications where size and weight are critical.

**Beam splitters and benders:** optical components to divide and direct the laser beam to the individual measurement axes.

### Electronic outputs

A range of output formats are available for the 5501A Laser Transducer which provide compatibility with a wide variety of measurement applications.

**Computer interface electronics:** interface the 5501A Laser Transducer to virtually any digital processor or controller. This universal binary interface is ideal for position control systems with the most demanding response requirements.

**Calculator interface electronics:** based on Hewlett-Packard Programmable Calculators and the Hewlett-Packard Interface Bus provide completely integrated measurement packages. Designed for acquiring, reducing and displaying measurement data, this interface allows simple application of the 5501A Laser Transducer to a wide variety of measurement oriented machines.

**English/metric pulse output electronics:** provide a universal interface to almost all numerical controls for machine tools. Designed primarily to facilitate installation of the 5501A Laser Transducer on machine tools by Original Equipment Manufacturers, this interface provides inch or metric value pulses over a wide range of resolutions.

### Specifications

**Resolution:** 0.16  $\mu\text{m}$  (6 microinches) or 0.08  $\mu\text{m}$  (3 microinches) using Plane Mirror Interferometer. Resolution Extension can increase measurement resolution up to a factor of 10.

**Accuracy:**  $\pm 0.5$  parts per million.

**Range:** up to 60 meters (200 feet) depending upon conditions (sum of axes for multi-axis configurations).

**Number of axes:** up to six, depending on system configuration and environmental conditions. Maximum allowable measurement velocity: 18.3 meters/min (720 inches/min).

### Ordering information

Ordering Information	Price
5501A Laser Transducer	\$5585
10780A Receiver	\$450
10700A 33% Beam Splitter	\$350
10702A Linear Interferometer	\$1350
10703A Retroreflector	\$550
10707A Beam Bender	\$250

### 5501A Options

261: Hewlett-Packard Interface Bus Electronics	\$5766
450: English/Metric Pulse Output	\$7136
Other optical and electronic interface options available; please request 5501A data packet.	



Model 5526A Laser/Display System Base

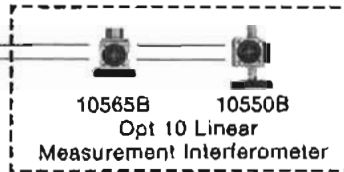

Choice of options for Length, Angle, Flatness, Straightness Non-contact and 2 Axes

### Configuration

The 5526A Laser Measurement System is a major advance in economical dimensional metrology. A choice of options allows the measurement of length, angle, flatness, straightness, squareness, and parallelism. In addition, output options are available to reduce the data to printed or plotted format. The 5526A, which forms the base of the system includes the 5500C Laser Head and the 5505A Laser Display. Measuring and output options are added to this base system to allow modular build-up of measurement capability.

### General capabilities

The system is a highly accurate displacement measuring tool with a resolution of one millionth of an inch (0.01  $\mu\text{m}$ ) for linear measurements and 0.1 arc-second for angular measurements. Fully automatic tuning, instant warm-up and remote interferometric measurement techniques assure drift-free accuracy from the moment of switch-on. A laser tube lifetime in excess of 10,000 hours can be confidently expected and the unique optical heterodyning principle makes for practical, convenient measurements in adverse environments.

### Measurement options

#### Opt 010 linear Interferometer

This option consists of the 10565B Remote Interferometer and a 10550B Retroreflector. Since the Remote Interferometer is completely passive, it makes for an almost perfect linear measuring instrument. Complete thermal stability is assured since the laser head can be some distance away on a tripod.

#### Opt 020 linear + angular/flatness Interferometer

While including all the capabilities of the Option 010 Linear Interferometer, this option also provides angular measurement ability. The addition of passive optical modules allows fast, accurate measurements of pitch, yaw, or flatness. The option also includes two turning mirrors designed especially for rapid calibration of surface plates.

#### Opt 030 straightness Interferometer

This option converts the 5526A into an interferometric straight-edge. Lateral deviations from a perfectly straight line are displayed to a resolution of one millionth of an inch (0.1  $\mu\text{m}$ ) over an axial range of 10 feet (3 m). Unlike alignment lasers, the Hewlett-Packard system does not depend on the pointing stability of the laser beam for its reference, but instead uses two rigidly mounted plane mirrors and a special prism interferometer. A long range version (Option 31) is also available with a resolution of ten millionths of an inch (0.1  $\mu\text{m}$ ) over an axial range of 100 feet (30 m).

Ideal for determining geometric characteristics of machine tools, the Straightness Option can also measure such parameters as parallelism and with an optional optical square, squareness.

#### Opt X55 series laser measurement/calculator systems

The combination of the 5526A Laser Measurement System with the Model 9815A Calculator provides a complete problem solving system for a wide variety of measurements.

A package of metrology applications programs enables fast data reduction and plotting of measurements such as surface plate calibration, lead error analysis and geometry characteristics of machine tools and measuring machines, including straightness, parallelism and squareness. One important program included implements the NMTBA (National Machine Tool Builders Association) recommendations for accuracy and repeatability of numerically controlled machine tools.

#### 5510A Automatic compensator

The 5510A Automatic Compensator provides accurate, continuous correction for variations in the refractive index of air and for temperature of the material being measured. Air temperature, pressure, humidity and material temperature are measured by rugged sensors designed especially for use in machine shops.

### Additional options

Other options to the 5526A Laser Measurement System are available including a Single Beam Interferometer which in conjunction with the non-Contact Converter measures displacement of reflective surfaces. The Plane Mirror Converter when added to the Remote Interferometer of Option 010 allows measurements from a plane mirror surface with relative insensitivity to mirror tilt.

### Brief specification

#### 5526A Laser/display

**Laser:** Helium-Neon type. Fully automatic tuning. Instant warmup. Accuracy (for all linear displacement measurements):  $\pm 0.5$  parts per million  $\pm 1$  count (Metric  $\pm 0.5$  parts per million  $\pm 2$  counts).

**Resolution:** normal and smooth modes.

**Normal 0.000,01 in. Metric: 0.1  $\mu\text{m}$ .** Angular: 1 arc-sec X10: 0.000,001 in. Metric 0.01  $\mu\text{m}$ . Angular: 0.1 arc-sec.

**Maximum allowable signal loss:** 95% (-13 dB).

**Maximum measuring velocity:** 720 in/min (182 m/min).

**Atmospheric and material compensation:** manual input from tables. 5510A Automatic compensator optional.

#### Opt 10 linear Interferometer

**Accuracy:** as for 5526A Laser Display.

**Maximum measuring range:** up to 200 feet (60 m) depending on conditions.

#### Opt 20 linear + angular/flatness Interferometer

Linear specifications are as for Opt 10.

**Accuracy:**  $\pm 0.1$  arc-second ( $\pm 1$  count in last digit) up to  $\pm 100$  arc-seconds.  $\pm 1$  arc-seconds ( $\pm 1$  count in last digit) up to  $\pm 1000$  arc-seconds.  $\pm 4$  arc-seconds per degree ( $\pm 1$  count in last digit) up to  $\pm 10$  degrees using correction table.

#### Opt 30 short range straightness Interferometer

##### Accuracy

**Inch:**  $\pm 5$  microinches/foot  $\pm 1$  count in last digit.

**Metric:**  $\pm 0.4$  micrometer/meter  $\pm 2$  counts in last digit.

**Calibration:**  $\pm 3\%$  of reading.

**Resolution:** as for 5526A Laser/Display.

**Lateral range:**  $\pm 0.1$  inch ( $\pm 2.5$  mm).

**Axial range:** 10 feet (3 m).

#### Opt 31 long range straightness Interferometer

**Accuracy:** as for Opt 030.

**Calibration:**  $\pm 10\%$  of reading.

##### Resolution

**Normal:** 0.0001 inch (1  $\mu\text{m}$ ).

**X10:** 0.00001 inch (0.1  $\mu\text{m}$ ).

#### 5510A automatic compensator

5526A/5510A System accuracy (worse case):

- For air temperature within range 68-85°F (20-30°C) 1.3 ppm  $\pm 1$  count (metric 1.3 ppm  $\pm 2$  counts).
- For air temperature within range 55-105°F (13-40°C) 1.5 ppm  $\pm 1$  count (metric 1.3 ppm  $\pm 2$  counts).

#### 5526A Options

010 Linear Interferometer

020: Linear + Angular/Flatness Interferometer

030: Straightness Interferometer

900: Rack Flange Kit

X55: Laser Measurement/Calculator System

#### Price

\$4520

\$7140

\$4375

\$10

\$35,905

### Ordering Information

5510A Automatic Compensator

\$5150

5526A Laser/Display

\$11,795

# PHYSICAL & OPTICAL MEASUREMENTS

## Quartz pressure gauge

Model 2811B

- 0.01 psi resolution (69 Pa)
- 0.025% Full Scale Accuracy
- Direct Surface Readout

- Simple Operation
- Long Term Stability
- 200-11000 PSIA Range

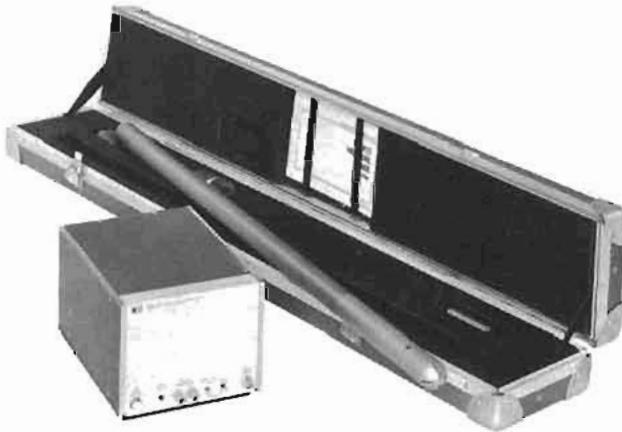

2811B Quartz Pressure Gauge

### 0.01 psi Resolution at 11 000 psi (69 PA @ 69 MPa)

The HP 2811B Quartz Pressure Gauge measures wellbore pressure with a resolution of 0.01 psi over a dynamic range in excess of 11 000 psi. This capability makes it possible to measure pressure changes that cannot be detected with conventional gauges using bourdon tube transducers.

This ability to detect and record small pressure changes allows sophisticated test techniques to be used economically. For example, since the super-sensitive HP Quartz Pressure Gauge can detect small pressure transients at observation wells, pulse tests can be conducted with extremely short pulse cycle times at the stimulus well. Because the shut-in time is reduced, the permeability and formation thickness between wells can be determined at a substantially lower cost.

With the 2811B recording options, pressure transients can be observed and recorded on the surface while the test is in progress. When the surface readout indicates the test is completed, the gauge can be retrieved immediately. Pressure data can be read directly without intermediate scaling or other calculations.

The 2811B Quartz Pressure Gauge was specifically designed for pressure measurement in oil and gas wells and it is used by many oil companies and well service companies. However, its high resolution pressure measuring capability and rugged construction also make it ideally suited for oceanographic research and subterranean hydrodynamic studies.

### Description

The 2811B consists of a 2813B Quartz Pressure Probe and a 2816A Pressure Signal Processor. A frequency signal proportional to pressure is transmitted from the bottom-hole pressure probe to the signal processor on the surface. It travels through a single conductor, armored electric line. The processor conditions the pressure-related signal to drive a separate electronic frequency counter for direct readout. If a preset counter is used (included in 2811B recording options), wellbore pressure will be displayed in psi. No scaling or intermediate calculations are necessary.

For field use, the 2811B Analog & Digital Recording Option is available. It provides a convenient method of obtaining direct visual

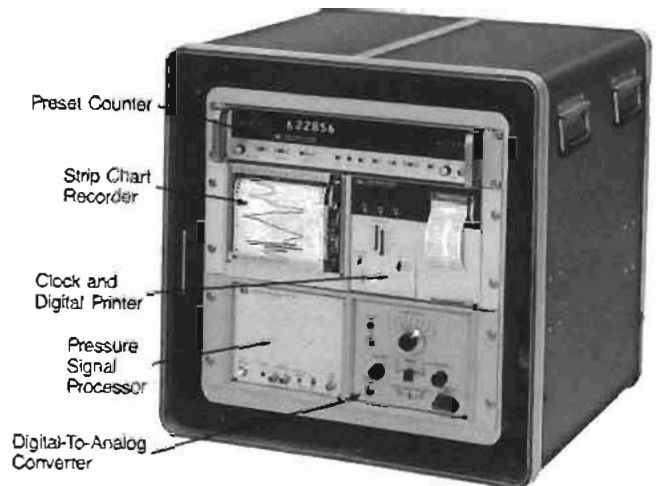

HP 2811 Analog & Digital Recording Option 026/027 Mounted in Field Case

display and a permanent record of pressure data. Pressure transients are recorded on a strip chart recorder and a digital printer. All instruments are shock mounted in a rugged field case to withstand rough handling.

### System specifications

**Sensitivity:** 105 Hz/psi nominal (105 Hz/6.9 kPa) output of signal processor.

**Probe operating pressure range:** 0–12 000 psi (0–82.7 MPa).

**Probe operating temperature range:** 32° to 302°F (0 to 150°C).

**Signal processor operating temperature range:** 32° to 131°F (0° to 55°C).

**Calibrated pressure range:** 200–11,000 PSIA (1.4–75.8 MPa).

**Resolution:** 0.01 psi (69 Pa) when sampling for a 1-second period.

**Repeatability:** ±0.4 psi (±2.76 kPa) over entire range.

**Accuracy (at thermal equilibrium) if operating temperature is known**

**within 1.8°F (1°C):** ±0.5 psi or ±0.025% of reading (±3.45 kPa or ±0.025%R).

**within 18°F (10°C):** ±1 psi or ±0.1% of reading (±6.89 kPa or ±0.1%R).

**within 36°F (20°C):** ±5 psi or ±0.25% of reading (±34.5 kPa or ±0.25%R).

### Dimensions and weights

**2813B Probe:** 17<sup>1</sup>/<sub>16</sub>" (36.5 mm) OD by 39<sup>7</sup>/<sub>8</sub>" (1000 mm) long.

Weight: 11 lb (5.0 kg).

**2816A Signal Processor:** 154 mm H × 197 mm W × 279 mm D (6<sup>1</sup>/<sub>16</sub>" × 7<sup>7</sup>/<sub>8</sub>" × 11")

### 2811B options

**026:** Analog & Digital Recording, 60 Hz, and English units

**027:** Analog & Digital Recording, 50 Hz, and Metric units

**Price**

add \$11,750

add \$11,750

### 2811B Quartz Pressure Gauge

**\$16,225**

Includes HP 2813B Quartz Pressure Probe and carrying case, calibration tables, manual and HP 2816A Pressure Signal Processor. Output of HP 2816A Pressure Signal Processor connects directly to recording options.





- 0.04°C Absolute Accuracy
- 0.0001°C or 0.001°F Resolution
- -80° to +250°C Range
- Display of Absolute or Differential Temperature
- Flexible HP-IB Systems Interface
- Variable Resolution Analog Output
- Easy Ice Point or Triple Point Adjustment



#### Ambient Temperature Stability

A temperature compensated crystal oscillator provides the internal reference time base. The displayed temperature will change less than 30 millidegrees C (54 millidegrees F) due to an instrument ambient temperature change from 0 to 55°C. A one MHz external frequency standard may be supplied to the 2804A through a rear panel connector to improve the ambient temperature stability.

#### 2804A specifications

**Temperature range:** -80 to +250°C (-112 to +482°F).

**Absolute accuracy:** less than 50 millidegree C (90 millidegree F) maximum error over the full temperature range with constant instrument temperature—NBS traceable to IPTS-68.

**Resolution three levels can be selected:**

Selection	Temperature Scale °C	°F
L	0.01	0.1
M	0.001	0.01
H	0.0001	0.001

#### General

**Display:** 7 digit LED with polarity, decimal, and degree C or F annunciator.

**Size:** 177 H × 212 W × 457 mm D (7" × 8.4" × 18").

**Probes:** a variety of probes are available for use with the 2804A. Refer to the data sheet for specifications and sheath configurations.

#### Options

**006:** Analog Output. Provides front panel controls, rear panel connector, and electronics for variable resolution analog output

**010:** HP-IB interface. Provides electronics, rear panel connector and display annunciators for HP-IB interface to computing controller or printer

#### Accessories and probes

**18107A** External Oscillator

**18108A** Line Amplifier

**18101A** Signature Analysis Diagnostic Kit

**18110A** Laboratory Probe and cal module, 25 mm (1")

**18111A** Laboratory Probe and cal module, 230 mm (9.1")

**18112A** Laboratory Probe and cal module 460 mm (18.1")

**18115A** Heavy Duty Probe and cal module, 30 mm (1.2")

**18116A** Heavy Duty Probe and cal module, 100 mm (3.9")

**18117A** Heavy Duty Probe and cal module, 180 mm (7.1")

2804A Quartz Thermometer

The 2804A Quartz Thermometer allows you to easily measure temperature with exceptionally high accuracy and resolution. Absolute accuracy is 40 millidegrees Celsius over the range of -50°C to 150°C, NBS traceable to IPTS-68. The useable resolution of 0.0001°C allows you to measure temperature changes that could not be detected by other digital thermometers.

The 2804A can be used with one or two temperature sensing probes. The temperature of either probe, or their difference, can be measured and displayed under pushbutton control. Display resolution is selectable from 0.01 to 0.0001°C (0.1 to 0.001°F) by pushbuttons. An internal switch allows you to easily select measurement in the Celsius or Fahrenheit temperature scale.

Temperature is measured and displayed automatically with the microprocessor and electronics provided in the 2804A package. There is no need to balance a bridge, perform calculations using resistance- or voltage-temperature tables or curves, or to use calibration correction tables. The only adjustment necessary to remove effects of thermal history on the sensor is a simple ice point or triple point calibration adjustment using the front panel thumbwheel switches.

#### How It Works

The 2804A temperature sensor is a quartz crystal whose precise angle of cut gives a stable and repeatable relationship between resonant frequency and temperature. Each quartz sensor is individually calibrated at the factory over the full temperature range. The calibration data for each sensor is processed and stored in a calibration module which is supplied with the probe.

In operation, a microprocessor in the thermometer performs the complex control and calculation operations to accurately measure temperature from the quartz sensor frequency and probe calibration information in the calibration module. The microprocessor also performs self-checks to detect fault conditions. If a problem occurs that would give an improper measurement, an error message is displayed to indicate the source of the problem.

#### System Oriented Design

The HP-IB option offers you a simple, yet flexible, way to connect the Quartz Thermometer to either an HP computing controller or printer. Temperature data can easily be sent to a calculator or computer for processing and recording. All front panel controls can be operated automatically by commands sent on the bus.

The optional analog output converts any three consecutive digits to a voltage between 0 and +10 volts to drive a chart recorder. Front panel controls allow easy adjustment of pen zero and full scale as well as normal or offset (center-zero) operation. Any three digits can be selected for conversion allowing you to change the full scale value on the recorder.

# PHYSICAL AND OPTICAL MEASUREMENTS

## Platinum Resistance Thermometer

### Model 2802A

- Dual Range Resolution
- Linear Analog Output

- Digital Temperature Display
- Simple one-point calibration



### Description

Two modular units make up the HP 2802A Thermometer: a thermomodule (lower unit) which contains temperature measuring circuits, probe connections, and operating controls; an HP 3740A display unit with 4½ digit light-emitting diodes, which snaps into place on the thermomodule. In addition, the display unit may be used with other HP snap in modules to make a voltmeter, a multimeter, a pre-amp ammeter, as well as other combinations offered by Hewlett-Packard in this catalog under Digital Voltmeters.

A variety of probes can be used with the 2802A. All HP probes offered are interchangeable and meet high standard, in-house electrical specifications which allow them to provide maximum accuracy. The HP 2802A drives very low current through the platinum sensor, so self-heating is negligible. Less than 0.1 mW is dissipated. A four-wire technique used to measure sensor resistance eliminates errors due to connector or lead resistances.

Rugged cast aluminum cases with shock resistant slides and chemically resistant paint provide ample protection for the HP 2802A in just about any operating environment.

### Specifications

These specifications are "total system specifications" meaning they apply to both the instrument and the probe working together (not just the best electronic specifications for the instrument by itself). HP 2802A Thermometer specifications relate directly to system performance under actual working conditions.

**Ranges:** -200° to +600°C and -100° to +200°C.

**Resolution:** 0.1°C on -200° to +600°C range.

0.01°C on -100° to +200°C range.

**Accuracy:** ±0.5°C ±0.25% of reading on both ranges.

**Display:** 4½ digits LED on HP 34740A Module.

**Stability:** ±0.2°C for 7 days (23°C ±5°C ambient).

#### Linear Analog Output

1 mV/°C on -200° to +600°C range (-0.2 V to +0.6 V F.S.)

10 mV/°C on -100° to +200°C range (-1.0 V to +2.0 V F.S.)

Voltage accuracy equal to that of digital display.

Output impedance 1 kΩ on both ranges.

**Environmental standard:** HP 2802A Thermometer operates within above specifications in environments of 0° to 50°C and up to 95% relative humidity over most of this temperature range. After calibration in some arbitrary ambient temperature, instrument calibration remains valid with ambient temperature changes up to 10°C.

**Power requirements:** operated on any of four, single phase ac line voltages: 100, 120, 220, or 240 volts rms (+5%, -10%), 48 to 440 Hz. Power dissipation is 8.7 volt-amperes.

**Dimensions:** thermomodule with display unit is 98 mm H × 159 mm W × 248 mm D (3 7/8" × 6 1/4" × 9 3/4").

**Weight:** net. 2.27 kg (5 lb). Shipping approx 3.39 kg (7 1/2 lb).

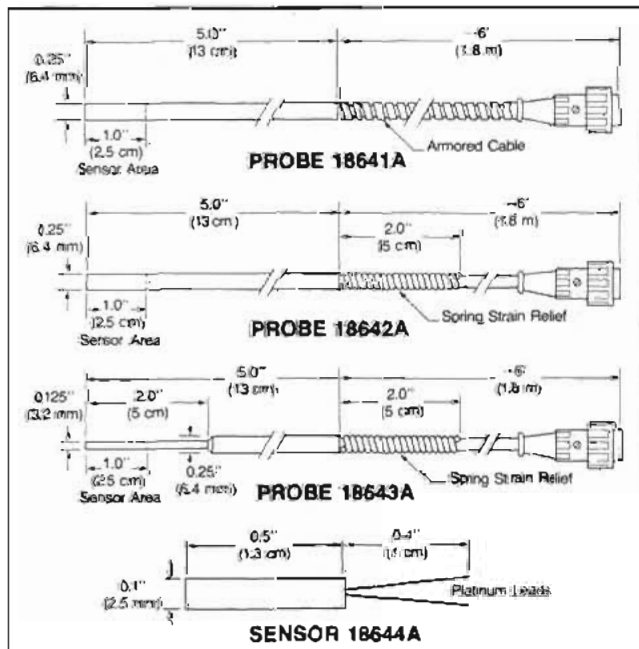

### Thermometer

2802A HP digital thermometer—Includes 4½ digit 34740A Display. Requires HP 18640 series probe and Opt 050 or 060. See list which follows

050: 50 Hz. ac. single phase

060: 60 Hz. ac. single phase

001: HP digital thermomodule-Thermometer unit only, without display unit or probe. NOTE: Since thermomodule will not operate without display, this option is for those planning to use thermomodule with their own HP 34740A or HP 34750A Display Modules.

### Probes

Note: Time constant for probes measured in water flowing at 1 m per sec.

#### 18641A High Temperature Probe

Stainless steel sheath. For -200° to +500°C, to +600°C short term (prevent cable movement above 250°C). Time Constant 5 sec.

#### 18642A General Purpose Probe

Same as 18641A probe except with teflon-insulated cable. Cable must be kept below 250°C.

#### 18643A Fast Response Probe

Stainless steel sheath, for -200° to +500°C, to +600°C short term. Teflon cable must be kept below 250°C. Time constant 1.8 sec.

#### 18644 Probe Kit

Includes platinum sensor cartridge, cable connector, complete instructions for four wire hookup. Time constant 0.5 sec.

### Price

\$895

N/C

N/C

less \$420

\$165

\$150

\$180

\$105



### Faxitron® cabinet systems

Radiography, the art and science of making pictures with X-rays, has an important place in modern technology. It is one of the major nondestructive test methods available to industry, provides an indispensable tool in scientific investigations and is a valuable aid to law enforcement agencies. Hewlett-Packard makes a major contribution to these activities with X-ray equipment that offers a "better way" through advanced technology and design. This equipment makes radiographs easier and safer to take, provides portability for field use or offers stop-motion capability for the study of dynamic events.

### Industrial Inspection

Industrial quality control and inspection procedures, especially in the field of electronics, benefit from nondestructive testing by radiography. The advantages of a testing method which does not harm the test objects are obvious. Radiography, therefore, offers benefits in design engineering, incoming inspection, production quality control, product reliability and failure analysis. X-rays are used to detect misregistration or plate-through problems in multi-layer P.C. boards; porosity, poor substrate bonding and wiring or lead location in transistors and integrated circuits; voids and other encapsulation problems in potted components; and solder balls or other defects in sealed relays.

Die casting is another industry that benefits from the nondestructive aspects and ability to "see inside" provided by radiography. Porosity, gas voids, tramp metal inclusion and other common defects can be easily detected and the cause determined. Expensive machining time can be avoided for castings found to be defective through X-ray inspection. The integrity of welds,

alignment of connectors, inspection for proper assembly and mechanical defects are further examples of tests which radiography performs for industry. The benefits of X-ray testing are reduced production costs, better quality assurance and product safety. The results are increased profits.

### Scientific applications

Oceanography, geology, marine biology, paleontology, pathology, botany, forestry and agricultural research are a few examples

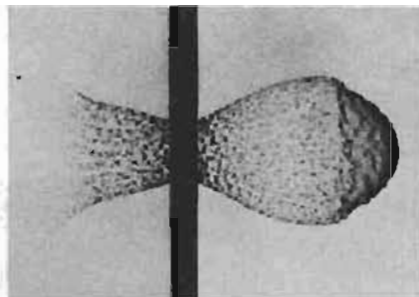

of scientific disciplines that use X-rays. Applications range from the study of the interior anatomy of fossils to determining the viability of seeds.

### Law enforcement applications

Radiography aids many law enforcement groups. Crime labs use X-rays to visualize certain types of latent fingerprints, for powder and lead splatter patterns in ballistics and for questioned-document examination. Medical examiners use X-rays for cause-of-death investigations and identification of remains. X-rays aid in examining parcels or mail to identify dangerous devices and to verify bomb circuitry.

These are among the many applications served by HP Faxitron® Cabinet X-ray Systems. They offer a unique combination of high quality radiographic capability, simplicity of operation and convenience of use which is expanding the capabilities of scientific and industrial concerns throughout the world.

### Portable X-ray systems

Portable systems of lightweight and small size are made possible by the field emission type tube. Hewlett-Packard markets several portable systems including the Model 43501, a self-contained battery-operated portable system specifically designed for the unique field use requirements of explosive ordnance demolition squads. Integral power capability and small, remotely operated X-ray tubes make possible X-ray examination of suspected bombs.

X-ray inspection of otherwise inaccessible components in complex structures is also facilitated by the 43501.



Model 43501B Portable X-ray

### Pulsed radiation sources

Hewlett-Packard has pioneered in the design and manufacture of cold-cathode, flash X-ray tubes and systems. Cold-cathode tubes, based on the field emission principle, are combined with a pulse generator and appropriate control units. The systems produce nanosecond bursts of X-rays, electrons or super radiant light (SRL). Output voltage and energy are provided by Marx-surge type energy storage modules charged in parallel and discharged in series through a pressurized spark gap switch mechanism.

A number of channels can often be operated from common controls enabling a series of stop motion radiographs at desired intervals.

Other capabilities include slow and fast cine-systems providing a series of motion picture-like radiographs at rates from 1 to 1000 frames/sec. These systems are custom designed from standard units.

HP pulse radiation systems yield a reproducible 5-10,000 ampere electron beam in air at energies of 400-2300 keV and pulse widths of 3-40 nanoseconds. Current densities of 12,500 amperes per cm<sup>2</sup> and dose rates up to 10<sup>14</sup> Rads/second can be obtained.

Their reproducibility, high dose-rate output, ease of operation and instrumentation and small space requirement make them ideal for radiation chemistry or pulsed radiolysis studies as well as radiation effects studies, radiation biology and laser pumping.

For specific information and consultation regarding HP X-ray systems, contact Hewlett-Packard, 1700 S. Baker Street, McMinnville, Oregon 97128, telephone: (503) 472-5101.

## Patient Monitoring

- Modular instruments to complete systems
- Computer-based Patient Data Management & Arrhythmia Detection Systems
- ECG Telemetry System for ambulatory patients
- New mobile Resuscitation System with batt./AC Defibrillator organizes supplies, drugs, instruments, etc. for resuscitation and 30 minutes' life support. *Request Catalog #5952-5254.*



## Respiratory Instrumentation

- Pulmonary Calculator System
- Ear Oximeter
- Single-Breath Diffusion System
- Respiratory Recording Systems (6)
- Modular Pulmonary Function Testing Instruments. *Request Catalog #5952-5257.*



## Perinatal Instrumentation

- Fetal/Maternal and Neonatal monitoring includes bedside fetal monitors, a Calculator-based System, and Central Stations
- Neonatal monitoring uses heart rate, respiration, temperature, ambient oxygen measuring instruments, and a Cardiorespirograph. *Request Catalog #5952-5258.*





### Cardiography Instrumentation

- Single- to 3-channel Electrocardiographs
- ECG Data Management Systems for computer-aided interpretation of ECGs.
- ECG Stress Testing Systems
- ECG/Heart Sound/Pulse Recording Systems
- ECG Computer Terminals for phone transmission or tape recording ECG data. *Request Catalog #5952-5255.*



### Cardiovascular Instrumentation

Includes complete systems from transducers to readout for clinical research and cardiac cath labs. Computerized Cath Data Analysis System automates on-line data collection and analysis. *Request Catalog #5952-5256.*



### Consumables

Wide choice for use with H-P and other medical electronic instruments includes:

- Disposable ECG monitoring electrodes (adult and infant)
  - Disposable transducer domes
  - Disposable scalp electrodes
  - Chemical thermal medical chart papers
  - Permapaper® chart papers
  - Disposable pressure kits
  - Redux® electrolytes
- Request Catalog #5952-5260*



### Radiology

HP offers a group of high performance medical X-ray machines with automatic exposure control. They include a Mobile X-ray System shown above) designed especially for handling difficult radiographic requirements in the Intensive Care area; a Dedicated High kV Chest X-ray System for rapid, consistent and low dose chest procedures; and Faxitron Cabinet X-ray Systems for specimen radiography and for laboratory training of radiological technicians.





Widely recognized as a leading supplier of electronic measuring instruments and data handling equipment for the engineer, Hewlett-Packard is also rapidly developing a similar position in analytical instrumentation for the scientist. HP's analytical products now include a full line of gas chromatographs, liquid chromatographs, automatic sampling systems for GC, data handling devices and systems for the analytical laboratory as well as GC/Mass Spectrometers and accessories.

#### Gas chromatographs

Although less than 20 years old, gas chromatography (GC) has taken over from classical methods of analysis the bulk of analytical work performed in laboratories around the world. There is an excellent reason for the revolutionary popularity of the gas chromatograph in analytical chemistry: no other method gets more accurate results, at greater speed, and for less cost.

For the scientist whose interest is the chemical analysis of unknown samples,

Hewlett-Packard offers two basic types of gas chromatographs.

**NEW — Model 5840A reporting gas chromatograph:** the second generation HP 5840A is a complete GC analytical system. It has an integral digital processor that operates the gas chromatograph and its accessories throughout the analytical run, following precisely the instructions that you give it *before the run*, on an easy-to-use keyboard or magnetic card reader.

The intelligent control center of the 5840A, the built-in digital processor, controls all aspects of the GC analysis: all temperatures, carrier flow rate measurement, detector operation, integration of peak areas, identification of components, calculation of concentrations, plotting of chromatogram and analysis report. After you set the analysis parameters on the keyboard and inject a standard sample, a single keyboard entry causes the 5840A to initiate a simple dialog which calibrates for the method; thereafter, the 5840A will analyze your samples, make the calculations

by whatever method you specify — normalization, internal standard or external standard — and report the results . . . all automatically.

Other HP 5840A features include: choice of universal injection port with glass or metal liners and on-column injection capability; a multi-purpose glass capillary inlet system; time programming which lets you make changes throughout an analysis at a precise, preset retention time; run programming which lets you preset analysis parameters for a series of samples before injecting the first one; plus a variety of glass, metal, packed or capillary columns . . . all in a high performance oven that can be controlled and programmed from  $-60^{\circ}$  to  $400^{\circ}$ C, to meet separation requirements for almost any type of sample!

**HP 5700 Series GC's digital, compact, modular, capable of full automation:** the HP 5700 Series breaks the traditional barrier between versatile but expensive "research" instruments and dedicated, more cost-conscious "routine" instruments. This series

embraces HP 5710 Dual Column, HP 5720 Single Column, and HP 5730 Dual Column/Multiple Detector GC's which serve every research or routine laboratory need.

New features of the 5700 include: specific detectors, including nitrogen/phosphorous FID and flame photometric... multi-detector capability, including simultaneous ECD/FID operation with Ne carrier... inert TC detector... dual input/dual output electrometer... electronic baseline compensation... inlet system for glass capillaries... metal capillary splitter... all-glass packed column system... low bleed septum mounting.

#### Liquid chromatographs

**HP 1084A:** first LC with Built-in Processor. The first high performance liquid chromatograph (HPLC) to be controlled by a built-in microprocessor, the HP 1084A gives users full control over separation parameters, minimizes quantitative errors, and is simpler to use than conventional instruments in routine chemical analyses and in developing new analytical methods. But the HP 1084A is much more than just a processor-based liquid chromatograph. New and advanced design features include a flow rate controlled pump, a semi-automatic variable volume injection system that only consumes the amount injected, an easily accessible temperature controlled column compartment and an RI compensated UV detector with low noise and drift characteristics.

Two-way communication with the HP 1084A system is via keyboard in terms that are simple and familiar to the chromatographer. Once instructed, the instrument injects the desired sample size (from 10 to 200 microliters) at full column pressure without interrupting flow, controls solvent composition, generates gradients, then collects and computes chromatographic data and reports them on heat-sensitive, smudgeless paper... all automatically!

**New automatic sampling system for HP 1084A:** HP's 79824A new automatic sampling system enables batches of up to 60 samples to be analyzed automatically in sequence, and in replicate if desired, by the HP 1084A HPLC.

As shown in the illustration, the detachable unit containing 60 glass vials is mounted on top of the liquid chromatograph. The variable-volume sample injector, standard part of the chromatograph, then samples each vial in numerical sequence. The injection volume can be preset manually to any point between 10 and 200 microliters. Only the sample amount injected is consumed by the system, making it possible to use micro-vials for applications where only small sample quantities are available.

**New, compact HP 1081A - offers high performance at a low price:** The new compact HP 1081A HPLC performs routine LC functions with a precision and repeatability similar to that of the top-of-the-line HP 1084A but at about one-third the price.

HP 1081A has a pushbutton-controlled, high performance reciprocating diaphragm pump with in-line pulsation damping and new design principles proven in the HP 1084A. Samples are injected at full column

pressures through a six-port valve (seven-port is optional). Separation columns locate in a protected compartment. A UV detector - one of the finest available - provides exceptional sensitivity and interfaces with strip-chart recorders, integrators and computer based data systems (other detectors can also be fitted).

#### Laboratory automation systems

HP Series 3350 Laboratory Automation Systems satisfy the combined data handling, control, and reporting needs of the analytical laboratory, from the chemist's to the lab manager's.

Chromatographic software supplied with all systems automatically processes the output of gas and liquid chromatographs using standard chromatographic methods. Through computer-initiated dialog, entirely in terms familiar to the chromatographer, the user determines the setting up of events, sample-handling tasks, data reduction parameters and report formats. No special knowledge of computers or programming is required by lab personnel. Self-checking procedures further assist the system operator.

The 3351A system, a low cost answer to your data analysis needs, handles data from up to 15 instruments and has capacity for 4 fully powered input/output devices.

The 3352C Lab Data System is a fully expandable system that allows your data processing needs to grow with those of your laboratory up to 30 on-line instruments with up to 8 terminals. BASIC language programming capability can be added and the 3352C is expandable to a 3354A system.

The new 3354A Lab Automation/Management System is a superior lab automation system which can handle as many as 30 instruments on-line, and handle up to 11 input/output devices through which users can develop methods, BASIC programs and route final reports for which any number of copies can be specified.

#### Reporting Integrators

HP 3380 Series Reporting Integrators provide an excellent data handling function for an existing gas or liquid chromatograph. Both integrators in this series provide the unique printer/plotter that draws the chromatogram, labels peaks with their retention times, lists instrument settings and prints a complete analysis report, all on a single piece of paper.

#### GC/Mass Spectrometer Data Systems

**New HP 5986A with dual source, built-in data system:** the new HP 5985A GC/Mass Spectrometer with its dual CI/EI source and built-in data system make it one of the most powerful analytical tools for qualitative and quantitative measurements. It incorporates the latest advances in dual CI/EI source and GC/MS technology, digital electronics, and dual disc data handling hardware and software. Features include a microprocessor-controlled GC, automatic tuning, simultaneous data acquisition/reduction, and BATCH processor software for full automatic system operation. Mass range is 10-1000 amu and sensitivity to picogram levels.

**New HP 5993A Benchtop GC/MS with Data System:** A new, middle-priced GC/MS, the HP 5993A, combines the integrated gas chromatograph/mass spectrometer of the benchtop HP 5992A with a powerful disc-based data system identical to that used with the HP 5985A. This powerful analytical tool incorporates the latest advances in GC/MS system technology and computer software innovations. Its mass range of 10-800 amu and its sensitivity to low picogram levels and its ease of operation make this system an excellent choice for identifying and quantifying organic samples in a variety of pollution, pesticide, drug, and biological studies.

**computer:** the HP 5992A, a benchtop size GC/MS with automatic tuning, provides excellent performance at an economical price. It consists of two fully integrated, compact modules; one is its easily-operated controller, a desktop computer with thermal printer-plotter; the other houses the microprocessor-controlled gas chromatograph and the mass spectrometer with its hyperbolic quadrupole mass filter. Outstanding features include mass range of 10-800 amu, software for data acquisition and display, library search, and quantitation using SIM; it offers high performance achieved with operating simplicity and convenience.

#### Service

With regional service centers throughout the world, HP lends a supporting hand where you need it, when you need it. Your local HP service engineer is factory trained and supported by an extensive inventory of parts, the latest test instruments, and complete service kits for the maintenance and repair of your HP instrument systems.

**Service Agreements:** choose from a variety of plans and options that:

- Supplement or eliminate the staffing and training of your own maintenance personnel
- Provide complete and timely worldwide service
- Maximize instrument reliability through regularly scheduled maintenance visits
- Minimize maintenance costs through efficient planning
- Simplify budgets through a known annual cost
- Tailor your agreement to match your specific support requirements

**Training:** in-depth customer training is available in both operation and maintenance. A broad range of courses and training materials have been developed for HP customers.

**Documentation:** complete documentation is supplied with each HP instrument or system. In addition, supplemental tutorial texts are available from your local HP sales office.

**Applications:** Hewlett-Packard Applications Chemists are available to help you get the most out of your HP instruments. In addition, the company has published numerous Application Notes which describe the practical uses of HP instrumentation for a variety of studies.

## • Transistors and diodes



HP low noise, general purpose and linear power microwave transistors are supplied in a wide variety of stripline and microstrip packages.

Hewlett-Packard components, utilized in consumer, industrial, military and other OEM equipment, assure optimum performance. Advanced machinery and processing techniques are employed to produce highly sophisticated Silicon and Gallium Arsenide devices. The product lines consist of Si bipolar and GaAs field effect transistors; Schottky, PIN, IMPATT and Step Recovery Diodes; MIS Chip Capacitors; and Integrated Products.

### Transistors

HP silicon bipolar and GaAs field effect transistors fill most requirements for multistage amplifiers from the VHF region through 12 GHz. Devices are available for the low noise input stage, the high gain intermediate stage and the power output stage. For example, the HXTR-6104 low noise silicon bipolar transistor typically offers 1.4dB NF with 14dB associated gain at 1.5 GHz. At 12 GHz, present HP GaAs field effect transistors can produce either 20mW of linear output power or 4.2dB noise figure with 6dB gain, depending on bias conditions.

Hewlett-Packard transistors are supplied in chip form, or in various stripline packages in either common-base or common-emitter configurations. Complete data sheet characterization and excellent processing uniformity make it possible to design your circuit by calculation instead of by trial-and-error.

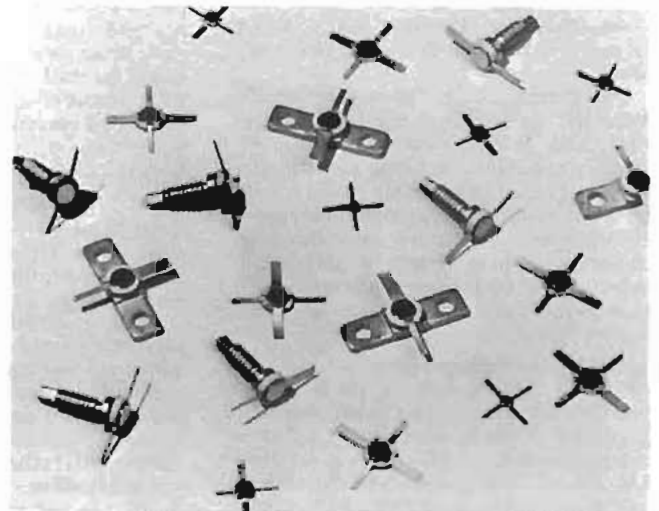

Schottky diode singles and matched quads are available in 3 types of microstrip packages: hermetic; low parasitic ceramic/plastic; and low cost ceramic/plastic.

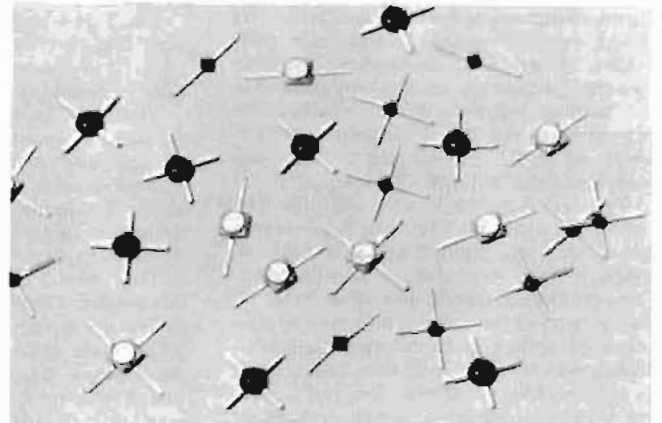

Various stripline and coaxial packages are used for Schottky, PIN, IMPATT and step recovery diodes.

### Diodes

**Schottky Barrier Diodes:** Schottky diodes combine extremely high rectification efficiency with pico-second switching speeds, low series resistance, and low noise characteristics. This combination makes the Schottky an excellent mixer/detector diode.

At HF, VHF, and UHF frequencies, HP delivers glass packaged devices in million piece quantities at economical prices. These same diodes have many digital circuit applications such as clipping and clamping where switching speed is important.

At microwave frequencies, their low noise and repeatable RF impedance lead to outstanding performance either as mixers or detectors. A new series of zero bias Schottky detector diodes offers improved detection efficiency without the dc bias requirement of conventional detector diodes. Package configurations for mixer/detector diodes include beam leaded devices as well as conventional ceramic, stripline and axial lead packages.

**PIN Diodes:** PIN diodes function as variable resistors at microwave frequencies. By controlling the DC bias, the RF resistance of a PIN diode can be varied from 1Ω to about 10KΩ. This unique property of the PIN diode makes it extremely useful as a switch, attenuator, modulator, phase shifter, limiter or AGC element at all frequencies from 1 MHz to 18 GHz and above. Package configurations include beam-leaded devices as well as conventional microstrip, ceramic and axial-leaded packages.



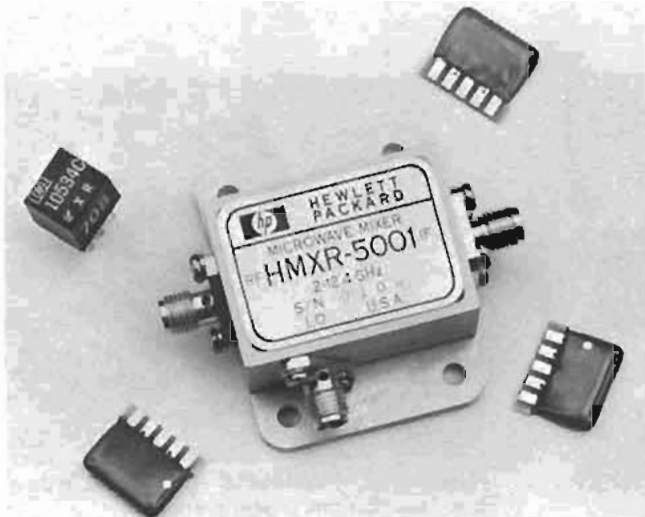

Hewlett-Packard's mixer product line includes low cost single balanced mixers for use to 1 GHz and double balanced mixers for both RF and microwave frequency ranges.



Solid state switches cover the frequency range from 0.1 to 18 GHz. An add-on switch driver features TTL compatible input.

**IMPATT Diodes:** IMPATT diodes are a fundamental source of RF power at frequencies above 4 GHz. CW devices can supply 3.5W at 6 GHz with 10% efficiency, while pulse-optimized devices operating at 10 GHz offer 14W at 800ns pulse width and 25% duty cycle.

**Step Recovery Diodes:** SRD's are intended for use as comb generators and harmonic frequency multipliers. When used as a comb generator, the abrupt termination of the diode's reverse recovery current generates voltage pulses up to tens of volts with pulse widths as narrow as 100ps giving useful power at frequencies in excess of 20 GHz. By optimizing the circuit around any specific harmonic, high efficiency frequency multiplication can be accomplished.

**MIS Chip Capacitors:** these Metal-Insulator-Silicon capacitor chips are processed with a composite insulator on silicon. The high density thermal oxide-nitride composite layer yields excellent reliability due to dielectric breakdown stability for both DC and RF fields. Capacitance values from 0.5-100pF are available.

**Integrated Products**

The combination of chip and beam lead diodes with hybrid thin-film circuit technology has led to an extensive product line of components for the conversion and control of RF signals.

The HMXR-5001 is a double balanced mixer which provides excellent broadband performance and reliability. This rugged mixer has low conversion loss and high isolation across the full 2-14.4 GHz RF/LO band, while retaining a wideband 1F of 0.01-1.0 GHz. For the HF-UHF range, both double balanced and low cost single balanced mixers are available.

• Integrated Products

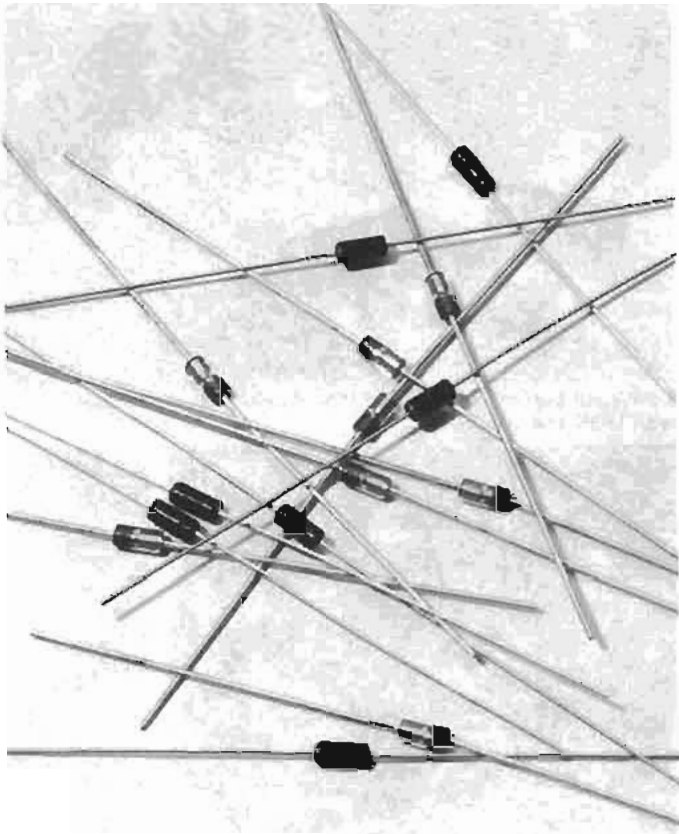

Glass package PIN and Schottky diodes are used for high volume price sensitive applications in the HF-UHF range and for general purpose switching.

SPST switches covering the frequency range from 0.1 to 18 GHz are offered either in modules or with connectors. Absorptive Modulators offer up to 80dB of isolation at 18 GHz. Other components include Limiters, Comb Generators and Mixer/Detectors.

**High Reliability Testing**

Many Hewlett-Packard components are space qualified. The reliability of these devices is established by one of the finest high reliability testing facilities in the microwave component industry. Hewlett-Packard's High Reliability Test Group maintains military approved JAN and JANTX parts in stock and can recommend HP standard screening programs, patterned after MIL-S-19500, for any HP component. Those who wish to design their own screening specifications can consult with and obtain quotations from Hewlett-Packard's staff of Hi Rel Test Engineers.

**Write for More Information**

Hewlett-Packard RF and microwave component capabilities are described in individual data sheets, application notes and application bulletins.

**Diode and Transistor Designer's Catalog:** This catalog contains detailed, up-to-date specifications on our complete product line. It is divided into the following major sections: Schottky Barrier Diodes, PIN Diodes for Signal Control, Microwave Source Diodes, Devices for Hybrid Integrated Circuits, Military Approved Devices, Microwave Transistors and Integrated Products.

### Optocouplers, displays

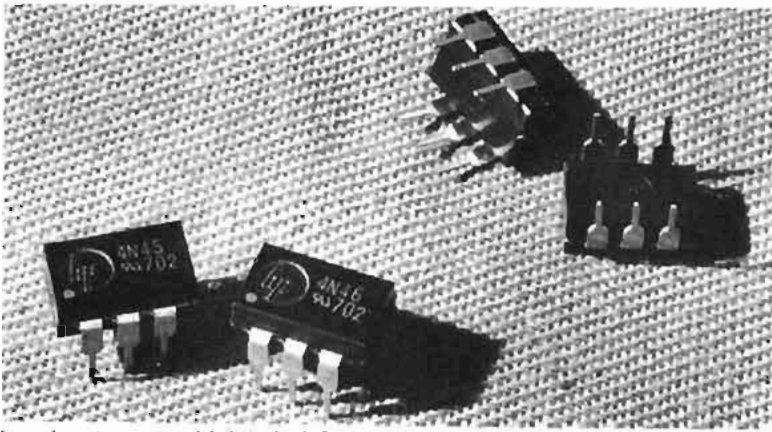

Low input current, high gain 6-PIN optocoupler is ideal for use with MOS and CMOS.

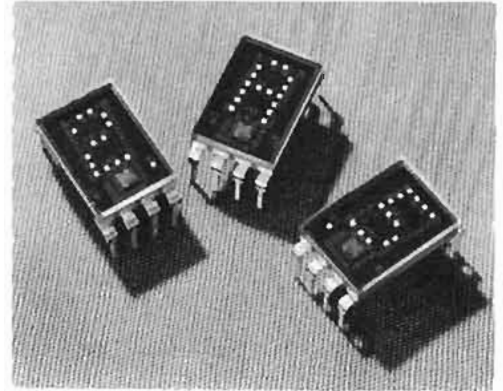

Numeric and hexadecimal displays for industrial applications have on-board decoder/drivers.

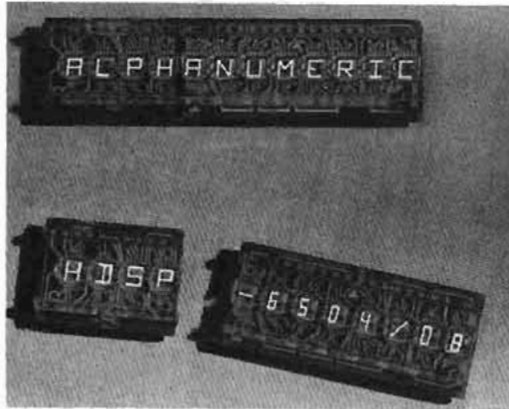

16-segment alphanumeric display has a 64-character ASCII set and special characters.

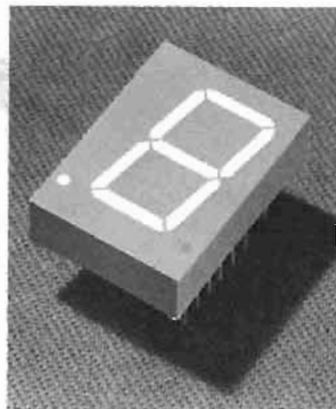

0.8" display can be viewed up to 10 metres (33 ft).

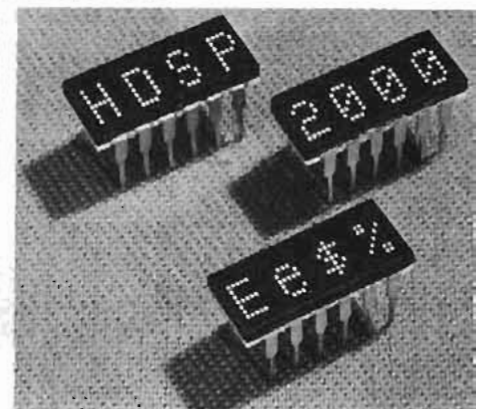

Four character, 5 x 7 dot-matrix LED alphanumeric display, has full ASCII code capabilities.

Low cost components, available from Hewlett-Packard, offer exceptional performance in consumer, industrial, military, and other OEM equipment. With sophisticated semiconductor processing equipment, and the industry's most extensive hybrid thin-film microcircuit manufacturing facilities, Hewlett-Packard applies newly developed technologies to component manufacturing, offering high performance solid state numeric and alphanumeric readouts plus LED lamps, optocouplers, emitters, and PIN photodiodes—in quantity at economically attractive prices.

#### Optoelectronics

Hewlett-Packard's Optoelectronic Division offers a complete line of GaAsP and GaP discrete light emitting diodes (LED's), numeric, hexadecimal, and alphanumeric displays. These components provide solid state reliability to any visible readout. As status indicators, arrays, multi-digit or multi-character displays, these compact LED's are electrically compatible with monolithic integrated circuits, with a useful life greater than 100,000 hours:

#### Optocouplers

Hewlett-Packard's family of optocouplers provide economical, high performance solutions to problems caused by ground loops and induced common mode noise in both analog and digital applications in commercial, industrial, and military products. Hewlett-Packard's original approach toward integrated output detectors provides performance not found in conventional phototransistor output optocouplers. With 3000 VDC isolation, the types of optocouplers available include high speed devices capable of 10 M bits and high gain devices which are specified at 400% CTR at input currents as low as .5 mA. In addition, highly linear optocouplers are useful in analog applications, and a new integrated input optically coupled line receiver can be connected directly to twisted pair wires without

additional circuitry. Most of these devices are available in dual versions, as well as in hermetic DIP packages. For military users, Hewlett-Packard's established hi-rel capability facilitates economical, hi-rel purchases.

#### Displays

Low cost numeric displays, packaged single or clustered, are available in character heights from .11" to .8". Low power, small character displays have been designed for portable instrumentation and calculator applications. These seven-segment display units are available in red, high efficiency red, yellow, and green packages.

Integrated LED displays (with on-board IC's), available in plastic and hermetic packages, solves the designer's decoding/driving problem. Numeric, hexadecimal and alphanumeric displays have been designed for low cost and ease of application in a wide range of environments. For example, the small alphanumeric display pictured above, features four 5 x 7 dot matrix characters and on-board shift registers for data storage. It is contained in a 16 pin DIP which is end-stackable for unlimited possibilities in alphanumeric display formatting.

The first 16-segment solid state LED alphanumeric displays from Hewlett-Packard are now available in four- and eight- character end-stackable modules. They are designed for use in computer peripheral products, automotive instrument panels, calculators, and electronic instruments and systems requiring low power consumption in an easy-to-read display. Magnification of the LED by an integral lens results in a character size of 3.8 mm (0.150 in). Drawing as little as 1.0 to 1.5 mA average current per segment, this enhances character intensity while keeping power use at a minimum.

These and other integrated displays in hermetic packages are available in hi-rel screened versions for military applications.

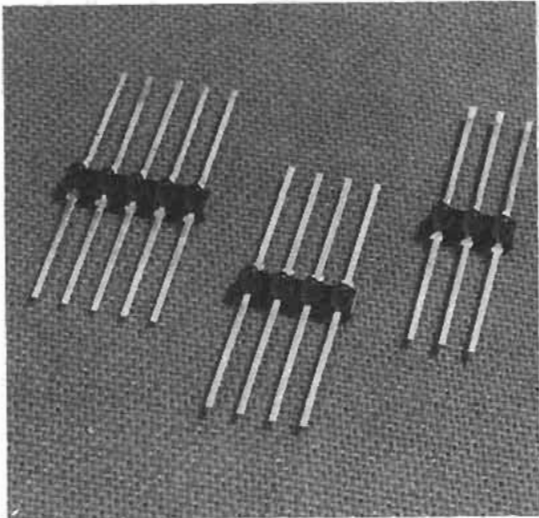

Excellent uniformity between elements and between arrays exist in these subminiature polyleds.

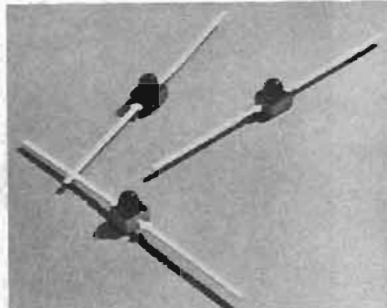

These subminiature resistor lamps contain rugged integral resistors and reverse protection diodes.

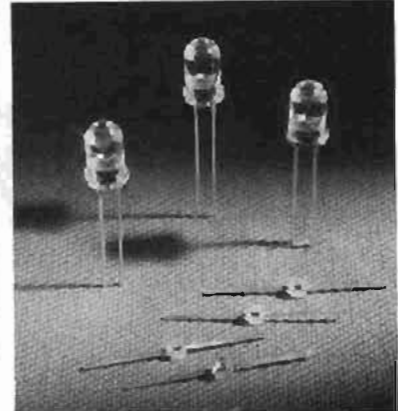

High radiant intensity emitters are obtainable in either T-1 1/4 or subminiature package.



Panel mountable hermetic solid state lamps are designed for protection against RFI panel leakage.

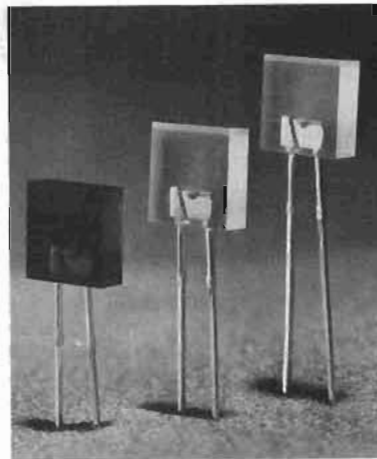

These rectangular LED's are available in high efficiency red, yellow and green.

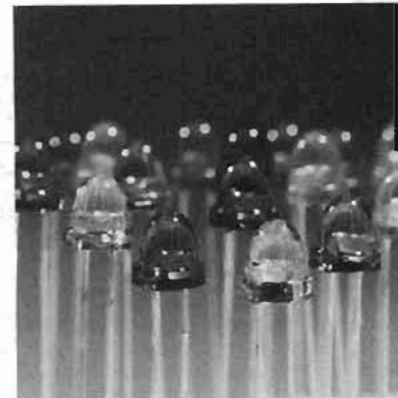

These low profile T-1 1/4 solid state lamps available in four bright colors.

#### Solid state lamps

Discrete LED indicator lamps are encapsulated in a panel mountable fixture designed for hi-rel applications. They can be mounted with clips or directly onto PC boards. Hewlett-Packard has also produced the first easy-to-mount hermetic lamp.

A wide selection of leads, lens, brightness, and package combinations are available in red, high efficiency red, yellow, and green epoxies. The rectangular solid state lamps are stackable on 2.54 mm (0.100 in) centers. They are ideally suited for backlighting legends and flush mounted panel indicators. Subminiature polyled arrays are available as three, four, or five elements.

#### Emitters

Hewlett-Packard offers high radiant intensity emitters near-IR in both floodlight and spotlight configurations. Emitters are ideally suited for use in optical transducers and encoders, smoke detectors, bar code scanners, paper-tape readers, and fiber optic drivers.

#### PIN Photodiodes

Hewlett-Packard PIN photodiodes are excellent light detectors with an exceptionally fast response of 1 ns, wide spectral response from near infrared to ultra-violet, and wide range linearity (constant efficiency over 6 decades of amplitude). With dark current as low as 250 pA at 10 V, these detectors are especially well-suited for operation at low light levels.

#### Write for more information

Hewlett-Packard Optoelectronic capabilities are described in individual data sheets, application notes, application bulletins, a complete catalog, and an applications manual.

**Solid State Displays and Optoelectronics Designer's Catalog:** this contains detailed, up-to-date information on our complete optoelectronic product line. It is divided into five major product sections: solid state lamps, solid state displays, optocouplers, emitters, and PIN photodiodes. Included in the 200 pages are product photographs, specifications, operating characteristics, and performance graphs.

**Optoelectronics Applications Manual:** this newly published manual is intended to serve as an engineering guide about the application of and designing with LED products. Each of the generalized LED product types are covered, with additional chapters on contrast enhancement techniques, photometry and radiometry, LED reliability, mechanical consideration of LED devices, photodiodes and LED theory. This book is available from Hewlett-Packard or from the McGraw-Hill Book Company.

All literature, including prices, are as near as your phone. Call any Hewlett-Packard Sales Office or contact any of our franchised distributors for product availability and information.



Hewlett-Packard, long recognized as the leading supplier of electronic measuring and computing instruments for the engineer, has developed a similar position in electronic distance/angle measurement and computation instrumentation for the surveyor. These instruments are briefly described on this page.

### HP3805A Distance Meter

The HP3805A Distance Meter is a low cost, short range, automatic readout, infrared light source instrument. The range of the HP3805A is one mile (1600 metres) with the measured distance displayed in feet or metres at the flip of a switch. The HP3805A features a built-in computer that controls the instrument's internal functions and communicates the quality of the measurement to the operator through the communicative display. A minimum of 3,000 readings are taken for each measurement and displayed in as little as six seconds. This instrument also has an internal self-check capability of verifying electronic performance in the field or office, and automatic atmospheric correction. The optional battery pod that snaps into the bottom of the instrument provides cable free operation for a lightweight portable field system.

### HP3810A Total Station

The HP3810A Total Station is a short range, automatic, direct reading, electro-optical distance and angle measuring instrument utilizing an infrared light source. The range of the HP3810A is one mile (1600 metres) with the measured distance displayed in feet or metres and angles displayed in degrees or grads. This instrument has the



ability to measure the slope distance, zenith angle, correct for the curvature and refraction and automatically compute and display the horizontal distance. Four parameters are selectable for display; zenith angle, slope distance, horizontal distance and vertical distance. The key to the Total Station's power is a built-in microcomputer and a vertical angle sensing device. The communicative display indicates the quality of the measurement, on target indication, and notifies the operator of a low battery. Horizontal angle measurements are made with the 20-second least count horizontal angle base with estimation to 5 seconds or 10<sup>cc</sup> on the micrometer scale. The HP3810A also features built-in atmospheric correction to one part per million, a snap-in battery pod, and a tracking mode for rapid point setting to one-tenth of a foot with updated measurements every three seconds. Precise measurements to one-thousandth of a foot can be made in less than six seconds.

### HP3820A Electronic Total Station

The HP3820A Electronic Total Station is a medium range, automatic, direct reading, electro-optical distance and angle measuring device utilizing a laser diode light source. Solid state electronics gives the HP3820A its high accuracy plus a range of 3+ miles (5km) which means long shots can be made without intermediate set-ups. The operator, by merely pressing a button, can electronically display both horizontal and zenith angles to one second. Both horizontal and zenith angles are automatically compensated for instrument mis-level—an HP exclusive. The instrument also displays relative



direction—that is—the clockwise angle from the previous direction to the current direction. In addition to angle measuring capability, the HP3820A has the ability to measure slope distance, zenith angle and automatically compute and display horizontal distance. Vertical distance and slope distance can also be displayed at the touch of a button. The HP3820A features a built-in atmospheric correction to one part per million plus a snap-in battery pod that fits into the instrument's left standard for a lightweight, compact, easy to use field instrument. A built-in output plug allows the operator to electronically transfer any of its measured components to an external Data Collector or calculator.

Hewlett-Packard's versatile Distance Meters and Total Stations are suited for such applications as layout, location, boundary, hydrographic, topographic, control and mine surveys. A short demonstration is all that is necessary for operator training on these instruments.

### Surveying Calculators

The Civil Engineering Division also markets Hewlett-Packard's line of desk-top programmable calculators and peripherals filling the surveyor's requirements for distance/angle measurements and computation instrumentation. Application and programming specialists have developed libraries of surveying programs for these systems.

For detailed specifications and prices on these instruments and optional accessories, contact the Civil Engineering Division, P.O. Box 301, Loveland, Colorado, 80537.



With Hewlett-Packard's extensive product line and worldwide customer mix there are two main avenues for technical customer training. These are live training sessions and video tapes. Live training sessions fall into three subcategories: applications, service and tutorial. Application seminars aimed at increasing your utilization of general purpose test instrumentation are often available at no charge. On the other hand, seminars on the operation of dedicated systems are more specific in nature and are generally charged for. Service seminars are available on a supply-and-demand basis and, as such, there is usually a charge. For detailed information on all HP seminars, contact your Hewlett-Packard field engineer or call the Hewlett-Packard office nearest you—see the inside back cover.

## HP video tapes

### A better way to learn

Part of the "extra value" which comes with each Hewlett-Packard product is our continuing commitment to provide Hewlett-Packard customers with useful training information in the areas of applications and service. In the past, this information has often been in the form of classroom seminars, either at your nearby Hewlett-Packard sales office or at one of our training facilities in California.

Now our capability is expanding by offering you both service and applications training via video tape. Video tape training is ex-

ceptionally convenient and readily available, ready for your own use at any time or any place, including within your own facilities.

**Effective:** Hewlett-Packard has found that video tape is a highly effective training medium. Video tapes can convey more information in less time, and with higher retention, than even the best live instruction. Hewlett-Packard programs are professionally produced and are based on measurable instructional objectives. They consider what the student already knows, emphasize what he needs to know, and omit what he does not need to know. Many video tapes utilize split-screen techniques, allowing students to watch a procedure on one part of the screen while observing its effect on another part. Most Hewlett-Packard video tapes are 100% visualized, as opposed to conventional, partially visualized video tape "lectures."

**Flexible:** With video tapes, you can tailor your training program to suit the many needs of your organization. You may select training programs for individuals with different backgrounds and specific needs, present effective programs to audiences of just one or hundreds, and offer a library of technical programs your staff members can easily consult on their own . . . for new information or for refresher purposes.

**Faster:** It has been our experience that Hewlett-Packard video programs compress learning time by a factor of up to 6-to-1. A video tape library also reduces the time

needed to organize and schedule your training. You can schedule highly professional presentations anytime and anywhere, without arranging for outside instructors or juggling the detailed logistics that are often required for live training sessions. More effective training in one-sixth the time!

**Convenient:** Video tape programs come on small, easy-to-file magnetic tape reels or cassettes. Inexpensive playback equipment is easily operated by unskilled personnel. Programs may be viewed on small portable monitors or on full-screen TV sets. Video tapes can be quickly searched for specific information using "fast forward" or "fast rewind," and many recorders can stop on a single frame for more detailed study.

**Time-tested:** All the video tapes offered in the Hewlett-Packard Videotape Catalog were developed to serve Hewlett-Packard's needs for a practical, low cost source of up-to-date training in a wide variety of subjects. Now, after having been tested in Hewlett-Packard training activities throughout the world, many of these video programs are available to help meet your training objectives.

### Digital troubleshooting 90420D

Now, from Hewlett-Packard comes a videotape series developed to train HP's own technicians. This course is especially useful in showing how to approach real problems in real equipment.

- Practical demonstrations
- Proven teaching techniques

- Flexibility of use for classroom or individual study
- Latest in digital troubleshooting tools
- Most recent logic symbology
- Useful troubleshooting tips

Digital troubleshooting was made for technicians. It is an appropriate transition from transistors to digital electronics. It also can be used as a refresher course. Equivalent in coverage to a college term of 13 weeks, the course is presented in color on 14 videocassettes having a total running time of 5 hours and 31 minutes. The lab demonstrations shown in video are from the workbook included with the series. Also included is a 180 page text and a study guide.

There is ample use of reinforcement in the presentation and in the self-scoring quizzes at the end of most of the modules.

### Digital troubleshooting videotapes

#### Introduction to digital electronics

90421D Lesson 1 12 Mins.

Digital products and techniques are becoming more popular and widely used. This lesson looks at some of the areas where digital techniques are used—areas such as computers, communications, telemetry, test equipment, industrial control, and consumer electronics. It also points out how the integrated circuit (IC) has caused a virtual explosion in the use of digital techniques. Widely used terms and concepts such as binary, digital, analog, gates, and memory are explained. The lesson concludes with a comparison of digital and analog techniques, a summary, and a short, self-scoring quiz.

#### Binary nature of digital circuits

90422D Lesson 2 18 Mins.

Digital circuits operate using the binary or two-digit number system. Binary digits (bits) are introduced in this lesson covering the operation of the pure binary and Binary Coded Decimal (BCD) systems. Mechanical or transistor switches can be used to control the two logic levels used to represent binary data. Either positive or negative logic systems can be used to represent binary numbers, and they can be transmitted in either serial or parallel fashion. This lesson concludes with a summary and a short, self-scoring quiz.

#### Basics of transistors and IC's

90423D Lesson 3 18 Mins.

Integrated Circuits have revolutionized digital electronics. An IC contains many transistorized circuits switch between two voltage levels that represent binary 1's and 0's. Because of their importance, this lesson reviews the basics of transistors and diodes. PN junction diodes are covered first, then PNP and NPN junction transistors are reviewed. The lesson then discusses how transistors can be operated as either saturated or non-saturated switches. Metal Oxide Semiconductor (MOS) transistor switches are also covered. Packaging and classification of Integrated Circuits are the final topic in this lesson followed by a summary and a short, self-scoring quiz.



#### Logic gates and symbols

90424D Lesson 4 25 Mins.

Logic gates and flip-flops are the two main digital building blocks. This program covers six basic logic gates and their symbols. The logic circuits covered are the AND, NAND, OR, NOR, Exclusive OR, and Inverter. After the operation of each logic element is explained using logic symbols, the operation of a circuit is demonstrated. Next, troubleshooting of gate circuits is covered, then the use of logic troubleshooting tools is demonstrated. The lesson ends with a summary and a short, self-scoring quiz.

Note: The logic symbols included in this series are based on ANSI Y32.14/IEEE 91-193. This industry standard document supersedes MIL-STD-806 B/C and is approved for use by the U.S. Department of Defense.

#### Introduction to digital IC families

90425D Lesson 5 29 Mins.

This is the first of two lessons dealing with digital IC families. In this section DCTL, RTL, and DTL are covered.

This videotape begins with a review of logic gates consisting of the circuit diagram, truth table, logic diagram, and Boolean expression. Several schematics from an actual instrument are explained. Equivalent gates, shown on these schematics, are discussed according to function. This is followed by a discussion of the history of gate design as it applies to the digital troubleshooter, so that bad troubleshooting practices can be avoided. The lesson concludes with a short, self-scoring test.

#### Modern digital IC families

90426D Lesson 6 27 Mins.

This is the second of two lessons dealing with digital IC families. In this section TTL, HTL, ECL and CMOS are covered.

This videotape begins with a review of the principles introduced in Lesson 5, then ex-

plains how the five subfamilies of TTL work (Standard TTL, Low Power TTL, High Speed TTL, Schottky TTL, and Lower Power Schottky TTL). Also explained are open-collector TTL and three-state logic. Similar discussion occurs about HTL, ECL, and CMOS families. The lesson concludes with troubleshooting as applied only to families.

#### Simple troubleshooting techniques

90427D Lesson 7 18 Mins.

Experienced service technicians use a number of simple troubleshooting tools and techniques to help reduce repair time and eliminate the need for electrical measurement, when servicing integrated circuit assemblies.

This program focuses attention on logical approach to troubleshooting, highlighting simple techniques of isolating and replacing defective components on integrated circuit assemblies.

#### Troubleshooting digital IC's

90428D Lesson 8 27 Mins.

Fundamental differences between analog and digital circuits make traditional troubleshooting tools inefficient. Products designed especially for testing digital circuits include: The Logic Clip, Logic Probe, Logic Pulser, Current Tracer, and Logic Comparator. This program takes a close look at these IC Troubleshooters. Also covered are the types of failures found in digital integrated circuits and how to troubleshoot them.

#### Flip-flops

90429D Lesson 9 31 Mins.

Flip-flops are one of the main building blocks of digital circuits. This program covers both the NAND and NOR RS, closed RS, D, T, and JK flip-flops. The

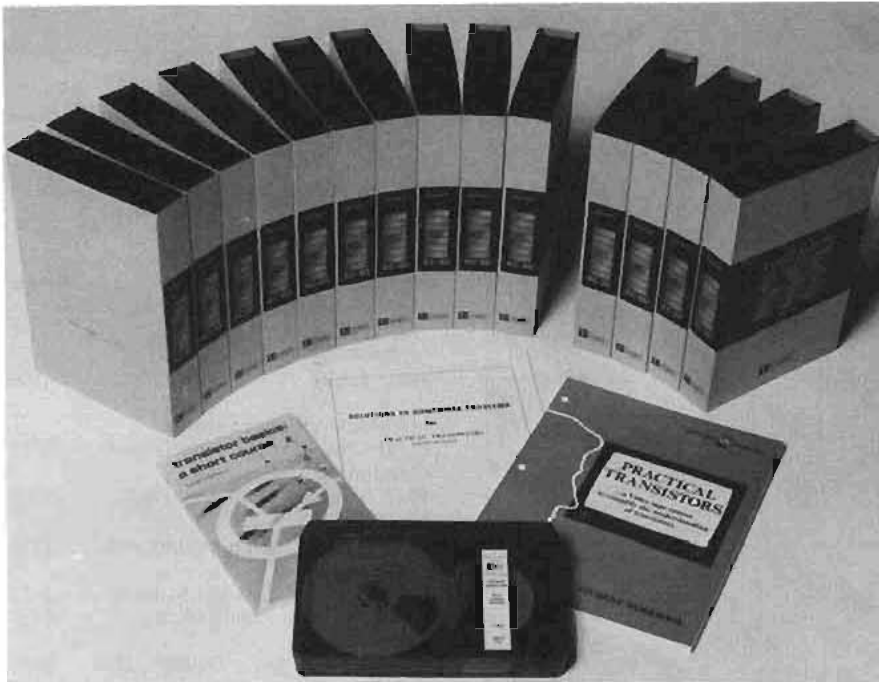

theory of operation of each flip-flop is covered using ANSI Y32.14/IEEE 91-1973 logic symbology. Then, the flip-flop is demonstrated and its operation summarized. Clocked logic, edge and level triggering, direct set and reset inputs, and troubleshooting flip-flops are also covered.

#### Counters and shift registers

**90430D Lesson 10 30 Mins.**  
Counters and Shift Registers are the two most popular uses of flip-flops. This program covers binary and decade counters, both ripple and synchronous types. Also covered are up and down counters, presettable counters, frequency dividers, circular shift registers and strobed displays. The operation of each circuit is first explained using logic symbols, then demonstrated. Troubleshooting is the final topic in this program. The lesson ends with a short, self-scoring quiz.

#### Combinational logic circuits

**90431D Lesson 11 30 Mins.**  
The basic building blocks of combinational logic circuits are gates. In this videotape we see how gates are combined to form line drivers, three-state drivers, one-shot multivibrators, multiplexers, adders, and code converters.

After an overview of the operation of these devices, they're shown in actual use in a production.

The program concludes with a section on troubleshooting, which deals with typical problems which may arise in combinational logic circuits.

#### Display technologies

**90432D Lesson 12 30 Mins.**  
A large variety of display technologies is used with digital circuits. This program looks at the types and configurations of dis-

plays, then discusses typical troubleshooting problems specific to them. Some of the types covered are neons, gaseous discharge tubes, and light emitting diodes (both segmented and dot matrix forms). Included is a discussion on planar tubes, incandescent displays, and liquid crystals.

In the troubleshooting section typical faults the technicians might encounter are discussed. Each of these faults is demonstrated and solutions are suggested.

#### IC manufacturing

**90433D Lesson 13 11 Mins.**  
A basic knowledge of IC manufacturing should prove helpful to anyone involved in servicing digital equipment.

Manufacturing IC's involves a photographic process, and a series of masks is used to control the areas where impurities are allowed to diffuse; forming semiconductors. This program shows the steps in the manufacture of IC's, starting with an actual wafer and following it through to a completed IC package.

#### Memories

**90434D Lesson 14 25 Mins.**  
Due to the many unique demands of today's users of computers and calculating devices, many different configurations for different types of memory. This lesson considers six types of memory-punched paper tape, punched cards, magnetic (reel-to-reel and cartridge), magnetic discs (hard and floppy), ferrite core, and semiconductor.

This lesson defines and describes the use of sequential access and Random Access Memory (RAM), volatile and nonvolatile memory, Read/Write Memory, Read-Only Memory (ROM) and Programmable Read-Only Memory (PROM). Tips on handling the various types of memory conclude the program.

### Practical Transistors 90100D

The widely used Practical Transistor Series is a definitive, 15-tape excursion into the exceedingly important (and mysterious) world of transistors. As outlined below, each highly informative program in the wide-ranging series is primarily concerned with examining the many practical aspects of transistors rather than just dwelling on theory and math. The end result, after viewing this popular series, will be a deeper working understanding of transistors which will make maintenance and troubleshooting problems far easier and more efficient. The series is therefore highly recommended for electronics students, service personnel and engineers.

A supplementary textbook by transistor authority George Stanley Jr. (who also hosts the series), plus a complete set of homework problems and answers, is included with the nearly nine hours of video taped material\*

#### Transistors vs. tubes

**90030D330 Lesson 1 30 Mins.**

The first program in the 15-part series introduces author George C. Stanley Jr., who defines the objectives of the course, describes the text upon which the course is based and explains the use of the homework problems. The rest of the program then reviews and builds upon the student's prior knowledge to make comparisons between vacuum tubes and transistors.

#### Temperature effects

**90030D316 Lesson 2 30 Mins.**

Part 2 develops the various common techniques of biasing transistors, and emphasizes the effects of heat on transistor circuits with demonstrations.

#### Current/voltage drive

**90030D317 Lesson 3 41 Mins.**

Part 3 is concerned with the comparison between voltage drive and current drive in transistor circuits. During this program, several concepts are developed which become important building blocks for the rest of the course.

#### Answers by inspection

**90030D318 Lesson 4 43 Mins.**

Part 4 develops the first of several valuable timesaving rule-of-thumb formulas: a simplified expression for voltage gain. Demonstrations serve to illustrate the usefulness and effectiveness of this formula.

#### Answers by Inspection

**90030D319 Lesson 5 40 Mins.**

Part 5 develops additional rule-of-thumb formulas for the calculation of voltage gain with feedback, input impedance, output impedance, and distortion in common emitter circuits.

#### Answers by Inspection

**90030D331 Lesson 6 37 Mins.**

Part 6 concentrates on the emitter follower circuit and develops expressions for its voltage gain, and input and output impedance.

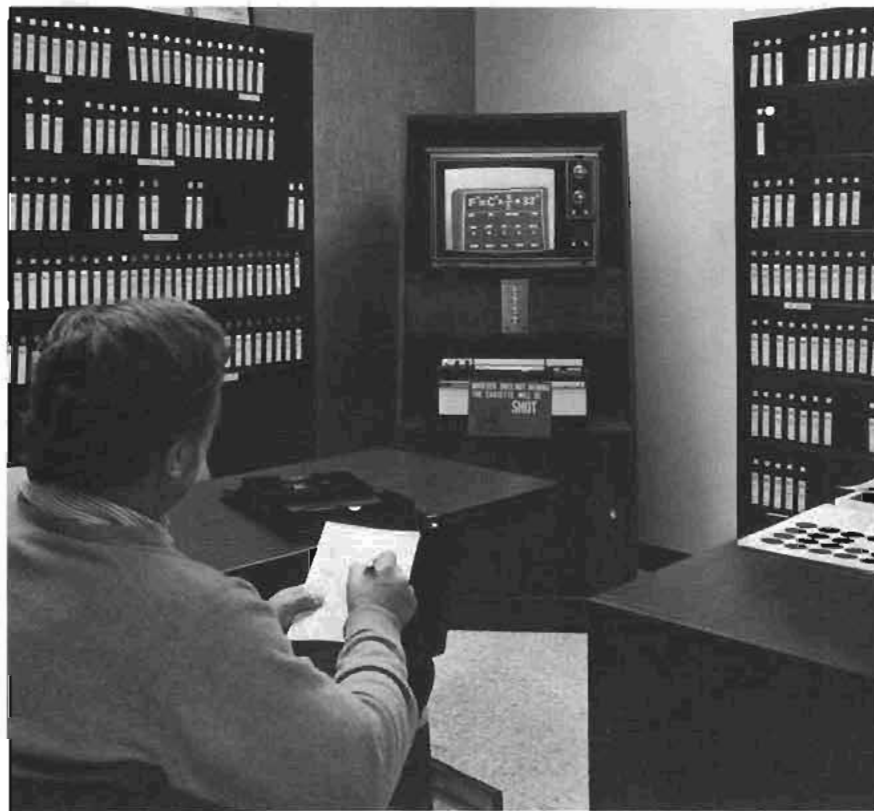
**Multistage amplifiers****90030D322 Lesson 7 44 Mins.**

Part 7 is devoted to applying the knowledge gained in Parts 4, 5, and 6 to an analysis of a three-stage transistor amplifier. Demonstrations on an actual circuit illustrate the accuracy of the approximations involved.

**Troubleshooting****90030D323 Lesson 8 43 Mins.**

The information obtained in preceding programs is further clarified in Part 8, which covers troubleshooting on both single-stage and multi-stage transistor circuits. Class problems are presented and solved using actual circuits.

**Feedback amplifiers****90030D324 Lesson 9 27 Mins.**

Part 9 first reviews single-stage and multi-stage circuits with feedback. Valuable troubleshooting tips for feedback circuits are then illustrated with demonstrations.

**Why a transistor amplifies****90030D325 Lesson 10 27 Mins.**

Part 10 illustrates how and why transistors amplify electrical signals. Discussion of the roles of majority and minority carriers leads to an intriguing example of the effect of nuclear radiation on transistor performance.

**Troubleshooting****90030D326 Lesson 11 33 Mins.**

Part 11 is devoted to more practical applications of what has been learned so far. Demonstrations of troubleshooting are given on

an actual multistage transistor amplifier to illustrate common failure patterns.

**Fets and unijunctions****90030D327 Lesson 12 34 Mins.**

Part 12 provides explanations of the operation of both junction and MOS field-effect transistors. Troubleshooting tips and the effects of nuclear radiation on these devices are given. The program concludes with the operation of the Unijunction transistor.

**Breakdown diodes****90030D328 Lesson 13 37 Mins.**

Part 13 compares Zener and avalanche diodes in terms of their temperature coefficient of voltage. This leads to a discussion of the use of various kinds of diodes for temperature compensation networks.

**SCR's and tunnel diodes****90030D329 Lesson 14 28 Mins.**

Part 14 covers the operation and the uses for silicon controlled rectifiers and tunnel diodes. Special video effects help to explain the complexities of tunnel diode operation. Comparisons are then drawn to other semiconductor devices.

**PIN, SRD, and HC diodes****90030D332 Lesson 15 28 Mins.**

Part 15 explains step recovery diodes, hot carrier diodes, and PIN diodes, and outlines their typical applications. The series concludes with a short presentation on how the many special video effects were created for the various tapes in the series.

**Ordering information**

To order video programs, books, or the Logic Lab, please contact your local Hewlett-Packard field engineer. As a convenience, regional Hewlett-Packard Sales and Service offices are listed inside back cover.

HP Product Number	Price
<b>90420D Digital Troubleshooting</b> (14 videocassettes, plus a textbook, lab workbook, and study guide)	\$3,600
<b>Individual videocassettes</b>	
<b>90421 Introduction to Digital Electronics</b>	\$275
<b>90422D Binary Nature of Digital Circuits</b>	\$300
<b>90423D Basics of Transistors and IC's</b>	\$325
<b>90424D Logic Gates and Symbols</b>	\$375
<b>90425D Introduction to Digital IC Families</b>	\$375
<b>90426D Modern Digital IC Families</b>	\$375
<b>90427D Simple Troubleshooting Techniques</b>	\$375
<b>90428D Troubleshooting Digital IC's</b>	\$375
<b>90429D Flip-Flops</b>	\$375
<b>90430D Counters and Shift Registers</b>	\$375
<b>90431D Combination Logic Circuits</b>	\$375
<b>90432D Display Technologies</b>	\$375
<b>90433D IC Manufacturing</b>	\$250
<b>90434D Memories</b>	\$375

**Books**

<b>90500E Digital Troubleshooting Textbook</b>	\$9.95
<b>90500F Digital Experiments (Lab Workbooks)</b>	\$8.95
<b>90500G Digital Troubleshooting Study Guide</b>	\$2.50

Lab experiments are used to reinforce learning. They require access to a digital experimenter's kit such as the HP 5035T Logic Lab.

**90100D Practical Transistors**

(15 monochrome videocassettes plus a textbook, workbook problem sets) \$1,687.50

**90100M Transistor Basics**

textbook \$5.95

**90100N Practical Transistors Student workbook**

\$8.50

Local taxes, shipping and handling will be added to all orders.

Midterm examinations, final examination, examination solutions and certificates of completion are supplied with the purchase of 90100D and 90420D, but are shipped separately. See your local HP field engineer for details.

Video programs are supplied in NTSC Standard only.

Formats other than 3/4" videocassette can be quoted on request.

Domestic U.S. Prices only



A selected listing of publications to help you in your measurements

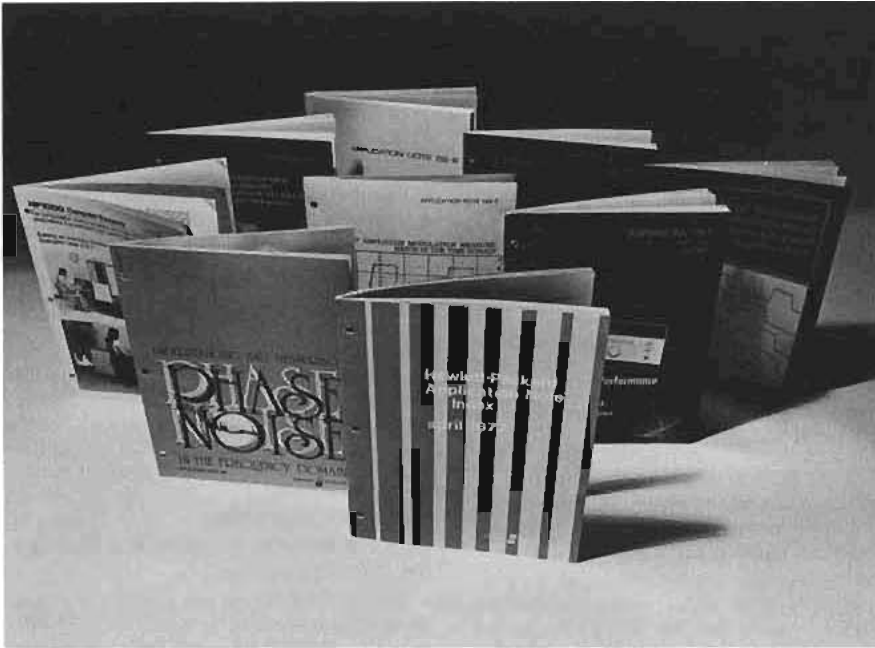

Hewlett-Packard Application Notes are a compilation of applications research and experience which have been written in collaboration with HP engineers and our customers.

Some notes are tutorial in nature, while others describe very specific "how-to" procedures. The *Application Note Index, April 1977* abstracts the current notes available. Included is a subject index and a listing of HP instruments for which application notes are available.

Copies of any of the notes or the index are available from your local field engineer or sales office. Or, write directly to Application Notes Editor, Hewlett-Packard, 1507 Page Mill Road, Palo Alto, California 94304, U.S.A.

### Automatic test systems

#### 201-1 Routine quality assurance measurements of precision resistors

Describes an HP-IB based 21MX computer-controlled installation system capable of measuring, printing and plotting statistical distribution of precision resistor values.

### Computers

#### 212-1 Building an inventory control data base

Using an HP 1000 computer system, the implementation of a common data base is simplified for a manufacturing information control system. The data networking capability of IMAGE/1000 integrates the data for both inventory and purchase order control. The interactive dialog involving the QUERY language for several sample inquiries and reports is also shown.

### CRT displays

#### 166-2 1304A Large screen display applications and interfacing

The HP 1304A Large screen high speed graphic display is designed for easy adaption for applications including: electronic test systems such as network analyzers or spectrum analyzers, machine vibration analysis readouts, weather or harbor radar, patient monitoring in ICU or CCU environments, diagnostic ultrasound systems, computer or calculator-based graphics, and chemical and physical analytical systems.

This note supplements AN 166; minor differences between the 1304A and the other HP large screen displays are explained as well as the setup, adjustments and/or modifications required for typical applications.

### Desktop computers

#### 161-11 King and King architects and the business information management system

One of the nation's oldest architectural firms found that their business record operations were falling behind their architectural activities. With the installation of an HP 9830 desktop computer, complete with HP's Business Management Software, reports are now arriving within a day after the end of the month and outstanding receivables were cut from 67% to less than 37% in the first 30 days of system operation.

### Digital design

#### 210-4 Designing digital circuits for testability

This note gives the designer some techniques to help avoid excessive costs of testing and fault isolation in the life of a complex digital logic product. These techniques are applicable to LSI, printed circuit board assemblies and complete digital systems.

Design considerations include initialization, feedback loops, biased logic, timing problems, test point selection, and addition of logic to help enable automatic test generation.

A section of non-electronic design considerations includes connectors, layout and test fixtures.

### Digital troubleshooting

#### 223 Oscilloscope measurements in digital systems

Designers who have struggled to verify that output signals happen correctly as a result of program operation will appreciate the examples given in this note. Using an HP 1740A or 1741A, with its third channel trigger view, all three ports of three-port gates can be viewed simultaneously.

Measurements of signals in a microprocessor-based system are enhanced by using a variable persistence storage oscilloscope, such as the HP 1741A, in conjunction with an HP 1600A Logic State Analyzer. Single shot measurements using the 1741A storage oscilloscope are discussed.

### Diodes

#### 989 An optimum zero bias Schottky detector diode

Describes the use of the HSCH-3171 and HSCH-3486 zero bias detector diodes. Their forward voltage characteristics are detailed as well as detailed discussions of voltage sensitivity including effects of junction capacitance, load resistance and reflection loss on sensitivity. Temperature characteristic curves for both devices are also included.

### Electronic counters

#### 173-1 Dynamic measurement of microwave voltage controlled oscillators with the 5345A electronic counter

A new class of electronic counter measurements is the frequency-vs-time characterization of microwave sources. The 5345A Electronic Counter is appropriate for these measurements due to its unique frequency averaging and external gating features. With the set-up described, the settling time and post-tuning drift of microwave VCO's can be measured to high resolution -- as short as 5 ns on the time axis and better than 1 MHz on the frequency axis. This technique is also applicable to measuring frequency-vs-time profiles within microwave pulses as narrow as 50ns.

### Frequency and time standards

#### 52-2 Timekeeping and frequency calibration

Describes use of precise frequency standards as clocks, effects of frequency calibration on time, sources or errors, and compensation for these errors. Methods of frequency standard comparison are discussed. Time and frequency transfer techniques are described and evaluated.

### Hewlett-Packard Interface Bus

#### 201-4 Performance evaluation of HP-IB using RTE operating systems

This brief contains performance data to help determine whether the Hewlett-Packard Interface Bus is suitable for various interface applications. A model is developed to help the HP-IB user determine the total time to send or receive a data message and the amount of HP 1000 or 21MX computer utilization. Performance examples with various devices, such as the HP 3455 digital voltmeter and the HP 2240 measurement and control processor are included.

**IMPATTS****968 IMPATTS amplifier**

Discusses IMPATT amplifier design. A waveguide amplifier produced 2 watts of power with 10 dB gain at 11.2 GHz. Using a coaxial structure, similar performance was obtained at 8.4 GHz.

**Instrumentation tape recorders****214-2 X-Y recorder dynamic response**

Due to recent improvements in dynamic response, some X-Y recorders now provide excellent performance when used in the higher frequency ranges normally associated with instruments such as direct writing oscillograph recorders. This improved performance capability is possible because of a rather obscure specification called acceleration. This note explains acceleration and its companion specification, slewing speed; relates them to specific performance characteristics, and indicates the typical dynamic performance capabilities of several HP X-Y recorders.

**Isolators****951-2 Linear applications of optically coupled isolators**

Optically coupled isolators can be used to transfer an analog signal between two isolated systems. In many instances, isolators can replace expensive transformers, instrumentation amplifiers, and A/D conversion schemes. This application note discusses several circuit techniques by which 5082-4350 series coupled isolators can be used to transmit analog information. The operation of each circuit is explained in detail and typical circuit performance is given.

**Logic test analyzer****167-6 Mapping, a dynamic display of digital system operation**

Describes the unique advantages of this new measuring technique. Mapping enables a dynamic viewing of digital system operation by providing a pseudo-continuous sweep display of system performance. It saves time by leading the investigator quickly to a specific data sequence and eliminating the tedious task of performing a state-by-state logic analysis. Included in the note are a number of photographs of sample map displays and interpretations of what they indicate. A separate section is devoted to a comparison of map and tabular formats.

**Logic test analyzers****167-19 Systematic "turn-on" of microprocessor systems using logic state analyzers**

Presents a systematic, section-by-section approach to test both hardware and software as you develop a microprocessor-based system using the same techniques usually used to develop a cascaded amplifier. Bring up your system "bit-by-bit" using the HP 1600/1607A Logic State Analyzer.

**Microprocessor-based systems****222 A designer's guide to signature analysis**

Signature analysis is a technique for field troubleshooting of microprocessor-based products. By designing the technique into digital products, a manufacturer can provide field service procedures, employing the HP 5004A Signature Analyzer, for component-level repair without dependence on board exchange programs.

**Microwave measurements****187-3 Three HP-IB configurations for making microwave scalar measurements**

This application note describes three HP-IB configured systems for measuring the scalar transmission and impedance characteristics of microwave components. One employs the HP 436A Digital Power Meter, another the HP 8755 Frequency Response Test Set, and the third the HP 8410B Network Analyzer. The specific hardware requirements are discussed and the relative merits of each approach compared.

**144 Understanding microwave frequency measurement**

Discusses the three principal down-conversion techniques for extending the frequency range of counters into the microwave spectrum—prescaling, heterodyne, and transfer oscillator. Compares the typical performance of the heterodyne and transfer oscillator techniques to allow the user to choose a counter appropriate for his application.

**Network analyzers****221 Semi-automatic measurements using the 8410B microwave network analyzer and the 9825A desktop computer**

Describes the configuration of a semi-automatic network analyzer using the Hewlett-Packard Interface Bus (HP-IB). Topics treated include: block diagram of suggested equipment; methods of digitizing magnitude and phase readings; sources of error in microwave measurements; fundamentals of one-port vector error correction; a sample program for the 9825A desktop computer; and typical results and operating procedures.

**Optoelectronics****966 Applications of the HP HDSP-2000 alphanumeric display**

This note is intended to serve as a design and application guide for users of the HP HDSP-2000 alphanumeric display device. Information presented covers the theory of the device design and operation considerations for specific circuit designs, thermal management, power derating, and heat sinking; and intensity modulation techniques.

**Oscilloscopes****185-4 Elimination of computation of analog measurements by using the direct reading oscilloscope 1722A**

With new demands for measurement accuracy, and repeatability, the 1722A dual-delayed sweep oscilloscope provides an extra measure for making voltage and time interval measurements. No longer do you need to count divisions, interpolate between divisions, or multiply by the appropriate scale factor. Readings are direct on the LED display.

Techniques for making the following waveform voltage measurements are briefly presented: differential voltage, dc and average voltage, and waveform percentage.

Timing measurements including pulse width and period measurements, propagation delay plus transition time measurements are also described.

**Pulse and word generators****227 Word generator techniques in multi-channel applications.**

This note is intended to acquaint the reader with the potential of a multi-channel signal

source, the HP 8016A Word Generator, in applications demanding digital simulation or stimulation. Four devices fundamental to a microprocessor system take the role of DUT for the four applications described in this note.

Although a multi-channel source dictates the theme for this note, a receiver capable of multi-channel display is required for monitoring device response. An HP 1600A Logic State Analyzer is therefore used to make logic state comparisons of response to signal stimulus.

**Pulse power measurements****64-1 Fundamentals of rf and microwave power measurement**

Describes the general principles of power measurement including basic standards and traceability. Explores in detail the three most popular power sensors: thermocouples, thermistors, and diodes. Provides a comprehensive error analysis with particular emphasis on mismatch error. Compares advantages and disadvantages of the methods mentioned as related to various applications. Also treats pulse power measurements.

**Spectrum analyzers****207 Understanding and using phase noise in the frequency domain**

Describes the theory and practice of making phase noise measurements from 5 Hz to 13 MHz from the carrier. Emphasis is placed on the correction factors required for making noise power spectral density measurements with wave and spectrum analyzers. Examples are given for both manual and automatic measurements.

**220 Operating the HP 8565A spectrum analyzer**

A complete operating guide to the HP 8565A Microwave Spectrum Analyzer (10 MHz-22 GHz). The reader is taken step-by-step through all the operating controls. Techniques for achieving optimum dynamic range and improved measurement accuracy are described. Measurements of such parameters as distortion, modulation, noise and electromagnetic interference are discussed.

**Synthesized signal generator****218-1 Applications and performance of the 8671A/8672A microwave synthesizers**

Describes detailed performance of the 2-18 GHz synthesizer including modulation, switching, and signal characteristics. Provides recommended configurations to obtain finer frequency-setting resolution of 1, 2, or 3 Hz over the range 2 to 18 GHz. Another section covers techniques and equipment for obtaining microwave signals from 1 MHz to 36 GHz by use of a complementary synthesizer and exterior doublers. Detailed software examples are given with annotated subroutines to assist in writing application programs.

**X-ray**

Describes the use of the Faxitron 43805 for non-destructive testing at your workbench or in your lab. Look inside encapsulated components, pinpoint defects in electronic assemblies, castings, or quickly view registration problems in PC boards. Applications requiring 10 kV to 130 kV as well as an explanation of the automatic exposure control are included. Order Publication Number 5952-6781.

When you purchase a Hewlett-Packard product, you also receive the assurance that it will continue to perform to its published specifications today, tomorrow, next week—and for a reasonable number of months and years in the future.

We firmly believe that our obligation to you as a customer goes much beyond just the delivery of your new HP product. This philosophy is implemented by Hewlett-Packard in two basic ways: (1) by designing and building excellent products with good serviceability, and (2) by backing up those products with a customer service program which can respond to your needs with speed and completeness.

The HP customer service program is one of the most important facets of our worldwide operations, providing a local service capability in many of our field offices (listed inside the back cover of this catalog.) Indeed, this customer service program is one of the major factors in Hewlett-Packard's reputation for integrity and responsibility towards its customers.

#### Warranty

As an expression of confidence in our products to continue meeting the high standards of reliability and performance that customers have come to expect, Hewlett-Packard products carry the following warranty:

*All Hewlett-Packard products are warranted against defects in materials and workmanship. The warranty period is specified in a warranty statement provided with each product. During the warranty period, HP will, at its option, repair or replace products which prove to be defective, subject to the terms and conditions listed in the warranty statement and to requirements for preventive maintenance or product protection which may be included with the product.*

*No other warranties are expressed or implied. HP specifically disclaims the implied warranties of merchantability and fitness for a particular purpose. HP is not liable for consequential damages.*

#### Certification

Some customers are especially interested in the test and quality assurance programs that HP applies to its products. These Hewlett-Packard programs are documented in a Certificate of Conformance which is available upon request at the time of purchase. This certification states:

*Products, materials, parts, and services furnished on this order have been provided in accordance with all applicable Hewlett-Packard specifications. Actual inspection and test data pertaining to this order is on file and available for examination.*

*Hewlett-Packard's calibration measurements are traceable to the National Bureau of Standards to the extent allowed by the Bureau's calibration facilities.*

*The Hewlett-Packard Quality Program satisfies the requirements of MIL-Q-9558A, MIL-I-45208A, and MIL-C-45662A.*

#### Repair service

Help in maintaining your Hewlett-Packard equipment in first-rate operating



With Hewlett-Packard, you get excellent products backed by a responsive customer service program

condition is as close as a telephone call to the nearest Hewlett-Packard field office. Whether you want to repair an instrument yourself, or send it to a Hewlett-Packard facility for repair, recalibration, or overhaul, your local Hewlett-Packard field office can offer a complete range of technical assistance.

Local repair facilities are backed up by Regional Repair Centers that are located in major industrial areas. The Regional Repair Centers have more sophisticated test equipment, factory-trained specialists, and a full line of replacement parts.

If your equipment installation is fixed, and if justified by the type of service required, Hewlett-Packard will perform service at your facility.

You have access to all of Hewlett-Packard's extensive service network through your local Hewlett-Packard field office.

#### Replacement parts

Replacement parts play a key role in Hewlett-Packard's customer service program. Prompt product maintenance, whether it's performed in your shop or ours, depends on the ready availability of replacement parts. Your replacement parts orders are transmitted via high speed communications systems to Parts Centers strategically located. Most orders are shipped the same day received at the Parts Centers.

When ordering a replacement part, please specify the Hewlett-Packard part number listed in the table and give the complete name. If circumstances require your ordering a part without specifying the part number, please include in your order the instrument model number, its serial number, a complete description of the part, its function, and its location in the equipment.

#### Customer service agreements

Your instrument maintenance requirements in many cases may be handled most economically by entering into a Hewlett-Packard Customer Service Agreement. When you have a customer service agreement, HP assumes your maintenance responsibilities for a basic annual fee. This relieves you of having to hire your own trained maintenance specialists, of having to maintain replacement parts inventories, and of having to set up the administrative procedures needed for proper maintenance scheduling. Please contact your nearest HP office for details.

#### Service publications

The Operating and Service Manual supplied with each Hewlett-Packard test and measuring product contains maintenance, calibration, diagnostic and repair procedures, with troubleshooting charts and circuit diagrams. All replaceable parts are listed. Extra manuals are available at reasonable cost from your nearby Hewlett-Packard field office. Most operating and service manuals with changes and service notes are now available on COSATI standard, positive microfiche.

New or special calibration procedures, instrument modifications, and special repair procedures are described in detail in Hewlett-Packard Service Notes. This series of publications serves as a convenient means of updating operating and service manuals.

*Bench Briefs*, a periodic newsletter, has servicing tips, new modifications and other suggestions to help repair and maintenance personnel get maximum performance from Hewlett-Packard instruments. It describes new service notes and other company publications as they become available. To become a regular subscriber, ask your local HP field office to place your name on the mailing list.

# ORDERING INFORMATION

Shipping, prices, and terms of sale

## Communicating with HP

Hewlett-Packard is committed to providing convenient local support and the best possible attention to customer needs on a worldwide basis. There are more than 172 sales and service offices located in 65 countries; A complete listing of offices appears on the inside back cover of this catalog.

Your entry point to the resources of Hewlett-Packard is through the local HP office nearest you. Our field engineers and order support specialists there are well-equipped to provide you with pre-sale assistance in product selection, as well as related business information such as current product availability and price delivered to your location.

Many HP field offices are tied into a sophisticated intra-company communications system. This not only means prompt transmission of orders to any of the 30 HP product responsible divisions—it also speeds the flow of regular messages among all HP field offices and factories. The objective, of course, is to provide the fastest possible response to your product interests.

## Placing your order

Hewlett-Packard people at the field office nearest you will be pleased to provide assistance in selecting the HP equipment most appropriate to your needs, and to help you prepare your order.

The information in this catalog will, in many cases, be sufficient for you to decide to buy a particular HP product. In those instances, a telephone call to the nearest HP office will provide you with (1) information on product availability, and (2) the product's price, delivered to your location (since any budgetary prices provided with this catalog are FOB appropriate HP factory or warehouse facility).

HP wants to be sure the product delivered to you is exactly the one you want. Therefore, when placing your order, please specify the product's catalog (model, accessory, or part) number, as well as the product's name. Be as complete as possible

in specifying exactly what you'd like, including standard options.

In the event you want special features or capabilities such as different color or a non-standard power line voltage, ask your HP field engineer about availability and cost of these "specials" first—and then, to prevent misunderstandings, include special instructions and specification details with your order.

## Shipping methods

**Inside the USA:** Shipments to destinations in the USA are made directly from factories or local warehouses. Unless specifically requested otherwise, express or truck transportation is used, whichever is less expensive and most serviceable to you. Small items are sent **parcel post**. If fast delivery is needed, we **gladly ship** by air freight, air express, or air **parcel post**, when specified on your order, at prevailing rates. In many parts of the USA, a consolidated air freight service provides the speed of air transport at surface rates. Ask your HP field engineer for details.

**Outside the USA:** Shipments to destinations outside the USA are made from the appropriate Hewlett-Packard facility by either surface or air, as requested. Sea shipments usually require commercial export packaging at a nominal extra charge.

## Budgetary prices

Price information which may be supplied with this catalog provides you with helpful budgetary guidance.

Prices appearing in this catalog, unless otherwise specified, are F.O.B. USA factory or shipping point and apply only to domestic U.S.A. customers.

Please call your nearby Hewlett-Packard field office to determine a product's delivered price outside of the U.S.A.

Prices furnished with this catalog are net prices prevailing at the time of printing. Hewlett-Packard reserves the right to change prices, and those prices prevailing at the time an order is received will apply.

## Quotations and pro forma invoices

Destination prices and other details you may need to know before ordering can be quickly obtained via telephone. Just call your nearest HP office.

If you are an international customer requiring formal paperwork such as pro forma invoices or FAX, CIF, or C&F quotations, please contact the Hewlett-Packard office or representative serving your area. Exportation or importation assistance is also available.

## Terms of sale

**Inside the USA:** Terms are net 30 days from invoice date. Unless credit with Hewlett-Packard has already been established, shipments will be made **COD** or on receipt of cash in advance.

Leasing and extended financial terms are available. However, the associated costs are not included in any product prices furnished with this catalog. Your nearby HP office will be pleased to discuss your requirements, and work with you in setting up an appropriate program.

**Outside the USA:** Terms for orders from customers outside the United States of America which are placed with the Hewlett-Packard Company, are irrevocable letters of credit or cash in advance—unless other terms have been previously arranged. Terms for orders placed with authorized Hewlett-Packard international subsidiaries or representatives/distributors are mutually determined.

## U.S. government sales

Most products in this catalog are covered on GSA federal supply schedule multi-award contracts.

## Product changes

Although product information and illustrations in this catalog were current at the time it was approved for printing, Hewlett-Packard, in a continuing effort to offer excellent products at a fair value, reserves the right to change specifications, designs, and models without notice.